

HI-FI / TAPE RECORDER ISSUE

MAR. 50c

# Radio-Electronics

TND

A GERNSBACK PUBLICATION

TELEVISION · SERVICING · HIGH FIDELITY

HUGO GERNSBACK, Editor-in-chief

**Check Tape Recorder Performance**

**Build a Humless Preamp**

**Which Tape Is Best?**

**Improved Recording**  
(See page 4)

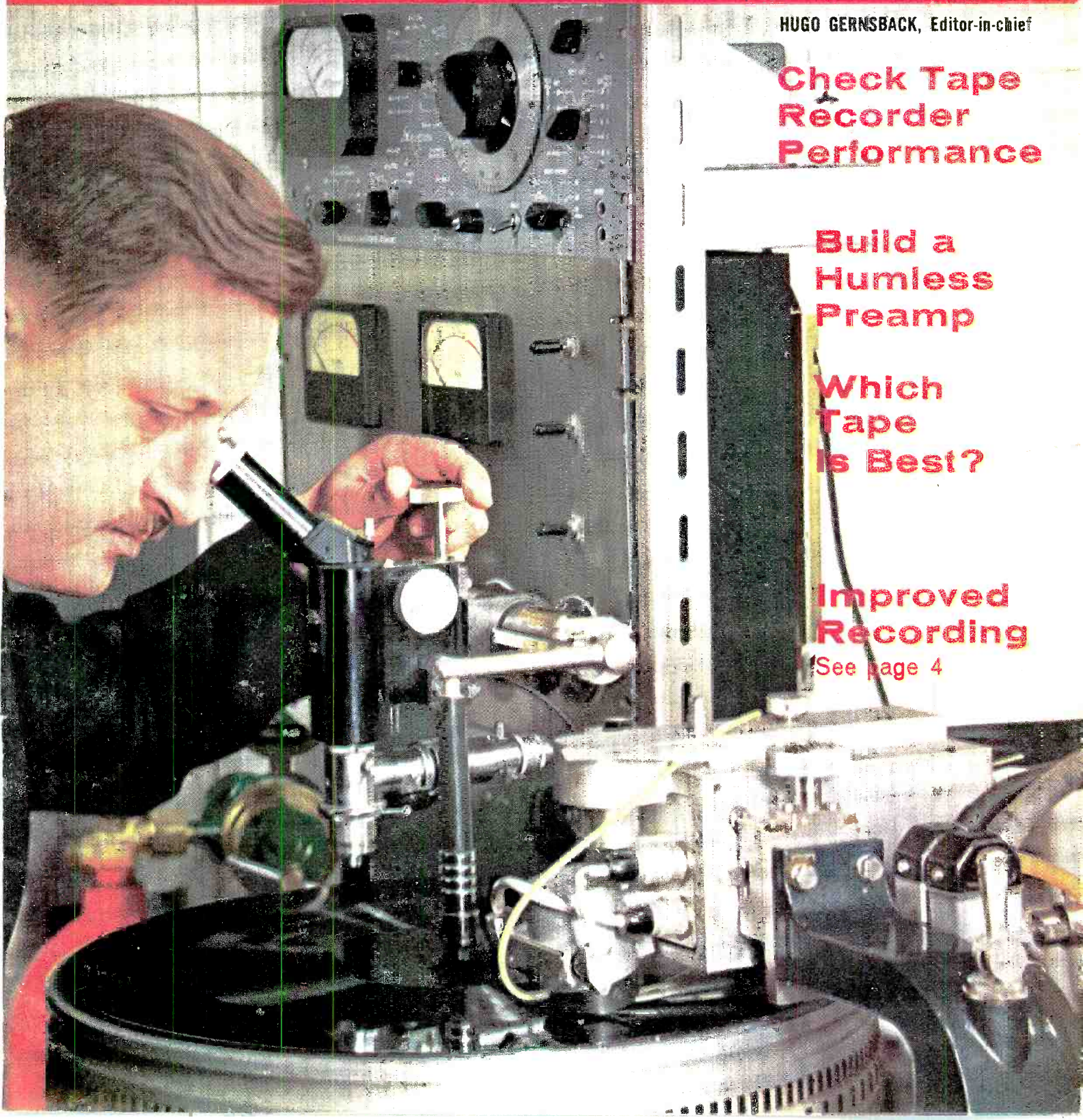

are you replacing  
top quality tubes  
with identical  
top quality tubes  
?

Now you can carry the identical tubes that you find designed into most of the quality TV sets you service. Chances are, you were not aware that these TV sets were designed around special Frame Grid tubes originated by Amperex and that even more tube types originated by Amperex are being designed into the sets you'll be handling in the future. Amperex frame grid tubes provide 55% higher gain-bandwidth, increase TV set reliability by simplifying circuits and speed up your servicing because their extraordinary uniformity virtually eliminates need for re-alignment when you replace tubes.

Tubes introduced by Amperex, currently used by major TV set makers include:

Frame Grid				Others	
2GK5	4GK5	6GK5	6EH7	6AL3	9A8
2ER5	4EH7	6ES8	6EJ7	6BL8	15CW5
3GK5	4EJ7	6EF5	6HC8	6BQ5	16AQ3
3EH7	4ES8	6FY5	7HG8	12AX7	27GB5

For optimum satisfaction for your customers and a better profit operation for yourself, make room in your caddy now for these matchless-quality tubes. Next time you visit your distributor, look for the green-and-yellow boxes and enjoy confidence in your work such as you never have before. Amperex Electronic Corporation, Hicksville, L. I., New York.



COLUMBIA STEREO TAPE CLUB NOW OFFERS YOU

# ANY 4 STEREO TAPES

of these exciting pre-recorded 4-track

**\$5.98**  
FOR ONLY  
Value up to \$39.80 at regular Club prices

if you join the Club now and agree to purchase as few as 5 selections from the more than 150 to be offered in the coming 12 months

**THE BARBRA STREISAND ALBUM**  
Happy Days Are Here Again  
A Sleepin' Bee  
Cry Me A River  
8 MORE



9034. Also: A Taste of Honey, My Honey's Loving Arms, etc.

**WEST SIDE STORY**  
Original Soundtrack  
Recording



9004. "The most adventurous musical ever made."—Life

**TCHAIKOVSKY: SWAN LAKE Ballet Suite**  
**ORMANDY**  
Philadelphia Orch.  
Includes a Special Booklet and Rare Illustrations



9048. "A treat, a delight all over again."—N.Y. Journal-Amer.

**ANDY WILLIAMS DAYS OF WINE AND ROSES**  
plus  
- Can't Get Used to Losing You  
- My Coloring Book  
- 5 more



9033. Also: What Kind of Fool Am I?, May Each Day, etc.

**Cherry Pink AND Apple Blossom White**  
Jerry Murad's **HARMONICATS**



9060. Ramona, Ruby, Fascination, Mack The Knife, 12 in all

**STRAVINSKY conducts The "FIREBIRD" COMPLETE BALLET**



9047. "Brilliant performance... lush... rich."—Musical Amer.

**JOHNNY'S NEWEST HITS**  
What Will Mary Say  
That's The Way It Is + 10 MORE  
**JOHNNY MATHIS**



9006. Also: Wasn't the Summer Short?, Marianna, etc.

**The New ANDRE KOSTELANETZ**  
"Wonderland of Sound"



9015. Be My Love, Unchained Melody, Volare, 12 in all

**ORFF: CARMINA BURANA THE PHILADELPHIA ORCHESTRA**  
soloists and chorus  
**ORMANDY** conducting



9038. "Superb...best of many performances."—Wash. Post

**TIME OUT THE DAVE BRUBECK QUARTET**



9025. "It soars and swings... lush... through."—Playboy

**LENER & LOEWIE Camelot**  
**RICHARD BURTON JULIE ANDREWS ROBERT GOULET**  
and Original Broadway Cast



9003. "Most lavish, beautiful musical; a triumph!"—Kilgallen

**Rhapsody in Blue An American in Paris**  
Leonard Bernstein plays Gershwin



9035. "Fierce impact and momentum."—N.Y. World-Telegram

**Themes for Young Lovers PERCY FAITH**  
I WILL FOLLOW YOU MY COLORING BOOK  
RHYTHM OF THE RAIN  
9 more



9022. Also: Go Away Little Girl, Up on The Roof, etc.

**THE GIANTS OF JAZZ**  
- BRUBECK  
- ELLINGTON  
- DAVIS - MONK  
- CONDON  
- 10 others



9031. A truly definitive cross-section of the great combos

**BEETHOVEN "Emperor" Concerto**  
**RUDDOLF SERKIN**  
**BERNSTEIN**  
N.Y. Philharmonic



9058. Most exciting and thrilling of all Beethoven concertos

**TONY BENNETT I Left My Heart in San Francisco**  
Tender Is the Night  
Smile - 9 more



9028. Also: Love for Sale, Candy Kisses, Marry Young, etc.

**GREAT MOTION PICTURE THEMES EXODUS NEVER ON SUNDAY THE APARTMENT**  
plus 13 more



9030. Also: Smile, Some Like It Hot, Magnificent 7, etc.

**REX HARRISON JULIE ANDREWS MY FAIR LADY**  
ORIGINAL CAST RECORDING



9001. The best-selling Original Cast recording of all time

**The Versatile HENRY MANCINI AND HIS ORCH.**



9009. Ebb Tide, The Breeze and I, Sleepy Lagoon, 12 in all

**TCHAIKOVSKY Symphony No. 5 LEONARD BERNSTEIN NEW YORK PHILHARMONIC**



9057. "A wholly persuasive performance!"—N.Y. Times

**MESSIAH**  
EUGENE ORMANDY  
The Philadelphia Orchestra  
THE MORMON TABERNACLE CHOIR



9044-9045. Two-Tape Set (Counts As Two Selections.) "Zestful... a powerful, vital statement!"—HiFi/Stereo Review

**TWIN-PACK Equivalent To Two Selections**



9024. "Walloping ensembles and stirring solos."—High Fid.

**Ray Conniff Singers SO MUCH IN LOVE**



9008. Chances Are, Just Walking in The Rain, 12 in all

**THE BLUE DANUBE A Johann Strauss Festival**



9042. "Performances that really sparkle and glow."—High Fid.

**A FESTIVAL OF MARCHES**  
March of the Treadors  
American Salute  
Stars and Stripes Forever  
Meadowlands  
9 more  
**PHILADELPHIA ORCH. - ORMANDY**



9059. "Abundance of pulsing rhythms."—St. Louis Globe Dem.

**FIRST TIME! DUKE ELLINGTON EETS COUNT BASIE**



9024. "Walloping ensembles and stirring solos."—High Fid.

**THE NEW CHRISTY MINSTRELS with RANDY SPARKS**  
This Land Is Your Land  
Nine Hundred Miles  
12 MORE



9007. Also: Railroad Bill, Cotton Pickers' Song, Whistle, etc.

**MARY MARTIN in RODGERS & HAMMERSTEIN'S THE SOUND OF MUSIC**  
with Original Broadway Cast



9002. A show that's "perfectly wonderful!"—Ed Sullivan

**FREE—if you join now**  
REVOLUTIONARY SELF-THREADING TAKE-UP REEL



Just drop the end of the tape over this reel, start your recorder, and watch it thread itself! Unique Scotch® process automatically threads up tape of any thickness, releases freely on rewind.

IF YOU ARE ONE OF THE FORTUNATE PEOPLE who own 4-track stereo tape playback equipment, you know the thrill of the near-perfect fidelity, the unsurpassed sound of tape. Now you have an exceptional opportunity to build an outstanding collection of superb stereo tapes at great savings through the most generous offer ever made by the Columbia Stereo Tape Club!

By joining now, you may have ANY FOUR of the magnificently recorded 4-track stereo tapes described here — sold regularly by the Club for up to \$39.80 — for only \$5.98!

TO RECEIVE YOUR 4 PRE-RECORDED STEREO TAPES FOR ONLY \$5.98 — simply fill in and mail the coupon today. Be sure to indicate which Club Division best suits your musical taste: Classical or Popular.

HOW THE CLUB OPERATES: Each month the Club's staff of music experts chooses outstanding selections for both Divisions. These selections are described in the Club Magazine, which you receive free each month.

You may accept the monthly selection for your Division . . . or take any of the wide variety of tapes offered in the Magazine to members of both Divisions . . . or take no tape in any particular month.

Your only membership obligation is to purchase 5 tapes from the more than 150 to be offered in the coming 12 months. Thereafter, you have no further obligation to buy any additional tapes . . . and you may discontinue your membership at any time.

FREE TAPES GIVEN REGULARLY. If you wish to continue as a member after purchasing five tapes, you will receive — FREE — a 4-track stereo tape of your choice for every two additional tapes you buy.

The tapes you want are mailed and billed to you at the regular Club price of \$7.95 (occasional Original Cast recordings somewhat higher), plus a small mailing and handling charge.

SEND NO MONEY — Just mail the coupon today to receive your four pre-recorded 4-track stereo tapes — ALL FOUR for only \$5.98!

**IMPORTANT NOTE:** All tapes offered by the Club must be played on 4-track stereo playback equipment. If your tape recorder does not play 4-track stereo tapes, you may be able to convert it simply and economically. See your local service dealer for complete details.

COLUMBIA STEREO TAPE CLUB Terre Haute, Ind.

**SEND NO MONEY—mail coupon to receive 4 tapes for \$5.98**

COLUMBIA STEREO TAPE CLUB, Dept. 424-8  
Terre Haute, Indiana

I accept your special offer and have written in the boxes at the right the numbers of the 4 tapes I would like to receive for \$5.98, plus a small mailing and handling charge. I will also receive my self-threading reel — FREE! Enroll me in the following Division of the Club:

CLASSICAL       POPULAR

I understand that I may select tapes from either Division. I agree to purchase five selections from the more than 150 to be offered in the coming 12 months, at the regular Club price plus a small mailing and handling charge. Thereafter, if I decide to continue my membership, I am to receive a 4-track, pre-recorded tape of my choice FREE for every two additional selections I accept.

Name..... (PLEASE PRINT)  
Address.....  
City..... Zone..... State.....

This offer is available only within the continental limits of the U.S.

48-IV

# Radio-Electronics

MARCH 1964 VOL. XXXV NO. 3

Over 55 Years of Electronic Publishing

## EDITORIAL

- 23 **Multiplex Video**.....Hugo Gernsback

## AUDIO-HIGH FIDELITY-STEREO

- 27 **Which Tape Is Best?**.....Hans Fantel  
*How to get the most for the money you spend*
- 30 **Quiet, Please . . . !**.....Don v. R. Drenner  
*. . . being a transistor preamplifier*
- Cover Feature 32 **Better Stereo Reproduction with 15° Stylus Angle**.....Albert B. Grundy, Jr.  
*Vertical tracking angle is important in stereo*
- 35 **Checking Out Tape Recorders**.....Herman Burstein  
*Stuff for the technician and the eager audiophile*
- 40 **Tape Recorder Problems**.....Herman Burstein  
*First of two parts: various electronic noises*
- 46 **R-E Guide to Test Tapes and Records**.....Robert F. Scott
- 48 **Tape and Disc Accessories—A Directory**
- 56 **Service Clinic**.....Jack Darr  
*Mysterious audio troubles*
- 62 **Audio Equipment Report: Heath AA-22 and Euphonics Ceramic**  
*All-transistor 40-watt amplifier and a stereo pickup*

## RADIO

- 42 **Improvising an FM Tuner**.....Oliver E. Wilson

## TELEVISION

- 44 **What Happens to Picture Tubes?**.....Jack Darr  
*Diagnose—and cure—picture-tube troubles*

## GENERAL

- 37 **What's Your EQ?**
- 43 **What's New**

## TEST INSTRUMENTS

- 24 **Build Yourself a Flutter Meter**.....John Wagner  
*Valuable low-cost addition to your audio service equipment*
- 38 **Black Box—A Stereo Analyzer**.....Bob White  
*Simple passive comparator checks phase and amplitude*
- 65 **Test Equipment Report: Eico 667 and Lafayette TE-46**  
*Dynamic conductance tube and transistor tester and a capacitor/resistor analyzer*

## THE DEPARTMENTS

- |                    |                               |                        |                  |
|--------------------|-------------------------------|------------------------|------------------|
| 14, 70 Corrections | 92 New Patents                | 6 News Briefs          | 97 Technotes     |
| 14 Correspondence  | 84 New Products               | 95 Noteworthy Circuits | 100 Try this One |
| 102 New Books      | 78 New Semiconductors & Tubes | 90 Technicians' News   | 99 50 years Ago  |
| 82 New Literature  |                               |                        |                  |



Member,  
Institute of High Fidelity  
Radio-Electronics  
is indexed in  
Applied Science  
& Technology Index  
(Formerly  
Industrial Arts Index).

HUGO GERNSBACK, *editor-in-chief and publisher*. M. HARVEY GERNSBACK, *editor*. Fred Shunaman, *managing editor*. Robert F. Scott, W2PWG, *technical editor*. Peter E. Sutheim, *associate editor*. Jack Darr, *service editor*. I. Queen, *editorial associate*. John J. Lamson, *eastern sales manager*. Wm. Lyon McLaughlin, *technical illustration director*.

GERNSBACK PUBLICATIONS, INC., 154 W. 14 St., N.Y. 10011. AL 5-7755. Board Chairman Hugo Gernsback, President M. Harvey Gernsback, Secy. G. Aliquo, Treas. Charles A. Raible

# A NEW WORLD OF OPPORTUNITY AWAITS YOU WITH N.T.S. ALL-PHASE HOME TRAINING IN ELECTRONICS

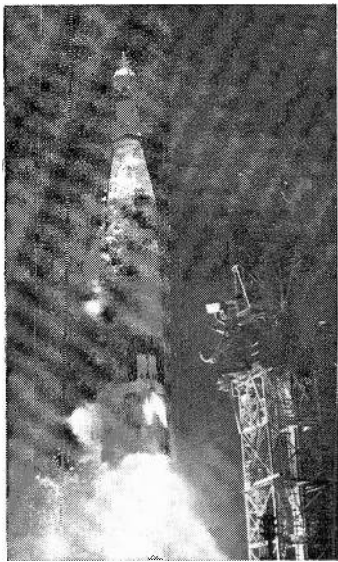

You can install and maintain electronic circuitry in missiles and rockets ... specialize in micro-waves, radar and sonar.

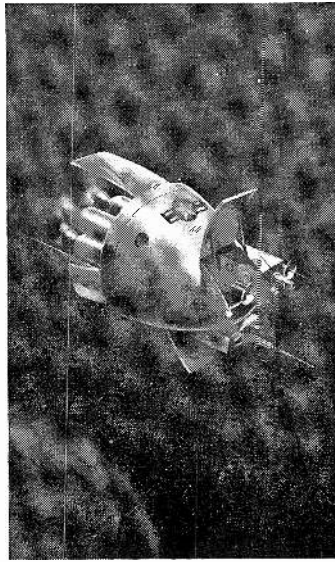

You can succeed in TV-Radio Communications ... prepare for F.C.C. License, service advanced satellites for industry and defense.

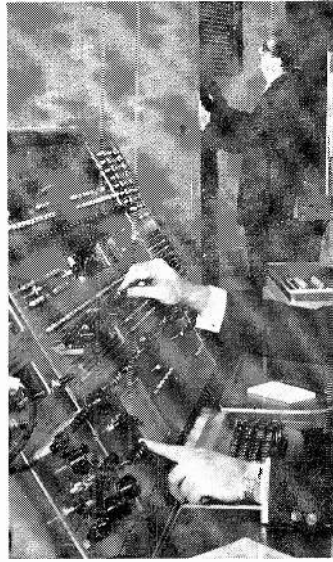

You can service and repair the electronic "brains" of industry — computers, data processing, and other automation equipment.

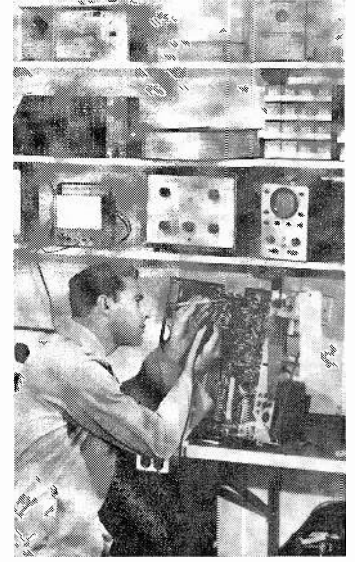

You can become a highly-paid TV-Radio Technician, an electronics field engineer, or succeed in your own sales & service business.

## The N.T.S. Master Course enables you to do more, earn more in ELECTRONICS • TELEVISION • RADIO Yet N.T.S. Training costs no more than other courses far less complete

There's a good reason why N.T.S. Master-Training opens a wide new world of opportunity for you in Electronics, Television, Radio.

Everything you learn, from start to finish, can be applied directly to all phases of the Electronics Industry.

As a result, the N.T.S.-Trained Technician can move ahead faster, in any direction — from TV-Servicing to Radio Communications to Space-Missile Electronics and Automation for industry and defense. You can go wherever pay is highest and opportunity unlimited.

Electronic circuitry, for example, is one of science's miracles that is basic to the entire field of Electronics. It is used in satellites, computers and space capsules as well as in today's television sets and high fidelity equipment. N.T.S. shows you how to service and repair electronic circuitry for all electronic applications.

You work on many practical job projects. You build a short-wave, long-wave superhet receiver, plus a large-screen television set from the ground up. N.T.S. training kits contain all the parts you need ... at no extra cost. (See box at right.) You also receive a professional Multimeter to use during training and on the job.

**ONE LOW TUITION.** You need training related to all phases of Electronics. Industry demands it. Only N.T.S. provides it ... in ONE Master Course at ONE low tuition.

### RESIDENT TRAINING AT LOS ANGELES

If you wish to take your Electronics-TV-Radio training in our famous Resident School in Los Angeles — the oldest and largest school of its kind in the world — write for special Resident School catalog and information, or check coupon.



**NATIONAL TECHNICAL SCHOOLS**

WORLD-WIDE TRAINING SINCE 1905  
4000 So. Figueroa St., Los Angeles, Calif 90037



**YOU ENROLL BY MAIL AND SAVE MONEY.** No salesmen means lower costs for us, lower tuition for you.

**START NOW.** A whole new world of opportunity awaits the man with Electronic Home-Training from National Technical Schools — a recognized leader in technical training for 58 years.



19 BIG KITS  
YOURS TO KEEP

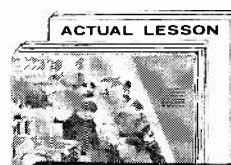

**MAIL COUPON NOW FOR FREE BOOK AND ACTUAL LESSON!**

NO OBLIGATION.  
NO SALESMAN WILL CALL.

**NATIONAL TECHNICAL SCHOOLS**

WORLD-WIDE TRAINING SINCE 1905

**National Technical Schools, Dept. RG-34**  
4000 South Figueroa Street, Los Angeles, California 90037

Please Rush FREE Electronics-TV-Radio "Opportunity" Book and Actual Lesson. No Salesman Will Call.

Name \_\_\_\_\_ Age \_\_\_\_\_

Address \_\_\_\_\_

City \_\_\_\_\_ Zone \_\_\_\_\_ State \_\_\_\_\_

Check if interested ONLY in Resident Training at L.A.

High school home study courses also offered. Check for free catalog.

RADIO-ELECTRONICS published monthly at Concord, N. H., by Gernsback Publications Inc. Second-class postage paid at Concord, N. H. Copyright © 1964, by Gernsback Publications Inc. All rights reserved under Universal, International and Pan-American Copyright Conventions. SUBSCRIPTION RATES: US and possessions, Canada: \$5 for 1, \$9 for 2, \$12 for 3 years. Pan-American countries: \$6 for 1, \$11 for 2, \$15 for 3 years. Other countries: \$6.50 for 1, \$12 for 2, \$16.50 for 3 years. Postmaster send form 3579 to 154 W. 14th St., New York 10011.

# NEWS BRIEFS

## New Weather Satellite Broadcasts Local Reports

Tiros VIII, latest of America's weather satellites, carries a special automatic transmitting system that sends pictures to earth via relatively simple ground stations.

The first seven satellites sent rather complex pictures on command for reception by special ground stations. Tiros, called "everyman's weather satellite," broadcasts its signals so that individual localities will be able to obtain direct readout pictures of what the weather activity over a local region looks like from 400 miles in space.

The pictures are recorded by facsimile rather than on film. The quality is not as good as that of film pictures but will provide as much information as local meteorologists will need. The new system, called APT, for Automatic Picture Transmission, is already transmitting to more than 50 ground stations throughout the world.

## Intercom Works Under Water

An underwater communications system recently announced by Bendix uses an electronic transmitter attached to a diver's air tank, a mouth mask that allows him to move his lips freely, and a throat microphone. A transducer at one end of the cylindrical transmitter sends audio signals directly into the water, where they can be heard by other divers without any equipment.

## British TV Recorder Demonstrated Here

Telcan, the low-price British TV tape recorder, announced in RADIO-ELECTRONICS October 1963, page 6, was demonstrated in New York City by Cinerama, Inc. Cinerama is the majority stockholder in a company formed to distribute Telcan in the United States.

Demonstrated in a basement room of the Cinerama theater in New York City, off-the-air taping gave a hardly acceptable picture. Another demonstration was a live pickup with a Telcan TV camera, the subject being photographed and the tape played back immediately. In the words of one observer the picture "would have

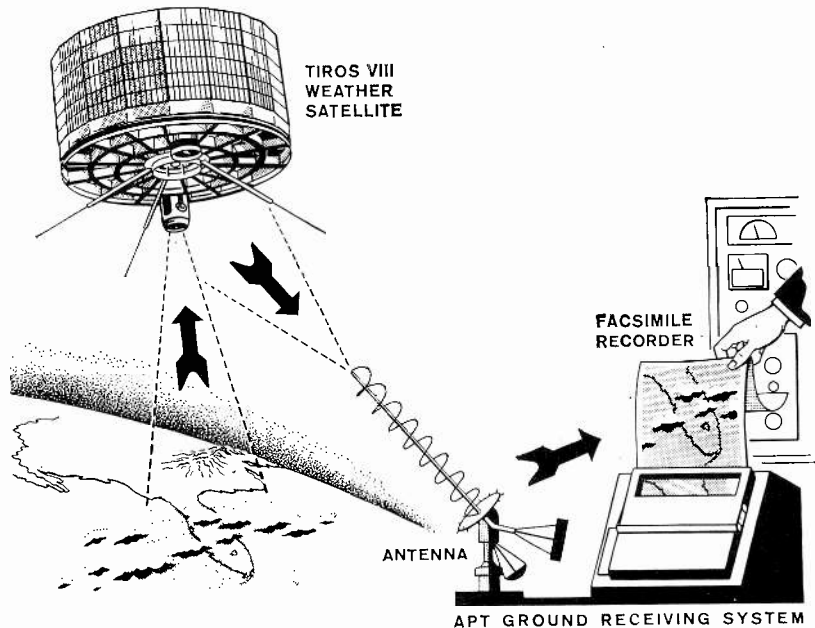

How Tiros VIII works. Viewing an area approximately 1,000 miles on a side, it snaps a picture on a special vidicon tube which retains the image on the screen for 208 seconds while it is being read out and transmitted to APT facsimile receivers. The facsimile picture is 8 inches on a side.

been considered good 10 years ago." Representatives of Telcan and Cinerama guessed that it might be possible to sell the recording unit for less than \$200, and possibly a home type electronic camera for about the same price.

Regular ¼-inch audio tape was used with half-track recording, 20 minutes on each side. Tape speed is 120 inches per second.

## Relay I Won't Quit

NASA's Communications Satellite, RELAY I, launched from Cape Canaveral on Dec. 13, 1962 kept working and merrily answering questions from earthmen after Dec. 31, 1963, which was supposed to be its last working day. It was equipped with a self-destructive timing device to switch off its power about a year after launching. Engineers believe that it failed to go off because of the extreme cold.

Richard P. Dunphy, RCA project manager for RELAY, explained that "the reason for the planned silencing of the satellite was that the more advanced RELAY is scheduled for launch shortly and, since RELAY I will have completed its mission, it was deemed good sense to silence it so that its signal would not be added

to the already limited radio-frequency spectrum." He said that an electrolytic material was placed inside RELAY which was supposed to eat away a connection between the main power lead and the solar panels at a predetermined rate. But unexpected coldness around the device has slowed down the erosion.

## Built-In Music Systems Becoming Popular?

Manufacturers of home music systems at the National Association of Home Builders Show in Chicago estimated that between 5% to 8% of new homes built in 1963 were equipped with intercom music systems. This figure may rise to 8% to 10% yearly.

Manufacturers say that most of

**Advertising Representatives:** Midwest — P. H. Dampers Co., 740 N. Rush St., Chicago 11, Ill., Tel. (312) MI 2-4245. South — J. Sidney Crane & Associates, 22 8th St., N. E., Atlanta, Ga., Tel. TRinity 2-6720. Florida: Neff Associates, 15 Castle Harbor Isle, Fort Lauderdale, Fla., Tel. LOgan 6-5656. West — Husted-Coughlin, Inc., 1830 W. 8th St., Los Angeles, Calif., Tel. 389-3132. 444 Market St., San Francisco, Calif., Tel. GARfield 1-0151. United Kingdom — Publishing & Distributing Co., Ltd., Mitre House, 177 Regent St., London W.1, England.

**Subscription Service:** Address form 3579 and correspondence to Radio-Electronics, Subscriber Service, 154 West 14th St., New York, N. Y. 10011. When requesting a change of address please furnish an address label from a recent issue. Allow one month for change of address.

# Men 17-55

**JOB OPPORTUNITIES!  
EXCITEMENT!  
MONEY!**

All this  
can be  
Yours as a trained

## Electronics TECHNICIAN

**OVER 6,000 FIRMS HAVE EMPLOYED  
DeVRY TECH GRADUATES!**

Thousands of companies in the United States and Canada who have employed DeVry Tech men prove two most important facts: (1) Electronics is one of the biggest, fastest growing opportunity fields of our time; and (2) DeVry Tech graduates are "WANTED" MEN.

Whether DeVry Tech prepares you in spare time at home or in its modern Chicago or Toronto Laboratories, your training is designed to get you ready to meet the exacting standards of industry. You get practical training that not only helps to fit you for a job or a service shop of your own — but also gives you a foundation for a career that can be profitable the rest of your life.

You work over 300 learn-by-doing experiments at home, using DeVry Tech's exclusive Electro-Lab method. You build and KEEP valuable equipment. With another DeVry Tech exclusive, you have the benefit of training movies that you can show over and over again until basic points are crystal clear. Special texts guide you every step of the way as well.

### HOW DeVRY TECH CAN "BLUEPRINT" YOUR CAREER!

DeVry's faculty not only know how to teach Electronics, but they also understand men. They most likely know the type of problems you face. From this staff you get help, advice and understanding. It is this "human" side of DeVry's program that has caused many of our graduates to say: "DeVry Tech not only trains you for a job, they actually help you blueprint a profitable future!"

### NO ADVANCED EDUCATION NEEDED!

Why don't you write for FREE FACTS today? Learn how you TOO can be a member of the great fraternity of DeVry Tech graduates across the continent . . . men who were properly trained, encouraged, appreciated and understood! SEND IN COUPON NOW!

#### EFFECTIVE EMPLOYMENT SERVICE

DeVry Tech's effective Employment Service is available to all graduates without additional cost.

**2 FREE BOOKLETS!**  
**Send Coupon Today!**

"One of North America's Foremost Electronics Training Centers"

# DeVry TECHNICAL INSTITUTE

Accredited Member of National Home Study Council

**CHICAGO • TORONTO**

Let DeVry help you to  
prepare and  
blueprint a  
Solid Career  
in this fast-  
Growing Field!



TELEVISION



COMPUTERS



MICRO-WAVES



RADAR



BROADCASTING



**DeVRY TECHNICAL INSTITUTE**  
4141 Belmont Ave., Chicago, Ill. 60641, Dept. RE-3-U

Please give me your two free booklets, "Pocket Guide to Real Earnings" and "Electronics in Space Travel"; also include details on how to prepare for a career in Electronics. I am interested in the following opportunity fields (check one or more):

- |  |   |
|--|---|
| <input type="checkbox"/> Space & Missile Electronics | <input type="checkbox"/> Communications         |
| <input type="checkbox"/> Television and Radio        | <input type="checkbox"/> Computers              |
| <input type="checkbox"/> Microwaves                  | <input type="checkbox"/> Broadcasting           |
| <input type="checkbox"/> Radar                       | <input type="checkbox"/> Industrial Electronics |
| <input type="checkbox"/> Automation Electronics      | <input type="checkbox"/> Electronic Control     |

Name \_\_\_\_\_ Age \_\_\_\_\_

Address \_\_\_\_\_ Apt. \_\_\_\_\_

City \_\_\_\_\_ Zone \_\_\_\_\_ State \_\_\_\_\_

Check here if you are under 16 years of age.

Canadian residents: Write DeVry Tech of Canada, Ltd.  
2075-A 970 Lawrence Avenue West, Toronto 19, Ontario

# NOW! CASTLE OFFERS YOU THE BIGGEST BARGAIN IN TV TUNER OVERHAULING!

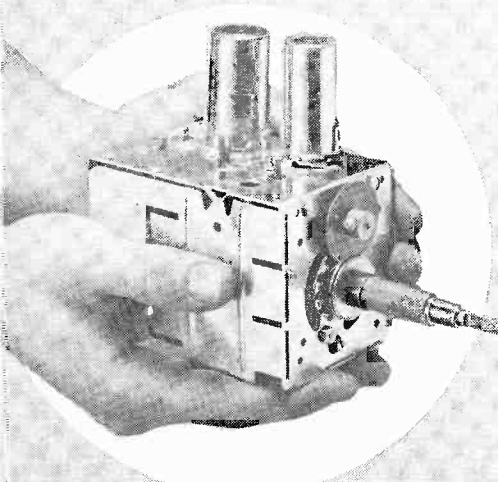

**ALL MAKES  
ALL LABOR  
AND PARTS  
(EXCEPT TUBES)\*  
ONE PRICE**

**9.95**

ONE LOW PRICE INCLUDES ALL UHF,  
VHF AND UV COMBINATION\* TUNERS

In a decade of experience overhauling TV Tuners of ALL MAKES, Castle has developed new handling and overhauling techniques which give you . . .

## Fast Service

A recent study at our Chicago Plant revealed that of all tuners accepted for overhauling, over 30% were completed and shipped within . . .  
**Seven Hours...all others within 24 Hours.**

Simply send us your defective tuner complete; include tubes, shield cover and any damaged parts with model number and complaint. 90 Day Warranty.

Exact Replacements are available for tuners unfit for overhaul. As low as \$12.95 exchange. (Replacements are new or rebuilt.)

\*UV combination tuner must be of one piece construction. Separate UHF and VHF tuners must be dismantled and the defective unit only sent in.

Pioneers in TV



Tuner Overhauling

**CASTLE**  
TV TUNER SERVICE, INC.

5715 N. Western Ave., Chicago 45, Illinois  
653 Palisade Blvd., Cliffside Park, N. J.  
Canada: 136 Main St., Toronto 13, Ontario

\*Major Parts are additional in Canada

their sales of built-in music intercom systems are to builders who install them. Generally, such installations are limited to higher-priced houses.

## WWV Increases Propagation Notices

WWV is now broadcasting propagation notices every five minutes following the code time announcement and just preceding the voice time announcement. Formerly, propagation notices were broadcast 19½ and 49½ minutes after the hour. These notices, in telegraphic code, consist of a letter (N, W or U) followed by a number from 1 to 9. They indicate propagation conditions over the North Atlantic.

W indicates ionospheric disturbance in progress or expected; U, conditions unstable but communications possible with high power; N, no warning. The numbers apply to expected conditions during the following 12 hours. They range from 1 for impossible to 9 for excellent. These notices are revised at midnight, 7 am, noon and 6 pm.

## New Training Device Takes Students "Undersea"

New training simulators, analogous to those used in training aviators, now make it possible for submarine navigators to go through every experience they would meet at sea, and even to rerun an actual 60-day patrol in a half day, with the help of "time compression."

Two of the trainers, designed and built by the Sperry Gyroscope Co.,

are in use at submarine bases in New London, Conn., and Charleston, S.C. Most of the equipment is the full-scale operating copy of the units aboard every Polaris submarine.

The voyages can be stopped, repeated or sped along 200 times faster than real time. An instructor at the computer console watches displays which tell him the "actual" position of the make-believe boat, while a printer types out a running log showing where the student navigators think they are, for after-class evaluations.

### CALENDAR OF EVENTS

**Los Angeles High-Fidelity Music Show**, Mar. 10-15; Ambassador Hotel, Los Angeles, Calif.

**International High-Fidelity Show**, Mar. 12-19; Paris France.

**Intercollegiate Broadcasting System (IBS) 25th Annual National Convention**, Mar. 21; Ferris Booth Hall, Columbia University, New York, N. Y.

**IEEE International Convention**, Mar. 23-26; Coliseum and New York Hilton Hotel, New York, N. Y.

**International Conference on Nonlinear Magnetics**, April 6-8; Shoreham Hotel, Washington, D. C.

**95th Technical Conference, Society of Motion Picture & Television Engineers (SPMTE)**, April 12-17; Ambassador Hotel, Los Angeles, Calif.

## 15-Mile-High Telescope Gathers New Data

A 36-inch fused silica mirror, lifted to 80,000 feet by a balloon and controlled by scientists on the ground with two on-board television cameras, was used to gather infrared data on Jupiter, the moon, several cool red giant stars and other targets. The flight was from Palestine, Tex., starting at 4 pm Nov. 26, and landing at 9:32 am near Newport, Miss. The telescope was in good condition when recovered.

A 450-pound mirror blank of



*Students aboard the simulated submarine find and track the North Star in a planetarium built above the telescope. The scope operator is helped by an electronic computer that automatically swings the scope to the designated star, then locks on the tiny spot of light.*



THE SAME ENGINEERING, SAME PLANT THAT  
PRODUCES AMERICA'S GREATEST SATELLITE-  
TRACKING AND TELEMETRY STATIONS, HAS CREATED

*the revolutionary new*

# PARALOG

TV/FM ANTENNA

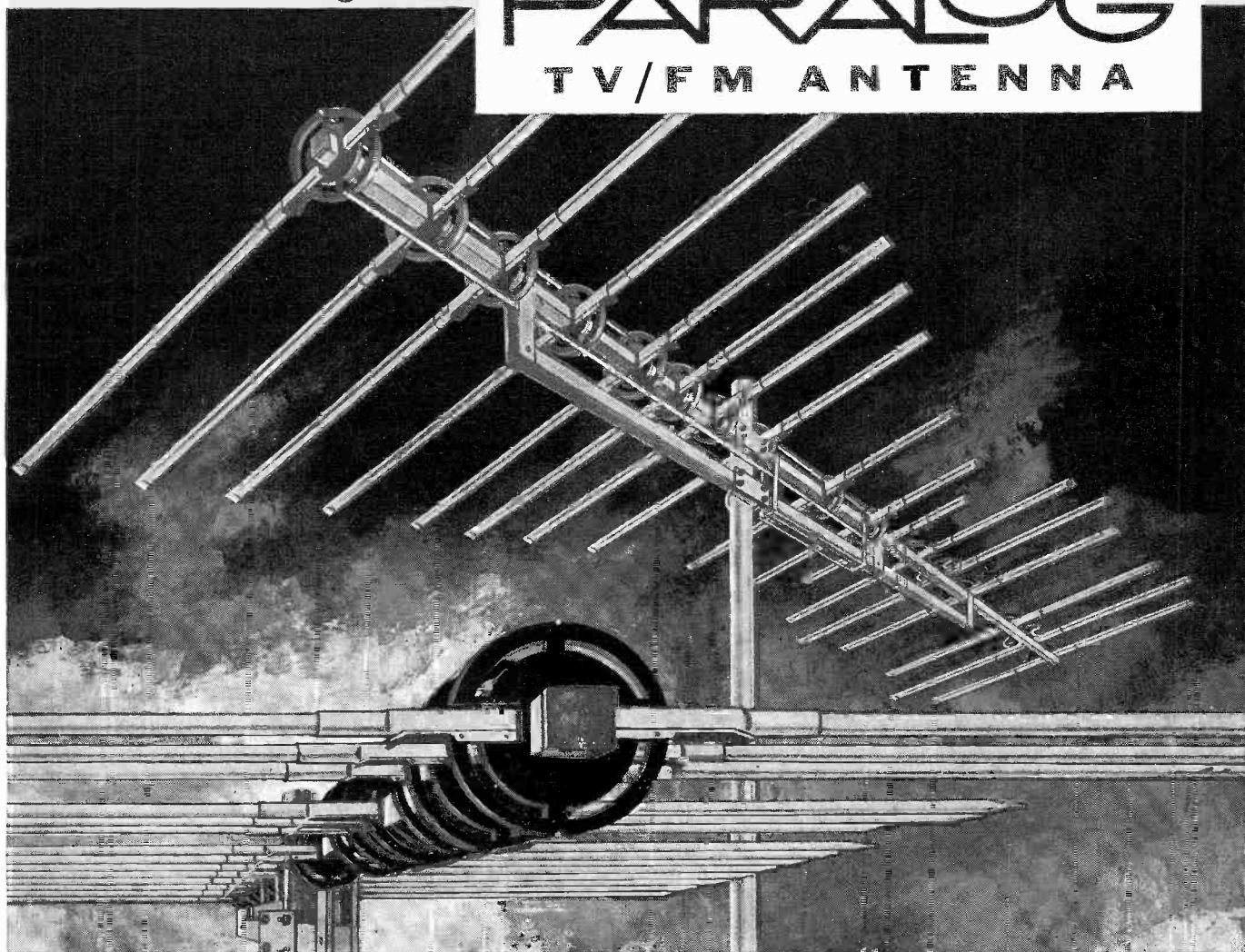

... Unparalleled performance because it has **ALL 5**:

- HIGHEST GAIN
- SHARPEST DIRECTIVITY
- EXTREMELY LOW VSWR
- BEST FRONT-TO-BACK RATIO
- RUGGED CONSTRUCTION

HERE IT IS—the space-age TV/FM antenna from the only manufacturer with actual experience in making space-probing antennas!

All new, the PARALOG is the first home antenna that really comes through with log-periodic

design plus a unique parasitic-element system for maximum all-channel gain and pinpoint directivity. Exclusive Cyclocac insulating mounts assure constant impedance, eliminate troublesome cross-feed design. Extremely rugged construction.



*There are fourteen PARALOG antenna models, listing from \$19.95, including four electronic PARALOGs with Super Powermate preamplifier, and three special FM stereo models. See your Jerrold-TACO distributor now, or write Jerrold Electronics, Philadelphia 32, Pa.*

these are

# Garrard's automatic turntables.



TYPE A  
\$79.50

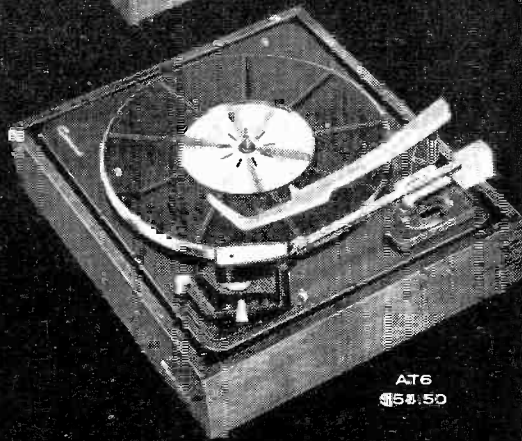

AT6  
\$58.50

consider this —

**more dealers  
recommend  
Garrard...  
more people  
are buying  
Garrard  
than any other component.**

fused silica (the purest glass known), made by Corning Glass Works at Bradford, Pa., was ground and finished by Perkin-Elmer Corp., Norwalk, Conn., who also constructed the telescope system. Fused silica was chosen because of its near-zero thermal expansion factor. Large and sudden temperature changes do not change the shape of the glass.

The telescope control system includes 40 command and 64 telemetry channels. The project is being conducted by Princeton University with financial aid from several Government bureaus.

## Laser Triode Invented

A new type of gas laser that can be modulated by varying the voltage on the grid in the tube, has been reported by Bell Telephone Laboratories. Excited by a beam of electrons of nearly identical energies emitted from a hot oxide cathode, the triode laser oscillates without the usual glow discharge of ordinary gas lasers.

Inside the triode laser tube are a cathode, grid and anode in the form of ribbons parallel to each other and extending about 8 inches along the horizontal axis of the laser. The electrons from the cathode are controlled by the grid to have an energy spread of only a fraction of a volt.

(In ordinary discharge lasers the energy spread is tens of volts, much of which is wasted because only a narrow band of energies is used in the excitation process. Thus, in the triode laser, the efficiency of excitation per electron is increased a hundredfold.)

By varying the grid voltage which controls the electron flow in the laser tube, the light beam can be

switched and amplitude modulated. At high electron energies and gas pressures, strong absorption of light instead of laser oscillation has been observed.

## Dr. John Pierce Among Scientists Honored At White House

The 1963 National Medal of Science has been awarded to John R. Pierce, executive director of the Bell Telephone Laboratories, Murray Hill, N.J., and to four other scientists.

The others honored at the White House presentations were Dr. Vannevar Bush, engineer, scientist and administrator; Luis W. Alvarez, associate director of the Lawrence Radiation Laboratory, Livermore, Calif.; Dr. Cornelius V. van Niel of the Hopkins Marine Station of Stanford University, Palo Alto, Calif., and Norbert Wiener, professor emeritus of the Massachusetts Institute of Technology, Boston.

## Parisian "Radio City" Receives Mixed Reviews

A 21-story radio headquarters, called "La Maison de la Radio" (The House of Radio), was inaugurated recently by President de Gaulle. Critics, pointing out that the center is designed for radio rather than TV, wondered why the Government spent \$40 million in the 1960's on a project that seemed more appropriate for the 1930's, when the US and Britain built their radio headquarters. M. Robert Bordaz, director-general of the State Radio & Television Service, expressed a desire for a TV center some time in the future, but said there were many unsolved problems.

"La Maison de la Radio" includes 50 studios, from a 1,000-seat

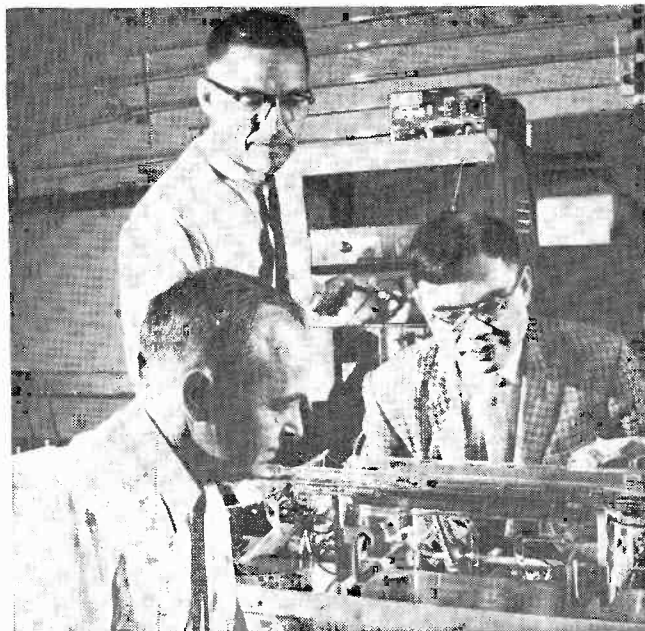

*Bell Labs scientists D. MacNair, H. L. Hodges (standing) and P. K. Tien at work on their invention, the triode laser.*



For Your Career in TV-Radio  
 Electronics-Automation  
**TRAIN AT HOME WITH**  
**THE LEADER** **nri**

**9 WAYS** to assure advancement or turn your hobby into a new career **TURN PAGE**

Perhaps you're working in Electronics now but feel the need for an FCC License or more math . . . perhaps you're a hobbyist trying to decide between a career in Automation and one in Communications . . . perhaps you're a beginner who left school early, but you're thinking about the career possibilities of building a spare-time or full-time business of your own servicing radio and television sets. Worker, hobbyist or beginner, whatever your desire, there is training for you among the nine specialized courses NRI offers. Read the descriptions of NRI training on the other side of this page, about successes of NRI graduates, about NRI training equipment included at no extra cost. Then, cut out and mail postage-free form for FREE NRI CATALOG.

**CUT OUT AND MAIL TODAY** 

FIRST CLASS  
 PERMIT  
 NO. 20-R  
 (Sec. 34.9, P.L. & R.)  
 Washington, D. C.

**BUSINESS REPLY MAIL**  
 No Postage Stamp Necessary If Mailed In The United States

POSTAGE WILL BE PAID BY



**National Radio Institute**  
**3939 Wisconsin Avenue**  
**Washington 16, D. C.**



# Join the Thousands Who Trained for Success with NRI

**CHOOSE YOUR CAREER**



Thousands of NRI graduates throughout the U. S. and Canada are proof that it's practical to train at home. NRI graduates are in every kind of Electronics work. Here are five typical success stories. Catalog tells more about what NRI graduates do and earn. Mail the postage-free form.



"I HAD A PROMOTION BEFORE I FINISHED the Communications Course," reports Ronald L. Ritter, 113 Helms Dr., Eatontown, N. J., "as well as the satisfaction I could handle a job of responsibility." He works for the U. S. Army Electronic Laboratories, Ft. Monmouth. He received one of the highest grades in Army proficiency tests.

**SPARE TIME EARNINGS OF \$3,800** in one year reported by Emerson A. Breda, 1620 Larkin Ave., San Jose 29, California. He has a Radio-TV Servicing shop as completely equipped as you would want for a full-time business. Says Mr. Breda, "The training I received from NRI is the backbone of my progress."



"THE FINEST JOB I EVER HAD" is what Thomas Bilak, Jr., RFD 2, Cayuga, N. Y., says of his position with the G. E. Advanced Electronics Center at Cornell University. He writes, "Thanks to NRI, I have a job which I enjoy and which also pays well."

**HAS SERVICE BUSINESS OF HIS OWN.** Don House, 3012 2nd Place, Lubbock, Texas, went into his own full-time business six months after finishing the NRI Radio-TV Servicing course. "It makes my family of six a good living," he states. "We repair any TV or Radio. I would not take anything for my training with NRI. I think it is the finest."



**MARINE RADIO OPERATOR** is the job of E. P. Searcy, Jr., 1916 Fern St., New Orleans, La. He works for Alcoa Steamship Company, has also worked as a TV transmitter engineer and holds FCC Radio-Telephone License. He says, "I can recommend NRI very highly."

## Special Equipment Included

The NRI "train-by-doing" method, using special training equipment, is the time-proved way to assure advancement or turn your hobby into a new and profitable career in the fast-growing fields of TV-Radio, Electronics-Automation. Most NRI courses include special equipment at no extra cost. You build circuits and work experiments. Theory you study comes to life in an interesting, easy-to-grasp manner. NRI catalog pictures and describes equipment you get. Mail the form for more facts about NRI courses, job opportunities, trial plan. NRI TRAINING, Washington 16, D. C.

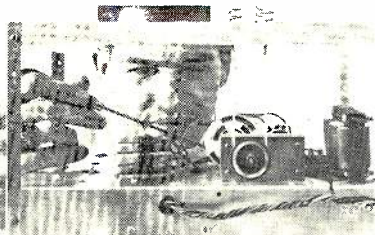

SEE OTHER SIDE



**Cut Out and Mail—No Stamp Needed**



**NATIONAL RADIO INSTITUTE**  
3939 Wisconsin Avenue  
Washington 16, D.C.

The Amazing Field of Electronics

Please send me your Electronics, Radio-TV catalog with complete information on 9 ways to train at home. (No cost or obligation. No salesman will call)

Name \_\_\_\_\_ Age \_\_\_\_\_  
(Please Print)

Address \_\_\_\_\_

City \_\_\_\_\_ Zone \_\_\_\_\_ State \_\_\_\_\_

ACCREDITED MEMBER NATIONAL HOME STUDY COUNCIL

- 1 TELEVISION-RADIO SERVICING**  
Learn to service black-and-white and color TV sets, AM-FM radios, stereo hi-fi, PA systems, etc. A profitable, interesting field for part-time or full-time business of your own.
- 2 INDUSTRIAL-MILITARY ELECTRONICS**  
Learn Principles, Practices, Maintenance of Electronic equipment used today in business, industry, defense. Covers Electronic controls and measurement, computers, servos, telemetry, multiplexing, many other subjects.
- 3 COMPLETE COMMUNICATIONS**  
A comprehensive training program for men seeking careers operating and maintaining transmitting equipment in Radio-TV Broadcasting or mobile, marine, aviation communications. Prepares you for FCC License.
- 4 FCC LICENSE**  
Prepares you quickly for First Class License exams. Every communications station must have one or more FCC-licensed operators. Also valuable for Service Technicians. You train at home.
- 5 BASIC ELECTRONICS**  
An abbreviated, 26-lesson course covering Automation-Electronics, Radio-Television language, components and principles. Ideal for salesmen, hobbyists and others who find it valuable to be familiar with the fundamentals of this fast-growing industry.
- 6 MATH FOR ELECTRONICS**  
A short course package of carefully prepared texts that take you from basic arithmetic review through graphs and electronic formulas. Quick, complete and low in cost.
- 7 AVIATION COMMUNICATIONS**  
For men who want careers working with and around planes. Covers direction finders, ranges, markers, loran, shoran, radar, landing systems, transmitters. Prepares you for FCC License exams.
- 8 MARINE COMMUNICATIONS**  
Shipboard transmitting equipment, direction finders, depth indicators, radar are all covered in this course. You prepare for your First Class Radiotelephone License with Radar Endorsement.
- 9 MOBILE COMMUNICATIONS**  
Training in installation and maintenance of mobile equipment and associated base stations like those used by fire and police departments, taxi companies, etc. Prepares you for your First Class FCC License exams.

**CUT OUT AND MAIL FOR FREE CATALOG**

*The first successful scanning electron microscope in the United States, being used to study surfaces of tiny microelectronic devices.*

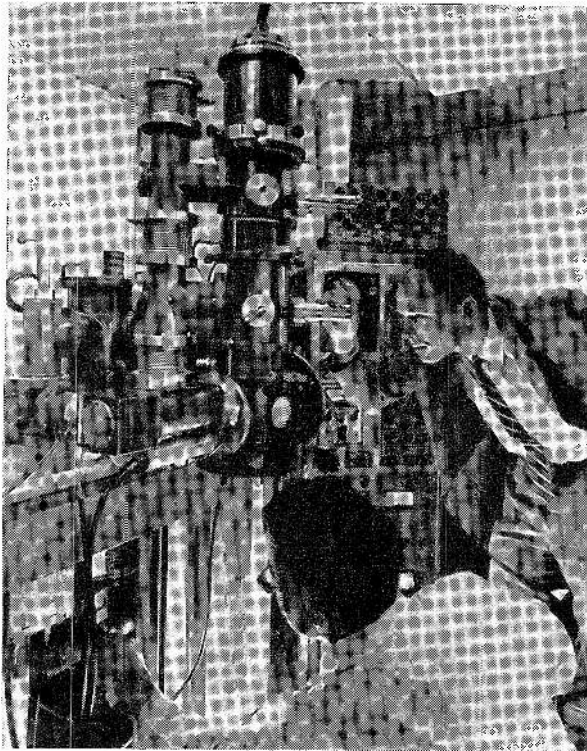

concert hall to announcing booths, grouped in a vast circle, a quarter-mile in circumference and 10 stories high. An inner circle houses technical facilities and a rectangular tower for record collections and archives.

### Sound Soothes Bees

Scientists at the University of Wisconsin have discovered that a sound wave of the right frequency is as effective in quieting bees as is the smoke commonly used by beekeepers. A 960-cycle note beamed into the hive would cause the bees to stop flying, apparently becoming calm and listless.

Researchers found that the bees pick up the sound through the vibrations of the object on which they were perched, rather than through the air. They found that the bees' forelegs are necessary either to receive the sound vibrations directly or to transmit them to sensitive organs.

### New Electron Microscope Uses Scanning Techniques

Combining the principles of the electron microscope and the TV receiver, a new instrument, designed by Westinghouse Research Laboratories, displays detailed pictures of areas only about 15 millionths of a square inch on a 5-inch screen. It also gives equally detailed pictures of the electric fields of the surface scanned. Thus one can see the actual voltage distribution across a resistor or transistor in operation.

As in the regular electron microscope, the electrons comprising the beam are accelerated to high speed

by an applied voltage and focused with magnetic coils on to the sample. Then magnetic coils like those on a TV yoke guide the beam across and down the surface in the scanning operation.

The electrons striking the surface cause the sample to emit low-voltage secondary electrons in quantities determined by the surface structure and charge. These electrons are collected, amplified and fed as an electrical control signal to a special TV picture tube, where a visible image of the surface is displayed.

The scanning time for a specimen can be varied from 1/4 to 4,000 seconds. The number of lines can be varied from 250 to 1,000, the 1,000-line setting giving about four times the picture detail of a regular television picture.

### Brief Briefs

Philco Corp., pioneer of car radio manufacturing, announced it will re-enter the auto radio field when it begins preliminary production of a newly developed model at its Lansdale, Pa., division, in late spring of 1964.

The dynamic modulation range of gallium arsenide lasers has been increased by a technique similar to that used in push-pull electronic amplifiers. Using two diodes with the output radiation collimated on the same optical path and the input modulation signals 90° apart, scientists of ITT Federal Laboratories, Nutley, N. J., balanced the second-harmonic sidebands in the modulated light output. END

EXCITING  
NEW LINE!  
EXCITING  
NEW SOUND!

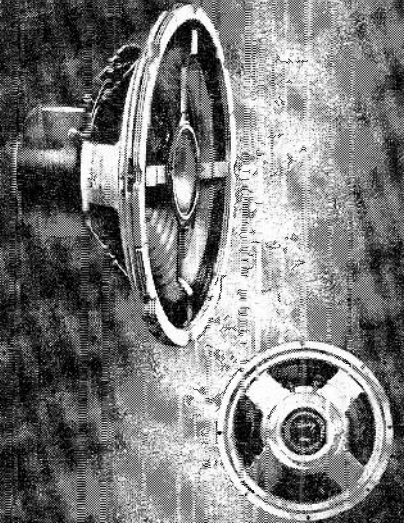

QUAM

## FULL FIDELITY HI-FI SPEAKERS

Slim-line styling! Ceramic magnets! Superb reproduction over the full audio spectrum! Complete choice: coaxials, extended range, tweeters, woofers! The new Quam hi-fi line is as modern as tomorrow—and it's designed to offer the *serviceman* a top-quality product at a list price that's lower than others' "audiophile net." (Quam never advertises net prices—to protect your mark-up!)

Use Quam Hi-Fi Speakers in new systems, as extension speakers in existing hi-fi systems, and as replacement improvements in stereo consoles. They'll open your way to exciting new sales!

Write for your free copy of the new Quam Hi-Fi Catalog HF-64.

**QUAM-NICHOLS COMPANY**  
234 East Marquette Road • Chicago, Ill. 60637

# ATR PRODUCTS FOR MODERN LIVING

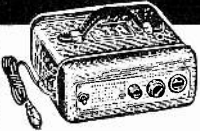

## ATR PLUG-IN TYPE PORTABLE INVERTERS\*

A.C. HOUSEHOLD ELECTRICITY Anywhere... in your own car, boat or plane Operates Standard A.C. • Record Players • Dictating Machines • Small Radios • Electric Shavers • Heating Pads, etc.

MODELS  
6-RMF (6 volts) 60 to 80 watts. Shipping weight 12 lbs. DEALER NET PRICE... \$36.50  
12T-RME (12 volts) 90 to 125 watts. Shipping weight 12 lbs. DEALER NET PRICE... \$36.50  
\*Additional Models Available

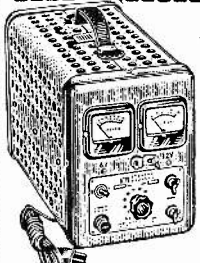

## ATR "A" Battery ELIMINATOR

For Demonstrating and Testing Auto Radios—TRANSISTOR or VIBRATOR OPERATED!

Designed for testing D.C. Electrical Apparatus on Regular A.C. Lines—Equipped with Full-Wave Dry Disc-Type Rectifier, assuring noiseless, interference-free operation and extreme long life and reliability.

MAY ALSO BE USED AS A BATTERY CHARGER  
MODEL 610C-ELIF... 6 volts at 10 amps. or 12 volts at 6 amps. Shipping weight 22 lbs. DEALER NET PRICE... \$55.00  
MODEL 620C-ELIT... 6 volts at 20 amps. or 12 volts at 10 amps. Shipping weight 33 lbs. DEALER NET PRICE... \$73.50

## AUTO-RADIO VIBRATORS



By every test ATR Auto-Radio Vibrators are best! and feature Ceramic Stack Spacers, Instant Starting, Large Oversized Tungsten Contacts, Perforated Reed, plus Highest Precision Construction and Workmanship and Quiet Operation!

There is an ATR VIBRATOR for every make of car! Ask your distributor for ATR's Low Priced type 1400, 6 volt 4-prong Vibrator; and 1843, 12 volt 3-prong; or 1840, 12 volt 4-prong Vibrator. THE WORLD'S FINEST!

## ATR ALL-TRANSISTOR MODEL 707

# Karadio®

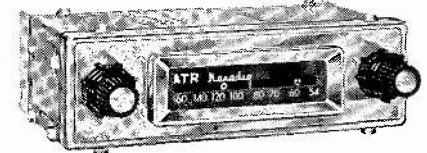

Feature for feature, you'll want to buy the all-new, all-transistor Karadio by ATR. **\$29<sup>95</sup>** Retail

- Hand wired • No printed circuitry. • Finger-tip tone control • 7-tuned circuits incl. RF stage • Automatic volume control • Utilizes "solid state" construction employing 7 semi-conductors • Superheterodyne circuit • 3-section Super "Magna-Wave" tuner • "Fits All" import and American cars and trucks • Fits under dash or in-dash • Complete with built-in speaker and external speaker jack • 12-volt neg. ground only • low battery drain • Overall size 5½" deep x 6½" wide x 2" high • Ship. weight 5 lbs.

SEE YOUR ELECTRONIC PARTS DISTRIBUTOR WRITE FACTORY FOR FREE LITERATURE...  
**ATR ELECTRONICS, INC.**  
Formerly: American Television & Radio Co.  
Quality Products Since 1931  
ST. PAUL 1, MINNESOTA—U.S.A.

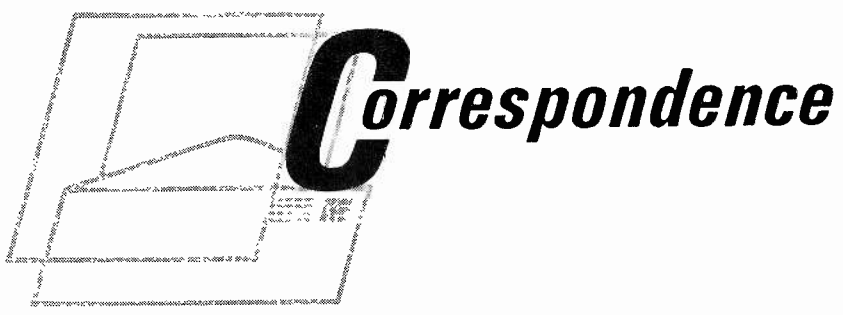

## Polarity Changed

Dear Editor:  
A note on "Transistors and Your Ohmmeter" (RADIO-ELECTRONICS, November 1963, page 80): The polarity listing for the Triplett 630 is correct up to approximately serial No. 186,000, after which the red lead is positive and the black one negative.

W. LAUBENGAYER  
Collins Radio Co.  
Cedar Rapids, Iowa

## New Institute Certifies Engineering Technicians

Dear Editor:  
Some of your readers may be interested in a relatively new organization called the Institute for the Certification of Engineering Technicians (ICET). The purpose of this organization is to help raise the standards of engineering technicians, and to examine and certify those technicians found qualified. Application is voluntary.

Many of the electronic technician readers of RADIO-ELECTRONICS are probably qualified for certification. Those interested in furthering their careers should apply. Certification will raise the status of a technician and could help bring about raises, promotions or a more responsible position. A future benefit of certification will be greater recognition for that group of individuals classified as engineering technicians.

Interested technicians should write the Institute for the Certification of Engineering Technicians, 2029 K Street, N.W., Washington 6, D.C., for further information and an application.

LOUIS E. FRENZEL, JR.  
Houston, Tex.

## Jack Still Has Friends

Dear Editor:  
I had a good chuckle over the "Full of Holes?" letter and Jack Darr's answer in the January RADIO-ELECTRONICS. When I read the letter I figured that Johnston worked in a machine shop, but if he can't grind a drill freehand, he's no machinist. He doesn't seem to know his mechanical punches, either.

The same kind of incident happened last spring when a mechanics magazine editor called a generator an alternator. The editor was right by the elec-

tronics dictionary, and the complainant by the regular one.

My belief here is, when a fellow talks so technical and won't realize what the other one means, then it's just talk. Jack answered him well.

PETER LEGON  
Malden, Mass.

## TV Towers: Menace to Birds?

Dear Editor:  
May I write to you about a problem which has nothing to do with television, but is created by modern improvements in TV? I refer to the destruction of birds due to the new super-high TV towers, which are so greatly increasing the service areas of many stations.

North American birds migrate in spring and fall. Most species migrate at night, feeding during the day. It is now generally believed that they travel by celestial navigation. They use the stars to steer by!

Early TV towers did not cause any particular hazard. Only when the thousand-foot structures, with their many supporting cables, started to go up, did collision casualties begin to become numerous. Since 1957, I estimate the victims at one single tower in this area to be over 250,000, usually small migrants. Occasionally geese and ducks have been reported, but this is rather rare.

It has been a study of mine to collect and identify birds that have hit the tower. Similar studies have been made and are being made by ornithologists all over the country. Some suggestions for remedies have been made. It was proposed that racks be placed around the tower, as has been done by lighthouses; the tower might be illuminated by bright multiple spotlight beams from below on cloudy nights. This might at least show up the cables. Another possible experiment would be to use a spotlight or series of spotlights on a cloud away from the tower to attract the birds away from the danger points. Perhaps fluorescent cables could be used.

I should explain that the big casualties occur when the skies are overcast and the stars are not shining. Apparently the birds—losing the stars that guide them—are attracted by the TV beacons high in the sky. They swarm around the tower like moths around a flame. As

# What are you aiming at?

What are your career objectives? Big pay? Job security? Greater prestige? Interesting work? Sure. All of these. But, these are rewards for hitting the bull's eye. Can you see the real target? Before you can hit it, you must see it clearly. And, your efforts might ricochet if "fired" from the wrong training program. Get "on target" with Grantham. Get your first class F.C.C. license on the first shot, and then continue with higher-level electronics training if you wish. Aim in the right direction by mailing the coupon for full details.

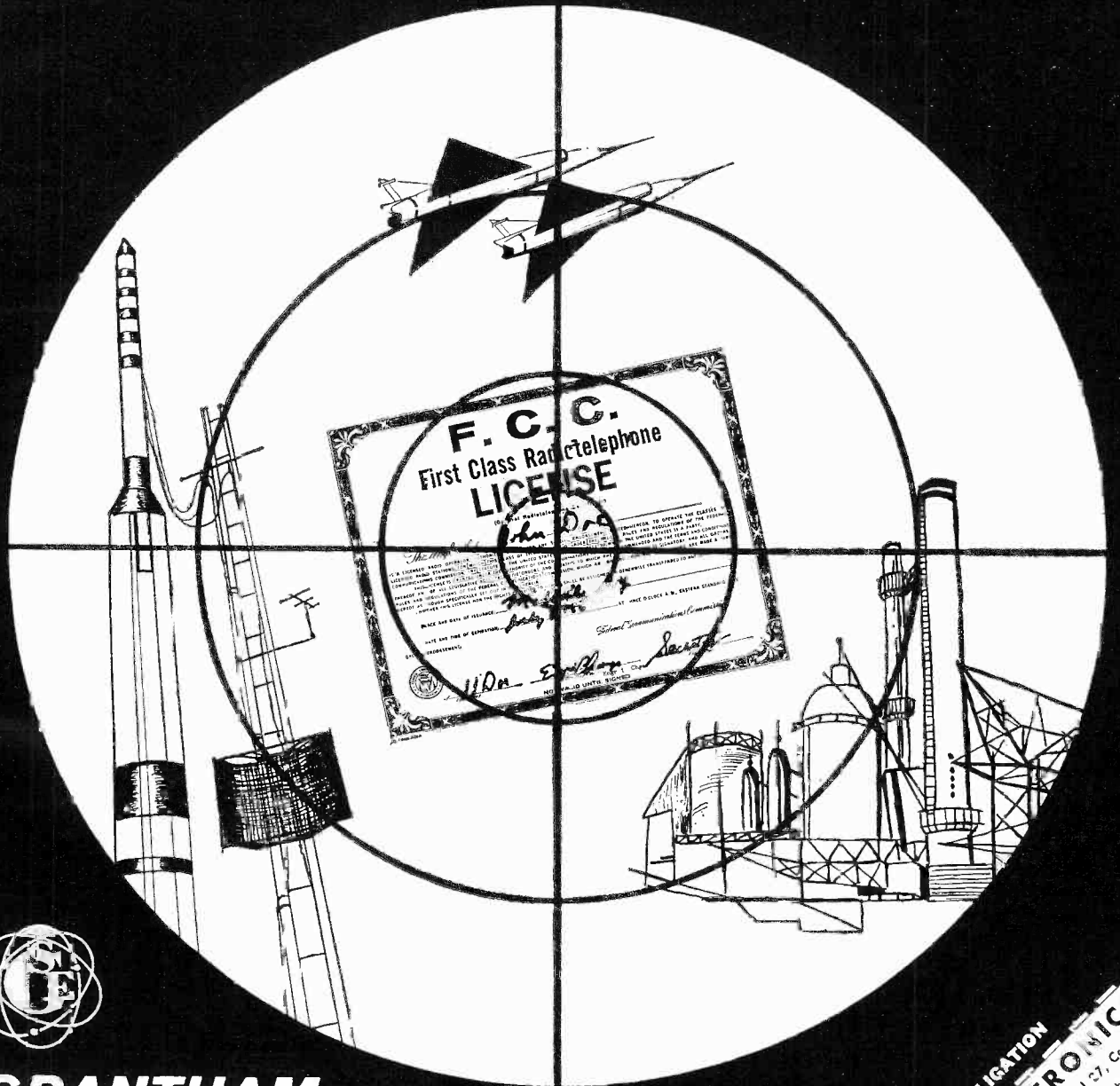

## **GRANTHAM** **SCHOOL OF ELECTRONICS**

Los Angeles Division, 1505 N. Western Ave., Los Angeles, Calif.  
South Gate Division, 9320 Long Beach Blvd., South Gate, Calif.  
Garden Grove Division, 12732 Garden Grv. Blvd., Garden Grove, Calif.  
Seattle Division, 408 Marion Street, Seattle, Washington  
Kansas City Division, 3123 Gillham Road, Kansas City, Mo.  
Washington Division, 821 - 19th Street, NW., Washington, D.C.

Train by correspondence, or at one of  
our classroom locations listed above.

**MAIL THIS COUPON TODAY - NO OBLIGATION**  
**GRANTHAM SCHOOL OF ELECTRONICS**  
NATIONAL HEADQUARTERS OFFICE, 1505 N. Western Ave. Hollywood 27, Calif.  
Upon receipt of this coupon, the School will send complete details by return mail. There is no obligation, and no salesman will call.  
Name \_\_\_\_\_  
Address \_\_\_\_\_  
City \_\_\_\_\_ State \_\_\_\_\_  
Age \_\_\_\_\_

# RCA BRINGS YOU TWO IMPORTANT NEW TEST INSTRUMENTS

TO GENERATE  
RF SIGNALS

TO PROVIDE STEREO  
FM SIGNALS



RCA WR-51A FM  
STEREO SIGNAL SIMULATOR

RCA WR-50A RF SIGNAL GENERATOR

Generates continuous wave or amplitude-modulated rf signals of sinusoidal waveform from 85 Kc to 40 Mc. Particularly useful for aligning and signal tracing in AM and FM radio receivers and Citizens' Band transceivers—and for aligning if amplifiers, and for signal tracing in TV receivers.

- Wide frequency range—continuous coverage 85 Kc to 40 Mc in 6 overlapping ranges
- Built-in crystal-calibrating oscillator circuit with front panel crystal socket
- Permanently attached, shielded output cables prevent errors, minimize time loss and inconvenience. Built-in DC blocking capacitors
- Internal 400 cycle audio oscillator
- Individual inductance and capacitance adjustments for each range
- Two-step rf attenuator switch plus a continuously variable attenuator control
- Easy-to-read dial scale—vernier tuning
- Readily portable—weighs only 5 pounds

\$5995\*

Generates signals necessary to service and maintain stereo multiplex FM receivers and adapters.

#### GENERATES:

- Four FM signals: Left stereo, right stereo, special phase test, monophonic FM
- Eight sine-wave frequencies: 400 cps, 1 Kc, 5 Kc, 19 Kc, 28 Kc, 38 Kc, 48 Kc, 67 Kc—available separately or for modulating FM signals.
- 100 Mc carrier signal tuneable  $\pm 0.8$  Mc to permit selection of a quiet point in the FM band
- 19 Kc subcarrier signal crystal-controlled within  $\pm 2$  cps
- 100 Mc sweep signal adjustable from 0-750 Kc at 60 cps sweep rate
- Choice of three composite stereo output signals: left stereo, right stereo, and special phase test

ALSO features crystal-controlled markers for receiver rf and if alignment. Zero-center meter for checking the balance of stereo amplifier output. Portable and compact: weighs only 14 pounds.

\$24950\*

\*User price (optional)

See them at your Authorized RCA Test Equipment Distributor  
RCA ELECTRONIC COMPONENTS AND DEVICES, HARRISON, N. J.

they circle it, many hit cables and fall to the ground.

If any of your readers have had similar experiences and know of any way to remedy or alleviate the situation, I—and many others—would greatly appreciate hearing from them.

CHARLES A. KEMPER, M.D.

Chippewa Falls, Wis.

### Notes on the G-Line (From the People Who Make It)

Dear Editor:

We enjoyed Mr. Patrick's fine article (February 1964, page 46) on how he constructed a private TV line with a home-grown version of our proprietary G-Line. The challenge presented by installing 3,400 feet of line over rough terrain proves the tenacity and ingenuity of the author, and incidentally confirms the message we have been preaching: that there is absolutely nothing equal to G-Line for low-loss, low-cost transmission of vhf, uhf and microwave energy.

Of course, we feel that Mr. Patrick could have saved considerable time, effort and even money if he had first contacted us. We could have supplied him with our standard launchers and cable for any frequency.

The amazing results reported by the author have been confirmed in numerous CATV and microwave systems, and we have even run G-Line through tunnels for vehicle-to-fixed-station communication.

For those who want to become familiar with surface conduction principles, our company has put on the market an inexpensive G-Line kit for uhf TV. It can eliminate boosters in some fringe-area installations.

A. PHILLIPS

Surface Conduction, Inc.  
New York, N. Y.

END

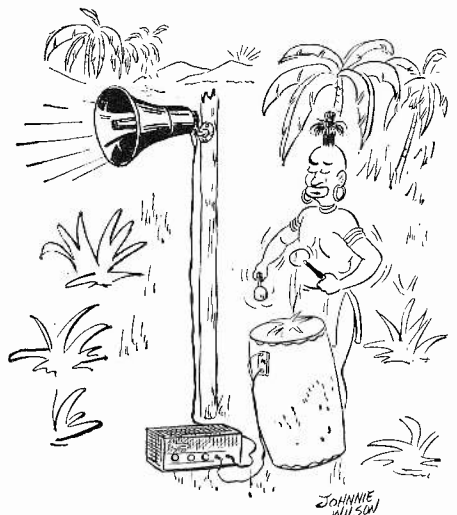

JOHNNIE WILSON

RADIO-ELECTRONICS



The Most Trusted Name in Electronics



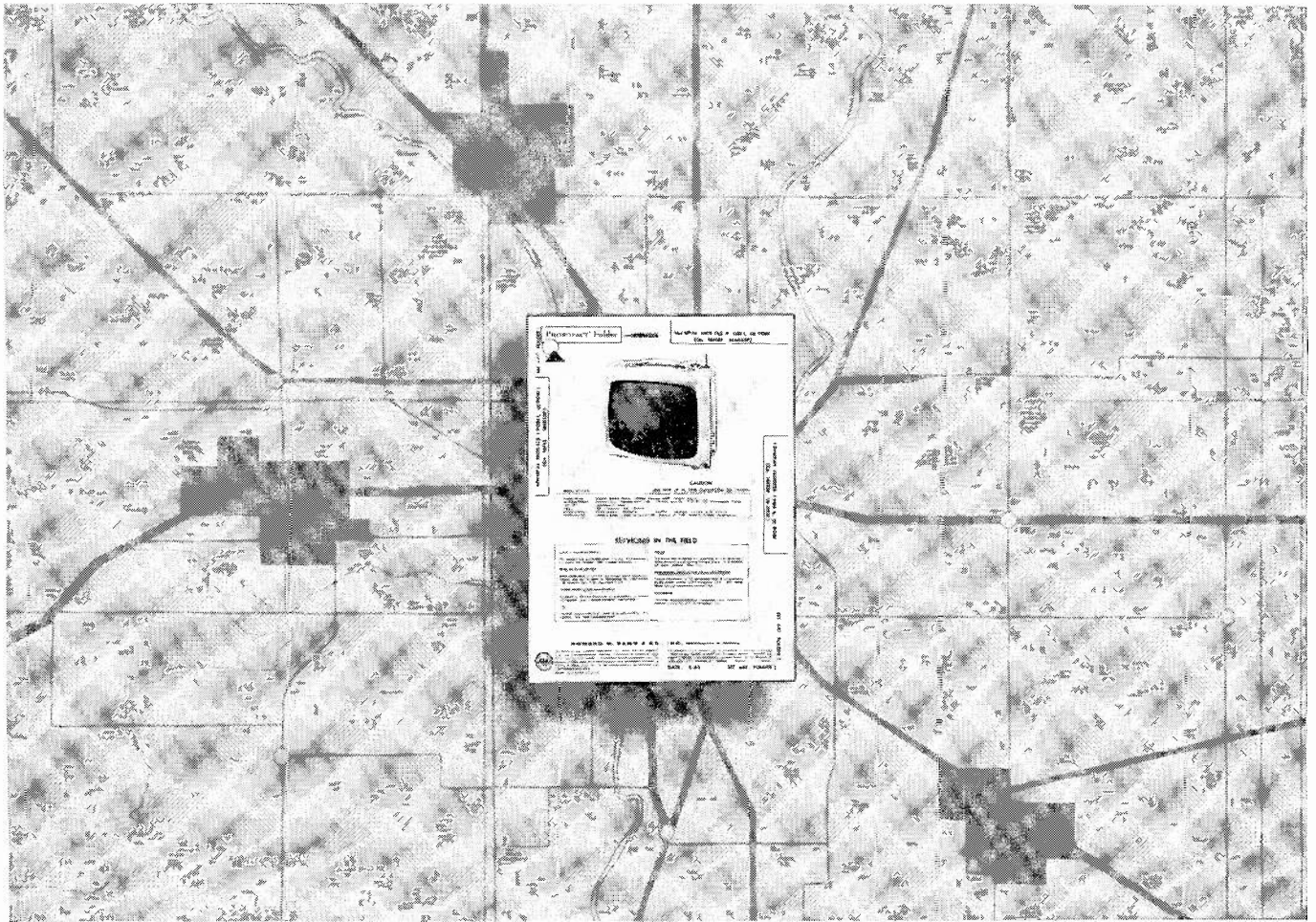

## “Like a road map.”

These are the very words a lot of technicians use to describe PHOTOFACT. A typical letter (unsolicited) reads like this:

“My PHOTOFACTS mean as much to my business as a road map does to a traveler. I would be lost without them.”

Getting “lost” is no way to make a profit in electronics service work. PHOTOFACT users have a perfect road map to the trouble source—with no costly backtracking or detours. On

almost any job, PHOTOFACT means all the difference between making a profit or not.

There are over 40 important “guide-post” features in every PHOTOFACT Folder, time-saving features to show you the way to *fast* TV-radio troubleshooting (the greatest, too, for pinpointing the trouble in those tough-dog jobs).

Users don't measure PHOTOFACT by its pennies-per-page cost. It's the

time-saving, profit-making worth of PHOTOFACT that counts.

Of course, you can get along without PHOTOFACT—a few do—and maybe they're making a living. But it's the hard way.

Doesn't it make good sense to see your Sams Distributor today for the interesting details on an Easy-Buy PHOTOFACT Library and Standing Order Subscription?

Or use the coupon below.

### A PHOTOFACT LIBRARY PAYS ITS OWN WAY—

Now, more than ever, it pays to own PHOTOFACT—the world's finest TV-radio service data. Now, you can start or complete your PHOTOFACT Library this Easy-Buy Way:

- **FREE** with your order for 180 Sets—a deluxe 4-drawer file cabinet worth \$38.95 • **Only \$10 down** • 30 months to pay • **No interest or carrying charges** • Prepaid transportation • **Add-on privilege of a year's advance subscription to current PHOTOFACT on the same Easy-Buy contract** • **Save 30% per Set—special \$1.95 price applies on Easy-Buy (instead of the regular \$2.25 price).**

**4 Ways to Select Your PHOTOFACT Library:** 1. Complete your present PHOTOFACT Library. 2. Order a PHOTOFACT “Start-up” Library—180 Sets (Sets 301 to 480—coverage from 1955 to 1960—only \$11.36 per month). 3. Order by brand name and year—see the handy selection chart at your Distributor. 4. Order a complete PHOTOFACT Library—get FREE file cabinets, *plus* a selection of invaluable books and Electronics Courses.

**SEE YOUR SAM'S DISTRIBUTOR FOR FULL DETAILS, OR MAIL COUPON** ▲

**Howard W. Sams & Co., Inc., Dept. REF-3**  
**4300 W. 62nd St., Indianapolis 6, Indiana**

Send **FREE** Photofact Cumulative Index

Send full information on Easy-Buy Plan

Enter my Photofact Standing Order Subscription

My Distributor is \_\_\_\_\_

Shop Name \_\_\_\_\_

Attn. \_\_\_\_\_

Address \_\_\_\_\_

City \_\_\_\_\_ Zone \_\_\_\_\_ State \_\_\_\_\_

# NEW IDEA

## Winegard Introduces An Amazing New Home TV and Music Outlet System



Turn on the HI-FI record player in the family room . . . listen to records on an AUDIO-PIX extension speaker plugged into the AUDIO-PIX outlet in the bedroom.

Watch TV in the kitchen (plug the TV set into an AUDIO-PIX outlet and receive TV antenna signals.)

All this electronic entertainment can go on simultaneously over a single wire without interference! That's the amazing new AUDIO-PIX system by Winegard.

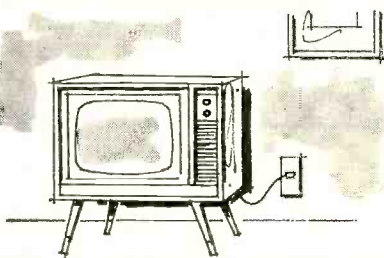

Plug TV set into any AUDIO-PIX outlet. Run one or more sets simultaneously from a single antenna.

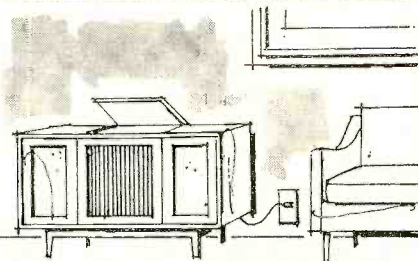

Run a HI-FI (record player, FM or AM, or tape recorder) and feed the sound into the system to be picked up at any AUDIO-PIX outlet.)

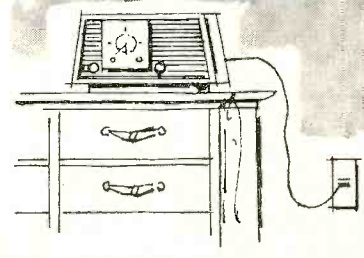

Plug an FM receiver into the AUDIO-PIX. The AUDIO-PIX serves as an FM antenna signal source, and at the same time automatically feeds the FM sound back into the system to the extension speakers.

# AUDIO-PIX delivers TV, FM or HI-FI

Anywhere Inside or Outside the House Over a Single Wire



*Audio-Pix comes beautifully packaged in a Winegard selling display carton with built-in carrying handle.*



Watch TV on the patio (the portable TV set is plugged into an AUDIO-PIX outlet and is receiving TV signals from the same antenna.)

AUDIO-PIX is two systems wrapped into one simple, inexpensive installation. It is both a TV-FM system (distributes TV/FM antenna signals) and a HI-FI music system at a price any home owner can afford. No new home is truly modern without AUDIO-PIX.

The AUDIO-PIX is a revolutionary new electronic entertainment convenience for the home which—

- (1) ... feeds TV (Ch. 2-83) and FM antenna signals to each AUDIO-PIX outlet.
- (2) ... feeds sound from a HI-FI (record player, FM and tape recorder) to the same AUDIO-PIX outlets.

The complete Winegard AUDIO-PIX system comes in a kit which contains a special AUDIO-PIX 6-outlet

coupler\*, 4 AUDIO-PIX outlets and plugs (any number of additional outlets may be added if desired), special AUDIO-PIX HI-FI extension speaker, a special AUDIO-PIX attachment for FM or HI-FI system, and 100 ft. of lead-in wire. Model APK-360, list price \$49.95.

Start selling AUDIO-PIX to your customers now. Write for spec sheets or ask your distributor.



\*Pat. Pend.

**Winegard**  
ANTENNA SYSTEMS

3013-C Kirkwood, Burlington, Iowa



## The commanding presence of Sony sound

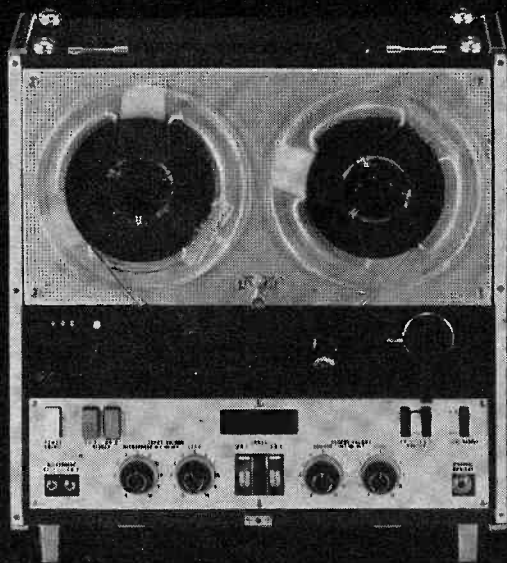

Now enter the world of the professional. With the **Sony Sterecorder 600**, a superbly engineered instrument with 3-head design, you are master of the most exacting stereophonic tape recording techniques.

Professional in every detail, from its modular circuitry to its 3-head design, this superb 4-track stereophonic and monophonic recording and playback unit provides such versatile features as: ■ vertical and horizontal operating positions ■ sound on sound ■ tape and source monitor switch ■ full 7" reel capacity ■ microphone and line mixing ■ magnetic phono and FM stereo inputs ■ 2 V.U. meters ■ hysteresis-synchronous drive motors ■ dynamically balanced capstan flywheel ■ automatic shut off ■ pause control and digital tape counter—all indispensable to the discriminating recording enthusiast. Less than \$450, complete with carrying case and two Sony F-87 cardioid dynamic microphones.

Multiplex Ready!



Sony tape recorders, the most complete line of quality recording equipment in the world, start at less than \$79.50. For literature or name of nearest dealer, write Superscope, Inc., Dept. T, Sun Valley, Calif. In New York, visit the Sony Salon, 585 Fifth Avenue.

# Centralab



BRAND NEW  
CENTRALAB  
**FASTATCH II®**  
FRK-200 KIT WITH  
**EXACT  
REPLACEMENT  
SHAFTS**

## Makes Control Replacement A SNAP!

- Centralab's new FRK-200 kit gives you the most convenient, most versatile, and simplest system for control replacement.
- Since it includes 13 sizes of exact replacement shafts, shaft cutting is eliminated on *all* the popular dual concentric controls and on almost 60% of all dual controls.
- The Fastatch II® Control System is a snap to use. Single and dual concentrics snap together without tools! Shafts plug in and are permanently locked. Assembled units can't loosen—shafts can't pull out.

### JUST CHECK THESE EXCLUSIVE FEATURES:

1. Just one control system for dual concentric or single controls.
2. Universal terminals.
3. Plug-in, permanently locking shafts.
4. Rotary or push-pull (snap-on) line switches attach to both front and rear controls.

The FRK-200 kit is contained in two stacking Equipto steel cabinets with plenty of extra space for expansion. *All* your control needs, including push-pull, are at your finger tips.

### THE FRK-200 KIT CONTAINS:

- |  |   |
|--|---|
| 35 Exact Front Shafts (7 sizes)          | 9 Assorted Rear Controls  |
| 30 Exact Rear Shafts (6 sizes)           | 40 Assorted Universal Shafts for<br>Single and Dual Concentrics |
| 5 Universal Push-Pull Shafts<br>(1 size) | 5 SPST on/off Switches  |
| 5 Push-Pull Line Switches                | 2 DPST on/off Switches  |
| 5 Twist-Tab Adapter Plates               | 1 DP on/off Switch  |
| 2 3-Drawer Equipto Cabinets              | Complete with current<br>cross-reference guides.                |
| 27 Assorted Front Controls               |   |

Dealer Net \$72.50

Less Credit for your old controls!



THE ELECTRONICS DIVISION OF GLOBE-UNION INC.  
922A East Keefe Avenue • Milwaukee 1, Wisconsin  
TWX: 414-731-8731

In Canada: Centralab Canada Ltd., P. O. Box 400, Ajax, Ontario

# Build your own top quality Eico Kits and save up to 50%

## New Tape Deck

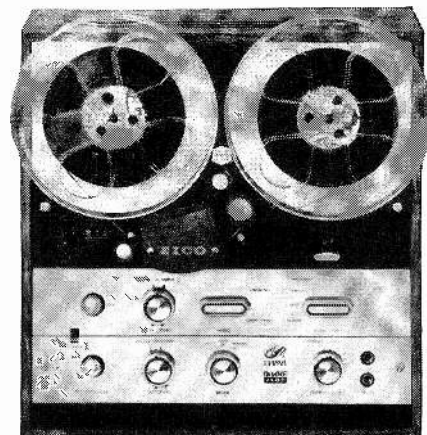

Eico Classic 2400 stereo/mono 4-track tape deck. Kit \$199.95; wired \$269.95 (Incl. oil finish walnut base)

## New 3" Portable Scope

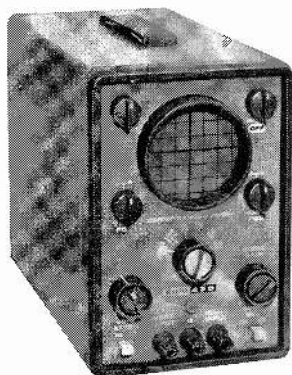

Eico 430 General Purpose 3" Scope. Kit \$65.95; wired \$99.95

COLOR  
AND  
B & W

## /FM Sweep Generator

New

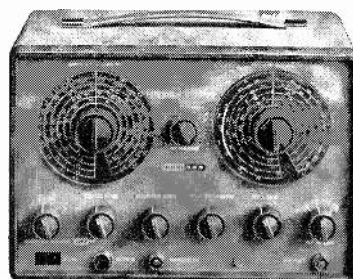

Eico 369 TV/FM Sweep generator, with built-in post injection marker adder. Kit \$89.95; wired \$139.95

## New CB Transceiver

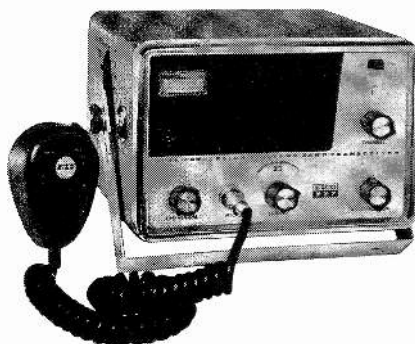

Eico 777 dual conversion 6 crystal-controlled channels, 5-watts. Kit \$119.95; wired \$189.95

## New Stereo Rcvrs.

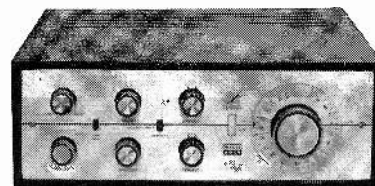

Eico Classic 2536 36-watt FM-MX Stereo Receiver. Kit \$154.95; wired \$209.95 (Incl. F.E.T.)  
New Stereo Tuner Eico Classic 2200 FM-MX Stereo Tuner. Kit \$92.50; wired \$119.95 (Incl. F.E.T.)

New Stereo Amplifiers Eico Classic 2036 36-watt. Kit \$79.95; wired \$109.95. Eico Classic 2050—50-watt stereo. Kit \$92.50; wired \$129.95. Eico Classic 2080 80-watt stereo. Kit \$112.50; wired \$159.95.

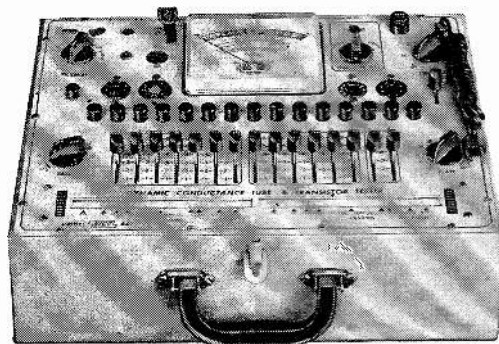

## New Tube Testers

Eico 667 Dynamic Conductance Tube & Transistor Tester. Kit \$79.95; wired \$129.95.  
Eico 628 Tube Tester. Kit \$44.95; wired \$59.95

Add 5% in West

EICO Electronic Instrument Co., Inc.  
131-01 39th Avenue, Flushing, N.Y. 11352  
Please send free  New 1964 catalog C-3  
 Name of nearest Eico dealer

Name \_\_\_\_\_  
Address \_\_\_\_\_  
City \_\_\_\_\_  
Zone \_\_\_\_\_ State \_\_\_\_\_



## MULTIPLEX VIDEO

... Multiple All-Channel Receiver Will Simplify Reception ...

**E**ver since the late 1940's, television receivers have remained practically static. Needed improvements have not been developed, with perhaps one exception: color.

Such improvements as the long-heralded three-dimensional TV, i.e., viewing TV in perspective; flat "picture-on-the-wall" TV; pocket and wristwatch TV—these and many others are still in the future.

Still another badly needed improvement is one to overcome a situation constantly spoken of with irritation by millions of TV viewers: the single-channel annoyance.

In many families there is constant bickering as to which channel to monopolize: Father wants a good prizefight or some other sport; mother wants a drama; the children, comic stuff. No one is satisfied. This often results in several television receivers per family, scattered through a number of rooms, which may not be the best solution of the problem.

Is it possible today or in the near future to have a **SIMULTANEOUS ALL-CHANNEL** single TV receiver? Yes, this can be done *right now*, if we are willing to pay the increased price over the present-day TV receiver.

*Multiplex or multi-channel* TV receivers are not only urgently desired by many home viewers, but by all broadcasting offices, TV writers, critics, reporters, TV actors and their staffs, advertisers and their agencies—in fact everybody in the television industry (numbering hundreds of thousands).

One important reason for a more sophisticated TV receiver is a very fundamental one for millions of viewers: they want to know *what other programs are on the air at the same time!*

Today one must go through the time-consuming chore of consulting the newspaper or TV program magazines daily to find out what's on the air. These programs are often inaccurate because they are printed far ahead and seldom contain late corrections, news of program switches, substitutions, etc. This gives rise to the impatient Channel-Switch-Bug. Every fifteen minutes or less, he goes on a channel-switching spree for fear of missing a program that he might never see otherwise.

This and other shortcomings are a sad commentary on our much-vaunted technological age. Yet there is a remedy which we recommend to the TV

set industry.

In the United States today there are thousands of localities that have anywhere from two to seven television channels. New York has seven, Chicago five, Los Angeles seven. The average for the country is four.

It is quite feasible at this time to enlarge the width of present-day TV receivers by some 8 inches. The old TV screen remains unaltered, as does the large video tube and many of the various components.

Then on each side of the main screen we add four 3-inch new video tubes in two vertical rows (see illustration). Each of these tubes gives a separate 3-inch picture, *one picture for each channel*. Each of these auxiliary video tubes is *permanently tuned to one channel*. Every channel has its own video and audio. *But the audio of these auxiliary video tubes can be heard only if you plug in a headset*. Thus as many listeners as there are channels can listen and view simultaneously; this also means extra headsets.

If the TV set is used by only one person, no headsets are required. Yet he will see all channels simultaneously, *but hear only one*.

Would it not be confusing to see such a multiplicity of channels together? No—not any more than seeing a three-ring circus. *A viewer will normally concentrate on the large picture*. Once in a while he will flick his eyes to the right or left over the other channels. Then if he wishes to switch to another channel on which he sees something worth-while, he proceeds thus:

He will hold in his hand a small portable channel selector. These are already in use today. They operate a remote, motorized channel switching assembly. Let us say he is watching channel 4 on the large screen and wants to switch to channel 13. He merely presses button 13. Instantly channel 13 flashes on the main screen, while at the same moment the auxiliary small screen 13 on the right goes dark.

From the above it becomes clear that when the viewer was watching channel 4 on the large screen, the small standby screen 4 was dark. This means that the auxiliary video tubes have no connection with the large "master" video tube. *Thus no auxiliary video tube can be "on" while the "master" video tube is on the same channel*.

(Continued on page 60)

# BUILD YOURSELF A

# FLUTTER METER

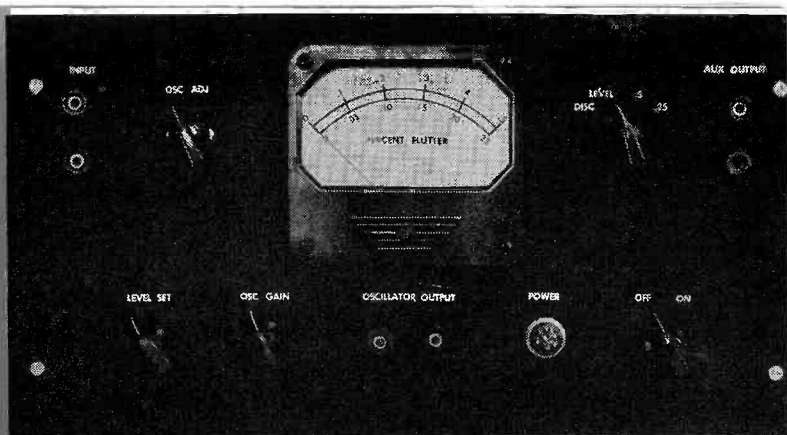

## Measures tape, disc or film-sound flutter directly

By **LT. (jg) JOHN WAGNER, USN (ret)**

MOST WELL MADE RECORD PLAYERS AND tape recorders meet wow and flutter specs when new, but what about them when they're a year or two old? If you want your high-fidelity system to sound "like new," or if you do any audio service work, you'll want to build this practical flutter meter.

No special skill is needed to build or calibrate this instrument — just some patience. It can be done with ordinary service type test equipment: a scope, an audio oscillator and a vtvm with a zero-center scale (most have one). The only noncommercial component is a toroidal transformer, which you must wind yourself. It isn't hard.

This instrument was checked against a commercial model, and the results were identical.

Fig. 1 is the schematic of the meter. V1 is a 3-kc transitron negative-resistance oscillator, designed for maximum stability. As measured on a frequency counter, the oscillator drifted  $1\frac{1}{2}$  cycles in 1 hour after a 20-minute warmup. Drift and short-term instability would cause false readings, and must be eliminated.

V2 is a cathode follower, intended to isolate the oscillator from the load and offer a low-impedance output. This output, via R18 and J3-J4, is fed to the device to be tested.

The "playback" signal, containing some unknown amount of flutter, is fed to J1-J2. V3 is a two-stage amplitude limiter, which prevents amplitude variations from affecting readings. About 0.4 volt rms produces full limiting with R4 set at maximum.

V4, together with T2, make up a frequency-discriminator circuit much like the one used in many FM tuners. Here the "carrier" frequency is 3 kc instead of 10.7 mc. The usable bandwidth of this discriminator is about 50 cycles—25 to either side of 3 kc (Fig. 2). The flutter signal, which is just frequency modulation of the 3-kc "carrier," appears at point A and at the grid of V5. A low-pass filter, L2 and C23, removes the 3-kc signal and leaves only the flutter. D1 and D2 rectify that flutter information, which is then read as a dc voltage on the meter.

V7 is the rectifier, and V6 holds the voltage constant to improve stability.

Selector switch S2 has four positions. The first allows the oscillator to be nulled to the discriminator. The second permits checking to see whether there is enough signal to saturate the limiters. The third and fourth are "read" positions, 0.5% and 0.25% flutter, respectively. The AUX OUTPUT is for a scope or mechanical recorder.

Use silver mica capacitors for all tank circuits. NOTE: Do not wire in C9, C10-a, C16, C17, C18, R9 or R21 until the instrument is ready for calibration. Be sure to plan to wire these parts in an easily accessible spot; they will have to be changed several times during calibration. C10-a may be mounted but not wired.

### Winding T2

Discriminator transformer T2 uses two Arnold A-254168-2 toroidal cores, wound as shown in Fig. 3. Be sure to use exactly the number of turns and size of wire specified, and place the windings exactly as shown.

The primary is 650 turns of No. 30 heavy Formvar magnet wire, with 5 turns around the secondary core for coupling. The secondary is two such windings (1,300 turns), placed as shown in Fig. 3, with the center tap made from the two adjacent winding ends.

Unless you have access to a toroidal coil winder, the easiest way to wind T2 is to make a shuttle from a 9-inch length of  $\frac{1}{4}$ -inch dowel with a slot cut in each end. Wind 85 turns of the wire around the shuttle, lengthwise, and dip each end into a bottle of service cement to keep the wire in place while winding.

Now wind the toroids by passing the shuttle through the center, once for each turn. The 85 turns on the shuttle will be enough for one 650-turn toroid winding.

When the windings are finished, wrap each completely wound core with plastic tape. Mount them one on top of the other with a  $\frac{1}{4}$ -inch insulating spacer between them. A strip of plastic or fiber can serve as a clamp with a long screw to fasten the completed transformer to the chassis (see photo).

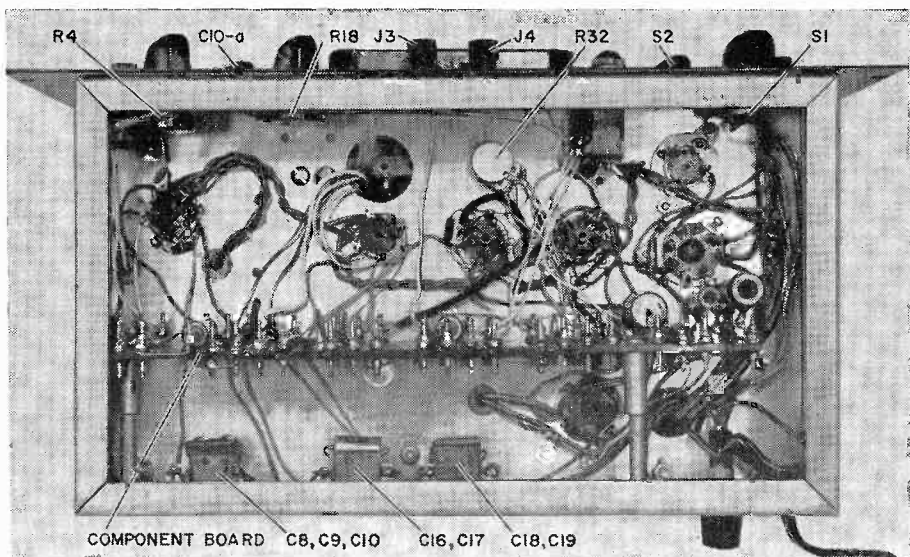

*Most of the components are wired on a terminal board, which makes wiring and servicing easier.*



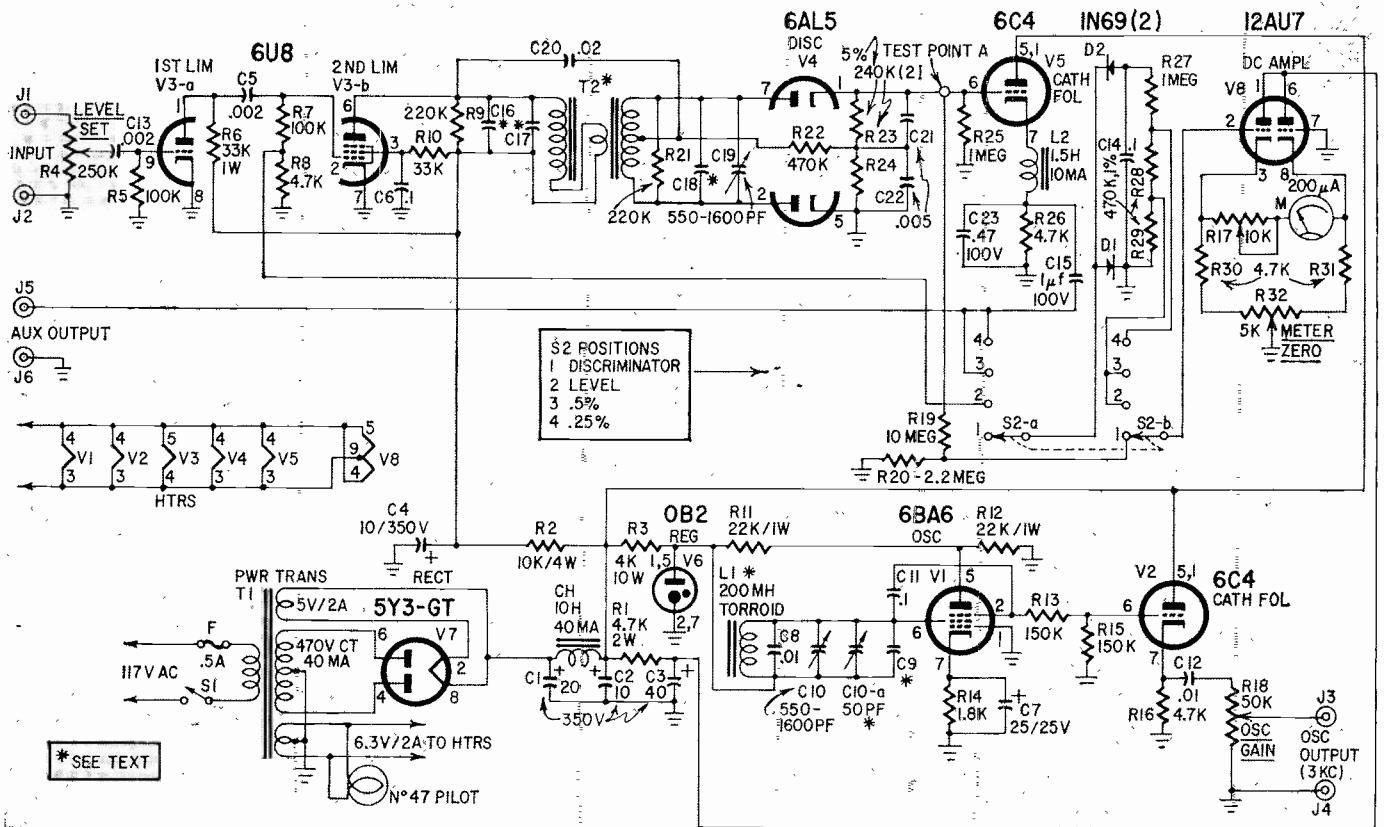

- C1—20  $\mu$ f, 350 v, electrolytic
- C2, C4—10  $\mu$ f, 350 v, electrolytic
- C3—40  $\mu$ f, 350 v, electrolytic
- (4-section electrolytic, 10-10-20-40  $\mu$ f, 350 v)
- C5, C13—.002  $\mu$ f, ceramic
- C6, C11, C14—.01  $\mu$ f, 200 v
- C7—25  $\mu$ f, 25 v, electrolytic
- C8—.01  $\mu$ f, silver mica
- C9, C16, C17, C18—see text
- C10, C19—trimmer, 550-1,600 pf (Elmenco 309 or equivalent)
- C10-a—50 pf, variable (see text)
- C12—.01  $\mu$ f, ceramic
- C15—.1  $\mu$ f, 100 v
- C20—.02  $\mu$ f, disc ceramic
- C21, C22—.005  $\mu$ f, disc ceramic
- C23—.47  $\mu$ f, 100 v
- CH—filter choke, 10 h, 40 ma
- D1, D2—1N69
- F—fuse, 1/2 a
- J1, J2, J3, J4, J5, J6—5-way binding posts
- L1—200-mh toroid inductor (Triad EK-200 or equivalent—order direct from Triad, 4055 Redwood Avenue, Venice, Calif., or your local Triad distributor)
- L2—1.5 h, 10 ma choke (Thoradson 26C40 or equivalent)
- M—0-200- $\mu$ a dc meter
- R1—4,700 ohms, 2 w
- R2—10,000 ohms, 4 w
- R3—4,000 ohms, 10 w
- R4—pot, 250,000 ohms
- R5, R7—100,000 ohms
- R6—33,000 ohms, 1 w
- R8, R16, R26, R30, R31—4,700 ohms
- R9, R21—220,000 ohms
- R10—33,000 ohms
- R11, R12—22,000 ohms, 1 w
- R13, R15—150,000 ohms
- R14—1,800 ohms
- R17—pot, 10,000 ohms
- R18—pot, 50,000 ohms
- R19—10 megohms
- R20—2.2 megohms
- R22—470,000 ohms
- R23, R24—240,000 ohms, 5%
- R25, R27—1 megohm
- R28, R29—470,000 ohms, 1%
- R32—pot, 5,000 ohms

- T1—power transformer: 470 vct, 40 ma; 5 v, 2 a; 6.3 v, 2 a (Stancor PC-8401 or equivalent)
- T2—see text
- V1—6BA6
- V2, V5—6C4
- V3—6U8
- V4—6AL5
- V6—0B2
- V7—5Y3-GT
- V8—12AU7

- Toroidal cores for T2—type A-254168-2, available from Arnold Engineering Co., PO Box G, Marengo, Ill., at \$1.30 each (2 required)
- No. 47 pilot light and fixture; chassis, cabinet to suit; No. 30 heavy Formvar magnet wire; sockets; miscellaneous hardware

Fig. 1—Complete circuit of the flutter meter.

### Calibration

This is not difficult, but does take patience. Time spent here will reward you with an accurate instrument.

The flutter meter is calibrated with 60-cycle ac line voltage and Lissajous figures. You will need a scope, an audio oscillator and a separate vtvm—the one in the flutter meter is not used except where specified.

The capacitor values used for calibration in this unit are given as starting points only. Each unit will use slightly different values. In the steps that follow, you may connect capacitors temporarily with clip leads until you determine the exact value.

Before you begin, zero the meter electrically by adjusting R32. Then disconnect one side of the meter to protect it during calibration.

### Oscillator precalibration

C9 is made up of paralleled capacitors chosen so that the 3-kc oscillator frequency may be varied from 2,980 to

3,020 cycles by tuning C10.

Allow at least 20 minutes for the instrument and test equipment to warm up. Use 60-cycle line sweep on the scope. Feed an audio oscillator to the scope's vertical input terminals and adjust it to exactly 600 cycles (10-to-1 Lissajous pattern). Now switch the scope to external-horizontal sweep and substitute the 600-cycle signal for the 60-cycle. Feed the 3-kc oscillator to the vertical input.

Adjust C10 to approximate mid-position, and add enough capacitance to resonate the 3-kc oscillator at 3 kc while still maintaining C10 at mid-position (about .014  $\mu$ f will be required).

When the 3-kc oscillator is tuned to exactly 3 kc, tune the audio oscillator to exactly 3 kc by using a 1-to-1 Lissajous figure. Mark this point carefully on the oscillator dial—you'll need it later.

Now check to see if you can tune C10 through the required frequency range. Using a 1-to-3 Lissajous with 60-cycle line sweep, set the audio generator to exactly 20 cycles. Remove the 60-

cycle sweep and substitute the 20-cycle. Feed the 3-kc signal to the vertical input and watch for Lissajous patterns at

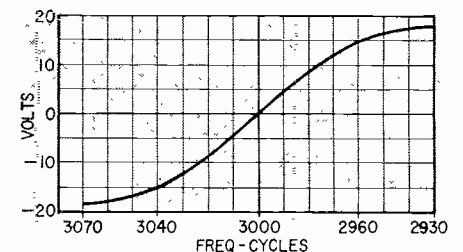

Fig. 2—Characteristic curve of discriminator in this flutter meter. Your curve should look as much like this as possible.

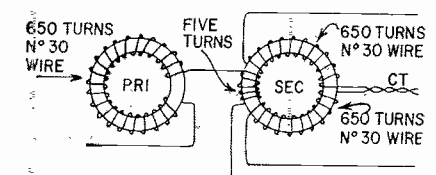
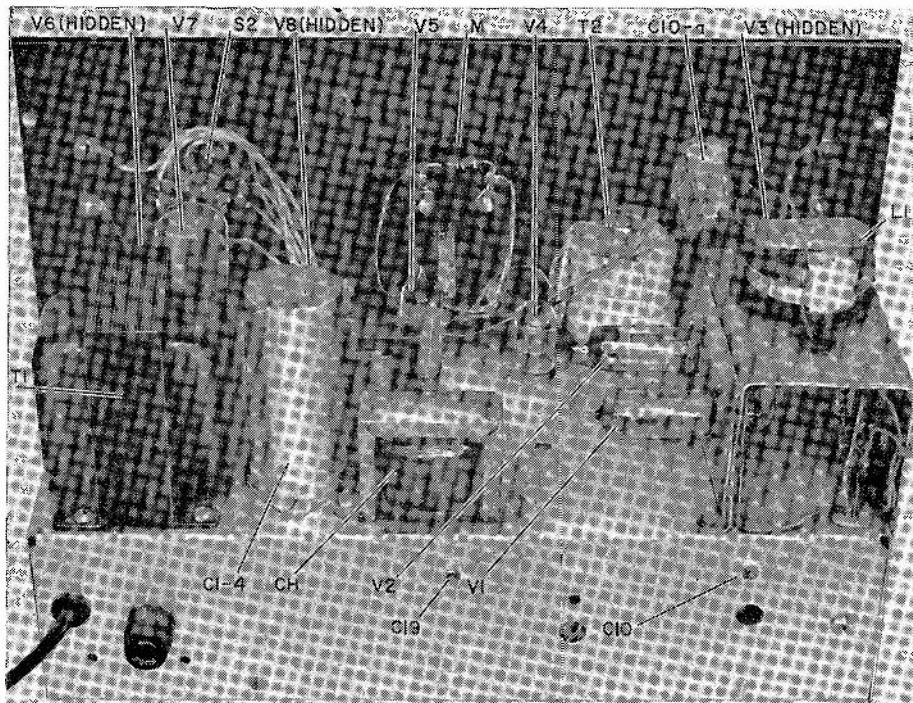

Fig. 3—Winding details of T2, discriminator transformer. It must be wound exactly as shown.



Rear view shows placement of major components. Layout has proved trouble-free.

2,980, 3,000 and 3,020 cycles. If you cannot get fixed patterns at those frequencies, you will have to change the value of C9.

#### Discriminator precalibration

The flutter meter power should be off for these next steps. Disconnect C20 from the center tap of T2. Insert about 500,000 ohms isolating resistance in series with the generator output lead, and set the generator to exactly 3 kc. Connect both the audio generator and the vtvm (set to an ac range) across T2's primary and add enough capacitance to tune it to resonance (C17) as indicated by a peak in meter reading. The value will be around .03  $\mu$ f.

Repeat the procedure for the secondary. This added capacitance makes up C18 and should be selected so that C19 remains near its mid-position at 3 kc.

Wire in R9 and R21, and reconnect C20 and the center tap of T2.

The final discriminator tuning consists of adjusting T2 so that discriminator output is zero at exactly 3 kc, and varies linearly above and below 3 kc as shown in Fig. 2. Set the audio signal generator to exactly 3 kc. Zero-center your vtvm and connect it between point A in Fig. 1 and ground. Feed the audio generator output to the flutter meter input (J1-J2). Turn the LEVEL SET control to maximum and the 3-kc OSC GAIN control to minimum. Adjust the signal generator output to about 2 volts.

Tune C19 for a null—zero-center reading on the (external) vtvm. When you tune the audio generator above and below 3 kc, the vtvm pointer must swing exactly the same amount positive and

negative. On my unit, the limits were 17 volts positive and negative. Adjust this by changing C16 as necessary.

Representative capacitance values are .0359  $\mu$ f for C16—made up of a .03, a .002 and a .0039 in parallel—and .0082 plus the variable for C18—.005, .0022 and .001  $\mu$ f in parallel (obtainable as a stock item in some types of capacitors).

#### Final calibration

Reconnect the flutter-meter vtvm circuit and allow the unit 30 minutes to warm up. Recalibrate the 3-kc oscillator to exactly 3 kc by using the 60-cycle line frequency as described earlier.

Set the signal generator to 20 cycles exactly, using Lissajous figures, and feed it to the horizontal input of the scope.

Turn the selector switch (S2) to LEVEL, the OSC GAIN control full clockwise (maximum) and the LEVEL SET control full counterclockwise (minimum). Connect the oscillator output to the instrument input, and connect a vtvm (ac range) from the junction of R7 and R8 to ground. Turn the LEVEL SET control clockwise until you read 0.4 volt on the ac vtvm. Mark this point on the panel and leave the control set at that position. This level assures full limiting.

Disconnect the external vtvm and leave everything else connected just as it is. Now connect the output of the internal 3-kc oscillator to the scope vertical input. Set the vtvm to dc and zero-center, and connect it to point A and ground. Adjust the discriminator (C19) for zero volts.

You should be able to get three Lissajous displays by tuning C10, at 2,980, 3,000 and 3,020 cycles. Record the voltage readings obtained at 2,980

and 3,020. Check again to be sure the oscillator is set at 3,000 cycles.

Use the voltage readings to calibrate the meter. Suppose you read 9 volts at each of the above extremes. This is 18 volts change for 40 cycles change, or 0.45 volt per cycle per second. A 0.5% flutter is a deviation of 15 cycles from 3,000 (i.e.,  $.005 \times 3,000$ ). In terms of voltage, this is  $0.45 \times 15$ , or 6.75 volts peak—4.77 volts rms. If now the full-scale reading of the flutter meter is adjusted for 4.77 volts, it would indicate a flutter of 0.5%.

Disconnect all leads and switch to the 0.5% range. Connect an ac vtvm across the output of the signal generator and adjust the generator to about 100 cycles. Feed the output of the generator to point A (Fig. 1) and adjust R17 until you get a full-scale deflection on the flutter-meter vtvm that agrees with the voltage calculated earlier (in the example, 4.77 volts, 0.5% flutter). Disconnect all test leads.

Switch S2 to the LEVEL position and connect the internal 3-kc oscillator output to the instrument's input. Turn the OSC GAIN control full clockwise and the LEVEL SET control to the position you marked earlier. Note the meter reading. This will be the voltage required to drive the instrument during actual tests. It might be wise to mark this voltage on the panel for easy reference.

Now wire discriminator zero-set capacitor C10-a across C10, and set C10-a to mid-position. Feed the 3-kc output to the input and set the LEVEL SET control for the correct amount of input signal. Switch S2 to the discriminator (DISC) position and adjust C10 for zero reading on the flutter-bridge vtvm. C10-a is now the oscillator control.

#### Using the meter

If a tape recorder you want to check for flutter has separate record and playback heads, feed the 3-kc signal to the recording input of the tape machine. The playback output goes to the flutter meter input. Set the LEVEL SET control for the correct input signal, switch the selector (S2) to the 0.5% range, and read percent flutter directly off the meter. Switch to the 0.25% scale if you can't read the percentage accurately.

In other cases, record the 3-kc signal on a piece of tape and play it back, reading flutter as before. Do the recording on the machine you want to test, to prevent speed differences from confusing the measurement. Flutter measured this way will be about twice as great as the figure obtained with simultaneous record/playback.

On most professional equipment, you can expect 0.1% to 0.15% with random excursions to 0.2% or 0.25%. Good home instruments will read about twice that, and cheap machines, between 0.5% and 1.2%. END

By HANS FANTEL

NEVER BEFORE HAS THERE BEEN SUCH a bewildering variety of tape types. Some tape recordists almost long for the days—not long gone—when one kind of tape was all you could buy. Yet each of today's tape categories is designed for specific applications. The problem is choosing the proper tape.

The first consideration is uninterrupted playing time. Nothing is sadder than the face of a tapester recording a once-in-a-lifetime event only to see his reel run out in the middle of it. The playing time of a reel of tape is determined by the tape thickness (more specifically, the thickness of the backing material to which the magnetic coating is applied). Standard thickness is 1.5 mils, and a standard 7-inch reel (1,200 feet) of such tape plays ½ hour at the standard speed of 7½ ips before it has to be flipped. To cram more uninterrupted playing time on a reel, tape thickness must be reduced. A 1-mil backing extends the playing time of a 7-inch reel to 45 minutes. Such tapes are known as extra-play tapes (1,800 feet). Further slimming to 0.5 mil produces double-play tape with a 1-hour run per reel at standard speed (2,400 feet).

Recently, 3-M introduced a triple-play tape (No. 290-36) which winds 3,600 feet on a 7-inch reel and permits 90 minutes of uninterrupted recording at 7½ ips. Presumably this tape is an outgrowth of 3-M's development work in tape cartridges. Slower recording speeds add time, but reduce frequency range and signal-to-noise ratio. At 3¾ ips, playing time is double the 7½-ips figure, and at 1⅞ ips it is double again.

Naturally, the thinner the backing, the more delicate the tape. It takes careful handling and a very gentle tape trans-

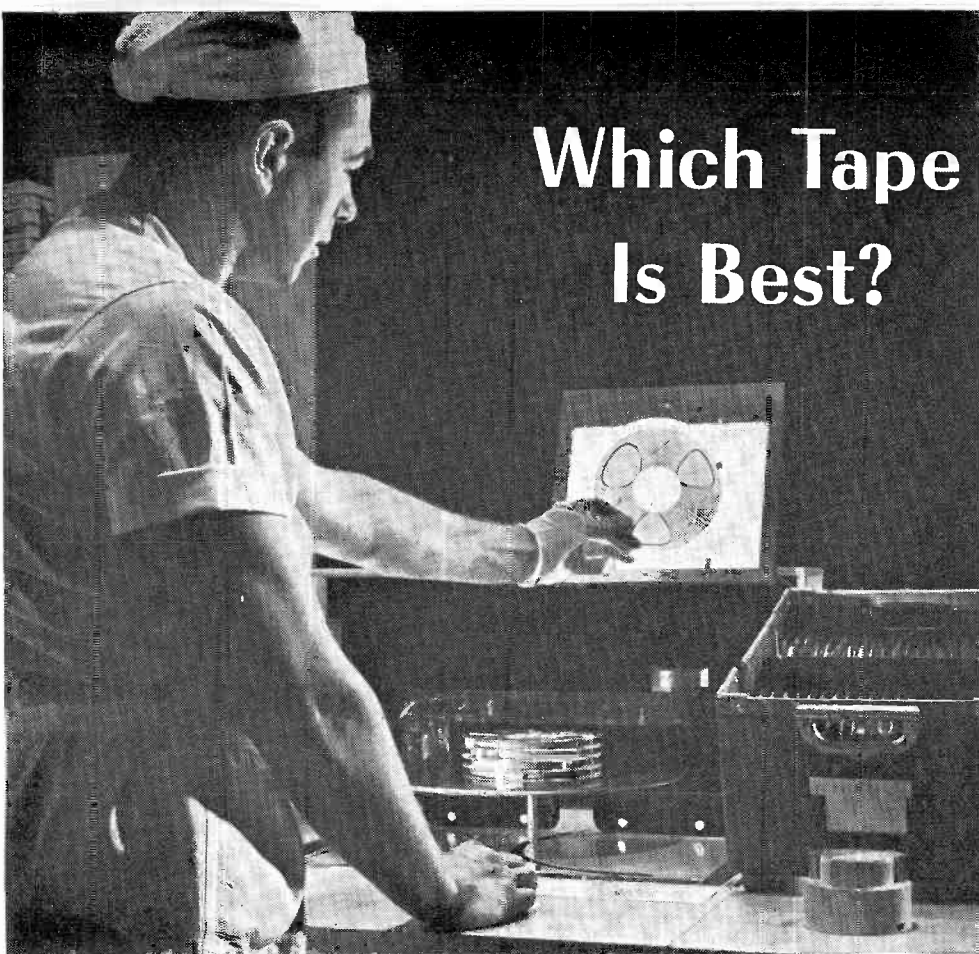

Kodak

*White-gloved worker inspects a reel of tape by transmitted light before packaging. Light shows up irregularities or foreign matter in winding.*

port mechanism to do back-and-forth editing on 0.5-mil tape without breaking or stretching. That's why professional users in general prefer the sturdiness of standard 1.5-mil tape, provided they can get sufficient playing time per reel for the job. Likewise, casual tape users with recorders that pull and jerk the tape had best stick with the standard thickness. Owners of battery-powered portable recorders often prefer thinner tape, for many of those small machines do not accept standard-size reels and the thin tape is necessary to extend recording time. Fortunately, battery-powered recorders operate at low tape tension so

there is less danger of damaging thin tape.

#### **Acetate vs Mylar**

Two principal types of material are used for the basic tape stock to which the oxide is applied: acetate and polyester—the latter commonly called Mylar, a trade name of Dupont, which pioneered its use. Both acetate and Mylar have staunch partisans, and their relative merits are always good for an argument. Mylar is almost twice as strong as acetate of the same thickness. Hence 0.5-mil Mylar and 1-mil acetate are about comparable in strength. But Mylar has a nasty habit of stretching like taffy before it breaks. If that happens, anything recorded on the stretched portion is ruined beyond repair. Acetate breaks clean, virtually without stretching, and the damaged tape can be spliced without losing any recorded program.

To overcome this drawback, Mylar makers came up with a special stretch-resistant "tensitized Mylar." It takes quite a tug to pull it out of shape, but during professional editing—rolling the tape back and forth for precise cuing—even tensitized Mylar might stretch. "I'd rather risk an acetate break I can patch than a Mylar stretch that would ruin an irreplaceable master tape," says Stewart Hegeman, the audio engineer and former chief engineer of Westminster Records.

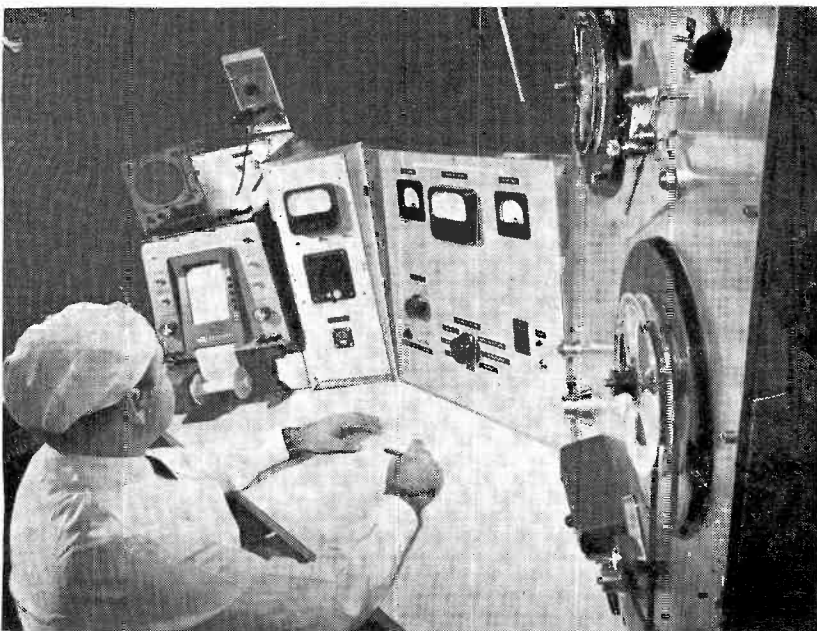

*Checking samples is a major part of quality control. Here, a Kodak engineer checks frequency response, distortion, noise, saturation and uniformity. Note surgical attire to help keep room (and tape) dust-free.*

Kodak

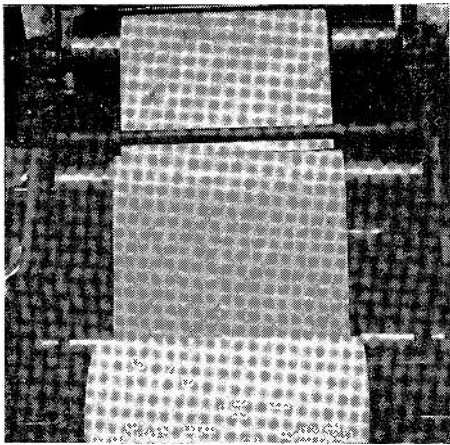

BASF

*Tape is made in wide sheets called "webs". After coating, webs are slit to proper width.*

Much has been done recently to improve the tensile strength of acetate. Kodak introduced a special acetate under the trade name Durol that combines the strength of Mylar with the low-stretch characteristics of other acetates.

Some professionals value the ability of Mylar to withstand changes in temperature and humidity that would seriously affect the performance of acetate tapes. Moreover, Mylar is impervious to age whereas acetate becomes brittle and stiff over the years as its plasticizer evaporates. For those who want to keep their recordings for years, the superior storage qualities of Mylar may well be the deciding factor. If in doubt whether a given reel is Mylar or acetate, hold the full reel against a strong light. Acetate is translucent; Mylar opaque.

A third type of tape material widely used in Germany, polyvinyl chloride (PVC), forms the basis of BASF tape (for Badische Aniline & Soda Fabrik AG, the German manufacturer), now being imported in this country. In addition to high strength and low stretch, PVC is extremely pliant and wraps itself closely around the record and playback heads, which contributes significantly to the smoothness of high-frequency response.

#### Special-purpose tapes

The next step is to pick among the magnetic characteristics of different tape types: all-purpose, high-output, low-print-through and special tapes with extended high-frequency response. Special-purpose are usually more expensive than all-purpose tapes, but certain situations may justify the investment.

For instance, during prolonged storage, a phenomenon known as print-through occurs between adjacent layers of tape on a reel. Loud passages, representing strong magnetic fields, imprint their images on the layers before and after the loud passage itself. Tapes with thin backing are especially susceptible to print-through because of the shorter

layer-to-layer distance. Where recorded material is to be preserved for years, low-print-through tape is worth the extra cost. The signal-to-print-through ratio of most all-purpose tapes is usually about 48–49 db. In low-print-through tapes it increases to about 53–54 db. BASF tape, however, claims a ratio as high as 58 db even on the all-purpose tape. Reduced print-through is usually achieved by coating a relatively thick base with a relatively thin layer of a special oxide formulation. Of course, print-through can be lessened on any tape by recording at lower levels so that volume peaks produce a weaker magnetic field.

In recording situations demanding utmost fidelity, so-called high-output tape offers an advantage. For instance, Kodak's new A304 produces double the output of standard tape, yielding 79-db signal-to-noise ratio as compared to standard values in the order of 50 db for all-purpose tapes. Another way to improve signal-to-noise ratios is to use tapes especially designed for a low background noise. For instance, 3-M's recently introduced No. 203 attains a 6-db gain in signal-to-noise ratio over all-purpose tape. Most low-noise varieties require a slightly stronger recording signal (about 2 db higher than standard tape) and some yield best results with a slight increase in bias current (about 15%).

Low-noise tape offers a particular advantage in multiple-mike recording. For instance, the loudness difference between a mike close to the orchestra and one positioned at the rear of the hall to pick up reverberation may be as high as 50 db. Unless the tape signal-to-noise ratio is greater than that, output from the distant mike is buried in the noise.

A number of firms, notably Reeves Soundcraft and Kodak, have lately put on the market tapes with extra fine-grain oxide layers to yield better high-frequency resolution. The improved high-frequency response of such tapes is especially noticeable when played with

narrow-gap playback heads. Less treble pre-emphasis is required, and the equalization of the recorder must be adjusted to the requirements of such tape. The lower pre-emphasis reduces background hiss and high-frequency distortion. Professional recorders have provisions for the equalization and bias adjustments required for special-purpose tapes. Unfortunately, such facilities are lacking on many home recorders.

#### Tape testing

Even the oxide on standard all-purpose tape varies somewhat between brands. A tape recorder with fixed bias and equalization may give better results with some brands than with others. One way to find out which sounds best on your recorder is to splice several lengths from various manufacturers and record the same test program on each. Then play back the composite reel to see if there is any difference between the sections. Watch for treble and bass response, hiss and distortion. (If all brands hiss considerably, chances are that your tape heads need demagnetizing.) Observe also the mechanical characteristics of the tapes. Do they pass over the head without binding or weaving up and down? Do they squeak or whistle as they run through the machine?

The answers to these questions are clues to other quality factors: dimensional constancy and lubrication. Uniform tape width is especially important in four-track operation. If uneven width causes the tape to weave up and down, the four tracks won't stay properly aligned with the head, resulting in crosstalk, poor signal-to-noise ratio, uneven output or even complete signal loss at times. (The track on full-track or half-track tapes is wide enough to be largely insensitive to such physical displacement.)

Tapes are permanently lubricated to increase their pliancy and give them good contact with the head surface. Such lubrication also keeps the tape from rubbing down the heads—an im-

*Full automation assures close tolerance in the German BASF tape plant.*

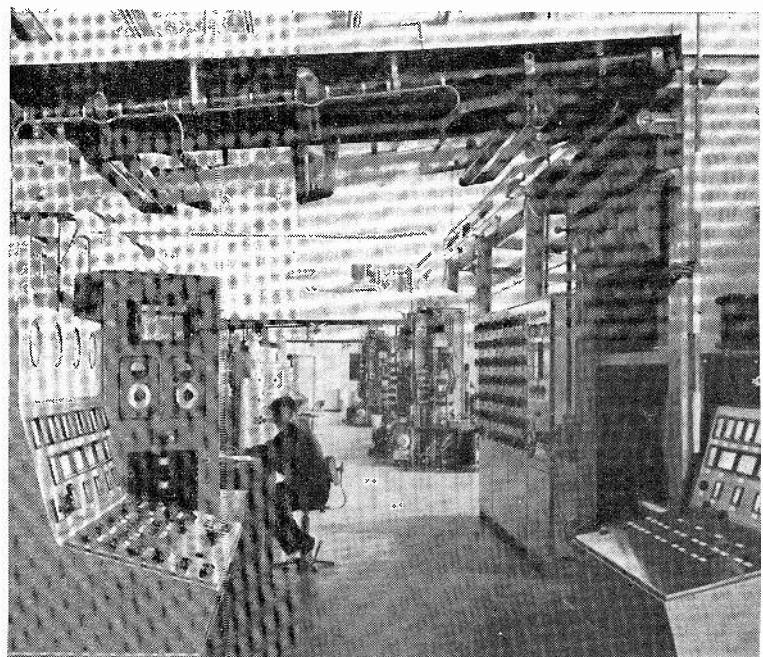

BASF

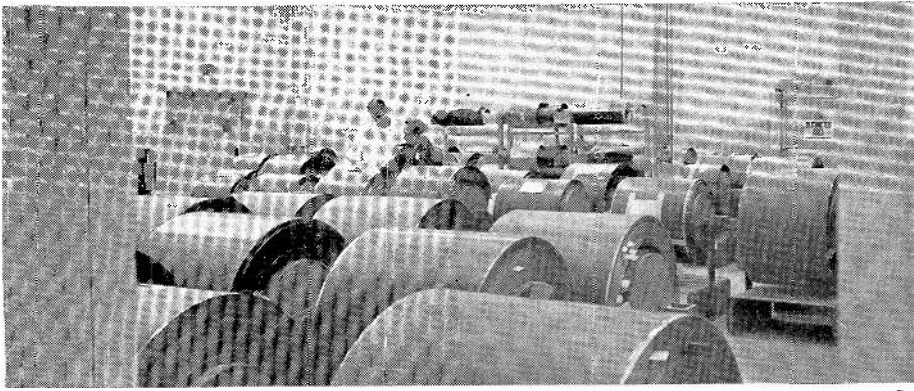

3M Co.

Large rolls of tape await slitting, winding and packaging.

portant factor with today's narrow-gap designs. If the tape squeals as it runs across the head, it is a sign of improper lubrication. Well lubricated tape also sounds cleaner because it moves across the head more smoothly.

Another important difference between brands lies in the adhesion of the oxide layer to the base. Any tape that sheds excessive amounts of oxide powder will soon clog the head gaps and impair performance. If you must clean your recorder heads after every two or three reels, choose another brand.

Some recording engineers complain about sizable variations in performance of a given tape brand and type from year to year. This is largely a matter of quality control, an expensive item in the overall cost of tape manufacturing. Most manufacturers are reluctant to discuss details, but E. O. Welker, marketing manager for RCA Victor tape, points out that no less than 100 quality checks are performed at the RCA tape plant in Indianapolis between raw-material testing and final inspection. Kodak explains that making photographic film is essentially similar to manufacturing recording tape and that the noted quality of Kodak tape is directly attributable to that company's long experience in the photographic field.

Some firms offer various grades of tape. RCA, for instance, sells tape that does not meet the exacting standards of Red Seal tape as the lower-priced "RCA Vibrant Series." While falling short of the most critical professional standards, these "second-line" tapes still satisfy the demands of most users.

### Bargain tapes

This brings up the controversial issue of bargain tapes. Since name-brand tapes are priced competitively, there are no "bargains" in that group. But if budget buying is more important to you than assured top results, investigate the house-brand tapes sold by some of the larger electronics supply firms at below-standard prices. House-brand tapes from reputable sources are usually good. Often they are name-brand rejects that failed to meet tight specifications but

may be undistinguishable in practical use from the name product. Frequently the only difference lies in greater variability of performance between one reel and another. Unless you do professional editing, splicing together "takes" from different reels, this is no major drawback.

Another source of house-brand tape is reject computer and instrumentation tape with minor faults unlikely to show up in the less critical audio applications. Some instrumentation tape, for instance, may have fallen short of the required 0.5-mc frequency range. Since audio requirements extend only to 15 kc, such tape would still be fine for home use. Computer tape, however, is usually optimized for high frequencies (to accommodate the rapid pulse sequence of computers) and its bass response may be poor.

Cheapest of all is so-called white-box tape, sold in unmarked boxes. With luck, good tape can be found in those nameless boxes. More likely, you'll wind up with reject TV tape, the most prolific source of white-box stock. This has some serious disadvantages.

For one thing, unlike audio tape, video tape has vertical particle orientation in the oxide layer. This reduces signal-to-noise ratio when used in audio recorders. Also, since TV tape is 2 inches wide, it must be slit to 1/4-inch width before being sold for audio use. Often the reject processors are quite lax about slitting tolerances, making the tape erratic in width and likely to weave up and down over the recording heads. (Quality tape is usually held to constant width within  $\pm 0.002$  inch). Finally, TV tape is not designed for flat audio response. It peaks on highs and its relatively thin coating restricts the dynamic range, causing magnetic saturation and distortion at loud passages.

Not all white-box tapes are rejects. Some are specifically made to sell cheaply. Though the rejects are erratic, these tapes are simply consistently inferior, clearly showing the marks of hurried processing (inadequate oxide milling time and slapdash coating) in terms of poor frequency response, high

noise level and mechanical difficulties. Perhaps their most troublesome defect is dropout—complete momentary signal failure because of uneven coating.

Some commercial studios use bargain tapes for economy. They usually specialize in making air checks for casual customers who simply don't care about fidelity. But such studios usually run a simultaneous safety recording on standard-brand tape. Should the bargain reel turn out defective, they have the standard tape to fall back on. Otherwise, they re-use it as a safety for the next job.

### General trends

Except for the bargain-basement trade, the general trend in the tape industry today is toward upgrading of quality. According to C. J. LeBel, vice president of Audio Devices, Inc., the makers of Audiotape, the impetus came from the more stringent quality requirements for computer and instrumentation tape. New production techniques developed to satisfy these demands have spilled over into the production of audio tape. Says LeBel: "Milling procedures, coating temperature, flow rate of the coating material, the rate of ribbon motion—all these affect the performance of the final product. Increasing process automation now enables us to keep tighter tolerances on all these factors than was possible with human control. The net result is greater consistency in frequency response, output and noise level in every type of tape." END

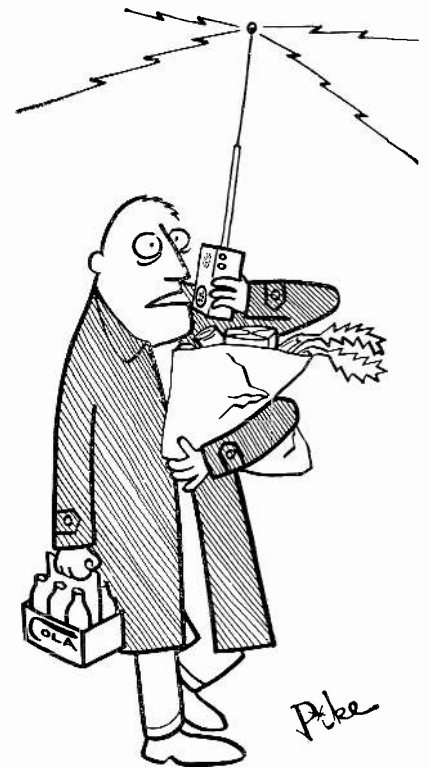

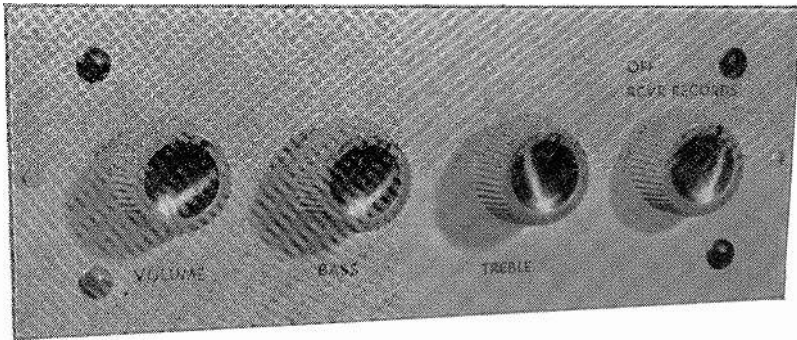

# Quiet, Please...!

Transistor preamp is a simple step to hissless, humless music

By DON V. R. DRENNER

OUR AMPLIFIER-SPEAKER COMBINATION has some sort of a record, for an engineer's, having been in almost daily use for four years without a single revision. We've been happy with the "Copy-Cat" amplifier (RADIO-ELECTRONICS, September 1957) and the Karlson enclosure—with a WE 728-B speaker—ever since.

The preamp for our VR-II cartridge, however, has long been a problem: HUM. To solve this, we've tried everything in all the books. The only solution has been to turn the thing off!

But the transistor preamp described here *does* offer absolute hum-free operation and while its behavior is different from the four-tube preamp we've always used, there are no problems you can't solve by using your ears. This preamp proves a point we've shouted about before—that bench testing and laboratory curves mean nothing unless the sound pleases your ears.

This preamp resulted from a few preconceived notions of what a preamp should be. Based on ideas other than our own (owing a great debt to G-E's transistor manual) but including a few tricks tried out with it as the front end of our amplifier, it is a neat package of quietness.

A glance at the photo will show what appears to be a printed-circuit board. Actually this is a 3/32 inch-thick phenolic board with small brass eyelets swaged into it as mounting holes for all components except the transistors. The resistors and capacitors are

R1—25,000 ohms\*  
R2, R7—100 ohms\*  
R3—1,500 ohms  
R4—6,800 ohms  
R5—500,000 ohms\* (see text)  
R6—8,900 ohms\*  
R8—3,300 ohms  
R9—pot, 5,000 ohms  
R10, R13—pot, 50,000 ohms  
R11—1,000 ohms  
R12—10,000 ohms  
R14—35,000 ohms\*  
R15—10,000 ohms\*  
R16—4,700 ohms  
R17—5,600 ohms\*  
R18—1,000 ohms\*  
Resistors marked \* are 1% metal film or deposited-carbon types (low noise).  
C1—25  $\mu$ f, 6 volts, electrolytic  
C2, C12—25  $\mu$ f, 25 volts, electrolytic

inserted into the eyelets, their leads clipped on the underside, a drop of solder used to anchor them securely. Then, No. 22 wire, mostly bare, is used to join each component by wiring from eyelet to eyelet to form the circuit. The result is a neat-appearing construction job that can be laid out almost exactly like the schematic.

The circuit (Fig. 1) was evolved from several sources, but seems to be basic. This is partly because transistors—like vacuum tubes—can be connected in only a few basic ways, and everybody has to remember about thermal runaway, beta and h-parameters. So the basic preamp, comprising the first two transistors, does what all preamps do: increases the signal level from the pickup and provides frequency compensation. The feedback frequency from collector to emitter does not follow exactly the recommended values for RIAA compensation, but this, again, is a matter of ears. If you want the real thing, the "true" values shown in Fig. 2 are for you. In our case, despite what the meter said when we ran a frequency

check, the increase in the bass turnover frequency *sounded* better.

The third transistor is an emitter follower. It isolates the input stages from loading effects and provides a low-impedance source for the tone controls.

All this is pretty conventional—as are the bass and treble control circuits—but the whole thing derived from a few trial-and-error gimmicks that made the results a little different. There is pretty terrific gain, even after the tone control circuits, so that the output stage had to be provided with both high- and low-level connections. Which you use will depend upon how much it takes to drive your main amplifier. If the output

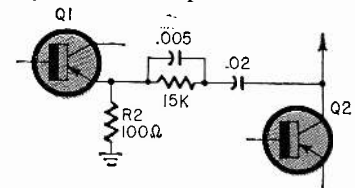
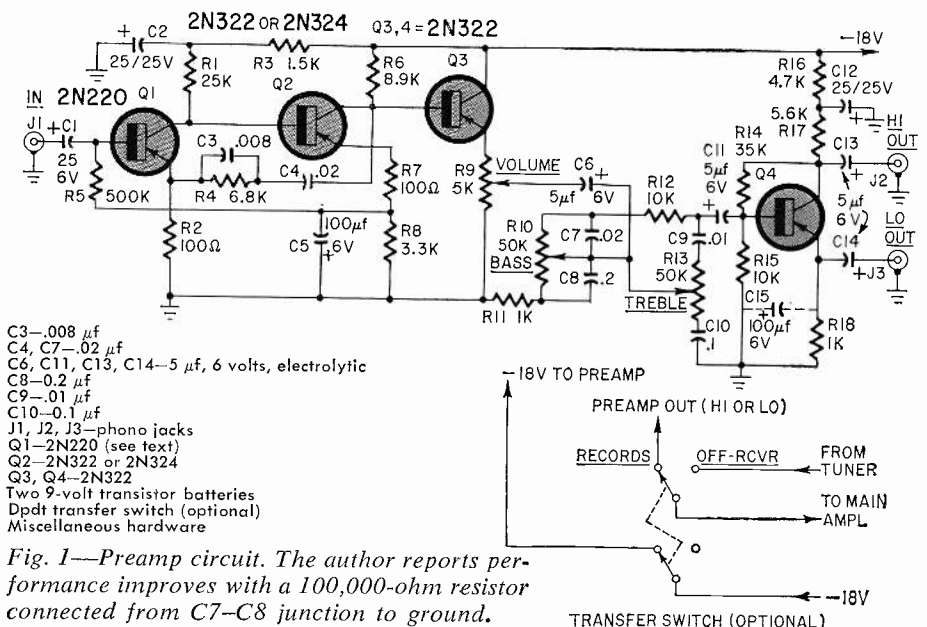

Fig. 2—RIAA equalization values. Values given in Fig. 1 and parts list are for author's preferred equalization, not RIAA. See text for details.



is taken from the collector, the dotted-in 100- $\mu$ f emitter bypass capacitor should be used. We used the emitter for the output, and the 1,000-ohm emitter bias resistor is used alone.

The brass eyelets used as connecting points are made by General Cement and are available from most radio parts stores. They come in various sizes, but the ones we used are 5/32 inch long and .085 inch in diameter. This small size allows three leads or wires to be inserted with ease, and provides a securely soldered connection. Small holes are drilled to provide a snug fit for the eyelet, and they are then swaged, or spread, with center punch and hammer.

The mounting board measures 2½ x 7 inches, and was laid out and drilled in a pattern that followed the schematic. We used transistor sockets, but the transistors could just as well be soldered to the eyelets if the leads are left long. If, after mounting a few components, you find you need an extra eyelet, the brass is soft and easily spread. So extra or additional parts can be mounted without damaging those already mounted.

You will note from the photo that the three controls and the off/on-transfer switch are not mounted directly on the phenolic board, but attached to a small subpanel. The front panel, sub-panel and mounting board are held together by metal spacers. Front-panel size (ours is 3 x 8 inches) and spacing are a matter of convenience, really, and anything you have in the junkbox will do. Our completed unit measures 3 x 3 x 8 inches, and fits nicely into a small cutout in the front of our wall-mounted amplifier system. I tried various transistors and the 2N220 worked best. If you have on hand a 2N508 or some of the Workman 99 series, they work fine with only a slight increase in noise level. The base-bias resistor for the input stage, R5, is adjusted for between 0.5–0.6 ma of emitter current. With the values shown, you should have (measured with a vtvm) 2.8 volts between collector and emitter of the 2N220, .06 volts between emitter and ground, and 2 volts between collector and base. The output stage should measure 5 volts between collector and emitter with 1 ma emitter current.

Output voltage at LO OUT is 0.25 rms using a G-E VR-II cartridge and a Columbia ZRD431-1A Standard Characteristic Recording. Output at HI OUT under the same conditions should be greater than 1 volt and can be increased by increasing R14.

The equalizer network can be adjusted to suit your needs (despite the purists). While the tone controls do give some flexibility, we like a lot of bass at normal listening levels, and the values

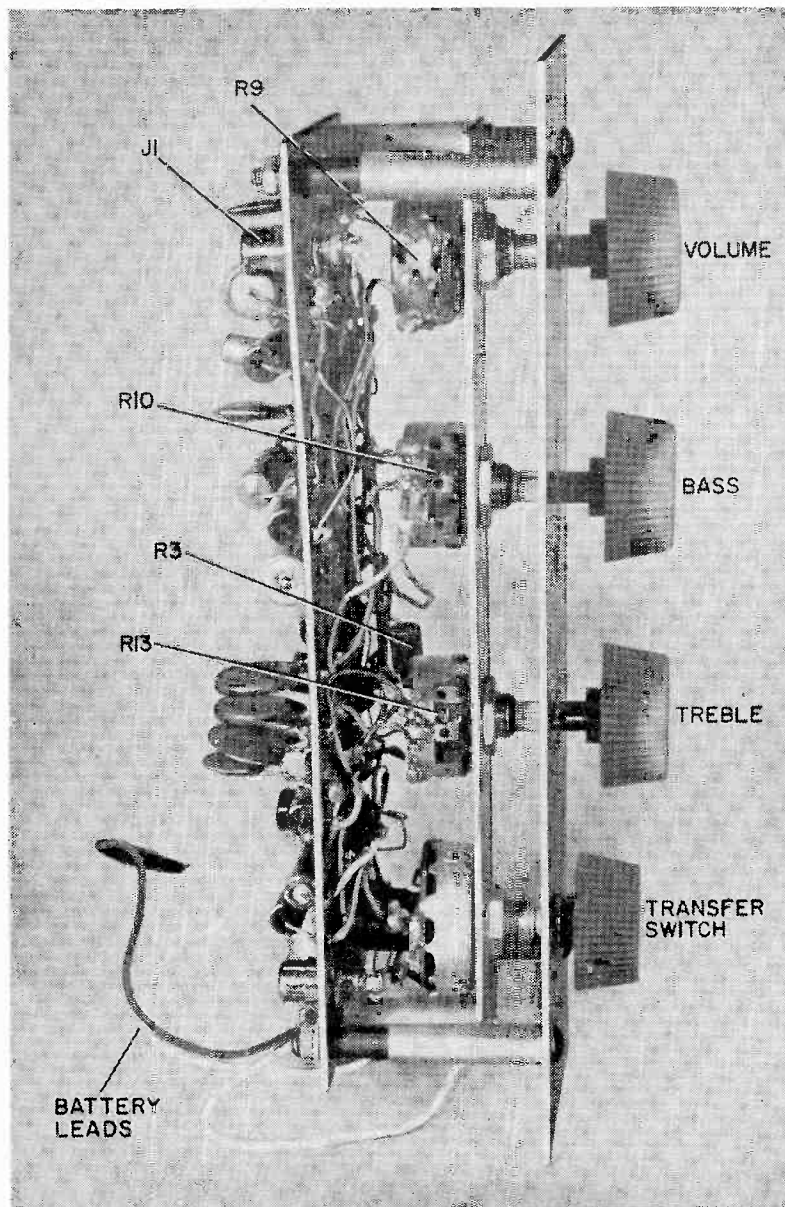

Bottom view of preamp.

shown in Fig. 1 please our ears! We measured the bass boost (about 20 db) with the treble control at "flat" and we like it that way *when we listen*, refusing

to be influenced by what we measured. The power supply is two 9-volt batteries connected in series. Total drain is 5 ma. END

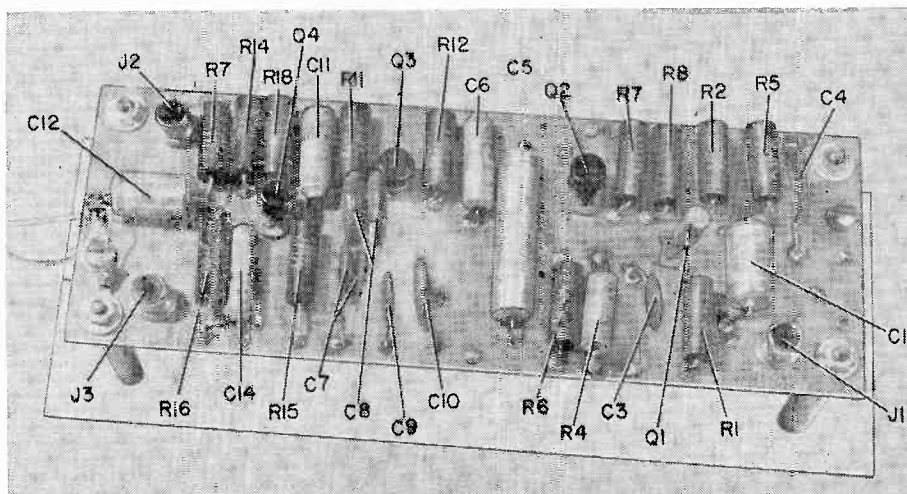

Preamp's "chassis"—phenolic board with eyelets swaged into it.

# BETTER STEREO REPRODUCTION WITH 15° STYLUS



## Tracking distortion in the vertical direction and how it can be avoided

A NEW POSSIBLE SOURCE OF DISTORTION in stereo phonograph record reproduction has received considerable attention recently—distortion due to the stylus-groove relationship. Record and equipment manufacturers, as well as stereo-ophiles, strive to free sound reproduction from distortion entirely. They diligently search out and correct any fault that stands in the way of this goal. The proposed RIAA (Recording Industries Association of America) standard of 15° vertical tracking angle is now the subject of lively controversy. A clear understanding of the mechanics of disc playback will help, not only to comprehend what the manufacturers are doing, but also to determine what you may do to improve sound in your playback equipment.

### Forms of distortion

Distortion in disc record playback is caused primarily by *tracing* and *tracking* errors. Obviously there could be many sources of distortion in other parts of the complete playback system but these two, due to the physical relationship of the playback stylus to the groove, are the most important.

**Tracing distortion** occurs because recordings are cut with a chisel-shaped stylus and played back with one that is spherical (Fig. 1). This spherical stylus cannot trace precisely the minute undulations cut by the chisel. Two conditions aggravate this misfit: recording at high level, and the slow groove speed at the inside diameters. It is possible for any normal cutter to cut angles, especially at high frequencies, which are actually less than the dimensions of the playback stylus.

Part of this distortion is called **pinch effect**. This occurs because the cutting stylus, in moving from side to

\*International Electroacoustics, Inc.

side to cut a groove in the record, actually produces a groove of varying width (Fig. 2). When this groove is played back, the playback stylus is actually forced to move up and down; up when the groove gets narrower and down when the groove gets wider. Since stereo cartridges have vertical as well as lateral response, this undesirable motion produces second-harmonic distortion in the

the pickup stylus not being able to get out of the record what the cutter put into it) is what causes records to sound duller at the inner diameters than they do at the outside. Along with the missing high frequencies there will, of course, be other distortion due to the bumping along of the stylus. Here again a smaller tip helps reduce the trouble.

These extremely small tip radii have two disadvantages: first, the tendency of a small tip to ride down into the bottom of the groove during high-level modulation when the groove is wide and deep; second, the extreme pressures that occur with the low contact area of the small tips. Unless the stylus force is held down to a gram or less, the record material will be destroyed.

### Our Cover

A recording lathe at the International Recording Co. in New York City, is being operated by Claude Rie. The equipment uses a stylus at the 15° angle, and the efficiency of the recording head is increased by removing heat from the coils with helium taken from the tank at the left (hoses may be seen on the cutting head). By cooling the coils as originally suggested by George Neumann of Germany, larger currents can be carried, and therefore more power applied to the cutter.

### Attacks on the problem

Two approaches have been recently advocated by different companies to try to eliminate tracing distortion. Ortofon has attacked the problem directly by introducing an elliptical-shaped playback stylus (Fig. 3). Since the elliptical stylus has essentially the same shape as the cutting stylus, it traces the actual groove path more closely. The ellipse maintains the same tangential contact with the groove walls as the side of the cutting stylus did while cutting the groove. The approximate dimensions of the elliptical tip are 0.7 mil for the major axis and 0.3 mil for the minor.

A more indirect approach is advocated by RCA. Here the signal fed into the cutting head is predistorted. What is actually engraved on the disc—in terms of present-day techniques—is a distorted signal but distorted in exactly the opposite way that tracing error distorts the signal during playback. When the predistortion on the record and the

cartridge output. This is because the groove undergoes this narrowing and widening twice each cycle of recorded sound. A smaller-radius playback stylus helps reduce this distortion. Hence the recent change from the standard 1-mil LP stylus to 0.7 and now 0.5 and even smaller radii.

Inner-groove distortion occurs when frequencies are high and modulation heavy. The angles engraved by the cutter are so sharp that a spherical stylus cannot maintain continuous contact with both sides of the groove. The stylus simply rides along over these high frequency tracks and does not reproduce them. This *translation loss* (loss due to

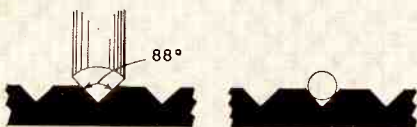

Fig. 1—How cutting and playback styli differ.

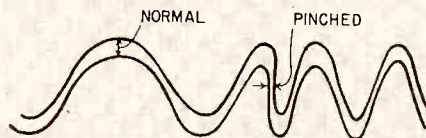

Fig. 2—Pinch effect will distort high frequencies.

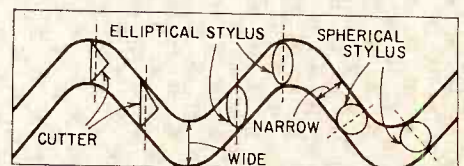
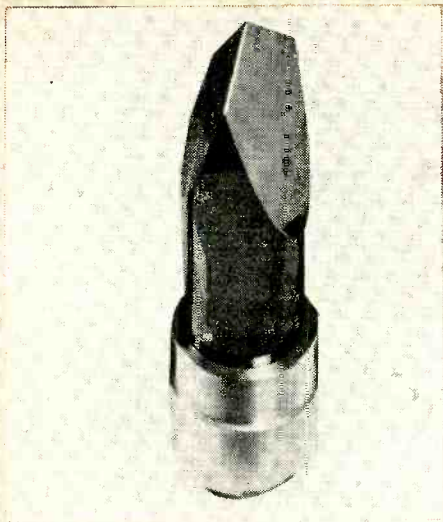

Fig. 3—Elliptical stylus reduces pinch effect.





This CBS Labs stylus is designed to cut at the 15° angle.

opposite tracing distortion of the playback are combined, the two cancel and distortion is reduced. This description is, of course, for an ideal system—one that takes into account simultaneously such factors as the complex frequency of the recorded signal and the instantaneous amplitude, velocity and acceleration of the cutting stylus as well as the radius at which the record is being cut. Such a device would be extremely sophisticated and built along the lines of a computer. Present-day devices certainly take some of these factors into account, but are still far from perfection.

**Tracking-error distortion** is much simpler to understand and correct. It occurs when the playback stylus does not move in the same direction that the cutting stylus did when engraving the record. In cutting laterally (the standard monophonic system), the recording stylus moves in a plane perpendicular to the surface of the record and along a radius of the record. The playback stylus should also move in the same direction in order not to introduce tracking distortion. Stylus motion of virtually all high-quality playback cartridges is identical to that of a cutting stylus, but since most playback arms are pivoted, the playback tip actually moves in an

arc across the record rather than in a straight line along a radius. This is the primary source of tracking distortion in lateral records.

If the playback arm were short and straight, the arc would have a radius equal to the arm length and be tangent to a radius of the record at only one point during playback. At this point the playback stylus moves along the same line that the cutting stylus did and the tracking distortion would approach zero. To overcome this fault, the head of most arms is bent at an angle toward the center of the record to give an effective radius much longer than the distance from the arm pivot to the stylus. Therefore the stylus moves across the record along a more nearly straight line and the lateral tracking distortion is considerably reduced.

In stereo records where the cutting stylus moves *both laterally and vertically*, a similar situation exists. It is generally assumed that the vertical modulation is produced by a direct up and down motion of the cutting stylus. This is not the case. It was learned very early that it would not be easy to build a playback cartridge in which the stylus moved in such a manner.

#### The stylus angle

When the Westrex stereo disc cutting head (Fig. 4) was designed, the stylus motion had a 23° angle leading the vertical. The 10 A stereo playback cartridge that Westrex manufactured in 1958 also included this 23° angle. Westrex recommended to all pickup manufacturers that this angle be included in the cartridge design. In Europe the direct vertical system was attempted and most European cutters are designed with the 0° system. Cartridge manufacturers in America attempted to follow the 23° design but many cartridges vary from close to 0° to almost 40°.

The whole question of vertical tracking angle in stereophonic records has gained much publicity in the past year from work done by B. B. Bauer at CBS Laboratories. In producing test records, he discovered that the assumption that the Westrex cutter was actu-

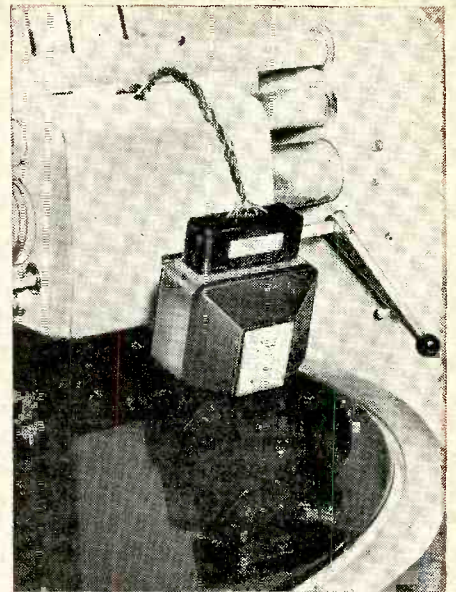

The Ortofon DSS601, an example of a modern stereo cutting head.

ally cutting vertical modulation at an angle of 23° was incorrect. It had been taken for granted that the modulation on the disc was cut at the same angle as the theoretical stylus motion. Bauer determined that actually the angle of the modulation cut into the record was very close to 0°.

Since the Westrex cutter has been used to cut the vast majority of stereo records available in America, Bauer's discovery shows that cartridges designed for 23° and higher were actually introducing considerable vertical tracking error when playing back these records. Tracking distortion is the result of this error. Many people feel that today's stereo records sound quite good as they are and that this tracking-angle error distortion must therefore be small. The distortion is at its maximum when the recorded level is very high and therefore may well be hidden by more overwhelming sources of distortion in other parts of the playback equipment. The distortion is also most apparent at the inner diameters and can easily be heard on organ and choral recordings, which are very susceptible to inter-modulation distortion.

Since this tracking-error distortion occurs only during vertical modulation, it may be best to take a look at what causes this modulation. The amount of vertical modulation in the record is determined by the *difference* signal, that is, how much the sound of the right channel differs from the left channel. As this difference becomes less, the vertical modulation becomes less, and if the difference becomes zero, the vertical modulation is zero and we have a standard monophonic record. In high-quality symphonic stereo recordings where true stereophony is desired, there is very little difference signal and a low

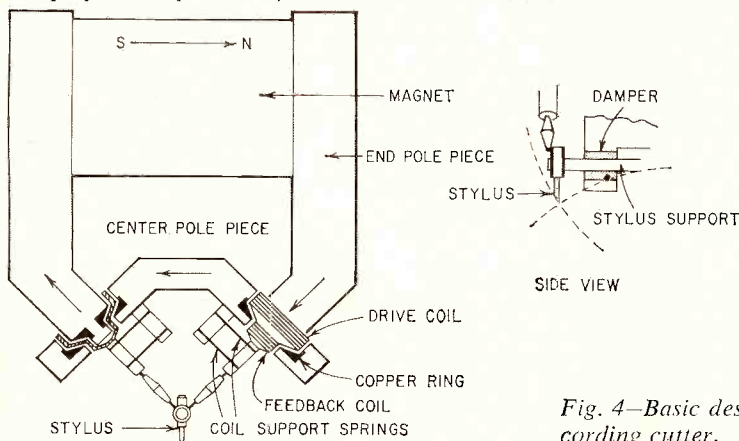

Fig. 4—Basic design of stereo recording cutter.

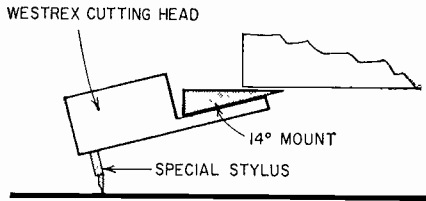

Fig. 5—Cutter modified for a 15° angle. Original cutter has approximate 1° tilt, hence the 14° mount.

level of vertical modulation. In trick recordings with exaggerated separation and so-called "ping-pong effects," the vertical modulation can be heavy and the tracking distortion quite severe.

In analyzing this difference between cutter angle and the resultant modulation angle, Bauer determined that the cutting stylus and its mounting were not perfectly stiff but would bend elastically and the precise motion of the cutter head was not transferred to the disc intact. This stylus elasticity accounts for about 40% of the discrepancy in the angle. The remaining 60% is caused by elasticity or *springback* in the lacquer coating of the master recording disc. The cutting stylus actually pushes some of the material of the lacquer as well as cutting it. After the stylus has passed this point in the record, the pushed part of the material springs back to its original position.

Since the 23° cutter produces modulation at approximately 0°, it would seem logical that a 0° standard should be accepted. There are two good reasons against it. Many thousands of magnetic playback cartridges in use today have angles in the range of 20° to 30° and many more ceramic types have vertical tracking angles very close to 15°. The second reason—brought out by Bauer more recently—is that it is actually possible to cut a higher level on the record with an angle greater than 0°.

These two reasons combined have led the RIAA to accept as a recommended standard a vertical tracking angle of 15°. It is therefore necessary to tilt the recording head approximately 15°, to produce modulation with a tilt of 15° in the recording being cut. It is, of course, necessary to use a special stylus in the cutter. This special stylus, introduced by CBS Laboratories, has its cutting face tilted this same 15° from the vertical (Fig. 5). In the case of European cut-

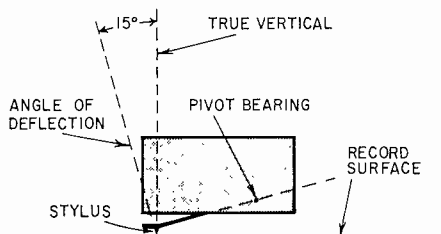

Fig. 6—What is meant by the 15° effective tracking angle.

ters it has been determined that even though they were designed for a 0° vertical tracking angle, the resultant modulation in the disc was actually less than zero (a negative angle) and therefore they also must be tilted to produce a 15° modulation slant in the record.

### The present situation

Most US recording companies have modified their stereo disc-cutting systems to agree with the RIAA recommended standard of 15°. It is, of course, desirable to have the playback stylus track exactly the same angle as the cutting stylus, but unfortunately there is very little that anyone can do to an existing playback cartridge to change its vertical tracking angle. The cantilever systems which hold the stylus and transfer its motion to the generating elements in the cartridge are extremely delicate and any attempt to bend one of these would more than likely result in total destruction.

Furthermore, it is extremely difficult to determine precisely at what angle any playback cartridge is actually tracking. The simplest method—actually quite complex—requires at the least, an intermodulation distortion meter and a test record that has been cut at varying vertical tracking angles. To measure the angle, it is necessary to play each band of the record and measure the intermodulation distortion produced at the various angles. The angle of the cut that produces the least amount would be the approximate tracking angle of the playback cartridge. If any change were made by bending the stylus assembly, it would be necessary to repeat this test to determine whether the stylus had been bent the proper amount. If by chance an angle closer to 15° were achieved, it would then be necessary to check all other specifications of the cartridge to be sure that frequency response, channel separation and compliance had not been altered. With modern sophisticated cartridges, it is difficult even for manufacturers with usually unlimited equipment to check these specifications.

Today most cartridge manufacturers have introduced or will soon introduce new models incorporating this change to 15° (Fig. 6). There have been many pro and con arguments, primarily based on whether the improvement is significant. Certainly the reduction of distortion will not show up on all records. Some of them will have sufficient distortion from other sources to overshadow the improvement gained by correcting the tracking angle. Nevertheless, total overall quality of your playback system is the sum of the quality of each individual part. Any improvement, however small, is another step toward achieving the goal of distortion-free sound reproduction. **END**

## How Long Will Your Tape Play?

By STEVE P. DOW

THE NORESCO 401 STEREO RECORDER has introduced to the audiophile the new extra-slow tape speed of  $\frac{15}{16}$  inches per second. Greentree Electronics, manufacturers of American brand tape, have introduced four new tape footages on 7-inch reels: 1,500, 2,000, 3,000 and 3,600 feet. Hence it's time to bring tape time charts up to date.

Below is a complete table showing playing time in minutes for every speed and reel size in current use on home recorders.

Tape Time Table					
Feet	Tape Speed—Inches Per Second				
	$\frac{15}{16}$	$\frac{17}{8}$	$3\frac{3}{4}$	$7\frac{1}{2}$	15
150	32	16	8	4	2
225	48	24	12	6	3
300	64	32	16	8	4
600	128	64	32	16	8
900	192	96	48	24	12
1,200	256	128	64	32	16
1,500	320	160	80	40	20
1,800	384	192	96	48	24
2,000	426	213	106	53	27
2,400	512	256	128	64	32
3,000	640	320	160	80	40
3,600	768	384	192	96	48

Time in minutes, calculated to nearest whole minute, 1 direction, 1 track only.  
 For total mono time on 4-track recorders, multiply time by 4.  
 For total mono time on 2-track recorders, multiply time by 2.  
 For total stereo time on 4-track recorders, multiply time by 2.  
 For total stereo time on 2-track recorders, use given figures.

### Tape Recorders Limited In California Classrooms

An addition to the California Education Code provides that "it shall be unlawful for anyone, including a student, to use without the prior consent of the teacher and the principal of the school having been obtained any electronic listening or recording device in any class of any public school of the state."

The law arose out of abuse of tape recording as a means of harassing teachers, but many in the tape industry feel that it will reduce the use of tape recorders for educational purposes for students, a practice which is becoming common in colleges and junior colleges. The red tape required to use a recorder, dealers feel, is likely to discourage the student from attempting to use a recorder in the classroom.

# CHECKING OUT TAPE RECORDERS

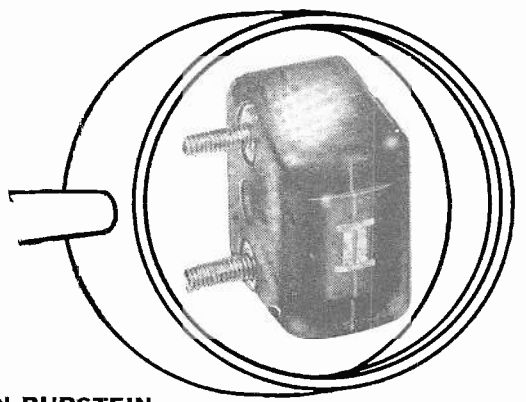

What you need, what to look for. Frequency response, signal-to-noise, equalization, speed

By HERMAN BURSTEIN

PERFORMANCE CHECKS OF TAPE RECORDERS include the vital factors of frequency response, distortion and signal-to-noise ratio. Equalization, bias current and azimuth alignment intertwine with the question of frequency response. Bias current also bears on distortion. If erasure appears inadequate, check oscillator current through the erase head. And check tape motion: accuracy and steadiness of speed (wow and flutter).

For these measurements, you will need at least an ac vtvm virtually flat from 20 to 100,000 cycles and with a full-scale range to 30 mv; audio generator operating from 20 to 100,000 cycles, with less than 0.5% distortion; a harmonic-distortion meter; a scope flat from 20 to at least 500,000 cycles; test tapes (playback-response, azimuth-alignment and "operating-level" tones); an audio system (amplifier and speaker); a stroboscopic device for measuring tape speed; a bulk eraser; a head demagnetizer; materials for cleaning the heads.

First clean and demagnetize the heads to avoid treble loss.

Connect an audio generator (Fig. 1), to the high-level input of the tape recorder, record a series of frequencies of equal magnitude covering the audio range, and measure the playback signal at the output jack with a vtvm. Record at least 20 db below maximum permissible level (as shown by the record-level indicators). Else you will saturate the tape at high frequencies and cause an apparent loss of treble. With the tape machine's record volume control well advanced, feed in a 400-cycle tone and adjust the audio generator's gain so that the record-level indicator shows maximum permissible level. Then back down 20 db on the generator's gain control.

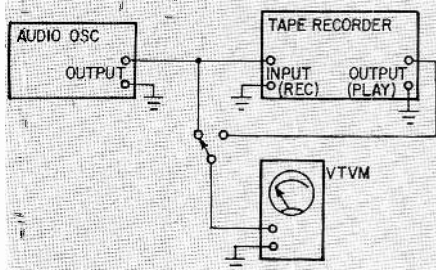

Fig. 1—Setup for checking overall record-playback response. Vtvm at oscillator output monitors level (which must be kept constant); at output of recorder, it reads playback output level. Ratio of the two in db is response variation.

This is your recording level.

The minimum number of test frequencies, in the interest of saving time, would be: 30, 50, 100, 250, and 500 cycles; 1, 2.5, 5, 7.5, 10, 12 and 15 kc. It would be desirable to use several additional frequencies above 5,000 cycles, where deviations from flat response are usually greatest.

There is no problem of identifying the test frequencies in playback if the machine under test has separate record and play heads and permits simultaneous recording and playback. If it hasn't, one method of identification is to intersperse announcements by microphone. Another, and perhaps preferable, method is to "mark" several key frequencies—say 100, 1,000 and 10,000 cycles—as mileposts. You can mark a frequency by momentarily increasing its level 10 or 20 db.

If the machine has a tone control, set it to "flat" before you check frequency response. If there is no "flat" position, set it at mid-position. You may want to check response at several settings to find out which gives flattest response, and mark that one for the customer's reference.

## Playback response

A check of playback response lets you determine two things: whether defective record-playback response is due to faulty playback (if not, the fault must occur in recording); whether playback response conforms to existing standards. The latter is most important at 7.5 ips because that is the prevailing speed for prerecorded tapes.

To measure playback response, play a standard test tape (Ampex tapes, probably the most widely used, are available for 15, 7.5 and 3.75 ips) and measure the playback signals with a vtvm. Ideally, response should measure flat. This procedure takes into account the tape machine's playback equalization, the frequency characteristics of the playback head in both the bass and treble regions, possible treble loss due to stray capacitance, and all other factors affecting playback response.

A number of top-grade home machines have no internal power amplifier and speaker. You will connect such a machine's output to an external amplifier-speaker as well as to a vtvm.

To avoid treble loss, remember to clean and demagnetize the heads before

measuring response. Magnetized heads can spoil an expensive test tape by partially erasing its high frequencies. And be sure to find out which tone-control position provides flattest response.

## Azimuth

This is the angle formed by the head gap and the length of the tape. Ideally, it should be exactly 90° (Fig. 2).

If there is treble loss when checking playback response, suspect azimuth alignment of the playback head. Frequency test tapes, such as Ampex, usually contain a prolonged high-frequency tone for checking and adjusting azimuth. While reproducing this tone, tilt the playback head slightly to the left or right to produce maximum output signal as indicated on a vtvm. Watch out for "false peaks", which are smaller than the true peak output at correct azimuth alignment. If the playback head is a stereo one, with two gaps, it is possible that the gaps are not in exactly the same straight line. Hence it will not be possible to obtain peak output on both channels in a given head position. You will have to determine a compromise azimuth alignment which gives equally good results on both channels (though not as good as on either alone).

If the tape recorder has separate record and playback heads, and if it has been necessary to change the azimuth of the playback head, the record head must be adjusted correspondingly. After the playback head has been adjusted, simultaneously record and play a high-frequency tone and adjust the record head for maximum playback signal as indicated on a vtvm. Some machines have separate record and playback heads but do not permit simultaneous recording and playback. In this case, wire the record head to the playback amplifier (disconnecting the playback head) and align its azimuth on the basis of the test tape. Because the record head probably has a wider gap than the playback head

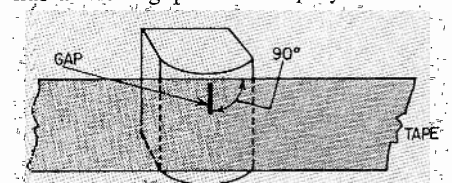

Fig. 2—Poor azimuth alignment ruins high-frequency response. Playback head gap must be perpendicular to direction of tape movement.

and therefore has difficulty reproducing high frequencies, reduce the frequency of the alignment tone by reducing tape speed.

### Equalization

If frequency response is unsatisfactory and if azimuth alignment and bias current (discussed later) are OK, check equalization.

To measure playback equalization, feed a series of very small signals of different frequencies and equal amplitude through the playback head and into the playback amplifier (Fig. 3). Measure output with a sensitive vtvm. The signals are inserted between the head's ground lead and ground, taking the head's electrical characteristics into account. To avoid overloading the head or amplifier, keep input signals small enough so that maximum output of the tape preamplifier, at the low end, is not more than about 1 volt. This usually means inputs of 1 to 5 mv.

NAB equalization is used virtually without exception at 15 ips, and also at 7.5 ips by many better-quality home machines. On these machines, the test of

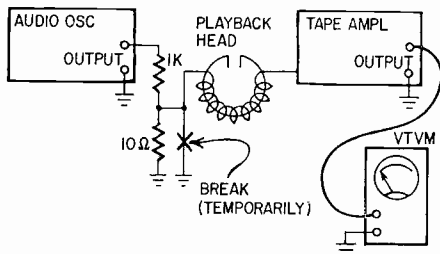

Fig. 3 — Measuring playback equalization. R1 and R2 divide down signal 100:1, provide low source impedance. Note that signal is injected in series with head. Audio oscillator output must be constant for all frequencies.

Fig. 3 should produce an output curve closely resembling Fig. 4; there may be moderate departures from the standard NAB playback curve to allow for the playback head's characteristics at the bass and treble ends. At 3.75 ips, playback equalization like that in Fig. 5 is often employed. Fig. 5 is the curve suggested by the Magnetic Recording Industry Association (MRIA) as a standard, though not yet officially adopted.

If the machine under test does not claim to follow the NAR or other widely accepted playback curve, consult the service manual to find out what that curve should look like.

The technique of Fig. 6 is employed to measure record equalization. First, it is imperative to remove the oscillator tube (or transistor). Feed signals into the high-level input jack of the record amplifier, and measure across a small resistor inserted between ground and the record head's ground lead. A 100-ohm resistor is usually best, but if your vtvm

is not sensitive enough to read the signal voltages across this resistor, try 1,000 ohms.

The important thing is that at the lowest audio frequency measured, the resistance should not exceed one-tenth the impedance of the record head in combination with its circuitry (driving tube or transistor, load resistor, constant-current resistor, etc.).

To avoid overloading the record head or associated circuitry at high frequencies, keep input signals about 20 db below maximum recording level as shown by the record-level indicator.

Consult the service manual of the machine under test to find out what the record equalization curve should look like. This will differ from one tape recorder to the next. Fig. 7 is a typical record equalization characteristic employed at 7.5 ips. It is important to understand that there is no such thing as a standard recording equalization curve. The NAB standard simply specifies that

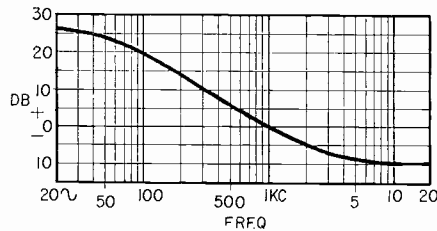

Fig. 4—NAB standard playback curve for 15 ips (used widely at 7.5 ips also).

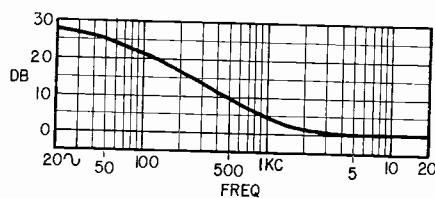

Fig. 5—MRIA-suggested playback equalization for 3.75 ips.

record equalization shall be tailored so that, in conjunction with the standard playback curve, the machine shall yield overall flat response.

### Bias and erase current

Bias current is fed to the record head along with audio current to reduce distortion and increase the amount of signal recorded on the tape. Correct bias is critical. Too much attenuates the high frequencies. Too little raises distortion sharply.

The technique of Fig. 6 can be used to measure bias current (with the oscillator tube in place). This presumes that you know the amount of bias current specified by the tape recorder manufacturer. A high-impedance head requires 0.2 to 1 ma; a low-impedance head, 5 to 10 ma. First allow the recorder to warm up about 15 minutes. Then measure voltage across the resistor in series with the record head, and calculate current by Ohm's law.

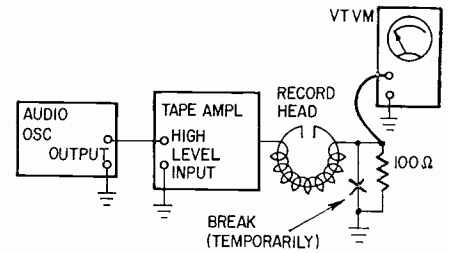

Fig. 6—Measuring record equalization. Reading audio voltage drop across 100-ohm resistor in series with head includes head characteristics in overall curve. Same technique is used for measuring bias current.

If the tape recorder permits simultaneous recording and playback, the manufacturer often specifies a simpler technique. A frequency, usually between 500 and 2,000 cycles, is simultaneously recorded and played back at a given tape speed. Bias current is adjusted for maximum playback signal. Sometimes the maker advises that bias be further increased until the playback signal falls ½ db below maximum level. This helps prevent slight changes in bias current (due to tube aging, fluctuations in line voltage, etc.) from having appreciable effect on distortion and treble response. When you adjust bias according to this technique, use the same kind of tape that your customer uses, because optimum bias tends to vary somewhat from one kind of tape to another.

To minimize noise produced in recording, the bias waveform should be as nearly a sine wave as possible. Check for gross distortion (about 5% or more) by viewing the bias waveform on a scope connected across the record head.

Bias frequency is also important. Too low a frequency may beat with the harmonics of the upper audio frequencies. Too high a frequency tends to undermine the effectiveness of the erase head (powered by the same oscillator that supplies bias current to the record head). Check bias frequency against the manufacturer's recommendation by connecting the vertical input of a scope to the record head and the horizontal input to an audio generator, set sweep to external, adjust the generator until you get a circle or ellipse on the scope (depending on phase relationships), signifying

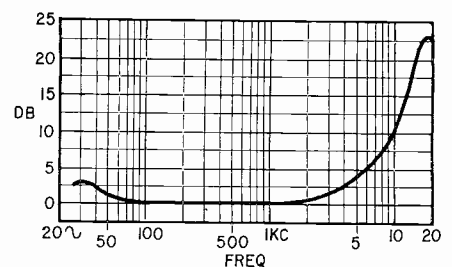

Fig. 7—Typical 7.5-ips record equalization used in high-quality home machine.

equal frequencies at both inputs. Read the frequency of the audio generator.

If erasure appears inadequate, check against the manufacturer's recommendation the amount of oscillator current going through the erase head. This usually lies between 10 and 50 ma. The technique is the same as in Fig. 6, except that the series resistor should be closer to 10 ohms than 100 because of the low impedance of the erase head.

### Distortion

Tape-recorder specifications are almost without exception in terms of harmonic rather than IM distortion (which runs much higher). Using your audio generator, record a 400-cycle signal and measure the harmonic content in playback with a harmonic distortion meter. A low frequency like 400 cycles is used: to provide a substantial number of harmonics before reaching the tape recorder's upper cutoff frequency; to avoid the treble emphasis that takes place in recording, which would exaggerate the distortion; because peak audio energy generally occurs around 400 cycles, so that a test in this region gives a good notion of the maximum distortion apt to be encountered.

The test of harmonic distortion has two purposes: to provide a reference point for measuring signal-to-noise ratio, as discussed in the next section; to check the calibration of the record-level indicator, as discussed in the next paragraph.

If the indicator is an "eye" tube or neon lamp, the recording level at 400 cycles that produces 3% harmonic distortion should also be the point at which the eye shadow closes or the neon lamp fires. If not, adjust the indicator calibration. (This assumes that you have previously checked that bias current is correct, because the recording level that produces 3% distortion varies with bias.)

If the indicator is a VU meter, the recording level that produces 1% harmonic distortion should read 0 VU. This recording level is about 6 to 8 db below the 3% distortion point. It provides a safety margin to compensate for the inertia of the meter, which understates distortion-producing signal peaks. Not all tape recorders with a VU (or similar) meter provide this safety margin. If the machine under test reads 0 VU at the 3% distortion level, advise your customer that for clean recording he should try to keep the pointer from swinging past approximately -6 VU.

### Signal-to-noise ratio

In good-quality home tape recorders, signal-to-noise ratio usually refers to the recording level that produces 3% harmonic distortion on the tape. "Noise" encompasses noise and hum due to the record and playback amplifiers, tape hiss, distortion of the bias waveform and imperfect erasure.

To measure signal-noise ratio, record a signal of 400 cycles on virgin or bulk-erased tape at the recording level that produces 3% harmonic distortion in playback. Measure the playback signal with a vtvm. Rewind the tape and put it through the recording process again, but this time with no signal input and with the recorder's volume control fully down. Again measure the playback signal, which now consists of noise. The signal-noise ratio is the relationship, in db, between the first playback signal and the second one.

You can also measure the "playback signal-noise ratio." This is particularly appropriate for a tape player (which cannot make recordings). The technique may be illustrated with reference to the 7.5 ips speed and Ampex test tape 31321-01. Play the "operating level" tone, a 700-cycle signal recorded at a level that produces 1% harmonic distortion on the tape. Measure the playback signal with a vtvm. Now play a reel of bulk-erased or virgin tape, and again measure the playback signal. Calculate the ratio between the first and second measurements in db; then add about 6 db to obtain the signal-noise ratio. The reason for adding 6 db is that the accepted reference level—a recorded tone producing 3% harmonic distortion—is roughly 6 db higher than a recorded tone producing 1% distortion (as on the Ampex test tape).

### Motion

Speed accuracy can be measured with a tape stroboscope—a wheel held against the moving tape. Bars on the wheel are viewed under a 60-cycle neon or fluorescent light source. The bars appear stationary if speed is exact, move in the same direction as the tape if speed is fast, and in the opposite direction if speed is slow. Seventy-two bars per minute moving past a given point (say a pencil point) correspond to 1% speed error. Another speed-measuring device consists of a loop of tape with stroboscopic bars, which is threaded past the heads and guides in usual fashion. Slack in the loop is taken up by light pressure of a pencil or similar object. The tape loop is run around and around, and the bars are viewed under a 60-cycle light source.

An accurate instrument for measuring wow and flutter is very expensive and therefore seldom found in a service shop. However, the ear is good for detecting even slight departures from perfection. Record and play (or, in the case of a tape player, just play) a 3,000-cycle tone. Listen for wow, which shows up as a quavering or pulsing quality. Listen for flutter, which appears as graininess or coarseness of tone. If possible, compare the performance of the machine under test with a professional or semiprofessional machine.

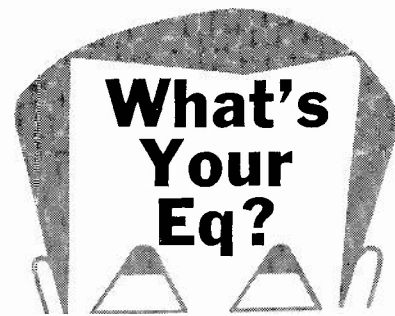

This month's answers on page 76.

### Always Half

An ac generator is connected to a network consisting of two resistors,  $R$  and  $R_v$ , and the black box shown in the diagram. It is found that the voltage be-

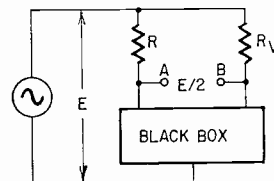

tween A or B is independent of the value of  $R_v$ . Whether  $R_v$  is shorted or open, the voltage across AB is  $E/2$  where  $E$  is the voltage of the generator. It is also independent of the frequency. Why?

—Qutaiba Bassim El-Dhuwaib

### What Voltage?

Three voltmeters are connected as shown. V1 is an electrostatic type, calibrated to read peak voltage values. It indicates that the output from the recti-

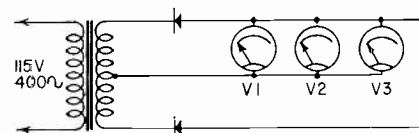

fier is 1,000 peak volts. V2 is a dc voltmeter of the d'Arsonval type. V3 is an ac voltmeter of the electro-dynamometer or iron-vane type. What will be the voltage indicated by voltmeters V2 and V3?

—Kendall Collins

### A Distorted Puzzler

This could be any voltage amplifier stage—most likely audio. Could also be

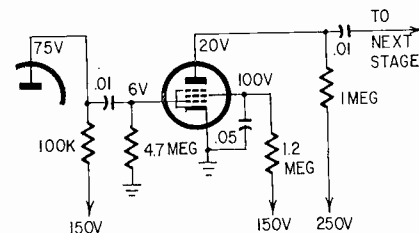

a triode. Signal is getting through, but with less than usual volume and with considerable distortion. The tube is good, the voltages are as shown. The components? Well, better check 'em. Won't have to disconnect anything to find any bad ones, though. Just look.—

Jack Darr

END

# BLACK BOX— A STEREO ANALYZER

With this device and a vtm, you can check phasing and balance of your stereo system.

By **BOB WHITE**



RADIO-ELECTRONICS' Technical Editor tries out the Black Box.

THE LACK OF LOW-COST, READY EQUIPMENT for setting up stereo systems and evaluating stereo recordings prompted me to build a simple, inexpensive device that could be connected to the speaker lines of my home stereo system. This "Black Box" balances the two channel levels, determines their proper overall phase connections, and evaluates the program material for its directional characteristics.

Fig. 1 shows the circuit of the device. Three identical output transformers step up the voltage from low-impedance left and right speaker lines. A toggle switch changes the circuit for either amplitude or phase measurement. In the amplitude position, the stepped-up voltage of each speaker line is applied in phase to a rectifier diode and a positive

voltage is developed across each of two load resistors. An external high-impedance dc voltmeter, or vtm, preferably with a zero-center adjustment, is connected across the two outputs to measure the voltage difference.

With no signal present (or if the two signals have identical content and amplitude), the meter is not deflected (see Fig. 2). If the left channel has a signal and the right none, the output is positive; if the right channel has a signal and the left none, the output is negative. When both left and right signals are present, the meter is moved by a voltage equal to the *difference* between the left voltage developed across R1 and the right voltage developed across R2.

With monaural program material it is easy to establish the exact balance, as the levels exactly correspond. Any frequency response differences or amplitude nonlinearities in the two channels would show up. With stereo program sources the levels do not correspond, so the meter readings will vary from positive to negative. Here, though, there is usually a strong component common to

both channels, and by watching the meter excursions from positive to negative, you can rapidly balance the two channels. The results of setting up the levels at one side of the room and then walking to the center listening position have been very satisfactory. The excursion of the meter for a given listening level is an indication of the spread of the sound between the two speakers.

In the PHASE position of the switch (see Fig. 3), one rectifier develops across load resistor R2 a positive dc voltage proportional to the two channels summed, and the other develops a positive dc voltage across load resistor R1 that is proportional to the difference. Then, with in-phase signals applied to the left and right channels, the voltage across R1 is zero, because the windings of T1 and T3 produce equal and opposite voltages that cancel. The voltage across R2 is positive and double what would be produced by one winding, because T1 and T2 are equal and additively phased. The meter is connected to take the difference, as before, and reads *negative*. By the same reasoning, the voltmeter reading with out-of-phase signals is *positive*.

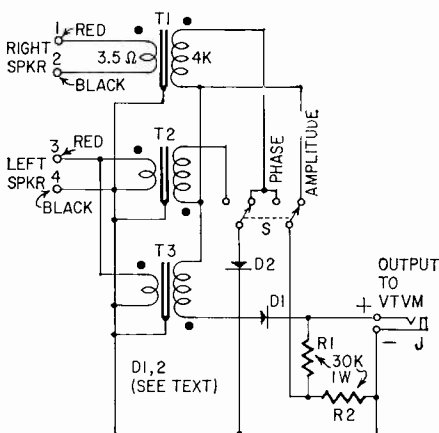

Fig. 1—Circuit of the Black Box.

R1, R2—30,000 ohms, 1 watt  
D1, D2—1N459, or 1N649 (see text)  
J—phone jack  
S—toggle switch, dpdt  
T1, T2, T3—output transformer; primary, 4,000 ohms; secondary 3.5 ohms; 3 watts  
Binding posts (4)  
Plastic case and panel, 6 1/4 x 3 3/4 x 2 inches  
Miscellaneous hardware

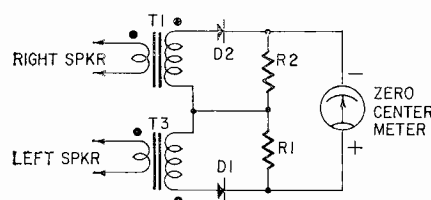

Fig. 2—Simplified diagram of amplitude sensing circuit. Dots at T1 and T3 indicate phasing of transformers; positive-going wave at dotted end of primary produces positive-going wave at dotted end of secondary. See text for explanation.

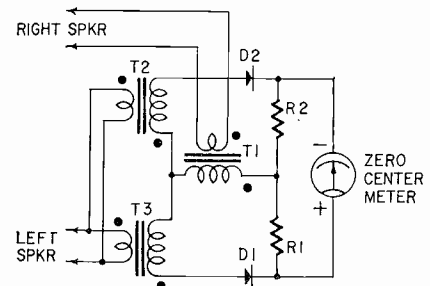
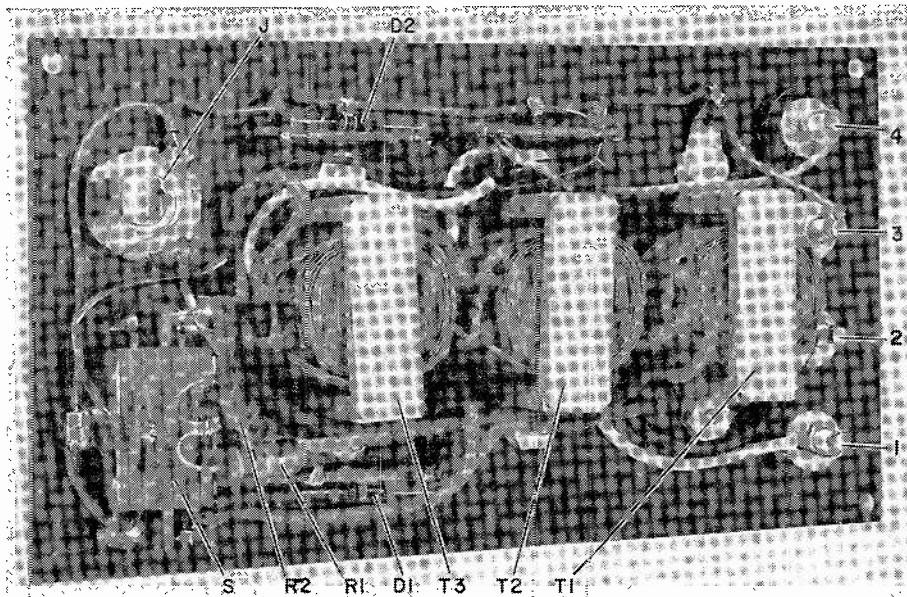

Fig. 3—Phase-sensing portion of analyzer. Dots at transformers indicate phasing, as in Fig. 2. Text describes operation.



All components are mounted and wired on panel of bakelite case.

The phase reading does not depend on the amplitudes of the two channel signals. As the level on either channel decreases, the deflection drops, but is always of the correct polarity. If one channel is silent, the output reading is zero. Another interesting case is when the phase difference between the two channels is not exactly zero or  $180^\circ$ . Then the meter readings drop and reach zero at a shift of  $90^\circ$ , which is halfway between in phase (zero degrees) and out of phase ( $180^\circ$ ).

Proper phasing of the entire stereo system from program source to speaker is extremely important. If the same sound source (mono) is used for both channels, then determining phase is just a matter of watching for correct polarity deflection. With stereo program material, the indication is not all in phase or out of phase, but the in-phase components in general predominate. It's fun to watch the meter with orchestral music and see how its indication corresponds with the instruments being played. With higher-frequency tones, the wavelengths are shorter and the sounds are equally likely to arrive in phase or out. With lower-frequency tones, they will more likely be in phase. In program material of no apparently predominant phase, the bass can be turned up and the treble down to accentuate in-phase readings and establish proper overall phasing from studio to listening room.

It's interesting too to listen to stereo recordings or broadcasts and correlate the meter indications with the judgment of the ear. The recordings that were most pleasant to me were strong on in-phase readings, and those that produced confused stereo sounds were strong in both polarity readings. Programs that were predominantly out of phase could be improved by reversing one set of speaker leads.

Surface noise on stereo recordings is out of phase with program content. This is because most of the surface noise is in the vertical component of the needle movement. It illustrates that a stereo cartridge used to play monophonic records with the channels tied together cancels the vertical groove noise.

#### Details of the Black Box

In the circuit shown, three identical output transformers were used across 4-ohm speaker lines. For other impedance lines, connect the Black Box to the 4-ohm taps of the audio power amplifiers while the speakers are connected to their required impedance taps. Or use three identical transformers of the desired impedance level. The actual impedances are not critical except that the speaker lines should be roughly matched to the transformers. The stepup connection causes a high voltage to be developed across the high-impedance windings and the rectifiers.

The amplifier output (each channel) must not exceed 10 watts sine-wave power, or an instantaneous peak power of 14 watts with the transformer impedances specified and 1N649 rectifiers. So keep the volume down! At 14 watts, a peak voltage of 600 is developed across the two windings and rectifiers. (For sinusoidal power levels of 1 watt or less, 1N459 diodes with a 200-volt peak inverse rating can be used.) If the specified transformers were connected to 8-ohm speaker lines, the maximum operating power level would be just half—5 watts rms and 7 watts peak.

In the plastic box shown in the photos, a good ground connection was made between the three transformer frames, the toggle switch frame and one speaker line terminal, as shown in the schematic. This prevents accidental shock from the various exposed metal

parts. The voltmeter indicator was set to a  $+7.5 - 0 - -7.5$ -volt range. This varies with normal listening levels.

Make sure that the speakers are properly phased with respect to the Black Box. One simple method is to disconnect the speakers from the system, and then momentarily touch a flashlight cell across the speaker voice-coil terminals. Both left and right speaker cones must move in the same direction when the positive battery terminal is touched to the speaker terminal which is to be connected to the red terminal on the Black Box.

[Some amplifiers have the 4-ohm output taps common to chassis and to each other, instead of the "ground" or "common" terminals. This allows simple two-terminal connection of a sum (left-plus-right) center-channel speaker. In such amplifiers, grounding the "common" taps as well would short half of each output transformer secondary. For that reason, the primary of T1 in Fig. 1 is left "floating".—Editor] END

#### REFERENCES

- J. P. Overley, "Energy Distribution in Music," *IRE Transactions on Audio*, September-October 1956, pp. 120-123.
- H. A. M. Clark, G. F. Dutton and P. B. Vanderlyn, "The 'Stereosonic' Recording and Reproducing System," *IRE Transactions on Audio*, July-August 1957, pp. 96-111.
- W. H. Beaubien and H. B. Moore, "Perception of Stereophonic Effect as a Function of Frequency," *IRE Transactions on Audio*, September-October 1960, pp. 144-153.
- B. B. Bauer, "Phasor Analysis of Some Stereophonic Phenomena," *IRE Transactions on Audio*, January-February 1962, pp. 18-21.

### Ingenious Replacement

SOME TIME AGO, A TECHNICIAN FRIEND of mine was faced with repairing an "off-brand" TV set, and needed a vertical blocking oscillator transformer. He enlisted my help and we started ransacking the shop, looking for any kind of transformer with two high-impedance windings on suitable laminations. All we could find was a variety of audio output transformers with one high-impedance and one low-impedance winding. I recalled that most vertical oscillator transformers had a 4-to-1 ratio, with a few having a 1-to-1.

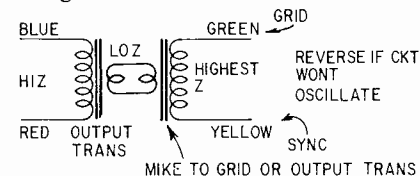

Then I wondered how two of his old audio transformers, hooked back to back, would work. We tried it, connecting them as shown in the schematic. It worked fine!

We tried three or four other transformers, and all worked. With only one was there a slight hitch: the vertical timing resistor had to be changed to keep the vertical hold control near mid-range.

If the circuit won't oscillate, reverse the two leads to any one winding.—*M. D. Velásquez*

# Tape Recorder Problems

## Part 1—Hum and noises

By HERMAN BURSTEIN

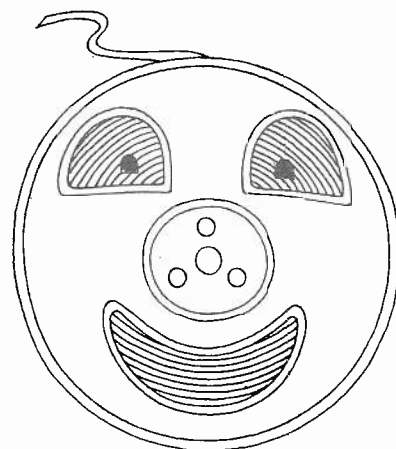
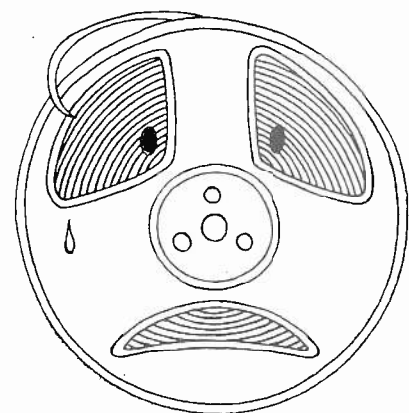

IT SIMPLY ISN'T IN THE NATURE OF A mechanism as complex as a tape recorder to operate indefinitely without trouble, the way some preamps and power amplifiers do. When trouble arrives, it falls into one of two categories:

1. The kind that requires a technician.
2. The kind the owner can cure himself.

Without attempting to draw a sharp line between the two categories, it is still true that a variety of elementary recorder problems can be handled by the user with little technical knowledge or equipment. This doesn't deprecate the technician's role. The simple measures the owner can try are often the technician's first steps in approaching a problem.

At the same time, it is important for the owner to know what he *can't* do and had best leave for the technician. Unwise tinkering may lead to extra trouble and expense.

This article is concerned largely with electronic rather than mechanical problems, which vary more than electronic troubles from one make to the next. Repairing mechanical faults almost always requires special skill, knowledge and parts.

### Hum

Playing a tape or recording from a microphone generates signals of only a few millivolts, so it is little wonder that hum is one of the most formidable problems in a tape recorder. The 60-cycle line frequency is apt to be the principal offender, but its 120- and 180-cycle harmonics may also be intrusive. Hum is usually more of a problem in playback than in recording because of

the large bass boost in playback.

When the tubes are heated by ac, a "hummy" tube can easily be responsible for excessive hum. Usually (though not always), it will be in the first stage of the record or playback amplifier. Keep a stock of replacement tubes on hand, so you can check tubes by substitution. Such a stock is not very expensive—the entire tape recorder may use only three or four tube types. It is a good idea to have at least two of the type used in the first stage.

A tube can pick up hum not only from its own heater but also from transformers and motors. Even though a tube is heated by dc, replacement by a tube less susceptible to hum may help.

Watch out for a missing tube shield, or one that is hanging loose and not making contact with ground.

Hum sometimes decreases noticeably when you ground the equipment via a heavy lead to a cold-water pipe or similar object (but never to a gas line).

A violent case of hum may be due to a break or poor contact in the ground lead from the playback head to the tape amplifier. If you are feeding the signal directly from a playback head to an external preamplifier, you may find that hum is due to a poor connection between the cable plug and the preamp's input jack. Try filing or scraping the contacting surfaces. Squeezing the shell of the plug slightly with pliers will help assure a firm ground connection.

Be careful how you route the cable from a playback head to an external preamp. If this path is close to a motor, power transformer or ac line, appreciable hum may result. Remember that even though the cable picks up only a minute amount of hum, this may be

large compared to the few millivolts of signal delivered by a tape head. The cable should be as short as possible.

Because of the large bass boost used in playback—as much as 36 db—anything that further, and unnecessarily, boosts the bass is apt to introduce noticeable hum. This might be a bass-boost control in your audio system which is advanced too far for the volume level (the higher the level, the less bass boost is ordinarily required). It might be a misadjusted loudness control (producing substantial volume well below a 12 or 1 o'clock setting).

### Other noises

Tubes are a prime cause of noise, as well as of hum. Again, suspicion initially focuses on the tube in the first stage of the playback amplifier (or of the record amplifier). Sometimes, though, a later stage will be responsible. Noise level can often be reduced by trying several tubes (of the same type, of course) in the first stage. Some equipment manufacturers use selected tubes in early stages to minimize noise.

Resistors are a well known source of noise. The least noisy resistors, wire-wound or deposited-metal film types, are expensive (\$2 or \$3 each). Even an expensive resistor can develop noise after a while. Deposited-carbon resistors have been suggested as low-noise types, but often they are hardly better than molded carbon units. Using a garden-variety resistor of excess wattage rating—for example, a 2-watt where a ½-watt might otherwise do, sometimes cuts noise. Low-noise resistors are called for in the plate load, and in the cathode load if the cathode is unbypassed. The audiophile with kit-building experience might have sufficient know-how to go about replacing resistors suspected of being noisy. Ordinarily, though, this is the technician's domain.

Tape heads become magnetized with use, producing noise in playback and also recording noise on the tape. Heads should be demagnetized after about every 8 hours of use. Head demagnetizers (Fig. 1) cost only a few dollars. They should be applied also to

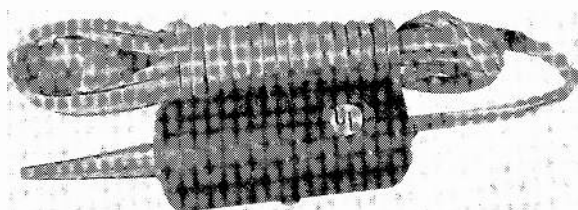

Fig. 1—A head demagnetizer, like this, is an absolute must for quiet recordings.

Robins Industries Corp.



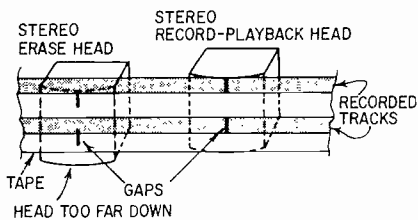
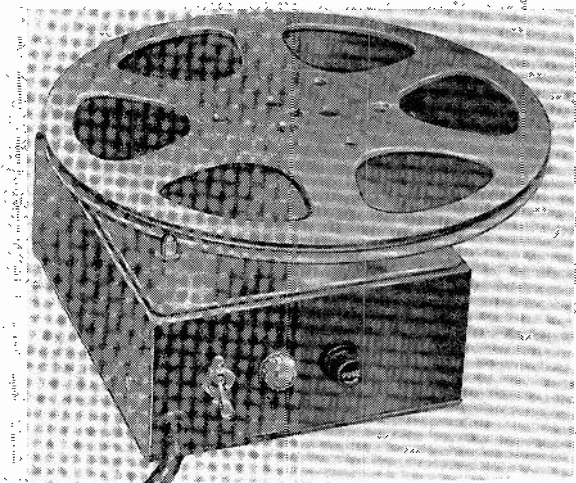

Fig. 2—A misaligned erase head can result in incomplete erasure of previously recorded material if it “wipes clean” only part of each track.



Lafayette Radio

tape guides and other metal parts of the machine contacted by the tape. (Turn off the machine when demagnetizing.)

In recording, the main cause of noise is distortion in the bias oscillator waveform. Bias is supplied to the record head (along with the audio signal) to minimize tape distortion and maximize the amount of signal recorded. Make a rough check for bias distortion: with no input signal and with the recording gain control at minimum, put several feet of blank (virgin or bulk-erased) tape through the recording process. Play it back and compare its noise level with that of the following “unrecorded” tape. There will always be *some* rise in noise level but, if this rise is strong, it suggests poor oscillator waveform (should be a perfect sine wave). Try replacing the oscillator tube. If that doesn't help, the service technician should take over.

Incomplete erasure belongs in the noise category. The cause may simply be that you are recording at an excessive level, which the erase head isn't designed to cope with. If that isn't the case, the trouble may be a defective erase head, insufficient erase current, too-high oscillator frequency or misalignment of the erase head with respect to the record head so that their gaps don't span the same portion of the tape (Fig. 2). All these are ordinarily problems for the technician.

Tapes that have been recorded at excessive level are best erased with a bulk eraser (Fig. 3). Unfortunately, this means erasing *all* tracks on the tape.

Crosstalk is another form of noise.

If a stereo head is positioned too high or too low relative to the tape, crosstalk may occur because the signal intended for one tape track overlaps onto the adjacent one when the reels are reversed. On a quarter-track stereo head, crosstalk may occur on tracks 2 and 3 (Fig. 4). If you are tempted to adjust head height, follow the manufacturer's instructions and make sure you follow up with azimuth alignment to avoid treble loss (discussed in the next article).

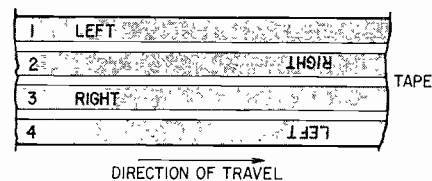

Fig. 4—Vertical misalignment of record-playback head can cause crosstalk between tracks 2 and 3.

levels as indicated by the record-level indicator, you will avoid print-through.

Tape squeal is a particularly annoying form of noise, not only as a direct air-transmitted sound, but it can also be recorded on the tape to mar all future playbacks of that recording. Squeal may be due to dry tape, rough pressure pads or excessive pad pressure. High-quality tape contains an efficient lubricant that helps avoid the problem. Moisture can be restored to dry tape by storing it for about a day in a closed container with a moist sponge. Audio stores carry lubricating devices and substances to be applied to the tape, heads, pressure pads and tape guides (but *not* to the capstan and pressure roller). Cleaning the heads, capstan and pressure roller with alcohol can help.

Under-recording is a source of noise. A low recording level means *relative* accentuation of tape hiss and tape amplifier noise. A faulty record-level indicator may be responsible for under-recording, and here you will need a technician to check and correct. Or the fault may simply be your own, in setting recording level.

Some recorders, used with an external preamplifier, produce electrical feedback—a violent howl or roar. Most home tape machines use the same head for recording and playback, and therefore only one amplifier for both purposes, with switching. In such machines, the output jack may remain connected to the tape amplifier in the record mode. If the tape machine is in the record mode and the selector switch of the external preamp is accidentally set to tape playback, a situation like Fig. 5 occurs. Any signal entering the machine's input jack

Crosstalk may result from poor isolation between channels in the tape amplifier, or poor electromagnetic isolation between the two sections of a stereo head. With stereo signals, a fair amount of crosstalk is ordinarily tolerable. But with unrelated mono signals, even slight crosstalk can be objectionable. One reason for the high price of a good-quality tape machine is the care taken to minimize crosstalk.

Recording at too high a level or using too thin a tape may cause *print-through*—transfer of sound (magnetically) from one layer of tape to the adjacent layers. The audible results are often called pre-echo and post-echo. Print-through increases with the length of time a recorded tape has been stored. Special low-print tapes are available, but if you use good quality conventional tape with a 1½- or 1-mil base, and if you stay within permissible recording

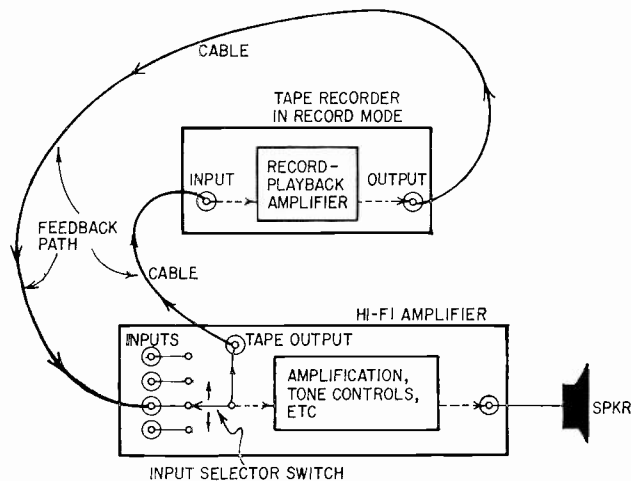

Fig. 5—Earsplitting feedback howl occurs in some installations because of switching arrangement shown here.

is amplified, goes to the machine's output jack, proceeds along the cable to the tape input jack of the preamp, goes to the preamp's selector switch and then its tape output jack, re-enters the tape machine, is further amplified and so forth. The obvious answer is to avoid turning the preamp selector switch to "tape playback" when the tape machine is in the record mode.

A better solution is to make sure when you purchase a preamp that it provides for breaking the feedback path. Such a preamp has a special input jack for tape playback, and a special "tape monitor" switch that bypasses the regular selector switch (Fig. 6). Alternatively, you can choose a tape recorder that interrupts the feedback path in the record mode.

A thump, click, pop or wavering sound may result from an improper splice. For a correct splice, cut the tape at a 45° angle and apply the splicing tape (special tape sold for the purpose, not ordinary cellophane tape) at the same angle (Fig. 7). This allows the

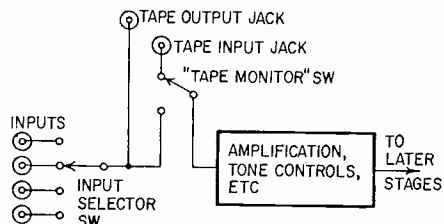

Fig. 6—"Tape Monitor" switch prevents feedback shown in Fig. 5.

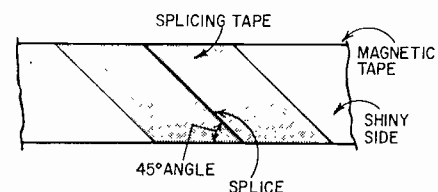

Fig. 7—Correct splice, cut and taped at 45° angle, is practically noiseless and very strong.

magnetic and splicing tapes to make gradual contact with the tape heads and pressure pads.

The harmonics of a stereo pilot signal (19,000 cycles) may beat with the high-frequency bias current, putting spurious signals on the tape. For example, the fourth harmonic, 76,000 cycles, might beat with a 70,000-cycle bias frequency, producing an audible 6,000-cycle note. Better stereo tuners and adapters keep the pilot signal and its harmonics negligibly small at their output. Some tape recorders have a special input filter. But if you do run into the problem, buy one of the commercially available filters and install it between the stereo tuner (or adapter) and the tape recorder.

The next article in this series will deal with bass and treble problems, distortion and disappearance of sound. END

## improvising an FM tuner

Get FM broadcasts on any intercarrier TV with the help of this little oscillator

By OLIVER E. WILSON

WHEN THE FIRST FM BROADCAST STATION opened in this area (on 95.9 mc) many would-be listeners wondered how they could pick up a sample broadcast before deciding whether to invest in equipment to take advantage of this source of good music.

Manufacturers and dealers were ready for the new market, but for the experimenter there was an opportunity to create or build something.

My first step was to pull the coarse- and fine-tuning knobs from the front of the TV set. With a flashlight, I explored the opening for access to the tuner adjustment slugs. Setting the tuner to unused Channel 6 brought the head of that slug into view and, with a long alignment screwdriver, about two turns got some sound output. Tuning with the fine-tuning knob was critical. The sound seemed to drift in and out and lacked fidelity.

After a little reflection, it dawned on me that the TV set with standard intercarrier circuitry requires two car-

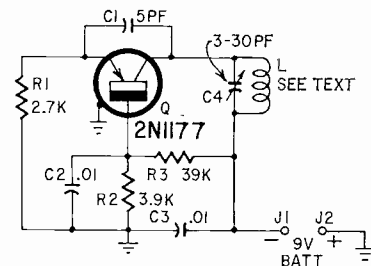

- R1—2,700 ohms
- R2—3,900 ohms
- R3—39,000 ohms
- All resistors 1/2 watt, 10%
- C1—5 pf ceramic
- C2, C3—.01 uf paper or ceramic
- C4—3—30-pf trimmer
- J1, J2—Snap terminals from discarded 9-volt transistor battery
- L—5 t. No. 14 enamel closewound on 1/4-in. slug-tuned form
- Q—2N1177 (RCA)
- Batt—9-volt transistor battery (Eveready 246, or equivalent)
- Plastic box
- Miscellaneous hardware

Circuit of simple common-base oscillator. Radiation from coil should be sufficient.

wound with 5 turns on an old slug-tuned 1/4-inch ceramic coil form (see photo). A larger air-core coil, with one or two more turns, should be equally good.

Mount all parts solidly to make the oscillator stable. The tuning is relatively free from drift and frequent tuning is not required. The unit is unshielded, so hand capacitance makes the initial tuning fairly critical.

If the coil dimensions given are followed, the unit should work without using a grid-dip meter to check it out, but if one is available it can be very convenient. Use a socket for the transistor to guard against possible heat damage during construction. END

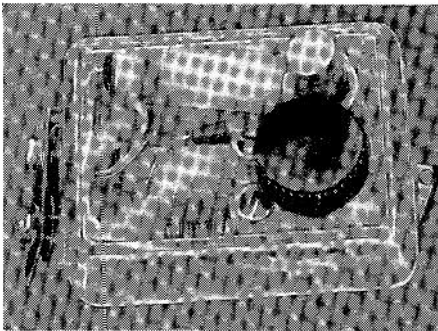

Tiny box tucks away inside TV, or almost anywhere.

riers (normally picture and sound)—to produce the 4.5-mc sound i.f. carrier.

I tuned my grid-dip meter between 90 and 100 mc, holding it several feet from the TV set. Careful tuning cleared the sound, and reception was excellent. The grid-dip meter, with an occasional correction for oscillator drift, helped make a quite satisfactory FM tuner.

A more permanent system was built in a small plastic box. The circuit, a transistor oscillator, is given in Fig. 1. The parts layout is not too critical, except that leads to the coil and capacitor combination must be short. The coil was

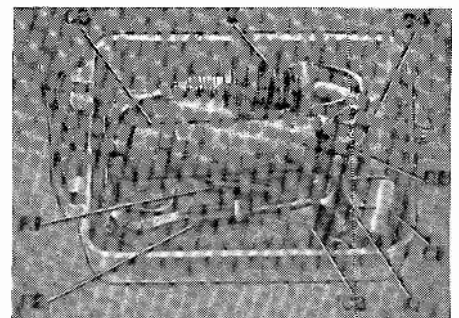

Completed oscillator shows snap terminals from old battery. 9-volt battery simply snaps onto the terminals. No switch needed.

# What's New

**NEW COMPUTER MEMORY** in which thin ferrite sheets are stacked, laminated and cured in a new process "borrowed by RCA from the plywood industry." Unfinished sheets are in the foreground; the complete memory, compared for size with an aspirin tablet, is in the rear.

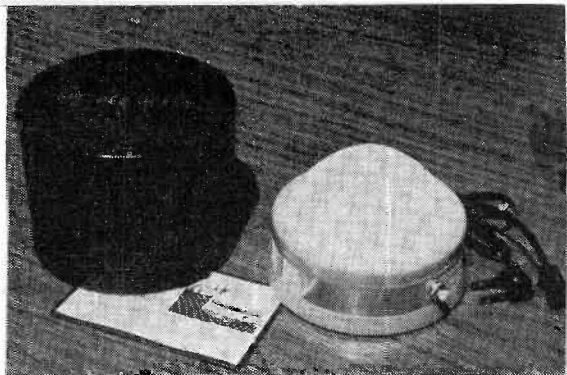

**MOTHER HEART MACHINE**, sleep-inducer for babies patterned after the device invented by Dr. Lee Salk, now marketed by a Japanese company. The battery-operated unit produces sounds resembling a mother's heartbeat, tranquilizing the infant.

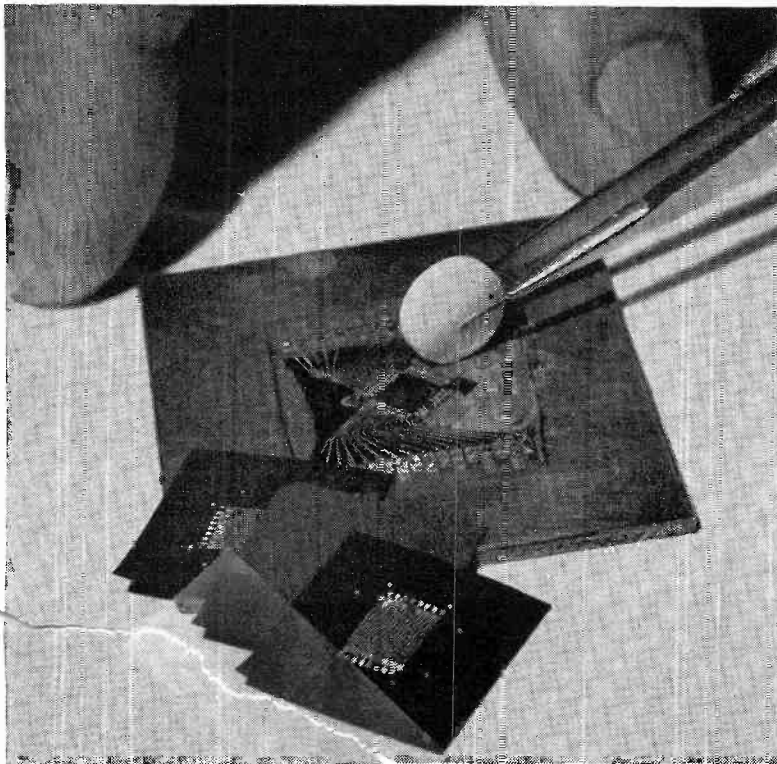

**FIRST VIDEO PLAYBACK-ONLY** tape machine has been announced by RCA. It is the unit displayed by John Salani of the RCA Broadcast & Communications Products Div. The equipment behind him makes the playback unit a complete recorder.

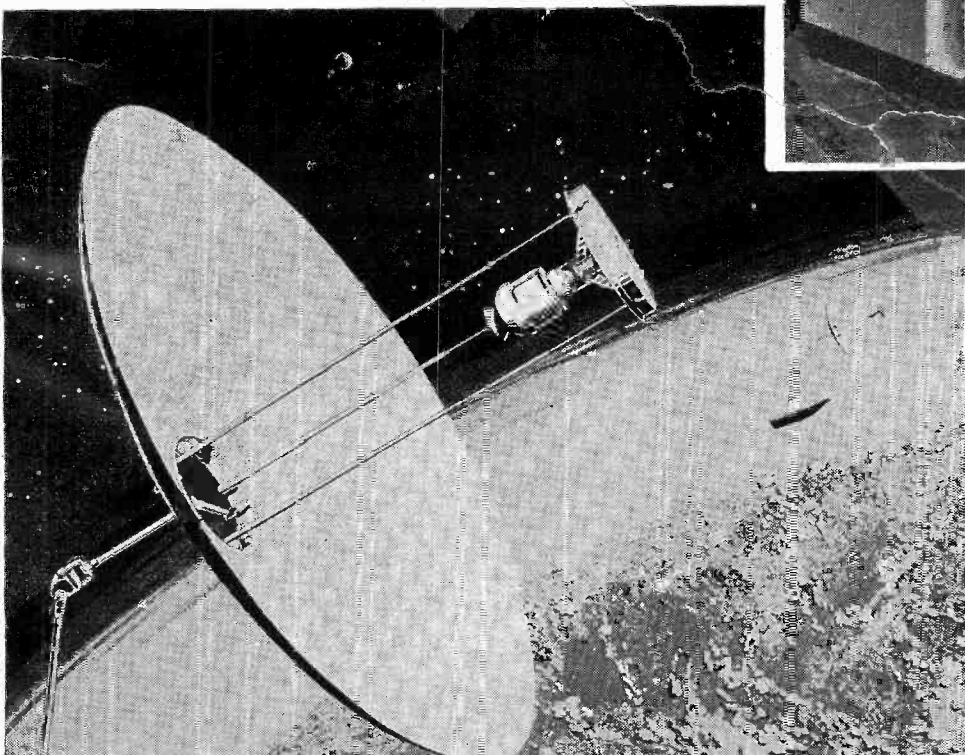

**SPACE-SHIP POWER PLANT** for manned space vehicles would consist of parabolic mirror with collector mounted at focus. Light-looking frame makes it possible to keep power plant oriented on the sun, and is strong enough for use in no-gravity conditions. Design was proposed by Sundstrand Aviation-Denver, a division of Sundstrand Corp.

# WHAT HAPPENS TO PICTURE TUBES?

By JACK DARR  
SERVICE EDITOR

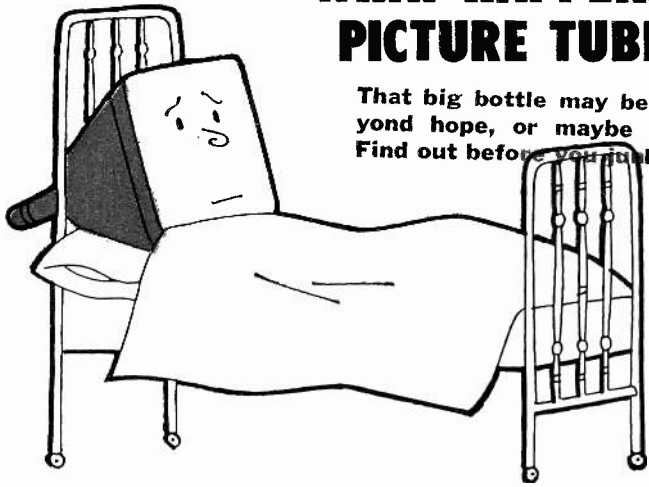

That big bottle may be beyond hope, or maybe not. Find out before you drink it!

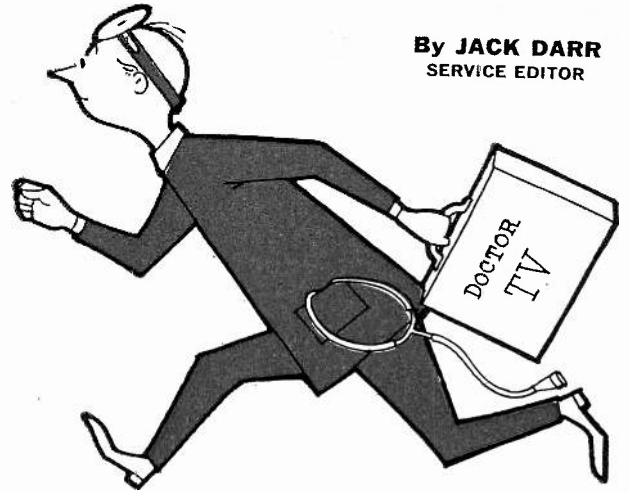

TO THE CUSTOMER, THE PICTURE TUBE is the most important part of his TV set. It's the most expensive! So we need to know what's going on in the "big bottle." Sad to relate, some perfectly good picture tubes have been replaced. Also, picture-tube testing can be a powerful "psychological warfare" weapon with the customer. By taking many pains to try to rejuvenate a dead CRT, you can make a good friend out of even the most contrary customer! (Of course, be sure to tell him, "Your picture tube's dead, I'm sorry to say. But I'm going to try to bring it back to life so that you can get some more use out of it." Even if you fail, he'll feel better if you're obviously *trying*.) Let's take the common troubles first.

Most common, of course, is the "weak" tube—4 to 6 years old, cathode pretty well exhausted. Symptoms: dim raster and poor contrast. However, this can be due to other things: video trouble or low high voltage. So let's be sure. A good CRT tester is essential. Fig. 1 shows the appearance of a weak tube, before rejuvenation. Focus is fair, as you can see in the gray areas, but the highlights "smear out" when the brightness is brought up. Many weak tubes won't show this much contrast. Remedy: rejuvenate it.

## Rejuvenation

This is a simple process, really. The cathode of a CRT is a wee dot of active material on the end of a metal cylinder;

the heater is inside this. After years of use, all the "goody" is gone from the surface, so we get few electrons and a thin beam. To restore emission, we tie all the other elements together, making a diode plate out of them, and feed a high dc voltage to that "plate." The resulting surge of emission will (we hope) burn off the outer layer of depleted material from the cathode. So, we get more emission. Fig. 2 shows this schematically.

## Testing for quality

To find out if this worked, we check the tube. Practically the same circuit. We tie the elements together, put a lower dc voltage on the plate and a milliammeter in series (Fig. 3). (This is the principle used in all emission testers.) Read the cathode current. If it is more than about 300 microamperes, we did it!

Some testers make a triode out of the CRT, as in Fig. 4. Positive dc voltage is fed to the "plate" (G2 and G3, if the tube has a G3), and the grid is returned to a variable bias voltage source. Now, we can not only check total emission but measure the grid cutoff voltage, to be sure that the tube is capable of being controlled by the bias as it should be. (Normal cutoff voltage for the average CRT is between  $-30$  and  $-50$ .) Incorrect cutoff bias will upset the video level, cause poor contrast, etc.

## Drastic measures

If the CRT is old, sometimes this rejuvenation won't "take" the first time.

So we resort to more drastic measures. CRT testers now have a heater voltage variable from 1.1 to 12. (Early models had only 6.3 volts ac, but they had provisions for increasing this, as we'll see.) Most CRT testers have three positions for rejuvenation that we might call "normal," "heavy duty" and "last resort"!

In "normal," only the dc voltage is applied. This cures most tubes. In "heavy duty," the heater voltage is increased by about 15% to bring the cathode temperature above normal and "boil" the active material. Then, when the dc is applied, it can "get in" much easier.

The last step should really be called "resuscitation" instead of "rejuvenation" since it is used only on tubes that are to all intents and purposes completely dead. (In none of these cases will we "bring back their lost youth," so "rejuvenation" is a misnomer!) The heater voltage is increased by 20% or more,

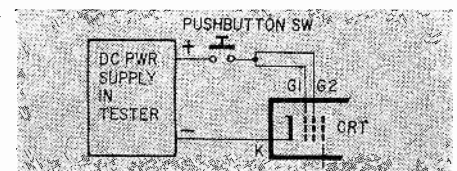

Fig. 2—Basic "rejuvenator" circuit. Push-button applies dc to "plate" (G1 and G2) of "diode", causing burst of current that pulls fresher cathode material to surface.

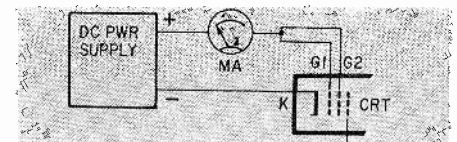

Fig. 3—CRT connected as diode for emission testing. Meter reads total current.

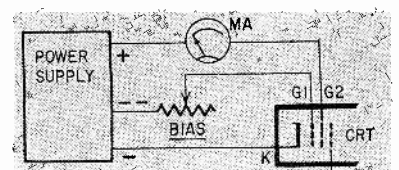

Fig. 4—Triode connection for testing. Grid bias can be varied to find out where tube cuts off.



Fig. 1—The picture looks like this when the tube gets weak. But video trouble can also cause this kind of thing.

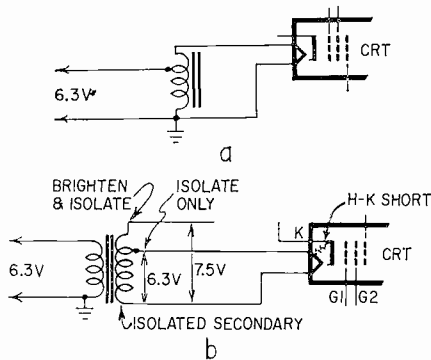

Fig. 5-a—Autotransformer brightener raises heater voltage, does not isolate circuit. In 5-b, a two-winding brightener, which can isolate heater from cathode circuit in case of internal short.

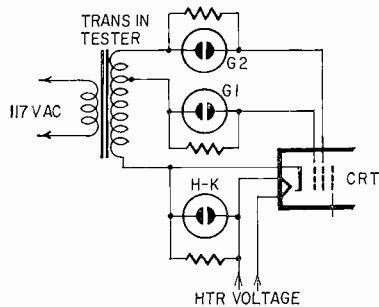

Fig. 6—Basic short-test circuit of CRT checker. Good element lights one side of neon lamp, shorted one lights both, and open element, neither side.

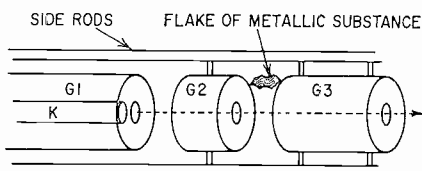

Fig. 7—Shorts between elements (except heater-to-cathode) usually result from flake of conductive material lodged between them.

and in some testers the dc voltage is raised. You'll usually see fire fly in the neck when you hit the button, on this one!

### Brighteners

Many tubes, after rejuvenation, will show good at first, then slowly die out as the cathode cools. This calls for a *brightener*. (Never say "booster"; that has a bad connotation. Many customers think a booster gadget raises the high voltage, causing X-ray emission, and all sorts of horrible things! Always explain to them that all it does is raise the heater voltage just a little—which is, of course, true.)

A brightener is a wee transformer; the primary goes to the original heater source, and the secondary has a stepup ratio to raise the voltage to about 15% above normal. Be sure to get the right type. Now, "if the base fits, the brightener fits." For early tubes, there are two types: "series" and "parallel," for heater strings of those types. The primary in-

ductance of the transformer matches the characteristics of each type. Using a parallel brightener in a series circuit, for instance, actually *lowers* the CRT heater voltage!

There are two types. The cheapest is an autotransformer (Fig. 5-a). This raises the voltage, but there is no isolation.

If the tube has a heater-cathode short, you'll see a clean raster, and the brightness control will have no effect at all. The cathode will be grounded, removing the bias, so that the tube can't be cut off. To cure this, install a transformer type brightener (Fig. 5-b). This isolates the cathode short, by lifting the heater above ground. Never try to "blow" heater-cathode shorts; you're more likely to damage the heater and ruin the tube forever. The transformer brightener makes a complete cure at a very small cost.

### Shorts testing

CRT testers have an ingenious circuit for testing shorts, which also gives an indication of continuity in each element. Fig. 6 shows the basic circuit. An ac voltage is applied to each element through small neon lamps, each shunted by a resistor. Each element of the tube becomes a "plate." If the element is connected, it will rectify the ac. So, one half of the neon lamp lights, showing that this element has continuity. If there is a short between any two elements, both will have ac on them, since they'll not rectify any longer! Then both halves of the corresponding neons light, showing which two elements are shorted.

This kind of short is usually due to flakes of conducting material lodged in the gun (Fig. 7). Place the set screen-down on a pad of some kind and jar the neck of the tube with the handle of a screwdriver—GENTLY!! In some cases, this will dislodge the flake, and it'll fall into the bell of the tube.

If this won't work, try applying dc between these two elements. (Never between heater and cathode!) You can connect to the dc power supply of another TV set or, easier, charge up an electrolytic capacitor of about 20–50  $\mu\text{f}$  and discharge it between the two elements. One CRT tester uses this method to apply the rejuvenation voltage. A large capacitor is charged, then discharged by the pushbutton. This prevents excess rejuvenation.

### Ion burns

One thing is incurable: an ion burn. Mostly found in the older tubes, it's caused by the ion-trap magnet (beam bender) being set wrong, allowing some of the heavier ions to go through and strike the phosphor screen. Because of their far greater mass, continued ion bombardment knocks off enough of the phosphor to cause a dim spot. In the

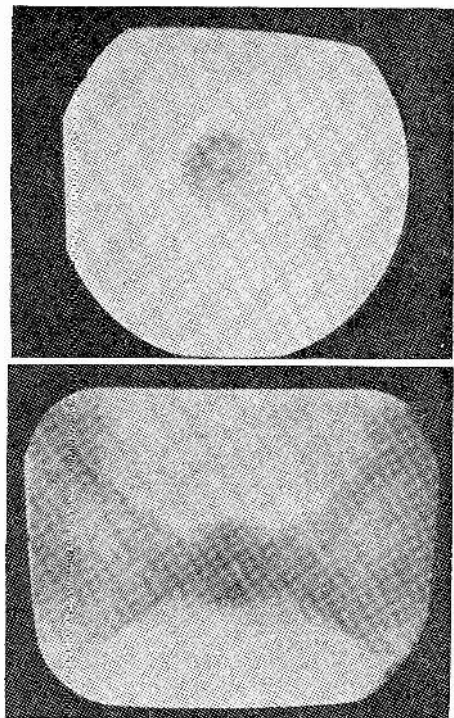

General Electric

Fig. 8-a—Approximately round spot caused by ion-burn in round CRT. Fig. 8-b shows "spider" burn in rectangular tube.

round tubes, this looked like Fig. 8-a, a round spot in the center of the screen. In rectangular types, you usually see "the spider," a round spot with four fuzzy arms, as in Fig. 8-b.

If this shows up, there's nothing to do but replace the tube—this can't be cured. In some cheap "rebuilt," the gun is replaced (?) and the original phosphor used. If the tube was ion-burned, it'll *still* be ion-burned! The rebuilt tubes from the better factories replace the phosphor screen, using nothing but the glass bulb of the old tube. Aluminized phosphors will not have this trouble; the aluminum backing prevents the ions from reaching the phosphor.

### Gassy CRT's

Once in a while, you'll find CRT's with gas, air leakage, etc. In some of these, you'll be able to see the electron beam as it goes through the gun, as a thin blue "pencil" of light! If the gas concentration is bad enough, you'll get an effect similar to that in Fig. 1—defocusing and loss of grid control. Replacement is the only cure. Some CRT testers have gas checks, the same circuits used on other tube testers.

### Grid damage

If the ion-trap magnet wasn't set right when the tube was installed, the electron beam can hit the side of the tiny hole in the grid or anode disc. This can, in time, chew away some of the metal! See Fig. 9. If the hole is too much enlarged, it can cause blurring and loss of focus. If all other tests show nothing, but the focus is still poor, this could be

the cause. There is no way to be *sure*, without taking the gun apart! When you install a new CRT, always be sure that the ion-trap magnet is properly set, for maximum *brightness*. In electrostatic-focus tubes, set it for maximum brightness by sliding it back and forth along the tube neck, then *very slightly* around the neck, watching the screen, for best *focus*. Don't use it to remove neck shadows!

#### Loose bases

The CRT base often came loose in older tubes, from aging of the cement.

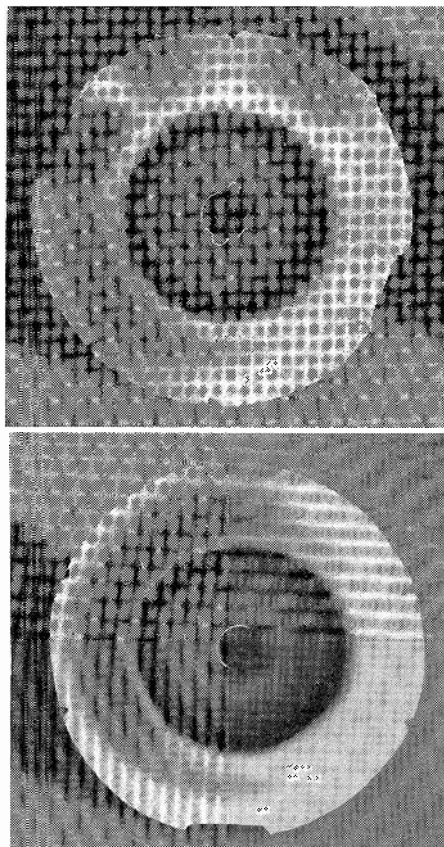

Allen B. DuMont Labs.

Fig. 9—Note the hole and ragged edges in the anode disc at top. Compare it with the undamaged disc, bottom.

Special tube-base repair cement can be found in parts houses. Run a thread of this around the base and let it dry well.

If the leads become loose in the pins, resolder them. Running a short piece of fine bare wire, well tinned, inside the pin, while heating the pin and feeding fresh solder to the tip, is a good trick. Don't let it go more than 1/2 inch inside the pin. Clip it off after the solder has cooled.

A pin crimper especially made for this purpose is also very handy. It crushes the base of the pin to make a firm contact to the wire lead. Always carry one in the tube caddy for emergencies.

When all of these tests have been tried, without results, there's only one thing to do: replace the CRT. On this, only one suggestion. *Don't drop it!* END

# R-E Guide to Test Tapes and Records

By ROBERT F. SCOTT TECHNICAL EDITOR

HIGH-FIDELITY AMPLIFIERS, TAPE RECORDERS and phonographs must be correctly installed and kept in top-notch condition. The hi-fi listener usually requires optimum reproduction. Tape decks and record players have to be checked and adjusted for minimum flutter and wow; cartridges must track correctly with minimum stylus pressure. Speakers in stereo and multi-channel systems must be correctly phased, stereo channels should balance and amplifier response and equalization meet minimum standards.

If you are wondering how your equipment meets these and other stringent requirements, why not give it a complete checkout by using test tapes and records. Some deficiencies can be corrected with a few simple adjustments. Others may require precision test instruments. A scope, audio vtm or VU meter is recommended as an output-level indicator. In emergencies, you can

connect a flashlight bulb (200–300 ma, 2–6 volts) across the speaker leads as an output indicator.

If you are a service technician, you will find test tapes and records invaluable in installing, troubleshooting and servicing high-fidelity audio equipment. Here is a review of some of the most popular test tapes and records and an outline of what they do and how to use them.

#### DIRECTORY

**Audio Devices**, 444 Madison Ave., New York, N. Y.  
**Audio Fidelity Inc.**, 770 11th Ave., New York, N. Y.  
**Audiotex Mfg. Co.**, Div. G-C/Textron Inc., 400 S. Wyman St., Rockford, Ill.  
**CBS Labs.**, Professional Products Dept., 227 High Ridge Rd., Stamford, Conn.  
**Command Records**, Div. Grand Award Record Co., 1501 Broadway, New York, N. Y.  
**Hi-Fi Stereo Review**, Ziff-Davis Publishing Co., 1 Park Ave., New York, N. Y.  
**Lafayette Radio Electronics**, 111 Jericho Turnpike, Syosset, N. Y.  
**Nortronics Co. Inc.**, 8101 10th Ave. No., Minneapolis, Minn.  
**RCA Victor Custom Record Sales**, 155 E. 24th St., New York 10, N. Y.  
**Vanguard Recording Society**, 154 W. 14th St., New York, N. Y.  
**Westminster Recording Co., Inc.**, 1501 Broadway, New York, N. Y.  
**Westrex Co.**, 1136 Las Palmas Ave., Hollywood, Calif.

## TEST RECORDS

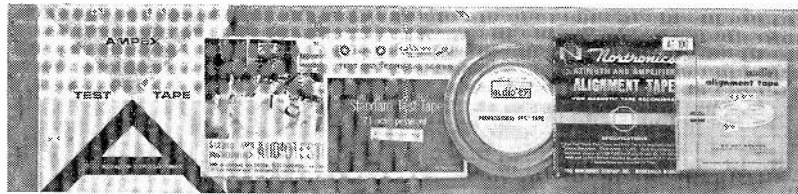

The gaps in tape recorder reproduce and record heads must be checked for precise alignment at right angles to the tape track. This brings performance from pre-recorded tapes to optimum and makes it possible to interchange tapes between different machines without loss of high-frequency response. Playback response, signal-to-noise ratio, wow, flutter and stereo balance must also be checked.

#### AmpeX Reproduce Alignment Tapes

These tapes are recorded for specific operating speeds. The tone designated for alignment has a wavelength of 1/2 mil on 7.5- and 3.75-ips tapes and 1 mil on 15-ips tapes. Voice announcements identify each tone frequency and level.

On the 31321-01 7.5-ips full-track tape reviewed here, a 700-cycle reference tone is recorded 10 db below the normal operating level. This is followed by a 15-kc signal for head alignment and then 10-second bands of tones of 12, 10, 7.5, 5, 2.5 and 1 kc and 500, 250, 100 and 50 cycles.

These tones are recorded 10 db below normal operating level and are used to check playback response. The playback amplifier gain should be adjusted so the VU meter reads 0 db. This setting is used for record adjustments and making signal-to-noise ratio tests.

We found that the time allowed for head alignment is not long enough. This makes it necessary to rewind and replay the alignment band to insure precise adjustments.

#### Audio Alignment Tape

This 4-in. reel of Mylar tape, produced by Audio Devices, Inc., is used to align record and play heads at 15 and 7.5 ips. It consists of 30 seconds each of 2- and 10-kc tones, 60 seconds at 15 kc and then 30 seconds of 10 and 2 kc when played at 15 ips. (All frequencies are halved and times doubled when played at 7.5 ips.) All tones are separated by 5-second intervals.

This tape is recorded symmetrically so it can be run in either direction and rewinding is not necessary. (Alignment tapes should never be subjected to high-speed rewind. This can cause stretching, which may

produce inaccuracies. The added stress on the tape also increases the likelihood of print-through.)

Connect a scope or vtm to the recorder's output terminals, play the 2-kc band. Set the recorder's volume control for normal listening level and adjust the output indicator's sensitivity control for a convenient reference level. Adjust the recording azimuth for maximum output at 10 kc and then at 15 kc.

If the machine has a separate recording head, record a high-frequency signal on blank tape and then play it back through the already aligned reproducing head. Adjust the recording head azimuth for maximum output from the machine.

#### Audiotex 30-206 and 30-208

The 30-206 (Standard Tolerance for Home Equipment) and 30-208 (Precision Tape for Professional Use) tapes open with a 60-second, 7,500-cycle band for head alignment. The next is a 1-kc reference tone to set level. Next, we have an ascending series of 10 tones from 30 to 10,000 cycles for checking overall frequency response. The next band is a continuous sweep of 10,000 to 30 cycles to indicate any serious peaks or dips in the overall response of the system and to pinpoint any resonant peaks in the speaker system or listening area.

The next band is 100 cycles and 7,000 cycles mixed 4 to 1 for intermodulation tests. Any buzz or fuzz indicates severe IM distortion caused by weak amplifier tubes, dirty heads or other troubles. An IM distortion meter is recommended for accurate measurements.

A 20-second, 3-kc tone, recorded at -6-db level, is used as a test for wow and flutter. These defects in reproduction are generally caused by a defective motor, idlers, slippery or worn capstan or pulleys, and must be corrected.

A band of metronome clicks is used to balance the volume of the two channels so the sound appears to come from midway between the two speakers. The tape concludes with a few sustained piano chords as a final check for wow, flutter and overall distortion.

### Nortronics AT-100



This is the only tape supplied without a detailed instruction sheet or booklet. Instructions are on the tape. The first band is a 30-second, 7,500-

cycle tone for head alignment. This is followed by a 400-cycle tone to get reference level. A 1-kc band follows. The recorder's tone controls are adjusted so the output meter reads the same as at 400 cycles. Bands of 4,000, 1,000, 400, 100 and 40 cycles are supplied for response checks.

### RCA Victor 12-5-61T Tape Recording



This is a 7.5-ips standard test tape. It is a two-track recording for testing half-track mono and two-track stereo machines. It has four parts

(1) A 1,000-cycle tone at normal recording level followed by the same tone 20 db lower as the reference level. (2) A 12,000-cycle tone for playback and alignment. (3) A rapid logarithmic sweep from 15,000 to 30 cycles with 17 announced spot frequencies for checking response and detecting dips and peaks in the overall response. (4) Frequency response run of spot frequencies from 15,000 to 30 cycles with voice announcements at 1-kc intervals from 15,000 to 1,000 cycles and at 700, 400, 300, 200, 100, 70, 50 and 30 cycles.

## TEST RECORDS

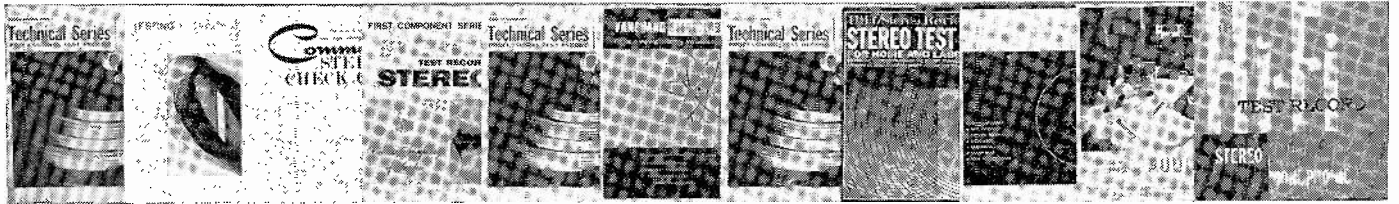

### Audio Fidelity FCS 50,000



This is a stereo test record with nine test bands on Side A and five orchestral demonstration selections on the other. The bands on Side A are: (1) Metronome for channel balance. (2) 1-kc tone on both channels as a reference level for subsequent tone tests. (3) 25 seconds of silence for checking for hum, turntable rumble and stylus wear. A worn stylus gives these grooves a grayish, dusty look. (4) Eleven spot frequencies between 1 and 15 kc recorded in phase in both channels at a constant velocity of 5 cm/sec. This band should be played back flat to give the correct impression of overall system response above 1 kc. (5) Nine frequencies between 1,000 and 30 cycles recorded with RIAA equalization and should be played back on an RIAA curve to check the low-end response of the system. (6) A 15 to 70-cycle sweep frequency to test for resonances in the pickup, arm and speaker system. (7) White-noise bursts to check speaker phasing. (8) 440-cycle Musician's A. (9 & 10) Mixed 800 and 3,000 cycles for checking channel separation, correct tracking force and cartridge alignment.

### Audiotex 30-200



Side A for monophonic tests and Side B for stereo. Bands 1 and 6 of Side A are 8-kc tones which should reproduce with equal volume and clarity. Lower volume or fuzziness on the inner band indicates a worn stylus or defective or dirty cartridge. Band 2 is the RIAA frequency response test. Tones at 11 spot frequencies between 15,000 and 30 cycles are compared to the 1-kc reference level. Band 3 consists of 100 and 7,000 cycles for IM tests. Severe IM distortion can be detected by ear but an IM meter is recommended for this test. The rumble test (band 4) consists of a very low-level (40 db down) 1-kc signal. Rumble signal should not be higher than the level of the 1-kc tone on a high-quality turntable. Band 5 is a slow sweep from 50 to 10 cycles recorded at 100% modulation to test tracking. Arm resonances at some frequencies in this range will cause the stylus to skip or jump out of the groove.

On the stereo test side, Bands 1 and 3 are for pickup alignment and channel separation tests. They consist of a 1-kc tone recorded on one channel and nothing on the other. With a good, correctly aligned pickup, the outputs of the two channels should have a voltage ratio of about 10 to 1 (20 db). Bands 2 and 4 check RIAA response (up to 10 kc) of the right and left channels, respectively, and crosstalk in the unmodulated channel. The stereo balance test on Band 5 is the familiar metronome. Band 6 is the rumble test with a 1-kc signal on both channels.

### CBS Labs test records



The STR 100 (Stereophonic Frequency Test Record) was prepared specifically as an engineering tool of particular interest to the advanced audiophile and audio service technician. Several bands are provided for studying the effects of stylus force, mass, radius and wear on high-frequency response. Other bands are used to measure compliance and other factors important to the engineer. Several sweep-frequency bands have keying tones for synchronizing automatic recorders and oscillographs.

STR 111 (Square Wave, Tracking and Intermodulation Tests) is a precise engineering tool featuring square-wave modulation for rapid tests of high-frequency stylus-tip mass, damping and tracking of phonograph cartridges. Low-frequency compliance and tracking are tested by a series of 300-cycle bands of progressively increasing amplitude. IM distortion is tested in graduated 200- and 400-cycle bands.

STR 100 (Wide-Range Pickup Test—10 to 50,000 Cycles) is prepared for the audio scientist and pickup designer. It tests pickup response from 10 to 50,000 cycles; checks standard level, rumble; surface noise.

STR 130 (RIAA System Response Test) is a professional test record with various types of sweep-frequency

and spot-frequency bands to facilitate response tests of phonograph reproducing systems.

### Command CSC-100



This is a stereo test record consisting of nine test bands on one side and four musical selections on the other. The first three test bands are 1,000-cycle tones for channel balance, channel identification and reference level. The fourth band has 12 spot frequencies between 30 and 10,000 cycles for RIAA response tests. The remaining bands are for checking phasing, acoustic balance of the speakers and turntable rumble.

### PR-14



This test record, made by Components Corp. for Lafayette Radio Electronics, has one side for stereo tests and one for monophonic tests using either a LP or stereo stylus. The stereo-test side has bands for channel identification, the familiar metronome balance test, speaker phasing using 100 cycles both in and out of phase and channel separation measurements. A band of sound effects is used to demonstrate fidelity and stereo spread.

Side B, for monophonic tests, has bands 1 and 7 to test stylus wear. Band 2 is a constant-velocity glide-tone band covering from 35,000 to 1,000 cycles with a "beep" at 5-kc intervals. This should be played back flat without equalization. On Band 3, spot frequencies are checked against a 1-kc reference level for RIAA equalization. Pickup tracking is tested on a glide band covering from 100 to 5 cycles with spaced grooves at 80, 60, 40, 30, 20, 15, 10 and 5 cycles. Bands 4 and 6 provide rigid tests for hum and rumble.

### RCA test records



The RCA 12-5-71, a 12-inch, 78-rpm banded stereo test record covering from 20,000 to 1,000 cycles in 1-kc steps. Side 1 contains modulation only on the left channel and Side 2 is modulated only on the right. Channel separation is better than 30 db at all frequencies. Particularly useful in checking pickup response and separation between 1 and 20 kc.

The RCA 12-5-73, is a 12-in., 33 1/2-rpm disc with bands at 30, 50, 70, 100, 200, 300, 400, 700 and 1,000 cycles in the right channel on one side and the same frequencies in the left channel on the other side. For checking system response, crosstalk and low-frequency resonances.

The RCA 12-5-77 (RL1476) is a 10-in., 33 1/2-rpm test record with the same material on both sides. It is used to adjust stereo phonograph systems for balance, level and phase. Band 1 is 1,000 cycles of about 3 minutes duration on the left channel. Band 2 is the same signal on the right channel. Band 3 is a 1-kc tone recorded laterally at 5.5 cm/sec peak velocity. It should produce equal in-phase signals from both channels. Band 4 is the same signal recorded vertically. It should indicate equal out-of-phase signals from both channels.

### Vanguard VSD-100



This Stereolab Test Record provides nine separate tests for aligning, calibrating and balancing stereo phonographs. The first two tests consist of 14 spot frequencies recorded with RIAA equalization on the left channel and then on the right. The next test is for balance with a 1-kc, 0-db tone on the left and the right channel. The fifth test band consists of a 1-kc tone recorded first laterally and then vertically for checking pickup output. This test can be used to check cartridge and preamplifier phasing by paralleling the outputs and measuring the resulting signal with a vtvm. It should be very high on the lateral (in-phase) cut and very low on the vertical cut.

Next, the speakers are checked for acoustic balance so that the repetitive staccato sound appears to originate midway between them. The seventh test uses a 150-cycle tone to check speaker phasing. Speakers are placed face-to-face and just far enough apart for sound to escape. Three bursts of 150-cycle signal will be heard.

If the first and third are lower than the second, the speakers are in phase. If the middle burst is lower, the speakers are out of phase and the leads to one should be reversed.

A 3-kc band is used for the flutter test. The next test is a 400-cycle signal recorded at plus 8, 6, 4 and 2 db and 0 level for checking distortion caused by excessive level and excessive tracking error. This is followed by an unmodulated groove for checking signal-to-noise ratio. The disc concludes with two musical excerpts. The second side is a duplicate of the first and should be used only as a reference to check the first side for possible wear or damage.

### Westminster SRX



This stereo test record begins with a 1-kc test and reference tone. Bands 2 and 3 are 100-cycle tones to check overall phasing. Band 2 should be louder. Improper phasing can be caused by incorrect connections to the cartridge or speaker. Bands 4, 5 and 6 are for checking RIAA response of left, right and both channels, respectively.

Band 7 is a unique test to check frequency response by ear. It has test tones recorded at levels to complement the Fletcher-Munson hearing curve so that all should be reproduced at approximately the same level.

Wow and flutter are tested with a 3-kc signal on Band 8. Band 9 is the musical equivalent of Band 7 with the test tones ranging from 29.1 cycles from a contrabassoon to 4,184 cycles from a piccolo. The tones are recorded at levels that will play back at approximately equal volume levels.

The second side of this disc uses musical instruments as sound sources to indicate frequencies, provide transients, to illustrate dynamic range and to check stereo separation and tracking.

### Westrex Stereodisk 1-A



This 45°-45° frequency test record covers most of the tests provided by the RCA 12-5-71 and 12-5-73. It is recorded in two frequency bands at constant velocity. Band 1 covers from 1 to 15 kc in 1-kc steps. When played at 78.26 rpm, stylus displacement from left and right channels has a peak constant velocity of 5.0 cm/sec ± 1 db. Band 2 has spot frequencies at 1 kc, 700, 400, 200, 100, 50 and 30 cycles. When played at 33 1/2 rpm, peak stylus velocity is 0.43 cm/sec ± 0.5 db. Since it is recorded at constant velocity, it can be used to measure overall response of the reproducing system directly. When played without RIAA equalization, the response will be flat except for variations in the gain of the reproducing system.

### Hi-Fi Stereo Review Model 211



This record is unique in that it uses warble tones instead of spot frequencies and sweeps for most tests. A warble tone that sweeps continuously from 80 to 160 cycles is used for speaker phasing. Frequency response runs on the right and left channels consist of 18 warble tones sweeping between 14,700 and 20,000 cycles on the high end and 20 to 40 cycles on the low end. Each test warble is identified by voice announcement and is preceded by a 920-1,300-cycle test warble for comparison.

Cartridge tracking at low frequencies is checked by a 300-cycle note that repeatedly swings to a high volume level and then back down again. Tracking force should be adjusted so this band plays without buzzing. For the high-frequency tracking test, 11,000 and 11,500 cycles are recorded simultaneously in a series of volume sweeps. The 500-cycle difference frequency should be almost inaudible or very short and steady. If it is loud, long and rough, increase stylus pressure.

Additional tracking tests are provided by short musical passages repeated at successively higher levels. Buzzing or shattering highs indicate incorrect stylus pressure.

Separation is checked with warble tones similar to those used in the response runs.

END

# Tape and Disc Accessories

... a directory

By ROBERT F. SCOTT, TECHNICAL EDITOR

## Bulk Tape Erasers

Bulk erasers assure 100% erasure and remove all recorded signals faster and more completely than most recorders. Save wear on heads, pressure pads, guides, clutches and other parts of the recorder.



**Magneraser 200C** features a 750-gauss erasing field with low power consumption. Handles 1/4-in. and 1/2-in. tape and 16- and 35-mm magnetic sound film on any reel from 5 to 15 in. Lowers background level 3 to 6 db below that of virgin tape. Also demagnetizes record - playback

and erase heads, reducing distortion and background noise. Draws 60 watts from 110-130 volt 50-60 cycle source. 2 1/2 in. high; 4-in. diameter. 3 1/2 lb. Push-button safety switch and 8-ft line cord.—**Amplifier Corp.**

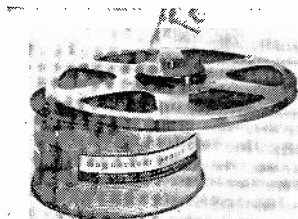

**Magneraser Senior.** Professional model for audio, computer, telemeter and machine-control tapes to 35 mm. Handles reels up to 10 1/2 in. without shifting. Erases all tapes better than 65 db below standard reference

level. Also demagnetizes tools, watches, tape guide posts, capstans, and magnetic sheet metal. Field intensity 800 gauss. Draws 175 watts from 50-60 cycle line. Model 300A, 100-130 volts Model 300B, 200-240 volts. 3 3/4 in. high, 7-in. diameter, 10 lb.—**Amplifier Corp.**

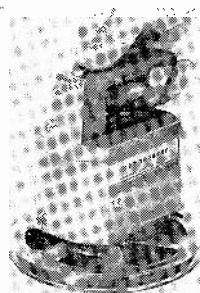

**Magneraser Junior,** model 150A concentrates maximum vertical erasing flux in tape up to 35 mm with a minimum of horizontal leakage flux. Also demagnetizes heads, guides, tools and metal. Field intensity 750 gauss. 110-130 volts, 105 watts. 4 3/8 x 4 3/8 x 2 1/2 in., 4 lb.—**Amplifier Corp.**

**Taperaser** (Cat. No. 30-114) combines advantages of powerful professional models with compactness of popular models. Magnetic field concentrated in relatively small area. Movable spindle slides tape reel across the field. Handles tape reels up to 10 1/2 in. and erases to minus 52-db level without low-frequency thumps or "spokes." Has 6-ft line cord and momentary on-off switch.—**Audiotex**

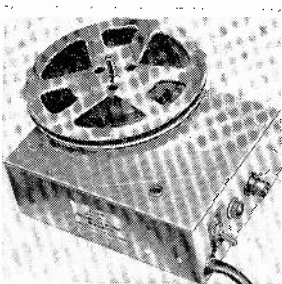

**Model ML-120,** a professional instrument featuring two separate coils for complete erasure of tapes up to 1 in. on reels up to 10 1/2 in. Reduces tape hiss to level of new virgin tape. Has heavy-duty line cord and switch, pilot light and fuse. 105-125

volts, 60 cycles, 9 amps. 6 1/4 x 7 7/8 x 3 1/2 in. 14 lb.—**Lafayette**

**ML-176,** similar to ML-120 for tapes up to 1/4 in. Reel must be turned over once. Has spindle positions for 3-, 5-, 7- and 10 1/2-in. reels. 105-125 volts, 60 cycles, 5 amps. 7 1/2 x 4 3/4 x 3 1/2 in. 9 lb.—**Lafayette**

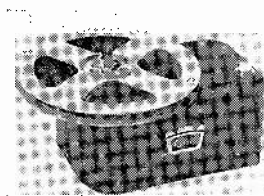

**No. 55-03** accommodates any size reel up to 10 in. and completely erases entire reel in seconds. Reduces background level far below that of normal

tape recorder erase heads.—**Roberts**

**Model ME-99** removes recorded and unwanted signals and reduces background noise 3 to 6 db below normal erase-head level. Demagnetizes tapes up to 1/2 in. wide on reels up to 10 1/2 in. 110-120 volts, 6 amps, 50-60 cycles. 3 3/4 x 5 1/4 x 6 3/4 in.—**Robins**

**Model ME-77,** low-cost version of the ME-99. For 1/4-in. tapes on reels up to 7 in. Reduces background

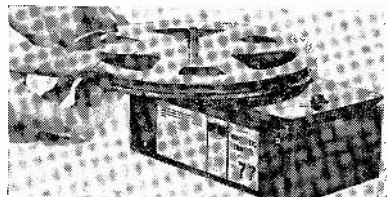

noise 2 to 4 db below erase-head level. 110-120 volts, 50-60 cycles. 2 3/8 x 3 3/4 x 6 1/4 in.—**Robins**

## Tape-Head Demagnetizers

High-level peaks in the recording signal and transients produced by noise on the power line and by stopping and starting the machine tend to magnetize the recording, playback and erase heads in the recorder. This may increase the noise level 5 to 10 db, distort the signal and gradually erase the high frequencies on any tape played on the recorder. Thus, the heads should be

demagnetized every 8 hours or so for optimum recorder performance.

Head demagnetizers consist of an ac electromagnet with narrow-gap pole pieces shaped to straddle the gap in the heads. The pole pieces are shaped to reach the heads in most recorders without removing the head covers. One demagnetizer, the **Lafayette PK-238**, has removable straight, 45° and 90° pole pieces for quick and easy use on any tape head. Some models have momentary on-off switches. Others are turned on by plugging them into the ac line.

Generally, pole pieces are tipped with a soft plastic material to protect the head surfaces.

To use the head demagnetizer, plug it into the line or close the switch, straddle the pole pieces across the gap in the recording head and run it up and down several times for a few seconds. Then gradually withdraw the unit from the head before turning it off. Repeat the operation on the play and erase heads and the tape guides.

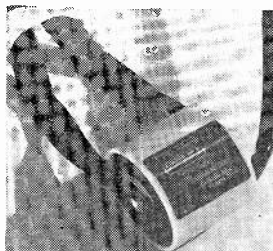

**Model 820** features flat contoured pole pieces.—**Ampex**



**Type 400** head demagnetizer has beveled tips to simplify operation.—**Audio Devices**



**Head-Demag** (Cat. No. 30-112) has built-in momentary switch.—**Audiotex**

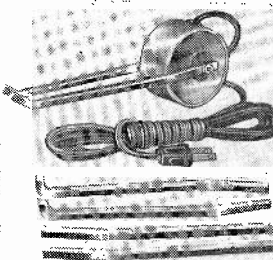

**PK-238** shown with three sets of pole pieces. Manufacturer's model MS-694 (not shown) is similar in appearance to the model 820.—**Lafayette**



**HD-3,** economy version of the manufacturer's UL

## DIRECTORY

- AR**—Acoustic Research, Inc., 24 Thorndike St., Cambridge 41, Mass.
- Ampex**—Ampex Corp., 934 Charter St., Redwood City, Calif.
- Amplifier Corp.**—Amplifier Corp. of America, 398 Broadway, New York 13, N. Y.
- Audio Devices**—Audio Devices, Inc., 444 Madison Ave., New York 22, N. Y.
- Audiotex**—Audiotex Co., Div. of GC-Textron Electronics, 400 W. Wyman St., Rockford, Ill.
- Elpa**—Elpa Marketing Industries, Inc., New Hyde Park, N. Y.
- Ferro**—Ferrodynamics Corp., Lodi, N. J.
- Garrard**—Garrard Sales Corp., 80 Shore Rd., Port Washington, N. Y.
- Grado**—Grado Laboratories, Inc., 4614 7th Ave., Brooklyn 20, N. Y.
- Kersting**—Kersting Mfg. Co., 504 S. Date St., Alhambra, Calif.
- Knight**—Allied Radio Corp., 100 N. Western Ave., Chicago 80, Ill.
- Lafayette**—Lafayette Radio Electronics, 111 Jericho Turnpike, Syosset, N. Y.
- Lektrostat**—Dexter Chemical Corp., 819 Edgewater Rd., New York 59, N. Y.
- Roberts**—Roberts Electronics, Inc., 5978 Bowcroft St., Los Angeles 16, Calif.
- Robins**—Robins Industries Corp., 15-58 127th St., Flushing 56, N. Y.
- Walco**—Walco Electronics Co., Junction Routes 3 & 46, Clifton, N. J.
- 3M**—3M Co., 2501 Hudson Rd., St. Paul 19, Minn.



approved HD-6. For less-often-used recorders.—**Robins**

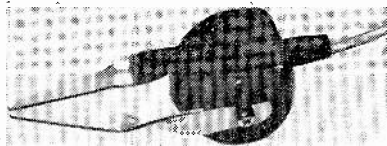

New demagnetizer replaces the model 54-02.—**Roberts**

## Tape and Head Cleaners

Tape-head cleaners consist of chemicals, cloths and reels of special tape to clean and lubricate tape heads and guides as the tape is run through the machine.

Kleen-Tape, a 30-ft., 3-in. reel of impregnated cloth tape.—**Audiotex**



**Kleen-Tape kit.** Reel of rubber-backed tape with extrasoft brush velvet face and a bottle of fluid to remove dirt and oxide deposits. Harmless to plastic, rubber or metal parts.—**Elpa**

RT-378. Tape impregnated with special cleaner. Can be reused many times. 100 ft. on 5-in. reel.—**Lafayette**

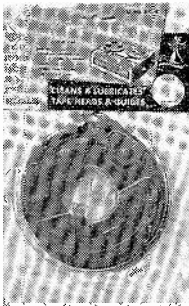

**Tape Clean,** 5-in. reel of chemically treated cloth tape cleans heads and guides and deposits layer of silicone lubricant to reduce friction.—**Robins**

**Tape Recorder Head Cleaner (Cat. No. 30-124-1)** A balanced formula of safe solvents to remove grease and dirt. For best results, use with **Tape Recorder Head Lubricant (Cat. No. 30-124-2)**, a silicone in a solvent base, to lubricate heads and guides to eliminate tape squeal and reduce wow and flutter. **Tape Cleaning Cloth (Cat. No. 30-026)** works two ways. Applies an antistatic agent to tape to repel dust and dirt and a thin coating of silicone lubricant to reduce abrasive friction.—**Audiotex**

**JCT-2 Jockey Cloth for Tapes, HC-2 Head Cleaner, RC-2-22 Head and Guide Lubricant, RC-2-23 Tape and Phono Drive Oil, RC-2-56 Non-Slip for Tape and Phono Drives**—**Robins**

## Tape Splicers

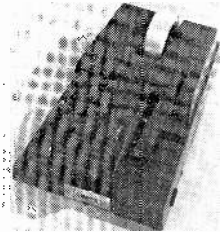

**Model 805 splicer** designed for precise requirements of splicing 4-track tape. Protects program material on tape. Has splicing tape dispenser and two cutting positions.—**Ampex**

**Metro-Splicer** splices either standard magnetic recording tape or 8-mm movie film. Features interchangeable channels calibrated in inches and millimeters. Nonmagnetic blade cuts at any angle. Transparent unit shows exactly where cut is made. Splicer made of high-

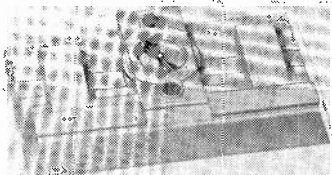

tensile nylon and is entirely nonmagnetic. Comes with replacement cutter unit.—**Elpa**

**Standard Stereo 4-Tape Splicer, TS-4S,** made of metal and plastic with replaceable cutter cartridge and blades. Has blade centering adjustment and integral

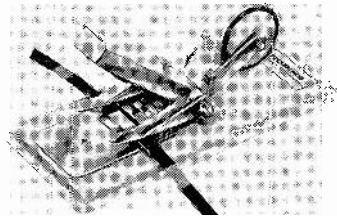

tape dispenser with 100-ft. roll of splicing tape. **TS-4J,** similar to the **TS-4S** without integral tape dispenser. **TS-8D** has features of and is similar in appearance to the model 805.—**Robins**

## Self-Threading Tape Reel

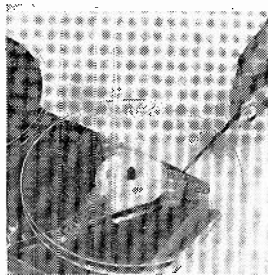

The clumsy hard-to-thread slots and grooves have been eliminated from the new self-threading tape reel shown. You simply hold the end of the tape against the hub and start the machine. Tape end is automatically anchored by pressure of three tiny spring clips.—**3M**

## Tape Care Kits

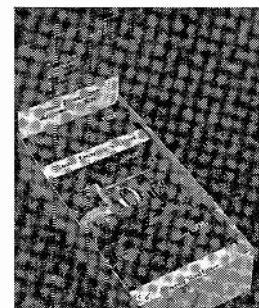

**Home Recorder Accessory Kit model 895** includes model 820 head demagnetizer, splicing and leader tapes, 4-oz. can of No. 823 head cleaner, model 805 tape splicer and box of swabs. **Professional Accessory Kit model 894** includes can of No. 823 head cleaner, model 820 head demagnetizer, bottle of lubricating

oil and box of swabs.—**Ampex**

**Maintenance and Service Kit (Cat. No. 30-099)** for language labs and professional users. Contains tape and record labels, splicing and leader tapes, tape strobe, bottle of head cleaner, bottle of head lubricant, roll of Kleen-Tape, head demagnetizer, splicer, hi-fi service tool kit and handy carrying case.—**Audiotex**

**TK-7** reel. tape kit contains two 3-in. reels, two 3 1/4-in. reels, two 5-in. reels, two 7-in. reels, two reels of 1200-A tape, splicer, splicing tape, two leader tapes, one strobe tape, six tape clips, marking

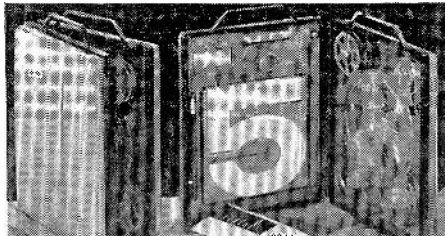

pencil, book "How to Make Better Tape Recordings" and an attractive carrying case. Kit **TK-3** has three 3-in. reels, two 3 1/4-in. reels, one 3-in. reel of tape, one 3 1/4-in. reel of tape, splicer, splicing tape, two leader tapes, strobe tape, six tape clips, marking pencil, recording booklet and carrying case.—**Ferro**

**Professional kit (Cat. No. 79 RX 898D)** for serious recordists (illus.). Consists of five 7-in. reels of 1 1/2-mil Mylar tape, head demagnetizer, tape cleaning cloth, 150 ft. of leader tape, tape splicer, tape threader, 2-oz. bottle of head cleaner, 30 adhesive tape labels, 12 tape clips and 24-page book on splicing and editing tape. **Low-Cost Kit (Cat. No. 79 RX 893D)** contains such recording essentials as three 7-in. reels of 1 1/2-mil Mylar, 150 ft. of leader tape, splicer, threader, head cleaner, labels, clips and book on splicing and editing. **Cat. No. 79 RU 896D,** kit for battery recorders, has three 3-in. reels of 1/2-mil tape, one empty reel, splicer,

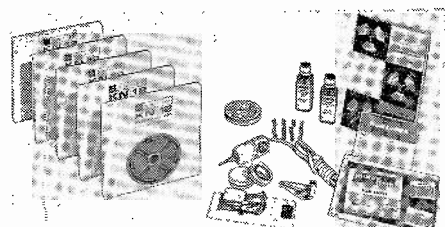

12 clips, 100 ft. of splicing tape, 2-oz. bottle of head cleaner, book on splicing and editing tape.—**Knigh**

**Gibson Girl Stereo 4 kits, AVK-1** for professionals, language labs, visual-aid departments, broadcast and audio studios. Contains manufacturer's MD-99 bulk eraser, HD-6 head demagnetizer, TS-8D splicer, TC-12 tape clips, SL-30 reel labels, JCT-2 tape cleaning cloth, six rolls of ST-500 splicing tape, TT-1 tape threader, TK-5 strobe and light, TK-6 head and guide lubricant and cleaner. **TK-4STD** is the standard accessory kit containing **TS-4J** tape splicer, 100 ft. of splicing tape, threader, tape clips, **HC-2** head cleaning fluid, tape cleaning cloth and "Guide Book to Better Tape Splicing and Editing."—**Robins**

## Magnetic-Tape Viewer

The No. 600, designed especially for use with instrumentation tapes, has several audio uses such as to

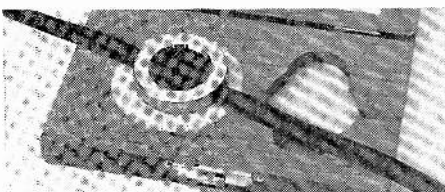

examine and synchronize the audio track on video tape, check head alignment and track placement and to study the pattern of the recorded sound.—**3M**

## Tape-Reel Adapter

No. 54-86 mounts on manufacturer's 997, 990A, 990S and 192 recorders so they handle 10 1/2-in. reels.

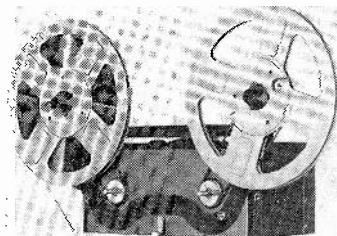

Increases total playing time up to 12 hours per reel. Up to 3 hours of stereo record or playback without changing reels. Makes recorders ideal as background music sources.—**Roberts**

## Record and Tape Files

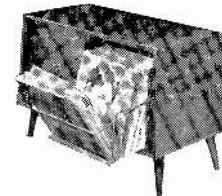

**Quick-See** all-metal slide-mounted record and tape files mount easily in built-in music centers, hi-fi cabinets, closets or shelves. Front-view visibility and flip-through convenience. Nine models to fit most storage areas. Hold up to 125 12-in. LP's, 150 45's or 30 tapes. Several cabinet styles and finishes.—**Kersting**

## Phono and Tape Strobes

The speed of a phonograph turntable or a tape recorder affects the pitch of the music. Simple stroboscopic devices are used to check the speed. Strobe discs for phonographs are available from a number of sources.

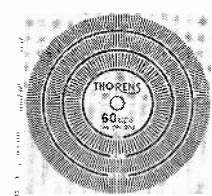

Cardboard types like the **Robins SD-4** are most common. Strobes are also available in metal (**Thorens-Elpa**, illus.) and plastic (**Audiotex 30-230**).

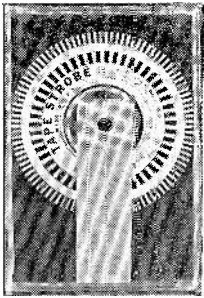

Tape Strobe 30-234 is driven directly by the tape. When viewed under neon or fluorescent light, the strobe disc appears motionless at the indicated speed. Checks 3 3/4- and 7 1/2-ips speeds.—**Audiotex**



.001%. No need to thread on reels. Just drape across heads as shown, operate machine and view tape under neon or fluorescent light.—**Lafayette**

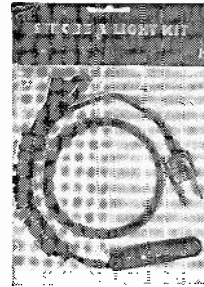

Strobe and Light Kit TK-5 contains neon lamp on 6-ft ac cord and five 24-in. strobe tapes. Splice one strip into continuous loop to test capstan drive. Splice strips into beginning, middle and end of full reel of tape to check machine speed under varying loads. ESK-5 consists of a stroboscopic disc and neon lamp for checking phono turntable or changer speeds.—**Robins**

### Stylus Pressure Gages

Stylus pressure must be correct for optimum tracking and sound and for minimum record wear and damage. Stylus gages are essential for measuring the pressure of the stylus on the record. In the most common type, the weight of the stylus on one end of a platform is balanced against a calibrated weight on the other.

The **Walco Microgram** (illus) and **Audiotex** (Cat. No. 30-222) have a single weight that is moved to

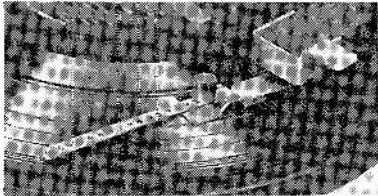

calibrated positions on the beam to measure stylus pressure. These are calibrated from 1 to 10 grams.

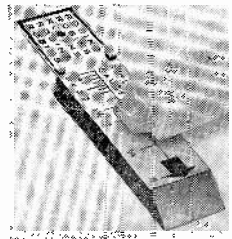

To use the **Robins SG-2**, we move the stylus to calibrated positions along the beam to balance it against a fixed weight on the other end. Measures 1/2 to 8 grams.



The **AR Needle Force Gauge** is an equal-arm balance with weights to 1/4 gram.

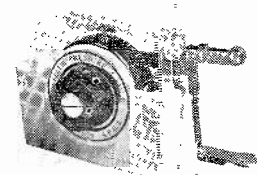

The **Garrard SPG3** features a large legible scale with easy-to-read 1/2-gram markings. A 5-gram standard weight is supplied to check and set accuracy.

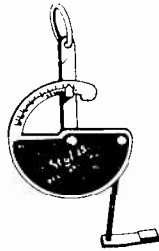

### Stylus Microscopes

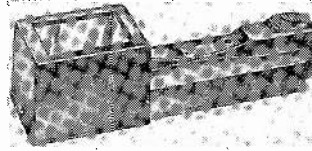

**Stylograph PK-634** for inspecting stylus tips for wear, chipping and other damage. Shows large illuminated silhouette of stylus tip on 1 x 1 1/2-in. ground-glass screen. Stylus need not be removed from cartridge or pickup arm. Complete with batteries, on-off switch and bulb. 5 3/4 x 1 5/8 x 1 5/8 in. PK-237 pocket-type inspection scope with 50X magnification. Similar in appearance to Robins MX-1 below.—**Lafayette**

**Model MX-1** (bottom) features precision-ground lenses and knurled focusing adjustment for clear mag-

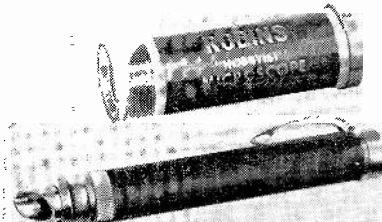

nification. Slot holds stylus assembly steady. Pen-type pocket clip. 1/2-in. diameter, 3/4 in. long. MX-40 Hobbyist is an inexpensive unit. Direct reading with clear plastic lens.—**Robins**

### Stylus-Wear Timer

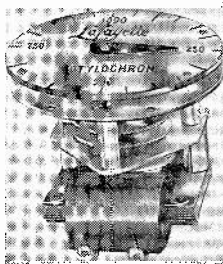

**Stylochron PK-224** keeps accurate record of actual time phono stylus is in use. Motor-driven timer begins to operate when turntable or changer starts, and stops when the turntable cuts off. The 2 3/8-in. 1,000-hour dial is marked in 50-hour units. Mounts on motor board or any convenient spot. Extends 1 7/8 in. below or behind panel.—**Lafayette**

### Record Cleaners and Record-Care Kits

Most record cleaners consists of an antistatic detergent and lubricant and a soft pad applicator that removes dust and grime.

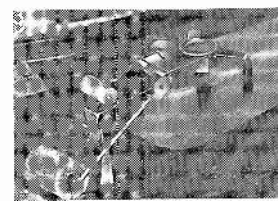

The **Watts Dust Bug** and **Changer Dust Bug** (illus) consist of a fine nylon brush that dislodges dirt before it reaches the stylus and a plush roller that applies the antistatic cleaner and collects surface dirt. The **Dust Bug** is on a pivoted arm with positions for 12- and 16-in. records. A suction cup mounts the arm on turntables and changers without interfering with the turntable or pickup arm operation. The **Changer Dust Bug** clips directly on the changer arm. Supplied with antistatic cleaner.

**Parastat MK 11A** is a manual adaptation of the **Dust Bug**. Nylon bristles and detergent reach deep into

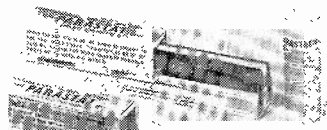

record grooves, removing accumulated dust, grime and residue. Improves reproduction of old records and sustains the hi-fi reproduction of new ones.

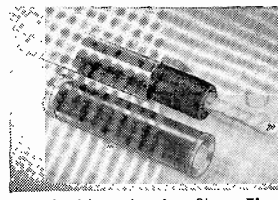

record without leaving film.—**Elpa**

**Dustar** velvet-surface brush on a swivel cleans entire record continuously during playback. Pivot mounts

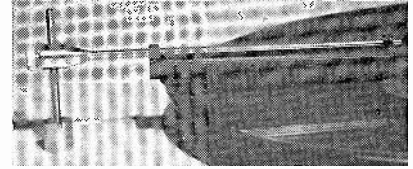

in suction cup or 1/4-in. hole drilled approximately 7 in. from center of turntable.—**Grado**

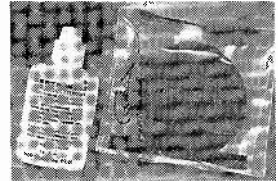

**Lektrostat Record Cleaning Kit** consists of a 1 1/4-oz squeeze bottle of antistatic detergent and an applicator of sheared acetate velvet fibers in a convenient plastic envelope. Cleans records, reduces pops and crackles from static electricity.—**Lektrostat**

**Disk-Whisk Kit** (similar in operation to **Changer Dust Bug**) consists of lightweight nylon brush, mohair cylinder and a bottle of antistatic fluid containing silicone lubricant and detergent. **Rob-O-Stat** is a record-cleaning kit consisting of a velvet and foam applicator mitt, 1 1/2-oz bottle of antistatic detergent and lubricant and a polyfoam pad for removing dust from the mitt.—**Robins**

**Phono Accessory and Care Kit** (Cat. No. 30-098) consists of a record brush, antistatic detergent and velvet pad applicator, package of 12 plastic record envelopes, pickup arm lift, stylus microscope, stylus pressure gauge, strobe disc and a vial of special phonograph and recorder oil.—**Audiotex**

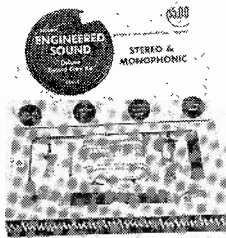

**Deluxe Record Care Kit**, ESK-3 helps you to bring out the best from your stereo or monophonic phonograph. Consists of stylus gauge, stylus microscope, turntable level, record cleaning cloth, needle brush, record brush and pickup arm lift.—**Robins**

### Pickup-Arm Controls

Remote controls for phonograph pickup arms minimize stylus and record damage caused by accidentally dropping the arm or sliding the stylus across the record. The control gently lowers the arm onto the record and lifts it off at the end of play. Ideal for cueing. Adaptable to most pickup arms and changers with manual features.

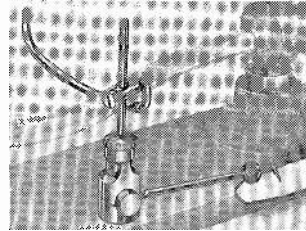

**Ortofon Hi-Jack** features air-cushioned lowering. Mounts on Thorens TD-124 and TD-121 turntables without drilling.—**Elpa**

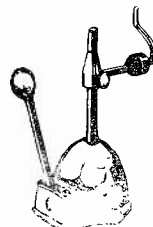

**MS-785** has adhesive mounting base to keep it in position and is supplied with both wood and metal mounting screws for permanent installations.—**Lafayette**

END

# New EASTMAN Sound Recording Tapes give you sound recording at its best.

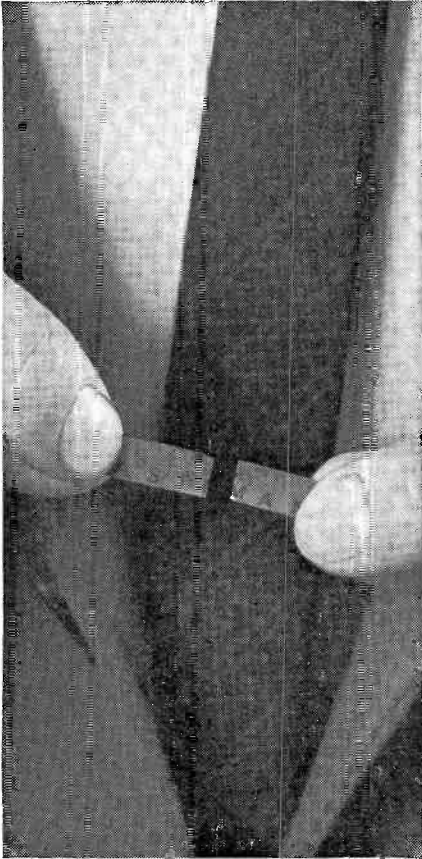

**STOP** New **DUROL Base** won't stretch. Special triacetate formulation has exceptional tensile and yield strength. Yet in case of equipment failure the tape breaks clean without stretching. Splices are quickly and easily made; program loss is reduced to an absolute minimum.



**LOOK** New "lifetime coding" assures highest quality. Permanent legend continuously printed on the back of the new Eastman tapes identifies Eastman Kodak Company as the manufacturer and provides a convenient indexing code.



**LISTEN** New "R-type" binder greatly improves sound quality. Smooth, tough, oxide layer of supreme uniformity suppresses tape noise and intermodulation distortion. High resistance to abrasion prevents oxide build-up at the recorder head. Great chemical stability results in long tape life.

The superb magnetic properties of the new binder make possible the development of two superlative sound-recording tapes.

Ask for the new Eastman tapes at **leading electronic supply houses**: Eastman tape, Type A303 (low-print) or Type A304 (high output with low noise).

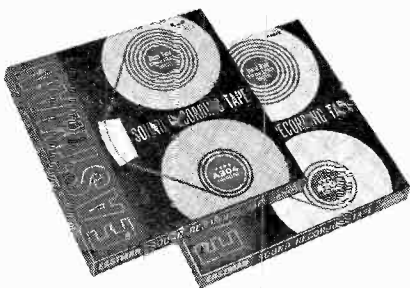

**Unique Thread-Easy Reel** allows fast, easy loading, has indexing scales and splicing jigs on both sides.

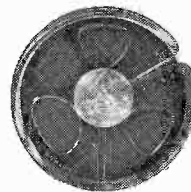

**EASTMAN KODAK COMPANY, Rochester, N.Y.**

© EASTMAN KODAK COMPANY MCHLXI

MARCH, 1964

**Kodak**  
TRADE MARK

Exclusive with **RCA** ...

# AUTOTEXT®

## the faster, easier way toward a career in electronics

Amazing home training method makes learning almost automatic

**Exclusive with RCA.** "AUTOTEXT" the revolutionary home training method introduced by RCA Institutes, Inc., is stirring the interest of thousands. Every day, "AUTOTEXT" is helping people like yourself join the thousands of other successful electronic students who are working toward profitable careers right now! This faster, easier way to learn electronics uses the latest scientific development in the field of home training—and "AUTOTEXT" is exclusive with RCA.

**New trend in education.** This exciting new trend in education represents a significant advance in teaching electronics. People who have been interested in careers in electronics in the past, but have had difficulty with conventional home training methods, can now begin to master the fundamental principles of electronics almost automatically. Tested in schools throughout the country, checked out and proved with thousands of students, programmed instruction is helping people learn more quickly and with less effort.

**Prove it to yourself now!** If you have a natural inclination or interest in the exciting field of electronics, that's all you need. RCA "AUTOTEXT" will help you do the rest.

And the future is unlimited. Jobs are available for qualified technicians in Space Electronics, Communications, TV, Computer Programming, Automation, and many other electronic fields. The important thing is to get started now!

**Complete course available.** Right now, RCA Institutes offers you a complete Home Training Course ("Introduction to Electronics") using the "AUTOTEXT" method. You get a complete set of theory lessons, service practice lessons, experiment lessons, and all the kits you need. And most important, "AUTOTEXT" takes most of the effort out of learning the all-important groundwork of the electronics field.

**FREE OFFER!** We'll send you complete information on amazing new RCA "Autotext" along with a FREE SAMPLE of a lesson to prove to you how easy it is to learn this new way. Send the attached postage-paid card and check "Autotext".

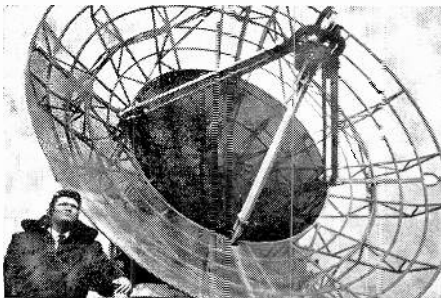
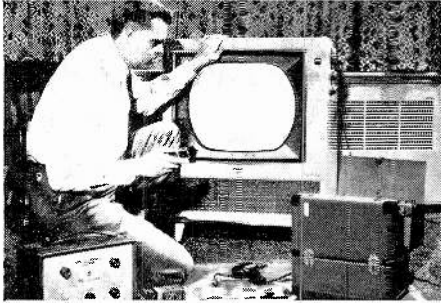
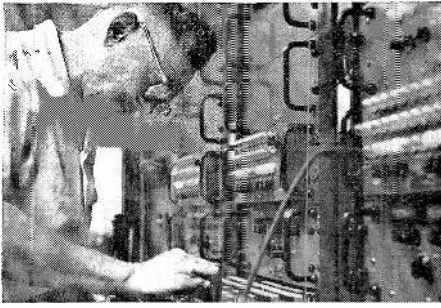

# Wide choice of Home Training courses in Electronics:

- Autotext Introduction to Electronics
- TV Servicing
- Color TV
- Communications Electronics
- FCC License Preparation
- Mobile Communications
- Automation Electronics
- Electronic Fundamentals (also available in Spanish)
- Computer Programming
- Transistors
- Electronic Drafting
- Industrial Electronics
  - Automatic Controls
  - Industrial Applications
  - Nuclear Instrumentation
  - Digital Techniques

RCA Institutes Home Training Courses are complete step by step easy-to-understand units. You get prime quality equipment in the kits furnished with you, and all of it is top grade. It's yours to keep and use on the job.

**Liberal Tuition Plan.** RCA Institutes Home Training Courses are available under a liberal tuition plan that affords you the most economical possible method of home training. You pay for lessons only as you order them. If, for any reason, you should wish to interrupt your training, you can do so and you will not owe a cent until you resume the course. No long-term obligations!

**Set Your Own Pace.** RCA Institutes Home Training takes into consideration your own ability, finances and time. You learn at your own speed, in the most effective manner, with personalized instruction every step of the way. You get theory, experiment, and service practice beginning with the very first lesson. All lessons are profusely illustrated—a complete training package in every way.

## CLASSROOM TRAINING

**Free Placement Service.** RCA Institutes Resident School graduates are now employed in important jobs at military installations, with important companies such as IBM, Bell Telephone Labs, General Electric, RCA, in radio and TV stations and in communications systems all over the country. Many other graduates have opened their own businesses. A recent New York Resident School class had 92% of the graduates who used the FREE Placement Service accepted by leading electronics companies, and had their jobs waiting for them on the day they graduated!

**Coeducational Day and Evening Courses** are available at Resident Schools. You can prepare for a career in electronics while continuing your normal, full-time or part-time employment. Regular classes start four times a year.

SEND POSTCARD FOR FREE ILLUSTRATED BOOK TODAY! SPECIFY "AUTOTEXT", HOME STUDY OR CLASSROOM TRAINING.

**RCA INSTITUTES, INC.** Dept. RE-34

A Service of Radio Corporation of America,  
350 West 4th St., New York, N. Y. 10014



**The Most Trusted Name in Electronics**

by Jack Darr  
Service Editor

# S Service clinic

This column is for your service problems—TV, radio, audio or general and industrial electronics. We answer all questions individually by mail, free of charge, and the more interesting ones will be printed here.

If you're really stuck, write us. We'll do our best to help you. Don't forget to enclose a stamped, self-addressed envelope. Write: Service Editor, Radio-Electronics, 154 West 14th Street, New York 10011.

IF YOU RUN INTO AN AUDIO AMPLIFIER that "just doesn't sound right," whether it's in a radio, TV, hi-fi, stereo, PA or anywhere else, look for ultrasonic oscillation! This can occur in any stage and really upset things. (Like the bias, for example.) As usual, a scope is the quickest way to be sure. Just hook it across the voice coil, with no signal input, and turn the gain control on the amplifier up and down. If you get a high-frequency waveform, there it is!

A similar complaint shows up when the amplifier is oscillating intermittently. In a lot of cases, it'll be going into the same kind of oscillation, but only on very high signal peaks. This is even harder to find, and almost impossible without the scope. Best check: feed a low-frequency sine wave through the amplifier—up to, say, 150 cycles. Set the scope sweep to hold the signal. Now turn up the gain of the amplifier and watch. (Reduce the scope's vertical gain to keep the pattern on the screen.) If you see things like Fig. 1 starting to show up, here we go again! The amplifier is going into oscillation when the signal

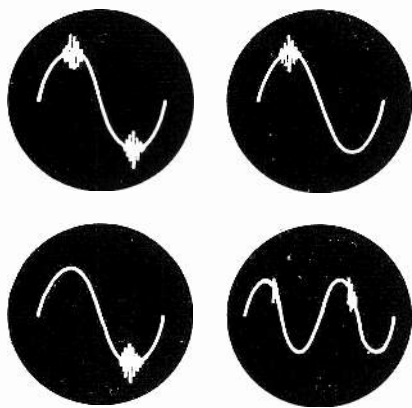

Fig. 1—A few examples of parasitic oscillation kicked off by high-amplitude signal. "Fuzz" may be on either peak or both, or neither.

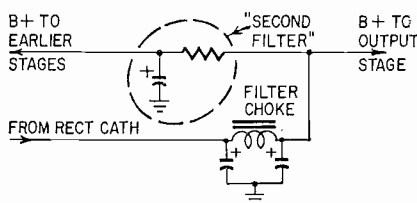

Fig. 2 — "Second filter" or decoupling network can improve stability in high-gain amplifiers. Sometimes, shunting existing electrolytics with a .05- $\mu$ f paper or ceramic capacitor helps.

gets above a certain level.

The major cause of this is some kind of resonance in the primary of the output transformer, it seems. The output stage causes most of the troubles. In low-priced amplifiers, the output stages are driven hard, and any tendency toward oscillation is "swamped out" by shunting a capacitor across the output transformer primary. Since this is usually a pretty high-frequency oscillation, often as high as 50 or 60 kc, even a small capacitor will have such a low shunting reactance that the stage won't oscillate.

If the capacitor isn't there, you can add it. By using the smallest size that kills the oscillation, you won't affect the frequency response too much. Start with about 100 pf. In cheap amplifiers any slight rolloff won't matter anyhow! In higher quality amplifiers, this kind of trouble will be due to opening up or aging of filter capacitors, usually in the "second filter," as in Fig. 2. The B-plus voltage comes through the "first filter," as in all sets. Then, in the good ones, it is filtered again before it is fed to the plates of the preamplifier and other high-gain stages.

(This is generally called a "decoupling network," but for some reason I have always thought of it as a filter: seems to do the same thing, anyhow!)

If you find such trouble in a home-

built amplifier, do the same things to get rid of it. Add a capacitor across the output transformer primary, add more filtering (a "second filter" if you don't have one). In a few cases, you can help things by lowering the voltage on plate or screen (if it's a pentode) of the input or preamp stage. This holds the gain down and prevents feedback of unwanted signals into the B-plus. Shunting an overall-feedback-loop resistor with a small capacitor (50 pf—.001  $\mu$ f) often helps, too.

Final word: If you find a powerful amplifier that's doing this, don't run it too long. Most especially, don't let it run without a load on the output transformer! If you can't stand the noise, hook a suitable resistor across the secondary to take the place of the speaker. But don't let it sit there and run with this oscillation going on. The voltage peaks reached in the output stage can often flash over the output transformer, and burn it up! This is made much worse if the load is removed: the output tubes are then working into a very high load impedance, so they can build up higher voltage peaks. So, watch it!

### Tape recorder frequency tests

I'm working on a pretty high-grade tape recorder. Is there any really accurate way to check tape speed and timing?—R. G. M., Oakland, Calif.

Several ways. Try this one: set the recorder up, and record several minutes of the 440-cycle tone from WWV, plus the "ticks." Now play this back, and feed both the output of the tape recorder and the signal direct from WWV into a scope. By comparing the frequencies, you can get a very good idea of how the speed is holding, etc. Feed the tape output to the horizontal input and the receiver output to the vertical, and make Lissajous patterns. They should be circles, lines or steady ovals.

For other methods, see "Test Tape Checks Recorder Speed" and tape strobes listed in the "Tape and Disc Accessories" directory on pages 100 and 49, respectively of this issue.

### Output transformer flashover

I've got a high-power PA system in for repair. Although it was trouble in the input stage to start with, now the output transformer flashes over when I turn the amplifier on with a test signal. Voltages, etc., are OK, and the signal shows no distortion on a scope.—H. P., Brooklyn, N.Y.

You must be running this system with the output transformer secondary open. Are you? If so, the flashover is natural! Running the output transformer secondary open will upset the loading on the output tubes. They will develop a tremendous peak voltage across the much higher load resistance, and usually flash over.

# From Parts...

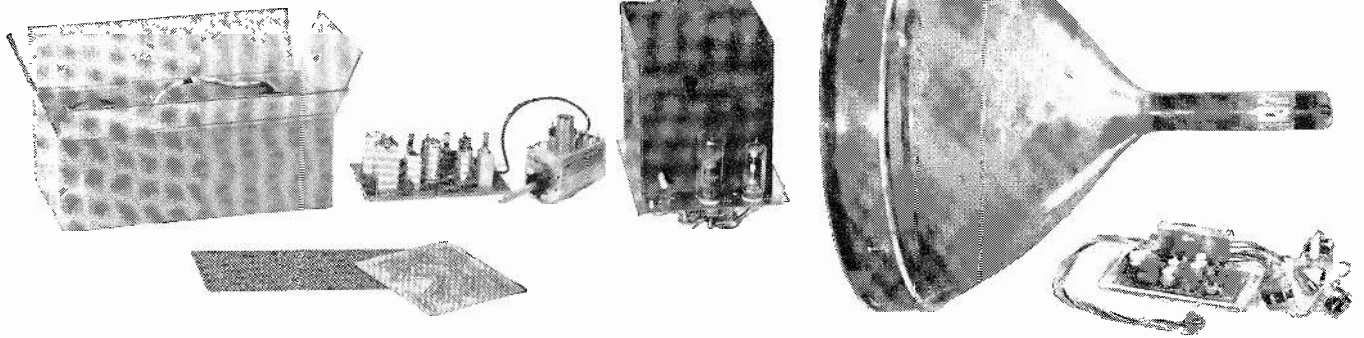

# To Picture In Just 25 Hours



## Heathkit High Fidelity Color TV For As Low As \$349

25 hours of relaxing, rewarding fun! That's all! And you've built the *new* Heathkit High Fidelity 21" Color TV with the finest color circuitry, components, and performance possible today. Goes together quickly, easily. *No* special skills or knowledge required! So simple anyone can build it! You'll enjoy 21 inches of beautiful, high fidelity picture that reproduces every color naturally, realistically, faithfully... you'll enjoy high fidelity sound that's sharp, crisp, clean...and you'll enjoy features and performance comparable only to units costing 50% more!

**Compare these Heathkit features with others:** • 27 tube, 8 diode circuit with optional UHF • High definition RCA 70° 21" color tube with anti-glare, bonded-face safety glass Automatic Color Control • Gated Automatic Gain Control for peak performance • 24,000 volt regulated picture power • Hi-Fi sound with outputs for speaker and hi-fi amplifier • Deluxe Nuvistor tuner with "push-to-tune" fine tuning for individual channels • 3-stage high gain video I.F. • Line thermistor for longer tube life and thermal circuit breaker for component protection • Degaussing coil and built-in dot

generator for perfect picture adjustments • All critical circuits factory-built and tested • Can be custom mounted or installed in handsome walnut cabinet • One year warranty on picture tube, 90 days on parts. **Save On Maintenance Costs!** In addition to the initial savings you realize by building this set yourself, you'll save on expensive repair bills too. The simple-to-follow Heathkit instruction manual contains circuit diagrams and a "Servicing Hints" section so you can easily make adjustments and replacements should it ever become necessary.

**Versatile Installation!** The chassis, tubes, and front panel of the Heathkit Color TV can be mounted in the handsome GRA-53-1 walnut-finished hardboard cabinet. Or if you prefer, it can be mounted in a wall or custom cabinet, and the sound signals fed to an external amplifier unit. Required custom mounting space dimensions: 24-3/4"D x 22-1/4"H x 28"W. In this case the GRA-53-3 Custom Mounting Kit should be ordered to provide physical support between the chassis and front panel.

**Optional UHF!** An optional UHF tuner is available for coverage of channels 14 to 82.

Kit GR-53, chassis and tubes, 118 lbs. .... \$349.00  
 GRA-53-1, walnut cabinet, 70 lbs. . . \$49.00  
 GRA-53-2, opt. UHF tuner, 3 lbs. . . \$20.00  
 GRA-53-3, custom mounting kit, 10 lbs. \$4.00

**FREE 1964 CATALOG**  
 See these and over 250 other exciting Heathkits available in easy-to-build kit form. Save 50% or more by doing the easy assembly yourself! Send for your free catalog today!

**HEATHKIT** 20-3-1  
*by Dayton*

**HEATH COMPANY**  
 Benton Harbor, Mich. 49023

Enclosed is \$ \_\_\_\_\_, plus shipping. Please send model (s) \_\_\_\_\_

Please send my Free 1964 Heathkit Catalog.

Name \_\_\_\_\_

Address \_\_\_\_\_

City \_\_\_\_\_ State \_\_\_\_\_ Zip \_\_\_\_\_

CL-166

*Buy Now! See Order Blank Page*

When checking such systems, always be sure that the secondary is loaded. I have an old 75-ohm 100-watt resistor I found in surplus, that I use as a dummy load by connecting it across the 100-volt output line. You can use any resistor of sufficient rating, and a resistance that is close to one of the output impedance taps. For instance, a 3- to 5-ohm resistor on a 4-ohm tap, and so on. Watch out, though: this resistor will get mighty hot!

### Transistor intercom motorboats

I'm using a transistorized intercom system, similar to the one shown in your June '62 issue. I use a single battery for the power supply. When I try to operate it from an ac power pack, I get motorboating.—W. D., Berwyn, Ill.

This seems to come up regularly in ac-powered transistor equipment. The main cause seems to be too high impedance in the power supply. In this case, only a few ohms is too high! To prevent interaction between stages, which is the major cause of motorboating, your power supply must have a very low impedance (Fig. 3). This, of course, means very large capacitors, and very low-resistance chokes, if used.

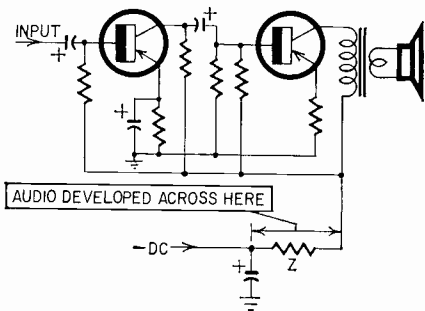

Fig. 3—As long as Z (representing the impedance of the power supply) is nearly zero ohms, circuit will not be unstable. But if Z increases too far (as with a defective or too-small output filter capacitor, or a weak battery), enough signal voltage may be developed across it to cause peaking or oscillation because of feedback to an earlier stage through the supply line.

The dual-battery power supply shown in the original circuit was used mainly for that reason, I suspect. Perhaps if you used two separate ac supplies, you'd cure the trouble.

### Speaker intermittents

I've had trouble in several speakers with intermittent voice-coil connections. Once in a while, one of the speakers makes a terrible squawk. Do you have any idea what causes this?—O. P. W., Roaring Spring, Pa.

Yes, sir! We used to find it in a lot of older speakers. Fig. 4 shows the rea-

son. The flexible wire between the terminals on the basket (frame) and the voice coil itself has a stringlike fiber core. The conductor is a copper braid wound on the outside. Continual flexing breaks the tiny strands, but the string holds the thing in place. So, a jar or movement of the cone can cause the open ends of the cone to touch. Because the wire is still in place, the break can open and close very rapidly. As the cone moves in, the contact is made, and when the cone moves out, it breaks. If this happens rapidly enough, you can get an "oscillation" that is actually caused by the speaker circuit opening and closing!

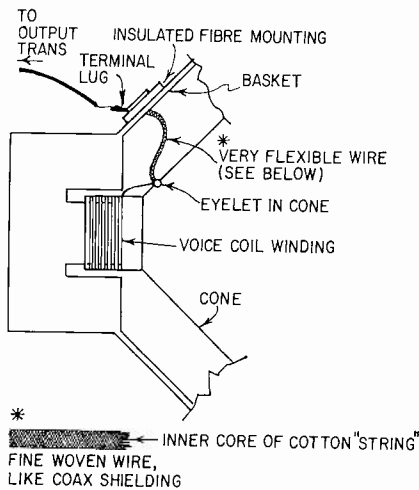

Fig. 4—Detail of woven-wire connection between terminal board and voice coil. Break in electrically conductive outer braid may be invisible, because of support from inner cloth core.

**Quick-check:** hook an ohmmeter across terminals, and move the flexible leads with a pencil or soldering-aid tool. **Repair:** take the leads from a discarded speaker. **Definite test:** using sharp-pointed test prods, check the voice coil at the two "dots" on the cone. These are the terminals of the voice coil itself, and you can measure from them to the terminals on the basket.

### Hot transistors at high frequencies

I have built the transistor amplifier described in the May 1963 issue. However, I've run into some problems. When I test with a sine-wave signal, the output transistors get very hot. They run cool at 1 kc, but heat up if I put a 10-12-kc signal in at the same level! The response drops off quite sharply at this end. What's the matter?—W. B. M., Toronto, Ont.

This is due to a little-known characteristic of most germanium-alloy power transistors. They tend to run away during prolonged high-level, high-frequency tests! The loss (dissipation) in the transistors increases rapidly with frequency, so the junctions heat. In normal use (music, etc.), the high-fre-

quency peaks are short. Also, the impedance of the speaker increases with frequency and tends to hold down the output. If you're testing into a noninductive load, such as a resistor, you won't have this, and the high-frequency dissipation may rise to such a point that you damage the transistors.

**Cure:** add a bit more feedback at the high end of the range. By increasing the high-frequency inverse feedback, you cut the high-end response and hold down the losses in the power transistors. This can be done in any of several ways, like using a larger capacitor for C19 (.001-.005  $\mu$ f) across the main feedback resistor. Or try a high-frequency rolloff network at Q4.

### Unstable audio "front ends"

I've built audio amplifiers of various types, and I always have a time trying to get the input stages to stop oscillating, being noisy and so on. Isn't there a cure for this? — S. P., Brookhaven, N.Y.

There's the one you thought I'd mention: be more careful in your construction techniques! Watch your lead dress, and shield liberally in all high-gain voltage-amplifier stages.

One way, which I thought was pretty crude when I first found it but which I've seen used with success in other circuits lately, is to use a 12-volt tube instead of a 6-volt. For example, a 12AU6 instead of a 6AU6 (on the 6-volt heater supply). Running the tube at such a low cathode temperature makes it a lot quieter, and there is usually ample gain! Try it.

### Locating Bogen "Challenger" data

I have a Bogen amplifier for repair, and I can't find a listing on it. I know it must be in there somewhere but I sure can't find it. It's a CHA-75.—P. F., Long Island City, N.Y.

Look for this under "Challenger" in Sams Photofact Index. (This one is in 395-7.) The Challenger line is built by David Bogen, as you saw from the label on the back, but listed under C for Challenger. END

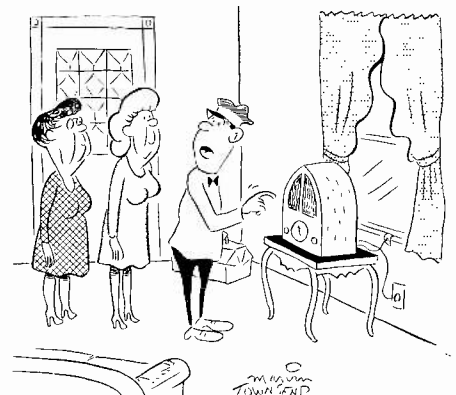

"You want this converted to fm stereo multiplex?"



# what's new at Heathkit?

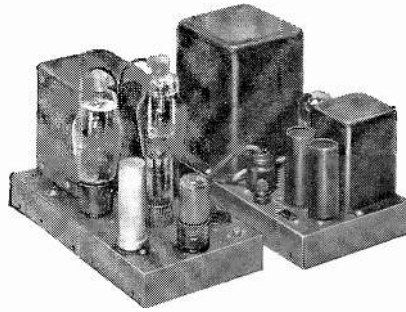

me!

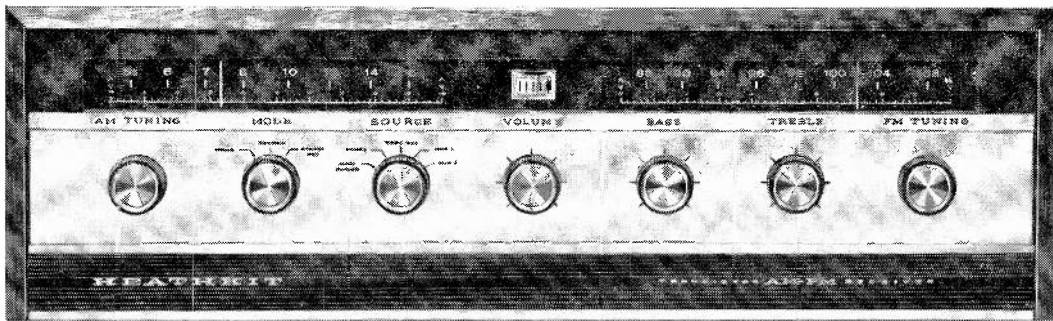

Thirteen years ago we introduced the "Williamson Type Amplifier Kit". It represented a breakthrough in "do-it-yourself" high fidelity. For the first time a truly high fidelity amplifier was made available in kit form at an "easy-to-afford" price. The old WA-1 and its successors including the famous W-5 provided high fidelity listening pleasure to hundreds of thousands of music lovers across the nation. Ever since, Heath's history has been one of major advances in the hi-fi/stereo field. And now today, another first from Heathkit! Heath's newest... an all-transistor Stereo Receiver Kit, incorporating the latest in solid-state circuitry, at a price far below similar units... only \$195.00!

**Now in one compact unit!**...two 20-watt power amplifiers, two separate preamplifiers, plus wide-band AM, FM, FM stereo... all superbly engineered to give you the clean, uncompromising realism of "transistor sound". All with transistor circuitry... a total of 43 transistors and 18 diodes... to give you the coolest, fastest, most-reliable operation possible! All handsomely housed in a single, smart-looking walnut cabinet with a striking extruded gold-anodized aluminum front panel... fashioned in Heathkit's modern low-silhouette styling! This is the beautiful new AR-13. This is the first all-transistor, all-mode stereo receiver in kit form! Compact in size, compact in price!

**Many advanced features** have been incorporated to make possible the advanced performance of the AR-13. You'll like the way this unit *automatically* switches to stereo, and the stereo indicator light silently verifies that stereo is being received. For all-around versatility there are three stereo inputs (mag. phono and two auxiliary) plus two filtered tape recorder outputs for direct "off-the-air" beat-free recordings. Dual-tandem controls

provide the convenience of simultaneous adjustment of volume, bass, and treble of both channels. Balancing of both channels is accomplished by a separate control. The AM tuner features a high-gain RF stage.

**Other quality features** include an FM local-distance switch to prevent overloading in strong signal areas; a squelch control to eliminate between-station noise; AFC for drift-free reception; heavy die-cast flywheel for accurate, effortless tuning; pin-point tuning meter; and external antenna terminals for long-distance reception. For added convenience the secondary controls are "out-of-the-way" under the hinged lower front panel to prevent accidental system changes. The slide-rule AM and FM dial is fully lighted.

**An exciting challenge** for the more experienced kit-builder. Takes approximately 35 hours to assemble. The "front-end" and AM-FM I.F. strip are already preassembled and prealigned to aid construction.

**Compare** the new AR-13 Stereo Receiver with similar units. You'll agree that for advanced features, advanced solid-state engineering, advanced styling, and money-saving price, no unit matches the AR-13. Start enjoying the "transistor sound" of tomorrow, today, by ordering the AR-13 now!

Kit AR-13...30 lbs. .... \$195.00

**SPECIFICATIONS** — Amplifier: Power output per channel (Heath Rating): 20 watts /8 ohm load, 13.5 watts /16 ohm load, 9 watts /4 ohm load. (IHF Music Power Rating): 33 watts /8 ohm load, 18 watts /16 ohm load, 16 watts /4 ohm load @ 0.7% THD, 1 KC. **Power response:** ± 1 db from 15 cps to 30 KC @ rated output; ± 3 db from 10 cps to 60 KC @ rated output. **Harmonic distortion** (at rated output): Less than 1% @ 20 cps; less than 0.3% @ 1 KC; less than 1% @ 20 KC. **Intermodulation distortion** (at rated output): Less than 1%, 60 & 6,000 cps signal mixed 4:1. **Hum & noise:** Mag. phono, 50 db below rated output; Aux. inputs, 65 db below rated output. **Channel separation:** 40 db @ 20 KC, 60 db @ 1 KC, 40 db @ 20 cps. **Input sensitivity** (for 20 watts output per channel, 8 ohm load): Mag. phono, 6 MV; Aux. 1, .25 v; Aux. 2, .25 v. **Input impedance:** Mag. phono, 35 K ohm; Aux. 1, 100 K ohm; Aux. 2, 100 K ohm.

**Outputs:** 4, 8, & 16 ohm and low impedance tape recorder outputs. **Controls:** 5-position Selector; 3-position Mode; Dual Tandem Volume; Bass & Treble Controls; Balance Control; Phase Switch; Input Level Controls (all inputs except Aux. 2); Push-Pull ON/OFF Switch. **FM: Tuning range:** 88 mc to 108 mc. **IF Frequency:** 10.7 mc. **Antenna:** 300 ohm balanced (internal for local reception.) **Quieting sensitivity:** 2½ uv for 20 db of quieting, 3½ uv for 30 db of quieting. **Bandwidth:** 250 KC @ 6 db down (full quieting.) **Image rejection:** 30 db. **IF Rejection:** 70 db. **AM Suppression:** 33 db. **Harmonic distortion:** Less than 1%. **Multiplex:** Bandpass: ± ½ db, 50 to 53,000 cps. **Channel separation:** 30 db, 50 to 2,000 cps; 25 db @ 10 KC. **19 KC Suppression:** 50 db down, from output @ 1 KC. **38 KC Suppression:** 45 db down, from output @ 1 KC. **SCA Rejection:** 30 db. **AM: Tuning range:** 535 to 1620 KC. **IF Frequency:** 455 kc. **Sensitivity:** 1400 KC, 3.5 uv; 1000 KC, 5 uv; 600 KC, 10 uv—standard IRE dummy antenna. **Bandwidth:** 8 KC @ 6 db down. **Image rejection:** 30 db @ 600 KC. **IF Rejection:** 45 db @ 600 KC. **Harmonic distortion:** Less than 1%. **Overall dimensions:** 17" L x 5½" H x 14½" D.

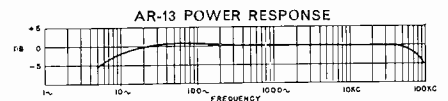

**FREE 1964 CATALOG**  
See these and over 250 other exciting Heathkits available in easy-to-build kit form. Save 50% or more by doing the easy assembly yourself! Send for your free catalog today!

**HEATHKIT** by *Crystal*

**HEATH COMPANY** 20-3-2  
Dept. 20, Benton Harbor, Mich. 49023

Enclosed is \$195.00, plus postage. Please send model no. AR-13.

Please send my Free copy of the 1964 Heathkit Catalog.

Name \_\_\_\_\_

Address \_\_\_\_\_

City \_\_\_\_\_ State \_\_\_\_\_ Zip \_\_\_\_\_

HF-155



## FM 2-WAY MOBILE RADIOS

**SAMPLE OFFERING.** 12V 30W or 60W mobile units. Reconditioned General Electric type MC series. Formerly used by N.J. State Police and serviced by N.J. Bell Telephone. Can be tuned and crystallized to frequencies within 30-50MC band. Complete with accessories less antenna and crystals **30W...\$ 98 ea.** Complete with accessories including antenna, crystals, fully narrow banded and tuned to your frequency. **60W...\$108 ea.**

**30W...\$198 ea.** **60W...\$208 ea.**



### SPECIAL PURCHASE

We bought a large quantity of 2-way radio units from a state police network and now pass huge savings on to you!

#### LINK 6000 NW SERIES

25-50mc 20F3 Emission

Fully narrow banded (TX and RX), 12 volt, 50 watt. Complete with all accessories, less crystals and antenna. **\$168.00**

Add \$40 for crystals, tuning and brand new antenna—ready to go on your frequency.

#### MOTOROLA 30-50mc T-51GGD or T-51AGD

6/12v 50-60 watts

Fully narrow banded (TX and RX). Complete with all accessories, less crystals and antenna. **\$228**

Same unit tuned to your frequency including brand new antenna, ready to be installed. **\$268**

(This unit may also be bought without accessories for \$198.)

#### RCA 148 to 172 mc

CMC30 (Vibrator Power Supply)—6/12 volt, 30 watt. Complete with all accessories less crystals and antenna. Wide band. **\$158**

Fully narrow banded (transmitter and receiver) **\$188**

Add \$35.00 for crystals, tuning and antenna. Ready for installation.

We Buy Late Model Equipment for Cash  
Write; Wire or Phone!



**GREGORY  
ELECTRONICS  
CORPORATION**

249-A Rt. 46 • Phone 773-7550  
Saddle Brook, N.J. • Area Code 201

CHANNEL 4 ON MASTER SCREEN

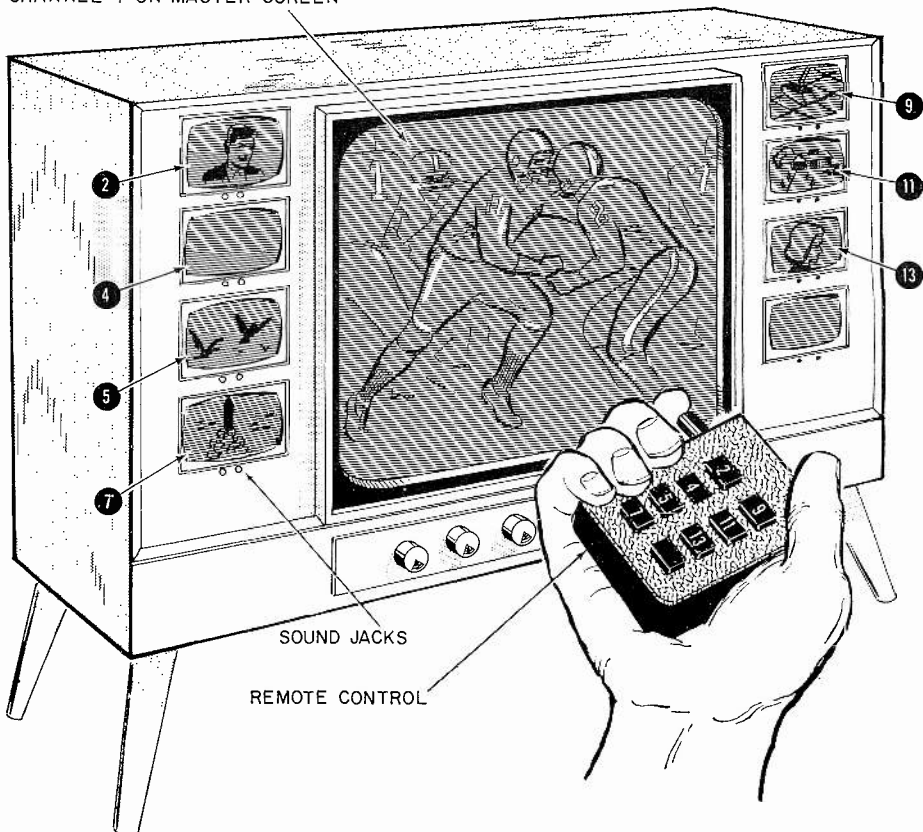

This proposed receiver shows all channels simultaneously, so viewers know every second what programs are on the air. TV receiver shown is for eight-channel reception. New York and Los Angeles each has seven channels. There is one more channel, unlabeled, that can be used in fringe areas. An eight-channel receiver, however, would be exceptional. For most of the US, a four-channel—and much less costly—receiver would probably be standard.

Note that all channels come in simultaneously and all are visible together. Audio, however, can be heard on the speaker only from the master channel. The small 3-inch auxiliary channels can be heard by plugging headsets in the respective jacks.

The auxiliary channels are labeled on both sides. By using the motorized remote control you switch from channel 4 as shown, let us say to 13. Note that auxiliary channel 4 is dark. As you switch to 13, this standby channel 13 goes dark, while the small tube on channel 4 shows a picture.

(Continued from page 23)

In the future, for economy sake, instead of having eight separate small video auxiliary tubes, we may be able to make two small "flat" video tubes each with four separate elements.

So as not to complicate the future color multiple-channel receiver, as well as raise its cost, the small auxiliary video tubes can be black and white.

Furthermore, the first multiplex TV sets will probably have only four auxiliary video tubes instead of eight.

In various parts of the country it is possible to receive as many as 15 channels with a given set, if one has a directional antenna able to get these channels. Here are some statistics that give the story of TV reception in the U.S.

As of 1961, 56% of the population could receive 4 or more vhf stations. Of the nation's 272 markets, 17 have 4 or more stations, 53 have 3 stations, 69 have 2 stations and 132 have 1 station.

How could a multiple simultaneous-channel TV receiver be constructed? The simplest—and probably most expensive—way to do it would be to set up independent receiver circuitry for each auxiliary viewing tube, with a switch that could transfer any program from a

small screen to the big one.

But possible combinations become apparent immediately. For instance, one power supply would be sufficient for all the circuitry. And a single TV tuner contains all tuned circuitry needed for all channels. Under some circumstances, it might be possible to combine other circuitry, using broad-band amplifiers.

For instance, it might be possible to use a single i.f. amplifier for several channels, picking out each signal with tuned circuits at the video detector.

True multiplexing offers other opportunities, limited, however, by the tremendous amount of information and the broadness of the band characteristic of television transmissions. Storage systems have been proposed in the past to make it possible to transmit less information and yet receive a good picture. The same principles would work for multiplex television. A slightly higher visual-persistence phosphor on the small auxiliary tubes would, for example, convert them into storage devices that would take advantage of the redundancy of the television scene to produce an acceptable picture with less information supplied, thereby possibly making sampling techniques practical. —H.G.

# MAKE MORE MONEY

Join the Technician's Book Club. Read helpful electronics books by leading authors — at tremendous savings. Books sent on approval. Write for free bulletin.

GERNSBACK LIBRARY, Inc.  
Dept. G, 154 W. 14 St., New York, N.Y. 10011

# TAKE Heathkit's Deluxe Transistor Stereo Amplifier

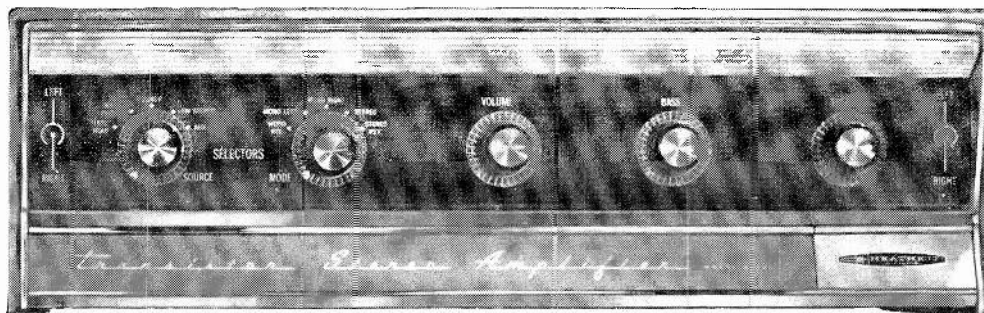

## ADD the Deluxe Transistor AM-FM Stereo Tuner

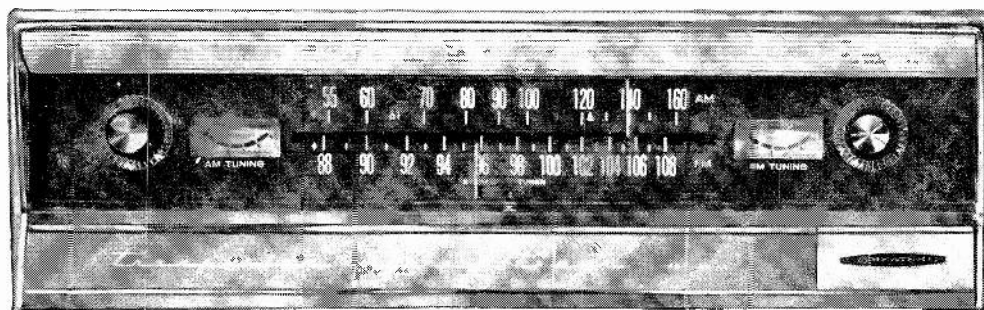

## ENJOY Total "Transistor Sound" Performance

Each instrument with its characteristic sound reproduced realistically, faithfully, naturally. This is "transistor sound." No faltering, no fading, no compromising... just the quick, clean sound that only transistors can reproduce. You enjoy this totally different dimension in stereo listening with the *total* transistor performance of the Heathkit *deluxe* 70-watt Stereo Amplifier and matching AM, FM, FM Stereo Tuner.

**Added performance features and luxurious** decorator styling. You enjoy "extras" like the unique "push-push" off/on switch, concealed secondary controls to prevent accidental system changes, automatic switch-to-stereo feature of the tuner, and pre-built, prewired encapsulated component modules in the amplifier for quick, easy assembly. You enjoy handsome matched tan vinyl-clad steel cabinet styling with polished aluminum trim and soft refracted lighting... complements any decor! Both units are easy to build... easy to own! Just a few of the reasons why you should move up to this all-transistor duo. Consider the AA-21 Amplifier...

**Full 70 watts** of continuous power, 100 watts music power at  $\pm 1$  db from 13 to 25,000 cps. Additional features include 26-transistor,

10-diode circuitry for cool, "hum-free" operation, smooth power delivery, and fast effortless "transient response"; complete freedom from microphonics; front-panel mounted controls with 5-position dual concentric source switch, 5-position mode switch, and dual concentric volume, bass and treble controls; circuit breaker protection of output transistors and AC power; and encapsulated preamplifier circuits in 6 epoxy-covered modules, all factory wired and sealed, ready for easy installation. Check the AJ-43 Tuner...

**Enjoy extra convenience.** Automatic switching to stereo; automatic stereo indicator light; filtered stereo tape recorder outputs for direct "beat-free" recording; Stereo Phase Control for maximum separation and minimum distortion; Automatic Gain Control for constant volume; 25-transistor, 9-diode circuitry for lower power consumption and cool operation; individual AM & FM tuning meters for pin-point tuning; effortless fly-wheel tuning; transformer operated power supply; and preassembled FM tuning unit and 4-stage FM I.F. circuit board for fast assembly.

Experience the "transistor sound" of tomorrow, with the total transistor performance

of Heathkit's Deluxe Transistor Twosome today! You'll be delighted with the advanced features, advanced styling, advanced sound... all at a typical Heathkit value price. Order both units now!

Kit AA-21, amplifier, 29 lbs. .... \$139.95

Kit AJ-43, tuner, 18 lbs. .... \$119.95

### FREE 1964 HEATHKIT CATALOG

See Heathkit's complete line of advanced stereo/hi-fi equipment as well as color TV, electronic organ, radios, amateur radio, test & lab, marine, and educational equipment. Over 250 in all... the world's largest selection! Send for yours now!



**HEATH COMPANY**  
Benton Harbor, Mich. 49023

20-3-3

Enclosed is \$ \_\_\_\_\_, plus postage. Please send

model (s) \_\_\_\_\_

Please send my Free 1964 Heathkit Catalog.

Name \_\_\_\_\_

Address \_\_\_\_\_

City \_\_\_\_\_ State \_\_\_\_\_ Zip \_\_\_\_\_

HF-159

**Buy Now! See Order Blank Page!**

## audio equipment reports

# Stereo Amplifier

a (Heathkit All-Transistor AA-22)

# Stereo Cartridge

(Euphonics Ceramics)

THE AA-22 LIVES UP TO THE HEATHKIT tradition and fulfills its specs in every detail. Power output varies according to the nominal impedance used. This should be explained: The maximum power of 20 watts per channel is available only into an 8-ohm load; 16 ohms (or any higher impedance) connects to the same pair of terminals as 8 ohms, and thus gets less power because only the same *voltage* output is available. Four-ohm impedances are connected to different terminals which reduce power by putting a resistor in series so only the same *current* is available as for the 8-ohm load.

I tested the amplifier with 16-ohm speakers, for which the 13.5 watts available is plenty unless your speakers are very inefficient.

The main panel controls, reading from left to right, are: MODE, SOURCE, VOLUME, BASS, TREBLE and ON-OFF. The MODE switch has three positions: MONOPHONIC (which combines inputs to both channels and thus cuts rumble effects with monophonic discs); STEREO (straight) and REVERSED STEREO (transposing left and right outputs). The SOURCE switch provides 5 choices: magnetic phono, tuner, tape recorder and two auxiliaries for which input sockets are at the back and preset input level controls behind the trim flap in front.

VOLUME, BASS and TREBLE controls are all dual, working on both channels simultaneously. The BALANCE control, screwdriver adjusted, is behind the trim flap. My room conditions required no off-center setting and the balance of the dual volume control was good enough at all level settings not to need a manual balance control, as did most equipment tested previously. So relegation of the balance control to a preset adjustment

represents an advance not previously possible, compatible with effectiveness.

Each tone control has an adjustment range that makes a clearly audible change in its respective component of the sound to an extent that sounds, musically and esthetically, just right.

The phase switch, which reverses the phase of one channel (right), is also behind the trim flap. This control will be needed less and less as source material in circulation conforms more completely to standard, so this location is appropriate.

After a spate of combining the on-off switch with other controls, such as volume, bass or treble (and even balance), I appreciate the separate pushbutton type, coupled with the neat indicator lights associated with the mode switch to show when the equipment is on. Pushbutton on-off has two main advantages: the uninitiated does not have to be informed how far to turn the knob when the amplifier comes on and the initiated can switch on and off without losing his control settings.

The sound from the AA-22 is extremely clean. The quality of the source material comes right through, and you are more conscious than usual of program defects or excellence. Recorded distortion that previously might not have been noticed—because the amplifier swamped it—becomes readily detectable to the conditioned ear. Absence of dis-

### SPECIFICATIONS

(All specifications are the manufacturer's)

**Simultaneous power output (per channel):** 20 watts into 8-ohm load; 13 watts into 16-ohm load; 9 watts into 4-ohm load. (IHF music power approx 1.6 times as great at all impedances). All outputs for 0.7% total harmonic distortion at 1 kc.

**Power response:**  $\pm 1$  db, 15 cycles to 30 kc at rated output

**Harmonic distortion (rated output):** less than 1% at 20 cycles; 0.3% at 1 kc; 1% at 20 kc

**IM distortion (at rated output, 60 and 6,000 cycles mixed 4:1):** less than 1%

**Hum and noise:** 50 db below rated output (MAG PHONO input); 65 db on AUX inputs

**Separation:** 60 db at 1 kc; 40 db at 20 cycles and 20 kc

**Dimensions:** 15 5/8 x 3 3/4 x 11 3/8 in. in walnut cabinet supplied

Heathkit AA-22 stereo amplifier.

tortion in the next record played shows the amplifier is clean. This clarity is particularly noticeable in all forms of transients, which the amplifier handles with apparent precision.

As other transistor amplifiers have acted similarly, I would say that transistor circuits are inherently better for audio amplifiers than tube types. I noted just one negative, but not very important, performance feature: every time the amplifier is switched off, there is a slight plop in the speakers. This seems to be a feature difficult to eradicate from transistor circuits using large amounts of feedback. As it occurs only at switching off, and not during active use, it is a small price to pay for the beautiful way the amplifier handles program material.

The compactness of this transistorized unit still amazes those of us who remember when 20-watt amplifiers were extremely bulky and with difficulty (and unsightliness) dissipated 100 watts or so of heat from big glass "bottles!"  
—Norman H. Crowhurst

### Euphonics Ceramic Stereo Cartridge

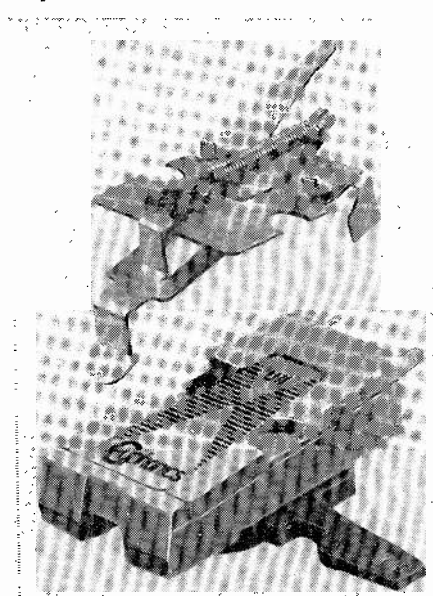

The particular model I tested is a two-element turnover piezoelectric stereo pickup in a spring-supported shock-resistant mount. It is intended for low-priced record changers operating at stylus forces in the 5-gram region. However, I found that it tracks cleanly at 3 grams and possibly lower in changers that will cycle with this force. The shock mounting is stiff, compared with that of the Shure Gardamatic series, and retraction occurs at forces considerably higher than 5 grams; but the protection apparently is sufficient to prevent chipping the stylus when the point is dropped on a record.

The frequency response is very smooth (Fig. 1), though the low end,

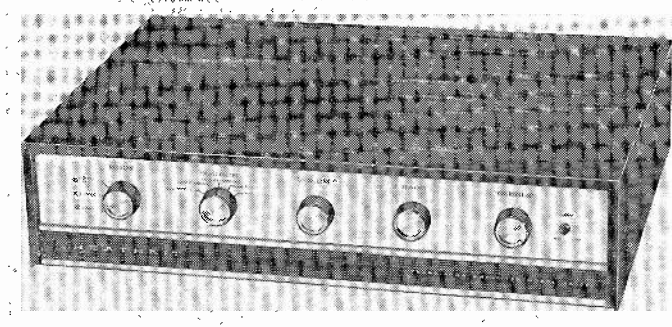

**CREI  
ANNOUNCES  
A UNIQUE  
HOME STUDY  
PROGRAM IN  
SPACE  
ELECTRONIC  
ENGINEERING  
TECHNOLOGY**

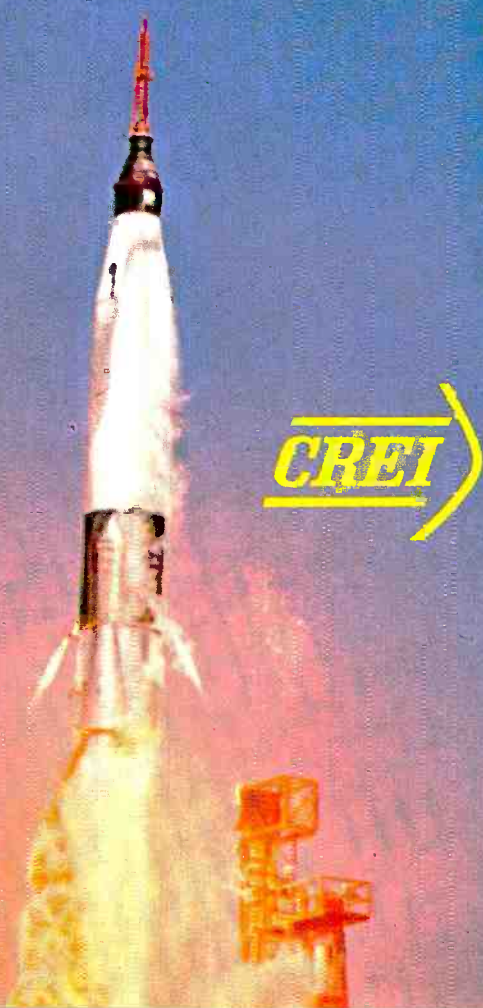

with your choice of these specialties

**SPACE DATA SYSTEMS** Includes analog and digital computers, information theory, data acquisition and processing.

**SPACE TRACKING SYSTEMS** Includes microelectronics, space propagation, masers, lasers, infrared techniques.

**SPACECRAFT GUIDANCE AND CONTROL** Includes inertial navigation, space radar, star tracker systems, tracking networks.

- The first educational program developed specifically to help electronics men apply their experience to the space effort.
- Content of program developed to meet employment requirements as determined by consulting government and private organizations in the space field.
- Text material prepared with the help of engineers and scientists holding key positions in leading space-oriented organizations. (Names on request.) You study exactly the material technical organizations in the space effort want their employees to know.

**YOU ARE ELIGIBLE FOR THIS PROGRAM IF YOU WORK IN ELECTRONICS AND HAVE A HIGH SCHOOL EDUCATION.**

**FREE BOOK GIVES FULL INFORMATION. TEAR OUT AND MAIL POSTPAID CARD or write CREI, Department 1403-B, 3224 Sixteenth Street, N. W., Washington, D. C. 20010**

**The Capitol Radio Engineering Institute**  
 Founded 1927 Accredited Member of the National Home Study Council  
 Dept. 1403-B, 3224 Sixteenth St., N. W.  
 Washington, D. C. 20010



Please send me FREE book describing CREI Home Study Programs including new Program in Space Electronics. I am employed in electronics and have a high school education.

Name \_\_\_\_\_ Age \_\_\_\_\_

Address \_\_\_\_\_

City \_\_\_\_\_ Zone \_\_\_\_\_ State \_\_\_\_\_

Employed by \_\_\_\_\_

Type of present work \_\_\_\_\_

Check:  Home Study  Residence School  G.I. Bill



# NOW CREI OFFERS SPECIALIZED EDUCATION IN EVERY IMPORTANT AREA OF ELECTRONICS

**SPACE DATA SYSTEMS (NEW)**  
**SPACE TRACKING SYSTEMS (NEW)**  
**SPACECRAFT GUIDANCE  
AND CONTROL (NEW)**  
**COMMUNICATIONS**  
**AERONAUTICAL AND  
NAVIGATIONAL**  
**TELEVISION**  
**AUTOMATION AND INDUSTRIAL**  
**NUCLEAR**  
**SERVOMECHANISMS  
AND COMPUTERS**

FIRST CLASS  
Permit No. 288-R  
Washington, D. C.

VIA AIR MAIL

**BUSINESS REPLY MAIL**

NO POSTAGE STAMP NECESSARY IF MAILED IN THE UNITED STATES

Postage will be paid by



**The Capitol Radio Engineering Institute**

3224 Sixteenth Street, N. W.

Washington, D. C. 20010

FREE BOOK GIVES COMPLETE INFORMATION  
ON CREI HOME STUDY PROGRAMS  
INCLUDING NEW PROGRAMS IN SPACE  
ELECTRONICS. TEAR OUT AND MAIL  
POSTPAID CARD FOR YOUR COPY TODAY.

PHOTOGRAPHS COURTESY OF  
NATIONAL AERONAUTICS &  
SPACE ADMINISTRATION

## test equipment reports

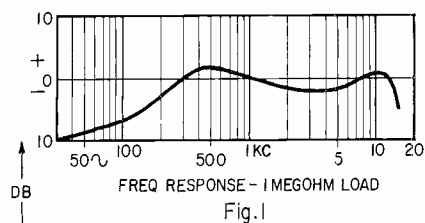

Fig. 1

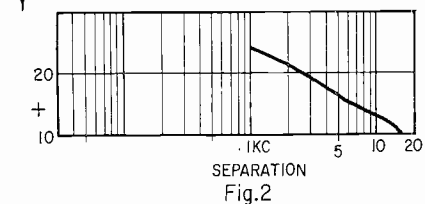

Fig. 2

Frequency response (Fig. 1) and channel separation (Fig. 2) of Euphonics ceramic pickup. Bass response is improved considerably with 3-megohm load.

### SPECIFICATIONS

(All specifications are the manufacturer's)

Type of cartridge:	stereo; ceramic generating elements
Frequency response:	16 to 25,000 cycles, RIAA curve
Output voltage:	0.5 volt at 1 kc (Westrex 1A record)
Separation:	24 db at 1 kc; 18 db at 4 kc (see curve)
Element capacitance:	450 pf (per channel)
Compliance:	$4 \times 10^{-6}$ cm/dyne
Weight:	3 grams
Mounting centers:	$1/2$ and $7/16$ inch; conform to EIA recommendations
Terminals:	4 (connectors supplied)

as in all piezoelectric pickups, varies with the loading. With the specified 3-megohm load, it is down only about 6 db at 30 cycles. With a 1-megohm load, it is down about 10 db. The high-end response follows the RIAA curve nicely—within  $\pm 2$  db between 250 and 13,000 cycles. The response drops to  $-5$  db at 15,000 and  $-10$  db at 20,000. There are no peaks anywhere in its range. The separation (Fig. 2) is better than 20 db below 3 kc, about 15 db at 5,000, and 10 db at 15,000 cycles.

Working into the 500,000-ohm load of a "spare" channel of a hi-fi amplifier, the cartridge is thin in the bass. But fed into the magnetic input through a pair of Sonotone type 9 equalizers, which I had on hand, and with loudness boost, it delivered excellent sound with commendably low distortion even on the very high levels of many pop records. As with other ceramic pickups, the high end is rather sharp, possibly because the slope at the bottom end tends to accentuate the highs. The performance on 78-rpm records was also very good.

The cartridge is particularly easy to mount and to remove for stylus replacement. The cartridge itself clips into a sheet-metal base attached to the arm with the usual two screws. To replace the stylus, pull the cartridge off the base and pull out the entire stylus assembly. A new one is easily inserted. The job is easily done even in the hard-to-get-at wells of furniture type hi-fi's, or in arms with limited lift.—Joseph Marshall

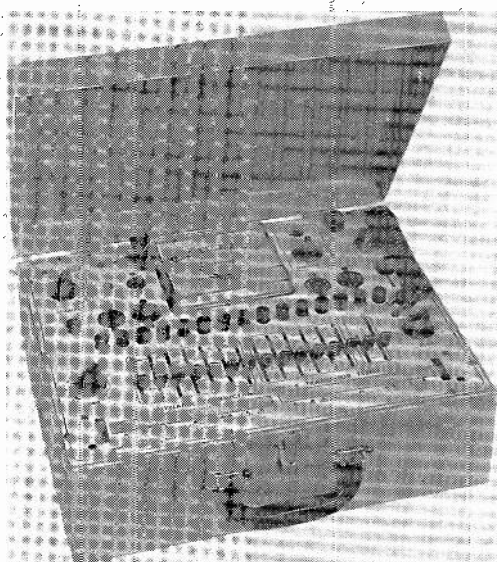

## Dynamic Conductance Tube & Transistor Tester (Eico 667)

and

## CR

## Analyzer

(Lafayette TE-46)

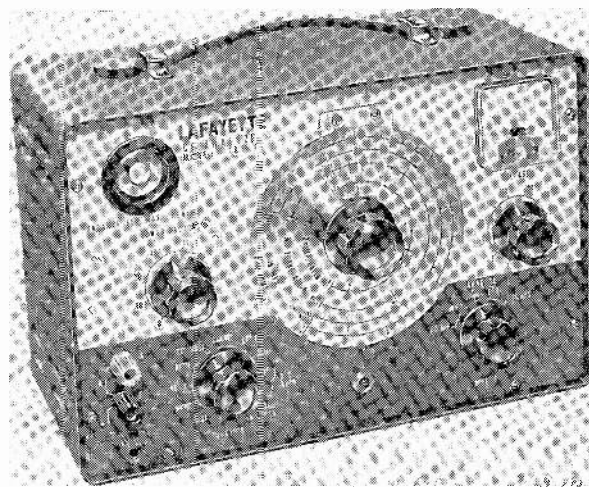

WITH ELECTRONIC CIRCUITS CONSTANTLY becoming more varied and critical, component tests must be more extensive and exacting. The EICO 667 dynamic conductance tube and transistor tester tests special-purpose tubes, low-power transmitting types, voltage regulators, cold-cathode rectifiers, electron-ray indicators, and even ballast tubes and pilot lamps.

The circuits used for the individual tests are quite simple. But their simplicity is hidden in the maze of wires of the switching circuits. Basically the tester is only a metering circuit and a power supply. There are fewer components than in most scopes or hi-fi tuner kits.

Leakage tests are supposed to be made *before merit* (quality) tests. (Excessive leakage, or a short, can ruin a meter in a fraction of a second.) There are four leakage tests, not one. The circuits used—basically ohmmeter types (Fig. 1)—are varied only by the switching.

Note that  $-70$  volts is applied to the plate and grids. This prevents tube emis-

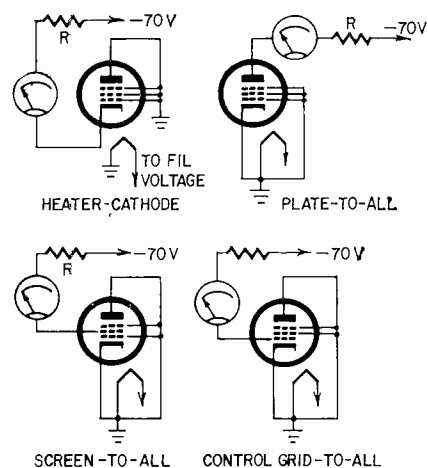

Fig. 1—In all tube leakage tests, one element goes to  $-70$  volts through current limiting resistor  $R$  and meter. All others are grounded.

Transistor leakage, too, must be

(Continued on page 68)

# UNIVERSITY OF ILLINOIS MAYES-CARRELL PATENT ON LOG-

United States Patent Office

3,108,280

Patented Oct. 22, 1963

Oct. 22, 1963

P. E. MAYES ET AL.  
LOG PERIODIC BACKWARD WAVE ANTENNA ARRAY

3,108,280

Filed Sept. 30, 1960

1 Sheet-Sheet 1

3,108,280

1 Sheet-Sheet 2

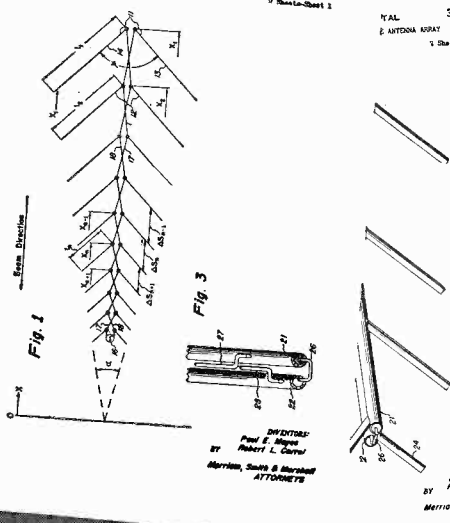

1. The antenna is fed at its rear end from a common input line 16, by means of a balanced mode line consisting of conductors 17 and 18 an electrical distance from the rear end of the antenna to the common input line 16, the distance being such that the antenna is a half wavelength long at the frequency of operation.

2. The length of the arms of the antenna, and the electrical distance between the common input line 16 and the rear end of the antenna, are related by the electrical distance between the common input line 16 and the rear end of the antenna, as follows:

$$L = \frac{2\pi}{\beta} \ln \left( \frac{L_1}{L_2} \right)$$

where  $L$  is the distance from the base line  $O$  to the rear end of the antenna,  $L_1$  is the length of the longest element,  $L_2$  is the length of the shortest element, and  $\beta$  is the phase constant of the antenna.

3. The antenna is fed at its rear end from a common input line 16, by means of a balanced mode line consisting of conductors 17 and 18 an electrical distance from the rear end of the antenna to the common input line 16, the distance being such that the antenna is a half wavelength long at the frequency of operation.

4. The length of the arms of the antenna, and the electrical distance between the common input line 16 and the rear end of the antenna, are related by the electrical distance between the common input line 16 and the rear end of the antenna, as follows:

$$L = \frac{2\pi}{\beta} \ln \left( \frac{L_1}{L_2} \right)$$

where  $L$  is the distance from the base line  $O$  to the rear end of the antenna,  $L_1$  is the length of the longest element,  $L_2$  is the length of the shortest element, and  $\beta$  is the phase constant of the antenna.

5. The antenna is fed at its rear end from a common input line 16, by means of a balanced mode line consisting of conductors 17 and 18 an electrical distance from the rear end of the antenna to the common input line 16, the distance being such that the antenna is a half wavelength long at the frequency of operation.

6. The length of the arms of the antenna, and the electrical distance between the common input line 16 and the rear end of the antenna, are related by the electrical distance between the common input line 16 and the rear end of the antenna, as follows:

$$L = \frac{2\pi}{\beta} \ln \left( \frac{L_1}{L_2} \right)$$

where  $L$  is the distance from the base line  $O$  to the rear end of the antenna,  $L_1$  is the length of the longest element,  $L_2$  is the length of the shortest element, and  $\beta$  is the phase constant of the antenna.

## LOG-PERIODIC BACKWARD WAVE ANTENNA ARRAY, U.S. PAT. NO. 3,108,280, OF PAUL E. MAYES AND ROBERT L. CARRELL, ASSIGNORS TO THE UNIVERSITY OF ILLINOIS FOUNDATION

### U.S. PATENT DISCLOSES THAT NEW LOG-PERIODIC

(Col. 1, lines 10-12 of Log-Periodic Patent)

(Col. 3, lines 73-75; Col. 4, lines 1 and 2)

Has "Unidirectional radiation patterns that are essentially independent of frequency over wide bandwidths."

"This antenna exhibited typical directivity gains ranging from 12 db over isotropic in the 3/2 wavelength mode to 17 db in the 7/2 wavelength mode with essentially constant input impedance within each mode."

(Col. 2, lines 62-66 of Log-Periodic Patent)



(Col. 4, lines 21 and 22)

"Increases directivity\*\*\* permits more effective utilization of antenna since the same structure can be used in several frequency modes to achieve coverage of different frequency bands."

"Moreover, the input impedance remains essentially independent of frequency."

(Col. 4, lines 40-43) "\*\*\*given by the formula  $\frac{L(n+1)}{L_n} \tau$

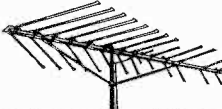
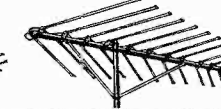
## ONLY THE JFD LOG PERIODIC LPV OPERATES ACCORDING TO THE PATENTED LOG-PERIODIC CELLULAR FORMULA $\frac{L(n+1)}{L_n} \tau$ TO PROVIDE FLAWLESS COLOR, BLACK AND WHITE TV, & FM STEREO!

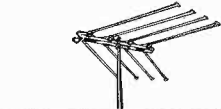
					
MODEL LPV17 JP TO 175 MILE RANGE \$59.95, list	MODEL LPV14 UP TO 150 MILE RANGE \$49.95, list	MODEL LPV11 UP TO 125 MILE RANGE \$39.95, list	MODEL LPV8 UP TO 100 MILE RANGE \$29.95, list	MODEL LPV6 UP TO 75 MILE RANGE \$21.95, list	MODEL LPV4 UP TO 50 MILE RANGE \$14.95, list



# FOUNDATION AWARDED PERIODIC V-ANTENNA—JFD LPV

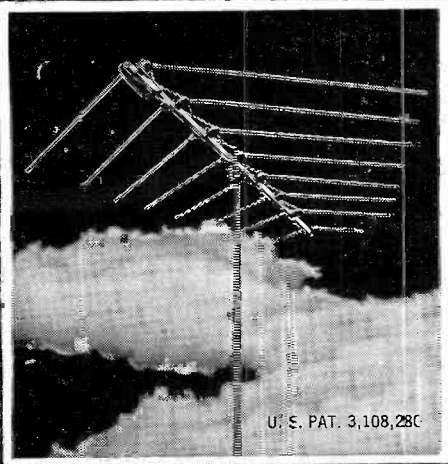

U. S. PAT. 3,108,280

## FOR THE RECORD

All claims by a competitor to the multiple V-type and straight inline active dipole array were rejected because of the prior Isbell "Straight dipole Log-Periodic" work published in the May, 1960 IRE Transactions on Antennas and Propagation, five months before our competitor's application was filed. This cover work done at the University of Illinois Antenna Research Laboratories since 1957.

Shown below are excerpts from the official files of the Patent office citing their reasons for rejecting our competitor's claims to multiple-V and straight inline dipole array patents. An official copy is available from JFD, on request.

(Note: All underscoring done by JFD.)

U. S. DEPARTMENT OF COMMERCE  
PATENT OFFICE  
WASHINGTON

PAPER No. 9

Harry Greenberg  
600 Madison Ave.  
New York 17, N. Y.

Applicant: Harry Greenberg		MAILED OCT 2 1962
Ser. No.	63 520	
Filed	October 19, 1960	PAT. DIV. 65
For	DUAL BAND TELEVISION ANTENNA	

Please find below a communication from the EXAMINER in charge of this application.

Commissioner of Patents.

Responsive to amendments filed January 2, 1962 and

September 12, 1962.

References made of record:

Kandoian 2,429,629 Oct. 28, 1947 343-844 X

IRE Transactions on Antennas and Propagation by D. E. Isbell;  
May 1960 Vol Ap-8 No. 3 pages 260-267 Copy in Scientific  
Library

\*\*\* Claims 2, 6, 7, 11-18, 20 and 23 are rejected as substantially met by the Isbell log periodic antenna shown in Fig. 3 of the above cited IRE article. Fig. 3 shows a coplanar array of dipoles of decreasing length in a direction towards the feed with a transposition harness inter-connecting the dipoles. The proportional energy radiation away from the feed vertex is described on the top of page 3 of the reference and this action is considered the equivalent of the proportional energy feature stressed in the claims. Regarding claim 14, the limitation "substantially equally spaced" is too vague to set out any invention over the Isbell antenna.

Claims 24-27 are rejected as unpatentable over the Isbell antenna of Fig. 3. \*\*\*

Claims 2, 6, 7, 11-18, 20, and 23-27 are rejected. \*\*\*

Examiner.

## DO NOT BE MISLED BY LOG-PERIODIC IMITATIONS OR MISLEADING PATENT CLAIMS

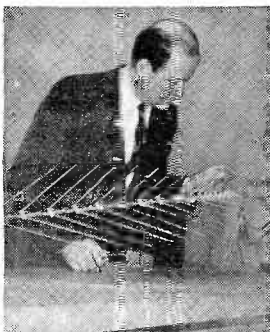

Professor Paul Mayes of the Antenna Research Laboratories of the University of Illinois, originator of the log-periodic V-dipole antenna concept.

THERE IS ONLY ONE GENUINE  
PATENTED LOG-PERIODIC  
V-ANTENNA—THE JFD LPV!

# JFD LPV

Only JFD is licensed exclusively by the University of Illinois Foundation to make the patented Log-Periodic LPV and all other Log-Periodic type TV and FM antennas. No other so-called Log-Periodic antenna can work like the JFD Log-Periodic LPV because **only JFD** uses the original **patented** Log-Periodic design formula of the Antenna Research Laboratories of the University of Illinois. Rely on the JFD LPV and see why At the Moment of Truth, The Picture is the Proof—that the LPV works **best!** Now in stock at your JFD distributor.

JFD will be glad to send you a copy of the official Log-Periodic Antenna U.S. Patent for your personal study and comparison.

# JFD

## JFD ELECTRONICS CORPORATION

15th Avenue at 62nd Street, Brooklyn, N. Y. 11219

JFD Electronics-Southern Inc., Oxford, North Carolina  
JFD International, 64-14 Woodside Ave., Woodside 77, N. Y.  
JFD Canada, Ltd., 51 McCormack Street, Toronto, Ontario, Canada  
401-144 W. Hastings Street, Vancouver 3, B.C.

(Continued from page 65)

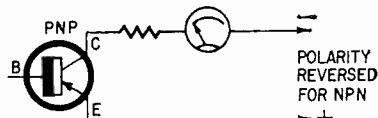

Fig. 2—Voltage for transistor leakage tests is 6 volts. Base circuit is open.

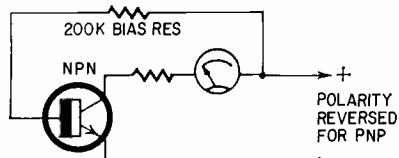

Fig. 3—Collector current of forward-biased transistor indicates its relative conductance.

measured before attempting a merit reading. The  $I_{ceo}$  of the transistor is measured in the EIA-prescribed manner—base open-circuited (Fig. 2). The merit test of the transistor applies a bias to the base connection through a 200,000-ohm resistor (Fig. 3) to measure the  $\beta$ . These simple tests indicate whether the

transistor is good or bad. More complex tests are needed to duplicate the factory checks of frequency response, input resistance, collector capacitance and other electrical characteristics used to classify transistors.

The tube merit test circuit (Fig. 4) differs from that of Fig. 3 only by the addition of the meter shunt resistance ( $R_s$ ), the additional elements in the tube envelope and the higher voltages required.

Dual tubes are tested for merit with voltages applied to all electrodes, except for full-wave power rectifiers. These are tested one plate at a time.

Voltage regulator tests use the filament voltage selector circuit connected in series with a constant ac voltage from another transformer secondary. The filament voltage selector is used as a vernier control to vary the voltage applied to the VR tube being tested. Once the starting potential of the VR tube is exceeded, the tube conducts and the meter gives an

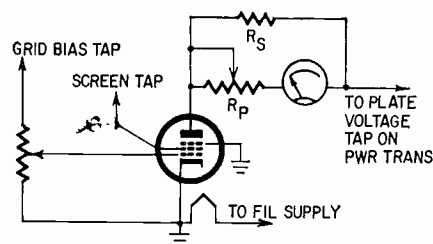

Fig. 4—In circuit similar to Fig. 3,  $R_s$  shunts part of tube current around sensitive meter for transistor tests.  $R_p$  adjusts meter to indicate 100% conductance.

indication of the current flow until the applied voltage drops below that needed to maintain conduction.

New roller charts will be available periodically and interim supplements will be issued when needed. To insure against the instrument becoming obsolete and to take care of seldom-encountered tube types, instructions for developing your own settings for tubes are included in the manual.—Elmer C. Carlson

## Lafayette TE-46 CR Analyzer

THIS IS NOT A TEST INSTRUMENT FOR the run-of-the-mill service technician. With 5% accuracy (better than 3% on the unit tested), you won't need it for servicing home entertaining equipment unless you take extraordinary pride in your work and want to be more exact, more certain of the condition of the components you deal with.

This CR analyzer will pay for itself in short order—just picking accurate values out of the junkbox or surplus parts assortments.

Besides indicating actual resistance and capacitance values, the TE-46 measures insulation resistance, in megohms, at 600 volts, or leakage current when a selected voltage between 3 and 600 is applied.

A unique feature is the circuit used to measure transformer turns ratio. (This can also be done by measuring the input and output voltages of a transformer, but you can burn out small transistor-circuit transformers with too-

high voltage. This method is safer).

The transformer turns-ratio test puts one winding on each side of the bridge (see diagram), and the range switch and the potentiometer (VR) dial are adjusted for a null indication on the eye tube.

Resistance and capacitance values are determined with a more common bridge circuit—a standard component in one leg, the unknown in the other.—Elmer C. Carlson

### SPECIFICATIONS

(All specifications are the manufacturer's)

**Capacitance ranges:** 200 pf–.005  $\mu$ f, .002–0.5  $\mu$ f, 0.2–50  $\mu$ f, 50–2,000  $\mu$ f.

**Resistance ranges:** 2–500 ohms, 200–50,000 ohms, 20,000 ohms–5 megohms, 5–200 megohms

**Transformer turns-ratio ranges:** 1:1–10:1, 10:1–200:1

**Transformer impedance-ratio ranges:** 1:1–100:1, 100:1–40,000:1

**Dc leakage test volts:** variable 3–600

**Leakage current ranges:** 0–1 ma, 0–10 ma

**Dc insulation test volts:** 600

**Indication:** "eye" tube

**Tube complement:** (1)—6X4, (1)—6E5

**Dimensions:** 10½ x 7 x 5¼ inches

**Weight:** 11 lb, with test leads

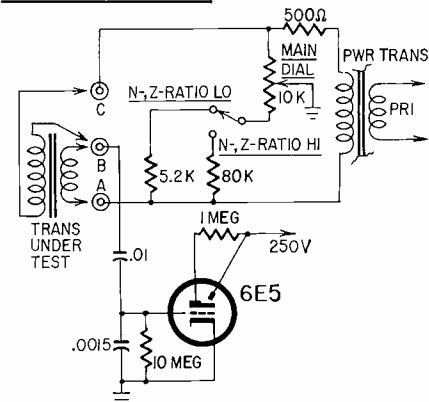

Partial schematic shows circuit used to measure transformer turns and impedance ratios. Main dial is adjusted until 6E5 "eye" tube opens, indicating null.

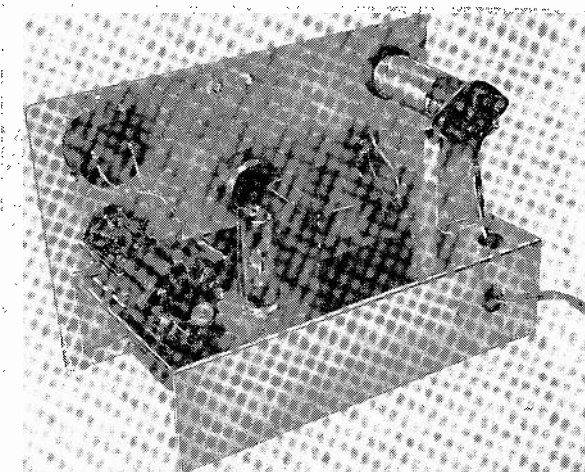

Back-of-chassis shot (left) shows husky power transformer and sturdy construction of TE-46.

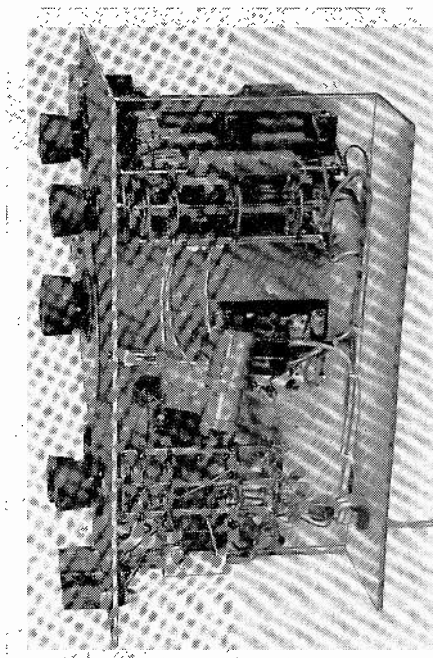

Wiring underneath (right) is neat and open. Note lacing of ac power wiring along back edge of chassis.



# TAKE ADVANTAGE OF THE **DYMO**<sup>®</sup> DEALER PLATFORM



**GET THE**



**DYMO  
DEALERS'**

**WINNING  
COMBINATION**

**FULL LINE  
15 MODELS  
6 TAPE SIZES  
15 TAPE COLORS**

**PROVEN  
PRODUCT**



**PROVEN  
SALES  
RECORD**



**POINT  
PLATFORM**

★★★★★★★★★  
Dymo Promises You:

**1. National Print Advertising**

Consistent advertising to millions of consumers... in magazines such as LOOK, LIFE, TV GUIDE, and SATURDAY EVENING POST; plus dozens of special interest publications.

**2. National Radio Advertising**

In all major markets, building traffic and sales at your store.

**3. National Sales Force**

Experienced DYMO merchandising specialists support local sales programs.

**4. Customer Satisfaction**

Strict quality control, 37 separate inspections insure consistency of manufacturing. DYMO offers full guarantee.

**5. Repeat Sales**

High profit DYMO tape sells fast because it sticks fast. Turnover creates profits for you.

**6. Complete Line**

Wide range of "sell-up" accessory items meet customer needs; sales-proven merchandising programs create store excitement.



**POINT  
PLATFORM**

★★★★★★★★★

**7. Proven Potential**

Based on heavy advertising, complete guarantee, and packaging for your trade. DYMO offers proven profit potential.

**8. Product Development**

Dramatic company history and product development, plus consistent promotion, have made DYMO tools, tape and kits real demand items!

**9. Dealer Support**

Point-of-sale displays and hard selling merchandising kits guide in-store promotions.

**10. National Publicity**

Throughout the year, major trade trade show exhibits, public relations and publicity activities back up DYMO advertising.

★★★★★★★★★

**Now — the complete labeling system!  
Raised-letter plastic labels, in seconds.**

Just dial letters, numbers, symbols — squeeze the handle. Permanent, professional labels made on-the-spot. Labels have crisp white letters embossed on a colored background, with self-sticking backing ready to be applied instantly.

★ THE ★  
**PEOPLE'S  
CHOICE**

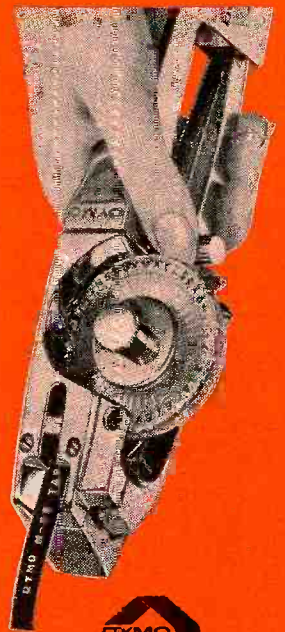

**DYMO  
M-55 TAPEWRITER**

**FREE: sample tapes  
and full details — write  
DYMO INDUSTRIES, INC.  
P. O. Box 1030, Berkeley, Calif.  
Dept. RE-3-55**



Professionals know this ... that's why all original recordings for L/P records are made on tape. Every professional recorder uses laminated core tape heads for the best sound recording and reproduction.

You want the best in sound or you wouldn't have a tape recorder. Nortronics manufactures quality, professional type, laminated core heads.



Not everyone can afford an expensive professional recorder. But, you can afford Nortronics laminated heads to assure the best possible performance from your recorder.

If you are replacing worn tape heads or purchasing a new recorder, insist on Nortronics because:

*"Music sounds best on tape—  
Tape sounds best with Nortronics heads"*



8137-J 10th Ave. No. • Minneapolis 27, Minn.

Write today for FREE copy of Nortronics Tape Head Replacement Guide.

Name \_\_\_\_\_  
 Address \_\_\_\_\_  
 City \_\_\_\_\_ State \_\_\_\_\_

## What's Your Eq?

These are the answers. This month's puzzles are on page 37. If you have an interesting or unusual puzzle (with an answer) send it to us. We will pay \$10 for each one accepted. We're especially interested in service stinkers or engineering stumbers on actual electronic equipment. We get so many letters we can't answer individual ones, but we'll print the more interesting solutions—ones the original authors never thought of.  
 Write EQ Editor, Radio-Electronics, 154 West 14th Street, New York, N. Y.—10011.

### Always Half

The black box contains a capacitor and a resistor equal to  $R$  as in Fig. 1. The voltage  $E_{CA} = E_{AD} = E/2$  having zero angle with  $E$ ; the voltage  $E_{BC}$  is 90° out of phase with  $E_{BD}$  and the vector sum is equal to  $E$ ; consider the modified vector diagram (Fig. 2).  $E_{BC}$  is always perpendicular to  $E_{BD}$ , thus point  $B$  will fall on

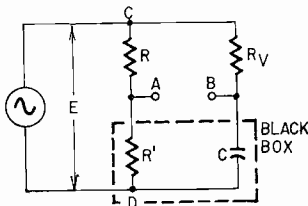

Fig. 1

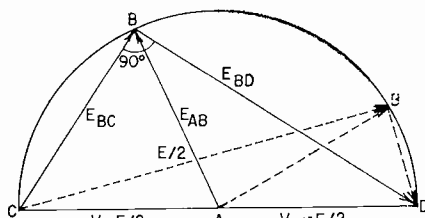

Fig. 2

the circumference of a circle having a diameter of  $E$  or a radius of  $E/2$ . Likewise, as point  $A$  falls in the center of this circle, the distance between  $A$  and  $B$  will become  $E/2$ . Whatever the resistance, only the phase shift will change.

This circuit is used often as a phase shifter to change phase without changing amplitude.

Note: This puzzle, in slightly different form, was published as "Output Voltage" by Cameron McCulloch in the October 1963 issue and evoked a flood of disbelieving letters as well as criticisms of an attempted abridged mathematical proof (Mr. McCulloch's proof was much longer than the one printed).

Readers may be assured that the circuit is "bench-tested," that it works, and is indeed so ruggedly based in theory that an unfortunate change of sign in one of the terms of the October explanation did not change the final result.

### What Voltage?

The output from the full-wave rectifier consists of negative half-cycles at the rate of 800 per second. Therefore the output is negative with respect to the center tap on the transformer secondary.

Unless otherwise stated, dc voltmeter readings should be taken as average values, and ac voltmeter readings should be taken as rms values. Observing polarity, the dc voltmeter ( $V_2$ ) reading is 636 volts, determined by multiplying 0.636 times the peak value of 1,000 volts. The ac voltmeter ( $V_3$ ) reading is 707 volts, determined by multiplying 0.707 times the peak value of 1,000 volts.

If ac voltmeter  $V_3$  is a basic d'Arsonval type, calibrated with and using a

half-wave rectifier, the indicated voltage will be entirely different. This method is used in some vom instruments. Again observing polarity, the meter would indicate 1,414 volts, or double the rms value, in the forward position and zero volts with the test leads reversed. The output waveform of the circuit shown

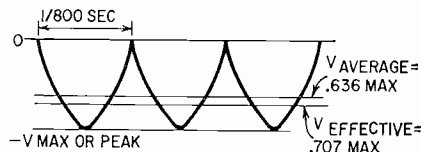

in the puzzler, along with the relative voltages, is shown in the diagram. The 0.636 factor applies to the average value of a sine wave and also to the output of an unfiltered full-wave rectifier.

### A distorted puzzler

A simple one, and not uncommon. The key is, of course, that 6 volts positive at the grid, which causes a high plate current and a low plate voltage. Pretty obviously, the .01- $\mu$ f input coupling capacitor is leaking badly.

### Correction

There were two errors in the solution to the EQ problem "Complex Black Box", on page 70 of the December 1963 issue. The next-to-last sentence should have ended, "we have a coil with an impedance of 100 ohms and a resistance of 12.5 ohms."

Our thanks to Mr. R. T. Schweigert of Merritt Island, Fla., for pointing out the error and also a second possible solution, based on the principle that for every parallel circuit there is a series circuit with the same characteristics. In this case, the series reactance would be about 100 ohms, and the series resistance about 800 ohms.

### 3-Phase Circuit: Out-of-Phase Head!

In the matter of getting single-phase voltages from a 3-phase supply (Power Supply Puzzler, page 39, October 1963): I was wrong! This was on a conveyor belt, with a photocell-operated shutoff (stopped the motor when a package got to the end). Everything worked except the photocell unit; it smoked. By isolating the power transformer, feeding it from single-phase supply, I could make it work. This started an argument, so I left in the middle of it.

Later, after the argument had be-  
*(Continued on page 76)*

*you get* **PRODUCT PLUS** *from your Sylvania Distributor*

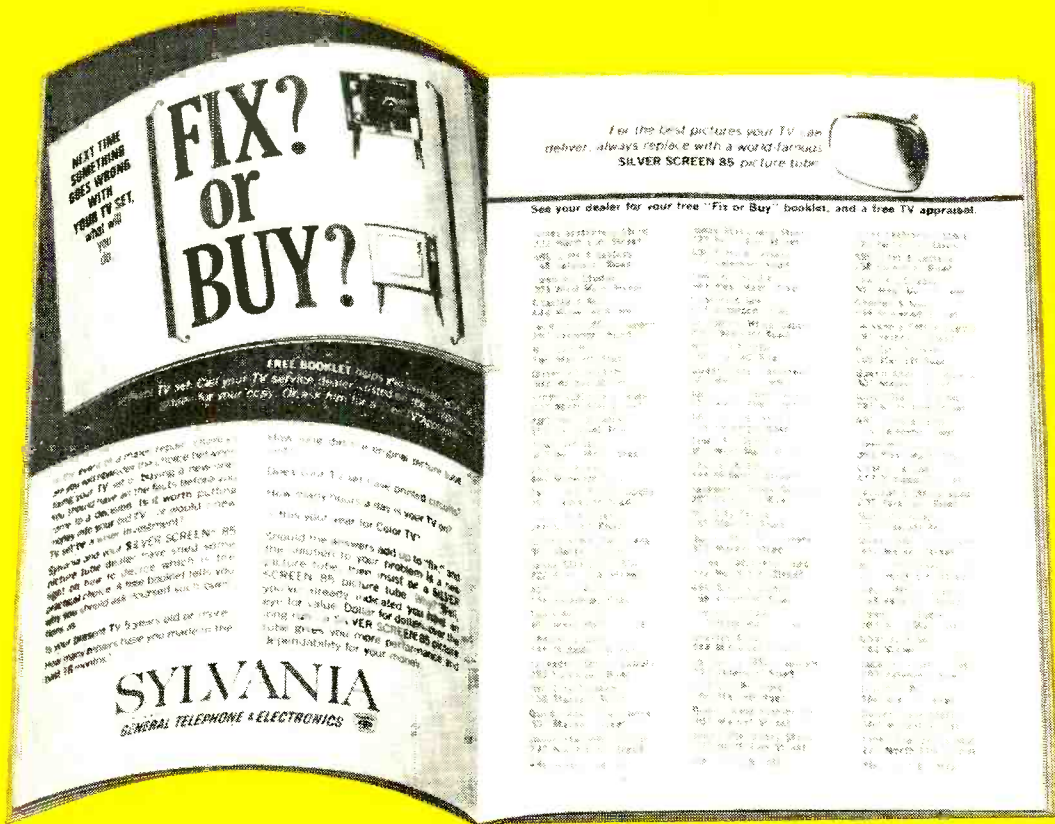

Was your name part of this hard-sell ad in



If you took advantage of the offer, February 8th TV Guide tells every reader in your neighborhood that you are the expert on whether they should repair or replace their TV set. And a helpful free booklet titled "Fix or Buy?" is in your hands for distribution free to your customers. ■ National advertising in TV Guide, the booklet, plus a banner advertising the booklet for your store—a triple-barreled way to hit your very best prospects. ■ Specials like this are available regularly through your participating Sylvania Distributor. They show that he is sincerely concerned with raising your profits and your prestige—and so is Sylvania. ■ You can expect more than the highest-quality tubes when you deal with your Product-Plus Sylvania Distributor.

**SYLVANIA**  
SUBSIDIARY OF  
**GENERAL TELEPHONE & ELECTRONICS** 

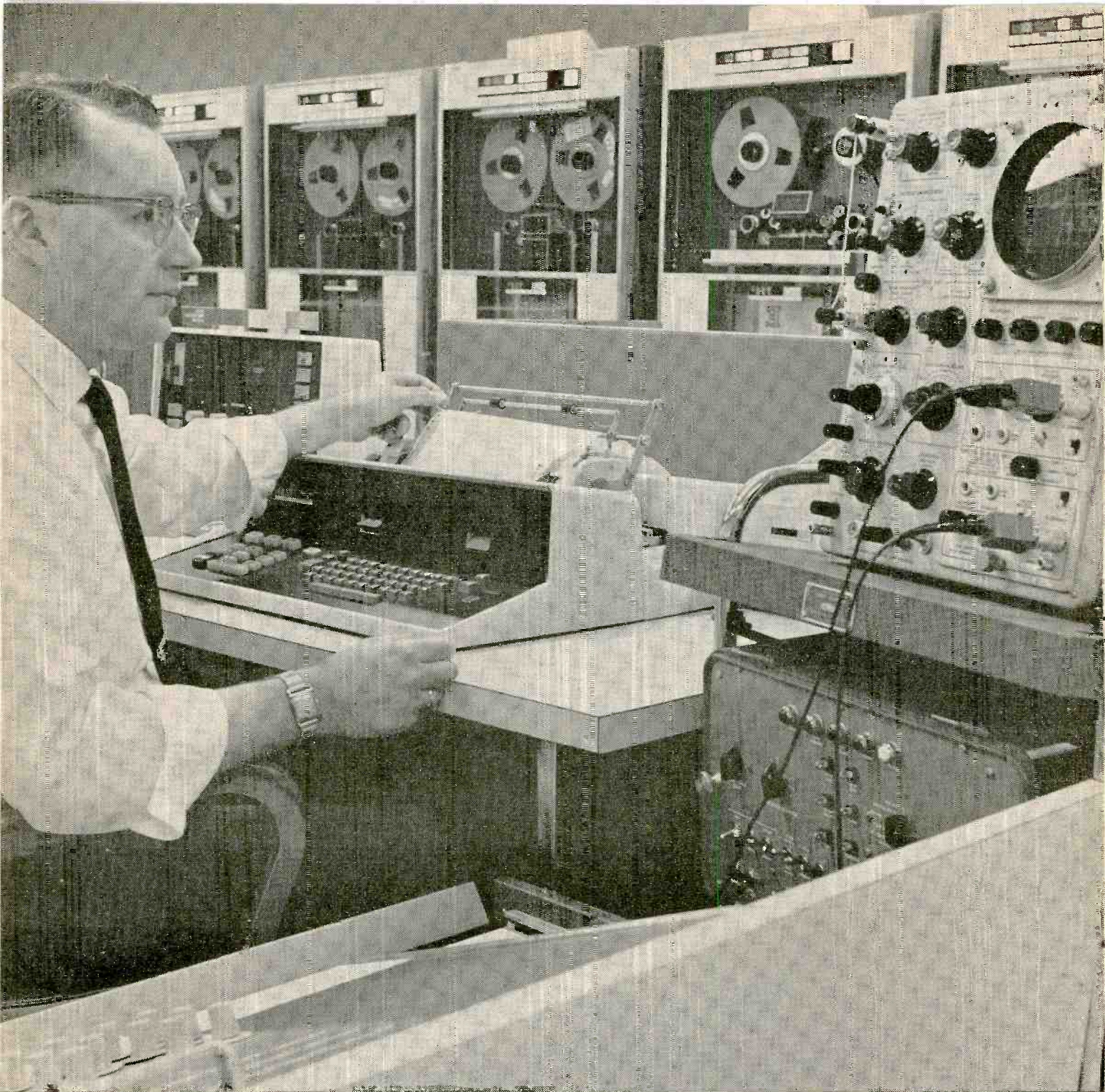

## Why Fred got a better job . . .

I laughed when Fred Williams, my old high school buddy and fellow worker, told me he was taking a Cleveland Institute Home Study course in electronics. But when our boss made him Senior Electronic Technician, it made me stop and think. Sure I'm glad Fred got the break . . . but why him . . . and not me? What's he got that I don't. There was only one answer . . . his Cleveland Institute Diploma and his First Class FCC License!

After congratulating Fred on his promotion, I asked him what gives. "I'm going to turn \$15 into \$15,000," he said. "My tuition at Cleveland Institute was only \$15 a month. But, my new job pays me \$15 a week more . . . that's \$780 more a year! In

twenty years . . . even if I don't get another penny increase . . . I will have earned \$15,600 more! It's that simple. I have a plan . . . and it works!"

What a return on his investment! Fred should have been elected most likely to succeed . . . he's on the right track. So am I *now*. I sent for my three *free* books a couple of months ago, and I'm well on my way to Fred's level. How about you? Will you be ready like Fred was when opportunity knocks? Take my advice and carefully read the important information on the opposite page. Then check your area of most interest on the postage-free reply card and drop it in the mail *today*. Find out how you can move up in electronics too.

# How You Can Succeed In Electronics

## . . . Select Your Future From Five Career Programs

### The "right" course for your career

Cleveland Institute offers not one, but five different and up-to-date Electronics Home Study Programs. Look them over. Pick the one that is "right" for you. Then mark your selection on the reply card and send it to us. In a few days you will have complete details . . . without obligation.

#### 1. Electronics Technology

A comprehensive program covering Automation, Communications, Computers, Industrial Controls, Television, Transistors, and preparation for a 1st Class FCC License.



#### 2. First Class FCC License

If you want a 1st Class FCC ticket *quickly*, this streamlined program will do the trick and enable you to maintain and service all types of transmitting equipment.

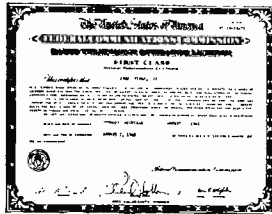

#### 3. Broadcast Engineering

Here's an excellent studio engineering program which will get you a 1st Class FCC License and teach you all about Program Transmission and Broadcast Transmitters.

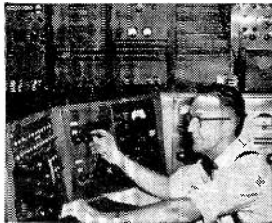

#### 4. Electronic Communications

Mobile Radio, Microwave, and 2nd Class FCC preparation are just a few of the topics covered in this "compact" program . . . Carrier Telephony too, if you so desire.

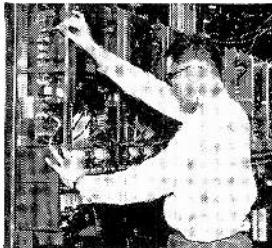

#### 5. Industrial Electronics & Automation

This exciting program includes many important subjects such as Computers, Electronic Heating and Welding, Industrial Controls, Servomechanisms, and Solid State Devices.



### An FCC License . . . or your money back!

In addition to providing you with comprehensive training in the area indicated, programs 1, 2, 3, and 4 will prepare you for a Commercial FCC License. In fact, we're so certain of their effectiveness, we make this *exclusive offer*:

The training programs described will prepare you for the FCC License specified. Should you fail to pass the FCC examination after completing the course, we will refund *all* tuition payments. You get an FCC License . . . or your money back!

### Cleveland Institute's new "Check-Point Plan" helps you learn faster and better

Cleveland Institute uses the new programmed learning approach. This "Check-Point Plan" presents facts and concepts in small, easy-to-understand bits . . . reinforces them with clear explanations and examples. Students learn more thoroughly and faster through this modern, simplified method. You too will absorb . . . retain . . . advance *at your own pace*.

### Job placement service . . . another CIE extra to help you get ahead in electronics

Once enrolled with CIE, you will get a bi-monthly listing of the many high-paying interesting jobs available with top companies throughout the country. Many Cleveland Institute students and graduates hold such jobs with leading companies like these: American Airlines, American Telephone and Telegraph, General Electric, General Telephone and Electronics, IBM, Motorola, North American Aviation, New York Central Railroad, Raytheon, RCA and Westinghouse.

### Electronics is a fast moving, dynamic industry . . . Cleveland Institute keeps you current

The Electron Bulletin is CIE's bi-monthly digest of new developments in the world's fastest growing industry. As a CIE student, you will get a free copy throughout your training to keep you up-to-date on Masers, Lasers, Solid State Devices, and other new inventions.



### Full accreditation . . . your assurance of competence and integrity

Cleveland Institute of Electronics is accredited by the Accrediting Commission of the National Home Study Council. You can be assured of competent electronics training by a staff of skilled electronics instructors.

**Your Future In Electronics Is Up To You. Make It A Brighter One. Mail Reply Card Today.**

# Cleveland Institute of Electronics

Dept. RE-89 1776 E. 17th St., Cleveland 14, Ohio

# You'd expect an FM booster designed by Blonder-Tongue to be something special...

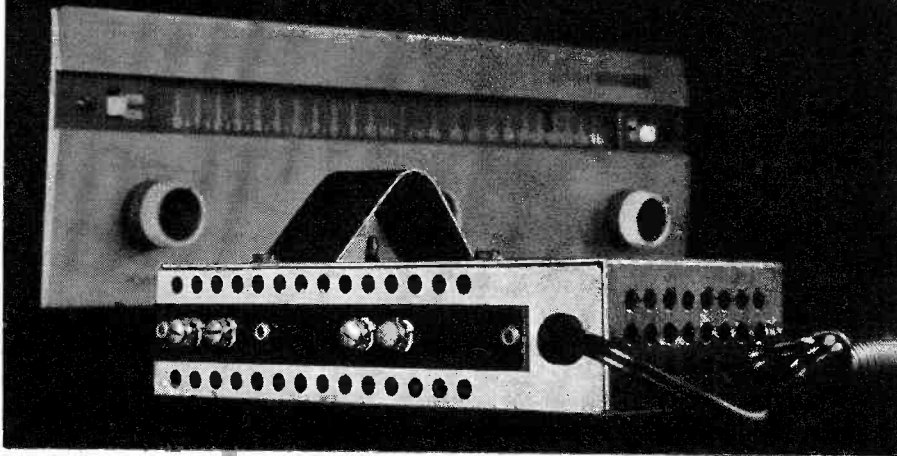

**this one is**

The Blonder-Tongue FMB STEREOBOOSTER is special because it increases signal strength 8 times (18 db gain), while keeping noise down to the bare minimum (noise figure 3.8 db) . . . because it eliminates distortion caused by phase and amplitude variation and by impedance mismatch (low VSWR) . . . because it doesn't overload when there are strong local stations present . . . and because it does all these things steadily and reliably. But since Blonder-Tongue is the company with the *most* experience in TV and FM signal amplification, how could you expect any less? A must for multiplex stereo, and for mono in weak signal areas . . . installed quickly & easily anywhere indoors. Improves reception with an FM antenna, your TV antenna, or a homemade twinlead dipole.

List **\$2240**

engineered and manufactured by  
**BLONDER-TONGUE** | CANADIAN DIVISION:  
 9 Alling St., Newark, 2 N.J. | BENCO TELEVISION ASSOC., LTD., TORONTO, ONT.

(Continued from page 70)

gun, I went back and traced it out in more detail. Fig. 1-a shows how it should have been connected; Fig. 1-b shows how it *was* connected. The "contactor coil," part of the motor control, should have been fed from the same phase that fed the power transformer. Instead, it was connected to *another* phase, and to the power transformer at the same time! We got a "vector sum voltage" and smoke. Things didn't burn up, because there must have been enough inductance in the circuit to hold the current down. Of course, we could only leave it on for a few seconds.

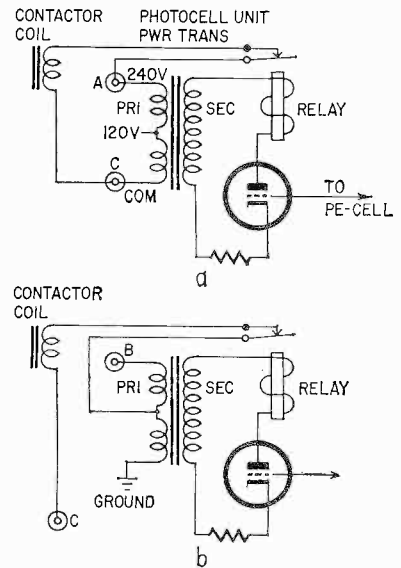

Fig. 1—In correct circuit (a), 240 volts between A and C operates coil and transformer primary. In no-good circuit (b), there are 2 phases (B-C and B-gnd) connected into same circuit. Letters refer to terminals in Fig. 2.

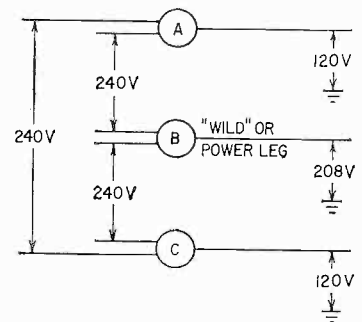

Fig. 2—Actual voltages to be found on 3-phase line.

Fig. 2 shows the true voltages in such a circuit, just as many readers wrote in to remind me. So, if the members of my Fan Club will lay down those baseball bats and let me get the egg off my face, I'll apologize! Too fast a diagnosis on too little evidence.

The Young Electrician said I was wrong. I said he was wrong. In that respect, at least, we were both right.—  
*Jack Darr*





## Tips for Technicians

Mallory Distributor Products Company  
 P.O. Box 1558, Indianapolis 6, Indiana  
 a division of P. R. Mallory & Co. Inc.

# Why Mallory Mercury Batteries work better in transistor radios

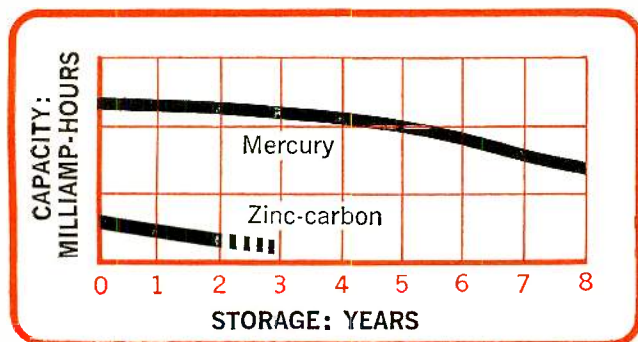
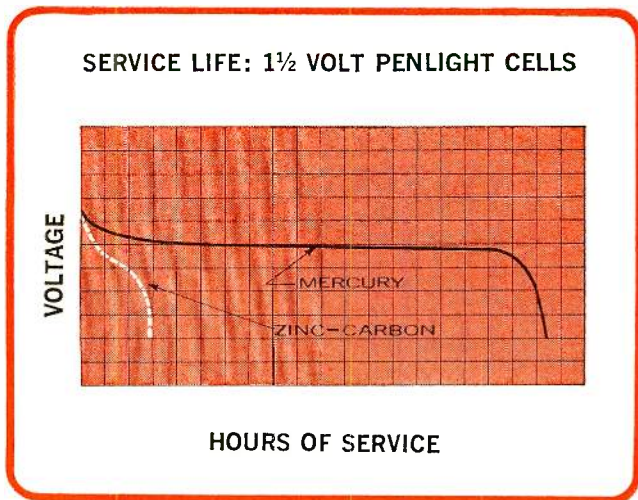
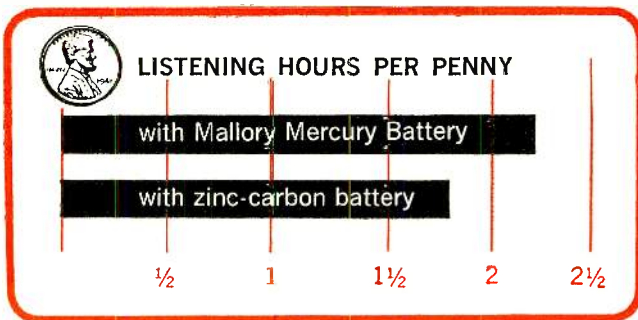

There are a lot of good reasons why more and more people are using mercury batteries in their transistor radios. And the reasons boil down to this—they're a better value, and they give better performance.

To get a comparison between mercury batteries and ordinary zinc-carbon batteries, let's look at a typical transistor radio. This radio uses size "AA" penlight batteries and has a current drain of 15 milliamperes. The Mallory Mercury Battery is the ZM9 and the zinc-carbon type would be the NEDA type 815. The ZM9 retails for 75¢ versus 20¢ for the 815. Got the picture?

Here's where the fun begins. The ZM9 will operate the radio for 165 hours versus only 35 hours for the zinc-carbon battery. This means that for one penny you'll get 2.2 hours of listening pleasure using the ZM9 versus 1.75 hours for the zinc-carbon battery. In other words, it costs you 0.57 cents per hour to use the zinc-carbon compared to only 0.45 cents for the mercury battery.

We're not through yet. Let's get back to *listening pleasure*. The mercury battery has essentially a flat discharge curve. This means that it presents a more constant voltage to the transistors. Result: you don't have to keep turning the volume control up while you're listening AND the radio *sounds* better because there's far less distortion.

Had enough? There's one more important point. Suppose you put the batteries in the radio and use it only slightly. Those 20¢ zinc-carbon batteries go "dead" in a few months whether you use them or not. But the mercury batteries can be stored 2 to 3 years and still deliver dependable power. Plus the fact that Mallory Mercury Batteries are guaranteed\* against leakage in your transistor radio.

We've used this "Tip" to illustrate the superiority of Mallory Mercury Batteries in transistor radios. But this superiority extends to *thousands* of other applications. So whether you're building test equipment, heart-pacers, or satellites, see your Mallory Distributor. He has a Mallory Mercury Battery that will do exactly the job you want done.

\*We guarantee to repair the radio and replace the batteries, free of charge, if Mallory Mercury Batteries should ever leak and damage a radio set. Send radio with batteries to Mallory Battery Company, Tarrytown, New York.



## AUDIO-COLOR

Add visual excitement to hi fi or stereo system with AUDIO-COLOR... a transistorized unit that can be easily attached to your hi fi, stereo, tape recorder... even most radios.

A moving panorama of color casts dancing images on a soft frosted screen as the music plays. Brilliance of light reflects the various volumes as it rises and falls with each beat of the music. AUDIO-COLOR is simple to build... screwdriver and soldering iron are all the tools you'll need.

Now you can see your favorite recordings or stereo tapes with the AUDIO-COLOR... a real conversation piece for music lovers and electronics enthusiasts alike.

Kit w/walnut finished cabinet.....\$32.95  
 Completely assembled unit in walnut finished cabinet .....\$39.95  
 Less cabinet, deduct \$4.00 from above

Complete instructions included / Shipped Railway Express Collect. Send check or money order to:

**SCOPE, INC.** 121 Fallfax Drive, Dept. RE-3  
 Falls Church, Virginia

# New Semiconductors and Tubes

You aren't likely to see many of these around your home, but they should find a wealth of industrial applications. The 7793 is called by the manufacturer (Tung-Sol) "an entirely new type of hydrogen-filled, indirectly heated half-wave diode tube possessing greater voltage and current-surge safety factors than... semiconductor stacks."

The new tube is claimed to handle higher voltages than comparable xenon tubes, and to work over a wider range of temperatures than comparable mercury-vapor tubes. It has a hydrogen reservoir with external connections, to replenish

hydrogen as necessary. The 7793 is intended for use as a high-voltage rectifier, clipper or backswing diode.

Maximum peak inverse voltage for shunt diode operation is 30 kv, and for rectifier service, 25 kv. Maximum cathode currents for those applications are 1,500 and 16 amperes, respectively.

### 6T9

A new triode-pentode compactron for audio applications has been registered by its designer, General Electric, as the 6T9. The pentode section is a power tube, similar to the old 6AQ5, and the triode section is similar to half of a 12AX7.

The power pentode section is rated

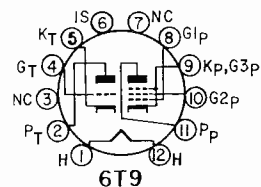

at 12 watts plate dissipation, has a transconductance of 6,500  $\mu$ mhos and a large

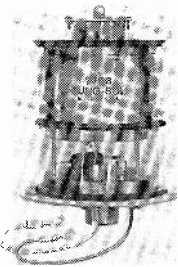

cathode for easy driving—8 volts peak audio for full 4.2 watts output.

Other ratings:

Heater volts: 6.3  
 Heater amps: 0.925

Pentode section

Plate and screen volts (max): 250  
 Grid 1 volts (class A): -8  
 Plate resistance (approx): 100,000 ohms  
 Max. sig. plate current (class A): 39 ma  
 Max. sig. screen current (class A): 7 ma  
 Load resistance: 5,000 ohms

Triode section

Plate volts (max): 250  
 Grid 1 volts (class A): -2  
 Amplification factor: 95

### Integral-mount CRT's

A new series of high-definition cathode-ray tubes with rugged integral, machined mounts has been announced by the Electron Tube Division of Litton Industries.

One of the new tubes is shown in the photograph. The mount is machined with reference to the tube faceplate to



## FREE SCOTT CUSTOM STEREO GUIDE

New 24-page 1964 Custom Stereo Guide packed with photos, descriptions, and specifications of all Scott tuners, amplifiers, tuner/amplifiers, speakers, and kits. Also... articles and pictures on decorating your home with stereo, selecting a tuner and amplifier, and how FM multiplex stereo works. Send for your Scott Custom Stereo Guide today.

Rush me the new 1964 Scott Guide to Custom Stereo.

Name.....

Address.....

City..... Zone..... State.....

H. W. Scott, Inc. 57003

111 Powdermill Road, Maynard, Massachusetts

EXPORT: Morhan Exporting Corp., 458 Broadway, N.Y.C. CANADA: Atlas Radio Corp., 50 Wingold Ave., Toronto



## LEADING SOURCE OF POWER FOR TESTING COLOR TV!

### Precision's G-36 Color Bar White Dot Generator

The *easiest-operating* generator of its kind!  
An essential instrument with only the essentials!  
Works *quickly, simply*... gets the job done profitably!  
Completely capable of testing and adjusting  
color phasing, matrixing, linearity and convergence  
circuits in all color receivers.

G-36K (Kit): \$119.95; G-36W (Factory Wired): \$179.95

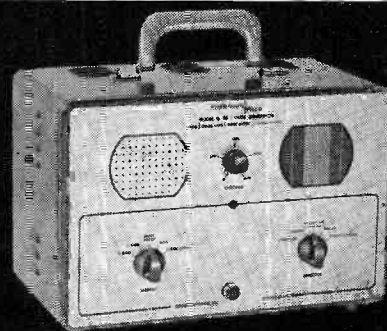

## LEADING SOURCE OF MULTIPLEX SIGNALS FOR TESTING STEREO!

### Precision's E-490 Multiplex Signal Generator

Specifically designed to fill the technician's need  
for a fast-working, high-quality multiplex signal source  
at a truly low price! Highly versatile, yet extremely  
simple to operate. Provides complete testing  
of multiplex circuitry in FM stereo receivers  
and multiplex adapters.

E-490 (Factory Wired): \$249.95

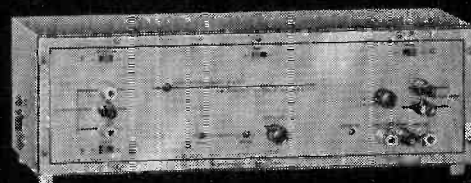

## LEADING SOURCE OF PROFIT FOR ALL TESTING NEEDS!

### Precision's Full Line of New Test Equipment

The perfect combination of superior quality  
at the very lowest possible price!  
A full line designed with one objective: to help you  
accurately handle all testing jobs faster,  
easier and *more profitably!* Never was there equipment  
designed with your real needs so much in mind!  
And it's available at your local distributor *now!*

As shown:

Model G-30—Kit: \$32.95; Semi-kit: \$39.95; Factory Wired: \$44.95

Model G-32—Kit: \$85.95; Factory Wired: \$159.95

Model S-55—Kit: \$99.95; Factory Wired: \$155.95

Model ES-550B—Factory Wired: \$279.95

Model S-51—Kit: \$89.95; Factory Wired: \$109.95



G-30 RF Signal  
Generator



G-32, Sweep Generator  
and Marker Adder

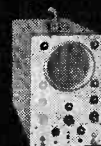

S-55  
DC to 5MC  
Oscilloscope



ES-550B  
Wide Band 5MC  
Oscilloscope



S-51, General  
Purpose  
Oscilloscope

Write for new Catalog No. PP631 describing the full new Precision line containing all the test equipment you need!

**PRECISION** Apparatus, Inc.

80-30 Cooper Ave., Glendale, N. Y. 11227, 212-TW 4-4293

Export: Morhan Exporting Corp., 458 Broadway, New York, N. Y. 10013

Canada: William Cohen, Ltd., 8900 Park Avenue, Montreal, Canada

within .001 inch after tube processing. Then the ring is drilled and tapped for

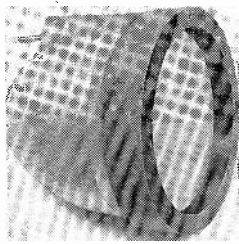

mounting. Inside and outside diameters of the mounting ring are machined concentric to the tube neck.

Advantages claimed for the new mount include highly accurate mechan-

ical connection between the CRT and its magnetic focus and deflection components, eliminating padding or resilient material. The close tolerances of the machined surfaces permit orienting the tube to an optical system for perpendicularity and concentricity of the faceplate, especially where depth of field is short.

#### CL703C, -703CL, -903C

These are new cadmium selenide high-speed photoconductive cells designed for use as photoelectric choppers at rates up to 1,000 cycles.

Rise and fall times of the cells are 0.4 and 3 msec, respectively. Light re-

sistances as low as 2,300 ohms, and dark resistances to 500 megohms are avail-

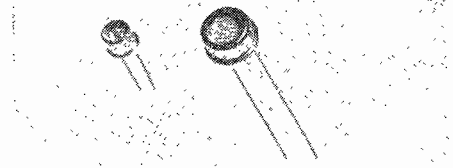

able in the three types. Voltage ratings are from 60 to 250 volts. Dissipation for the CL703C and -703CL (TO-5 cases) is 125 mw; for the CL903C (TO-18 case), 50 mw. All are hermetically sealed.

#### GaAs infrared diode

This is a piece of semiconductive esoterica from Philco—a gallium arsenide infrared-emitting diode with a strontium titanate lens.

It radiates intensely at a very restricted beam angle—about 30°. Though

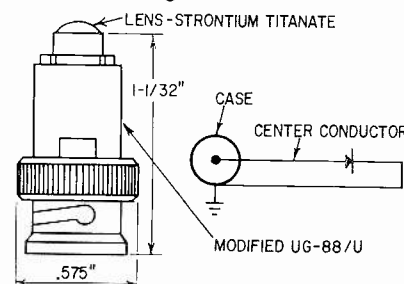

its efficiency sounds dreadfully low by most standards, it isn't so bad compared with devices of a similar nature: .06%. It can be modulated by frequencies up to 1 gc (= 1 kmc, or  $10^9$  cycles).

The diode is packaged in a UG-88/U type BNC connector for quick mounting and interconnection to other parts of the system. Want one? \$190!

#### Hv silicon rectifiers

These are intended to replace, mechanically as well as electrically, high-voltage mercury-vapor rectifiers like the 872-A, 8008 and 575-A, used extensively in broadcast transmitters and industrial equipment.

The photograph shows one of the silicon devices lying on its side. At right are the base pins, which plug directly into the tube socket without further ado, and at left is the top (plate) cap, which again is connected just as though it sat on top of a tube. The string of silicon diodes is housed in an epoxy-sealed phenolic tube.

The rectifiers are available in piv's of up to 15,000 volts, and in average dc outputs to 1.75 amps. Voltage transient protection is provided by avalanche di-

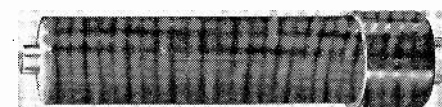

odes. The devices, made by Syntron Co., offer advantages over thermionic rectifiers: longer life, less heat, no warmup.

END

every  
word  
clearly  
heard

with the **Ampli-Vox**  
**ROVING**<sup>®</sup>  
**ROSTRUM**

*A complete high volume  
sound system in a  
single case!*

- Powered by flashlight batteries
- Portable—weighs only 22 lbs.
- Simple to use

**Adaptable for  
Audience  
Participation**



The Ampli-Vox Roving Rostrum delivers high quality, high volume sound (voice or music) to audiences as large as 1000! Completely self-contained in a smartly styled Royalite<sup>®</sup> luggage-type case, it weighs only 22 lbs. and works on 10 flashlight batteries that last a year with average use.

For professional quality sound combined with utmost operating simplicity and a surprisingly low price, you'll be delighted with the Ampli-Vox Roving Rostrum. Write today for full information.

#### The Ampli-Vox Roving Rostrum<sup>®</sup> includes:

- 25 watt transistor amplifier (40 watt peak)
- Microphone and accessories
- 2 full fidelity loudspeakers
- Auxiliary input
- Retractable legs for reading height adjustment
- All in one case—which becomes the lectern.

All for **\$149.95** (less batteries)

Manufactured in U.S.A. by

**AMPLI-VOX** / A Division of **Perma-Power<sup>®</sup> COMPANY**

5740 North Tripp Avenue, Chicago, Illinois 60646, Area Code 312, 539-7171



This **Weller**<sup>®</sup>  
**Heavy Duty Soldering Kit**



has a professional  
 240/325 WATT

# Dual Heat Gun

No other soldering set offers you such versatility. The heavy duty Weller gun is the same professional tool used by technicians. Two trigger positions let you switch instantly to either 240 or 325-watt heat. In this single tool you have a choice of heat to suit the job, and tip temperature high enough to handle the tough ones. Instant heat saves time and current.

Kit includes 3 different tips for soldering, cutting, sealing and smoothing; tip-changing wrench and supply of solder. Everything is in a sturdy plastic carrying case. **\$12.95** LIST  
 Model D-550PK. Weller Electric Corp., Easton, Pa.

FOR HOBBIES, HOMECRAFT AND MONEY-SAVING REPAIRS

Hi-fi kit building

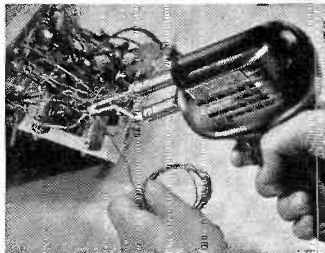

Electrical work

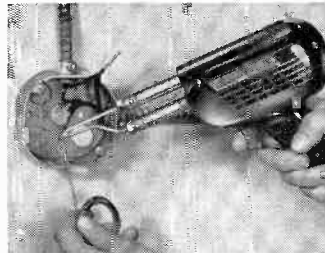

Repairing plastics

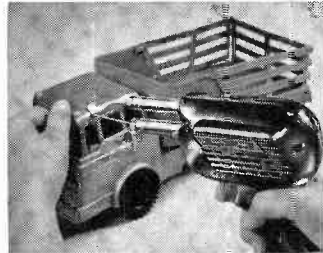

Sealing plastic bags

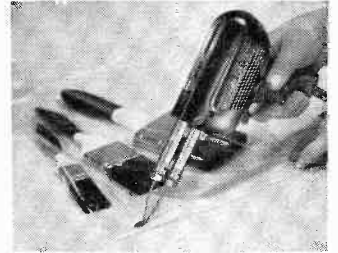

Appliance repairs

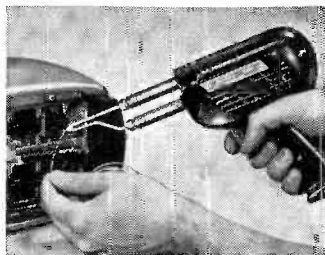

Metal work



Model RR connections

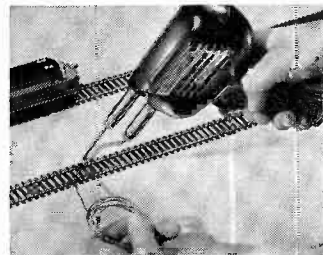

Cutting plastic tile



# NEW SAMS BOOKS

## Practice Problems for Electronics Calculations

by **Allan Andrews**. A valuable book for "boning up" on the mathematics of electronics (for FCC exam studies, for job upgrading, etc.). Explains and gives examples for fundamental math concepts used in electronics; presents practice problems for all types of calculations. Chapters: Working With Numbers; Algebra & Trigonometry; Units of Measurement; DC Circuits; Alternating Current; AC Circuits; Power Supplies; Amplifiers & Oscillators; Transmitting Equipment; Receivers; Measurements; Logarithms & Their Applications. 160 pages; 5½x8½". Order **MAH-1**, only \$395

## ABC's of Electric Motors & Generators

by **Lytel**. A clear explanation of how AC and DC motors and generators work. Principles are made easily understandable. Covers applications of all types of motors from the enormous equipment used at Niagara Falls to the smallest fractional-watt type. Has special section on brushless AC generators. Chapters: Basic Magnetics; AC Generators; DC Generators; AC Induction Motors; AC Synchronous Motors; DC Motors; Motor Control. Well-illustrated and clearly written. 128 pages; 5½ x 8½". Order **EMG-1**, only \$195

## LATEST EDITIONS OF TWO FAMOUS HOWARD W. SAMS HANDBOOKS!



### Tube Substitution Handbook

still the leading reference—lists 10,000 Tube Substitutions. Absolutely indispensable! 7 Sections cover: Cross-reference of American Receiving Tubes; Cross-reference of Subminiature Tubes; Industrial Substitutes for Receiving Tubes; Communications and Special-Purpose Tubes; Foreign Substitutes for American Types; American Substitutes for Foreign Types; Picture Tube Substitutions. Tells when and how to make proper substitutions; lists direct replacements only, requiring no socket rewiring. 128 pages; 5½ x 8½". Order **TUB-7**, still only \$150



### Transistor Substitution Handbook

Computer-Selected Substitutes for Over 5,000 Transistors—Updated! Lists over 40,000 direct substitutions, including all popular types used in transistor radios and similar equipment. Shows biasing diagrams, polarity identification and manufacturers for over 5,000 types. Special section lists more than 15,000 American replacements for foreign transistors—plus a semiconductor and diode guide containing 800 substitutions. 128 pages; 5½ x 8½". Order **SSH-5**, still only \$150

## Amateur Radio Mobile Handbook

by **Charles Caringella**. A comprehensive handbook on Amateur radio mobile installations, for the beginner as well as the experienced operator. Covers all equipment used in mobile operations, with full details on converters, antennas, power supplies, transmitters, and transceivers. Covers the entire spectrum from single sideband, 2 meters, 6 meters, etc. Describes converter circuitry, antenna types, tuning procedures; tells how to eliminate ignition noise in typical installations, how to construct unique antennas, how to improve your present setup. 160 pages; 5½ x 8½". Order **AMH-1**, only \$295

## Television Antenna Installation Handbook

by **Larry Stechler**. A complete guide for home television antenna installers—tells how to select the proper antenna for various applications, how to install for the best possible reception. Gives full details on selecting antenna site, mounting considerations, minimizing noise and ghost problems, choosing suitable transmission wires and cables, etc. Covers UHF antennas, multiple-receiver installations, and amplified antenna systems. Explains electrical codes and requirements. 128 pages; 5½ x 8½". Order **THS-1**, only \$295

## HOWARD W. SAMS & CO., INC.

Order from your Sams Distributor today, or mail to Howard W. Sams & Co., Inc., Dept. RE-3, 4300 W. 62nd Street, Indianapolis 6, Ind.

Send me the following books:

- MAH-1     TUB-7     AMH-1  
 EMG-1     SSH-5     THS-1

\$\_\_\_\_\_ enclosed.  Send FREE Booklist

Name \_\_\_\_\_

Address \_\_\_\_\_

City \_\_\_\_\_ Zone \_\_\_\_\_ State \_\_\_\_\_

My Distributor is \_\_\_\_\_

IN CANADA: A. C. Simmonds & Sons, Ltd., Toronto 7

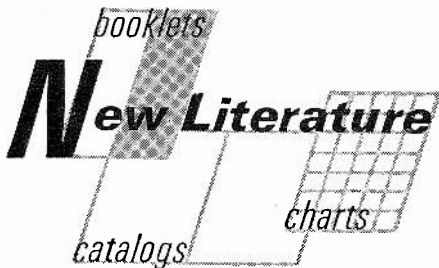

**LOUDSPEAKERS**, principles and methods of setting them up in a living room, etc. described in 4-page reprint of article, "How to Get the Most From Your Loudspeakers."—**Acoustic Research, Inc.**, 24 Thorndike St., Cambridge, Mass.

**TAPE RECORDER DIRECTORY** includes 67 manufacturers and more than 200 different machines. 36 pages, illustrations of recorders, specs of units, suggested list prices.—**Audio Devices**, 444 Madison Ave., N.Y. 22. 25¢

**WINDOW POSTER**, 17 x 22 in. black-and-white poster entitled, "Are TV Service Dealers Gyps?" concludes they are not. Humorous cartoon at top.—**Sprague Products Co.**, North Adams, Mass.

**ENTERTAINMENT PRODUCTS** indexed in 23 page, excellently illustrated catalog. Product lines include radio-TV silicon and selenium rectifiers, entertainment diodes and transistors, silicon tube-replacement rectifiers, etc.—**General Instrument Corp.**, 65 Gouverneur St., Newark 4, N.J.

**RECORD PLAYBACK COMPONENTS** described technically in 8-page illustrated brochure. Points on care and evaluation of disc-record playback systems and recommendations for a basic stereo record library.—**Empire Scientific Corp.**, 845 Stewart Ave., Garden City, N.Y.

**25 THINGS TO DO WITH A TAPE RECORDER**. 8-page booklet suggests family, business, church recording, for extra income, etc.—**Stanford International**, 569 Laurel St., San Carlos, Calif.

**LOW-FREQUENCY INSTRUMENTS** described in 31-page booklet. Includes generators, transmission measuring sets, miniature instruments, mountings, theory behind instrument performance (circuit theory, dial accuracy, etc.). Illustrations, specs.—**Waveforms, Inc.**, 333 Sixth Ave., New York, N.Y.

**TV/FM ANTENNA PREAMPLIFIERS** described in 4-page illustrated spec sheet. 3 models, indoor and outdoor.—**Jerrold Electronics**, Philadelphia 32, Pa.

**TAPE RECORDER CATALOG**, 16 pages, extensive specs. Describes manufacturer's line of recorders and accessories.—**Superscope, Inc.**, 8150 Vineland Ave., Sun Valley, Calif.

**HIGH-CURRENT SILICON RECTIFIER STACKS** covered in 16-page illustrated catalog. Specs for single-phase center tap, single-phase bridge, 3-phase bridge and 6-phase star assemblies. Selection chart with output current, output voltage and prv rating of silicon rectifiers used in four types of assemblies.—**Tung-Sol Electric, Inc.**, 1 Summer Ave., Newark 4, N.J.

**AUDIO TAPE RECORDERS, ACCESSORIES**, discussed in 12-page catalog No. 1817 for Government procurement agencies. Covers items approved by General Services Administration under Contract No. GS-00S-44680. Illustrations, specs.—**Ampex Corp.**, Mail Stop 6-1, 401 Broadway, Redwood City, Calif.

**PORTABLE TAPE RECORDER**, 3-speed with self-contained ac power supply and batteries, described in spec sheet.—**Freeman Electronics Corp.**, 729 N. Highland Ave., Los Angeles 38, Calif.

**CAPACITORS**, Mylar and foil, metallized. Mylar, Teflon and foil, described in 24-page booklet, includes graphs, charts, specs. Illustrates temperature characteristics.—**Texas Capacitor Co.**, 4310 Langley Rd. Houston 16, Tex.

**PROFESSIONAL REVERBERATION UNIT** explained in 8-page illustrated booklet. Discusses problems and origins of reverberation, and construction data. Full specs and details.—**Gotham Audio Corp.**, 2 W. 46 St., New York 36, N.Y.

**SILICON RECTIFIERS AND ZENER DIODES** described in 3 bulletins. *Bulletin B-113*

covers silicon entertainment rectifiers, gives electrical and mechanical specs. *B-107* is silicon rectifier chart listing 500 types. *B-110* is Zener diode reference chart listing about 230 Zener diodes.—**National Transistor**, 500 Broadway, Lawrence, Mass.

**16-MM TECHNICOLOR SOUND FILM** available to any CB group or club. Runs for about 15 minutes; explains functions and instructions of CB units.—**Sonar Radio Corp.**, Jim Liebman, 73 Wortman Ave., Brooklyn 7, N.Y.

**METAL-CASED PAPER CAPACITORS** described in 12-page catalog. Complete specs, dimensions, ratings, application information.—**General Electric Co.**, Schenectady 5, N.Y.

**PHILADELPHIA WIRELESS TECHNICAL INSTITUTE** described in 28-page school catalog. Lists courses, departments, general entrance requirement information, fees.—**Philadelphia Wireless Technical Institute**, 1531-33 Pine St., Philadelphia 2, Pa.

**TAPE RECORDERS**, their use and care, described in 96-page booklet. Illustrations, photos, troubleshooting chart. Chapters on motors, tape transports, magnetic heads, bias oscillator, and glossary of recording terms.—**Robins Industries Corp.**, 15-58 127th St., Flushing, N.Y. \$1.00

**SOUND-LEVEL METER; OCTAVE FILTER SET** detailed in 12-page spec sheet. Includes applications, accessories available, complete specs. Graphs, charts, diags.—**B&K Instruments, Inc.**, 3044 W. 106th St., Cleveland 11, Ohio

**SPEAKERS AND ACCESSORIES** described in 8-page catalog. High efficiency speakers, radial, sound paging, sound column, etc.—**Atlas Sound**, 1419-51 39th St., Brooklyn, N.Y.

**CALIBRATION AND TESTING SERVICES** provided to science and industry listed in 103-page booklet. Includes listing of the Bureau's calibration and test fee schedules. Statement of statutory functions, testing policy.—**US Department of Commerce**, National Bureau of Standards, Washington, D.C. 70¢

**ENTERTAINMENT TRANSISTORS** which can be used as replacements for most types used in radio and other entertainment products, featured in a *Replacement and Interchangeability Guide*.—**General Instrument Corp.**, 65 Gouverneur St., Newark 4, N.J.

**AMENDMENT 2 OF MIL-R-5757D**, which supersedes Amendment 1, and which makes important revisions and additions to the basic relay specification, reprinted in 7-page booklet.—**Filters, Inc.**, East Northport, N.Y.

**ELECTRONIC ORGAN KITS** described in 20-page booklet. Flexible 7-inch phonograph record demonstrates sound of different models. Specs, illustrations.—**Schober Organ Corp.**, 43 W. 61 St., New York, N.Y. 10023.

**1964 GUIDE TO CUSTOM STEREO** includes explanation of FM multiplex, hints for selecting amplifiers and tuners. 24-page booklet has photos and suggestions on stereo installation.—**H. H. Scott, Inc.**, Dept. P., 111 Powdermill Rd., Maynard, Mass.

**MAGNETIC RECORDING TAPE STORY** told in 16-mm color film "Magnetic Memory", available on free loan to clubs and other organizations. 25-minute film describes theory of sound and recordings, manufacturing process.—**3M Co.**, Dept. Z3-580, 2501 Hudson Rd., St. Paul 19, Minn.

**PLANS FOR 2 HI-FI CABINET INSTALLATIONS**, include space for tuners, amplifiers, record player and record storage space. Large 17 x 22-inch sheets.—**Institute of High Fidelity, Inc.**, 516 Fifth Ave., New York 36, N.Y.

"WHAT'S THIS ALTERNATOR TALK ALL ABOUT?" answered in 8-page cartoon booklet. Explains in layman's language operation of typical automotive electrical system. Applies to boats, trucks, emergency vehicles.—**Leece-Neville Co.**, 1374 E. 51 St., Cleveland, Ohio. END

Any or all of these catalogs, bulletins, or periodicals are available to you on request direct to the manufacturers, whose addresses are listed at the end of each item. Use your letterhead—do not use postcards. To facilitate identification, mention the issue and page of RADIO-ELECTRONICS on which the item appears. UNLESS OTHERWISE STATED, ALL ITEMS ARE GRATIS. ALL LITERATURE OFFERS ARE VOID AFTER SIX MONTHS.

# 23 CRYSTAL CONTROLLED CHANNELS

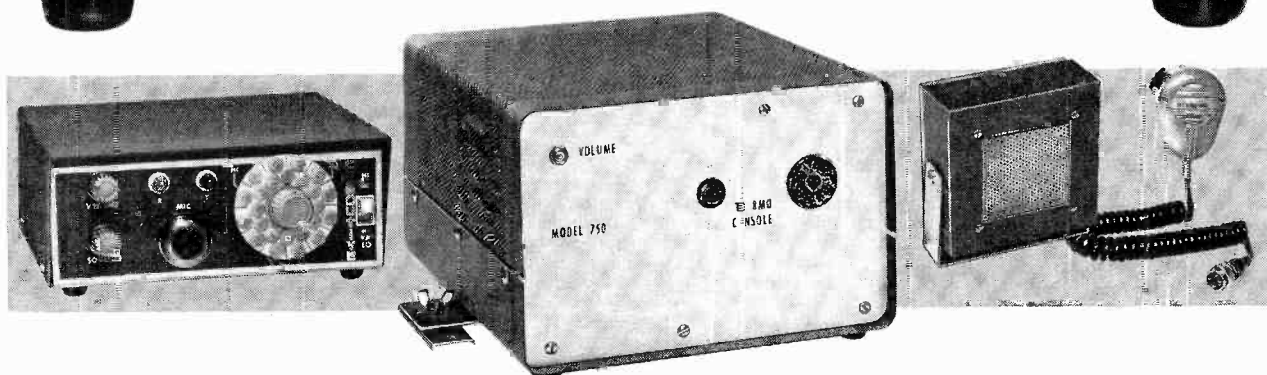
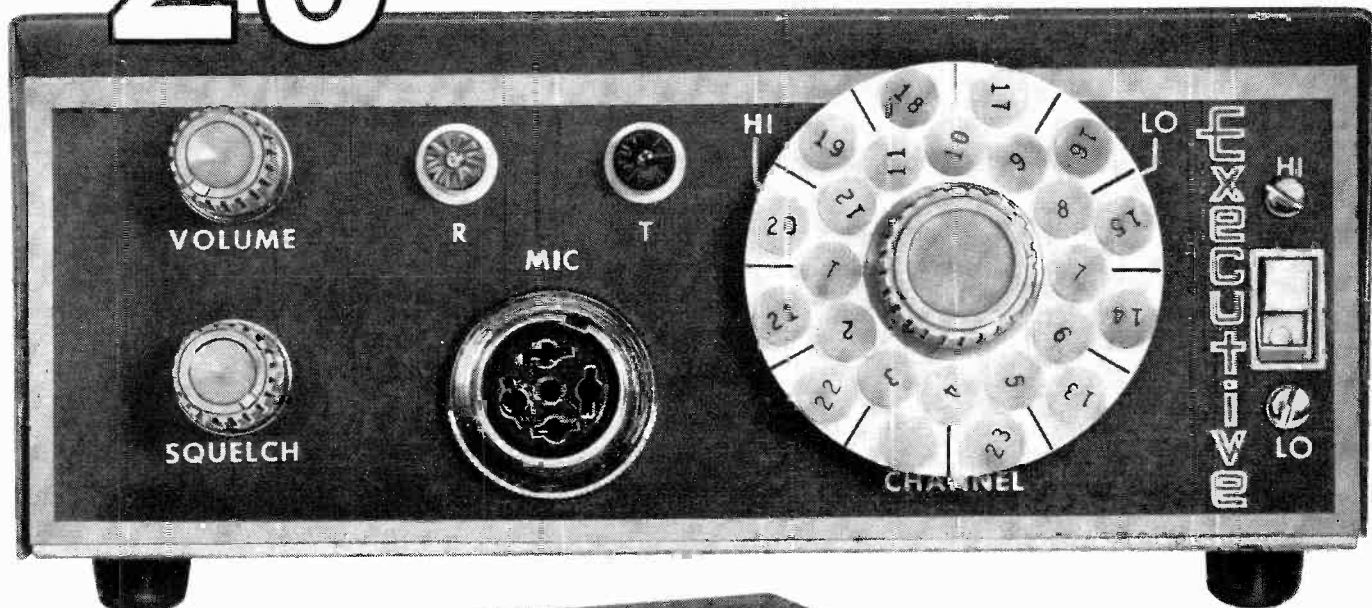

## THE NEW EXECUTIVE 750

Discover new operating performance with International's Executive 750 citizens band transceiver. Turn the illuminated Channel Selector dial . . . transmit and receive on any one of 23 crystal controlled channels.

Set the HI-LO switch in the LO position . . . dial Channel 1 through 12. Set the switch in the HI position . . . dial Channel 13 through 23.

The Remote Console, installed under the auto dash, gives you complete remote operation. It turns the set (in the trunk) on or off, adjusts speaker volume and squelch at the desired threshold.

The Executive 750 is complete with crystals, external 4" speaker with cabinet, mounting rack for Remote Console, trunk mounting rack

for set, push-to-talk microphone, DC power cable, plus all necessary connecting cables.

International takes pride in introducing the Executive 750 . . . engineered for mobile operation . . . 23 crystal controlled channels . . . operates on 6 vdc, 12 vdc, or 115 vac.

Available at your International dealer . . . \$229.00

WRITE TODAY FOR OUR 1964 CATALOG.



# new Products

**CB ANTENNA, model GAM CB-11.** Base-loaded mobile antenna for 27-mc CB unit. Whip 38 in. long. Tunable loading coil at base. VSWR



less than 1.2:1 on 23 CB channels when correctly adjusted.—**GAM Electronics, Inc.**, 138 Lincoln St., Manchester, N.Y.

**RADIO SCRAMBLER.** Privacy for 2-way AM and FM radios. Electronically rearranges sound of spoken voice into unintelligible patterns. Gibberish then broadcast. Can be retranslated to original

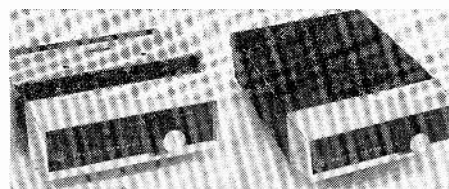

message only by similarly coded instrument. Mobile and base station units.—**Delcon Corp.**, 943 Industrial Ave., Palo Alto, Calif.

**CB TWO-WAY RADIO, Champion II,** all-transistor universal power supply. 5 fixed channels tunable to transmit 23 channels with external crys-

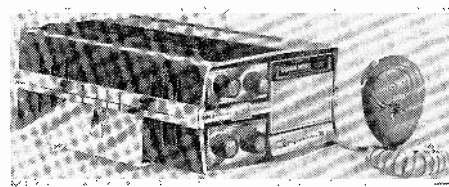

tal socket. Hand-wired circuitry, preset noise limiter, aluminum chassis.—**Pearce-Simpson, Inc.**, 2295 N.W. 14th, Miami, Fla.

**6-CHANNEL CB TRANSCEIVER** for home and office, *model TWR-4.* Built-in S-meter indicating transmitter and receiver performance. Prewired

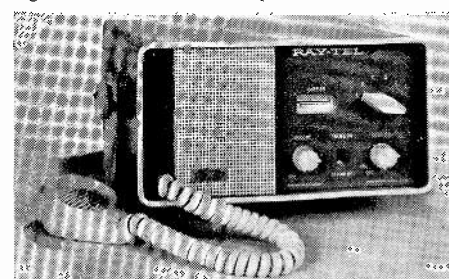

with external socket to accommodate selective calling unit. Automatic volume control, adjustable squelch circuit.—**Raytheon Co.**, Lexington 73, Mass.

**FM MONO 18-WATT RECEIVER,** with paging facility, *model 2716.* Tuner: Antenna input 300 ohms balanced; IHF usable sensitivity: 3  $\mu$ v (30 db quieting); i.f. bandwidth: 280 kc at 6 db points; ratio detector bandwidth: 1 mc peak-to-peak separation. IHF signal-to-noise ratio: 55 db. *Amplifier:* Power: 18 watts IHF music, 14 watts continuous; IM distortion: 2% at 14 watts; frequency response:

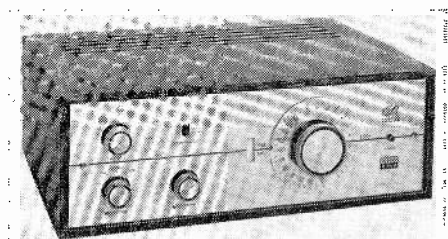

$\pm 1$  db 15 cycles—40 kc; sensitivity: 240 mv on phono, tape; 4 mv on mike; noise: 80 db down on phono and tape, 60 db down on mike.—**EICO Electronic Instrument Co., Inc.**, 131-01 39th Ave., Flushing N.Y. 11354.

**GENERAL-COVERAGE RECEIVER, model NC-121.** Continuous coverage 550 kc to 30 mc in 4 bands. Built-in 5-in. PM speaker, separate rf and audio gain controls, SSB/CW age and product de-

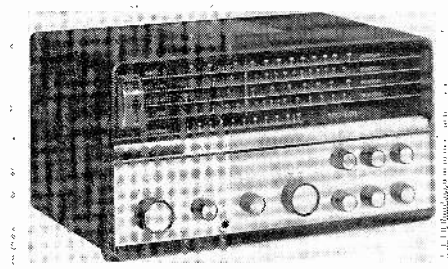

tector, automatic series-gate noise limiter, full-wave transformer-operated power supply.—**National Radio Co., Inc.**, Dept. P, 37 Washington St., Melrose 76, Mass.

**FM STEREO RECEIVER, model 2536.** Tuner: antenna input: 300 ohms balanced; IHF usable sensitivity: 3  $\mu$ v (30 db quieting), 1.5  $\mu$ v for 20 db quieting; i.f. bandwidth: 280 kc at 6 db points; IHF signal-to-noise ratio: 55 db; harmonic distortion: 0.6%; channel separation: 30 db. *Amplifier:* power: 36 watts IHF music; 28 watts continuous;

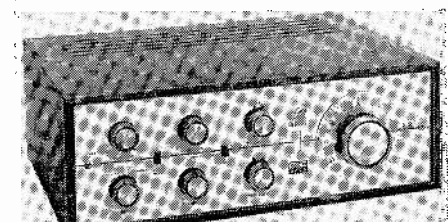

IM distortion (each channel); 2% at 14 watts, 0.7% at 5 watts, 0.2% at 1 watt; harmonic distortion (each channel): 0.6% at 10 watts, 40 cycles—10 kc; frequency response:  $\pm 1$  db 15 cycles—40 kc; speaker output: 8 and 16 ohms. 5 $\frac{1}{2}$  x 15 $\frac{3}{4}$  x 13 $\frac{3}{8}$  in.—**EICO Electronic Instrument Co., Inc.**, 131-01 39th Ave., Flushing, N.Y. 11354.

**STEREO POSITIONER** gradually moves stationary sound source from left channel to right channel and back again. Input: low-level 50–600 ohms unbalanced; high-level 5,000–15,000 ohms unbalanced. Output: approximately 15,000 ohms each channel, unbalanced; output level: 1 volt; gain: 60 db; distortion: less than 1% total har-

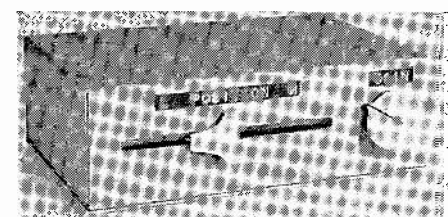

monic; signal-to-noise ratio: better than 60 db. 4 x 6 x 2 in. Self-contained 9-volt battery. Controls: panning, gain.—**UltraAudio**, PO Box 821, Beverly Hills, Calif.

**70-WATT TRANSISTOR STEREO HI-FI AMPLIFIER, Knight-Kit KG-870,** (22 transistors, 4 silicon diodes). Power output: IHF music power: 70 watts; 35 watts per channel. Sine wave, 28 watts per channel. Response:  $\pm 1$  db, 20–25,000 cycles. Distortion at rated power: IM, less than 1%. Hum: tuner, –80 db; Mag phono, –68 db, tape head,

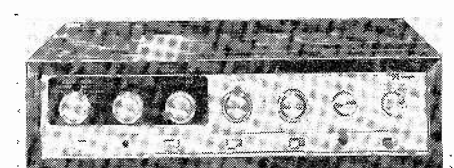

–60 db. Channel separation: exceeds 30 db. Output circuitry thermal stability protects transistors. No capacitors or transformers in output stages. Low current drain. Variable loudness control. Tape-monitor input switch. Rumble and scratch filters. Speaker phasing switch. 2 $\frac{3}{4}$  x 13 x 11 in.—**Allied Radio Corp.**, 100 N. Western Ave., Chicago 80, Ill.

**80-WATT STEREO AMPLIFIER, model S-5500III,** for home music systems with tape decks, phonographs, tuners. Noise and hum: 72 db below rated output. Phono input sensitivity: 1.2 mv. Tape-

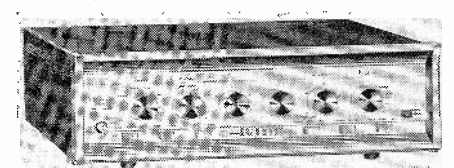

head sensitivity: 1.6 mv; tuner sensitivity: 0.25 volt. Frequency response 20–20,000 cycles  $\pm \frac{1}{2}$  db. Music power: 40 watts each channel; 36 watts continuous at 1 $\frac{1}{2}$ % IM distortion.—**Sherwood Electronic Laboratories, Inc.**, 4300 N. California Ave., Chicago, Ill.

**40-WATT STEREO AMPLIFIER, model LA-260.** Harmonic distortion: less than 1% at rated output. Frequency response:  $\pm 1$  db 40–20,000 cycles. Hum and noise: tuner: 75 db; magnetic phono: 58 db. Sensitivity: for full output: mag-

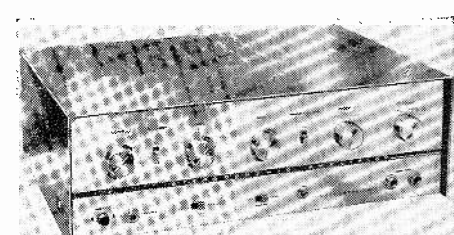

phono 4.5 mv; high level: .5 v. 14 $\frac{3}{4}$  x 5 $\frac{1}{8}$  x 11 in.—**Lafayette Radio Electronics Corp.**, 111 Jericho Turnpike, Syosset, N.Y.

**SUBMINIATURE STEREO PICKUP, model 500AT Micro Fluxvalve.** Less than 5 grams. For automatic turntables utilizing low-mass tone-arm



systems. 15° playback angle.—**Stanton Magnetics, Inc.**, Terminal Drive, Plainview, N.Y.

**STEREO TAPE RECORDERS, F-44 series,** replaces 1200 series. (Model F-4460 portable illus-



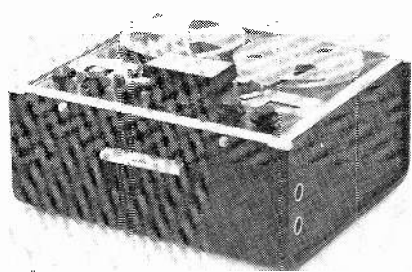

trated.) 4-track stereo/4-track monophonic. Frequency response 50-15,000 cycles  $\pm 2$  db at 7½ ips; outputs about 1.0 volt rms; signal-to-noise ratio better than 53 db at 7½ ips, 48 db at 3¾ ips. Flutter and wow under 0.15% rms at 7½ ips; under 0.2 at 3¾ ips. Timing accuracy  $\pm 1.0\%$ .—**Ampex Corp.**, 934 Charter St., Redwood City, Calif.

**ALL-TRANSISTOR TUNER, model AJ-43.** AM, FM, FM stereo. 25 transistors, 9 diodes. FM section: sensitivity: 2  $\mu$ v for 30-db quieting; capture ratio: 7.5 db; harmonic distortion: less than 1%; output voltage: 0.5. FM stereo converter section: separation: 30 db at 10,000 cycles. AM section: sensitivity: 1000 kc. 5  $\mu$ v for 10 db S/N; harmonic distortion: less than 1%; hum and noise:

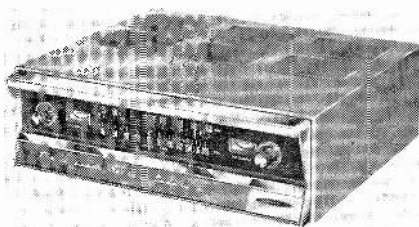

35 db below 30% mod.—**Heath Co.**, Benton Harbor, Mich.

**TRANSISTOR TAPE RECORDER, Butoba MT-7.** 4 x 6-in. speaker. Operates 20 hours on 4 flashlight batteries, also on 6- or 12-v car battery

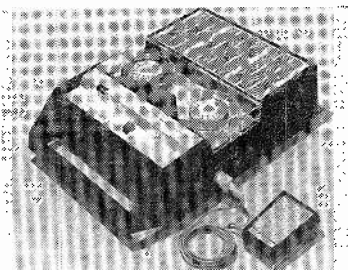

or ac power. Response: 70-12,000 cycles at 3¾ ips; 100-5,000 cycles at 1½ ips.—**Stanford International**, 569 Laurel St., San Carlos, Calif.

**PORTABLE TAPE RECORDER, 660 Senior.**

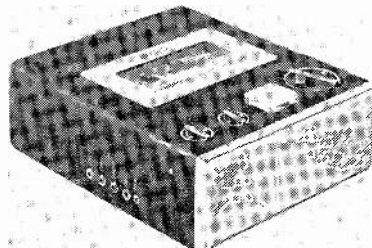

7½ x 9 x 3 in. 8½ lb. 3-speed (7½, 3¾, 1½), built-in stroboscope for 7½ ips on capstan.—**Freeman Electronics**, 729 N. Highland Ave., Los Angeles 38, Calif.

**DESK STAND** for mikes any shape, size or weight. Heavy 8 in. diameter base and anodized collar. 4 in. long. Terminates with standard ½ in.

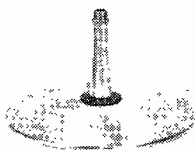

-27 precision thread.—**Atlas Sound**, 1419-51 39th St., Brooklyn, N. Y.

**5-SPEAKER SYSTEM, SK-300WX.** Four

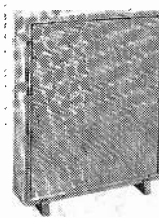

6½-in. low-resonance speakers and one 2½-in. cone type tweeter. Frequency response: 50 to 18,000 cycles. Power handling capacity: 50 watts continuous, 30 watts peak. Impedance: 8 ohms. Size: 17¾ x 21¾ x 4¼ in. 17 lb.—**Lafayette Radio Electronics Corp.**, 111 Jericho Turnpike, Syosset, N. Y.

**TRANSISTORIZED IGNITION SYSTEM, model K-70.** does not require removal, short-out, or bypass of ignition ballast resistance. Installed without disturbing old ignition ballast resistance

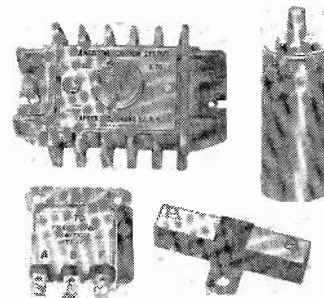

or bypass. Installation involves removing distributor condenser and replacing old ignition coil.—**Kapner, Inc.**, 1924 Washington Ave., Bronx 57, N. Y.

**NOISE-SUPPRESSION KIT** controls whines associated with worn generator brushes and pop-

# ALL NEW SENCORE component substitutor



MODEL RC121

## All your favorite Sencore Substitution Time-Savers in One Compact Unit

A complete range of carbon resistors, wire wound power resistors, capacitors, electrolytics, and universal selenium and silicon rectifiers.

Imagine, all of these hard to locate parts at your finger tips for on the spot substitution. Say goodbye to messy, crumpled parts, unnecessary unsoldering and soldering of components for testing purposes only. Save valuable servicing time and be sure, by substituting.

NEW . . . each section operates independently with a value close enough for every substitution need. Components in each section are isolated from chassis and from the other sections. For example, a complete power supply can be constructed using the RC121 Components only.

NEW . . . dual electrolytics provided. A new circuit enables you to substitute up to 25 single electrolytic values or 9 duals. Exclusive surge protector provides protection on both singles and duals for both you and the circuit.

You save space and money. Equivalent Sencore substitution-pieces purchased individually (H36, PR111, RS106, ES102) cost you \$54.00

**RC121** (all hand wired, all American made) only **3995**  
**RC121K** (Kit) . . . . . **27.95**

Now in stock at your Sencore Distributor. See him today!

**SENCORE**  
ADDISON 2, ILLINOIS

# KNOWLEDGE

## Your Most Important Hi-Fi Investment

Build knowledge... supplement the fine articles in this special RADIO-ELECTRONICS issue... with these outstanding books from Gernsback Library. And, remember, Gernsback books are edited with expert skill to make you a skilled expert in high-fidelity.



**THE STORY OF STEREO: 1881**—by John Sunier. Development of tape, film and disc stereo from first ideas to present.  
No. 98—Paperback \$2.95  
Clothbound \$5.00

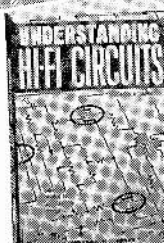

**UNDERSTANDING HI-FI CIRCUITS**—by Norman H. Crowhurst. An authority analyzes circuits, tells how they work, helps you pick 'em for your purposes.  
No. 64—Paperback \$2.90

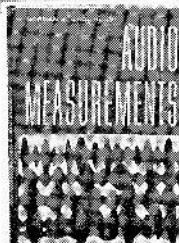

**AUDIO MEASUREMENTS**—by Norman H. Crowhurst. Shows how to make audio tests, instruments to use, interpreting results.  
No. 73—Paperback \$2.90



**INSTALLING HI-FI SYSTEMS**—by Jeff Markell and L. Jerome Stanton. Avoid pitfalls by planning before you purchase—a complete guide.  
No. 86—Paperback \$3.20

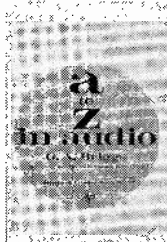

**A TO Z IN AUDIO**—by Gilbert A. Briggs. A light-hearted, yet practical, one-volume hi-fi encyclopedia. Illustrated.  
No. 97—Paperback \$3.20

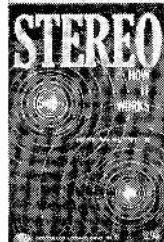

**STEREO—HOW IT WORKS**—by Herman Burstein. Theory and operating techniques—recording, playback, broadcasting, multiplexing.  
No. 80—Paperback \$2.90

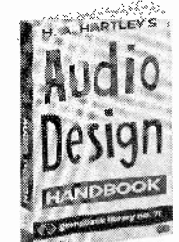

**H. A. HARTLEY'S AUDIO DESIGN HANDBOOK**. The "ins" and "outs" of audio design by a master of clear, practical exposition.  
No. 71—Paperback \$2.90  
Clothbound \$5.00



**MAINTAINING HI-FI EQUIPMENT**—by Joseph Marshall. Tells how to locate and correct mechanical, acoustic and electronic troubles.  
No. 58—Paperback \$2.90

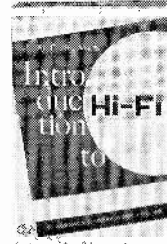

**INTRODUCTION TO HI-FI**—by Clement Brown. Takes up hi-fi theory, components and systems with a novel approach.  
No. 88—Paperback \$3.20



**DESIGNING AND BUILDING HI-FI FURNITURE**—by Jeff Markell. Make your hi-fi system look as good as it sounds with fine furniture.  
No. 79—Paperback \$2.90  
Clothbound \$5.00



**ELEMENTS OF TAPE RECORDER CIRCUITS**—by Herman Burstein and Henry C. Pollak. Answers hundreds of questions on tape recorder electronics.  
No. 67—Paperback \$2.90  
Clothbound \$5.00



**HIGH-FIDELITY CIRCUIT DESIGN**—by Norman H. Crowhurst and George Fletcher Cooper. Learn to build 'em on paper for best results.  
No. 56—Clothbound \$5.95

Buy these books at your electronic parts distributor, or clip and mail coupon

### GERNSBACK LIBRARY, INC.

154 West 14th Street, New York, N.Y. 10011

Gentlemen:

I enclose \$..... Please send me the books checked. I understand I may return them within 10 days and receive a full refund if not satisfied.

Name.....

Address.....

City..... State.....

Zip Code.....

REMITTANCE MUST ACCOMPANY ORDER

98  80  67

97  79  64

88  73  58

86  71  56

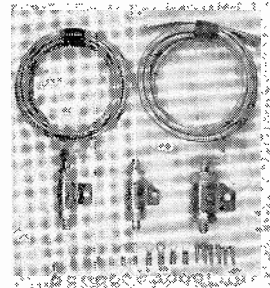

ping caused by making and breaking of voltage regulator contacts.—Webster Manufacturing, 317 Roebling Rd., So. San Francisco, Calif.

**MINIATURE THERMAL TIME-DELAY RELAY** fits 9-pin miniature tube socket. Bi-metal relay in shatterproof metal shell. Contact rating 2



amps resistive at 115 v ac or 28 v dc. Normal time-setting tolerance of  $\pm 20\%$ .—G-V Controls Inc., Livingston, N.J.

**CONNECTOR, Series REMI** removable re-

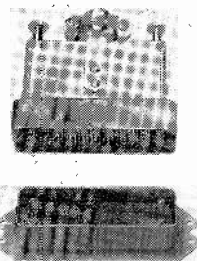

entrancy miniature crimp type, MI miniature and SMI subminiature types. Available with bath-tub type shells and mounting plates for protection against pin damage and certain environmental conditions. Shells meet latest Mil Spec MS-17775. .040 thick aluminum, sulphuric anodized finish. 7 polarization positions available.—U.S. Components, Inc., 1320 Zerega Ave., Bronx, N.Y.

**PRECISION INSERTED TIP WIRE CUTTERS** for cutting wire up to .025 in. diam. Repairs by factory include sharpening and realignment; replacement when required. Hard chrome-plated;

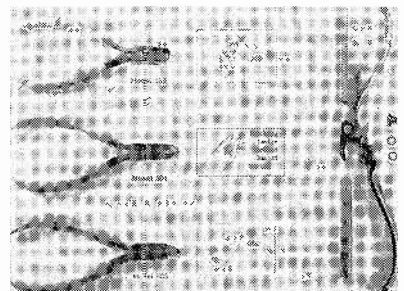

assembled with precision screw and shims; cutting edges diamond-honed to optimum.—ETM Corp., 112 S. Magnolia, Monrovia, Calif.

**15-PIECE RELAY SERVICING TOOL KIT**. All tools made of carbon steel, with heavy chrome plating. Most tools insulated for up to 10,000 volts

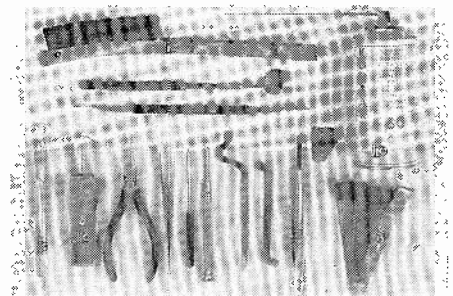

# a complete range of quality **NUVISTORS** *by*

# HITACHI

RELIABLE  
LOW POWER REQUIREMENTS

SELF-SHIELDING

UNIFORM

STABLE

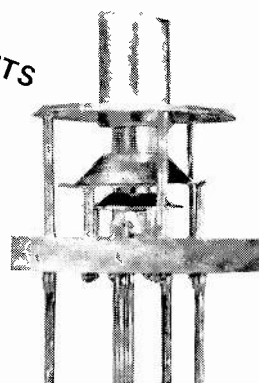

HITACHI now offers a complete range of nuvistors to the radio and television industry. Included are useful new HITACHI designed types. They are made with the precision, care and pride that go into every HITACHI product. Every nuvistor is carefully inspected before leaving the factory. Write HITACHI for detailed technical information and prices. Discover the advantages of specifying HITACHI nuvistors for your product.

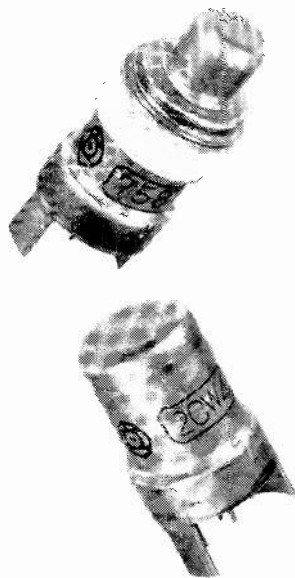

HITACHI	
6CW4	TRIODE, FOR VHF-AMPLIFIER IN STANDARD TV.
2CW4	SAME AS 6CW4, FOR 450 MA TRANSFORMERLESS TV.
2B-H5	SAME AS 6CW4, FOR 600 MA TRANSFORMERLESS TV.
6DS4	SEMI-REMOTE TRIODE, TV VHF-AMPLIFIER.
2DS4	SAME AS 6DS4, FOR 450 MA TRANSFORMERLESS TV.
2N-H11	SAME AS 6DS4, FOR 600 MA TRANSFORMERLESS TV.
6DV4	TRIODE, FOR UHF-OSCILLATOR IN STANDARD TV.
2DV4	SAME AS 6DV4, FOR 450 MA TRANSFORMERLESS TV.
2N-H12	SAME AS 6DV4, FOR 600 MA TRANSFORMERLESS TV.
6N-H10	LOW NOISE TRIODE, AUDIO PRE-AMPLIFIER.
6N-L7	TRIODE, FOR VERY LOW-B+ APPLICATIONS.
7586	TRIODE, FOR INDUSTRIAL APPLICATIONS.
7587	TETRODE, FOR INDUSTRIAL APPLICATIONS.
8056	TRIODE, FOR LOW-B+ APPLICATIONS.
8058	TOP-PLATE TRIODE, FOR UHF APPLICATIONS.



**Hitachi, Ltd.**

TOKYO, JAPAN

CABLE ADDRESS: "HITACHY" TOKYO

666, 5th Ave., New York 19, N.Y., U.S.A. Tel: JUDSON 6-4757  
100 California St., San Francisco, Calif., U.S.A. Tel: YUKON 1-7871

333, N. Michigan Avenue, Chicago 1, Ill., U.S.A. Tel: 726-4572/4  
Graf Adolf Strasse 37. Duesseldorf, West Germany Tel: 10846

to permit operation on "live" equipment. Spring adjusters, pliers, inspection mirror, gauges, etc.—**Jonard Industries Corp.**, 3733 Riverdale Ave., Bronx 63, N.Y.

**SOLDERING PISTOL, model 75.** Tip heat of 100-watt device from peak surge rating of 50 watts

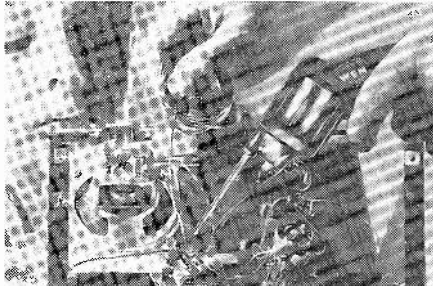

and normal draw of 30 watts. Tip will not over-heat. 9 in. long, 4½ in. high, 1 lb.—**Wen Products, Inc.**, 5810 Northwest Highway, Chicago 31, Ill.

**MAGNETIC LEVEL, model ML-7,** usable as

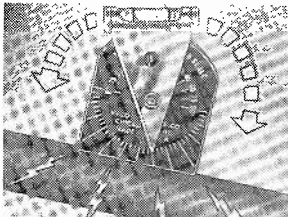

level or plumb, protractor, rule and square. Protractor vial head swivels left and right, allowing reading of any angle up to 90°. Level magnetized on sides and bottom. Placed on any surface to be checked and protractor adjusted until bubble centered. Reading then taken.—**Vaco Products Co.**, 317 E. Ontario St., Chicago, Ill.

**LOCK TYPE HOLDER.** 2-position stainless steel snaplock. Insulated handle. Serrated jaws provide heat sink and clamp for soldering transistors, thermistors and diode, etc. Straight or curved.—



**Techni-Tool, Inc.**, 1216 Arch, Phila., Pa.

**MINIATURE SOLDERING IRONS.** High thermal capacities. In 2 sizes and 5 wattage ranges. Replaceable copper alloy or solid nickel tips de-

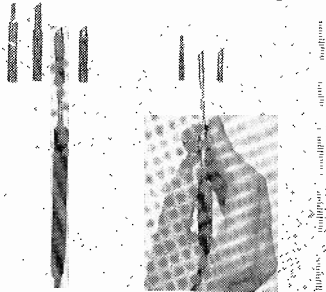

liver maximum heat at production speeds. Sealed element maintains constant temperature within ±2% of indicated heat under normal operating conditions.—**Meadow Corp.**, 2712 W. Montrose, Chicago, Ill.

**VOLTAGE REFERENCE, models 1118 A, B, C and D,** cover 10 μv to 1/10 v; accuracy ±0.5%. Self-contained, own power source. Mercury cell and 0.25% resistors used. Cell capacity 14,000 mil-

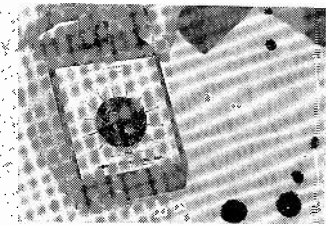

liampere hours.—**Emcee Electronics, Inc.**, 1202 Arnold Ave., Greater Wilmington Airport, Wilmington, Del.

**CAPACITANCE-RESISTANCE ANALYZER, model BF-71A,** measures all low- and high-voltage capacitor and resistor values. 0-500-volt variable dc supply for measuring leakage cur-

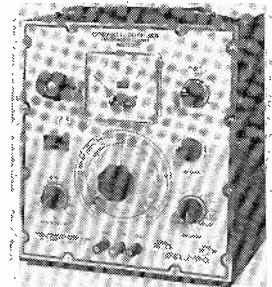

rent at rated capacitor voltage. Measures capacitor values 10 pf to 2,000 μf; resistor values 2.5 ohms to 25 megohms; capacitor leakage current 1 μa to 100 ma, and power factor from 0-50% at 60 cycles.—**Cornell-Dubilier Electronics Div.**, 50 Paris St., Newark 1, N.J.

**RF ATTENUATOR, model TG-9050,** covers 82.5 db in 0.5-db steps. Toggle-switch type attenu-

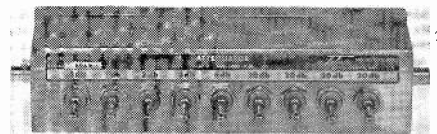

ator incorporating 9 pi-pads. Frequency range dc to 300 mc. Impedance 50 ohms.—**Telonic Industries, Inc.**, 60 N. First Ave., Beech Grove, Ind.

**AUDIO SIGNAL GENERATORS, models H-1, J-1 and J-2.** Sinusoidal signal over entire af spectrum, 15 to 50,000 cycles. H-1, squarewave output. J-1, J-2 less than 2% distortion at 1-watt output and output impedance of 600 ohms with alternate 5-ohms output. H-1, continuously variable square-

When A Man Bites A Dog  
It's News... Big News!

# "MAN BITES DOG"

It will be even bigger news  
if you find anyone, anywhere  
who can match our prices!

Our TREMENDOUS BUYING POWER & PURCHASING EXPERIENCE make it possible. We invest Thousands of Dollars (in just a single item) to create a good DOLLAR BUY, resulting in the AMAZING & EXCITING OFFERS that follow:

**10% OFF & FREE GIFT ON ORDER OF \$10 OR OVER (ON DOLLAR BUYS)**

- \$15.00 RADIO PARTS "JACKPOT" handy assortment ..... \$1
- 3-ASST. SIZES RADIO CHASSIS PANS drilled & plated ..... \$1
- 3-VARIABLE CONDENSERS asst. popular super-het types ... \$1
- 50-RADIO & TV SOCKETS all type 7 pin, 8 pin, 9 pin ... \$1
- 50-ASST. RADIO KNOBS all selected popular types .... \$1
- UNIVERSAL 4" PM SPEAKER Alnico 5 magnet, quality tone... \$1
- UNIVERSAL 5" PM SPEAKER Alnico 5 magnet, quality tone... \$1
- ELECTROSTATIC 3" TWEETER SPEAKER for FM, HI-FI, etc. ... \$1
- 3 - SPEAKER CABINETS for 2½" to 3" speaker, all purpose \$1
- UNIVERSAL 3" PM SPEAKER for Cabinet above (or others)... \$1
- 2-UNIVERSAL 2" PM SPEAKERS for Trans Radios, Intercom \$1
- 10-SPEAKER PLUG SETS deluxe type, 2 conductor, wired \$1
- 3 - AUDIO OUTPUT TRANSFORMERS 50GL type ..... \$1
- 3 - AUDIO OUTPUT TRANSFORMERS 6K6, 6V6 ..... \$1
- 3 - AUDIO OUTPUT TRANSFORMERS 3V4, 3Q4, 384 ..... \$1
- 4 - I.F. COIL TRANSFORMERS 450kc, most popular type \$1
- 3 - I.F. COIL TRANSFORMERS 262kc, for auto radios ... \$1
- 3 - I.F. COIL TRANSFORMERS 10-7mc for FM ..... \$1

- 100 - ASSORTED ½ WATT RESISTORS some in 5% ..... \$1
- 70 - ASSORTED 1 WATT RESISTORS some in 5% ..... \$1
- 35 - ASSORTED 2 WATT RESISTORS some in 5% ..... \$1
- 50 PRECISION RESISTORS asst. list prices \$50 less 98% \$1
- 20 - ASS'TED WIREWOUND RESISTORS, 5, 10, 20 watt ... \$1
- 50 - ASST. DISC. CERAMIC CONDENSERS popular numbers \$1
- 50 - ASST. CERAMIC CONDENSERS some in 5% ..... \$1
- 50-ASST. MICA CONDENSERS some in 5% ..... \$1
- 50 - ASST. TUBULAR CONDENSERS. 001 to .47 to 600v \$1
- 20 - STANDARD CONDENSERS. .047-600v 85% top quality \$1
- 10 - ASST. RADIO ELECTROLYTIC CONDENSERS ..... \$1
- 5 - ASST. TV ELECTROLYTIC CONDENSERS ..... \$1
- 3 - ELECTROLYTIC CONDENSERS 50/80-150v ..... \$1
- 2 - ELECTROLYTIC CONDENSERS 40/40mfd-400 volts ... \$1
- 10 - ASSORTED VOLUME CONTROLS less switch ..... \$1
- 5-ASSORTED VOLUME CONTROLS with switch ..... \$1
- 5 - 50K VOLUME CONTROLS less switch ..... \$1
- 5 - ½ MEG VOLUME CONTROLS less switch ..... \$1

- \$15.00 TELEVISION PARTS "JACKPOT" best buy ever ... \$1
- REGO INDOOR TV ANTENNA hi-gain, 3 section, tiltproof .. \$1
- 70° FLYBACK TRANSFORMER \$1 universal incl schematic
- 70° TV DEFLECTION YOKE \$1 wired network, incl schematic.
- 90° TV DEFLECTION YOKE \$1 wired network, incl schematic
- 5 - TV HI-VOLT ANODE \$1 LEADS 20" length .....
- 10-TV PICTURE TUBE SOCKETS wired with 20" leads ... \$1
- 20 - ASSORTED TV KNOBS ESCUTCHEONS etc. \$20 value \$1
- 20-ASSORTED TV COILS I.F. video, sound, ratio, etc. ... \$1
- 20 - ASSORTED GRID CAPS \$1 for 1B3, 1X2, 6BG3, 6BQ6, etc.
- 50'-HI-VOLTAGE WIRE \$1 for TV, special circuits, etc. ...
- 100' - TWIN TV LEAD-IN WIRE 300 ohm, heavy duty .. \$1
- 5-TV CHEATER CORDS \$1 with both plugs .....
- 50' - FLAT 4-CONDUCTOR WIRE many purposes ..... \$1
- STANDARD CASCODE TUNER \$9 21mc, 3¼" shaft, complete with Tubes and schematic diagram..
- STANDARD 41mc TV TUNER \$9 Complete with Tubes, schematic for installation, long shaft ...

## MARKET SCOOP COLUMN

- STARLITE TRANSISTOR RADIO \$1 has Cabinet, Speaker & many Parts—sold as-is & not-tuck ..
- DELUXE AM-FM 11-TRANSISTOR RADIO PORTABLE, new complete & perfect ..... \$17
- STARLITE 9-TRANSISTOR RADIO complete needs slight adjustm't \$8
- \$50 STARLITE AM-FM RADIO complete in factory cartons, needs slight adjustment ..... \$17
- \$12 TALKING DOLLS 25" TALL \$5 sophisticated - blonde, brunette or redhead, 11 cute recitations
- 4-IBM COMPUTER SECTIONS \$1 loaded with valuable parts ..
- STANDARD UHF INPUTUNER \$1 (less cabinet & 6AF4 tube) as is
- STANDARD TUNER UHF STRIPS \$1 26K, 34K, 43K, 46K, 48K, 51K, 54Q, 56F, K or Q, 58K, each
- G.E. SINE WAVE GENERATOR \$1 sold as is, less tubes .....
- 2-PRINTED CIRCUIT BOARDS \$1 Part over 100-count guaranteed
- 10 - DUAL CONTROLS \$1 350-1 meg, long shaft, 101 uses
- 10-25K DUAL CONTROLS .. \$1
- WESTERN ELECTRIC Piece of \$1 Equipment with valuable parts
- \$17.50 WEBSTER DIAMOND CARTRIDGE ±SC2-D Stereo .. \$1
- 50-G.E. FLASHLIGHT BULBS \$1 #PR-9, 2.7 volts .....
- 50-RCA PHONO PLUGS \$1 Standard for phonos, male ....

**BROOKS RADIO & TV CORP., 84 Vesey St., Dept. A, New York 7, N.Y.** TELEPHONE ORtlandt 7-2359

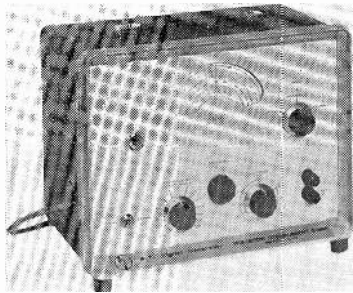

wave output of 80 mv to 80 v, peak to peak, and continuously variable sine-wave output voltage of 200 mv to 20 v rms. Distortion less than 1% at 1 kc at level of 20 v. Rise time less than 3 μsec. Frequency response of all signal generators flat ±1 db.—**Houston Instrument Corp.**, 4950 Terminal Ave., Bellaire 101, Tex.

**5-INCH SCOPE**, model PS127, requires no narrow-band facility due to high sensitivity of .017 volt rms for 1-inch deflection on broad band. Z-

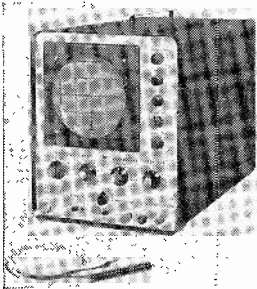

axis modulation, direct plate connections on rear. Low frequencies down 3 db at 10 cycles, horizontal sweep range up to 500 kc, positive synclocking.—**Sencore, Inc.**, 426 So. Westgate Dr., Addison, Ill.

**PRECISION VOLT-OHM-MILLIAMMETERS**, models 120 and 120M, feature silicon varistor to prevent damage to meter-movement even

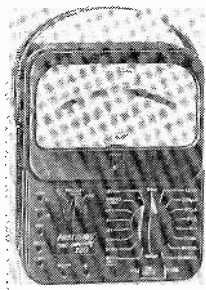

when subjected to accidental transient overloads of 1,000 times or more.—**Precision Apparatus, Inc.**, 80-00 Cooper Ave., Bldg. #3, Glendale 27, N. Y.

**PORTABLE VHF-UHF TRANSLATOR** provides service technician and TV showroom with uhf television signals when none available through local telecasting stations. Color info as well as black-and-white. Bias control varies signal strength from 100 μv to 10 mv or higher, depending on

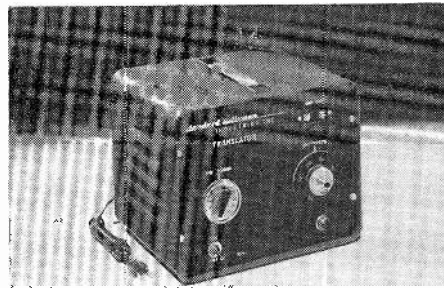

strength of vhf station. Operates on 110-125 volt 50-60 cycles with 30 watts maximum power consumption.—**Standard Kollman Industries, Inc.**, 2085 N. Hawthorne Ave., Melrose Park, Ill.

*All specifications from manufacturers data.*



Fill in coupon for a FREE One Year Subscription to **OLSON ELECTRONICS Fantastic Bargain Packed Catalog**—Unheard of **LOW, LOW, DISCOUNT PRICES** on Brand Name Speakers, Changers, Tubes, Tools, Stereo Amps, Tuners, CB, Hi-Fi's, and thousands of other Electronic Bargains. Credit plan available.

NAME \_\_\_\_\_

ADDRESS \_\_\_\_\_

CITY \_\_\_\_\_ ZONE \_\_\_\_\_ STATE \_\_\_\_\_

If you have a friend interested in electronics send his name and address for a FREE subscription also.

**OLSON ELECTRONICS, INC.**

745 Forge Street, Akron, Ohio 44308

**IMMEDIATE DELIVERY... SCIENTIFIC LIGHT PACKING** for safe delivery at minimum cost. **HANDY WAY TO ORDER**—Pencil mark items & enclose with check or money order, add extra for shipping, excess refunded with advantage to customer. Tearsheet will be returned with order, as your packing slip.

- 20 — INSTRUMENT POINTER \$1  
KNOBS selected popular types
- 15 — RADIO OSCILLATOR \$1  
COILS standard 456kc
- 50—ASSORTED PRINTED CIR-  
CUIT SOCKETS best types
- 25 — ASST. CLOCK RADIO \$1  
KNOBS in colors
- 50 — ASSORTED TERMINAL \$1  
STRIPS 1, 2, 3, 4 lugs
- 100' — FINEST NYLON DIAL \$1  
CORD best size, .028 gauge
- 20—ASST. PILOT LIGHTS \$1  
=44, 46, 47, 51, etc.
- 20 — PILOT LIGHT SOCKETS \$1  
bayonet type, wired
- 10 — SURE-GRIP ALLIGATOR \$1  
CLIPS 2" plated
- 10 — SETS PHONO PLUGS & \$1  
PIN JACKS RCA type
- 100 — ASST RUBBER & FELT \$1  
FEET FOR CABINETS best sizes
- 50—ASSORTED #3AG FUSES \$1  
Popular assorted ampere ratings
- 1000—ASST. HARDWARE KIT \$1  
screws, nuts, washers, rivets, etc.
- 250—ASST. WOOD SCREWS \$1  
finest popular selection
- 250—ASST. SELF TAPPING \$1  
SCREWS #6, #8, etc.
- 150—ASST. 6/32 SCREWS \$1  
and 150 6/32 HEX NUTS
- 150—ASST. 8/32 SCREWS \$1  
and 150—8/32 HEX NUTS
- 150—6/32 HEX NUTS \$1  
and 150—8/32 HEX NUTS
- 500 — ASSORTED WASHERS \$1  
most useful selected sizes
- 500 — ASSORTED RIVETS \$1  
most useful selected sizes

- 100—MIXED DEAL "JACKPOT" \$1  
Condensers, Resistors, Surprises
- 15—ASST. ROTARY SWITCHES \$1  
all popular types \$20 value
- 4—TOGGLE SWITCHES \$1  
SPST, SPDT, DPST, DPDT
- 10 — ASSORTED SLIDE \$1  
SWITCHES SPST, DPDT, etc.
- 100'—MINIATURE ZIP CORD \$1  
2 conductor, serves 101 uses
- 10—6' ELECTRIC LINE CORDS \$1  
with plug
- 4 — 50' SPOOLS HOOK-UP \$1  
WIRE 4 different colors
- 50 — STRIPS ASSORTED SPA- \$1  
GHETTI handy sizes
- 100 — ASSORTED RUBBER \$1  
GROMMETS best sizes
- 50' — INSULATED SHIELDED \$1  
WIRE #20 braided metal jacket
- 32'—TEST PROD WIRE \$1  
deluxe quality, red or black
- 200'—BUSS WIRE #20 tinned \$1  
for hookups, special circuits, etc.
- 250—ASST. SOLDERING LUGS \$1  
best types and sizes
- 50—FUSES #3AG, 1 AMP. \$1
- 50—FUSES #3AG, 5 AMP. \$1
- 3—1/2 MEG VOLUME CON- \$1  
TROLS with switch, 3/4 shaft
- 5 — ASST. 4 WATT WIRE- \$1  
WOUND CONTROLS
- 5—I.F. COIL TRANSFORMERS \$1  
sub-min for Transistor Radios
- 5 — AUDIO OUTPUT TRANS- \$1  
FORM sub-min for Trans Radios

- 4 — ITT TRANSISTOR 9-VOLT \$1  
BATTERIES (as Eveready =21¢)
- 30—BALL POINT PENS \$1  
retractable, assorted colors
- 8—ASST. LUCITE CASES \$1  
hinged cover, handy for parts
- EMERGENCY AUTO LAMP \$1  
Red dome blinker, incl Battery  
saves lives on highway stops
- 3—\$2.50 SAPPHIRE NEEDLES \$1  
guaranteed 5000 playings
- 2—SAPPHIRE STYLUS NEEDLES \$1  
for all type pickups
- RONETTE DUAL SAPPHIRE \$2  
CARTRIDGE Slipover type
- \$20—SHURE M-7D DIAMOND \$3  
NEEDLE exact replacement
- WESTINGHOUSE 8XP4 CR \$17  
TUBE for test picture on re-  
pair bench
- 25—HEAT SINKS for Transistors \$1
- 25—2 TERMINAL PIN JACKS \$1  
asst types for various uses
- 50 — WHITE TUBE CARTONS \$1  
assortment of all 4 important  
sizes
- 50 — ASSORTED TV PEAKING \$1  
COILS all popular types
- 10—DIODE CRYSTALS 1N34 \$1
- 10—ASST. DIODE CRYSTALS \$1  
5-1N60 and 5-1N64
- 2—SILICON RECTIFIERS \$1  
750ma, 400 PIV
- 3—SILICON RECTIFIERS \$1  
Top Hat 500ma-400 PIV
- 2—SELENIUM RECTIFIERS \$1  
1-100 ma and 1-250 ma
- 2—SELENIUM RECTIFIERS \$1  
1-65ma and 1-450ma

**MARKET SCOOP COLUMN**

- 2—TUNGSOIL 5U4 TUBES \$1
- ALL AMERICAN TUBE KIT \$2  
12BA6, 12BE6, 12AV6, 50C5,  
35W4
- 10—TOGGLE SWITCHES SPST \$1  
deluxe U.L. approved, 101 uses
- 30—GOOD-ALL CONDENSERS \$1  
.19-600v (tests .25-1000v)
- 8 — ASTRON ELECTROLYTIC \$1  
CONDENSERS 8mf-450v
- 10—ASSORTED TUBES \$1  
Radio, Television and Industrial
- 3—TOP BRAND 35W4 TUBES \$1
- 5—SYLVANIA 6AK4 TUBES \$1
- 10—SYLVANIA 1U4 TUBES \$1  
brand new Jan. individual car-  
tons also serves as IT4
- 5 — ASST. SELENIUM RECTI- \$1  
FIERS 63ma, 100ma, 300ma, etc.
- 3-3" RECORDER TAPES \$1  
quality acetate, 150 feet
- 12-3" RECORDER TAPE REELS \$1
- 100'—STANDARD ZIP CORD \$1  
2 conductor #18 white or brown
- 1 — LB SPOOL ROSIN-CORE \$1  
SOLDER 40/60
- 4 — TV ALIGNMENT TOOLS \$1  
most useful assortment
- 1—SQ. YARD GRILLE CLOTH \$1  
most popular brown & gold design
- HEARING AID AMPLIFIER \$1  
incl. 3 Tubes, Mike, etc. (as is)
- CHAPT ZU DI MITZIA "JACK- \$1  
POT" double your money back  
if not completely satisfied

**BROOKS RADIO & TV CORP., 84 Vesey St., Dept. A, New York 7, N. Y.** TELEPHONE  
COrtlandt 7-2359

## 3 IMPORTANT HANDBOOKS FROM MCGRAW-HILL

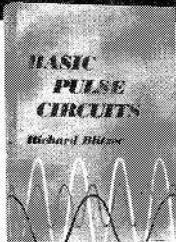

### 1. BASIC PULSE CIRCUITS

BY RICHARD BLITZER  
448 pages, \$11.75

Here is expert, practical know-how on such subjects as Network Circuits, Pulse Amplifiers, Linear and Non-linear Wave Shaping, Multivibrators, Time Base Oscillators and Generators, Binary and Octal Systems and Electronic Counters, Gates, and Applications of Pulse Circuits. This book covers the entire circuiting of such advanced equipment as radar, computers, and guided missiles.

The author explains theory and applications with a minimum of mathematics, reviews electronics fundamentals, and provides abundant illustrations for maximum clarity.

### 2. BASIC TELEVISION

PRINCIPLES AND SERVICING  
Third Edition

by BERNARD GROB — 672 pages, \$11.95

More than ever the indispensable reference in this field, this updated, revised, and expanded Third Edition provides A-to-Z coverage of TV principles and practices for servicemen, technicians and all others concerned with quicker, easier TV servicing.

### 3. LOGICAL ELECTRONIC TROUBLESHOOTING

A PROGRAMMED BOOK

by Donald H. Schuster—320 pages, \$5.95

Here you will find needed know-how for dealing with the majority of trouble-shooting situations. This book shows you how to analyze malfunctioning systems logically and correct them without guesswork. Programmed and written for quick, easy understanding.

BUY THESE BOOKS AT YOUR BOOKSTORE OR SEND COUPON BELOW:

MCGRAW-HILL BOOK CO., Dept. V-RE-34  
327 West 41 St., New York, N.Y. 10036

Send me the book(s) circled below for 10 days on approval. In 10 days I will remit for book(s) I keep, plus a few cents for delivery costs, and return unwanted book(s) postpaid. (We pay delivery costs if you remit with this coupon. Same examination and return privilege.)

1      2      3

NAME (print) \_\_\_\_\_

ADDRESS \_\_\_\_\_

CITY \_\_\_\_\_ STATE \_\_\_\_\_ ZIP CODE \_\_\_\_\_

For price and terms outside U.S., write McGraw-Hill Int'l., N.Y.C. V-RE-34



### St. Louis TESA Looks at 1964

The December 1963 issue of TESA News, official organ of the St. Louis, Mo., TV-Electronic Service Association, contained a capsule prognosis of trends in TV for 1964. Three items singled out are "overwhelming sale of portables", fewer tubes being used and extended warranties.

Fewer tubes are being sold, apparently because of greater reliability and smaller tube complements of recent TV sets. Coupled with the continuing avalanche of new tube types, this makes tube inventory a thing to be watched closely.

Extended warranties "will mean the rapid exchange of parts and careful control, but . . . more service with little or no parts sales." The article concluded by noting that service technicians have too long let parts sales produce the profit. ". . . Service is what we have to sell . . . If we have no parts to sell, will our service and shop charges keep us in business?"

### All That Glitters Is Not New

There's been quite a stir recently over rebuilt and regunned picture tubes being sold as new, or at least with advertising and labeling that suggest very strongly to the customer that the tubes are new.

Rebuilt tubes (from reputable factories, large or small) carry a notice to the effect that all materials and parts in them are new except for the envelopes, which have been inspected and tested to the same standards as new envelopes.

But Gene Love, editorial member of TESA News (official publication of the Television Electronic Service Association of St. Louis, Mo.), reports inspecting a CRT carton with a notice like this: "This tube is **Completely New** with the exception of the envelope, screen and coating." He writes that "completely new" is emphasized in bold print, and mentions parenthetically that we can soon expect to see notices like "The box surrounding this tube is **Completely New**!"

Love points out that in cases of misrepresentation to the ultimate consumer, the technician is likely to be the fall guy, because it may be very difficult

to lay blame on anyone else. The only possible defense, he says, is *never* to use the word *new* in selling a picture tube. In fact, genuinely new tubes are relatively rare among replacements; most are rebuilt. As long as the label says so, there is no fraud involved. Honestly rebuilt tubes can represent quite a bargain, since their performance is equivalent to that of a new tube, at about 40% lower cost.

Gene Love suggests using terms like "first-line," "second-line," "regunned" and "clean". A first-line tube might be, say, a completely new one (even the envelope); a second-liner, a truly rebuilt one (new gun, screen and coating). A regunned tube would be one in which only the electron gun is new, the screen and coatings being the originals. A "clean" tube is, in Mr. Love's words, "just a plain second-hand tube with the dirt washed off."

### Two New "Dirty" Words?

Semantic change marches on. Two words frequently encountered in the TV service industry (and elsewhere) are on the road to being officially black-listed: "discounter" and "repairman."

"Discounter" may soon be out for use as part of a firm's name, according to the National Better Business Bureau. The organization is recommending a ban on the term in the new rules being formulated by the Federal Trade Commission.

The NBBB has been campaigning for more consumer protection in pricing and the advertising of prices. It is also asking the FTC to clamp down on slogans used by retailers and others which lead the public to believe that they offer lower prices or "more for your money" than generally available in the marketplace.

And now the venerable catch-all "repairman" is on its way down and out, if the National Alliance of Television & Electronic Service Associations has its way.

"The word repair has fallen into disrepute. To most people repairing implies makeshift work. For instance, your wife might repair your socks by darning them, not reweaving the break. Thus if 'repairing' has connotations of slipshod 'make-do' activity, how do you think the word 'repairman' rates?"

The article in the NATESA Scope goes on to suggest that people who service electronic equipment call themselves "technicians" and refer to their work as "professional technical services." It concludes by saying, "Let's conclusively delegate 'repairman' to its rightful place, one step below 'serviceman,' which in turn is at least one big step below 'technician.' Let us consider 'repair' and 'repairman' as dirty words unfit to be heard in the American home." END



**TWO BIG SECTIONS**

# IEEE SHOW '64

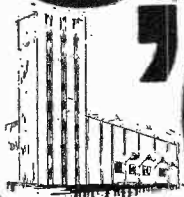

**march 23-26**  
**9:45 A.M. - 9 P.M.**

at the  
**NEW YORK  
COLISEUM**  
all 4 floors!

- **ELECTRONICS EXHIBITS**
- **CONVENTION PAPERS**

See the finest products of industry,  
hear famous men speak! Just one entrance  
fee lets you visit both sections.

Buses to the N. Y. Hilton every few minutes

PRODUCTS • PAPERS • PEOPLE • PRODUCTS • PAPERS • PEOPLE

**ONE GREAT SHOW!**



at the  
**NEW YORK  
HILTON**

**2 floors, including Hilton's  
main exhibition area**

- **ELECTRICAL EXHIBITS**
- **CONVENTION PAPERS**

IEEE Members: \$1.00  
Non-members: \$3.00  
Minimum age: 18

# IEEE SHOW '64

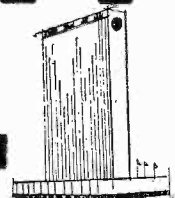

**march 23-26**  
**9:45 A.M. - 9 P.M.**

Buses to the N. Y. Coliseum every few minutes

• PRODUCTS • PAPERS • PEOPLE • PRODUCTS • PAPERS • PEOPLE

To kit builders who go

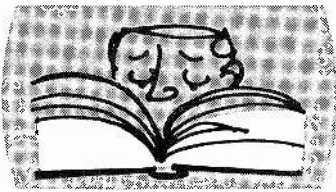

through THICK and THIN

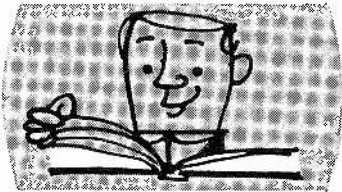

to get the best ...

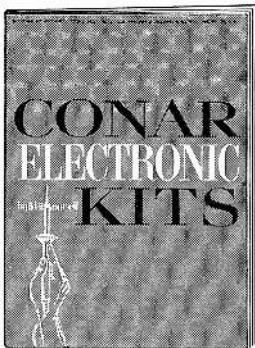

SEND FOR THE THIN!

You don't judge a book by its cover. Nor by the number of pages. If you're looking for weight, don't bother with the Conar catalog. But if you're looking for quality electronic kits backed by a *no-loopholes guarantee*, you'll want our careful selection of do-it-yourself and assembled units. There's something for everyone: TV set kits to transistor radios, VTVM's to scopes, tube testers to tools. For years of pleasurable performance, for pride in assembly, mail coupon. Discover why Conar, a division of the National Radio Institute, is the fastest growing entry in the kit and equipment business.

**CONAR**

MAIL NOW!

CC4C

CONAR  
3939 Wisconsin Ave., Washington 16, D.C.  
Please send me your catalog.

Name \_\_\_\_\_  
Address \_\_\_\_\_  
City \_\_\_\_\_ Zone \_\_\_\_\_ State \_\_\_\_\_

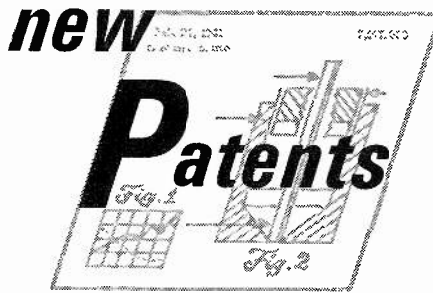

**Magnetic Fluid Relay**

PATENT No. 2,944,127

William L. Carlson, Jr., Bloomington, Minn.  
(Assigned to Minneapolis-Honeywell Reg. Co. Minneapolis, Minn.)

This relay switches large currents by remote control. It consists of a magnetic core whose gap is filled by electrodes A and B. These electrodes form part of the wall of the tubing that passes through the magnet gap and are connected to a source of high-current, low-voltage dc (not shown). The tubing contains a conductive fluid and is term-

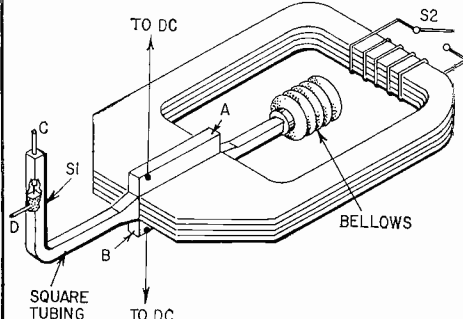

inated at a bellows, which acts as a flexible storage tank for the liquid, at one end, and at switch S1 with contacts C and D at the other end.

When any current flows through a conductor in a magnetic field, that conductor tends to move perpendicularly, both to the current and the field. Here the fluid itself is the conductor. Current between A and B flows through the fluid and also generates the magnetic field. As a result, the fluid is forced into S1 and it shorts terminals C and D. When S2 is closed, it weakens the magnetic field. This permits the fluid to return into the bellows (under the force of gravity).

**Light Amplifier for Color**

PATENT No. 3,005,108

Radames K. H. Gebel, Dayton, Ohio (Assigned to USA as represented by Secretary of US Air Force)

Certain phosphors glow when they are suspended within a dielectric between electrodes and excited by ac. The color depends upon the particular phosphor and the frequency. For example, zinc sulphide (with copper and lead impurities) glows green at 50 cycles, blue at 500.

Narrow phosphor strips (see the diagram) are placed between upper and lower electrodes. When excited, they glow red (R), green (G) or blue (B), as the case may be. The photoconductor's resistance is high but, when light shines on it, sufficient ac flows to energize the phosphor above it. At the bottom are filter strips which can transmit light of the same color as the corresponding phosphor.

A colored image to be amplified is focused through an optical system onto the filter. Where the

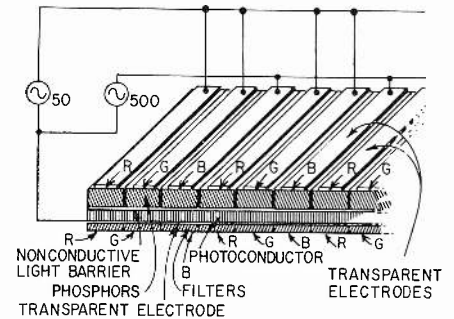

**NEW! LAFAYETTE 12-TRANSISTOR 2-WAY "WALKIE TALKIE" WITH SQUELCH**

only **39.95** 2 for 78.88

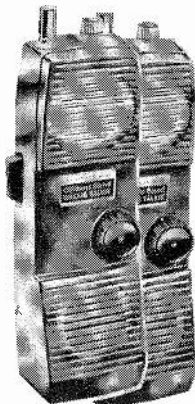

More fun ... better performance ... greater value, than ever. Superb for fishing, hunting or business use. No age restrictions or license requirements when used as per Part 15 FCC regulations. Features: separate microphone and speaker for better sending and receiving, excellent noise squelch; crystal controlled receive and transmit, positive action push-to-talk switch and 46" telescoping antenna. As a bonus feature, the HE-100 may be operated in the home with an AC power pack. (Optional see below) Saves batteries too! Includes crystals, earphone, leather carrying case and batteries.

ies. Shpg. wt., 22 oz. Imported  
HE-100L Walkie-Talkie Net 39.95  
Pair for 78.88

**NEW! AC POWER PACK**

Converts 117VAC to 9V DC. Plugs into HE-100. HE-97 Net 7.45

**ORDER A PAIR TODAY!**

LAFAYETTE Radio ELECTRONICS  
Dept. JC-4 P.O. Box 10  
Syosset, L.I., N.Y.

Send me: Walkie Talkie (HE-100L)  
AC Power Pack (HE-97),  
Shipping charges collect. \$ enclosed.

Name \_\_\_\_\_  
Address \_\_\_\_\_  
City \_\_\_\_\_ Zone \_\_\_\_\_ State \_\_\_\_\_

Because you've got to SEE it to BELIEVE it... we will send you a FREE sample!

*instant lettering*

**A REVOLUTIONARY NEW METHOD FOR MARKING ELECTRONIC EQUIPMENT**

Simply try the sample. You'll agree "Instant Lettering is the easiest, quickest way to get professional lettering you've ever seen. Self-adhesive letters printed on a special plastic sheet are just pressed down into position on any equipment, drawing, schematic, etc. Transfers instantly to practically any surface. Looks like printing.

AVAILABLE IN THE FOLLOWING SETS

**TITLES FOR ELECTRONIC EQUIPMENT**

... this set contains 24 sheets ... thousands of pre-printed titles ... researched to give you up to 95% of all electronic panel marking. For labeling, marking, titling, all electronic control panels, drawings, prototypes, etc.  
No. 958 - Black.....\$4.95 No. 959 - White.....\$4.95

**TERMINAL & CHASSIS MARKING KIT**

... 24 sheets of all the necessary letters, letter combinations and numerals for marking chassis, printed circuit and terminal boards, rotating components, etc.  
No. 966 - Black.....\$4.95 No. 967 - White.....\$4.95

**THE DATAK CORPORATION**

63 71st ST. GUTTENBERG, NEW JERSEY

SEND FOR FREE FOLDER AND SAMPLE



# announcing a new book club exclusively for engineers!

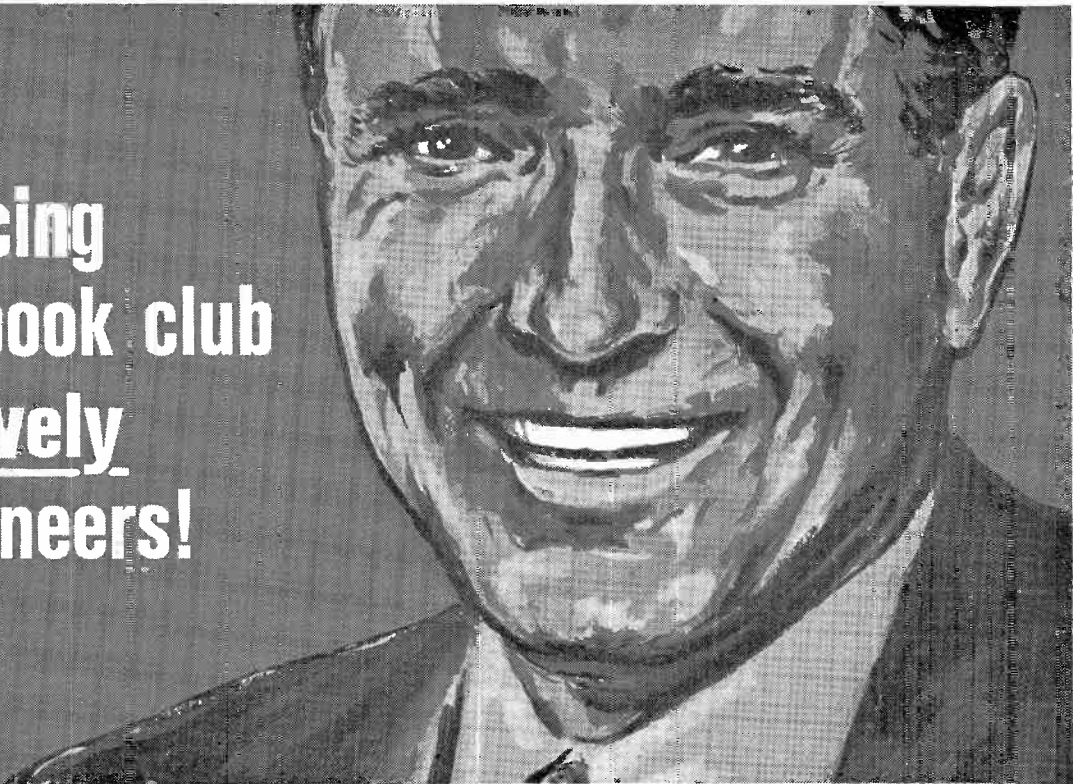

## Now you can move ahead faster, gain more professional recognition, by building your storehouse of knowledge

Would you like to forge ahead faster, professionally? Top engineers agree that the fastest way to advance is to improve your storehouse of knowledge so that you can cope successfully with each new problem and challenge in your career. To help you build and broaden your engineering skills, and to keep abreast of important developments in your field, join the new *Engineer's Book Club*, founded by the Gernsback Library in response to suggestions from professional societies and prominent engineers.

### Why You Should Join Now

The Engineer's Book Club is open exclusively to engineers in all specialties. It is the *only* book club that offers you selections from *every leading publisher*, including Holt, Rinehart and Winston, Prentice-Hall, Macmillan, Pergamon Press, Gernsback and others, at a *substantial saving*. Your membership entitles you to *discounts ranging up to 30% and higher* on all books offered through the club! Each book is complete and unabridged, and is published in a handsome, deluxe edition, with fine binding, top-grade stock and clear, legible typography. You will be building an excellent professional library of your own, of which you will be particularly proud.

### What Kind of Books Are Available?

All books offered by the Engineer's Book Club are pre-screened by the Gernsback Engineers Panel, composed of eminent practicing professionals. They select only those books which have relevance to the needs of the engineer today, regardless of his specialty. For example, here is a sample listing of the books we are planning to offer:

	Publisher's price	Club Member's Cost
Electronic Computers	\$13.50	only \$ 5.95
Signal Flow Graphs and Applications	\$11.00	only \$ 4.62
Six Language Dictionary of Electronics	\$16.95	only \$ 7.96
Principles of Solid State Microelectronics	\$ 6.95	only \$ 4.57
Process Dynamics and Control	\$ 6.95	only \$ 5.55
Linear Programming	\$ 8.95	only \$ 7.15

Semiconductor Diode		
Parametric Amplifiers	\$10.00	only \$ 6.95
Handbook of Laplace Transformations	\$ 5.25	only \$ 3.75
Transistors Handbook	\$10.65	only \$ 8.43
Magnetic Amplifiers	\$ 9.00	only \$ 7.15
Microwave Theory and Measurements	\$ 8.95	only \$ 6.90
Network Synthesis	\$14.00	only \$11.15
Handbook of Transistor Circuit Design	\$16.95	only \$13.35
Coding Theorems of Information Theory	\$9.35	only \$ 7.45

### Many Additional Benefits

In addition to substantial savings, you also enjoy these extra advantages:

1. All books purchased from the Club are tax deductible on your Federal income tax as they are wholly for use in your profession.
2. Club members pay no dues, fees or assessments, nor do you pay sales taxes or postage charges. The Club assumes these costs.
3. You enjoy the convenience of having books mailed directly to your home or office, plus bulletins on current publications of interest and importance to you.
4. There is no risk on your part, no obligation. If you do not want a particular selection, just return it.
5. You can examine each selection at your

home or place of business, for 10 full days, without obligation to purchase.

6. Large selection of modern, up-to-date books, of leading publishers in the engineering field.
7. No fuss, no bother, no need to "shop around".
8. Quantity publishing by the Engineer's Club means big savings—savings which can be passed along to you.

### How the Club Works

Every two months, you will receive the current selection of the Club, *on approval*. You have the privilege of a 10-day inspection period at no cost. At the end of that time, you either send a check for the book (at the reduced price indicated), or you return the book and you owe nothing. Your only obligation as a member is to purchase a total of 4 books from the many offered during the next 12 months. After that, you may cancel your membership at any time, if you desire.

### How to Join

Enroll in The Engineer's Book Club today and start building your own professional library. To join, simply fill out and mail the coupon below. Your first selection, plus regular bulletins, will start coming to you shortly. You owe it to your own career advancement to join The Engineer's Book Club today.

### THE ENGINEER'S BOOK CLUB

E34A

154 West 14th Street, New York, N. Y. 10011

Please register my name in the Engineer's Book Club. I understand that I am under no obligation to make any purchases at this time. By returning this coupon, I shall expect to receive The Engineer's Book Club selections on approval.

Name \_\_\_\_\_  
Address \_\_\_\_\_  
City \_\_\_\_\_ State \_\_\_\_\_ Zip Code \_\_\_\_\_

My principal engineering field of interest is \_\_\_\_\_

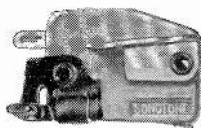

This Sonotone cartridge can replace

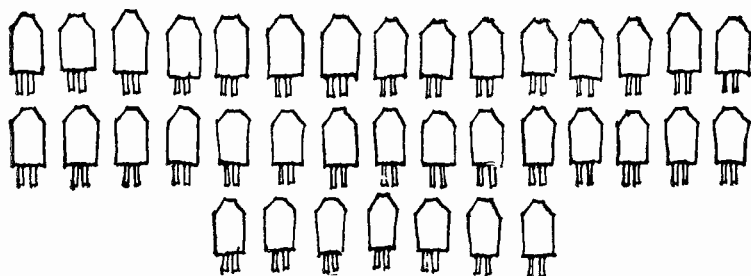

37 Brand A types

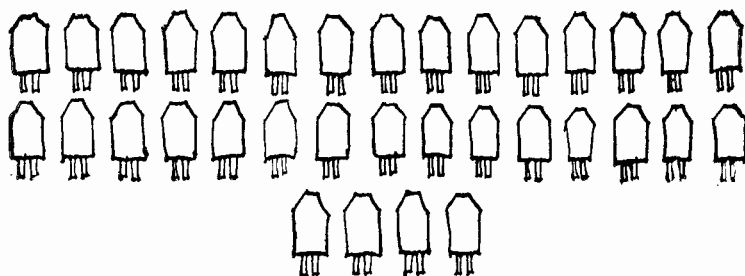

34 Brand B types

and itself!

The 2TA pictured above is just one member of the Sonotone line, the most versatile cartridge line available today.

The Sonotone cartridge line offers the electrical and mechanical flexibility to substitute for dozens of competitive types. Of course, Sonotone cartridges are direct replacements in over 14,000,000 phonographs that use Sonotone cartridges as original equipment, too. Which means: If you stock the compact Sonotone line, you'll have replacement cartridges for just about every phonograph that comes into your shop. You'll also have the famous **Sonoflex**<sup>®</sup>, the needle that puts an end to profit-robbing callbacks caused by bent and broken shanks.

The Sonotone Cartridge Replacement Manual tells you what Sonotone cartridge to use. Want an idea of how simple life can be with Sonotone? For a limited time, we'll be glad to send you a **free** copy of the manual—normally, it's 50 cents. Write:

# Sonotone

Sonotone Corporation, Electronic Applications Division, Elmsford, New York  
Cartridges • Speakers • Microphones • Headphones • Hearing Aids • Batteries

image contains *red*, for example, beneath a *red* filter, this color passes through. Falling on the photoconductor, it lowers its resistance and ac flows to excite the *red* phosphor at that point. If the phosphor strips are narrow, the reproduced color image will have good detail. If there is sufficient input power, the output image will be more intense than the original.

Note that the same phosphor can be used for green and blue, color being determined by the frequency.

## Photocell Sine Generator

PATENT No. 3,093,785

Albert K. Edgerton, Sunland, Cal.

This is a simple, efficient and variable source of sine waves. It uses a Lucite rod that rotates

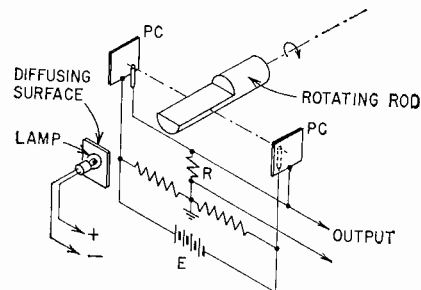

Fig. 1

between photocells (PC). Part of the rod is flattened as shown (Fig. 1). Diffused light from a lamp source enters the end face of the Lucite semicylinder and is radiated from the flat surface. The curved surface is painted opaque.

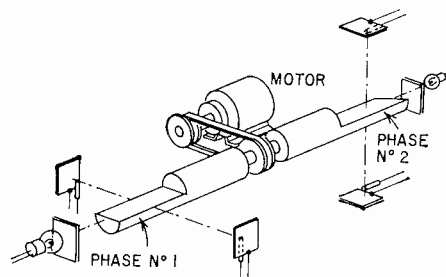
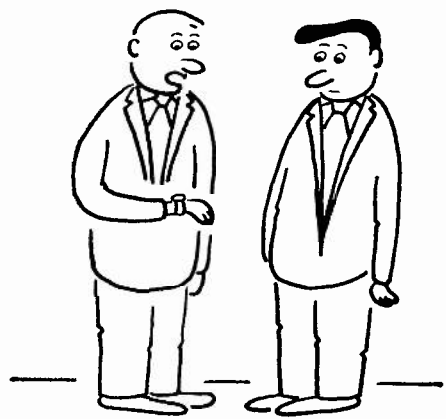

Fig. 2

The amount of light from the illuminated (flat) surface varies with the sine of the angle of rotation. Therefore each cell delivers one-half of a sine wave. Since the cell outputs appear across R out of phase, the result is a complete sine wave. Frequency depends upon speed of rotation.

Other possibilities of this device include various waveforms (by using nonplanar surfaces); optical modulation; multi-phase output. Fig. 2 shows a 2-phase generator. The phase angle is determined by the position of the cells. **END**



Rispoli

"I'll have to have my watch repaired.  
It's 15 nanoseconds fast again."

RADIO-ELECTRONICS

# noteworthy

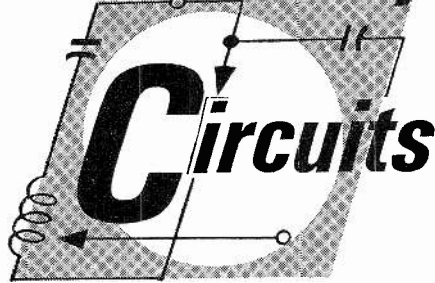

## Speaker Switching Circuit

Have you ever wanted to add remote speakers to your radio system and didn't know just how to hook them up? If so, why not try the circuit used by Admiral in some of their stereo consoles. The diagram shows the basic switching circuit of one of the stereo

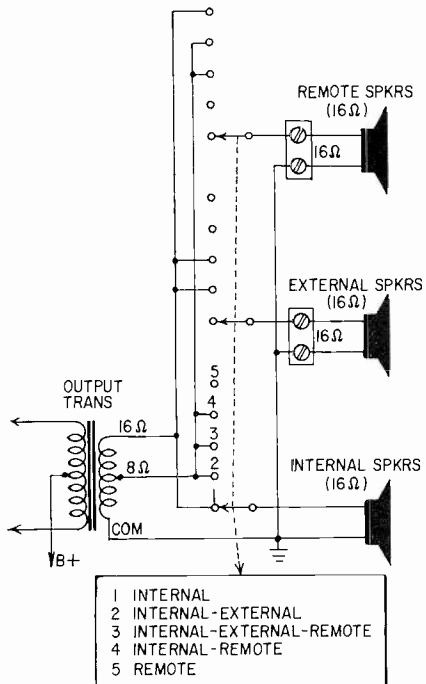

channels. When a single speaker is used, it is connected across the transformer tap equal to its impedance. When two or three speakers are used, they are paralleled across the tap equal to half the impedance of a single speaker.—*E. Wilhelm*

## Unusual Recorder Circuit

The Grundig TK1 and TK1-E battery operated transistor tape recorders use a unique circuit to provide recording bias and plate and filament voltages for the DM71/IN3 recording level indicator. The tube requires 1.4 volts at 25 ma for the filament and 50 to 90 volts on the plate. The bias oscillator circuit is shown in the diagram.

The filament of the DM71 is in series with the transistor emitter and thus supplies a measure of thermal stability for the oscillator. The plate is connected to a high-voltage winding on the oscil-

# BRAND NEW

## UNITED'S FIRST QUALITY TUBES DISCOUNTS up to 80% OFF

**GUARANTEED ONE FULL YEAR! NOT USED! NO PULLS! WHY PAY MORE?**

Tube	Price	Tube	Price	Tube	Price	Tube	Price	Tube	Price	Tube	Price	Tube	Price	Tube	Price
0A2	.80	3DK6	.58	6AQ5	.52	6CS7	.67	6GY8	1.35	7F7	1.95	12CU6		17GW6	1.64
0A3	.90	3DT6	.52	6AR6	.69	6CU5	.56	6GZ5	.94	7J8	1.34	12CX6	1.10	17H3	.95
0A4G	1.35	3EH7		6AR5	.84	6CV5	1.05	6H6	.56	7G7	.95	12CX6	.52	17JL8	1.45
0B2	.80	3F55	1.19	6AR6	.65	6CW8	1.75	6HG8	1.65	7H7	.95	12D4	.67	18A5	1.54
0B2WA	1.95	3GK5	1.97	6AR6	2.45	6CW4	1.75	6HJ8	1.25	7J7	1.75	12D65	1.05	18FW6	1.47
0B3	1.20	3H58		6AR11	1.64	6CW5	1.10	6HSB	1.10	7K7	1.45	12DE8	.81	18FX6	.51
0C2	.90	3Q4	.61	6AS5	.59	6CX8	1.52	6J4	2.95	7L6	.98	12DL8	.85	18FY6	1.48
0C3	.63	3S4	.73	6AS7	2.45	6CY5	.68	6J4WA	3.65	7C7	.65	12DQ3	1.02	19A4	.85
0D3	.60	3V4	.64	6AS7	2.45	6CY5	.68	6J4WA	3.65	7N7	1.25	12DQ7	1.33	19B6	1.35
0Y4	1.20	4AU6	.89	6AS8	1.20	6CY7	.64	6J6	2.95	7Q7	.90	12DS7	.82	19E48	1.77
0Z4	.77	4AV6	.70	6AS11	1.87	6D10	1.56	6J7	1.65	7R7	1.15	12DT5	.70	19JN8	1.30
1A2	.75	4BA6	.66	6A85	1.47	6D4	1.40	6J5M	.95	7S7	1.60	12DT7	.77	19Y8	1.44
1A5	.75	4BC5	.95	6AT8	.84	6D4	1.75	6J6	.69	7V7	1.45	12DT8	.76	19Z8	1.87
1A6	.70	4BC8	1.68	6AU4	.83	6D6	2.50	6J6WA	3.25	7X6	.95	12DW8	.87	21EX6	1.47
1A7	.75	4BL8	.90	6AUS	1.75	6D10	1.56	6J7	1.65	7Y7	1.25	12DZ6	.60	21FX4	1.68
1AD2	1.15	4BN6	1.35	6AU6	.50	6D10	1.56	6J8	1.40	7Z7	1.25	12E6	.95	25AK4	.65
1AF4	1.30	4BQ7	.99	6AU7	.54	6D10	1.56	6J8	1.40	7Z7	1.25	12E6	.95	25BK5	1.38
1AG4	1.75	4BR6	1.75	6AUS	.85	6DA5	1.19	6J11	1.83	7A4	.95	12E8	1.38	25C8	.51
1AX2	.60	4BU8	1.29	6AV5	1.75	6DB5	2.25	6JE6	3.25	7B7	1.45	12E8	.60	25CA5	1.57
1B3	.77	4BZ6	.95	6AV6	.39	6DB5	2.25	6JEB	1.85	7C7	.88	12E8	.60	25CD6	1.50
1C5	.65	4C5	.95	6AV11	1.49	6DB5	2.25	6JEB	1.85	7D7	.95	12E8	.60	25CA5	1.57
1DN5	.53	4C6B	.95	6AW8	.88	6DB5	2.25	6JEB	1.85	7E7	.95	12E8	.60	25CA5	1.57
1G3	.77	4C6S	.95	6AX3	.98	6DE6	.59	6K6	.61	7F7	.95	12E8	.60	25CA5	1.57
1G6	.80	4DEE	1.19	6AX4	.64	6DE6	.59	6K6	1.45	7G7	.95	12E8	.60	25CA5	1.57
1H4	.69	4DK6	.57	6AX5	.95	6DE6	.59	6K6	1.45	7H7	.95	12E8	.60	25CA5	1.57
1H6	.70	4DT6	.55	6AX8	1.30	6DE6	.59	6K6	1.45	7J7	.95	12E8	.60	25CA5	1.57
1J3	.77	4EWE	1.19	6AY3	.99	6DE6	.59	6K6	1.45	7K7	.95	12E8	.60	25CA5	1.57
1L2	.65	4EY8	1.25	6B2	.88	6DE6	.59	6K6	1.45	7L7	.95	12E8	.60	25CA5	1.57
1J6	.95	4G6M	.66	6B3	1.15	6DE6	.59	6K6	1.45	7M7	.95	12E8	.60	25CA5	1.57
1K3	.77	4GZ5	1.49	6B4	1.30	6DE6	.59	6K6	1.45	7N7	.95	12E8	.60	25CA5	1.57
1L4	1.30	4HM6	1.92	6B6	1.30	6DE6	.59	6K6	1.45	7P7	.95	12E8	.60	25CA5	1.57
1LA5	2.50	4HT6	.99	6B7	1.34	6DE6	.59	6K6	1.45	7Q7	.95	12E8	.60	25CA5	1.57
1A6	1.45	4HT6	.99	6B7	1.34	6DE6	.59	6K6	1.45	7R7	.95	12E8	.60	25CA5	1.57
1B4	1.80	5AM8	.77	6B7	1.34	6DE6	.59	6K6	1.45	7S7	.95	12E8	.60	25CA5	1.57
1LC5	1.05	5AQ5	.52	6B7	1.34	6DE6	.59	6K6	1.45	7T7	.95	12E8	.60	25CA5	1.57
1C6	1.80	5AS8	1.90	6B7	1.34	6DE6	.59	6K6	1.45	7U7	.95	12E8	.60	25CA5	1.57
1D5	1.95	5AS8	1.90	6B7	1.34	6DE6	.59	6K6	1.45	7V7	.95	12E8	.60	25CA5	1.57
1LE3	1.20	5BE8	1.10	6B7	1.34	6DE6	.59	6K6	1.45	7W7	.95	12E8	.60	25CA5	1.57
1L2	1.05	5BK7	.84	6B7	1.34	6DE6	.59	6K6	1.45	7X7	.95	12E8	.60	25CA5	1.57
1N5	1.15	5BR8	.81	6B7	1.34	6DE6	.59	6K6	1.45	7Y7	.95	12E8	.60	25CA5	1.57
1N5	1.25	5BR8	.81	6B7	1.34	6DE6	.59	6K6	1.45	7Z7	.95	12E8	.60	25CA5	1.57
1O5	.95	5C6R	.79	6B7	1.34	6DE6	.59	6K6	1.45	7A7	.95	12E8	.60	25CA5	1.57
1R4	.80	5C8	.82	6B7	1.34	6DE6	.59	6K6	1.45	7B7	.95	12E8	.60	25CA5	1.57
1R5	1.75	5DJ4	.84	6B7	1.34	6DE6	.59	6K6	1.45	7C7	.95	12E8	.60	25CA5	1.57
1S4	.75	5EUB	.79	6B7	1.34	6DE6	.59	6K6	1.45	7D7	.95	12E8	.60	25CA5	1.57
1S5	.73	5EUB	.79	6B7	1.34	6DE6	.59	6K6	1.45	7E7	.95	12E8	.60	25CA5	1.57
1T4	.80	5EW6	1.12	6B7	1.34	6DE6	.59	6K6	1.45	7F7	.95	12E8	.60	25CA5	1.57
1T5	.57	5GW6	1.95	6B7	1.34	6DE6	.59	6K6	1.45	7G7	.95	12E8	.60	25CA5	1.57
1U5	.62	5J6	.70	6B7	1.34	6DE6	.59	6K6	1.45	7H7	.95	12E8	.60	25CA5	1.57
1V2	.70	5L8	.84	6B7	1.34	6DE6	.59	6K6	1.45	7J7	.95	12E8	.60	25CA5	1.57
1X2B	.80	5U8	.82	6B7	1.34	6DE6	.59	6K6	1.45	7K7	.95	12E8	.60	25CA5	1.57
2A3	5.00	5V3	.55	6B7	1.34	6DE6	.59	6K6	1.45	7L7	.95	12E8	.60	25CA5	1.57
2A3W	5.00	5V3	.55	6B7	1.34	6DE6	.59	6K6	1.45	7M7	.95	12E8	.60	25CA5	1.57
2A5	1.00	5V6	.55	6B7	1.34	6DE6	.59	6K6	1.45	7N7	.95	12E8	.60	25CA5	1.57
2A7	1.50	5W4	.95	6B7	1.34	6DE6	.59	6K6	1.45	7P7	.95	12E8	.60	25CA5	1.57
2AF4	.93	5X4	.80	6B7	1.34	6DE6	.59	6K6	1.45	7Q7	.95	12E8	.60	25CA5	1.57
2A2	1.25	5X8	.80	6B7	1.34	6DE6	.59	6K6	1.45	7R7	.95	12E8	.60	25CA5	1.57
2B3	.98	5V3	.45	6B7	1.34	6DE6	.59	6K6	1.45	7S7	.95	12E8	.60	25CA5	1.57
2B7	.70	5Z3	1.00	6B7	1.34	6DE6	.59	6K6	1.45	7T7	.95	12E8	.60	25CA5	1.57
2B4	.80	5Z4	1.40	6B7	1.34	6DE6	.59	6K6	1.45	7U7	.95	12E8	.60	25CA5	1.57
2E5	.80	5Z4	1.40	6B7	1.34	6DE6	.59	6K6	1.45	7V7	.95	12E8	.60	25CA5	1.57
2E5	.80	5Z4	1.40	6B7	1.34	6DE6	.59	6K6	1.45	7W7	.95	12E8	.60	25CA5	1.57
2E5	.80	5Z4	1.40	6B7	1.34	6DE6	.59	6K6	1.45	7X7	.95	12E8	.60	25CA5	1.57
2E5	.80	5Z4	1.40	6B7	1.34	6DE6	.59	6K6	1.45	7Y7	.95	12E8	.60	25CA5	1.57
2E5	.80	5Z4	1.40	6B7	1.34	6DE6	.59	6K6	1.45	7Z7	.95	12E8	.60	25CA5	1.57
2E5	.80	5Z4	1.40	6B7	1.34	6DE6	.59	6K6	1.45	7A7	.95	12E8	.60	25CA5	1.57
2E5	.80	5Z4	1.40	6B7	1.34	6DE6	.59	6K6	1.45	7B7	.95	12E8	.60	25CA5	1.57
2E5	.80	5Z4	1.40	6B7	1.34	6DE6	.59	6K6	1.45	7C7	.95	12E8	.60	25CA5	1.57
2E5	.80	5Z4	1.40	6B7	1.34	6DE6	.59	6K6	1.45	7D7	.95	12E8	.60	25CA5	1.57
2E5	.80	5Z4	1.40	6B7	1.34	6DE6	.59	6K6	1.45	7E7	.95	12E8	.60	25CA5	1.57
2E5	.80	5Z4	1.40	6B7	1.34	6DE6	.59	6K6	1.45	7F7	.95	12E8	.60	25CA5	1.57
2E5	.80	5Z4	1.40	6B7	1.34	6DE6	.59	6K6	1.45	7G7	.95	12E8	.60	25CA5	1.57
2E5	.80	5Z4	1.40	6B7	1.34	6DE6	.59	6K6	1.45	7H7	.95	12E8	.60	25CA5	1.57
2E5	.80	5Z4	1.40	6B7	1.34	6DE6	.59	6K6	1.45	7J7	.95	12E8	.60	25CA5	1.57
2E5	.80	5Z4	1.40	6B7	1.34	6DE6	.59	6K6	1.45	7K7	.95	12E8	.60	25CA5	1.57
2E5	.80	5Z4	1.40	6B7	1.34	6DE6	.59	6K6	1.45	7L7	.95	12E8	.60	25CA5	1.57
2E5	.80	5Z4	1.40	6B7	1.34	6DE6	.59	6K6	1.45	7M7	.95	12E8	.60	25CA5	1.57
2E5	.80	5Z4	1.40	6B7	1.34	6DE6	.59	6K6	1.45	7N7	.95	12E8	.60	25CA5	1.57
2E5	.80	5Z4	1.40	6B7	1.34	6DE6	.59	6K6	1.45	7P7	.95	12E8	.60	25CA5	1.57
2E5	.80	5Z4	1.40	6B7	1.34	6DE6	.59	6K6	1.45	7Q7	.95	12E8	.60	25CA5	1.57
2E5	.80	5Z4	1.40	6B7	1.34	6DE6	.59	6K6	1.45	7R7	.95	12E8	.60	25CA5	1.57
2E5	.80	5Z4	1.40	6B7	1.34	6DE6	.59	6K6	1.45	7S7	.95	12E8	.60	25CA5	1.57
2E5	.80	5Z4	1.40	6B7	1.34	6DE6	.59	6K6	1.45	7T7	.95	12E8	.60	25CA5	1.57
2E5	.80	5Z4	1.40	6B7	1.34	6DE6	.59	6K6	1.45	7U7	.95	12E8	.60	25CA5	1.57
2E5	.8														

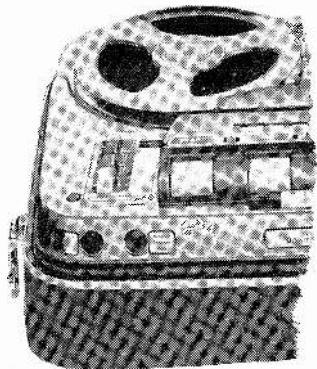

## Don't own half a tape recorder

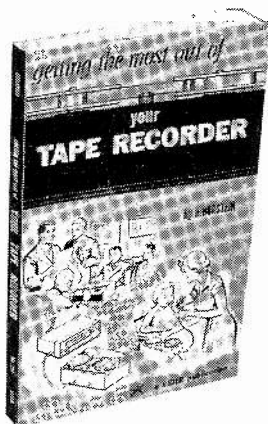

**GETTING THE MOST OUT OF YOUR TAPE RECORDER** by Herman Burstein. Owning and getting full enjoyment out of the tape recorder are two different things. The more you know about your tape recorder, the more enjoyment and use you'll get out of it. This book authored by noted high fidelity authority, Herman Burstein, emphasizes the way in which you can get the best performance and the greatest use from your tape recorder. It also answers questions by prospective tape recorder buyers regarding what makes one tape recorder operate better than another; and how the best performance can be obtained from any given tape recorder. The book goes on to tell how tape heads operate and how many are needed and shows how tape recorder can be added to an audio system. Tells you how to select the best tape recorder for the money and your needs. It delves into the special requirements of stereo. #251—\$4.25.

### other Rider books

**UNDERSTANDING DIGITAL COMPUTERS** by Ronald M. Benrey. Excellent first step if you want to get to know your way around digital computers and understand their operation. #319 paper, \$3.75; #319-H cloth \$5.45.

**MATHEMATICS FOR ELECTRONICS & ELECTRICITY** by National Radio Institute Staff. Gives you all the math you'll need for electronics. #311, paper \$3.95; #311-H cloth, \$5.60.

Available at parts distributors or use coupon below.

**ORDER TODAY—10-DAY APPROVAL**

**JOHN F. RIDER PUBLISHER, INC.**  
Div. of Hayden Publishing Co., Inc.  
116 West 14th Street, N. Y. 10011

Please send ( ) copies for free 10-day examination. Within 10 days of receipt, I shall remit payment plus postage or return books without obligation.

Getting the Most out of your Tape Recorder \$4.25

Understanding Digital Computers

Paper—\$3.75       Cloth—\$5.45

Mathematics for Electronics & Electricity

Paper—\$3.95       Cloth—\$5.60

Name \_\_\_\_\_

Address \_\_\_\_\_

City \_\_\_\_\_ Zone \_\_\_\_\_ State \_\_\_\_\_

Payment enclosed we pay postage.

Free catalog of all Rider books.

3435

frequency erasing. This is because of the extra power that would be required from the oscillator. This would increase the drain on the batteries.

Most recorders use a bar type magnet for erasing. This one uses a circular

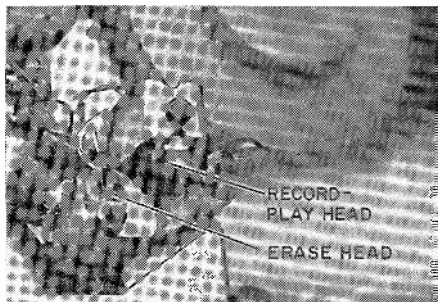

magnet on a pivot as shown in the photo. A chain and gear assembly rotates the magnet so its gap faces the tape when the function selector switch is in the RECORD position. The selector turns the gap away from the tape in the play, reverse and off positions.—Steve P. Dow

### Radio-TV Speaker Switching

A common speaker system is generally used in radio-TV combinations. In many cases, the secondaries of the radio and TV output transformers are connected in series and the speaker voice coil is connected across the two. The audio circuit not in use is de-energized

so its output transformer has little or no effect on the overall operation.

General Electric has come up with a new and unusual gimmick when the clock radio is added to the SY TV chassis. The basic diagram shows the plates

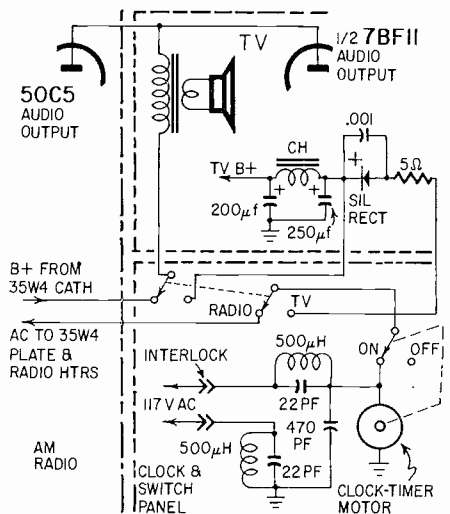

of the radio and TV audio output tubes are connected in parallel at the primary of the common output transformer. The TV-radio switch feeds ac to the power supply of the selected circuit and B-plus to the primary of the transformer.—Henry O. Maxwell END

**COYNE TRAINS YOU IN SPARE TIME AT HOME**

**COYNE QUALITY TRAINING AT LOWEST COST**

**TELEVISION COLOR TV-RADIO-ELECTRONICS**

**FREE of Extra Charge to Graduates**

**TWO WEEKS Shop Training in Chicago**

Coyne—and only Coyne—can give you this modern TV Home Training. Easy to follow 2150 photos and diagrams covering Radios-TV, Color, UHF, Transistors. We also show you how to start making money while learning, right at home. Get your basic training at home, then make a flash finish with 2 weeks of actual shop work in Chicago under direction of same instructors who guide our resident students.

**LOW COST—Easy to Pay**  
You don't pay for costly "put together" kits. Small monthly payments and low, low cost make it easy for everyone to train. Free employment service for graduates—or we show you how to start your own service business on a "shoestring." Send name today for complete facts and valuable book on Television. No salesman will call. Everything mailed free, postpaid.

**Coyne Electrical School**  
Chartered as an Educational Institution Not for Profit  
1501 W. Congress Parkway  
Dept. 34-H5, Chicago 7, Ill.

**B. W. Cooke, Pres. Home Training Division, Dept. 34-H5**  
1501 W. Congress Parkway, Chicago 7, Ill.

Please mail free book and offer of two weeks personal training in Chicago without extra tuition for home study graduates. Explain low monthly payments.

NAME \_\_\_\_\_

ADDRESS \_\_\_\_\_

CITY & STATE \_\_\_\_\_

**TIME & PLACE**

The time to sell is when you have a customer. And the place to sell is where you have some 157,000 customers—Radio-Electronics Market Center.

**CASH FOR YOU—REPAIR BUSTED**

**Electric APPLIANCES**

Learn at Home • \$3 to \$5 an Hour  
Spare Time, Full Time • Be Your Own Boss

**FREE BOOK** tells about profitable business you can run—right at home. Repair Electric Appliances using simple tools. Pays \$3-\$5 an hour!

**QUICK WAY TO GET STARTED**  
For less than 20¢ a day, our easy instruction—backed by 45 years of success in home-training—prepares you for top earnings. Earl Reid of Thompson, Ohio, says: "Made \$510 in one month spare time." At no extra charge you get Appliance Tester, too. Finds trouble-spots, checks your work. Get your FREE Book and FREE Sample Lesson! Mail coupon below, letter or postcard, now.

**CASH IN ON THIS BIG BOOM**  
400 MILLION Appliances are in American homes right now. People need them fixed. You make good money doing it. In your basement, garage, even your kitchen.

**NATIONAL RADIO INSTITUTE, Appliance Div.**  
Dept. FC-4, Washington 16, D. C.

Send Free Book, Free Appliance Repair Course Lesson. Am interested in:

Spare Time Earnings       My Own Business

Better Job

Name \_\_\_\_\_

Address \_\_\_\_\_

City \_\_\_\_\_ Zone \_\_\_\_\_ State \_\_\_\_\_

Accredited Member National Home Study Council

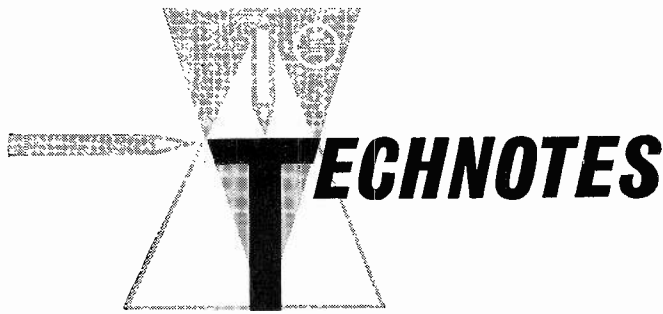

# TECHNOTES

All the Technotes in this month's special Audio Issue were contributed by Steve P. Dow, Vancouver, B. C. All concern tape recorders, domestic and foreign, and all are examples of small, recurrent, off-beat problems that are worth knowing about.

## Revere TR-1200 Recorder

If the speed-change lever won't stay in either the 7½- or the 3¾-ips position, the lever detent spring has become detached. Remove the bottom plate and locate the spring, between the motor and the mike compartment. It goes between the cam roller attached to the equalization switch on the speed-change shaft and the screw that holds the digit counter—the one farthest from the motor. Pinch the spring loop on the retaining bolt to keep the same thing from happening again.

## Uher SR III Speed Change, On-Off Switch Failure

If the speed change on this machine doesn't work, the spring retaining the flywheel idler wheel has slipped off. Before you replace the spring, check the idler for flat spots and tears—replace it if it has any.

To remove the idler, slide back the spring retainer (on

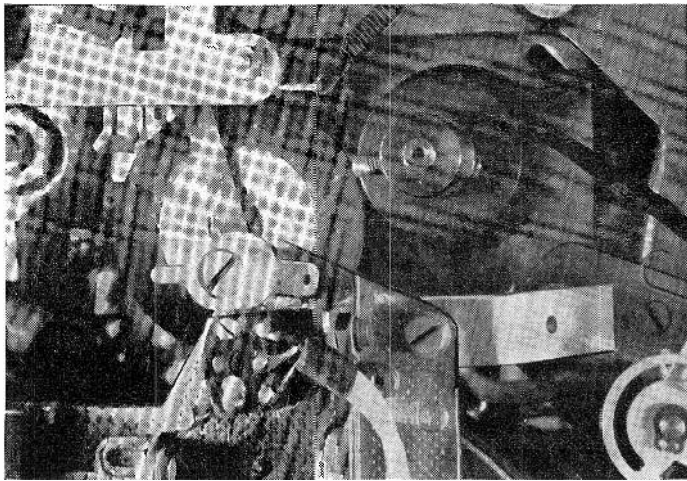

top of idler in photo) while the speed and power switch is in the 7½-OFF position.

To protect the idler in this machine, avoid changing speed from high to low without letting the flywheel stop. This takes about 5 seconds.

## Large-hub Reels Fool Automatic Stop

Large-hub reels won't operate the automatic stop on some machines, when the tape is fitted with conductive foil at either end. The stop contact is normally adjusted to touch the tape only when the angle of the tape to the center of the feed spindle indicates the end of a standard (small-hub) reel. This prevents the machine from stopping when it has just been threaded, because of the foil at the start end.

To readjust these machines to work with newer reels,

MARCH, 1964

# BECOME A RADIO TECHNICIAN for only \$26.95

## BUILD 20 RADIO

CIRCUITS AT HOME

with the New Progressive  
RADIO "EDU-KIT"®

Reg. U.S.  
Pat. Off.

All Guaranteed to Work!

PRACTICAL only  
HOME RADIO COURSE \$26.95

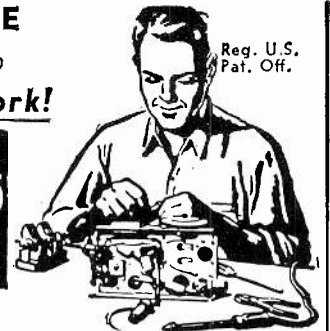

- NOW INCLUDES**
- ★ 12 RECEIVERS
  - ★ 3 TRANSMITTERS
  - ★ SQ. WAVE GENERATOR
  - ★ AMPLIFIER
  - ★ SIGNAL TRACER
  - ★ SIGNAL INJECTOR
  - ★ CODE OSCILLATOR

TRAINING ELECTRONICS  
TECHNICIANS SINCE 1946

- ★ No Knowledge of Radio Necessary
- ★ No Additional Parts or Tools needed
- ★ Excellent Background for TV
- ★ School Inquiries Invited
- ★ Attractively Gift Packed

### FREE EXTRAS

- SET OF TOOLS • RADIO & ELECTRONICS TESTER • ELECTRIC SOLDERING IRON • TESTER INSTRUCTION MANUAL • MEMBERSHIP IN RADIO-TV CLUB; CONSULTATION SERVICE • HI-FI GUIDE • QUIZZES • TV BOOK • FCC AMATEUR LICENSE TRAINING • RADIO BOOK • PRINTED CIRCUITRY • PLIERS-CUTTERS • ALIGNMENT TOOL • WRENCH SET • CERTIFICATE OF MERIT • VALUABLE DISCOUNT CARD

### WHAT THE "EDU-KIT" OFFERS YOU

The "Edu-Kit" offers you an outstanding PRACTICAL HOME RADIO COURSE at a rock-bottom price. Our kit is designed to train Radio & Electronics Technicians, making use of the most modern methods of home training. You will learn radio theory, construction, servicing, basic Hi-Fi and TV repairs, code, FCC amateur license requirements.

You will learn how to identify radio symbols, how to read and interpret schematics, how to mount and lay out radio parts, how to wire and solder, how to operate electronic equipment, how to build radios. Today it is no longer necessary to spend hundreds of dollars for a radio course. You will receive a basic education in radio, worth many times the small price you pay, only \$26.95 complete.

### THE KIT FOR EVERYONE

The Progressive Radio "Edu-Kit" was specifically prepared for any person who has a desire to learn radio. The "Edu-Kit" has been used successfully by young and old in all parts of the world, by many Radio Schools and Clubs in this country and abroad, for training and rehabilitation of Armed Forces Personnel and Veterans throughout the world.

The Progressive Radio "Edu-Kit" requires no instructor. All instructions are included. Every step is carefully explained. You cannot make a mistake.

### PROGRESSIVE TEACHING METHOD

The Progressive Radio "Edu-Kit" is the foremost educational radio kit in the world, and is universally accepted as the standard in the field of electronics training. The "Edu-Kit" uses the modern educational principle of "Learn by Doing." Therefore, you will construct radio circuits, perform jobs and conduct experiments to illustrate the principles which you learn.

You begin by examining the various radio parts included in the "Edu-Kit." You then learn the function, theory and wiring of these parts. Then you build a simple radio. With this first set, you will enjoy listening to regular broadcast stations, learn theory, practice testing and troubleshooting. Then you build a more advanced radio, learn more advanced theory and techniques. Gradually, in a progressive manner, and at your own rate, you will find yourself constructing more advanced multi-tube radio circuits, and doing work like a professional Radio Technician.

Included in the "Edu-Kit" course are 20 Receiver, Transmitter, Code Oscillator, Signal Tracer, Signal Injector, Square Wave Generator and Amplifier circuits. These are not unprofessional "bread board" experiments, but genuine radio circuits, constructed by means of professional wiring and soldering on metal chassis, plus the new method of radio construction known as "Printed Circuitry." These circuits operate on your regular AC or DC house current.

In order to provide a thorough, well-integrated and easily-learned radio course, the "Edu-Kit" includes practical work as well as theory; troubleshooting in addition to construction; training for all, whether your purpose in learning radio be for hobby, business or job; progressively-arranged materials, ranging from simple circuits to well-advanced topics in Hi-Fi and TV. Your studies will be further aided by Quiz materials and our well-known FREE Consultation Service.

### THE "EDU-KIT" IS COMPLETE

You will receive all parts and instructions necessary to build 20 different radio and electronics circuits, each guaranteed to operate. Our Kits contain tubes, tube sockets, variable, electrolytic, mica, ceramic and paper dielectric condensers, resistors, tie strips, coils, hardware, tubing, punched metal chassis, Instruction Manuals, hookup wire, solder, selenium rectifiers, volume controls, switches, knobs, etc.

In addition, you receive Printed Circuit materials, including Printed Circuit chassis, special hardware and instructions. You also receive a useful set of tools, a professional electric soldering iron, and a self-powered Dynamic Radio & Electronics Tester. The "Edu-Kit" also includes Code Instructions and the Progressive Code Oscillator, in addition to the F.C.C. type Questions and Answers for Radio Amateur License training. You will also receive lessons for servicing with the Progressive Signal Tracer and the Progressive Signal Injector, and a High Fidelity Guide and Quiz Book. Everything is yours to keep.

J. Statistis, of 25 Poplar Pl., Waterbury, Conn., writes: "I have repaired several sets for my friends, and made money. The "Edu-Kit" paid for itself. I was ready to spend \$240 for a course, but I found your ad and sent for your Kit."

### UNCONDITIONAL MONEY-BACK GUARANTEE

The Progressive Radio "Edu-Kit" has been sold to many thousands of individuals, schools and organizations, public and private, throughout the world. It is recognized internationally as the ideal radio course.

By popular demand the Progressive Radio "Edu-Kit" is now available in Spanish as well as English.

It is understood and agreed that should the Progressive Radio "Edu-Kit" be returned to Progressive "Edu-Kits" Inc., for any reason whatever, the purchase price will be refunded in full, without quibble or question, and without delay.

The high recognition which Progressive "Edu-Kits" Inc. has earned through its many years of service to the public is due to its unconditional insistence upon the maintenance of perfect engineering, the highest instructional standards, and 100% adherence to its Unconditional Money-Back Guarantee. As a result, we do not have a single dissatisfied customer throughout the entire world.

### ORDER FROM AD—RECEIVE FREE BONUS RESISTOR AND CONDENSER KITS WORTH \$7.00

- Send "Edu-Kit" Postpaid. I enclose full payment of \$26.95.
- Send "Edu-Kit" C.O.D. I will pay \$26.95 plus postage.
- Send me FREE additional information describing "Edu-Kit."

Name .....  
Address .....

**Progressive "EDU-KITS" Inc.** 1186 Broadway, Dept. 218G  
Hewlett, N. Y.

# EIGHT INSTRUMENTS IN ONE

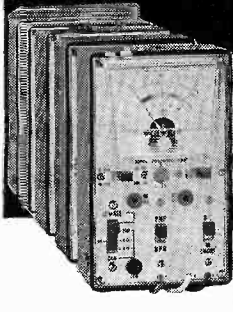

- Out-of-Circuit Transistor Analyzer
- Dynamic In-Circuit Transistor & Radio Tester
- Signal Generator
- Signal Tracer • Voltmeter
- Milliammeter
- Battery Tester
- Diode Checker

## Transistor Analyzer Model 212

Factory Wired & Tested — \$18.50  
Easy-to-Assemble Kit — \$13.50

**YOU DON'T NEED A BENCH FULL OF EQUIPMENT TO TEST TRANSISTOR RADIOS!** All the facilities you need to check the transistors themselves — and the radios or other circuits in which they are used — have been ingeniously engineered into the compact, 6-inch high case of the Model 212. It's the transistor radio troubleshooter with all the features found only in more expensive units. Find defective transistors and circuit troubles speedily with a single, streamlined instrument instead of an elaborate hook-up.

### Features:

Checks all transistor types — high or low power. Checks DC current gain (beta) to 200 in 3 ranges. Checks leakage. Universal test socket accepts different base configurations. Identifies unknown transistors as NPN or PNP.

Dynamic test for all transistors as signal amplifiers (oscillator check), in or out of circuit. Develops test signal for AF, IF, or RF circuits. Signal traces all circuits. Checks condition of diodes. Measures battery or other transistor-circuit power-supply voltages on 12-volt scale. No external power source needed. Measures circuit drain or other DC currents to 80 milliamperes. Supplied with three external leads for in-circuit testing and a pair of test leads for measuring voltage and current. Comes complete with instruction manual and transistor listing.

EMC, 625 Broadway, New York 12, N. Y.

Send me **FREE** catalog of the complete value-packed EMC line, and name of local distributor.

NAME \_\_\_\_\_ RE-3

ADDRESS \_\_\_\_\_

CITY \_\_\_\_\_ ZONE \_\_\_\_\_ STATE \_\_\_\_\_

## EMC

ELECTRONIC MEASUREMENTS CORP.  
625 Broadway, New York 12, New York  
Export: Pan-Mar Corp., 1270 B'way, N. Y. 1

# ELECTRONIC TECHNICIANS

## IMMEDIATE OPENINGS

### ■ RADAR FIELD ENGINEERS

1. Excellent Stateside locations for men who qualify as Radar Field Engineers. Must have 8 years' experience in ground or shipboard systems and 2 years' technical education.

2. Alaskan openings also available for men who have 3 years' experience on heavy ground radar, one year of which must have been on an AC and W site.

### ■ TEST EQUIPMENT TECHS

Stateside and Overseas openings for men who have 3 years' electronic experience, 2 years of which must be in the repair and calibration of test equipment.

Interested Candidates, Please Write or Send Resume To Department 804.

## PHILCO TECHREP DIV.

A Subsidiary of Ford Motor Company

P. O. BOX 4730 PHILADELPHIA, PA., 19134

An Equal Opportunity Employer

thread the tape, wind it (on "fast-forward") to its end, and adjust the contact to touch the tape. Be careful not to change the height of the feed guidepost, for that will alter tracking. Make sure the surface of the contact is smooth and even: it will be touching the tape longer now with standard reels.

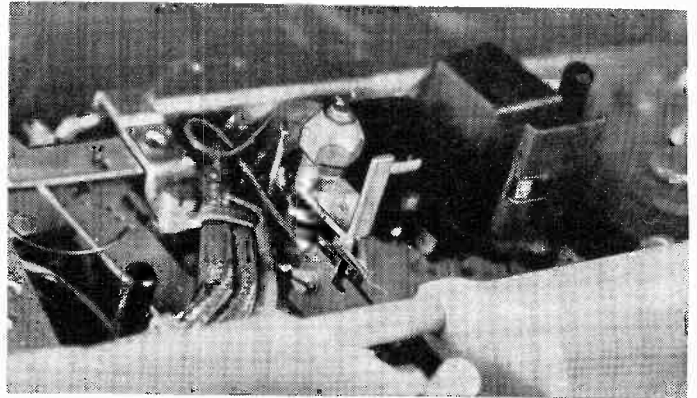

The photo shows the angle-selective contact on a Philips EL3515-D. The contact is grounded by the foil on the tape, when the foil passes the grounded guidepost. This discharges a capacitor (the output-stage cathode bypass) through a relay coil, which in turn operates the automatic stop magnet by discharging the output B-plus filter capacitor through the stop-magnet coil.

### Grundig TK42 and TK45

In these machines, intermittent recording and playback can be traced to the amplifier muting contacts, shown in the

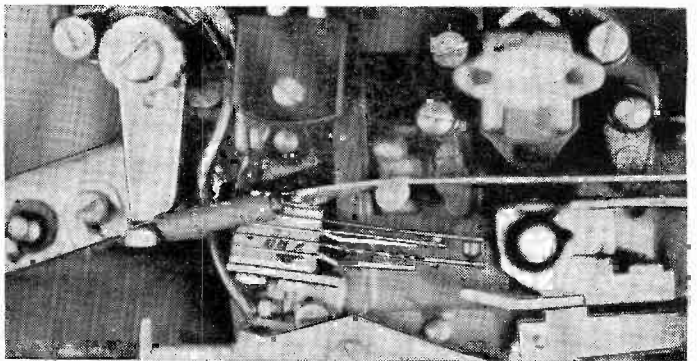
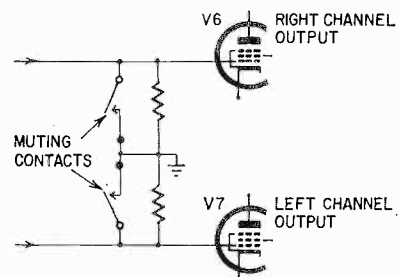

photo. The adjustment arm should be bent so that there is 1/16-inch clearance between the switch contacts. Clean the contacts with wood alcohol; other solvents may melt the plastic spacer bead.

### Muting on Webcor Recorders

Tape machines that operate on long standby intervals should keep silent when they are not actually in use. Muting switches to short the output of the playback heads, as in the



Webcor EP-2008-5, cannot kill noise generated in the preamp stage.

Solve the nuisance by reconnecting the muting switches at the output stage grids, as shown in the diagram. Now the machine will be completely quiet until it is started. END

## 50 Years Ago

In Gernsback Publications

HUGO GERNSBACK, Founder	
Modern Electrics .....	1908
Wireless Association of America .....	1908
Electrical Experimenter .....	1913
Radio News .....	1919
Science & Invention .....	1920
Practical Electrics .....	1921
Television .....	1927
Radio-Craft .....	1929
Short-Wave Craft .....	1930
Television News .....	1931

Some larger libraries still have copies of Modern Electrics and the Electrical Experimenter on file for interested readers.

In March, 1914, Electrical Experimenter

A New Wireless Relay, by Henri Mea.  
New "Electro" Loading Inductance.

Experimental Electricity Course, by S. Gernsback and H. W. Secor.

Construction of an Improved Loose Coupler, by H. Winfield Secor.

A Pocket Wireless Set.

Wireless Receiving Set Without Aerial or Ground, by H. Gernsback

A Switch-Board for Wireless Stations, by H. C. Graham.

A Unique Receiving Transformer, by J. Fink.

# SCHOOL DIRECTORY

## EARN Electronics Engineering DEGREE

You can earn an A.S.E.E. degree at home. College level HOME STUDY courses taught so you can understand them. Continue your education, earn more in the highly paid electronics industry. Missiles, computers, transistors, automation, complete electronics. Over 27,000 graduates now employed. Resident school available at our Chicago campus—Founded 1934. Send for free catalog.

American Institute of Engineering & Technology  
1139 West Fullerton Parkway, Chicago 14, Ill.

**FOR AN  
ELECTRONICS  
CAREER**

Write For Free Catalog RE

WEEKLY TUITION

**MICROWAVE TECHNIQUES — TV  
INDUSTRIAL ELECTRONICS  
COMPUTERS—RADIO TRANS-  
MITTERS—RADAR—TRANSISTORS**

**PHILADELPHIA WIRELESS  
TECHNICAL INSTITUTE**

1533 Pine Street Philadelphia 2, Pa.  
Founded in 1906 • A Non-Profit Corp.

## GET INTO ELECTRONICS

V.T.I. training leads to success as technicians, field engineers, specialists in communications, guided missiles, computers, radar and automation. Basic & advanced courses in theory & laboratory. Electronic Engineering Technology, an ECEP accredited Technical Institute curriculum. Assoc. degree in 29 mos. B.S. also obtainable. G.I. approved. Graduates in all branches of electronics with major companies. Start Feb., Sept. Dorms, campus. High school graduate or equivalent. Catalog.

**VALPARAISO TECHNICAL  
INSTITUTE**  
Department C, Valparaiso, Indiana



**ETI** Engineering Technician  
A.S. Degree—2 Years  
Electronics Engineer  
B.S. Degree  
Evening Courses Available

**ELECTRONIC TECHNICAL INSTITUTE**  
970 W. Manchester Ave., Inglewood, Calif.  
4863 El Cajon Blvd., San Diego, Calif.

## TRAIN FOR A CAREER IN ELECTRONICS AT PHILCO TECHNOLOGICAL CENTER

Prepare for a rewarding career as an Electronics Engineering Technician or Electronics Maintenance Technician with comprehensive training at Philco Technological Center in Philadelphia. Training by industry experts to meet industry's needs.

WRITE FOR FREE BOOKLET

**PHILCO TECHNOLOGICAL CENTER**

Ontario & C Sts., P.O. Box 4730, Philadelphia 34, Pa.

## ENGINEERING EDUCATION for the Space Age

**NORTHROP INSTITUTE of Technology** is a privately endowed, nonprofit college of engineering offering a complete Bachelor of Science Degree Program and TWO-YEAR accredited technical institute curricula. Students from 50 states, many foreign countries. Outstandingly successful graduates employed in aeronautics, electronics, and space technology. Write today for catalog—no obligation.

**NORTHROP INSTITUTE OF TECHNOLOGY**  
1181 West Arbor Vitae Street, Inglewood 1, California

## B. S. Degree in 36 months

Small professionally-oriented college. Four-quarter year permits completion of B.S. Degree in three years. Summer attendance optional. **Engineering:** Electrical (electronics or power option), Mechanical, Civil, Chemical, Aeronautical. **Business Administration:** General Business, Accounting, Motor Transportation Administration. One-year Drafting-Design Certificate program. Outstanding placement of graduates. Founded 1884. Rich heritage. Excellent faculty. Small classes, 200-acre campus. Well equipped labs. New library. Residence halls. *Modest costs.* Enter June, Sept., Jan., March. For Catalog and View Book, write J. G. McCarthy, Director of Admissions.



## TRI-STATE COLLEGE

2434 College Avenue • Angola, Indiana

C. L. Foster, President, Central Technical Institute, says:



"Why be satisfied with home study electronics training that goes only half way?"

Get facts about new, modern training in  
**PRACTICAL ELECTRONICS**  
plus . . . bonus training in  
**APPLIANCE and ELECTRICAL  
REPAIR and WIRING**

## Trained Men Needed NOW FOR . . .

- Color TV Servicing
- Broadcasting
- Industrial Electronics
- Manufacturing
- Guided Missile Systems
- HI-FI and Sound Installation



for optional advanced training in Broadcasting, Communications, Nuclear Power or Aero Space Industry to help you specialize. Rush coupon for new FREE BOOK. Est. 1981 . . . Accredited by National Home Study Council.

## FREE BOOK - MAIL COUPON

Central Technical Institute, Dept. 03034  
1544 Wyandotte St., Kansas City 8, Mo.

Rush latest edition "Practical Electronics" telling about careers in Electronics for trained men—FREE!

Name.....  
Address.....  
City..... Zone..... State.....

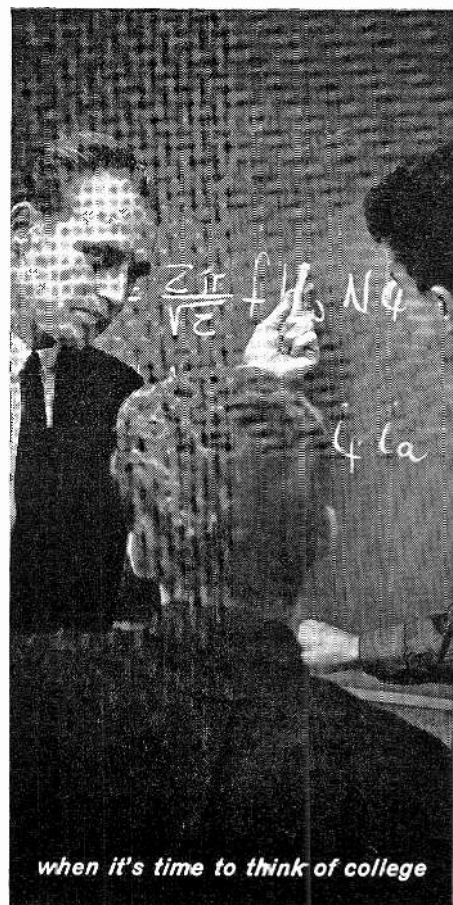

when it's time to think of college

## find out about engineering at MSOE

Planning your education correctly now will enhance your career later! That's why you should obtain all the facts about MSOE programs in Electrical and Mechanical Engineering and Technology.

Learn about courses leading to 4-year Bachelor of Science and 2-year Associate in Applied Science degrees. Find out about MSOE scholarships, financial aids, job placement opportunities, and other services.

Assure yourself of a bright future in the exciting field of space age engineering and technology. Write for your free "Career" booklet which will tell you about educational advantages at MSOE.

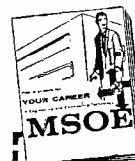

## MSOE

**MILWAUKEE  
SCHOOL OF ENGINEERING**  
Dept. RE-364  
1025 N. Milwaukee St.  
Milwaukee, Wisconsin 53201

Tell me about an engineering career through residence study in:

Electrical fields     Mechanical fields

Name..... Age.....

Address.....

City, State.....

# TRANSISTOR RADIO HANDBOOK



—simplified circuit theory, plus practical construction projects

Handbook covers a wide range of communication uses for both amateur radio and commercial applications.

Includes audio and speech amplifiers, V.H.F. transmitting and receiving equipment, single sideband exciters (both filter and phasing types), and also a complete S.S.B. transceiver.

BOOK #044 **\$5.00** ea. (foreign \$5.50)

Order from your favorite electronic parts distributor.

If he cannot supply, send us his name and your remittance, and we will supply.

**EDITORS and ENGINEERS, Ltd.**

Summerland 5, California 93067



Dealers: Electronic distributors, order from us. Bookstores, libraries, newsdealers order from Baker & Taylor, Hillside, N. J. Export (exc. Canada), order from H. J. Snyder Co., 440 Park Ave. So., N.Y. 16.

**Advertise in the  
Classified Ad Section of  
RADIO-ELECTRONICS**

**55¢ per word. (10 word  
minimum.)**

**Send your copy and check to:**

**RADIO-ELECTRONICS**  
154 West 14th Street  
New York, N.Y. 10011

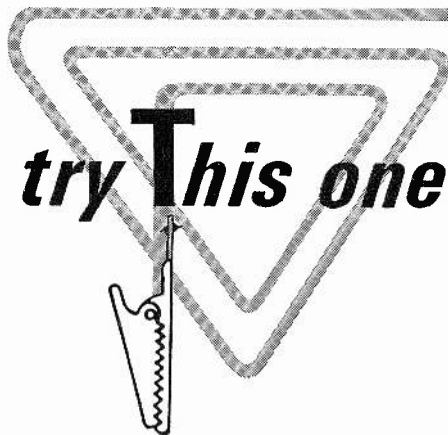

## Breaking in a Woofer

To limber up the cone suspension of a new all-paper-cone woofer and improve its bass response, connect it to a 6.3-volt filament transformer through a 100-ohm rheostat or potentiometer. Set the control for maximum resistance, and plug the transformer into the ac line. Set the pot now until the cone vibrates vigorously but not violently enough to spring anything. You can muffle the hum by putting the whole setup in a large trunk or closet with plenty of clothing or pillows around the speaker.

After a few hours, when you disconnect the speaker and hook up to your hi-fi system, you'll find that this "aging" makes quite a difference in the mellow-

ness of the low notes. This method is not good for cloth-surround speakers or other nonpaper types.—*John Comstock*

## Test Tape Checks Recorder Speed

Though this method doesn't show up wow and flutter, it does show whether two recorders are operating at the same speed, which is important whenever tape recorded on one machine is played back on another. It gives a very precise check on long-term speed accuracy.

The machines for which I tried this all ran at  $7\frac{1}{2}$  ips— $37\frac{1}{2}$  feet per minute. For that speed, mark off  $37\frac{1}{2}$ -foot intervals on a new reel of tape, using bits of white splicing tape as markers. Put the tape on the machine, set it to record, and start it up.

Pick a convenient fixed spot on the recorder near the supply reel as a reference point. When the first mark passes the point, say "start" into the mike. When the second spot comes up, say "one," and so on until all the marks have been accounted for.

To determine if the machine is running at the right speed (in this case,  $7\frac{1}{2}$  ips), set the machine to play back and cue up to the "start" mark. Using a sweep-second-hand clock or stopwatch, start the machine at any convenient point on the clock dial. If you start at "straight up," then (assuming that the

## build your own bozak

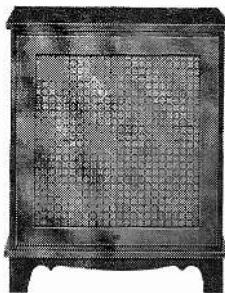
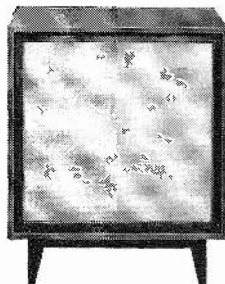

**URBAN OR EARLY AMERICAN  
INFINITE-BAFFLE SPEAKER CABINETS**

Complete kits ready for assembly, and finishing to your taste. For the Bozak 2-way B-300 and 3-way B-302A Systems. See your Bozak Dealer, or write Bozak.

**Bozak**

DARIEN / CONN.  
06821

## NEW PRICES from QUIETROLE

the oldest, most  
widely proved and  
sold radio and TV  
lubricant

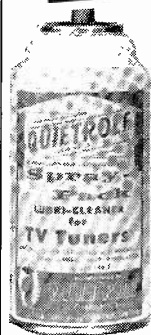

2 oz. bottle with dropper	LIST \$1.49
4 oz. bottle	LIST 2.54
4 oz. bottle (brush-n-cap)	LIST 2.64
8 oz. bottle	LIST 5.07
6 oz. spray can — with extender	LIST 2.79
3 oz. spray can — with extender	LIST 1.79



Quietrole is your guarantee of the most effective, quick silencer of noisy radio and TV controls — the quality product that is a top value. Get Quietrole at quality jobbers.

Some territories still available for experienced representation.





speed is correct) you should hear your voice saying "one," "two," and so on, each minute at "straight up." If the point on the clock dial at which you hear your voice "drifts" clockwise with each mark, the machine is slow; if it heads counter-clockwise, the machine is fast.

Note that this method does not depend on the speed accuracy of the machine you used to make the tape, since you have marked the tape in length, not time, intervals. If you suspect that a particular machine is off speed, about 10 minutes of this tape will tell if so and how much. You can use it for any other speed, too.—*J. C. Craver*

### Substitute Pickup Saves Wear on Expensive One

When Mr. Ardent Audiophile buys an expensive changer and an expensive cartridge to use in it, he's naturally afraid to let the kids use the family hi-fi for a stack of twist discs. An easy solution is to supply him with an inexpensive extra cartridge in a head that fits the particular changer he has.

You can get a pretty good, rugged stereo crystal or ceramic cartridge for

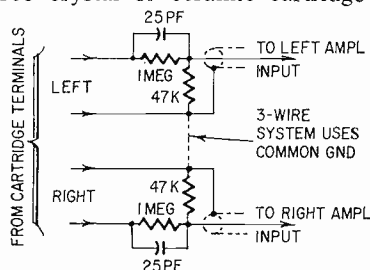

about \$5. You may have to weight the spare head to get the proper tracking force for the new cartridge—about 5 to 6 grams for most recent types.

Because the signal level from a piezo cartridge is much higher than from the magnetic type your man is using, you will have to attenuate its output and shape its frequency response so it can be fed to the magnetic-phono input on the amplifier without changing connections. The diagram shows a simple network that does that job. If you use 1/4- or 1/10-watt resistors and tiny ceramic capacitors, you can build it right into the pickup shell.

Fixing a customer up with an accessory like this can make the difference between selling him a good component setup and a package "hi-fi."—*S. P. Dow*

### Solder Remover

Do you have trouble opening up the holes in printed-circuit boards after removing components? Hunt up a 6-inch-long piece of nichrome wire (used in toasters, electric irons, etc.). Straighten it out and make a little loop in one end as a handle.

Now you can heat the solder in the hole and poke it clean with the wire. Solder won't stick to nichrome.—*K. N. Gray*

# FREE NEW 1964 GIANT CATALOG

100's OF BARGAINS NOT IN ANY OTHER CATALOG

100's of new items listed for first time

EVERYTHING IN HI-FI AND STEREO

Satisfaction GUARANTEED or your money back!

TOP VALUES IN POWER & HAND TOOLS

100's of pages packed with savings

SAVE UP TO 50% ON CHOICE KITS

TUBE PARTS ETC. AT LOWEST PRICES

1964

ANNUAL CATALOG

BA

SINCE 1927

RADIO TV ELECTRONICS

INDEX PAGE 226 . . . PHONE Baltimore 1-1555

APPLEBEE CO. 1012-14 MCGEE ST., KANSAS CITY 6, MO.

NO MONEY DOWN PLUS NEW REVOLVING CHARGE ACCOUNT

BURSTEIN-APPLEBEE CO. Dept. RE,  
1012-14 McGee St., Kansas City 6, Mo.

Rush me the FREE 1964 B-A Catalog.

NAME \_\_\_\_\_

ADDRESS \_\_\_\_\_

CITY \_\_\_\_\_ STATE \_\_\_\_\_

FOR 37 YEARS THE  
OUTSTANDING  
**MONEY  
SAVING**

**BUYING GUIDE FOR:**

- Stereo & Hi-Fi Systems and Components
- Tape Recorders
- Electronic Parts, Tubes, Books
- Phonos & Records
- Ham Gear
- Test Instruments and Kits
- Cameras and Film
- Public Address
- Citizens Band
- Transistor & FM-AM Radios.

**RUSH COUPON TODAY**

**WANT  
BACK  
ISSUES?**

Back numbers of most issues of RADIO-ELECTRONICS are available upon request:

This year's issues 50¢

Last year's issues 55¢

Previous year 60¢, etc.

Maximum ....\$1.00

**RADIO-ELECTRONICS**  
154 WEST 14TH STREET, NEW YORK, N.Y. 10011

**Jobs Look for YOU  
in ELECTRONICS**

Literally thousands of BIG PAY JOBS or a BUSINESS OF YOUR OWN await you in Electronics. MTI's exclusive SELECT-A-SKILL method trains you FAST at home or resident classes in Jacksonville for lifetime security in COMMUNICATIONS or INDUSTRIAL ELECTRONICS, or RADIO & TV SERVICING. Hundreds of students earn enough while making 7 MASTER ELECTRONIC KITS to pay for entire course. Find out how.

**SKILLS PAY BILLS**  
Let MTI give you the skills to insure your earning power from now on.

**SEND TODAY** for 32-page FREE BOOK and SELECT-A-SKILL Opportunity Finder. No obligation. Address Massey Technical Institute, Dept. 14-BC-02, Jacksonville 6, Florida.

# ELECTRONICS

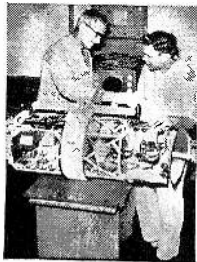

## Engineering-Technicians

Bachelor of Science Degree, 30 Months  
Save Two Years' Time

The Nation's increased demand for Engineers,

- Radio-Television Plus Color Technician (12 Months)
- Electronics Engineering Technology (15 Months)
- Electronics Engineering (B.S. Degree)
  - Electrical Engineering (B.S. Degree)
  - Mechanical Engineering (B.S. Degree)
  - Civil Engineering (B.S. Degree)
  - Architecture (B.S. Degree) (36 Months)

Electronic Technicians, Radio TV Technicians is at an all time high. Heald Graduates are in demand for Preferred High Paying Salaries. Train now for a lucrative satisfying lifetime career.

Approved for Veterans

### DAY AND EVENING CLASSES

Write for Catalog and Registration Application. New Term Starting Soon.

Your Name .....

Address .....

City .....

State .....

# HEALD'S

ENGINEERING COLLEGE

Est. 1863—100 Years  
Van Ness at Post, RE  
San Francisco, Calif.

**ZIP** stands for the Post Office Department's new Zoning Improvement Plan. When renewing your RADIO-ELECTRONICS subscription, or sending us a change of address, please let us know what your ZIP Code is. We'll add it to your address mailing plate... and you'll get speedier delivery service from the Post Office. By the way, when writing to us, address: RADIO-ELECTRONICS, 154 West 14th St., New York, N. Y. 10011.

# TUBES

Tubes are new, seconds or used and so marked.  
**ONE YEAR GUARANTEED**

OZ4	6BA6	6K7	12AT7
1B3	6BC5	6Q7	12AU7
1J3/1K3	6BD6	6S4	12AX7
1H5	6BG6	6SA7	12BA6
1L4	6BH6	6SC7	12BD6
1T4	6B/6	6SH7	12BE6
1U4	6BL7	6S/7	12BF6
1X2	6BN4	6SK7	12BH7
3CB6	6BN6	6SL7	12BL6
5U4	6BQ6	6SN7	12BY7
5Y4	6BZ6	6SQ7	12C5
5Y3	6C4	6SR7	12CA5
6A6	6C6	6U7	12SH7
6A8	6CB6	6U8	12SQ7
6AB4	6CD6	6V6	25L6
6AC7	6GF6	6W4	25Z6
6AG5	6CG7	6WG	35W4
6AK5	6CG8	6X4	35Z3
6AL5	6CM7	6X5	35Z5
6AN8	6CZ5	7A7	50L6
6AQ5	6D6	7A8	24
6AS5	6DA4	7B6	24
6AT6	6DE6	7B7	27
6AT8	6DQ6	7B8	41
6AU4	6EAM5	7C5	45
6AU5	6F6	7N7	47
6AU6	6H6	7Y4	75
6AV6	6J5	12AD6	77
6AW8	6J6	12AE6	78
6AX4	6K6	12AF6	84/6Z4

# 33¢

PER TUBE

100 TUBES OR MORE:  
**30¢ PER TUBE**

If not shipped in 24 hrs  
**YOUR ORDER FREE!**

★ ★ ★ ★ ★

SEND FOR FREE LIST OTHER TUBES, CRT'S, SELF SERVICE TESTERS, RADIO AND TV COURSES ALL AT LOW PRICES.

**Special!**  
With every \$10 Order  
**25¢** per tube  
(No Limit) from this list.

6AG5	6SN7
6AU6	6V6
6AQ5	6W4

★ ★ ★ ★ ★

TERMS: FREE POSTAGE ON PREPAID USA ORDERS. Under \$5.00 add 50¢ for handling. Send 25¢ deposit on C.O.D. orders. No Canadian or foreign C.O.D.'s — include postage. No 24 Hr. Free Offer on personal check orders. 5-DAY MONEY BACK OFFER!

NO SUBSTITUTIONS WITHOUT YOUR PERMISSION

**CORNELL ELECTRONICS CO.**  
Dept. RE3  
4217 University Ave.,  
San Diego, Calif. 92105 • Phone: AT 1-9792

"New 1964 Catalog" #12



★ A complete catalog of specialized industrial Electronic TUBES and COMPONENTS... featuring Barry Electronics savings to industry, Servicemen, Experimenters, and purchasing agents. 64 pages.

RCA 21" COLOR CATHODE RAY PICTURE TUBE #21AXP22A UNUSED ORIGINAL CARTON SPECIAL \$90.

We'll also purchase your equipment and unused tubes. Send details.

**BARRY ELECTRONICS**  
512 BROADWAY,  
New York, N. Y.  
10012

14 YEARS OF BUYERS' CONFIDENCE  
**CORPORATION** Walker 5-7000  
AREA CODE 212  
TWX: 571-0484

Please send me a copy of the new 1964 "Greensheet" and add my name to your mailing list. (RE-3)

Name ..... Title .....

Company .....

Address .....

City ..... State .....

# new Books

101 WAYS TO USE YOUR COLOR-TV TEST EQUIPMENT, by Robert G. Middleton. Howard W. Sams & Co., Inc., 4300 W. 62 St., Indianapolis 6, Ind. 8 1/2 x 5 1/2 in., 144 pp. Paper, \$2.50.

Latest of the "101" book series, this one is divided into short, easily grasped sections averaging about a page, and is extremely well illustrated with actual scope photographs.

GETTING STARTED IN ELECTRONICS. Publications Div., Allied Radio Corp., Chicago 80, Ill. 5 1/2 x 8 1/2 in., 112 pp. Paper, \$5.00.

Described as a book "for everyone," this work uses the simplest possible language and clear photographic illustrations or drawings to start the beginner in electronics. Schematics are not introduced until nearly halfway through the book and the first construction project is wiring a doorbell. (Transistor radios come later.)

THEORY OF NETWORKS AND LINES, by James L. Potter and Sylvan J. Fich. Prentice-Hall, Inc., Englewood Cliffs, N. J. 6 x 9 in., 436 pp. Cloth, \$16.

Basic theory for advanced engineering students. A well-organized text, with problems and math tables.

DICTIONARY OF ELECTRONICS COMMUNICATIONS TERMS, by Howard W. Sams Engineering Staff. Howard W. Sams & Co., Inc., 4300 W. 62 St., Indianapolis 6, Ind. 5 1/2 x 8 1/2 in., 157 pp. Paper, \$3.95.

More than 2,500 terms, including non-technical ones such as "fist" and "rock," are clearly defined. Modern and apparently reasonably complete.

THE MATHEMATICAL THEORY OF COMMUNICATION by Claude E. Shannon and Warren Weaver. University of Illinois Press, Urbana, Ill. 5 1/2 x 8 in., 117 pp. Paper, \$9.95.

This reprint of an original 1949 cloth-bound edition contains Claude Shannon's original paper, "The Mathematical Theory of Communication" plus a shorter piece, "Recent Contributions to the Mathematical Theory of Communication," written in 1949 by Warren Weaver of the Rockefeller Foundation.

STATIC ELECTROMAGNETIC DEVICES, by William T. Hunt, Jr. and Robert Stein. Allyn & Bacon, 150 Fremont St., Boston 11, Mass. 9 1/4 x 6 1/4 in., 395 pp. Cloth, \$10.50.

A complete engineering treatment, beginning with characteristics of magnetic materials, and going through transformers, reactors and magnetic amplifiers. The book contains many examples and problems.

TRANSISTOR IGNITION SYSTEMS, by Brice Ward. Howard W. Sams & Co., Inc., 4300 W. 62 St., Indianapolis 6, Ind. 5 1/2 x 8 1/2 in., 128 pp. Paper, \$2.50.

The author, himself a designer and constructor of transistor ignition systems, covers the theory of transistor ignition, describes a number of commercial units

and gives some hints on installation and troubleshooting.

A HISTORY OF ELECTRICITY, by Edward Tatnall Canby. Hawthorn Books, Inc., Englewood Cliffs, N.J. 6 1/2 x 10 1/2 in., 112 pp. Cloth, \$5.95.

This excellent work, beginning with the early static experiments of the Greeks, the magnetic compass of the Chinese and Peregrinus and the early experiments of European scientists, continues to the modern laser. The illustrations are remarkable, largely old woodcuts and line drawings, taken from sources contemporary with the experiments described. They range from

illustrations of Otto von Guericke's experiments to photographs of a radio telescope.

MOST-OFTEN-NEEDED 1964 RADIO DIAGRAMS (Vol. R-24), compiled by M. N. Beitman. Supreme Publications, 1760 Balsam Road, Highland Park, Ill. 8 1/2 x 11 in., 192 pp. Paper, \$2.50.

Compilation of original manufacturers' schematics and service data covering nearly 700 chassis and models of home, auto and portable AM, FM, and FM-AM radios; phonographs and combinations of 33 makes and brands.

SEMICONDUCTOR FUNDAMENTALS, by A. H. Seidman and S. L. Marshall. John Wiley & Sons,

605 Third Ave., New York 16, N.Y. 6 x 9 in., 278 pp. Cloth, \$6.50.

Transistors and circuits discussed at engineering level, for students familiar with vacuum tubes. Includes tunnel diodes and computer logic.

TV SERVICE PRICING MANUAL, by PF Reporter editorial staff. Howard W. Sams & Co., Inc., 4300 W. 62 St., Indianapolis 6, Ind. 4 1/2 x 6 1/2 in., 96 pp. Paper, \$1.50.

How to compute and estimate servicing time, hourly rates and profits. Discusses cost of doing business, service contracts and shop records. END

# Radio-Electronics Market center

## TRANSISTORS\*\*\*NEW

I.F. converter, switch, audio, also high frequency: PNP and NPN . . . . . 3/\$1.00  
 Power transistors—20 to 70 watts . . . . . 60¢  
 Brand New: original packages, full leads; Guaranteed— RCA, GDS, Raytheon, Texas Instru., U.S. Transistor, General Transistor, Philco.  
 Telex Stereo Earphones (Hi-Fi) . . . . . pr. \$12.50  
 PAI Speaker—13 1/2" diam. X 1 1/2" deep . . . . . ea. \$1.00  
 1N537—1N539—Tophat; Raytheon, Motorola, General Electric, Rectifier, Silicon . . . . . 3/\$1.00  
 1N60—Micro-miniature diodes . . . . . 8/\$1.00  
 Stud type Rectifier—400 PIV—750 MA. . . . . .50  
 Zener Diodes—12 volt; 1 amp. . . . . . \$1.00  
 Transistor sockets—3 lead—(Cinch Co.) . . . . . 10/\$1.00  
 Driver Transformer—sub-miniature—1/2-1/2-1/2 for transistor P.C. center-tapped . . . . . 2/\$1.00  
 Audio Output Transformer—sub-miniature—1/2-1/2-1/2 for Transistor P.C. center-tapped . . . . . 2/\$1.00  
 2K and 10K ohm volume control with switch—P.C. (CPS) miniature . . . . . 3/1.00  
 500 K ohm volume control with switch (Cutler-Hammer) . . . . . 4/\$1.00  
 455 KC. I.F. sub-miniature transformer . . . . . 3/\$1.00  
 455 KC. Dual I.F. sub-miniature transformer . . . . . ea. .60  
 Parts for 2 Watt Audio Power amplifier Consisting of 3 transistors, including 1 power transistor, resistors, electrolytic capacitors, together with schematic. Can be built in a 2" X 2" box . . . . . \$3.00  
 Preamp. to Match Above with schematic . . . . . ea. \$1.50  
 Parts for 12 volt. 1 amp. REGULATED power supply, with schematic and instructions . . . . . \$8.95  
 Code Oscillator module; completely assembled Matchbook size with schematic, etc. . . . . \$1.00  
 P. A. Amplifier Module; completely assembled with schematic—3 lead and instructions . . . . . \$2.00  
 Dual Plateur Moogite, transistorized Flipflop . . . . . \$2.00

WRITE FOR FREE ADDITIONAL CATALOG.

Minimum order \$3.00  
 Prepaid Postage Free in U.S.

## TRANSISTORS UNLIMITED COMPANY

Post Office Box #442, Great Neck, L. I., New York

## Hi CANADIANS

LOWEST PRICES • FAST DELIVERY  
 BRAND NEW 1st QUALITY MERCHANDISE  
 GUARANTEED NO SECONDS • STD VALUES

15 0.01x400v Tubulars \$1 20 Asst Res 1/2 Watt  
 15 0.1 x400v Tubulars 20 Asst Res 1 Watt  
 15 Assorted Tubulars MOST FREQUENTLY USED VALUES  
 Surprise Package 4 Pots 500K; 1, 2 & 3 meg STANDARD SHAFTS  
 ALWAYS DIFFERENT

HUNDREDS OF BARGAINS ■ WRITE FOR MONTHLY LIST  
**ARLAY ELECTRONICS**  
 P.O. BOX 1537 • STA. B • MONTREAL 2 • QUEBEC, CANADA

# RENT

FREE BROCHURE

## STEREO TAPES

Postpaid 2 to 5 day delivery (48 States)

## stereo-parti

1616-D TERRACE WAY, SANTA ROSA, CALIF.

Convert any television to sensitive

## BIG-SCREEN OSCILLOSCOPE

with minor, inexpensive changes. Ingenious circuit. No electronic experience needed to follow our clearly illustrated plans. **TECHNICIANS, HAWKS, EXPERIMENTERS, BROAD-CASTERS.** Use in shop, school, lab. Any size—any size.

**FULL PLANS \$2**

RELCO, Dept. RE-3, Box 10563, Houston 18, Tex.



## WOLLENSAK Tape Recorders

deliver a wallop bigger than many twice the size.

ATTN: SCHOOLS & GOVERNMENT PURCHASING AGENTS. We have the most complete selection anywhere. New models include: 524, 1400, 1440, 1500, 1515-4, 1570, 1780, 1580, 1980, 1981 and 422, & SA-421 speaker/amplifier. Whether you order 1 or 1000 units, your order receives prompt attention.

**REQUEST COMPLETE TAPE RECORDER DISCOUNT SHEET**

### SAXITONE RECORDING TAPE

275' plastic, 3" (in mailable box)	.35
600' acetate (plastic), 5 inch.	.75
600' MYLAR 5 inch reel	.85
900' MYLAR (Polyester), 5 inch.	.89
1200' MYLAR, 1/2 mil, 5 inch reel	1.18
1200' MYLAR, tensilized, 5 inch.	1.59
1200' acetate (plastic), 7 inch.	1.15
1200' MYLAR, 1 1/2 mil, (strong)	1.29
1800' acetate (plastic), 7 inch.	1.39
1800' MYLAR 1 mil, thick, 7 inch.	1.89
2400' MYLAR, untensilized, 7 inch.	2.59
2400' MYLAR, tensilized, 7 inch.	2.89

(Greater discounts to quantity buyers)

Plus Postage Save **30-60%**

4-track Stereo music on tape. FREE 50-page catalog

**SAXITONE**  
 div. Commission Electronics, Inc.  
 1776 Columbia Rd. N.W., Wash. 9, D.C.

## FREE Catalog

OF THE WORLD'S FINEST ELECTRONIC GOV'T SURPLUS BARGAINS

HUNDREDS OF TOP QUALITY ITEMS — Receivers, Transmitters, Microphones, Inverters, Power Supplies, Meters, Phones, Antennas, Indicators, Filters, Transformers, Amplifiers, Headsets, Converters, Control Boxes, Dynamotors, Test Equipment, Motors, Blowers, Cable, Keys, Chokes, Handsets, Switches, etc., etc. Send for Free Catalog—Dept. RB.

**FAIR RADIO SALES**  
 2133 ELIDA RD. • Box 1105 • LIMA, OHIO

## LOW-COST BUSINESS AIDS FOR RADIO-TV SERVICE

Order books, invoice forms, job ticket books, service call books, cash books and statement books for use with your rubber stamp. Customer file systems, book-keeping systems, many others. Write for **FREE 32 PAGE CATALOG** now.

**OELRICH PUBLICATIONS**  
 6556 Higgins Rd., Chicago, Ill. 60656

## METER and EQUIPMENT REPAIR and CALIBRATION

Free estimates & mailing pack on all meters, multimeters, VTVM's, signal generators & scopes. We repair obsolete Triplett meters & test equipment. Free catalog on repairs & electronic part sales. Kits constructed; 20% of kit cost.

**BIGELOW ELECTRONICS**  
 P.O. BOX 71, DEPT. E1 BLUFFTON, OHIO

## SILICON TOP HATS OR DIODES

750 MA LOWEST PRICES GUARANTEED

LOW LEAKAGE NEWEST TYPE

PIV/RMS 50/35 .05 ea.	PIV/RMS 100/70 .09 ea.	PIV/RMS 200/140 .12 ea.	PIV/RMS 300/210 .18 ea.
PIV/RMS 400/250 .23 ea.	PIV/RMS 500/350 .28 ea.	PIV/RMS 600/420 .38 ea.	PIV/RMS 700/490 .50 ea.
PIV/RMS 800/560 .58 ea.	PIV/RMS 900/630 .68 ea.	PIV/RMS 1000/700 .78 ea.	PIV/RMS 1100/770 .88 ea.

**ALL TESTS! AC & DC & FWD & LOAD**  
 100 Dif. Pre. Res. 1/2, 1, 2 WATT—1% Tol. \$1.25  
 G.E. IN91 Diode—10 for \$1.00, 100 for \$8.00  
 Special 1000 PIV—750 MA. 10 for \$7.50

### SILICON POWER DIODE STUDS

Amps 50 Piv \$0.15	Amps 25 Piv \$0.05
3 100 .30	35 100 1.20
3 200 .35	35 200 1.50
3 400 .50	35 400 3.00
3 600 .60	50 50 2.25
12 100 .60	50 100 3.25
12 200 1.00	50 200 4.00
12 400 1.50	100 100 3.75
12 600 2.00	100 300 4.00

Money Back guarantee. \$2.00 min. order. Orders F.O.B. NYC. Include check or money order. Shpg. charges plus. C.O.D. orders 25% down.

**WARREN ELECTRONIC COMPONENTS**  
 NYC 7, NY 87 Chambers St. Wo 2-5727

## TREASURE FINDERS

Supersensitive new transistor models detect buried gold, silver, coins, firearms. Locate Indian burial grounds, explore beaches, shacks, ghost towns. \$19.95 up. FREE CATALOG.

**RELCO** Dept. RE-3, Box 10563, Houston, Texas 77018

## TV TUNERS REBUILT

and Exchanged \$9.50 plus shp. chgs.

All Makes-Models **ONLY \$9.50**

- Includes All Parts Except Tubes
- Aligned to Factory Specifications
- 90 Day Full Warranty
- \*Practical repairs

Ship tuner complete with tubes, broken parts, tuner cover. Give model # and state complaint.

**VALLEY TV TUNER SERVICE** • PO 9-4730  
 5641-A Cahuenga Blvd., North Hollywood, Calif.

## FREE CATALOG!

148 PAGES • NEARLY 4,000 BARGAINS  
 OPTICS • SCIENCE • MATH

Completely new, enlarged edition. New items, categories, illustrations, 148 new, easy-to-read pages packed with nearly 4000 items. Dozens of electrical and electromagnetic parts, accessories. Enormous selection of Astronomical Telescopes, Microscopes, Binoculars, Magnifiers, Magnets, Lenses, Prisms. Many war surplus items for hobbyists, experimenters, workshop, factory. Write for catalog "EEL".

**CLIP AND MAIL COUPON TODAY**

**EDMUND SCIENTIFIC CO.,** Barrington, N. J.  
 PLEASE SEND ME FREE CATALOG "EEL"

Name \_\_\_\_\_  
 Address \_\_\_\_\_  
 City \_\_\_\_\_ State \_\_\_\_\_

# Classified Ads

Rates—55¢ per word . . . minimum 10 words. Payment must accompany all ads except those placed by accredited advertising agencies. Misleading or objectionable ads not accepted. Copy for May issue must reach us before March 14th. Figure one word: name of city (New York), name of state (New Jersey). Sets of characters as in key (741-RE), also abbreviations as 8x10 mm, A.C., D.C., C.O.D. Hyphenated words not normally considered such count as two words (Hi-Fi). ZIP CODE FREE. RADIO-ELECTRONICS, 154 West 14 St., New York, N. Y. 10011.

## WANTED

G-R, H-P, L&N, etc., Special tubes, manuals, military electronics. **ENGINEERING ASSOCIATES**, 434 Patterson Road, Dayton 19, Ohio.

**PROFITABLE OCCUPATIONS — INVESTIGATE ACCIDENTS.** Earn to \$1,700 monthly. Men urgently needed. Car Furnished. Expenses paid. No selling. No college education necessary. Pick own job location. Investigate full time, or earn \$6.44 hour spare time. Free Information. No obligation. Write **UNIVERSAL**, CER-2, 6801 Hillcrest, Dallas 5, Texas.

**MANUFACTURE Cleaners — Polishes — Anything.** Formula catalog, 10¢. **KEMERON**, Park Ridge, Ill.

**QUICK CASH . . . for Electronic EQUIPMENT, COMPONENTS, unused TUBES.** Send list now! **BARRY**, 512 Broadway, New York, N. Y. 10012, 212 WALKER 5-7000.

## Audio—Hi-fi

**WRITE** for highest discounts on components, recorders, tapes, from franchised distributors. Send for **FREE** monthly specials. **CARSTON**, 125-R East 88, N.Y.C. 10028.

**SALE ITEMS — tapes — recorders — component quotes.** **BAYLA**, Box 131-RE, Wantagh, N. Y.

**WRITE FOR LOWEST QUOTATIONS.** Components, Recorders, No Catalogs. **HI-FIDELITY SUPPLY**, 2817-SC Third, New York 55, N.Y.

**TAPE** recorders, Hi-Fi components, Sleep-learning equipment, Tapes, Unusual values. Free catalog. **DRESSNER**, 1523 Jericho Turnpike, New Hyde Park 5, N.Y.

**RENT STEREO TAPES—over 2,500 different—** all major labels — free brochure. **STEREO-PARTI**, 811-RE, Centralia Ave., Inglewood 3, Calif.

**RECORDS!** Discounts on all LP's. Free details. **CITADEL RECORD CLUB**, 545 5th Ave. Dept. 4, New York 17, N. Y.

**TRANSISTORIZED WIRELESS MICROPHONES,** transmit into broadcast receivers, AM and FM models \$14.95. **NOVELTRONICS**, Box 35065, Houston, Tex.

**AUDIO AMPLIFIER** for transistor portables, 2 watt output from 12 volts, \$9.95. **NOVELTRONICS**, Box 35065, Houston, Tex.

**HI-FI COMPONENTS,** Tape Recorders at guaranteed "We Will Not Be Undersold" prices. All Brands in stock. 15 day money back guarantee. 2 year warranty. Write for quotation; your requirements. No Catalog. **HI-FIDELITY CENTER** —1797 1st Ave., N. Y., N. Y. 10028.

## BUSINESS AIDS

1,000 Business Cards, "Raised Letters" \$3.75 postpaid. Samples. **ROUTH**, RE3, 2633 Randleman, Greensboro, N.C. 27406.

**\$100 WEEKLY POSSIBLE.** Address-mail letters featuring real merchandise. Get \$10 orders in every mail-keep \$8 profit. Everything furnished. Details free. **NATIONAL PLANS**, Box 718, Long Beach, New York.

**MAKE \$25-\$50 WEEKLY** clipping newspaper items for publishers. Some clippings worth \$5.00 each. Particulars free. **NATIONAL**, Box 718, Long Beach, New York.

**MORE TV SERVICE COMPANIES ARE GETTING** more calls and making more money with our circulars. Information free. **JASON**, 2336 Orthodox, Philadelphia, Pa. 19137.

## MISCELLANEOUS

**READER'S DIGEST—15 MONTHS \$1.87!** (Introductory) **LEVITT**, 3145 Brighton 4th, Brooklyn, N.Y. 11235.

**HORROR FANS—free literature.** "The Detective is a Monster!" No obligation, fast service. The World Famous **TRANS-INTERNATIONAL PUBLISHING CO.**, Box 2942, Paterson, N.J.

## EDUCATION/INSTRUCTION

**LEARN ELECTRONIC ORGAN SERVICING.** New Home Study courses covering all makes electronic organ including transistors. Experimental kits — schematics — troubleshooting. Accredited NHSC-GI Approved. Write for free booklet. **NILES BRYANT SCHOOL**, 3631 Stockton Blvd., Dept. F. Sacramento 20, Calif.

**SLEEP LEARNING.** Hypnotism! Tapes, records, books, equipment. Details, strange catalog **FREE.** **RESEARCH ASSOCIATION**, Box 24-RD, Olympia, Wash.

**CANADIAN INSTITUTE OF SCIENCE & TECHNOLOGY LTD.** The world wide institute of home study—now offers a complete course in basic electronics, incorporating only the elementary principles of mathematics, for as little as \$40.00—send for details and your free sample lesson now. 498 Garden Bldg., 263 Adelaide St., West, Toronto.

**HOW COMPUTERS WORK.** Send \$2.00 for this easy to understand bulletin. **ELECTRONICS RESEARCH LABORATORY**, Box 154, Colonial Park, New York, N.Y. 14439.

**FCC LICENSE** in 6 weeks. First Class Radio Telephone. Results Guaranteed. **ELKINS RADIO SCHOOL**, 2603E Inwood, Dallas, Tex.

**HIGHLY—effective home study review** for FCC commercial phone exams. Free literature! **COOK'S SCHOOL OF ELECTRONICS**, Craigmont, Idaho 83523.

## Electronics

**10 RADIO, TELEVISION DIAGRAMS.** Our choice. \$1.00 Plus 20¢ stamps. **DIAGRAMS**, Box 1151 RE, Manchester, Conn. 06042.

**1N538 "TEXAS" silicon rectifiers . . . 35¢ ea. TESTED-PRV. 200 @ 750MA, 1-cycle surge 15A. MIN. ORDER—\$1.00.** **A. ASHLEY**, 1727 Westgate Ave., Los Angeles 25, Calif.

**GOVERNMENT SURPLUS.** Voltmeters — \$1.05, Freqmeters—\$4.37, Transmitters—\$6.18, Oscilloscopes, Multimeters, Speakers, Parts, Typical Surplus Prices. Exciting Details **FREE.** Write: **ENTERPRISES**, Box 402-F17, Jamaica 30, New York.

**PRINTED CIRCUIT BOARDS.** Hams, Experimenters. Free Catalog. **P/M ELECTRONICS**, Box 6288, Seattle, Wash. 98188.

**CONVERT** any television to sensitive, big-screen oscilloscope. Only minor changes required. No electronic experience necessary. Illustrated plans \$2. **RELCO**, Box 10563, Houston 18, Tex.

**110VAC 60cy** from car generator. Powers lights, refrigerator, transmitter, receiver etc. Simple, easy to convert. Plans, \$2.00. **TEDCO**, Box 12098-A, Houston, Texas 77017.

**DIAGRAMS FOR REPAIRING RADIOS \$1.00.** Television \$2.50. Give make, model. **DIAGRAM SERVICE**, Box 1151 RE, Manchester, Conn.

**TV CAMERAS** and parts at lowest prices. Catalog 10¢. **VANGUARD**, 190-48—99th Ave., Hollis, N.Y. 11423.

**PROFESSIONAL ELECTRONICS PROJECTS —** Organs, Timers, Computers, etc.—\$1 up. Catalog free. **PARKS**, Box 1665, Seattle, Wash. 98125.

**DIAGRAMS: RADIO, \$1.00 T.V. \$2.25, SCHEMATICS,** 618 4th St., Newark, N.J. 07107.

**CB transmitters \$6.00.** Other bargains, catalog 10¢. **VANGUARD**, 190-48 — 99th Ave., Hollis, N.Y. 11423.

**RESISTORS — RETMA Values—1/4W—3¢; 1/2W—4¢; 1W—5¢.** **T. J. SOUND STUDIOS**, 139 Pugsley, Bronx 72, N.Y.

**TRANS-NITION Electronic Ignition parts kit,** Negative ground \$20. Coil, Manual **SPECIAL \$8.50 Manual \$2.** **ANDERSON ENGINEERING**, Wrentham, Mass.

**10 DISTANCE Crystal set plans—25¢; 20 different—50¢.** Catalog. **LABORATORIES**, 1131-B Valota, Redwood City, Calif.

**BEFORE You Buy Receiving Tubes, Test Equipment, Hi-Fi Components, Kits, Parts, etc. . . .** send for your Giant Free Zalytron Current Catalog, featuring all **STANDARD BRAND TUBES** all Brand New Premium Individually Boxed, One Year Guarantee—all at **BIGGEST DISCOUNTS** in America! We serve professional servicemen, hobbyists, experimenters, engineers, technicians. **WHY PAY MORE? ZALYTRON TUBE CORP.**, 461 Jericho Turnpike, Mineola, N. Y.

## General

**AMAZING ELECTRET PLASTIC** has 5000 Volt permanent static charge. Send \$1.00 for sample. **GOOD SALES CO.**, P.O. Box 468, Flemington, N.J.

## Canadians

**GIANT SURPLUS BARGAIN PACKED CATALOGS.** Electronics, Hi-Fi, Shortwave, Amateur, Citizens Radio, Rush \$1.00 (Refunded), **ETCO**, Box 741, Dept. R. Montreal 1, Can.

## SERVICES

**METERS—MULTIMETERS REPAIRED** and calibrated. **BIGELOW ELECTRONICS**, Box 71-B, Bluffton, Ohio.

**TRANSISTORIZED products dealers catalog,** \$1. **INTERMARKET**, CPO 1717, Tokyo, Japan.

**ALL MAKES OF ELECTRICAL INSTRUMENTS AND TESTING** equipment repaired. **HAZELTON INSTRUMENT CO.**, 128 Liberty St., New York, N.Y.

**SPEAKER RECONING.** Satisfaction Guaranteed. **C & M RECONO CO.**, 18 E. Trenton Ave., Morrisville, Pa.

# RAD-TEL'S

## QUALITY

# BRAND NEW TUBE SALE!

LOW, LOW PRICES--COMPARE

UP TO

# 75% OFF\*



\*Manufacturers Suggested List Price

## ONE YEAR GUARANTEE

RAD-TEL WILL REPLACE ANY TUBE THAT DOES NOT GIVE EFFICIENT PERFORMANCE FOR 1 YEAR FROM DATE OF PURCHASE.

## ONE DAY SERVICE OVER 500 TYPES IN STOCK

ORDER TYPES NOT LISTED

• **FREE!** Send For New Tube & Parts Catalog •  
• **FREE!** Send For Trouble Shooting Guide •

### TUBE SUBSTITUTION BOOK



**\$1.25**  
No. 193

- Over 11,000 direct tube substitutes
- Only all-inclusive directory of electron tube equivalents:
  - For USA electron tubes
  - Substitutes for foreign tubes
  - Picture tubes, newer models
  - Picture tubes, older models
  - transistor replacements
  - Army-Navy, V.T. substitutes



**CHEATER CORD** Easy to work on set while panel is off.  
6 ft., No. 154..... **29¢** ea. Lots of 3—25¢ ea.

**RAD-TEL TUBE CO.** TV, RADIO AND HI-FI  
DEPT. RE 55 CHAMBERS STREET, NEWARK, NEW JERSEY 07105

TERMS: 25% deposit must accompany all orders, balance C.O.D. Orders under \$5. add \$1 handling charge plus postage. Orders over \$5: plus postage. Approx. 8 tubes per 1 lb. Subject to prior sale. No C.O.D.'s outside continental U.S.A.

Fast, Dependable service — Selling direct by mail for over 16 years

RAD-TEL Tube Co. Total Tubes \$ \_\_\_\_\_  
DEPT. RE Total Part(s) \$ \_\_\_\_\_  
55 Chambers Street Postage \$ \_\_\_\_\_  
Newark, New Jersey 07105 Grand Total \$ \_\_\_\_\_

ENCLOSED IS \$ \_\_\_\_\_ Please rush order.

**SEND:** \_\_\_\_\_ TUBE SUBSTITUTION BOOK, No. 193 @ 1.25 EACH  
Cheater Cord 29c ea. Lots of 3 - 25c ea. #154

Orders under \$5.00 - Add \$1.00 handling charge - plus postage.

**FREE!**  Send FREE Tube and Parts Catalog  
 Send FREE Trouble Shooting Guide

NAME \_\_\_\_\_

ADDRESS \_\_\_\_\_

CITY \_\_\_\_\_ ZONE \_\_\_\_\_ STATE \_\_\_\_\_

### EACH TUBE ATTRACTIVELY BOXED & BRANDED RAD-TEL

Qty.	Type	Price	Qty.	Type	Price	Qty.	Type	Price	Qty.	Type	Price
—	0Z4	.79	—	6AU8	.87	—	6K6	.63	—	12CU5	.58
—	1AX2	.62	—	6AV6	.41	—	6S4	.52	—	12CU6	1.06
—	1B3	.79	—	6AW8	.90	—	6SA7GT	.99	—	12CX6	.54
—	1DN5	.55	—	6AX4	.66	—	6SH7	1.02	—	12D4	.69
—	1G3	.79	—	6AX5	.74	—	6SJ7	.88	—	12DE8	.83
—	1J3	.79	—	6BA6	.50	—	6SK7GT	.95	—	12DL8	.88
—	1K3	.79	—	6BC5	.61	—	6SL7GT	.84	—	12DQ6	1.04
—	1R5	.77	—	6BC8	1.04	—	6SN7	.65	—	12DS7	.84
—	1S5	.75	—	6BE6	.55	—	6SQ7GT	.94	—	12DT5	.76
—	1T4	.72	—	6BF5	.90	—	6T4	.99	—	12DT7	.79
—	1U5	.65	—	6BF6	.44	—	6T8	.85	—	12DT8	.78
—	1X2B	.82	—	6BG6	1.70	—	6U8	.83	—	12DW8	.89
—	2AF4	.96	—	6BH8	.98	—	6V6GT	.54	—	12DZ6	.62
—	3AL5	.46	—	6BJ6	.65	—	6W4	.61	—	12E05	.62
—	3AU6	.54	—	6BJ7	.79	—	6W6	.71	—	12EG6	.62
—	3AV6	.42	—	6BK7	.85	—	6X4	.41	—	12EK6	.62
—	3BC5	.63	—	6BL7	1.09	—	6X8	.80	—	12EL6	.50
—	3BN6	.75	—	6BN6	.74	—	7A8	.68	—	12EZ6	.57
—	3BU8	.78	—	6BQ6	1.12	—	7AU7	.65	—	12F8	.66
—	3BY6	.58	—	6BQ7	1.00	—	7EY6	.75	—	12FA6	.79
—	3BZ6	.56	—	6BU8	.70	—	7Y4	.69	—	12FM6	.50
—	3CB6	.56	—	6BX7	1.11	—	8AU8	.90	—	12FR8	.97
—	3CS6	.58	—	6BZ6	.55	—	8AW8	.93	—	12FX8	.90
—	3DG4	.85	—	6BZ7	1.03	—	8BQ5	.60	—	12GC6	1.06
—	3DK6	.60	—	6C4	.45	—	8C7	.63	—	12J8	.84
—	3DT6	.54	—	6CB6	.55	—	8CM7	.70	—	12K5	.75
—	3GK5	.99	—	6CD6	1.51	—	8CN7	.97	—	12L6	.73
—	3Q4	.63	—	6CG7	.61	—	8CS7	.74	—	12SF7	.69
—	3S4	.75	—	6CG8	.80	—	8EB8	.94	—	12SK7GT	.95
—	3Y4	.63	—	6CL8	.79	—	8F7	.56	—	12SL7	.80
—	4BQ7	1.01	—	6CM7	.69	—	9CL8	.79	—	12SN7	.67
—	4CS6	.61	—	6CN7	.70	—	11CY7	.75	—	12SQ7GT	.91
—	4DT6	.55	—	6CQ8	.92	—	12A4	.60	—	12U7	.62
—	4GM6	.60	—	6CR6	.60	—	12AB5	.60	—	12V6	.63
—	5AM8	.79	—	6CS6	.57	—	12AC6	.55	—	12W6	.71
—	5AN8	.90	—	6CS7	.69	—	12AD6	.57	—	12X4	.47

### RAD-TEL TUBE CO. NOT AFFILIATED WITH ANY OTHER MAIL ORDER TUBE COMPANY

—	5AQ5	.54	—	6CU5	.58	—	12AE6	.50	—	17AX4	.67
—	5AT8	.83	—	6CU6	1.08	—	12AE7	.94	—	17DQ6	1.06
—	5BK7	.86	—	6CY5	.70	—	12AF3	.73	—	18FW6	.49
—	5BQ7	1.01	—	6CY7	.71	—	12AF6	.67	—	18FX6	.53
—	5BR8	.83	—	6DA4	.68	—	12AJ6	.62	—	18FY6	.50
—	5CG8	.81	—	6DE6	.61	—	12AL5	.47	—	19AU4	.87
—	5CL8	.76	—	6DG6	.62	—	12AL8	.95	—	19B66	1.39
—	5CQ8	.84	—	6DJ8	1.21	—	12AQ5	.60	—	19EA8	.79
—	5EA8	.80	—	6DK6	.59	—	12AT6	.50	—	19T8	.85
—	5EU8	.80	—	6DN6	1.55	—	12AT7	.76	—	21EX6	1.49
—	5I6	.72	—	6DQ6	1.10	—	12AU6	.51	—	25AX4	.70
—	5T8	.86	—	6DT5	.81	—	12AU7	.61	—	25C5	.53
—	5U4	.60	—	6DT6	.53	—	12AV6	.41	—	25CA5	.59
—	5U8	.84	—	6DT8	.94	—	12AV7	.82	—	25CD6	1.52
—	5V6	.56	—	6EA8	.79	—	12AX4	.67	—	25CU6	1.11
—	5X8	.82	—	6EB5	.73	—	12AX7	.63	—	25DN6	1.42
—	5Y3	.46	—	6EB8	.94	—	12AY7	1.44	—	25EH5	.55
—	6AB4	.46	—	6EM5	.77	—	12AZ7	.86	—	25L6	.57
—	6AC7	.96	—	6EM7	.82	—	12B4	.68	—	25W4	.68
—	6AF4	1.01	—	6EU8	.79	—	12BD6	.50	—	32ET5	.55
—	6AG5	.70	—	6EV5	.75	—	12BE6	.53	—	35C5	.51
—	6AH4	.81	—	6EW6	.57	—	12BF6	.60	—	35L6	.60
—	6AH6	1.10	—	6EY6	.75	—	12BH7	.77	—	35W4	.42
—	6AK5	.95	—	6FG7	.69	—	12BK5	1.00	—	35Z5	.60
—	6AL5	.47	—	6FV8	.79	—	12BL6	.56	—	36AM3	.36
—	6AM8	.78	—	6GH8	.80	—	12BQ6	1.16	—	50B5	.69
—	6AQ5	.53	—	6GK5	.61	—	12BR7	.74	—	50C5	.53
—	6AS5	.60	—	6GK6	.79	—	12BV7	.76	—	50EH5	.55
—	6AT6	.49	—	6GN8	.94	—	12BY7	.77	—	50L6	.61
—	6AT8	.86	—	6H6	.58	—	12BZ7	.86	—	70L7	.97
—	6AU4	.85	—	6J5GT	.51	—	12CN5	.56	—	117Z3	.85
—	6AU6	.52	—	6J6	.71	—	12CR6	.67	—	807	.75

# DOUBLE BONUS SALE

**FREE \$25.00 BONUS #1** WORTH OF **★ TRANSISTORS ★ DIODES**  
**★ RECTIFIERS ★ COILS**  
**★ RESISTORS ★ KNOBS**  
**★ CONDENSERS ★ ETC.**  
 Add 25¢ for handling

**FREE \$1.00 BONUS #2** PLUS **CHOOSE ANY \$1.00 ITEM LISTED BELOW FREE**  
 FREE POLY PAK

**BOTH BONUS #1 AND #2 FREE WITH ANY \$10.00 ORDER**

## WORLD'S MOST POPULAR \$1 PARTS PAKS

- INFRA-RED PHOTO DETECTOR TRANSDUCER ...\$1
- INFRA-RED PARABOLIC REFLECTOR & FILTER ...\$1
- 30 PRECISION RESISTORS, 1/2, 1, 2W, 1% ...\$1
- 5 TANTALUM ELECTROLYTICS, only 1/4x1/4" sizes \$1
- 20 'CORNING' LOW NOISE RESIST'S, 1/2, 1, 2W \$1
- 300-FT. HOOKUP WIRE, asst colors, sizes ...\$1
- 50 ALLEN BRADLEY L-WATT'S, resistors, 5% too \$1
- 60 TUBULAR CONDENSERS, to .5mf to 1KV ...\$1
- 40 DISC CONDENSERS, 27mmf to .05mf to 1KV \$1
- 60 TUBE SOCKETS, receptacles, audio, etc ...\$1
- 10 PANEL SWITCHES, rotary-micro-slide-power \$1
- 10 TRANSISTOR SOCKETS for pnp-npn transistors \$1
- 30 POWER RESISTORS, to 50W, to 24 Kohms ...\$1
- 50 MICA CAPACITORS, to .01mf, switches too ...\$1
- 10 VOLUME CONTROLS to 1 meg, silver too ...\$1
- 50 RADIO & TV KNOBS, asst. colors, styles ...\$1
- 10 TRANSISTOR ELECTROLYTICS, 10 to 100mf \$1
- \$25 RADIO-TV SURPRISE, wide variety ...\$1
- 50 COILS & CHOKES, rf-if, osc-peaking-etc ...\$1
- 35 ALLEN BRADLEY TWO WATERS, 5% too ...\$1
- 100 ASST. HALF WATT RESISTORS, 5% too ...\$1
- 60 HI-Q RESISTORS, 1/2, 1, 2W to 1 meg, 5% too \$1
- 10 PHONO PLUG-N-JACK SETS, tuners-amps ...\$1
- 50 TERMINAL STRIPS, asst 1-to-10 lug types ...\$1
- 60 CERAMIC CONDENSERS, discs, npo's, to .05mf \$1
- 4 TRANSISTOR TRANSFORMERS, worth \$25 ...\$1
- 40 WORLD'S SMALLEST RESIST, 5% too, 1/10W \$1
- 40 SUBMINIATURE COND., to .05mf, ceramf too \$1
- 10 'MICRO' SNAP SWITCHES, 115vac, 15amp ...\$1
- 3 'TINY' V. CONTROLS, w/sw. 2K, .5meg, 1meg \$1
- 10 'TINY' TRANSFORMERS, asst. worth \$25 ...\$1
- 2 VIBRATOR TRNSFMRS, 12V. to 200V. @ 55MA \$1
- 25 'CERAFIL' CONDENSERS, ultra-tiny to .1mf ...\$1

## FACTORY TESTED SEMI-KON-DUCTORS

- 2 150mc 'MESA' TRANSTRS, silicon, npn, 2N703 \$1
- 2 'TINY' 20-WATT TRANSTRS, TO5, 2N1038, pnp \$1
- 1 3N35 TETRODE 150mc TRANS STOR, silicon ...\$1
- 5 SUN BATTERIES TO 1 1/2" sizes, lite sensitive \$1
- 3 2N255 PWR TRANS STORS, or equal, TO3 case \$1
- 2 3-AMP 1000 PIV S L'CON RECT'FIERS, stud ...\$1
- 1 2-AMP 1500 PIV S L'CON RECT FIER ...\$1
- 30 'KL-P-IN' D.OD'S, like 1N82 of CBS ...\$1
- 25 SEMI-KON-DUCTORS: transistors, diodes, rect. \$1
- 2 40-WATT TRANS STORS, 2N174 type, TO36 ...\$1
- 2-15amp 100 PIV AXIAL LEAD RECT'FIERS ...\$1
- 3 ONE WATT ZENERS 0V, gold, axial ...\$1
- 5 GENERAL ELECTRIC 2N107 PNP TRANS:STORS \$1
- 4 GENERAL ELECTRIC 2N 170 RF NPN TRANSISTRS \$1
- 1 HOFFMAN SATELITE S L'CON SUN CELL, 3/8x1" \$1
- 15 UPRIGHT S L'CON D.OD'S, worth \$40 ...\$1
- 2 'MESA' 4-WATT TRANSTRS, npn, silicon, TO5 \$1
- 4 2N35 NPN TRANS STORS, TO22 case ...\$1
- 6 TRANS STOR RADIO SET, osc-if-driver, p-p ...\$1
- 2-25-AMP S L'CON STUD RECT FIERs ...\$1
- 3 40-WATT POWER TRANS STORS, threaded case \$1
- 2 500MC 'MESA' TRANS STORS, pnp, TO18 case \$1
- 1 20-AMP S L'CON CONTROLLED RECT'FIER \$1
- 1 85W S L'CON PWR TRANSTR, npn, like 2N1212 \$1
- 10 2-AMP S L'CON POWER RECT'FIERS, stud ...\$1
- 2 TRANS:TRON 1N429 ZENER REFERENCES ...\$1
- SILICON PLANARS: 2N497, 2N498, each ...\$1
- 'TEXAS' 20W, TO5 CASE TRANSTR, with stud \$1
- 20 TOP HAT RECT.FIERS, 750 mil, silicon ...\$1
- 10-WATT ZENER DIODE, choose 12, 24, 42, 80V \$1
- 2-2-AMP SCR S L'CON CONTRLD RECTIFIER ...\$1
- 4 2N219 TRANS STORS, mixer-conv, TO22 ...\$1
- 5 2N155 TYPE POWER TRANS STORS, TO3 case \$1
- 10 PHILCO 30mc TRANS:STORS, TO1, pnp ...\$1
- 4 TEXAS INSTR. S L'CON TRANSSTRS, pnp, TO22 \$1
- 4 CK721 TRANSSTRS in new aluminum case, pnp \$1
- 4 S L'CON NPN 2N333 TO5 TRANSISTORS ...\$1
- 4 SUBMINIATURE 2N131 TRANSSTRS, rf-if, pnp \$1
- 25 'EPOXY' SILICON DIODES, untested ...\$1
- 10 SWITCHING TRANSSTRS, npn, 2N440 equals \$1
- 2 CB5 35W PWR TRANSTRS, 2N1434, pnp, stud \$1
- 10 FAMOUS CK722 TRANSISTORS, pnp ...\$1
- 15 PNP TRANSISTORS, asst types and cases ...\$1
- 15 NPN TRANSISTORS, asst types and cases ...\$1
- 5 100mc SB-100 TYPE TRANSISTORS, TO1 case \$1
- 15 CB5 GERMANIUM DIODES, 1N34 equals ...\$1
- 2-2N341 NPN SILICON TRANSISTORS, 1 watt \$1
- 3 CB5 20-WATT TRANSTRS, pnp, stud, 2N1320 \$1
- 3 CB5 20-WATT TRANSTRS, npn, stud, 2N1321 \$1
- 25 TRANSISTORS, pnp 'n' npn's, TO5 cases ...\$1

## TEXAS INSTRUMENT

### 150 WATT TRANSISTOR

- Ignition • TO3 Case • Switching • PNP \$1.47
- 2N1046\*  2N1907\*  2N5114\*\* \$1 EA.
- \*Over 15 mc. \*\*25 amp

## SILICON POWER DIODE STUDS

AmpsVolts Sale	AmpsVolts Sale	AmpsVolts Sale
6 200 \$ .37	12 50 \$ .49	25 50 \$ .99
6 400 .59	12 100 .69	25 100 1.29
6 600 .69	12 200 .89	25 200 1.60
6 800 .89	12 300 1.19	25 300 1.75
6 1000 .95	12 400 1.37	25 400 1.95

### 85 WATT "MESA" TRANSISTOR \$1

SILICON NPN 2N424

10¢ FOR OUR "SPRING" BARGAIN CATALOG ON:  
 Semiconductors  Poly Paks  Parts

## POLY PAKS

TERMS: send check, money order, include postage—47¢, w/ per pak 1 lb. Rated, net 30 days. CODs 25%

P.O. BOX 942R  
 SO. LYNNFIELD, MASS.  
 "PAK-KING" OF THE WORLD

## TRANSITRON SCRs\*

TESTED SILICON CONTROLLED RECTIFIERS

BRAND	PRV	5 AMP	10 AMP	25 AMP
NEW	50	1.00	1.25	2.50
LOWEST	100	1.50	1.95	2.95
PRICES	150	1.75	2.25	3.50
	200	1.95	2.50	3.45
	250	2.25	2.95	3.75
	300	2.69	3.15	3.75
	350	2.95	3.50	4.25
	400	—	3.95	4.25

\*See ELECTRONICS WORLD magazine, Oct. 1963 for uses 'n' hookup

# ADVERTISING INDEX

American Elite Co. ....	Cover 3
Amperex Electronics Corp. ....	Cover 2
Anglo American Acoustics Ltd. ....	106
ATR Electronics Inc. ....	14
Barry Electronics Corp. ....	102
Blonder-Tongue Labs. ....	76
Bozak ....	100
Brooks Radio & TV Corp. ....	88-89
Burstein-Applebee Co. ....	101
Capitol Radio Engineering Institute ....	63-64
Castle TV Tuner Service ....	8
Centralab (Div. of Globe-Union) ....	21
<b>CLASSIFIED</b> ....	<b>104</b>
Cleveland Institute of Electronics ....	72-75
Columbia Stereo Tape Club ....	3
Conar Instruments (Div. of National Radio Institute) ....	92
Cornell Electronics ....	102
Coyne Electronics Institute ....	96
Datak Corp. (The) ....	92
DeVry Technical Institute ....	7
Dymo Industries Inc. ....	69
Eastman Kodak Co. ....	51
Editors & Engineers ....	100
EICO Electronic Instrument Co. ....	22
Electronic Measurement Corp. (EMC) ....	98
Garrard (British Industries Corp.) ....	10
Gernsback Library ....	86, 93
Grantham School of Electronics ....	15
Gregory Electronics Corp. ....	60
Heald's Engineering College ....	102
Heath Co., ....	57, 59, 61
Hitachi Ltd. ....	87
I-Triple-E ....	91
International Crystal Mfg. Co., Inc. ....	83
JFD Electronics Corp. ....	66-67
Jerrold Electronics Co. ....	9
Lafayette Radio ....	92
(P. R.) Mallory Co., Inc. ....	77
Massey Technical Institute ....	101
McGraw Hill Book Co. ....	90
National Radio Institute ....	11-12, 96
National Technical Schools ....	5
Nortronics Co., Inc. ....	70
Olson Electronics Inc. ....	89
Perma-Power Co. ....	80
Philco (Techrep Div) ....	98
Polypaks ....	106
Precision Apparatus Inc. (PACO) ....	79
Progressive "Edu-Kits" Inc. ....	97
Quam-Nichols Co. ....	13
Quietrol Co. ....	100
Rad-Tel Tube Co. ....	105
RCA Institutes ....	52-55
RCA (Test Equipment) ....	16
RCA (Tube Div.) ....	Cover 4
(John F.) Rider Publishing Inc. ....	96
(Howard W.) Sams & Co. ....	17, 82
Scope Inc. ....	78
(H. H.) Scott Inc. ....	60
Score ....	85
Sonotone Corp. ....	94
Sony Superscope ....	20
Sylvania Electronics Instrument Co. ....	71
United Radio ....	95
Weller Electric Co. ....	81
Winegard Co. ....	18-19
<b>MARKET CENTER</b> ....	<b>103</b>
Arlay Electronics	
Bigelow Electronics	
Edmund Scientific Co.	
Fair Radio Sales	
Oelrich Publications	
Relco	
Saxitone (Div. of Commission Electronics)	
Stereo Parti	
Transistors Unlimited Co.	
Valley TV Tuner Service	
Warren Electronic Components	
<b>SCHOOL DIRECTORY</b> ....	<b>99</b>
American Institute of Engineering and Technology	
Central Technical Institute	
Electronic Technical Institute	
Milwaukee School of Engineering	
Northrop Institute of Technology	
Philadelphia Wireless Technical Institute	
Philco Technological Center	
Tri-State College	
Valparaiso Technical Institute	

# GUARANTEED!

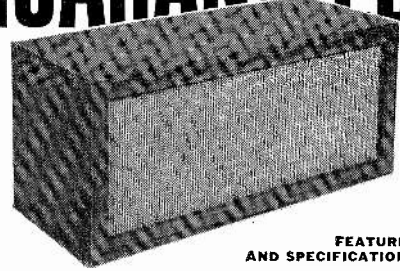

- Outperforms speakers costing five times more
- Three year warranty against manufacturing defects
- Complete satisfaction or your money back

**the KENT** \$19.95  
**all new...all wood**  
**1964 model only**

Anglo American Acoustics Ltd. RE 3-64  
 129 Maryland Ave., Freeport, New York  
 Gentlemen: Enclosed is my check for \$  
 Please ship me \_\_\_\_\_ "Kent" natural wood cabinet speaker(s) at \$19.95 each.  
 I UNDERSTAND THAT THESE SPEAKER SYSTEMS ARE GUARANTEED AND IF I AM NOT COMPLETELY SATISFIED I MAY RETURN FOR A FULL REFUND WITHIN TEN DAYS AFTER RECEIPT.  
 NAME .....  
 ADDRESS .....  
 CITY ..... ZONE ..... STATE .....

**FEATURES AND SPECIFICATIONS**  
 24" wide, 10" high, 9" deep; 8" high compliance woofer; 3" hardened tweeter cone; coaxial wound 1" voice coil; silicone treated edge allows for 3/4" cone displacement; Alcomax III 1-lb. 5oz. magnet; 10,000 gauss flux density; 8 ohm impedance; zero external magnetic field; 40-18,000 cps; up to 30 watts power capacity; 1450 cubic inch volume; Fibreglass acoustic dampening; matched for stereo. Solid wood—not a composite.  
**ORDER NOW** to insure prompt delivery! This remarkable speaker is probably the best investment you'll ever make in hi-fi equipment! Price —\$19.95 F.O.B. Factory. Shipping weight 18 pounds.



FROM THE INVENTORS OF TAPE RECORDING...

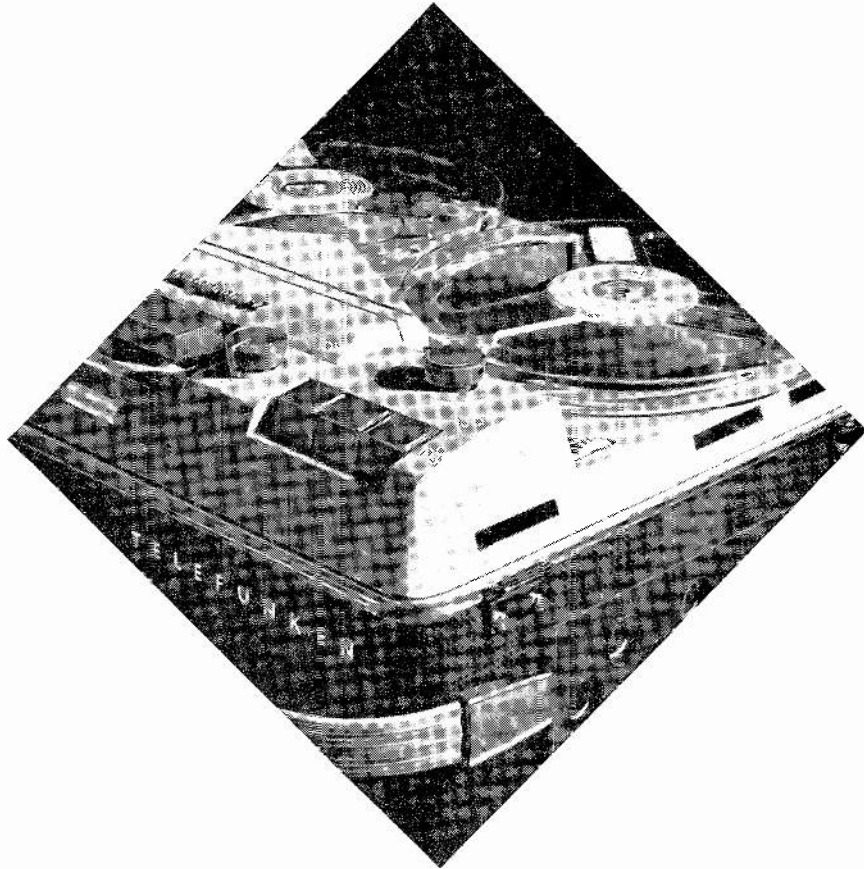

## NOW HEAR THIS:

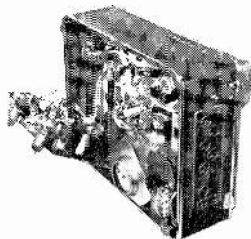

**EASY MAINTENANCE:** Amplifier plate opens on hinge for easy, fast servicing ... one of many special TELEFUNKEN features.

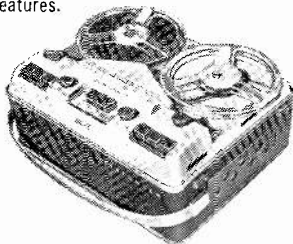

**EASY PORTABILITY:** Weighs only 26½ lbs. including carrying case. Overall dimensions 9" x 11½" x 16".

**The Perfect Tape Recorder...** is instantly revealed...in Telefunken's Magnetophon 97 de Luxe. With push-button ease, this fully self-contained 4-track stereo record/stereo playback system with 2 loudspeakers shows its Telefunken lineage. *No compromises here: are you sure you're not in the concert-hall?*

Now, hear the secrets of its marvelous sound...Telefunken's patented extra-sensitive brake mechanism assures correct tape tension always, protecting heads and tapes. Pre-amplifier equalization automatically optimizes fre-

quency response (30-18,000 cps at 7½ ips, 30-16,000 at 3¾, 30-9,000 at 1⅞). At 7½ ips wow and flutter are less than 0.15%, and signal-to-noise ratio better than 50 db.

Versatility? The Magnetophon 97 de Luxe takes reels to 7", offers sound-on-sound recording, mixing, and transcription from one track to another. You can edit, monitor and use it as a public address system. There's a built-in tape splicing groove and a digital counter—and a full line of accessories. Hear the "touch of perfection" to believe it.



Since 1903

See your TELEFUNKEN DEALER today or write for literature on the complete TELEFUNKEN line of tape recorders to: American Elite, Inc., Dept. 10, 48-50 34th Street, Long Island City 1, N. Y.

# SEE HOW RCA RECEIVING TUBES KEEP GETTING BETTER

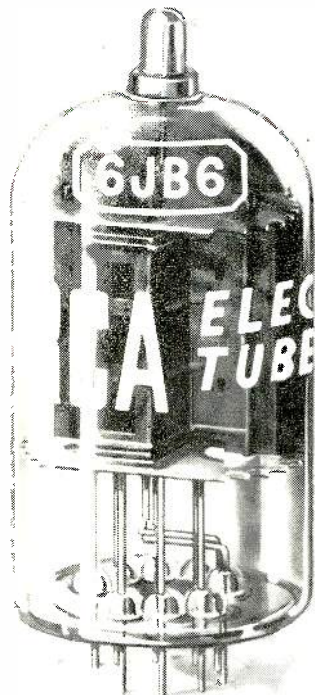

1959—*N-132 Cathode Base Material*  
1960—*S-311 Plate Material*  
1961—*RCA Dark Heater*

...AND 1963

## THE BONDED CATHODE

Ends cathode peeling,  
even after long periods of  
high-temperature, high-  
voltage tube operation.

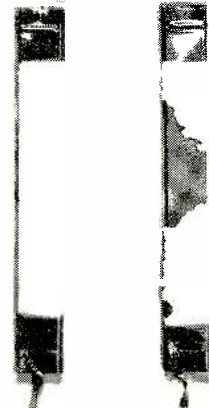

Picture on right is an example of peeling which may occur in non-bonded cathode of a horizontal-deflection-amplifier tube after several hundred hours of operation in a TV receiver.

From RCA research comes another major contribution to electronic performance and reliability: the bonded cathode. Its emissive coating will not peel even after extended service under high-voltage, high-temperature conditions encountered in TV horizontal-deflection-amplifier tubes and damper diodes. Permanent adhesion of the emissive-oxide coating of the RCA bonded cathode improves over-all tube performance and reliability. Here's why:

### THE NEW RCA BONDED CATHODE:

- virtually eliminates peeling of emissive oxide coating
- reduces cathode interface-type impedance effects during life
- reduces grid-to-cathode shorts during life
- improves stability of cathode-to-grid spacing

- improves anode-voltage-per-mil-spacing safety factor in damper diodes
- transmits heat more efficiently and uniformly—thereby providing more uniform cathode-current density

The RCA bonded cathode was first applied with outstanding success in beam power tube types 6DQ6-B and 6JB6 and half-wave vacuum rectifier types 6AU4-GTA and 6AY3. This new development is now being incorporated in a growing number of types where service conditions show a need.

Such RCA developments as the bonded cathode result in reliable components for you to sell and install. Use RCA receiving tubes for all replacements. You have the benefit of continuing tube improvement from the research, design and development facilities of the world's broadest-based electronics company—RCA!

RCA ELECTRONIC COMPONENTS AND DEVICES, HARRISON, N. J.



The Most Trusted Name in Electronics