

**SPECIAL COLOR TV ISSUE**

■ DEC. 50c

# Radio-Electronics

TELEVISION • SERVICING • HIGH FIDELITY

A  
GERNSBACK  
PUBLICATION

HUGO GERNSBACK, Editor-in-chief



## COLOR TV:

What's New In The '64 Sets?  
Antenna and Booster Facts  
Service? It's Not So Hard!  
Color's Past and Future

▲ The RCA CTC-15  
Circuit Features / See p.4



**WORLD'S LARGEST SELLING  
AND WORLD'S NEWEST**

**Hand Size v.o.m's**

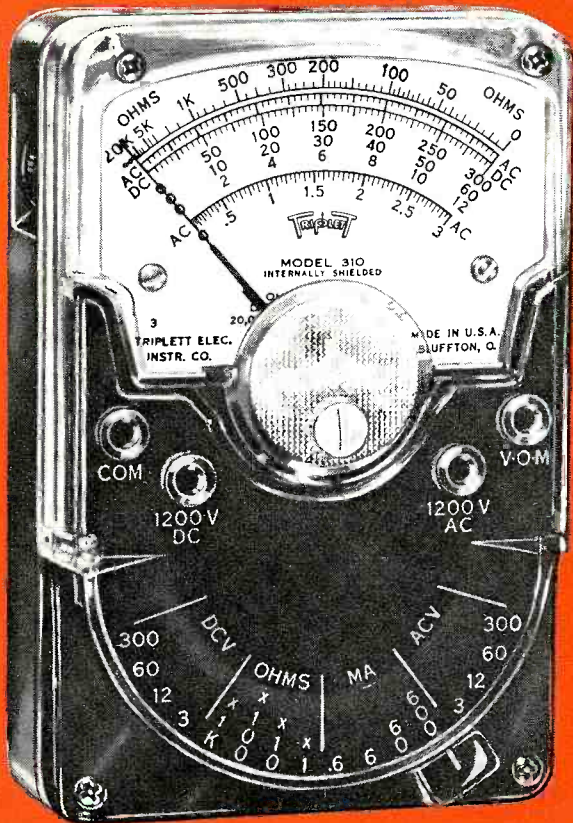

**MODEL 310**  
World's Largest Selling  
Volt-Ohm-Milliammeter

**MODEL 310-C**  
World's Newest  
Volt-Ohm-Milliammeter

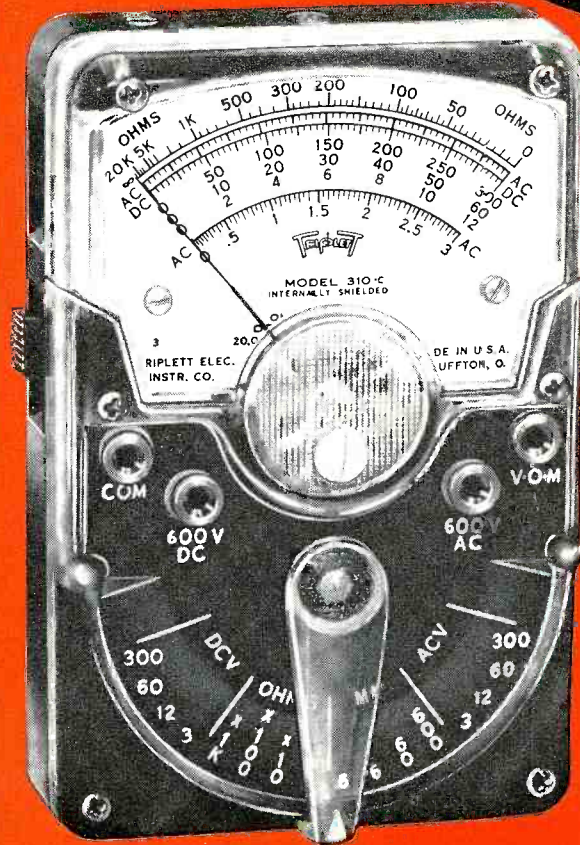

**BOTH TESTERS  
SHOWN  
ACTUAL SIZE**

- 1** HAND SIZE AND LIGHTWEIGHT, but with the features of full-size V-O-M's.
- 2** 20,000 OHMS PER VOLT DC; 5,000 AC (310)—15,000 AC (310-C).
- 3** EXCLUSIVE SINGLE SELECTOR SWITCH speeds circuit and range settings. The first miniature V-O-M's with this exclusive feature for quick, fool-proof selection of all ranges.

SELF-SHIELDED Bar-Ring instrument; permits checking in strong magnetic fields. FITTING INTERCHANGEABLE test prod tip into top of tester makes it the common probe, thereby freeing one hand. UNBREAKABLE plastic meter window. BANANA-TYPE JACKS—positive connection and long life.

Model 310—\$37.50      Model 310-C—\$44.50      Model 369 Leather Case—\$3.20

ALL PRICES ARE SUGGESTED U.S.A. USER NET, SUBJECT TO CHANGE

**THE TRIPLET ELECTRICAL INSTRUMENT COMPANY, BLUFFTON, OHIO**

### 310-C PLUS FEATURES

1. Fully enclosed lever range switch
2. 15,000 Ohms per volt AC (20,000 O/V DC same as 310)
3. Reversing switch for DC measurements

### MODELS 100 AND 100-C

Comprehensive test sets. Model 100 includes: Model 310 V-O-M, Model 10 Clamp-on Ammeter Adapter; Model 101 Line Separator; Model 379 Leather Case; Model 311 leads. (\$67.10 Value Separate Unit Purchase Price.)

MODEL 100—U.S.A. User Net. \$64.50

MODEL 100-C —  
Same as above, but  
with Model 310-C.  
Net. .... \$71.50



**USES UNLIMITED: FIELD ENGINEERS • ELECTRICAL, RADIO, TV, AND APPLIANCE SERVICEMEN • ELECTRICAL CONTRACTORS • FACTORY MAINTENANCE MEN • ELECTRONIC TECHNICIANS • HOME OWNERS, HOBBYISTS**  
THE WORLD'S MOST COMPLETE LINE OF V-O-M's • AVAILABLE FROM YOUR TRIPLET DISTRIBUTOR'S STOCK

# EXPERIMENTER, SWL or RADIO AMATEUR

Select your receiver, transmitter, or VFO from easy-to-build International A O C kits.

Simple step-by-step instructions show you how to assemble factory prewired units. Designed for top performance at a low cost!

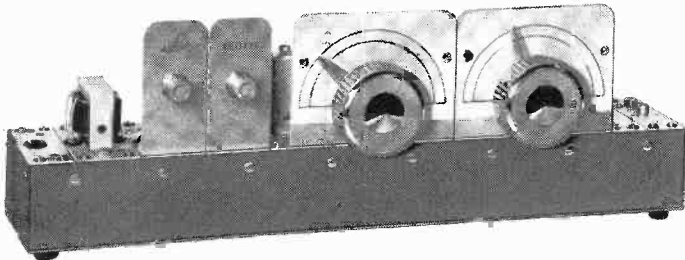

## RECEIVER KITS

This new line of International receiver kits cover a wide range of amateur, citizens band and special frequencies. Designed for AM, CW, or SSB reception, this basic receiver using a superheterodyne circuit\* with regenerative second detector may be expanded to a more elaborate receiver by the addition of other Add-On-Circuits. Sensitivity usable to below 10 microvolts for voice and 1 microvolt for code. Nuvistor rf amplifier, mixer, oscillator, I.F. transformer, detector/1st audio, and power audio amplifier. Tube lineup: 6DS4 nuvistor, 6BE6, 6U8, 6AQ5. Shipping weight: 15 lbs.



## TRANSMITTER KIT

A compact package delivering a plate input of 50 watts for CW operation on 80 or 40 meters. 12BY7 crystal oscillator—6DQ6 power amplifier. Pi-network final. When used with AOR-44 receiver, transmitter operates from receiver power supply. Meter and TR switch.

ACT-50 transmitter kit less power supply and key, but with one 40 meter novice band crystal. Shipping weight: 5 lbs. .....\$35.00

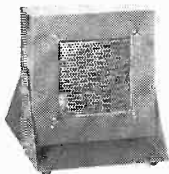

Receiver kit includes 4" speaker and power supply.

Kit	Frequency	Price
AOR-40	Special	\$69.00
AOR-41	150 kc — 450 kc	62.50
AOR-42	2 mc — 6 mc	62.50
AOR-43	6 mc — 18 mc	62.50
AOR-44	80 meter/40 meter	62.50
AOR-45	15 meter/10 meter	62.50
AOR-46	6 meter	66.50
AOR-47	2 meter	66.50
AOR-48	Citizens 27 mc	62.50

\*AOR-41 uses a tuned rf circuit with 6BA6

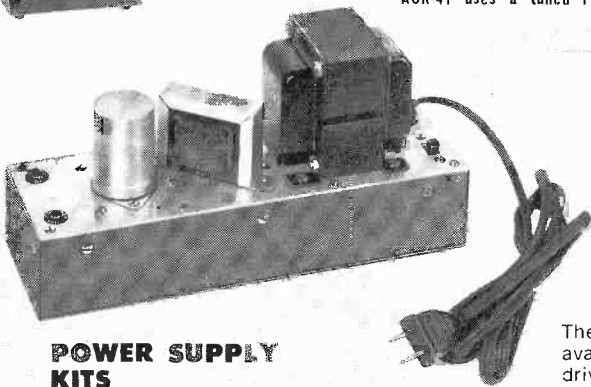

## POWER SUPPLY KITS

**AOP-100** 350 volts, 150 ma intermittent or 100 ma continuous service, 6.3 volts @ 5 amps. Shipping weight: 8 lbs.....\$18.50

**AOP-200** 650 volts, 250 ma intermittent or 200 ma continuous service, 6.3 volts @ 10 amps. Shipping weight: 10 lbs.....\$32.50

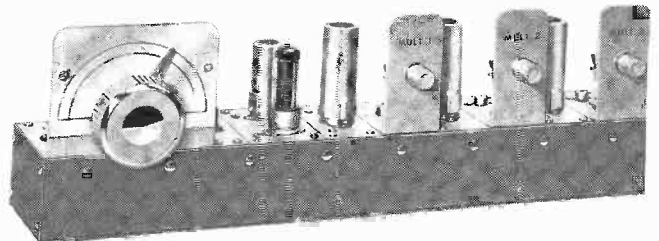

## VFO KITS

The International AOF series of variable frequency oscillator kits is available in three versions. For example, the AOF-91 kit is a complete driver unit to be used with 6 meter and 2 meter transmitters. Approximately .5 watt of power is available on both bands. Tube lineup: 6BH6 oscillator, OB-2 voltage regulator, 12BY7 buffer-amplifier/multiplier. Shipping weight: 5 lbs.

Kit	Frequency	Price
AOF-89	VFO 8 mc — 9 mc and buffer	\$22.00
AOF-90	VFO 8 mc — 9 mc plus buffer multiplier and 6 meter output	29.00
AOF-91	VFO 8 mc — 9 mc plus buffer multiplier, 6 meter/2 meter output	36.00

INTERNATIONAL CRYSTAL MFG. CO., INC.  
18 NORTH LEE, OKLAHOMA CITY, OKLAHOMA

Please ship \_\_\_\_\_

I enclose \$ \_\_\_\_\_ Send free catalog \_\_\_\_\_

Name \_\_\_\_\_ (print)

Address \_\_\_\_\_

City \_\_\_\_\_ Zone \_\_\_\_\_ State \_\_\_\_\_

Include sufficient remittance to cover postage. See shipping weight.

**INTERNATIONAL  
CRYSTAL MFG. CO., INC.**

18 NORTH LEE • OKLAHOMA CITY, OKLAHOMA



# Radio-Electronics

DECEMBER 1963 VOL. XXXIV NO. 12

Over 55 Years of Electronic Publishing

## COLOR TELEVISION

- 28** Replacing Your First Color TV Tube.....Homer L. Davidson  
*Know how it's done before you have to do it*
- 32** 1964 Color TV Roundup.....Wayne Lemons  
*Complete rundown of new sets and circuits*
- 36** Color TV Today and Tomorrow!.....David Lachenbruch  
*How big is color TV? Where does it go from here?*
- 39** Color TV Service Is Simple.....John Fitzgibbon  
*Got preconceived ideas? Don't get a color complex!*
- 42** New Tubes for Color TV.....Peter E. Sutheim  
*Special designs improve performance and reliability*
- 44** Antennas and Boosters for Color TV.....Arthur Cunningham  
*Practical advice for installers and servicers*
- COVER 47** The CTC 15: RCA's Newest Color Chassis (Cover Feature).....A. Hilderbrand  
*An RCA man takes you on a guided tour*
- 53** Service Clinic.....Jack Darr

## SEMI-ANNUAL INDEX

- 91** Index for July—December 1963, inclusive

## EDITORIAL

- 27** Microminiature Color Television.....Hugo Gernsback

## AUDIO-HIGH FIDELITY-STEREO

- 58** Corner Speaker Fits Your Home.....G. A. Briggs  
*Build one to please you acoustically, the lady visually*

## ELECTRONICS

- 38** Zener Diode Bias Supply.....Ronald L. Ives  
*Simple circuit reduces power losses*
- 72** Servicing Sound Movie Projectors.....Jack Darr  
*Part 3: Amplifiers and exciter lamps*
- 84** Fuses—Are They Resistors?.....Frank G. Stiver  
*Actually, yes—in low-voltage circuits*

## GENERAL

- 43** How Well Do You Know Your Units?.....Tom Jaski  
*(Answers are on page 77)*
- 46** Handy Log Scales
- 49** What's Your EQ?  
*(Answers on page 70)*
- 82** Hexnash—Electric Game.....Jack Allison  
*Parlor and party fun for kids (and non-kids, too)*

## RADIO

- 56** Automatic Announcement Reminder and Alarm.....Ronald L. Ives  
*For hams and others bound to sign calls every 10 minutes*
- 65** Peewee Attacks Radio.....Mike Wayne  
*... and graduates from simple TV to fearsome ac-dc 5-tubers*

## TEST INSTRUMENTS

- 50** Color Test Equipment for 1964.....Robert F. Scott  
*A directory of instruments designed especially for color TV service*
- 63** A Hybrid Dc Millivoltmeter.....Bert J. Hill  
*Useful instrument measures tiny potentials*

## THE DEPARTMENTS

- |                           |                                      |                                |                         |
|---------------------------|--------------------------------------|--------------------------------|-------------------------|
| <b>18</b> Correspondence  | <b>115</b> New Patents               | <b>6</b> News Briefs           | <b>105</b> Technotes    |
| <b>116</b> New Books      | <b>98</b> New Products               | <b>108</b> Noteworthy Circuits | <b>113</b> Try This One |
| <b>104</b> New Literature | <b>88</b> New Semiconductors & Tubes | <b>110</b> Technicians' News   | <b>114</b> 50 Years Ago |



Member,  
Institute of High Fidelity  
Radio-Electronics  
is indexed in  
Applied Science  
& Technology Index  
(Formerly  
Industrial Arts Index).

HUGO GERNSBACK, editor-in-chief and publisher. M. HARVEY GERNSBACK, editor. Fred Shunaman, managing editor. Robert F. Scott, W2PWG, technical editor. Peter E. Sutheim, associate editor. Jack Darr, service editor. I. Queen, editorial associate. Frank T. Baker, director advertising sales. John J. Lamson, eastern sales manager. Wm. Lyon McLaughlin, technical illustration director.

GERNSBACK PUBLICATIONS, INC., Editorial, Advertising Offices, 154 W. 14 St., N.Y. 10011. AL 5-7755. Board Chairman Hugo Gernsback, President M. Harvey Gernsback, Secy. G. Aliquo



# A NEW WORLD OF OPPORTUNITY AWAITS YOU WITH N.T.S. ALL-PHASE HOME TRAINING IN ELECTRONICS

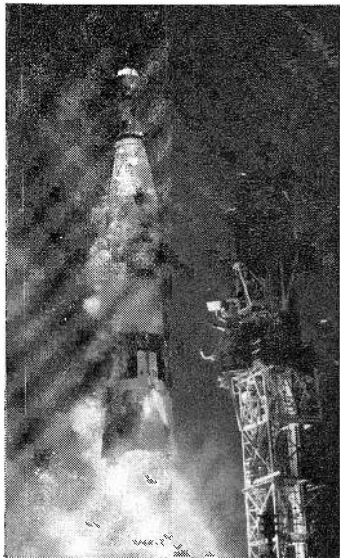

You can install and maintain electronic circuitry in missiles and rockets ... specialize in micro-waves, radar and sonar.

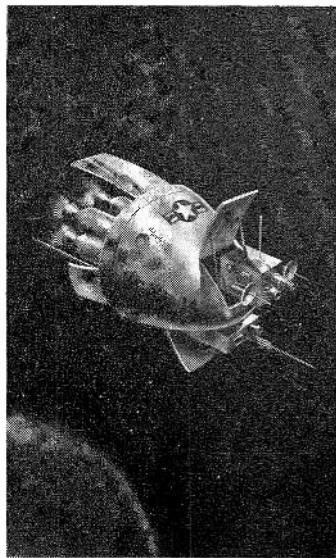

You can succeed in TV-Radio Communications ... prepare for F.C.C. License, service advanced satellites for industry and defense.

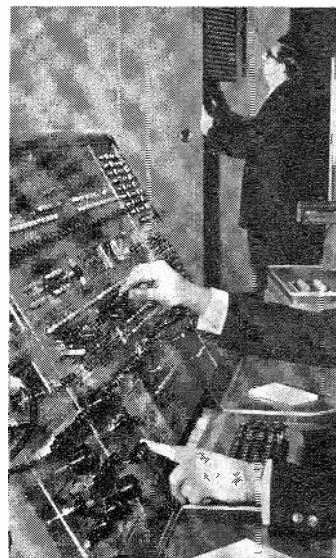

You can service and repair the electronic "brains" of industry — computers, data processing, and other automation equipment.

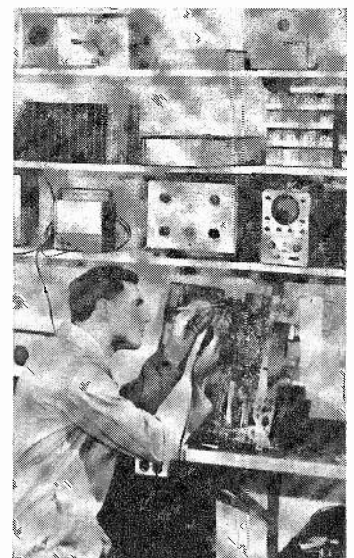

You can become a highly-paid TV-Radio Technician, an electronics field engineer, or succeed in your own sales & service business.

## The N.T.S. Master Course enables you to do more, earn more in ELECTRONICS • TELEVISION • RADIO Yet N.T.S. Training costs no more than other courses far less complete

There's a good reason why N.T.S. Master-Training opens a wide new world of opportunity for you in Electronics, Television, Radio.

Everything you learn, from start to finish, can be applied directly to all phases of the Electronics Industry.

As a result, the N.T.S.-Trained Technician can move ahead faster, in any direction — from TV-Servicing to Radio Communications to Space-Missile Electronics and Automation for industry and defense. You can go wherever pay is highest and opportunity unlimited.

Electronic circuitry, for example, is one of science's miracles that is basic to the entire field of Electronics. It is used in satellites, computers and space capsules as well as in today's television sets and high fidelity equipment. N.T.S. shows you how to service and repair electronic circuitry for all electronic applications.

You work on many practical job projects. You build a short-wave, long-wave superhet receiver, plus a large-screen television set from the ground up. N.T.S. training kits contain all the parts you need ... at no extra cost. (See box at right.) You also receive a professional Multitester to use during training and on the job.

**ONE LOW TUITION.** You need training related to all phases of Electronics. Industry demands it. Only N.T.S. provides it ... in ONE Master Course at ONE low tuition.

### RESIDENT TRAINING AT LOS ANGELES

If you wish to take your Electronics-TV-Radio training in our famous Resident School in Los Angeles — the oldest and largest school of its kind in the world — write for special Resident School catalog and information, or check coupon.



**NATIONAL TECHNICAL SCHOOLS**

WORLD-WIDE TRAINING SINCE 1905  
4000 So. Figueroa St., Los Angeles, Calif 90037



19 BIG KITS  
YOURS TO KEEP



**MAIL COUPON NOW FOR FREE  
BOOK AND ACTUAL LESSON!**

NO OBLIGATION.  
NO SALESMAN WILL CALL.

**NATIONAL TECHNICAL SCHOOLS**

WORLD-WIDE TRAINING SINCE 1905

**National Technical Schools, Dept. RG-123**  
4000 South Figueroa Street, Los Angeles, California 90037

Please Rush FREE Electronics-TV-Radio "Opportunity"  
Book and Actual Lesson. No Salesman Will Call.

Name \_\_\_\_\_ Age \_\_\_\_\_

Address \_\_\_\_\_

City \_\_\_\_\_ Zone \_\_\_\_\_ State \_\_\_\_\_

Check if interested ONLY in Resident Training at L.A.

High school home study courses also offered. Check for free catalog.



# NEWS BRIEFS

## Gold May Superconduct At Lowest Temperatures

Gold may be a superconductor at very low temperatures, according to four physicists of the University of California. They cooled an alloy containing one part of barium to five parts of gold to 0.7° Kelvin (-457.7° F). At that temperature, the alloy became superconductive. The scientists believe that at even lower temperatures pure gold might superconduct, but did not have equipment to reach the necessary low temperature.

The work is part of a research program to determine whether most metals are superconductors. More than half of all metallic elements do lose all resistance when cooled to extremely low temperatures, and the scientists are interested in finding out whether this may not be true of almost all metals.

## New Standard Stations On Lower Frequencies

Standard broadcast stations WWVB and WWVL have been added to the National Bureau of Standards facilities. WWVB at Boulder, Colo., operates at 60 kc and WWVL at 20 kc. At present, these stations are sending only frequency signals, but time signals will be added later. These signals will be much more stable and accurate than those transmitted by high-frequency stations WWV and WWVH.

Accuracy of the high-frequency

signals is affected by changes in the height and density of the ionosphere, since they depend on multiple reflections to reach their destination. In the low- and very-low-frequency regions, the radio waves follow the curvature of the earth. The ionosphere acts as the upper limit of a gigantic duct rather than as a reflector. Thus its variations have little effect on the travel of the waves.

WWVB broadcasts with a radiated power of 5 kw. It is designed to serve the continental United States with more stable coverage at distances up to 2,000 miles, than its sister station WWVL with a radiated power of 1 kw. The 20-kc signal provides intercontinental reception, with a precision of one part in 10 billion in an observing period of approximately one day.

## Photoparametric Diode Detects 10<sup>-9</sup> Watt

A single semiconductor diode, which is both a photodetector and a parametric amplifier, can boost receiver sensitivity of laser space communication and radar systems 100 times. Scientists at the Sperry Rand Research Center (Sudbury, Mass.) have detected and amplified less than one-billionth (10<sup>-9</sup>) watt of light. It is hoped more advanced electronics for the device may make it possible for it to detect and amplify a quintillionth (10<sup>-18</sup>) watt. As a detector of modulated light, it has a frequency

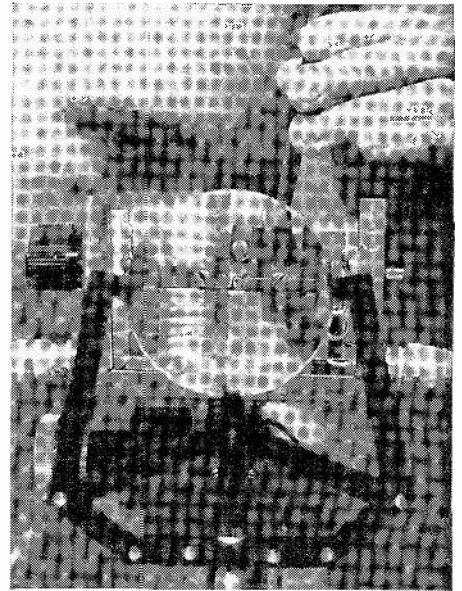

The new photodetector-parametric amplifier is the small white dot framed in the lens. Sperry technician Curtis Potter is aligning the 1/8-inch diameter diode for a test in which a laser fires a beam from the position of your eye into the tiny aperture of the silicon semiconductor device.

range from direct current to about 2 gc.

## New Electronic Pen Improves Oscilloscopes

A new electronic pen that writes a perfect hand at 100 feet a second may greatly improve the frequency range of recording oscilloscopes. Designed by Richard G. Sweet of Stanford University, the new pen squirts fountain-pen ink at the paper in tiny drops only 2/1,000 inch in diameter. With the new pen, signals or electronic impulses that operate as fast as 10,000 times a second can be recorded. Present mechanical stylus equipment used for recording signal impulses on paper can't record oscillations much faster than 100 per sec-

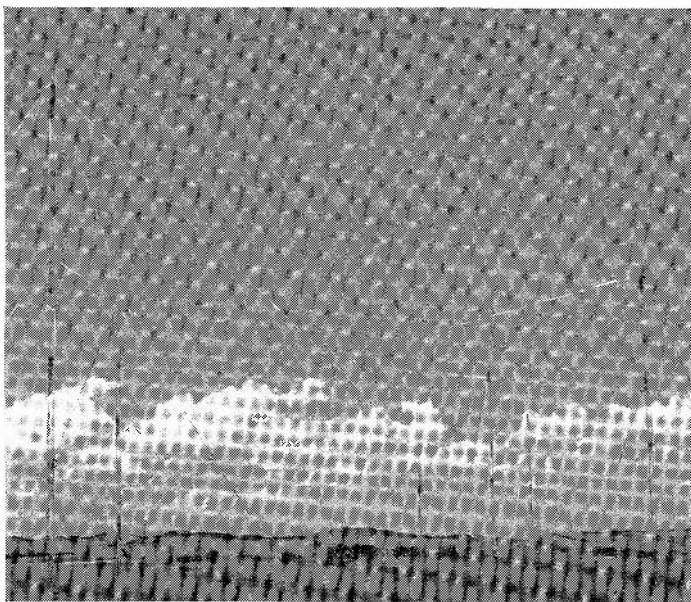

The antenna arrays for WWVB and WWVL. Towers are 400 feet high, arranged in a diamond 1,900 feet long by 750 feet wide.

**Advertising Representatives:** South — J. Sidney Crane & Associates, 22 8th St. N. E., Atlanta, Ga., Tel. TRinity 2-6720. Florida: Neff Associates, 15 Castle Harbor Isle, Fort Lauderdale, Fla., Tel. LOgan 6-5656. West—Husted-Coughlin, Inc., 1830 W. 8th St., Los Angeles, Calif., Tel. 389-3132. 444 Market St., San Francisco, Calif., Tel. GARfield 1-0151. United Kingdom — Publishing & Distributing Co., Ltd., Mitre House, 177 Regent St., London W.1, England.

**Subscription Service:** Address form 3579 and correspondence to Radio-Electronics, Subscriber Service, 154 West 14th St., New York, N. Y. 10011. When requesting a change of address please furnish an address label from a recent issue. Allow one month for change of address.





## Men of most All Ages — from many walks of Life have profited by DeVry Electronics Training

Electronics training has given job opportunities to thousands of men of most ages. Many went on for years looking for the "big break," and never even thought they had a chance in electronics. Then, sooner or later, an item in the paper, a coupon in a magazine, a word of advice from a friend — led them to Electronics. It's an ideal field for the lad just graduated, the man just married, the man looking for a "second chance."

**DeVRY TECH STANDS BACK OF EVERY DeVRY MAN — EVEN AFTER HIS TRAINING!**

Thorough, practical training has made DeVry outstanding for 32 years. Equally important is DeVry Employment Service, which is always available to our trained men. In addition, DeVry Consultation Service helps our men with any technical problem they may face at any time.



### DeVry Technical Institute

Chicago • Toronto

Accredited Member of National Home Study Council

Electronics training has done so much for so many men, and DeVry Tech offers practical programs to suit almost anyone 17-55. You can train in one of our modern laboratories, day or evening. Or, you can keep your present job and train at home — even earn while you learn! No previous technical experience is required to get started. Send for our free booklets today and find out how you, too, may prepare for a bright, more profitable tomorrow — in electronics.



**SEND FOR FREE BOOKLETS**

**DeVRY TECHNICAL INSTITUTE**

4141 Belmont Ave., Chicago 41, Ill., Dept. RE-12-T

Please give me your two free booklets, "Pocket Guide to Real Earnings" and "Electronics in Space Travel"; also include details on how to prepare for

a career in Electronics. I am interested in the following opportunity fields (check one or more):

- |  |   |
|--|---|
| <input type="checkbox"/> Space & Missile Electronics | <input type="checkbox"/> Communications         |
| <input type="checkbox"/> Television and Radio        | <input type="checkbox"/> Computers              |
| <input type="checkbox"/> Microwaves                  | <input type="checkbox"/> Broadcasting           |
| <input type="checkbox"/> Radar                       | <input type="checkbox"/> Industrial Electronics |
| <input type="checkbox"/> Automation Electronics      | <input type="checkbox"/> Electronic Control     |

Name \_\_\_\_\_ Age \_\_\_\_\_

Address \_\_\_\_\_ Apt. \_\_\_\_\_

City \_\_\_\_\_ Zone \_\_\_\_\_ State \_\_\_\_\_

Check here if you are under 16 years of age.

Canadian residents: Write DeVry Tech of Canada, Ltd.  
970 Lawrence Avenue West, Toronto 19, Ontario

2086



# NOW! CASTLE OFFERS YOU THE BIGGEST BARGAIN IN TV TUNER OVERHAULING!

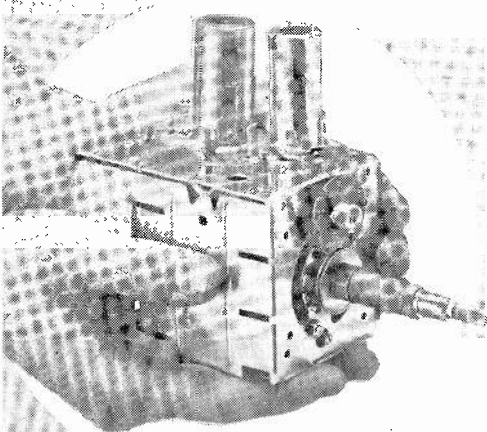

**ALL MAKES  
ALL LABOR  
AND PARTS  
(EXCEPT TUBES)\*  
ONE PRICE**

# 9.95

ONE LOW PRICE INCLUDES ALL UHF, VHF AND UV COMBINATION\* TUNERS

In a decade of experience overhauling TV Tuners of ALL MAKES, Castle has developed new handling and overhauling techniques which give you

## Fast Service

A recent study at our Chicago Plant revealed that of all tuners accepted for overhauling, over 30% were completed and shipped within **Seven Hours**... all others within 24 Hours.

Simply send us your defective tuner complete, include tubes, shield cover and any damaged parts with model number and complaint. 90 Day Warranty.

Exact Replacements are available for tuners unfit for overhaul. As low as \$12.95 exchange. (Replacements are new or rebuilt.)

\*UV combination tuner must be of one piece construction. Separate UHF and VHF tuners must be dismantled and the defective unit only sent in.

Pioneers in TV



Tuner Overhauling

# CASTLE

**TV TUNER SERVICE, INC.**

5715 N. Western Ave., Chicago 45, Illinois  
653 Palisade Blvd., Cliffside Park, N. J.  
Canada: 136 Main St., Toronto 13, Ontario

\*Major Parts are additional in Canada

*Tiny signal-charged ink droplets draw trace on moving paper in new electronic pen.*

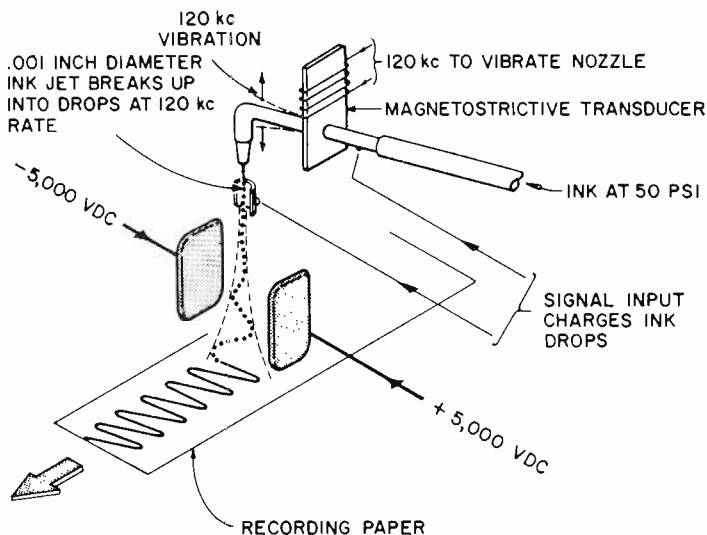

ond. Sweet has compared his new pen with the electron gun of a television tube. Instead of firing a stream of electrons, it shoots a fine stream of ink, .0013 inch in diameter, at the paper. At the same time, the drawn-glass nozzle of the "ink gun" vibrates 100,000 times a second. This breaks the stream into precisely equal blobs, .002 inch in diameter, delivered at the rate of 100,000 per second. As each of the drops is formed, it passes through a cylindrical electrode to which the desired input signal is connected. This gives each drop an electrical charge proportional to the signal at the moment of passage. The stream of drops then passes between deflection plates, held at a fixed voltage. These attract or repel the drops to one side or the other, according to the charge on each drop, causing them to write out the wave pattern of the signal on the paper.

\$30.50 per year, which owners found reasonable. They were also satisfied with the ease of tuning, and 92% of the 17,000 families surveyed believed their color reception to be excellent.

Mansfield estimates that 872,500 color sets were sold from the time color TV started to the end of 1962. They expect that between 500,000 and 750,000 will be sold in 1963, and that the number will increase in 1964, with the number of sets sold likely to run over a million in 1966 or 1967.

### CALENDAR OF EVENTS

**EIA Winter Conference**, Dec. 3-5; Statler Hilton Hotel, Los Angeles, Calif.

**14th National Conference on Vehicular Communications**, Dec. 5-6; Adolphus Hotel, Dallas, Tex.

**1963 Fall Meeting, International Scientific Radio Union (URSI)**, Dec. 9-12; University of Washington, Seattle, Wash.

**10th National Symposium on Reliability and Quality Control**, Jan. 7-9, 1964; Statler Hilton Hotel, Washington, D.C.

**1964 Southwestern Electronic Conference (SWELCON)**, Jan. 12-16, 1964; Baker Hotel, Dallas, Tex.

### Radio Pioneer Dies

Emil J. Simon, whose interest in radio began in 1903, died Sept. 14 at the age of 74. During the 1920's, as founder and president of the Intercity Radio Telegraph Co., he established stations in six cities. He was the inventor of the Simon Radioguide, a 30-lb direction finder used in military and commercial aviation in the 1930's. During World War II, he directed manufacture of military radio equipment for the Radio Navigational Instrument Co. After the war he worked as a consultant.

### Color TV Owners Like Their Sets

Owners of color receivers are enthusiastic about their sets, according to Sylvania Market Research's Frank W. Mansfield. Sylvania's survey discovered that they were not satisfied, however, about the number of quality television programs.

The average repair bill was about

### FM Wireless Microphones Legal

FM wireless microphones have been legalized on the 88-108-mc broadcast band under Part 15.201(c) of the FCC Rules adopted July 1, 1963. They must be type-approved commercial units and shall not be used for two-way communications. Details are covered in Section 15.212.

Emissions must be confined to a 200-kc channel centered on an operating frequency within the band. Field strength shall not exceed 50  $\mu$ v per meter 50 feet or more from the transmitter. Outside the 200-kc channel, field strength must not exceed 40  $\mu$ v at 10 feet or more.

Custom-built telemetering equipment for experimenting in educational institutions is also permitted under 15.201(c) of the Rules. Bandwidth, frequency and field-strength limitations are the same as for FM wireless microphones. The educational institu-

**MICROELECTRONICS** — Medium-size ant dwarfs integrated semiconductor circuit (black square) containing 8 transistors, 12 resistors.  
Photo courtesy of *Business Week*.

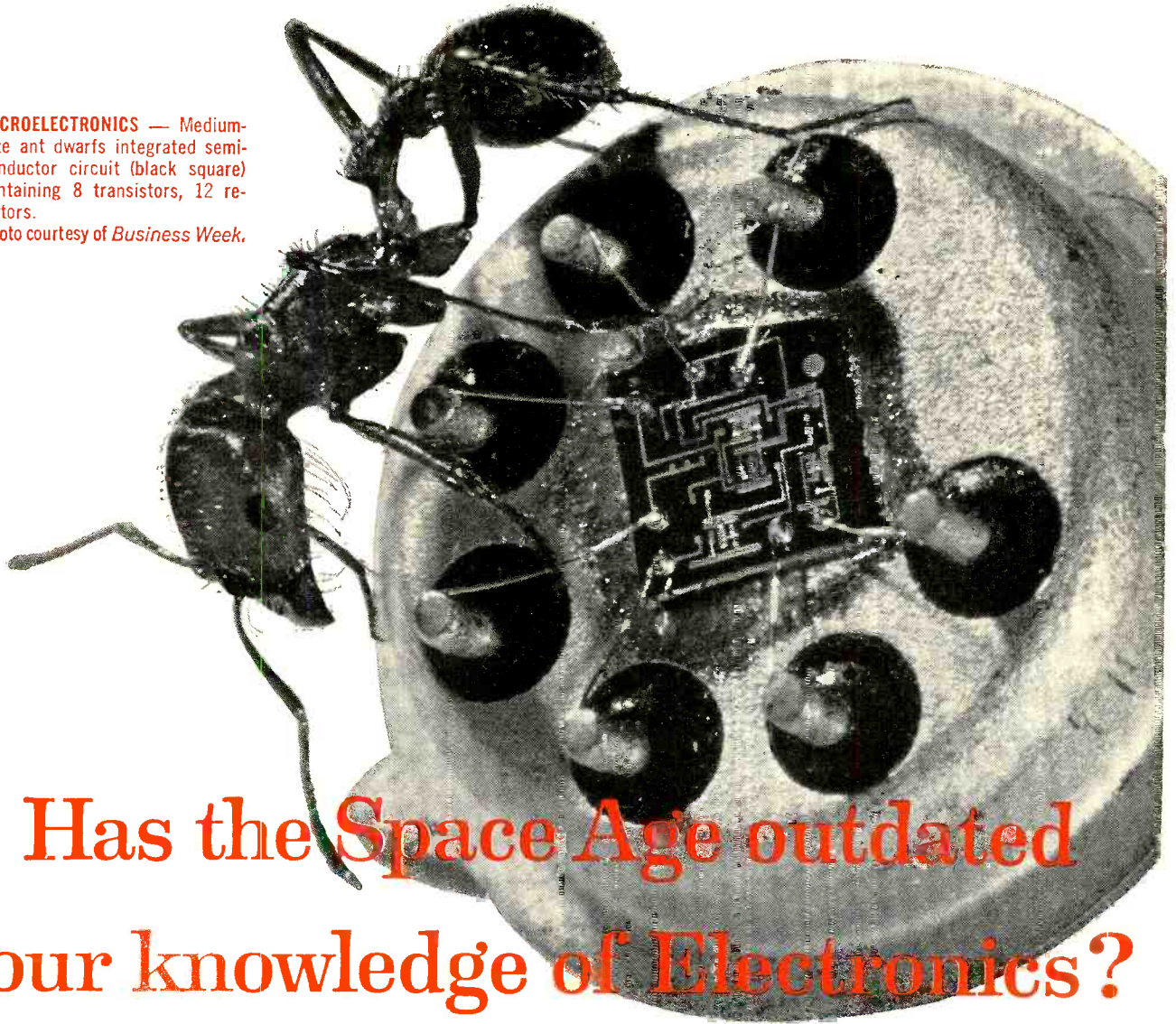

# Has the Space Age outdated your knowledge of Electronics?

The photo above shows just one of the dramatic technical breakthroughs of the space age. Each day new developments are out-dating conventional systems and components—and are out-dating electronics men who can't measure up to more demanding employment requirements. Protect your career by supplementing your education with a CREI Home Study Program. CREI offers you specialized knowledge in every field of advanced electronics including new program in Space Electronics which covers Space Data Systems, Space Tracking Systems, Spacecraft Guidance and Control. If you work in electronics and have a high school education, mail coupon for FREE book or write: Dept. 1412-A, 3224 16th St., N.W., Washington, D. C. 20010.

Accredited Member of the National Home Study Council

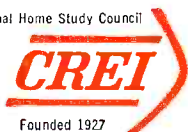

## SEND FOR FREE BOOK



**THE CAPITOL RADIO ENGINEERING INSTITUTE**  
Dept. 1412A, 3224 Sixteenth St., N.W.  
Washington, D. C. 20010

Please send me FREE book describing CREI Home Study Programs including new Program in Space Electronics. I am employed in electronics and have a high school education.

Name \_\_\_\_\_ Age \_\_\_\_\_

Address \_\_\_\_\_

City \_\_\_\_\_ Zone \_\_\_\_\_ State \_\_\_\_\_

Employed by \_\_\_\_\_

Type of Present Work \_\_\_\_\_

Check:  Home Study  Residence School  G. I. Bill

E-3



attend the world's largest  
annual  
electronics  
exposition

from February 7th to 12th, 1964

in Paris, Porte de Versailles

INTERNATIONAL  
EXHIBITION  
OF

# ELECTRONIC

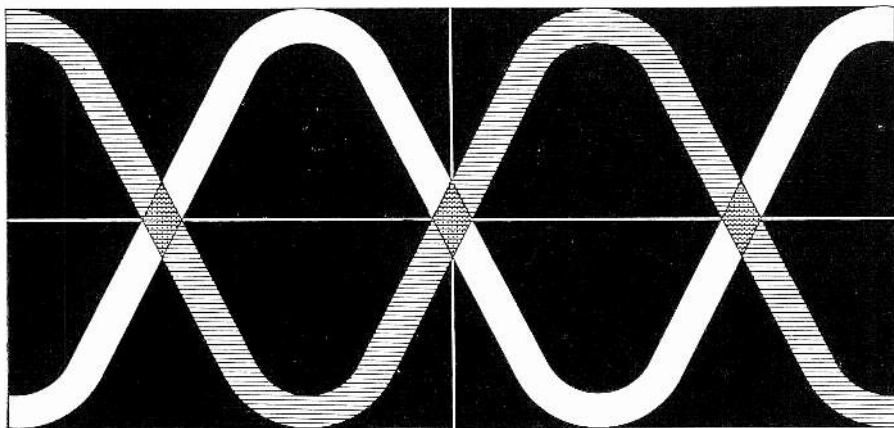

# COMPONENTS

All parts, tubes,  
and semiconductors,  
electro-acoustic  
measuring equipment,  
control apparatus



For  
information  
and literature

**SDSA 23 RUE DE LUBECK  
PARIS 16. Tel: PASy 01-16**

tion must supply the engineer-in-charge of the local FCC office (in advance and in writing) of the date and place where the equipment will be operated, the purpose for which it will be used, and a description of the device including operating frequency, rf power output and antenna. The notice shall be accompanied by a statement, prepared by a qualified technician, certifying that the equipment complies with the technical provisions of Part 15.212.

## More Color Sets

Since the closing date for articles in this issue, three more companies have announced new color models.

A new color chassis by Setchell-Carlson—in several cabinet models—features unitized construction consisting of a master chassis with plug-in subchassis. Its plug-in chroma unit can be removed for servicing and the set will continue to produce a black-and-white picture. All maintenance controls are available from the front. All models have push-pull audio and twin front-mounted speakers.

Andrea has a custom professional component color television set that can be installed in any 30 x 22-inch opening with 25-inch clearance behind the mounting surface. The set has 23 tubes plus picture tube (24 in uhf models) and can be fitted with a remote control.

Sylvania has announced the new 21-inch lowboy, model 21LC3, with a suggested list price of \$529.95.

## Electric Boomerang For Satellite Signals

The quality and quantity of information sent to earth by satellites has been substantially increased by a space communications system developed by Sylvania Electronics Systems. The boomerang is an electronic antenna system that automatically directs its radio signals to any earth station that requests information from the unit. The return signal follows the same path used by the ground station to request the information.

According to Walter Serniuk, director of engineering of Sylvania Electronic Systems, conventional satellite transmission systems must broadcast their signals over a large portion of the earth's surface to communicate with a specific ground station. The new system uses a set of satellite antennas which steer the beams electronically without altering the positions of the antenna or of the satellite. Thus the signals can be directed right at the target, with considerable "power gain." The new system uses tunnel-diode transceivers,

# SIT RIGHT DOWN AND EARN \$600 A MONTH



## ... after you get your FCC License

That's right . . . \$500 . . . \$600 . . . \$700 a month and more awaits the man who has official proof of his electronics skill and knowledge . . . a Commercial FCC License. And the quickest, easiest, most economical way to get your license is Cleveland Institute of Electronics Home Study. Will it work for you? Cleveland Institute is so sure of it they make this exclusive promise: "Should you fail to pass your Commercial FCC License examination after completing one of our licensing programs, we will refund all your tuition payments." The offer is as straightforward as it sounds . . . you get your FCC license or your money back!

You'll be amazed how fast, how easily you can learn electronics with a Cleveland Institute Check-Point Plan of Home Study. Facts and concepts are presented in small, easy-to-understand segments, then reinforced with clear explanations and examples. Through this modern, proven method, you will learn at your own pace . . . and remember what you learn!

So pick the program that fits your career objective, mark your choice on the coupon, and mail it today. We'll

send you, without obligation, complete details on Cleveland Institute home study. Act right now . . . there will never be a better time to start towards a high-paying, interesting job in electronics.

## Cleveland Institute of Electronics

1776 E. 17th Street, Dept. RE-86 Cleveland 14, Ohio



### Mail Coupon TODAY For FREE Catalog

#### Cleveland Institute of Electronics

1776 E. 17th St., Dept. RE-86  
Cleveland 14, Ohio

Please send FREE Career Information prepared to help me get ahead in Electronics, without further obligation.

#### CHECK AREA OF MOST INTEREST—

- |   |  |
|---|--|
| <input type="checkbox"/> Electronics Technology | <input type="checkbox"/> First Class FCC License   |
| <input type="checkbox"/> Industrial Electronics | <input type="checkbox"/> Electronic Communications |
| <input type="checkbox"/> Broadcast Engineering  | <input type="checkbox"/> _____<br>other            |

#### How to Succeed in Electronics

Your present occupation \_\_\_\_\_

Name \_\_\_\_\_ Age \_\_\_\_\_  
(please print)

Address \_\_\_\_\_

City \_\_\_\_\_ Zone \_\_\_\_\_ State \_\_\_\_\_

Approved for Veteran's Training under Korean GI Bill. RE-84



NEW FROM ATR

# ATR

## ALL-TRANSISTOR

MODEL

# 707

## Karadio®

"the oldest name in radio"

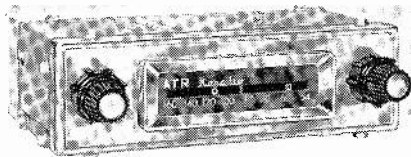

Suggested \$29.95  
Retail Price

... for those who want the finest! Check the features of this all-new, all-transistor Model 707 Karadio by ATR... features galore that make sales easier, keep users happier! Compare... and without hesitation place your order NOW for the new all-transistor ATR Karadio.

- Large easy-to-read illuminated dial.
- Finger-tip tone control to adjust tone as you desire.
- 7-tuned circuits including RF stage to provide maximum sensitivity and selectivity.
- Automatic volume control to keep signals strong and steady.
- Utilizes "solid state" construction employing 7 semiconductors (5 transistors and 2 diodes).
- Superheterodyne circuit.
- 3-Section Super "Magna-Wave" tuner.
- Hand wired. No printed circuitry.
- Has one-piece self-contained chassis for easy installation.
- "Fits-All" universal construction. For use with practically all import and American cars and trucks.
- Fits under-dash or in-dash utilizing standard trim plate kits.
- Comes complete with built-in speaker.
- External speaker jack provided.
- Available for 12-volt negative ground installations only.
- Low battery drain.

Neutral Gray-Tan baked enamel finish. Overall size approximately 5½" deep x 6½" wide x 2" high. Shipping Weight 5 lbs.

SEE YOUR ELECTRONIC PARTS DISTRIBUTOR  
WRITE FACTORY FOR FREE LITERATURE...

**ATR ELECTRONICS, INC.**

Formerly: American Television & Radio Co.



Quality Products Since 1931

ST. PAUL 1, MINNESOTA—U.S.A.

How the signal from the satellite is "boomeranged" back to earth along the same route as the triggering signal is shown in this artist's drawing.

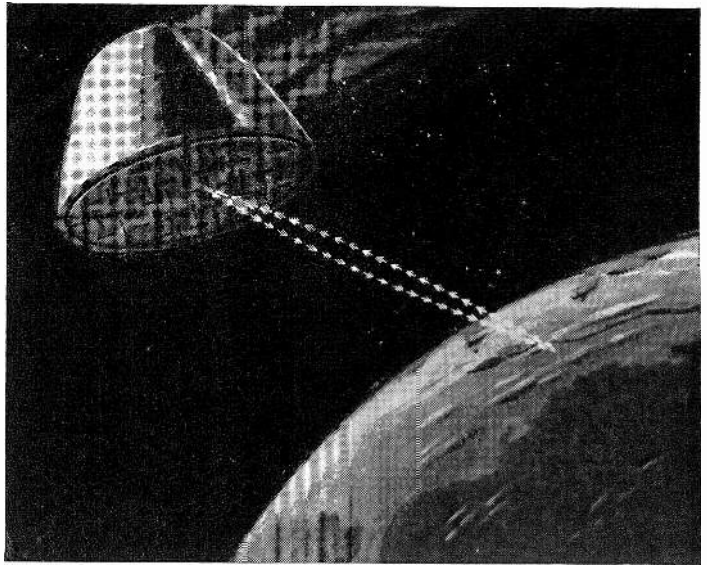

which are about 100 times more resistant to the high energy of the Van Allen belt than transistorized units. The power required is very low, permitting the equipment to function with only 1/20th the number of solar cells required by conventional systems.

A model of the system, working in the S-band (1,550-5,200 mc), has been constructed for the Aeronautical Systems Division of the Air Force Systems Command at Wright-Patterson Air Force Base, Dayton, Ohio.

### Canada Prefers FM To Color TV

The chairman of Canada's Board of Broadcast Governors, Dr. Andrew Steward, told the EIA of Canada that one of CBC's chief goals in 1964 was the expansion of its FM network service. Other aims include new FM (and AM) stations for areas not now covered, and expansion of CBC television.

### Transistors Step Forward With Multiemitter Units

Transistors have made many advances in a field ruled completely by vacuum tubes up to a few years ago, but in one respect have lagged behind. Almost all transistors have been simple triodes. Now Plessey Co. (England) has introduced a transistor with five emitters. Thus we have multielement transistors as well as multielement tubes.

Not only will it be possible to combine more than one circuit with the multielement transistor as with its opposite number in the tube family, but the new transistor can do jobs not easily performed by multielement tubes. For example, one emitter can be used as it would be in a normal transistor. Another emitter can be used in the avalanche mode to behave, in effect, like a Zener diode connected to the base, while a third would

act as a small base input capacitance. The new transistor actually takes over some of the functions of more complex integrated circuits.

### Brief Briefs

New laser achieves a high pulse rate by arranging six lasers around a central axis and firing them in sequence like the barrels of a Gatling gun.

General Electric has announced a new rapid-charge nickel-cadmium battery that can be charged in about one hour as against 15 hours for present types. The new battery is expected to be especially valuable as a power source for portable tools.

No less than 5 Japanese TV receiver manufacturers expect to be in full production with 16-inch color receivers early this winter. Most expect to export color sets to the United States, but they are not sure when.

Lasers, not so long ago the "farthest out" instrumentality in the electronics field, can now be bought from your favorite radio mail-order house. Prices are about \$450 for calcium fluoride laser crystals, \$1,125 for a gallium arsenide injection laser.

Radio WWVH, Maui, Hawaii, has eliminated its 34-minute silence at 1900 UT daily. The silent period from 15 to 19 minutes past each hour is being continued.

IBM scientists report that a new material, europium orthosilicate, is nearly 10 times as effective as previously known materials in rotating the plane of polarization of light when subjected to a magnetic field. This discovery may be very important in such applications as modulating lasers.

END

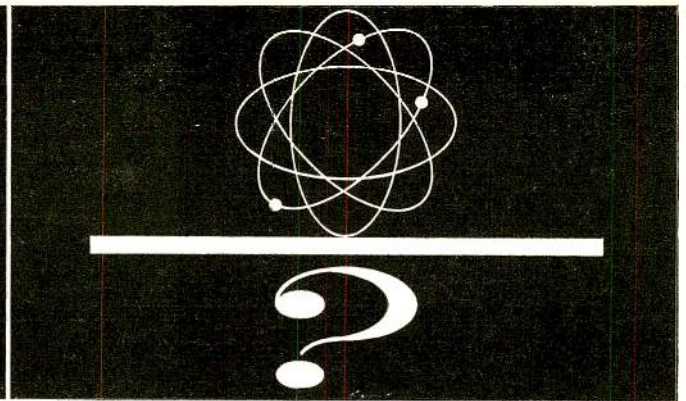
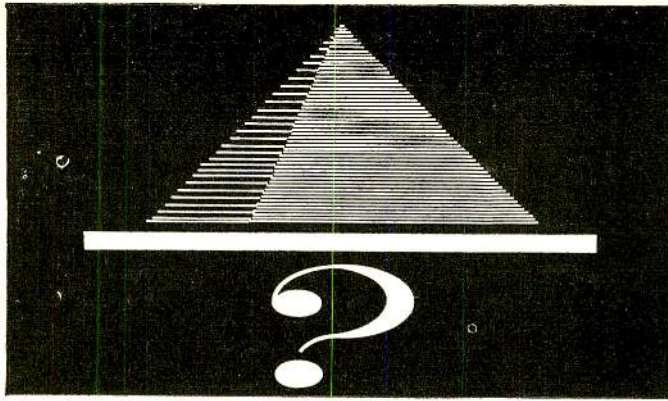

## WHAT IS THE COMMON DENOMINATOR OF AN ANCIENT EGYPTIAN PYRAMID AND A SUCCESSFUL MODERN ELECTRONICS CAREER?

# A STRONG FOUNDATION!

The Egyptian pyramid was built on a strong foundation. *What about your electronics career?* Advancement in electronics depends on a solid understanding of basic principles. If you are handicapped by a poor understanding of these vital "basics," you need training—the *strong foundation training* offered by Grantham School of Electronics.

Beginning at the beginning, Grantham training progresses in a logical, step-by-step manner up through the complex theory of the Missile Age—and all of the math you will need is taught as an integral part of our lessons. Because we present these all-important basic principles with maximum penetration, *you will learn to think and reason electronics* rather than relying on half-understood concepts and rote-memory.

The Grantham program is made up of three consecutive steps, and each completed step increases your value as an electronics man. The following is a "thumb-nail sketch" of the Grantham 3-step program for electronics advancement:

- ▲ Section IA leads to attainment of your First Class FCC License and may be completed in the classroom or through home study.
- ▲ Section IB gives you practical experience on a great variety of "live" electronics equipment in four weeks of intensive, supervised training in the Grantham Student Laboratory.
- ▲ Section II offers Advanced Electronics Training through home study and is designed to assure your advancement after you are on-the-job.

The above program may be taken as a whole, or you may complete only that step which best suits your individual needs!

To obtain full details on Grantham training, fill out and mail the coupon on the right. We will be glad to send you (without charge or obligation) our free 44-page booklet, **CAREERS IN ELECTRONICS**.



**GRANTHAM**  
SCHOOL OF ELECTRONICS

FIVE CONVENIENT TRAINING DIVISIONS:

1505 N. Western Ave., Los Angeles, Calif., 90027  
9320 Long Beach Blvd., South Gate, Calif., 90280  
408 Marion Street, Seattle, Wash., 98104  
3123 Gillham Rd., Kansas City, Mo., 64109  
821 - 19th Street, NW, Washington, D. C., 20006



HO 7-7727  
564-3421  
MA 2-7227  
JE 1-6320  
ST 3-3614

—Mail in envelope or paste on postal card—

To: **GRANTHAM SCHOOL OF ELECTRONICS**

NATIONAL HEADQUARTERS OFFICE

1505 N. WESTERN AVE., LOS ANGELES, CALIF., 90027

Please send me your FREE 44-page booklet,  
"CAREERS IN ELECTRONICS."

Name \_\_\_\_\_ Age \_\_\_\_\_  
(PLEASE PRINT)

Address \_\_\_\_\_

City \_\_\_\_\_

State \_\_\_\_\_

I AM INTERESTED IN:  HOME STUDY  RESIDENT CLASSES 34T



# WHY

## risk your reputation with "just-as-good" capacitors?

When you pay little or no attention to quality in tubular replacement capacitors, you leave yourself wide open for criticism of your work . . . you risk your reputation . . . you stand to lose customers. It just doesn't pay to take a chance on capacitors with unknown or debatable performance records when it's so easy to get guaranteed dependable tubulars from your Sprague distributor!

## There's no "maybe" with these 2 great SPRAGUE DIFILM® TUBULARS!

The ultimate in tubular capacitor construction. Dual dielectric . . . polyester film and special capacitor tissue . . . combines the best features of both. Impregnated with HCX®, an exclusive Sprague synthetic hydrocarbon material which fills every void in the paper, every pinhole in the plastic film *before it solidifies*, resulting in a rock-hard capacitor section . . . there's no oil to leak, no wax to drip.



**DIFILM® BLACK BEAUTY®**  
Molded Tubular Capacitors

The world's most humidity-resistant molded capacitors. Tough, protective outer case of non-flammable molded phenolic . . . cannot be damaged in handling or installation. Designed for 105°C operation with *no voltage derating*. . . will withstand the hottest temperatures to be found in any TV or radio set, even in the most humid climates.



**DIFILM® ORANGE DROP®**  
Dipped Tubular Capacitors

A "must" for applications where only radial-lead capacitors will fit . . . the perfect replacement for dipped capacitors now used in many leading TV sets. Double-dipped in rugged epoxy resin for positive protection against extreme heat and humidity. No other dipped tubular capacitor can match Sprague Orange Drops!

For complete listings, get your copy of Catalog C-615 from your Sprague distributor, or write to Sprague Products Company, 81 Marshall Street, North Adams, Massachusetts.



WORLD'S LARGEST MANUFACTURER OF CAPACITORS

It used to take 2 men to pull  
a color TV set into the shop...

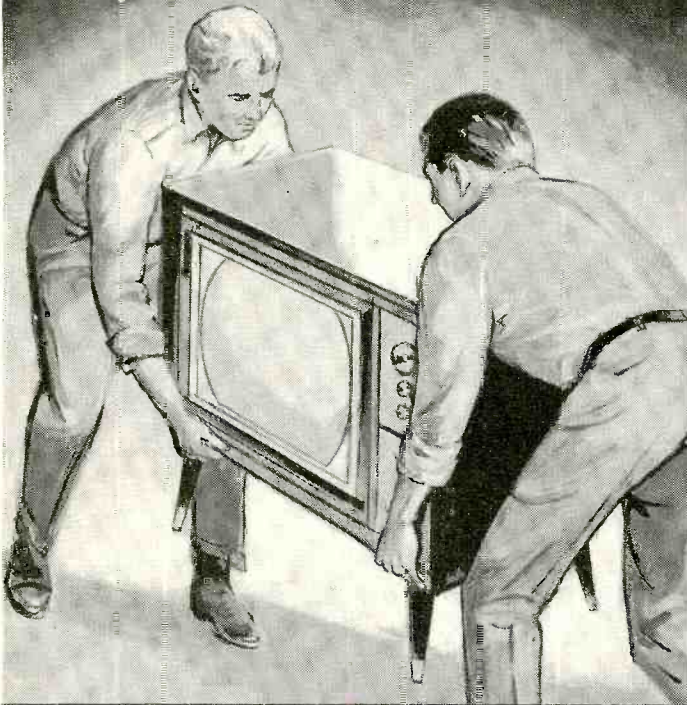

BUT NO MORE

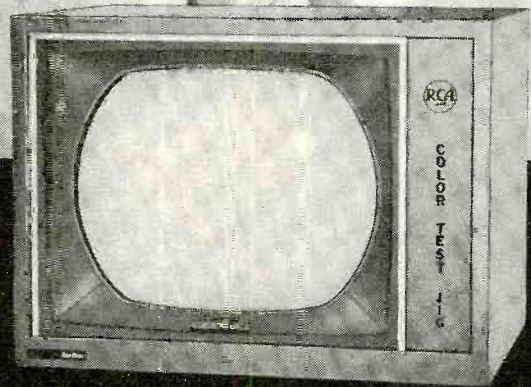

## RCA COLOR TV TEST JIG

Cuts your manhours on Color-TV home service calls

Here is a real "must" for anyone servicing or planning to service color TV sets.

No longer must you send two men to a customer's home to pull in his entire color set. Now, one man can simply remove the chassis and bring it back to your shop for testing, troubleshooting and alignment in your RCA Color TV Test Jig.

Look at some of the extra advantages built into this money-saving unit:

- **Minimizes costly damage claims.** Pulling chassis eliminates possibility of scratching or damaging a customer's cabinet when transporting it to and from his home.
- **Saves time.** Eliminates need to reconverge a customer's set when chassis is returned. Convergence control panel on Test Jig provides static and dynamic convergence for CTC-10, CTC-11 and CTC-12 chassis.
- **Versatile.** Can be used with CTC-4, 5, 7, 9, 10, 11 and 12 chassis.
- **Safe.** Supplied with factory-installed safety glass and kine mask.
- **Complete components kit,** supplied with unit, provides all necessary service components and instructions for installing RCA Color Picture Tube.
- **Professional appearance.** Finish matches that of your other RCA test instruments.

The RCA Color TV Test Jig is available through your Authorized RCA Parts and Accessories Distributor. See him this week to find out how this versatile instrument can help you capitalize on the growing Color TV servicing market.

For information on where you may obtain the RCA Color Test Jig, and for additional specifications, fill out and mail the coupon below.

RCA PARTS AND ACCESSORIES, CAMDEN, N. J.



The Most Trusted Name in Electronics

RCA Parts and Accessories  
P.O. Box 654, Camden, New Jersey

Please send me full specifications on the RCA Color TV Test Jig, and the name of the nearest distributor where I may obtain it.

Name \_\_\_\_\_

Company or Service Shop \_\_\_\_\_

Address \_\_\_\_\_

City \_\_\_\_\_ Zone \_\_\_\_\_ State \_\_\_\_\_



**AT THE MOMENT OF TRUTH -- THE PICTURE IS THE PROOF!**

**THE JFD LOG-PERIODIC LPV IS BEST FOR COLOR, BLACK AND WHITE TV, AND FM STEREO.**

Model LPV11 (illustrated)

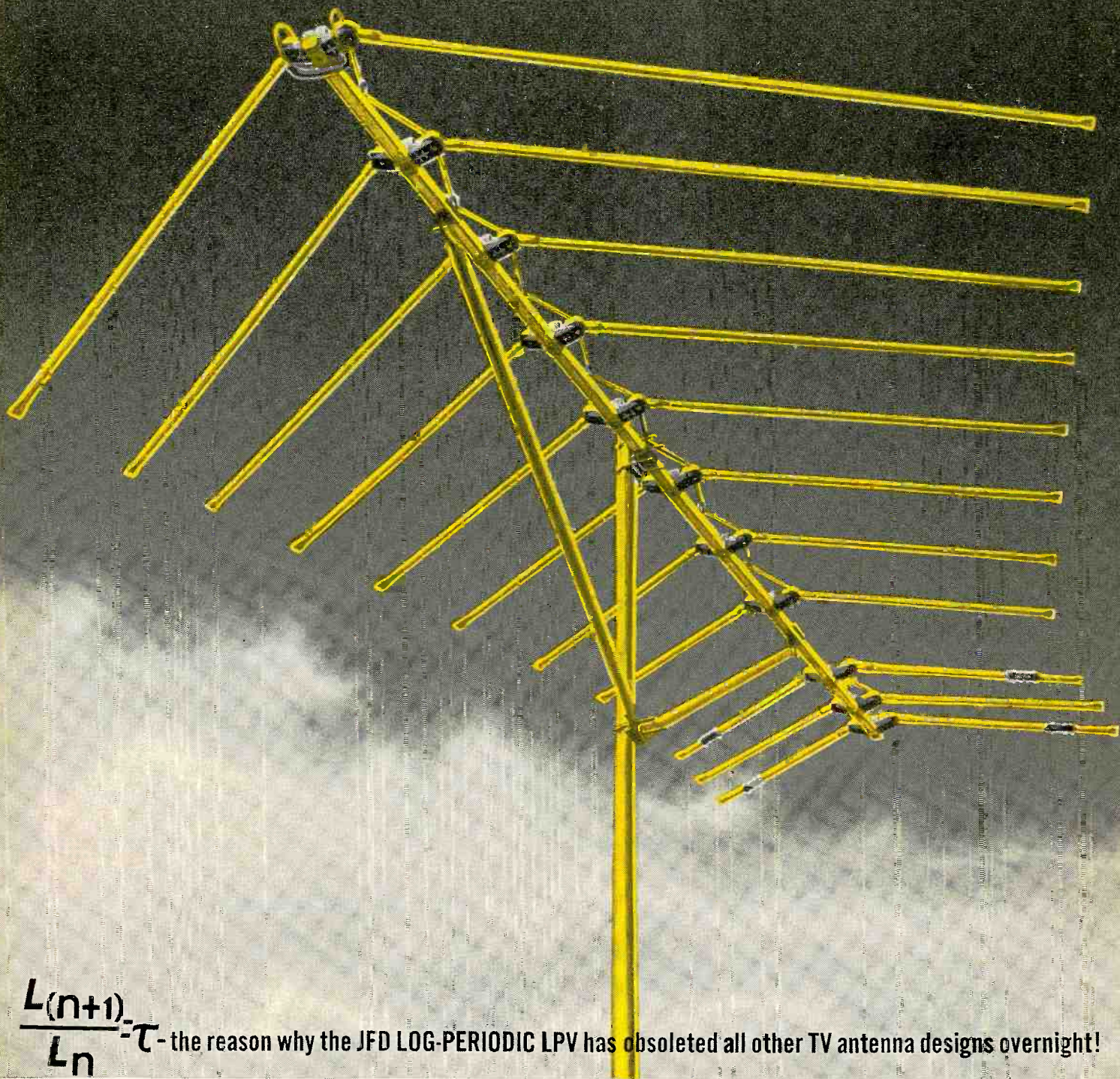

$\frac{L_{(n+1)}}{L_n} = \tau$  - the reason why the JFD LOG-PERIODIC LPV has obsoleted all other TV antenna designs overnight!

**Performance has made the LPV first in antenna sales—not claims or words. JFD will gladly abide by that moment of truth that proves the true caliber of any antenna's performance—THE PICTURE IS THE PROOF!**

LICENSED UNDER ONE OR MORE OF U.S. PATENTS 2,958,081; 2,985,879; 3,011,168 AND ADDITIONAL PATENTS PENDING IN U.S.A. AND CANADA. PRODUCED BY JFD ELECTRONICS CORPORATION UNDER EXCLUSIVE LICENSE FROM THE UNIVERSITY OF ILLINOIS FOUNDATION.



# THE FIRST TV/FM ANTENNA BASED ON THE GEOMETRICALLY-DERIVED LOGARITHMIC-PERIODIC SCALE DEVELOPED BY THE ANTENNA RESEARCH LABORATORIES OF THE UNIVERSITY OF ILLINOIS FOR SATELLITE TELEMETRY.

No longer must you sacrifice directivity or gain to obtain broader bandwidth, as with single-channel Yagis and "all-channel" Yagi types. Now the new JFD Log-Periodic LPV breaks through the bandwidth barrier to put an end to cumbersome antenna compro-

mises. The reason?...The patented geometric concept -  $\frac{L(n+1)}{L_n} = \tau$  that scientifically formulates individual cells (dipole lengths and spacings) to bring you performance that's **frequency independent** for:



**Model LPV17:** 18 Active Cells and Director System for areas up to 175 miles distant. \$59.95 list.



**Model LPV14:** 15 Active Cells and Director System for areas up to 150 miles distant. \$49.95 list.



**Model LPV11:** 11 Active Cells and Director System for areas up to 125 miles distant. \$39.95 list.

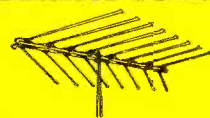

**Model LPV8:** 8 Active Cells and Director System for areas up to 100 miles distant. \$29.95 list.



**Model LPV6:** 6 Active Cells for areas up to 75 miles distant. \$21.95 list.



**Model LPV4:** 4 Active Cells for areas up to 50 miles distant. \$14.95 list.

- **HIGHER FORWARD GAIN** Element for element you get two to three times **more** gain than with similar-priced competitive makes. **Flat** gain across each channel, too, for vivid color rendition. (**More** driven elements do it.)
- **SHARPER DIRECTIVITY** Because the LPV has bandwidth to spare. Its narrow unidirectional beam **does not change with frequency**—does **not** intercept the ghosts and interference picked up by other broad main-lobed competitive makes.
- **LOWER VSWR** Down to 1.2 to 1—derived from optimum impedance match across the VHF and FM Stereo bands.
- **GOLD ALODIZED** Electrically **conductive** golden alodizing that is **part** of the aluminum—assures **continuous** signal transfer—does **not** insulate contact points like competitive anodizing.
- **HIGHER FRONT-TO-BACK RATIOS** All elements are fed in phase opposition to **reinforce** signals arriving from the front end. The crossed harness creates a 180 degree phase shift in the signal path from rear—effectively **cancelling out** rear pick-up of unwanted signals. (e.g., the LPV11 maintains a front-to-back ratio of **35 db** on each VHF channel).



*Harmonically Resonant V-Elements, Operating on the Patented Log-Periodic Cellular Formula, in the Fundamental and Third Harmonic Modes, Provide Flawless COLOR... Black and White TV... FM Stereo!*



The technical press... the news press... the consumer press... the trade press—never before have so many so acclaimed a new TV antenna!

#### ADVERTISED IN LOOK

One of America's most vital and widely read magazines—now alerting millions to the new Log-Periodic antenna concept.

#### ADVERTISED IN SUNSET

The favorite "home" magazine of millions.

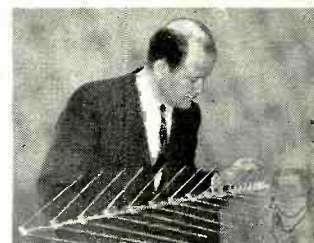

Professor Paul Mayes of the Antenna Research Laboratories of the University of Illinois, originator of the log-periodic V-dipole antenna concept.

ORDER NOW FROM YOUR JFD LPV DISTRIBUTOR AND STEP UP INTO THE MODERN LOG-PERIODIC ANTENNA ERA OF PERFORMANCE AND PROFITS!

# JFD

**THE BRAND THAT PUTS YOU IN COMMAND OF THE MARKET**  
**JFD ELECTRONICS CORPORATION**

15th Avenue at 62nd Street, Brooklyn 19, N.Y.

JFD Electronics-Southern Inc., Oxford, North Carolina  
JFD International, 15 Moore Street, New York, N.Y.

JFD Canada, Ltd., 51 McCormack Street, Toronto, Ontario, Canada.  
401-144 W. Hastings Street, Vancouver 3, B.C.



# Andrea TV component chassis: Color or Black & White with or without remote control

Exceptionally slim in dimension, clean in design, the Mercury and the Explorer install in an opening only 29¼" wide x 21 7/8" high x 25"\* deep. The Navigator and the Satellite require even less area. After fast and easy installation, you'll enjoy the matchless, high definition picture that thousands of owners now view with a technician's pride.

Quality and superb circuit design are responsible for the exceptional performance of these component TV chassis. Andrea builds them using only the best: pre-tested, climate-sealed components, bonded picture tubes, high gain Nuvistor turret-type tuners with pre-set fine tuning, hi-fi detector audio output jack (for simple integration into your own hi-fi audio system), self contained amplifier and speaker and power transformer chassis. Andrea has been respected worldwide for quality in home entertainment, industrial and military electronics for over 30 years.

For specifications on these remarkably trouble-free chassis, fill out and mail the coupon below:

\*includes 6" tube cap

**THE NAVIGATOR,**  
Black & White, with  
Spacemaster Deluxe  
Remote Control

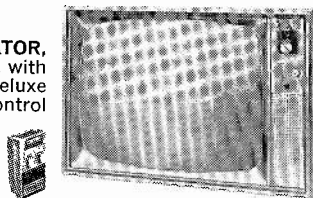

**THE SATELLITE,**  
Star Performer,  
Black & White

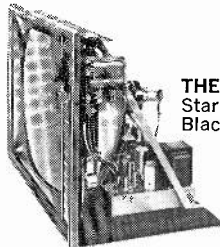

**THE EXPLORER,**  
Color  
magnificence  
for custom  
installation

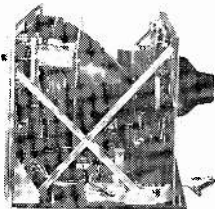

**THE MERCURY,**  
Color chassis  
supreme with  
Spacemaster Deluxe  
Remote Control

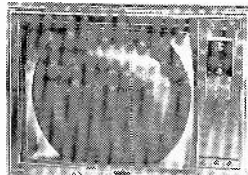

**ANDREA RADIO CORPORATION, DEPT. RE 1**  
27-01 BRIDGE PLAZA NORTH  
LONG ISLAND CITY, N.Y. 11101

Gentlemen: Please send me complete specifications for black and white and color Andrea TV component chassis.

NAME \_\_\_\_\_

COMPANY \_\_\_\_\_

ADDRESS \_\_\_\_\_

CITY \_\_\_\_\_ ZONE \_\_\_\_\_ STATE \_\_\_\_\_

Please check the appropriate box:

I am a

TELEVISION SERVICE ENGINEER

TELEVISION/HI-FI DEALER

OTHER (Specify) \_\_\_\_\_

Please send brochure on the complete Andrea line of television and stereophonic consoles.

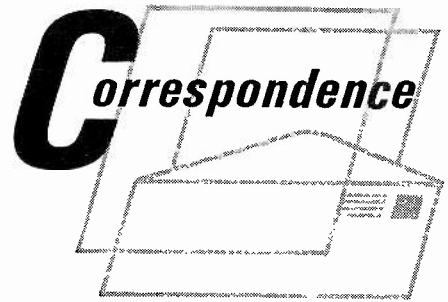

## New Tricks with Diodes — Revisited

Dear Editor:

I've been getting many letters with requests for further information ever since my article "New Tricks with Diodes" was published (RADIO-ELECTRONICS, July 1963, page 36). One of the most frequent queries concerns the kind of transformers to use for T1, T2, T3 and T4. I recommend the UTC "Sub-Ouncer" type SO-13, which has a 500-ohm primary and a split secondary, 50 ohms each winding. It is widely available, one source being Newark Electronics Corp., 223 W. Madison St., Chicago 6, Ill. Its catalog number is 3F597, the price, \$4.20 plus postage.

Another question: yes, it is all right to use a negative-ground supply. Only the battery polarity with respect to the transistors matters.

People also ask about parts toler-

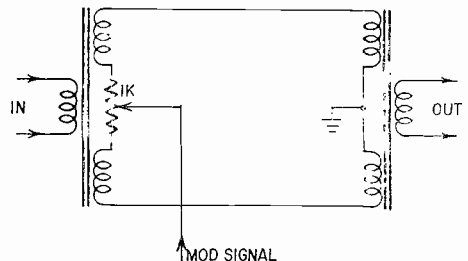

ance. Resistor values are not especially critical, and even 20% tolerance is acceptable.

I suggest you use a 1,000-ohm balancing pot between split windings of the transformer, as shown in the diagram. This lets you compensate for transformer irregularities and other circuit imbalance for complete scrambling.

LEONARD E. GEISLER

*Radio Astronomy Laboratory  
University of Michigan*

[Also see Mr. A. H. Taylor's letter in the October, 1963 *Correspondence* column (page 21). He pointed out ways of balancing and gave several references to articles on SSB and balanced modulators.—Editor]

## Improved Power Resistor Substitution Box

Dear Editor:

Mr. H. L. Davidson's article, "Substitution Box for Power Resistors" in your April 1962 issue (page 64) interested me because most substitution

# WHICH WILL YOU PICK? Now NRI offers you 9 WAYS to train at home in spare time for a career in TV-RADIO ELECTRONICS AUTOMATION



## 1 TELEVISION-RADIO SERVICING

Learn to service black-and-white and color TV sets, AM-FM radios, stereo hi-fi, PA systems, etc. A profitable, interesting field for part-time or full-time business of your own.

## 2 INDUSTRIAL-MILITARY ELECTRONICS

Learn Principles, Practices, Maintenance of Electronic equipment used today in business, industry, defense. Covers Electronic controls and measurement, computers, servos, telemetry, multiplexing, many other subjects you need for a successful career.

## 3 COMPLETE COMMUNICATIONS

A comprehensive training program for men seeking careers operating and maintaining transmitting equipment in Radio-TV Broadcasting or mobile, marine, aviation communications. Prepares you for your License. First class FCC Radiotelephone License.

## 4 FCC LICENSE

Prepares you quickly for First Class License exams. Every communications station must have one or more FCC-licensed operators. Also valuable for Service Technicians. You train at home.

## 5 BASIC ELECTRONICS

An abbreviated, 26-lesson course covering Automation-Electronics, Radio-Television language, components and principles. Ideal for salesmen, hobbyists and others who find it valuable to be familiar with the fundamentals of this fast-growing industry.

## 6 MATH FOR ELECTRONICS

A short course package of carefully prepared texts that take you from basic arithmetic review through graphs and electronic formulas. Quick, complete and low in cost.

## 7 AVIATION COMMUNICATIONS

For men who want careers working with and around planes. Covers direction finders, ranges, markers, loran, shoran, radar, landing systems transmitters. Prepares you for FCC License exams.

## 8 MARINE COMMUNICATIONS

Shipboard transmitting equipment, direction finders, depth indicators, radar are all covered in this course. You prepare for your First Class Radiotelephone License with Radar Endorsement.

## 9 MOBILE COMMUNICATIONS

Training in installation and maintenance of mobile equipment and associated base stations like those used by fire and police departments, taxi companies, etc. Prepares you for your First Class FCC License exams.

SEE OTHER SIDE

TRAIN AT HOME WITH THE LEADER **nri**

NRI training of the 60's is based on nearly half a century of leadership in home study for Radio-TV, Electronics-Automation. Specializing in these fields makes it possible for NRI to provide a variety of courses for ambitious men seeking careers that provide higher pay, more interesting work, better futures. No matter how much or how little education you have, one of NRI's nine courses can help you, just as they have helped tens of thousands of others. Read success stories on the other side of this page. Read about special training equipment NRI provides at no extra cost to make training easier, faster. Then check and mail the postage-free form for FREE NRI CATALOG.

CUT OUT AND MAIL

FIRST CLASS PERMIT NO. 20-R (Sec. 34.9, P.L. & R.) Washington, D. C.

BUSINESS REPLY MAIL  
No Postage Stamp Necessary If Mailed In The United States

POSTAGE WILL BE PAID BY



National Radio Institute  
3939 Wisconsin Avenue  
Washington 16, D. C.



# Where You Train is as Important as Your Decision to Train

## **nri** JOIN THE THOUSANDS WHO GAINED SUCCESS WITH NRI

Thousands of NRI graduates throughout the U.S. and Canada are proof that it's practical to train at home for careers in Electronics-Automation, TV-Radio. NRI graduates are in every kind of Electronics work. Here are five typical success stories from NRI files. Catalog tells more about what NRI graduates do and earn. Mail the postage-free form.



**AVERAGES \$150-\$170 A MONTH SPARE TIME.** "My spare time business fixing Radio and TV sets picks up every month," writes William L. King of Yoakum, Texas. "Looks like I'll have to go into it full time. I wish it were possible to tell every man of the wonderful advantages in this field."



**FROM TEXTILE WORKER TO TECHNICIAN.** That's the story of Harold L. Hughes, 225 Civiley Blvd., Indian River City, Fla. After graduating from NRI he worked in a TV shop, is now employed by an engineering firm as a Senior Electronics Technician. He says, "I shall be eternally grateful to NRI."



**HAS SERVICE BUSINESS OF HIS OWN.** Don House, 3012 2nd Place, Lubbock, Texas, went into his own full-time business six months after finishing the NRI Radio-TV Servicing course. "It makes my family of six a good living," he states. "We repair any TV or Radio. I would not take anything for my training with NRI. I think it is the finest."



**WORKS FOR FIRM BUILDING DC WELDERS.** "Your school helped me get this job," writes Lawrence S. Cook, 529 South Bounds St., Appleton, Wis. He has also done broadcast work, TV repair, and builds custom stereo systems and medical electronic equipment. "I thought very highly of the Communications course. I still use the texts."



**ELECTRONIC TECHNICIAN FOR POST OFFICE.** "NRI training enabled me to land a very good job as Electronic Technician with the Post Office Dept.," reports Norman Ralston, 1947 Lawn Ave., Cincinnati, Ohio. "I finished 6th out of 139. I also have a very profitable spare-time business fixing Radios and TV."

SEE OTHER SIDE

### Cut Out and Mail—No Stamp Needed

**nri** NATIONAL RADIO INSTITUTE  
3939 Wisconsin Avenue  
Washington 16, D.C. 3F

Please send me your Electronics, Radio-TV catalog with complete information on 9 ways to train at home. (No cost or obligation. No salesman will call)

Name \_\_\_\_\_ Age \_\_\_\_\_  
(Please Print)

Address \_\_\_\_\_

City \_\_\_\_\_ Zone \_\_\_\_\_ State \_\_\_\_\_

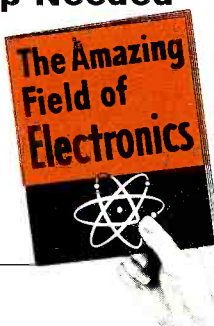

ACCREDITED MEMBER NATIONAL HOME STUDY COUNCIL

More ambitious men are deciding to train for careers in Electronics-Automation, Radio-TV, because they recognize the opportunities in this exciting field to advance and prosper. But where a man trains and how the school of his choice teaches Electronics . . . how it encourages him to reach his goals and realize his ambitions . . . is most important to his success.



THE OLDEST AND LARGEST SCHOOL OF ITS KIND.

In this fast changing world, a school offering Electronics training must keep pace. That's why NRI—with nearly 50 years of specialized experience—now offers you *nine* choices of training within the one field of Electronics. Select the course of most interest to you and receive the kind of training that prepares you for a specialized career. NRI's large staff is always on the job keeping course material up-to-date, helping you earn your way while you train, assisting you with job placement when ready. In short, whatever branch of Electronics you select, NRI is qualified through knowledge and experience to help you grow.

### Special Equipment Included

NRI training of the 60's is built around time-proved "learn-by-practice" methods perfected over nearly half a century of experience in home study training. Most NRI courses include—at no extra cost—special training equipment designed to give shop and laboratory experience right in your own home. You build circuits and work experiments. Theory you study comes to life in an interesting, easy-to-grasp manner. Your first projects are measuring voltage and current in circuits you build yourself. You use a Vacuum Tube Voltmeter which you construct. Later on, you progress into more involved experiments. And all equipment you build is yours to keep.

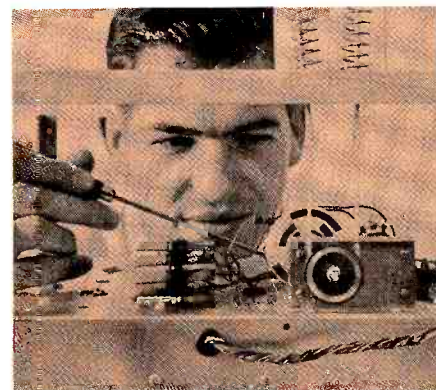

TRAIN FASTER, EASIER WITH EQUIPMENT NRI SENDS YOU.

Because NRI provides training right in your own home, there's no time wasted getting to school. You fit study hours to your own spare-time schedule, progressing as fast or as slow as you like. NRI catalog pictures and describes equipment you get, courses you can take, facts about job opportunities, NRI trial plan, convenient terms. Mail the postage-free form today. NRI TRAINING, Washington 16, D.C.



CUT OUT AND MAIL FOR FREE CATALOG

boxes use only ½- or 1-watt resistors and are limited in usefulness.

I built the unit and added some features to it. The multirange resistors come in pairs. I wired the four sections of the extra MR2 in parallel, bringing each end to a binding post, which gave me a 5.5-ohm resistor. I wired the four sections of the extra MR5 in series for 50,000 ohms and brought the ends to another set of posts. I installed a midget 5,000-ohm 12½-watt rheostat, with its own set of terminals.

These additions extended the range of the unit and provide for an almost infinite variety of resistances, since many terminals can be connected in series or parallel combinations, with or without the rheostat.

H. FISK TARBOX

Darien, Conn.

### Experiments on Horizontal Speakers and Reflectors

Dear Editor:

I have experimented with horizontally mounted speakers and reflecting surfaces and have observed the same improvement Glen R. Travis mentioned in his August 1963 article ("Add Depth to Your Speakers," page 28). Uncanny as it may seem, I have also developed an enclosure that duplicates, within a few inches, the one in Fig. 5 of his article. The only difference is in the speaker and position of the port.

Mr. Travis concludes that improvement is due to the speaker's relationship with the internal cabinet dimensions, but I can find no theoretical basis for this. I am convinced from observations that improvement is related to (1) location of the apparent sound source at an optimum point, about the height of the listener's head, (2) wider dispersion of high frequencies because of the reflecting surface, and (3) increase in the proportion of reflected to direct sound. I think the third condition is responsible for the new sound.

JOHN C. PEARSON

San Pedro, Calif.

### Tube Data in Tear-out Form

Dear Editor:

Your *New Semiconductors and Tubes* section each month is very useful to me in setting up my tube tester and in figuring out new circuits I come across.

But I think it would be much more useful if you printed it with perforations so it could be torn out to make a tube data file.

A. M. LACEY

Manito, Ill.

[Thank you for the suggestion, Mr. Lacey. As it is, we can't perforate our pages because the high-speed presses we are printed on do not allow it. Still, we (Continued on page 24)

# over 100,000,000 already sold!

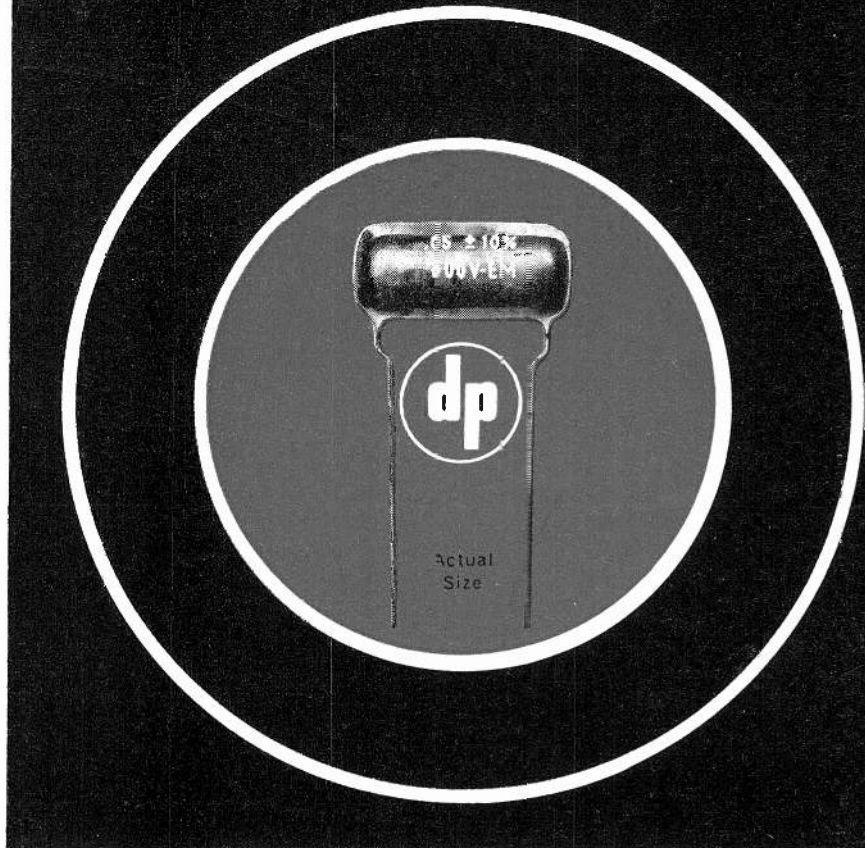

MINIATURIZED  
**ELMENCO**

## Dipped Mylar\*Paper Capacitors

### first choice with service technicians!

Now being used in millions of television sets, radios, phonographs, electronic circuitry

**NOW AT NEW LOW PRICES**

and military applications. ■ Operates at 125° C without derating. ■ Standard Tolerance ±10% ■ Missile Reliability ■ Completely moisture proof ■ Up to 50% smaller than other types.

**DON'T ACCEPT SUBSTITUTES OR IMITATIONS!**

Available at all reputable ARCO distributors in U.S.A.

# ARCO

electronics inc.

Community Drive  
Great Neck, New York  
Branches:  
Dallas 7, Los Angeles 35







## Pardon us while we change you into Santa Claus

Do your Christmas shopping early at your G-E Distributor's. He has lots of wonderful gifts that you can get with the purchase of General Electric tubes . . . gifts for your family, friends and favorite customers. And there're some you'll want for yourself . . . such as a tube caddy that

looks like fine luggage. You can also get Christmas cards designed only for service dealers . . . to mail to customers and friends.

See your General Electric Distributor and start packing your bag *today*. You're going to be a sensational Santa!



**Start packing your bag!**

These Kodak Flashfun camera outfits include everything that young photographers need: Hawkeye camera, film, clip-on neck strap, batteries, flash bulbs and instruction manual. They're yours when you buy G-E tubes.



Be good to yourself this Christmas. You can get these Armor Clad® tube caddies when you purchase G-E tubes. They look like fine pieces of luggage and the special vinyl coverings are longer lasting. They are reinforced with nickel plate at all stress points.

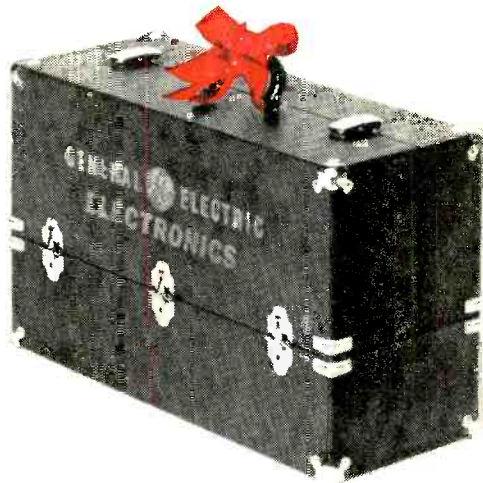

These Dick Tracy Power-Jet Squad Guns by Mattel® will be a hit with any boys you know. They're automatic cap-firing guns that shoot a stream of water 35 feet... farther than any water guns ever made. Give one to any boy and then stand clear.



Little girls will go wild over these Mattel® Sister Belle talking dolls. They're 17" tall and have a rag body and plastic head. Each one says eleven different things that little girls like to hear... like "Let's play house," "Give me a kiss." No batteries needed.



These G-E electric carving knives will make a great gift for the lady of the house. They even slice through hot bread or hot meat with smooth precision. Get several from your G-E Tube distributor.

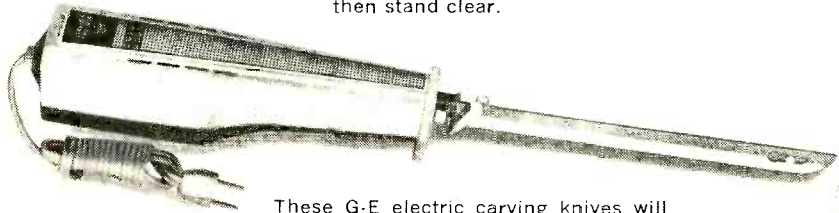

Get these Christmas cards... prepared especially for you. They're in color on heavy, high-gloss stock and show a cartoon of you adjusting a TV set to say "Happy Holidays." 50 cards and 50 envelopes to a box. Get yours now for early mailing.



ANOTHER ACCENT ON VALUE FROM G-E ELECTRONICS DISTRIBUTORS

*Progress Is Our Most Important Product*

**GENERAL  ELECTRIC**



Announcing the new line of world-famous Schober Organ Kits...

# ASSEMBLE YOUR OWN ALL-TRANSISTOR SCHOBER ELECTRONIC ORGAN

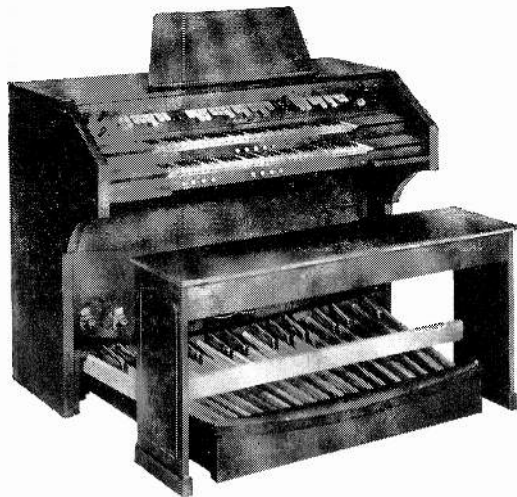

## All-New, All-Transistor Schober Recital Organ

- 32 voices, 6 couplers delight professional musicians... make learning easy for beginners.
- Standard console, pedals, keyboard correspond exactly to pipe-organ specifications.
- Printed circuit construction and detailed, illustrated instructions make for easy assembly... no previous experience necessary.
- Highly accurate church and theatre pipe tone in 5 pitch registers make every kind of organ music sound "right".
- Optional: Combination Action, Schober Reverbatape Unit, Repetitive Theatre Percussions.
- All-transistor circuitry makes possible full 5-year guarantee.

Designed by organists for organists, the new Schober Recital Organ actually sounds like a fine pipe organ. The newly-invented Schober Library of Stops provides you with an infinite number of extra voices so that you can instantly plug in the exact voices you prefer for a particular kind of music. Thirteen-piston, instantly resettable Combination Action makes the

Recital Organ suitable for the most rigorous church and recital work. The Schober Reverbatape Unit gives you big-auditorium sound even in the smallest living room. An instrument of this caliber would cost you \$5000 to \$6000 in a store. Direct from Schober, in kit form (without optional percussions, pistons, Reverbatape Unit) costs you only \$1500.

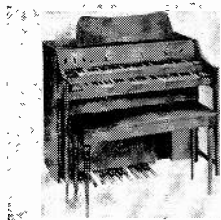

## New, All-Transistor Schober Consolelette II

Here's the most luxurious "home-size" organ available today... with the same circuitry and musical design as the impressive Recital Organ. Full 61-note manuals, 17 pedals, 22 stops and coupler, 3 pitch registers, and authentic

theatre voicing leave little to be desired. Musically much larger than ready-made organs selling for \$1800 and more... the Consolelette II, in kit form, costs only \$850.

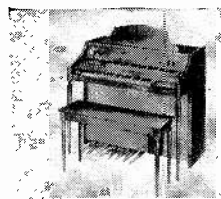

## New Schober Spinnet

The Schober Spinnet is among the very smallest genuine electronic organs; only 39 1/4 inches wide, it will fit into the smallest living room or playroom - even in a mobile home. Yet it has the same big-organ tone and almost the

same variety of voices as the larger Consolelette II. The Schober Spinnet far exceeds the musical specifications of ready-made organs selling for \$1100 and more. In easy-to-assemble kits... only \$550.

## HERE'S WHY YOU SHOULD BUILD A SCHOBER ORGAN!

You cannot buy a finer musical instrument for over twice the price. You get the finest in musical and mechanical quality.

It's easy to assemble a Schober Organ. If you can read and use your hands, you can easily make your own superb organ. Everything you need is furnished... including the know-how; you supply only simple tools and time—no knowledge or experience is required.

You can buy the organ section by section... so you needn't spend the whole amount at once.

You can begin playing in an hour, even if you've never played before—with the ingenious Pointer System available from Schober.

Thousands of men and women—teenagers, too—have already assembled Schober Organs. We are proud to say that many who could afford to buy any organ have chosen Schober because they preferred it musically.

Schober Organ Kits are sold in the U.S. only by...

THE *Schober Organ* CORPORATION

43 West 61st Street, New York, N.Y., 10023

Dealers in Canada, Australia, Hong Kong, Mexico, Puerto Rico and the United Kingdom.

### SEND FOR FREE SCHOBER BOOKLET

... Describes the exciting Schober Organ and optional accessories in detail; it includes a FREE 7-inch "sampler" record so you can hear before you buy.

### Also available:

10-inch high-quality, long playing record... fully illustrates all three models with different kinds of music. Price is refunded with first kit purchase... \$2.00



The Schober Organ Corp., Dept. RE-28  
43 West 61st St., New York, N.Y., 10023

Please send me, without cost or obligation, the Schober Organ Booklet and free 7-inch "sampler" record.

Enclosed find \$2.00 for 10-inch quality, LP record of Schober Organ music. (\$2.00 refunded with purchase of first kit.)

Name \_\_\_\_\_  
Address \_\_\_\_\_  
City \_\_\_\_\_ State \_\_\_\_\_ Zip No. \_\_\_\_\_

(Continued from page 21)

might compile data for all important tubes to the same length, so they could be cut out and filed conveniently.

Another problem is makeup (laying out a magazine is like assembling a jigsaw puzzle). It isn't always easy to back up the tube data section with an ad. But we'll experiment and see what we can come up with.—Editor]

## Organ-Tuning Notes

Dear Editor:

In "Electronic Organ Tuning Made Easy" (RADIO-ELECTRONICS, July 1963, page 58), Mr. Korte suggests using a tuning fork to obtain the 440-cycle tone for the note A.

WWV transmits this tone at regular intervals and can be picked up by almost any good receiver that tunes to 10 and 15 mc. [And in the US, 2.5 and 5 mc.—Editor] At times the 10-mc signal will be better than the 15-mc. The advantage in using WWV is that the signal volume can be more nearly matched to the organ volume, and you can check the beat note for several minutes, instead of for just a few seconds with a tuning fork.

For a shop that plans to do a considerable amount of organ tuning, a Conn Strobotuner (made by C. G. Conn, Ltd., 1101 E. Beardsley Ave., Elkhart, Ind.) is a worth-while investment. With it, you can be certain of every note, and the professional equipment makes a good impression on musicians. (It is a good idea, in fact, to have the organist around to witness the tuning.) It takes much less time to tune an organ with a professional instrument than by the zero-beat method.

Get a service manual and circuit diagram before you attempt repairs to an electronic organ. Even if you are a good radio-TV technician, you can look rather uninformed if the organ trouble is not obvious. An impressive, confidence-inspiring job should be performed on such instruments, which cost from \$550 to over \$10,000. Tuning can be profitable. The standard fee should range from \$10 to \$25.

A. O. BURDEN

Medellin, Colombia

## Hold It! Don't Start Yet

Dear Editor:

In "Start Service on a Shoestring" (July, page 46), the Old-Timer forgot one thing: a good TV service handbook that explains circuits and their troubles. He should find out *why* a tube shorted before he replaces it.

That, and a good electronics dictionary, will get him going. He'll get better use of your TV service notes and understand better the technical terms used today.

PETER LEGON

Malden, Mass.

END

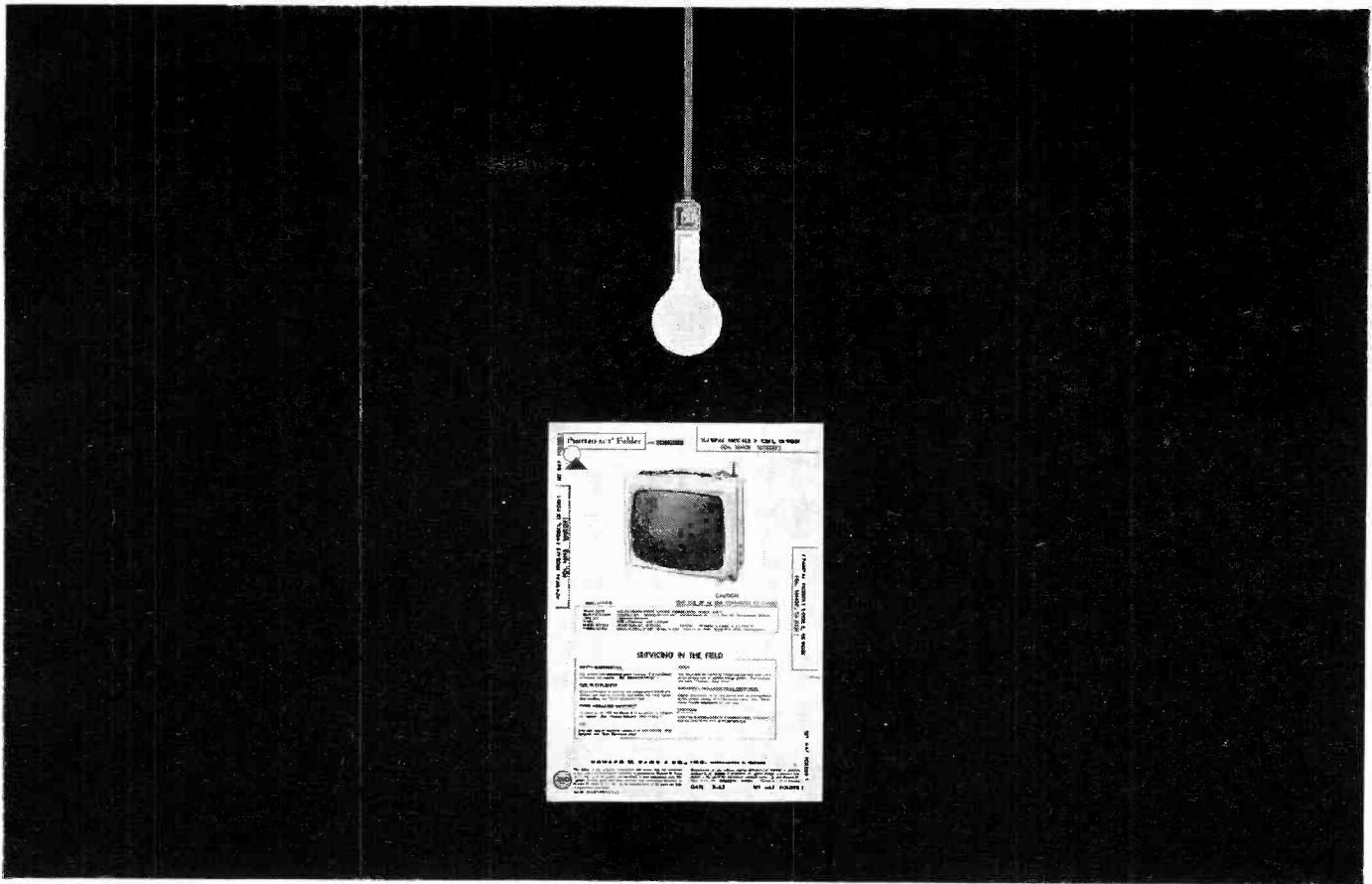

**"...like switching on the light in a pitch-dark room..."**

Come to think of it, this is a pretty good way to describe PHOTOFACT. We didn't dream it up—it's part of a letter that came to us (unsolicited) from a PHOTOFACT user, a letter that goes like this:

"Opening a Sams schematic to me is like switching on the light in a pitch-dark room. It actually pinpoints the 'needle in the haystack'—many times in *one minute*."

Switching on the light is a great way to find what you're looking for in a hurry. There are over 40 illuminating features in every PHOTOFACT Folder which will help light your way to *fast* TV-radio troubleshooting. (The greatest, too, for pinpointing the "needle" in those tough-dog jobs.)

Users don't measure PHOTOFACT by its pennies-per-page cost. It's the *light*—the time-saving, profit-making

light that counts.

Of course, you can get along without PHOTOFACT—a few do—and maybe they're making a living. But it's the hard way.

Doesn't it make good sense to see your Sams Distributor today for details on an Easy-Buy PHOTOFACT Library and Standing Order Subscription?

Or use the coupon below.

**A PHOTOFACT LIBRARY PAYS ITS OWN WAY—**

Now, more than ever, it pays to own PHOTOFACT—the world's finest TV-radio service data. Now, you can start or complete your PHOTOFACT Library this Easy-Buy Way:

- **FREE** with your order for 180 Sets—a deluxe 4-drawer file cabinet worth \$38.95 • **Only \$10 down** • 30 months to pay • **No interest or carrying charges** • **Prepaid transportation** • **Add-on privilege of a year's advance subscription to current PHOTOFACT on the same Easy-Buy contract** • **Save 30¢ per Set—special \$1.95 price applies on Easy-Buy (instead of the regular \$2.25 price).**

**4 Ways to Select Your PHOTOFACT Library:** 1. Complete your present PHOTOFACT Library. 2. Order a PHOTOFACT "Starter" Library—180 Sets (Sets 301 to 480—coverage from 1955 to 1960—only \$11.33 per month). 3. Order by brand name and year—see the handy selection chart at your Distributor. 4. Order a complete PHOTOFACT Library—get **FREE** file cabinets, *plus* a selection of invaluable books and Electronics Courses.

**SEE YOUR SAMS DISTRIBUTOR FOR FULL DETAILS, OR MAIL COUPON ▲**

Howard W. Sams & Co., Inc., Dept. REF-12  
 4300 W. 62nd St., Indianapolis 6, Indiana

Send **FREE** Photofact Cumulative Index 

Send full information on Easy-Buy Plan

Enter my Photofact Standing Order Subscription

My Distributor is \_\_\_\_\_

Shop Name \_\_\_\_\_

Attn. \_\_\_\_\_

Address \_\_\_\_\_

City \_\_\_\_\_ Zone \_\_\_\_\_ State \_\_\_\_\_



Let's start with scopes—essential for the experimenter. EICO has an excellent variety to choose from. The new full performance 430 General Purpose compact with 3" flat-face CRT; the 427 General Purpose DC scope; and one of the best thought of scopes in the DC wide band field, the 5" CRT 460.

If you work with transistor circuits, EICO has the team for you: the 1020 Power and Bias Supply with 0.005% ripple; and the 680 Transistor & Circuit Tester which combines transistor parameter measurements with a 20k $\Omega$ /V multimeter for dc voltage (to 50v) and resistor measurements.

If you're interested in RF you'll need a good, wide coverage RF signal generator with built-in audio modulation such as the EICO 324 (150 kc-435 mc), and a good VTVM such as the EICO 222 or peak-to-peak VTVM the 232. Use either one with RF VTVM probe PRF-11.

If you're interested in audio, EICO has an excellent Sine and Square Wave Audio Generator ranging from 20 cps to 200 kc, the 377. You'll also need an AC VTVM. The 12-range EICO 250 (measures 100  $\mu$ V to 300V) is an excellent choice. It has a panel switch that converts it to a broadband amplifier with 60 db gain and over 5V undistorted output. The EICO 261 AC VTVM and Wattmeter has 11 ranges (measures 1 mv to 1000V) and it includes a tapped 4, 8, 16 and 600 ohms power resistor handling up to 80 watts as well as load compensated wattmeter ranges. In general you will need an EICO 222 or 232 VTVM as well, for measuring up to 1500 VDC or AC, and for resistance measurements.

If you like to draw materials from a "junk" box, you'll need a Resistance-Capacitance Bridge, EICO 950B, which measures capacity from 10  $\mu$ mf to 5000  $\mu$ f, resistance from 0.5 ohm to 500 meg., and contains a continuously variable 0-500 VDC

supply for a sensitive capacitor leakage test. Complementing it is the 955 for in-circuit capacitor short—open testing, and capacity measurements with unique shunt resistance balancing.

For trouble shooting audio, IF, and RF circuits, the 147A Multi-Signal Tracer has both RF & audio inputs with demod & direct probes, noise locator circuit, wattmeter, substitution tests, & eye-tube and speaker monitors. And for testing tubes nothing beats the economical EICO 628 Emission Type Tube tester. The new 667 Dynamic Conductance Tube and Transistor Tester is the best in the field. Both test all the new tube types including Nuvistor, Novar, 10-pin, Compactrons, etc.

Other handy items are EICO substitution and decade boxes: EICO 1100 covers EIA resistance values from 15 ohms to 10 meg.; the 1120 EIA capacitance values from 100 mmf to 0.22 mf. The 1140 combines both 1100 and 1120 in one box and permits series or parallel combinations as desired. The 1171, a Precision Decade Resistance Box, covers 1 to 99,999 ohms in 1-ohm steps; and EICO 1180, a precision Capacitance Decade Box, covers 100 mmf to 0.111 mf in 100 mmf steps.

If you want to know how a circuit performs with varying line voltage, or to correct for varying line voltage during an experiment, the EICO 1078 Metered Variable Auto-Transformer AC Bench Supply provides 0-140 VAC continuously variable, from 120 VAC line input with a 7½ amp. current rating. Output current and voltage are separately metered.

If you're an experimenter or technician, you'll find that EICO test equipment can make any job easier. You can also be sure, that when you select EICO instruments, as a kit or factory-wired, you get the most performance for your dollar.

See the most complete line of test instruments (kit and factory-wired) at your distributor.

## A guide to what the well equipped experimenters' workbench looks like



PRICES OF EICO EQUIPMENT (k=kit; w=wired)—430 (k. \$65.95; w. \$99.50); 427 (k. \$69.95; w. \$109.95); 460 (k. \$89.95; w. \$129.50); 1020 (k. \$23.95; w. \$29.95); 680 (k. \$25.95; w. \$39.95); 324 (k. \$28.95; w. \$39.95); 222 (k. \$27.95; w. \$42.95); 232 (k. \$49.95; w. \$99.95); PRF-11 (k. \$3.95; w. \$4.95); 377 (k. \$37.95; w. \$54.95); 250 (k. \$49.95; w. \$79.95); 261 (k. \$49.95; w. \$79.95); 950B (k. \$23.95; w. \$29.95); 955 (k. \$19.95; w. \$39.95); 147-A (k. \$29.95; w. \$44.95); 628 (k. \$44.95; w. \$59.95); 667 (k. \$79.95; w. \$129.95); 1100 (k. \$7.95; w. \$12.95); 1120 (k. \$6.95; w. \$10.95); 1140 (k. \$14.95; w. \$19.95); 1171 (k. \$24.95; w. \$29.95); 1180 (k. \$17.95; w. \$24.95); 1078 (k. \$42.95; w. \$54.95).

<b>EICO</b> ELECTRONIC INSTRUMENT CO., INC.	
131-01 39th Avenue, Flushing, N.Y. 11352	
Send free	
<input type="checkbox"/>	28 page catalog C-12
<input type="checkbox"/>	Short Course for Novice License
<input type="checkbox"/>	Send 36-page Stereo Hi-Fi Guide for which I enclose 25c for postage and handling.
Name _____	
Address _____	
City _____ Zone _____ State _____	

## MICROMINIATURE COLOR TELEVISION

... TV on the Micro-molecular Level on the Horizon ...

**I**N THIS new era of microminiaturization, there is no longer any valid technical reason why television—particularly color television—should not benefit by the great electronic shrinking process now becoming well-nigh universal.

Indeed, if television and science keep in step, the next decade will record astonishing advances in TV, medicine, biology, technology and the sophisticated arts—applications undreamt-of today.

As our insight into life processes, down to the molecular and atomic levels, increases rapidly, we need new and exceedingly refined tools to unravel the secrets of nature and understand them.

The X-ray and the electron microscope have already pioneered the way into the micro-unknown, but the black-and-white photographs they produce are no longer sufficient to science, technology and biology. These instrumentalities must be linked to color TV. We need color X-ray and color electron microscopes as well as TV color motion pictures, the combination of which is not in existence today.

We have reported certain phases of microtelevision in an earlier issue.\* Here is an excerpt from that issue:

“We can use standard iconoscopes by attaching the recently developed *optical cables* to them. Made of flexible glass fibers, these standard cables can be less than  $\frac{1}{8}$  inch in diameter and conduct light readily. Each glass fiber, the thickness of a thread, transmits its own quota of light. When they are fashioned into a supple cable of hundreds of glass fibers, a strong light can be conducted around curves and corners.

“Thus we can mount a powerful yet tiny electric light bulb directly behind the end of the light cable and illuminate the inside of an artery, look into the ear or other organ at will, via TV. Urologists urgently need such a tool which, inserted through the ureter, can view the kidney for lesions, stones, or similar disorders.

“For other purposes we also require mini-TV transmitters. For surveillance at a distance, optical cables are useless—here inconspicuous tiny cameras that can be readily concealed are needed.

“In missiles and spacecraft such as satellites, the weight of 1 ounce and the space of 1 square inch are

often extravagant, and frequently not permissible. Hence micro-TV transmitters are vital here. How small can a TV camera shrink? No one knows.”

To the above can be added important “bloodless” explorations into the human body, via veins, arteries and the various internal organs such as parts of the heart, glands, and even the brain. *This can readily be accomplished once our microminiature TV cameras have shrunk down to the size of the opening of a hypodermic needle.*

The great advantage of introducing color television cameras into presently inaccessible parts of the human anatomy is obvious. Just imagine color TV enlargements of electron microscopic images from 300,000 diameters upward of, say, an internal *starting* cancer, or a benign tumor, or other diseases!

Once we have such versatile tools, the entire human body, for all practical purposes, will have become as transparent as if it were clear glass or plastic! This includes not only the “soft” parts of the human anatomy, but the bony structures as well.

The scientist, the biologist, the geneticist, all will work in new light, *in color*, instead of in abysmal dark as they mostly do now when it comes to the inaccessible parts of the human body.

In technology as well as in biology the probing microminiature TV color camera will literally have thousands of new uses. Coupled with the X-ray and the electron microscope, such future cameras will ferret out points of weaknesses in electronic equipment and a high percentage of potential failures, not apparent otherwise.

Take only one example—our present-day rockets, missiles and our various satellites. Today's percentage of failure is intolerable. Its cost is well-nigh astronomical. Often failures occur once the space vehicle has been in orbit for a considerable length of time. *But most occur before they are off the ground.*

All these potential failures could be anticipated and overcome with miniature color TV probes *on the molecular level*. They would be cheap at any price. —H.G.

\*“Microtelevision,” RADIO-ELECTRONICS, August, 1960.

Merry Christmas—Happy New Year

The Staff of Radio-Electronics



# replacing your FIRST color TV tube?

Do it confidently with this step-by-step procedure

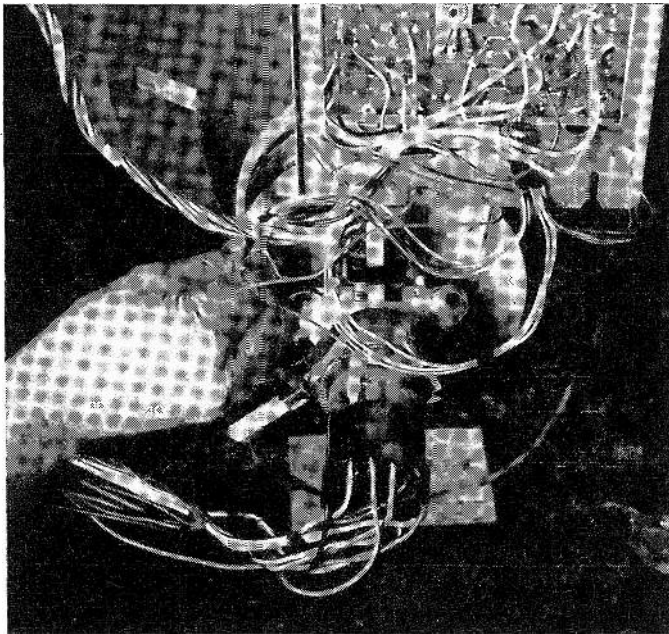

*Unhooking leads from yoke assembly so set chassis can be removed.*

WHEN A DEFECTIVE COLOR PICTURE TUBE must be replaced, don't throw up your hands in despair and wonder how you'll ever do it. This will be your first reaction—I remember the first color tube I ever replaced and I didn't know how to tackle the job. This article deals with the replacement step by step so that any service technician can do it. The photos show the exact settings of the units on the neck of the color tube and the text follows along the same lines.

Installing a new color picture tube is a five-step procedure:

1. Removing the chassis and picture tube.
2. Removing components from the picture tube.
3. Installing components on the new picture tube.
4. Installing the tube and replacing the chassis in the cabinet.
5. Receiver convergence.

*With the chassis removed only the color-CRT and the convergence chassis are left.*

*With color tube on bench, start removing yoke and convergence assemblies.*

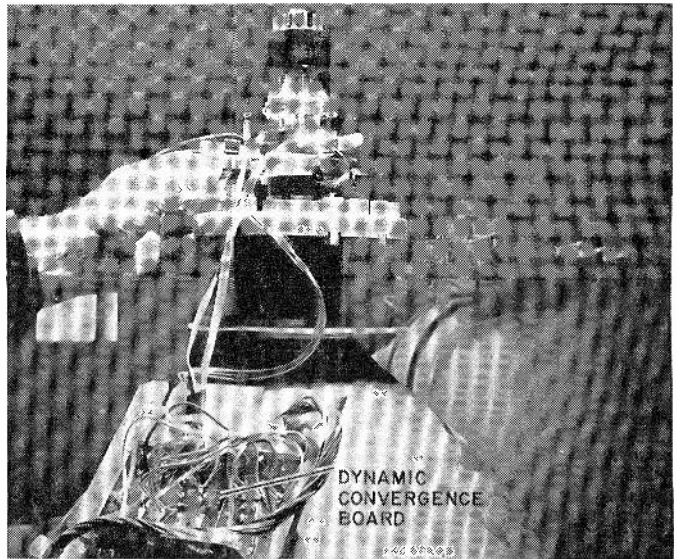
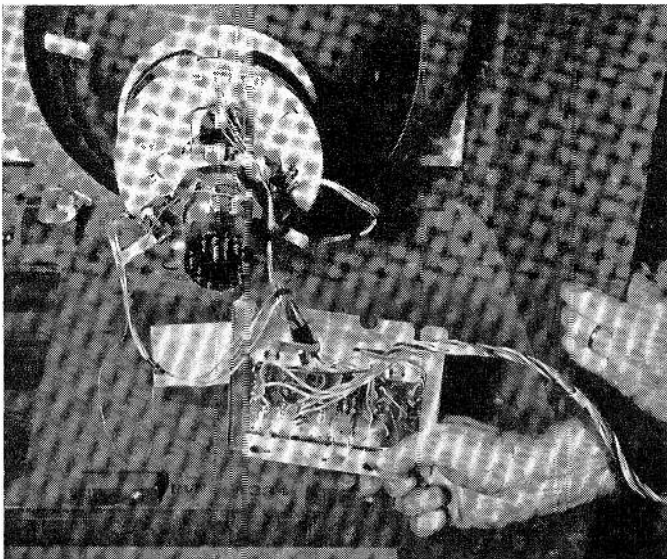

The receiver described in this article is a RCA set although replacing most other color picture tubes calls for the same procedure.

### Removing chassis and CRT

After pulling off all front knobs and removing the rear cabinet cover, disconnect the high-voltage lead going to the picture tube. In older sets, this lead must be unfastened from the metal box before you open the box lid. Push down against the high-voltage connection with a long insulated screwdriver to discharge the high voltage. This lead will pull straight out of a pin socket. In newer sets, the high-voltage lead unplugs from the glass picture tube.

Now remove all wires connected to components on the picture tube. Remove the picture-tube socket and the yoke leads. All the colored wires going to the deflection yoke are marked on the yoke where they plug in. There is little danger of getting them wrong when replacing them. Unhook the blue lead from ground to the blue lateral magnet. Unplug the speaker cable. Unplug the convergence yoke cable from the top of the chassis and loosen the two 1/4-inch bolts that hold the antenna assembly to the case. Slide the antenna assembly out and down.

One or two chassis bolts at the top of the chassis and two bolts in the bottom of the chassis must be removed. Now slide the chassis out about 3 inches and loosen the 1/4-inch metal screw that holds the small-controls assembly down. Slide the unit back and then lift up. The chassis is now free and can be removed. After the chassis has been removed, it may be wise to turn the cabinet over on its face before removing the CRT—especially if the top and side of the set you are working on are not removable.

Four nuts hold the picture tube in

*Measuring position of elements around CRT neck in relation of base of tube.*

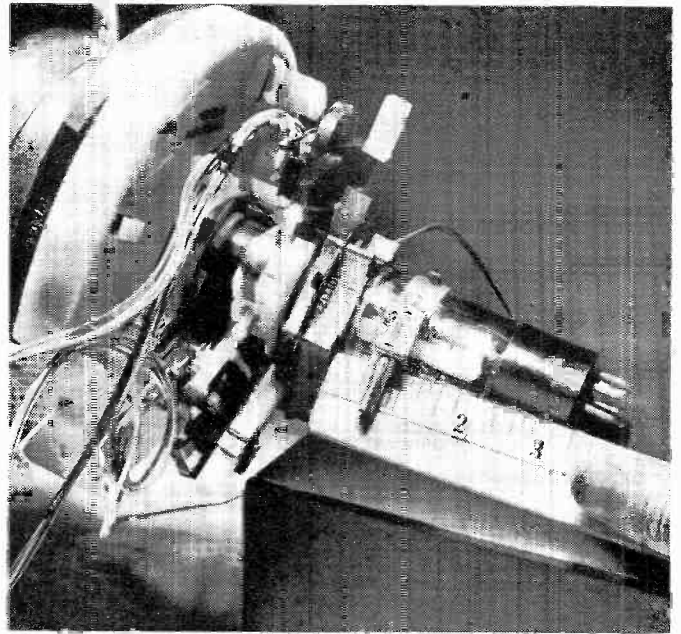

*View of assemblies around the CRT neck.*

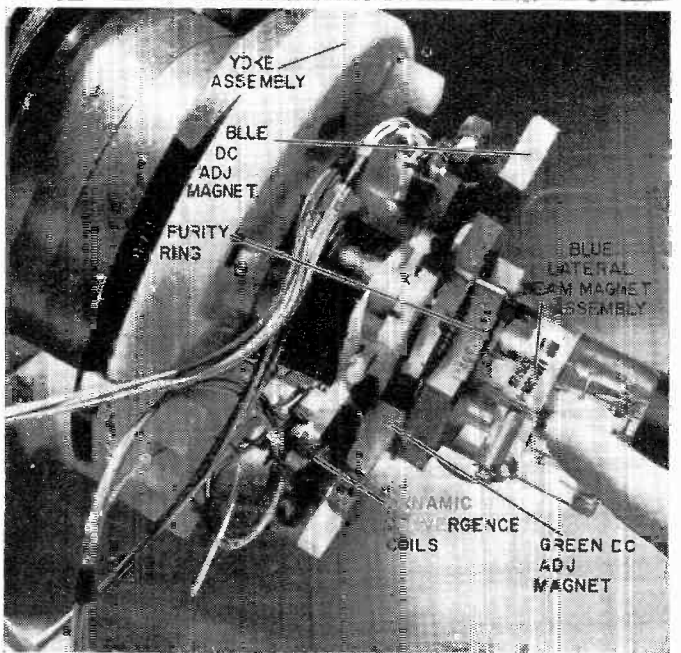

*Center purity ring is lined up with red stripe on neck of CRT.*

*Closeup shows greater detail of convergence elements.*

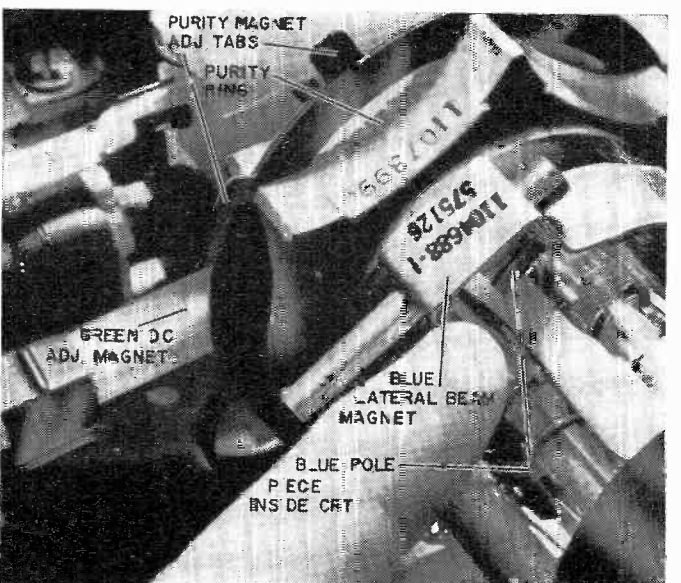
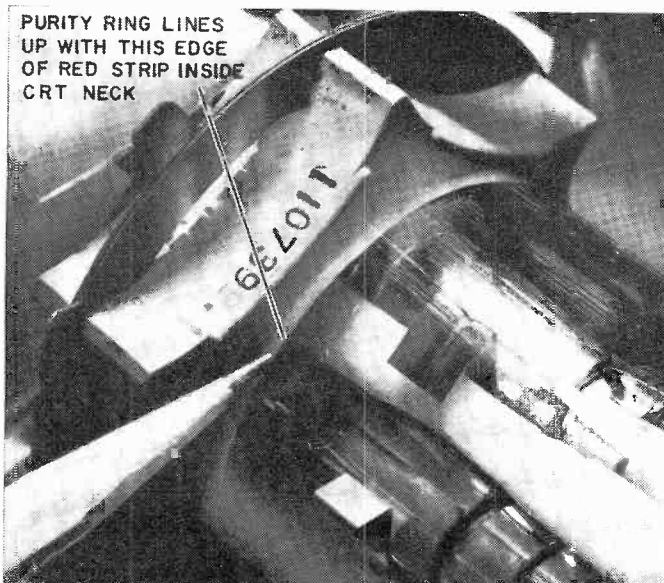



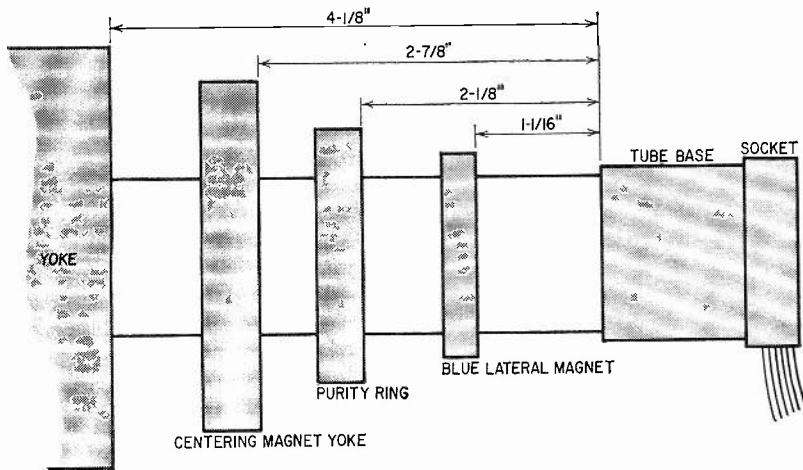

Fig. 1—Measure component spacing before they are removed from CRT neck. Measurements are approximate, but help when replacing parts on neck of new CRT.

place—two at the top and two at the bottom of the assembly. Loosen the bottom nuts first, then the top two. Two men should work together to remove the picture tube from the receiver cabinet. We have used only one man, but the cabinet starts to crawl and the picture tube is heavy too.

You can remove the components from the tube while it is in the cabinet or on the bench. I left everything on the color tube so pictures could be taken as each was removed.

#### Removing components from CRT

Place the kinescope face down on a drop cloth or newspaper to protect the face from scratches. To be sure that the components will be replaced on the new tube correctly, measure the settings, with a ruler, from the base of the kinescope. Fig. 1 shows the settings in inches for a tube I removed. When you remove the blue lateral magnet, you will notice that it sits right over a clip inside the picture tube.

The purity ring sets over the red

ring marked inside the tube. Notice that the center adjustment magnet and convergence yoke are mounted at the opposite end of the red ring. Note that the blue wires from this yoke are at the top of the picture tube over the blue gun, the red wires at the right side and the green wires on the left going to the green dynamic convergence coils.

The large deflection yoke is loosened with a 1/4-inch nut driver and slid off the end of the tube. It is heavy; don't be surprised into dropping it.

The masking must be removed from the front edge of the picture tube. On older sets, the mask extends several inches down onto the tube. Plastic tape holds or seals the joint of the mask section.

#### Replacing components

When placing the mask on the new picture tube, be sure that the center of the face mask (there is a mark on the new mask showing the center) is placed in line with the blue gun. The blue gun is always at the top of the screen. Use

either plastic tape or masking tape to hold the mask in place. At this time, the new color CRT can be placed in the receiver cabinet.

First, be sure the safety glass has been washed and cleaned. Also, make sure there is no lint or dirt on the face of the new CRT. Then tip the picture tube and push it into the cabinet. Check to make sure that the blue gun is up and set the tube into its plastic holders. Help is needed here. At this time, check to see if any foreign matter has fallen into the front glass. If not, place the four nuts over the metal tube harness and tighten them.

Now slide the yoke into place and tighten the 1/4-inch bolt slightly. You should still be able to push the yoke back and forth on the picture tube neck. Install the other components, making sure they are in proper order and spacing them according to the measurements you made when you removed them from the defective tube. Now replace the TV chassis and reconnect all leads. Once everything is back in place, turn on the receiver and let it run for 15 or 20 minutes before converging the set.

#### Receiver convergence

Before starting to converge the TV screen, turn the dot-bar generator on and let it warm up thoroughly. While it is stabilizing, take your degaussing coil and demagnetize the set. After degaussing, if you see any color shading anywhere on the screen, purity must be adjusted.

To start the purity adjustment, turn off the set and unplug the i.f. cable going to the tuner. Plug the ac interlock cord back in and, after the receiver warms up, short out the green and blue grids through a 100,000-ohm resistor. There are commercial kinescope grid-shorting

*Dc magnet assembly is lined up at this end of red stripe on color CRT*

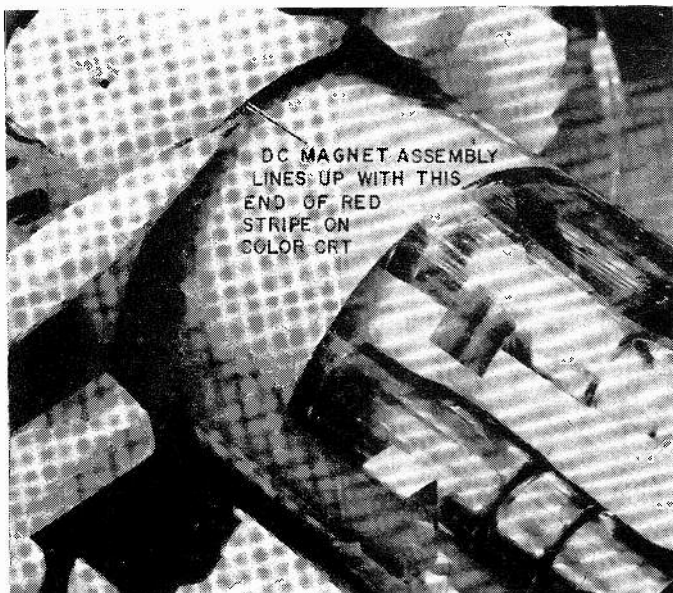

*Removing yoke from defective color CRT. Watch out, it's heavier than you think.*

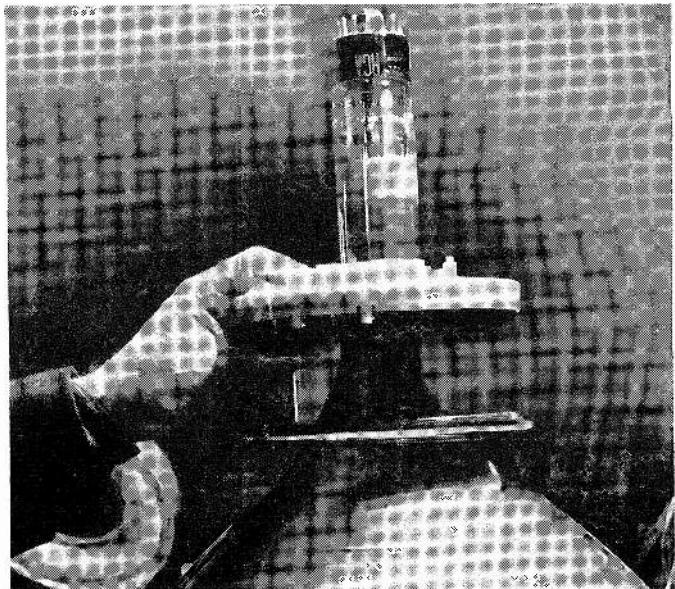

switch boxes on the market for this purpose. Now the screen is red. Adjust the center purity ring for a center red coloring. Then push the yoke back and forth and adjust the purity ring until the entire screen has an even red tint.

If this is done correctly, the green and blue shading will fall in line. It is always best to check each one separately by shorting the other two grids to ground through a 100,000-ohm resistor. If there is still shading or color at the edges, adjust the hairpin magnets at the outside or (on the older sets) bell of the tube to erase them. These magnets are not used on the newer sets. If a little shading persists, try degaussing the kinescope again.

At this point, check two things. Be sure the picture is level and in focus. The temperature and black-and-white adjustments generally are not too far off if these controls did not get bumped. Check receiver operation on black-and-white. If adjustment is required, follow the manufacturer's setup procedure.

On later-model receivers, convergence adjustment is comparatively easy. Connect the dot-bar generator to the antenna terminals and set the generator to the same channel as the TV receiver. Remove the convergence board assembly from the back of the set and place it on the slots at the top and back of the receiver. Tighten the two metal screws so the board is solidly in place. Watch the wires that connect to this board and the yoke assembly so that they do not get hung up.

Do the vertical convergence first. If the receiver was properly converged when the picture tube went out, the dynamic convergence controls will need only a touchup. Put the dots on the screen and check down the center for a white dot. Short out the blue gun with the 100,000-ohm resistor. Bring the red and green dots together in the center of the screen, sliding the green and red beam center magnets to set the dots on top of one another. Check and readjust this setting several times to make sure it is right.

If they won't quite come together, rotate the red magnet a half turn and reinsert it, and the dots will come together. Once they are together in the center of the screen, short the green grid and line up the red and blue dots. The blue-beam center magnet moves the blue dot up and down. The blue lateral beam moves the blue dot horizontally. Place them on top of one another. Go back and check the red and green guns again. Now check all three dots, which should result in a white dot. The amplitude and the tilt controls should be adjusted unless the dots fail to drop in.

It is best to step back and take a look at the screen with a station tuned

*Removing front protective mask from face of tube.*

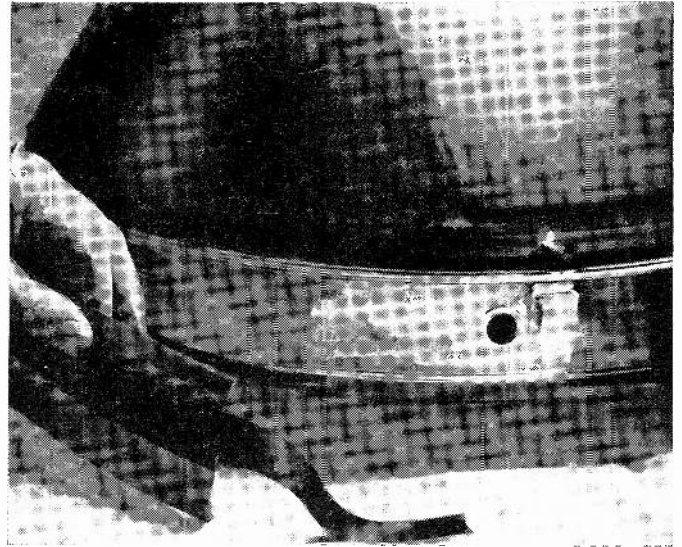

*Replacing the yoke assembly.*

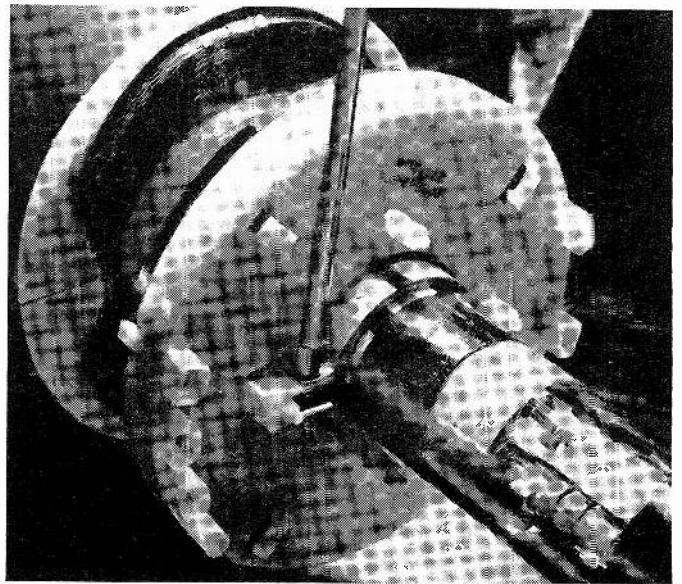

in, to observe the colors that are bleeding through. After this observation, switch the dots back on and check vertical convergence across the screen.

On later receivers, half the screen can be converged at a time. Short the blue grid to ground. Adjust RG1 (Fig. 2) to make the vertical dots converge on the left side. Then adjust RG2 to

and touch them up again.

Now short out the green grid and converge the red and blue dots. Check to make sure the red and blue dots converge down the center of the screen. Adjust coil B1 to make the blue dots fall on the red dots in the right side and adjust B2 to adjust the horizontal blue dots to fall on the red dots on the left side. If the blue dots are too high, lower them with the blue beam centering magnet. If they are to the right or left, adjust with the blue lateral positioning magnet. Remove the short from the green grid and white dots should appear all over the screen. It is impossible to get a 100% converged screen, although the new color sets are much easier to converge than those of several years ago.

Go over convergence adjustments several times. Be sure you are satisfied with the convergence. Check the focus of those dots, for changing the focus will throw the convergence off. Practice makes perfect, but be sure to fill out the warranty tag for the new color picture tube just installed.

END

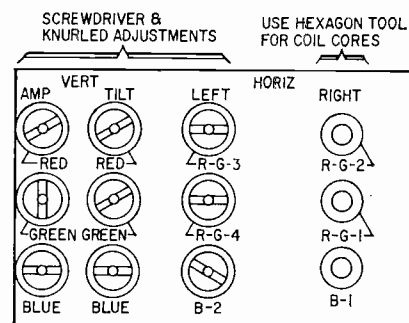

Fig. 2—Typical convergence adjustment board.

make the horizontal dots converge on the right side. Adjust RG4 to make the red and green horizontal dots converge on the left side of the screen. Go back



Now that there are more than just two chassis, you need a scorecard! **By WAYNE LEMONS**

ONE OF THE OUTSTANDING THINGS ABOUT color TV this year is the spirit of change. There are no longer just two chassis hiding behind a multitude of brand names. And, as in the early days of black-and-white, the color chassis is gaining individuality as each manufacturer incorporates new design ideas. Although there are no revolutionary developments in circuitry this year, the first rectangular color tubes, a 16-inch by Toshiba and a 23-inch by Motorola, are no doubt the harbingers of a new color era.

All chassis except Zenith and Toshiba use X and Z color demodulators followed by R — Y and B — Y amplifiers. The G — Y signal is then derived by picking off and mixing the right amounts of the reversed outputs of the R — Y and B — Y amplifiers.

Zenith uses "switch tube" high-level demodulation (as it has since its entrance into color) with no amplifiers between the demodulator and the CRT grids. Toshiba uses a slightly different method of demodulation than either of the above. They demodulate on the R — Y, B — Y and G — Y axes directly rather than deriving the G — Y in the amplifiers. This they do by taking a third phase axis from the 3.58-mc oscillator (Fig. 1), and supplying all three

of the demodulator grids with selected amounts of the color signal from the second bandpass amplifier. The cathodes of the color amplifiers which follow these demodulators use a common cathode resistor even though the G — Y signal has already been derived. This common connection is necessary so that blanking can be applied through the color amplifiers to all three color grids simultaneously.

The greatest design changes in color chassis this year have been in the black-and-white circuitry; different tuners, i.f. strips, sync circuits, etc. The convergence circuits, except for some refinements and slight rearrangement of controls in some models, are virtually unchanged. Convergence procedures are pretty much what they have been for the last 3 or 4 years.

Many companies are using turret tuners this year, and all but Toshiba (which uses a cascode type) have neutralized triode rf amplifiers. Admiral, Curtis Mathes, RCA, G-E and perhaps others use Nuvistor 6CW4 or 6DS4.

An almost universal design feature for 1964 is the inclusion of some method of controlling video response. Most designers have chosen a three-position switch but at least one (Zenith) has a continuous control. Fig. 2 shows the

method selected by Admiral. By switching in different values of capacitance across the contrast control, the high-frequency response of the video amplifier can be reduced or increased at all but the maximum setting of the control.

The switch can be used to compensate for variations in transmission conditions, depending upon where the set is used and the program material that is transmitted. For example, in fringe areas, snow can be reduced by reducing the high frequency response. On the other hand, old films can be "livened up" by increasing the high-frequency response so that outlines stand out better against the background. Fig. 3 shows the continuous "video peaking" control used on Zeniths.

### Power supplies

Another feature found on many sets this year is "boosted boost." This is an added voltage obtained from the fly-back and normal boost circuit so that

Fig. 1—Simplified schematic of Toshiba 16WM color demodulation and amplifier circuits.

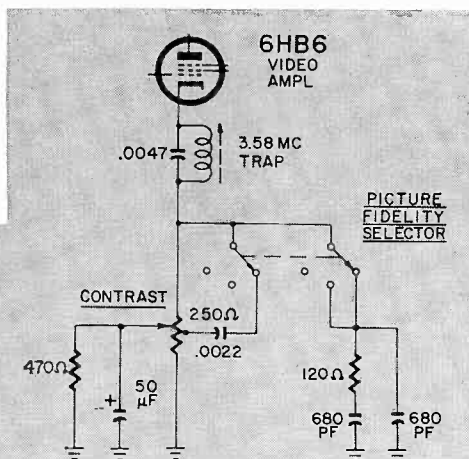
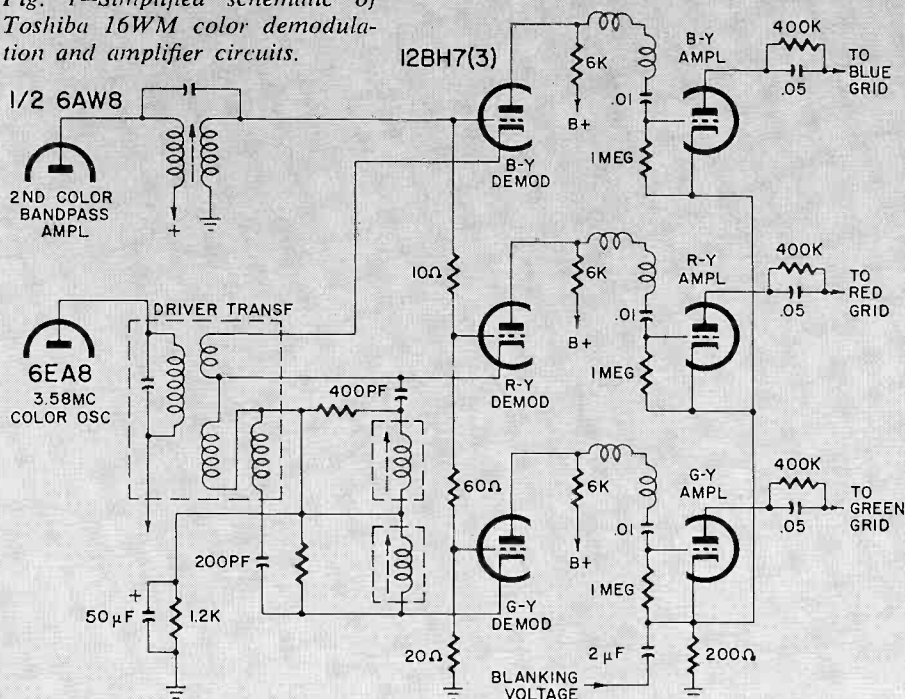

Fig. 2—Admiral's picture-fidelity selector varies response of video output stage.

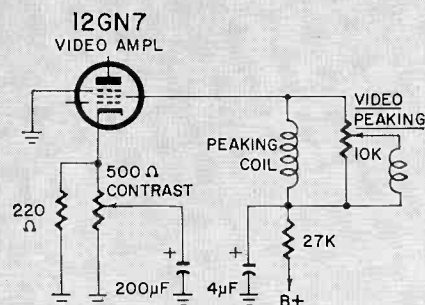
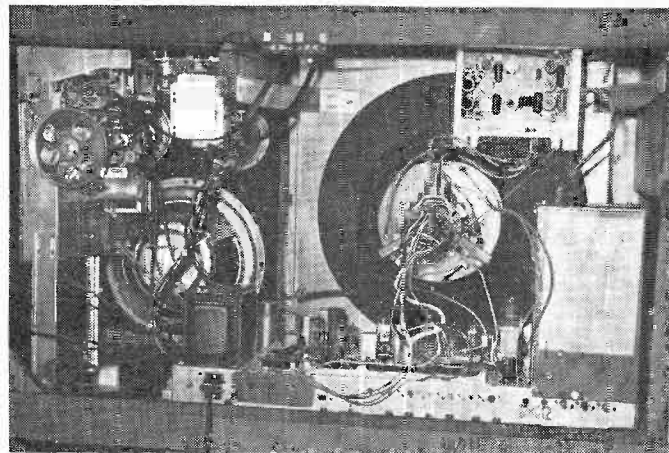
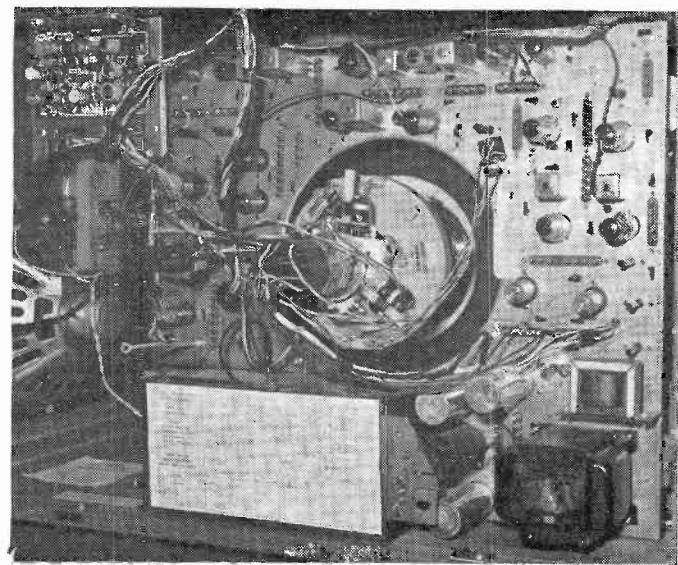

Fig. 3—Zenith's video peaking circuit inserts reactance in screen of video tube.



◀ Fig. 4—Packard-Bell vertical "wraparound" chassis swings left, out for easy access.

▲ Fig. 5—Curtis Mathes combination: basic CTC 12 color chassis, plus AM-FM tuner and hi-fi audio.

several hundred volts more is available for the screens of the color tube. This is said to produce both a brighter picture and somewhat better focus. The circuit used in Packard-Bell and RCA sets is typical. (See the RCA CTC 15 article in this issue, page 00.) A high-voltage selenium rectifier tapped up on the fly-back develops an additional 420 volts over the normal boost supply.

One other feature popular this year is a high-voltage selenium diode as a focus rectifier instead of a 1V2 tube. This has the advantage that no sweep power is used to supply the focus rectifier filament. A circuit of this kind is also used by G-E, RCA and Philco.

#### Mechanical construction

Packard-Bell is building this year what is probably the first vertical "wrap-around" color chassis. This is not as bad as it might sound. (See Fig. 4.) All adjustments are located on the rear side of the chassis with the exception of the convergence boards which is mounted separately (upper left). The beauty of this chassis is that, when underchassis service is needed, all you do is remove two nuts on the right and the chassis swings out, over the picture tube to the left, making all parts underneath accessible.

Most manufacturers have at least one or two models of color sets that also include radio, phonograph and hi-fi amplifier. Fig. 5 shows the rear view of a Curtis Mathes combination. This chassis is similar to RCA's CTC 12 except that no audio output tube is used. (You might think a tube is missing, since the socket *hasn't* been removed.) The sound from the quadrature detector is channeled through the radio-phonograph amplifier. Curtis Mathes markets color sets only in combinations.

#### Setup and convergence

A setup switch that sets the bias on

the picture tube and at the same time kills the vertical deflection for making gray-scale tracking adjustments is a standard feature on all American-built sets. The Toshiba color set does not use this switch but does have individual gun killer switches mounted on the convergence panel (a "why not" feature that would be a welcome addition to any color set). The killer circuit is interesting and is shown in Fig. 6. Note that 100,000-ohm resistors are switched in but *not* in the control grid circuit. These are switched into the circuit to reduce the voltage on the CRT screens. This permits long leads without the possibility of video deterioration.

Several new sets (and many of last year's) use an H-bar plastic magnet holder for the dc convergence adjustments and a slightly different design for the blue lateral magnet. These changes are shown in Fig. 7.

#### Hv regulator changes

High-voltage regulator circuits are

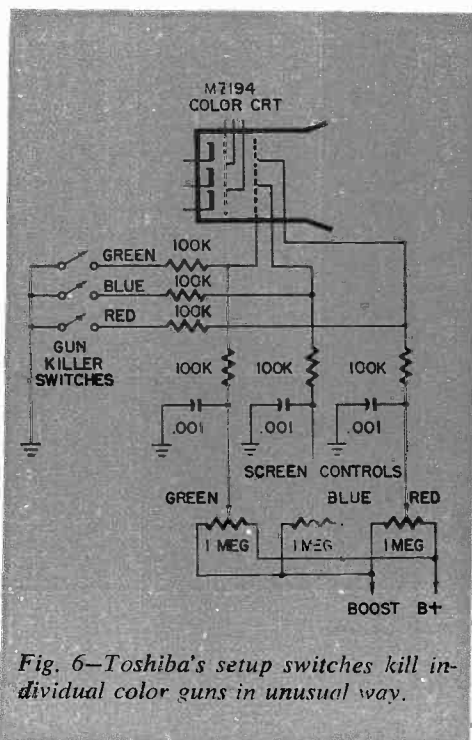

Fig. 6—Toshiba's setup switches kill individual color guns in unusual way.

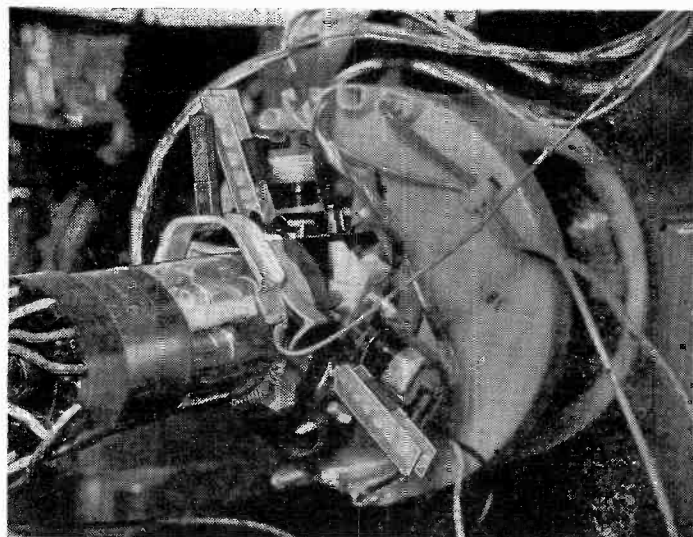

Fig. 7—Closeup of CRT neck shows "H" — cross-section convergence magnet holders and sliding blue lateral magnet.





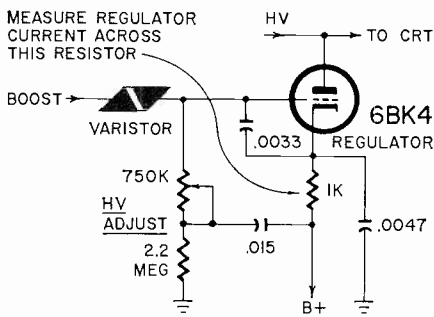

Fig. 8—Motorola circuit regulates high voltage with a varistor.

starting to feel the effects of refinement. G-E, Magnavox, Philco and RCA have a "video controlled" circuit. (You'll find a schematic of this, too, in the RCA CTC 15 article.) This circuit tends to reduce blooming when there is a large amount of white in the picture. Compensation is needed because the picture tube draws more current from the high-voltage supply when the white content of the picture increases.

The RCA circuit feeds a monitoring voltage from the plate of the video amplifier to the grid of the high-voltage regulator through a 12-megohm resistor. When white content is high, the plate voltage of the video amplifier is lower. This lower voltage lowers the regulator grid voltage slightly and the regulator tube draws less current, puts less load on the high voltage, and the high voltage rises.

Motorola uses a varistor in series with the boost voltage to the grid of the 6BK4 shunt regulator (Fig. 8). This voltage-dependent resistor tends to accentuate the effects of boost-voltage changes and so provides somewhat better regulation. An ordinary resistor here would pass the boost-voltage change to the grid in a 1-to-1 ratio while a varistor of this kind passes more current with an increase in voltage than you'd expect

from Ohm's law. The resistor looks like less resistance in the circuit when the voltage is higher, and like more resistance when the voltage falls.

### Pincushion correction

The 23-inch rectangular tubes are not without circuit problems. One major one is the more noticeable effects of pincushioning (lines bent) at the outer edges of the raster. Permanent magnets, as used with wide-angle black-and-white tubes, are not the answer in color because the magnets affect both convergence and purity. To whip this problem, Motorola developed a "Dynamic Pin Cushion Corrector" (DPCC) circuit. Fig. 9 is a simplification explaining how it works. A pulse from the plate of the vertical output tube is shaped and fed to the grid of the DPCC tube. In addition, a horizontal pulse is fed into both sides of the primary of the DPCC transformer (one side by way of the cathode of the DPCC tube). The secondary of this transformer is in series with the vertical yoke windings. The combinations of these voltages provide a method of speeding or slowing the scan at the upper and lower edges of the tube.

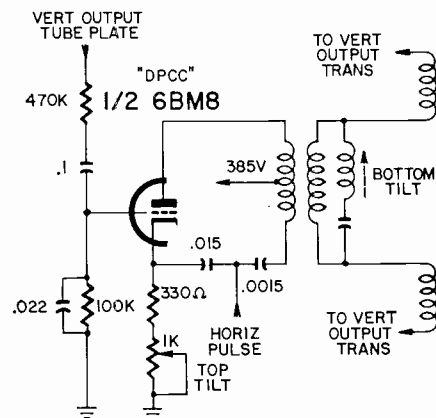

Fig. 9—Dynamic Pincushion Corrector circuit in Motorola 23-inch color set.

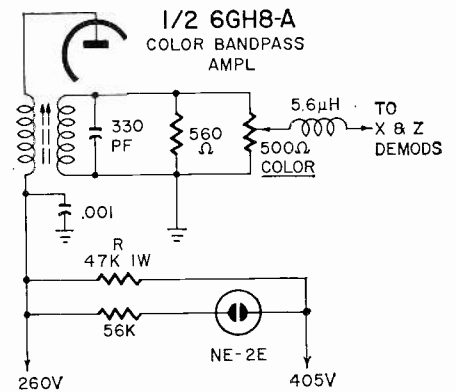

Fig. 10—Magnavox modified the RCA CTC 15 by adding a color program indicator light.

A control in the cathode circuit is simply adjusted for most correction (straightening of the bent lines) at the top of the picture while the slug-tuned coil across the transformer secondary is adjusted for best correction at the bottom of the screen.

### "Color" indicator lights

Motorola and Magnavox have lights to indicate that the set is receiving a color program. Fig. 10 shows how Magnavox modified the RCA CTC 15 chassis to provide an indicator. When no color program is being received, the color killer keeps the bandpass or "color i.f." stage cut off; this means there is no drop across R and the neon does not light. During a color program, the bandpass tube is on and the drop across the 47,000-ohm resistor exceeds the firing voltage of the NE-2E, which then glows.

The "1964 Color Facts Chart" shows you how the sets compare. Check it over to see what new tubes you may need to stock. [Too late to work it in here, we learned that Motorola has introduced a new chassis, the TS-912A-00, which has several new tubes and simplifying features. We hope to describe it in an early issue.—Editor] **END**

The 1964 Admiral color TV chassis.

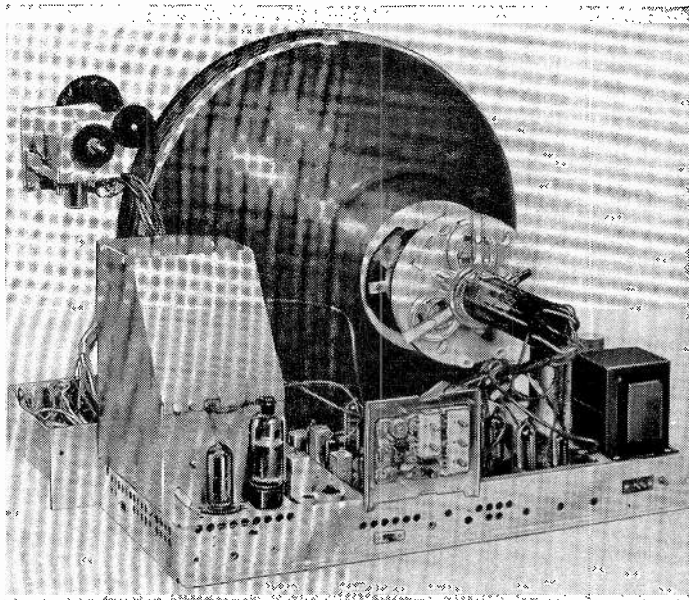

Toshiba's 16WM has several new ideas, described in this article.

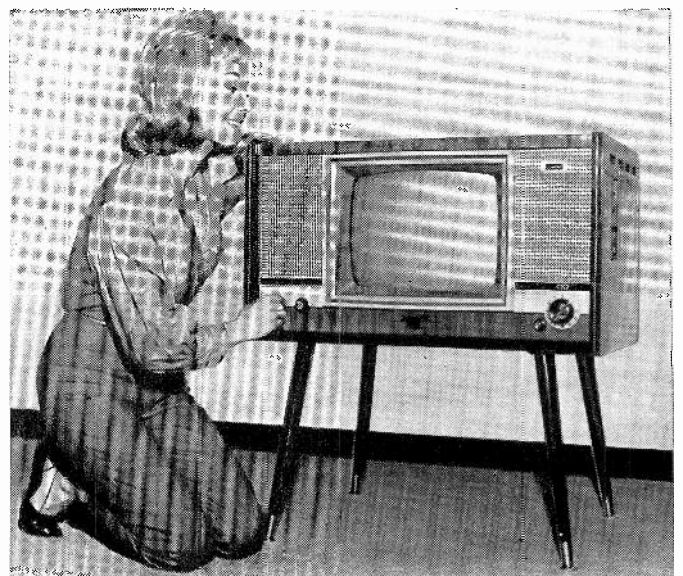



# COLOR TV!

## Today & Tomorrow

By DAVID LACHENBRUCH

### Color television's first decade—and a look at its future

THE COLOR TELEVISION BOOM, EXPECTED almost continuously since 1954, is at hand. The tenth anniversary year of the commercialization of color TV—1964—will be the first year in which sales of color sets to the public will probably exceed one million. Commercial color broadcasting was officially authorized by the FCC on Jan. 2, 1954, and the first color receivers rolled off production lines on March 17 of the same year.

Industry forecasters expect color sets to account for about 14% of TV unit sales next year, and fully 30% of television sales dollar volume. And color will be contributing a continually increasing percentage of TV servicing revenues.

The saga of RCA's unflagging persistence, and its investment of more than \$130 million in color, is a familiar one.

As a result of this almost single-handed effort, the shadow-mask tube and associated circuits represent the only commercially accepted method of obtaining a color TV picture in the home to this very day.

Where does color go from here? What of the various inventions we have heard of since 1954? Are there new tubes, new circuits and new principles in the works which promise to simplify, improve and economize home color TV? Many of the clues lie in color's 10-year commercial history.

RCA quite frankly expected color television to catch fire from its very introduction in 1954. The American public had other ideas, and the first color set—the 15-incher which gave a 12-inch picture at about \$1,000—laid an egg. People wanted a bigger picture, it was said.

This condition was remedied the next year, when the 21-inch color set was born. It had a round tube, with 70° deflection, similar in appearance and principle to today's color tubes. Not only RCA, but Admiral, Emerson, General Electric, Magnavox, Motorola, Sylvania and others began color set production, some using RCA's 21-inch tube and others using 21- or 19-inch shadow-mask tubes produced by other makers.

Public response continued listless. Word spread that color sets were difficult to tune, almost impossible to keep in adjustment and that all you could see on them was purple people-eaters. By 1956, RCA cut list prices on its color sets to a low of \$695 and then to \$495, but color had a bad name. Most other set manufacturers—although affirming their faith that color was inevitable—ended production and liquidated their color inventory for what it would bring.

From 1956 through 1959, color sales leveled off at between 75,000 and 90,000 sets per year, as compared with 6 to 6.5 million black-and-white sets. In 1958, CBS ended all regular color broadcasts. Those were color's bleakest years. Nevertheless, NBC continually expanded its color broadcast schedule, and RCA engineers continued to engineer improvements into the color chassis and tube. These improvements were slow and gradual—there were no dramatic breakthroughs.

Color sales showed signs of more life in 1960, when they broke through the 100,000-set barrier, while network programs exceeded 1,000 hours for the first time. RCA and Packard-Bell were actually the only ones making color sets at the time, but Admiral was having some success in marketing sets built for it by RCA. The increase in programming and the improvements in color sets, together with RCA's advertising campaign, were beginning to influence the industry, particularly at the dealer level.

Color's real turning point came in

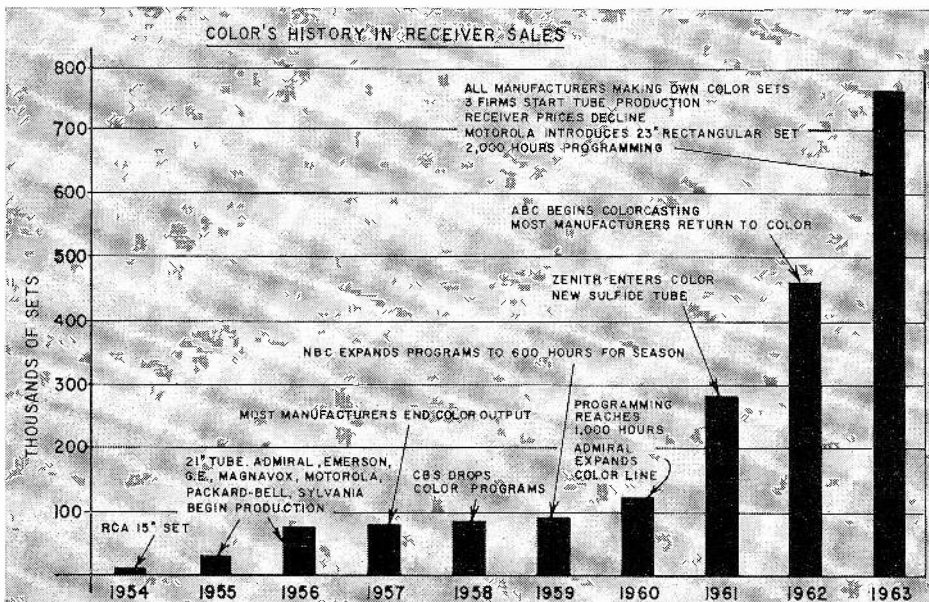

This chart shows slow start of color television, and the sudden rise in the number of sets sold during the past two years. These are author's estimates, since there are no official statistics. Each year brought with it some significant event—sometimes negative, as in color's "bleak years" 1956–1959, sometimes positive, as in the years since 1959.

1961, with the dramatic announcement that RCA's arch-rival, Zenith, was preparing a line of color sets at the request of its dealers, to give them a "full line" to compete with anything other manufacturers had to offer. The remainder of the set manufacturers quickly fell in line. Most of them, however, had once been burned by heavy losses on color, and were unprepared—or unwilling—to set up for their own production. RCA was only too willing to help them by supplying complete color chassis or kits of essential parts.

The same year, RCA introduced a new version of its 21-inch round 70° color picture tube. Sulfide phosphors—of the same type used for black-and-white—increased brightness and contrast, and reduced color smearing and trailing. Sales more than doubled in 1962. The ABC television network edged into color broadcasting, although CBS was (and still is) holding out.

But color was still highly controversial. Manufacturers began to dust off and re-evaluate old color receiver systems they had developed in the early 1950's and shelved. Among major set manufacturers, Motorola was one of the few which had not re-entered color, insisting that the bulky, round 21-inch 70° picture tube made color cabinets too ungainly for most living rooms.

While color set sales boomed, the picture-tube controversy accelerated. Working with National Video Corp., a Chicago picture-tube manufacturer, Motorola developed and demonstrated prototypes of a 23-inch rectangular 90° picture tube, about 6 inches shorter than RCA's round tube. RCA countered with the announcement that it would change over to a new shorter color tube, still a 21-inch round, but with 90° (instead of 70°) deflection. Then, as 1962 neared an end, RCA Tube Div. told its set-making customers that it would be unable to deliver the new short tube because of "technical difficulties" and reliability problems.

Color roared into 1963, and sales this year are expected to end up between 650,000 and 850,000. Among these will be some using the new 23-inch Motorola rectangular 90° tube, which is based on the same shadow-mask principles as the RCA 21-inch. The glass bulb is basically the same as that used for 23-inch black-and-white tubes, but reformed to color's more exacting tolerances.

This year saw the first reductions in the base price of color sets in 7 years. Admiral shocked the industry by introducing a table model at \$399.95, and the rest of the industry came down to \$449.95. Meanwhile, the year closes with three new manufacturers of color tubes—Sylvania, Rauland (Zenith) and National Video—in addition to RCA.

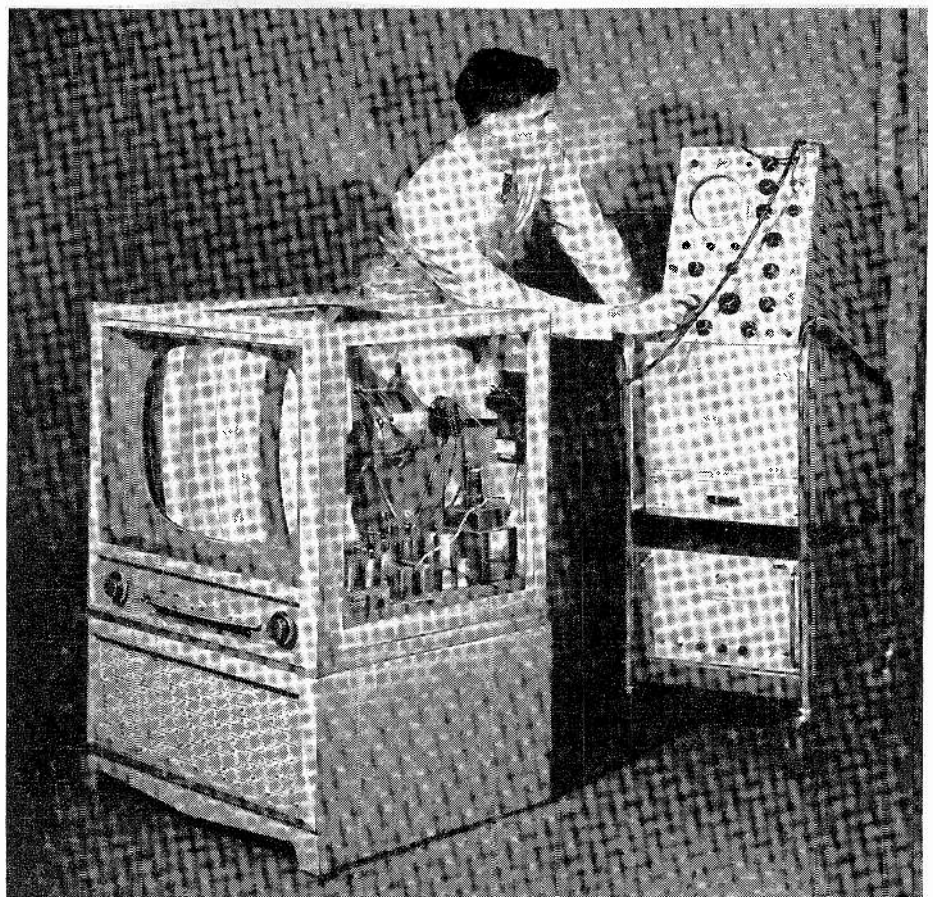

*The old Apple tube, developed by Philco around 1956. Somewhat similar principles have been used in later inventions, including the recently announced Goodman tube.*

Perhaps this year's most significant color action was RCA's decision to discontinue the manufacture of color chassis and kits for its competitors by the end of 1963. It needed the production capacity for itself. So, as 1963 ends, virtually every American TV manufacturer is building its own color sets.

Today there are probably 1.7 million color sets in use—about 70% of them sold within the last 2 years. (Since no color TV sales statistics are released, all figures in this article are unofficial estimates by the author.) Color sales are generally expected to exceed one million next year, with color sets in use passing the three-million mark early in 1965.

#### **What of the future?**

The current color TV set, despite many refinements and improvements, is basically a highly reliable and somewhat simplified version of the receiver built by RCA in 1955. What are the prospects for significant changes and completely new concepts in color receivers in the near future?

There's no question that the first important change will be in the picture tube. The 70° round tube is nearing the end of its cycle. Now being built by RCA, Rauland and Sylvania, it has perhaps another year or so to run. The industry is expected to standardize on a new color tube of the square-cornered rectangular type, with 90° deflection and measuring 25 inches diagonally. There may be an additional small color tube—a 19-inch rectangular, also with a 90° angle.

Glass bulbs for these new-size color tubes are being developed by Corning Glass Works. The new 25-inch rectangular color sets could reach the market in spring 1965—possibly as early as late 1964—completely supplanting the current round tube. (Motorola's 23-inch color sets are built to accommodate the 25-inch tube as a replacement.)

The 25-inch tube won't be new in its operating principles. It will use the same shadow-mask concept featured in all production color tubes since 1954. It will require relatively minor changes in chassis design. In fact, the new color chassis (CTC 15) introduced by RCA last summer already goes a long way toward accommodating this new 90° tube.

#### **Revolutionary developments**

Of all the other color TV tubes and receiving systems proposed in the early 1950's, the Chromatron, or Lawrence tube, has been the most durable. Paramount Pictures, which owns the rights to the tube, has periodically demonstrated to set manufacturers two versions—the single-gun Chromatron, claimed to make possible a color set at only 25% more than the cost of black-and-white, and a three-gun version, which provides more brightness than present color tubes.

No American manufacturer has recently shown an overwhelming interest in Chromatron. But Sony Corp., of Tokyo, has taken out a license with an eye to developing a portable color set using Chromatron principles. Sony offi-



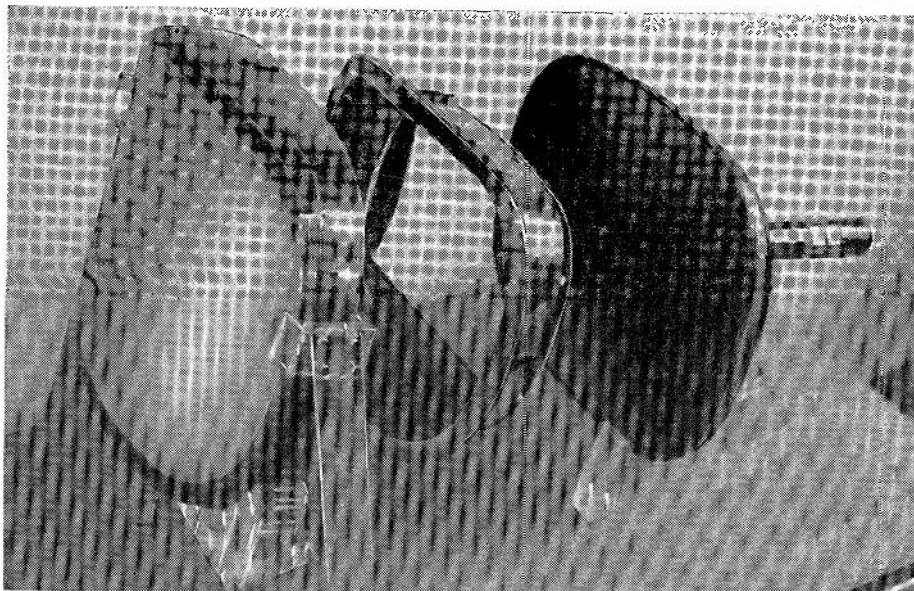

Exploded model of Chromatron. Fine wire grid that deflects electrons onto correct color strip is held by center section, and cannot be seen in photo.

cials, however, say that they are still far from knowing whether they can, or will, produce such a set.

Another development of the mid-1950's, similar in principle to the Chromatron, was General Electric's post-acceleration tube. Of course, there's no way of knowing whether this development is being revitalized in G-E's labs, but there's no evidence that it is.

Philco's beam-indexing "Apple" system created a stir in color's early days, but it's not believed that company is pursuing it now. A New York inventor, David M. Goodman, recently received a patent for a system similar to Apple in many respects. Several set manufacturers have studied his development, but that's about as far as it has gone.

A new company, Video Color Corp., has been formed on the West Coast to develop a thin color tube based on the patents of W. Ross Aiken (thin tube) and C. Willard Geer (color tube). Its major efforts for the time being, however, will be devoted to military display devices.

Color projection systems have always had some appeal because they promise to eliminate the complex three-color direct-view tube. Projection in color, however, has suffered from the same failing which prevented projection from gaining widespread use in black-and-white—poor brightness. In addition, there are color registration problems.

Two color projection systems, which claim to overcome these shortcomings, have recently attracted attention as potential home TV devices. One, invented by J. H. Owen Harries (Harries Electronics Corp., Bermuda), is a low-cost system using a special plastic distortion-correcting lens and four projection tubes, claimed to result in possibly 50% greater brightness than the direct-view system.

Another projection system, developed for theater use, may eventually have potential for the home. It's G-E's Talaria light-valve projector, whose giant-screen version sells in the \$50,000 range. Instead of cathode-ray tubes, this projector modulates a thin layer of fluid with two electron guns (one for green, the other for red and blue). A xenon light, beamed through the fluid, produces a color TV image of movie brightness. It's believed G-E is developing a smaller version of Talaria, but its cost probably will be well up in the thousands of dollars for some time, precluding use in the home.

The plain fact is that introduction of a radically new color receiving system is unlikely in the near future. The reasons are economic as well as technical. The tremendous costs of development and tooling of completely new systems would outweigh many of the advantages. Today's receiving system is far more than adequate. Any new system would have to promise markedly better performance or much lower cost to receive serious consideration. Even a system which could be proved to be slightly better or slightly cheaper would probably be rejected—and, to the best of our knowledge, nothing of this kind is in sight.

Nevertheless, you can expect many changes and improvements within the present approach to color TV reception. For the first time, color TV is competitive. "Ghost manufacturing" is past; every manufacturer makes its own sets. Finally there's a strong incentive for each to develop its own proprietary circuits and cost-reduction systems for better, more economical and more reliable receivers.

Color's decade of pioneering is coming to a close. The era of color TV in the home has begun. END

## Zener diode bias supply

By RONALD L. IVES

IN A WIDE VARIETY OF AMATEUR, EXPERIMENTAL and industrial electronic assemblies, a stable low-voltage source of negative bias is necessary or desirable. Conventional bias supplies usually burn up several watts while supplying only milliwatts. Also, they are bulky.

With dependable Zener diodes, much of this bias supply difficulty can be eliminated, and a regulated fixed or variable bias voltage can be obtained from the plate supply circuit.

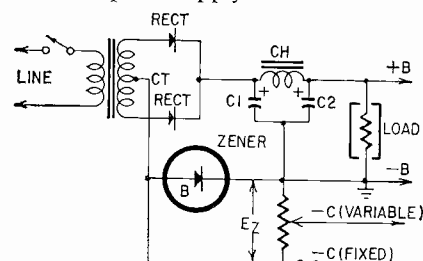

A typical Zener bias supply circuit is shown in the diagram. Here, the plate supply transformer center tap has been lifted from ground, and a Zener diode of the desired voltage (or higher) has been inserted between the transformer center tap and ground. The center tap is now negative, with respect to ground, by the Zener voltage  $E_z$ . Fixed bias can be taken from the transformer center tap, and will be regulated at the Zener voltage. For variable bias, shunt the Zener diode with a potentiometer and take the bias off at the arm.

Once the bias voltage is decided upon, calculate the wattage rating for the Zener diode by multiplying the maximum current in the negative return circuit by the rated voltage of the diode. Be sure that the current value is the true maximum. Select a wattage rating slightly higher than that called for.

Be sure to follow the manufacturer's instructions regarding heat sinks. Adequate heat sinks are *much* cheaper than replacement Zeners.

Where variable bias is required, the resistance of the potentiometer across the Zener diode can be almost anything from 50 ohms per volt to more than 1,000 ohms per volt. It doesn't matter much except where substantial currents are drawn from the bias tap. *However, at minimum current, the voltage drop across the potentiometer must be greater than the Zener voltage, or the Zener diode will not regulate.*

As should be obvious, the bias voltage we get this way is subtracted from the plate voltage. Where the loss (generally small) is important, it can usually be restored by increasing the value of C1, the first filter capacitor. END

# COLOR TV SERVICE IS SIMPLE



It's like black-and-white plus a few new circuits — and they are not that new

By JOHN FITZGIBBON

I'M GOING TO MAKE A CONTROVERSIAL statement: Color TV is no harder to service than black-and-white! You do *not* need a Master's degree in electronic engineering and thousands worth of test equipment. You can even service color at the same service charges as black-and-white—and make money! Prove it? OK, I will!

Pause and consider this indisputable fact—each circuit in a color set uses tubes, resistors, capacitors and transformers. How many other kinds of parts are there? If you can find a leaky coupling capacitor in a black-and-white set, you can surely find one in a color set!

The really “complicated” troubles seldom occur. From your own experience, how many really rough jobs do you run into in black-and-white—percentage-wise, I mean? About 5%, just like everyone else. All the rest are easy. Dead tubes, burned resistors, leaky capacitors, bad filters and so on. If you serviced nothing *but* color TV, you'd find exactly the same proportions; after all, they're *TV sets*, aren't they?

*Example:* one set's picture suddenly turned a bright green. Picture good, sound OK. Give me a diagnosis? Sure! Trouble in the green amplifier tube. Heater-cathode short, no bias, tube ran wide open, and the green drowned out the other two colors. Tube replacement and cure took less than 3 minutes. Many others are equally simple.

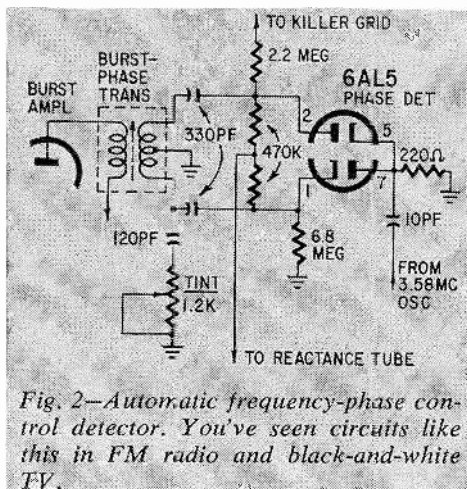

Fig. 2—Automatic frequency-phase control detector. You've seen circuits like this in FM radio and black-and-white TV.

In black-and-white servicing, what do we look for in the way of symptoms? What *is* there, and what *isn't* there—sound, video, sync, etc. From this, we make our first diagnosis and then proceed to check it out. We use the process of elimination to find out just which one of the many possible causes is responsible.

The same process will work in color. You're going to find that the great majority of troubles in color sets are *the same* as those in black-and-white—sound, sync, horizontal sweep, and so on—and you've been fixing those for years. There are only a few extra circuits, just as simple as the rest, and they will give you a very definite set of symptoms when they're not working right!

## Color vs black-and-white

Are there any *new* circuits in a color TV receiver? Circuits that you've never seen before? Let's start at the video detector. Up to this point, the circuits are *exactly* the same as those in black-and-white: tuner, i.f., sweeps, sync, agc, power supply, etc. Let's go down the line and examine each color circuit.

**1. The burst amplifier (Fig. 1).** This is a standard pentode tube, with normal plate and screen voltages. The grid is keyed by a pulse from the flyback transformer, so that the tube actually con-

ducts only during horizontal blanking intervals. So, what does it do? It amplifies the burst signal, which is on the back porch of the horizontal sync. How is this burst separated from the sync, video, etc. signal? How do we separate a 4.5-mc sound signal? Feed it through a sharply tuned transformer! See it in the plate circuit? This transformer has a center-tapped secondary, which feeds the...

**2. Phase detector,** sometimes called  $\epsilon$ pc and other complex names (Fig. 2). Don't let 'em fool you—it's just a plain old ratio detector, discriminator or whatever you want to call it! Compares the phase of the burst signal from the transformer with the signal being developed by the local oscillator, and develops a dc correction voltage to apply to the...

**3. Reactance tube** (Fig. 3), which certainly should be familiar to all the old-timers. The same circuit is used in lots of older TV sets, to control the horizontal oscillator! Afc, in other words.

The small dc control voltage from the phase detector is applied to the grid. This controls the phase angle of the control tube's plate voltage and current, making it behave like a reactance. Thus we can make the tube control the oscillator circuit automatically, by varying the amount of reactance it appears to be. The control comes from the correction voltage, which is in turn developed by the color signal itself. So, we keep the

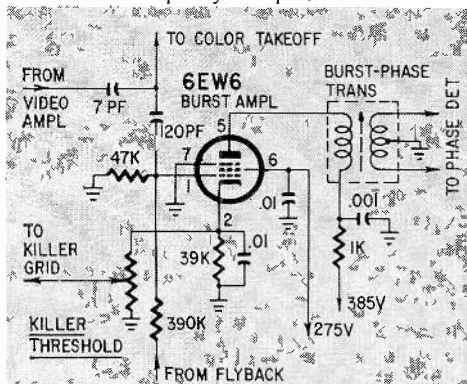

Fig. 1—Burst amplifier amplifies burst only, because it's keyed on grid with a flyback pulse. Input is from video stage.

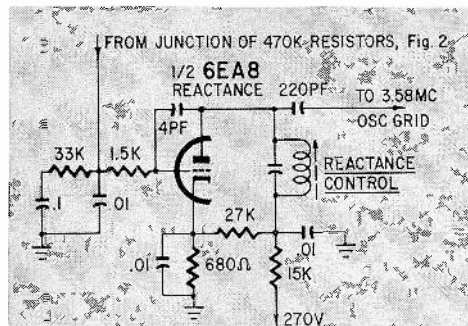

Fig. 3—Reactance tube thinks it's a coil or capacitor! Controls 3.58-mc oscillator. Some TV's used this to control horizontal oscillator.



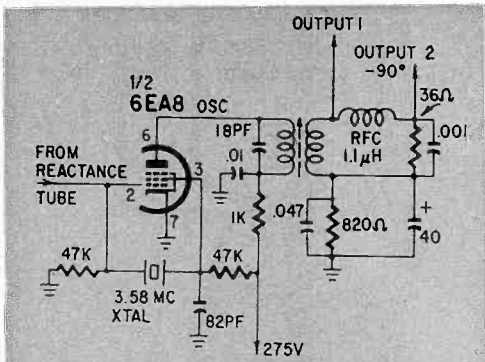

Fig. 4—Pentode Pierce oscillator generates 3.58-mc subcarrier. Same kind of circuit used with pentagrids in AM sets.

3.58-mc oscillator right on frequency.

**4. The 3.58-mc oscillator.** This is usually a standard crystal oscillator circuit. Sometimes it's even a Pierce, which is about as simple as you can get. Tube, crystal, and a few oddments like plate voltage and stuff. Fig. 4 shows a typical oscillator circuit, which, come to think of it, is a Pierce, the original version. This uses the screen grid as the oscillator plate, leaving the real plate free to take off the 3.58-mc signal. (Is this unusual? How about the oscillator circuit in some small radios where a pentagrid tube is used as mixer-oscillator? The screen's the oscillator plate, and the i.f. signal is taken from the real plate. Same thing.)

Control for this oscillator, which isn't needed too badly anyhow, comes from the reactance tube through the 220-pf coupling capacitor. Just enough to keep it right on frequency at all times.

Servicing? Measure the negative voltage on the control grid. If it's about 4-5 volts, the circuit is oscillating; if it's zero or positive, it isn't. About the only thing that can keep a Pierce circuit from oscillating is a dead tube or crystal! The coil in the plate circuit has no effect on the operating frequency; it merely provides a place to get the output signal from. Note the tiny rf choke across the secondary. This shifts the phase of part of the 3.58-mc output so that we can have two signals to use in our color

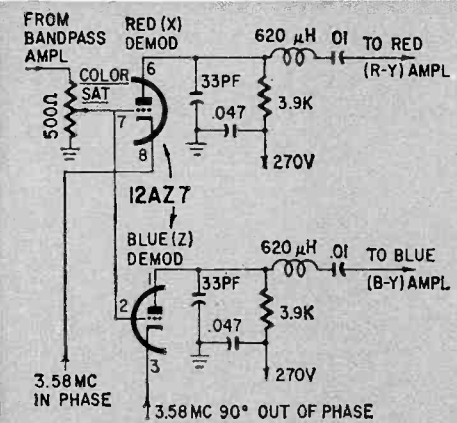

Fig. 5—Color demodulators work in quadrature, keyed by direct and 90°-shifted 3.58-mc voltage.

detectors (one in phase with the burst and another 90° out). These signals are fed to the cathodes of the...

**5. Color demodulators** (Fig. 5). You'll find these called X and Z, I and Q, R and G, you name it—any combination of letters. They all do the same thing: separate the color information from the video signal. How? Phase detection. A good simile is the quadrature-detector circuit used in sound detectors with the 6DT6 or 6BN6.

How do we get the colors separated? Notice that a combination signal, with all colors in it, is applied to both grids. This signal comes from the bandpass amplifier, which we'll get to in a minute. The color signals are all in there, in the form of different phases of the basic 3.58-mc color subcarrier (which was removed at the transmitter to save postage—the 3.58-mc oscillator puts it back in at the receiver).

So, with all of the colors on the grids, we put a 3.58-mc signal from the oscillator on the cathodes. Now, each tube passes only the part of the color signal that's in phase with its cathode signal. Same principle as keyed agc. In the output, we get red in one plate circuit and blue in another. "Wait a minute!" somebody says, "Where's the green?" OK, we make it, in the...

**6. Color Amplifiers** (Fig. 6). Three simple triode amplifier stages. But, you still want to know, where does the green come from? We're putting our red and blue signals onto the grids of the top and bottom tubes. The cathodes are all tied together. So, the cathode voltage on the green amplifier is a combination of the other two colors. Now, the whole color signal is red + blue + green, isn't it? So, what would we have left if we

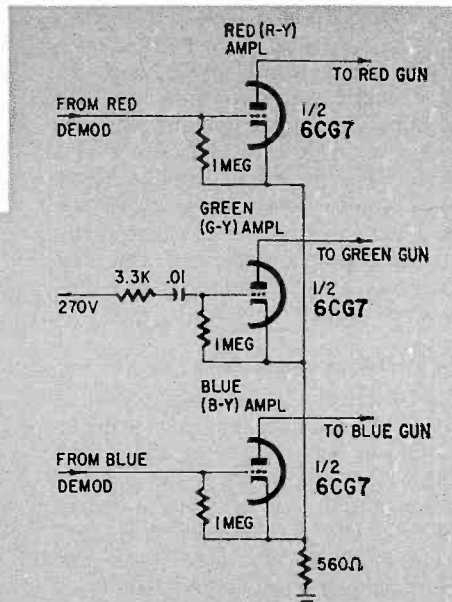

Fig. 6—Color amplifiers. Green signal is "made right in your own home" by subtracting red-blue signal from total color signal.

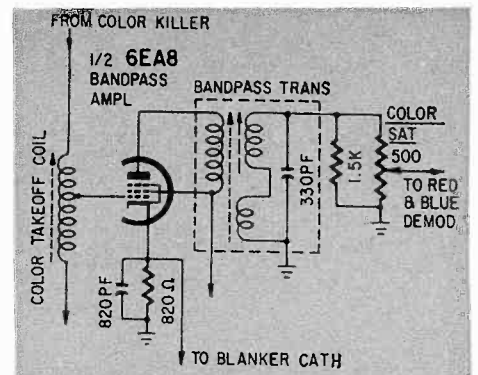

Fig. 7—Bandpass amplifier sounds mysterious, but is no different from typical AM, FM or TV i.f. stage.

subtracted red and blue? Green?

This is what takes place in this tube, because of the arrangement of the cathode and grid voltages. It becomes a sort of backward adding machine, and subtracts the red and blue signals, leaving the green. These are amplified and fed on to the green gun of the color picture tube.

Let's back up and get a few things we had to leave while we were following the color signal through the circuit to the picture tube. One of these is the bandpass amplifier we mentioned as feeding the color demodulator stages.

**7. Bandpass amplifier** (Fig. 7). Actually, this is hardly worth illustrating. If you've ever seen an i.f. stage in a radio or the sound i.f. in a TV set, you've seen the same circuit. Color signal goes to the grid from the color takeoff coil, and the plate feeds the "bandpass" transformer. This is used to clean up the color signals and keep out interference from other circuits. On the secondary of the transformer is a control usually called *saturation*, but which I think ought to be called a "color volume control," since that's how it works. It simply regulates the amount of color signal.

Since this stage handles the whole color signal, it's a good place to put the...

**8. Color Killer** (Fig. 8). What's this for? Its only purpose is to cut off the bandpass amplifier during black-and-white transmissions. Some men have had trouble understanding the thing, because it "works backward," in a way. During color reception, the killer is cut off, and the bandpass amplifier works. During black-and-white reception, the killer works (conducts, that is) and the bandpass amplifier's cut off.

This is basically a keyed stage; see the pulse being applied to the plate from the flyback? So, this tube conducts only during horizontal retrace time. Notice the "balance" circuit in the grid. We get -45 volts from the phase detector by connecting this to one end of the two 470,000-ohm resistors.

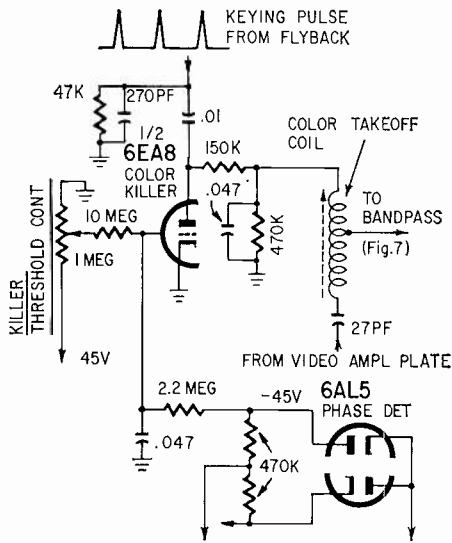

Fig. 8—Color killer. It, too is keyed by pulse from flyback.

(While a color signal is being received, a negative voltage is developed there. During black-and-white reception, this voltage disappears, because there's no color burst to make it show up.) The other end of the 10-megohm resistor goes to a source of +45 volts (the burst amplifier cathode in this case—all we need is a source of positive voltage at the right level). This is fed through the killer threshold control so that we can adjust the grid voltage on the killer stage.

If the killer tube is not conducting, we don't get any voltage drop across the 150,000-ohm resistor in the plate circuit. So, the bandpass amplifier is allowed to pass the signal, which is color. (Killer cut off, bandpass amplifier working.)

When the killer tube *is* conducting, the drop across the plate load resistor puts a negative voltage on the grid of the bandpass amplifier. (Killer working, bandpass amplifier blocked.) So, it can't pass any signal at all because it's

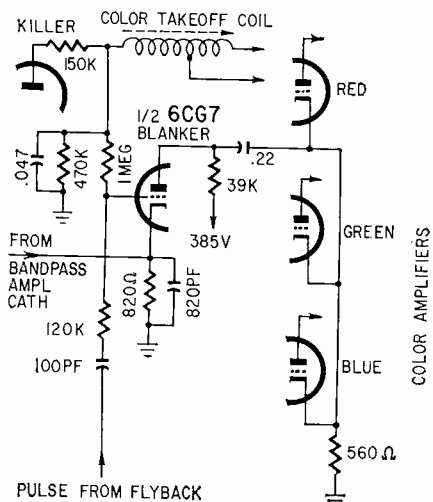

Fig. 9—Blanking amplifier—conventional vertical and horizontal retrace blanking, plus amplifier stage.

biased to cutoff. This keeps the whole color circuit from operating, since all of the color signals have to come through the bandpass amplifier. So, during black-and-white reception, we don't have colored snow on the screen, or "confetti", as they used to call it. This stage is as simple to service as any keyed stage (You *can* fix keyed agc stages, can't you?)

**9. The blanking tube** (Fig. 9). Because there are so many signals going in so many directions around here, we don't want any trouble with retrace of either kind. So, we add the blanking amplifier stage, Fig. 9. This is nothing but amplified retrace blanking. Same circuit used in uncounted jillions of black-and-white sets, except that we are using a tube to be sure that the picture tube stays cut off during horizontal and vertical retrace times.

**The delay line**

The video signal (that is, the one we use in black-and-white containing only brightness signals) goes straight to the picture tube grids. The poor little color signal, on the other hand, gets chased around through all sorts of phase-shifting networks and stuff before it is allowed to reach the picture tube. We have to give the video a little "handicap" so that everybody will reach the finish line at the same time. Actually, this isn't much—usually about 1 micro-second!

The theory of a delay line is very complicated, but a practical delay line may be nothing more than an 8-inch piece of coaxial cable! It takes a signal slightly longer to get through the cable than it does in free space. (The velocity of propagation is lower.) If a greater delay is needed, sometimes a small coil is used inside the delay line, slowing the signal down still more. Only two possible troubles: a broken wire or a short to ground, both fairly easy to find. It isn't possible for the time constant to be changed by any defect.

So, there you have it. We've taken a black-and-white TV receiver and added the color circuits. (Up to the video detector, the circuits are exactly the same as in black-and-white, and subject to the same faults.) While we discussed nine functions, one popular make does them all with only seven tubes.

"But!" somebody says, "they don't all work that way!" So? How about black-and-white sets? Are they all alike? If they were, you could carry your Sams Photofact file in your shirt pocket! Naturally, there are differences. Circuits are changed and simplified all the time, just as in black-and-white. The earliest practical color set was a fat 24 inches on each side, weighed about 75 pounds and used 44 tubes. The latest is half that volume, uses 24 tubes and you can carry

it in one hand.

Natural differences in approach are trivial. RCA, for example, uses a three-stage video amplifier. Zenith uses a single high-gain tube. What's the difference? Both circuits work, and work very well, and are equally easy to service.

**Test equipment**

"But," comes that same plaintive voice from the back row, "You've got to have so much *equipment* to service color TV"! Are you in again? I thought you'd left. Well, let's see. On how many black-and-white sets do you use a scope, sweep generator, marker-adder, flyback tester, capacitor tester, pattern generator? *About 5% or less.* Most of the troubles are *simple*: dead tube, bad capacitor and the like. You're going to find color *exactly* the same.

So you can use your present test equipment to service color. Later on, you can add color bar generators, etc. You must have them if you want a completely equipped shop. However, if you *can* service 95% of the sets with your present equipment, what better percentage do you want? The most useful piece of test equipment in the shop is that mass of gray mud between your ears!

**Service information**

Fortunately for us, a mass of service information and help is available. Set manufacturers have spent millions printing color training courses, holding service meetings, and doing everything they could to get the basic idea of color over to us. We ought to be grateful to them, and most of us are.

While I have been mildly critical of them at some times in this discussion, it was intended to be helpful. Although they were the culprits at first in complicating things, they have begun to use the "simplifying" approach to the subject, and it is showing up in the increasing number of men who are happily and profitably servicing color TV.

I am firmly convinced, from associating with them for the past 35 years, and from being one myself, that the US electronics technicians are unequalled in all the world. From the simple circuits of radio, they tackled the infinitely more complicated apparatus of television, FM, hi-fi, etc., and mastered it. The difficulties we have had with color in the past have not been due to any lack of either ability or capability, but simply to that subconscious fear, the block set up by the *apparent* complexity of the circuits.

Once we realize that color television is *not* as complex as it might seem, we're well over the hump. After all, and always remember this—we're not *designing* these circuits: we're just *repairing* them! They did work once, and they can be made to work again. All we have to do is locate the defective part and replace it. Let's go! END



# NEW TUBES for COLOR TV

Why all the new numbers? What's been improved?

By **PETER E. SUTHEIM**  
ASSOCIATE EDITOR

WHEN COLOR SETS FIRST APPEARED almost a decade ago, most of the tubes in them were familiar to anyone who had worked with TV. As in the earliest days of black-and-white, existing tubes were pressed into service—sometimes even strained to their limits—for new applications. Remember when the only damper tube was a 5V4-G? When 6L6's and 807's were used as horizontal output tubes?

But increasing demands brought special tube types for special needs, and now it sometimes seems that manufacturers develop a new type at the slightest provocation. Let's take a ramble through this bewildering welter of new tubes designed for color TV, and see if we can make some order out of it.

## Rf and i.f. tubes

Since the signal requirements for color TV are stricter than for black-and-white, there has been a trend toward higher-transconductance, lower-noise rf amplifier tubes. The Zenith 25LC20 chassis is using two recent AmpereX types: the 6HA5 and 6GJ7, as rf amplifier and mixer-oscillator tubes. They are among the highest-transconductance tubes today—20,000  $\mu$ mhos for the 6HA5 and a conversion transconductance of 5,000 for the 6GJ7. The front-end gain with these two tubes is something over 200, with a low noise figure.



Though RCA has made no changes in its front-end complement, there is a new tube in the first i.f. amplifier socket—a stage that demands high gain with low noise and wide bandwidth. Where the CTC 12 used the 6BZ6—already a pretty “hot” tube—the CTC 15 has the new 6JH6. Similar to the 6BZ6 in most ways, it has a tightly controlled cutoff point intended to provide headache-free interchangeability with others of the same type. According to RCA engineers, there were problems with certain 6BZ6's in the agc'd first i.f. stage, which is critical about its bias voltage. The new 6JH6 is said to introduce less cross-modulation distortion in areas where channels 6 and 8 are strong.

The newly introduced Heath color

TV kit also uses the 6JH6 as first i.f. amplifier.

## Deflection tubes

The husky 6DQ5 in the RCA CTC 12 chassis has been replaced in the 15 by the still-more-rugged 6JE6. Heath is using it, too. It has a nine-pin “novar” button base instead of a cemented-on bakelite base, to dissipate heat better than before and to eliminate soldered connections between elements and base—always a potential failure spot. Dual connections to control and screen grids raise the dissipation rating to 25 watts total. It has a lead-glass bulb, which reduces electrolysis and eventual gas contamination, and a copper-core plate structure to prevent “hot spots.”

The Zenith 25LC20 chassis uses a 6HF5 compactron as horizontal output. Its plate and screen dissipation ratings are 28 and 5.5 watts, respectively, and it can withstand a peak cathode current of 1.1 amperes. Designed for a plate supply voltage (boost plus dc power supply) of 990, it should stand up well to the demands of high-energy deflection in color circuits.

In the vertical department, a 6GF7 makes its debut with RCA, replacing the older 6EM7 octal. The new tube is simply a novar-base version of the 6EM7—electrical characteristics are the same. A high- $\mu$  section is the oscillator, and the low- $\mu$  section is the vertical output stage.

A 6U10 triple-triode compactron is used in the Zenith chassis this year to simplify the horizontal oscillator and afc wiring.

Zenith uses a 6HE5 compactron as vertical output. It has a 12-watt plate and a 2.75-watt screen dissipation, and is more or less a compactron version of the 6EZ5 octal. The compactron base again offers greater reliability, like the novar. (The construction of the two base types is similar.)

The vertical oscillator in the Zenith

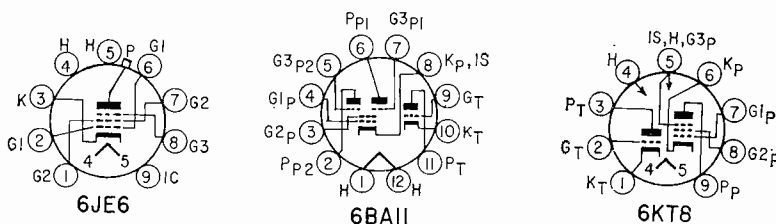

The only distinctly new base diagrams among the tubes mentioned here are those of the 6JE6 horizontal output tube, the 6KT8 triode-pentode, and the 6BA11 triode-dual-pentode. The 6U10 compactron is similar to previous triple-triode compactrons (6C10, 6D10, 6AV11, etc.) except that pin 8 is not used at all. Note the connection in the 6KT8 of the suppressor grid to one side of the heater.

is the triode of a 6BA11 compactron that also works as sync separator and agc amplifier. Besides the triode, it contains a dual pentode of the 6HS8-6BU8 type, with independent No. 3 grids and plates. Related functions were merged into one envelope to reduce wiring. According to Zenith, this made it possible to use the separate 6HE5 vertical output tube without increasing complexity.

#### Color circuits

A 6GH8-A has replaced last year's 6EA8 as bandpass amplifier and color killer in RCA's circuitry, to give higher drive levels to the color demodulators. The pentode section, used as bandpass amplifier, has higher gain than the earlier type. Base connections and ratings are identical for both. The 6GH8 has been around, and really only the "A" is new: it denotes the use of RCA's "dark



heater," to increase tube life and stability.

The red and blue amplifiers are the two sections of a 6GU7 nine-pin miniature, and the green amplifier and blanker are the two halves of another. The 6GU7's have replaced the 6FQ7's of the CTC 12 because the new CRT in the CTC 15 has higher drive limits. To take advantage of that, RCA engineers designed a tube with higher plate current, and point out that the combination of new CRT and new amplifiers gives better color brightness and contrast.

Zenith uses two color amplifier stages before demodulation: the pentode sections of a 6KT8 and a 6HL8. Both pentode sections feature transconductance of 10,000  $\mu$ mhos and up, and are otherwise similar except for basing. Both are paired with triode sections in the same nine-pin miniature envelope. The 6HL8 triode section is a medium-mu tube (40) used as a cathode follower to present a low source impedance to the delay line and Y-amplifier. The pentode section's high gain gives the set greater ability to hold color under adverse conditions, according to Zenith engineers.

Previous Zenith circuitry used the pentode of a 6GH8 followed by a

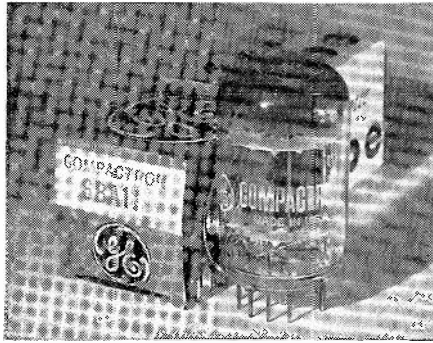

6AU6 as color amplifiers, both of which have considerably lower transconductance than the tubes now used. The single-function 6AU6 has been replaced by the 6KT8 pentode-triode pair, again reducing cost and complexity of wiring. The high-mu triode section is the color killer.

The new 12GN7 pentode is used in both Zenith and Heath chassis as video output. It has very high transconductance (36,000) and was chosen to give adequate drive with good bandwidth.

#### Sound detector

The RCA CTC 15 uses a new gated-beam limiter and sound demodulator, the 6HZ6. Heir to the noble tradition of the 6BN6, which started it all about 10 years ago, the new tube offers greater audio recovery for the same FM deviation. Unlike the 6DT6 and 6GX6, both similar types, the 6HZ6 has a special screen-grid shielding construction to suppress uhf parasitics that cause trouble during uhf reception. This same tube is also used, incidentally, in RCA black-and-white sets with uhf.

#### High voltage

A new high-voltage rectifier is the 3AT2, used in the Zenith 25LC20 chassis as main high-voltage rectifier. It's a compactron with a heater-cathode and multiple connections for heater and cathode to simplify wiring. The tube has an internal corona shield connected to cathode and heater (which are electrically common to each other). In the Zenith, it produces 25 kv with no apparent strain.

Zenith also uses a new focus rectifier interchangeably with the 1V2, the 1AU2. It is a more rugged tube, and has a 1.1-volt 0.19-amp filament.

New color-TV tubes will be described as they appear, in the "New Semiconductors and Tubes" department of RADIO-ELECTRONICS.

So—there *are* reasons for these new tubes. The differences are often subtle and slight, but they are part of an overall trend toward refinement, "de-bugging" and greater reliability. Improvements like these help turn color TV from a risky, temperamental "plaything of the idle rich" into a practical, dependable home-entertainment medium. Stick around! END

## HOW WELL DO YOU KNOW YOUR UNITS?

BY TOM JASKI

IN RADIO, ELECTRONICS AND HI-FI, WE make daily use of certain units of measurement. Do you really know what these units mean, what their precise scientific definitions are? Certainly, you can measure an ampere with an ammeter, and you know that if you send 1 ampere through a resistance of 1 ohm, you must have 1 volt to do it. But what are these units? See if you can answer these, then turn to page 77 for the correct answers.

1. Define a volt.
2. Define an ampere.
3. Define an ohm.
4. How much of what is a maxwell?
5. Ever hear of a gilbert?
6. Know what a joule is?
7. What do you think a myriawatt is?
8. Where will you find a weber, and what is it?
9. What are a dyne and an erg?
10. Ever hear of an oersted?
11. How much of what do we measure with a gauss?
12. Now for a tough one. What is a baud?
13. Tell us what a sabin is?

Answers on page 77. How did you do?

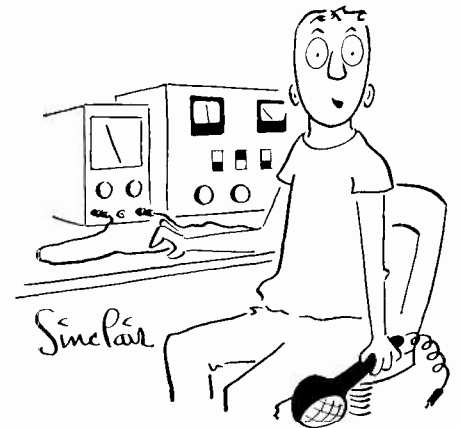

"Why, yes sir, your photoflash equipment is ready."





Winegard

# ANTENNAS and BOOSTERS for COLOR TV

Signal strength can make the difference between good and poor color—or none at all!

By ARTHUR CUNNINGHAM

A COLOR TV SET WITHOUT THE RIGHT antenna is usually a color TV set without color. The cliché about the Cadillac that won't run without gasoline applies equally well to color TV. A thousand-dollar set can't make satisfactory color pictures without the right antenna.

The color antenna must have three things: good gain, ample bandpass and complete freedom from parasitic resonances. This last includes the entire system: antenna, transmission line and booster, if one is used. Pattern shape and front-to-back ratio are very important, in some applications, for maximum freedom from ghosts and interference.

These requirements are not hard to fill. Any *good* antenna will. Ordinarily, if an antenna gives really good pictures on black-and-white, it will be suitable for color.

## Antenna troubles

The symptoms of antenna trouble in color reception are definite. 1. Excessive snow or confetti indicates that the signal level is too low. 2. Intermit-

tent drift or sudden shift in colors is usually caused by parasitic resonances, called "dropouts" or "suckouts", in the antenna system. These cause standing waves on the lead-in, and cancel the color burst or shift its phase.

A good quick-check for this last condition is to disconnect one side of the lead-in as you watch a color program. If the color returns, though the picture goes down into the snow, standing waves are probably cancelling the burst. Wrap a small piece of tinfoil around the lead-in and slide it back and forth while watching the color. If you find a point where the trouble disappears, tape the foil there. This point may not be the same for all channels—you'll have to experiment.

A third trouble, found mainly in fringe areas, is multipath reception from distant stations. The delayed reception of the second signal causes wavering colored ghosts and color shifts because of phase differences between the two bursts. There is no foolproof remedy

for this, but it is almost always temporary, lasting 2-3 minutes at most.

## Primary-area troubles

Primary areas also have their share of antenna troubles. If rabbit-ears or built-in antennas are used for color reception, field interference caused by people walking between set and station, reflections from steel-framed buildings or similar objects, can cause color trouble. This is usually in the form of a sudden loss of color. If the set can be placed on the wall of the room nearest the station, the effects will not be so noticeable.

A better remedy is to relocate the antenna. Mount the rabbit-ears on the wall above the set, or use a window or attic antenna. The method depends on the circumstances. A simple dipole in an interference-free area up in the eaves, for example, will often help. This should be cut to channel, of course.

In suburban areas, attic antennas are very useful. They are made in several types, some quite directional, with rotators, and are fastened to the underside of roof rafters. An easier installation can be made with the small roof-mount antennas such as the one of Fig. 1. They are made in several sizes, depending on the needs of an installation. The model shown has medium gain and directivity. Others have more elements, to give you a narrower pattern if you need it. This is often necessary to eliminate ghosts caused by reflections from nearby objects.

## Signal levels

Too much signal can cause as much trouble as too little. Tuners in color sets are very sensitive, and very high signals can cause curve shift to the point where

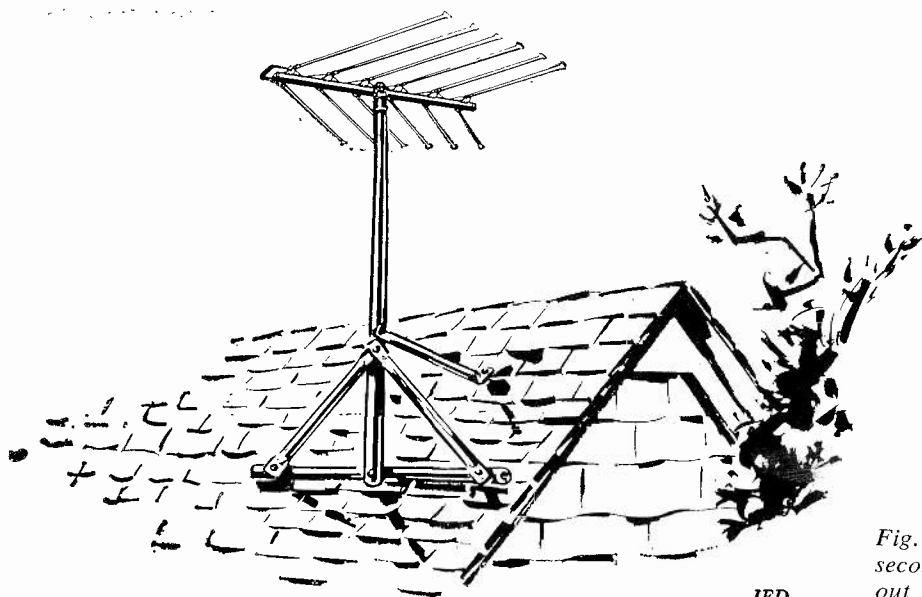

JFD

Fig. 1—Small roof-mount antenna for secondary areas may be sufficient without booster.

**Table I**  
**ANTENNAS FOR DIFFERENT AREAS**

Area (miles)	Antenna type	Booster?
Primary: 0-10	Rabbit-ears, built-in, simple dipole, window-mount, attic-mount.	
Secondary: 10-50	Roof-mount: dipole-reflector, small combination types, broad-band, log-periodic. Conical with reflector.	Under some circumstances. Test for improvement in picture.
Fringe: 50-100	Broad-band Yagi, log-periodic. Same, with built-in booster. Rotator probably needed also.	Yes. Built-in or added later. Top-mounted or connected behind TV set.
Deep Fringe: 100-150	"Long" broad-band Yagi; multiple elements, with built-in booster. Individual Yagis, each with built-in booster, plus matching network.	Always. Every bit of signal needed here. (For long runs of lead-in, use low-loss open wire line. Never use coaxial lead-in; loss much too high.)

**Table II**

The diagram shows a balanced H-pad which can be used to attenuate too-strong TV signals. The two formulas are used to figure the two resistor values; A is the number of times the input signal is to be decreased —not the number of db. That is, to get an output equal to half the input, you decrease the input two times. Hence A = 2.

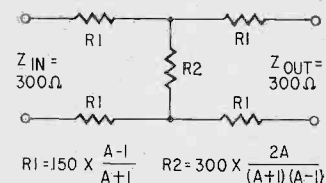

In the 20-db pad of Fig. 2, the formula works out this way:

$$R1 = 150 \times \frac{10 - 1}{10 + 1} = 150 \times \frac{9}{11} = 123 \text{ ohms}$$

$$R2 = 300 \times \frac{2 \times 10}{(10 + 1)(10 - 1)} = 300 \times \frac{20}{99} = 60 \text{ ohms}$$

The nearest EIA 1/2-watt, 10% values are satisfactory for these pads. In our example, these would be 120 and 56 (or 68) ohms.

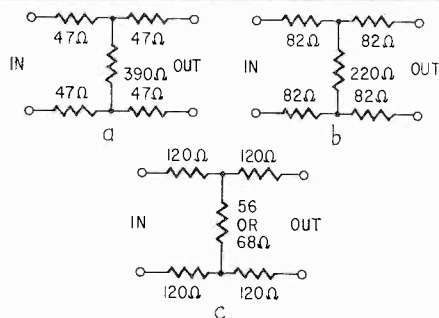

Fig. 2—Attenuator pads to prevent strong-signal overload: (a) is 6-db pad (1/2 signal voltage to set); (b) 10-db pad (1/3 signal voltage to set); (c) 20-db pad (1/10 signal voltage to set).

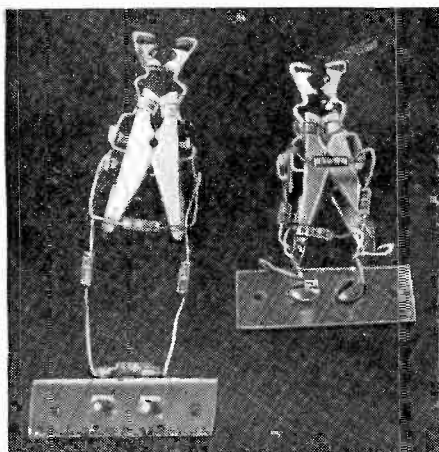
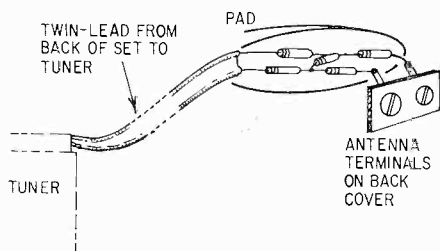

Fig. 3—Carry a few clip-on pads with you to check out suspected overload problems.



color will be attenuated or pop in and out. This is due to Miller effect in rf and i.f. amplifier stages. The age is unable to deal with such great overloads. The answer is to reduce the signal.

The simplest way is to add a resistive pad in series with the input. Fig. 2 shows resistance values for three typical pads. These will cover most situations. A quick way to find out which one you need is to make up one of each, attached to clothespin antenna clips (Fig. 3). These can be clipped in series with the lead-in.

After you hit on the right pad, make up a permanent one and attach it to the antenna terminals. A handy place for this is inside the cabinet. Unsolder the lead-in to the tuner, and connect the pad in series (Fig. 4).

The formula for computing other values of attenuation pads is shown in Table II. However, those in Fig. 2 will cover almost every situation, since the age action of the receiver gives a great deal of latitude.

[Several manufacturers make printed-circuit resistor pads in several attenuation values, and some have "substitution box" devices, permitting you to switch in different amounts of attenuation before deciding on an optimum value. Check catalogs or your distributor.—Editor]

**Secondary areas**

In secondary area installations (within 50 miles of the station) many people try to use existing antenna installations. If they are more than 2 or 3 years old, they may not be good enough for color. Deterioration of the lead-in, corrosion at the antenna termi-

Fig. 4—Once you determine how much attenuation an overloaded set needs, wire the pad permanently inside the set, in the tuner input line.

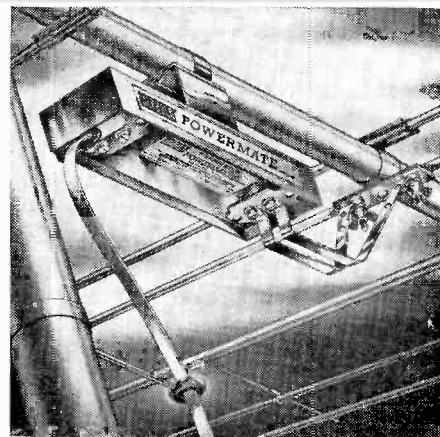

Fig. 5—Best place for booster is at the antenna. Most boosters draw power through signal lead-in.

nals, misorientation and many other troubles show up. The signal strength must be checked before making the color installation final.

In cases where the existing antenna is fair but signal levels are low, the remedy is a booster. The newer transistorized boosters can be very helpful in these cases. Many of the later antennas include "built-in" transistor boosters, with gains up to 14 or 16 db, as in the type shown in Fig. 5. The best location for these is at the antenna terminals, as shown, but they can be used at the back of the set (Fig. 6) to avoid the time and expense of lowering and raising a tall antenna.

The simplest way to find out whether a booster will help is to try one. Many technicians carry one of the small transistor boosters, fitted with clothespin connectors, in their service kits. It may be snapped into circuit instantly to see how much improvement results. Performance will be slightly better with the booster installed at the antenna.



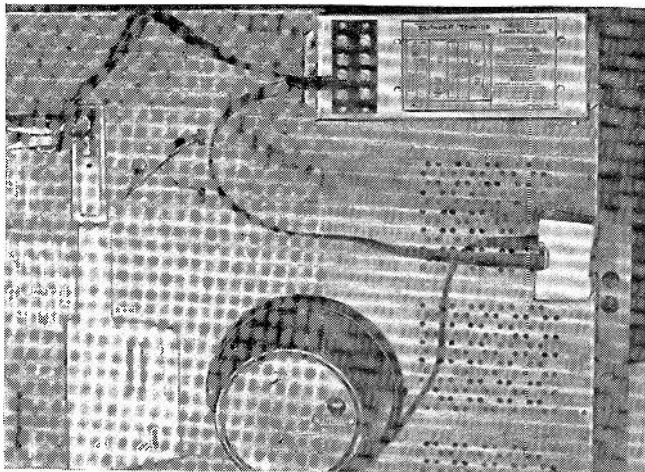

Fig. 6—Back of set is convenient place for untuned, broad-band booster.

Precautions: No booster can *make* a picture; this is the purpose of the antenna. Boosters can *improve* any picture, but a fair amount of signal must be there to start with. The major purpose of the booster is to clean up marginal signals, remove snow and give more positive color lock.

#### Fringe areas

The precautions needed in secondary areas are also necessary in fringe areas. Antennas must be the highest-gain types available, and the powerful boosters are also a must. Antennas of the type in the head photo may give reception over distances up to 150–175 miles under good conditions.

Absolute height is not the important factor that it was once thought, although it is decisive in some areas. In many fringes today, antennas are about 30 feet in height, instead of 100 feet or even more. Field testing disclosed that this was about the optimum height for good reception. Very careful installation techniques are necessary to keep these taller, heavier antennas up.

#### Amplified distribution systems

Color sets are often connected to amplified signal distribution systems. These may be community antenna systems in small towns, or systems in large apartment houses or hotels. The very broad-band amplifiers used with these systems give good reception, for there

is no chance of clipping color bursts, as was once thought possible.

However, in high-signal areas, one peculiar trouble has been found: undesired direct pickup at the receiver. Since the signal suffers some delay in traveling through the coaxial cable of the distribution system, the direct pickup will be slightly out of phase. This phase delay results in color trouble, as usual showing up as cancellation of burst and sudden dropouts of color.

To test for this condition, remove the antenna connection and connect a temporary dipole or rabbit-ears antenna to the set. If there is enough signal to make even a snowy picture, there is a possibility of interference. The remedy is to shield the antenna connection. Use shielded 300-ohm two-conductor cable between the distribution system terminal box and the set. It may be necessary to replace the short link between the terminal board and tuner with the shielded wire.

Just as in all other branches of TV work, selection and installation procedure will vary with individual technicians. There are no hard and fast rules for success. Thorough field testing, with a careful evaluation of the results, will be the most helpful single factor. There is no such thing as the "one right antenna" for any area: there will always be a choice between types and makes. Select a well built, well designed one, and the chances of success are much improved.

END

## Handy Log Scales

Frequency response and other curves that use a wide range of units are generally constructed on semi-log paper. However, semi-log paper with more than 2 cycles is not always available. Here is a simple method to make your own. The table shows the logarithms of integers. Using an engineer's scale, or any scale with decimal units (a cm scale will also work), you can measure off the distances in the table. The result will be a log scale, and the number of cycles on the paper will depend on the divisions

used. For example the 4-cycle scale below was made with 1/40-inch divisions and the 3-cycle scale with 1/30-inch divisions. Using 1/50-inch divisions would allow 5 cycles on 8½ x 11 paper. Having drawn the scale on one side of the paper, you can then draw your graph by using a T-square and triangle. These scales can be used under a piece of tracing paper to make a piece of log or semi-log paper quickly. For log-log paper use the same scale for both vertical and horizontal divisions.—Tom Jaski

Logarithms of Scale numbers			
Numbers	Logs	Numbers	Logs
1.0	0000	6.0	77815
1.5	17609	6.5	81291
2.0	30103	7.0	84510
2.5	39794	7.5	87506
3.0	47712	8.0	90309
3.5	54407	8.5	92942
4.0	60206	9.0	95424
4.5	65321	9.5	97772
5.0	69897	10.0	100000
5.5	74036		

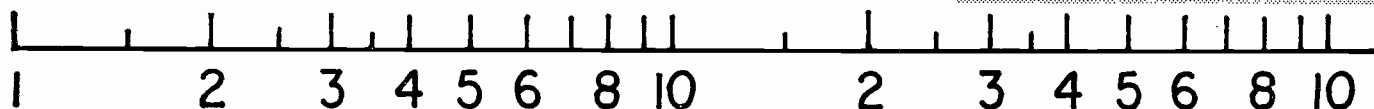

3 CYCLE LOG SCALE

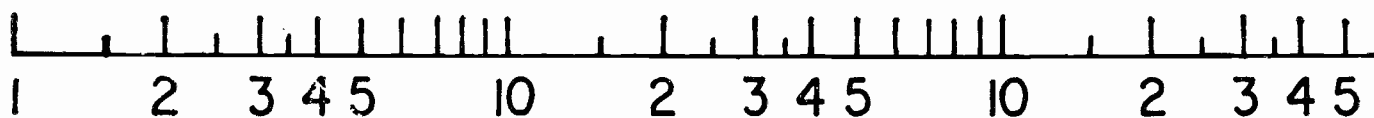

4 CYCLE LOG SCALE

The sections of log scales above can be traced to make scales 10 inches long. The top drawing shows two cycles of a 10-inch, 3-cycle scale. On the bottom line we have two and one-half cycles of a 10-inch, 4-cycle log scale.

## **The CTC 15:**

# RCA'S NEWEST COLOR CHASSIS

IN THE CTC 15, RCA'S NEWEST COLOR chassis, a great deal of emphasis has been placed on serviceability. Controls and circuit elements are precisely identified. Novar-base tubes offer high reliability, and special attention is given to chassis ventilation and heat dissipation.

The physical layout conforms generally to previous RCA color receivers. All circuit boards are mounted for good ventilation and easy access to all components and connections on either side of the board. The rf tuner can be mounted on the rear apron whenever necessary to transport the chassis.

The high-voltage compartment is designed to permit full accessibility to the components. The upper portion is well louvered for increased ventilation.

### **In the circuit**

The horizontal output tube in the CTC 15 is a 6JE6, a tube with a novar base and a separate suppressor grid connection. A positive voltage applied to the suppressor grid in uhf versions minimizes the possibility of high-frequency radiation that could interfere with uhf reception.

This voltage is critical. Best results are obtained in the 40-50-volt range. Below 30 volts, the snivets are still present. Above 70 volts, the efficiency of the tube is impaired somewhat.

In the vhf chassis, the vertical output cathode is returned to ground through 3,900 ohms. In the uhf chassis, the resistor is removed and replaced by two series resistors of 2,200 and 1,800 ohms with the 1,800 ohm resistor connected to ground. The junction of these two resistors provide the necessary suppressor grid voltage at low impedance.

The 6JE6 has higher power sensitivity than previous horizontal output tubes and runs cooler. The socket for this tube is mounted on a raised portion of the chassis which provides additional ventilation by a "chimney" effect (Fig. 1). The tube operates almost 40°C below its maximum allowable operating temperature.

\*Product Performance, RCA Sales Corp., Indianapolis, Ind.

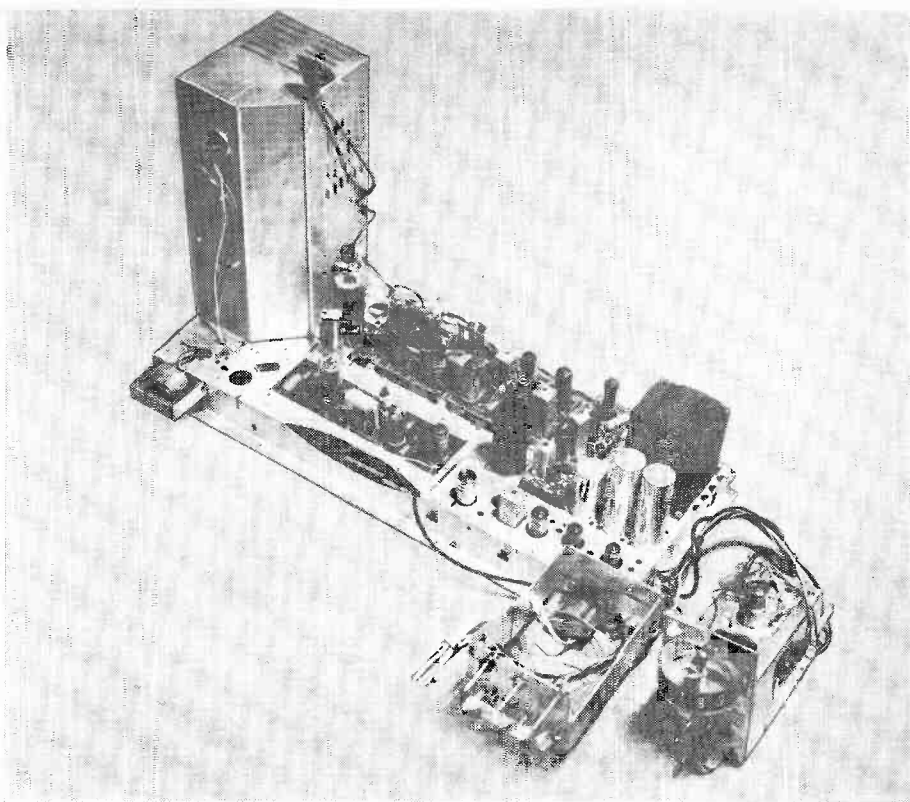

Front view of CTC 15 chassis. Most service controls are on rear skirt.

## A well-known circuit made more reliable and easier to adjust

By A. HILDERBRAND\*

Fig. 1—Horizontal output tube, a 6JE6 (top of photo), is set on "shelf" with plenty of air circulation.

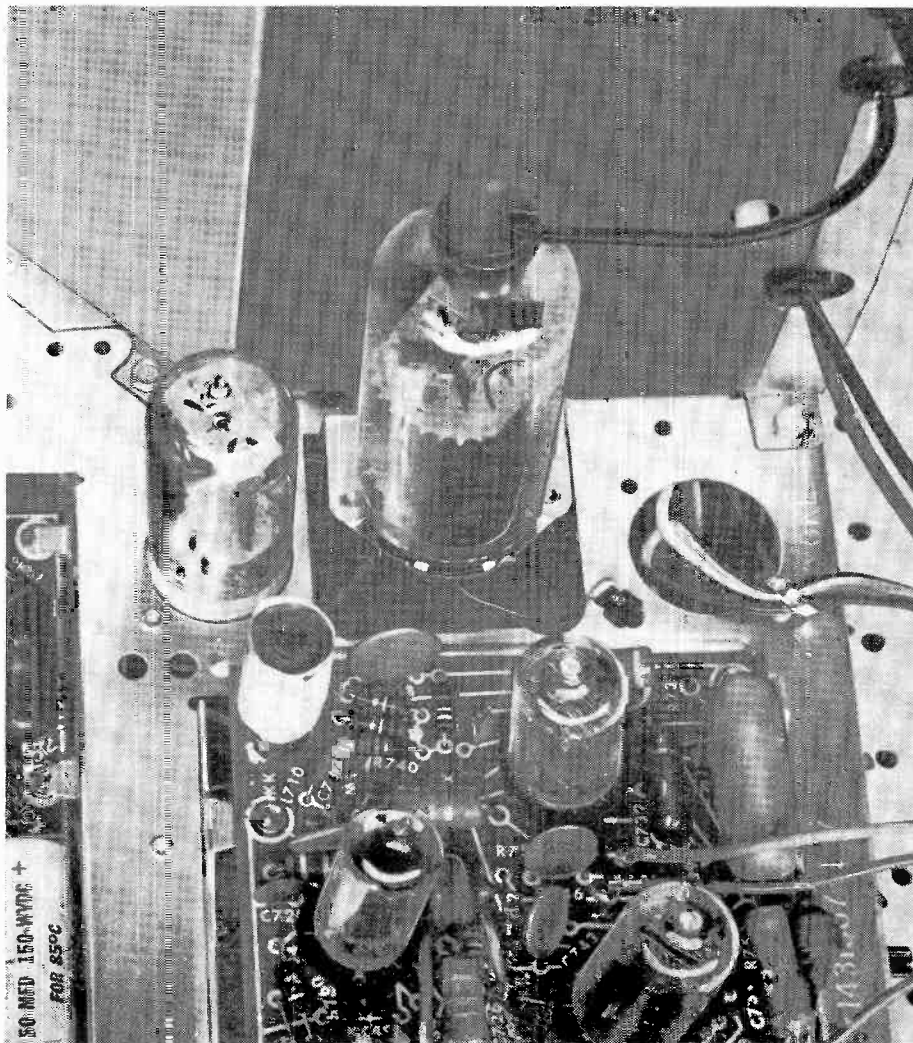



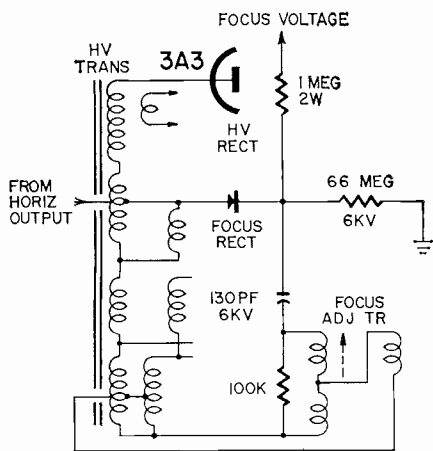

Fig. 2—Solid-state focus rectifier simplifies circuit and generates less heat than tube.

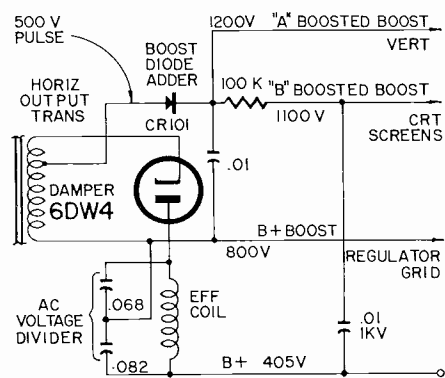

Fig. 3—Diode boost adder provides "boosted boost" level for vertical output and CRT screens.

Other novar-base tubes employed in the CTC 15 include the vertical oscillator-output tube, a 6GF7, and the damper, the 6DW4.

Another circuit arrangement for reliability and heat reduction is the use of a solid-state focus rectifier (Fig. 2). It has extremely long life and, since no filament voltage is required, there is less loading on the high-voltage transformer and less heat.

One of the most noteworthy features of the CTC 15 is its high picture detail. A very sharp raster is produced by operating the picture-tube screen circuits at a higher positive voltage than in previous chassis.

A new adder circuit, shown in Fig. 3, supplies to the picture-tube screens the higher voltages essential for the smaller spot size and the sharper raster. The 500-volt pulse produced by the collapsing field of the horizontal output transformer during flyback time is applied to CR101, the "boost diode adder", and effectively added to the normal B-plus boost of 800 volts. The higher "boosted boost" voltage of 1,200 is used for the vertical oscillator. A voltage divider derives the 1,100 volts for the picture-tube screens.

Another circuit refinement in the CTC 15 is the high-voltage regulation system (Fig. 4).

In addition to the usual shunt regulator circuit, the CTC 15 has a connection between the third video amplifier plate circuit and the shunt regulator grid. Normally, white areas of the picture load the high-voltage supply because of the additional beam current drawn by the picture tube. To compensate for this, video of the same polarity as appears at the picture-tube cathodes is coupled to the shunt regulator grid through a 12-megohm resistor. This tends to keep the high voltage at the same level when large white areas are displayed on the picture tube. The long time constant formed by the 12-megohm resistor and the .01- $\mu$ f capacitor in the regulator grid circuit insures that only long-term video variations are coupled to the shunt regulator.

Another refinement in the CTC 15 is the video peaking switch (S103), mounted on the rear chassis apron. Three positions of the switch permit selecting three degrees of video peaking (Fig. 5).

The peaking switch is in the contrast control circuit in the cathode of the

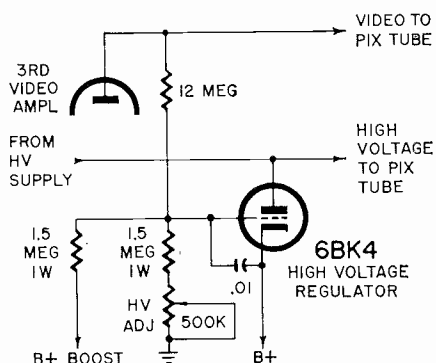

Fig. 4—Tie-in from video stage helps high-voltage regulator adjust to heavy current drain during "white" picture portions.

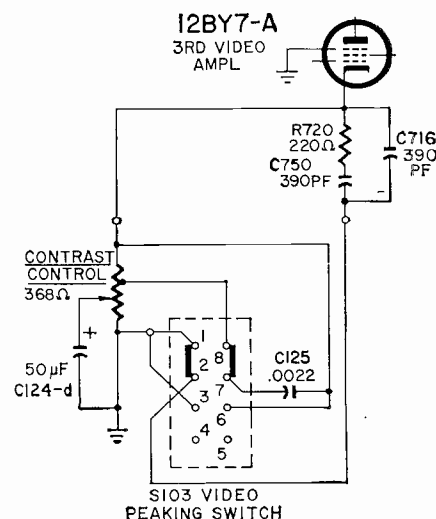

Fig. 5—Three degrees of peaking adjust picture to customers' tastes.

third video amplifier. It has maximum effect when the contrast control is near the three-quarters clockwise position. The peaking results in better transient response and sharper transition from black to white.

In Fig. 5, the upper position gives highest peaking. The combination of R720, C750 and C716 is connected (through points 1 and 2 of the switch) across the contrast control, and C125 is connected (through points 7 and 8) to the tap of the contrast control. In the middle position of the switch, C125 is out of the circuit (points 7-8 are open), and only the resistor-capacitor combination is connected. In the lowest position (least peaking), that combination is also out, leaving only the contrast control and C124-d in the circuit.

### Color circuits

Complementing the high detail of the black-and-white picture, the CTC 15 produces higher color definition also. This is achieved largely by the same circuit refinements that improve the black-and-white picture, since the picture detector and first video amplifier are common to both black-and-white and color information. Additional peaking of the G-Y signal further enhances color performance (Fig. 6).

The picture tube itself is one of the most important elements producing high-quality color pictures. RCA's 21-FJP22 is used in all sets with the CTC 15 chassis. The 21FJP22 is a glare-proof bonded picture tube.

A picture-tube bias switch (Fig. 7) is provided on the CTC 15 to adjust for differences in picture tube characteristics. This three-position slide switch selects three values of plate load resist-

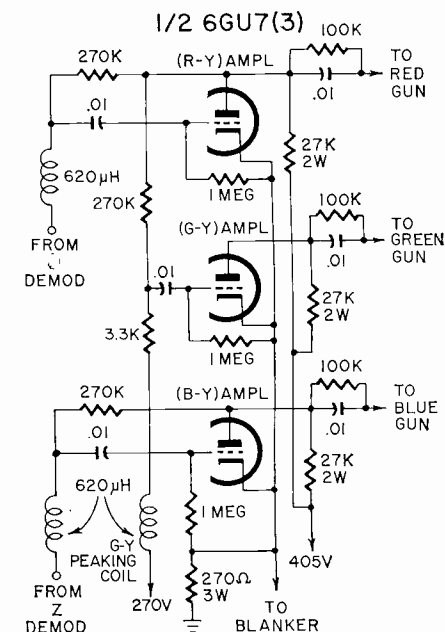

Fig. 6—Color amplifiers are very similar to CTC 12's. Note new tube type 6GU7 and extra peaking coil in G-Y amplifier.

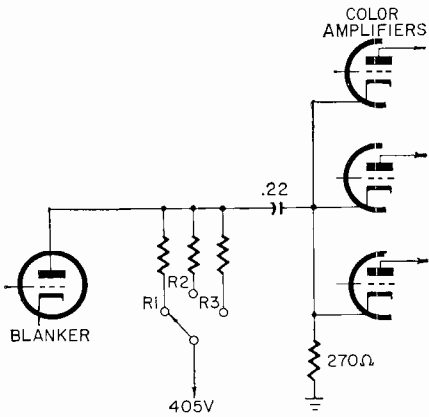

Fig. 7 (above) — Simplified schematic of switchable CRT bias, to compensate for different characteristics.

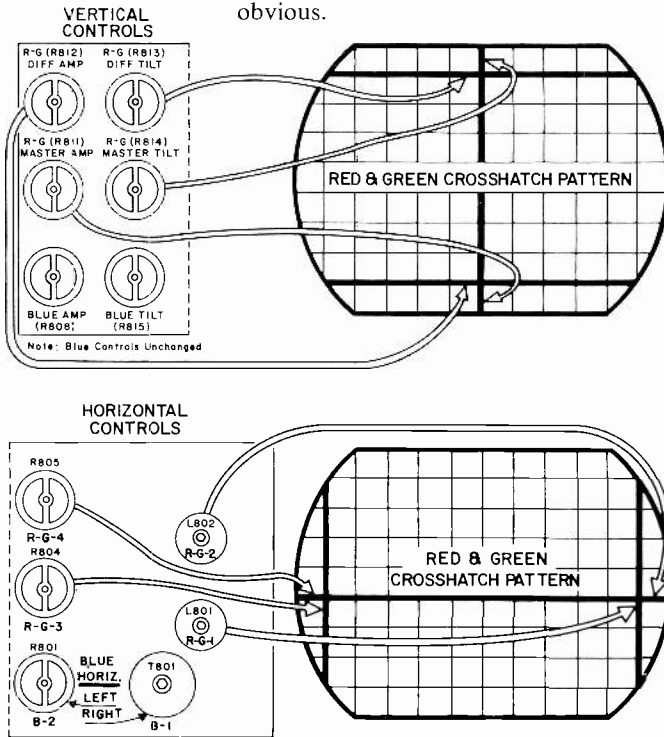

Fig. 8—The convergence controls and their effects on a crosshatch display.

ance for the blanking amplifier. This changes the amplitude of the blanking pulse fed to the common cathodes of the R-Y, B-Y and G-Y amplifiers, changing the average bias on these tubes with each position of the switch. This results in a plate-voltage change, and since the picture tube control grids are dc-coupled, it appears at the picture tube. This way, the cathode circuitry of the picture tube is undisturbed for any setting of bias. This allows for a constant load on the third video amplifier at any setting of picture-tube bias switch.

### Setup and convergence

The setup procedure for the CTC 15 is very simple. A switch on the rear apron of the chassis removes vertical deflection when thrown to the SERVICE position. The three screen controls are adjusted until each just produces a line on the picture tube. This takes care of low-level tracking. When the switch is thrown to NORMAL, the blue and green video drive controls can be adjusted for a white raster. You can thus get black-

and-white tracking over the entire usable brightness range.

Converging the CTC 15 is also simple. The effects of each convergence control are easily identified when you watch a dot or cross-hatch pattern. The entire top row of controls is adjusted by watching horizontal lines of a cross-hatch pattern, and the entire second row by watching vertical lines on the pattern (Fig. 8). Blue vertical amplitude and tilt controls behave very much like the familiar height and linearity controls. And blue horizontal left and right controls influence the blue raster in their respective areas so that the proper setting is obvious.

Some of the sets using the CTC 15 chassis include RCA's Wireless Wizard remote-control feature. This is an all-transistor ultrasonic system providing up-and-down control of tint, color and volume, channel selection, and a "full off" position.

The rf tuners used in the CTC 15 chassis vary according to the cabinet style. However, all tuners use a 6DS4 Nuvistor rf amplifier and a 6EA8 oscillator-mixer. All 1964 RCA vhf color receivers are adaptable to uhf with a field conversion kit. Factory-built uhf models are also available.

A low-voltage overload circuit breaker, easily reset by the set owner, eliminates the need for service calls because of harmless momentary surges.

Complete details of the CTC 15 chassis including specifications, setup procedures, alignment procedures and circuit diagrams are available in RCA Victor Service Data file number 1963 No. T6, published by the RCA Sales Corp., 600 N. Sherman Drive, Indianapolis, Ind. END

# WHAT'S YOUR

# EQ?

Three puzzlers for the student, theoretician and practical man. Simple? Double-check your answers before you say you've solved them. If you have an interesting or unusual puzzle (with an answer) send it to us. We will pay \$10 for each one accepted. We're especially interested in service stinkers or engineering stumblers on actual electronic equipment. We get so many letters we can't answer individual ones, but we'll print the more interesting solutions—ones the original authors never thought of.

Write EQ Editor, Radio-Electronics, 154 West 14th Street, New York 11, N. Y.—10011.

Answers to this month's puzzles are on page 70.

## What's the Impedance?

The network below is shown as an iterative lattice. What is the impedance

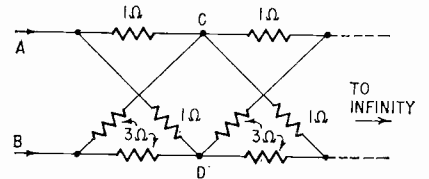

between A and B?—B. F. Jacoby

## Complex Black Box

A voltmeter across the 100-ohm resistor shows 100 volts. Another 100

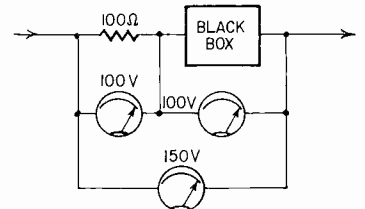

volts appears across the black box. Yet the voltage across the whole circuit is 150. What are the parameters of whatever is in that box?—Peter R. Smith

## Mixed-up Currents?

Meter A reads ac and meter B reads dc. Each 100-ohm resistor naturally conducts both ac and dc. How

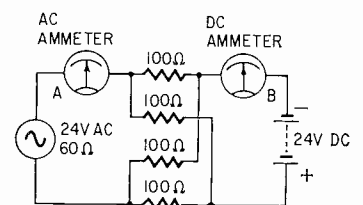

much dc flows through the ac ammeter? —Kendall Collins



# COLOR

## TEST EQUIPMENT FOR



In the Big Year For Color, the right test equipment is going to be more important than ever. As usual, your regular test equipment will take care of most jobs, but it'll be the specialized color equipment that'll make the difference. Here are photos and brief descriptions of the latest.

The "bar-dot-crosshatch-color bar" generator is going to be the "vtvm" of color service. Both keyed rainbow and countdown types are crystal controlled for accuracy. They're a necessity for installations, and a big time-saver for home and bench service work. A scope can trace the easily-recognizable color-bar signal through all color circuits, making this job a lot easier. By showing the customer "colors", you won't have to waste time waiting for a color program to come on!

They come in all kind and prices; kits and ready-made. They range from the compact bar-generators to large and elaborate analysts, which furnish rf, i.f. and video signals. These can be used in black-and-white servicing, too.

The test equipment you now have will tell you what else you need for color service. A good bar-generator is a must. If you already have analysts and similar instruments, it'll be all you need. If you don't, the more elaborate instruments will be a good investment. The added versatility of these instruments makes them well worth the small extra cost, for everything but the color bars themselves can be used for both b/w and color servicing. Choose the one that will give you the most functions, to round out your test equipment setup for all kinds of service jobs.

### B & K

#### Model 850 Color Analyst

Produces dot patterns, crosshatch, vertical lines, horizontal lines, burst signal and individual colors for fast, easy receiver tests and adjustments. Crystal-controlled and produces NTSC type signals. Pattern to be displayed on screen is shown in viewer on front panel for visual comparison and quick and easy setup of color set.

Automatic deconvergence feature eliminates need for continual static convergence adjustments. Automatically deconverges a white dot into color-dot trio or white vertical or horizontal lines into red, green and blue parallel lines for rapid dynamic convergence adjustments.

Has 15,750-cycle output jack for scope sweep during demodulator adjustments. Provides 4.5-mc sound signal for receiver tuning and sound-trap adjustments.

#### Model 1074 Television Analyst

A compact, lightweight version of the 1076. Useful for black-and-white and color TV servicing in the home or shop. Has 15,750-cycle output for scope sync. Tests yoke and output transformer for shorts, opens.

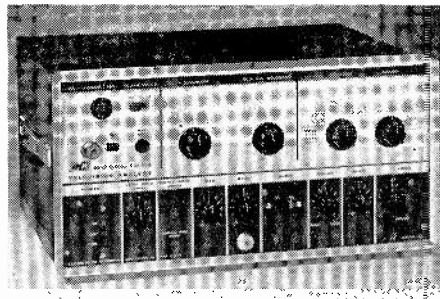

#### SPECIFICATIONS

**Rf output:** Rf and i.f. video signals modulated by cross-hatch, dots, or vertical or horizontal lines and tone audio-modulated. Green, blue, B - Y, R - Y and red bars—one at a time.

**Video output:** Any of four types of video signals at output jack, either negative or positive polarity.

**Audio output:** 4.5-mc FM signal modulated at 900 cycles.

**Sync output:** Composite sync with negative or positive polarity and amplitude variable to 50 volts.

**Sweep drive:** Separate vertical and horizontal grid and plate driving signals for checking sweep circuits.

**Test patterns:** Dot pattern, crosshatch, vertical and horizontal lines, color bars (green, blue, B - Y, R - Y and red) individually.

**Size:** 14½ in. wide x 7 high x 11 deep.

**Weight:** 13½ lb.

**Price:** \$249.95.

#### Model 1076 Television Analyst

Universal test instrument for point-to-point signal injection when servicing and adjusting black-and-white and color receivers. Uses flying-spot scanner to produce test patterns. Includes adjustable negative and positive bias supplies for checking sync, agc and afc troubles. Provides agc keying pulse and high-level test signal for modulating CRT directly.

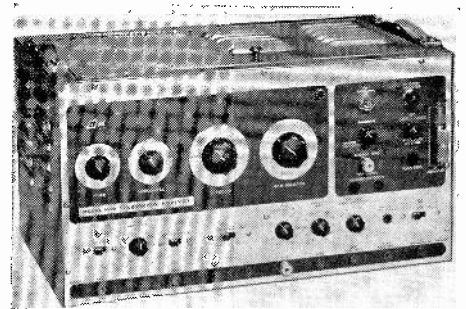

#### SPECIFICATIONS

**Rf output:** See model 1074.

**Video output:** White dot, crosshatch and crystal-controlled color-bar pattern. Adjustable-level burst and color signals, available at front panel for signal injection. Keyed rainbow color display and color-bar pattern for checking color sync and hue, and for aligning color demodulators.

**Audio output:** 4.5-mc FM signal with 400-cycle modulation.

**Sync output:** See model 1074.

**Sweep drive:** See model 1074.

**Test patterns:** 10 color bars, crosshatch and dots.

**Size:** 17 in. wide x 10½ high x 10 deep.

**Weight:** 29 lb.

**Price:** \$329.95.

*B & K Mfg. Co., Div. Dynascan Corp., 1801 W. Belle Plaine Ave., Chicago 13, Ill.*

### GC ELECTRONICS

#### Model 36-610 Color TV

#### Test Pattern Generator

A low-cost, lightweight instrument designed especially for color convergence adjustments in the home. Not a replacement for the more elaborate color pattern generators used for troubleshooting and bench work. Feeds video pattern signals direct to CRT.

Color-gun killer switch disables any combination of the three color guns for fast purity and convergence checks without upsetting receiver's color controls. Bar and dot patterns locked in sync with signal from local TV sta-

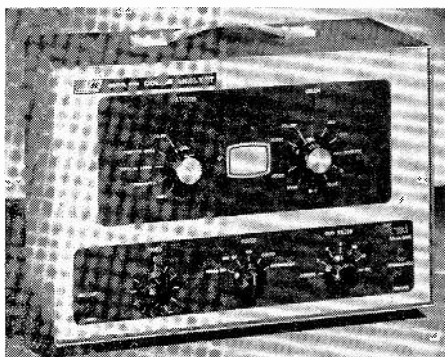

#### SPECIFICATIONS

**Rf output:** Channels 3, 4 and 5.

**Test pattern:** Dots, crosshatch, vertical and horizontal lines, green, cyan, blue, B - Y, Q, magenta, R - Y, I and burst—one at a time.

**Size:** 12¼ in. wide x 9 high x 8½ deep.

**Price:** \$199.95.

tion. Width and brightness of patterns are variable.

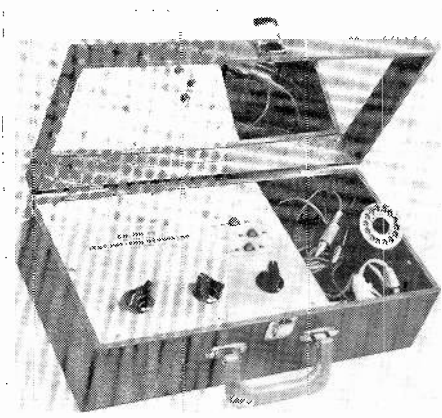

#### SPECIFICATIONS

**Test patterns:** 582 small dots for static convergence, 21 vertical or 23 horizontal bars for dynamic convergence adjustments.

**Power:** 117 volts, 50-60 cycles, 20 watts.

**Size:** 16 in. wide x 5 high x 8 1/2 deep.

**Weight:** 10 lb.

**Price:** \$59.50.

*GC Electronics Co., Div. of Textron Electronics, 400 S. Wyman St., Rockford, Ill.*

#### HEATH

### Model IG-62 Color Bar and Dot Generator

Designed for linearity, color and convergence adjustments. Color bars produced by offset-carrier method may be used for phase, afc and matrix adjustment.

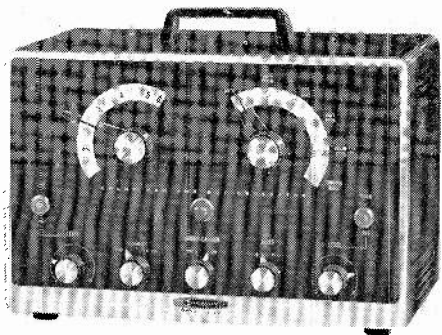

#### SPECIFICATIONS

**Rf output:** Channels 2-6. Output voltage variable approximately 100-100,000uv. Crystal-controlled sound carrier (unmodulated) has on-off switch.

**Video output:** Crystal-controlled, positive or negative, variable from 0 to 10 volts p-p, open circuit. Impedance about 1,000 ohms.

**Test patterns:** 180 small (about 2 lines diameter) white dots, crosshatch of 12 vertical and 15 horizontal lines (less those lost in blanking), 15 horizontal bars, 12 vertical bars, 10 vertical color bars. Wide-bar crosshatch pattern with four brightness levels for screen and background adjustments.

**Power:** 117 volts, 50-60 cycles, 70 watts.

**Size:** 13 in. wide x 8 1/2 high x 7 deep.

**Weight:** 10 lb.

**Price:** \$64.95 in kit form.

*Heath Co., Benton Harbor, Mich.*

#### HICKOK

### Model 656XC Color Bar/White Dot-Bar Generator

Versatile generator producing the standard fully saturated NTSC color bar pattern and R-Y, B-Y and G-Y signals for chroma alignment. Also provides a choice of: crosshatch (20 vertical and 15 horizontal lines), horizontal lines only, vertical lines only and a dot pattern. All color signals locked to 315-kc crystal oscillator. Sound carrier permits correct adjustment of receiver's local oscillator frequency.

#### SPECIFICATIONS

**Rf output:** Channels 2-6, modulated with choice of color signals. Separate output from 3.58-mc burst oscillator.

**Video output:** 0-2 volts p-p, open circuit, across 100 ohms with positive or negative output.

**Test patterns:** 3 primaries, 3 complementaries, plus black-and-white. All standard alignment signals.

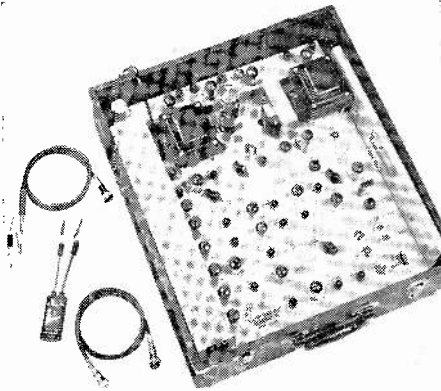

**Crosshatch:** Choice of 20 vertical or 15 horizontal bars or both (less those lines lost in blanking region). 300 dots per frame (less those lost in blanking region). Minimum size of dots and lines, 2 scanning lines.

**Power:** 105-125 volts, 60 cycles, 40 watts.

**Size:** 16 1/4 in. wide x 18 1/8 long x 7 1/2 deep.

**Weight:** 34 lb.

**Price:** \$549.50.

### Model 660 White Dot-Bar Color Display Generator

Similar to model 656XC, but designed for fast in-the-home servicing of TV color receivers. All color signals crystal-controlled.

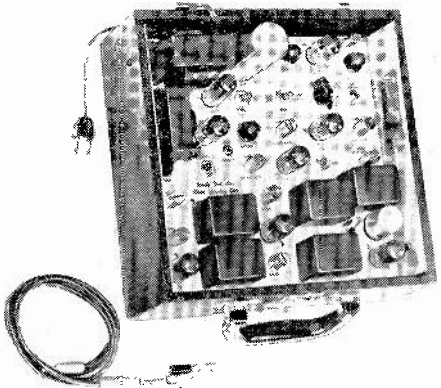

#### SPECIFICATIONS

**Rf output:** Channels 2-6, .05 volt max .001 volt min modulated 60% by video output.

**Video output:** 0-4 volts p-p across 300 ohms, black positive or negative.

**Burst output:** 1 volt p-p.

**Test patterns:** Six crystal-controlled color bars. Dots and crosshatch (see 656XC).

**Ratio of sync to video:** Variable 10% to 90%.

**Power:** 105-125 volts, 60 cycles, 40 watts.

**Size:** 10 in. wide x 10 1/2 long x 5 1/4 deep.

**Weight:** 15 lb

**Price:** \$245.00.

### Model 661 Chrom-Aligner

A white-dot and crosshatch generator that generates individual NTSC 100% saturated color adjustments in the home.

#### SPECIFICATIONS

**Rf output:** Channel 3 or 4.

**Video output:** 1.5 volts p-p across 75 ohms.

**Test patterns:** Dots and crosshatch (see model 656XC).

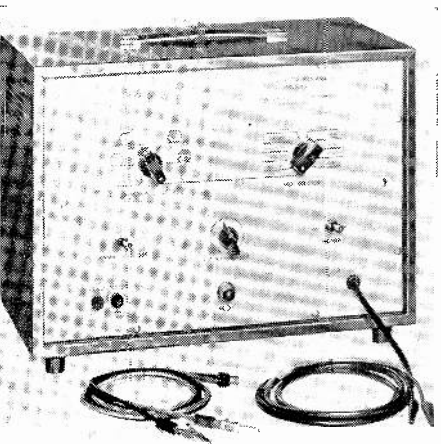

**NTSC color signals:** (1). Yellow—chroma 13°—luminance 0.37. (2). Red—chroma 74°—luminance 0.30. (3). Magenta—chroma 120°—luminance 0.41. (4). Blue—chroma 183°—luminance 0.11. (5). Cyan—chroma 256°—luminance 0.70. (6). Green—chroma 300°—luminance 0.59. Also provides R-Y, B-Y, G-Y and -(G-Y) for demodulator alignment.

**Power:** 105-125 volts, 60 cycles, 20 watts.

**Size:** 15 in. wide x 10 high x 7 1/2 deep.

**Price:** \$349.50.

*Hickok Electrical Instrument Co., 10514 Duport Ave., Cleveland 8, Ohio.*

#### JACKSON

### Model 800 Color Bar-Dot Generator

New pushbutton-operated, crystal-controlled instrument for purity, gray-scale, convergence and demodulator adjustments. Generates dot and crosshatch patterns, horizontal and vertical lines and eight individual color bars similar to NTSC specifications. Push-buttons marked with pattern or color that will appear on CRT screen.

Gun-killer switch disables the color guns singly or in combination. A jack is provided for connecting a scope to view the waveform at each of the color grids.

Video signals without carrier are available with variable amplitude and polarity for signal tracing and injection.

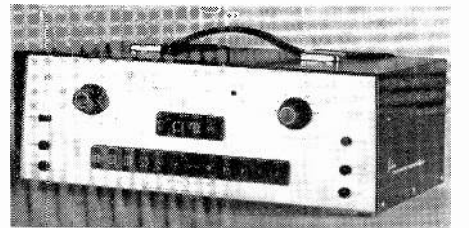

#### SPECIFICATIONS

**Rf impedance:** 300 ohms.

**Rf output:** Channels 3, 4 and 5.

**Video impedance:** 1,000 ohms.

**Video output:** 0-1.25 volts; video plus sync 2 volts.

**Test patterns:** Crosshatch, vertical and horizontal lines, dots and yellow, red, R-Y, magenta, blue, B-Y, cyan and green bars.

**Sync level at output jack:** 7 volts.

**Size:** 13 1/2 in. wide x 4 3/4 high x 9 deep.

**Weight:** 14 lb.

**Price:** \$239.95.

*Jackson Electrical Instrument Co., 124 McDonough St., Dayton, Ohio.*

#### PACO

### Model G-36 Color-Bar White-Dot Generator



#### SPECIFICATIONS

(See Precision E-450)

**Size:** 13 in. wide x 8 1/2 high x 7 1/4 deep.

**Weight:** 12 lb.

**Price:** Model G-36 (kit), \$119.95; G-36W (factory wired), \$179.95.

*PACO Electronics Co., 8000 Cooper Ave., Glendale 27, N. Y.*

#### PRECISION

### Model E-450 Color Generator

Displays 15 horizontal bars, 10 vertical bars or both in crosshatch pattern, and dot pattern for static and dynamic convergence. Ten color bars spaced at 30° intervals for checking and servicing color circuits in re-

ceiver. Provides white raster for color purity adjustments.

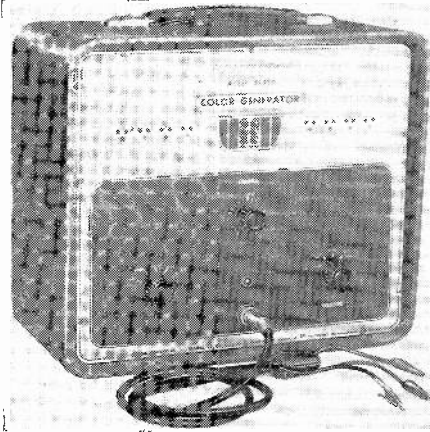

#### SPECIFICATIONS

**Rf output:** Prealigned on channel 3 with video carrier of about 20,000  $\mu$ v and sound carrier (unmodulated) of about 2,000  $\mu$ v. Tunable to channel 4.  
**Output impedance:** 300 ohms.  
**Test patterns:** Color bars, vertical bars, horizontal bars, crosshatch, dots and white raster.  
**Power:** 105-125 volts, 60 cycles, 60 watts.  
**Size:** 13 in. wide x 12 high x 8 deep.  
**Weight:** 12 lb.  
**Price:** \$189.95.

Precision Apparatus Co., 8000 Cooper Ave., Glendale 27, N. Y.

#### RCA

### Model WR-64A Color Bar/Dot/Crosshatch Generator

A compact, lightweight instrument including all facilities for adjusting color phasing, matrixing, linearity and convergence circuits.

Completely crystal-controlled, uses offset-subcarrier method to generate 10 color bars accurately spaced 30° apart. Brightness pulses are added to edges of each bar to check registration of brightness and color signals.

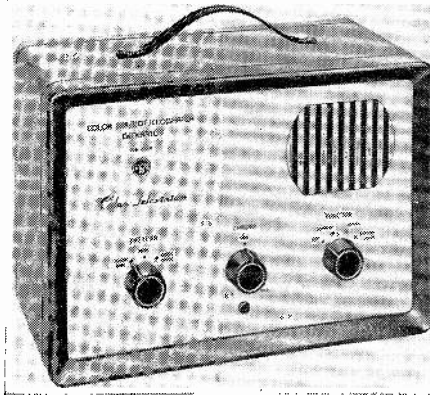

#### SPECIFICATIONS

**Rf output:** Prealigned on channel 3 with .05-volt (max) picture carrier. Sound carrier 10% of pix carrier. Tunable to channel 4.  
**Output impedance:** 300 ohms.  
**Test patterns:** Color bars, dots, crosshatch.  
**Power:** 105-125 volts, 60 cycles, 40 watts.  
**Size:** 13 1/2 in. wide x 10 high x 8 deep.  
**Weight:** 13 3/4 lb.  
**Price:** \$189.50.

RCA Electronic Components & Devices, 415 S. 5th St., Harrison, N. J.

#### SCENCORE

### CA122 Color Circuit Analyzer

Portable tester checks color receiver from tuner through picture tube. Generates every signal normally received from TV station, plus convergence and color test patterns. Signals can be injected into audio, video and sync circuits for trouble-shooting.

#### SPECIFICATIONS

**Rf output:** Channels 2-6.  
**I.f. output:** 20-50 mc, variable for i.f. troubleshooting and alignment.  
**Rf-i.f. output levels:** .002, .001 and 0.1 volt rms.  
**Output impedance:** 93 ohms, rf and i.f.  
**Sound carrier:** 4.5 mc away from pix carrier. Crystal-controlled, unmodulated.

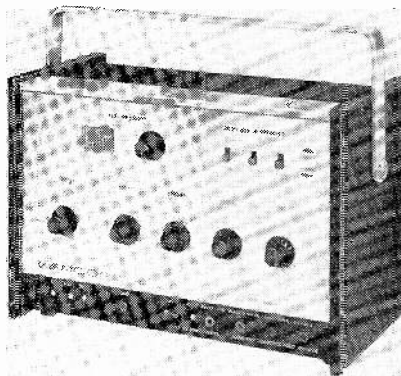

**Video output:** 0-30 volts, positive and negative; 5,000 ohms impedance. Six modulated patterns.

**Test patterns:** 140 small dots, crosshatch of 10 vertical and 14 horizontal bars, 10 vertical bars. Shading bars with three shades of brightness (for background adjustments), 10 color bars (developed by offset-carrier method).

**Audio signal:** 900 cycles, 3 volts p-p.  
**External sync:** 30 volts p-p, positive or negative, variable.

**Power:** 117 volts, 60 cycles, 45 watts.  
**Size:** 14 in. wide x 9 1/2 high x 7 7/8 deep.  
**Weight:** 15 lb.  
**Price:** \$187.50.

### CG126 Color Generator

New low-cost color test instrument especially designed for service in the home. Crystal-controlled, develops keyed color bars with 30° phase change between each. Color output variable 0-20%.

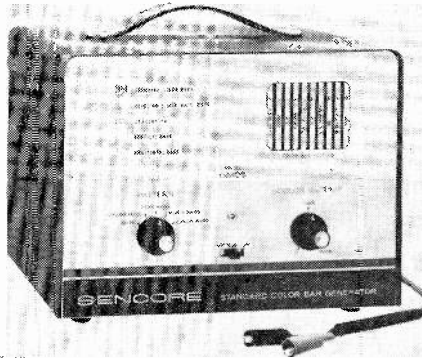

#### SPECIFICATIONS

**Rf output:** Preset to channel 4. Tunable to channel 3 or 5.

**Test patterns:** 10 keyed color bars, 117 adjustable-size white dots, crosshatch of 9 vertical and 13 horizontal lines, 9 vertical bars, 13 horizontal bars.

**Power:** 117 volts, 60 cycles, 35 watts.  
**Size:** 11 in. wide x 8 high x 6 deep.  
**Weight:** 9 1/2 lb.  
**Price:** \$99.50.

Scencore, Inc., 426 S. Westgate Dr., Addison, Ill.

#### SIMPSON

### Model 434A Varidot White-Dot Gen.

Provides white dots for adjusting convergence in color receivers and checking linearity, frequency response, and sync stability in black-and-white and color sets. Features independent dot height and width controls with minimum dot size one line high and one line wide. Negative and positive polarity video output, vernier control of vertical sync frequency to check receiver performance on line frequency and

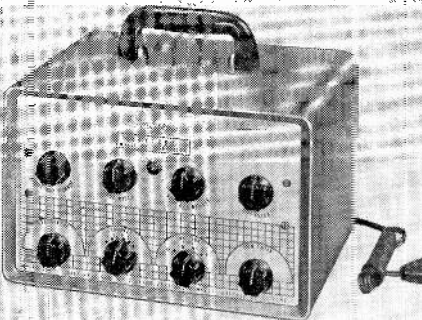

off-line frequency (as in some network programs).

#### SPECIFICATIONS

**Rf output:** Channels 2-6 variable to 50,000  $\mu$ v open-circuit.

**Output impedance:** 300 ohms balanced and unbalanced for rf and video.

**Dot width:** Variable from 0.2 to .8  $\mu$ sec at points 20% from pulse base.

**Dot height:** Variable from 1 to 8 lines high.

**Vertical dot number:** Variable from 6 to 12.

**Horizontal dot number:** Variable from 6 to 11.

**Power:** 115 volts, 60 cycles, 50 watts.

**Size:** 11 1/2 in. wide x 9 1/2 high x 9 1/2 deep.

**Weight:** 11 1/2 lb.

**Price:** \$149.95.

### Model 430 Color Bar Generator

Complete color signal generator for checking overall frequency response, matrixing, chroma levels, delay-line operation and other characteristics of a color receiver.

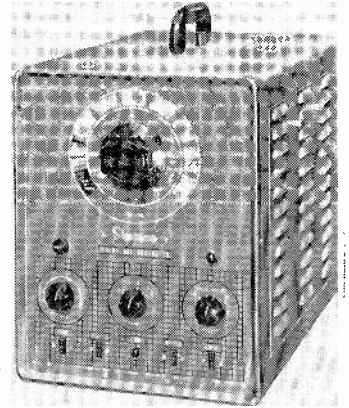

#### SPECIFICATIONS

**Rf output:** Channels 2-6 on fundamentals, 7-13 on harmonics

**Modulation or video output:** Y, chroma, standard NTSC color pattern, I, Q, I/Q, R-Y, B-Y, R-Y/B-Y, G-Y (90° phase), burst/sync.

**Color bar sequence:** Red, yellow, green, cyan, white, magenta, blue, black. Color chroma phase accuracy: 5%. Demodulator chroma phase accuracy:  $\pm 3^\circ$ . Attenuator range: Video, 0-3.5 volts p-p. Rf, maximum output more than 10,000  $\mu$ v on channels 2-6. 15-db control.

**Chroma attenuator:** Fixed -6, -15 db. Variable, -15 to +5 db.

**Size:** 14 in. wide x 17 1/2 high x 19 1/4 deep.

**Weight:** 21 lb.

**Price:** \$395.

Simpson Electric Co., 5200 W. Kinzie St., Chicago 44, Ill.

#### WINSTON

### Model 250 Color Convergence Dot Generator

Provides all patterns needed for color convergence tests and adjustments.

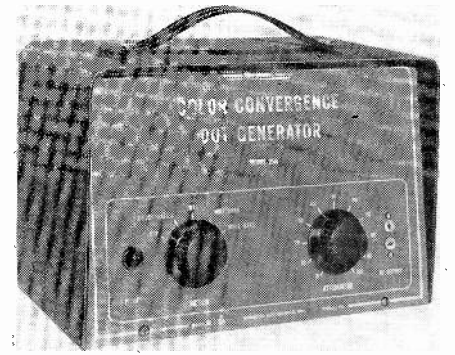

#### SPECIFICATIONS

**Rf output:** Preset to channel 2, but can be retuned to channel 3 in the field. Amplitude variable over 30 db.

**Output impedance:** 300 ohms.

**Test patterns:** White crosshatch of 18 vertical and 14 horizontal lines. White dots, 14 horizontal and 18 vertical rows, interlaced 2 lines high. White bars, 18 vertical or 14 horizontal.

**Power:** 105-125 volts, 60 cycles, 30 watts.

**Size:** 10 1/2 in. wide x 7 high x 6 deep.

**Weight:** 9 1/2 lb.

**Price:** \$129.95.

Winston Electronics, Div. Jetronic Industries, Inc., Main & Cotton Sts., Philadelphia 27, Pa.

END



by Jack Darr  
Service Editor

# S Service clinic

This column is for your service problems—TV, radio, audio or general and industrial electronics. We answer all questions individually by mail, free of charge, and the more interesting ones will be printed here.  
If you're really stuck, write us. We'll do our best to help you. Don't forget to enclose a stamped, self-addressed envelope. Write: Service Editor, Radio-Electronics, 154 West 14th Street, New York 10011.

YOU CAN SEE SOME ODD COLORS IN COLOR TV sets. You can also hear some very odd and loud noises! Flashes of blue-white light, and perhaps smoke! The hysterical set owner is convinced the whole thing's burning up! Considering the cost, you can't blame him! So, our first task when we get there is to get him calmed down enough to tell us what's happened. After we get him down off the wall, we can usually find and fix the fireworks without too much trouble. Components in color TV high-voltage circuits are usually pretty well built, and they'll stand up to a pretty severe arc-over if it's caught in time.

This is sometimes due to high humidity, but more often to some trouble inside the set. With the very high voltages, color sets are more apt to flash over than black-and-white. Let's look at the circuits and see what's going on.

Clue: color sets are about the only ones using regulated high voltage. If

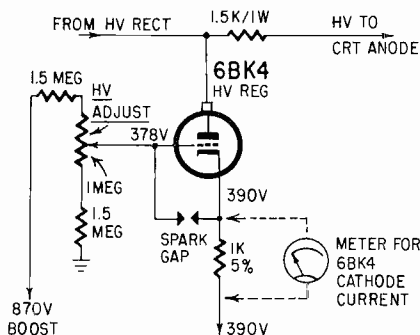

Fig. 1—High-voltage regulation circuit can have some critical values. Regulation depends on voltage divider in grid circuit of 6BK4.

the regulator tube opens up, or isn't working, the high-voltage will go up, since there will be no control on it at all.

In these flashovers, it is not the high voltage that is doing the arcing; it's usually the *boost*. In color circuits, this runs about 800 volts. The 6BK4's

plate is connected directly to the 25-kv line (Fig. 1). It usually draws a preset amount of plate current, thus shunting the high voltage. The more plate current this tube draws, the lower the high voltage, because the tube acts as a shunt-load across it.

Now, we have to have a "signal" voltage on the grid, to tell the tube when to draw more current. This is the boost voltage. The total boost is fed to a voltage divider, and the regulator grid is tapped off that. B-plus goes to the cathode. If something happens (say, an increase in line voltage) the boost rises (goes more positive). This increases the positive voltage on the grid of the 6BK4, and it draws more plate current, reducing the high voltage because it makes more load across it. Simple, huh?

Now, in some sets (for instance the Zenith 25LC20 chassis), they have thoughtfully provided a spark gap in this circuit. This is just one of the regular solder-terminal boards used on these and several other makes—see Fig. 2. (This particular one is set close to the base of the 6BK4 tube, for obvious reasons.) Other terminals on the same board can be used to make tests; more on this in a minute.

Normally, flashovers *should* take place between 1 and 2 on this board. Most of the time, they will. However, in some cases, you'll see flashovers at the high voltage control on the back apron of the chassis. Because of the high voltage present, you'll find an arc-over from the end of the resistance element to avoid a callback.

Most of these troubles start with a bad 6BK4. For example, if the heater burns out, we lose all regulation. This can cause a flashover, but if the air is pretty dry, you may see loss of focus, too much brightness, and similar symp-

toms in the picture. Take the lid off the high-voltage cage, turn the set on, and look at the 6BK4 heater. If you can't see it, because of the very large insulating plate cap on top, turn the set off, wait a minute or two, then feel the tube. If it's cold, it's out. Just watch where you put your hands, though!

While this tube has very wide spacing, it *can* short, just as a 1B3 can, if it wants to. Look for this; it's a common cause of arcovers. After you have replaced the shorted tube, check the set. The shorted regulator tube can overload the high-voltage rectifier, and even the horizontal output. If so, you'll get a narrow raster, loss of brightness, and possibly some tinting.

Check the cathode current of the output tube. In most sets, you can lift the high voltage fuse and connect a milliammeter across the holder. In the Zenith shown in Fig. 2, disconnect the fuse and connect the meter between terminals 3 and 4 on the same strip. The service data will tell you what the

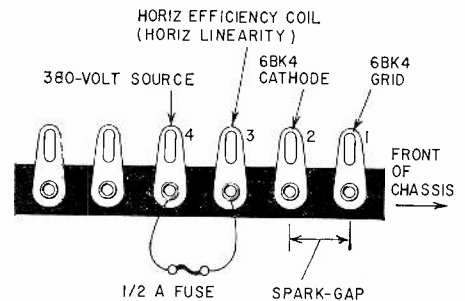

Fig. 2—Terminals 1 and 2 on this strip are used as protective spark gap on some Zenith models.

correct current is. In this set, it's 215 ma. If this current is very low, but B-plus voltages are normal, the horizontal output tube is weak and will have to be replaced. Leave the meter in place until you get the new tube in and working. Always check this cathode current whenever the output tube is replaced, just to be sure. It takes only a little while, and it's a big help in avoiding a callback!

Regulator action can be checked at this same terminal strip. In other chassis, test-points will be provided. Normal cathode current on this tube, with high voltage set at the correct value, about 24–24.5 kv, should be about 0.9 ma. In this circuit, you can read the dc voltage across the 1,000-ohm resistor in series with the cathode. In others, the meter is hooked into the cathode circuit, and the resistor opened. Follow the procedure given in the service data for whatever set you're working on.

If the current is low or high, adjust something. If the high voltage has been set at the rated value, and the current's too low, reset the horizontal efficiency coil (horizontal linearity) to bring it up. The horizontal-output tube's cathode-current meter should still be in the cir-

circuit when this is done, of course, to keep the tube from getting too much current.

Check all resistors in the 6BK4 grid circuit. Since the two 1.5-megohm resistors and the high-voltage control form a voltage divider, they're pretty critical. An increase or decrease in any of them can throw the circuit beyond the range of the control. For a horrible example, if the upper resistor decreased in value, the 6BK4 grid would go highly positive. This would cause a great increase in its plate current, and the result could easily be a burned out 6BK4 and a melted-down flyback! So check 'em!

### Vertical retrace lines

In a G-E color TV chassis CW, it looks to me as if the retrace lines are too prominent. Shouldn't they be well blanked, especially in a color set?—R. G., Danville, Ill.

Yes, indeed, as in all sets, color or black-and-white. In this particular chassis, try reducing the series resistance in the vertical blanking network. This will raise the amplitude of the blanking pulse. Also, check the capacitor for any small leakage, since this will tend to broaden the pulse and at the same time reduce its peak amplitude. Fig. 3 shows the location of these parts.

Vertical blanking in this chassis is fed from the vertical output plate, pin 2

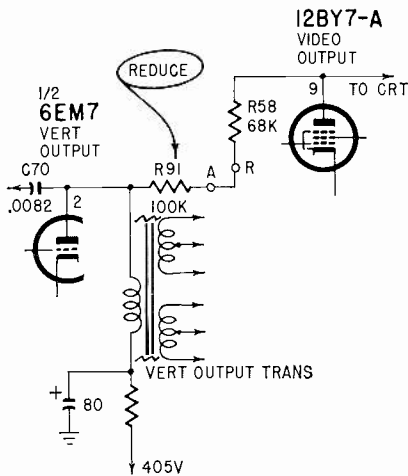

Fig. 3—To increase vertical blanking, reduce R91 in small steps from 100,000 ohms.

of the 6EM7, through a two-resistor network to the plate of the video output tube, the 12BY7A. Reduce the 100,000-ohm resistor in small steps until blanking is OK.

### Bad color sync

In RCA CTC 5 chassis, I can't get any color sync; bars or program material just "run" all the time. Color seems to be pretty good—that is, it's bright enough, but no color lock action. Tubes and voltages all look pretty close.—M. G. A., Watkins Glen, N. Y.

Check the .022- $\mu$ f bypass capacitor at the bottom of the grid winding on the

burst keyer transformer. This is shunted across a 1-megohm resistor. If it opens up, the grid impedance rises and seems

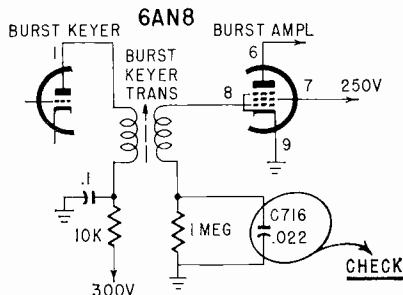

Fig. 4—Check circled capacitor if sync is poor.

to cut off the burst amplifier tube. At any rate, no color sync, or very badly reduced color sync, gets through to the color circuits. Fig. 4 shows where this capacitor is located.

### Bloomin' highlights

We're getting a bad blooming in the highlights on an RCA CTC 7 color chassis, and we can't seem to find a setting on the color temperature adjustments that will stop it. Voltages all seem to be normal, and we have plenty of high voltage.—D. G., Bronx, N. Y.

This is most likely due to too much current in the 6BK4 high-voltage regulator. Try adding about 470,000 ohms to the grid resistor. This is a 1.8-megohm 1-watt resistor between the 6BK4 grid and boost voltage (R133 in the RCA's 1957 T18 manual and R131 in Sams 399-3). See Fig. 5.

Check the 100-megohm resistor between grid and cathode of the 6BK4,

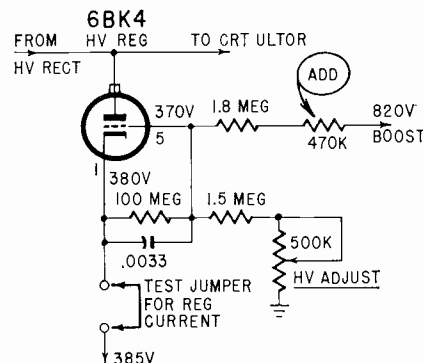

Fig. 5—If too-high hv-regulator current causes blooming, add 470,000 ohms to grid circuit.

also the 1.5-meg in series with the high-voltage adjust control. Be sure that the voltages on the regulator tube are OK, and check the current as specified in the instructions. This could also apply to any of several later chassis like the CTC 9, 10 and 11.

### Weak picture and agc

While I was checking a CTC 12 color TV for what looked like agc trouble, all of a sudden I lost a lot of rf gain. Now my picture is weak, and the

agc doesn't have as much effect. I thought I smelled a resistor burning, but I can't find one! Tubes all substituted, no change in gain.—H. G., New York, N. Y.

You did smell a resistor! This is a little bit "wild", but you'll have to watch out for it, in this, in the CTC 15 chassis and in all sets (even black-and-white) using frame-grid tubes in the video i.f.

In this chassis, a 6EJ7 frame-grid

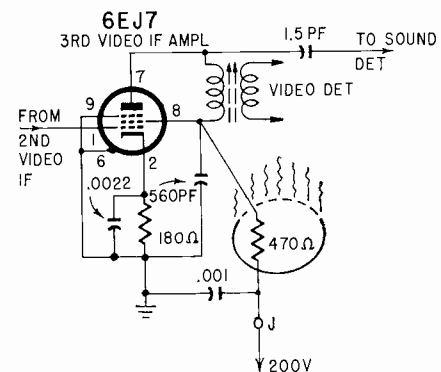

Fig. 6—Off-beat trouble in CTC 12 and 15 chassis is due to frame-grid video i.f.

tube is used as the last video i.f. amplifier. If the agc tube is pulled with the set on, this tube draws a very heavy plate current, because of the loss of bias. This overheats its plate dropping resistor, as shown in Fig. 6. These always seem to rise in value when this happens, cutting the plate voltage and, of course, the gain. Then you wind up with a weak picture.

So, always turn the set off when checking the agc or first or second video i.f. tubes.

### Low brightness

I don't think the brightness is high enough in this RCA CTC 12, although it makes a pretty good picture. Can you suggest anything?—W. B., Huntsville, Ala.

You might check, and, if possible,

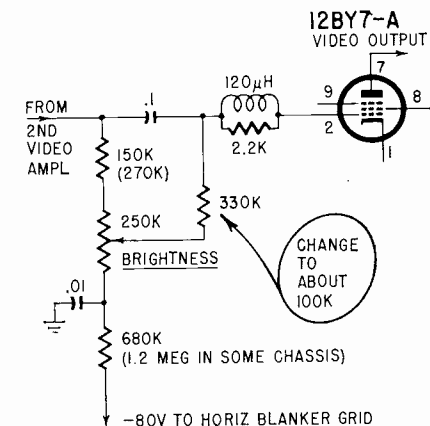

Fig. 7—More brightness in CTC-12 by making this change.

change the grid resistor of the third video amplifier tube, near the brightness

control. This 330,000-ohm resistor is marked R158 in RCA's 1962 T7 service data, and R63 in Sams 640-3.

Try about 100,000 ohms here and see if it doesn't give you a bit more control over the brightness, and perhaps a little more total brightness. See Fig. 7.

### Insufficient vertical tilt

*I'm having trouble getting convergence on a CTC 10 color chassis. The worst thing seems to be a lack of range in the vertical tilt controls. The vertical amplitude could be OK, but I can't get enough tilt to cover the lines all the way down.—L. S., New York, N. Y.*

This is probably due to low amplitude of the convergence waveform itself.

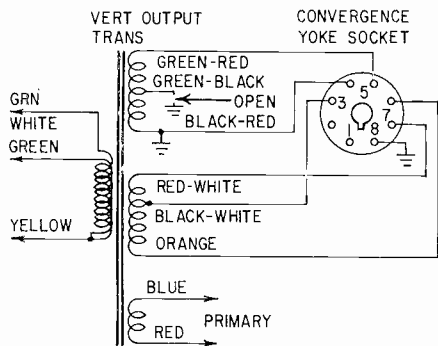

Fig. 8—Insufficient vertical tilt range can be fixed by moving ground on vertical output transformer.

This comes from the vertical output transformer, T104 in RCA's 1960 T5 service data.

Look at the transformer. If the green-black wire is grounded, change this ground to the black-red wire. This will give you a higher-amplitude waveform for application to the vertical convergence circuits, and should help out. Fig. 8 shows the change.

### Poor horizontal hold in CTC 9

*The horizontal hold action in this RCA color TV isn't very good. I get a pretty severe horizontal bend, and the picture isn't as stable horizontally as it should be. Tubes check OK and the voltages are almost normal. Grid voltage on pin 7 of the horizontal oscillator is low about -80 volts.—W. R., Okla.*

Check some of the resistors around the horizontal oscillator and afc circuits.

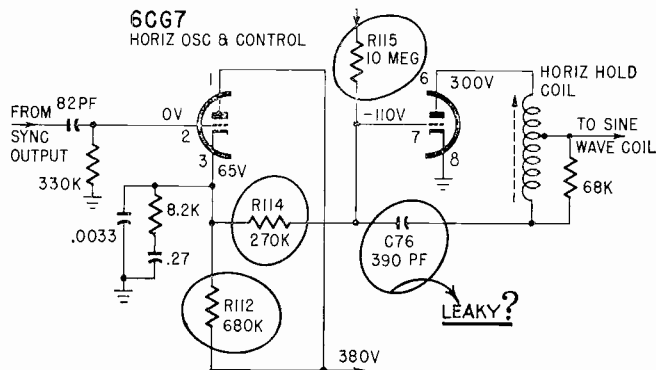

Fig. 9—Check these parts in tracking down poor horizontal stability in CTC9.

I think you'll find that one of them has drifted pretty badly (Fig. 9). The most likely suspect with the voltage readings you have would be R114, the 270,000-ohm; R115, the 1-megohm, or R112, the 680,000-ohm. Don't try to read these in-circuit (too many parallel paths). Lift one end of each and measure, to be sure.

Check the 390-pf capacitor for leakage. Even a very small leak here will throw your oscillator far off frequency.

### Low brightness again

*I'm not satisfied with the brightness I'm getting in an Admiral 25UD6 color set. My high voltage and everything else seem to check out OK, but I'm afraid to take it back to the customer unless I can get more brightness.—P. S., Short Islands, Neb.*

This is probably due to incorrect bias on the video amplifiers, which, in this circuitry (with the dc coupling), can control the brightness directly. Check

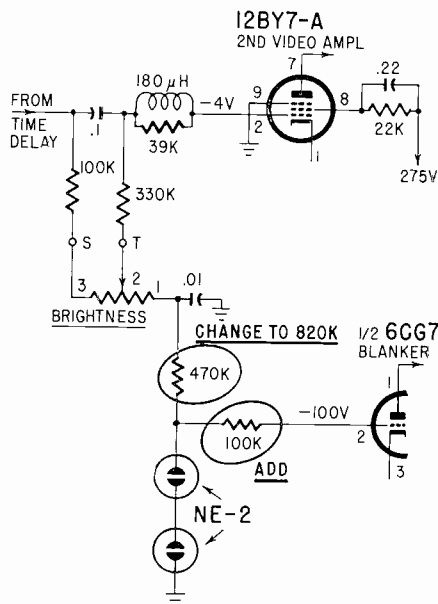

Fig. 10—Changes in brightness control circuit of Admiral 25UD6.

the voltage on the blanker grid, pin 2 of the 6CG7, V707B in Admiral's service data. If this is more than -150 volts, make the changes shown in Fig. 10 and

you'll probably see some improvement.

If we have too much negative bias on the second video amplifier grid, we reduce brightness.

### Poor definition

*We have an RCA CTC 12 chassis on the bench, and are not satisfied with the picture definition. While the picture is almost all right, it's one of those annoying things: we feel that it could be better! Any ideas?—F. S., Newark, N. J.*

RCA's field engineers recommend changing the i.f. alignment curve on this chassis, from that shown in the original service data (Fig. 11-a). The "hay-

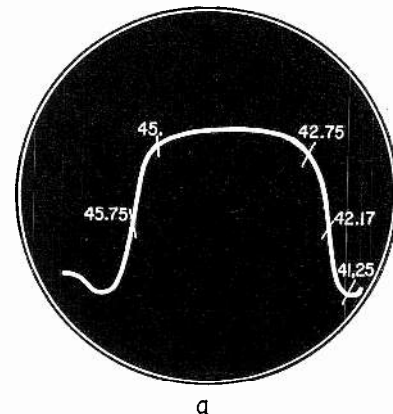
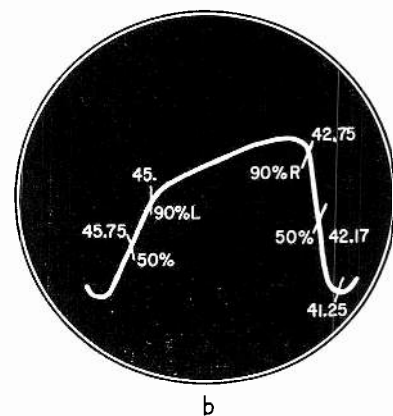

Fig. 11-a—Original CTC 12 i.f. curve can be improved for better definition as in (b) below. The adjustments do interact, and it may be necessary to line up each transformer a couple of times.

stack" curve doesn't seem to give the best picture definition.

Fig. 11-b shows the recommended curve. Set the first i.f., T302, to put the 45.75-mc marker at the 50% point on the left; the second i.f., T303, to get the



42.17-mc color subcarrier marker at 50% on the right side, and the third i.f., T304, to get the proper tilt to the top of the curve.

These adjustments all interact as usual, but you can get the proper curve with careful alignment. Be sure to set the 45.0-mc markers and the 42.75-mc markers at 90%, as shown on left and right shoulders of the curve.





.02- $\mu$ f disc ceramic capacitor across its contacts.

The reminder lamp is housed in a meter case, which facilitates mounting, placement of the legend and arrangement of the light diffusers. Details of the lamp housing are shown in Fig. 2. The legend "Announce Call Letters and Time" is a film negative in which the letters are transparent. Reminder lamp and thermal flasher are operated from a separate low-voltage transformer.

### How to build it

Construction of this announcement reminder is fairly simple and noncritical, as neither high frequencies nor high voltages are involved. The chassis is a 5 x 7 x 2-inch unit, which exactly fits the case. All power connections are brought out to the rear. The photos show the parts layout. Other arrangements can be used, but be sure to arrange components so the relay contacts, timer cams, etc. are easily accessible for cleaning and adjustment. Also, bolt all components firmly in place, using lock washers, to prevent loosening in service and trouble.

To prevent connection pileups and to firm up the wiring, tie points are used at strategic locations, and wiring is cabled. Leave enough slack so that any component can be demounted and swung out of position for testing or servicing without disconnecting it. Bolt the buzzer firmly to the end of the chassis so it will resonate, enhancing the tone and volume. Use insulated sleeving liberally to protect and isolate the various terminals and connections. Use grommets in all chassis holes to prevent abrasion of insulation and resultant shorts to chassis.

Labels indicate the function of each control and exposed component, and the proper replacement information for those likely to fail (fuse, pilot lamps) is cemented to front and rear panels.

Operation is simple. Place the unit in a convenient location and turn it on. Every 10 minutes, the reminder light starts flashing. At the first transmission break after the operator observes the light, he announces the station call and time, and presses the RESET button, which extinguishes the light until the next announcement interval comes up. If the operator disregards the light, the buzzer sounds 45 seconds after the light starts flashing, and stays on until he presses the RESET button.

Servicing and maintenance are minimized as all components except the power pilot have a rated service life of more than 10,000 hours. Life of the power pilot is extended by using a series resistor so it has to be replaced about every 2,500 hours. Life of the reminder lamp (G-E 88) in flasher service is problematical. The only one tested lasted more than 20,000 hours, which is far in excess of the manufacturer's continuous service rating.

If you have a problem with forgetting to sign, this automatic reminder and alarm, or any one of a number of rather obvious modifications of it, should solve the problem and effectively shut off the flow of pink tickets. END

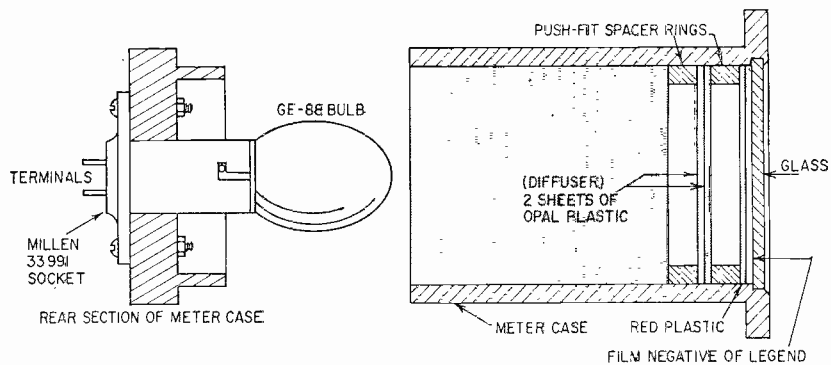
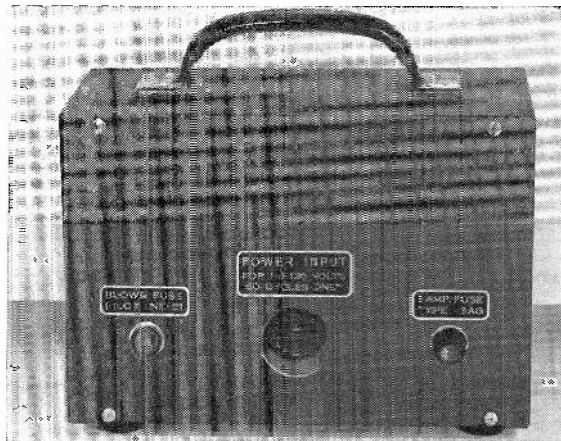
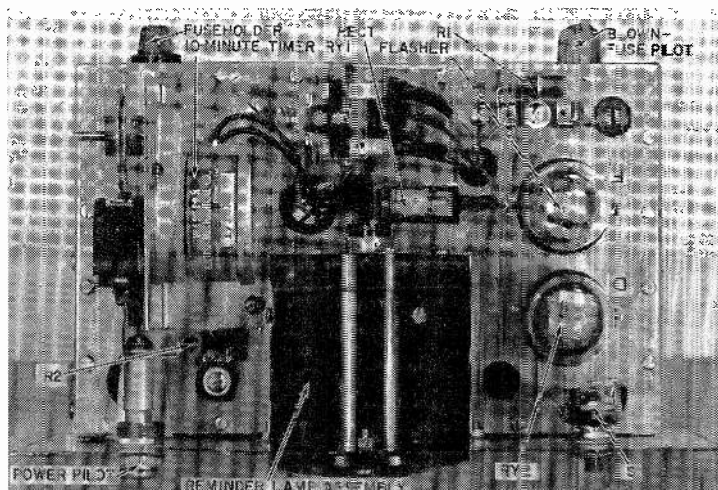

Fig. 2—Details of reminder-light assembly.

*A look at the back of the case. If the fuse blows, the neon lamp lights.*



Parts layout above the chassis.



*Parts are placed so they are accessible for cleaning or replacement.*

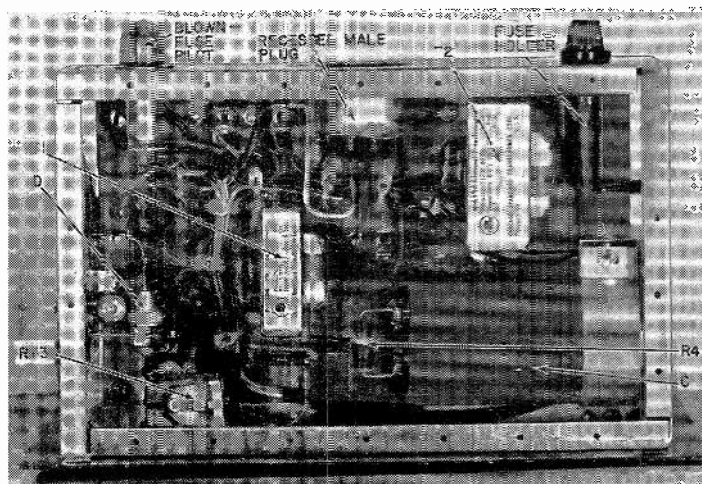

# CORNER SPEAKER fits your home

By G. A. BRIGGS\*

Britain's top authority on speakers says "corner position is best," shows how to build one that looks and sounds good

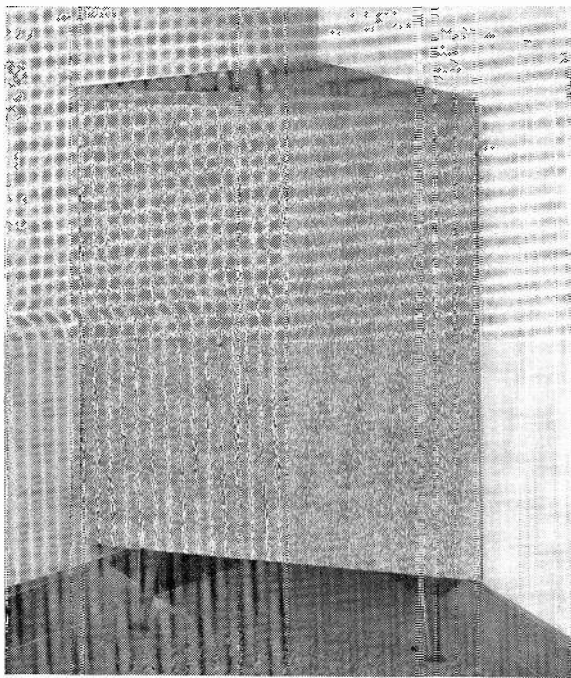

IF I WERE ASKED TO NAME THE TWO pioneers in corner-speaker development, my reply would be: the two Pauls. Paul Klipsch in the US and Paul Voigt in the UK. It is now about 30 years since I first heard the Voigt corner horn, and the famous Klipschorn was fully described in a 1946 issue of the *Journal of the Acoustical Society of America*.

My own efforts to corner the speaker market began, so to speak, in 1948, when we built our first 9-cubic-foot brick corner enclosure at a cost of 35 shillings — (say five dollars in real money). I can honestly say that the structure is as sound today as it was then.

The corner horn designs were very efficient and would give ample domestic volume level with a 5-watt amplifier. But

it has been found to be much cheaper to increase amplifier output than to concentrate on speaker efficiency, although I still favor high flux density for good transient response. Then stereo records in 1958 showed that two speakers produced more bass than one of the same size, and the large corner systems suffered a decline in popularity.

But it is still true that for optimum bass the corner is the best position in the average room, and — provided room shape is oblong rather than square — two corners at a narrow end usually give the best stereo.

The fact that two small corner cabinets can look very attractive and quite unobtrusive in a nicely furnished room is illustrated by a photograph taken

from my recently published book *More About Loudspeakers*.

In this case, the lady of the house wanted to have the speakers in the corners, but limited to a height of 30 inches because of other furniture (hence the shortened legs).

There could well be a revival of interest in corner positions and the editor of this journal has invited me to give full details of the model referred to, so here we go:

The main considerations are these:  
1. The corner speaker plays into the longest air path in the room and reflects

## Speaker Types

Wharfedale Model No.	Nominal size (inches)	Resonance (cycles)
Super 8/RS/DD	8	50-60
Super 10/RS/DD	10	38-43
Super 12/RS/DD	12	26-32

RS = Roll Surround; DD = Double Diaphragm



Commercial versions of the corner cabinet are shown in corners of this elegant Yorkshire room.

tions from two walls and floor help the low-frequency radiation.

2. As the enclosure shown is only 2 cubic feet in volume, the bass assistance from No. 1 is an advantage.

3. Diagonal facing is generally best for stereo in the average room, and distances of 8 to 12 feet between speakers are satisfactory with room lengths proportionately longer.

4. The cabinets can be placed a few inches out from the corner if there is too much bass resonance, or to reduce the distance between them for natural stereo.

5. The triangular shape is good acoustically because the only two reflecting parallel surfaces are the base and top,

\*Managing director, Wharfedale Wireless Works Ltd., Idle, Bradford, Yorks.



Fig. 1—Details of assembly, showing all dimensions. Use resin, casein or "white" glue and 1½-inch wood screws.

**DIMENSIONS and ASSEMBLY**

**Material:** ¼-inch plywood or chipboard (chipboard better acoustically but harder to cut). 1-inch lining of absorbent wadding (glass wool, ozite, etc.).

**Volume:** 2 cu. ft.

**Weight:** approx. 30 lb without speaker.

**Front panel:** 27½ x 26⅛ in., beveled 2 sides at 45°.

**Backs:** One 26¾ x 16⅞ in.  
One 26¾ x 17⅜ in.  
Both beveled on one long edge at 45°. Drill 4 holes for screwing to front panel.

**Top:** 18⅞ x 18⅞ x 26⅞. Front edge veneered or covered with strip of solid wood.

**Base:** 17⅞ x 17⅞ x 26⅞ in. Vent opening as in Fig. 1.

**Duct:** ⅜-in. plywood 17 x 7½, beveled on 2 edges 45° to fit to backs. (For 10- and 12-in. speakers only.)

**Glue blocks, etc.:** 2 long corner blocks for holding front panel to sides; cut diagonally from 1 piece 26¾ long x 1¼ in. sq. One rail for fixing front panel to base: 19⅞ long x ⅞ in. sq. Two rails for fixing top: 13½ long x ⅞ in. sq. White pine.

**Assembly:** Glue and screw backs together at right angles (butt joint—see Fig. 1). Glue and screw base in position. Glue top to fit flush with sides.

**Legs:** Suitable 6-inch legs can be bought and fitted without difficulty. Set rear as close to vent as possible.

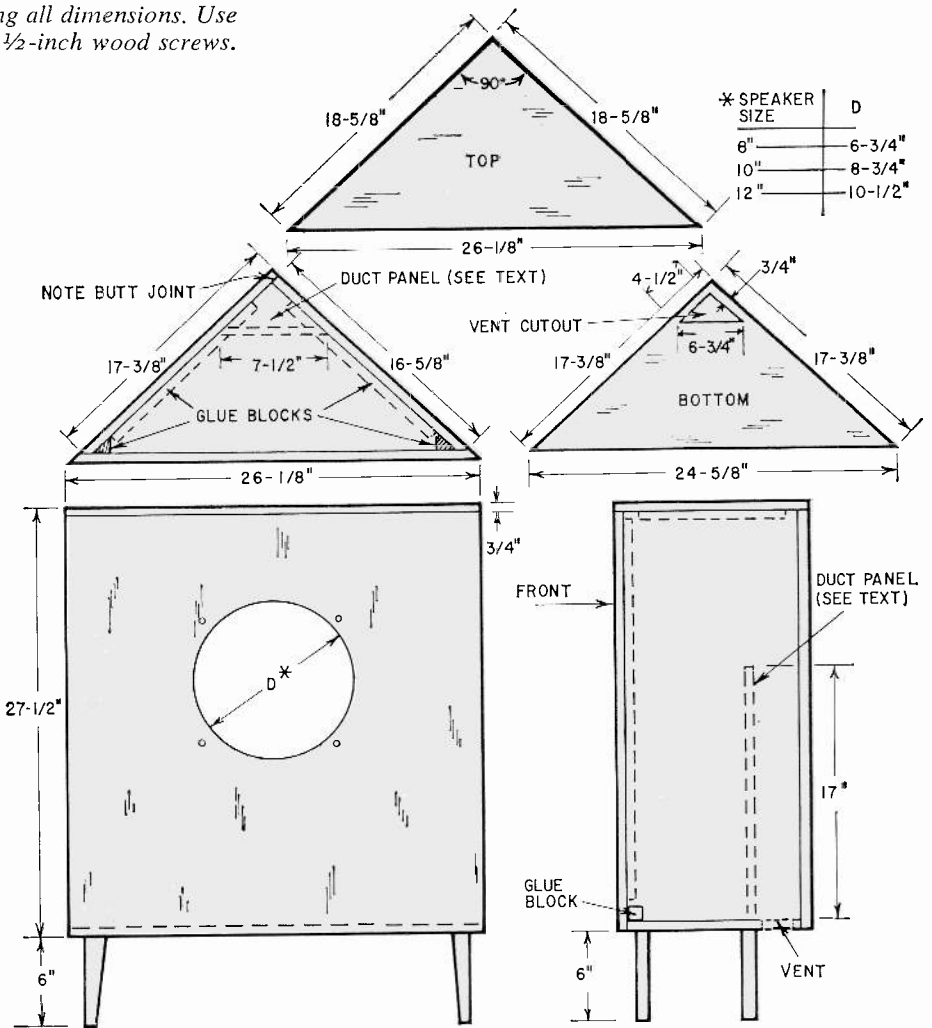

which are small in area and farthest apart.

**Construction details**

The drawing of Fig. 1 shows the overall dimensions of the cabinet, and the photograph gives an inside view with 12-inch unit and absorbent material fixed in position.

The details in the "Dimensions and Assembly" box will help in constructing the cabinet, which must be firmly glued and screwed together to provide an airtight enclosure, apart from the vent near the back. The last assembly job is to screw the front panel in position.

To facilitate lifting, two hand holes 3½ x 1 inch can be made, one in each back panel 4½ inches from the top and 4½ inches from the front. The openings must be covered with a piece of plywood on the inside to make them airtight.

**Damping materials**

The material shown in the cabinet interior photo is bonded acetate fiber in sheet form. Other suitable absorbents are glass fiber and cotton wool. Completely filling the corner cabinet with absorbents improves the reproduction of speech but takes some of the warmth out of music.

As a rule, the amount of absorbent treatment can be reduced when smaller speakers are used, because less internal resonance is heard through the cone.

**Speakers**

This enclosure gives very good results with wide-range single speakers, 8, 10 or 12 inches, provided the open

baffle resonance is not higher than specified with the test units. The long, ducted vent suits both the 10- and 12-inch types, but for 8-inch units the simple open vent is best.

Reasonable response down to 40 cycles is possible, but the larger units will obviously give bigger and better low-frequency output from cone and vent.

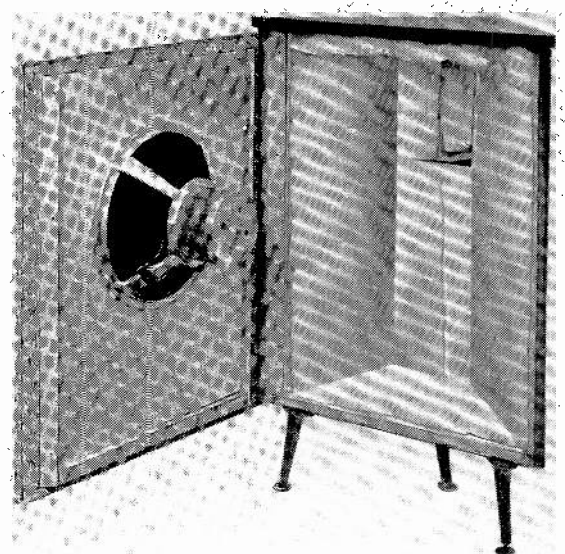

All that remains is to fasten the front panel in place. Note how padding covers all interior except back of panel. Though speaker is 12-inch model, duct is shown in this photo.

# INSTALL and SERVICE COLOR TV in the HOME



**FAST-SIMPLE  
COLOR and  
Black & White  
SERVICING**

ONLY

**6950**



## TEST PATTERN GENERATOR

Designed for low cost color servicing . . . on location! Light-weight, compact, GC's new Color Test Pattern Generator eliminates lugging heavy, bulky equipment into the customer's home—allows Color set-up, final convergence and purity checks to be made quickly, easily . . . economically!

Simple to operate . . . easily connected, the generator produces 3 different patterns; includes individual switching for any combination of three color guns . . . for fast purity or convergence checks without upsetting color controls.

PLUS . . . many more features! Complete specifications are available from your GC distributor or by writing GC.

**No. 36-610-A Complete in rugged,  
handsome carrying case . . . Net \$69.50**

**GC ELECTRONICS CO.**

DIVISION OF TEXTRON ELECTRONICS, INC., 400 S. WYMAN STREET, ROCKFORD, ILLINOIS, USA

GENERATES THESE PATTERNS

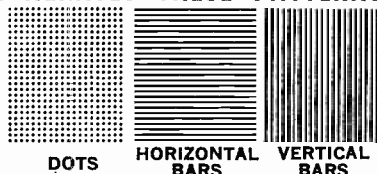

DOTS

HORIZONTAL  
BARS

VERTICAL  
BARS

Write for the all new GC 340 page Master catalog . . . with the complete Test Equipment line and over 12,000 other products.



The tests of Fig. 2 indicate the performance at 40 and 50 cycles, using the Wharfedale speakers listed in the table. These are available in the USA. The oscillograms were taken with the microphone close to the cone and also close to vent opening. The input level was set as high as possible at 40 cycles without running into noticeable distortion. The power ratings are in rms watts. (The figures would be doubled for peak watts.)

Separate tests were made for vent output. As expected, there is less dis-

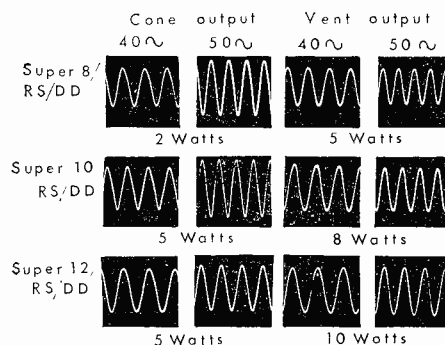

Fig. 2—Oscillograms of acoustic output with various speakers at different power levels and frequencies. No evidence of serious distortion.

ortion here as the power is increased than there is at the output direct from the cone. This is one of the benefits of reflex loading.

### Finished appearance

We now come to that hi-fi department to which it is usually necessary to admit the ladies. If I take a speaker cabinet home and my wife says she does not like its appearance, I tell her to close her eyes and listen to it, but few men could get away with this sort of behavior in England (and possibly fewer in the US).

The two cabinets shown in the Ilkley photograph were fitted with a veneered plywood frame ( $\frac{3}{16}$  inch thick) after the grille cloth had been fixed to the front panel, but this needs some skill to avoid the use of panel pins to hold the frame in position. We therefore tried a simpler method. The two side edges of the front panel were rounded off slightly with a plane to avoid sharp corners, and the grille cloth was taken round the edges and fixed at rear of panel with glue and staples.

Should any American readers try this design and assemble a cabinet, I hope the Mrs. American Readers will approve.

In conclusion, I should like to acknowledge the help I have had from our technical manager, Mr. K. F. Russell, A.M.I.E.E., and his assistant, Mr. W. Jamieson, who have done all the experimental work and testing involved in the production of this compact corner speaker system, well suited to the home constructor.

END

# GUARANTEED!

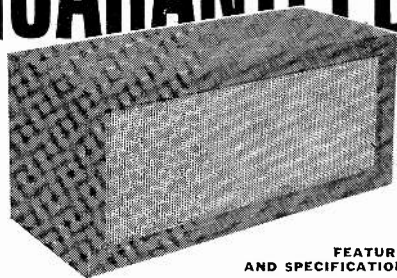

**FEATURES  
AND SPECIFICATIONS**

24" wide, 10" high, 9" deep; 8" high compliance woofer; 3" hardened tweeter cone; coaxial wound 1" voice coil; silicone treated edge allows for  $\frac{3}{4}$ " cone displacement; Alcomax III 1-lb. 5-oz. magnet; 10,000 gauss flux density; 8 ohm impedance; zero external magnetic field; 40-18,000 cps; up to 30 watts power capacity; 1450 cubic inch volume; Fibreglass acoustic dampening; matched for stereo. Solid wood—not a composite. **ORDER NOW** to insure prompt delivery! This remarkable speaker is probably the best investment you'll ever make in hi-fi equipment! Price —\$19.95 F.O.B. factory. Shipping weight 18 pounds.

- Outperforms speakers costing five times more
- Three year warranty against manufacturing defects
- Complete satisfaction or your money back

**the KENT** **\$19<sup>95</sup>**  
**all new...all wood**  
**1964 model only**

Anglo American Acoustics Ltd. RE 12-63  
129 Maryland Ave., Freeport, New York

Gentlemen: Enclosed is my check for \$\_\_\_\_\_

Please ship me \_\_\_\_\_ "Kent" natural wood cabinet speaker(s) at \$19.95 each.

I UNDERSTAND THAT THESE SPEAKER SYSTEMS ARE GUARANTEED AND IF I AM NOT COMPLETELY SATISFIED I MAY RETURN FOR A FULL REFUND WITHIN TEN DAYS AFTER RECEIPT.

NAME \_\_\_\_\_

ADDRESS \_\_\_\_\_

CITY \_\_\_\_\_ ZONE \_\_\_\_\_ STATE \_\_\_\_\_

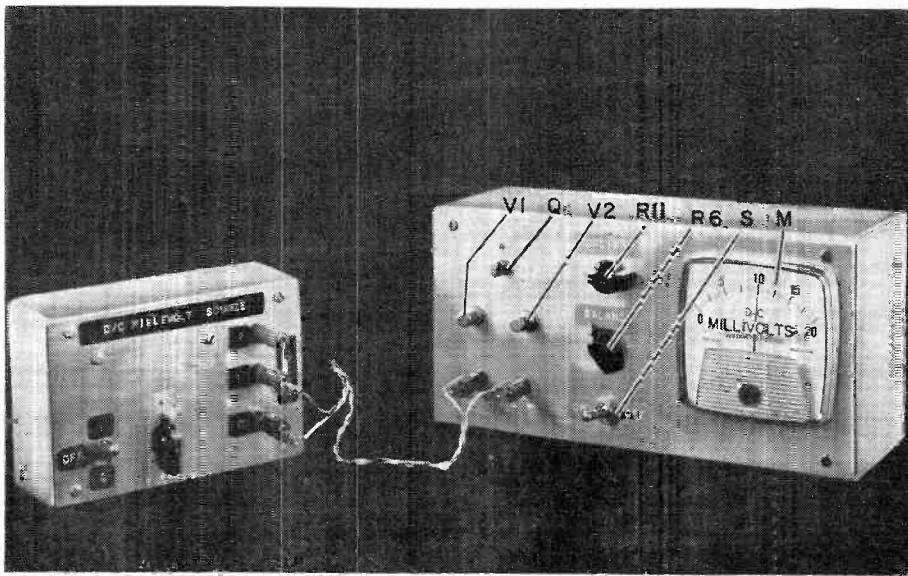

The meter being calibrated from a dc millivolt source. If your vtvm or vom is accurate, rig up a 2-volt or 20-volt dc source with a 100:1 or 1,000:1 resistive divider to calibrate the millivoltmeter.



## A HYBRID DC MILLIVOLTMETER

Nuvistor-transistor meter finds use in many labs. Reads 20 mv full scale **By BERT J. HILL\***

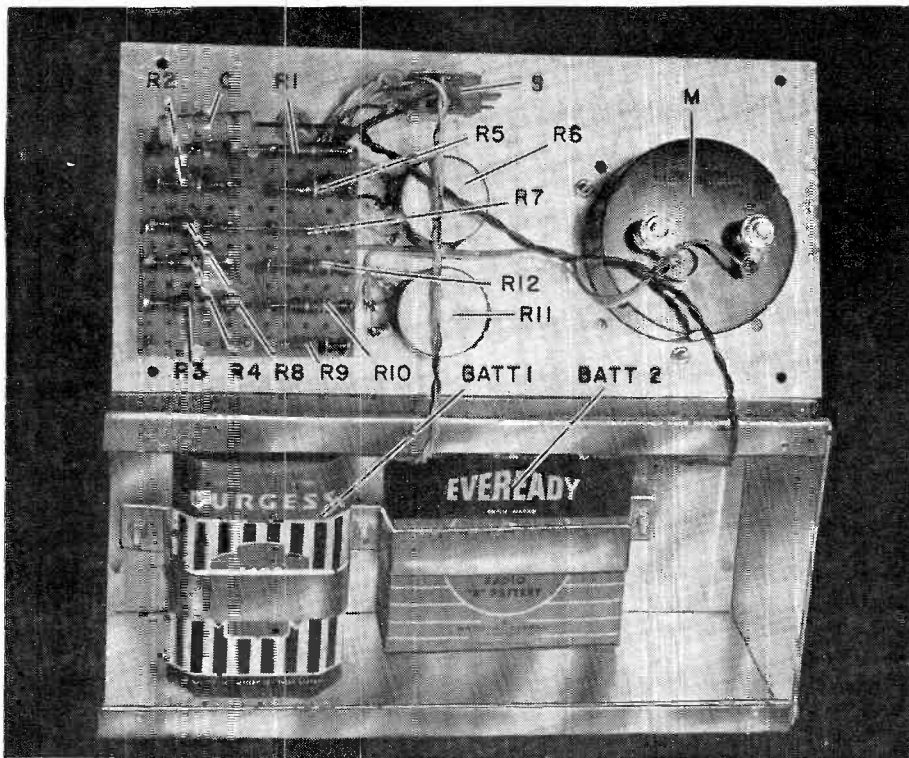

Inside the millivoltmeter. Wiring and layout need not be critical. No ac for miles around!

THIS INSTRUMENT CAN MEASURE A FRACTION of a millivolt dc with minimum loading of the circuit or device under test. It does not use mechanical or electrical choppers, complicated feedback or elaborate temperature compensation. Anyone interested in measuring small potentials, such as in biology, electrochemistry, geophysics or metallurgy, will find it very useful.

The instrument consists of two nuvistors in a balanced input circuit whose output feeds a single p-n-p transistor in a common emitter configuration. Self-contained batteries power the unit.

Nuvistors were chosen for their low drain, stability and low-voltage operation. The triodes tested were the 6CW4 and the industrial version, the 7586. The 7586 performed better.

The circuit is shown in the diagram. The input signal is fed to the grid of V1 which, in conjunction with V2, forms the usual balanced input stage. This circuit is often used to minimize the effects of voltage supply changes, temperature variations, etc. The 90-volt battery (BATT 2) supplies plate voltage for both nuvistors. The 1,000-ohm balance potentiometer (R6) is used to

\*Research Department, Central Scientific Co.



# FOR SHARP, CLEAR 2-WAY COMMUNICATION

Fixed or mobile,  
business or pleasure  
Get the new, low-cost

## RCA MARK VIII

27-Mc Citizens Band Radio-Phone

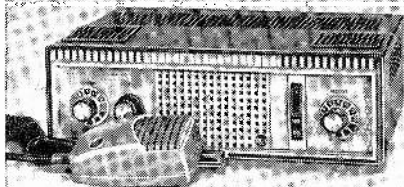

Here's the LOW-COST C-B radio-phone for car, boat, home, office, or shop. High sensitivity receiver pulls in weak signals. 2½ watt speaker output delivers ample volume to overcome engine noise. Automatic noise suppressor minimizes ignition interference. Light and compact—only 3½ inches high, weight only 9 pounds; fits easily under the dashboard of even compact cars.

### PLUS THESE PREMIUM FEATURES— RCA MARK VIII RADIO-PHONE

- 9 crystal-controlled transmit and receive channels
- Tunable receiver permits reception of all 23 C-B channels; dial marked in both channel numbers and frequency
- Exceptionally good voice reproduction—high intelligibility
- Excellent modulation characteristics
- Operates from standard 117-volt AC; separate 6- and 12-volt DC power supplies (optional) for mobile installations
- Electronic switching—no relay noise or chatter
- Illuminated "working channel" feature plus many more features to increase usefulness and efficiency.

AC Unit only **\$149.50\***

DC Power Supplies, Where Needed, \$19.95\*

\*Optional list price



**The Most Trusted Name  
in Electronics**

—MAIL COUPON FOR MORE INFORMATION—

RCA Electronic Components and Devices  
Commercial Engineering Dept. L-39-R  
415 South Fifth Street, Harrison, N. J.

Please send more information on the RCA  
Mark VIII 27-Mc 2-Way Radio-Phone.

Name \_\_\_\_\_

Address \_\_\_\_\_

City \_\_\_\_\_ Zone \_\_\_\_\_ State \_\_\_\_\_

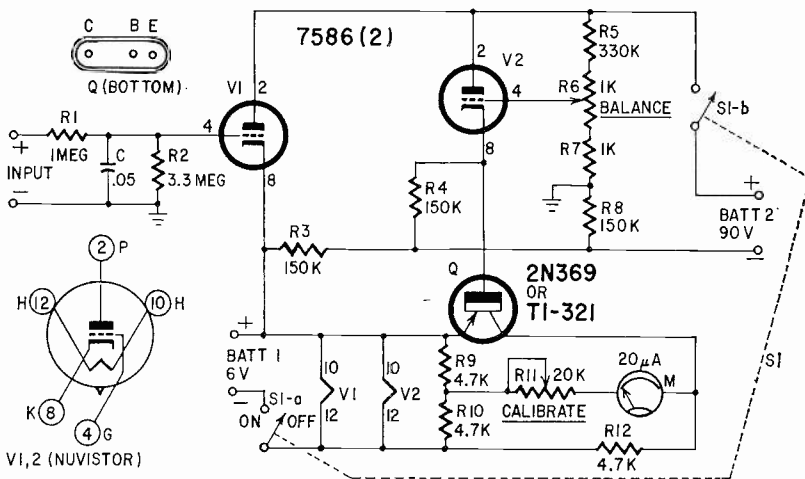

The circuit of the millivoltmeter. Familiar dc vtvm bridge is augmented by high-gain transistor amplifier stage.

- R1—1 megohm
- R2—3.3 megohms
- R3, R4, R8—150,000 ohms
- R5—330,000 ohms
- R6—Pot, 1,000 ohms, linear
- R7—1,000 ohms
- R9, R10, R12—4,700 ohms
- R11—Pot, 20,000 ohms, linear
- All resistors ½ or 1 watt 5%
- C—.05 µf, 200 v

- M—0—20-µa dc meter (G-E, Weston 301, Triplett)
- V1, V2—7586 nuvistor
- Q—2N369 or Texas Instruments TI-321
- S—dpst switch
- Batt 1—4.5- or 6-volt A-battery. See text
- Batt 2—90-volt B-battery
- Chassis to suit
- Sockets
- Miscellaneous hardware

vary the bias on the grid of V2 and thus adjusts the voltage level between the cathodes. This voltage is fed to the base and emitter of transistor Q, controlling the current in the collector circuit. A balanced-bridge circuit is formed by R9, R10, R12 and the collector of Q. Thus, microammeter M can show the signal-caused current *change* rather than the total current.

After zeroing the instrument, calibrating rheostat R11 is used to adjust it to show full-scale deflection when a 20-mv dc signal is connected to the input terminals.

The 6-volt battery (BATT 1) powers the transistor stage as well as the nuvistor heaters. The unit functioned well with the 6-volt battery, but I got less drift and better stability after warmup with a 4.5-volt battery as BATT 1. In addition, the current drain de-

creased by about 40 ma, increasing battery life.

Linearity was excellent and there was no trouble in calibration. Drift is negligible for short-term measurements, but rezeroing is required for repeated longer-term measurements. This is no disadvantage as long as you make simple nonrecording voltage readings.

The input resistance is more than 4 megohms—practically no load to low-voltage dc sources such as thermocouples, electrodes used in pH measurements, or biological potential sources.

This instrument, while not designed to compare with expensive chopper-stabilized microvoltmeters, certainly gives us a simple unit for measuring dc millivolts effectively. It has proved its value in general laboratory work on more than one occasion. END

### Couplers May Kill Color

In many cases the color set does not supersede the old black-and-white receiver, but makes the home into which it comes a two-set household. If the two sets are used with a TV coupler, it is necessary to be sure that the coupler is one that will pass color. If two black-and-white sets are already in use in the household, the color coupler may be an old type which may "suck out" the 3.58-mc frequency on which color depends.

In any case, where a coupler or dual outlet booster is used and there is trouble with color but not with black-and-white, try the color set on the antenna alone without a coupler before deciding that the trouble is somewhere inside the set or in the antenna.

By MIKE WAYNE

# Peewee Attacks Radio

Can a 5-lug oscillator coil with an open winding be the trouble? Peewee thinks so

"WHAT ABOUT THIS RADIO?" I ASKED Peewee, my diminutive assistant. It was a five-tube ac-dc job that had been sitting on the bench with its innards exposed for 2 or 3 days.

"It's got a bad oscillator coil," he replied. "I've been meaning to tell you, so you could order a new one."

"We have a lot of universal oscillator coils. Why can't you use one of them?"

"Well, this one's sorta special. It has five terminals."

"Five terminals?" I questioned. "One of 'em must be a tie point."

"Nope," he declared, "I looked. There is a lead going into the coil from each terminal."

"Oh, I begin to understand. You cut your repair teeth on TV. I'd forgotten that you're not up on radio repair—it is a lot more complicated." Peewee must have noted the sarcasm in my voice. He asked, "Just what do you mean by that?"

"First, let me ask you a question. Just how did you come to the conclusion that the oscillator coil was defective?"

"Well," Peewee began, "I checked the radio and all I could hear was some noise. No stations. I remembered once you told me that when there is noise but no stations, it's likely that the oscillator stage isn't working."

"So?"

"So, I checked the 12BE6 oscillator-mixer and all the voltages. Then I decided to check the oscillator coil with the ohmmeter. That's when I found it."

"Found what?" I asked.

"The open winding. One of the windings wasn't connected to any other terminal on the coil."

"Did you say the voltages on the 12BE6 were OK?" I asked. "What about pin 1, the oscillator grid?"

"It was 6 or 8 volts negative, as I recall," said Peewee.

"Then it's obvious that the oscillator was working."

"Yeah, I thought so too, maybe, but with that winding open I figured it must be off frequency or something."

I looked at the coil connections before answering. "You know how this coil came out?"

"If you mean, can I hook it back up, the answer is yes. I made a drawing here on this scratch pad."

Hook it up again

"Well, then, get it hooked back up. I want to check this set myself. I'm tired of it cluttering up the bench."

"But . . .," he began.

"No buts," I interrupted. "Put it back!"

He did. In 15 minutes he was through.

"Well, there it is," Peewee muttered unhappily.

"Fine. Turn the set on."

There appeared to be no stations but there was an unusual amount of noise, very similar to atmospheric static.

"Hand me the vtvm," I instructed. "I want to check the oscillator grid voltage on pin 1 of the 12BE6." I did. It was 7 volts negative. I touched my finger to pin 7, the signal grid, and turned the dial to our strongest local station. I could hear it faintly through the static-like noise. "Well, t'aint the oscillator stage," I concluded.

"How do you know?" Peewee asked.

"Well, that's pretty simple. Listen. Hear that station? Recognize the announcer?"

"Sure." He nodded. "That's Joe Slatery on KWTO."

"Look at the dial," I said.

"I'll be darned!" exclaimed Peewee. "Right on 560. Just where it should be."

"So?"

"So, like you say, t'aint the oscillator stage, I reckon."

"I reckon not," I gibed.

"Well, then, what is the trouble?" he wanted to know.

"I'm not certain," I said, "but I'll bet a milkshake that we have a bad i.f. transformer."

"How come you think so?"

"Mainly the staticlike noise. I've run into this trouble a jillion times before, and because it doesn't look like rain, I'll bet I win the milkshake."

"OK," Peewee said. "I'll go along. It'll be worth the milkshake to get you off my back. How do we tell for sure if it is an i.f.?"

## ANYONE can build a professional FM stereo tuner with a new Scott Kit



Scott's Chief Kit Engineer, Gaylord Russell, watches while one of 100 novices builds a pre-production sample of a new Stereo Tuner Kit. The unique alignment procedure uses the indicator on the tuner itself, permitting laboratory-accurate results and pinpoint alignment. Even at the hands of a novice, every tuner kit will meet or exceed published specifications.

Scott's exciting new kit building techniques make it possible for anyone to build a high-quality FM Stereo Tuner. Special alignment procedures make it possible to obtain high sensitivity without the need for expensive test equipment. A major innovation is the full-color instruction book, showing each part and wire in exact size and color.

Two tuner kits are available. The LT-110, at \$164.95 features sensitivity of 2.2 microvolts, pre-wired multiplex section and famous Sonic Monitor. The economical LT-111 at \$119.95, with sensitivity of 3.5  $\mu$ v, uses new compacton tubes for ease of assembly. There are 5 additional kits available from Scott. Prices start at \$99.95.

Prices slightly higher West of Rockies.

H. H. SCOTT INC.  
111 Powdermill Road  
Maynard, Mass. Dept. 570-12

Rush me your authoritative free Stereo Component Guide as soon as it comes off the press.

Name \_\_\_\_\_

Address \_\_\_\_\_

City \_\_\_\_\_ Zone \_\_\_\_\_ State \_\_\_\_\_

**SCOTT**

H. H. Scott, Inc., 111 Powdermill Rd., Maynard, Mass. Export: Morhan Exporting Corp., 458 Broadway, N.Y.C. Canada: Atlas Radio Corp., 50 Wingold Ave., Toronto

ANOTHER REASON WHY HEATHKIT

# SOLID-STATE\* STEREO

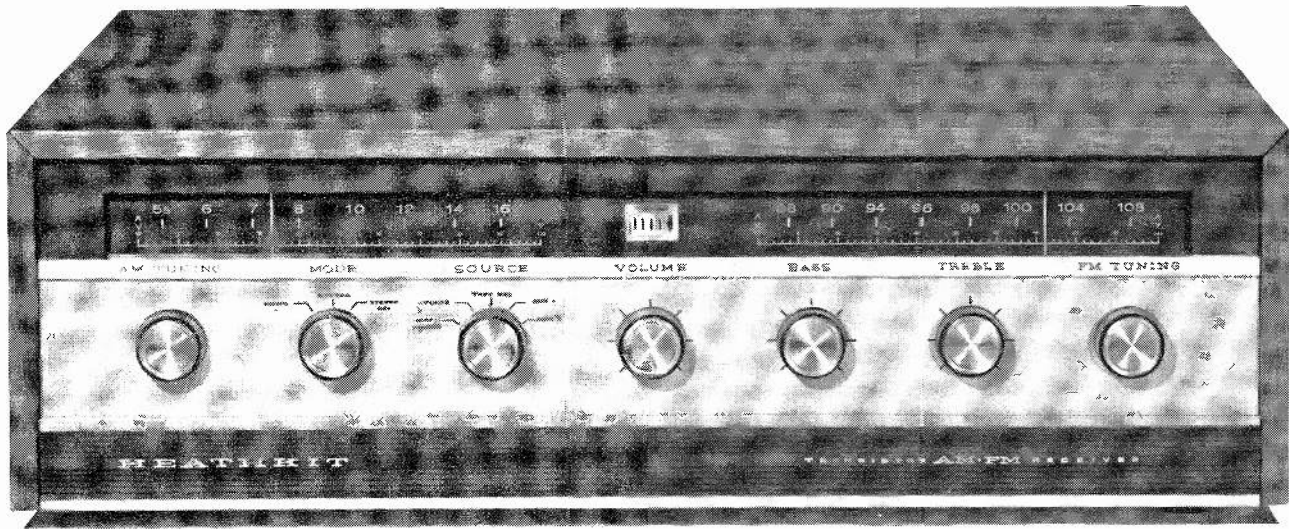

**NEW! AR-13 STEREO RECEIVER...only \$195<sup>00</sup>**

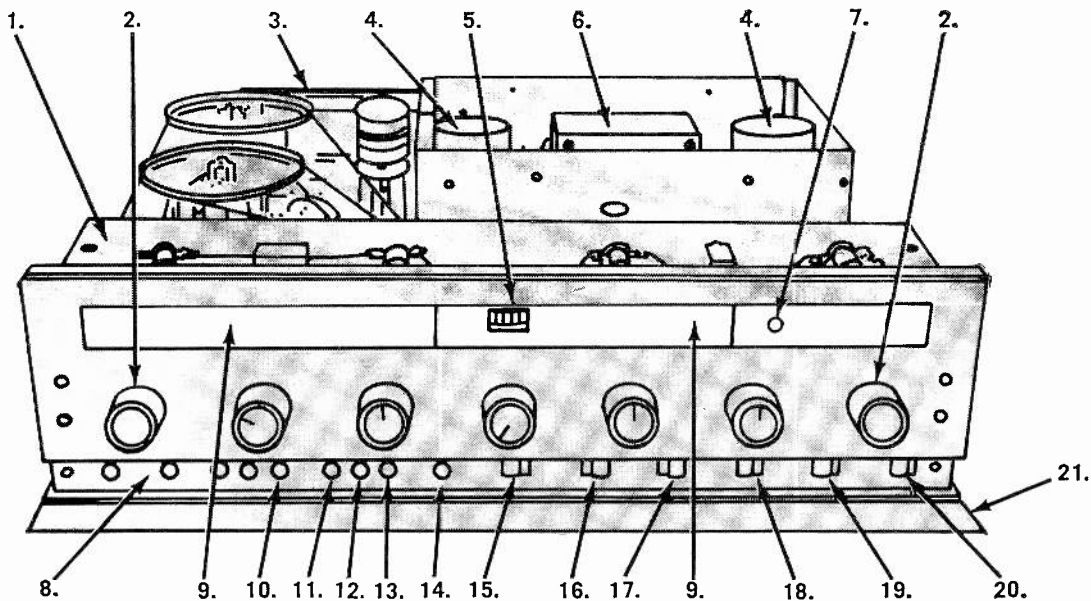

1. Preassembled FM Front End
2. Individual AM and FM Tuning
3. AM Rod Antenna
4. Regulated & Electronic Filtered Power Supply
5. Tuning Meter
6. Transformer Operated Power Supply
7. Stereo Indicator Light
8. Input Level Controls
9. Illuminated Slide Rule Dials
10. Phase Adjust Control
11. Converter Balance Control

12. Stereo Separation Control
13. FM Squelch Control
14. Level Balance Control
15. Phase Adjust Switch
16. AFC Switch
17. Local-Distance Switch
18. SCA Filter Switch
19. Noise Filter Switch
20. Speaker Phase Switch
21. Hinged Lower Front Panel  
(conceals secondary controls)

\* 43 Transistor, 16 Diode Circuitry



LEADS IN TRANSISTOR STEREO

# TUNER-AMPLIFIER

by Heathkit

## FIRST IN KIT FORM!

ALL-TRANSISTOR AM-FM & FM STEREO TUNER PLUS  
ALL-TRANSISTOR 40-WATT STEREO AMPLIFIER—ALL  
IN ONE SMART WALNUT CABINET FOR JUST \$195.00

Now in time for Christmas giving, Christmas listening! Two 20-watt power amplifiers...two separate preamplifiers...plus wide-band AM, FM, and FM Stereo...all beautifully housed in this one, compact Heathkit All-Transistor Stereo Receiver. For Heathkit this means another first! For you it means experiencing the uncompromising realism of "transistor sound" in a handsomely styled receiver that *won't* overheat...just the coolest, fastest, most "hum-free" operation possible! Just the purest, most "solid sound" possible! This is the why of transistor stereo. This is why you should move up to the new AR-13 Receiver. And the traditional Heathkit economy makes this advanced performer easy to own...just \$195.00

All the electronics you need for a complete music system are "Heath-Engineered" into this handsome unit...just add two speakers and a phonograph or tape recorder! And there's plenty of advanced features to match the advanced performance of the AR-13. You'll like the way this unit *automatically* switches to stereo, thus eliminating any manual operation. In addition the automatic stereo indicator light silently signals when stereo is being received. For versatility there's three stereo inputs (mag. phono and two auxiliary) plus two filtered tape recorder outputs for direct "off-the-air" beat-

**SPECIFICATIONS—Amplifier: Power output per channel (Heath Rating):** 20 watts/8 ohm load, 13.5 watts/16 ohm load, 9 watts/4 ohm load. (IHFM Music Power Output): 33 watts/8 ohm load, 18 watts/16 ohm load, 16 watts/4 ohm load @ 0.7% THD, 1 KC. **Power response:**  $\pm 1$  db from 15 cps to 30 KC @ rated output;  $\pm 3$  db from 10 cps to 60 KC @ rated output. **Harmonic distortion (at rated output):** Less than 1% @ 20 cps; less than 0.3% @ 1 KC; less than 1% @ 20 KC. **Intermodulation distortion (at rated output):** Less than 1%, 60 & 6,000 cps signal mixed 4:1. **Hum & noise:** Mag. phono, 50 db below rated output; Aux. inputs, 65 db below rated output. **Channel separation:** 40 db @ 20 KC, 60 db @ 1 KC, 40 db @ 20 cps. **Input sensitivity (for 20 watts output per channel, 8 ohm load):** Mag. phono, 6 MV; Aux. 1, .25 v; Aux. 2, .25 v. **Input Impedance:** Mag phono, 35 K ohm; Aux. 1, 100 K ohm; Aux. 2, 100 K ohm. **Outputs:** 4, 8, & 16 ohm and low impedance tape recorder outputs. **Controls:** 5-position Selector; 3-position Mode: Dual Tandem Volume; Bass & Treble Controls; Balance

free stereo recording. Dual-tandem controls provide simultaneous adjustment of volume, bass, and treble of both channels. Balancing of both channels is accomplished by a separate control. The AM tuner features a high-gain RF stage and high-Q rod antenna.

Other quality features include a local-distance switch to prevent overloading in strong signal areas; a squelch control to eliminate between-station noise; AFC for drift-free reception; heavy die-cast flywheel for accurate, effortless tuning; pin-point tuning meter; and external antenna terminals for long-distance reception. For added convenience the secondary controls are "out-of-the-way" under the hinged lower front panel to prevent accidental system changes.

Building the AR-13 is quick and easy with the pre-assembled FM "front-end" and 3-stage AM-FM I.F. strip, plus circuit board construction. Styled in Heathkit's new low-silhouette design, the beautiful walnut cabinet accented with the extruded gold-anodized aluminum front panel makes the AR-13 a handsome addition to any home decor. This Christmas, move up to the better listening of "transistor sound" with the new AR-13 Stereo Receiver...another example of superb Heathkit quality at unmatched savings.

**Kit AR-13, 30 lbs., no money dn., \$19 mo. . . . \$195.00**

Control; Phase Switch; Input Level Controls (all inputs except Aux. 2); Push-Pull ON/OFF Switch. **FM: Tuning range:** 88 mc to 108 mc. **IF frequency:** 10.7 mc. **Antenna:** 300 ohm balanced (internal for local reception). **Quieting sensitivity:** 2½ uv for 20 db of quieting, 3½ uv for 30 db of quieting. **Bandwidth:** 250 KC @ 6 db down (full quieting). **Image rejection:** 30 db. **IF rejection:** 70 db. **AM suppression:** 33 db. **Harmonic distortion:** Less than 1%. **Multiplex:** bandpass:  $\pm 1/2$  db, 50 to 53,000 cps. **Channel separation:** 30 db, 50 to 2,000 cps; 25 db @ 10 KC. **19 KC suppression:** 50 db down, from output @ 1 KC. **38 KC suppression:** 45 db down, from output @ 1 KC. **SCA rejection:** 30 db. **AM: tuning range:** 535 to 1620 KC. **IF frequency:** 455 kc. **Sensitivity:** 1400 KC, 3.5 uv; 1000 KC, 5 uv; 500 KC, 10 uv—standard IRE dummy antenna. **Bandwidth:** 8 KC @ 6 db down. **Image rejection:** 30 db @ 600 KC. **IF rejection:** 45 db @ 600 KC. **Harmonic distortion:** Less than 1%. **Overall dimensions:** 17" L x 5¼" H x 14¼" D.

HEATHKIT-1964



**NEW! FREE 1964 HEATHKIT CATALOG.** See the latest new products in Heathkit's wide, wonderful line. Over 250 do-it-yourself kits for stereo/hi-fi, marine, TV, electronic organs, amateur radio, test instruments, educational, and home and hobby items that will save you up to 50%. Send for your free copy today!



**HEATH COMPANY** Benton Harbor 20, Michigan 49023

- Enclosed is \$195.00, plus postage. Please send Model No. AR-13.  
 Please send Free Copy of New 1964 Catalog.

Name \_\_\_\_\_

Address \_\_\_\_\_

City \_\_\_\_\_ State \_\_\_\_\_



“. . . One of the windings wasn't connected to any other terminal on the coil.”

(Continued from page 65)

“First,” I pointed out, “we'll localize the trouble. It could be either i.f. transformer.”

“OK, so localize,” he said. “How do we do that?”

“First, we pull out the 12BE6. See—we still have the noise; that just about proves that the noise is in the oscillator stage or before it.”

“But this is a series-heater set. Doesn't pulling out one of the tubes keep the rest of the tubes from working?”

“It just removes the heater voltage, but the cathodes stay hot long enough to operate satisfactorily for 30 to 40 seconds. Plenty of time for us to make our tests.”

“OK, just checking.”

“Let's proceed then,” I went on. “If we still have the noise when we pull out the 12BE6, our next step is obvious. We know our trouble follows this stage.”

“So we can pull out the 12BA6 i.f. amplifier and check again,” reasoned Peewee.

“Right,” I said. “If the noise disappears, we'll know that the first i.f. is probably defective. If we still have the noise, then it's likely the second i.f.—or the third i.f. transformer, if this set happened to have two i.f. stages, which it doesn't. Point is, we can knock off possibilities one by one just by pulling tubes in succession like this.”

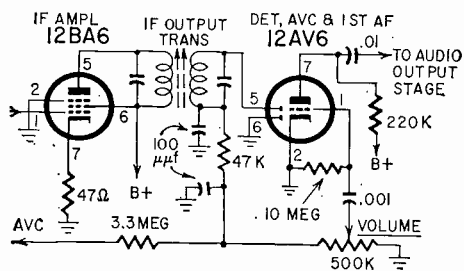

Fig. 1—Leakage between the i.f. windings caused positive voltage on the detector plate, pin 5 of the 12AV6.

### And the audio stages?

“Couldn't it be further on—in the audio stages?” asked Peewee.

“Well, yes it could be,” I agreed. “I'm glad you're thinking, for a change. But we can eliminate that possibility. See—when I turn the volume down, the noise is gone. The trouble has to be located before the first audio tube. Right?”

“Seems that way,” he agreed.

We pulled the 12BA6 i.f. amplifier. The static noise continued.

“Now,” I said, “for the final check. Lemme have the vtvm again.”

“What range?” Peewee asked, with his hand on the function switch.

“Any low range. Just so it's dc and positive,” I answered. “Now take the probe and touch it to the diode plate terminal of the 12AV6 socket. The one connected to the second i.f.”

He did. “It's about 0.5 volt positive.”

“Now watch the meter while I pull the 12AV6 detector and first audio tube out,” I instructed.

“Wow!” he yelled. “The meter went off scale.”

“Then I guess we trapped our culprit—the second i.f. transformer.”

“What's it doing?” he asked. “Leaking between windings?”

“Well, that's about it,” I agreed. “Actually, this type of small i.f. usually breaks down between the fixed capacitors that are connected across the windings. The capacitors are molded in plastic at the bottom of the i.f. The connecting lugs are extensions of the capacitor plates. Anyway, the leakage is from the primary to the secondary.”

“Do the capacitors short, or what?” he asked.

“Very seldom,” I replied. “The leakage is usually in the megohms. Most likely caused by moisture or dirt collections.”

### And the voltage?

“How come the voltage went so high when you pulled the 12AV6?”

“Well, take a look at the schematic (Fig. 1), the secondary of the i.f. is tied to the detector diode plate in the 12AV6.

And when you tie a positive voltage to a diode plate—what happens?”

“It'll conduct.”

“Right. And a conducting diode has very little resistance. So most of the positive voltage is shunted to ground—especially since the leakage in the transformer is a high resistance. When we pulled the tube, the shunt was removed, and the voltage rose tremendously.”

“But what if it had been the first i.f. transformer?”

“Same thing holds true,” I said. “The grid of the 12BA6 would act as a diode and shunt the positive voltage to ground.”

“Isn't the voltage always negative at these points?”

“Right,” I agreed.

“Then if there was any positive voltage at all on the 12BA6 grid or the detector diode plate—we could be pretty sure that the i.f. is bad?”

“Well, at least we would know we had trouble and just about where it is—so it wouldn't be too hard to find. The sure-fire way to find a leaky i.f. is to disconnect all wires from the secondary winding and check for any positive voltage on the secondary with a vtvm. With practice, though, simply pulling the tube and measuring the voltage is sufficient. Partially open windings can be spotted with a quick resistance check.”

“Does a defective i.f. always make this noise?”

“Certainly not. Although I'd say about 50% to 60% do. But the set invariably has low sensitivity.”

“I'm ready to buy the milkshake if you'll explain the oscillator coil,” he said. “How come it's working with an open winding?”

“Elementary, my dear Peewee,” I said condescendingly. “That's how it's made.”

“You mean they make it with an open winding?”

“Yep. If you ever bothered to glance at the schematic (Fig. 2), you'd see.”

He looked and it was there. A winding with an open end tied to the oscillator grid.

“It's a gimmick,” I said. “That capacitance couples the feedback voltage to the oscillator grid. It's cheaper for the manufacturer than the separate capacitor it replaces.”

Peewee was appalled. “You're dern right it's a gimmick,” he said. I could see he was serious.

END

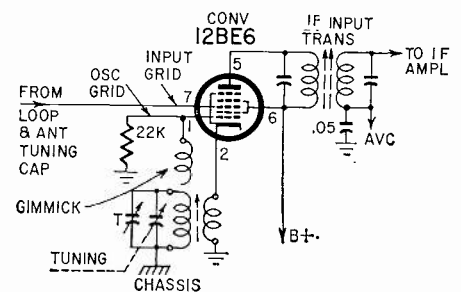
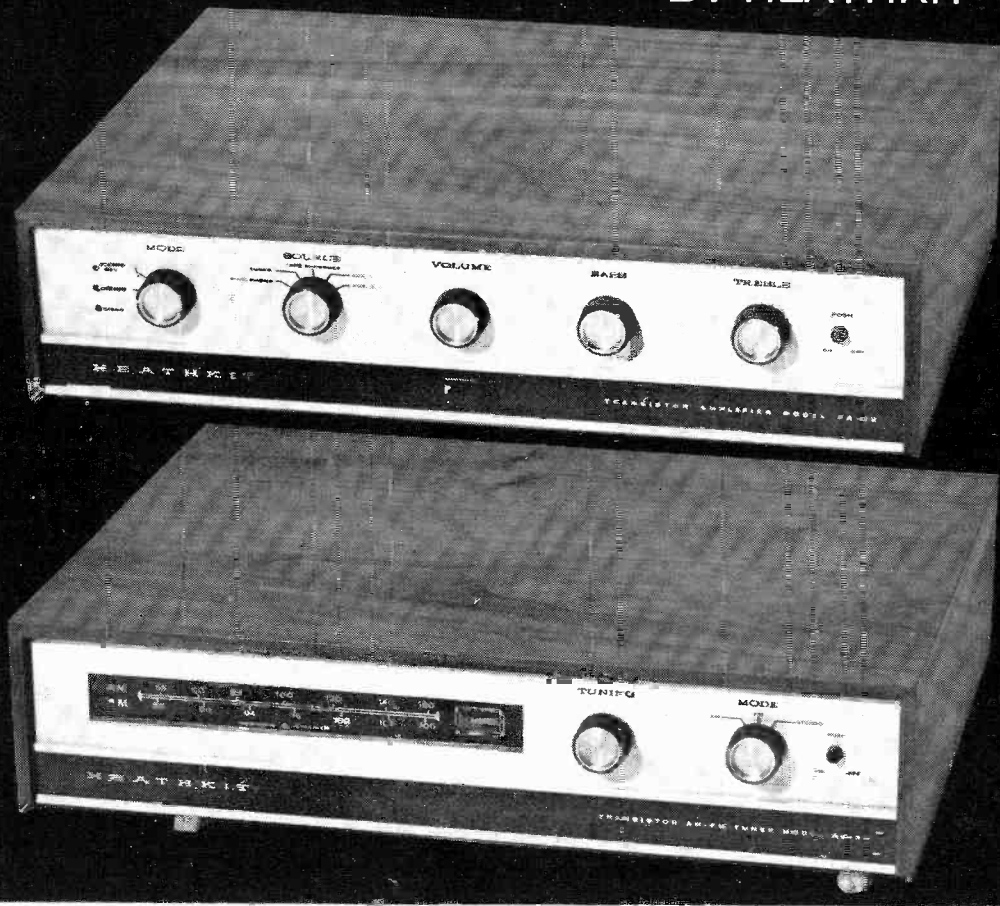

Fig. 2—The converter circuit with 5-lug oscillator coil that threw Peewee for a loss.

# SOLID-STATE STEREO

BY HEATHKIT



## NEW! Low-Cost All-Transistor, All Mode Stereo Tuner and Matching 40-Watt Stereo Amplifier

Cooler, faster operation . . . lower power consumption . . . longer life . . . and the clean, quick realism of "transistor sound." You'll enjoy all this and more with Heathkit's newest All-Transistor Stereo "Twins." Compact, low-silhouette styling magnificently fashioned in rich walnut cabinets neatly fits this handsome pair into a "proud place" in any hi-fi stereo system. Add to this extruded brushed gold-anodized aluminum front panels that serve practically to conceal secondary controls and decoratively to enhance over-all beauty. The AA-22 Amplifier provides 40 watts of continuous power at  $\pm 1$  db from 15 to 30,000 cps with no fading, no faltering . . . just pure solid sound! The AJ-33 Tuner offers selection of AM, FM, or FM Stereo to please any listening preference. Check both unit's features and discover why Heathkit leads in Transistor Stereo. The price? A great value, you'll agree . . . \$99.95 each!

AA-22 40-watt Transistor Stereo Amplifier, 14 lbs. \$10 mo. . . . . \$99.95

AJ-33 Transistor AM-FM-FM Stereo Tuner, 14 lbs. \$10 mo. . . . . \$99.95

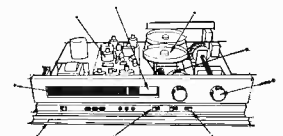
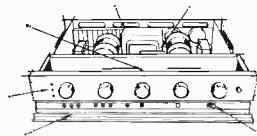

- 40 watts of power (20 per channel)
- 5 stereo inputs
- Speaker phase switch
- Miniature indicator light for each position on mode switch
- Transformerless output circuits
- Brushed gold-anodized aluminum front panel conceals secondary controls
- Walnut cabinetry

- Stereo phase control
- Automatic stereo indicator
- AFC and AGC
- Filtered stereo tape recorder outputs
- Built-in stereo demodulator
- Tuning meter
- Flywheel tuning
- Slide-rule dial
- Prealigned FM tuner and circuit board construction
- Brushed gold-anodized aluminum front panel conceals secondary controls
- Walnut cabinet



HEATHKIT-1964



**NEW! FREE 1964 HEATHKIT CATALOG**  
See the latest new products in Heathkit's wide, wonderful line. Over 250 do-it-yourself kits for stereo/hi-fi, marine, TV, electronic organs, amateur radio, test instruments, educational, and home and hobby items that will save you up to 50%. Send for your free copy today!

**HEATH COMPANY** Benton Harbor 20, Michigan 49023

Enclosed is \$\_\_\_\_\_, plus postage. Please send model No. \_\_\_\_\_

Please send Free Copy of New 1964 Catalog.

Name \_\_\_\_\_

Address \_\_\_\_\_

City \_\_\_\_\_ State \_\_\_\_\_



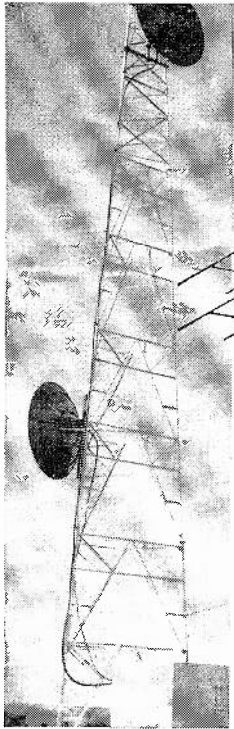

The most Famous Name in  
**TOWERS of ALL KINDS!**

Here are the advantages you get  
when you insist on **ROHN TOWERS**

**LARGEST FULL RANGE OF TOWERS**—you can get anything from home TV and amateur radio towers to heavy-duty communication and micro-wave towers. Included are 170 foot self-supporting towers, 1,000 foot guyed towers, and "fold-over" towers. Regardless of your needs, ROHN can supply it.

**UNQUESTIONED LEADERSHIP IN DESIGN AND MANUFACTURE**—you get the latest in advanced tower engineering. All communication towers are engineered to EIA specifications, and are proved by thousands of installations. No other manufacturer can surpass the quality and fine reputation of ROHN.

**QUALITY MATERIALS AND WORKMANSHIP**—Only highest quality steel is used which fully meets the specifications for the job. ROHN towers are hot-dipped galvanized *after fabrication*—a feature ROHN pioneered!

**SERVICE WHEREVER YOU WANT IT**—ROHN representatives are world-wide. Complete erection service for communication systems, broadcasting, micro-wave, and other needs is available; also competent engineering service to help you.

**Settle for the BEST in TOWERS—ROHN**—today the world's largest, exclusive manufacturer of towers of all kinds!

*For your needs, contact your local ROHN salesman, distributor or dealer; or write direct for information.*

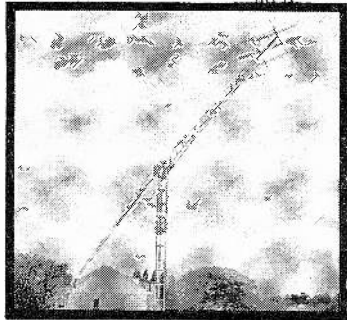

SEND THE HANDY COUPON INDICATING YOUR NEEDS

**ROHN**  
Manufacturing  
Company  
BOX 2000  
PEORIA, ILLINOIS

ROHN Manufacturing Company  
Box 2000  
Peoria, Illinois

Send me complete literature on the following ROHN Products:

- |   |  |
|---|--|
| <input type="checkbox"/> Home TV Towers       | <input type="checkbox"/> Amateur Towers            |
| <input type="checkbox"/> Communication Towers | <input type="checkbox"/> AM-FM Broadcasting Towers |
| <input type="checkbox"/> Micro-Wave Towers    | <input type="checkbox"/> Government                |

Name \_\_\_\_\_

Firm \_\_\_\_\_

Address \_\_\_\_\_

City \_\_\_\_\_ State \_\_\_\_\_

## Coming Next Month in Radio-Electronics

### WHAT'S NEW IN PHONO PICKUPS?

Roundup of recent improvements and developments.

### POOR BOY'S VTVM

Build a practical instrument for a minimum of cost.

### SUPER RECEPTION ON THE SHORT WAVES

Build an antenna that will pick up those distant signals.

### WHAT IS A DECIBEL?

The article tells you in language you can understand.

**JANUARY ISSUE on sale December 19**

# What's Your Eq?

These are the answers.  
Puzzles on page 49.

## What's the impedance?

Actually, a lattice section is just a fancy way of drawing a common bridge circuit. If the first lattice section is re-drawn as a bridge, it is seen that since

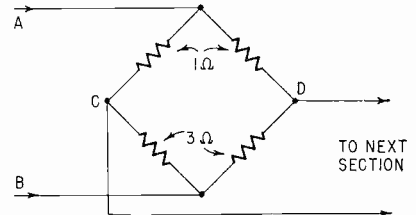

the bridge of the first section is balanced, all subsequent sections have no effect. So the total impedance is 2 ohms.

## Complex Black Box

Since the current through the 100-ohm resistor is 1 ampere, that must also be the current through the black box. Therefore, the black-box impedance is 100 ohms. The impedance of the circuit, containing both the resistor and the black box, is 150 ohms. Since the first guess is that the object in the black box is a complex impedance, an inductance or capacitance (probably the former), we can say:

$$100 = \sqrt{R^2 + X^2} \text{ (for black box alone)}$$

$$150 = \sqrt{(R + 100)^2 + X^2} \text{ (for whole circuit)}$$

With these two simultaneous equations, we find that  $R = 12.5$  ohms and  $X = 99.2$  ohms. The impedance could be an inductor or capacitor, but from the ratio of resistance to reactance, it would seem reasonable that we have a coil with a reactance of 100 ohms and a resistance of 5.5 ohms. The supply voltage is, of course, sine-wave ac.

## Mixed-up Currents?

The 100-ohm resistors make up a perfectly balanced bridge circuit. As a result, the resistors provide a load for the ac generator and the battery, while

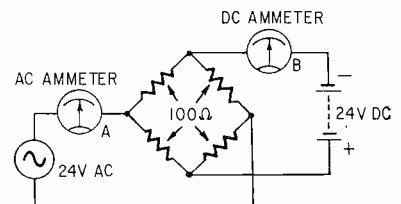

simultaneously preventing the flow of current between the two sources. No dc flows through the ac ammeter, and no ac through the dc ammeter.

# Introducing The FIRST In A New Series of Deluxe Heathkit SSB Amateur Radio Gear!

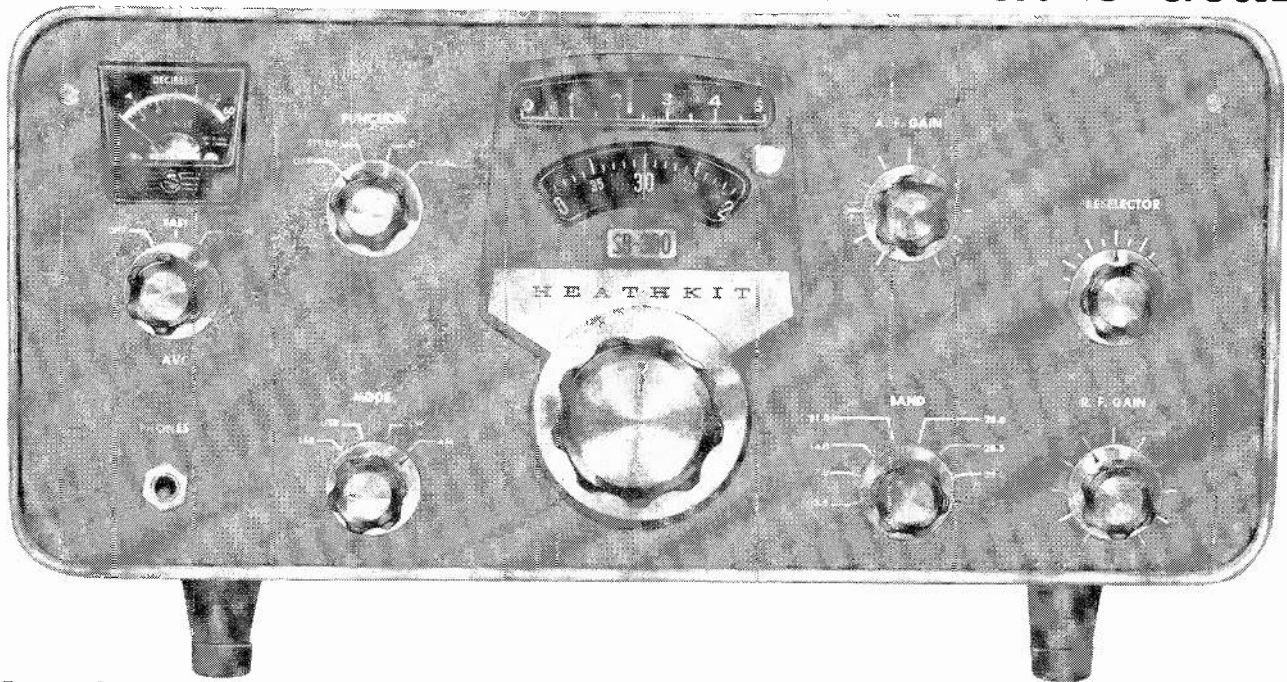

**New SB-300 SSB Receiver With Quality Features & Performance Found Previously On Units Costing Twice as Much... Only \$264.95!**

- Professional styling & features at 60% savings!
- Complete coverage of 80 through 10 meter amateur bands with all crystals furnished, plus provision for VHF converters
- Prebuilt, calibrated linear master oscillator (LMO) • 25 KC per tuning knob revolution offers bandspread equal to 10 feet per megacycle
- Built-in crystal calibrator • 2.1 KC crystal bandpass filter • Stability of 100 cps after initial warmup
- Wiring harness & two heavy-duty circuit boards for easy assembly

The SB-300 SSB Receiver is the first in an exciting new series of Heathkit SSB amateur gear designed to bring you the finest in communications facilities at great savings. Its professional styling, quality and features offer performance never before found in kit equipment.

Features include a crystal-controlled front-end for same rate tuning on all bands; prebuilt, Linear Master Oscillator (LMO) for linear tuning with 1 kc dial calibrations; built-in crystal calibrator; hermetically-sealed 2.1 kc crystal bandpass filter; smooth, non-backlash vernier dial drive mechanism; optional AM & CW filters; high frequency I.F.; AGC control; provision for transceiver operation with matching transmitter available soon. This new deluxe Heathkit SSB series is the greatest value ever announced in the Amateur Radio Industry! Send for free specifications on the SB-300 today, or order now for early delivery!

Kit SB-300... 17 lbs.... no money dn., \$25 mo.....	\$264.95
SBA-300-1 CW Crystal Filter (400 cps).... 1 lb.....	\$ 19.95
SBA-300-2 AM Crystal Filter (3.75 kc).... 1 lb.....	\$ 19.95

**WATCH FOR ANNOUNCEMENT OF OTHER MODELS IN THIS DELUXE HEATHKIT HAM SB SERIES!**



HEATH COMPANY, Benton Harbor 20, Michigan 49023

Please send FREE 1964 catalog.  Enclosed is \$ \_\_\_\_\_, plus postage. Please send model \_\_\_\_\_

Name \_\_\_\_\_

Address \_\_\_\_\_

City \_\_\_\_\_ Zone \_\_\_\_\_ State \_\_\_\_\_

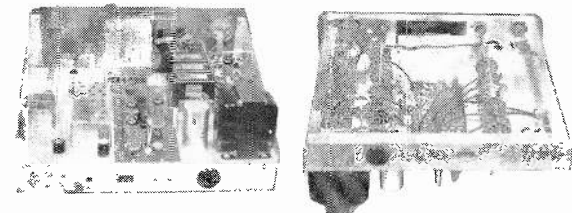

**SPECIFICATIONS**—Frequency range (megacycles): 3.5 to 4.0, 7.0 to 7.5, 14.0 to 14.5, 21.0 to 21.5, 28.0 to 28.5, 28.5 to 29.0, 29.0 to 29.5, 29.5 to 30. Intermediate frequency: 3.395 megacycles. Frequency stability: 100 cps after warmup. Visual dial accuracy: Within 200 cps on all bands. Electrical dial accuracy: Within 400 cps on all bands. Backlash: No more than 50 cps. Sensitivity: Less than 1 microvolt for 15 db signal plus noise-to-noise ratio for SSB operation. Modes of operation: Switch selected: LSB, USB, CW, AM. Selectivity: SSB: 2.1 kc at 6 db down, 5.0 kc at 60 db down (crystal filter supplied). AM: 3.75 kc at 6 db down, 10 kc at 60 db down (crystal filter available as accessory). CW: 400 cps at 6 db down, 2.5 kc at 60 db down (crystal filter available as accessory). Spurious response: Image and IF rejection better than 50 db. Internal spurious signals below equivalent antenna input of 1 microvolt. Audio response: SSB: 350 to 2450 cps nominal at 6 db. AM: 200 to 3500 cps nominal at 6 db. CW: 800 to 1200 cps nominal at 6 db. Antenna input impedance: 50 ohms nominal. Muting: Open external ground at Mute socket. Crystal calibrator: 100 kc crystal. Front panel controls: Main tuning dial; function switch; mode switch; AGC switch; band switch; AF gain control, RF gain control; preselector; phone jack. Rear apron connections: Accessory power plug; HF antenna; VHF #1 antenna; VHF #2 antenna; mute; spare; anti-trip; 500 ohm; 8 ohm speaker, line cord socket; heterodyne oscillator output; LMO output; BFO output; VHF converter switch. Tube complement: (1) 6BZ6 RF amplifier; (1) 6AU6 Heterodyne mixer; (1) 6AB4 Heterodyne oscillator; (1) 6AU6 LM osc.; (1) 6AU6 LMO mixer; (2) 6BA6 IF amplifier; (1) 6AU6 Crystal calibrator; (1) 6HF8 1st audio, audio output; (1) 6AS11 Product detector, BFO, amplifier. Power supply: Transformer operated with silicon diode rectifiers. Power requirements: 120 volts AC, 50/60 cps. 50 watts. Dimensions: 14 1/2" W x 6 1/2" H x 13 1/2" D.

## FREE CATALOG!

Send for your free copy today! Fully describes over 250 exciting Heathkits at savings of 50% or more! Choose from the world's largest selection of quality ham gear... "Mobile"... "Fixed" and Accessories.

# SERVICING SOUND MOVIE PROJECTORS

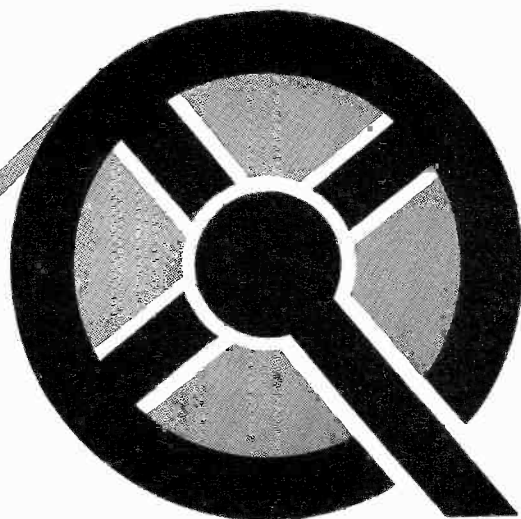

## Part 3 / sound and lamp troubles

By **JACK DARR**  
SERVICE EDITOR

LAST MONTH WE LEARNED A BIT ABOUT how projectors work, how to thread and run them, and how to make some adjustments. This time, we'll examine the

the coaxial cable and Amphenol plug used to connect the phototube, which is on the projector chassis in this machine.

Fig. 2 shows the bottom of a different projector. The four outside screws are removed to let the amplifier chassis

slip down and out. In this model, the entire amplifier chassis is inside the projector housing. The inner screws allow the bottom shield to be removed (Fig. 3). Fig. 4 is a top view of the amplifier. Notice the large phototube mounted on the right end of the amplifier chassis. The beam of light from the exciter lamp is reflected onto the tube by a mirror inside the sound-head drum.

### Amplifier servicing

The amplifiers used in these projectors are "conventional" (much as I dislike that word) after you get past the phototube input. Power output runs 7-10 watts for the ac-powered amplifier of Fig. 4, and 3-5 watts for the ac/dc amplifier of Fig. 1. There is one other novel feature, the method of lighting the exciter lamp, which we'll get to in a minute.

Phototubes used in the older models are mostly 923's, a four-pin type, seen in Fig. 4. This has been replaced in many circuits by the newer 930. Some machines use the smaller three-pin 927.

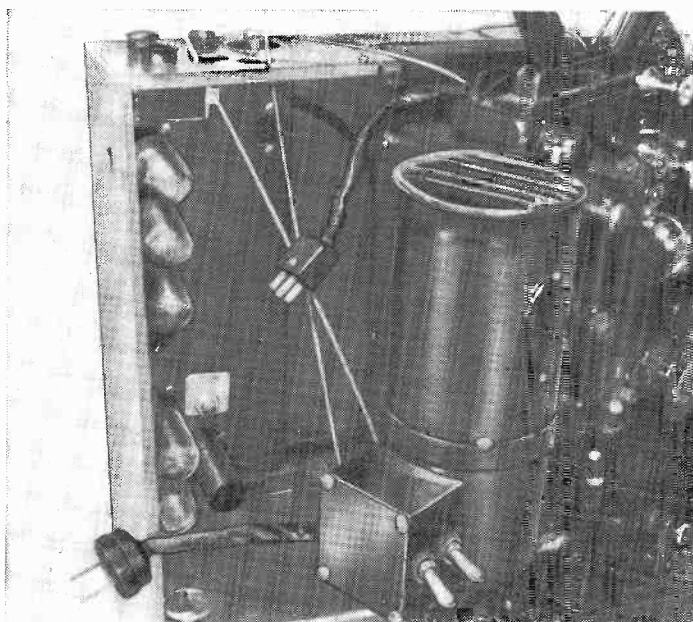

*Fig. 1—Projector partly disassembled for service. Amplifier tubes are in vertical row at left.*

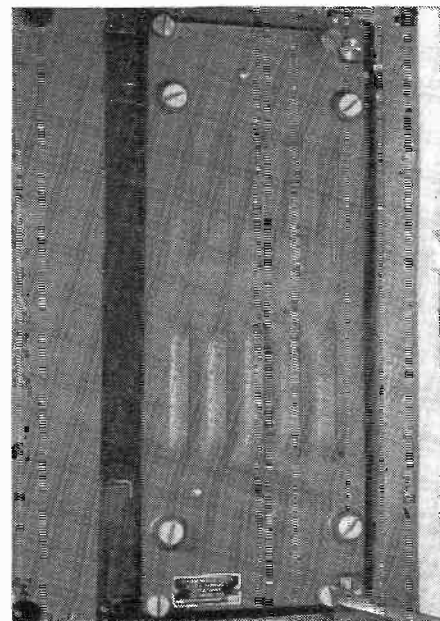
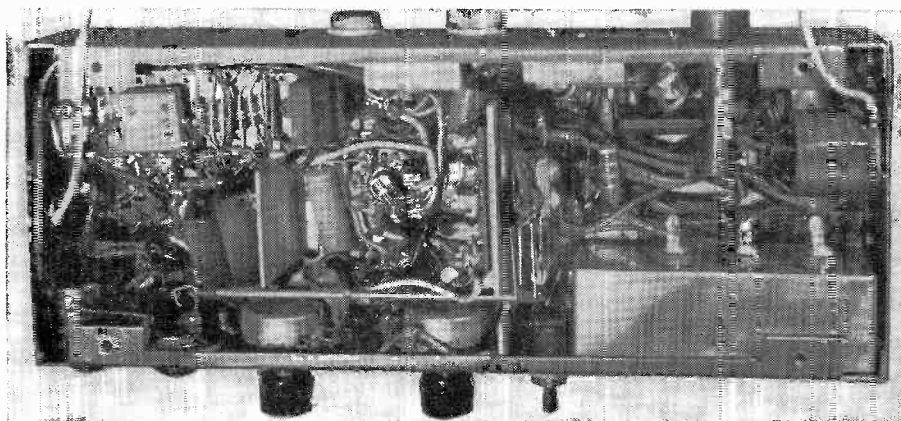

*Fig. 2—Bottom of another machine. Four captive screws (screwdriver, lower left) hold amplifier in case.*

electronics peculiar to movie projectors and talk about some of the more common electrical and mechanical troubles.

### Disassembly for servicing

Fig. 1 shows a projector partly disassembled to allow the amplifier to be removed. Here, the amplifier chassis is vertical, with bolts holding the top, while the bottom end of the chassis sits on a spring-loaded metal plate, to provide a little shock mounting. Screws through the bottom of the case hold the projector unit. The plugs connecting the exciter lamp and input power can be seen. At the right bottom side of the amplifier are



*Fig. 3—Amplifier of Fig. 2, with bottom cover removed.*



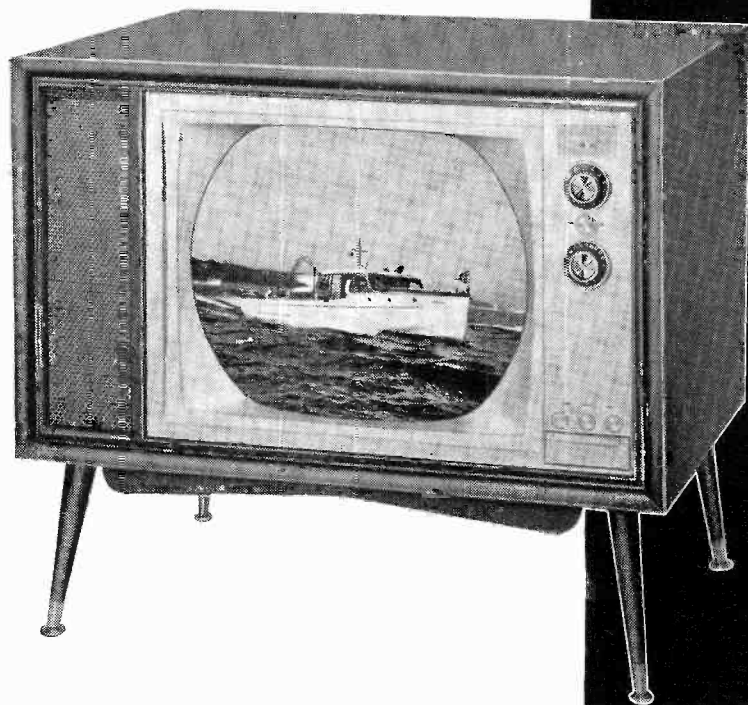

Who says  
you can't  
afford  
Color TV?

You Can With This New Heathkit

High Fidelity 21" Color TV Kit For As Little As \$349<sup>00</sup>

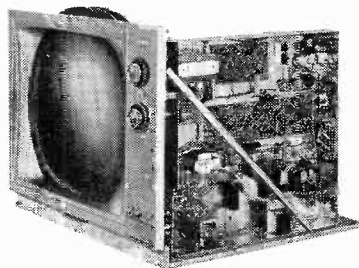

- 27 tube, 8 diode circuit with optional UHF • High definition RCA 70° 21" color tube with anti-glare, bonded face safety glass
- Built-in dot generator for initial set-up adjustments
- All critical circuits factory-built and tested • Automatic Color Control • Gated Automatic Gain Control for peak performance • Hi-Fi sound with outputs for speaker and hi-fi amp
- 24,000 volt regulated picture power • Deluxe Nuvistor tuner with "push-to-tune" fine tuning for individual channels • 3-stage high gain video I.F. • Line thermistor for longer tube life and thermal circuit breaker for component protection • Can be custom mounted or installed in handsome walnut cabinet • Degaussing coil for demagnetizing picture tube

Automatic Color Control • Gated Automatic Gain Control for peak performance • Hi-Fi sound with outputs for speaker and hi-fi amp • 24,000 volt regulated picture power • Deluxe Nuvistor tuner with "push-to-tune" fine tuning for individual channels • 3-stage high gain video I.F. • Line thermistor for longer tube life and thermal circuit breaker for component protection • Can be custom mounted or installed in handsome walnut cabinet • Degaussing coil for demagnetizing picture tube

The sharpest, clearest high fidelity picture and sound, plus the latest advanced Color TV circuitry possible in the industry today! Unmatched savings . . . compare it with sets costing \$600! Easy to build . . . from parts to picture in just 25 hours and no experience needed! These are the reasons why you'll be wise to choose the new Heathkit 21" Color TV.

- Kit GR-53, Chassis & all tubes, 118 lbs., \$23 mo. . . . . **\$349.00**
- GRA-53-1, Walnut-finish cabinet, 70 lbs., \$5 mo. . . . . **\$49.00**
- UHF Tuner, GRA-53-2, 3 lbs. . . **\$20.00**



HEATH COMPANY, Benton Harbor 20, Mich. 49023

- Please enter my order for a Heathkit Color TV Kit subject to conditions below\*
- Please send FREE copy of 1964 Heathkit Catalog.

Name \_\_\_\_\_

Address \_\_\_\_\_

City \_\_\_\_\_ State \_\_\_\_\_

\*Delivery Limited by tube availability send no money until we confirm shipping date. Orders processed in sequence of receipt.

CL-164

HEATH-KIT-1964



SEND FOR FREE 1964 HEATHKIT CATALOG Gives full description and specifications of units above, plus 245 others in Test, Amateur Radio, Hi-Fi, Marine, Educational and General Hobby fields of interest. Send for your free copy today and get the complete story on money-saving Heathkits.

# powerful and portable

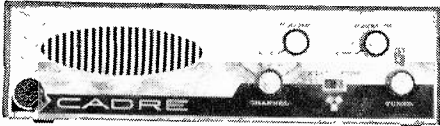

**POWERFUL** — 5-watts, 5-channel crystal-controlled channels, 100% all-transistor, the Cadre series of transceivers can be used in any vehicle, boat or office. They deliver sharp, clear reception over the greatest transmission range possible in the 27 mc citizens band. Five fixed crystal-controlled channels spell accurate, fast communication contact. Sensitive dual superheterodyne circuit responds to weakest signals. Tuned ceramic filters increase selectivity. Reception is clear, free of noise—automatic noise limiter defeats ignition noise; adjustable squelch eliminates annoying background signals. Extended range AGC provides uniform audio output. Solid state circuitry throughout means no heat problems, no tubes to burn out, ability to withstand vibration and shock, negligible current drain, compact size.

Four Cadre 5 watt, 5-channel models.

CADRE 515—AC/DC unit for use anywhere.

\$199.95

CADRE 510-A—AC/DC unit. 23 ch. manual tuning.

\$219.95

NEW! CADRE 520—DC only with DC power cord and mounting kit—ideal for mobile and portable use—operates from 12 volt auto battery or special battery pack.

\$187.50

NEW! CADRE 525—for complete field portability. Standard AC cord permits recharging of two built-in nickel-cadmium batteries, telescoping antenna, carrying handle.

\$269.95

**PORTABLE** — Power is only a part of the story with Cadre transceivers. These units go anywhere—operate anywhere. An optional accessory, (Cadre 500-1 Portable Pack) adapts Cadre 510, 515 and 520 for field use. The Portable Pack is a lightweight case which contains rechargeable battery supply (two 500-2 nickel-cadmium 6-volt batteries). These units can be used for base or mobile application as well as in the field. Cadre 5-watt models in the Portable Pack weigh less than 9 lbs. Cadre 500-1, \$29.95, Cadre 500-2, \$10.95.

For the finest CB transmission anywhere, rely on Cadre. For literature write:

## CADRE 5-WATT ALL TRANSISTOR CB RADIOS



CADRE INDUSTRIES CORP. □ COMMERCIAL PRODUCTS DIVISION ENDICOTT, NEW YORK Canada: Tri-Tel Assoc., 81 Sheppard Ave. W., Willowdale, Ont. Export: Morhan Export, B'way, N. Y. 13.

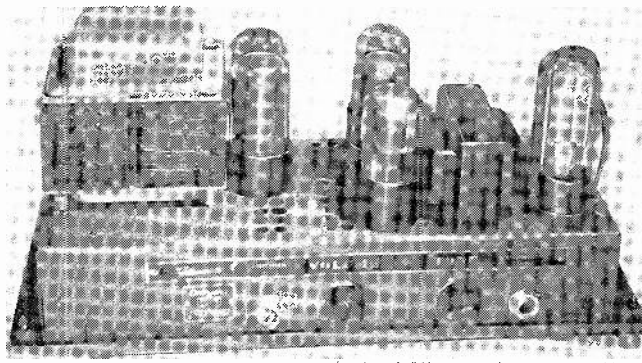

Fig. 4—Fig. 2 amplifier again. Note photocell at right front corner.

Characteristics of all are about the same. A typical circuit appears in Fig. 5.

### Checking photocell inputs

There is a good "quick-check" for sound troubles: simply turn the amplifier on and shine the beam of a penlight on the sound head, so that some of the light can get through the slot to the photo-

case of the flash with your fingernail. This will give you a loud "bong!" Apparently this comes from the movement of the lamp filament in the flashlight. About the simplest test is to slip the shielding cover off the phototube, near the bench lights. If you hear a loud 60-cycle hum, the cell is OK.

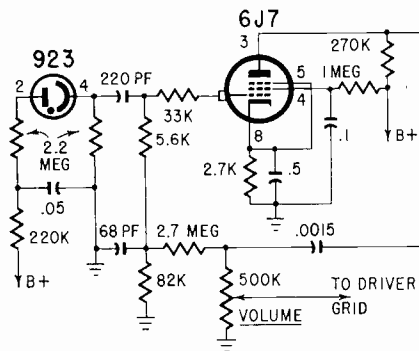

Fig. 5—Typical film-sound input circuit.

tube. (No film in the sound head, of course.) If you can hear a "thump" every time the light strikes the cell, the amplifier is OK. This depends on the volume of the thump, of course. A little practice will soon tell you how loud it should be.

Another interesting test is shining the flashlight on the cell and tapping the

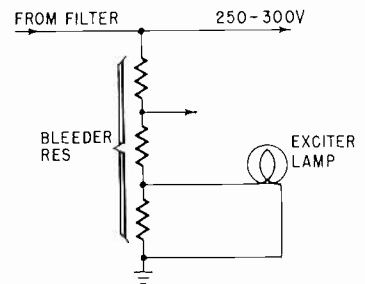

Fig. 6—One way of lighting exciter lamp humlessly—tap off a little B-plus.

### Checking for weak sound

The first thing that must be checked on a complaint of weak sound is the alignment of the various parts of the sound head. Exciter lamps often have shields with holes in them. If the hole is turned so that its edge is partially blocking the light, the volume will be reduced. If the tiny slot in the sound head is full

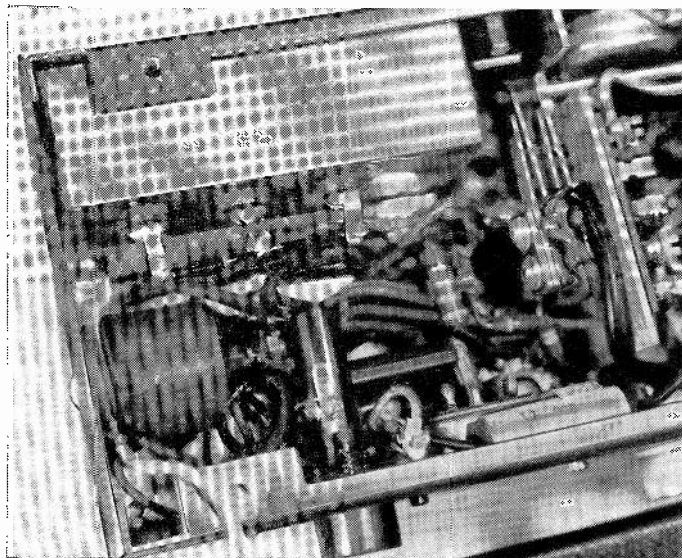
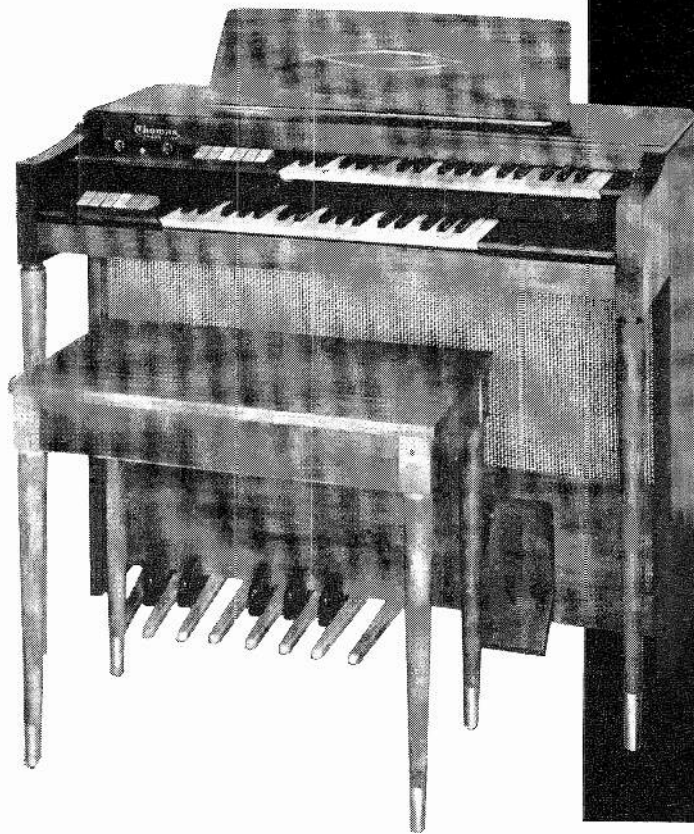

Fig. 7—Another way is to use an ultrasonic oscillator. Oscillator transformer is in lower left corner of photo, next to fuse holder.



Who says  
you can't  
afford  
an organ  
this  
Christmas?

**This New Feature-Packed 1964 Model Of The HEATHKIT  
2 Keyboard "Transistor" Organ Costs Just \$349.95 ...  
AND YOU CAN BUILD IT!**

What a delightful surprise on Christmas morning! And there's endless hours of fun, relaxation, education and achievement ahead for the whole family with Heathkit's 1964 version of the famous Thomas Organ. You'll be saving big money too, by easily building it yourself! No experience necessary! And you're assured long, faithful performance with the full 5-year warranty on tone generators. Can't play a note? Learn quickly and easily with a complete 48-lesson self-teacher course on 4 LP records (GDA-232-2) that's valued at \$50 . . . it's yours for only \$19.95! Like to hear it perform? Send 50c to the address below, and ask for demonstration record GDA-232-5. Plan now to give your family the exciting dimension of live music with the 1964 Heathkit Electronic Organ this Christmas!

**Kit GD-232R, Organ, 160 lbs., no money dn., \$23 mo. . . . . \$349.95**  
**GDA-232-1, Matching walnut bench, 16 lbs., no money dn., \$5 mo. . . . . \$24.95**

**Attention Heathkit Organ Owners!** Add Variable Repeat Percussion to your Heathkit Organ with the easy-to-install kit.

**GDA-232-4, 1 lb. . . . . only \$9.95**

**COMPARE THESE FEATURES  
WITH UNITS COSTING  
TWICE AS MUCH!**

\* **10 True Organ Voices;** Trombone, Reed, Flute, Oboe, Cornet, Violin, Saxophone, Horn, Viola, Diapason \* **New! Variable Repeat Percussion;** produces effects of banjo, marimba, mandolin, balalaika, etc. \* **Variable Bass Pedal Volume Control** \* **Manual Balance Control;** adjusts volume of keyboards in any degree for solo work \* **Variable Vibrato** \* **Standard Expression Pedal;** adjusts volume from soft to full \* **13-Note Heel & Toe Bass Pedals** \* **Two Over-Hanging Keyboards;** each with 37 notes, range C thru C \* **Beautiful Walnut Cabinet;** modern styling, hand-rubbed, hand-crafted \* **20-Watt Peak-Power Amplifier & Speaker** \* **Compact Size;** 34½" H x 39¾" W x 21½" D \* **Transistorized;** for longer life, better tone, trouble-free operation.



**NEW! FREE  
1964 HEATHKIT CATALOG**  
See all the latest products in Heathkit's exciting line. Over 250 do-it-yourself electronic kits in all . . . by far the world's largest line! There's something for every interest . . . stereo/hi-fi . . . marine . . . amateur radio . . . test and lab . . . television . . . home . . . and hobby. Send for your free copy today, and learn how you can save up to 50%.

- Enclosed is \$349.95, plus postage, please send my Heathkit Electronic Organ, model no. GD-232R.
- Enclosed is \$24.95, plus postage, please send matching walnut bench, model no. GDA-232-1.
- Please send my free copy of the new 1964 catalog.

**HEATH COMPANY,** Benton Harbor 20, Michigan 49023

Name \_\_\_\_\_  
(please print)

Address \_\_\_\_\_

City \_\_\_\_\_ Zone \_\_\_\_\_ State \_\_\_\_\_



## New Sonotone Sono-Flex<sup>®</sup> Stylus

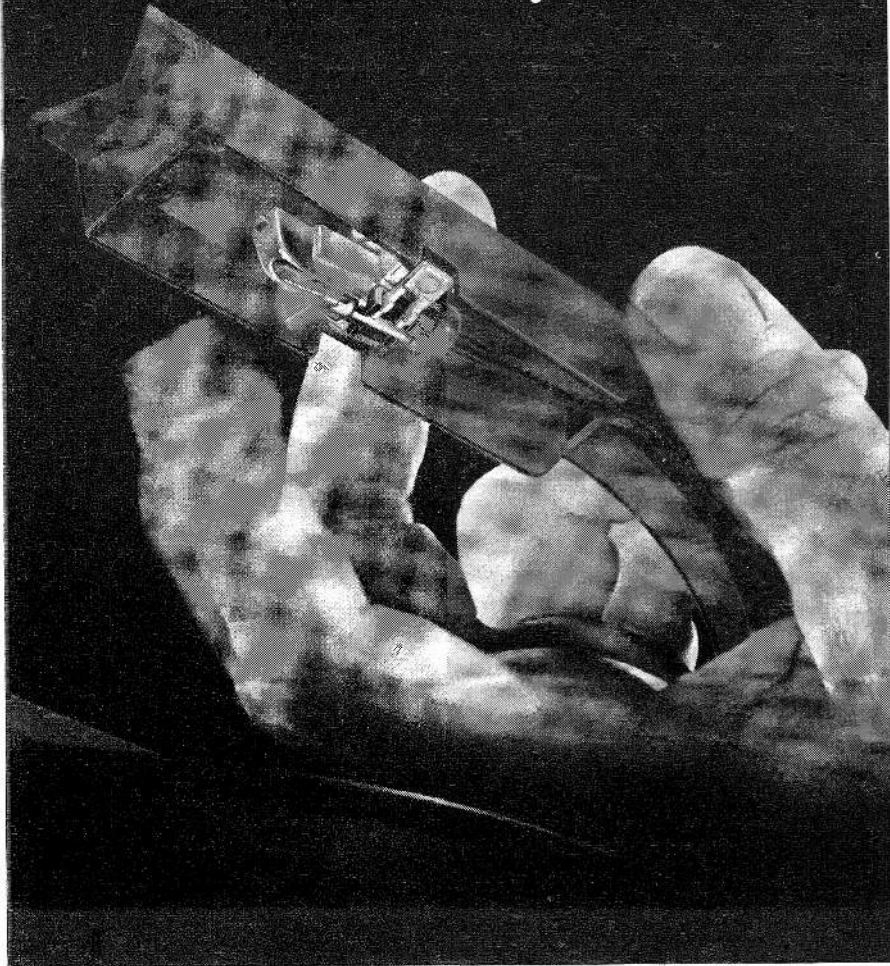

**try this with any other cartridge**  
(at your own risk)

No way to treat a cartridge, for sure—That is, any cartridge except the Sonotone models featuring the new Sono-Flex<sup>®</sup> needle. No more bent or broken needle shanks caused by flicking off some lint, dropping the arm, or scraping it across the record.

The newly developed Sonotone Sono-Flex<sup>®</sup> needle to the rescue! Gripped in a resilient butyl rubber mount, you can flex this needle shank in a 360-degree orbit without breaking. Pluck it—flick it—bend it—bump it—it will continue to perform as good as new.

Moreover, the Sono-Flex brings advantages in performance never before offered by any replacement cartridge: Higher compliance, wider and flatter frequency response, lower IM distortion, and longer needle and record life.

### Sonotone Sono-Flex<sup>®</sup> increases your profits two ways

Sonotone cartridges are better than ever, easier to sell, because they're better performers. Further, you eliminate callbacks because of broken needle shanks. Sono-Flex needles are standard right now in these Sonotone cartridges models: 9TAF, 16TAF, 916TAF and the Velocitone Mark III.

Sono-Flex opens up lucrative needle replacement business for upgrading these Sonotone cartridges models: 9T, 9TA, 9TV, 9TAV, 16T, 16TA, 16TAF and 916TA, original equipment in over a million phonographs. Replacement is fast, simple—requires no tools—assembly snaps into position easily, and gives immediate proof of better performance plus abuse-proof, longer needle life.

See your distributor today and ask for Sonotone cartridges with the Sono-Flex<sup>®</sup> needle.

**SONOTONE CORPORATION** Electronic Applications Division Elmsford, New York  
In Canada: Atlas Radio Corp., Ltd., Toronto • cartridges • speakers • batteries  
• microphones • electron tubes • tape heads • hearing aids • headphones

of lint, the same thing happens. Phototubes, too, are sometimes shielded by a round metal cover, with one small hole for the light. If this has been removed and replaced improperly, the light may be partially blocked. Always check all of these things before tearing into the amplifier!

Also, most projectors have a microphone input jack. (One can be seen on the control panel in Fig. 4.) Plug a mike in and check for volume. While it seldom happens, phototubes can weaken. So if the mike input shows ample volume, but film sound is weak, try a new phototube.

Some projectors use the brilliance of the exciter lamp as a volume control. The more light, the higher the volume. With this "volume control" turned all the way down, the exciter lamp is out. This has caused the replacement of quite a few perfectly good exciter lamps!

By threading the light-colored semi-opaque "leader" of a film into the machine, you can get a good check of the focus and position of the spot of light on the film. The lens and slot should always make a clean, sharply defined bar of light on the film, not just a blur. The slot can be cleaned with an old toothbrush.

### Exciter lamp and power supply

The exciter lamps used in these machines resemble automotive types, but have a longer bulb. Filament voltages between 4 and 6 are common, at fairly low direct currents (ac would cause hum).

In one circuit, the exciter lamp is simply tapped across the last few volts in the B-plus (Fig. 6).

Another circuit, used in a very popular make of projector for many years now, uses an ultrasonic oscillator for lighting the exciter lamp. This circuit uses the same type tube as those in the power output stage. Notice the three 6V6's on the amplifier in Fig. 4? One of these is the oscillator. Fig. 7 shows the oscillator transformer. The circuit of

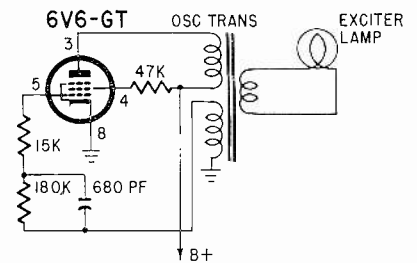

Fig. 8—Exciter lamp oscillator.

this is shown in Fig. 8. The frequency is around 20-30 kc, but isn't too important as long as it is above audibility.

Incidentally, if the exciter lamp refuses to light, and all the tubes check good, try swapping the 6V6's around! We've found a few that didn't want to oscillate, but worked perfectly in the amplifier stages.

TO BE CONTINUED

## Answers to the "Units" Quiz

(See questions, page 43)

If you get more than 12 right, you should be a professor of electrical engineering. Most engineers know at least 8 of these. As for me, well, I looked them up to make sure you were getting the straight dope!

1. A *volt* is the difference in potential between two points of a conductor carrying a constant current of 1 ampere when the power dissipated between the points is 1 watt. But you can call it right if you said that it is the potential required to give 1 ampere current in a resistance of 1 ohm.

2. An *ampere* is defined as that current which, if maintained through two parallel wires of infinite length 1 meter apart in a vacuum, causes a force between the wires of  $2 \times 10^{-7}$  newton per meter of length. A more practical definition says the ampere is the current which, from a carefully specified solution of silver nitrate, deposits .001118 gram of silver per second.

3. We can now say that an *ohm* is defined by the current from a 1-volt source, but such a definition would be circular, because of our "volt" definition above. An ohm is the resistance of a column of mercury at 0°C, 14.4521 grams in mass, of a constant cross-section and 106.300 cm long.

4. A *maxwell* is a measure of magnetic flux, and defined by the answer to No. 8, or you can say it is the magnetic flux giving a density of one line of force per unit area ( $\text{cm}^2$ ).

5. A *gilbert* is a measure of magnetomotive force equal to the magnetomotive force produced by 0.7958 ampere-turn (ampere in one turn).

6. A *joule* is a unit of work or energy equal to 0.2389 gramcalorie, or the heat required to raise 0.2389 gram of water at 4°C 1°C in temperature.

7. A *myriawatt* is simply 10,000 watts or 10 kw.

8. A *weber*, as you may have guessed by now, is also a unit of magnetic flux. It is a very large unit,  $10^8$  maxwells (or lines), and a more practical measure to use in calculations.

9. The *dyne* is the centimeter-gram-second unit of force. It is the force that will accelerate a 1-gram mass 1 centimeter per second. An *erg* is the work done by a force of 1 dyne acting through a distance of 1 cm. An erg is also equal to  $10^{-7}$  Joule or to  $0.7376 \times 10^{-7}$  foot-pounds.

10. Back to the magnetic field to find that an *oersted* is the same as a gilbert per centimeter, a measure of magnetizing force, equal to .0795 ampere turn per cm.

11. This could be tricky. A *gauss* is a unit of magnetic induction—1 *maxwell* per square centimeter. Before 1932, it was used as a unit of magnetic field intensity, a meaning now obsolete. The *oersted* is now used instead (see question 10).

12. A *baud* is a unit of signaling speed used by telegraph engineers. It represents the number of code elements transmitted per second.

13. A *sabin* is something for hi-fi fans. It is a measure of sound absorption, the absorption of 1 square foot of perfectly absorptive surface.

# NEW!

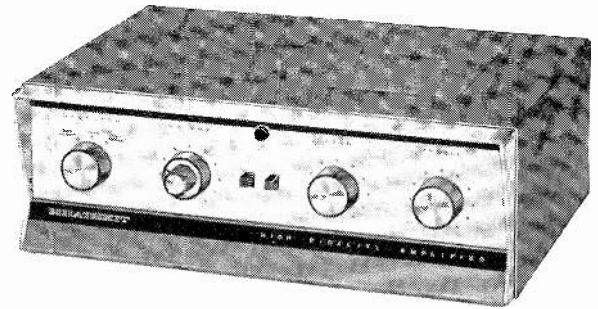

16-WATT HEATHKIT STEREO AMPLIFIER . . . OPERATES WITH MAGNETIC PHONOGRAPH CARTRIDGES; DELIVERS FULL POWER WITHIN  $\pm 1$  DB FROM 30 TO 30,000 CPS; HAS FULL-RANGE CONTROLS, 4 STEREO INPUTS, 2 FOUR-STAGE PREAMPLIFIERS, 2 PUSH-PULL POWER OUTPUT STAGES; PLUS NEW MOCHA BROWN, BLACK & SILVER STYLING; AND IT COSTS JUST \$39.95! COMPARE AND ORDER NOW!

**SPECIFICATIONS**—Simultaneous power output per channel: 8 watts (16 watts total); IHFM music power output per channel: 10 watts (20 watts total). **Frequency response:**  $\pm 1$  db from 30 cps to 30,000 cps at rated output. **Harmonic distortion:** (at rated output) 2% @ 20 cps, 0.7% @ 1000 cps, 2% @ 15,000 cps. **Intermodulation distortion:** (at rated output) Less than 3% using 60 and 6000 cps, mixed 4:1. **Hum & noise:** Mag. phono input 48 db below rated output. Aux input, 65 db below rated output. **Channel separation:** 42 db @ 30 cps, 45 db @ 1000 cps, 30 db @ 15,000 cps. **Input sensitivity:** Mag. phono, 6 mv; Ceramic phono, 250 mv; Tuner, .25 V; Aux. .25 V. **Input impedance:** Mag. phono, 47 K ohm; Ceramic phono, 2.2 meg.; Tuner, 470 K ohm; Aux. 470 K ohm. **Outputs:** 4, 8, and 16 ohm. **Damping factor:** 9. **Feedback:** 18 db. **Tube complement:** 3-6EU7 and 4-ECL-86 (6GW8). **Power requirements:** 105-125 V. 50-60 cps AC. 85 watts at 120 volts. **Dimensions:** 13½" W x 4-11/16" H x 9½" D.



**HEATH COMPANY**  
Benton Harbor 20 Michigan 49023

- Enclosed is \$39.95 plus postage. Please send model AA-32 16-Watt Stereo Amplifier (15 lbs.).
- Please send my Free copy of the 1964 Heathkit catalog.

Name \_\_\_\_\_  
Address \_\_\_\_\_  
City \_\_\_\_\_ State \_\_\_\_\_ Zip No. \_\_\_\_\_

**FREE 1964 HEATHKIT CATALOG**  
See the entire exciting array of the latest in do-it-yourself electronic kits from the world's largest manufacturer... Heathkit. Over 250 in all!

Shop for the newest and latest in electronics in RADIO-ELECTRONICS MARKET CENTER on Page 119

Exclusive with **RCA** ...

**AUTOTEXT®**

**the faster,  
easier way  
toward a career  
in electronics**

**Amazing home training method makes learning almost automatic**

**Exclusive with RCA.** "AUTOTEXT" the revolutionary home training method introduced by RCA Institutes, Inc., is stirring the interest of thousands. Every day, "AUTOTEXT" is helping people like yourself join the thousands of other successful electronic students who are working toward profitable careers right now! This faster, easier way to learn electronics uses the latest scientific development in the field of home training—and "AUTOTEXT" is exclusive with RCA.

**New trend in education.** This exciting new trend in education represents a significant advance in teaching electronics. People who have been interested in careers in electronics in the past, but have had difficulty with conventional home training methods, can now begin to master the fundamental principles of electronics almost automatically. Tested in schools throughout the country, checked out and proved with thousands of students, programmed instruction is helping people learn more quickly and with less effort.

**Prove it to yourself now!** If you have a natural inclination or interest in the exciting field of electronics, that's all you need. RCA "AUTOTEXT" will help you do the rest. And the future is unlimited. Jobs are available for qualified technicians in Space Electronics, Communications, TV, Computer Programming, Automation, and many other electronic fields. The important thing is to get started now!

**Complete course available.** Right now, RCA Institutes offers you a complete Home Training Course ("Introduction to Electronics") using the "AUTOTEXT" method. You get a complete set of theory lessons, service practice lessons, experiment lessons, and all the kits you need. And most important, "AUTOTEXT" takes most of the effort out of learning the all-important groundwork of the electronics field.

Get complete information now without obligation. Send the attached postcard and check "AUTOTEXT".



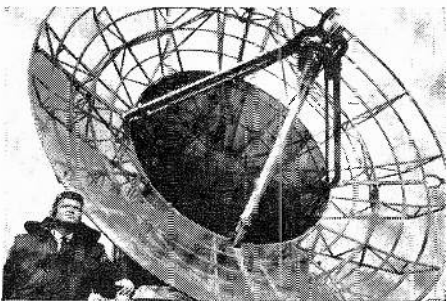
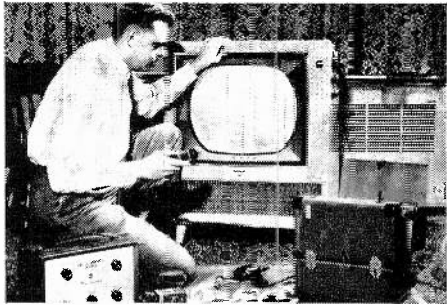
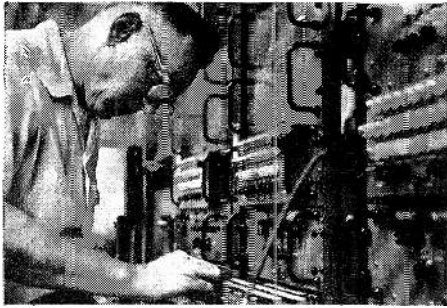

# Wide choice of Home Training courses in Electronics:

- Autotext
  - Introduction to Electronics
  - Introduction to Semiconductors
- TV Servicing
- Color TV
- Communications Electronics
- FCC License Preparation
- Mobile Communications
- Automation Electronics
- Electronic Fundamentals (also available in Spanish)
- Computer Programming
- Transistors
- Electronic Drafting
- Industrial Electronics
  - Automatic Controls
  - Industrial Applications
  - Nuclear Instrumentation
  - Digital Techniques

RCA Institutes Home Training Courses are complete step by step easy-to-understand units. You get prime quality equipment in the kits furnished to you, and all of it is top grade. It's yours to keep and use on the job.

**Liberal Tuition Plan.** RCA Institutes Home Training Courses are available under a liberal tuition plan that affords you the most economical possible method of home training. You pay for lessons only as you order them. If, for any reason, you should wish to interrupt your training, you can do so and you will not owe a cent until you resume the course. No long-term obligations!

**Set Your Own Pace.** RCA Institutes Home Training takes into consideration your own ability, finances and time. You learn at your own speed, in the most effective manner, with personalized instruction every step of the way. You get theory, experiment, and service practice beginning with the very first lesson. All lessons are profusely illustrated—a complete training package in every way.

## CLASSROOM TRAINING

RCA Institutes Resident Schools in New York City, Los Angeles and RCA Technical Institute in Cherry Hill near Camden, N. J., offer classroom training that will prepare you to work in rewarding research and production positions in many fields of electronics. No previous technical training required for admission. You are eligible even if you haven't completed high school.

**Free Placement Service.** RCA Institutes Resident School graduates are now employed in important jobs at military installations, with important companies such as IBM, Bell Telephone Labs, General Electric, RCA, in radio and TV stations and in communications systems all over the country. Many other graduates have opened their own businesses. A recent New York Resident School class had 92% of the graduates who used the FREE Placement Service accepted by leading electronics companies, and had their jobs waiting for them on the day they graduated!

**Coeducational Day and Evening Courses** are available at Resident Schools. You can prepare for a career in electronics while continuing your normal, full-time or part-time employment. Regular classes start four times a year.

SEND POSTCARD FOR FREE ILLUSTRATED BOOK TODAY! SPECIFY "AUTOTEXT", HOME STUDY OR CLASSROOM TRAINING.

### RCA INSTITUTES, INC. Dept. RE-D3

A Service of Radio Corporation of America,  
350 West 4th St., New York 14, N. Y.  
Pacific Electric Bldg., 610 S. Main St., Los Angeles 14, Calif.

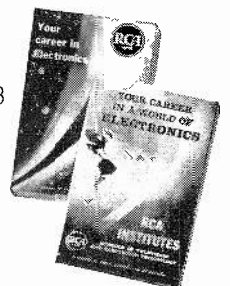

**The Most Trusted Name in Electronics**

# HEXNASH - electric game

Keep the junior engineer out of your laboratory equipment

By JACK ALLISON

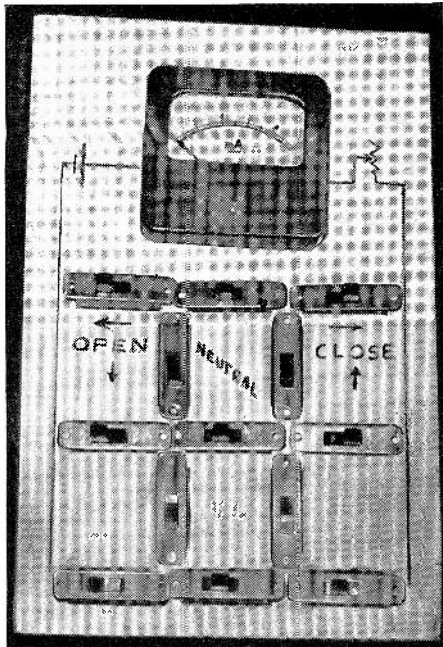

Schematic symbols on panel help keep grid configuration in mind.

HERE'S A GAME THAT HAS A VERY FANCY background! It's based on a game devised by Claude Shannon of Bell Labs and often played between a researcher and an electronic brain. You don't have to be an electronic brain to win at it but, as you read on, you'll see it takes a little more head-scratching than its ancestor, Tic-Tac-Toe.

Fig. 1 shows a switched grid of resistors with a meter and battery in series with them. The idea is to have one player attempt to get a direct connection through the grid while his opponent

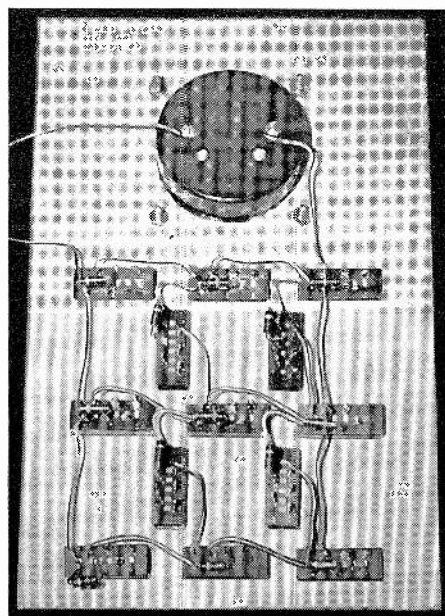

Check terminals and positions of switches you use before wiring.

tries to open the grid and have no "juice" through the circuit. In technical language, from a neutral position, one man is going for the maximum current; the other man, the minimum.

Since each resistor is 1,500 ohms, the total resistance of the grid is still 1,500 ohms. The 2,000-ohm rheostat is set for approximately 1,500 ohms. This makes the total resistance 3,000 ohms. We are using 1.5 volts, so by Ohm's law we get a reading on the meter of 0.5 ma, or the neutral spot on the dial for the beginning of the game. As each player makes his move, the needle will swing toward 1 or 0, depending on the "slickness" of the move. The first one to reach his intended 1 or 0 is the winner!

spective drawing (Fig. 2) is good for the Stackpole switch. END

## Rules of the game

1. Close the switches to get a 1 reading and, using the pot, set the needle at 1 on the nose.
2. Set all switches to the middle position and you are ready to play.
3. As each game is played, each player must alternately choose to take either the "close" or "open" strategy. Players take turns on who goes first.
4. The first player throws a switch, depending on whether he is "opening" or "closing." The other player then moves a switch in his direction.
5. Once a switch has been opened or closed, it cannot be touched again.

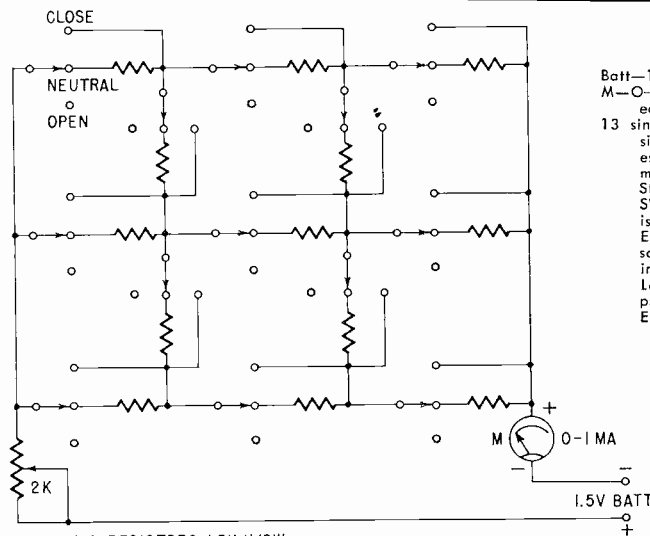

ALL FIXED RESISTORS 1.5K/1/2W  
ALL SWITCH POSITIONS AS PER SECTION IN UPPER LEFT

Fig. 1—Grid of resistors makes up active part of circuit. Resistors are either in, out or shorted, depending on switch position.

The unit is really a number of small switch-resistor combinations made up as shown in the bottom-view photo and Fig. 2. The switch-resistor units are mounted on a 7 x 11-inch sheet of cardboard or Masonite. In the author's breadboard hookup, the potentiometer was connected in the battery lead and was handheld. A neat job would include fastening the sheet to a wood chassis or base (or over the open top of a shallow box) mounting the pot on the base and the battery inside.

If you are willing to sacrifice the logically preferable 1,500-ohm center position, you can use dpdt center-off slide or toggle switches. (See Fig. 3 for wiring details in that case, and note that the center position is the open one.) Otherwise use one of the switches given in the parts list. The Stackpole is the "official" switch, but the others all achieve the same result by different means. The per-

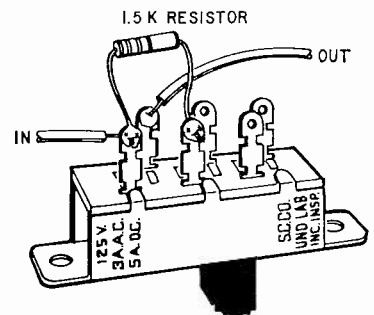

Fig. 2—This is how author wired switches he used. If you use different kind, find out which terminals are jumped to which in various positions.

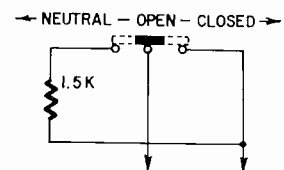

Fig. 3—If you can't find 3-position slide switches, try spdt or dpdt center-off's. Wire as here. "Neutral" (resistor in) will not be in center, however.

# GET ANY OF THESE DELUXE HARD-COVER ELECTRONICS BOOKS for only

# 67¢

CERTIFIED VALUE UP TO \$17.85

(limit 3 for \$2.00)

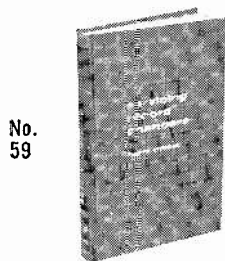

No. 59

**SERVICING RECORD CHANGERS**, By Harry Mileaf—Makes servicing changers easy. Complete text plus line drawings explain intricate mechanisms clearly. Reg. price \$4.60.

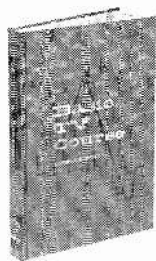

No. 105

**BASIC TV COURSE**, By George Kravitz—A book on TV as it is today. Even transistorized portables are discussed. A thorough practical discussion of circuit operation, sync methods, sweep systems, tuners, amplifiers, variations in power supplies. Presentation of technical detail in easy-to-follow writing style. Reg. price \$5.75.

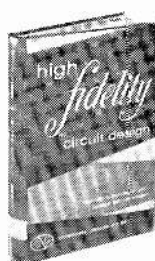

No. 56

**HIGH-FIDELITY CIRCUIT DESIGN**, by Norman H. Crowhurst and George Fletcher Cooper—Plan and build amplifiers—on paper—then construct the amplifier best suited to your needs. Reg. price \$5.95.

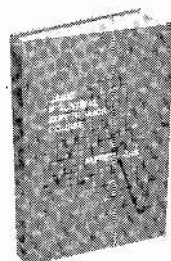

No. 109

**BASIC INDUSTRIAL ELECTRONICS COURSE**, By Alfred Haas—Reduces apparently complex industrial electronics devices to size. Describes assembly and maintenance. A key to a new, profit-making field. Reg. price \$5.95.

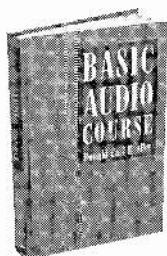

No. 66

**BASIC AUDIO COURSE**, By Donald C. Hoefler—A complete easy-to-read authoritative book on fundamentals, covering everything from the physics of sound to advanced techniques, including amplifiers, feedback, power supplies, distortion, attenuators, etc. Reg. price \$5.00.

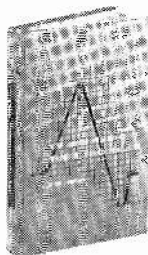

No. 68

**TV AND RADIO TUBE TROUBLES**, By Sol Heller—Trace any tube trouble to the source in minutes with this new sure-fire symptom analysis technique. Save servicing time. Reg. price \$4.60.



No. 87

**PRACTICAL AUTO RADIO SERVICE**, By Jack Greenfield—Covers transistor, hybrid FM and AM models. Compares auto with home radio servicing. Covers removal, installation, troubleshooting, power supplies, interference, suppression, tuner theory, etc. Reg. price \$4.60.

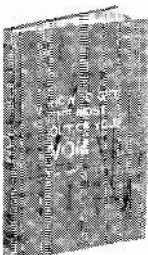

No. 85

**HOW TO GET THE MOST OUT OF YOUR VOM**, By Tom Jaski—Get more mileage out of this versatile instrument. How to choose, build, work with and extend the use of the VOM. Reg. price \$4.60.

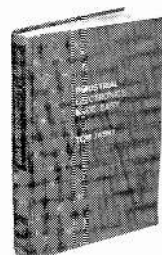

No. 99

**INDUSTRIAL ELECTRONICS MADE EASY**, By Tom Jaski—Operation and maintenance of industrial equipment, dielectric, induction and microwave heating processes and applications. Control systems actuated by photo-electric, infrared, pressure, and other transducers. Reg. price \$5.95.

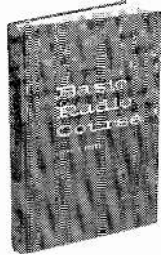

No. 104

**BASIC RADIO COURSE** (revised ed.), By John T. Frye—The original sold out through eight printings! Everything—Ohm's law, capacitance, tubes, transistors and how they work in a receiver—practical servicing techniques—discussed in a lighthearted style that makes what's being taught stick. Reg. price \$5.75.

## WHY THIS SPECTACULAR OFFER?

Gernsback Library is making this offer to persuade you to join the helpful Technician's Book Club. As striking as this offer is — it is only an introduction to the many advantages club members receive. The club gives you the chance to acquire, at bargain prices, deluxe hard-cover books written by top technical writers and published by leading technical publishers on techniques that will help you get ahead and stay ahead in electronics.

This is the technical book bargain of the year — not a collection of old or outdated volumes — but new books taken from the top of the Gernsback list of best sellers. Priced up to \$5.95 each — total value \$17.85.

## HERE'S THE WAY THE CLUB WORKS

About every two months a new and important hard-covered book on some timely phase of electronics will be sent to you **ON APPROVAL**. You look the book over in your home. You will have up to 10 full days to examine the book. If you like it, keep it and send us your check. If you don't, send the book back. It's as simple as that.

You agree to purchase four additional books in the next 12 months — at discounts of up to 27% — and you may cancel your membership any time after that.

Choose up to **THREE** books (worth \$17.85) for only 67¢ each

<b>GERNSBACK LIBRARY, Inc.</b>		write book no. here	
154 West 14th Street		<input type="checkbox"/>	<input type="checkbox"/>
New York, N.Y. 10011		<input type="checkbox"/>	<input type="checkbox"/>
Enroll me as a member of the G/L Technician's Book Club. I am to receive hard-cover books of leading technical publishers at discounts ranging to 27%. Start my membership with the book (or books) I've indicated for only 67¢ each (plus postage). Thereafter send a new selection every two months on the "no-risk approval" plan. I understand that my only obligation is to purchase just 4 additional books within the next 12 months, and that I may cancel anytime thereafter. I also understand that I may cancel immediately, simply by returning within 10 days the introductory book (or books) ordered herewith.			
Name _____			
Address _____			
City _____		State _____ Zip Code _____	
We pay postage if you remit with this coupon. You have the same return privilege. Remittance enclosed. <input type="checkbox"/>			
(This offer good in U.S.A. and Canada only) 123			



# the most noise-free recordings you have ever heard

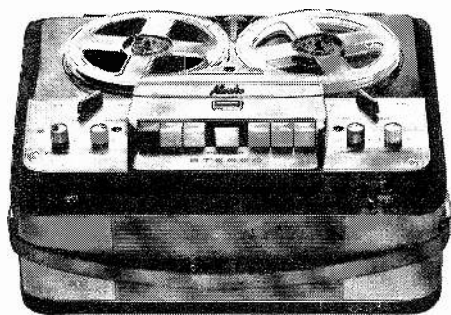

will be made on the new all-transistorized Norelco Continental '401' Stereo Tape Recorder, the only recorder using the newly developed AC107 transistors in its two preamplifiers. The AC107 is the only transistor specifically designed for magnetic tape head preamplifiers utilizing specially purified germanium to achieve the extraordinary low noise figure of 3 db, measured over the entire audio band (rather than the usual single frequency). This noise figure remains stable over large collector-emitter voltage swings and despite large variations in source resistance.

Hear the new transistorized Norelco Continental '401' • 4-track stereo/mono record and playback • 4 speeds: 7½, 3¾, 1½ and the new 4th speed of 1¼ ips which provides 32 hours of recording on a single 7" reel • fully self-contained with dynamic stereo microphone, two speakers (one in the removable cover for stereo separation), dual preamps and dual recording and playback amplifiers • self-contained PA system • mixing facilities • can also play through external hi-fi system • multiply facilities.

**Specifications:** Frequency response: 60-16,000 cps at 7½ ips. Head gap: 0.00012". Signal-to-noise ratio: better than -48 db. Wow and flutter: less than 0.14% at 7½ ips. Recording level indicator: one-meter type. Program indicator: built-in, 4-digit adjustable. Inputs: for stereo microphone (1 two-channel); for phono, radio or tuner (2). Foot pedal facilities (1). Outputs: for external speakers (2), for external amplifiers (1 two-channel); headphone (1). Recording standby. Transistor complement: AC 107 (4), OC75 (6), OC74 (2), OC44 (2), 2N1314 (2), OC79 (1). Line voltage: 117 volts AC at 60 cycles. Power consumption: 65 watts. Dimensions: 18½" x 15" x 10". Weight: 38 lbs. Accessories: Monitoring headset and dual microphone adapter.

For a pleasant demonstration, visit your favorite hi-fi dealer or camera shop. Write for Brochure F-12, North American Philips Company, Inc., High Fidelity Products Division, 230 Duffy Avenue, Hicksville, Long Island, New York.

**Norelco**

## fuses— are they RESISTORS?

By FRANK G. STIVER

Their resistance has to be considered in low-voltage circuits

THE STUDY OF TRANSISTORS IS STILL constantly filled with comparisons and contrasts with vacuum tubes. One of the important differences between the two is that transistors are basically low-voltage, high-current devices while tubes work with low currents and high voltages. This basic difference has made it necessary for us to change some of our preconceived vacuum-tube ideas.

Recently I ran into two separate but identical situations that emphasized this basic difference. The problem in both was a transistorized regulated power supply that had poor regulation. One was designed for use in a laboratory, with several distribution points. When constructed and tested it provided over 4 amperes at 12 volts with better than 1% regulation. The other was rated at 6 volts, ½ ampere, with better than 1% regulation.

In both cases the cause of the voltage variation was not in the regulator. The poor regulation was due to a large (for transistors) voltage drop across a ½-amp fuse in the distribution line. At first when I measured a drop of over ½ volt across the ½-amp fuse, I thought there must be a bad solder joint at the holder. A measurement directly across the fuse quickly eliminated that possibility. My next thought was a bad internal connection in the fuse, but replacing the fuse resulted in an even larger voltage drop.

I finally got around to applying Ohm's law and found that ½ volt at the 400-ma test current I was using made the fuse resistance around 1.2 ohms. (After all, a fuse is a heat-operated device and must generate enough I<sup>2</sup>R to activate it.)

I decided to investigate the resistance of fuses with other current ratings. Written material on the subject was very scarce; the best way of finding what I wanted to know was actually

TABLE II—Manufacturers' resistance ratings of high-speed fuses.

Amp Rating	Resistance (ohms)	Amp Rating	Resistance (ohms)
1/100	263.4	1/2	2.7
1/32	40.0	3/4	2.0
1/16	6.9	1	0.24
1/8	6.0	1 1/2	0.13
1/4	4.7	2	0.10
3/8	3.0	3	0.060

to measure the resistance of various fuses.

The results of my measurements on five fuses of each current rating are recorded in Table I. All fuses except the one ½-amp Slo-Blo group were the medium-lag type most commonly used in electronic equipment. Notice that resistance varies among fuses with the same current rating. I made no measurements on the high-speed fuses used in delicate test equipment. However, Table II lists the resistances quoted in the catalog of one of the leading fuse manufacturers.

It is interesting to note from Table I that the product of fuse resistance times rated current will give a drop centering around ½ volt across all fuses. It is also evident that, for any given current, a fuse with higher current rating will cause a smaller voltage drop.

Perhaps the easiest solution to the fuse resistance problem is to keep fuses out of low-voltage circuits where good regulation is important. Instead, wherever possible, such as in power supply circuits, let's put the fusing in the primary. If we *must* put fuses in the low-voltage circuits, let's be sure to use fuses with the largest fuse rating consistent with adequate protection, and remember that each fuse is a small resistor.

In conclusion: Low-voltage, high-current circuits, so common with transistors, force us to think of sources of resistance that can often be ignored in vacuum-tube circuits. Vacuum tubes operate at such high voltages and relatively small currents that the small voltage drop across fuses and meters can normally be ignored. In low-voltage, relatively high-current transistor circuits we must be very watchful of these small resistances. Otherwise even our good friend the fuse may become one of our problems.

END

TABLE I—Measured resistance of medium-lag fuses.

Amp Rating	Measured Resistance (ohms)				
1/16	8.5	36.0	7.3	7.1	6.7
1/8	6.0	4.8	6.0	4.6	5.4
1/4	3.0	3.5	3.3	3.1	3.0
1/2	1.4	1.3	1.1	1.2	1.2
3/4	0.6	0.8	0.8	0.8	0.7
1	0.4	0.4	1.6	0.6	0.5
2	0.2	0.2	0.2	0.2	0.2
1/2 S-B	1.9	1.8	2.0	1.7	2.0

RCA—PIONEER OF COLOR TV—BRINGS YOU

ALL YOU  
NEED FOR

# COLOR-TV SERVICING



WR-64A



WR-91A

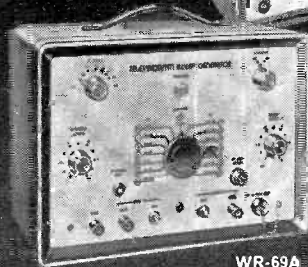

WR-69A



WR-70A



WR-99A

## RCA Color-Bar/Dot/ Crosshatch Generator

Low-cost, lightweight, portable instrument that provides all essential Color-TV test patterns. Simple to operate: only 3 controls. RF output leads connect directly to antenna terminals of receiver; no external sync leads required. Crystal-controlled signals assure rock-steady patterns, free from "jitter" and "crawl." Extra-wide-range chroma control. Generates:

- **Color-bar pattern:** ten bars of color, including R-Y, B-Y, G-Y, I and Q signals spaced at 30° phase intervals for checking phase and matrixing, and for automatic frequency and phase alignment. Permits accurate alignment of the "X" and "Z" demodulators which are used extensively in RCA Victor and many other makes of color TV receivers
- **Crosshatch pattern:** a grid-like pattern of thin sharp lines for adjusting vertical and horizontal linearity, raster size, and overscan
- **Dot pattern:** a pattern of small sized dots facilitating accurate color convergence adjustments

\$189.50\* with output cables.

## RCA 5-Inch Oscilloscope for Color-TV

A wideband scope excellent for checking colorburst signals and general troubleshooting of wideband color circuits and other electronic equipment. Multi-scale calibrated graph screen makes measurement of peak-to-peak voltage as easy as with a VTVM.

- New 2-stage sync separator assures stable horizontal sweep lock-in on composite TV signals
  - Dual bandwidth: 4.5 Mc at 0.053 volt rms/in. sensitivity. 1.5 Mc at 0.018 volt rms/in. sensitivity
  - Continuously adjustable sweep frequency range: 10 cps to 100 Kc
  - 3-to-1 voltage-calibrated, frequency-compensated step attenuator for "V" amplifier
  - Simplified, semi-automatic voltage calibration for simultaneous voltage measurement and wave-shape display
  - Vertical-polarity reversal switch for "upright" or "inverted" trace display
- \$249.50\*, including direct/low capacitance probe and cable, ground cable, and insulated clip.

## RCA Television FM Sweep Generator

Specifically designed for visual alignment and troubleshooting of color and black-and-white TV receivers, and FM receivers. The RCA WR-69A has pre-set switch positions for all VHF TV channels, FM broadcast band, and TV video, chrominance, and IF frequencies. The WR-69A has these important features:

- IF/Video output frequency continuously tunable from 50 Kc to 50 Mc
- Sweep-frequency bandwidth continuously adjustable from 50 Kc to 20 Mc on IF/Video and FM; 12 Mc on TV channels
- Output level—0.1 volt or more
- Attenuation range: TV channels, 60 db IF/Video, 70 db FM, 60 db
- Return-trace blanking
- Two adjustable bias voltages on front panel

\$295.00\* including all necessary cables.

## RCA RF/VF/IF Marker Adder

Designed for use with a marker generator (such as RCA's WR-99A) and a sweep generator (such as RCA's WR-69A), this instrument is used for RF, IF, and VF sweep alignment in both color and black-and-white TV receivers. In visual alignment techniques, it eliminates distortion of sweep response pattern. Important features:

- Choice of four different marker shapes provided by front panel switch for different types of sweep-response curves and for positive and negative sweep traces
  - Provides very high-Q markers of high-amplitude and narrow bandwidth
  - Complete front panel control of marker shape, marker amplitude, marker polarity, sweep amplitude, and sweep-trace polarity
- \$74.50\* complete with cables.

## RCA Crystal-Calibrated Marker Generator

Supplies a fundamental frequency RF carrier of crystal accuracy for aligning and troubleshooting color and B&W TV receivers, FM receivers and other electronic equipment in the 19-260 Mc range. Combines functions of multiple-marker generator, re-broadcast transmitter, and heterodyne frequency meter.

- Highly stable output
  - May be calibrated at 240 separate crystal check points—accurate calibration provided at 1-Mc and 10-Mc intervals
  - Matched-impedance pad-type attenuator and double shielding of the oscillator provide effective attenuation of all frequencies
  - Most-used IF and RF frequencies are specially indicated on the dial scale
  - Sound and picture carrier markers available simultaneously
- \$242.50\* complete with output cable and phone tip.

ELECTRONIC COMPONENTS AND DEVICES, Harrison, N. J.



The Most Trusted Name in Electronics

\*User Price (Optional)



# NEW IDEA

## Winegard Introduces An Amazing New Home TV and Music Outlet System

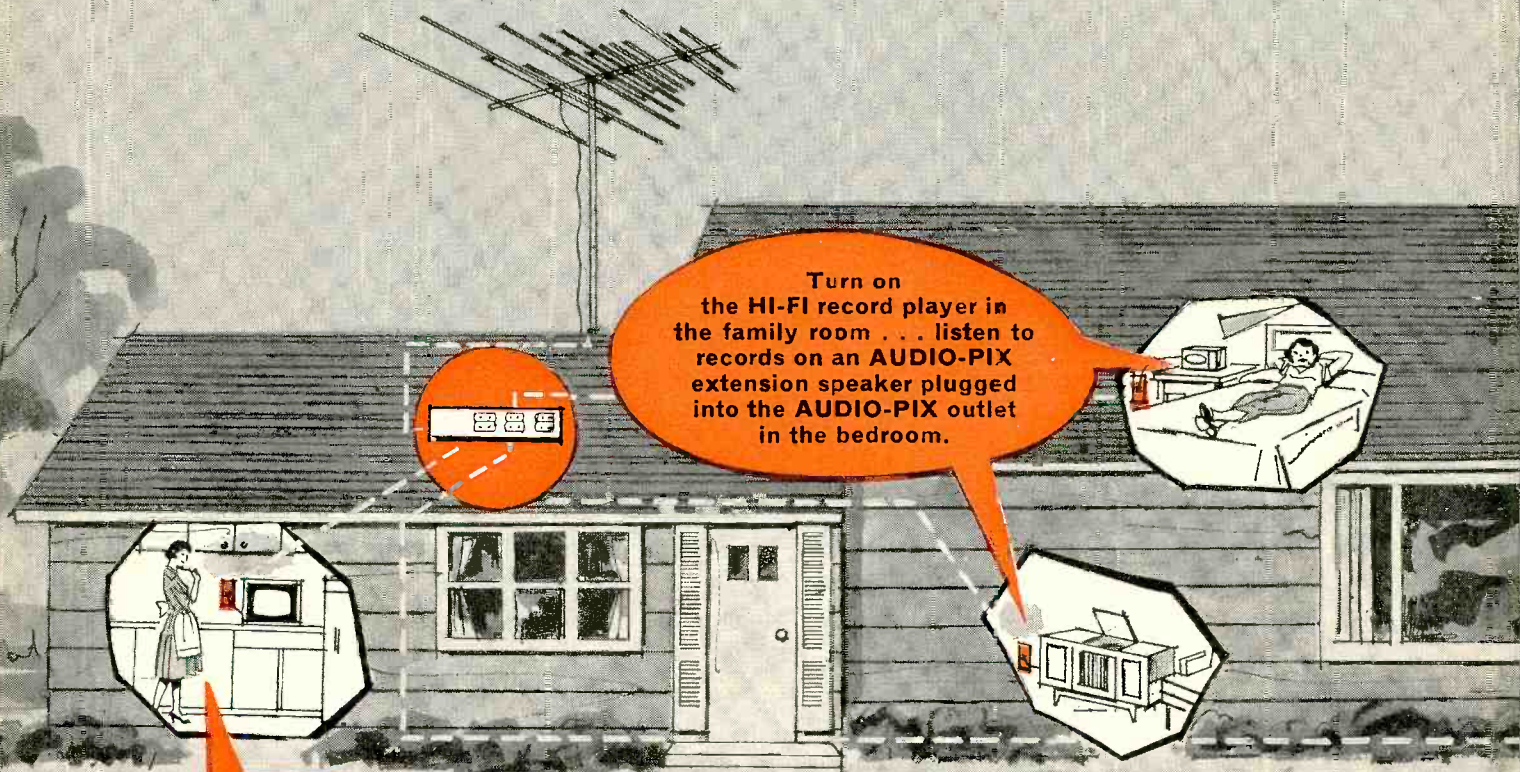

Turn on the HI-FI record player in the family room . . . listen to records on an AUDIO-PIX extension speaker plugged into the AUDIO-PIX outlet in the bedroom.

Watch TV in the kitchen (plug the TV set into an AUDIO-PIX outlet and receive TV antenna signals.)

All this electronic entertainment can go on simultaneously over a single wire without interference! That's the amazing new AUDIO-PIX system by Winegard.

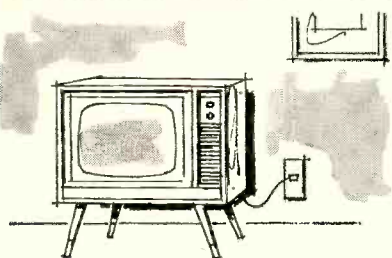

Plug TV set into any AUDIO-PIX outlet. Run one or more sets simultaneously from a single antenna.

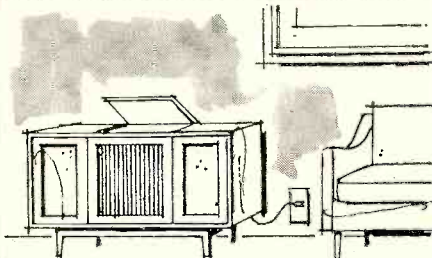

Run a HI-FI (record player, FM or AM, or tape recorder) and feed the sound into the system to be picked up at any AUDIO-PIX outlet.)

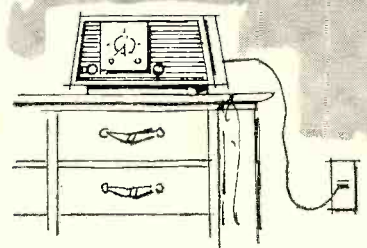

Plug an FM receiver into the AUDIO-PIX. The AUDIO-PIX serves as an FM antenna signal source, and at the same time automatically feeds the FM sound back into the system to the extension speakers.



# AUDIO-PIX delivers TV, FM or HI-FI

## Anywhere Inside or Outside the House Over a Single Wire



*Audio-Pix comes beautifully packaged in a Winegard selling display carton with built-in carrying handle.*



Watch TV on the patio (the portable TV set is plugged into an AUDIO-PIX outlet and is receiving TV signals from the same antenna.)

AUDIO-PIX is two systems wrapped into one simple, inexpensive installation. It is both a TV-FM system (distributes TV/FM antenna signals) and a HI-FI music system at a price any home owner can afford. No new home is truly modern without AUDIO-PIX.

The AUDIO-PIX is a revolutionary new electronic entertainment convenience for the home which—

- (1) ... feeds TV (Ch. 2-83) and FM antenna signals to each AUDIO-PIX outlet.
- (2) ... feeds sound from a HI-FI (record player, FM and tape recorder) to the same AUDIO-PIX outlets.

The complete Winegard AUDIO-PIX system comes in a kit which contains a special AUDIO-PIX 6-outlet

coupler\*, 4 AUDIO-PIX outlets and plugs (any number of additional outlets may be added if desired), special AUDIO-PIX HI-FI extension speaker, a special AUDIO-PIX attachment for FM or HI-FI system, and 100 ft. of lead-in wire. Model APX-360, list price \$49.95.

Start selling AUDIO-PIX to your customers now. Write for spec sheets or ask your distributor.

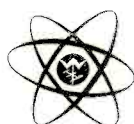

\*Pat. Pend.

# Winegard

ANTENNA SYSTEMS

3013-12 Kirkwood, Burlington, Iowa



# NEW SAMS BOOKS

NEWLY REVISED 5TH EDITION OF  
THE FAMOUS HOWARD W. SAMS

## Transistor Substitution Handbook

Completely updated! Lists over 40,000 direct substitutions, including replacements for all popular types used in transistor radios and similar equipment. Shows basing diagrams, polarity identifications and manufacturers for over 5,000 transistor types. Special section lists more than 15,000 American replacements for foreign transistors—PLUS a semiconductor diode and rectifier guide containing 800 substitutions. 144 pages, 5½ x 8½". Order **SSH-5**, still only... \$150

## North American Radio-TV Station Guide

by Vane A. Jones. New 1964 edition—most complete, up-to-date listing of radio and TV stations available. Lists frequencies, call letters, locations, etc., for all AM, FM, and TV stations in the U.S. and possessions, Canada, Cuba, the West Indies. Includes vital data on over 7,500 stations. Special maps for each of the 12 VHF channels, show location and protected area for every TV station; additional maps for UHF TV and FM station locations. Invaluable for technicians, DX'ers, broadcasters. 128 pages; 5½ x 8½". **RSG-2**, only... \$195

## Transistor Transmitters for the Amateur

by Don Stoner, W6TNS. Begins with a basic explanation of transmitter theory, then guides you through the construction and operation of various types of transistorized transmitters. Shows how to build a crystal oscillator, low-power CW transmitter, power amplifier, 5-watt CW rig (80 or 40 meter bands). 100-mw CW rig for CB, MCW modulator, 100-mw Class B audio modulator circuit for CW/MCW voice transmitter, 2-transistor phone rig for 10 or 11 meters, tunnel diode CW rig, etc. 160 pages; 5½ x 8½". Order **TTS-1**, only... \$295

## Fundamentals of Computer Math

by Allan Lytel. An introductory book completely devoted to the mathematical methods of problem-solving utilized by digital computers. Fully explains weighted numbering systems, polynomials, interpolation, iteration, numerical integration and differentiation, and other numerical methods. Shows how a computer performs these techniques through the use of a single operation—addition. 160 pages, 5½ x 8½"; hardbound. Order **CMF-1**, only... \$495

## Handbook of Electronic Component Tests and Measurements

by Robert G. Middleton. Everyone who tests electronic components will consult this invaluable book daily. Arranged handily in sections by types of components (resistive, capacitive, inductive, tube, transistor, etc.) Each section provides general testing data, followed by complete, specific "how-to" details for making numerous tests and measurements, using standard equipment available. 160 pages, 5½ x 8½". Order **TMM-1**, only... \$295

## Transistor Circuits for Magnetic Recording

by N. M. Haynes. This comprehensive book fully analyzes and illustrates all the phases of transistor circuit applications for tape recording systems. Begins with a clear explanation of the fundamental characteristics of transistors, then systematically describes circuit stabilization, noise reduction and, magnetic recording techniques using transistors. Twenty fact-filled chapters cover: Transistors, Magnetic Recording Elements, Sectional Circuitry, and System Circuitry. 384 pages; 5½ x 8½"; hardbound. Order **MTR-1**, only... \$995

## Broadcast Engineering Notebooks, Vol. 4: TV Broadcast Operations & Maintenance

by Harold E. Ennes. Covers everything in television broadcast systems, from the switcher input through the antenna. Includes pulse generation and distribution, studio-to-transmitter links (STL) with diplexed sound, and the complete transmitter. Reviews necessary theory, then devotes 8 comprehensive sections to details of every phase of TV broadcast operations and maintenance. Useful appendices include decibel tables, TV channel-frequency tables, etc. 288 pages; 5½ x 8½". **BEN-4**, only... \$595

## HOWARD W. SAMS & CO., INC.

Order from your Sams Distributor today, or mail to Howard W. Sams & Co., Inc., Dept. RE-12, 4300 W. 62nd Street, Indianapolis 6, Ind.

Send me the following books:

- SSH-5    TTS-1    TMM-1    BEN-4  
 RSG-2    CMF-1    MTR-1

\$\_\_\_\_\_ enclosed.  Send FREE Booklist

Name \_\_\_\_\_

Address \_\_\_\_\_

City \_\_\_\_\_ Zone \_\_\_\_\_ State \_\_\_\_\_

My Distributor is \_\_\_\_\_

IN CANADA: A. C. Simmonds & Sons, Ltd., Toronto 7

# New Semiconductors and Tubes

THE TWO SEMICONDUCTORS SHOWN in these photographs are top candidates for the Littleness prize this month. If you aren't careful, they may get swept off your bench along with the solder droplets and wire cuttings.

The first is one of a series of miniature silicon planar transistors produced by Nippon Electric Co., Ltd. They are inexpensive, and intended for ordinary radio and TV applications. The one in the photo is about 1/16 inch thick, and is shown next to a perfectly ordinary

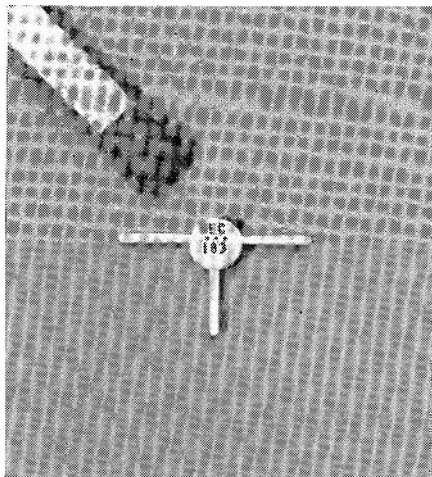

paper match. Despite the size, its collector dissipation is 150 mw and its collector-emitter breakdown voltage, 15.

The second photo shows a bead thermistor that is like a piece of dust

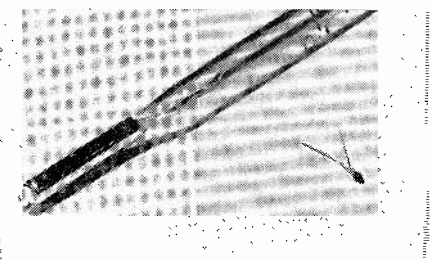

with leads. Made by G-E, it is .043 inch in diameter and has ¼-inch, .004-inch-diameter platinum leads. It is useful up to 400°C for control, measurement and time delay. That's an ordinary fever thermometer next to it.

## 6BK4-A

The "A" suffix to this well known type indicates the increased plate dissipation rating of 30 watts, compared to the 25-watt rating of the 6BK4. Other ratings and all mechanical features re-

main the same, and the 6BK4-A is unilaterally interchangeable with the 6BK4 as a shunt high-voltage regulator in color TV sets.

## 6DY4

The 6DY4 and its series-string types 1-, 2- and 3DY4 are strap-frame grid triodes for uhf TV local oscillator service. They have standard 7-pin miniature bases. Transconductance is 11,000 μmhos. Sylvania cautions that the grid-to-cathode spacing is so small that it is

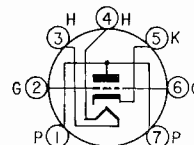

1,2,3,6DY4

risky to use more than 30 volts dc or peak ac between those elements. Watch your tube tester!

Maximum plate voltage is only 135, and the tube oscillates quite comfortably at 90 volts. At that voltage, and with a cathode resistor of 180 ohms, the tube draws 10.4 ma.

## 6HA6

Here is a video amplifier pentode made specially for low-B-plus black-and-white TV sets. Its high transconductance (20,000 μmhos), sharp cutoff and low plate knee characteristic make it very

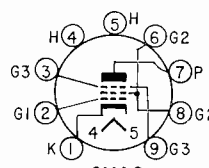

6HA6

linear over a wide operating range, according to Raytheon.

The tube can also be used as a wide-band power amplifier in other applications.

Salient points:

Plate volts (max)	300
Screen volts (max)	250
Plate dissipation	8 w

Plate resistance is 20,000 ohms at plate and screen voltages of 150 and 100, respectively, and with a cathode bias resistor of 33 ohms. Plate current under those conditions is 28 ma, screen current 3.5 ma.

The 6HA6 has four series-string siblings: the 8HA6, 10HA6, 15HA6 and 29HA6.

## 6HJ5

This husky compactron is a horizontal-deflection amplifier (horizontal output, that is) for low-B-plus TV sets

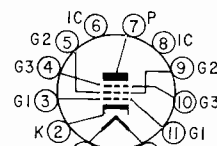

6,21,30HJ5



SERVICE TECHNICIANS, ENGINEERS, TEST LABS SAY . . . THE POPULAR MIGHTY MITE IS

**"The Best Tube Checker they ever used."**

Here it is . . .

THE **MIGHTY MITE**

Designed for the present and far into the future. Tests all of your present tubes plus the new RCA Nuvistors and Novars, GE Compactrons and Sylvania and 10 pin tubes.



Finds 'em Fast!  
Checks 'em All!

A complete tube tester that is smaller than a portable typewriter yet outperforms testers costing hundreds of dollars. A real money maker for the serviceman and a trusty companion for engineers, maintenance men and experimenters.

Even though the Mighty Mite weighs less than 8 pounds, new circuitry by Sencore enables you to use a meter to check grid leakage as high as 100 megohms and gas conditions that cause as little as one half microamp of grid current to flow. Then too, it checks for emission at operating levels and shorts or leakage up to 120,000 ohms between all elements. This analytical "stethoscope" approach finds troublesome tubes even when large mutual conductance testers fail. And it does all this by merely setting four controls labeled A, B, C, & D.

Check these plus Sencore features: New, stick-proof D'Arsonval Meter will not burn out even with a shorted tube • Meter glows in dark for easy reading behind TV set.

- New large Speedy Set-Up Tube Chart in cover, cuts set-up time
- Rugged, all-steel carrying case and easy grip handle
- Smallest complete tester made, less than one foot square.
- The Mighty Mite will test every standard radio and TV tube that you encounter, nearly 2000 in all, including foreign, five star, auto radio tubes (without damage) plus the new GE Compactrons, RCA Nuvistors and Novars and Sylvania 10 pin tubes.

Mighty Mite also has larger, easy-to-read type in the set-up booklet to insure faster testing. Why don't you join the thousands of servicemen, engineers, and technicians who now own a Mighty Mite tube tester? Tube substitution is becoming impossible and costly with nearly 2000 tubes in use today. Ask your authorized Sencore Distributor for the New Improved Mighty Mite. Size: 10 1/4" x 9 1/4" x 3 1/2". Wt. 8 lbs.

**MODEL TC114**

Dealer Net **\$74.50**

Sencore Sam says . . .  
"They all agree . . . the Mighty Mite  
is the real answer for the man on the go."

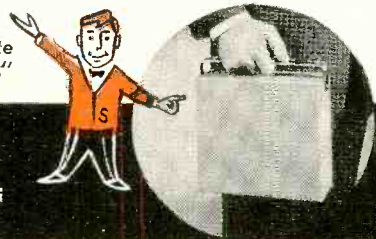

**SENCORE** ADDISON, ILLINOIS





# Your 1964 copy is waiting

**FREE!** For fun and pride in assembly, for long years of pleasure and performance, for new adventures in creative electronics mail the coupon below and get Conar's new 1964 catalog of quality do-it-yourself and assembled kits and equipment. Read about items from TV set kits to transistor radios . . . from VTVM's to scopes . . . from tube testers to tools. And every item in the Conar catalog is backed by a no-nonsense, no-loopholes money back guarantee! See for yourself why Conar, a division of National Radio Institute, is just about the fastest growing entry in the quality kit and equipment business.

# CONAR

**MAIL THIS COUPON NOW**

KC3C

CONAR 3939 Wisconsin Ave., Washington 16, D.C.

Please send me your 1964 catalog.

Name \_\_\_\_\_

Address \_\_\_\_\_

City \_\_\_\_\_

Zone \_\_\_\_\_

State \_\_\_\_\_

## Q.

*Where can you buy modern, hand-somely clothbound books on servicing, test instruments, shop practice and electronic theory for only 67 cents each?*

## A.

ON PAGE 83.

## HOTTEST VALUE EVER OFFERED!

**\$200 HEARING AID (as shown)—Your Price . . . \$2**

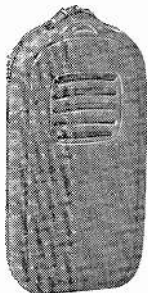

We scooped the Market on 15000 of these HEARING AIDS from one of the Leading Manufacturers (name withheld) who switched to the Transistor Type. Each HEARING AID INSTRUMENT is a Complete AUDIO AMPLIFIER and includes—a CRYSTAL MICROPHONE, 3 SUB-MINIATURE TUBES and a Superb Beige Phenolic CABINET.

Indeed a TOP ITEM for the Experimenter—can be modified and converted to: RADIOS—INTERCOMS—TRANSMITTERS—SECRET LISTENING DEVICES — MICROPHONE for Tape Recorders — PRE-AMP & MICROPHONE COMBINATION for Public Address Systems—ETC.

5" x 2½" x 1"—Shipping Weight 1 lb.

Complete as illustrated—Including a detailed informative SCHEMATIC DIAGRAM (less Earphone and Battery) . . . . .

**\$2**

8" PM SPEAKER 6.8 mag. dual-cone ...\$3.59

8" OUTDOOR SPEAKER metal case \$9.69

12" PM SPEAKER 6.8 mag. dual-cone ...5.97

15" JENSEN SPEAKER 10-oz. mag. ....7.84

**BROOKS RADIO & TV CORP., 84 Vesey St., New York 7, N.Y.**

and for color sets. It has a separate suppressor-grid connection to permit using a positive bias for "snivet squelching"—eliminating the troublesome uhf parasites that crop up in some circuits. Dual pin connections to control and screen

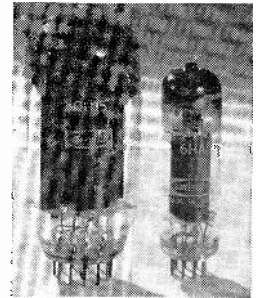

30HJ5 and 6HA6

grids offer better heat dissipation.

Companion types 21HJ5 and 30HJ5 have different heaters but are otherwise identical.

Maximum ratings:

Plate volts (B-plus and boost)	770
Screen volts	220
Plate dissipation	24 w
Avg. cath. current	280 ma
Bulb temperature	240°C

Raytheon is the manufacturer. END

STATEMENT REQUIRED BY THE ACT OF OCTOBER 23, 1962, SECTION 4369, TITLE 39 UNITED STATES CODE SHOWING THE OWNERSHIP, MANAGEMENT, AND CIRCULATION OF RADIO-ELECTRONICS, published monthly at 10 Ferry Street, Concord, Merrimack County, New Hampshire 03302. The General Business offices of the Publisher are located at 154 West 14 St., New York, N. Y. 10011.

1. The names and addresses of the publisher, editor and managing editor are: Publisher, Hugo Gernsback, 154 West 14 St., New York, N. Y. 10011; Editor, M. Harvey Gernsback, 154 West 14 St., New York, N. Y. 10011; Managing Editor, Fred Shunaman, 154 West 14 St., New York, N. Y. 10011.

2. The owner is: Gernsback Publications, Inc., 154 West 14 St., New York, N. Y. 10011; Hugo Gernsback, 154 West 14 St., New York, N. Y. 10011; M. Harvey Gernsback, 154 West 14 St., New York, N. Y. 10011.

3. Known bondholders, mortgagees, and other security holders owning or holding 1 percent or more of total amount of bonds, mortgages or other securities: None.

4. The above paragraphs include, in cases where the stockholder or security holder appears upon the books of the company as trustee or in any other fiduciary relation, the name of the person or corporation for whom such trustee is acting, also the statements in the two paragraphs show the affiant's full knowledge and belief as to the circumstances and conditions under which stockholders and security holders who do not appear upon the books of the company as trustees, hold stock and securities in a capacity other than that of a bona fide owner. Names and addresses of individuals who are stockholders of a corporation which itself is a stockholder or holder of bonds, mortgages or other securities of the publishing corporation have been included in the above paragraphs when the interests of such individuals are equivalent to 1 percent or more of the total amount of the stock or securities of the publishing corporation.

5. The average number of copies each issue during the preceding 12 months are: (A) Total number copies printed (net press run): 226,125; (B) Paid circulation: (1) To term subscribers by mail, carrier delivery or by other means: 87,273; (2) Sales through agents, news dealers, or otherwise: 69,087; (C) Free distribution: 2,242; (D) Total number of copies distributed: 158,602. The number of copies single issue nearest to filing date are: (A) Total number copies printed (net press run): 224,292; (B) Paid circulation: (1) To term subscribers by mail, carrier delivery or by other means: 90,515; (2) Sales through agents, news dealers, or otherwise: 64,313 (C) Free distribution: 2,148; (D) Total number of copies distributed: 156,976.

I certify that the statements made by me above are correct and complete.

(Signed) M. Harvey Gernsback  
Editor

RADIO-ELECTRONICS

# 1963 SEMI-ANNUAL INDEX

## RADIO-ELECTRONICS

July-December, 1963 of Vol. XXXIV

### A

Add Depth to Speaker (Travis) (Corres) Aug 28; Dec 21  
Antennas—see Radio, Television

#### AUDIO-HIGH FIDELITY-STEREO

Amplifier, Ultra-Linear Rf Type (NC) Jul 95  
Amplifiers, Prefab Transistor, End Building Headaches (Turner) Sep 74  
Booster for Transistor Radios (Adamke) Oct 62  
Feedback, Cathode, Nomo (Kyle) (Corres) Jul 23; Oct 18  
Improving Hi-fi Bottom (Marshall) (Corres) Jul 14  
Metronome, Unijunction\* (Lederer) (Corres) Jul 40; Oct 18  
Music All Over House—Without Wires (Scott) (Corres) Aug 21  
Organ, Electronic, Tuning Made Easy (Korte) (Corres) Jul 58; Dec 24  
Output Matching, Mysticism in (Ravenswood) Aug 37  
Preamp, Stabilizing (NC) Sep 107  
Sound, Wiring for (CI) Oct 51  
Speaker  
Add depth to\* (Travis) (Corres) Aug 28; Dec 21  
Bookshelf\* (Neinast) Sep 70  
Corner, Fits Your Home\* (Briggs) Dec 58  
Measurements, Simple (Crowhurst) Sep 37

Stereo  
Adapter, Heathkit Multiplex (NC) Nov 102  
Adapters, MPX, Alarm for (Johnson) Nov 64  
Alarm for MPX Adapters (Johnson) Nov 64  
Amplifier, 20 Watts, 3 Tubes\* (Sutheim) Nov 28  
Balance Indicator (Maxwell) (Corres) Jul 29; Oct 21  
Multiplex, with Adapter (Burstein) Nov 44  
Preamp and Control Center—Citation A (Hegeman) Jul 32  
Receiver, Bell Imperial 1000 Nov 36  
Tape Playback Preamp Sep 43  
Transistors in Ascendant at New York Hi-fi Show (NB) Nov 6  
Volume Control, Remote (Pat) Sep 88  
Wiring for Sound (CI) Oct 51

Announcement Reminder and Alarm, Automatic\* (Ives) Dec 56  
Audio Sweep Generator\* (Stein) (Corr) Sep 28; Nov 55  
Automatic Announcement Reminder and Alarm\* (Ives) Dec 56  
Automobile(s)  
Dwell Angle, Measure\* (Bryce) Sep 52  
Ignition  
Engine Analyzers, Electronic Working With (Kramer) Nov 32  
Quick-Start Circuits Improved (NC) Aug 94  
Simple Transistor\* (Schollmeyer) Jul 24  
Radio  
Reverberation in (NC) Nov 102  
Servicing—see Servicing, Radio

### B

Batteries, Watch Those Jul 67  
Battery Charger, Solar-Cell (Pat) Dec 115  
Battery Holder\* (Pugh) Jul 66  
Beginner's Lab for Pennies\* (Frantz) Aug 48  
Beginner's Lab, Using\* (Frantz) Sep 49  
Bell Imperial 1000 Nov 36  
Bias Supply, Zener Diode\* (Ives) Dec 38  
Big Noise (Kernin) Aug 59  
Blinker Circuit, Light-Controlled (Turner) Jul 41  
Bookshelf Speaker\* (Neinast) Sep 70  
Booster, Audio, for Transistor Radios\* (Adamke) Oct 62  
Boosters and Antennas for Color TV (Cunningham) Dec 44

### C

Capacitor and Dielectric Analyzer\* (Sutton) Oct 44  
Capacitor Tester, Simple (Heath CT-1 and IT-22) (NC) Dec 108  
Cathode Feedback Nomo (Kyle) (Corr) (Corres) Jul 23; Oct 18  
C B—see Radio; Servicing, Radio  
Chopper-Stabilized Dc Amplifier\* (Hansen) Aug 40  
Church Amplifier, Custom-Built\* (Lemons) Oct 37  
Citation A—Stereo Preamp and Control Center (Hegeman) Jul 32  
Color TV—See Television, Color; also Servicing, Television

### KEYS TO SYMBOLS AND ABBREVIATIONS

\* Construction Articles  
† Section of full-length article  
§ Transistorized  
CI ..... Service Clinic  
Corr ..... Correction  
Corres ..... Correspondence  
NB ..... News Briefs  
NC ..... Noteworthy Circuits  
Pat ..... New Patents  
Tech ..... Technotes  
TTO ..... Try This One  
WN ..... What's New  
Regular departments not itemized are New Books, New Literature, New Products, Technicians' News, What's Your EQ?

Contact Load Multiplier (Ives) (Corres) Aug 18  
Continuity Checker (Patrick) Sep 47  
Corner Speaker Fits Your Home (Briggs) Dec 58  
CTC 15, RCA's Newest Color Chassis (Hilderbrand) Dec 47  
Curve Plotter, Instant; X-Y Recorder (Kramer) Jul 69

### D

Deflection Troubles Can Be Sneaky (Darr) Sep 46  
Diagnosis and Frozen Brain (Fitzgibbon) Nov 43  
Diode, Photoparametric, Detects 10<sup>-9</sup> Watt (NB) Dec 6  
Diodes, New Tricks With\* (Geisler) (Corres) Jul 36; Oct 21; Dec 18  
Direct-Reading Capacitance Meter\* (Watters) Aug 32  
Do-It-Yourself TV Repairs, R-E Reports on (Kramer) Aug 26  
Do You Know the Law? (Jaski) Nov 40

### E

Editorials (by Hugo Gernsback unless otherwise stated)  
Beyond the Transistor Jul 19  
Electronic Robots Nov 27  
Electronic Weather Control Oct 25  
Language Rectification (Corres) Aug 22  
Microminiature Color Television Dec 27  
Radio Optics Forecast Sep 27  
Resonant Sky (Clarke) Aug 25  
Education  
Language Labs Oversold? (NB) Aug 10  
Schools Get 31 Channels (NB) Oct 6  
Telemetering Equipment, FM Wireless Microphones Legal (NB) Dec 8  
TV, Foreign Language Channel Added (NB) Nov 8  
Uhf May Rescue Schools (NB) Jul 10  
8-Channel Radio-Control Receiver\* (Cole) Jul 30

### ELECTRONIC(S)

Amplifier, Low-Noise (Pat) Nov 107  
Amplifier, Zener-Coupled (Pat) Oct 104  
Automaton, Mobile, Feeds Itself Oct 47  
Camera, Electron Diffraction (WN) Jul 35  
Computer(s)  
Fanatics Flatter (NB) Sep 6  
Satellite Research Movies (NB) Nov 14  
Thin-Film Memory (WN) Sep 48  
Darkroom Thermometer (Karp) Oct 60  
Dialing System, Automatic (WN) Sep 48  
Dog Howling Counterspy (NB) Aug 16  
Electron Beam Drills Holes (WN) Nov 49  
Generator, Odd-Harmonic (Pat) Jul 82  
Home Study Takes Step Forward Illumination, Automatic (Pat) Sep 31  
Industrial—see Industrial Electronics  
Integrated Circuitry, What and Why of (Stern) Oct 34  
Inverter, 3-Level (Pat) Sep 87  
Laser—see Laser  
Magnet May Become Kitchen Tool (NB) Nov 8  
Medicine—see Medicine  
Microelectronics, Thin-Film Approach (Simmons) Nov 38  
Microwaves, Dc Through GaAs Generates (NB) Nov 14  
Multi-Oscillator (Pat) Oct 104  
Needle Belt Orbits (NB) Aug 12  
Optical Lens Testing (NB) Oct 6  
Organ Tuning Made Easy (Korte) (Corres) Jul 58; Dec 24  
Oscillator, Tunnel-Diode, Crystal (Pat) Sep 88  
Pen Improves Oscilloscopes (NB) Dec 6  
Photocell Housing, Inexpensive (TTO) Nov 104  
Photoparametric Diode Detects 10<sup>-9</sup> Watt (NB) Dec 6

Radio Astronomy and TV Struggle for Channel 37 (NB) Aug 12  
Radio Telescope, Millimeter, Housed in Standard Observatory (NB) Sep 8  
Re-entry Blackout Study Equipment (WN) Aug 47  
Regulator Bridge, Self-Balancing (Pat) Aug 95  
Regulator, Constant-Current (NC) Dec 109  
See-Saw Circuit, Novel (NC) Jul 94  
Signal Identification (Pat) Nov 107  
Solar-Powered Boat (WN) Nov 49  
Solenoid, Superconductor, has 100,000-Gauss Field (NB) Oct 6  
Speech From Written Characters, New Device Makes (NB) Nov 6  
Superconductor at Lowest Temperatures, Gold 2 (NB) Dec 6  
Switch, High-Voltage Pushbutton (TTO) Sep 103  
Terms Adopted Sep 10  
Test Paper (Gernsback) Jul 34  
Thermopaper Commercially Available (NB) Sep 18  
Transients, Watch Out for (Leftwich) (Corres) Jul 14; Oct 18  
Translates Chinese, Machine (NB) Aug 6  
Tropospheric Telephone (NB) Aug 6  
Type-Reading Device (Pat) Jul 82  
Vacuum, New Techniques Make Fantastic Weather Bureau Oct 33  
Wife Tamer (Cramp) Sep 51  
Zener Bridge, Temperature-Compensated (Pat) Dec 115  
Zener Diode Bias Supply\* (Ives) Dec 38

### F

FM  
In Fringes (Marshall) Aug 51  
Multiplex  
Adapter, Going Multiplex With (Burstein) Nov 44  
Adapter, Heathkit (NC) Nov 102  
Adapters, Alarm for MPX, Stereo (Johnson) Nov 64  
Stereo Indicator (NC) Aug 93  
Wireless Microphones Legal (NB) Dec 8  
Frequency Synthesis Improves CB Coverage (Scott) Aug 44  
Fuses, Are They Resistors (Stiver) Dec 84

### G

Going Multiplex With Adapter (Burstein) Nov 44

### H

Handy Log Scales (Jaski) Dec 46  
Hexnash-Electric Game\* (Allison) Dec 82  
Home Electronics Study Takes Step Forward Sep 31  
How Well Do You Know Your Units? (Jaski) Dec 43  
Hybrid Dc Millivoltmeter\* (Hill) Dec 63

### I

Ignition—see Automobile  
Improving Hi-fi Bottom (Marshall) (Corres) Jul 14  
Inductance Bridge, Precise\* (Krueger) Sep 44

### Industrial Electronics

Big Noise (Kernin) Aug 59  
Contact Load Multiplier (Ives) (Corres) Aug 18  
Flaw Detection (Pat) Dec 115  
Glide-Path Indicator (Pat) Nov 108  
Monitoring, Instant (Pat) Nov 108  
RR Scanner Works Fast (NB) Jul 8  
Tone Alarm (NC) Nov 101  
TV Sees Invisible (NB) Nov 6  
X-Y Recorder Instant Curve Plotter (Kramer) Jul 69  
Instant Curve Plotter, X-Y Recorder (Kramer) Jul 69  
Integrated Circuitry, What and Why of (Stern) Oct 34  
Intercom, Simple (NC) Jul 92  
Is That Pic Tube Really Gone? (Fitzgibbon) (Corres) Jul 26; Oct 21

### J

Just Plain Flash\* (Henry) (Corres) Aug 21

### K

Kill that Mobile Noise! (Dudley) Oct 26

### L

Laser(s)  
Europium Orthosilicate for (NB) Dec 12  
Frequency-Modulated (NB) Jul 6  
High Pulse Rate by Sequence Firing (NB) Dec 12  
Long-Wave, Carries 10 Messages (NB) Oct 12  
Mail-order (NB) Dec 12

Plastic (WN)	Jul	35
Pocket-Size (WN)	Nov	49
Range of Injection Devices Extended (NB)	Oct	10
Solid-State, Is Phone Transmitter	Sep	66
Transmits 118 Miles (NB)	Aug	16
Leakage Checker, Add to Vtvm (Lemons)	Jul	39
Light-Controlled Blinker Circuit (Turner)	Jul	41
Low-Cost Transistor Regulated Power Supply (Powell)	Jul	48

**M**

Major Improvements for Short-Wave Reception (Churchill)	Jul	20
Marker Adder for Sweep Generator*§ (Wiles)	Jul	62
Measure Dwell Angle* (Bryce)	Sep	32

**Medicine**

Analgesic, White-Noise (Pat)	Aug	96
Brain Waves Cross Ocean (NB)	Jul	8
Hearing Aid in Tooth (Pat)	Aug	95
Larynx, Artificial (Pat)	Sep	87
Listening-Aid Amplifier§ (NC)	Dec	108
Nurse, Electronic (WN)	Jul	35
Rat Power Runs Radios (NB)	Oct	6
Transmitter Fits in Tooth*§ (Gillings)	Nov	60
TV for Blind Forecast (NB)	Aug	12

Metronome, Unijunction*§ (Lederer) (Corres)	Jul 40; Oct	18
---	-------------	----

Microelectronics, Thin-Film Approach (Simmons)	Nov	38
--	-----	----

Minimizing Vtvm Pointer Shift (Centerville)	Nov	48
---	-----	----

More Signals—Less Space (McQuay)	Aug	34
More Talk-Power for CB Rig (Scott)	Oct	48

Movie Projectors, Servicing Sound—see Servicing		
---	--	--

Music All Over House—Without Wires (Scott) (Corres)	Aug	21
---	-----	----

Mysticism in Output Matching (Ravenswood)	Aug	37
---	-----	----

**N**

New Tricks with Diodes* (Geisler) (Corres)	Jul 36; Oct 21; Dec	18
--	---------------------	----

New Tubes for Color TV (Sutheim)	Dec	42
----------------------------------	-----	----

1964 Color TV Roundup (Lemons)	Dec	32
--------------------------------	-----	----

**O**

100-Kc Crystal Calibrators*§ (Queen)	Aug	77
--------------------------------------	-----	----

Organ, Electronic, Tuning Made Easy (Korte) (Corres)	Jul 58; Dec	24
--	-------------	----

Our Policy on Freebies (Margolis)	Oct	76
-----------------------------------	-----	----

**P**

Pattern Depends on Probe (Cunningham)	Nov	31
---------------------------------------	-----	----

Pewee Attacks Radio (Wayne)	Dec	65
-----------------------------	-----	----

Photography		
-------------	--	--

Darkroom Thermometer, Electronic* (Karp)	Oct	60
--	-----	----

Just Plain Flash* (Henry) (Corres)	Aug	21
------------------------------------	-----	----

Power Amplifier, Transistor, Circuit Directory (Geisler)	Oct	32
--	-----	----

Power Dissipation in Resistors or Transistors (Todd)	Aug	31
--	-----	----

Power Supply		
--------------	--	--

Low-Cost Transistor Regulated (Powell)	Jul	48
--	-----	----

Unusual (NC) (Corres)	Jul 92; Nov	24
-----------------------	-------------	----

Vibrator, Transistorized (NC)	Aug	93
-------------------------------	-----	----

Precise Inductance Bridge*§ (Krueger)	Sep	44
---------------------------------------	-----	----

Prefab Transistor Amplifiers End Building Headaches (Turner)	Sep	74
--	-----	----

Pushbuttons Add Ohms or Mf's (Fred) (Corres)	Sep	20
--	-----	----

**R**

**Radar**

Jamming Suppressor (Pat)	Oct	104
--------------------------	-----	-----

Helicyl Antenna (WN)	Aug	47
----------------------	-----	----

RATAN in N. Y. Harbor (NB)	Jul	8
----------------------------	-----	---

Short Pulse, Has High Resolution (NB)	Sept	15
---------------------------------------	------	----

Weather, Makes Flying Safer (Bowen)	July	50
-------------------------------------	------	----

<b>RADIO(S)</b>		
-----------------	--	--

Booster, Audio, for Transistor*§ (Adamek)	Oct	62
---	-----	----

<b>CB</b>		
-----------	--	--

Frequency Synthesis Improves Coverage (Scott)	Aug	44
---	-----	----

Operator, Illegal, Faces Several Charges (NB)	Nov	6
---	-----	---

Servicing with CB Set (Sands)	Sep	34
-------------------------------	-----	----

Talk-Power, More for Rig (Scott)	Oct	48
----------------------------------	-----	----

Code Oscillator and Monitor§ (NC)	Dec	108
-----------------------------------	-----	-----

FM in Fringes (Marshall)	Aug	51
--------------------------	-----	----

Inventors of (Bartlett)		
-------------------------	--	--

Lodge, Sir Oliver Joseph	Aug	50
--------------------------	-----	----

Popoff, Alexander Stepanovitch	Oct	28
--------------------------------	-----	----

Millimeter Communications System (NB)	Sept	10
---------------------------------------	------	----

More Signals—Less Space (McQuay)	Aug	34
----------------------------------	-----	----

Rat Power Runs (NB)	Oct	6
---------------------	-----	---

Remote-Control Receiver, 8-Channel*§ (Cole)	Jul	30
---	-----	----

<b>Short-Wave</b>		
-------------------	--	--

Dx from VOA (NB)	Oct	10
------------------	-----	----

Ham Gossip, Space News Heard (NB)	Aug	14
-----------------------------------	-----	----

Reception, Major Improvements for (Churchill)	Jul	20
---	-----	----

Standard Stations, New, on Lower Frequencies (NB)	Dec	6
---	-----	---

Transmitter Fits in Tooth*§ (Gillings)	Nov	60
--	-----	----

Transistor, Audio Booster for § Adamek Tuner, 3-Transistor, Saves Time and Money (D'Airo)	Oct	62
---	-----	----

	July	56
--	------	----

Random Noise Generator* (Lederer)	Aug	68
-----------------------------------	-----	----

R-E Reports on Do-It-Yourself TV Repairs (Kramer)	Aug	26
---	-----	----

Relay, Photoelectric § (NC)	Oct	84
-----------------------------	-----	----

Reminder and Alarm, Automatic Announcement* (Ives)	Dec	56
--	-----	----

Replace Them with Silicons! (McCall)	Aug	54
--------------------------------------	-----	----

Replacing Your First Color TV Tube? (Davidson)	Dec	28
--	-----	----

Resistors, Are Fuses (Stiver)	Dec	84
-------------------------------	-----	----

Resistors or Transistors, Power Dissipation in (Todd)	Aug	31
---	-----	----

Reverberation in a Car Radio (NC)	Nov	102
-----------------------------------	-----	-----

Reverse Voltage Protection for Transistors (Ives)	Oct	36
---	-----	----

**S**

<b>Satellite(s)</b>		
---------------------	--	--

Computer Makes Movies for Research (NB)	Nov	14
---	-----	----

Corner Reflectors for S-66 (WN)	Aug	47
---------------------------------	-----	----

Electric Boomerang for Signals (NB)	Dec	10
-------------------------------------	-----	----

Telstar Rides Again (NB)	Jul	10
--------------------------	-----	----

<b>SERVICING—see also specific subject</b>	Aug	98
--	-----	----

Alligator Clips, Securing (TTO)		
---------------------------------	--	--

<b>Audio—High Fidelity—Stereo</b>		
-----------------------------------	--	--

Adapters, Pin Plug to Mike Jack (TTO)	Jul	90
---------------------------------------	-----	----

Amplifier (Heathkit W-5M) (Tech)	Jul	80
----------------------------------	-----	----

Record Player, Magnet Anchors Washers (TTO)	Oct	107
---	-----	-----

Record Player, Phono Cartridge, Two-Faced (CI)	Sept	51
--	------	----

Sound, Wiring for (CI)	Oct	51
------------------------	-----	----

Tape Recorders		
----------------	--	--

Microphone Hum (CI)	Nov	52
---------------------	-----	----

Tone Control (Ekotape 111) (Tech)	Aug	84
-----------------------------------	-----	----

Tone Poor (Stelman, Airline) (Tech)	Aug	85
-------------------------------------	-----	----

Back-Savers (TTO)	Jul	90
-------------------	-----	----

Cable Stripper (TTO)	Aug	98
----------------------	-----	----

Capacitor Check, Vom (TTO)	Oct	105
----------------------------	-----	-----

Case Histories, Bench Tape Recorder for (TTO)	Nov	105
---	-----	-----

Clock Confusion, Relay Prevents (TTO)	Oct	107
---------------------------------------	-----	-----



**TWO BIG SECTIONS**

at the

**NEW YORK COLISEUM**

all 4 floors!

- ELECTRONICS EXHIBITS
- CONVENTION PAPERS

See the finest products of industry, hear famous men speak! Just one entrance fee lets you visit both sections.

Buses to the N. Y. Hilton every few minutes

PRODUCTS • PAPERS • PEOPLE • PRODUCTS • PAPERS • PEOPLE



Control-Shaft Jig (TTO)	Sep 103
Cord Tangles, Cure for (TTO)	Nov 106
Engine Analyzers, Electronic, Working with (Kramer)	Nov 32
Insulators, Small Standoff (TTO)	Sep 105
PC Solder Holes, Rod Cleans (TTO)	Nov 106
Phono Pin Plugs, Coupler for (TTO)	Nov 104
Radar 1N23-C Replacement (Tech)	Jul 81
Radar Plate Current Excessive (Airfield Video-Line) (Tech)	Aug 84
<b>Radio</b>	
Ac-Dc, Sound Out (Tech)	Nov 97
Automobile	
Antennas, BC-CB (Cl)	Aug 64
Delco 1963 AM/FM (Powell)	
Part I—Systematic Trouble	
Shooting	Sep 40
Part II—FM Section	Oct 42
Fuses Blow (Motorola 84MF) (Tech)	Aug 84
Noisy (Oldsmobile 986131	
Transportable) (Tech)	Jul 80
Power Supply, Low-Cost Transistor Regulated (Powell)	Jul 48
Soundout (Chevrolet 987368) (Tech)	Sep 84
Calibration Error (Cl)	Aug 64
CB Transceivers (Kyle)	Nov 46
CB Servicing, with CB Set (Sands)	Sep 34
Clock, Knobs (Tech)	Nov 96
Daytime Operation Only (Zenith Transoceanic) (Tech)	Oct 97
Extra Eyes (TTO)	Oct 107
Intermittent (Philco T66) (Tech)	Sep 86
Noise, Kill That Mobile (Dudley)	Oct 26
Oscillator Coil (Emerson) (Cl)	Nov 50
Peewee Attacks Radio (Wayne)	Dec 65
Power Transformer (German Kaiser) (Cl) Oct 54; (Grunow 588) (Cl)	Oct 57
Rectifier Replacement (Cl)	Jul 54
Stations Lost (Emerson 888 Vanguard) (Tech)	Jul 81
Superhet Oscillator, "Fish" Kills for Alignment (TTO)	Dec 114
Transistors, Test In-Circuit (McKinney)	Oct 40
Trimmer Replacement (TTO)	Jul 91
Reamer, Rotating Rat-tail (TTO)	Nov 105
Relay Tip (TTO)	Jul 91
Resistors, Fusible (Cl)	Nov 52
Shaft-Hole Marker (TTO)	Aug 99
Shafts and Switches, Protective Covers for (TTO)	Dec 113
Silicons, Replace Them with (McCall)	Aug 54
Snipbill Usefulness Doubled (TTC)	Aug 98
Sound Movie Projectors (Darr)	
Part I—Mechanical Troubles	Oct 29
Part II—Clutch Mechanisms, Threading, Safety Precautions	Nov 41
Part III—Sound and Lamp Troubles	Dec 72
Start on Shoestring (Darr) (Corres)	Jul 46; Nov 18; Dec 24

<b>Television</b>	
Adjusting Unadjustable (Cl)	Sep 60
Agc (DuMont RA-105) (Cl)	Aug 66
Agc Drift (Zenith 19M20) (Cl)	Aug 62
Alignment with Pattern Generator (Cl)	Sep 64
Antenna	
Community, Leakage (Cl)	Oct 54
Hardware, Solder (TTO)	Nov 105
Yagi Conversion (Cl)	Aug 62
B-Plus Voltage (Sylvania 1-502-1, -2) (Tech)	Sep 84
Bars, Squirrel Behind (Tech)	Nov 97
Brightness (RCA KCS-127) (Cl)	Oct 51
Buzz, Warmup (Sylvania 232-B-152MV) (Cl)	Sep 60
<b>Color</b>	
Agc and Weak Picture (RCA CTC 12) (Cl)	Dec 54
Antennas and Boosters (Cunningham)	Dec 44
Brightness Low (Admiral 25 UD6) (Cl) (RCA CTC 12) (Cl) Dec 55;	Dec 54
Brilliance Blooms Out (RCA CTC 10) (Tech)	Dec 106
Brilliance Out (RCA CTC 10) (Tech)	Dec 106
Contrast Intermittent (RCA CTC 9) (Tech)	Dec 106
Contrast Low (RCA CTC 9) (Tech)	Dec 106
Conversion to (Cl)	Sep 61
Definition Poor (RCA CTC 12) (Cl)	Dec 55
Flashovers (Cl)	Dec 53
High Voltage Out (RCA CTC 9) (Tech)	Dec 106
Highlights Blooming (RCA CTC 7) (Cl)	Dec 54
Horizontal Hold Poor (RCA CTC 9) (Cl)	Dec 55
Horizontal Output Failure (RCA 800, 900 Series) (Tech)	Nov 96
Horizontal Range Poor (RCA CTC 9) (Tech)	Dec 105
Horizontal Tearing (RCA CTC 9) (Tech)	Dec 105
Picture Lost (RCA 21-CS-7815) (Tech)	Jul 81
Raster Out (RCA CTC 12) (Tech)	Dec 106
Replacing Your First Color TV Tube? (Davidson)	Dec 28
Service Hints (Roy)	Aug 43
Service Is Simple (Fitzgibbon)	Dec 39
Setup and Service, Speed (McCarthy)	Jul 42
Sync Out (RCA CTC 5) (Cl) (RCA CTC 10) (Tech)	Dec 105
Tuner Input Impedance (Middleton)	Nov 30
Vertical Roll (RCA CTC 10) (Tech)	Dec 106
Vertical Tilt Insufficient (RCA CTC 10) (Cl)	Dec 55
Vertical Retrace Lines (G-E CW) (Cl)	Dec 54
Volume Will Not Lower (RCA CTC 9N, -P) (Tech)	Dec 106
Weak or None (RCA CTC 10) (Tech)	Dec 106
Width Poor, No Focus (RCA CTC 9) (Tech)	Dec 105
Conversion (RCA 21T15-DE (Cl) Nov 52; (Silvertone) (Cl)	Nov 52

CRT Replacement (Cl) Nov 50;	Sep 65
(Philco 9L60) (Cl)	Sep 65
Deflection Troubles Can Be Sneaky (Darr)	Sep 46
Diagnosis and Frozen Brain (Fitzgibbon)	Nov 43
Do-It-Yourself Repairs, R-E Reports On (Kramer)	Aug 26
Flicker (Cl) (Corres)	Jul 56; Oct 18
Flyback Overheats (RCA KCS-68B) (Cl)	Aug 64
Flyback Replacement	
(Jackson 277) (Cl) (Radio Craftsmen PC201) (Cl) Oct 56;	Sep 61
Dc Resistance (Coronado TVI-9330) (Cl)	Oct 56
Focus (Motorola TS118) (Tech)	Jul 81
Foldover (Silvertone 528 47700) (Cl)	Aug 64
Freebies, Our Policy on (Margolis)	Oct 76
Horizontal Bending (Olympic CA-105) (Cl) Jul 54; (Olympic GBF-7) (Cl) Sep 65; (RCA KCS-136) (Cl)	Nov 52
Horizontal Hold (Philco 190) (Tech)	Sep 86
Horizontal Instability (Crosley HC-21HCL) (Cl)	Oct 54
Horizontal Linearity Control	
Fixed-Tuned Circuits (Cl)	Aug 62
Flyback Circuits (Cl)	Jul 53
Horizontal Oscillator Unstable (Stewart-Warner 9126) (Cl)	Sep 64
Horizontal Output Parasitic Oscillation (Westinghouse V-2342) (Tech)	Oct 96
Horizontal Sync	
Drift (RCA 140-P-020) (Cl)	Aug 66
Unstable (Motorola) (Tech)	Oct 96
Identifying Chassis (Cl)	Jul 56
Interference (CBS 22C38) (Cl)	Aug 66
Intermittent (Olympic 17C44, 17K41, etc.) (Tech) Aug 84; (RCA 21D7425U) (Tech)	Aug 85
Jumper for Series-String Sets (TTO)	Nov 104
PC Trouble (RCA KCS-94A) (Cl)	Nov 55
Picture	
Double (Bendix 3033) (Cl)	Aug 62
Out (RCA KCS47, -48, -49) (Tech)	Sep 86
Tube Really Gone? (Fitzgibbon) Jul 26; (Corres)	Oct 21
Shadow on Left (Sylvania I-177) (Cl)	Oct 56
6CU5 Audio Output Tube (Philco 7L40-7L70) (Tech)	Aug 85
60-Cycle Trouble in 25-Cycle Sets (Sylvania 533003S) (Tech)	Nov 96
Snow (Tech)	Nov 97
Sound Buzz (GE 14T007-14T020) (Tech) Oct 97; (Hotpoint 14S201-Q Line) (Tech)	Oct 97
Speaker Replacement (Cl)	Aug 64
Streaking (RCA KCS-136) (Cl)	Nov 52
Sync (G-E 14T007-14T020) (Tech) Oct 97; (Hotpoint 14S201-Q Line) (Tech)	Oct 97

Continued on page 96

# ONE GREAT SHOW!

at the  
**NEW YORK HILTON**

2 floors, including Hilton's main exhibition area

- ELECTRICAL EXHIBITS
- CONVENTION PAPERS

IEEE Members: \$1.00  
Non-members: \$3.00  
Minimum age: 18

Buses to the N. Y. Coliseum every few minutes

- PRODUCTS ● PAPERS ● PEOPLE ● PRODUCTS ● PAPERS ● PEOPLE

# IEEE SHOW '64

march 23-26  
9:45 A.M. - 9 P.M.



## How 6½ sq. ft. can speed up your picture-tube service:

10 versatile "Universal" picture-tube types from Sylvania's SILVER SCREEN 85 line may be all you need to fill 52% of your renewal needs! This fact, verified by a recent industry survey, stems from a remarkable streamlining of the Sylvania line—making fewer, more versatile types that can be used as replacements for many others. Already 54 types can replace 217.

Think what the versatility of these "Universal" tubes

can mean. An in-shop inventory of a few popular types can help you quickly take care of most of your renewal calls. Ordering is simplified...and distributor calls for special tubes can be cut way down.

Start profiting now from Sylvania's SILVER SCREEN 85 picture tubes. Call your Distributor and put an inventory in your own shop—where it can enhance your reputation for fast service and quality replacements.

**SILVER SCREEN 85 Picture Tubes are made only from new parts and materials except for the envelopes which, prior to reuse, are inspected and tested to the same standards as new envelopes.**



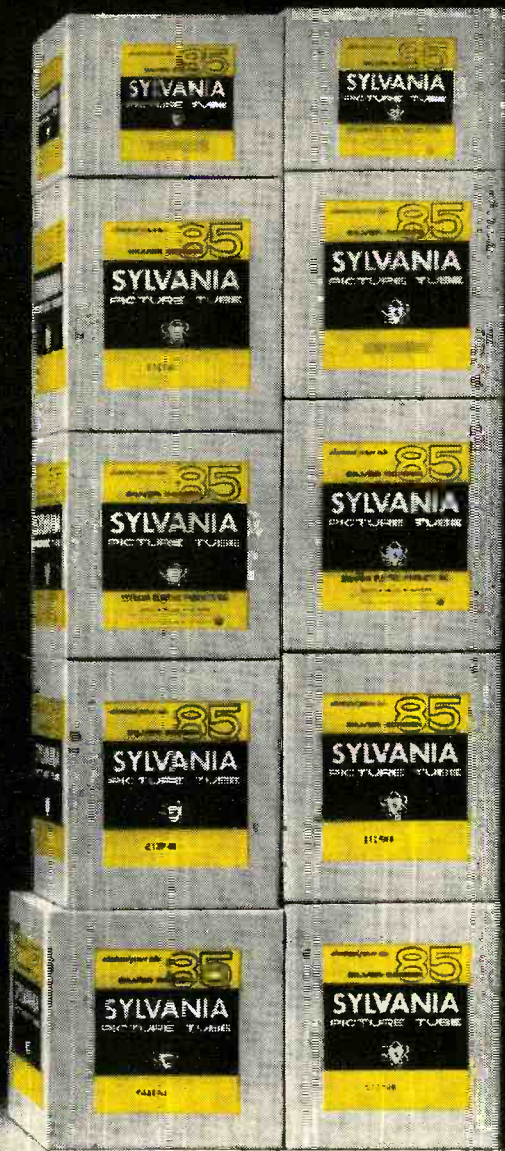

use it for **SILVER SCREEN 85<sup>®</sup> tubes...**  
 (10 "Universal" types meet half of all renewal needs)



The "Big 10" Tubes that fill  
 52% of all renewal needs:

- 21CBP4A
  - 21ZP4B } 24%
  - 21ACP4A
  - 21YP4A
  - 21EP4B
  - 21FP4C
  - 24AP4
  - 21DFP4
  - 21AUP4A
  - 21DEP4A
- } 41%
- } 52%

# SYLVANIA

SUBSIDIARY OF  
**GENERAL TELEPHONE & ELECTRONICS**





# A REVOLUTIONARY NEW METHOD FOR MARKING ELECTRONIC EQUIPMENT

*instant lettering*

## DRY TRANSFER MARKING KITS

This is the newest easiest way to get professional lettering *instantly* on all electronic equipment, drawings, schematics, etc. NOT A DECAL... NO WATER... NO TAPES... NO SCREENS... NO ENGRAVING. Goes on instantly and stays on practically any surface... looks like printing. Makes prototypes look like finished equipment.

It's as simple as this...

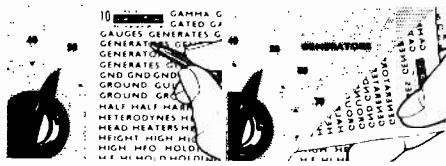

1. Place "Instant Lettering" sheet over equipment with proper word or number in position. Rub over entire word with a ball-point pen or soft pencil.

2. Lift away carrier sheet carefully and there you have perfect lettering... professional looking lettering in an instant.

*instant lettering*

dry transfer

## TITLES FOR ELECTRONIC EQUIPMENT

...this set contains 24 sheets... thousands of pre-printed titles... researched to give you up to 95% of all electronic panel marking. For labeling, marking, titling all electronic control panels and drawings, etc.

No. 958  
Titles for Electronic Equipment (black).....\$4.95

No. 959  
Titles for Electronic Equipment (white).....\$4.95

*instant lettering*

dry transfer

## TERMINAL & CHASSIS MARKING KIT

... 24 sheets of all the necessary letters and numerals for marking prototypes, chassis, engineers drawings, printed circuit & terminal boards, schematics, rotating components, etc.

No. 966  
Terminal & Chassis Marking Kit (black).....\$4.95

No. 967  
Terminal & Chassis Marking Kit (white).....\$4.95

WRITE — WIRE — PHONE

FOR FREE FOLDER AND SAMPLE  
**DATAK CORPORATION**

63 71st STREET

GUTTENBERG, NEW JERSEY

OR YOUR PARTS DISTRIBUTOR

96

SERVICING—Continued from page 93

<b>Color</b>		
Test Patterns, Broadcasting (Cl)	Jul	54-
Tough Fight, Ma, But I Won (Salerno)	Nov	66
Translator, \$15 Answer to (Tech)	Oct	97
Tuner Replacement (G-E 17T2) (Cl)	Jul	54
Tuners, Fix or Trade? (Margolis)	Aug	57
Vertical Circuits (Zenith) (Tech)	Jul	80
Video Amplifier (Motorola) (Tech)	Jul	80
Width		
Coil Replacement (Zenith H2329RZ) (Cl)	Sep	64
Half Inch More (Cl)	Nov	50
Insufficient (Zenith 16C24) (Cl)	Nov	55
Narrow (Zenith 24G26) (Cl)	Nov	52
<b>Test Instruments</b>		
Audio Analyzer (Heath AA-1) (Tech)	Oct	96
Grid-Dip Meter (Heath GD-1B) (Tech)	Sep	84
Pin-Tip Repair (TTO)	Jul	90
Tool, Handy Service (TTO)	Dec	114
Tools, Demagnetize Small (TTO)	Jul	90
Tubes, Test Before Selling (TTO)	Aug	98

Silicons, Replace Them With (McCall)	Aug	54
<b>Soldering</b>		
Gun, Automatic (Pat)	Jul	82
Tips (TTO)	Sep	105
<b>Sound Movie Projectors (Darr)</b>		
Part I—Mechanical Troubles	Oct	29
Part II—Clutch Mechanism, Threading, Safety Precautions	Nov	41
Part III—Sound and Lamp Troubles	Dec	72
<b>Space</b>		
Ionosphere's Creation Watched (NB)	Sep	6
Needle Belt Orbits (NB)	Aug	12
Station Design (WN)	Nov	49
Speaker Measurements, Simple (Crowhurst)	Sep	37
Speed Color Setup and Service (McCarty)	Jul	42
Start Service on Shoestring (Darr) (Corres)	Jul 46; Nov 18; Dec	24
Stereo—see Audio—High Fidelity—Stereo; FM		
Substitution Box for Power Resistors* (Davidson) (Corres)	Dec	18

## TELEVISION

<b>Antenna(s)</b>		
and Boosters for Color TV (Cunningham)	Dec	44
Matching System, Automatic (Munzig)	Jul	60
Zig-zag Transmitting (WN)	Sep	48
Cameras on Research Vessel (NB)	Aug	6
Closed Circuit (TV Camera You Can Build, W. E. Parker, May and June 1962) (Corres)	Sep	20
Closed Circuit, Sees Invisible (NB)	Nov	6
<b>Color</b> —see also Servicing, Television, Color		
Antennas and Boosters (Cunningham)	Dec	44
Canada Prefers FM to (NB)	Dec	12
CTC 15, RCA's Newest Chassis (Hilderbrand)	Dec	47
1964 Roundup (Lemons)	Dec	32
Owners Like Sets (NB)	Dec	8
Proposed German, Improves on American	Oct	63
Sets, More (NB)	Dec	10
Test Equipment for 1964 (Scott)	Dec	50
Today and Tomorrow (Lachenbruch)	Dec	36
Tubes, New (Sutheim)	Dec	42
Education—see Education		
Fringe-Lock Circuit, New (NC)	Sep	107
Radio Astronomy and TV Struggle for Channel 37 (NB)	Aug	12
Soviet Union Has 35 Million Viewers (NB)	Aug	14
Tape Recorder for Less Than \$200? (NB)	Oct	6
Telcan Coming to US (NB)	Nov	16
<b>Tubes</b> —see Tubes		
Tuners, Fix or Trade? (Margolis)	Aug	57
Uhf		
Adapter Uses Tunnel Diode (NB)	Sep	6
May Rescue Schools (NB)	Jul	10
Picture Brightens (NB)	Jul	12

## TEST INSTRUMENTS

Af Oscillator Bandsread Tuning (NC)	Aug	94
Audio Sweep Generator* (Stein) (Corr)	Sep 28; Nov	55
Bandsread Tuning for Af Oscillator (NC)	Aug	94
Beginner's Lab for Pennies* (Frantz)	Aug	48
Beginner's Lab, Using* (Frantz)	Sep	49
Bias Supply for Testing Tunnel Diodes (NC)	Oct	84
Big Noise (Kernin)	Aug	59
Capacitance Meter, Direct-Reading* (Watters)	Aug	32
Capacitor and Dielectric Analyzer* (Sutton)	Oct	44
Capacitor Testers, Heath CT-1 and IT-22 (NC)	Dec	108
<b>Color</b>		
Analyst (B&K 850)†	Dec	50
Bar/Dot/Crosshatch Generator (RCA WR-64A)†	Dec	52
Bar/Dot Generator (Heath IG-62)† (Jackson 800)†	Dec 51; Dec	51
Bar Generator (Simpson, 430)†	Dec	52
Bar/White Dot—Bar Generator (Hickok 656 XC)†	Dec	51
Bar/White Dot Generator (Paco G-36)†	Dec	51
Chrom-Aligner (Hickok 661)†	Dec	51
Circuit Analyzer (Sencore CA122)†	Sep 80; Dec	52
Convergence Dot Generator (Winston 250)†	Dec	52

Generator (B&K 850)† (Precision E-450)† (Sencore CG 126)†	Aug 71; Dec 50; Dec 51; Dec	52
Television Analyst (B&K 1074, 1076)†	Dec	50
Test Equipment for (Scott)	Dec	50
Test Pattern Generator (GC 36-610)†	Dec	50
Varidot White-Dot Generator (Simpson 434A)†	Dec	52
White Dot/Bar Color Display Generator (Hickok 660)†	Dec	51
Continuity Checker (Patrick)	Sep	47
Crystal Calibrators, 100-kc*§ (Queen)	Aug	77
Dc Amplifier, Chopper-Stabilized* (Hansen)	Aug	40
Dc Millivoltmeter, Hybrid*§ (Hill)	Dec	63
Dielectric and Capacitor Analyzer* (Sutton)	Oct	44
Dolly (TTO)	Oct	105
Frequency Meter as Oscillator Dial (NC)	Sep	108
Generator-Tracer, Af/Rf (Olson KB-141)†	Nov	74
Inductance Bridge, Precise*§ (Krueger)	Sep	44
Leakage Checker, Add to Vtvm* (Lemons)	Jul	39
Marker Adder for Sweep Generator* (Wiles)	Jul	62
Milliohmometer (Simpson 657)†	Oct	68
Multimeter (Lafayette TK-10)*	Sep	80
Multiplex Generator (Marshall)	Jul	45
Multi-Tester, 200,000 Ohms/Volt (Trimlett 630-NS)†	Nov	76
Ohmmeter, Transistors and Your (Madison)	Nov	80
Oscillator Dial, Frequency Meter As (NC)	Sep	108
Oscilloscopes, New Electronic Pen Improves (NB)	Dec	6
Probe Capacitance, Stay (NC)	Oct	85
Probe, Pattern Depends On (Cunningham)	Nov	31
Pushbuttons Add Ohms or Mf's (Fred) (Corres)	Sep	20
Random-Noise Generator* (Lederer)	Aug	68
Scope Kits (Cl)	Jul	54
Scope Probes, Tray for (TTO)	Sep	105
Sine/Square-Wave Generator (Lafayette TE-22)†	Aug	71
Substitution Box for Power Resistors* (Davidson) (Corres)	Dec	18
Sweep Generator, Marker Added for* (Wiles)	Jul	62
Test Prods, Bicycle Spokes Make (TTO)	Dec	113
Tube Tester, 1.2-Megawatt (WN)	Jul	35
Vom Battery, Clip-in Holder for (TTO)	Dec	113
Vtvm		
Ac/Dc/Audio (Radio Shack Realistic)†	Oct	68
Leakage Checker, Add to* (Lemons)	Jul	39
Pointer Shift, Minimizing (Centerville)	Nov	48
Test Transistors In-Circuit (McKinney)	Oct	40
Zero-Center Reading for dc (Pugh)	Aug	74
Test Transistors In-Circuit (McKinney)	Oct	40
Tough Fight, Ma, But I Won (Salerno)	Nov	66
Transmitter Fits in Tooth*§ (Gillings)	Nov	60
Transients, Watch Out for (Leftwich) (Corres)	Jul 14; Oct	18
<b>Transistor(s)</b>		
Ascendant at New York Hi-fi Show (NB)	Nov	6
Multi-emitter Units (NB)	Dec	12
Ohmmeter and (Madison)	Nov	80
Power Dissipation in Resistors or (Todd)	Aug	31
Test In-Circuit (McKinney)	Oct	40
Reverse Voltage Protection (Ives)	Oct	36
<b>Tube(s)</b>		
Cold-Cathode (Pat)	Sep	87
Color TV		
23-inch Motorola (NB)	Aug	16
Motorola 23-inch, 92° Rectangular (NB)	Sep	8
New for (Sutheim)	Dec	42
<b>CRT</b>		
Six-in-One Electron Gun (WN)	Sep	48
Steel Shell Protects (NB)	Sep	6
2-Way View (NB)	Jul	12
Profusion of (Corres)	Jul	14
Replace Them with Silicons (McCall)†	Aug	54
Tuner Input Impedance (Middleton)	Nov	30
Tuner, 3-Transistor, Saves Time and Money (D'Airol)	Jul	56
20 Watts Stereo, 3 Tubes* (Sutheim)	Nov	28
<b>U</b>		
Uhf—see TV		
Unijunction Metronome*§ (Lederer) (Corres)	Jul 40; Oct	18
<b>V</b>		
Vacuum, New Techniques Make Fantastic	Nov	56
<b>W</b>		
Watch Out for Transients (Leftwich) (Corres)	Jul 14; Oct	18
Weather Radar Makes Flying Safer (Bowen)	Jul	50
Wife Tamer, Electronic (Cramp)	Sep	51
Working with Electronic Engine Analyzers (Kramer)	Nov	32
<b>X-Y-Z</b>		
X-Y Recorder, Instant Curve Plotter (Kramer)	Jul	69
Zener Bridge, Temperature-Compensated (Pat)	Dec	115
Zener Diode Bias Supply (Ives)	Dec	38
Zero-Center Reading for Dc Voltmeters (Pugh)	Aug	74

## LEADING SOURCE OF POWER FOR TESTING COLOR TV!

### Precision's G-36 Color Bar White Dot Generator

The *easiest-operating* generator of its kind!  
An essential instrument with only the essentials!  
Works *quickly, simply* . . . gets the job done profitably!  
Completely capable of testing and adjusting  
color phasing, matrixing, linearity and convergence  
circuits in all color receivers.

G-36K (Kit): \$119.95; G-36W (Factory Wired): \$179.95.

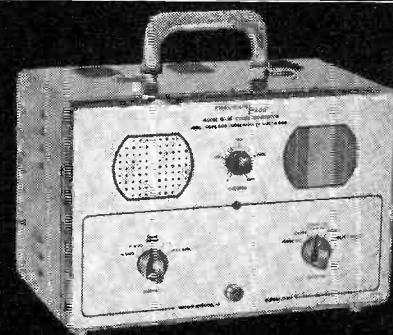

## LEADING SOURCE OF MULTIPLEX SIGNALS FOR TESTING STEREO!

### Precision's E-490 Multiplex Signal Generator

Specifically designed to fill the technician's need  
for a fast-working, high-quality multiplex signal source  
at a truly low price! Highly versatile, yet extremely  
simple to operate. Provides complete testing  
of multiplex circuitry in FM stereo receivers  
and multiplex adapters.

E-490 (Factory Wired): \$249.95

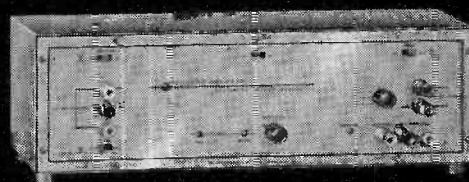

## LEADING SOURCE OF PROFIT FOR ALL TESTING NEEDS!

### Precision's Full Line of New Test Equipment

The perfect combination of superior quality  
at the very lowest possible price!  
A full line designed with one objective: to help you  
accurately handle all testing jobs faster,  
easier and *more profitably!* Never was there equipment  
designed with your real needs so much in mind!  
And it's available at your local distributor *now!*

As shown:

Model G-30—Kit: \$32.95; Semi-kit: \$39.95; Factory Wired: \$44.95

Model G-32—Kit: \$85.95; Factory Wired: \$159.95

Model S-55—Kit: \$99.95; Factory Wired: \$155.95

Model ES-55CB—Factory Wired: \$279.95

Model S-51—Kit: \$69.95; Factory Wired: \$109.95



G-30 RF Signal  
Generator

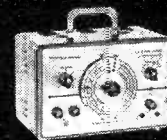

G-32, Sweep Generator  
and Marker Adder



S-55  
DC to 5MC  
Oscilloscope



ES-55CB  
Wide Band 5MC  
Oscilloscope



S-51, General  
Purpose  
Oscilloscope

Write for new Catalog No. PP631 describing the *full* new Precision line containing *all* the test equipment you need!

**PRECISION** Apparatus, Inc.

80-00 Cooper Ave., Glendale, N.Y. 11227, 212-TW 4-4290

Export: Morhan Exporting Corp., 453 Broadway, New York, N.Y. 10013

Canada: William Cohen, Ltd., 8900 Park Avenue, Montreal, Canada

# new Products



**CB WALKIE-TALKIE, HA-60L.** 10-transistor, separate mike, speaker. Crystal-controlled

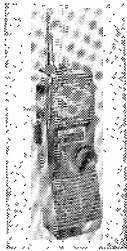

transistor circuit. Sensitivity better than  $1 \mu\text{v}$  for 10-db signal-to-noise. No license required for use under Part 15 of FCC Rules. 8 penlight batteries.—**Lafayette Radio Electronics Corp.**, 111 Jericho Turnpike, Syosset, N.Y.

**REMOTE CONTROL RADIO TRANSMITTER, model AT-10.** Palm-sized, operates garage doors. 125-ft. transmission range, uses one of 21

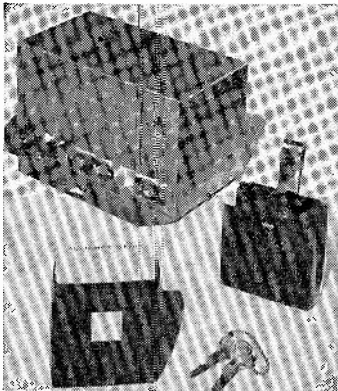

available channels.  $3\frac{3}{4} \times 2\frac{3}{4} \times 1\frac{1}{4}$  in. 9 oz. 22½-volt battery. Also kit with receiver and mounting hardware.—**Alliance Mfg. Co., Inc.**, Dept. MJ, Alliance, Ohio.

**CB TRANSCEIVER, TR-70C Mobile.** 12 tubes plus 4 silicon rectifiers; 7 double-tuned rf

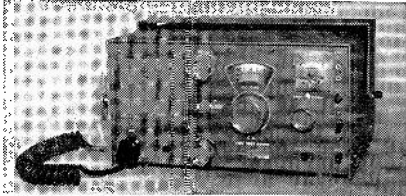

and i.f. transformers; transistor power supply; 23-position transmit/1-crystal receive; adjustable squelch; ac on-off and volume control, 4-inch speaker. Power 6 volts, 14 amps or 12 volts, 7 amps.—**Tram Electronics Inc.**, PO Box 187, Winnsquam, N.H. 03289.

**CB TRANSCEIVER, 24-channel crystal-con-**

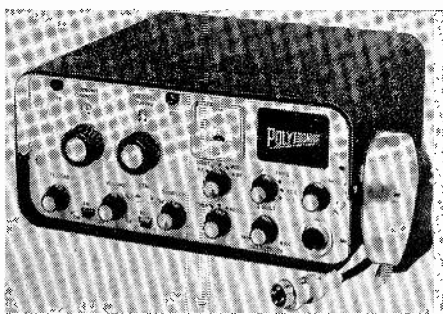

trolled transmitter, tunable receiver. Nuvistor front end, cascade rf amplifier, nuvistor 1st mixer, crystal and tunable oscillator. Tunable receiver with 6:1 vernier dial, 6-mc 1st i.f., 455-ke 2nd i.f.; separate peak, null controls. Sensitivity  $0.1 \mu\text{v}$  for 6-db signal-to-noise; min. output 3.5 watts all channels. Transmit and receive neon indicator lights; silicon diode power supply; meter shows rf output, signal strength and audio level for PA.—**Polytronics Laboratories Inc.**, 88 Clinton Road, West Caldwell, N.J.

**MOBILE MIRROR ANTENNA, model 50037.** Fender-mounted rear-view mirror conceals omnidirectional vhf antenna. 150–174-mc range; swr less

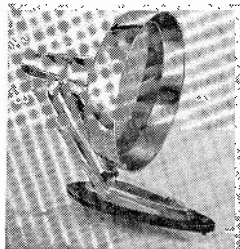

than 1.5:1 at design frequency, equals  $\frac{1}{4}$ -wave whip mounted in same location.—**Sinclair Radio Laboratories Inc.**, 523 Fillmore Ave., Tonawanda, N.Y.

**COLOR ANTENNA, Colortron model C-44,** for deep-fringe and fringe areas (vhf); color, black-and-white. All-channel (2–13), 30-element

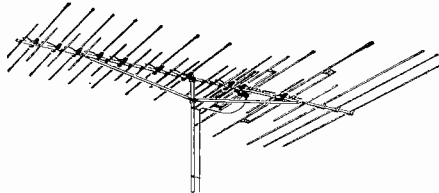

vhf Yagi; high uniform gain all channels; response:  $\pm \frac{1}{2}$  db across any 6-mc channel. 300-ohm impedance, swr 1.5:1; triple-tuned reflector for max. front-to-back ratio; no side lobes. Insulators with extra large, triple moisture barrier prevent loss of signal transfer during wet weather; double boom braces; widest element: 110-in.; boom length: 190-in.—**Winegard Antenna Systems**, 3000 Kirkwood St., Burlington, Iowa.

**OUTDOOR TV AND FM ANTENNAS,** combine all-channel Yagi and end-fire array. High gain, flat frequency response, high front-to-back ratio. For color and black-and-white, Electro-lens director system. 8-element FM Yagi, **RCA 500**, receives 88 to 108 mc; vswr 1.25:1; flat frequency

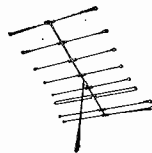

response with average 8-db gain.—Available through **RCA** parts and accessories distributors.

**INDOOR ELECTRONIC FM ANTENNA, Multitron.** Antenna system included with 2-transistor broad-band amplifier on PC board (see illus.). Connects to ac outlet. Min. gain over tuned dipole,

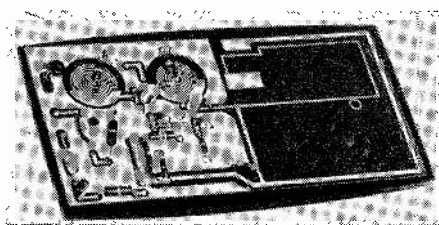

20 db at FM broadcast frequencies. Fixed-tuned transformers. Matches 72- or 300-ohm FM tuner inputs. White or black plastic case.—**Antronics, Inc.**, 309 Queen Anne Rd., Teaneck, N.J.

**INDOOR TV-FM ANTENNAS, Model 3731** (illus), for FM mono and stereo reception; built-in single-transistor amplifier peaked to cover FM

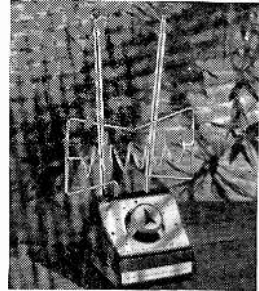

broadcast band. Gain, 7 db; noise figure, 4 db. Usable to 60 miles from station. **Model 3718, Aurora**, for TV and FM, unamplified. Tuning knob eliminates frequent readjustment of dipole arms. **Model 3721, Apollo**, for TV only. Built-in single-transistor amplifier, switch for peaking to channel. Low-band gain, 17 db; high-band, 11 db. Noise figure 4 and 4.5 db, respectively. For suburban locations.—**Channel Master Corp.**, Ellenville, N.Y.

**TRANSISTOR INDOOR ANTENNA, Spico Transistar model TR-11.** Black-and-white, color TV; mono, stereo FM. Adjustable; calibrated coarse and fine tuning. Foldaway dipoles; printed



circuit; directional. Plugs into ac line.  $9 \times 7\frac{3}{4} \times 2\frac{3}{4}$  in.—**Spiriting Products Co., Inc.**, Hicksville, N.Y.

**ROTOR SYSTEM** for intermediate amateur loads, **TR-44.** Increases torque, braking, accuracy for large vhf arrays and small hf combination antennas. Rotator in all-weather bell-shaped casting;



electrical motor cutoff stops rotator  $5^\circ$  before mechanical stop. 100% more torque than standard TV rotators; 50 ball-bearing movement. Mounts on masts up to 2-in. diam. or flat plate.—**Cornell Dubilier Electronics Div.**, 50 Paris St., Newark 1, N.J.

**SWEEP CIRCUIT BOOSTERS.** Insufficient width due to component aging cured by inserting



booster between damper tube and socket. Fits all octal dampers.—**Colman Electronics Products**, PO Box 2965, Amarillo, Tex.

**TV PICTURE WIDENER, No. 8760.** Capacitor lowers resonant frequency of flyback transformer secondary, thus lowering rate of change



# From RCA Victor—another big advance in Space-Age Sealed Circuitry

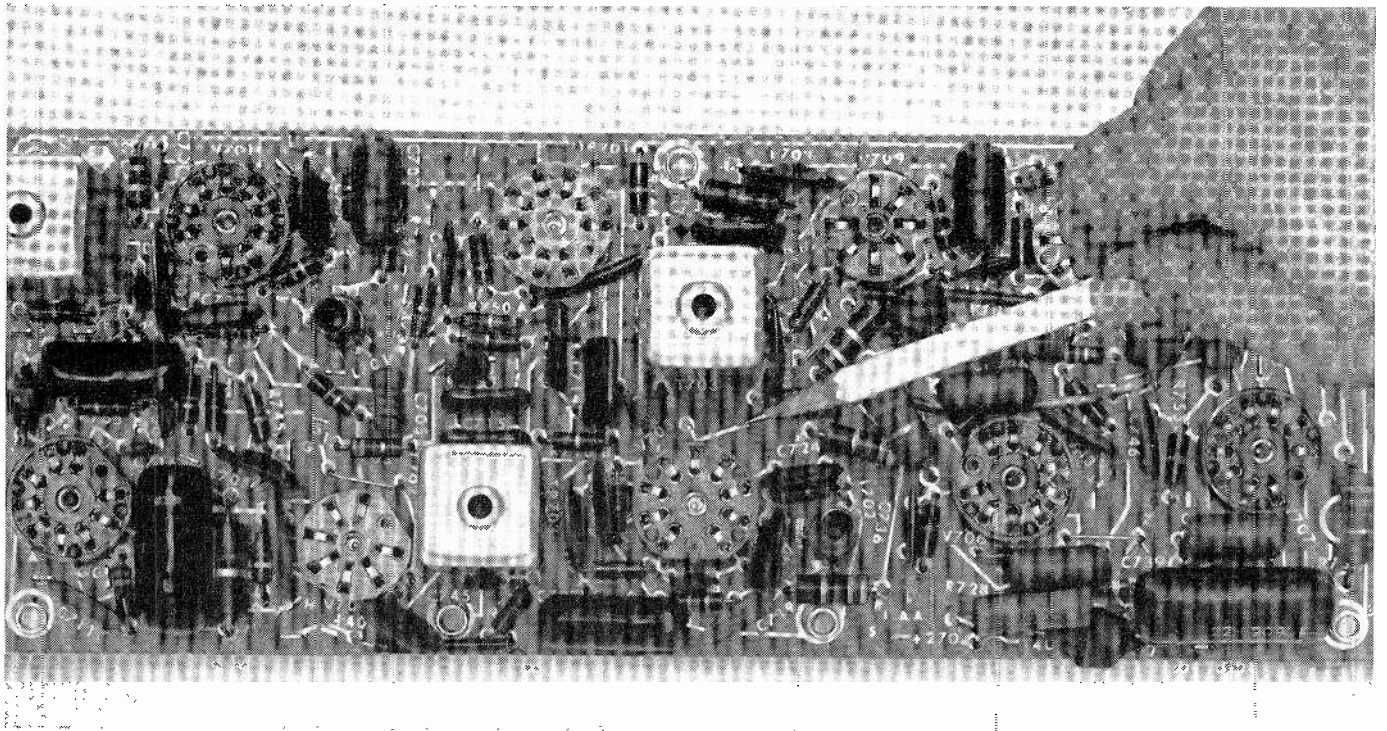

RCA Victor Color TV Chroma Circuitry

You can see at a glance how new streamlined “road-mapping”  
makes servicing faster, easier, surer than ever before

Pictured above is the “new look” in RCA Space Age Sealed Circuitry . . . the new precision-crafted boards that you’ll see in *all* 1964 New Vista Color and in most RCA Victor black-and-white television sets for 1964.

This new schematic diagram “road-mapping” consists of *straight white lines* that run *directly* from *point-to-point*. No confusion, no difficult paths. And the extra space gained has been used

to make the label markings larger. You can see and trace the circuits at a glance.

Here again RCA Victor has made a vitally important contribution to easier, faster and more accurate servicing. It is part of our continuing research program to offer the utmost in reliability with Space Age Sealed Circuitry.

See Walt Disney’s “Wonderful World of Color,”  
Sundays, NBC-TV Network.



The Most Trusted Name in Electronics



during flyback. No soldering required; slips over pins of damper tube.—**GC Electronics Co.**, Div. Textron Electronics Inc., 400 So. Wyman St., Rockford, Ill.

**PORTABLE VIDEO RECORDER, VR-660 Videotape.** Under 100 lb. Use on air with no extra equipment, meets FCC standards. 60 or 50 cycles.

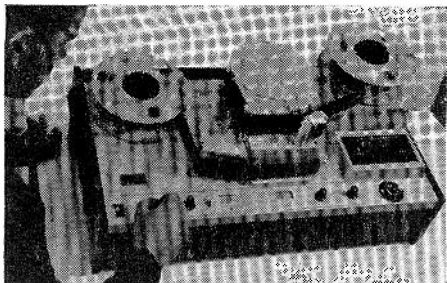

Tape speed 3.75 ips; records up to 5 hours continuous material on 1 1/2-inch reel of standard 2-inch video tape.—**Ampex Corp.**, 401 Broadway, Redwood, City, Calif.

**ELECTRONIC TEST CLAMP.** Retractable spring clamp activated by light pressure on head of handle. Grips wire, retracts into insulating

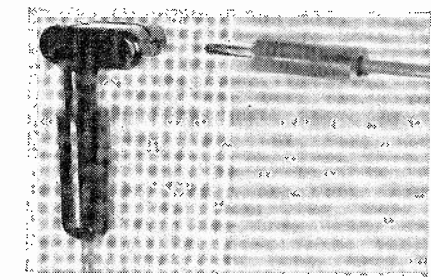

sleeve. Use in high-density circuitry without shorting. Head has standard banana jack.—**Hunter Associates**, 321 Highland Ave., Orange, N.J.

**TEST LEADS/RETRACTABLE PROBE, Gator Probe.** Standard test leads with insulated alligator type clips with retractable probe, 52 in.

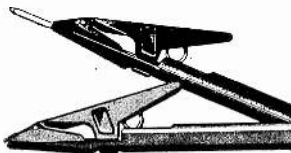

18-gage test lead wires connect to banana-tip or pin-receiving plug; swivel jaw clips clamp 1/4-in. to .005 wire. Plastic parts withstand 10,000 volts dc.—**Gator Probe Corp.**, Subsidiary of Holes, Inc., Hollister, Calif.

**HETERODYNE VOLTMETER, model 604.** Frequency 20 cycles to 30 mc; measures selective voltages at carefully controlled frequencies; built-in

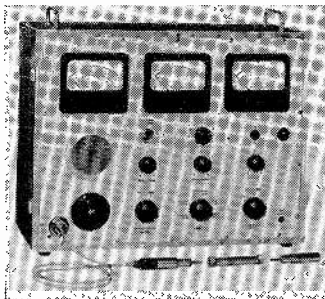

speaker; input impedance 5 megohms at 100 kc, 90,000 ohms at 30 mc, paralleled by 5.5 pf. Voltage: 15, 150, 1500 uv, 15 and 150 mv. Capacitive attenuator extends voltage range to 1.5 and 15.—**B&K Instruments Inc.**, 2044 W. 106 St., Cleveland 11, Ohio.

**EXPANDED-SCALE VOLTMETER,** Zenodiode references, accuracy  $\pm 0.5\%$ . 3 1/2- or 4 1/2-in. ac or dc. Min. span: 16% of mid-span rating (12-270 volts self-contained). Standard ratings ac: 110-130, 105-125 volts; dc: 24-30, 110-130, 220-

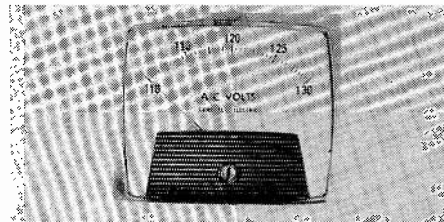

260 volts. Max. sensitivity: 100 ohms/volt; current drain: 10 ma; max. temperature influence  $\pm 0.25\%$  of mid-span value for  $\pm 10^\circ\text{C}$  variation from  $25^\circ\text{C}$ ; at  $65^\circ\text{C}$ , not over 0.5% of mid-span. Max. frequency influence 0.3% of mid-span from 25-4000 cycles; 0.6% at 10,000 cycles.—**General Electric**, Schenectady 5, N.Y.

**DC MILLIVOLTMETER, model 300.** Electronic, fully transistorized, chopper-stabilized. Sensitivity .001 volt. 10 ranges: 0-.001, .003, .01, .03, 0.1, 0.3, 1, 3, 10, 30 volts. Input resistance 100,000 ohms below 0.1 volt, 1 meg per volt above that.

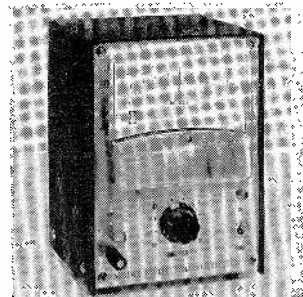

Zero-center accuracy  $\pm 2\%$  full scale.—**IB Instruments Inc.**, 7016 Euclid Ave., Cleveland 3, Ohio.

**TUBE TESTER, model 107B.** All tube test results on meter and scale. 2 socket systems test TV, radio, industrial, foreign tubes. No setup data required; 40 prewired sockets accommodate 63 basic arrangements. Separate plug-in chassis, eight sockets connected to 14 pin selectors. Checks for leaks, shorts, grid emission, relative transconductance,

# CALL ME SANTA CLAUS FREE GIFTS ON ALL ORDERS

**OLD SANTA—can't give you 25 CHRISTMAS TREE LIGHTS for \$2...25" TALKING DOLL for \$8...TRANSISTOR KIT for \$3...5-TUBE RADIO for \$5...ETC. ETC.** In fact he's too old to understand Electronics & can't make any of the following offers:

- |   |  |   |  |
|---|--|---|--|
| <input type="checkbox"/> CHRISTMAS TREE LIGHTS (25) \$2<br>wired socket units, asst colors                              | <input type="checkbox"/> 25" TALL — TALKING DOLL \$8<br>sophisticated — blonde, brunette or redhead, 11 cute recitations | <input type="checkbox"/> RADIO KIT (2 TRANSISTOR) \$11<br>complete, including instructions                          | <input type="checkbox"/> COMMODORE 5-TUBE RADIO \$5<br>AC-DC, complete ready to play |
| <input type="checkbox"/> STEREO PORTABLE PHONO \$39<br>packed with features, reg. \$69                                  | <input type="checkbox"/> MAJOR HI-FI PORTABLE \$29<br>PHONO deluxe, fine tone 4-speed changer, value \$49 ...            | <input type="checkbox"/> G.E. CLOCK RADIO \$16<br>complete, excellent for gift                                      | <input type="checkbox"/> DELUXE STEEL CABINET \$4<br>9"x10"x6" 18 see-thru drawers   |
| <input type="checkbox"/> 19" OLYMPIC TV PORTABLES \$99<br>Complete, factory sealed etc.                                 | <input type="checkbox"/> UA-14 MONARCH RECORDS CHANGER complete with 45 rpm spindle ..... \$18                           | <input type="checkbox"/> EMERGENCY AUTO LAMP \$1<br>Red dome blinker, incl battery saves lives on highway stops ... | <input type="checkbox"/> 6—TV ALIGNMENT TOOLS \$1                                    |
| <input type="checkbox"/> 1—5" PM SPEAKER \$1<br>Alnico #5 magnet .....  | <input type="checkbox"/> 3—3" RECORDER TAPES \$1<br>quality acetate, 150 feet ....                                       | <input type="checkbox"/> 10—6' ELECTRIC LINE CORDS \$1<br>with plug .....   | <input type="checkbox"/> 100 — ASSORTED 1/2 WATT \$1<br>RESISTORS some in 5% .....   |
| <input type="checkbox"/> 1—4" PM SPEAKER \$1<br>Alnico #5 magnet .....  | <input type="checkbox"/> 10—3" RECORDER TAPE REELS \$1   | <input type="checkbox"/> 4 — 50' SPOOLS HOOK-UP \$1<br>WIRE 4 different colors .....                                | <input type="checkbox"/> 70 — ASSORTED 1 WATT \$1<br>RESISTORS some in 5% .....      |
| <input type="checkbox"/> 3 — SPEAKER CABINETS for 2 1/2" to 3" speaker, all purpose \$1                                 | <input type="checkbox"/> 10 — SURE-GRIP ALLIGATOR CLIPS 2" plated .....  | <input type="checkbox"/> 50 — STRIPS ASSORTED SPAGHETTI handy sizes .....   | <input type="checkbox"/> 35 — ASSORTED 2 WATT \$1<br>RESISTORS some in 5% .....      |
| <input type="checkbox"/> 1—3" PM SPEAKER \$1<br>for above cabinet or others ..  | <input type="checkbox"/> 10 — SETS PHONO PLUGS & PIN JACKS RCA type .....  | <input type="checkbox"/> 100 — ASSORTED RUBBER GROMMETS best sizes .....  | <input type="checkbox"/> 50—ASST. MICA CONDENSERS some in 5% .....                   |
| <input type="checkbox"/> 4—AUDIO OUTPUT TRANSFORMERS 50L6 type .....  | <input type="checkbox"/> 20—ASST. PILOT LIGHTS #44, 46, 47, 51, etc. ....  | <input type="checkbox"/> 50' — INSULATED SHIELDED WIRE #20 braided metal jacket                                     | <input type="checkbox"/> 50 — ASST. DISC. CERAMIC CONDENSERS popular numbers         |
| <input type="checkbox"/> 3—AUDIO OUTPUT TRANSFORMERS 6K6 or 6V6 type ..   | <input type="checkbox"/> 20 — PILOT LIGHT SOCKETS bayonet type, wired .....  | <input type="checkbox"/> 32'—TEST PROD WIRE deluxe quality, red or black ..   | <input type="checkbox"/> 10—ASST. DIODE CRYSTALS 5-1N60 and 5-1N64 .....             |
| <input type="checkbox"/> <b>CHAPT ZU DI MITZIA "JACKPOT"</b> — DOUBLE YOUR MONEY BACK IF NOT COMPLETELY SATISFIED ..... | <input type="checkbox"/> 50 — ASSORTED TERMINAL STRIPS 1, 2, 3, 4 lugs .....   | <input type="checkbox"/> 50'—HI-VOLTAGE WIRE for TV, special circuits, etc. ..                                      | <input type="checkbox"/> 2—SILICON RECTIFIERS 750ma, 400 PIV .....                   |
| <input type="checkbox"/> 3—1/2 MEG VOLUME CONTROLS with switch, 3" shaft ..   | <input type="checkbox"/> 100' — FINEST NYLON DIAL CORD best size, .028 gauge ..  | <input type="checkbox"/> 100' — TWIN TV LEAD-IN WIRE 300 ohm, heavy duty ..   | <input type="checkbox"/> 3—SILICON RECTIFIERS Top Hat 500ma-400 PIV ....             |
| <input type="checkbox"/> 5—ASST. 4 WATT WIRE-WOUND CONTROLS .....   | <input type="checkbox"/> 50—RADIO & TV SOCKETS all type 7 pin, 8 pin, 9 pin ..   | <input type="checkbox"/> 50' — FLAT 4-CONDUCTOR WIRE many purposes .....  | <input type="checkbox"/> 4—PNP TRANSISTORS general purpose, TO-5 case ...            |
| <input type="checkbox"/> 10 — ASSORTED VOLUME CONTROLS less switch .....  | <input type="checkbox"/> 25—ASSORTED PRINTED CIRCUIT SOCKETS best types .....  | <input type="checkbox"/> 5 — TV HI-VOLT ANODE LEADS 20" length .....  | <input type="checkbox"/> STANDARD TUNER UHF STRIPS 26K, 34K, 46K, 51K .... each      |
| <input type="checkbox"/> 5—ASSORTED VOLUME CONTROLS with switch .....   | <input type="checkbox"/> 3—PUSHPULL AUDIO OUTPUT TRANSFORMERS 50L6 .....   | <input type="checkbox"/> 10—TV PICTURE TUBE SOCKETS wired with 20" leads .....                                      | <input type="checkbox"/> 50 — ASST. CERAMIC CONDENSERS some in 5% .....              |
| <input type="checkbox"/> 4—TOGGLE SWITCHES SPST, SPDT, DPST, DPDT ...   | <input type="checkbox"/> 3 1/2" TWEETER SPEAKER deluxe type for HI-FI .....  | <input type="checkbox"/> 5—TV CHEATER CORDS with both plugs .....   | <input type="checkbox"/> TELEPHONE JACK, PLUG & 50' extension wire & instruct.       |
| <input type="checkbox"/> 10 — ASSORTED SLIDE SWITCHES SPST, DPDT, etc. ...  | <input type="checkbox"/> \$17.50 WEBSTER #9 STANDARD 41mc TV TUNERS Complete with Tubes, schematic                       | <input type="checkbox"/> \$9 TRIM HEADPHONES 8Ω   | <input type="checkbox"/> 500 — ASSORTED WASHERS most useful selected sizes .....     |
| <input type="checkbox"/> \$17.50 WEBSTER #9 STANDARD 41mc TV TUNERS Complete with Tubes, schematic                      | <input type="checkbox"/> \$9 TRIM HEADPHONES 8Ω  | <input type="checkbox"/> 50—RCA PHONO PLUGS Standard for phonos, male .....   | <input type="checkbox"/> 500 — ASSORTED RIVETS most useful selected sizes .....      |

**BROOKS RADIO & TV CORP., 84 Vesey St., Dept. A, New York 7, N. Y.** TELEPHONE COrtland 7-2359

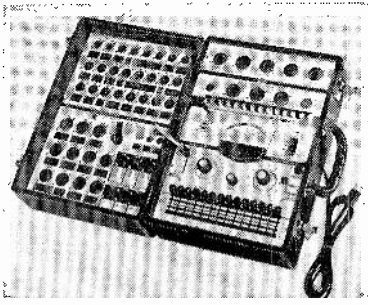

gas error.—Seco Electronics Inc., Dept. 164, 1201 S. Clover Drive, Minneapolis 20, Minn.

AM, FM, FM-STEREO TUNERS, S-2100II FM stereo MX/AM tuner and S-2100IV FM/AM tuner.

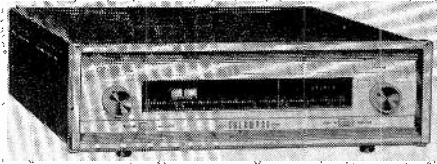

D'Arsonval tuning meter reads zero at exact center-point of frequency band-width. Sensitivity ranges 1.8  $\mu$ v (IHF); 2.4-db capture ratio.—Sherwood Electronic Laboratories Inc., 4300 No. California Ave., Chicago 18, Ill.

MICROVOLTER, model 24-D. 23 CB fre-

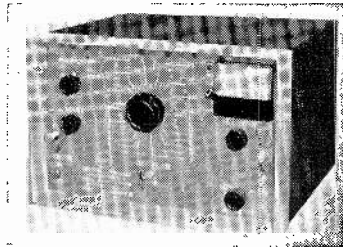

quencies plus 9 optional i.f. signals; .005% accuracy. Frequencies crystal controlled. Internal and external modulation, metered outputs 0.1 to 100,000  $\mu$ v full scale. 25 lbs. 10½ x 19½ x 8 in.—Ferris Instrument Co., 110 Cornelia St., Boonton, N.J.

MUSIC RECEIVER/PAGING SYSTEM, model FA-10C. Hi-fi FM tuner, 10-watt amplifier for mike, phonograph and tape recorder. Afc, sen-

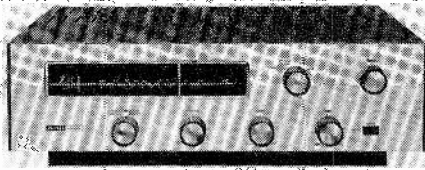

sitivity rating 2.5  $\mu$ v for 20-db quieting; response, 20-40,000 cycles  $\pm$  1 db; 1% total harmonic distortion.—Harman-Kardon Inc., Ames Court, Plainview, N.Y.

PERSONAL PORTABLE SOUND SYSTEM, model 300, self-powered, fully transistorized, self-contained PA system. On-off switch, volume con-

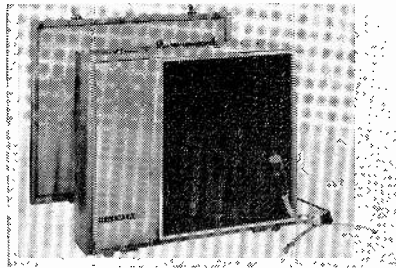

trol at mike that may be worn as lavalier. Powered by 2 flashlight lantern batteries. 15 lb. 4½ x 15 x 17¼ in.—Wm. A. Holmin Corp., 1325 Seventh St., Rockford, Ill

MATCHED SPEAKER AND ENCLOSURE, weather-resistant, for background music, PA, extension to hi-fi equipment. "Floating" speaker, no hardware to cause vibration or distortion. 8¾ x

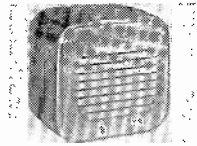

8¾ x 4¼ in. Impedance 8 ohms; 3.16-oz. magnet; frequency response 70 to 13,000 cps; power handling 8 watts.—Minneapolis Speaker Co., 3806 Grand Ave. So., Minneapolis 9, Minn.

SPUN ALUMINUM CONE SPEAKER, Utah WP4A, drive-in speaker unharmed by moisture or



sunlight. 4 in. square; 1-11/16 in. deep. 0.68-oz. Alnico V magnet. 3.2-ohm voice coil handles 4 watts audio power.—Utah Electronics Corp., 1124 E. Franklin St., Huntington, Ind.

NEW STYLE STEREOPHONES, model SEP-100, fit atop head or under chin. Separate earphone



level control; stereo-mono switch. Response: 25-18,000 cps.—Freeman Electronics Corp., 729 No. Highland Ave., Los Angeles 38, Calif.

## 10% DISCOUNT ON ORDERS OF \$10 OR OVER (ON DOLLAR BUYS)

IMMEDIATE DELIVERY . . . SCIENTIFIC LIGHT PACKING for safe delivery at minimum cost. HANDY WAY TO ORDER — Pencil mark items & enclose with check or money order, add extra for shipping, excess refunded with advantage to customer. Tearsheet returned with order, as your packing slip.

- |  |   |   |  |
|--|---|---|--|
| <input type="checkbox"/> 3-ASST. SIZES RADIO CHASSIS PANS drilled & plated . . . \$1<br><input type="checkbox"/> 3-VARIABLE CONDENSERS asst. popular super-het types . . . \$1<br><input type="checkbox"/> 15 - RADIO OSCILLATOR COILS standard 456kc . . . \$1<br><input type="checkbox"/> 4 - I.F. COIL TRANSFORMERS 456kc, most popular type . . . \$1<br><input type="checkbox"/> 3 - I.F. COIL TRANSFORMERS 262kc, for Auto Radios . . . \$1<br><input type="checkbox"/> 3 - I.F. COIL TRANSFORMERS 10.7mc for FM . . . \$1<br><input type="checkbox"/> 3-LOOPSTICK ANTENNAS hi-gain, ferrite, adjustable . . . \$1<br><input type="checkbox"/> 20 - INSTRUMENT POINTER KNOBS selected popular types . . . \$1<br><input type="checkbox"/> 50-ASST. RADIO KNOBS all selected popular types . . . \$1<br><input type="checkbox"/> 250-ASST. WOOD SCREWS finest popular selection . . . \$1<br><input type="checkbox"/> 250-ASST. SELF TAPPING SCREWS #6, #8, etc. . . . \$1<br><input type="checkbox"/> 150-ASST. 6/32 SCREWS and 150 6/32 HEX NUTS . . . \$1<br><input type="checkbox"/> 150-ASST. 8/32 SCREWS and 150-8/32 HEX NUTS . . . \$1<br><input type="checkbox"/> 150-6/32 HEX NUTS and 150-8/32 HEX NUTS . . . \$1<br><input type="checkbox"/> 250-ASST. SOLDERING LUGS best types and sizes . . . \$1<br><input type="checkbox"/> 1-LB SPOOL ROSIN-CORE SOLDER 40/60 . . . \$1<br><input type="checkbox"/> 1000-ASST. HARDWARE KIT screws, nuts, wash'rs, rivets, etc. . . \$1<br><input type="checkbox"/> 100-STANDARD ZIP CORD 2 conductor #18 white or brown . . . \$1<br><input type="checkbox"/> 100-MINIATURE ZIP CORD 2 conductor, serves 101 uses . . . \$1<br><input type="checkbox"/> 50-GOODALL CONDENSERS molded .1-200v (test 600v) . . . \$1 | <input type="checkbox"/> \$15.00 TELEVISION PARTS "JACKPOT" best buy ever . . . \$1<br><input type="checkbox"/> 50-PRECISION RESISTORS asst. list price \$50 less 98% . . . \$1<br><input type="checkbox"/> 200-TUBULAR CONDENSERS 100-.002 and 100-.004 . . . \$1<br><input type="checkbox"/> 8 - ASTRON ELECTROLYTIC CONDENSERS 8mf-450v . . . \$1<br><input type="checkbox"/> 5-C D ELECTROLYTIC CONDENSERS 30/20-350v, 13-250v . . . \$1<br><input type="checkbox"/> 15-STANDARD ELECTROLYTIC CONDENSERS 2mf-450v . . . \$1<br><input type="checkbox"/> 15-STANDARD ELECTROLYTIC CONDENSERS 400mf-25v . . . \$1<br><input type="checkbox"/> 3 - ELECTROLYTIC CONDENSERS 50/30-150v . . . \$1<br><input type="checkbox"/> 50 - ASST. TUBULAR CONDENSERS .001 to .47 to 600v . . . \$1<br><input type="checkbox"/> 50 - ASST MOLDED CONDENSERS short leads . . . \$1<br><input type="checkbox"/> 20-GOODALL TUBULAR CONDENSERS .047-600v . . . \$1<br><input type="checkbox"/> 10 - ASST. RADIO ELECTROLYTIC CONDENSERS . . . \$1<br><input type="checkbox"/> 5 - ASST. TV ELECTROLYTIC CONDENSERS . . . \$1<br><input type="checkbox"/> 300-ASST. ½ W RESISTORS Top Brand, short leads, excellent . . . \$1<br><input type="checkbox"/> 2-SELENIUM RECTIFIERS 1-65ma and 1-450ma . . . \$1<br><input type="checkbox"/> 50- RESISTORS 16K 2W 10% . . . \$1<br><input type="checkbox"/> 10-SILICON RECTIFIERS Top Hat, 350 ma, 200 pIV . . . \$1<br><input type="checkbox"/> 5 - ASST. SELENIUM RECTIFIERS 65ma, 100ma, 300ma, etc. . . \$1<br><input type="checkbox"/> 20 - ASS'TED WIREWOUND RESISTORS, 5, 10, 20 watt . . . \$1<br><input type="checkbox"/> 15-ASST. ROTARY SWITCHES all popular types \$20 value . . . \$1<br><input type="checkbox"/> 100-ASSORTED FUSES 3AG and other popular uses . . . \$1 | <input type="checkbox"/> \$15.00 RADIO PARTS "JACKPOT" handy assortment . . . \$1<br><input type="checkbox"/> 500'-CHOICE HOOKUP WIRE asst colors cut in handy lengths some stripped and tinned . . . \$1<br><input type="checkbox"/> 1-5Q. YARD GRILLE CLOTH most popular brown & gold design . . . \$1<br><input type="checkbox"/> 100 - ASST RUBBER & FELT FEET FOR CABINETS best sizes . . . \$1<br><input type="checkbox"/> 200'-BUSS WIRE #20 tinned for hookups, special circuits, etc. . . \$1<br><input type="checkbox"/> 1-INDOOR TV ANTENNA hi-gain, 3 section, tiltproof . . . \$1<br><input type="checkbox"/> 70' FLYBACK TRANSFORMER universal type for many uses . . . \$1<br><input type="checkbox"/> 70' TV DEFLECTION YOKE wired network, long leads . . . \$1<br><input type="checkbox"/> 90' TV DEFLECTION YOKE wired network, schematic diag. . . \$1<br><input type="checkbox"/> 20 - ASSORTED GRID CAPS for 1B3, 1X2, 6BG6, 6BQ6, etc. . . \$1<br><input type="checkbox"/> 1-6" x 9" OVAL PM SPEAKER (one to a customer) . . . \$1<br><input type="checkbox"/> 8-ASST. LUCITE CASES hinged cover, handy for parts . . . \$1<br><input type="checkbox"/> 10-DUAL CONTROLS 350-1 meg, long shaft, 101 uses . . . \$1<br><input type="checkbox"/> WEBSTER #PT-1 MONAURAL CARTRIDGE in factory carton . . . \$1<br><input type="checkbox"/> WEBSTER #MC-3 MONAURAL CARTRIDGE in factory carton . . . \$1<br><input type="checkbox"/> WEBSTER #SC-3 STEREO CARTRIDGE in factory carton . . . \$1<br><input type="checkbox"/> 3 - \$2.50 SAPPHIRE NEEDLES guaranteed 5000 playings . . . \$1<br><input type="checkbox"/> 2-SAPPHIRE STYLUS NEEDLES for all type pickups . . . \$1<br><input type="checkbox"/> RONETTE DUAL SAPPHIRE CARTRIDGE flipover type . . . \$1<br><input type="checkbox"/> \$20-SHURE M-7D DIAMOND NEEDLE exact replacement . . . \$3 | <h3>MARKET SCOOP COLUMN</h3> <input type="checkbox"/> 4-IBM COMPUTER SECTIONS \$1 loaded with valuable parts . . . \$1<br><input type="checkbox"/> 10 - TOGGLE SWITCHES deluxe U.I., approved, SPST, 101 uses . . . \$1<br><input type="checkbox"/> G. E. EQUIPMENT SECTION \$1 with sockets, condensers, etc. . . \$1<br><input type="checkbox"/> 20-GE #NE-2 TUBES Neon Glow Lamp for 101 uses . . . \$1<br><input type="checkbox"/> 50-G.E. FLASHLIGHT BULBS #PR-9, 2.7 volts . . . \$1<br><input type="checkbox"/> ALL AMER. TUBE KIT top brand 12BA6, 12BE6, 12AV6, 50C5, 35W4 . . . \$2<br><input type="checkbox"/> 10-SYLVANIA 1U4 TUBES brand new Jan. individual cartons also serves as IT4 . . . \$1<br><input type="checkbox"/> 3-TOP BRAND 35W4 TUBES \$1<br><input type="checkbox"/> 10-ASSORTED TUBES Radio, Television and Industrial . . . \$1<br><input type="checkbox"/> 10-SYLVANIA 6AK4 TUBES \$1<br><input type="checkbox"/> 5-MOTOROLA 12BL6 TUBES \$1<br><input type="checkbox"/> 20-SYLVANIA 2C4 TUBES . . . \$1<br><input type="checkbox"/> 6-TRANS. RADIO BATTERIES 9 volt, same as Eveready #216 . . . \$1<br><input type="checkbox"/> 30-BALL POINT PENS retractable, assorted colors . . . \$1<br><input type="checkbox"/> 20 - ELECTRIC LINE CORDS approved 2½' with plug . . . \$1<br><input type="checkbox"/> 50-ASSORTED TV COILS I.F. video, sound, ratio, etc. . . \$1<br><input type="checkbox"/> 20 - ASSORTED TV KNOBS ESCUTCHEONS etc. \$20 value . . . \$1<br><input type="checkbox"/> 1-HEARING AID AMPLIFIER incl. 3 Tubes, Mike, etc. (as is) . . . \$1<br><input type="checkbox"/> 2-\$3 TELEX EARPIECES standard 4 ohm for radio or TV, also serves as a microphone . . . \$1 |
|--|---|---|--|

(Due to a typographical error in the November advertisement, p. 101, 50 ASST. TUBES should read 10; 100 ASST. TUBULAR CONDENSERS should read 50.)

**BROOKS RADIO & TV CORP., 84 Vesey St., Dept. A, New York 7, N.Y.** TELEPHONE COrtlandt 7-2359



**80-WATT STEREO AMPLIFIER, model 299D.** Front-panel headphone output for private listening without speakers; center-channel output for driving independent speaker system without

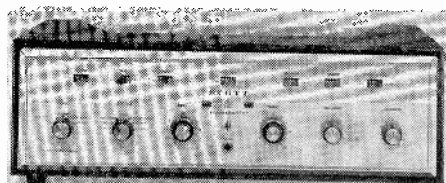

separate power amplifier. IHF power, 40 watts per channel; power band,  $\pm 1$  db, 19-25,000 cycles; harmonic distortion 0.8%; hum level -80 db. Steady-state rating 32 watts per channel.—**H. H. Scott Inc.**, Dept. P, 111 Powdermill Rd., Maynard, Mass.

**FM STEREO TUNER SEMI-KIT, model 2200.** Front-end, i.f. strip containing 4 i.f. stages and ratio detector. Rotary tuning dial, bar type

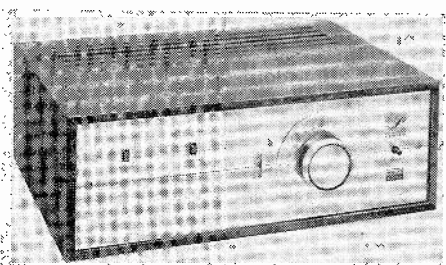

electron-ray tuning indicator, stereo defeat switch. Input: 300 ohms; sensitivity 3  $\mu$ v (30-db quieting); signal-to-noise 55 db; harmonic distortion 0.6%; audio output 1 volt; ratio detector bandwidth 1 mc; output impedance 5,000 ohms.—**EICO Electronic Instrument Co. Inc.**, 33-00 Northern Blvd., Long Island City 1, N.Y.

**STERECORDER, Sony model 600,** 4-track stereo and mono recorder. Vertical or horizontal operation, mike and line mixing, source and tape monitoring, 2 VU meters, sound-with-sound, sound-

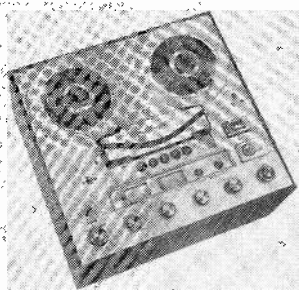

on-sound, separate monitor level controls, hysteresis-synchronous drive motor. 7½ and 3¼ ips. Frequency response 30-18,000 at 7½ ips; signal-to-noise 50 db; flutter and wow 0.17% or better at 7½ ips; bias frequency 100 kc; inputs: 2 high-level line, 2 mike or magnetic phono. Outputs: 2 600-ohm 8-db lines, 600-ohm binaural earphone monitor.—**Superscope Inc.**, Audio Electronics Div., 8150 Vineland Ave., Sun Valley, Calif.

**TAPE RECORDER, Retro-matic 220,** 2-speed quarter-track stereo recorder with 2-directional playback. Capstan between 2 playback heads so

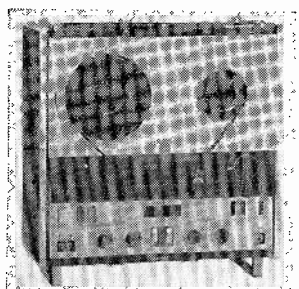

tape pulled over head in forward or reverse playback. Automatic reverse playback controlled by timed silence sensing device to detect end of program. Amplifier 6 watts per channel, 20-25,000 cycles response for record/playback at 7½ ips.—**Viking of Minneapolis Inc.**, 9600 Aldrich Ave. So., Minneapolis, Minn. 55420.

**40-WATT STEREO AMPLIFIER,** all transistor, model AA-22. 70 watts music power (IHF). Full power response at  $\pm 1$  db 15-30,000 cycles. 5 stereo inputs; outputs for 4-, 8-, 16-ohm speakers, tape recorders. Output per channel: 20 watts with 8-ohm load; IM (at rated output) less than 1%; hum and noise: Mag phono. 50 db below rated output, aux inputs 65 db below rated output, 5-position selector switch; 3-position mode switch;

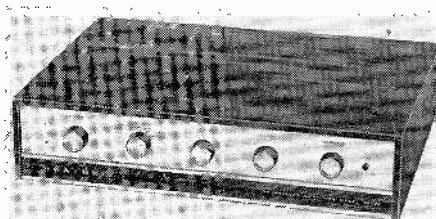

dual tandem volume, bass and treble controls; phase switch, input level controls; push-on, push-off switch. 20 transistors, 10 diodes.—**Heath Co.**, Benton Harbor, Mich.

**100-WATT STEREO AMPLIFIER,** all-transistor. 19 transistors, 8 diodes. Stereo headphone; 2-position record-monitor switch; circuit breaker. 100 watts IHF power output; response,  $\pm 1/2$  db, 20-25,000 cps; harmonic distortion, 1.0% at full rated output; sensitivity, 0.1 volt, tuner and aux; 2.5 mv, tape; 2.0 mv, phono inputs for full rated output power. Outputs: 4, 8, 16 ohms per channel

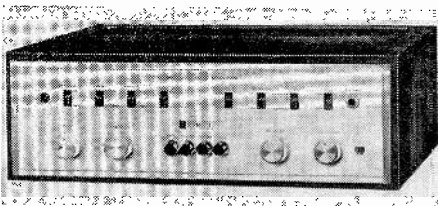

to speakers; hi-Z center channel; hi-Z to stereo recorder; low-Z to stereo headphones.—**Allied Radio Corp.**, 100 N. Western Ave., Chicago, Ill. 60680.

**MAGNETIC RECORDING TAPE, Scotch brand No. 175,** 15 times working life of former similar tape. Heavy-duty oxide coating. For class-

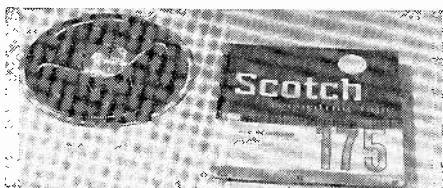

room use, high-speed computers. Resists heat and oxide ruboff.—**3M Co.**, 2501 Hudson Road, St. Paul 19, Minn.

**COMPACT MIKE, model 561.** Attached cable and standard 3/8-27 thread for mounting on flexible gooseneck or fixed pipe. Frequency response 40 to 10,000 cycles with rising characteristic to 4,500

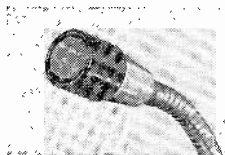

cycles. Output level -56.0 db; impedance 50 to 250 ohms. 5 oz.—**Shure Brothers Inc.**, 222 Hartrey Ave., Evanston, Ill.

**MIKE WITH TABLE STAND, Ceramike-Pak. Models CMC-10A, CMC-11A** for tape re-

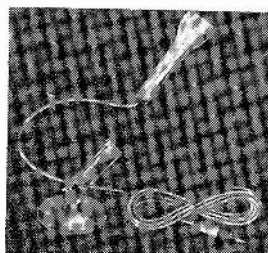

corders, home movie equipment, PA systems, conference pickups, audio-visual labs. Model CM-11A used when greater sensitivity desired.—**Sonotone Corp.**, Elmsford, N.Y.

**PHONO CARTRIDGE, model U-11R Soft Touch.** Lifts stylus automatically if abnormal pressure is applied to tone arm; brings soft plastic guard nib into position between cartridge and rec-

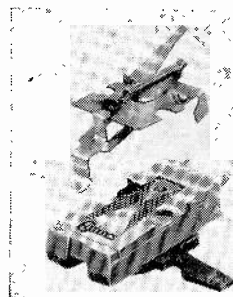

ord so stylus cannot contact record until abnormal pressure is removed. Frequency response 20-20,000 cycles. Compliance  $8 \times 10^{-6}$  cm/dyne. Capacitance 1,100 pf per channel. Separation 25 db at 1,000 cycles. Output 0.4 volt at 5 cm/sec. .0007 diamond stylus, .003 synthetic sapphire stylus. Photo was shown upside down in October issue.—**Euphonics Corp.**, Guaynabo, Puerto Rico, USA.

**BREADBOARD KITS** for experimental component assembly; conversion into operational unit.

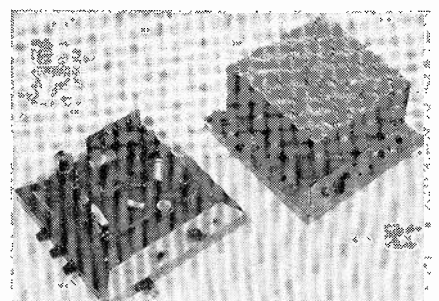

Top surface punched insulating board for mounting, placed atop metal chassis to accommodate pot, switches, monitor lights. Chassis sides at 45° angle. XXXP, epoxy paper, epoxy glass in .093- or .062-in. holes.—**Alan Kits Inc.**, Marketing Dept., PO Box Y4, Anaheim, Calif.

**UPRIGHT REED RELAYS, series 800 and 900,** multi-circuit applications; space saver on printed board or chassis. Anodized aluminum housings; magnetic shielding; varnish-impregnated coil assemblies for moisture-, shock-resistance. *Series*

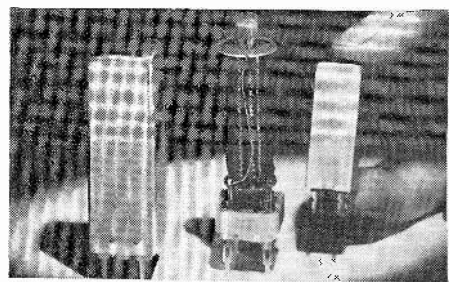

900: ½ x ½ x 1¼ in. Coil voltages: 6, 12, 24 dc at 250 mw. Contact systems in gold, tungsten, mercury-wetted; ratings 15 va, 15 watts dc, 1,000 volts. *Series 800:* ¾ x ¾ x 2¾ in. Coil voltages: 6, 12 dc at 250 mw; 48 dc at 1 watt. Contact systems gold, rhodium, silver, tungsten or mercury-wetted, 15-50 va, 15-50 watts dc, 250-1,500 volts.—**Standard Grigsby Inc.**, Reed Relays Div., Arlington Heights, Ill.

**VERTICAL OUTPUT TRANSFORMERS.** Exact replacement for all TV sets, including current models. VO-120 replaces Zenith, Silvertone; VO-122, Silvertone; VO-123, Airline and Westing-

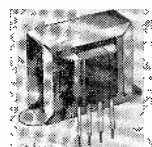

house part number; VO-126, 2 RCA types; VO-127, 4 RCA part numbers plus 2 Olympic units and Packard Bell.—**Stancor Electronics Inc.**, 3501 Addison St., Chicago 18, Ill. END

All specifications from manufacturers data.

ANOTHER GREAT ADDITION TO THE FAMOUS SERIES OF B&K ANALYSTS

# SIMPLIFIES AND SPEEDS TV SERVICING

# NEW!



Compact Model 1074  
TELEVISION

# ANALYST

FOR BLACK & WHITE  
and COLOR

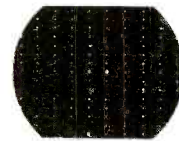
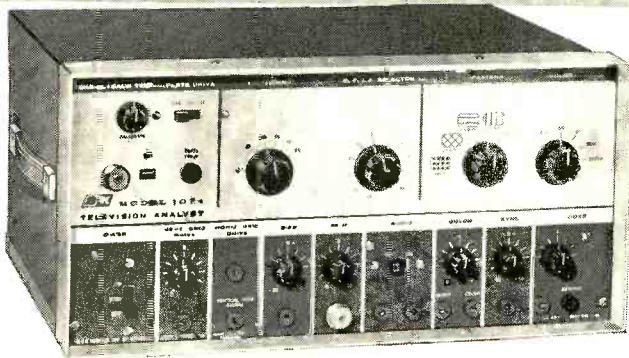

Dot Pattern



Crosshatch



Vertical Lines



Horizontal Lines

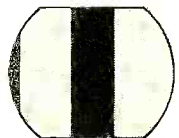

Color Pattern

Here is an exciting new addition to the famous B&K series of Television Analysts—*designed to give every service technician a faster, easier way to service more TV sets!*

The compact "1074" gives you a complete TV signal generating source of your own. Using the B&K *point-to-point signal injection technique*, you can isolate and pinpoint any performance problem for quick correction.

By injecting your own signals, with a visual check on the TV screen, *you can easily signal-trace and troubleshoot any stage* throughout the video, audio, r.f., i.f., sync and sweep sections of black & white and color television sets.

It becomes much easier to find and fix "tough dogs," and troublesome intermitents, as well as to solve other general TV set troubles—to the satisfaction of your customer, and to your own profit. Net, \$24995

Supplies complete r.f. and i.f. signals, with pattern video and tone audio. Video signals are switch selected for fast, visual troubleshooting. Provides FM modulated 4.5 mc sound channel, with built-in 900 cycle tone generator. Provides composite synchronizing signals. Provides separate vertical and horizontal plate and grid driving signals to check complete output circuit and interrelated components. Many other features.

### Makes it Easy to Set-up and Service Color TV

Provides dot pattern, crosshatch, vertical lines, horizontal lines, burst signal and individual colors (Green, Blue, B-Y, R-Y, Red, I, and Q) one at a time on the TV set—all crystal controlled for maximum accuracy. Color phase angles are maintained in accordance with NTSC specifications. Thin lines and high stability assure fastest, easiest convergence and linearity adjustments. Color display makes demodulator alignment extremely simple.

Time-Saving, Money-Making Instruments Used and Preferred by Professional Servicemen Everywhere.



Model 375 Dynamatic Automatic VTVM



Model 360 V O Matic Automatic VOM

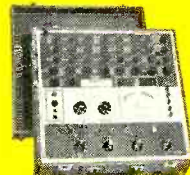

Model 700 Dyna-Quik Tube Tester



Model 850 Color Generator



Model 445 CRT Tester Rejuvenator

See Your B&K Distributor  
or Write for Catalog AP21-E



**B&K MANUFACTURING CO.**  
DIVISION OF DYNASCAN CORPORATION  
1801 W. BELLE PLAINE AVE. • CHICAGO 13, ILL.  
Canada: Atlas Radio Corp., 50 Wingold, Toronto 19, Ont.  
Export: Empire Exporters, 253 Broadway, New York 7, U.S.A.





**Olson**

**FREE**

Fill in coupon for a FREE One Year Subscription to OLSON ELECTRONICS Fantastic Bargain Packed Catalog—Unheard of LOW, LOW, DISCOUNT PRICES on Brand Name Speakers, Changers, Tubes, Tools, Stereo Amps, Tuners, CB, Hi-Fi's, and thousands of other Electronic Bargains. Credit plan available.

NAME \_\_\_\_\_  
 ADDRESS \_\_\_\_\_  
 CITY \_\_\_\_\_ ZONE \_\_\_\_\_ STATE \_\_\_\_\_

If you have a friend interested in electronics send his name and address for a FREE subscription also.

**OLSON ELECTRONICS, INC.**  
 742 Forge Street, Akron, Ohio 44308

## COYNE PIONEERS NEW WAY TO LEARN TELEVISION

Men who want to open their own Radio-TV Service Businesses, or get a big pay job in Electronics can now, for the first time, take their basic training at home in spare hours—then finish with TWO WEEKS of personal training on actual projects in the great shop-Labs of Coyne in Chicago.

### NO EXTRA COST FOR TUITION

Yes, Coyne again leads the way. For men who can't spend six months or longer in our resident school, we now give you all your basic training with 2150 photos and diagrams in spare hours at home. Then, let us finish with practical, personal training in our Chicago Shops. And, we have not added one cent to the low, low cost of our home training course. Your post-graduate work in Chicago is free of all tuition charges. The basic home training you receive is not an old radio course up-dated. It is up-to-the-minute in Radio, TV, Color TV, UHF, and Transistor service. The 2150 photos and diagrams with their simple explanations make it easy to learn—and quick—in spare hours.

### NO "KITS" TO PAY FOR—LOW COST—SMALL PAYMENTS

Save the cost of "put together" kits. Get your practical work in Chicago under guidance of same instructor who teaches our resident students and on same equipment. Pay less—and pay in small monthly checks. Upon graduation, you get Free certificate entitling you to two weeks in Chicago without extra cost.

Send Name Valuable book on Radio-TV Service Opportunities will be mailed to you, Free and postage prepaid. No salesman will call. Be among the first to cash in on Coyne's pioneer offer. Send name on coupon now!

**COYNE ELECTRICAL SCHOOL**  
 Chartered as an Educational Institution for Profit  
 1501 WEST CONGRESS PARKWAY  
 DEPT. 93-H5 • CHICAGO 7, ILLINOIS

**FREE!**

Sending for this book has been the first step to success in businesses of their own for many men who owe their prosperity to Coyne Training. Send your name, today.



B.W. Cooke, Pres. Home Training Division, Dept. 93-H5  
 1501 W. Congress Parkway, Chicago 7, Ill.  
 Please mail free book and offer of two weeks personal training in Chicago without extra tuition for home study graduates. Explain low monthly payments.

NAME \_\_\_\_\_  
 ADDRESS \_\_\_\_\_  
 CITY & STATE \_\_\_\_\_

booklets  
**New Literature**  
 catalogs charts

**SILICON DIODES AND RECTIFIERS** described in 36-page General Catalog include Zener, Varicap diodes. Descriptions of manufacturer's lines of circuit modules and four pages of dimension data.—**TRW Electronics/Semiconductors Inc.**, 14520 Aviation Blvd., Lawndale, Calif.

**TV PICTURE-TUBE REPLACEMENT CHART** includes interchangeability guide and details of 575 tube types. Can be mounted for ready reference. Available through authorized **General Electric** tube distributors.

**NEW MAGNETIC TAPE HEADS**, 4-track, 4-channel, for record—reproduce on 1/4-inch tape, described in data sheet *No. 7146*. Includes full specs, outline drawings.—**Nortronics Co., Inc.**, 8101 10th Ave. No., Minneapolis 27, Minn.

**TV-FM AIDS FOR HOME RECEPTION** described in 8-page, illustrated catalog *DC-CS-002*. Contains specs on 2-transistor, mast-mounted TV preamplifier; Powermate; vhf preamplifiers, Silver-Circuit uhf preamplifiers, amplified TV coupler and others. Prices included.—**Jerrold Electronics Corp.**, Distributor Sales Div., 15th & Lehigh Ave., Philadelphia 32, Pa.

**3 NEW MERCURY-WETTED CONTACT RELAYS** described in 16-page *JM* catalog, includes other previously offered relays. Table lists available range of assemblies of relays. Full specs and data. More than 300 relays categorized by resistance and wire turns.—**Potter & Brumfield**, Princeton, Ind.

**PEDESTAL HEIGHT ADJUSTMENT** in tape recorders described in 3-page bulletin, *Sound Talk No. 39*. Examines deficiencies and corrections.—**3M Co.**, Dept. Z3-499, 2501 Hudson Road, St. Paul 19, Minn.

**COMPLETE EXPERIMENTAL LABORATORY** described in 8-page catalog. Lists instruments available separately and in package, for use as lab portion of Malmstadt-Enke book-course *Electronics for Scientists* (See *New Books, RADIO-ELECTRONICS*, May 1963, p. 97). Describes idea behind book and lab, gives detailed specs on chart recorder, power supplies, vtvm, oscilloscope, sine-square generator, operational amplifier, substitution boxes, other lab equipment.—**Heath Co.**, Benton Harbor, Mich. 49023.

**VHF AND UHF ANTENNAS**, mobile and fixed, described in 4-page illustrated brochure. Full specs and details, radiation patterns.—**GAM Electronics Inc.**, 138 Lincoln St., Manchester, N. H.

**TV ACCESSORY LINE** described in 40-page brochure. Includes mast strap standoffs, U-bolts, turnbuckles, roof, wall and chimney mounts, poles, antennas.—**Parker Metal Goods Co.**, 85 Prescott St., Worcester, Mass.

**RMS VOLTMETER/AMPLIFIERS** detailed in 8-page illustrated spec sheet. Includes block diagram of instruments, description, related models, applications and test setups, accessories and full specs.—**B&K Instruments Inc.**, 3044 W. 166 St., Cleveland 11, Ohio.

**TRANSFORMER SELECTION CHART** lists and describes small high-frequency transformers. Chart is classified according to pulse or sine-wave type. Drawings and photographs cross-indexed to *Aladdin Transformer Encyclopedia* or specific bulletin.—**Aladdin Electronics**, 703 Murfreesboro Road, Nashville 10, Tenn.

**ALL-PURPOSE ECONOMY RELAYS**. 4-page illustrated catalog includes descriptions of many types of economy relays, including quick-disconnect, open relays, latch relays, mechanical actuators, plug-in and time-delay relays, plastic and metal housed units. Full specs.—**Artisan Electronics Corp.**, 171 Ridgedale, Morristown, N.J.

**SUBMINIATURE CONNECTOR WITH INTEGRAL LOW-PASS FILTER** data sheet, con-

tains complete technical and dimensional specs.—**Sealectro Corp.**, 139 Hoyt St., Mamaroneck, N. Y.

**ELECTRICAL SERVICEMAN'S INVENTORY HANDBOOK**, personal guide with tube listings, columns for designating whether purchased or sold for each month. Total column indicates which moving tube stock is best to carry for your area. Includes notes, ready references.—**W. Lacy**, 4311 Baldwin Drive, Huntsville, Ala. 35805. 60¢

**1/3 AND 1/1 OCTAVE-BAND FILTER SET** described in 4-page brochure. Gives full specs, description, applications; also includes description of accessory, the 1/3 and 1/1 Octave-Band Extension filter set.—**B&K Instruments Inc.**, 3044 W. 106th St., Cleveland 11, Ohio.

**NEW STOCK RELAY CATALOG**. 6-page brochure lists 285 relays, including new time-delay, dry-reed, general-purpose, telephone type, plug-in, hermetically sealed and dust-covered relays. Full descriptions, specs and prices.—**Magnecraft Electric Co.**, 5581B No. Lynch Ave., Chicago 30, Ill.

**NEON PILOT LIGHTS** spec sheet, *JCA-663* details features and list prices of four differently-styled neon pilot lights. Includes data on application.—**Industrial Devices Inc.**, Edgewater, N. J.

**SECTIONAL DELAY LINES**. 4-page catalog details design, performance, mechanical data of separate delay line segments.—**Nytronics Inc.**, 550 Springfield Ave., Berkeley Heights, N. J.

**ILLUMINATED PUSHBUTTON SWITCHES** and indicator lights, detailed in 8-page catalog *No. L-169A*. Contains full specs, technical data and lamp and legend information; has illustrations, drawings, circuit diagrams and catalog number charts.—**Dialight Corp.**, 60 Stewart Ave., Brooklyn, N. Y. 11237.

**INDUSTRIAL TOOLS** catalog *No. 62*. 8-page brochure includes inspection tools, all-angle ball-joint mirrors, thumb-action adjustable mirrors, refill mirrors, retrieving tools, screw starters, heavy-duty compressors. Illustrations and prices.—**Ullman Devices Corp.**, Ridgefield, Conn.

**"CORDLESS BATTERY POWER,"** reprint of published article on complete line of manufacturer's commercial, rechargeable sintered-plate, nickel-cadmium battery cells. 4-page illustrated folder details cross-section views, operational curves, packaging. Charts and tables, photos.—**Sonotone Corp.**, Battery Div., Elmsford, N. Y.

**MINIATURE STRIP-CHART RECORDERS**, manufacturer's full product line, accessories, leads, adapters, included in 4-page, illustrated catalog. Specs, descriptions and prices given.—**Amprobe Instrument Corp.**, Dept. AAD36, 630 Merrick Road, Lynbrook, N. Y.

**53-AMP ALTERNATOR SYSTEM** described in data sheet. Gives complete performance data. Diagrams show how to connect unit to positive or negative-ground automotive battery-charging systems.—**Leece-Neville Co.**, 1374 E. 51 St., Cleveland 3, Ohio.

**PACKAGED ELECTRONIC CIRCUIT GUIDE** *No. 7*. 8-page booklet contains complete listing of packaged electronic circuits, with replacement data, plus information on how to select, test and replace PEC's used in radio, TV and hi-fi.—**Centralab, PO.** Box 591, Milwaukee, Wis. 53201.

**1964 HEATHKIT CATALOG**. 100-page illustrated brochure presents wide selection of electronic kits, including complete specs and details. Product lines include: stereo/hi-fi, color and black-and-white TV, electronic organ, CB equipment, tape recorders, short-wave and amateur radio equipment.—**Heath Co.**, Benton Harbor, Mich.

**SCOPE AND CAMERA CATALOG**. 12-page illustrated brochure *No. 129* presents manufacturer's line of oscilloscopes, scope record cameras, pulse generators, probes and accessories. Pertinent specs on current instruments including the new transistorized high-frequency 765 series together with plug-ins.—**Du Mont Laboratories**, Scientific Instrument Dept., Clifton, N.J. END

Any or all of these catalogs, bulletins, or periodicals are available to you on request direct to the manufacturers, whose addresses are listed at the end of each item. Use your letterhead—do not use postcards. To facilitate identification, mention the issue and page of RADIO-ELECTRONICS on which the item appears.

UNLESS OTHERWISE STATED, ALL ITEMS ARE GRATIS. ALL LITERATURE OFFERS ARE VOID AFTER SIX MONTHS.



# TECHNOTES

## Special Color Notes

The items in this month's column were all contributed by Mr. Arthur R. Richman, and all deal with color TV troubles. Each item names the chassis, lists the complaint and points out parts to check. The partial schematics help you locate the correct portion of the circuit. Codes (such as R701, C212, etc.) are from RCA manuals.

### CTC9: poor horizontal range

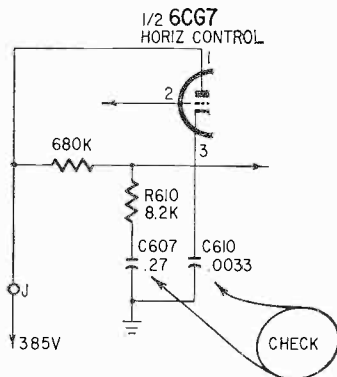

### CTC9: horizontal tearing

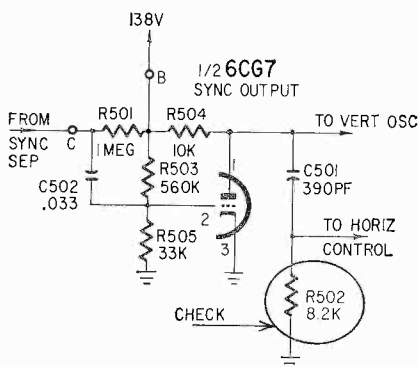

### CTC9: poor width, no focus

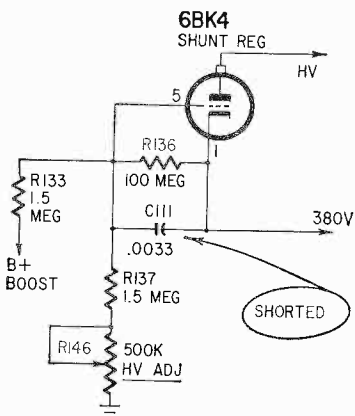

# FREE

## NEW 1964 GIANT CATALOG

**BURSTEIN-APPLEBEE CO. Dept. RE,**  
 1012-14 McGee St., Kansas City 6, Mo.

Rush me the FREE 1964 B-A Catalog.

NAME \_\_\_\_\_

ADDRESS \_\_\_\_\_

CITY \_\_\_\_\_ STATE \_\_\_\_\_

FOR 37 YEARS THE  
 OUTSTANDING  
**MONEY  
 SAVING**

**BUYING GUIDE FOR:**

- Stereo & Hi-Fi Systems and Components
- Tape Recorders
- Electronic Parts, Tubes, Books
- Phonos & Records
- Ham Gear
- Test Instruments and Kits
- Cameras and Film
- Public Address
- Citizens Band
- Transistor & FM-AM Radios.

**RUSH COUPON TODAY**

YOUR ONE COMPLETE  
 SOURCE for HAM-TV, ATV,  
 CCTV Equipment

Test Monotrons type  
 1698 only \$9.95 pp

FREE FLYER #771...  
 Full of bargains!!!

CATALOG 50¢  
 #1273... "How to  
 Build Low Cost TV  
 Cameras"

Catalog #1273 plus  
 LARGE size schematic \$1.50

Phone: 203-875-5198

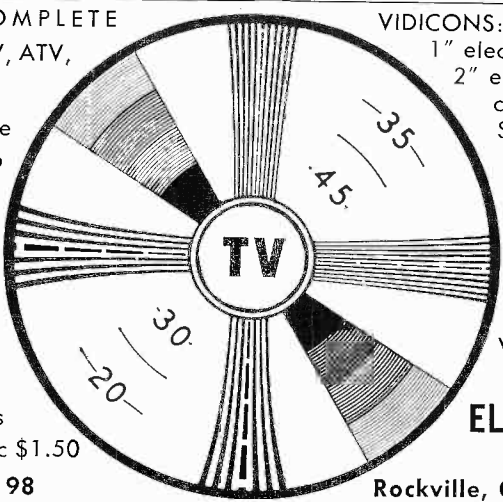

VIDICONS: \$34.50-up  
 1" electromagnetic or  
 2" electrostatic, your  
 choice: Grade C:  
 \$34.50; Grade B:  
 \$60.00; Grade  
 Ham A: \$100.00

All types Ham-TV  
 equipment  
 Bought-Sold-  
 Traded

WRITE!  
**DENSON  
 ELECTRONICS  
 CORP.**

Rockville, Connecticut

**5 CORES**

**WETS FASTER**      **MELTS FASTER**

**Solders Better**

**ERSIN Multicore**

**5-CORE SOLDER**

**WORLD'S FINEST**

31C ENDORSED QUALITY

Multicore Sales Corp. Port Washington, N.Y.

For information, write Department MX-383

**PROFESSIONAL technicians use Dave Rice's OFFICIAL ORDER BOOKS for every TV-RADIO service call**



This is the businesslike approach to service record keeping. Triplicate forms serve as order form, invoice and office record, with spaces for complete information on every job. Separate listings for receiving tubes, pix tube, parts, serial numbers, labor and tax charges, signatures, etc. 75c a book, \$6.50 for dust-proof box of 10. In stock at your distributor.

**FREE**

Write for your free folder describing Dave Rice's OFFICIAL ORDER BOOKS, including an actual size sample copy of the handy order form.

**ELECTRONIC PUBLISHING CO., INC.**  
133 N. JEFFERSON ST.  
CHICAGO 6, ILLINOIS

**CTC9N and P (with remote control): volume will not lower**

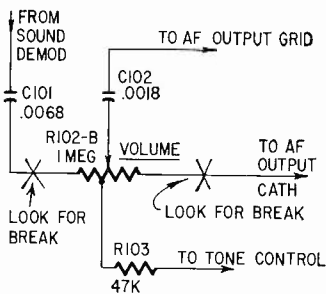

**CTC9: low contrast**

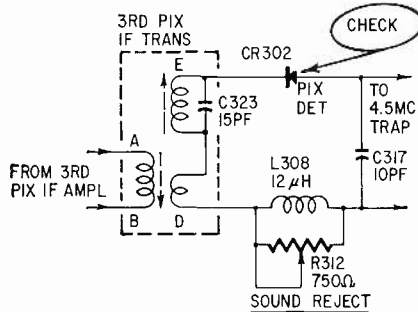

**CTC9: no high voltage**

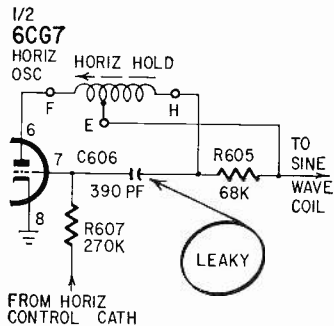

**CTC9: intermittent contrast**

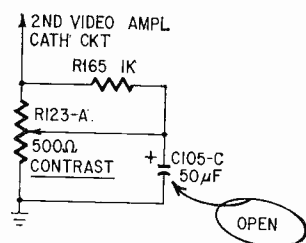

**CTC10: weak or no color**

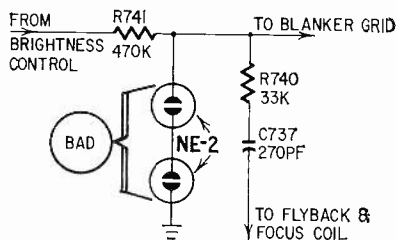

**CTC10: no brilliance**

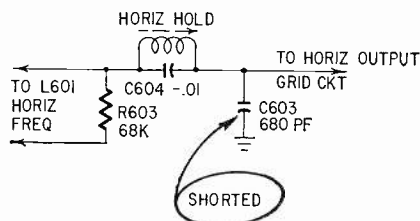

**CTC10: vertical roll**

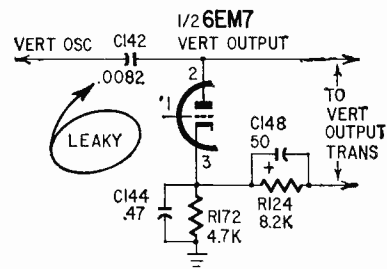

**CTC10: brilliance blooms out**

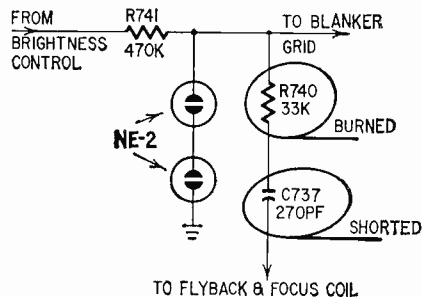

**CTC10: no color sync**

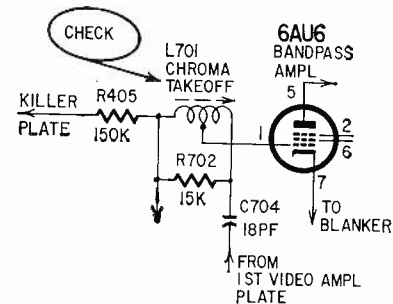

**CTC12: no raster**

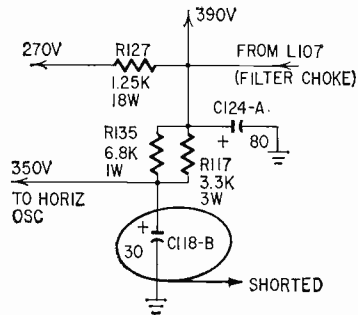

END



JOHN MORRIS  
"You service hi-fi?"



# SEASONS GREETINGS RAD-TEL'S

QUALITY

# BRAND NEW TUBE SALE!

AT LOW, LOW PRICES--COMPARE

UP TO  
**SAVE 75% OFF\***

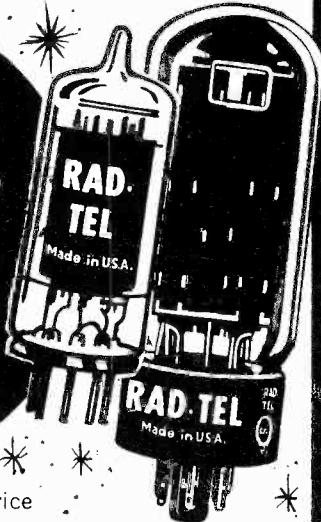

\*Manufacturers Suggested List Price

## ONE YEAR GUARANTEE

RAD-TEL WILL REPLACE ANY TUBE THAT DOES NOT GIVE EFFICIENT PERFORMANCE FOR 1 YEAR FROM DATE OF PURCHASE.

## ONE DAY SERVICE OVER 500 TYPES IN STOCK ORDER TYPES NOT LISTED

**FREE!** Send For New Tube & Parts Catalog  
Send For Trouble Shooting Guide

### TUBE SUBSTITUTION BOOK



**\$1.25**  
No. 193

- Over 11,000 direct tube substitutes
- Only all-inclusive directory of electron tube equivalents:
  - For USA electron tubes
  - Substitutes for foreign tubes
  - Picture tubes, newer models
  - Picture tubes, older models
  - transistor replacements
  - Army-Navy, V.T. substitutes

Easy to work on set while panel is off.



**CHEATER CORD**  
6 ft., No. 154 ..... **29¢ ea.** Lots of 3—25¢ ea.

## RAD-TEL TUBE CO. TV, RADIO AND HI-FI

DEPT. RE-12 55 CHAMBERS STREET, NEWARK, NEW JERSEY 07105

TERMS: 25% deposit must accompany all orders, balance C.O.D. Orders under \$5: add \$1 handling charge plus postage. Orders over \$5: plus postage. Approx. 8 tubes per 1 lb. Subject to prior sale. No C.O.D.'s outside continental U.S.A.

### EACH TUBE ATTRACTIVELY BOXED & BRANDED RAD-TEL

Qty.	Type	Price	Qty.	Type	Price	Qty.	Type	Price	Qty.	Type	Price
—	0Z4	.79	—	6A08	.87	—	6K6	.63	—	12CU5	.58
—	1AX2	.62	—	6AV6	.41	—	6S4	.52	—	12CU6	1.06
—	1B3	.79	—	6AW8	.90	—	6SA7GT	.99	—	12CX6	.54
—	1DN5	.55	—	6AX4	.66	—	6SH7	1.02	—	12D4	.69
—	1G3	.79	—	6AX5	.74	—	6SJ7	.88	—	12DE8	.83
—	1J3	.79	—	6BA6	.50	—	6SK7GT	.95	—	12DL8	.88
—	1K3	.79	—	6BC5	.61	—	6SL7GT	.84	—	12DQ6	1.04
—	1R5	.77	—	6BC8	1.04	—	6SN7	.65	—	12DS7	.84
—	1S5	.75	—	6BE6	.55	—	6SQ7GT	.94	—	12DT5	.76
—	1T4	.72	—	6BF5	.90	—	6T4	.99	—	12DT7	.79
—	1U5	.65	—	6BF6	.44	—	6T8	.85	—	12DT8	.78
—	1X2B	.82	—	6BG6	1.70	—	6U8	.83	—	12DW8	.89
—	2AF4	.96	—	6BH8	.98	—	6V6GT	.54	—	12DZ6	.62
—	3AL5	.46	—	6BJ6	.65	—	6W4	.61	—	12E05	.62
—	3AU6	.54	—	6BJ7	.79	—	6W6	.71	—	12EG6	.62
—	3AV6	.42	—	6BK7	.85	—	6X4	.41	—	12EK6	.62
—	3BC5	.63	—	6BL7	1.09	—	6X8	.80	—	12EL6	.50
—	3BN6	.75	—	6BN6	.74	—	7A8	.68	—	12EZ6	.57
—	3BU8	.78	—	6BQ6	1.12	—	7AU7	.65	—	12F8	.66
—	3BY6	.58	—	6BQ7	1.00	—	7EY6	.75	—	12FA6	.79
—	3BZ6	.56	—	6BU8	.70	—	7Y4	.69	—	12FM6	.50
—	3CB6	.56	—	6BX7	1.11	—	8AU8	.90	—	12FR8	.97
—	3CS6	.58	—	6BZ6	.55	—	8AW8	.93	—	12FX8	.90
—	3DG4	.85	—	6BZ7	1.03	—	8BQ5	.60	—	12GC6	1.06
—	3DK6	.60	—	6C4	.45	—	8CG7	.63	—	12J8	.84
—	3DT6	.54	—	6CB6	.55	—	8CM7	.70	—	12K5	.75
—	3GK5	.99	—	6CD6	1.51	—	8CN7	.97	—	12L6	.73
—	3Q4	.63	—	6CG7	.61	—	8CS7	.74	—	12SF7	.69
—	3S4	.75	—	6CG8	.80	—	8EB8	.94	—	12SK7GT	.95
—	3V4	.63	—	6CL8	.79	—	8FQ7	.56	—	12SL7	.80
—	4BQ7	1.01	—	6CM7	.69	—	9CL8	.79	—	12SN7	.67
—	4CS6	.61	—	6CN7	.70	—	11CY7	.75	—	12SQ7GT	.91
—	4DT6	.55	—	6CQ8	.92	—	12A4	.60	—	12U7	.62
—	4GM6	.60	—	6CR6	.60	—	12AB5	.60	—	12V6	.63
—	5AM8	.79	—	6CS6	.57	—	12AC6	.55	—	12W6	.71
—	5AN8	.90	—	6CS7	.69	—	12AD6	.57	—	12X4	.47

### RAD-TEL TUBE CO. NOT AFFILIATED WITH ANY OTHER MAIL ORDER TUBE COMPANY

—	5AQ5	.54	—	6CU5	.58	—	12AE6	.50	—	17AX4	.67
—	5AT8	.83	—	6CU6	1.08	—	12AE7	.94	—	17DQ6	1.06
—	5BK7	.86	—	6CY5	.70	—	12AF3	.73	—	18FW6	.49
—	5BQ7	1.01	—	6CY7	.71	—	12AF6	.67	—	18FX6	.53
—	5BR8	.83	—	6DA4	.68	—	12AJ6	.62	—	18FY6	.50
—	5CG8	.81	—	6DE6	.61	—	12AL5	.47	—	19AU4	.87
—	5CL8	.76	—	6DG6	.62	—	12AL8	.95	—	19B6G	1.39
—	5CQ8	.84	—	6DJ8	1.21	—	12AQ5	.60	—	19EA8	.79
—	5EA8	.80	—	6DK6	.59	—	12AT6	.50	—	19T8	.85
—	5EU8	.80	—	6DN6	1.55	—	12AT7	.76	—	21EX6	1.49
—	5J6	.72	—	6DQ6	1.10	—	12AU6	.51	—	25AX4	.70
—	5T8	.86	—	6DT5	.81	—	12AU7	.61	—	25C5	.53
—	5U4	.60	—	6DT6	.53	—	12AV6	.41	—	25CA5	.59
—	5U8	.84	—	6DT8	.94	—	12AV7	.82	—	25CD6	1.52
—	5V6	.56	—	6EA8	.79	—	12AX4	.67	—	25CU6	1.11
—	5X8	.82	—	6EB5	.73	—	12AX7	.63	—	25DN6	1.42
—	5Y3	.46	—	6EB8	.94	—	12AY7	1.44	—	25EH5	.55
—	6AB4	.46	—	6EM5	.77	—	12AZ7	.86	—	25L6	.57
—	6AC7	.96	—	6EM7	.82	—	12B4	.68	—	25W4	.68
—	6AF4	1.01	—	6EU8	.79	—	12BD6	.50	—	32E5	.55
—	6AG5	.70	—	6EV5	.75	—	12BE6	.53	—	35C5	.51
—	6AH4	.81	—	6EW6	.57	—	12BF6	.60	—	35L6	.60
—	6AH6	1.10	—	6EY6	.75	—	12BH7	.77	—	35W4	.42
—	6AK5	.95	—	6FG7	.69	—	12BK5	1.00	—	35Z5	.60
—	6AL5	.47	—	6FV8	.79	—	12BL6	.56	—	36AM3	.36
—	6AM8	.78	—	6GH8	.80	—	12BQ6	1.16	—	50B5	.69
—	6AQ5	.53	—	6GK5	.61	—	12BR7	.74	—	50C5	.53
—	6AS5	.60	—	6GK6	.79	—	12BV7	.76	—	50EH5	.55
—	6AT6	.49	—	6GN8	.94	—	12BY7	.77	—	50L6	.61
—	6AT8	.86	—	6H6	.58	—	12BZ7	.86	—	70L7	.97
—	6AU4	.85	—	6J5GT	.51	—	12CN5	.56	—	117Z3	.85
—	6AU6	.52	—	6J6	.71	—	12CR6	.67	—	807	.75

— Fast, Dependable service — Selling direct by mail for over 16 years —

RAD-TEL Tube Co. Total Tubes \$ \_\_\_\_\_  
 Dept. RE 12 Total Part(s) \$ \_\_\_\_\_  
 55 Chambers Street Postage \$ \_\_\_\_\_  
 Newark, New Jersey 07105 Grand Total \$ \_\_\_\_\_

ENCLOSED IS \$ \_\_\_\_\_ Please rush order.  
**SEND:** \_\_\_\_\_ TUBE SUBSTITUTION BOOK, No. 193 (or) 1.25 EACH  
 \_\_\_\_\_ Cheater Cord 29c ea. Lots of 3 - 25c ea. #154  
 Orders under \$5.00 - Add \$1.00 handling charge - plus postage.  
**FREE!**  Send FREE Tube and Parts Catalog  
 Send FREE Trouble Shooting Guide

NAME \_\_\_\_\_  
 ADDRESS \_\_\_\_\_  
 CITY \_\_\_\_\_ ZONE \_\_\_\_\_ STATE \_\_\_\_\_



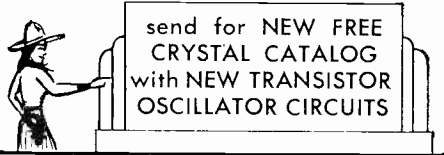

**3 PLANTS TO SERVE YOU BETTER  
HERMETICALLY SEALED  
PRECISION GROUND  
CUSTOM-MADE  
NON-OVEN CRYSTALS**

Gold or silver plated, spring mounted, vacuum sealed or inert gas, high freq. stability, 10 milliwatt max. current cap. Meet mil. specs.  
1000KC to 1600KC (Fund. Freq.) .....  
1601KC to 2000KC (Fund. Freq.) ..... \$5.00 ea.  
2001KC to 2500KC (Fund. Freq.) ..... 4.00 ea.  
2501KC to 5000KC (Fund. Freq.) ..... 3.50 ea.  
5001KC to 7000KC (Fund. Freq.) ..... 3.90 ea.  
7001KC to 10,000KC (Fund. Freq.) ..... 3.25 ea.  
10,001KC to 15,000KC (Fund. Freq.) ..... 3.75 ea.  
15MC to 20MC (Fund. Freq.) ..... 5.00 ea.

**OVERTONE CRYSTALS**  
15MC to 30MC Third Overtone ..... \$3.85 ea.  
30MC to 40MC Third Overtone ..... 4.10 ea.  
40MC to 65MC Third or Fifth Overtone 4.50 ea.  
65MC to 100MC Fifth Overtone ..... 6.00 ea.  
DRAKE 2-B Receiver Crystals ..... \$4.00  
(All Channels—Order by Freq.)

**OVEN-TYPE CRYSTALS**  
For Motorola, GE, Gonset, Bendix, etc.  
Add \$2.00 per crystal to above prices  
SUB-MINIATURE PRICES slightly higher

**ORDER FROM CLOSER PLANT  
TEXAS CRYSTALS**

DEPT. RE  
1000 Crystal Drive  
FORT MYERS, FLORIDA  
Phone 813 WE 6-2109  
TWX 813-334-2830  
AND  
4117 W. Jefferson Blvd.  
LOS ANGELES, CALIF.  
Phone 213-731-2258  
TWX 213-737-1315



Christmas Seals fight Tuberculosis and other Respiratory Diseases

**ONLY MERRELL KITS  
HAS THESE STEREO RECEIVERS**

**20 WATT FM STEREO RECEIVER, \$6995**  
Also: FM MULTIPLEX, AM-FM, AM-FM MULTIPLEX  
Complete line from \$19.95. 5% higher W. of Rockies  
Detailed Instructions, Diagrams, Covers extra.  
Write for Brochure, Name of Nearest Dealer  
**MERRELL KITS, 519-R Hendrix St., Brooklyn 7, N. Y.**

# noteworthy Circuits

## Heathkit CT-1 and IT-22

Most in-circuit capacitor testers of this type have separate B-plus rectifiers, oscillator and electron-ray indicator tubes. In these two testers the 1629 indicator tube performs all three functions. (The circuit of the CT-1 is shown.) When testing a capacitor for opens, the triode section of the tube is used as a self-rectifying 19-mc oscillator. Coupling to the tank circuit is tight enough to stop oscillations.

When a good or shorted capacitor

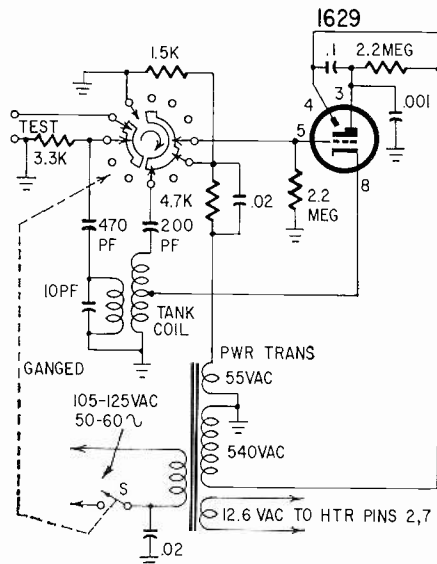

is connected to the test terminals, the circuit is detuned, developing a bias that closes the eye. For the short test, the capacitor is connected between the grid and ground. A shorted capacitor short-circuits the bias and opens the eye.—Allan Glaser

## Code Oscillator and Monitor

This simple unit provides the amateur with an inexpensive CW monitor and the prospective ham with a code-practice oscillator. The transistor oscillator is a simplified version of the modulator in the tunnel-diode R-C transmitter in the June 1963 issue. A Bourns Trimpot salvaged from a surplus printed-circuit board is used for R, the pitch control. A fixed resistor of 1,000 to 5,000 ohms that gives the desired tone can be substituted. C also affects the frequency and may be changed to get the desired frequency range if you use a pot.

The values of R and C shown on the diagram provide a frequency range of 200 to 5,000 cycles.

The diode isolates the oscillator from the transmitter when used as a CW monitor. Its piv rating must be higher than the open-circuit voltage across the transmitting key. The piv rating of the 1N2070-A is 400 and is high enough for most transmitters. If you will use the unit exclusively for code practice, replace the diode with a short.

Almost any p-n-p transistor will work. I tried Poly-Paks' 15-for-\$1.00

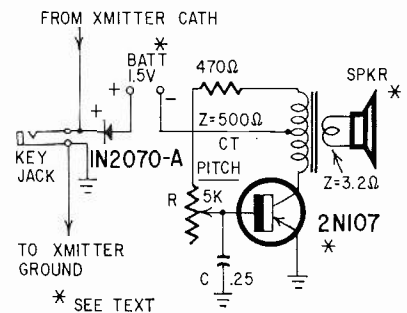

transistors and most of them worked in this circuit.

The oscillator's volume is adequate for the ham shack but falls short for group code practice. A larger speaker and 3-volt battery will solve this problem.

I constructed the unit in a small interlocking utility box. You can build

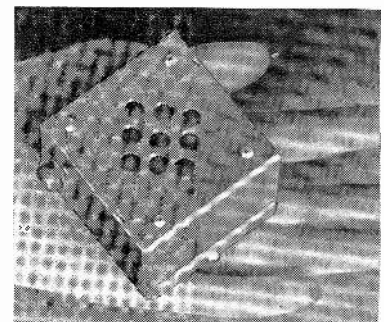

into your transmitter. When using it as a CW monitor, be sure that the positive lead from the transmitter connects to the diode's cathode. Improper polarity will key the transmitter and burn out the transistor.—Earl Palmer, W7POG

## Listening-Aid Amplifier

Recently a co-worker purchased a Telex model LCP90 TV Listener for his hard-of-hearing daughter. While the unit worked quite satisfactorily, there was one drawback in this particular application. The youngster's hearing is 80% restricted in one ear and 60% in the other. Consequently she required extremely high audio level to hear anything on her earphones. This proved unbearable to others watching TV on this same receiver.

One inexpensive solution was this simple two-transistor amplifier that packs a hefty signal. Without rearrangement of components already existing in

the Telex TV Listener, there is ample room to build the entire amplifier and battery inside the bakelite case. The only physical change was replacing the original 100-ohm volume control with a small 10,000-ohm pot. Component values are not critical and may vary over a wide range. Transistors may be almost

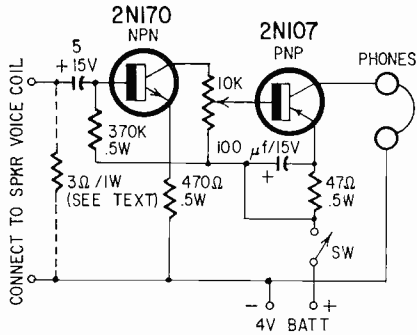

any inexpensive general audio types such as the 2N170, 2N107.

At high audio inputs, there is some tendency to overload, in which case the input can be loaded down with a 3-ohm resistor. Where less amplification is required, or desired, the input stage may be eliminated and the audio input fed to the 2N107.—*Domenic Ripani, W9JAG*

### Constant-Current Regulator

Fig. 1 shows a regulator circuit that delivers a steady current at any preset level between 1 and 200 ma although the power supply output might fluctuate between 1.5 and 30 volts. The unit may be connected simply between the supply and load (see Fig. 1-a).

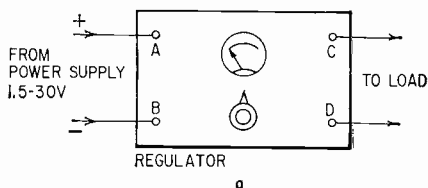

Circuit operation (Fig. 1-b) is based on the flat constant-current characteristic of a small power transistor in the common-base connection. The output current level is set by adjusting the rheo-

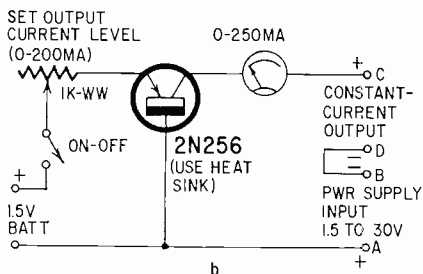
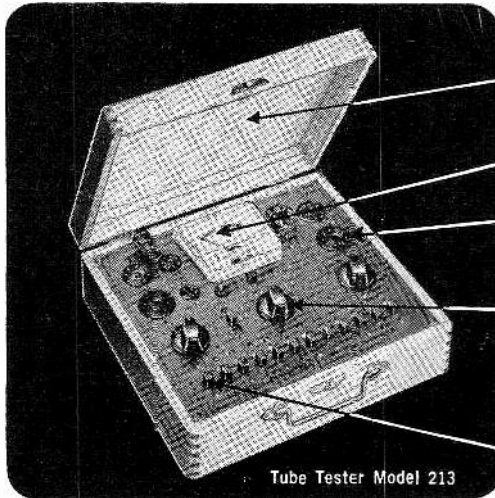

Fig. 1

stat and read from the milliammeter. The 1.5-volt battery may be replaced with a midjet transformer-rectifier unit, if desired.—*Rufus P. Turner* END

# NO COMPETITORS

Nobody else but **EMC** designs in so much value



- Compact, light-weight portability. Use it on the bench or in the field.
- Full-view meter gives direct, clear-cut quality indications.
- Full complement of sturdy sockets accepts compactron (12-pin), nuvistor, novar, 10-pin, 9-pin, octal, octal, and miniature tubes.
- Three heavy-duty controls for quick set-up of all tests. Check a fistful of tubes in the time it often takes to test one.
- 12 slide switches for individual selection of tube pins provides versatility in testing, prevents obsolescence.
- Precise programming. Only one socket per tube-base configuration prevents accidental plug-in.

THE MODEL 213 saves you time, energy, money ■ Checks for shorts, leakage, intermittents, and quality ■ Tests all tube types including magic eye, regulator, and hi-fi tubes ■ Checks each section of multi-purpose tubes separately ■ Gives long, trouble-free life through heavy-duty components, including permanently etched panel ■ Keeps you up to date with FREE, periodic listings on new tubes as they come out ■ Your best dollar value in a tube tester. Available in high-impact bakelite case with strap: \$28.90 wired; \$18.90 in kit form. Wood carrying case (illustrated) slightly higher.



**ELECTRONIC MEASUREMENTS CORPORATION**  
625 Broadway, New York 12, New York  
Export: Pan-Mar Corp., 1270 B'way, N. Y. 1, N. Y.

EMC, 625 Broadway, New York 12, N. Y.  
Rush me FREE catalog describing all EMC value-loaded test instruments and name of local distributor.

NAME \_\_\_\_\_  
ADDRESS \_\_\_\_\_  
CITY \_\_\_\_\_ ZONE \_\_\_\_\_ STATE \_\_\_\_\_

RE 12-63

## RADIOTELEPHONE

### LICENSE MANUAL

\$5.75

(foreign \$6.25)  
Book #030

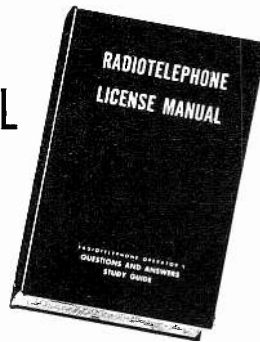

— helps you prepare for all U.S.A. commercial operator's license exams

Here are complete study-guide questions and answers in a single volume. Helps you understand every subject needed to obtain an operator's license.

**RADIO HANDBOOK** — largest comprehensive reference source on radio ever published. More "How-to-build" data than any book in the field. Gives simplified theory... latest design data. Book #166.....\$9.50 (foreign, \$10.50)

**WORLD'S RADIO TUBES** (Brans' Radio Tubes Vade Mecum). World's most complete tube book. Book #471.....\$8.00 (foreign, \$8.50)

**WORLD'S EQUIVALENT TUBES** (Brans' Equivalent Tubes Vade Mecum). Over 32,900 comparisons. Book #493 \$8.00 (foreign, \$8.50)

**SURPLUS RADIO CONVERSION MANUALS** — practical conversions of popular surplus equipment. Send stamped envelope for full data.

Order from your favorite electronic parts distributor.

If he cannot supply, send us his name and remittance, and we will supply.

**EDITORS and ENGINEERS, Ltd.**

Summerland 5, California 93067  
Dealers: Electronic distributors, order from us. Bookstores, libraries, newspapers order from Baker & Taylor, Hillside N. J. Export (exc. Canada), order from H. M. Snyder Co., 440 Park Ave. S., N. Y. 16.

SEE  
YOUR  
COSTS  
SHRINK  
WITH KEY  
DISCOUNTS

Prove it for yourself! Rush us your list of stereo hi-fi components for an immediate price-busting quotation.

Enjoy these advantages:

- LOWEST PRICES
- SPEEDY DELIVERY
- FACTORY WARRANTY
- EASY PAYMENT PLAN

For a real eye-opener, send for our valuable money-saving audio discount catalog A-17, featuring the latest in stereo equipment.



**KEY ELECTRONICS CO.**  
518 East 95th St., Bklyn. 12, N. Y.

**CORNELL**

**33¢** PER TUBE

100 TUBES OR MORE:  
**30¢ PER TUBE**

**TUBES**  
**1 YR. GUARANTEED**

Mutual Conductance Lab-tested, Individually  
Boxed, Branded and Code Dated

OZ4	6AU4	6CZ5	6SH7	7B6	12BL6
1B3	6AU5	6D6	6SJ7	7B7	12BY7
1H5	6AU6	6DA4	6SK7	7B8	12C5
1L4	6AV6	6DE6	6SL7	7C5	12CA5
174	6AW8	6DQ6	6SN7	7Y4	12DQ6
1U4	6AX4	6EM5	6S07	12AD6	12SN7
1X2	6BA6	6F6	6SR7	12AE6	12SQ7
2A5	6BC5				25L6
3CB6	6BD6				25Z6
5U4	6BG6				35W4
5V4	6BH6				35Z3
5Y3	6BJ6				35Z5
5Z3	6BL7				50A5
6A6	6BN4				50L6
6A8	6BN6				24
6AB4	6BQ6	6H6	6U7	12AF6	27
6AC7	6BZ6	6J5	6U8	12AT7	41
6AG5	6C4	6J6	6V6	12AU7	45
6AL5	6CB6	6K7	6W4	12AX7	47
6AN8	6CD6	6L6	6W6	12BA6	75
6AQ5	6CF6	6Q7	6X4	12BD6	77
6AS5	6CG7	6S4	6X5	12BE6	78
6AT8	6C68	6SA7	7A7	12BF6	80
	6CM7	6SC7	7A8	12BH7	84/6Z4

If not shipped in 24 hrs  
**YOUR ORDER FREE!**

Other tubes and CRT's at low prices—send for free list

**LIVE IN THE EAST?**  
**WAITED MONTHS FOR DELIVERY FROM OTHERS?**  
AIR MAIL AN ORDER TO CORNELL  
AND RECEIVE DELIVERY TO THE EAST COAST  
IN AS LITTLE AS 72 HOURS!!!  
**NO SUBSTITUTIONS WITHOUT YOUR PERMISSION**

Tubes are new, seconds or used and so marked.  
TERMS: FREE POSTAGE ON PREPAID USA ORDERS. Under \$5.00 add 50¢ for handling. Send 25% deposit on COD orders. No Canadian or foreign COD's—include postage. No 24 Hr. Free Offer on personal check orders. 5-DAY MONEY BACK OFFER!

**Special!**  
With every \$10 Order  
**25¢** per tube  
(No Limit) from this list.

6AG5	6SN7
6AU6	6V6
6CG7	6K6
	6W4

**CORNELL ELECTRONICS CO.**  
Dept. RE12 4217 University Ave., San Diego 5, Calif. • Phone: AT 1-9792



**Mass. License Bill Goes Through**

After several years of work, the radio-TV technicians' licensing bill sponsored by the Massachusetts Electronic Technicians Guild has passed the legislature and been signed by the governor.

The act establishes a board of radio and television technicians empowered to license applicants upon proof of competence and payment of the required fees. There will be two license grades: Master Technician License, issued to persons 21 years old and over, who have had at least one year's experience in radio-TV repair, and a Technician License, issued to persons at least 18 years old and employed by a service dealer or working under a Master Technician's supervision.

No one is permitted to do service work for pay without a license.

The licensing board created under the new law will examine applicants. In the words of the act, "the board shall require proof that the applicant has the knowledge, practical experience and skill necessary for the proper maintenance and repair of television and radio receivers and shall require a practical demonstration of the applicant's skill."

Licenses expire after a year and may be renewed without examination within 1 year from the expiration date, on payment of the renewal fee.

Initial exam fee is \$15, as are the license fees for the Master grade. Subsequent examinations cost \$10. The issuance fee for the Technician grade is \$10, and \$5 for renewal.

Penalties are stiff. For doing service work without a license there is a maximum fine of \$500, or a prison term of up to three months, or both.

The new law includes a "grandfather clause." Any applicant who files before June 30, 1964, and is actively engaged in service work will be granted a license on payment of the fees, but without examination.

Chairman of the ETG Licensing Committee was Nicholas A. Averinos, who announced with justifiable pride that the total cost of getting the bill through was under \$1,500—which includes legal fees, car expenses, stamps, stationery, but, he says, "No expensive lunches, dinners or any other frills."

**Ohio TSA Elects**

Jack Fain of Lorain, Ohio, was elected president of the Television Service Association of Ohio at the group's two-day annual convention recently. He succeeds John Graham of Columbus.

Also elected were Arthur Clough, Akron, secretary, and Arthur Spahr, Cincinnati, treasurer. Regional vice presidents are Carl Hepp, Youngstown, northern zone; Robert Hammond, Columbus, central zone, and Harry Hansen, Cincinnati, southern zone.

**New Mexico TESA Told Service Vital to Color**

TV service technicians have a key role in the rapidly blossoming field of color television, said Lysle O. Shanafelt, RCA's manager of distributor sales coordination, speaking to TESA—New Mexico's annual convention.

**SUPERIOR'S NEW MODEL 85 TRANS-CONDUCTANCE TYPE TUBE TESTER**

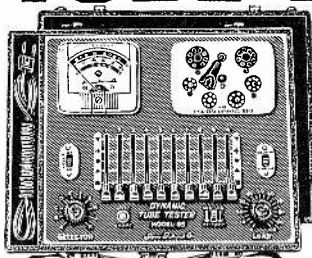

Model 85—Trans-Conductance Tube Tester. Total Price \$52.50  
Terms: \$12.50 after 10 day trial, then \$8.00 monthly for 5 months if satisfactory. Otherwise return, no explanation necessary.

• **FREE FIVE (5) YEAR CHART DATA SERVICE.** Revised up-to-date subsequent charts will be mailed to all Model 85 purchasers at no charge for a period of five years after date of purchase.

Model 85 comes complete, housed in a handsome portable cabinet with slip-on cover. Only **\$52.50**

**SHIPPED ON APPROVAL NO MONEY WITH ORDER—NO C.O.D.**

Try it for 10 days before you buy. If completely satisfied then send \$12.50 and pay balance at rate of \$8.00 per month for 5 months—No interest or finance charges added. If not completely satisfied, return to us, no explanation necessary.

MOSS ELECTRONIC, INC. All prices net, F.O.B., N.Y.C.  
Dept. D-965 3849 Tenth Ave. New York 34, N. Y.  
Please rush Model 85. If satisfactory, I will pay on terms specified. Otherwise I will return tester.

Name \_\_\_\_\_  
Address \_\_\_\_\_  
City \_\_\_\_\_ Zone \_\_\_\_\_ State \_\_\_\_\_



# BUILD 20 RADIO

## CIRCUITS AT HOME

with the New

### PROGRESSIVE RADIO "EDU-KIT"®

#### A Practical Home Radio Course

only  
**\$26<sup>95</sup>**

Reg. U. S.  
Pat. Off.



Training Electronics Technicians Since 1946

#### Now Includes

- ★ 12 RECEIVERS
- ★ 3 TRANSMITTERS
- ★ SQ. WAVE GENERATOR
- ★ SIGNAL TRACER
- ★ AMPLIFIER
- ★ SIGNAL INJECTOR
- ★ CODE OSCILLATOR

- ★ No Knowledge of Radio Necessary
- ★ No Additional Parts or Tools Needed
- ★ EXCELLENT BACKGROUND FOR TV
- ★ School Inquiries Invited
- ★ Sold in 79 Countries

**YOU DON'T HAVE TO SPEND  
HUNDREDS OF DOLLARS FOR A RADIO COURSE**

The "Edu-Kit" offers you an outstanding PRACTICAL HOME RADIO COURSE at a rock-bottom price. Our Kit is designed to train Radio & Electronics Technicians, making use of the most modern methods of home training. You will learn radio theory, construction practice and servicing. THIS IS A COMPLETE RADIO COURSE IN EVERY DETAIL.

You will learn how to build radios, using regular schematics; how to wire and solder in a professional manner; how to service radios. You will work with the standard type of punched metal chassis as well as the latest development of Printed Circuit chassis. You will learn the basic principles of radio. You will construct, study and work with RF and AF amplifiers and oscillators, detectors, rectifiers, test equipment. You will learn and practice code, using the Progressive Code Oscillator. You will learn and practice trouble-shooting, using the Progressive Signal Tracer, Progressive Signal Injector, Progressive Dynamic Radio & Electronics Tester, Square Wave Generator and the accompanying instructional material.

You will receive training for the Novice, Technician and General Classes of F.C.C. Radio Amateur Licenses. You will build 20 Receiver, Transmitter, Square Wave Generator, Code Oscillator, Signal Tracer and Signal Injector circuits, and learn how to operate them. You will receive an excellent background for television, Hi-Fi and Electronics.

Absolutely no previous knowledge of radio or science is required. The "Edu-Kit" is the product of many years of teaching and engineering experience. The "Edu-Kit" will provide you with a basic education in Electronics and Radio, worth many times the complete price of \$26.95. The Signal Tracer alone is worth more than the price of the entire Kit.

#### THE KIT FOR EVERYONE

You do not need the slightest background in radio or science. Whether you are interested in Radio & Electronics because you want an interesting hobby, a well paying business or a job with a future, you will find the "Edu-Kit" a worth-while investment. Many thousands of individuals of all

ages and backgrounds have successfully used the "Edu-Kit" in more than 79 countries of the world. The "Edu-Kit" has been carefully designed, step by step, so that you cannot make a mistake. The "Edu-Kit" allows you to teach yourself at your own rate. No instructor is necessary.

#### PROGRESSIVE TEACHING METHOD

The Progressive Radio "Edu-Kit" is the foremost educational radio kit in the world, and is universally accepted as the standard in the field of electronics training. The "Edu-Kit" uses the modern educational principle of "Learn by Doing." Therefore you construct, learn schematics, study theory, practice trouble shooting—all in a closely integrated program designed to provide an easily-learned, thorough and interesting background in radio.

You begin by examining the various radio parts of the "Edu-Kit." You then learn the function, theory and wiring of these parts. Then you build a simple radio. With this first set you will enjoy listening to regular broadcast stations, learn theory, practice testing and trouble-shooting. Then you build a more advanced radio, learn more advanced theory and techniques. Gradually, in a progressive manner, and at your own rate, you will find yourself constructing more advanced multi-tube radio circuits, and doing work like a professional Radio Technician.

Included in the "Edu-Kit" course are twenty Receiver, Transmitter, Code Oscillator, Signal Tracer, Square Wave Generator and Signal Injector Circuits. These are not unprofessional "breadboard" experiments, but genuine radio circuits, constructed by means of professional wiring and soldering on metal chassis, plus the new method of radio construction known as "Printed Circuitry." These circuits operate on your regular AC or DC house current.

#### THE "EDU-KIT" IS COMPLETE

You will receive all parts and instruction necessary to build 20 different radio and electronics circuits, each guaranteed to operate. Our Kits contain tubes, tube sockets, variable, electrolytic, mica, ceramic and paper dielectric condensers, resistors, tie strips, coils, hardware, tubing, punched metal chassis, Instruction Manuals, hook-up wire, solder, selenium rectifiers, volume controls and switches, etc.

In addition, you receive Printed Circuit materials, including Printed Circuit chassis, special tube sockets, hardware and instructions. You also receive a useful set of tools, a professional electric soldering iron, and a self-powered Dynamic Radio and Electronics Tester. The "Edu-Kit" also includes Code Instructions and the Progressive Code Oscillator. In addition to F.C.C.-type Questions and Answers for Radio Amateur License training. You will also receive lessons for servicing with the Progressive Signal Tracer and the Progressive Signal Injector, a High Fidelity Guide and a Quiz Book. You receive Membership in Radio-TV Club. Free Consultation Service. Certificate of Merit and Discount Privileges. You receive all parts, tools, instructions, etc. Everything is yours to keep.

#### PRINTED CIRCUITRY

At no increase in price, the "Edu-Kit" now includes Printed Circuitry. You build a Printed Circuit Signal Injector, a unique servicing instrument that can detect many Radio and TV troubles. This revolutionary new technique of radio construction is now becoming popular in commercial radio and TV sets.

A Printed Circuit is a special insulated chassis on which has been deposited a conducting material which takes the place of wiring. The various parts are merely plugged in and soldered to terminals.

Printed Circuitry is the basis of modern Automation Electronics. A knowledge of this subject is a necessity today for anyone interested in Electronics.

#### FREE EXTRAS

##### • SET OF TOOLS

- SOLDERING IRON
- ELECTRONICS TESTER
- PLIERS, CUTTERS
- ALIGNMENT TOOL
- WRENCH SET
- VALUABLE DISCOUNT CARD
- CERTIFICATE OF MERIT
- TESTER INSTRUCTION MANUAL
- HIGH FIDELITY GUIDE • QUIZZES
- TELEVISION BOOK • RADIO TROUBLE-SHOOTING BOOK
- MEMBERSHIP IN RADIO-TV CLUB: CONSULTATION SERVICE • FCC AMATEUR LICENSE TRAINING
- PRINTED CIRCUITRY

#### SERVICING LESSONS

You will learn trouble-shooting and servicing in a progressive manner. You will practice repairs on the sets that you construct. You will learn symptoms and causes of trouble in home, portable and car radios. You will learn how to use the professional Signal Tracer, the unique Signal Injector and the dynamic Radio & Electronics Tester. While you are learning in this practical way, you will be about to do a repair job for your friends and neighbors, and charge fees which will far exceed the price of the "Edu-Kit." Our Consultation Service will help you with any technical problems you may have.

#### FROM OUR MAIL BAG

J. Stataitis, of 25 Poplar Pl., Waterbury, Conn., writes: "I have repaired several sets for my friends, and made money. The "Edu-Kit" paid for itself. I was ready to spend \$240 for a Course, but I found your ad and sent for your Kit."

Ben Valerio, P. O. Box 21, Magna, Utah: "The Edu-Kits are wonderful. Here I am sending you the questions and also the answers for them. I have been in Radio for the last seven years, but like to work with Radio Kits and like to build Radio Testing Equipment. I enjoyed every minute I worked with the different kits; the Signal Tracer works fine. Also like to let you know that I feel proud of becoming a member of your Radio-TV Club."

Robert L. Shuff, 1534 Monroe Ave., Huntington, W. Va.: "Thought I would drop you a few lines to say that I received my Edu-Kit, and was really amazed that such a bargain can be had at such a low price. I have already started repairing radios and phonographs. My friends were really surprised to see me get into the swing of it so quickly. The Trouble-shooting Tester that comes with the Kit is really swell, and finds the trouble, if there is any to be found."

#### UNCONDITIONAL MONEY-BACK GUARANTEE

**ORDER DIRECT FROM AD—RECEIVE FREE BONUS  
RESISTOR AND CONDENSER KITS WORTH \$7**

- Send "Edu-Kit" postpaid. I enclose full payment of \$26.95.
- Send "Edu-Kit" C.O.D. I will pay \$26.95 plus postage.
- Rush me FREE descriptive literature concerning "Edu-Kit."

Name.....

Address.....

**PROGRESSIVE "EDU-KITS" INC.**

1186 Broadway, Dept. 215G, Hewlett, N. Y.

# Jobs look for YOU in ELECTRONICS

Learn FAST—EARN FAST with  
MTI's Unique Exclusive  
Training.

Whether it's a BIG PAY JOB you want or the chance to be YOUR OWN BOSS—your big opportunity today is WAITING for YOU in ELECTRONICS! MTI's unique SELECT-A-SKILL method quickly, easily qualifies you for the type of electronic work that's exactly right for YOU — COMMUNICATIONS ELECTRONICS, INDUSTRIAL ELECTRONICS, or RADIO & TV SERVICING. Previous experience proved unnecessary. Age no obstacle. Right at home or through resident classes in Jacksonville you learn by doing, using your hands as well as your head—building electronic equipment, testing and experimenting with SEVEN BIG MASTER ELECTRONIC KITS! And you can earn while you learn!

**Massey Technical Institute**  
Dept. 14-AX-02, Jacksonville 6, Florida

ACCREDITED Member, National Home Study Council

MAIL COUPON TODAY for FREE BOOK  
and MTI's unique SELECT-A-SKILL  
Opportunity Finder that can take the guess-  
work out of YOUR FUTURE!



## SKILLS PAY BILLS

With millions unemployed — there is NO PLACE for men without special skills! Let MTI give you the training you NEED to insure your future!



**MASSEY TECHNICAL INSTITUTE**  
Dept. 14-AX-02, Jacksonville 6, Florida

I am interested in:  
 Home Training  Classroom Training

Name .....

Address .....

City..... Zone..... State.....

Please rush to me, without obligation your FREE BOOK "Pick Your New World of Opportunity in Electronics" PLUS your SELECT-A-SKILL Opportunity Finder.

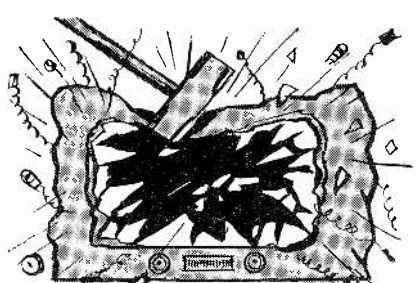

## STOP!

### WRECKING YOUR TV...

Inrush surge currents at 'Turn-On' destroy more TUBES, RECTIFIERS, and CAPACITORS than all other causes. . . .

EFFECTIVE, AUTOMATIC REDUCTION of the punishing inrush currents is immediately provided by the . . .

### WUERTH SURGISTOR®



117 V.  
AC-DC

Watts Range	Wuerth No.	Workman No.	G-C No.	List Price
100-275	4100-2	SR-1	25-894R	1.95
250-400	8050-4	SR-2	25-896R	2.95
300-500	8050-5	SR-3	.....	3.90

Use SURGISTORS with your TV, Hi-Fi, Film Projector, or any device requiring inrush surge current protection. SEE your distributor or dealer TODAY. Or, send order direct to us for prompt action.

**WUERTH PRODUCTS CORP.**  
1931 Moffett St. Hollywood, Florida

## MOVING?

If you are going to move, don't forget to send us your OLD address (as it appears on your latest copy of Radio-Electronics) as well as your NEW address.

If possible, send us the actual address label which is pasted on the front cover. Be sure to include your ZIP code number with your new address.

If we receive this information before the 20th of the month, you will continue to get Radio-Electronics without interruption.

Please notify  
Subscriber's Service  
RADIO-ELECTRONICS  
154 West 14th Street  
New York, N. Y. 10011

Pointing out that color set owners and repairmen are the most important salesmen for color, he said, "Consumer demand for color television would not increase unless color receivers were being properly serviced and were delivering satisfactory performance."

He urged technicians to take advantage of the opportunities offered by the growth of color TV sales.

## CSEA Sets Service Advertising Standards

The California State Electronics Association has drawn up a list of 10 principles to be followed for honest TV service advertising. Each item of the list mentions a particular type of claim that CSEA considers "misleading, untruthful" or a part of "bait" or "come-on" advertisements.

Here are the 10 points summarized:

1. Ads shall contain all information about the firm's legal name, address and telephone number. The phone number must be the one actually listed with "Information" under the business name of the company.

2. Words or phrases like "guaranteed" or "no fix, no pay" are permitted if the ad states clearly the nature and extent of the guarantee, and who the guarantor is—manufacturer or retailer.

3. Phrases like "24-hour service" should not be used unless such service is actually available to the public 24 hours a day.

4. Words "manufacturer" or "laboratory" should not be used unless the advertiser does actually manufacture or sell factory parts or use a laboratory. "Direct from factory to you" is taboo unless it is a statement of fact.

5. If an ad uses an expression like "repaired in your home," it should state that there is a charge if the work cannot be completed in the home to the customer's satisfaction.

6. If the price of picture tube is quoted, the ad should state whether the price is for a new or used tube, and whether it includes installation.

7. "Free" should not be used unless the article or service is actually free. This also applies to phrases like "without cost or obligation," etc.

8. Phrases like "factory-trained," "authorized," "licensed," etc., should be based on demonstrable facts.

9. Avoid "price ads." Artificially low prices quoted in ads lead to dishonest practices such as hidden charges, padded bills or hurried, sloppy work.

10. Be careful with business names that closely resemble established trade names or that use service marks much like those of other companies.

The list was apparently intended to be distributed to newspapers and periodicals. It closes by pointing out that "No honest, legitimate businessman, willing to represent his product or service fairly and openly to the public, should have the slightest fear of these standards."

## New NATESA President Lists Gripes

The newly elected president of the National Alliance of Television & Electronic Service Associations, Larry Dorst of Milwaukee, has three pet peeves.

First, he says, is captive service. Running close behind are manufacturers' built-in warranties and the lack of licensing of TV service dealers.

## Philco Forms Technicians' Councils

Philco Corp. will form councils of independent TV service technicians to put the company in immediate touch with any problems that develop in the field.

Charles Hakimian, Philco's director of distribution and customer services, announced at a meeting of the Ohio TSA that "these councils will meet with us, at our expense, to work on any and all problems that affect our relationship."

Hakimian also told the state meeting that Philco will resume introducing its new lines to service technicians at the same time the merchandise is displayed for dealers. END

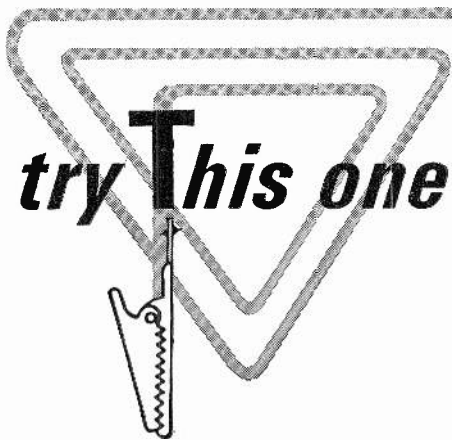

### Protective Covers for Shafts and Switches

To keep calibrating potentiometer adjustments from being disturbed, cover the shaft with the empty can taken from an old bathtub type capacitor. These cases are easily salvaged with a solder-

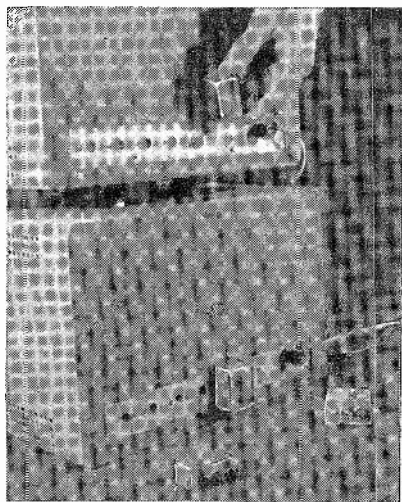

ing iron. Lined with insulating paper they make neat covers for hot terminal screws or fuse clips. They can also keep crucial switches from being hit on or off accidentally.—*Hugh Lineback*

### Clip-in Holder for Vom Battery

I own a vom that uses a Z-cell (penlight size) as an ohmmeter current source. Every time I wanted to replace it I had to unsolder the old cell and solder in the new one.

So I mounted a battery holder (Lafayette stock No. MS139) in the case and soldered the two battery leads to its terminals. Much better.—*Bernard J. Singer, Jr.*

### Bicycle Spokes Make Test Prods

When I had trouble getting probes into tight wiring without shocking myself or shorting something, I made my own probes from an ordinary test-prod shank and some bicycle spokes.

The drawings will show you how easy it is. All you have to do is drill out

# All you need to know about SERVICING COLOR TV

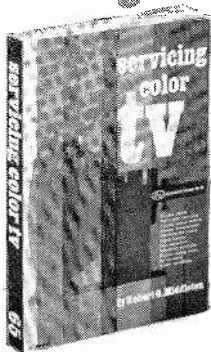

By Robert G. Middleton. A practical book that tells how to service color TV sets and make money doing it. Packed with information. Illustrated with hundreds of photos, drawings and troubleshooting charts. 224 pages.

G/L No. 65 \$2.90

## and then some...



**RAPID TV REPAIR**  
By G. Warren Heath. Lists over 500 TV troubles alphabetically. Helps you fix the toughest troubles fast. Cross-referenced. 224 pages.  
G/L No. 60 \$2.90



**NEW SHORTCUTS TO TV SERVICING**  
By Leonard C. Lane (2 vols.) A practical servicing speed-up course. No theory or math, but heavy on test and repair techniques that save time and help you get those sets off your bench. 320 pages.  
G/L \$9.50 set/\$5.90



**BASIC TV COURSE**  
By George Kravitz. A book on TV as it is today. Technical details presented in easy-to-follow writing style.  
G/L No. 105 \$4.10

BOOKS PURCHASED FOR PROFESSIONAL PURPOSES ARE TAX DEDUCTIBLE. Buy these books from your electronic parts distributor or send in the coupon below.

GERNSBACK LIBRARY/154 West 14th Street, New York, N.Y. 10011



123A

ENCLOSED is \$..... Name.....  
Please send me the books indicated.  
Write book number: Street.....  
    City..... State..... Zip Code.....

"New Fall Catalog" #11

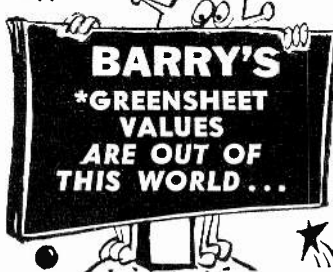

\* A complete catalog of specialized industrial Electronic TUBES and COMPONENTS... featuring Barry Electronics savings to industry, Servicemen and Experimenters.

RCA 21" COLOR CATHODE RAY PICTURE TUBE #21AXP 22A UNUSED ORIGINAL CARTON SPECIAL \$90.

We'll also purchase your equipment and unused tubes. Send details:

**BARRY ELECTRONICS**

512 BROADWAY,  
New York 12,  
NEW YORK

12 YEARS OF BUYERS' CONFIDENCE

**CORPORATION**

WAiker: 5-7000  
AREA CODE 212  
TWX: 571-0484

Please send me a copy of the new 1964 \*Greensheet and add my name to your mailing list. (RE-10)

Name ..... Title .....  
Company .....  
Address .....  
City ..... State .....

### Breakthrough In Design, Materials, Performance

ATLAS SOUND EC-10  
ALL-NEW  
PAGING SPEAKER

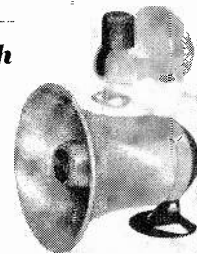

\$1425 net

Every way you look at it, this compact, weather-proof, American-made speaker is 100% NEW. It's a powerhouse of crisp, articulate sound for a wide variety of uses. Precision-molded Implex\* horn assures vibration-free, resonance-free output. Improved magnetic circuit features new ceramic magnet. Handsome 2-tone colors blend with any decor. Adjustable, versatile bracket.

Specs: 6 watts; 8 ohms (also 45 ohms); Length 6 3/4"; Bell Diameter 6 1/4"; Weight 2 lbs. Special Model T-4 line matching transformer available.

\*tm. Rohm & Haas — new, tough, all-weather plastic.



Write for full details and latest catalog

**ATLAS SOUND**

Division of  
American Trading and Production Corporation  
1419-51 39th Street, Brooklyn 18, N. Y.  
In Canada: Atlas Radio Corp. Ltd., Toronto



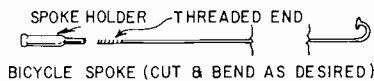
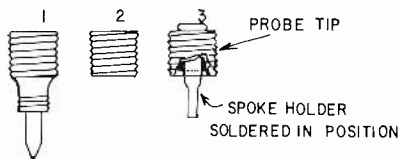

the old tip, insert and solder in a spoke holder (see your local bike shop) and screw in a bicycle spoke. The spoke can be cut, shaped and bent to meet your needs. Make several kinds, and screw in the one you need.—*M. P. Willoughby*

### "Fish" Kills Superhet Oscillator For Alignment

In aligning radio i.f.'s it is often advantageous to disable the oscillator. Instead of looking around for a jumper or any old piece of metal to jam between the plates (and possibly damage them), I use a little gadget that I call "the fish." To make it, take a piece of thin aluminum such as a plate from an old tuning capacitor. Cut it to match the general outline of a "fish" about 2½-inches long. Round out the tail and pound it to a tapering thinness. Put a hole (the eye) in the other end to hang it up by

Now you have a perfectly safe shorting strip to stuff between the oscillator-section plates.—*Nicholas B. Cook*

### Handy Service Tool

If you have a worn-out nutdriver lying around the shop gathering dust, try this. Cut off the socket with a hacksaw and make a ¼-inch cut at the end of the shaft. You now have a handy tool for twisting the mounting tabs on filter capacitor cans, tab-mounted controls, tab-mounted tuner shields, tab-mounted

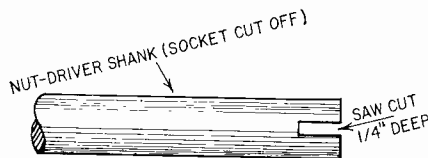

transformers, etc. It will do a much better job than long-nose pliers, it will reach tight spots where pliers will not fit, and it will handle heavier material than long-nose pliers.—*Albert J. Krukowski*

[The nut driver must have a solid—not a hollow—shank.—*Editor*]

### Loose-leaf Binder Keeps Magazine Contents Pages

I file my issues of RADIO-ELECTRONICS in order in boxes for future reference. But first I clip out the contents pages and file them in a loose-leaf notebook. Your system of arranging

articles in categories makes searching for a particular article very easy. If I want to build a preamp, I look in my notebook under "audio-high fidelity-stereo" until I find what I want. Then I look at the top of the page to see what month's issue the article is in and get the magazine from the box.—*Bernard A. Bernsen*

[As an additional aid, try clipping and filing away the annual (now semi-annual) indexes in the December and June issues, respectively.—*Editor*] END

### 50 Years Ago In Gernsback Publications

HUGO GERNSBACK, Founder	
Modern Electrics .....	1908
Wireless Association of America .....	1908
Electrical Experimenter .....	1913
Radio News .....	1919
Science & Invention .....	1920
Practical Electronics .....	1921
Television .....	1927
Radio-Craft .....	1929
Short-Wave Craft .....	1930
Television News .....	1931

Some larger libraries still have copies of Modern Electrics and the Electrical Experimenter on file for interested readers.

In December, 1913, *Electrical Experimenter*

Dr. de Forest on the Audion Amplifier.  
Modern Radio-Telegraphic Receiving Sets, by H. Winfield Secor.  
Constructing an Oscillation Transformer, by Samuel Cohen.  
How to Make a Novel Wireless Recorder, by Albert E. Shaw.  
Variable Condenser Connections.

The time to sell is when you have a customer. And the place to sell is where you have some 157,000 customers—the classified pages of RADIO-ELECTRONICS.

## FIX ELECTRIC APPLIANCES

PAYS \$3 TO \$5 AN HOUR  
Spare Time, Full Time • Learn at Home

FREE BOOK offered below shows how YOU can now have a good-paying business of your own, right in your home. No experience needed, just simple tools. Learn to repair Electric Appliances. Pays \$3-\$5 an hour!

400 MILLION Appliances are in American homes right now. 76 Million MORE bought each year. People need them fixed, good times or bad. YOU make good money doing it. In your basement, garage, even on your kitchen table.

Quick Way To Get Started For less than 20¢ a day our easy, pictured instruction—backed by 45 years of success in home training—prepares you for top earnings in this booming field. Earl Reid of Thompson, Ohio says: "Made \$510 in one month spare time. NRI course is priceless." At no extra charge you even get all parts for your own Appliance Tester, too. Finds trouble-spots, speeds and checks your work.

Get your FREE Book and FREE Sample Lesson! Mail coupon below, letter or postcard, now.

### FREE BOOK • FREE LESSON

NATIONAL RADIO INSTITUTE, Appliance Division  
Dept. FNS, Washington 16, D. C.

Send Free Book, Free Appliance Repair Course Lesson. Am interested in:

Spare Time Earnings  My Own Business  
 Better Job

Name.....  
Address.....  
City..... Zone..... State.....  
Accredited Member—National Home Study Council

## NEW! LAFAYETTE 12-TRANSISTOR 2-WAY "WALKIE TALKIE" WITH SQUELCH

only **39.95** 2 for **78.88**

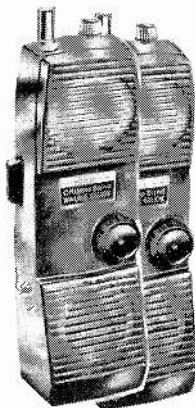

More fun... better performance... greater value, than ever. Superb for fishing, hunting or business use. No age restrictions or license requirements when used as per Part 15 FCC regulations. Features: separate microphone and speaker for better sending and receiving, excellent noise squelch; crystal controlled receive and transmit, positive action push-to-talk switch and 46" telescoping antenna. As a bonus feature, the HE-100 may be operated in the home with an AC power pack. (Optional see below) Saves batteries too! Includes crystals, earphone, leather carrying case and batteries.

ies. Shpg. wt., 22 oz. Imported HE-100L Walkie-Talkie Net 39.95 Pair for 78.88

### NEW! AC POWER PACK

Converts 117VAC to 9V DC. Plugs into HE-100. HE-97 Net 7.45

ORDER A PAIR TODAY!

LAFAYETTE Radio ELECTRONICS  
Dept. JH-3, P.O. Box JL-3  
Syosset, L. I., N. Y.

Send me: Walkie Talkie..... (HE-100L)  
AC Power Pack..... (HE-97),  
Shipping charges collect. \$..... enclosed.

Name.....  
Address.....  
City..... Zone..... State.....

## NO FREE premiums NO PRIVATE labels NO ineffective liquids or carbon tet ALL YOU GET IS GENUINE "NO NOISE" QUALITY

- formulas developed by chemists
- 14 years of recognized leadership

### BEWARE OF CHEAP IMITATIONS INSIST ON NO-NOISE



- VOLUME CONTROL and Contact Restorer
  - TUNER-TONIC for all tuners including water type
  - FORMULA EC-44 for all electrical contacts
- PLUS FREE with all No-Noise products, 5" plastic extender push-button assembly for pin-point applications. Does not cause shorts!

## ELECTRONIC CHEMICAL CORP.

813 Communipaw Avenue Jersey City 4, N. J.

**new**

Vol. 21, 2082  
1963

52/72, 603

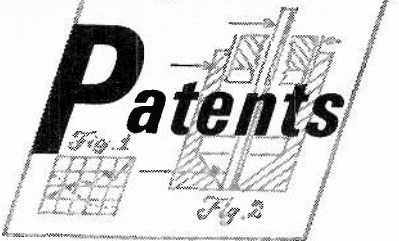

**Temperature-Compensated Zener Bridge**

PATENT No. 3,087,109

Melville D. Bowers, Lake Valhalla, Montville, N.J.  
(Assigned to McGraw-Edison Co., Milwaukee, Wis.)

By making one arm of a Wheatstone bridge a Zener diode (D) and the other arms fixed resistors, the bridge becomes voltage-sensitive. Balance oc-

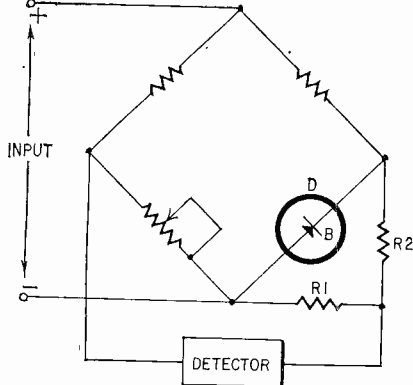

curs only with a definite input voltage.

Temperature error may be eliminated by adding R1, R2, across D (see diagram). R2 has a pos-

itive temperature coefficient. To preserve balance in spite of changes in temperature, we must choose the proper temperature coefficient. The current through R1 must not change.

**Flaw Detection**

PATENT No. 3,097,337

Herbert S. Polin, Vevrier (Geneva) Switzerland

To check for possible cracks or flaws in a metal casting, a nonconducting phosphor powder is dusted over the metal. A fixed electrode and a movable probe are connected across high voltage ac (at

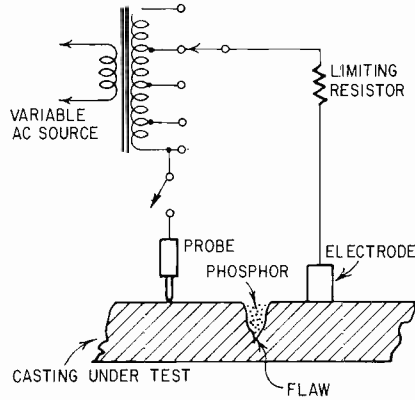

least 100 volts). Where the powder has penetrated the surface, it acts as a dielectric with respect to the adjacent metal. The alternating field excites the phosphor, causing it to glow. This points out the location and size of the flaw.

**Solar-Cell Battery Charger**

PATENT No. 3,089,070

Eugene L. Ralph, Skokie, Ill. (Assigned to Hoffman Electronics Corp.)

A combination of a solar cell and battery may be used to supply radios or other low-power equipment. An ordinary solar cell has low impedance in both directions, however, so the battery discharges through it when the sun is hidden.

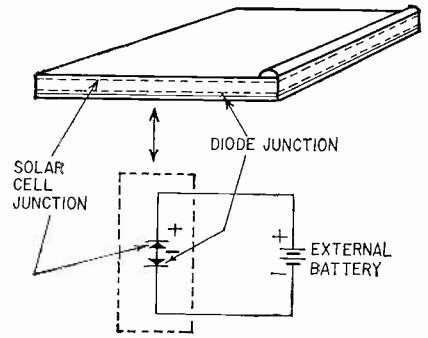

The new device has two junctions. The lower one is a high-reverse-impedance rectifier. Thus the battery cannot discharge through it.

**Automatic Illumination**

PATENT No. 3,093,744

Michael Tabet, Norfolk, Va.

This lamp goes on automatically as darkness approaches, and off with the coming of dawn.

The drawing shows a heater in series with a photocell across the line. Daylight reduces cell

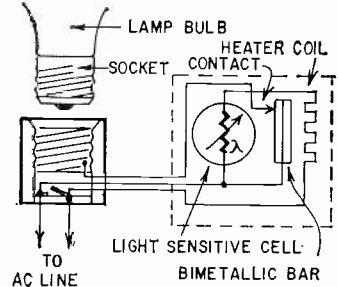

resistance and permits a large current to heat the bi-metal bar. It bends away from the fixed contact to open the lamp circuit. During darkness, the bar cools, closing the contacts.



**SELF-SERVICE TUBE TESTERS**  
are **BIG INCOME PRODUCERS**

**NEW** MODERN EYE-STOPPING TESTERS... TOPS  
in PERFORMANCE... QUALITY... and VALUE

Here is everything you want in self-service tube testers at down-to-earth prices. **MORE VERSATILITY**—Tests emission, shorts and gas of over 1200 tube types including the very latest NUVIDIORS, NOVARS, COMPACTRONS, etc... Also tests fuses, pilot lights, 6 and 12 volt auto radio vibrators, all type batteries under load. **SMARTER LOOKING**—Modern cabinet design finished in a rich green and white color combination with gold trim... Eye-stoppers in any location—will attract do-it-yourself customers as never before and sell tubes in a big way. **MORE QUALITY FEATURES**—Completely self-service... Only two easy-to-use controls are required to test any tube... Easy-to-read quick flip tube charts list over 1200 tube types... Engineered to accommodate new tube types as they are introduced... Etched aluminum panel always retains its handsome appearance... 63 phosphor-bronze beryllium tube sockets assure positive contacts and long life.

Replace old self-service tube testers with Mercury testers and spark-up your present locations... place them in new locations and be assured of the greatest profit results.

*Slightly higher in the West*

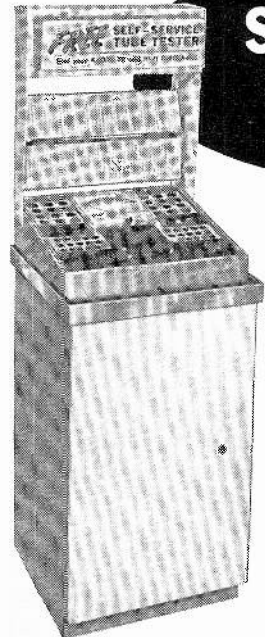

**Model 202-LB**  
(Lo-Boy Floor Model) Dealer Net **\$184.50**

**Model 202-C**  
(Counter Model) Dealer Net **\$129.95**

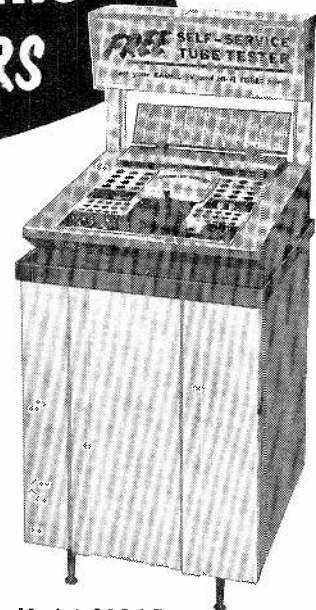

**Model 203-LB**  
(Deluxe Lo-Boy Floor Model) Dealer Net **\$254.50**

**Model 203-C**  
(Deluxe Counter Model) Dealer Net **\$166.95**

**MERCURY ELECTRONICS CORPORATION, 111 ROOSEVELT AVENUE, MINEOLA, NEW YORK**

"ELECTRONIC **Spico** BREAKTHROUGH"

# TRANSISTAR

## FIRST TRANSISTORIZED INDOOR TV & FM ANTENNA

TV & FM SIGNALS UP TO 35 TIMES MORE POWERFUL  
For: Black & White • Color • FM • Monaural • Stereo

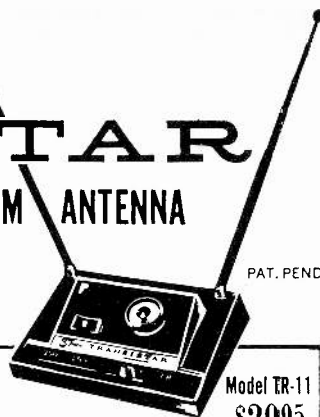

NO MORE NEED FOR COSTLY OUTDOOR INSTALLATIONS IN FRINGE AREAS, up to 60 MILES!

See and hear this scientific fact with your own eyes and ears . . .

The results of three years research by Spico — the **electronic breakthrough** that introduces the first **transistorized** indoor antenna for Television, Black and White, Color; FM, Monaural or Stereo. TV and FM signals are boosted up to 35 times more powerful through **transistor amplification**, which **guarantees the strongest, clearest pictures**. Snow and ghosts go on TV. It delivers as much volume and clarity on weak, distant FM and Stereo stations, as desired, without distortion. Equipped with adjustable, calibrated Radar Probe, for preliminary tuning and Adjusta-Knob for final, micro-fine tuning. The **TRANSISTAR** plugs into any AC line. No Couplers needed for multiple operation of TV, FM and Stereo sets.

THE MOST REVOLUTIONARY INDOOR ANTENNA MADE SINCE THE ADVENT OF TELEVISION.  
SPIRLING PRODUCTS CO., INC. • HICKSVILLE, L. I., N. Y.

# new Books

ELEMENTS OF ENGINEERING REPORTS, by Dale S. Davis. Chemical Publishing Co., Inc., 212 5th Ave., New York 10, N. Y. 5 1/2 x 8 1/2 in., 200 pp. Cloth, \$8.50.

A detailed text with a number of examples of reports reproduced exactly.

TV TROUBLESHOOTER'S REFERENCE HANDBOOK, by Stuart Hoberman. Howard W. Sams & Co., Inc., 4300 W. 62 St., Indianapolis 6, Ind. 5 1/2 x 8 1/2 in., 128 pp. Paper, \$2.95.

A systematic approach for interpreting symptoms, isolating troubles, and repairing in shortest time. Color problems are included.

ELECTRONIC DEVICES AND NETWORKS, 217 pp. ELECTRONIC CIRCUIT TECHNIQUES, 212 pp. Both volumes edited by E. E. Zepler and S. W. Punnett. D. Van Nostrand Co., Inc., Princeton, N.J., 6 x 9 in. Cloth, \$6.50 each.

These volumes cover theory, with math, of tubes, transistors, and the circuits that use them, including amplifiers, oscillators, pulse generators, etc. Written particularly for scientists and engineers who work in other fields, but must know how to use and operate electronic instruments.

CB RADIO CONSTRUCTION PROJECTS, by Len Buckwalter. Howard W. Sams & Co., 4300 W. 62 St., Indianapolis, Ind. 5 1/2 x 8 1/2 in., 111 pp. Paper, \$2.50.

You can build these test equipment projects and accessories to get more out of CB radio.

ELECTRIC CIRCUITS, by E. Norman Lurch. John Wiley & Sons, 440 Park Ave. South, New York 16, N.Y. 6 x 9 in., 565 pp. Cloth, \$7.50.

Introduction to (nonelectronic) dc and ac circuits using high school math up to trig functions and complex numbers. Many numerical problems are supplied with answers.

ABC'S OF ELECTRONIC DRAFTING, by Howard W. Sams Engineering Staff. Howard W. Sams & Co., Inc., 4300 W. 62 St., Indianapolis 6, Ind. 5 1/2 x 8 1/2 in. 96 pp. Paper, \$1.95.

Covers the subject extraordinarily well for its small size. The chapter on symbols is especially useful.

MATHEMATICAL ASPECTS OF PHYSICS: AN INTRODUCTION, by Francis Bitter. Anchor Books, Doubleday & Co., Inc., Garden City, N.Y. 7 1/4 x 4 1/4 in., 188 pp. Paper, \$1.25.

MATHEMATICS AND THE PHYSICAL WORLD, by Morris Klein. Anchor Books, Doubleday & Co., Inc., Garden City, N.Y. 7 1/4 x 4 1/4 in., 546 pp. Paper, \$1.95.

These two books tend to complement each other in their coverage. *Mathematical Aspects of Physics* is slanted toward the physical side with chapter heads and sub-heads such as "The Significance of Physical Measurement," "Motion of Earth Around the Sun," "Mechanical Vibrations," "The Fields of Coils," etc., while *Mathematics and the Physical World* uses such chapter

## Want Back Issues?

Back numbers of most issues of **RADIO-ELECTRONICS** are available upon request

This year's issues	50¢
Last year's issues	55¢
Previous year	60¢, etc.
Maximum	\$1.00

RADIO ELECTRONICS • 154 West 14th Street, N. Y., N. Y. 10011

# ELECTRONICS

## Engineering-Technicians

Bachelor of Science Degree, 30 Months  
Save Two Years' Time

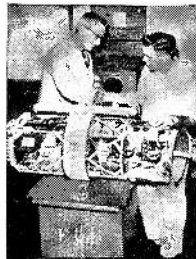

The Nation's increased demand for Engineers,

Electronic Technicians, Radio TV Technicians is at an all time high. Heald Graduates are in demand for Preferred High Paying Salaries. Train now for a lucrative satisfying lifetime career.

- Radio-Television Plus Color Technician (12 Months)
- Electronics Engineering Technology (15 Months)
- Electronics Engineering (B.S. Degree)
  - Electrical Engineering (B.S. Degree)
  - Mechanical Engineering (B.S. Degree)
  - Civil Engineering (B.S. Degree)
  - Architecture (B.S. Degree) (36 Months)

Approved for Veterans  
DAY AND EVENING CLASSES

Write for Catalog and Registration Application.  
New Term Starting Soon.

Your Name .....

Address .....

City .....

State .....

# HEALD'S

ENGINEERING COLLEGE  
Est. 1863—100 Years  
Van Ness at Post, RE  
San Francisco, Calif.



# Classified Ads

## Audio—Hi-fi

WRITE FOR LOWEST QUOTATIONS, Components, Recorders, No Catalogs. **HI-FIDELITY SUPPLY**, 2817-SC Third, New York 55, N.Y.

4/TR STEREO TAPES—bought, sold, rented, traded! Bargain closeouts! Catalog/**COLUMBIA**, 9651 Foxbury, Rivera, Calif.

STEREO TAPE CLUB—All major labels, latest releases. Fast service, worldwide membership, no minimum purchase. **STC**, Box 652-C, Santa Barbara, California 93102.

FREE INFORMATION how to add professional sound to tape recorders. **FAK**, 14 RE, Stockholm 10, Sweden.

TAPE recorders, Hi-Fi components, Sleep-learning equipment, Tapes, Unusual values. Free catalog. **DRESSNER**, 1523 Jericho Turnpike, New Hyde Park 5, N.Y.

SALE ITEMS—tapes—recorders—component quotes. **BAYLA**, Box 131-RE, Wantagh, N.Y.

RENT STEREO TAPES—over 2,500 different—all major labels—free brochure. **STEREO-PARTI**, 811-RE, Centralia Ave., Inglewood 3, Calif.

HI-FI COMPONENTS, tape recorders at guaranteed "We Will Not Be Undersold" prices. All brands in stock. 15-day money-back guarantee. 2-year warranty. Write your requirements for quotation. No catalog. **HI-FIDELITY CENTER**, 1797D 1st Ave., New York 28, N.Y.

ATTACH ADAPTOR to conventional Stereo Amplifier. Add two speaker cabinets. Witness full natural sound reproduced with full incremental locations. Unit encapsulated. Guaranteed. \$39.95 Prepaid USA. **"STEREOSPHERE"** 441 South Edgement Cr., Huntsville, Alabama 35811.

## MISCELLANEOUS

PRINTING PRESSES, Type, Supplies. Lists 5¢. **TURNBAUGH SERVICE**, Mechanicsburg, Pa.

JUST STARTING IN TV SERVICE? Write for FREE 32 PAGE CATALOG of Service Order books, invoices, job tickets, phone message books, statements and file systems. **OEIRICH PUBLICATIONS**, 6556 W. Higgins, Chicago, Ill. 60656.

SONGS INTO \$\$\$\$\$. New, unknown Songwriters, Songpoets, Composers share \$33 millions yearly. Any subject, we collaborate, publish, promote. Free appraisals, free samples, details. **NORDYKE PUBLISHERS**, 6000 Sunset, Hollywood, Calif. 29-90028.

## SERVICES

SPEAKER RECONING. Satisfaction Guaranteed. **C & M REONE CO.**, 18 E. Trenton Ave., Morrisville, Pa.

TV TUNERS REBUILT AND ALIGNED Per manufacturer's specification. Only \$9.50. Any make UHF or VHF. We ship COD. 90-day written guarantee. Ship complete with tubes or write for free mailing kit and dealer brochure. **J. W. ELECTRONICS**, Box 51D, Bloomington, Ind.

ALL MAKES OF ELECTRICAL INSTRUMENTS AND TESTING equipment repaired. **HAZELTON INSTRUMENT CO.**, 128 Liberty St., New York, N.Y.

METERS—MULTIMETERS REPAIRED and calibrated. **BIGELOW ELECTRONICS**, Box 71-B, Bluffton, Ohio.

TRANSISTORIZED products dealers catalog. \$1. **INTERMARKET**, CPO 1717, Tokyo, Japan.

TV TUNERS REBUILT AND ALIGNED per Manufacturer's specifications. Only \$9.50. Guaranteed. We ship COD. **VALLEY TUNERS**, 5641-A Cahuenga, No. Hollywood, Calif.

## WANTED

QUICK CASH... for Electronic EQUIPMENT, COMPONENTS, unused TUBES. Send list now! **BARRY**, 512 Broadway, New York, N.Y. 10012, 212 WALKER 5-7000.

WANTED Transistors, Tubes all types. Test Equip., Ground Equip., PRC, GBC, TB, UBM, UPM, Aircraft Communications & Navigation Equip. **ELECTRONIC TUBES**—Industrial, Special Purpose, Receiving-TV, Transistors-Diodes LAB TEST EQUIPMENT, AIRCRAFT & GROUND COMM EQUIPMENT INTERNATIONAL. Write or Phone **V & H RADIO**, 2053 Venice, L.A. 6, Calif. RE 5-0215.

G-R, H-P, L&N, etc., Tubes, manuals, military electronics. **ENGINEERING ASSOCIATES**, 434 Patterson Road, Dayton 19, Ohio.

Rates—55¢ per word... minimum 10 words. Payment must accompany all ads except those placed by accredited advertising agencies. Misleading or objectionable ads not accepted. Copy for February issue must reach us before December 14th. Figure one word: name of city (New York), name of state (New Jersey). Sets of characters as in key (741-RE), also abbreviations as 8x10 mm, A.C., D.C., C.O.D. Hyphenated words not normally considered such count as two words (Hi-Fi). **ZONE NUMBER FREE. RADIO-ELECTRONICS**, 154 West 14 St., New York, N.Y. 10011.

## EDUCATION/ INSTRUCTION

DO YOU KNOW HOW TO STUDY? Over 90% do not except to read, reread and try to remember. The **MAXWELL SIMPLIFIED METHOD OF STUDY** will teach you within an hour how to study for better grades and self improvement. Simple, efficient, practical, systematic proven 3rd edition, \$2 from **STUDY METHODS**, Drawer 419, Pacific Grove, Calif.

SLEEP LEARNING. Hypnotism! Tapes, records, books, equipment. Details, strange catalog FREE. **RESEARCH ASSOCIATION**, Box 24-RD, Olympia, Wash.

LEARN ELECTRICITY, appliance repair in 32 compact lessons. **WORLDWIDE INSTITUTE**, Dept. 102, 2555 Shelley, Indiana, Penna.

FCC LICENSE in 6 weeks. First Class Radio Telephone. Results Guaranteed. **ELKINS RADIO SCHOOL**, 2603E Inwood, Dallas, Tex.

LEARN ELECTRONIC ORGAN SERVICING. New Home Study courses covering all makes electronic organ including transistors. Experimental kits—schematics—troubleshooting. Accredited **NHSC-GI** Approved. Write for free booklet. **NILES BRYANT SCHOOL**, 3631 Stockton Blvd., Dept. F. Sacramento 20, Calif.

MATHEMATICS. ELECTRONICS. Pay as you learn. Free brochure. **INDIANA HOME STUDY INSTITUTE**, P.O. Box 282, Saxonville, Mass.

LEARN WHILE ASLEEP. 92% effective. Build dynamic personality. Improve health. Motivate success. Details free. **A.S.R. FOUNDATION**, Box 70721RE, Henry Clay Sta., Lexington, Ky.

## FOR SALE

ANTIQUA EDISON CYLINDER PHONOGRAPHS released from 50 years storage. All work. Complete. Concert Horn, Cylinders. Each — \$70. **WHITLOCK'S STORAGE**, 114 State, Brewer, Me.

## BUSINESS AIDS

1,000 Business Cards. "Raised Letters" \$3.75 postpaid. Samples. **ROUTH**, RE12, 3105 Collier Drive, Greensboro, N.C. 27403.

10,000 CIRCULARS. \$39.00. Information and samples free. **JASON**, 2336 Orthodox, Philadelphia, Pa., 19137.

CB—QSL CARDS; Distinctive Business Printing. Free Samples. **THE PRINT SHOP**, Ramseur, North Carolina.

## General

TV SERVICE ORDER BOOKS for use with your rubber stamp. Duplicate or triplicate. Low cost. Write for FREE 32 PAGE CATALOG and Special Rubber Stamp Offer. **OEIRICH PUBLICATIONS**, 6556 W. Higgins, Chicago, Ill. 60656.

1000 BUSINESS CARDS \$3.95. Rubber stamps \$1.00. Free Bargain List. **ALCO**, Box 244-R, Urbana, Ill.

\$30.00 VALUE—7" TV test picture tube, perfect for 70° and 90° sets, built-in ion trap—your cost \$6.99. Tubes-new, jobber-boxed RCA, G.E., etc.—65% off list prices. Special: Tube #6146—\$2.95 each. Send your order. We pay postage (you save 4%). Immediate delivery. Write for Free Catalog listing thousands of parts, phono needles, tubes, etc. **ARCTURUS ELECTRONICS CORP.**, Dept. RE, 502 22nd St., Union City, N.J.

BEFORE You Buy Receiving Tubes, Test Equipment, Hi-Fi Components, Kits, Parts, etc... send for your Giant Free Zalytron Current Catalog, featuring all STANDARD BRAND TUBES all Brand New Premium Individually Boxed, One Year Guarantee—all at BIGGEST DISCOUNTS in America! We serve professional servicemen, hobbyists, experimenters, engineers, technicians. WHY PAY MORE? **ZALYTRON TUBE CORP.**, 461 Jericho Turnpike, Mineola, N.Y.

JAPANESE MERCHANDISE from Radio to Camera. Any inquiries answered. Catalog, information and pricelist \$1.00. **TOMIO UENO**, No.538 Shibamatacho, Katushikaku, Tokyo.

## Canadians

GIANT SURPLUS BARGAIN PACKED CATALOGS. Electronics, Hi-Fi, Shortwave, Amateur, Citizens Radio, Rush \$1.00 (Refunded), **ETCO**, Box 741, Dept. R. Montreal 1, Can.

## Electronics

BOOK. 200 ELECTRIC STUNTS. \$1.00 **CUT-TRADO**, 875 Arastradero, Palo Alto, Calif.

GOVERNMENT SURPLUS. Voltmeters — \$1.05. Frequency — \$4.37. Transmitters — \$6.18. Oscilloscopes. Multimeters, Speakers, Parts. Typical Surplus Prices. Exciting Details FREE. Write: **ENTERPRISES**, Box 402-F17, Jamaica 30, New York.

DIAGRAMS, service material. Radio, Television, \$1.00. **SUPREME PUBLICATIONS**, 1760 Balsam, Highland Park, Illinois, 60035.

CB TRANSMITTERS \$6.00. Other bargains, send 10¢ for list. **VANGUARD**, 190-48 99th Ave., Hollis 23, N.Y.

RADIO, TV components, testers, etc. Imported. **UNITA**, 545 Fifth, New York 17.

VIDICON LENSES FOCUSING TYPE C MOUNTS 25 mm f1.9 \$17.95, f1.4 \$24.95. Others available. **TELEVISION ASSOCIATES**, 2816 E. Norwich, Fresno, Calif.

CONVERT any television to sensitive, big-screen oscilloscope. Only minor changes required. No electronic experience necessary. Illustrated plans \$2. **RELCO**, Box 10563, Houston 18, Tex.

PROFESSIONAL ELECTRONICS PROJECTS — Organs, Timers, Computers, etc.—\$1 up. Catalog free. **PARKS**, Box 1665, Seattle, Wash. 98125.

"COIL WINDING METHODS" Handbook—50¢. Experimenter's catalog 250 exclusive items—25¢, refundable. **LABORATORIES**, 1131-B Valota, Redwood City, California.

PRINTED CIRCUIT BOARDS. Hams, Experimenters. Free catalog. **P/M ELECTRONICS**, Box 6288 Seattle, Wash. 98188.

SAVE DOLLARS on radio, TV tubes, parts at less than manufacturer's cost. 100% guaranteed! No rebrand, pulls. Request Bargain Bulletin. **UNITED RADIO**, 1000-R, Newark, N.J.

DIAGRAMS FOR REPAIRING RADIOS \$1.00. Television \$2.50. Give make, model. **DIAGRAM SERVICE**, Box 1151 RE, Manchester, Conn.

TV CAMERA under \$40.00—Completely transistorized space age flying spot scanner—schematic, pictures and plans for \$3.00. **BECK**, 777 Ruth, Newbury Park, Calif.

TRANS-NITION Electronic Ignition parts kit, Negative ground \$20. Coil, Manual **SPECIAL \$8.50**. Manual \$2. **ANDERSON ENGINEERING**, Wrentham, Mass.

DIAGRAMS for TV. \$2.00; for radio, \$1.00. **HIETT DIAGRAMS**, 1307 Iturbide, Laredo, Tex.

# SCHOOL DIRECTORY

## ENGINEERING B.S. DEGREE SCIENCE IN 36 MOS. MATH

U.S. NEEDS 50,000 NEW ENGINEERS A YEAR!  
EARN ACCREDITED B.S. DEGREE in Science or  
Engineering in 36 months—year-round program optional.  
27-month engineering diploma also available. Classes  
start Jan., Sept., March, June. QUALITY EDUCATION.  
Graduates employed throughout the U. S. and abroad.  
Government approved for veteran training. Students from  
50 states, 40 countries, 20 buildings; dorms, gym, Campus,  
New library and laboratories. Employment help provided.  
SAVE TIME AND MONEY. Write for catalog.  
1616 E. Washington Boulevard, Fort Wayne 2, Indiana

## Indiana Institute of Technology formerly Indiana Technical College

**Engineering Technician**  
A.S. Degree—2 Years  
**Electronics Engineer**  
B.S. Degree  
Evening Courses Available  
**ELECTRONIC TECHNICAL INSTITUTE**  
970 W. Manchester Ave., Inglewood, Calif.  
4863 El Cajon Blvd., San Diego, Calif.

## ENGINEERING EDUCATION for the Space Age

**NORTHROP INSTITUTE of Technology**  
is a privately endowed, nonprofit college of engineering  
offering a complete Bachelor of Science Degree Program  
and TWO-YEAR accredited technical institute curricula.  
Students from 50 states, many foreign countries. Outstand-  
ingly successful graduates employed in aeronautics, elec-  
tronics, and space technology. Write today for catalog—  
no obligation.  
**NORTHROP INSTITUTE OF TECHNOLOGY**  
1181 West Arbor Vitae Street, Inglewood 1, California

C. L. Foster, President, Central Technical Institute, says:  
"Why be satisfied  
with home study  
electronics training  
that goes only half way?"

Get facts about new, modern training in  
**PRACTICAL ELECTRONICS**  
plus... bonus training in  
**APPLIANCE and ELECTRICAL  
REPAIR and WIRING**

You Get All These New  
"INSTANT" KITS FOR  
LEARN by DOING  
PRACTICE

One of America's Leading  
Electronics Schools Now Offers  
Important "Plus Training"

Rush coupon to find out how much  
more Central Technical Institute  
offers! Our new course in **Prac-  
tical Electronics Technology**  
prepares you for a good paying  
career in this booming industry.  
Qualify for opportunities open to  
trained men in Radio-TV Servicing,  
Color Television, Manufacturing,  
etc. Get **bonus** training **with-  
out added cost** in profitable Ap-  
pliance Servicing and Electrical  
Wiring. Earn extra money in spare  
hours while training! New easy-to-  
understand "plain language" les-  
sons! You "learn-by-doing" with  
training kits we supply. Graduate  
resident training available, with  
full credit for home study. **Prac-  
tical Electronics Technology** also

gives you essential background  
for optional advanced training in Broadcast-  
ing, Communications, Nuclear Power or Aero  
Space Industry to help you specialize. Rush  
coupon for new FREE BOOK. Est. 1931...  
Accredited by National Home Study Council.

**FREE BOOK - MAIL COUPON**

Central Technical Institute, Dept. 03123,  
1644 Wyandotte St., Kansas City 8, Mo.

Rush latest edition "Practical Electronics" telling about  
careers in Electronics for trained men—FREE!

Name.....  
Address.....  
City..... Zone..... State.....

## small college year-round program

Professionally-oriented education... *Bachelor of  
Science Degree in 36 Months* in Electrical (Elec-  
tronics or Power option), Mechanical, Civil,  
Chemical, Aeronautical Engineering; in Business  
Administration. One-year Drafting-Design Certifi-  
cate Program. Founded 1884... rich heritage.  
Excellent faculty. Small classes. 200-acre campus.  
New library. Well-equipped labs. Residence halls.  
Modest costs. Outstanding placement of graduates.  
Enter Jan., March, June, Sept. Write J. G.  
McCarthy, Director of Admissions.

## TRI-STATE COLLEGE

24123 College Avenue • Angola, Indiana

**ENGINEERING DEGREES**  
Electronics, Mechanical,  
Also LIBERAL ARTS &  
MAJOR IN ACCOUNTING  
earned by  
**HOME STUDY**  
Resident Classes Also  
Available if Desired  
Specify course preferred  
**PACIFIC  
INTERNATIONAL  
COLLEGE OF ARTS  
& SCIENCES**  
Primarily a correspondence school  
Chartered 1935  
5719-M Santa Monica Blvd. Hollywood 38, Calif.

**EARN Electronics DEGREE**  
Engineering  
You can earn an A.S.E.E. degree at home. College  
level HOME STUDY courses taught so you can under-  
stand them. Continue your education, earn more in the  
highly paid electronics industry. Missiles, computers,  
transistors, automation, complete electronics. Over  
27,000 graduates now employed. Resident school  
available at our Chicago campus—Founded 1934. Send  
for free catalog.  
**American Institute of Engineering & Technology**  
1139 West Fullerton Parkway, Chicago 14, Ill.

**FOR AN  
ELECTRONICS  
CAREER**  
Write For Free Catalog RE  
WEEKLY TUITION

**MICROWAVE TECHNIQUES—TV  
INDUSTRIAL ELECTRONICS  
COMPUTERS—RADIO  
TRANSMITTERS—RADAR**

**PHILADELPHIA WIRELESS  
TECHNICAL INSTITUTE**  
1533 Pine Street Philadelphia 2, Pa.  
Founded in 1908 • A-Non-Profit Corp.

**GET INTO  
ELECTRONICS**

V.T.I. training leads to success as  
technicians, field engineers, special-  
ists in communications, guided mis-  
siles, computers, radar and automation.  
Basic & advanced courses in theory &  
laboratory. Electronic Engineering  
Technology, an ECPD accredited Techni-  
cal Institute curriculum. Assoc. degree  
in 20 mos. B.S. also obtainable. G.I.  
approved. Graduates in all branches of  
electronics with major companies. Start  
Feb., Sept. Dorms, campus. High  
school graduate or equivalent. Catalog.

**VALPARAISO TECHNICAL  
INSTITUTE**  
Department C, Valparaiso, Indiana

CAR RADIOS  
REPAIRED  
ALL MAKES

"We ran into a little  
trouble - he's stuck."

headings as "The Laws of Space and  
Forms," "Deductions from the Law of  
Gravitation," "The Mathematics of Oscilla-  
tory Motion" and "Mathematical Oscilla-  
tions of the Ether," to name four of the 27  
chapters. Together, they tend to bridge the  
gap, felt by many students, between mathe-  
matics and the things that mathematics  
describes.

**BASIC RADIO REPAIR** (2 vols.), by Marvin Tep-  
per. John F. Rider Publisher, Inc., 116 W. 14th  
St., New York 11, N.Y. 6 x 9 in., 106 pp. (each  
vol.) Paper, \$2.65 (each vol.)

Well illustrated, clear explanations.  
Vol. 1 covers test instruments and servicing  
of tube sets; Vol. 2 continues with FM,  
transistor sets and transmitters.

**HIGH-SPEED SWITCHING TRANSISTOR HAND-  
BOOK.** Motorola Semiconductor Products, Inc.  
PO Box 955, Phoenix 1, Ariz. 5 1/2 x 8 1/2 in.,  
346 pp. Paper, plastic ring bound, \$2.50.

Comprehensive coverage of theory  
and applications, with numerous charts,  
graphs and examples, for design engineers.

**TROUBLESHOOTING WITH THE OSCILLOSCOPE,**  
by Robert G. Middleton. Howard W. Sams & Co.,  
Inc., 4300 W. 62 St., Indianapolis 6, Ind. 5 1/2 x  
8 1/2 in., 160 pp. Paper, \$2.50.

How to use your scope to locate  
trouble quickly, particularly in TV circuits.  
Typical waveforms show normal and de-  
fective conditions.

**AN INTRODUCTION TO HI-FI & STEREO,** by  
Hans Fantel. Institute of High Fidelity, Inc., 516  
Fifth Avenue, N. Y. 36, N. Y. 6 1/2 x 9 1/2 in., 64 pp.  
Paper, \$25 (handling charge).

This 64-page book explains high-fidel-  
ity in the language of the layman. Intended  
for the person interested in music who may  
plan to buy high-fidelity equipment, it ex-  
plains each component in terms that en-  
lighten without confusing. Includes a  
glossary of high-fidelity terms.

**AMATEUR RADIO CONSTRUCTION PROJECTS,** by  
Charles Caringella. Howard W. Sams & Co., Inc.,  
4300 W. 62 St., Indianapolis 6, Ind. 5 1/2 x 8 1/2  
in., 136 pp. Paper, \$2.50.

Complete data for building novice  
transmitters, crystal converters, walkie-  
talkies and other ham equipment.

**SILICON CONTROLLED RECTIFIER HOBBY MAN-  
UAL.** General Electric Rectifier Dept., Auburn,  
N.Y. 5 1/2 x 8 1/2 in., 70 pp. Paper, \$1.00.

This book presents the silicon con-  
trolled rectifier for home experimenters. It  
explains how to make dimmers, timers, con-  
trols for motors, heaters, etc.

**BASIC SERVOMECHANISMS,** by Ed Bukstein.  
Holt, Rinehart & Winston, Inc., 383 Madison Ave.,  
New York 17, N.Y. 9 1/4 x 6 1/4 in., 190 pp. Cloth,  
\$5.25.

The how and why of closed-loop con-  
trol systems and the elements that make  
them up, written so the person without pre-  
vious experience with servomechanisms can  
understand it.

**DESIGN AND OPERATION OF DIGITAL COM-  
PUTERS,** by Dr. Gerhard Haas. Howard W. Sams  
& Co., Inc., 4300 W. 62 St., Indianapolis 6, Ind.  
5 1/2 x 8 1/2 in., 272 pp. Cloth, \$6.95.

Analysis of circuits, components and  
techniques, for engineers and designers en-  
tering the computer field. END

# Radio-Electronics Market center

**TRANSISTORS\*\*\*NEW**  
 I.F. converter, switch, audio, also high frequency; PNP and NPN ..... 3/\$1.00  
 Power transistors—20 to 70 watts ..... 3/\$1.00  
 Brand New; original package; full leads; Guaranteed—RCA, CBS, Raytheon, Texas Instru., U.S. Transistor, General Transistor, Philco.

**DIODES\*\*\*NEW**  
 1N217—Hoffman Elec. Upright, gold leads Rectifier ..... 25  
 1N537—1N539—Tophat; Raytheon, Motorola, General Electric; Rectifier, Silicon ..... 50  
 1N60—Micro-miniature diodes ..... 8/\$1.00  
 Stud type Rectifier—400 PIV—750 MA. .... .50  
 Zener Diodes—12 volt; 1 amp. .... \$1.00  
 Transistor sockets—2 lead—(Chen Co.) ..... 10/\$1.00  
 Driver Transformer—sub-miniature—1/2-1/2-1/2 for transistor P.C. center-tapped ..... 2/\$1.00  
 Audio Output Transformer—sub-miniature—1/2-1/2-1/2 for Transistor P.C. center-tapped ..... 2/\$1.00  
 2 K ohm volume control with switch—P.C. (CPS) miniature ..... 3/\$1.00  
 500 K ohm volume control with switch (Cutter-Hammer) ..... 3/\$1.00  
 455 KC. I.F. sub-miniature transformer ..... 2/\$1.00  
 455 KC. Dual I.F. sub-miniature transformer ..... ea. 60  
 Parts for 2 Watt Audio Power amplifier Consisting of 3 transistors, including 1 power transistor, resistors, electrolytic capacitors, together with schematic. Can be built in a 2" X 2" box ..... \$3.00  
 Parts for 12 volt, 1 amp. REGULATED power supply, with schematic and instructions ..... \$8.95  
 Code Oscillator module; completely assembled Matchbook size with schematic, etc. .... \$1.00  
 P. A. Amplifier Module; completely assembled with schematic—3 lead and instructions ..... \$2.00

**WRITE FOR FREE ADDITIONAL CATALOG.**  
 Minimum order \$3.00  
 Prepaid Postage Free in U.S.  
**TRANSISTORS UNLIMITED COMPANY**  
 Post Office Box #442, Great Neck, L. I., New York

**Convert any television to sensitive**  
**BIG-SCREEN OSCILLOSCOPE**  
 with minor, inexpensive changes. Ingenious circuit. No electronic experience needed to follow our clearly illustrated plans. **TECHNICIANS, HAM RADIO EXPERIMENTERS, BROADCASTERS.** Use in shop, school, lab. Any size screen.  
**FULL PLANS \$2**  
**RELCO, Dept. R-12, Box 10563, Houston 18, Tex.**

**TV TUNERS REBUILT**  
 And Exchanged  
 All Makes-Models **ONLY \$9.50** plus shp. chgs.  
 • Includes All Parts Except Tubes  
 • Aligned to Factory Specifications  
 • 90 Day Full Warranty  
 \*Practical repairs  
 Ship tuner complete with tubes, broken parts, tuner cover. Give model and state complete.  
**VALLEY TV TUNER SERVICE • PO 9-4730**  
 5641-A Cahuenga Blvd., North Hollywood, Calif.

**SILICON TOP HATS OR DIODES** 750 MA **LOWEST PRICES GUARANTEED**

**LOW LEAKAGE NEWEST TYPE**

PIV/RMS 50/35 .05 ea.	PIV/RMS 100/70 .09 ea.	PIV/RMS 200/140 .12 ea.	PIV/RMS 300/210 .18 ea.
PIV/RMS 400/280 .23 ea.	PIV/RMS 500/350 .28 ea.	PIV/RMS 600/420 .38 ea.	PIV/RMS 700/490 .50 ea.
PIV/RMS 800/560 .58 ea.	PIV/RMS 900/630 .68 ea.	PIV/RMS 1000/700 .78 ea.	PIV/RMS 1000/770 .88 ea.

**ALL TESTS! AC & DC & FWD & LOAD**  
 100 Dif. Pre. Res. 1/2, 1, 2 WATT—1% Tol. \$1.25  
 G.E. IN91 Diode—10 for \$1.00, 100 for \$8.00  
 Special 1000 PIV—750 MA. 10 for \$7.50

**SILICON POWER DIODE STUDS**

Amps	Piv	Sale	Amps	Piv	Sale
3	50	\$0.15	35	50	\$.95
3	100	.35	35	100	1.20
3	200	.35	35	200	1.50
3	400	.50	35	400	3.00
3	600	.60	35	600	3.25
12	50	.60	50	50	2.25
12	100	.80	50	200	4.00
12	200	1.00	100	50	2.75
12	400	1.50	100	100	3.50
12	600	2.00	100	300	4.00

Money Back guarantee. \$2.00 min. order. Orders F.O.B. NYC. Include check or money order. Shpg. charges plus. C.O.D. orders 25% down.  
**WARREN ELECTRONICS CO.**  
 NYC 7, NY 87 Chambers St. We 2-5727

**FAST SHIPMENTS**  
**RECORDERS • TAPES**  
**COMPONENTS • KITS**  
 • BEST-BY-COMPARISON PRICES  
 • FACTORY SEALED CARTONS  
 VISIT OUR STORE • SEND FOR "QUOTES" ON PACKAGE DEALS AND SAVE MORE  
**WRITE FOR MONTHLY SPECIALS**  
**CARSTON Studios**  
 125-R East 88 St., New York 28, N. Y.

**FREE Catalog**  
**OF THE WORLD'S FINEST ELECTRONIC GOV'T SURPLUS BARGAINS**  
**JUST OUT — NEW EDITION**  
 IF YOU HAVEN'T RECEIVED A COPY OF OUR BIG NEW 1963 FALL/WINTER CATALOG, WRITE FOR YOUR COPY NOW! IT'S FREE!  
 Address Dept. RE  
**FAIR RADIO SALES**  
 2133 ELIDA RD. • Box 1105 • LIMA, OHIO

**CONVERT TO COLOR TV**  
**COLORDAPTOR**—A simple 10-tube circuit and rotating color wheel converts any size B & W TV to receive compatible color.  
**COLORDAPTOR** — Easily attached to any TV set, does not affect normal operation, often built from parts experimenters have on hand, **BRILLIANT COLOR!**  
 Complete booklet—gives theory of operation, all construction details, schematic, and sample color filters..... **\$195**  
 Essential Parts Kit—Includes all special parts—coils, delay line, crystal, color filters. Add \$1.00 for sets over 16". **\$19.95**  
**COLORDAPTOR** 1798 Santa Cruz, Menlo Park, Calif.

**SOLVE ELECTRONICS PROBLEMS FAST WITH SPECIAL NEW PROFESSIONAL SLIDE RULE!**  
 Try this patented, high quality aluminum-alloy instrument free for 10 days. Designed especially to solve electronic problems, it locates decimal points, eliminates converting units, carries special scales and formulas for fast, accurate short cuts. You get attractive carrying case, easy 123-page illustrated instruction manual with practice problems, and 90 day period of free consultation service ... all for only \$14.95. Send cash or money order today, try it out for 10 days ... and get your money back if not fully satisfied!  
**CLEVELAND INSTITUTE OF ELECTRONICS**  
 1776 East 17th Street • Cleveland 14, Ohio Dept. B

**A NEW CB BREAKTHROUGH FROM VOCALINE**  
 From Vocaline, manufacturer of the finest line of CB radios on the market, the new incredible Commaire ED-278. A superior transceiver on every count, an outstanding addition to Vocaline's ED-27M, ED-276 and the PT-27 line.  
 For both professional and commercial use, this ruggedized 8-channel set was designed to meet the highest reliability demands, and yet has true simplicity of operation. Most important, the ED-278 though quality engineered, is low in cost, and can be operated on the amateur band. Such a transceiver with real diversification is quite a find. Take a look at some specs: 8 channels, crystal controlled receive and transmit; Sensitivity—better than .1 microvolt for 10 DB S&N/N; Selectivity—6 DB down at ±2.5 K.C. 58 DB down at ±10 K.C.; Receiver type—dual conversion superhet; Noise figure 2; Squelch—adjustable .1 to 400 microvolts; Image response—60 DB all other responses—70 DB.  
 More good news from Vocaline. Recently the prices have been lowered on its complete line of CB units. A prospective buyer can now certainly find a good model to meet his requirements at a reasonable price.  
 Free literature is available from:  
**VOCALINE COMPANY OF AMERICA**  
 OLD SAYBROOK, CONN. • Attention: S. RAE

**8 1/2" PORTABLE TV**  
**\$99** Discount to Service Men & Hams Free Catalog  
**GM PHOTOELECTRONICS**  
 623 So. Gay Street Knoxville 2, Tenn.

**LOW-COST BUSINESS AIDS FOR RADIO-TV SERVICE**  
 Order books, invoice forms, job ticket books, service call books, cash books and statement books for use with your rubber stamp. Customer file systems, book-keeping systems, many others. Write for **FREE 32 PAGE CATALOG** now.  
**OELRICH PUBLICATIONS**  
 6556 Higgins Rd., Chicago, Ill. 60656

**RENT STEREO TAPES**  
 FREE BROCHURE | Postpaid 2 to 5 day delivery (48 States)  
**EO stereo-parti**  
 1616 D TERRACE WAY, SANTA ROSA, CALIF.

**NEW GIANT CATALOG FREE!**  
 Completely new, enlarged edition. New items, categories, illustrations. 148 new, easy-to-read pages packed with nearly 4000 items. Dozens of electrical and electromagnetic parts, accessories. Enormous selection of Astronomical Telescopes, Microscopes, Binoculars, Magnifiers, Magnets, Lenses, Prisms. Many war surplus items; for hobbyists, experimenters, workshop, factory. Write for free catalog "EH".  
**CLIP AND MAIL COUPON TODAY**  
**EDMUND SCIENTIFIC CO., Barrington, N. J.**  
 PLEASE SEND ME FREE CATALOG "EH"  
 Name .....  
 Address .....  
 City ..... State .....





CHRISTMAS SPECIAL

2 Amp SCR SILICON CONTROLLED RECT. STUD only 77¢



SILICON PLANAR

ANY TYPE \$1.00 AND MESA TRANSISTORS IN TO5 CASE

CHRISTMAS DOUBLE BONUS

FREE \$25.00 GIFT PAK

Radio & TV Parts—Add 25¢ for handling

PLUS CHOOSE ANY \$1 ITEM FREE

BOTH "GIFTS" FREE WITH \$10.00 ORDERS

TRANSITRON SCR's\*

Table with columns: Volts, 10 Amp, 25 Amp, Silicon Controlled Rectifiers. Values range from 50 to 400 volts.

\*See Electronics World Magazine, Oct. 1963 for uses 'n' hookups.



SALE ON "TEXAS"

Imagine! 20 watts in TO5 case. 2N1039 with built-in heat sink... only \$1.00

2 - 2N614 Silicon Transistor NPN \$1.00

10 WATT ZENER DIODE

\$1.00

STUD



ADVERTISING INDEX

Radio-Electronics does not assume responsibility for any errors appearing in the index below

Large index table listing various companies and their page numbers, including F.A.D. Andrea Radio Corp., Anglo American Acoustics Ltd., Arco Electronics, Inc., etc.

SILICON MESA HIGH POWER

50 WATTS NPN TO-10 TRANSISTOR (like 2N424) \$1.00

SEMI-KON-DUCTORS

- 6 2N408 TRANSISTORS, TO1, pnp, output... \$1
4 2N219 TRANSISTORS, mixer-conv, TO22... \$1
6 ZENER DIODES, TO24, UPRITES, asst. V... \$1
5 2N155 TYPE POWER TRANSISTORS, TO3 case... \$1
4 2N211/CK879 I.F. TRANSISTORS, pnp, TO22... \$1
2 1 PHILCO 30-MC. TRANSISTORS, TO1, pnp... \$1
3 1000 MIL 800V TOP HAT RECTIFIERS, leads... \$1
4 TEXAS INSTR. SILICON TRANSRS, pnp, TO22... \$1
4 CK721 TRANSRS in new aluminum case, pnp... \$1
4 SILICON NPN 2N333, TO5 TRANSISTORS... \$1
4 SUBMINIATURE 2N131 TRANSRS, rf-if pnp... \$1
25 "EPOXY" SILICON DIODES, untested... \$1
10 SWITCHING TRANSRS, nnp, 2N438 equals... \$1
2 CBS 35W PWR TRANSRS, 2N1434, pnp, stud... \$1
10 FAMOUS CK722 TRANSISTORS, pnp... \$1
15 PNP TRANSISTORS, asst. types and cases... \$1
15 NPN TRANSISTORS, asst. types and cases... \$1
4 100mc 58-100 TYPE TRANSISTORS, TO1 case... \$1
10 TOP HAT RECTIFIERS, 750 mil, 400V... \$1
500-MC 'MESA' SUBMINIATURE TRANSR, pnp... \$1
15 CBS GERMANIUM DIODES, 1N34, 1N48 equals... \$1
4 CBS 15W TRANSISTORS, 2N1504, stud... \$1
3 CBS 20-WATT TRANSRS, pnp, stud, 2N1320... \$1
3 CBS 20-WATT TRANSRS, nnp, stud, 2N1321... \$1
5 SUN BATTERIES TO 1 1/2" sizes lite sensitive... \$1
25 AMP SWITCHING TRANSISTOR, ignition too... \$1
20 "KLIP IN" DIODES, like 1N82 of CBS... \$1
25 SEMI-KON-DUCTORS: transrs, diodes, rect... \$1
2 40-WATT TRANSISTORS, 2N174 type, TO36... \$1
4 GENERAL ELECTRIC OUTPUT TRANSRS, 2N43... \$1
15 AMP 200PIV AXIAL LEAD RECTIFIER, silicon... \$1
5 GENERAL ELECTRIC 2N107 PNP TRANSISTORS... \$1
4 GENERAL ELECTRIC 2N170 RF NPN TRANSRS... \$1
HOFFMAN SATELLITE SILICON SUN CELL... \$1
15 UPRIGHT 1N434 SILICON DIODES, worth \$40... \$1
10 TRANSISTOR SET, 5 PNP, 5 NPN, pop types... \$1
150 WATT TRANSISTOR, 2N1015A, stud... \$1
2 'MESA' 4-WATT TRANSRS, nnp, silicon, TO5... \$1
4 2N35 NPN TRANSISTORS, TO22... \$1
6 TRANSISTOR RADIO SET, osc-if's-driver-p.p... \$1
2 25-AMP SILICON STUD RECTIFIERS... \$1
3 40-WATT POWER TRANSISTORS, threaded case... \$1
10 1000 MIL "EPOXY" RECTIFIERS, silicon... \$1

WORLD'S MOST POPULAR \$1 PARTS PAKS

- 10 'MICRO' SNAP SWITCHES, 115 vac, 15A... \$1
40 PRECIS'N RESISTORS, 1/2, 1, 2W, 1% & better... \$1
5 TANTALUM ELECTROLYTICS, only 1/4x1/4" sizes... \$1
30 'CORNING' LOW NOISE RESIST'S, 1/2, 1, 2W... \$1
300-FT. HOOKUP WIRE, asst. colors, sizes... \$1
50 ALLEN BRADLEY 1-WATT'S, resistors, 5% too... \$1
60 TUBULAR CONDENSERS, to .5mf to 1KV... \$1
40 DISC CONDENSERS, 27 mmf to .05mf to 1KV... \$1
60 TUBE SOCKETS, receptacles, audio, etc... \$1
10 PANEL SWITCHES, rotary-micro-slide-power... \$1
10 TRANSISTOR SOCKETS for pnp-npn transistors... \$1
30 POWER RESISTORS to 50W, to 24 Kohms... \$1
50 MICA CAPACITORS to .01mf, silvers too... \$1
10 VOLUME CONTROLS to 1 meg, switch too... \$1
10 ELECTROLYTICS to 450V to 500mf... \$1
50 RADIO & TV KNOBS, asstd. colors, styles... \$1

10¢ FOR OUR CHRISTMAS BARGAIN CATALOG ON:

- 10 TRANSISTOR ELECTROLYTICS, to 1000mf... \$1
\$25 RADIO-n-TV SURPRISE, wide variety... \$1
50 COILS & CHOKES, rf-if, osc-peaking-etc... \$1
35 ALLEN BRADLEY TWO WATTERS, 5% too... \$1
100 ASST. HALF WATT RESISTORS, 5% too... \$1
60 HI-Q RESISTORS, 1/2, 1, 2W to 1 meg, 5% too... \$1
10 PHONO PLUG-n-JACK SETS, tuners-amps... \$1
50 TERMINAL STRIPS, asst. 1-1010 lug types... \$1
35 SILVER MICAS, asst. values & voltages... \$1
60 CERAMIC CONDENSERS, dies, npo's to .05mf... \$1
4 TRANSISTOR TRANSFORMERS, worth \$25... \$1
40 WORLD'S SMALLEST RESIST, 5% too, 1/10W... \$1
40 SUMINIATURE COND., to .05mf, cerall too... \$1
100 PARTS SURPRISE, worth \$25, p. ckt. too... \$1
INFRA-RED PHOTO DETECTOR TRANSDUCER... \$1
INFRA-RED PARABOLIC REFLECTOR & FILTER... \$1
6 UNPUNCHED PTD. CIRCUIT BDS., 3x7" sizes... \$1

SILICON POWER DIODE STUDS table with columns: Amp. V., Sale, Amp. V., Sale, Amp. V., Sale. Values range from 6 200 to 6 600.

POLY PAKS TERMS: send check, money order, include postage-avg. wt. per pak 1 lb. Rated, net 30 days. COD's 2 1/2% P.O. BOX 942R SO. LYNNFIELD, MASS. "PAK-KING" OF THE WORLD

POWER TRANSISTORS TO3 CASE CHOOSE any 2 for \$1.00 2N155 2N236 2N255 2N256 2N285 2N301 2N307 2N1245 2N296

MAKE MORE MONEY

Join the Technician's Book Club. Read helpful electronics books by leading authors - at tremendous savings. Books sent on approval. Write for free bulletin.

GERNSBACK LIBRARY, Inc.

Dept. 123C, 154 West 14th Street, New York, New York 10011

MARKET CENTER page 119

- Carston
Cleveland Institute of Electronics
Colordaptor
Edmund Scientific Co.
Fair Radio Sales
GM Photoelectronics
Oelrich Publications
Relco
Stereo-Parti
Transistors Unlimited Co.
Valley TV Tuner Service
Vocaline Corp.
Warren Electronics Co.

SCHOOL DIRECTORY page 118

- American Institute of Technology
Central Technical Institute
Electronic Technical Institute
Northrop Institute of Technology
Pacific International College of Arts & Sciences
Philadelphia Wireless Technical Institute
Tri-State College
Valparaiso Technical Institute
Printed in U.S.A.

THE SAME ENGINEERING, SAME PLANT THAT  
PRODUCES AMERICA'S GREATEST SATELLITE-  
TRACKING AND TELEMETRY STATIONS, HAS CREATED

*the revolutionary new*

# PARALOG

TV/FM ANTENNA

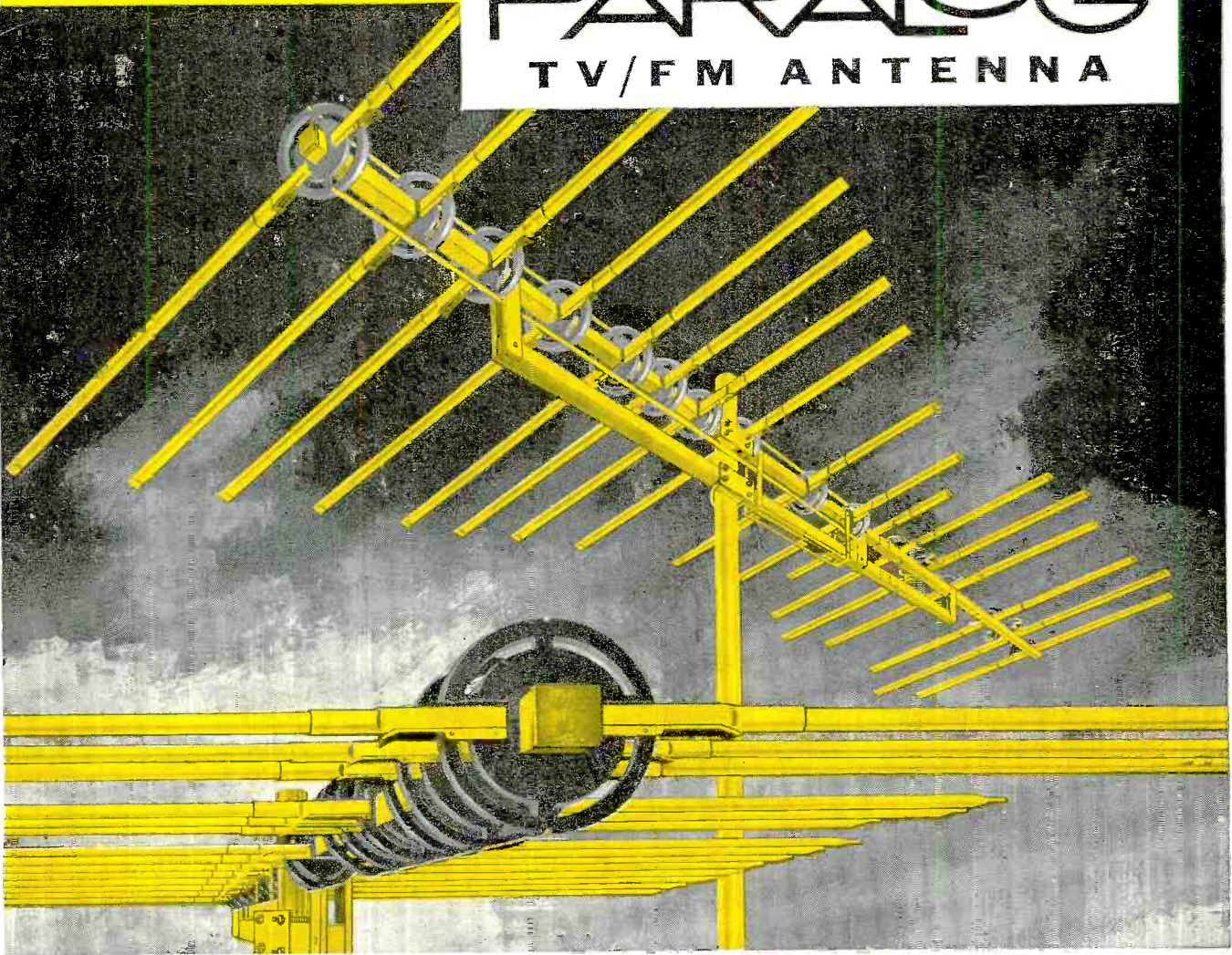

... Unparalleled performance because it has **ALL 5:**

- HIGHEST GAIN
- SHARPEST DIRECTIVITY
- EXTREMELY LOW VSWR
- BEST FRONT-TO-BACK RATIO
- RUGGED CONSTRUCTION

HERE IT IS—the space-age TV/FM antenna from the only manufacturer with actual experience in making space-probing antennas!

All new, the PARALOG is the first home antenna that really comes through with log-periodic

design plus a unique parasitic-element system for maximum all-channel gain and pinpoint directivity. Exclusive Cyclocac insulating mounts assure constant impedance, eliminate troublesome cross-feed design. Extremely rugged construction.



*There are fourteen PARALOG antenna models, listing from \$19.95, including four electronic PARALOGs with Super Powermate preamplifier, and three special FM stereo models. See your Jerrold-TACO distributor now, or write Jerrold Electronics, Philadelphia 32, Pa.*



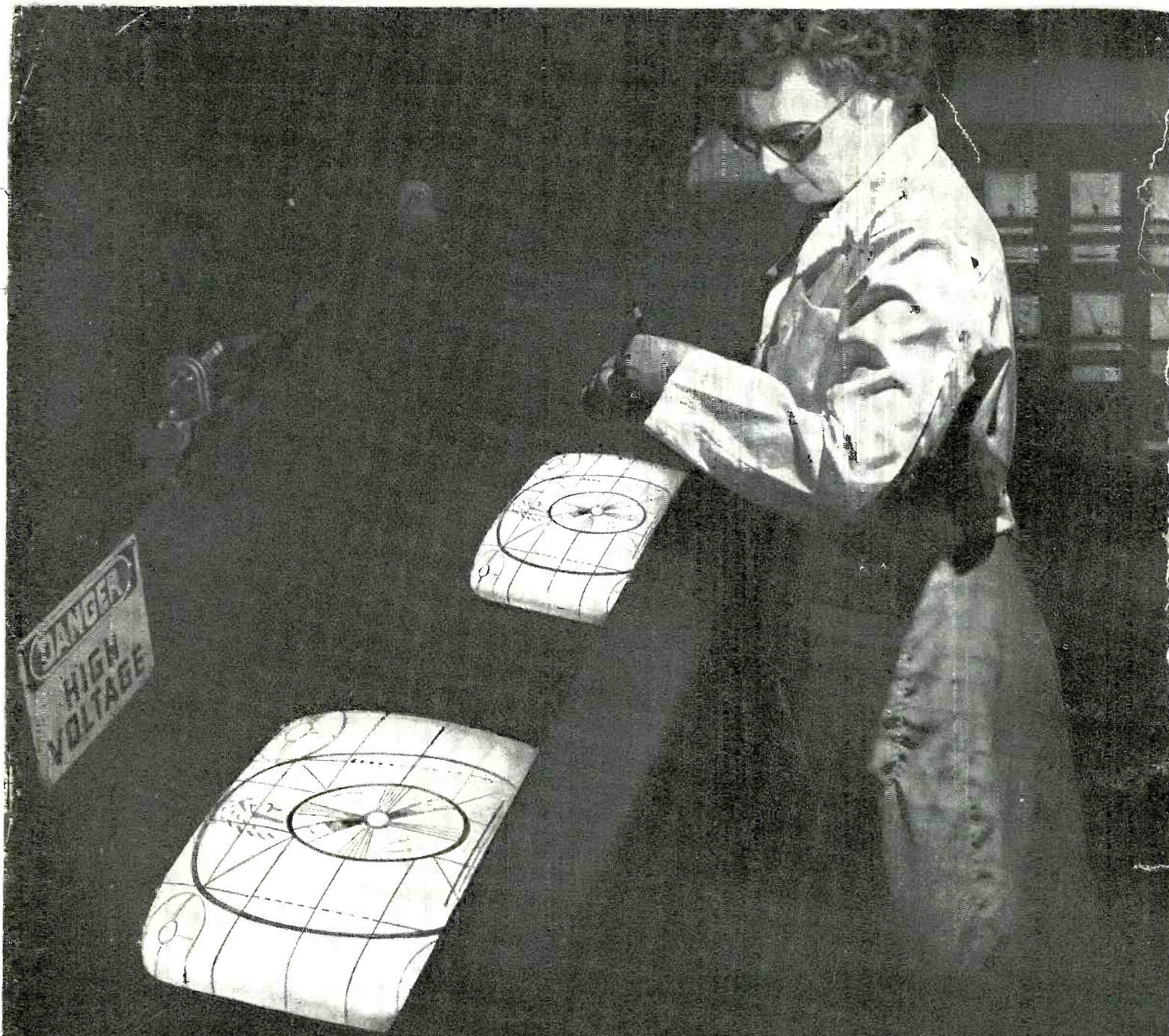

## TRAP FOR FAULTY PICTURE TUBES

### RCA Guards Against Callbacks 26 Ways

Under the watchful eyes of trained inspectors, RCA Silverama® Picture Tubes are carefully scrutinized for screen quality and focus.

All Silverama replacement picture tubes as well as those destined for original equipment undergo a battery of 26 automated tests. These include: warm-up, emission, gas, leakage, electron-gun performance, and other critical factors that can spell the difference between long-term performance or costly callback. Tubes failing a single test are automatically tagged and rejected. In addition to automatic testing, every tube lot leaving the RCA plant has been sampled by Quality Control.

Nothing is left to chance; part by part, inside and out, from base to faceplate the quality of each tube has been carefully controlled and assured prior to assembly. Even the Silverama envelope is carefully inspected prior to re-use, and is internally scrubbed, buffed, and restored to the peak of its optical capabilities. Result: a superior picture tube, an RCA Silverama. Make it your next installation choice.

RCA ELECTRONIC COMPONENTS AND DEVICES, HARRISON, N. J.



**The Most Trusted Name in Electronics**



**CARRY EACH SILVERAMA FACTORY-FRESH INTO YOUR CUSTOMER'S HOME.** New Foam-Lined RCA Picture Tube Tote Bag makes scratched, marked, or scuffed faceplates a thing of the past. Makes carrying both easier and safer. Two sizes: one for 16" to 19" tubes, one for 20" to 24" tubes.

**SEE YOUR AUTHORIZED RCA PICTURE TUBE DISTRIBUTOR FOR DETAILS**