

How to Put More Power Into Your CB Antenna

MAY

Radio-Electronics

TELEVISION • SERVICING • HIGH FIDELITY

HUGO GERNSBACK, Editor-in-chief

**8 Transistors —
10 Hi-Fi Watts**

**Electronic Flash
You Can Build**

**FM Tuners, \$29.95
(And up, Up, UP!)**

**Check Transistors
With Your Scope**

**How to Handle
Color Customers**

**This Amplifier
Needs No Service** ▶

See page 29

50c

A L FRIDDY 6-63
BOX 133 BRANCH RD RT 1
BELLE WEST VIRGINIA

are you replacing
top quality tubes
with identical
top quality tubes
?

Now you can carry the identical tubes that you find designed into most of the quality TV sets you service. Chances are, you were not aware that these TV sets were designed around special Frame Grid tubes originated by Amperex and that even more tube types originated by Amperex are being designed into the sets you'll be handling in the future. Amperex frame grid tubes provide 55% higher gain-bandwidth, increase TV set reliability by simplifying circuits and speed up your servicing because their extraordinary uniformity virtually eliminates need for re-alignment when you replace tubes.

Tubes introduced by Amperex, currently used by major TV set makers include:

Frame Grid				Others	
2GK5	4GK5	6GK5	6EH7	6AL3	9A8
2ER5	4EH7	6ES8	6EJ7	6BL8	15CW5
3GK5	4EJ7	6ER5	6HG8	6BQ5	16AQ3
3EH7	4ES8	6FY5	7HG8	12AX7	27GB5

For optimum satisfaction for your customers and a better profit operation for yourself, make room in your caddy now for these matchless-quality tubes. Next time you visit your distributor, look for the green-and-yellow boxes and enjoy confidence in your work such as you never have before. Amperex Electronic Corporation, Hicksville, L. I., New York.



*no question
about it—*

the **JFD**
LPV $\frac{L(n+1)}{L_n} \cdot \tau$
IS A WINNER

**“6 db BETTER
THAN THE BEST!”**

If you are installing JFD Log Periodic LPV's, no doubt you will agree with this report from R. L. Monroe, a leading TV antenna service-dealer of Charleston, West Virginia—a problem reception area.

“It beats all, it beats everything that I have ever seen. Not only that, but this antenna is better than 6 db better than the best that I have installed. It pulled in a consistently clear picture from Columbus, over 130 miles away.

****** “It's just great on color—turns browns into real reds, faded bluish greens into brilliant greens, and completely eliminates the chronic ghost problems we have been suffering from in this area.”*

****I have been in this business since 1948, which is a considerable time, particularly in the valley, and have yet to see any antenna, even near to this log periodic antenna in performance of the things I have wanted.”*

Why the JFD Log Periodic LPV Outperforms Every TV Antenna Ever Made!

The log-periodic LPV blows the whistle on cumbersome antennas with their “Chinese puzzle” combinations of collectors, directors and reflectors. Now a single precisely-engineered antenna—the first based on a geometrically-derived *logarithmic* scale—actually *tunes* itself to the desired channel for unprecedented performance in crisp black and white or stunning color—plus FM STEREO. Is it any wonder that never before have so many installers and techni-

cians so quickly acclaimed a TV antenna?

We would like to tell you more about the LPV, and how its *frequency independent* characteristics, have broken through distance, ghost and interference barriers to bring clear, steady pictures into previously “impossible” areas. Write today for your log periodic LPV Sales Kit. Better yet, call your JFD distributor and try one with our money-back guarantee of a better picture. You will prove it to yourself.

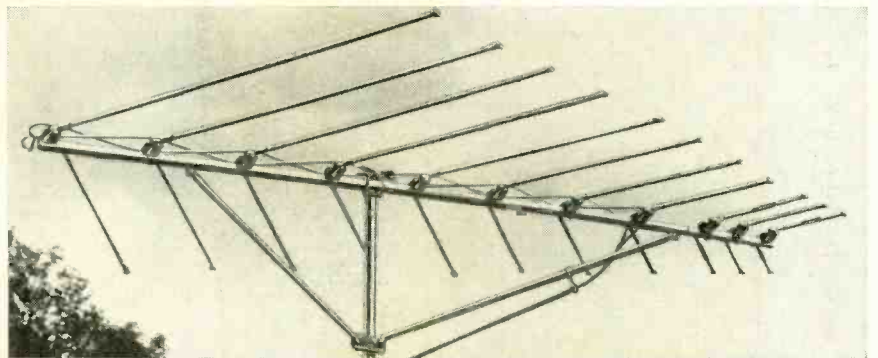

Developed by the University of Illinois Antenna Laboratory—Now Serving in Satellite Telemetry—Adopted to TV by JFD! **THE LOG PERIODIC LPV ENDS THE ERA OF ANTENNA COMPROMISE! FOR THE FIRST TIME ONE SCIENTIFICALLY FORMULATED ANTENNA CONFIGURATION SATISFIES ANY LOCATION DEMAND:**

Harmonically resonant V-element operate on the Log-Periodic Cellular Principle in the Fundamental and Third Harmonic Modes for unprecedented performance—in color—in black and white—plus FM STEREO

LPV17:	18 Active Cell and Director System—up to 175 miles	\$59.95, list
LPV14:	15 Active Cell and Director System—up to 150 miles	\$49.95, list
LPV11:	11 Active Cell and Director System—up to 125 miles	\$39.95, list
LPV8:	8 Active Cell and Director System—up to 100 miles	\$29.95, list
LPV6:	6 Active Cell System—up to 75 miles	\$21.95, list
LPV4:	4 Active Cell System—up to 50 miles	\$14.95, list

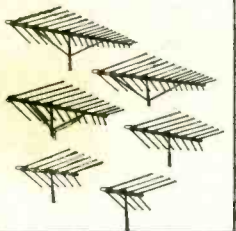

JFD **ELECTRONICS**
CORPORATION

15th Avenue at 62nd Street, Brooklyn 19, N.Y.
JFD Electronics-Southern Inc., Oxford, North Carolina
JFD International, 15 Moore Street, New York, N.Y.
JFD Canada, Ltd., 51 McCormack Street, Toronto, Ontario, Canada
401-144 W. Hastings Street, Vancouver 3, B.C.

Radio-Electronics

MAY 1963
VOL. XXXIV No. 5

Formerly RADIO CRAFT—Incorporating SHORT WAVE CRAFT—TELEVISION NEWS—RADIO & TELEVISION*

editorial

Hugo Gernsback 23 Language Rectifiers

audio-high fidelity-stereo

Don v. R. Drenner 26 Inboard Preamp Boosts FM Tuner Sensitivity

Leonard J. D'Airo 44 8 Transistors for 10 Watts of Hi-Fi
Build this compact amplifier for your system

Joseph Marshall 49 Improving the Hi-Fi Bottom
A "super-woofer" can do a lot for your stereo or mono system

electronics

Carl Henry 24 Just Plain Flash
An electronic flash anyone can build

James A. Fred 46 Novel Dc-to-Dc Supply

E. H. Marriner 62 Make Diode Rectifiers Last Longer
A little capacitor can extend useful life

general

34 What's Your EQ?

Gordon E. Kaye 40 Inside the Dry Cell
See how and why they differ

43 What's New

radio

28 No Service Needed on This Amplifier
(Cover Feature)

Richard Stiebel 30 Put Maximum Power Into Your CB Antenna
The lower the swr, the greater the range

Leonard Feldman 36 FM Tuners—\$29.50 and Up, and Up, and Up!
How come FM tuners cost so little—and so much?

Jim Kyle 60 Tube Inventory for CB Service

television

Jack Darr 29 Reshoeing a Picture Tube

Harry D. Parker 42 Polish That Faceplate Yourself

Walter R. McCarty 47 Handling the Color TV Customer
Don't keep him in the dark

Jack Darr 52 Service Clinic
Rf pickup in audio amplifiers

Warren Roy 67 Unique Audio Takeoff

test instruments

Forrest H. Frantz, Sr. 27 Spiker
Make spikes the easy way

Daniel P. Smith 32 Check Transistors with Your Scope
Another use for the service bench workhorse

Robert F. Scott 35 Ignition Analyzer for Hobbyist or Pro
What makes the Lafayette TE-40 tick

Q. B. El-Dhuwaib 48 Continuity Checker
64 3-Inch Wide-Band Scope and a Tunnel Dipper
Equipment Report: Sencore PS120 and Heathkit HM-10A

the departments

16 Correspondence
97 New Books

90 New Literature
91 New Patents
72 New Products

80 New Semiconductors & Tubes
6 News Briefs
69 Noteworthy Circuits

87 Technicians' News
84 Technotes
93 Try This One

Over 55 Years
of Electronic Publishing

EDITOR-IN-CHIEF AND PUBLISHER
Hugo Gernsback

EDITOR

M. Harvey Gernsback

MANAGING EDITOR

Fred Shunaman

TECHNICAL EDITOR

Robert F. Scott, W2PWG

ASSOCIATE EDITOR

Peter E. Sutheim

EDITORIAL ASSOCIATE

I. Queen

EDITORIAL ASSISTANT

Ramona Goldman

SERVICE EDITOR

Jack Darr

TECH. ILLUSTRATION DIRECTOR

Wm. Lyon McLaughlin

ART ASSOCIATE

Fred Neinast

DIRECTOR OF PRODUCTION

Elizabeth Stalcup

DIRECTOR, ADVERTISING SALES

Frank T. Baker

EASTERN SALES MANAGER

John J. Lamson

CIRCULATION MANAGER

G. Aliquo

DIRECTOR, NEWSSTAND SALES

Joseph L. Bund

—on the cover—

(Story on page 28)

Technician at the Western Electric plant, Clark, N. J., inspects a soldered joint through a jeweler's loupe before approving it.

Color original by
Western Electric

Gernsback Publications, Inc.

EXECUTIVE, EDITORIAL, ADVERTISING OFFICES

154 W. 14 St., New York 11, N.Y.
Telephone AL 5-7755

CHAIRMAN OF THE BOARD
Hugo Gernsback

PRESIDENT

M. Harvey Gernsback

SECRETARY

G. Aliquo



Radio-Electronics is indexed in
Applied Science & Technology Index
(Formerly Industrial Arts Index)

*Trademark registered U. S. Pat. Office

A NEW WORLD OF OPPORTUNITY AWAITS YOU WITH N.T.S. ALL-PHASE HOME TRAINING IN ELECTRONICS



You can install and maintain electronic circuitry in missiles and rockets ... specialize in micro-waves, radar and sonar.

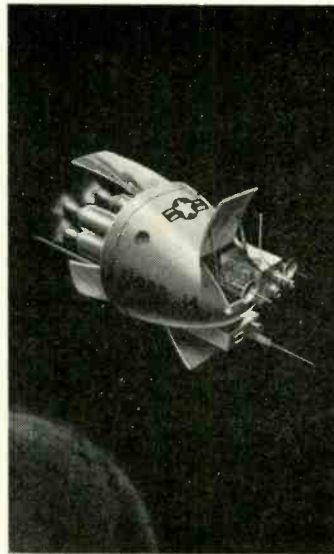

You can succeed in TV-Radio Communications ... prepare for F.C.C. License, service advanced satellites for industry and defense.



You can service and repair the electronic "brains" of industry — computers, data processing, and other automation equipment.



You can become a highly-paid TV-Radio Technician, an electronics field engineer, or succeed in your own sales & service business.

The N.T.S. Master Course enables you to do more, earn more in ELECTRONICS • TELEVISION • RADIO Yet N.T.S. Training costs no more than other courses far less complete

There's a good reason why N.T.S. Master-Training opens a wide new world of opportunity for you in Electronics, Television, Radio.

Everything you learn, from start to finish, can be applied directly to all phases of the Electronics Industry.

As a result, the N.T.S.-Trained Technician can move ahead faster, in any direction — from TV-Servicing to Radio Communications to Space-Missile Electronics and Automation for industry and defense. You can go wherever pay is highest and opportunity unlimited.

Electronic circuitry, for example, is one of science's miracles that is basic to the entire field of Electronics. It is used in satellites, computers and space capsules as well as in today's television sets and high fidelity equipment. N.T.S. shows you how to service and repair electronic circuitry for all electronic applications.

You work on many practical job projects. You build a short-wave, long-wave superhet receiver, plus a large-screen television set from the ground up. N.T.S. training kits contain all the parts you need ... at no extra cost. (See box at right.) You also receive a professional Multitester to use during training and on the job.

ONE LOW TUITION. You need training related to all phases of Electronics. Industry demands it. Only N.T.S. provides it ... in ONE Master Course at ONE low tuition.

RESIDENT TRAINING AT LOS ANGELES

If you wish to take your Electronics-TV-Radio training in our famous Resident School in Los Angeles — the oldest and largest school of its kind in the world — write for special Resident School catalog and information, or check coupon.



NATIONAL TECHNICAL SCHOOLS
WORLD-WIDE TRAINING SINCE 1905
4000 So. Figueroa St., Los Angeles 37, Calif.

Accredited Member N.H.S.C.



YOU ENROLL BY MAIL AND SAVE MONEY. No salesmen means lower costs for us, lower tuition for you.

START NOW. A whole new world of opportunity awaits the man with Electronic Home-Training from National Technical Schools — a recognized leader in technical training for 58 years.



19 BIG KITS
YOURS TO KEEP



ACTUAL LESSON

MAIL COUPON NOW FOR FREE BOOK AND ACTUAL LESSON!

NO OBLIGATION.
NO SALESMAN WILL CALL.

NATIONAL TECHNICAL SCHOOLS

WORLD-WIDE TRAINING SINCE 1905

**National Technical Schools, Dept. RG-53
4000 S. Figueroa St., Los Angeles 37, Calif.**

Please Rush FREE Electronics-TV-Radio "Opportunity" Book and Actual Lesson. No Salesman Will Call.

Name _____ Age _____

Address _____

City _____ Zone _____ State _____

Check if interested ONLY in Resident Training at L.A.

High school home study courses also offered. Check for free catalog.

News Briefs

High-Speed Character Reader Uses Television Techniques

A new high-speed optical reader with a capacity of 90,000 documents an hour has been announced by RCA. Called Videoscan, the new device reads computer-printed lines of data at the rate of 1,500 characters per second. It is intended for use with "turnaround" documents—items like telephone or gas bills which are sent out by a company and are returned to the same company.

The Videoscan uses a special vidicon tube, which makes a series of high-speed vertical scans of each character. The resulting video signals are relayed in digital form to a character-recognition device that stores them until a full pattern has been established. The completed character signal is converted to RCA 301 code and fed into an RCA 301 computer, from which it can be handled as desired or printed out.

Theaters Contract for Large-Screen Color TV

A new light-valve projector makes theater-size color TV practical, states General Electric. The Talaria light-valve projector uses a special control fluid through which the



Gloria Duraczynski, of RCA, loads the input stacker of the Videoscan. Bills run along the track at the rear, past the TV tube in central housing. Part of the RCA 301 is in the background.

light of a 5-kw xenon arc lamp is projected onto the screen. The optical system is so arranged that no light reaches the screen as long as the control layer is smooth. Scanning the control layer with the electron beam deforms the surface in accordance with the incoming picture information, causing the light to reach the

screen in such a way as to reproduce the original scene.

All three primary colors are projected with only two light beams, resulting in a simpler and more reliable projector, and considerably less difficulty in registration. Because color is determined by optical filters rather than dyes, the Talaria system is said to be capable of producing a wider gamut of colors than the best color film available.

A contract has been signed between General Electric and National General Corp., giving it exclusive US distribution rights for the projector in the commercial theatrical entertainment field. Initially, the Talaria projectors will be used in National General's own key city theaters, which are expected to offer color TV programs in early 1964.

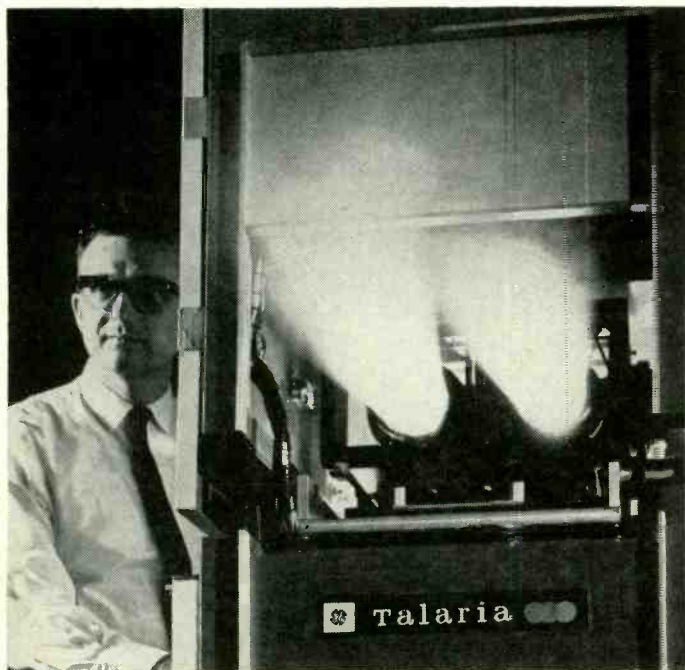

The new General Electric color-projection system, showing the two guns (green and magenta). The primary red and blue are obtained from the single magenta beam.

Advertising Representatives: South—J. Sidney Crane & Associates, 22 8th St. N.E., Atlanta, Ga., Tel. TRinity 2-6720. Florida: Neff Associates, 15 Castle Harbor Isle, Fort Lauderdale, Fla., Tel. LOGan 6-5656. West—Husted-Coughlin, Inc., 1830 W. 8th St., Los Angeles, Calif., Tel. 389-3132. 444 Market St., San Francisco, Calif., Tel. GARfield 1-0151. **United Kingdom**—Publishing & Distributing Co., Ltd., Mitre House, 177 Regent St., London, W.1, England. **Subscription Service:** Address form 3579 and correspondence to Radio-Electronics, Subscriber Service, 154 West 14th St., New York 11, N. Y. When requesting a change of address please furnish an address label from a recent issue. Allow one month for change of address.

3 More Big Training Advantages



DEVRY TECH Exclusive!

WITH TRANSISTORIZED
METER . . . PLUS NEW "MODULAR
CIRCUITS" TO BUILD
AT HOME!

Now Prepare for **GOOD
JOB OPPORTUNITIES IN
ELECTRONICS** Faster—with

1. **METER** — Transistorized, Portable AC-DC Multimeter
2. **SCOPE** — 5-inch New Streamlined Commercial-Type Oscilloscope
3. **ELECTRO-LAB*** — For 3-Dimension Circuit Building

To help you get ready F-A-S-T-E-R . . . and THOROUGHLY . . . for good-paying job opportunities in the fast growing Electronics field, DeVry Technical Institute now presents the newest and finest training advantages in its over 30 years of experience. Now . . . AT HOME . . . in your spare time, you prepare with "industry-type" home laboratory equipment. To provide real PRACTICAL EXPERIENCE, you build a quality Transistorized Meter and a 5-inch industrial-type Oscilloscope . . . work with small, 3-dimensional circuits on DeVry's new Design Console . . . use highly instructive home training movies . . . and follow up-to-date lessons with many time-saving fold-out diagram sheets.

Little wonder DeVry men qualify for such fine opportunities in Space-Missile Electronics, Automation, Computer Work, Radio-TV, Industrial Controls, and other fields.

You learn PRACTICAL techniques important in today's Space Age industry, because you build many compact circuits with the streamlined Electro-Lab, using exclusive solderless "modular connectors." You perform over 300 construction and test procedures in all! Your self-built test equipment has function-grouped controls, meter scales color-keyed to the panel markings—much like instruments used on today's jobs. What's so important, the home laboratory and the test equipment are YOURS TO KEEP!



OSCILLOSCOPE

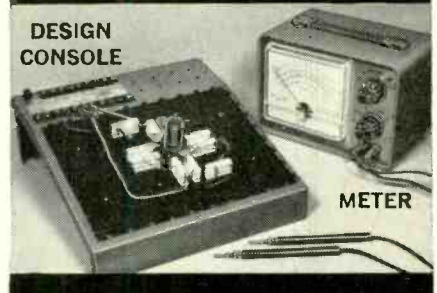

DESIGN
CONSOLE

METER

INDUSTRY NEEDS TRAINED MEN

Through this remarkable 3-way method, DeVry Tech has helped thousands of ambitious men prepare for good jobs or their own profitable full-time or part-time service shops. It is the newest in a long series of PRACTICAL training aids that we have pioneered and developed in more than three decades of experience. Sound interesting? Then see how DeVry Tech may help YOU. Mail the coupon today.

From RADIO to SPACE- MISSILE ELECTRONICS

DeVry's training goes all the way from radio repair . . . to space-missile electronics. That's the range of subjects covered in its programs AT HOME or in its well-equipped training centers in Chicago and Toronto. You learn up-to-date techniques, working with new equipment, modern texts, movies—one of today's finest combinations of training equipment . . . geared for RESULTS!

EMPLOYMENT SERVICE

When you complete the program, DeVry's efficient Employment Service is ready to help you get started. There is no extra charge—ever—for this aid.

ACCREDITED MEMBER, NATIONAL HOME STUDY COUNCIL

**DEVRY TECHNICAL
INSTITUTE**
CHICAGO • TORONTO

* Trademark ®

MAIL COUPON FOR FREE FACTS

DEVRY TECHNICAL INSTITUTE 2082
4141 Belmont Ave., Chicago 41, Ill., Dept. RE-5-T
Please give me your two free booklets, "Pocket Guide to Real Earnings" and "Electronics in Space Travel"; also include details on how to prepare for a career in Electronics. I am interested in the following opportunity fields (check one or more):

<input type="checkbox"/> Space & Missile Electronics	<input type="checkbox"/> Communications
<input type="checkbox"/> Television and Radio	<input type="checkbox"/> Computers
<input type="checkbox"/> Microwaves	<input type="checkbox"/> Broadcasting
<input type="checkbox"/> Radar	<input type="checkbox"/> Industrial Electronics
<input type="checkbox"/> Automation Electronics	

Name _____ Age _____

Address _____ PLEASE PRINT Apt. _____

City _____ Zone _____ State _____

Check here if you face military service.

Canadian residents: Write DeVry Tech of Canada, Ltd.
970 Lawrence Avenue West, Toronto 19, Ontario

look what happens when you
**buy a
dozen
vu-brites...**

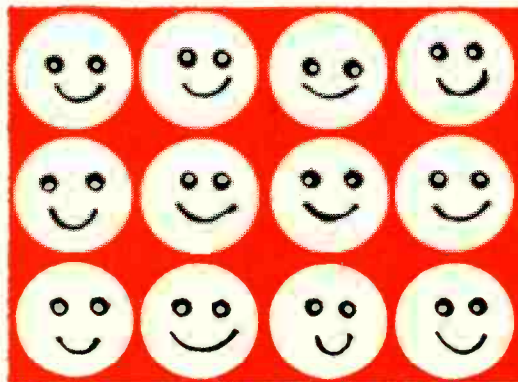

**You get the spin cast
fish lures free . . .**

beautifully finished, live-action lures practically guarantee to bring in the "big ones!" Yours free with the purchase of 12 Vu-Brites.

**You get twelve
happy customers . . .**

because 12 CRT's will be given an extra lease on life, 12 households will enjoy TV more, thanks to the brighter picture you (and Perma-Power's Vu-Brite) have provided.

what a deal!

For a limited time, Perma-Power is offering you this wonderful gift absolutely free with the purchase of 12 Vu-Brites at the regular price. Vu-Brites are the Briteners that really do a job—on parallel or series sets (Model C401 for parallel; Model C402 for series). They come colorfully packaged in individual boxes . . . and are priced at \$9.95 the dozen, net.

**Perma-Power
COMPANY**

3106 N. ELSTON AVENUE
CHICAGO 18, ILLINOIS

*Hurry—this special gift offer will end when current stocks are gone.
Call your distributor today.*

**Why not take advantage of the Radio-Electronics
4-POINT SUBSCRIPTION PLAN**

1	2	3	4
It saves you money	It assures you of getting every copy every month	It protects you against possible price increases	It gives you the best articles by the best authors

1 YEAR \$5 • 2 YEARS \$9 • 3 YEARS \$12

Law from Computers?

Computers can develop "scientific law," says Reed C. Lawlor, Los Angeles attorney (RADIO-ELECTRONICS, November 1962, page 16). Mr. Lawlor addressed the 1962 Computer Applications Symposium in Chicago, sponsored by Armour Research Foundation of Illinois Institute of Technology. Computers, he says, can analyze large bodies of data and select important facts. The word count of the Federal statutes doubles every 16 years so a computer is the ideal tool for information retrieval and analysis.

**Understanding Aid
Developed**

A new electronic device, designed for those who can hear but have trouble understanding words, due to a nerve loss, has been developed by Zenith Radio Corp.'s Hearing Aid Div.

Called the *Acoustic Modifier*, the equipment was tested at the Speech & Hearing Center of the Illinois Eye & Ear Infirmary of the University of Illinois, and proved effective for persons whose understanding difficulty stems from nerve loss. Such persons often miss high-frequency sounds, making words like "shred" and "thin" sound like "red and in".

A hearing aid offering normal amplification increases both high and low sounds, letting the low frequencies interfere. The new Acoustic Modifier, used with a Zenith hearing aid, provides a shunting action against low frequencies, letting high frequencies reach the ear in full strength.

Calendar of Events

SMPTC Convention, Apr. 21-26 (exhibits Apr. 22-25): Traymore Hotel, Atlantic City, N.J.

Electronic Components Conference (IEEE sponsored), May 7-9: International Inn, Washington, D.C.

1963 National Telemetering Conference, May 20-22: Hilton Hotel, Albuquerque, N.M.

Electronic Parts Distributors Show, May 20-22: Conrad Hilton Hotel, Chicago. RADIO-ELECTRONICS and GERNSBACK LIBRARY will be in Booth 4501, West Hall, and Rm. 655.

Third International Television Symposium, May 20-24: Montreux, Switzerland.

Product Engineering and Production Conference, May 27-28: Northeastern University, Boston.

17th Annual Frequency Control Symposium, May 27-29: Shelburne Hotel, Atlantic City.

National Electronic Packaging and Production Conference (NEP/CON), June 4-6: New York Coliseum, New York City.

EIA Annual Convention, June 18-20: Pick-Congress Hotel, Chicago.

**New Diode Has
Two Whiskers**

The two whiskers on the germanium diode are there to reduce input impedance, not to try to make a transistor out of it. The new development is designed to act as a low-level microwave mixer, converting input

Pick the course for your career...

Electronics Technology

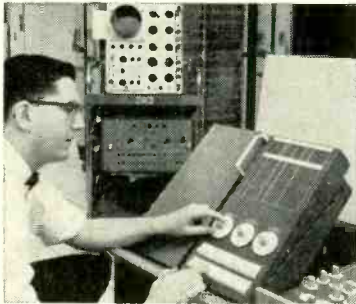

A comprehensive program covering Automation, Communications, Computers, Industrial Controls, Television, Transistors, and preparation for a 1st Class FCC License.

Electronic Communications

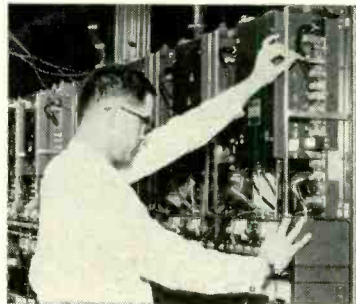

Mobile Radio, Microwave and 2nd Class FCC Preparation are just a few of the topics covered in this "compact" program . . . Carrier Telephony too, if you so desire.

First Class FCC License

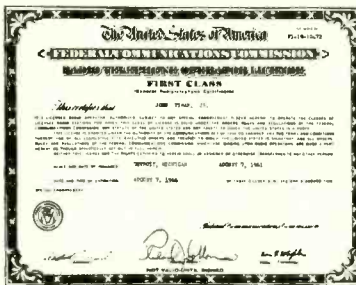

If you want a 1st Class FCC ticket quickly, this streamlined program will do the trick and enable you to maintain and service all types of transmitting equipment.

Broadcast Engineering



Here's an excellent studio engineering program which will get you a 1st Class FCC License and teach you all about Program Transmission and Broadcast Transmitters.

Get A Commercial FCC License ...Or Your Money Back!

A Commercial FCC License is proof of electronics skill and knowledge. Many top jobs require it . . . every employer understands its significance. In your possession, an FCC Commercial Ticket stamps you as a man who knows and understands electronics theory . . . a man who's ready for the high-paid, more challenging positions.

Cleveland Institute home study is far and away the quickest, most economical way to prepare for the FCC License examination. And that's why we can make this exclusive statement:

The training programs described above will prepare you for the FCC License specified. Should you fail to pass the FCC examination after completing the course, we will refund *all* tuition payments. You get an FCC License . . . or your money back!

Before you turn this page, select the program that fits your career objective. Then, mark your selection on the

Cleveland Institute of Electronics

1776 E. 17th Street, Dept. RE-79
Cleveland 14, Ohio



Accredited Member

MAY, 1963

coupon below and mail it to us today. We'll send you . . . without obligation . . . complete details on our effective Cleveland Institute home study. Act NOW . . . and insure *your* future in electronics.

Mail Coupon TODAY For FREE Catalog

Cleveland Institute of Electronics

1776 E. 17th St., Dept. RE-79
Cleveland 14, Ohio

Please send FREE Career Information prepared to help me get ahead in Electronics, without further obligation.

CHECK AREA OF MOST INTEREST—

- | | |
|---|--|
| <input type="checkbox"/> Electronics Technology | <input type="checkbox"/> First Class FCC License |
| <input type="checkbox"/> Industrial Electronics | <input type="checkbox"/> Electronic Communications |
| <input type="checkbox"/> Broadcast Engineering | <input type="checkbox"/> _____ other |

Your present occupation _____

Name _____ (please print) Age _____

Address _____

City _____ Zone _____ State _____

Approved for Veteran's Training under Korean GI Bill. RE-79

**How to Succeed
in Electronics**

NOW! CASTLE OFFERS YOU THE BIGGEST BARGAIN IN TV TUNER OVERHAULING!

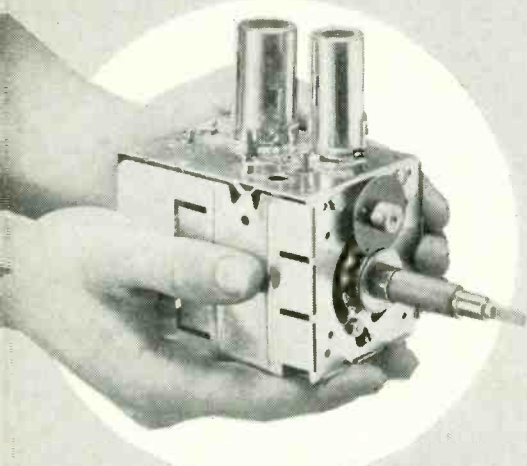

**ALL MAKES
ALL LABOR
AND PARTS
(EXCEPT TUBES)*
ONE PRICE** **995**

ONE LOW PRICE INCLUDES ALL UHF,
VHF AND UV COMBINATION* TUNERS

In a decade of experience overhauling TV Tuners of ALL MAKES, Castle has developed new handling and overhauling techniques which give you . . .

Fast Service

A recent study at our Chicago Plant revealed that of all tuners accepted for overhauling, over 30% were completed and shipped within . . .
Seven Hours...all others within 24 Hours.

Simply send us your defective tuner complete; include tubes, shield cover and any damaged parts with model number and complaint. 90 Day Warranty.

Exact Replacements are available for tuners unfit for overhaul. As low as \$12.95 exchange. (Replacements are new or rebuilt.)

*UV combination tuner must be of one piece construction. Separate UHF and VHF tuners must be dismantled and the defective unit only sent in.

Pioneers in TV



Tuner Overhauling

CASTLE

TV TUNER SERVICE, INC.

5715 N. Western Ave., Chicago 45, Illinois
653 Palisade Blvd., Cliffside Park, N. J.
Canada: 136 Main St., Toronto 13, Ontario

*Major Parts are additional in Canada

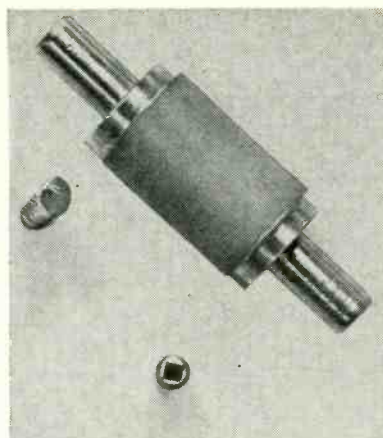

The new English diode. The two small pieces are the "insides" and show the actual crystal and the two catwhiskers.

signals to a 70-mc intermediate frequency. According to Standard Telephones & Cables, Ltd., British associate of ITT, who developed the new diode, this reduces the source impedance, normally about 200 ohms for the best germanium mixers, to a value of about 100 ohms for the best low-noise match. This is done without the increase in capacitance which would result in trying to reduce the series resistance by more conventional methods.

Navy Joins MARS

The Navy has announced that it is now an official member of the Military Affiliate Radio System

New TV Camera Beats Human Eye



A new all-transistor camera chain, designed around the ZL-7806 image orthicon, will make air reconnaissance possible at night, according to General Electric's Light Military Electronics Department, designers of the new equipment. The system will operate at 10^{-6} foot candle—the equivalent of a cloudy, moonless night, and generate a 300-line TV picture. The sensitivity is from 10 to 100 times as great as that of the human eye.

(MARS) which is now operating as an Army-Air Force project. MARS is a cooperative venture of the Armed Forces and American amateurs.

Any amateur 16 years or older, having a station capable of operating on two or more MARS frequencies, may apply for membership without becoming obligated for military service. Applications are made to OCSigO, Attn: SIGMR, Washington 25, D. C.

Special Protection for New Radio Telescope

The radio telescope of the University of Illinois, which has just come into use in Danville, Ill., is expected to have protection from interference on TV Channel 37 for a radius of 600 miles, according to Rep. William L. Springer (R., Ill.).

Mr. Springer told officials of the university that he had been informed by reliable sources that the FCC was likely to take an early official stand on the matter, and that it was unlikely that any allocation would be made in that frequency until it could be decided what frequencies to designate for radio astronomy.

Scientists feel that Channel 37 is in the best part of the spectrum for that type of work, and that protection from TV interference would be a useful first step in preventing man-

(Continued on page 14)

GRANTHAM GRADUATES DISTINGUISH THEMSELVES...

Based on the results of a recent survey of Grantham graduates (1957 to 1960), we find that we have trained a pretty distinguished group. Their approximate average annual income is \$7,000.00 (spectacularly above the National average). We are justifiably proud of this and of the fact that our graduates are employed by virtually every major electronics firm in the country. To learn more about our training, simply complete and send us the coupon which appears below. Meanwhile, you might like to read the representative response to our questionnaire which follows:

GRANTHAM GRADUATE QUESTIONNAIRE

1. Where are you currently employed? I am now employed by Edgerton, Germeshausen, & Grier, Inc.
2. What position do you hold? I am an electronics technician in the communications branch.
3. What is your annual income (approximately)? My annual income here is approximately \$10,000. This consists of \$6,500 base pay, and the remaining \$3,500 in field bonuses and overtime.
4. What influence (if any) did Grantham training have on your job?
 - a. Is the work you are doing different from what it would have been if you had not taken the Grantham course? Although without the Grantham School training I would still be working as a technician, I would not be working in the "Commo" section; nor would I have been able to acquire my previous position as a microwave transmission technician with the American Tel & Tel Co.
 - b. If you are in the same type of work as before you took the Grantham course, have you advanced your position, salary or prestige due to the course? I feel that my "first phone" (a result of your training) is the main factor which enables me to do more technical work at a higher rate of pay (and enjoy the added responsibility, etc.) than men with much more age and experience. To say that my position, salary, and prestige have been advanced due to your training would be a gross understatement!
5. Would you recommend our course to someone wishing to begin or advance in electronics? I most certainly would (and in fact have) recommended your course to anyone who desires to learn or advance in electronics. I was amazed that such a complete study of electronics, covering things in such detail that those with previous education and/or experience could still learn a lot and yet those with absolutely no such education or experience could understand it completely, could be presented in such a short time.
6. Do you have any suggestions as to how our training might be improved? I have no suggestions as to improving your course; it seemed 100% O.K. to me, so I'll use this space to put a feather in the cap of your Seattle instructor, Mr. Robert Genn. Not only is Mr. Genn a very competent instructor, but he is also one of the finest individuals I have ever had the pleasure of meeting. At all times he displayed a very personal relationship with each student, displayed almost impossible patience trying to get a point through our sometimes thick skulls, and displaying true concern as to our success in both the F.C.C. exams and in our futures in electronics. I am sure that any student who attended your Seattle school left, as I did, with a warm spot in his heart for Mr. Genn and for Grantham School. He is truly a credit to your organization.
7. Would you like to have a complimentary copy of the new Grantham lesson on transistors? I would appreciate a copy of your new lesson on transistors.
8. May Grantham School use the foregoing information (or a specified part thereof) for promotional purposes? You may use the statements in this questionnaire as you like. I am very pleased that you asked my opinions and I grant permission to use them as you please. I would, in fact, be proud to recommend your school in any manner that I could.

Signed: Douglas S. Atkinson

Date: January 30, 1963

GRANTHAM SCHOOL OF ELECTRONICS, 1505 NORTH WESTERN AVENUE, HOLLYWOOD 27, CALIFORNIA



GRANTHAM SCHOOL OF ELECTRONICS

Train through Home Study or at one of our four convenient resident locations shown below:

1505 N. Western Ave.
Los Angeles 27, Calif.
(Phone: HO 7-7727)

408 Marion Street
Seattle 4, Wash.
(Phone: MA 2-7227)

3123 Gillham Road
Kansas City 9, Mo.
(Phone: JE 1-6320)

821-19th Street, N.W.
Washington 6, D. C.
(Phone: ST 3-3614)



(Mail coupon for complete details)

To: **GRANTHAM SCHOOL OF ELECTRONICS**
NATIONAL HEADQUARTERS OFFICE
1505 N. Western Ave., Hollywood 27, Calif.

34-E

Upon receipt of this coupon, the School will send complete details by return mail. There is no obligation, and no salesman will call. (Please indicate the division of the School in which you are interested.)

Hollywood classes, Seattle classes, Kansas City classes, Washington classes, Home Study.

Name _____ Age _____

Address _____

City _____ State _____

MAY, 1963

11

NEW TV CO

amazing color-coded system pinpoints

- individual COLORGRAM CHARTS highlight specific TV receiver functions
- RAPID REPAIR MANUAL

Complete
Colorgrams
Service-Pak
only **\$195**

Designed
By Leading
Authorities

Paul B. Zbar,
head of electronic dept.
Voorhees
Technical
Institute, and
Robert Cornell,
former technical
editor of
Electronic
Technician
Magazine.

B+ COLORGRAM

B+ DISTRIBUTION FOR HORIZONTAL
MULTIVIBRATOR & OUTPUT IN COLOR

GENERAL ELECTRIC 

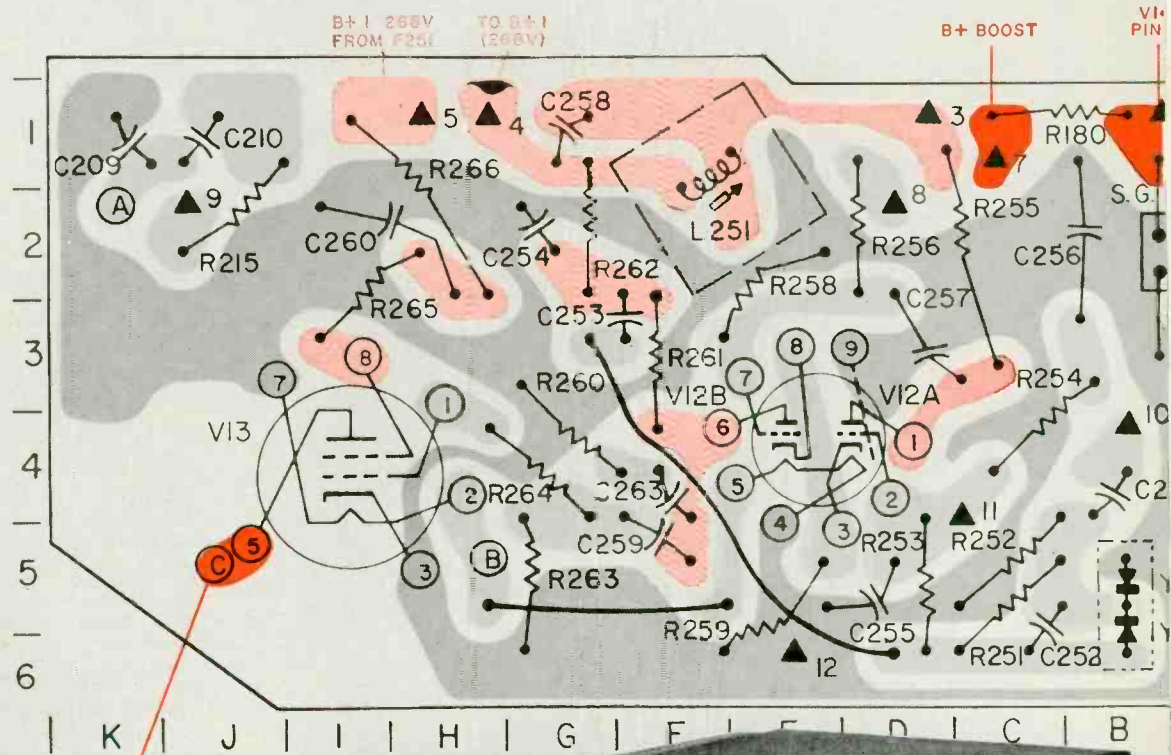

B+ BOOST

VI2A 1/2 6CG7
HORIZ MV

©1962

 COLORGRAMS INC

*Trademark registration pending

COLORGRAMS*

hard-to-find components, conductors

● COLOR-KEYED MASTER SCHEMATIC

● all based on original TV manufacturers' data

COLORGRAM Charts (see sample on left hand page) are the key to a remarkable new method designed to help you isolate TV receiver difficulties in less time and with less effort than has ever before been possible. The COLORGRAM system simplifies the use of any repair procedure you normally use.

EACH COLORGRAM CHART SHOWS SEPARATE CIRCUIT SECTIONS

Each COLORGRAM Chart is clearly color-coded to show signal-flow and continuity as distinctly as the color-marked route on a road map. Each COLORGRAM Chart shows test points and voltages. The entire ground conductor is shown in its own distinctive color throughout all the COLORGRAM Charts. Every component in the circuit is clearly identified, and its relationship to other components made readily recognizable.

There is a COLORGRAM Chart (like the sample shown) for each of these TV receiver functions: *IF, Video, Audio, Vertical* and *Horizontal*, (showing sync and sweep circuits), *B+* distribution and *AGC* circuitry.

COLORGRAMS ISOLATE TROUBLE AREAS

Each COLORGRAM Chart enables you to color-shoot with little or no reference to schematic or manual. If you have a video problem, refer to the Video COLORGRAM Chart—audio problem, the Audio COLORGRAM. The circuit is conveniently color-coded, localized and isolated. Even when a signal leaves the board and then returns, components and signal path are clearly indicated. You can concentrate on that small portion of the set most likely to be the cause of trouble. There's no time wasted working back and forth between schematic and set looking for test points—wading thru superfluous information—identifying components incorrectly.

SPEED PRINTED CIRCUIT SERVICING

Where receivers use printed circuits, each COLORGRAM Chart represents the actual signal conductor pattern of the specific PC board, exactly as you see it in the set. Color-coding helps you easily concentrate on the signal flow of interest. And each component is clearly located and identified.

COLOR-KEYED MASTER SCHEMATIC IDENTIFIES COLORGRAM CHART AREAS

Easy-to-read schematic, provides an overall view of the receiver circuit. Shows the *Tuner, IF, Video, Audio, Vertical* and *Horizontal* sections, color-keyed to the colors used in individual COLORGRAM Charts. Also includes test points, waveforms, voltage, resistance, capacitance, practical alignment data, etc.

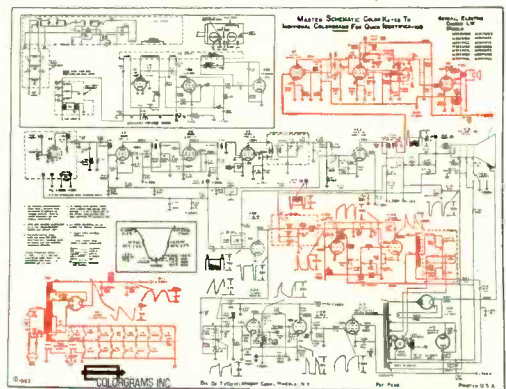

RAPID-REPAIR MANUAL CONTAINS PRACTICAL SERVICE DATA

This effective guide to the use of the COLORGRAM System contains original manufacturer's service notes, special instructions, circuit modifications, parts list and parts numbers. Includes Pictorial Tube and Component Location Charts, Tube Failure Guide.

COLORGRAMS can help you with your TV repair problems—ACT TODAY!



COLORGRAMS* INC.

Division of TVDevelopment Corp.
469 JERICHO TURNPIKE
MINEOLA, NEW YORK



Please send me:

- () Free cross-referenced COLORGRAM catalog.
() Name of nearest Colorgram distributors

NAME _____
(please print)

COMPANY _____

ADDRESS _____

CITY _____ ZONE _____ STATE _____

Please fill in this information. My occupation is:

- () TV technician () Engineer () Hobbyist () Other _____
(please specify)

www.americanradiohistory.com

CHASSIS: LW



COMPONENT LOCATION GUIDE

RESISTORS

- R178-A2
- R180-B1
- R215-J2
- R251-C5
- R252-C5
- R253-D5
- R254-C4
- R255-C2
- R256-D2
- R258-E2
- R259-E5
- R260-G4
- R261-F3
- R262-G2
- R263-G5
- R264-G4
- R265-I3
- R266-H2

DIODE

- Y251A/B-B5

CAPACITORS

- C209-K1
- C210-J1
- C251-B4
- C252-C5
- C253-F3
- C254-G2
- C255-D5
- C256-B2
- C257-D3
- C258-G1
- C259-F5
- C260-H2
- C263-F4

COILS

- L251-F1

B+ BOOST

B+

GROUND CONDUCTOR

PRINTED U.S.A.

NOW AVAILABLE

TV Colorgram Service Paks For:

- ☆ RCA ☆ General Electric
- ☆ Motorola ☆ Admiral
- ☆ Emerson ☆ Philco ☆ Westinghouse ☆ Magnavox. Other popular makes and circuits to be announced soon.

get the colorgram story use this coupon

Nothing fits all your
CB needs like
Hallicrafters' versatile
new transistorized CB-5

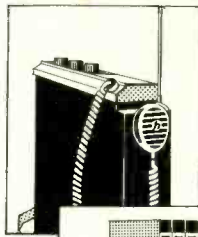

AC Pedestal Power Supply,
Battery Pak and
Tone-Coded Squelch
accessories optional
at extra cost.



Wherever and however you use citizens band, no transceiver made gets around with the effortless efficiency and consistent high performance of the new CB-5.

A fraction over 3 inches high, 10 inches wide and 8 inches deep, its 18-transistor design solves all normal space problems in mobile or airborne use. Weight: 6¾ lbs.

It has no vibrator, of course, and battery drain is negligible.

Specifications: 5 watts in; 100% modulation capability; 6 crystal-controlled channels; 1 µv sensitivity for 10 db. S/N ratio; 45 db. adj. channel rej.; PTT ceramic mike; 6 kc. selectivity at 6 db.; 18 transistors, 9 diodes, 3 instant-heat transmit tubes. Price: \$199.95.

(Continued from page 10)
made interference which could hamper studies of radiation in space.

Electronic Pioneer Honored

Benjamin Franklin Miessner, pioneer electronic inventor, was given the new de Forest Audion Award of the Veteran Wireless Operators Association (VWOA) at their annual meeting in New York City.

Mr. Miessner, seen at the left in the photograph, is the holder of



200 patents, including some that go back to patents on cat's-whiskers for the early crystal detectors. Later ones include noise-cancelling microphones (dating back to World War I), early developments in the phonograph pickup field, and a large number on electronic music devices. Others cover missile control and telemetry.

Brief Briefs

The electronics industry will be the nation's fourth largest by the end of 1963, predicts the Electronic Industries Association. 1962's sales volume of \$13.1 billion pushed the industry to fifth place. By the end of this year, says the EIA, it should rise to \$15 billion, and to \$20 billion by 1970.

Interface connections on double-sided printed-circuit boards can be made with pins instead of eyelets or plated-through-hole connections. The new method, developed by General Electric, promises to be less costly and more reliable.

Educational Television will cover 90% of United States population within the next 10 years, according to educational broadcasters' president John F. White. By 1972, he thinks, the ETV system will probably include not only a large number of closed-circuit installations but many regular stations serving classrooms, and a similar group of stations serving shut-ins and adults at home.

END

RADIO-ELECTRONICS

Hallicrafters CB-3A . . .
Unsurpassed for range
and reliability. \$159.95.



- 8 channel, crystal-controlled convenience.
- Dual conversion for maximum rejection without loss of sensitivity.
- Optional S-Meter and "Rocket Buster" Noise Eliminator with knock-out front-panel mounting.
- 100% modulation capability; output over 2 watts; 6 kc. selectivity; sensitivity less than 1 µv for 10 db. S/N ratio.

the new ideas
in communications
are born at . . .



hallicrafters

Dept. 15-E, 5th & Kostner Aves., Chicago 24, Ill.
Overseas Sales: Contact Export Dept., Hallicrafters
Canada: Gould Sales Co., Montreal, P. Q.

COMING

IN
THE
JUNE
ISSUE
OF
RADIO-
ELECTRONICS

Log-Periodic V TV Antenna—The most-talked-of-at-the-moment antenna.

How to Get the Best from the Ceramic Cartridge—This lower-priced pickup can give excellent results—but only if it is properly handled.

Tunnel-Diode Transmitter—Practical unit for use as garage-door opener and other purposes.

Base-dip Oscillator—Ingenious method maintains constant output over the tuning range. Its many uses are just beginning to be appreciated.

JUNE ISSUE

on sale
May 18



NEW

JERROLD
TACO

COLOR GUARD



TV ANTENNA

Big performance,
little price

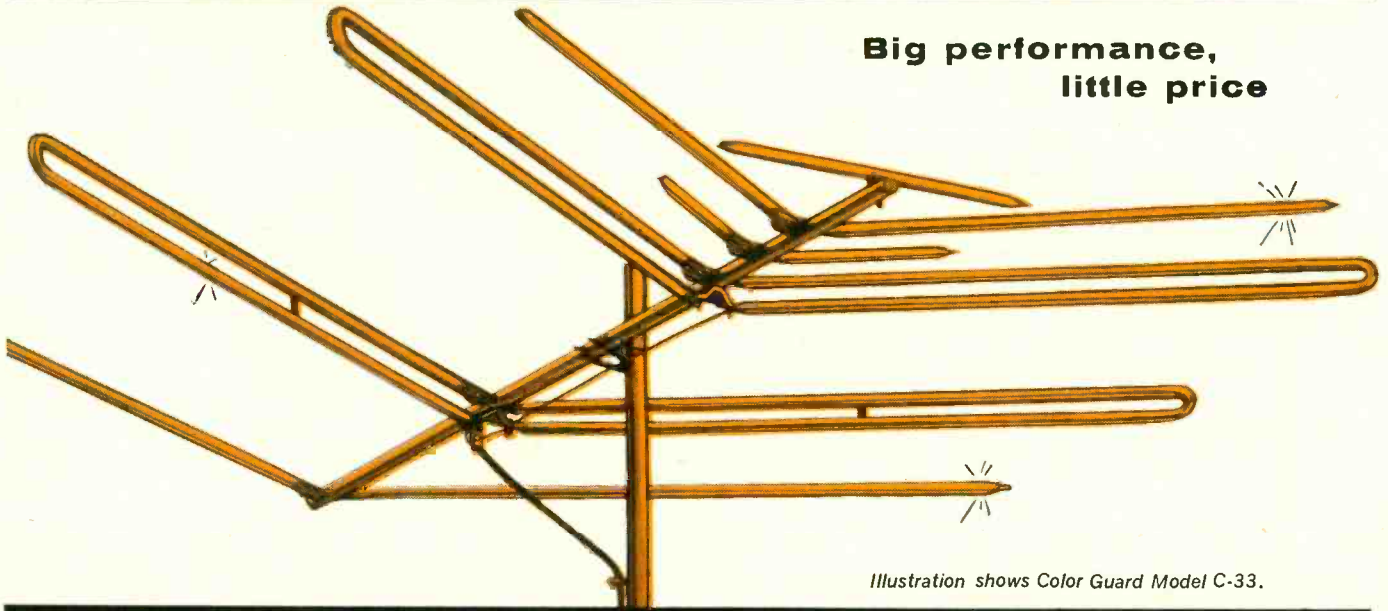

Illustration shows Color Guard Model C-33.

Engineered for metropolitan and suburban areas, delivers sparkling color—superb black-and-white

The day of the old conical and V-cone antennas is definitely over. Today you need something better to pull in satisfactory pictures on modern big-screen sets.

The new **Color Guard** is just that — something better! It's patterned after the large, rugged fringe-area antennas; but it's compact, a top performer, and budget-priced for high volume throughout metropolitan and suburban reception areas.

Listing from \$7.95 (Model C-31) to \$17.95 (Model C-33), **Color Guard** antennas give you the flat response and gain to meet your customers' needs at modest prices. Get on the color bandwagon with the JERROLD-TACO **Color Guard**. See your Jerrold distributor today, or write:

JERROLD ELECTRONICS

Distributor Sales Division • Philadelphia 32, Pa.

A subsidiary of THE JERROLD CORPORATION



CLASSROOM TRAINING COURSES IN
LOS ANGELES AND NEW YORK CITY

START YOUR CAREER IN ELECTRONICS NOW AT RCA INSTITUTES...

Choose from this list

	Course	Qualifications	Length of Course
A	Electronics Technology (T-3)	High School Grad, with Algebra, Geometry, Physics or Science	Day 2¼ yrs. (N.Y., L.A.) Eve. 6¾ yrs. (N.Y.)
B	Industrial and Communications Electronics (V-7)	2 yrs. High School with Algebra, Physics or Science	Day 1½ yrs. (N.Y., L.A.) Eve. 4½ yrs. (N.Y.) Eve. 3 yrs. (L.A.)
C	Electronics and Television Receivers (V-3)	2 yrs. High School with Algebra, Physics or Science	Day 9 mos. (N.Y., L.A.) Eve. 2¼ yrs. (N.Y.) Eve. 1½ yrs. (L.A.)
D	Electronic Drafting (V-11, V-12)	2 yrs. High School with Algebra, Physics or Science	Eve. Basic: 1 yr. (N.Y.) Advanced: 2 yrs. (N.Y.)
E	Automation Electronics (V-14)	Radio Receiver and Transistor Background	Sat. 44 wks. (N.Y.) Eve. 9 mos. (N.Y.)
F	Digital Computer Electronics (V-15)	Radio Receiver and Transistor Background	Sat. 30 wks. (N.Y.) Eve. 6 mos. (N.Y.)
G	Fundamentals of Computer Programming (CP-1)	College Grad. or Industry Sponsored	Sat. 15 wks. (N.Y.) Eve. 3 mos. (N.Y.)
H	RCA 301 Computer Programming (CP-2)	CP-1 or Equivalent	Sat. 15 wks. (N.Y.) Eve. 3 mos. (N.Y.)
I	RCA 501 Computer Programming (CP-4)	CP-1 or Equivalent	Sat. 15 wks. (N.Y.) Eve. 3 mos. (N.Y.)
J	IBM 1401 Computer Programming (CP-3)	CP-1 or Equivalent	Sat. 15 wks. (N.Y.) Eve. 3 mos. (N.Y.)
K	Color Television	Television Background	Eve. 3 mos. (N.Y., L.A.)
L	Transistors	Radio Background	Eve. 3 mos. (N.Y., L.A.)
M	Technical Writing	Electronics Background	Eve. 3 mos. (N.Y.)
N	Preparatory (P-1)	1 yr. High School	Day 3 or 6 mos. (N.Y.) Day 3 mos. (L.A.)
O	Preparatory Mathematics (P-0A)	1 yr. High School	Eve. 3 mos. (N.Y.)

RCA Institutes is one of the largest technical institutes in the United States devoted exclusively to electronics. Free Placement Service. Applications now being accepted for next term classes in Los Angeles and New York.



The Most Trusted Name
in Electronics

RADIO CORPORATION OF AMERICA



Send to the school nearest you -

RCA Institutes, Inc. Dept. RER-53

Pacific Electric Building 350 West Fourth Street
610 S. Main St., L.A. 14, Calif. New York 14, New York

Please send me your FREE catalog. I am interested in the courses circled below.

A B C D E F G H I J K L M N O

Name _____ (please print)

Address _____

City _____ Zone _____ State _____

For Home Study Courses See Ad On Opposite Page

Correspondence



Diodes Reverse Motor

Dear Editor:

I read avidly your May 1962 issue—especially the article on “A Sun-Tracking Robot Furnace.” The servo system looked pretty good to me, so I decided to build one to track the moon and planets with a telescope.

I had a hard time getting the polar relays, but I finally found surplus Barber-Colman Micropositioner relays, operating on 0.83 ma. They worked fine, but I still had no servo-motor.

The only geared motor I could locate was an Oster B-9-1 shunt-wound job requiring 27.5 volts dc at 0.7 ampere. This

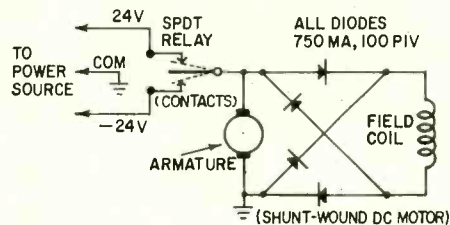

was fine, but how would I reverse its rotation by reversing its polarity? My solution appears in the drawing.

I found two rf chokes in the end of the motor case. I removed them, and had a good place for the diodes. Now the motor takes off as fast in one direction as the other!

SEABORN H. CHILES

San Francisco, Calif.

[The B-9-1 is available at Fair Radio Sales Co., 2133 Elida Road, PO Box 1105, Lima, Ohio, and other surplus outlets.—Editor]

A Fly in the Tracer?

Dear Editor:

Regarding Turner's “Tunable Af Signal Tracer” (December 1962, page 36): there is a discrepancy between the response curve and the text. With the instrument used as a wave analyzer, the attenuation at 2f (35 db) was quoted instead of the 0.5f attenuation of 25 db. That means that when the second harmonic is tuned in as f, the fundamental is 0.5f, attenuated only 25 db. The fundamental alone would read 5.6% of full scale—even without any second harmonic (2f) at all. Similarly, the third harmonic is wrong—the fundamental alone would show 3.2% with the instrument tuned to 3f. Thus the instrument is not very useful for distortion less than 10%.

The tracer will not perform well as an intermodulation analyzer either, because of its poor skirt selectivity. Usually, IM test frequencies are 60 and 7,000 cycles, and the first sidebands are 6,940 and 7,060 cycles. You would need more selectivity than this tracer has, to distinguish the sideband frequencies from the “carrier”.

Using a triple-gang pot as the tuning element has several disadvantages, the most serious being poor tracking, which changes the peak height with frequency. Further, the impedance of the twin-T changes with frequency, particularly undesirable with transistors. This leads to the difficulty cited in

RCA training at home can be the smartest investment you ever made

Look what you get in the Course in Radio and Electronic Fundamentals

40 Fascinating THEORY LESSONS



Containing all the basic principles of radio and electronics in easy-to-understand form.

40 EXPERIMENT LESSONS



Each containing absorbing, practical experiments bound together in 20 books.

40 SERVICE PRACTICES

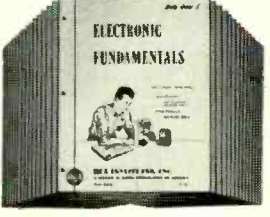

Full of practical, time-saving and money-saving servicing tips, bound into 20 books.

PLUS ALL THIS AT NO EXTRA COST...

15 KITS

to build a Multimeter, AM Receiver and Signal Generator. Kits contain new parts for experiments, integrated so as to demonstrate what you learn in the lessons and to help you develop technical skills. Each kit is fun to put together!

MULTIMETER



A sensitive precision measuring instrument you *build* and *use* on the job. Big 4½" meter with 50 micro-amp meter movement. 20,000 ohms-per-volt sensitivity d-c, 6,667 a-c.

AM RECEIVER



Have the satisfaction of building your own radio receiver with this high-quality 6-tube superheterodyne set. Big 5" speaker, fine tone!

SIGNAL GENERATOR



A "must" for aligning and trouble-shooting receivers. Build it for your own use. 170 KC to 50 MC fundamental frequencies for all radio and TV work.

Also, comprehensive, fully-integrated home study courses in: TV Servicing • Color TV • Communications Electronics • FCC License Preparation • Mobile Communications • Automation Electronics • Computer Programming • Transistors • Electronic Drafting. Stake out your future in electronics with any one of these courses. SEND FOR FREE HOME STUDY CATALOG TODAY!

Practical work with the very first lesson! Pay-only-as-you-learn! No long-term contracts to sign! No monthly installments required. Pay only for one study group at a time, if and when you order it!

RESIDENT SCHOOL COURSES in Los Angeles and New York City offer comprehensive training in Television and Electronics. Day and Evening classes. Free Placement Service. Catalog free on request.



RCA INSTITUTES, INC.
A Service of Radio Corporation of America • 350 W. 4th St., New York 14, N. Y. • 610 S. Main St., Los Angeles 14, Calif.

RCA INSTITUTES, INC. Home Study School, Dept. RE-53
A Service of Radio Corporation of America
350 West Fourth Street, New York 14, N. Y.

Without obligation, rush me the FREE 64-page illustrated booklet "Your Career in Electronics" describing your electronic home study training program. No salesman will call.

Name.....
Address.....
City..... Zone..... State.....
Veterans: Enter discharge date.....

CANADIANS—Take advantage of these same RCA courses at no additional cost. No postage, no customs, no delay. Send coupon to: RCA Victor Company, Ltd., 5581 Royalmount Ave., Montreal 9, Quebec.



The Most Trusted Name in Electronics



offers you the **GREATEST VALUE**
in **TUBE TESTERS**

TOP QUALITY • SPEED • ACCURACY • LOW PRICES
...sell more tubes—earn more money

a true **DYNAMIC MUTUAL CONDUCTANCE TUBE TESTER**
for only **\$79⁹⁵**
Net



Model 1000
MUTUAL CONDUCTANCE TUBE TESTER

Tests for true dynamic mutual conductance (Gm)

Tests for shorts and leakage between any tube elements

Tests for gas and grid emission... sensitivity over 100 megohms

Tests picture tubes

Here, for the first time is a true dynamic mutual conductance tube tester to sell for less than a hundred dollars... in fact it bears a price tag of only \$79.95... truly, one of the greatest values in test equipment to come your way in a long time.

Size: 14x9½x4¾"

Model 1100 TUBE TESTER

... an outstanding tester—yet amazingly low in price!

Tests for shorts and leakage

Tests for dynamic cathode emission



Tests for grid leakage

Tests for gas content

\$39⁵⁰
Net

Size: only 10¾x8¼x3¼"

Here is the answer to technicians who seek a dependable, professional performing tube tester at a minimum cost. The Model 1100 has a range of operation that will outperform many, more expensive testers. It boasts an exclusive meter bridge circuit, found only in more expensive testers. Conveniently compact in size—a whale of a money-maker.

ALL MERCURY Tube Testers have these features:

- Also test the new tube types including Novars, Nuvisitors, Compactrons, new 10-pin tubes as well as battery type tubes, auto radio hybrid tubes, voltage regulators, foreign and hi-fi tubes, thyratrons and most industrial tube types.
- Check each section of multi-section tubes separately
- Handsome, two-tone long lasting etched aluminum panel
- Housed in sturdy carrying case with handsome leatherette finish.

Model 1200
MUTUAL CONDUCTANCE TUBE TESTER

Tests for true dynamic mutual conductance (Gm)

Tests for shorts and leakage between any tube elements

Tests for gas and grid emission... sensitivity over 100 megohms

\$119⁹⁵
Net

Here is a deluxe dynamic mutual conductance tube tester with a unique push-button set-up method that can be compared with the ease of selecting a record on a juke box. Push buttons provide complete flexibility in accommodating all present and new tube types and basing arrangements. The Model 1200 is the most versatile tube tester available today.

Deluxe
Dynamic Mutual Conductance Tube Tester with FAST PUSH BUTTON SETTINGS

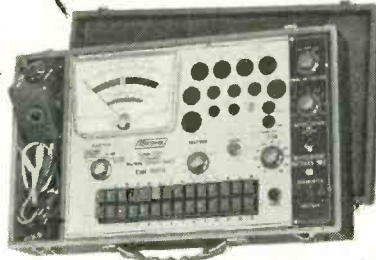

TREMENDOUS VALUE!

Also tests black and white and color picture tubes.

Also tests transistors.

Also tests batteries under load

Size: 18¼x10¼x4¾"

See your electronics parts distributor or write for complete Mercury catalog



ELECTRONICS CORPORATION

manufacturers of quality electronic products

111 Roosevelt Avenue, Mineola, New York

the Bench Tested report—gain and selectivity change as frequency is varied with the ganged pot.

I do not deny the usefulness of the tracer around shop, shack or lab, but what I object to is claims about its excellence as a wave analyzer (low selectivity), vswr indicator (too-low gain), IM analyzer (low selectivity) and in telemetering (poor shape factor).

T. C. PENN

Richardson, Tex.

Mr. Turner Replies

Dear Editor:

My thanks to reader Penn for catching the disagreement between the tuning curve and the figures given in the text. The curve is correct. Regrettably, I jumbled the performance data for tuned-amplifier and wave-analyzer functions. The disputed figures apply, of course, to tuned-amplifier performance. As a wave analyzer, the instrument will read a second harmonic above 5.6%, third harmonic above 3.2%, fourth harmonic above 2.5%, etc. It is not as bad as the 10% + Mr. Penn arrives at, seemingly by arithmetic addition of the components. This is not valid for harmonic percentages.

On intermodulation, I am unable to agree with Mr. Penn. As an intermodulation meter, the instrument reads a minimum of 15% IM with 1,000–50-cycle test signal. On vswr indication, the instrument is entirely practical at the 50-mv level; it was not intended to compete with 60-db laboratory jobs. Regarding telemetering, it depends on the system you use. The instrument has been used to extract at will a 50-, 500-, or 2,500-cycle data signal from the mixture on a line. It is certainly usable that way.

And I must disagree about the instrument's inaccuracy as an audio frequency meter. What Mr. Penn says might be true if calibration were made from resistance settings, but, after one year, the instrument still agrees with the audio oscillator against which it was calibrated.

The article says that gain changes with dial setting, and that the gain control should be calibrated and readjusted to compensate. Further, the original manuscript did not suggest that the commercial three-gang potentiometer is a match for the costly, precision-tracked units available to those who have the money to spend, but proclaimed to the experimenter the good news that the cheap pot has been found to work as well as the curve shows. Unfortunately, the editor's scissors caught that statement!

RUFUS P. TURNER

Altadena, Calif.

END

Learn RADIO TELEVISION ELECTRONICS

by Practicing at Home in Your Spare Time

Electronics is the outstanding career field of the 1960's. There are more better-than-average opportunities in Electronics than in any other field—openings for which you could qualify through NRI training. Thousands of men like yourself have stepped up to good money in Industrial Electronics, Radio and TV Broadcasting and Radio and TV Servicing with NRI training.

Make More Money Soon

If you decide to be a Radio-TV Service technician, NRI training can help you step up your income soon after you enroll. We show you how to apply your knowledge to make extra cash in spare time doing Electronic repairs or servicing radios and TV sets for friends and neighbors. If desired NRI assists you in job placement when you're ready. In short, whatever branch of Electronics you select, NRI is well qualified to help you grow in your new career . . . in usefulness, in prestige, in monetary gain.

Train With The Leader



NRI is America's oldest and largest home-study Radio-TV, Electronics training school. For nearly half a century NRI has maintained the confidence and respect of students, graduates and the Electronics Industry by constantly supplying practical, complete, up-to-date home-study training at a cost most everyone can afford. Read the capsule descriptions of NRI courses on the other side of this page. Then, mail the postage-free card today for the FREE NRI CATALOG. National Radio Institute, Washington 16, D. C.

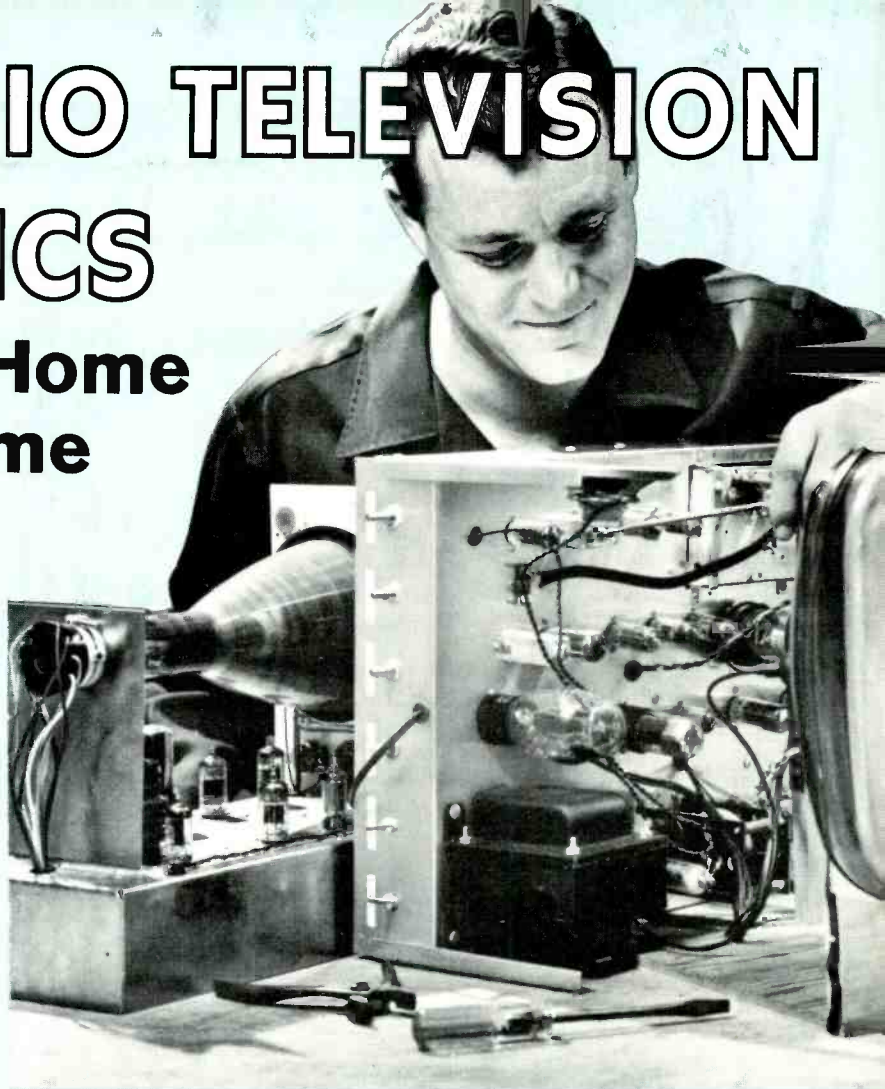

Equipment You Get Makes Training Faster, Easier

The NRI "train-by-doing" method, using special training equipment, is the time-proved way to assure advancement or to turn your hobby into a new and profitable career in the fast-growing field of Electronics. All NRI courses, except FCC License training, includes special equipment at *no extra cost*. You build circuits and work experiments. Theory you study comes to life in an interesting, easy-to-grasp manner. NRI catalog pictures and describes equipment you get. Mail the postage-free card for more facts about NRI training and opportunities awaiting you in Electronics, Radio-TV.

Turn Page For Facts On NRI Courses ➤

Cut Out and Mail—No Stamp Needed

NATIONAL RADIO INSTITUTE
WASHINGTON 16, D. C. RF

Please send me your Electronic, Radio-TV catalog without cost or obligation. I am interested in the course checked below. (No salesman will call. PLEASE PRINT.)

- | | |
|--|--|
| <input type="checkbox"/> Industrial Electronics | <input type="checkbox"/> FCC License |
| <input type="checkbox"/> Radio-TV Servicing | <input type="checkbox"/> Mobile Communications |
| <input type="checkbox"/> Math for Electronics | <input type="checkbox"/> Aircraft Communications |
| <input type="checkbox"/> Communications (Complete) | <input type="checkbox"/> Marine Communications |

Name _____ Age _____

Address _____

City _____ Zone _____ State _____

ACCREDITED MEMBER NATIONAL HOME STUDY COUNCIL

Approved for Veteran's under Korean GI Bill

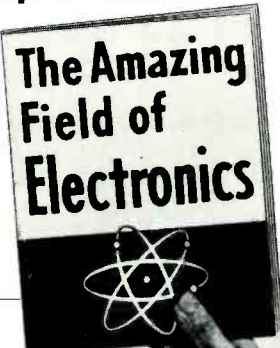

PICK THE CAREER YOU WANT IN THE WONDERFUL FIELD OF ELECTRONICS TRAIN AT HOME WITH THE LEADER

INDUSTRIAL ELECTRONICS



Prepare for a career as an Electronic Technician in industry, business, government, the military, with this NRI course in Electronics—Principles, Practices, Maintenance. Computers, telemetry, automation, missiles, rockets all employ the same basic principles . . . and that is what this NRI course stresses with illustrated lessons, special training equipment.

TELEVISION-RADIO SERVICING (INCLUDES COLOR TV)

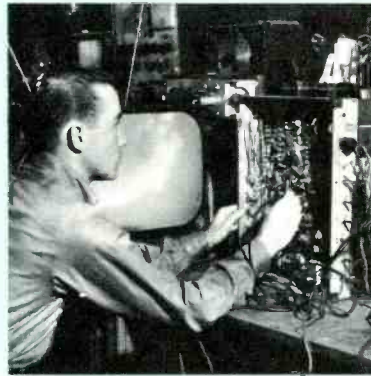

NRI's time-tested course in Servicing not only trains you to fix radios, TV sets, hi-fi, etc., but also shows you how to earn spare-time money starting soon after enrolling. Fast growth in number of sets, color-TV, stereo, means money-making opportunities in your own spare-time or full-time business or working for someone else. Special training equipment included.

TV-RADIO COMMUNICATIONS



In the NRI Communications course you get *actual experience* as NRI prepares you for your choice of Communications fields and an FCC License. Commercial methods and techniques of Radio and TV Broadcasting; teletype; facsimile; microwave; radar; mobile and marine radio; navigation devices; FM stereo multiplexing are some of the subjects covered. You work with special training equipment.

FCC COMMERCIAL LICENSE



For men with Radio-TV experience who want to operate or service transmitting equipment used in broadcasting, aviation, marine, microwave, facsimile or mobile communications. A Service Technician is *required by law* to have an FCC License to work on C-Band, other transmitting equipment. From Simple Circuits to Broadcast Operation, this new NRI course trains you quickly for your Government exams.

← SEE OTHER SIDE →

ALSO: Special courses in Mobile Communications; Aircraft Communications and Guidance; Marine Communications; Math for Electronics.

Today, a career in Electronics offers unlimited opportunity. Job counselors advise, "For an interesting career, get into Electronics." The National Association of Manufacturers says, "There is no more interesting and challenging occupation in American industry."

When you train for a career in Electronics through NRI home-study methods your home becomes your classroom, and you the only student. You pick your own study hours, study when you want, as long as you want. No need to give up your job or go away to school. And there are no special requirements of previous Electronics experience or education. Train with the leader. Your NRI training is backed by nearly 50 years of success. Mail the postage-free card. **National Radio Institute, Washington 16, D.C.**

FIRST CLASS
PERMIT
NO. 20-R
(Sec. 34.9, P.L.&R.)
Washington, D.C.

BUSINESS REPLY MAIL
NO POSTAGE STAMP NECESSARY IF MAILED IN THE UNITED STATES

POSTAGE WILL BE PAID BY

NRI  **National Radio Institute**
3939 Wisconsin Avenue
Washington 16, D.C.



← **Mail Postage-Free Card**

The **HIDDEN 600*** wrote these **6 SUCCESS STORIES...** **Service Technicians supply the happy endings!**

Capacitor success stories are no novelty at Sprague. The "Hidden 600", Sprague's behind-the-scenes staff of 600 experienced researchers, have authored scores of them! And customers add new chapters every day. But none has proved more popular than the 6 best sellers shown here. Developed by the largest research organization in the capacitor industry, these 6 assure happy endings to service technicians' problems.

1 DIFILM® BLACK BEAUTY® MOLDED TUBULAR CAPACITORS



The world's most humidity-resistant molded capacitors. Dual dielectric—polyester film and special capacitor tissue—combines best features of both. Exclusive HCX® solid impregnant produces rock-hard section—nothing to leak. Tough case of non-flammable phenolic—cannot be damaged in handling.

2 DIFILM® ORANGE DROP® DIPPED TUBULAR CAPACITORS



Especially made for exact, original replacement of radial-lead tubulars. Dual dielectric combines the best features of both polyester film and special capacitor tissue. Exclusive HCX® solid impregnant—no oil to leak, no wax to drip. Double dipped in bright orange epoxy resin to beat heat and humidity.

3 TWIST-LOK® ELECTROLYTIC CAPACITORS



The most dependable capacitors of their type. Built to "take it" under torrid 185°F (85°C) temperatures—in crowded TV chassis, sizzling auto radios, portable and ac-dc table radios, radio-phono combinations, etc. Hermetically sealed in aluminum cases for exceptionally long life. Withstand high surge voltages. Ideal for high ripple selenium rectifier circuits.

4 ATOM® ELECTROLYTIC CAPACITORS



The smallest dependable electrolytics designed for 85°C operation in voltages to 450 WVDC. Small enough to fit anywhere, work anywhere. Low leakage and long shelf life. Will withstand high temperatures, high ripple currents, high surge voltages. Metal case construction with Kraft insulating sleeve.

5 LITTL-LYTIC® ELECTROLYTIC CAPACITORS



Ultra-tiny size for use in transistorized equipment. High degree of reliability at reasonable price. All-welded construction—no pressure joints to cause "open" circuits. Withstand temperatures to 85°C (185°F). Hermetically sealed. Extremely low leakage current. Designed for long shelf life—particularly important in sets used only part of the year.

6 CERA-MITE® CERAMIC CAPACITORS



Tiny, tough, dependable in practically every application. Low self-inductance of silvered flat-plate design gives improved by-pass action in TV r-f circuits. Higher self-resonant frequency than tubular ceramics or micas. Tough moisture-proof coating. Designed for 85°C operation.

*The "Hidden 600" are Sprague's 600 experienced researchers who staff the largest research organization in the electronic component industry and who back up the efforts of some 8,500 Sprague employees in 16 plants strategically located throughout the United States.

Handy Hanging Wall Catalog C-457 gives complete service part listings. Ask your Sprague Distributor for a copy, or write Sprague Products Company, 81 Marshall Street, North Adams, Massachusetts.

68-347 R1
MAY, 1963



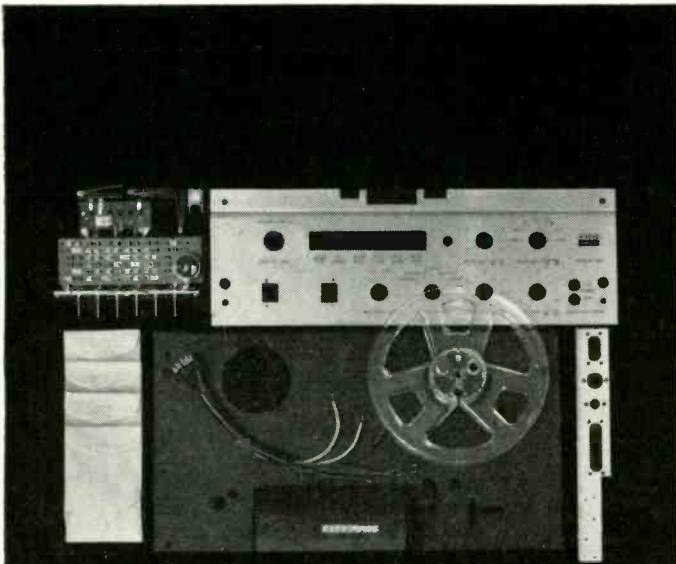

from kit...

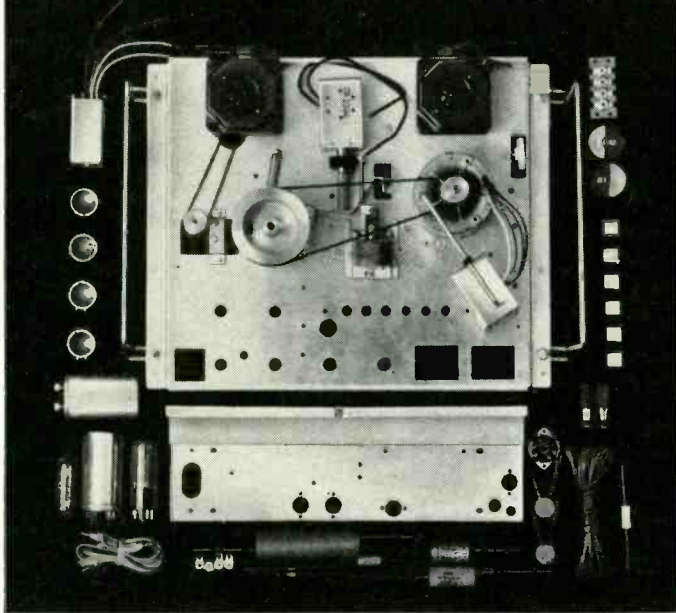

to Eico RP-100 professional transistor stereo tape deck



(and you save \$100)

Just pushing the start button tells the quality of the EICO RP-100. Instantly, tape flows with the smoothness and precision you would expect only in a studio console. Hit the stop button: D.C. brakes halt the tape with hairbreadth accuracy. Rewind—and watch a full reel whizz through in less than a minute. Aside from the decisive snap of the solenoid controls, all runs silently—thanks to rugged construction. No mechanical whirring and buzzing obtrudes on the music. And the solid heavy-gauge chassis maintains vital mechanical tolerances under heavy use.

You can't top the RP-100 for versatility: 4-track or 2-track, stereo or mono, with each channel separately erasable, 2 speeds (7½ and 3¾ ips), monitoring directly from tape, sound-on-sound recording, facilities for mixing two inputs with separate level controls for each channel, and for recording two programs simultaneously.

... and as for quality factors: 3 motors—hysteresis synchronous capstan drive—transistorized electronics to eliminate hum and microphonics—automatic tape lifters—automatic shutoff—3 precision-lapped shielded heads adjustable in all planes—narrow-gap (0.0001 inch) playback head for maximum frequency response—consistency of high frequency response improved by hyperbolic-ground heads—separate record and playback amplifiers—high-torque tape start for precise cueing and editing—jamproof speed shift—dual recording level meters—non-critical bias setting—record safety interlock—rapid loading in sweep-line path

that assures tight tape wrap-around on heads, no need for troublesome pressure pads—permanent bearing lubrication—digital tape index.

And the sound? Frequency response 30 to 15,000 cps \pm 2 db at 7½ ips with 55 db signal-to-noise ratio. At 3¾ ips the frequency response is 30 to 10,000 cps \pm 2 db with 50 db signal-to-noise ratio. Wow and flutter are below 0.15% at high speed, under 0.2% at low speed.

Summing up: "THE EICO RP-100 will do as good a job as many recorders costing up to twice as much, and it is probably more flexible than any of them." That's the unbiased test report of Hirsch-Houck Laboratories, published in Hi-Fi/Stereo Review. As a semi-kit the EICO RP-100 is \$299.95. You can also buy it factory-wired for \$399.95. Even then it's unmatched for the money. See the superb RP-100 and the complete EICO line of high fidelity components at dealers everywhere. For FREE 32 page catalog, 36 page Stereo Hi-Fi Guide (enclose 25¢ for handling & dealers' name, write: EICO ELECTRONIC INSTRUMENT CO., INC., 3300 Northern Blvd., L.I.C. 1, N.Y.

Dept. C-5

Add 5% in West



RADIO-ELECTRONICS

LANGUAGE RECTIFIERS

... In the Coming Century the Language Barrier Will Have Vanished ...

LAST March a full-page IBM advertisement appeared in various mass-publication magazines. It featured a German and a Japanese tot playing with wooden alphabet blocks in their respective languages. The advertisement read:

WHEN THEY GROW UP, WILL LANGUAGE STILL BE A BARRIER?

As modern technology makes the world smaller, the need for understanding between peoples grows more pressing. But the barrier of language still hinders our efforts to communicate with each other. Even today, only a small fraction of the world's information ever passes beyond the frontiers of its original language.

How can we broaden the flow of information from one language to another? One answer may lie in the growing versatility of computer technology. For instance, a technique for automatic translation is now under development at IBM. Russian, French and Chinese technical literature has already been translated into English at electronic speeds. The recent success in translating technical Chinese—a language that has no alphabet—indicates that all languages eventually may lend themselves to automatic translation.

Now let us turn back the pages of history 52 years to 1911 and quote a passage from the writer's novel, *Ralph 124C 41+*:

"At this moment the voice ceased and Ralph's faceplate became clear. Somewhere in the Teleservice company's central office the connection had been broken. After several vain efforts to restore it, Ralph was about to give up in disgust and leave the Telephot when the instrument began to glow again. But instead of the face of his friend there appeared that of a vivacious beautiful girl. She was in evening dress and behind her stood a lighted lamp.

"Startled at the face of an utter stranger, an unconscious Oh! escaped her lips, to which Ralph quickly replied:

"I beg your pardon, but 'Central' seems to have made another mistake?"

"Her reply indicated that the mistake of 'Central' was a little out of the ordinary, for he had been swung onto the Intercontinental Service as he at once understood when she said, '*Pardon, Monsieur, je ne comprends pas!*'"

"He immediately turned the small disc of the Language Rectifier on his instrument till the pointer rested on 'French.'

"The service mistakes are very annoying,' he heard her say in perfect English. . . ."

Note that both spoke over the *Telephot*, the telephone of the future with television, still to be realized. Television did not come into universal use until almost 40 years later.

Note further that Ralph spoke in English, she in French, but they understood each other perfectly, thanks to the electronic *Language Rectifier*—which should be in universal use within the next 25 years or so. The writer chose the term *rectifier* purposely, rather than *translator*, for reasons which will become clear in this article.

While it has recently become possible to translate various languages by means of computers, we are still a long way from *universal* telephone translators. True, we can translate words and very simple sentences from one language into some others, but even this is quite a complex and expensive undertaking. Furthermore, the total apparatus re-

quired to do even this is cumbersome and does not lend itself to commercial use.

Not until true microminiaturization of most electronic components and simplified computers is finally achieved can we hope for telephone and television language translators in all their phases. Then, too, in the future we must have *automatic* translation. Ralph's 1911 method, in which he used a knob marked "French," will not do in the future. *The sound of each language itself must do the correct switching automatically and unfaillingly.* This may appear as a tall order now, but it will be done in time.

At first the switchboard operator, say in New York, will probably call a number, perhaps in Turkey. That operator will rectify the call from Turkish into English, while the New York operator dials English into Turkish. This manual method, however, will be superseded in time by a *fully automated* language rectification.

The problems encountered in electronic multi-language translation are vastly complex. When we talk of English as an example, what is meant by that? A man in the Ozarks wishes to speak to a client in Boston. They both speak in "English" but each may speak in a distinct dialect which causes difficulty for the other. The same is true for the Parisian who talks to a Marseillaise. There is what is known as a High German in Hanover and a Low German in Cologne, plus other dialects in Baden and elsewhere. Many Chinese speak—in addition to their native dialect—Mandarin, or northern Chinese, which is the largest dialect and the "official" language. Those who do not speak Mandarin frequently cannot understand each other.

Then we have individual characteristics such as indistinct pronunciation, slurring, too rapid talking, loud voices or almost whispering.

All this puts an almost unsurmountable obstacle in the way of electronic translation. Yet this is only a beginning. Add expression, meaning, sense and hundreds of other factors, and you begin to appreciate the difficulties of robot translating.

Take the French sentence in the eighth paragraph of this article:

"Pardon, monsieur, je ne comprends pas."

It translates verbatim to: "Pardon, sir, I not understand no." But the word *pas* also means step, gait, stride! Such multiple meaning of words is true in most languages and frequently plays havoc with robot computers. Thus we require super-computers to distinguish between words, sense and meaning, let alone such sophistications as play on words and deliberate puns.

Perhaps what is needed is a special *audio sound filter-analyzer* that not only translates via a computer but simultaneously distinguishes between inflection, tone characteristics and other voice elements.

So far we have only talked about voice, that is audio. But in translating we must also consider the printed word: newspapers, magazines, books. Here we use video. Our task is simplified in a fashion because we have far fewer elements to consider. Indeed, there are now in existence electronic machines that can "read" various commercial documents, such as bills, checks, bank balances and others.

But routine commercial book or magazine translating machines are still in the (foreseeable) future. —H.G.



Nothing fancy — just a basic electronic photoflash with 50-, 100-, and 160-watt-second outputs

By CARL HENRY

JUST PLAIN FLASH

PHOTOGRAPHY AND ELECTRONICS overlap at many points, and those of us who are interested in photography can use our electronic experience profitably. Electronic experience is especially useful in flash photography. Building an electronic flash fits into this category, but is a project that many are quick to start and slow to finish.

Perhaps the main reason for this is the complexity habit of many electronic construction enthusiasts. When we begin a complex flash unit, the cost of capacitors, transistors, transformers, vibrators, rectifiers and flash tubes is enough to write an early end to our ambition.

The basic circuit of an electronic flash is not complicated (Fig. 1). The

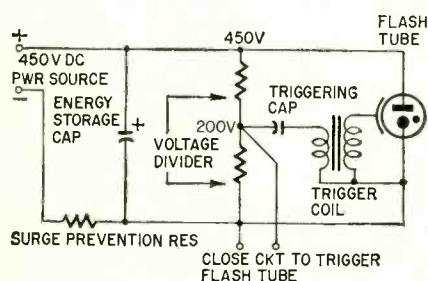
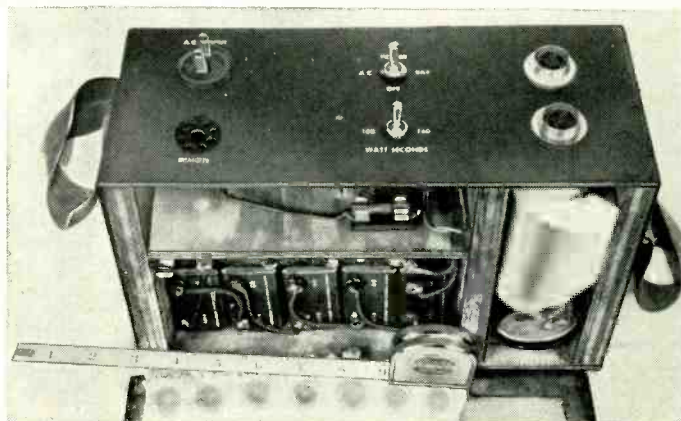

Fig. 1—Basic circuit for an electronic photoflash.

basic components are a source of voltage and current (power), a large capacitor to store this power, a flash tube, and a trigger circuit to discharge the flash tube at the proper time.

From the capacitor on, all flash circuits are very similar. Most complications arise in the simplest circuit of all, the power supply. A typical 50 watt-second flash requires 450 volts at a current which begins near 100 ma and decays to 1 ma in several seconds. There are several ways to fill this requirement. The most popular type of power supply among amateur photographers seems to be the dc-to-dc convert-

Completed flash unit. Note dual connector for flash heads, ideal for indoors where it may be desirable to use two flashes simultaneously.



er. You start with a 2-, 6-, or 12-volt battery (either dry cell or rechargeable), feed this through some sort of power monitoring circuit to cut the current drain between flashes to either a vibrator or a transistor oscillator, then step up the voltage from the oscillator and rectify it.

Cost per flash

The cost, with a dc-to-dc converter using dry cells, is about 1 cent a flash, lower if you use rechargeable batteries (but, you may have a discharged battery just when you need it most). Also these batteries do not have an indefinite life. Two years of frequent recycling is usually enough to finish them. Therefore, the cost per flash for the rechargeable battery is very nearly equal to the cost of using dry batteries.

In addition to the cost per flash, electronic parts have an exasperating habit of wearing out. The more complex the circuit, the more parts to go bad. Transistors short, vibrators won't vibrate, capacitors short, resistors change value, in spite of all we do. We can improve this by using only the highest quality components, but this will increase cost considerably.

Now how can we avoid this complexity and extra trouble? Easy. Reduce the power supply to its simplest possible circuit! Use a high-voltage dry battery. There is a hitch, of course. These batteries cost from \$11 to \$17. The cost per flash, however, is similar to the cost per flash of a dry-cell dc converter—1 cent a flash. *This holds true only if you take a minimum of 1,500 flash shots each year. If you limit your picture taking to the holidays, the dry-cell converter type will be more economical.* If you use your camera several times a week, the high-voltage battery type will match the cost of the converter circuit, at a considerable decrease in the cost of construction.

What type power supply

This question of power supply must be settled according to your requirements. I find the high-voltage battery type is in general smaller, lighter and

easier to handle when taking photos. The 3-second recycle time is also very useful. The larger type of high-voltage battery power supply about matches the dc converter in size and weight.

The high-voltage battery type of power supply is very easy to build but, before you start, decide exactly what you want and need. If you will use the flash only for family snapshots, a 50-watt-second rating will be adequate. If you do industrial or studio work, or much work in color, you will want a 150-watt-second rating at minimum. Size, weight and cost are directly dependent on the watt-second rating of the power supply. Fig. 2 shows a typical electronic flash of the high-voltage battery type. Designed as a professional unit, it operates from ac or internal batteries, and allows the selection of 50, 100, or 160 watt-seconds.

In the 100- and 160-watt-second positions, up to 300 ma is drawn from the battery. This requires a heavy-duty battery if it is to last one year or so. This flash unit can use any of three types of batteries. Either seven Eveready type 467, five type 490 or two type 492 can be used. It has provisions for two flash heads (a frequent necessity in industrial work), and may be controlled through the REMOTE socket CON 3 by a phototube or other external triggering device.

Let's go to work

The case is fibrous glass, reinforced with 5/8-inch plywood, and cemented together with polyester resin. This type of rugged box is usually necessary for field work, and allows the kids to jump on it without distracting your photography. The flash head is from an old Kodak flash holder. Mount a 4-prong socket in place of the regular flashbulb socket. Place the triggering capacitor in the barrel of the flash holder, and cut a hole in the side to mount the ready light. I tried mounting the neon light directly in the hole but, after breaking several, I placed a pilot-lamp jewel over the bulb. A four- or five-conductor cord connects the flash head to the power supply. A small coiled cord (two-conductor) connects to the camera for the sync. The completed unit weighs about 15 pounds. You can figure on about a pound for each 10 watt-seconds of energy.

R1, R2—1,000 ohms, 2 watts
R3—1.5 megohms, 1/2 watt
R4, R5—3.3 megohms, 1/2 watt
All resistors 10% tolerance
C1, C2, C3—525 μ f, 450 volts (Sprague FF-1 or equivalent)
C4—.05 μ f, 600 volts, tubular paper
C5—0.25 μ f, 600 volts, tubular paper
BATT—450 volts (see text)
CON 1, CON 2—4-terminal shielded cable connectors (female)
CON 3—octal socket

CON 4—4-terminal shielded cable connector (male to match CON 1 and 2)
D1, D2, D3, D4—silicon rectifiers, 130 volts, 500 ma (Sarkes-Tarjian M500 or equivalent)
F—1 amp, slow blow
PL—chassis mounting ac plug
S1, S2—two-pole-three position (center off) toggle switch (Lafayette SW-558 or equivalent)
S3—spst pushbutton (Lafayette 435 or equivalent)
T1—power transformer: primary 117 volts ac; secondary, 250 volts, 25 mc; 6.3 volts, 1 amp. Filament winding is not used (Stancor PS-8416 or equivalent)
T2—trigger transformer (in flash lamp)
V—flash lamp (Kemlight DX or equivalent)
Ready lamp—NE-51

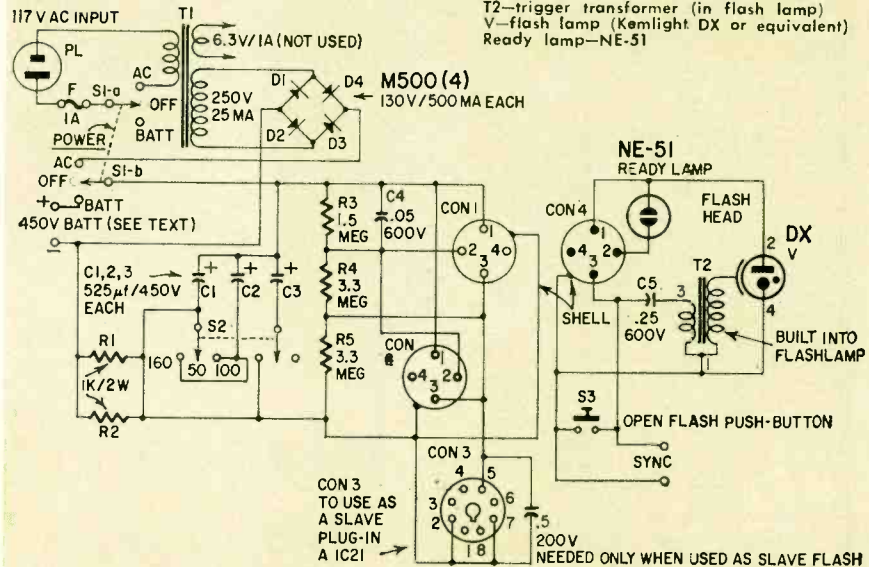

Fig. 2—This flash unit offers a choice of three light outputs.

I must confess I use the small power supply shown in Fig. 3 much more than I do the larger one. Smaller, lighter and much more convenient, it does have several disadvantages. First, since it uses a smaller battery, the watt-second rating is limited to 50, if any reasonable life is to be expected from the battery. This is adequate for most black-and-white photography, but not enough for color work, since it gives a guide number of 30—in other words, f3.5 at 8 1/2

ft. If your camera has an f2 lens, you can take pictures up to 15 feet. The smallness and convenience of the unit make up for this in actual use.

The small flash is built in a 1/4-inch plywood box. The box is put together with epoxy cement. A liberal coating of the epoxy is applied to all wood surfaces, for waterproofing.

The small unit uses five resistors (two in parallel), three capacitors, one switch and one connector—the ultimate in elec-

The smaller flash unit has only one output and one flash intensity.



R1, R2—1,000 ohms, 2 watts
R3—1.5 megohms, 1/2 watt
R4, R5—3.3 megohms, 1/2 watt
All resistors 10% tolerance
BATT—see text
C1—525 μ f, 450 volts (Sprague FF-1 or equivalent)
C2—.05 μ f, 600 volts, tubular paper
C3—0.25 μ f, 600 volts, tubular paper
CON 1—4-terminal shielded cable connector (female)
CON 2—4-terminal shielded cable connector (male to match CON 1)
S1—spdt toggle switch
S2—spst pushbutton switch
T—trigger transformer (in flash lamp)
V—flashlamp (Kemlight DX or equivalent)
Ready lamp—NE-51
Case—see text

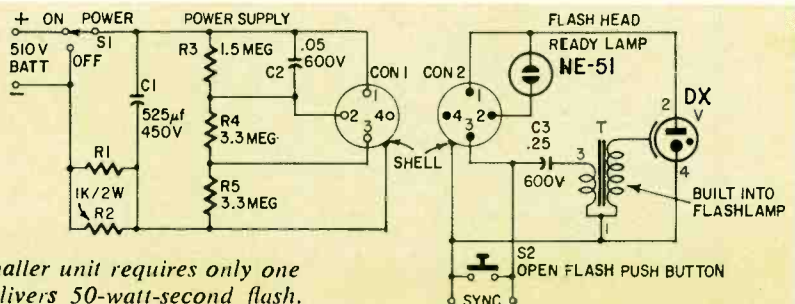

Fig. 3—Smaller unit requires only one battery, delivers 50-watt-second flash.

tronic flash simplicity. The battery costs \$11 and must be replaced every 2 years in minimum service (one photo every day), or every 6 months in maximum service (12 photos a day).

In both schematics, the flash tube is triggered by connecting a 0.25- μ f capacitor, charged to approximately 200 volts, across the primary of the tube's internal trigger transformer. The shutter contacts are used for this switching action.

The remote socket lets you use the unit as a slave flash. Get a 1C21, scrape away a little square of the black paint covering it and plug it in. A flash going off anywhere in the room will then trigger the unit.

The hardest part of building a flash unit is getting an even light coverage with no "hot spots" from the flash head. A 30° spread will increase your guide number by a factor of 1.5 to 2, but will leave the edges of your negative too thin or unexposed. A 60° spread is just about right for most situations. This covers an area greater than your normal lens, and gives you an extra margin for error.

To get this 60° spread, frost the flash tube and reflector with a permanent dulling spray (you can get a can at most photo supply stores). Install a transparent plastic cover over the front of the flash reflector and frost the inside of this cover. Your light will now be even and soft, much softer than a regular flash bulb. A guide number of 100 is normal with this reflector (50 watt-seconds) using Verichrome Pan film.

Frosting is essential if you make your own flash reflector; however, you do lose about 30% of the light produced. A complete line of integral flash-tube-reflector units is available that may solve this problem. They will also allow you to match your reflector to your lens; that is, you can use a 30° reflector for your telephoto lens, or a 65° reflector for your wide-angle lens.

These formulas will be useful when building your flash.

1. Watt-seconds or joules equals $CV^2/2$; capacitance in microfarads, voltage in kilovolts.
2. Flash duration is equal to $RC/2$, where R is the resistance of the flash tube at ionization, and C is the capacitance of the energy storage capacitor in farads (the resistance of most low-voltage tubes will be about 2 ohms).
3. Charging current is equal to $C \times E \times .001 \times N$, where C is in microfarads, E in kilovolts, and N the number of flashes per second. For example, with the small flash unit discussed in this article, if C is 525 μ f, E is 0.45 kilovolt, and the tube is flashed every 5 seconds, the average charging current would be: $525 \times 0.45 \times .001 \times \frac{1}{5}$ or .047 amps (47 ma). END

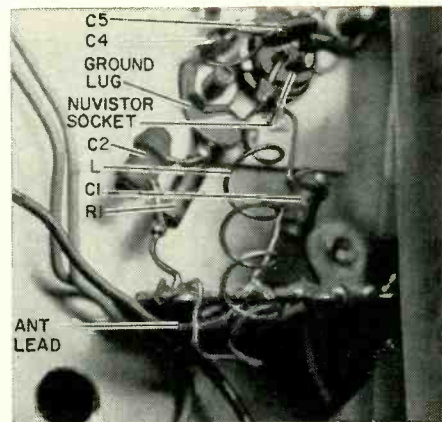
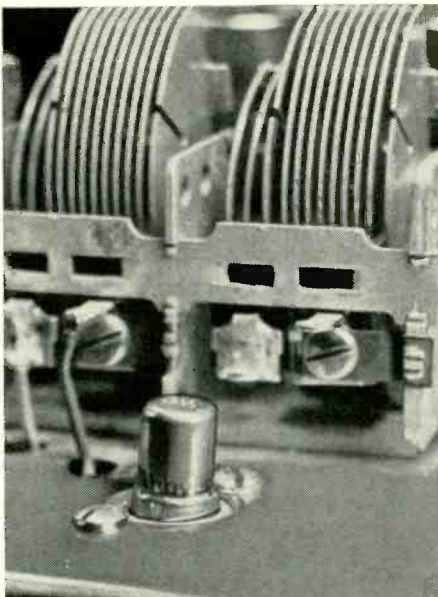

(Above) How everything fits. Output connection, through C3, not shown.

(Left) Nuvistor dwarfed in corner by the tuner's other components. All connections underneath chassis.

Inboard Preamp Boosts FM Tuner Sensitivity

By DON V. R. DRENNER

FOR SOME TIME OUR FM RECEPTION has been pretty erratic. A high-gain tuner and five-element Yagi brought in two distant stations—sometimes! But four new stations—reception indifferent—have now gone on the air, and we decided to improve matters. The solution was a simple inboard preamplifier requiring no tuning. The only measurement we made was to use our ears; full limiting on most signals about 85% of the time. Our conclusion: it's worth the handful of parts, plus an evening's tinkering.

The circuit is a grounded-grid triode, using a nuvistor 6CW4. The input is broad-band and not critical. Capacitance coupling to the existing tuner simplifies connecting the output, and you'll probably find little or no retuning necessary.

The nuvistor tube and socket are hardly larger than many transistors, so almost any space will serve to mount them and the few parts. Choose a

point as close as possible to the grid of the rf stage, and keep all leads short! The input coil L is made of 4½ turns of No. 22 enameled wire, wound on a ¼-inch dowel and allowed to spring out to a diameter of about ¾ inch. Before soldering it into place, stretch it to about 1¾ inches long.

The 6.3 volts ac for the filament can be taken from any convenient point. Keep plate voltage at 200 or less. If it's higher, making dropping resistor R3 larger so that the nuvistor plate voltage is 80 to 100. (Use a vtvm or 20k Ω /volt vom for this!)

The only tuning necessary is to stretch or squeeze the turns of L for maximum gain over the FM band. We did this by using a vtvm at the discriminator load and adjusting as we tuned in a signal at both the low and high ends of the band. A compromise is necessary, unless all your area stations are at one end of the band; then, of course, you can peak it there.

We're receiving stations in Kansas City, Wichita and Lawrence, Kans.—all between 80 and 150 miles away. Some of them we hadn't heard before, so this simple preamp does work! END

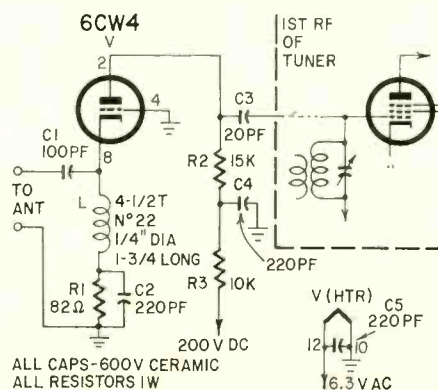

- R1—82 ohms
R2—15,000 ohms
R3—10,000 ohms
All resistors 1-watt, 10%
C1—100 pf
C2, C4, C5—220 pf
C3—20 pf
All capacitors 600 volts, ceramic
L—see text
V—6CW4 nuvistor
Nuvistor socket, miscellaneous hardware

Circuit of simple preamp.

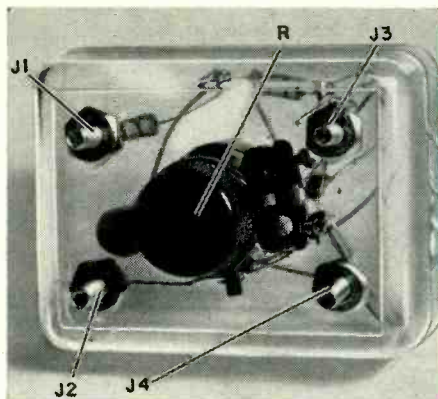

Completed unit in its little plastic case.

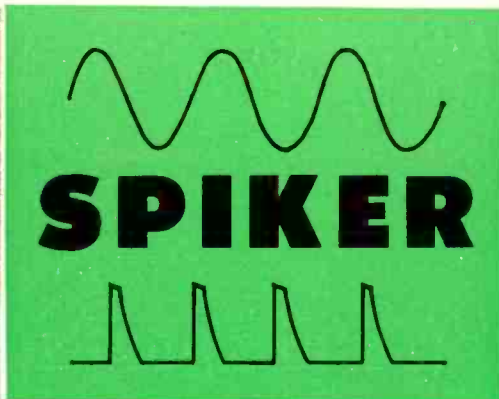

By FORREST H. FRANTZ, SR.

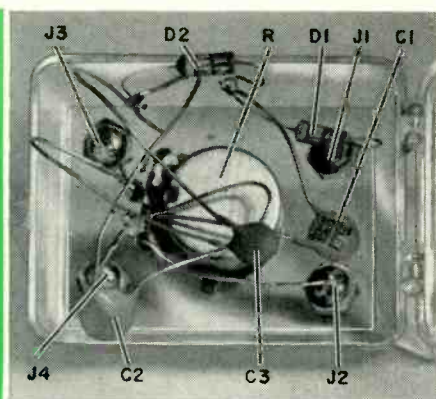

From back, with case open, a good view of the parts layout.

Passive device changes sine waves into pulses

Spike waveforms may be used for timing oscilloscope displays, computer and instrumentation applications. The Spiker converts sine waves applied to its input into spikes. Thus, the accuracy of the 60-cycle ac line or an audio signal generator signal can be converted into timing pulses of equivalent accuracy. The Spiker performs well from 20 to about 500 cycles. By changing capacitor values, performance range is changed to about 100 to 4,000 cycles.

The diagram shows the Spiker's circuit. D1 rectifies the sine wave and charges C1 during the positive half cycle of the input sine wave. C1 charges for less than 1/4 cycle and discharges for more than 3/4 cycle. Waveforms shown at the lettered points in the schematic show what happens to the sine wave. It is applied at A. If all the circuit to the right of D1 is disconnected, the positive half cycle (B1) is observed. If all the circuit to the right of C1 is disconnected, the waveform of B2 is observed.

D2 and C2 sharpen the sawtooth waveform further to produce the waveform at C. C3 and R act on the waveform to produce the spike at D. The action of R-C3 is derivative. The voltage at D changes rapidly as the voltage at C changes.

The steep leading edge of the sawtooth waveform produces a rapid changing rate. But, the voltage drops

slowly along the ramp portion of the waveform, and the differentiating circuit sees this slow rate of change as nearly no rate of change. Consequently, the voltage at D drops to the reference level and stays till the next wave.

Construction

The Spiker is built into a 1 5/8 x 2 1/8 x 1-inch plastic case. Make four 3/32-inch diameter holes each about 3/8-inch from the adjacent edges of the case (on the front face of the case) for the terminal screws. Also, make a 1/4-inch diameter hole in the center of the front face of the case. The best way to make the smaller holes is with a heated icepick. Then trim away the build-up around the edges with a pocket knife after the material hardens. Start the 1/4-inch center hole with a heated icepick and ream it to size with a taper reamer.

Tin the heads of the four 6-32 x 1/2-inch machine screws and let them cool before you place them in the case. Cut the potentiometer shaft to a 3/8-inch length and place the pot in the case. Then wire it. Double-check diode polarities.

Where to use it

Capacitor values in the parts list are for the low-frequency unit. R must be adjusted for a good waveform at the applied frequency. At 30 cycles, the output spike height is about 1/3 the value of the applied rms voltage. At 100 cycles, the output pulse height is about 1/20 the applied rms voltage. At 500 cycles, the

ratio is about 1/500. You can adjust R for higher ratios, but the waveform won't be very clean. I used inputs of 5 volts rms at 30 and 100 cycles and 10 volts rms at 500 cycles.

I prefer the low-frequency unit because the timing accuracy of the 60-cycle line is extremely good. But, if you want to use higher frequencies from your audio generator, you can build the unit to work from about 100 to 4,000 cycles. Simply make C1 and C2 .01 μ f and C3 500 μ f. At 100 cycles, with a 5-volt rms input, you get about 0.5-volt pulse out. At 1,000 cycles, 5 volts gives about 0.1 volt out, and at 5,000 cycles 10 volts in will get about .01-volt peaks out. The waveform degrades at the higher frequencies. And because the output level is so low, you will have to resort to shielding. Aluminum foil tied to a ground terminal does the job.

To use the Spiker for timing, use the leading edges of succeeding spikes to measure time. The time between leading edges is 1/f, where f is the frequency in cycles. Thus, the time between leading edges of the spikes for a 60-cycle input is 1/60, or .01667 second, or 16.67 msec. Similarly, a 1,000-cycle input will produce pulses with .001 second or 1 msec between leading edges of adjacent pulses.

The leading edges are used as reference points for time measurements because they are steep and very distinct. The trailing edge is not steep, and would be difficult to use as a reference.

The Spiker can also generate gating pulses for instrumentation equipment and for digital computers.

Input to the Spiker should not exceed 30 volts rms.

END

- R—pot, 1 megohm, miniature (Lafayette VC-38 or equivalent)
- C1, C2—0.1 μ f, 50 volts, ceramic
- C3—.005 μ f, 50 volts, ceramic
- D1, D2—1N66
- Plastic case, 1 5/8 x 2 1/8 x 1-inch (Lafayette MS-156 or equivalent)
- Miscellaneous hardware

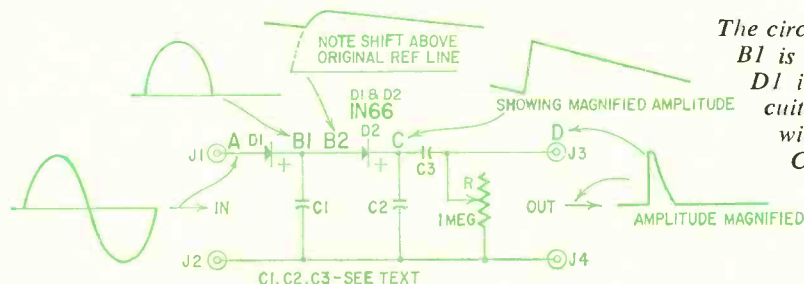

The circuit. Wave B1 is with only D1 in the circuit; at B2, with D1 and C1.

BENCH



Operates as specified by the author. Scope patterns compare with those in the author's illustrations. Is simple to build and simpler to operate.

TESTED

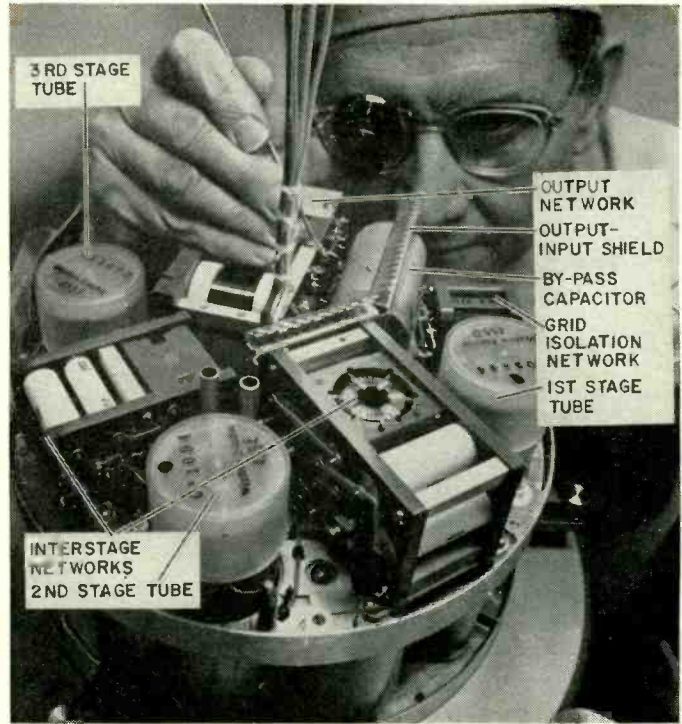
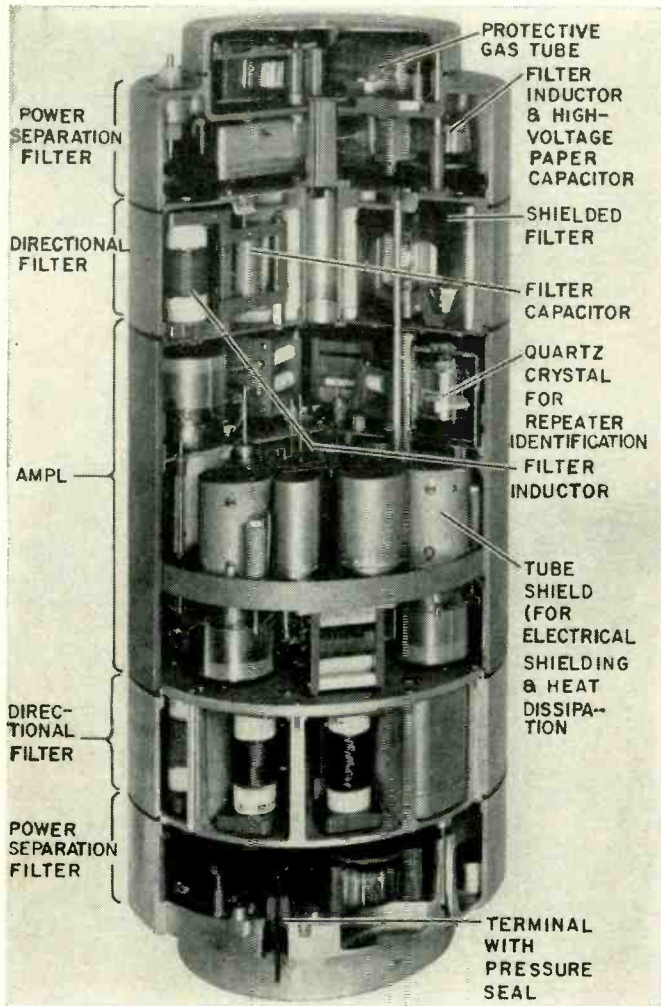

(Above) This is what is in the amplifier on the cover, and (left) components of the complete repeater.

No Service Needed on this Amplifier

It's designed to work under water 20 years before repairs

AN AMPLIFIER THAT IS EXPECTED TO work perfectly for at least 20 years without maintenance or repair is the subject of our cover this month.

The amplifier is the central feature of a new submarine telephone repeater. Installed 20 miles apart along a new transoceanic cable, these repeaters will make it possible for the cable to carry 128 two-way telephone messages (almost twice as many as on any present transoceanic cable).

It is possible to service an amplifier submerged under a mile or two of water, but fantastically difficult and expensive. The unit must first be located, then brought to the surface for repair. So Western Electric engineers made every effort to assure that the equipment will function reliably for at least 20 years. The tubes (W-E 455's) alone go through a process of aging and testing for nine months, during which time each tube is tested some 2,900 times. Only about one out of every ten survives the program. Upon completion of the aging and testing period, each tube's

record is scanned by an acceptance committee, and the tube is accepted or rejected on that record. The committee is able to distinguish between these near-perfect tubes. The lowest-noise type is used in the first stage, and that with the highest power output capability in the third. The tubes are shipped in matched groups of six—lettered A to F—enough for one amplifier.

Quality control

Other components are equally carefully inspected, and quality control is so detailed that a semi-automatic data system is required to handle it. Many of the components—such as mica and paper capacitors—are manufactured to Western Electric's own tolerances in the Clark, N. J. plant where the repeaters are being constructed. Others, such as certain resistors, are bought outside and subjected to grilling tests in the plant. A resistor that costs 30¢ originally may have some \$3.00 worth of testing put in on it before it is

finally accepted. The complete amplifiers are valued at \$60,000 to \$70,000 each.

All work on the equipment is done in "clean rooms", where scrubbed-up technicians in special garments work in a moisture and temperature-conditioned, dust-free atmosphere.

The amplifiers are in twin pairs, as shown in the figure and photographs. (The technician on the cover is inspecting a solder joint on the amplifier, with the help of a jeweler's loupe.) Three of the six Western Electric 455 A-F tubes are seen in their plastic housings. They extend down into the shield cans in the section between the two amplifiers.

The amplifiers are paralleled, to reduce the possibility of breakdown. The signal normally goes through the two amplifiers in parallel, but should one amplifier fail, the other one can take over the whole job. Special gas tubes (WE 456 A and 458 A) prevent possible damage by surges, and if one of the tube heaters opens, a fusible link is

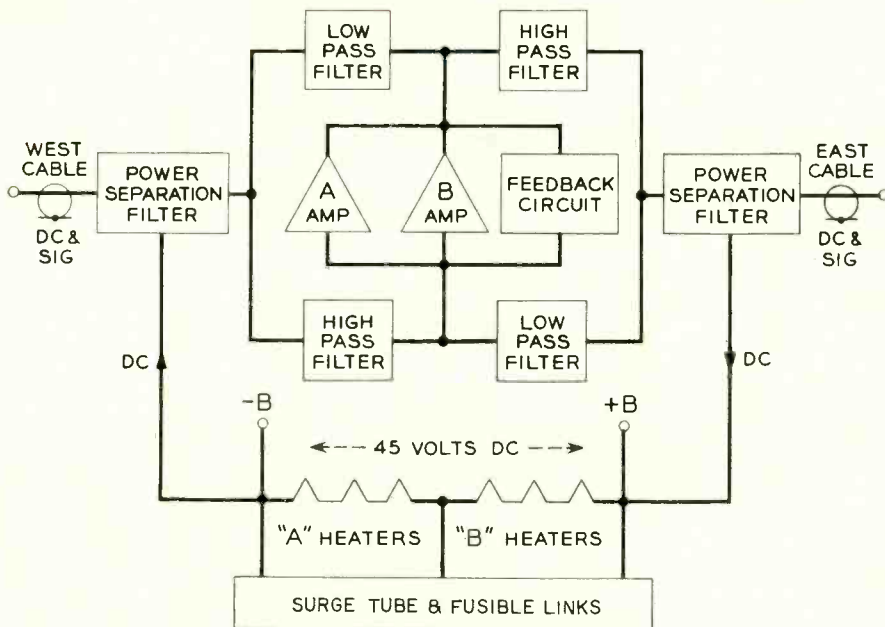

Functional diagram of the repeater.

provided to bypass it and insert an equivalent resistance in its place.

Each repeater uses about 400 milliamperes at 45 volts. The 45-volt drop across the heaters furnishes the plate voltage. Up to 11,000 volts can be supplied for the transoceanic circuit, using a 5,500-volt generator at each end of the cable.

Each repeater is supplied with a quartz crystal set to an individual frequency for that repeater. The gain of any given repeater can then be measured by sending a signal of the correct frequency through the cable.

The filters

The complete undersea repeater in-

cludes, besides the two amplifiers in the center section, two directional filters—one at each side of the amplifier—and two power filters, at the ends of the repeater. The dc power and the signals are separated by the power filter as they enter from the cable. The signals are modulated on two carriers, the east-west ranging from 116 to 512 kc, and the west-east from 652 to 1052. (Each telephone conversation covers a 3-kc band.) The broadband amplifiers cover the whole spectrum with equal efficiency, aided by a special inverse feedback network, not shown in the functional diagram.

A signal from the west, after leaving the power separation filter, goes through the west high-pass filter, through the parallel amplifiers, through the east high-pass filter, then on through the filter that unites it with the power supply in the cable going east. Signals in the opposite direction are on the low band, and reverse the process, being directed through the low-pass filter into the input of the amplifiers, and so on through the second low-pass filter toward the west cable.

The entire repeater is about 26 inches long and 8 inches in diameter. Cased for submersion, it is 40 inches long and 13 inches in diameter. Weight is about 500 pounds. END

Reshoeing a Picture Tube

By JACK DARR,
SERVICE EDITOR

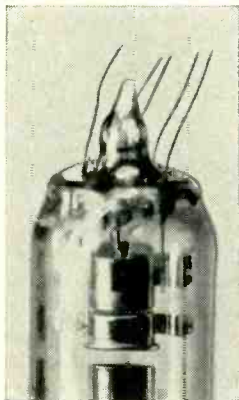

The barefoot CRT.

You never pull the base off a dead picture tube — not even when you want to. But take a good tube out ever so gently, and whoops—there goes the base!

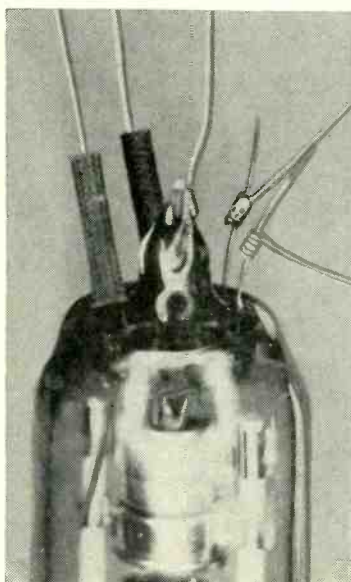

Wind tiny spirals of fine wire (with a Twirl-Con tool, if you have one), and slip them over the original wire leads. Solder, trim, and slip on spaghetti (not too much—there is very little space inside the tube base).

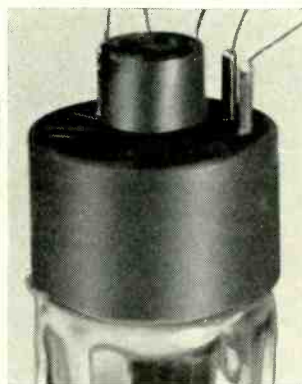

Thread the extensions through cleaned-out base pins (good idea to get them through the right pins!).

Solder, clip off surplus, and apply a coat of tube-base cement. Let dry overnight. You can scrape off excess dried cement with a knife blade.

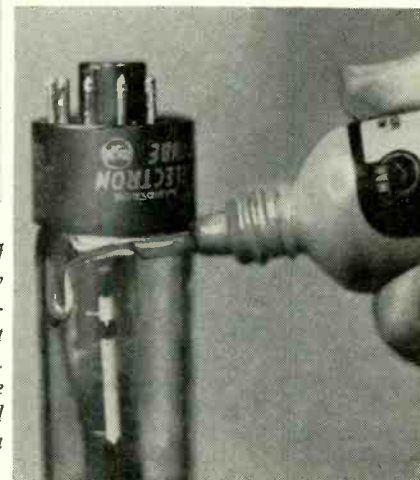

How to get the most out of that 5-watt transmitter

put
maximum
power



into your CB antenna

By RICHARD STIEBEL*

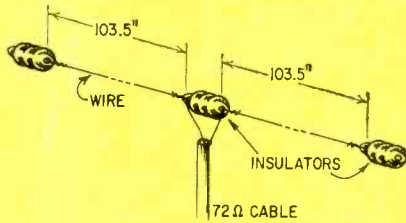

Fig. 1—Dipole is simplest antenna.

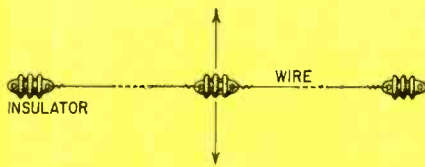

Fig. 2—Looking down on the dipole, the double-headed arrow shows its directivity.

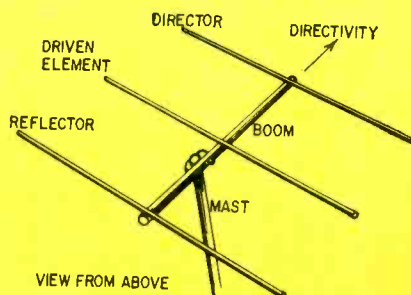

Fig. 3—Top view of a three-element beam.

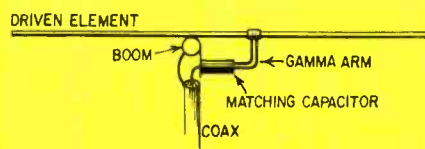

Fig. 4—Details of the popular gamma match.

FOR MAXIMUM PERFORMANCE, THE CBER must have his station in A-1 order. Even with the 5-watt power limit, great distances can be covered reliably when a well-matched antenna helps extend the range of both the transmitter and the receiver. An swr power meter is a great help in setting up, maintaining and adjusting transmitter and antenna for optimum results.

What is swr? It means standing wave ratio. When an antenna is not perfectly matched to the cable connecting it to a transmitter, undesirable radio energy (waves) appear on the antenna lead. The standing wave ratio is a measure of the mismatch between the load and the cable. In terms of performance, the presence of standing waves means less communication range, more difficult transmitter adjustment and greater interference—all due to less radiated power.

Whether the antenna you have is a dipole, beam or vertical, the chances are that your swr is greater than 1 to 1. Here's how to get a perfect reading and optimize your equipment's performance.

You'll have to hook up your swr meter before you go any further. It goes in series with the transmission line, either at the transmitter or at the antenna. As we are concerned with adjusting the antenna in this article, you will find it most convenient to insert the swr meter at the antenna end of the transmission line.

Base-station antennas

Dipoles

The dipole is the simplest base-station antenna (Fig. 1). Each dipole half should be cut so that the overall length after the wires have been connected to the insulators is 215 inches. The outer coaxial conductor is soldered to one wire and the inner conductor to the other. The cable can be RG-59/U or, for lower losses, RG-11/U. This type of antenna is bidirectional, perpendicular to its length (Fig. 2).

If the swr is above 1 to 1 when using a dipole fed by 72-ohm coaxial cable, the mismatch must be caused by wrong antenna length. Begin by adding 2 inches of wire to each end of the dipole. If the swr decreases, continue adding wire until the swr reads 1 to 1. If the swr *increases* with increasing length, go back to the original length and cut off an inch at a time from the ends of the antenna until the swr reads 1 to 1.

Beam

The three-element beam in Fig. 3 is popular for communication from one fixed point to another. It is highly directional in the forward direction (looking from the reflector through the driven element toward the director), giving an 8-db gain. This is equivalent at the receiving end to increasing transmitter power more than 6 times.

Probably the most common matching system used on 11-meter beams is the gamma (Fig. 4). Even though assembly instructions say that the gamma

*Project engineer, Allied Radio Corp.

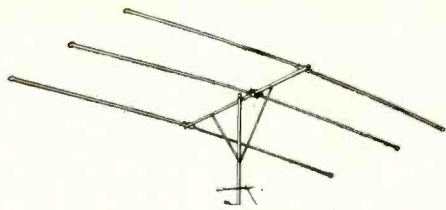

Typical three-element CB beam antenna.

arm is preset at the factory, some improvement can be had by adjusting the individual antenna further.

These beams have three basic variables: (1) The length of the elements, which generally do not need adjusting because they are cut for CB use. (2) The length of the gamma arm, (3) and the matching capacitor, both of which should be adjusted, while watching the swr meter, for a minimum reading.

The matching capacitor (Fig. 4) is often made up of two concentric tubes separated by an insulator. Its capacitance is varied by adjusting the amount of the smaller tube inside the larger one. This, of course, varies the length of the gamma arm. Therefore, these adjustments interact. Repeat them until no

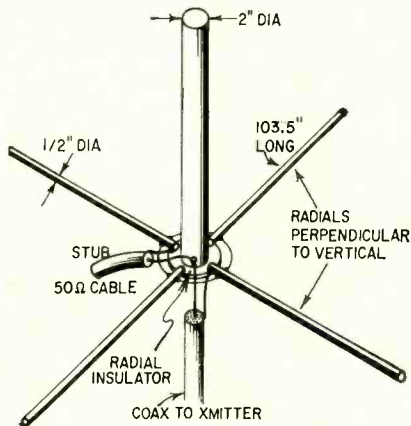

Fig. 5—An omnidirectional ground-plane antenna.

further improvement is possible. In a beam, factors such as element spacing and diameter also affect the swr. However, like the element length, these are usually accurately preset by the manufacturer.

Ground-Plane

Because ground-plane antennas are omnidirectional, they are commonly used in base-station-to-mobile communication. A typical ground-plane antenna is shown in Fig. 5. The radials act as an artificial ground surface, giving this antenna its low angle of radiation, so helpful in extending communication with a mobile.

With this antenna, the stub acts as the matching device between the coax and the vertical radiator. The braided shield of the stub is connected to the radials and to the cable braid. The center conductor connects to the vertical element and to the center element of the coaxial cable. When the antenna in

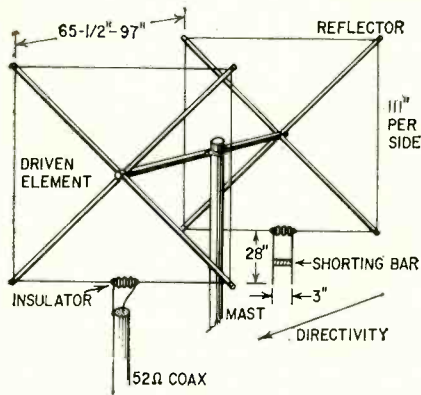

Fig. 6—Details of a two-element cubical quad.

Fig. 5 is fed by 50-ohm cable, the stub should be approximately 39 inches. With an swr bridge in the line, stub length can be adjusted for an swr of 1 to 1.

Cubical Quad

The performance of the two-element cubical quad is as good as the three-element beam discussed above, but the antenna is more compact, inexpensive and relatively easy to construct and adjust (Fig. 6). For optimum performance, the cross-supports and the T top of the mast should be nonmetallic. Bamboo poles can serve as lightweight cross-supports, and a piece of 2 x 2 or 2 x 4 pine as the T. The mast can be metal. Give the wood frame several coats of weatherproofing compound to insure long life. Use No. 14 copper wire for the elements and the stub. Make a simple shorting bar from a short piece of coat hanger with an alligator clip soldered to each end.

To adjust the quad for optimum performance, simply insert an swr bridge in the coaxial feed line and vary the position of the shorting bar for minimum reflected power, and you are on the air.

Mobile antennas

The standard 102-inch quarter-wave mobile whip antenna is commonly fed by 52-ohm cable. A mismatch with this type of antenna is likely. After

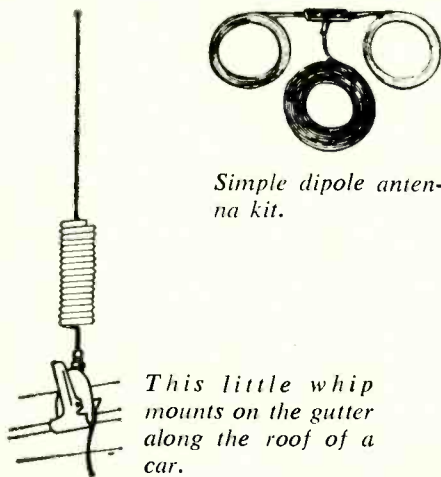

adjusting whip length for minimum swr, you may have to insert a small matching coil at the base of the whip (Fig. 7) to make the swr 1 to 1. The bottom of this coil is connected to ground (the car) and the top to the antenna base. The outer shield of the coaxial cable is grounded, and the inner conductor is connected to the coil. Make the first connection near the bottom of the coil. Adjust the position of the center conductor on the coil for a 1-to-1 swr reading. Adding this matching coil effectively lengthens the antenna, which must

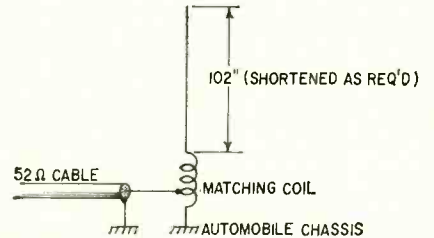

Fig. 7—Coil at the base of whip antenna matches the antenna to the 52-ohm coax.

now be shortened to return it to resonance.

Base-loaded whip

The short base-loaded clip-on-the-gutter whip antenna is quite sensitive to position on the car. Swr will be greater than 1 to 1 when it is fed by 52-ohm cable. An swr bridge will help locate the best mounting point. Note that this antenna comes with an electrical half wavelength (Approximately 12 feet) of coaxial cable. Do not shorten this cable. Use it even if you do not need the length, as it permits the transmitter to deliver power to the antenna just as if the antenna were located right at the transmitter.

Be sure the clip is grounded to the

Fig. 8—Matching to a base-loaded whip.

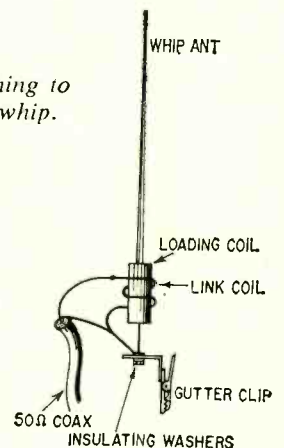

gutter, as this affects the swr.

A perfect match can be obtained with this type of whip with relatively little work. The insulated spring-loading coil is an integral part of the whip. Wrap a one- or two-turn link coil around the middle of the loading coil (Fig. 8). Remove the insulating washers from between the bottom of the antenna and

transistors with your scope

As a transistor checker, there are few better instruments

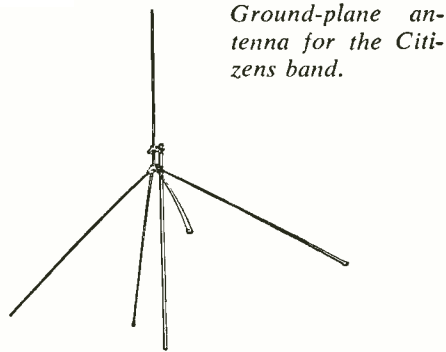

Ground-plane antenna for the Citizens band.

the bracket. When replacing the nut, connect the bottom lead of the small coil and the braid of the coax to the gutter clamp so that they too will be grounded. Connect the center of the coax to the top of the link coil. Tie the coaxial cable to the gutter clamp to relieve any tension on the small coil.

Using an swr bridge, adjust the position of the link up or down for mini-



Bumper-mounted mobile whip for CB use.

mum swr. When this point has been found, adjust the number of turns of the link for a 1-to-1 swr. Using 52-ohm coax, I found that a one-turn link positioned slightly above the middle of the loading coil gave an swr of 1 to 1. Once you have a perfect match, the exact length of the coaxial cable is an important factor no longer.

Handie-Talkie Whips

The loading coil for whips on hand-carried transceivers is generally inaccessible, though some whips are merely an extension of the tuned circuit. Because these units are very small, using an swr bridge disturbs the ground pattern and makes the instrument's value questionable.

Now that you have all the data, you should be ready to get an swr bridge (beg, borrow, etc.) and see how much you can improve the performance of your CB equipment. END

References

- Magagna, "A Dual Quad for 15 and 10", QST, May 1956.
- Pomery, "A Tri Band Quad," QST, September 1956.
- Leslie, "A Cubical Quad for 20 Meters," QST, January 1955.
- Brownstein, "86 Quad for Six," 73 Magazine, November 1961.
- Katz, "The Half-Wave Transmission Line," 73 Magazine, March 1962.
- Goodman, "My Feedline Tunes My Antenna," QST, March 1956.
- Lemons, "New CB Transmitter Testers," RADIO-ELECTRONICS, December 1961.
- Equipment Report—"Knight P-2 SWR/Power Meter," RADIO-ELECTRONICS, February 1963.

THE SCOPE'S HORIZONTAL INPUT IS PROBABLY one of this instrument's least-used features. Yet, when you fool around with it a little, you begin to see its possibilities. For example, how many people who own a scope realize that with a handful of parts from the junkbox they can build a transistor tester that will not only test the transistor, but actually graph its characteristic automatically?

The most valuable characteristic for the experimenter is the one graphing output current against input current. This shows at a glance how much gain the transistor has, whether it has much distortion, how sharp the cutoff is, etc. Fig. 1-a shows the basic circuit for this type of test; Fig. 1-b, a practical circuit.

This circuit produces a trace on the scope screen that shows how output current varies with input current. Since the input resistor (R1) is 20 times as

large as the output resistor (R2), the vertical *current* scale must be made 20 times as great as the horizontal current scale when the scope's horizontal and vertical voltage sensitivities are made equal.

Suppose we have set both horizontal and vertical gain so that sensitivity is 2 squares per volt. Then each horizontal square represents 0.5 volt across 10,000 ohms (10,000 ohms in the circuit), or an input current of 50 μ a, while each vertical square represents 0.5 volt across 500 ohms (470 ohms in the circuit) or an output current of 1 ma.

With the scope set this way, the graph of a typical p-n-p transistor might look something like Fig. 2. The curve has three parts: the *operating range*, (usually close to a straight line), the *knee*, and the *instep*.

As input current increases through the operating range, so does the output current. In this case, the output increases exactly 2 ma for every 100- μ a increase in input current. That is, the changes in output current are always exactly 20 times as great as the changes in input current, and we say the transistor has a *gain* of 20.

The transistor does not supply power itself. It can only control the current flowing from the battery. In our circuit, we have a 3-volt battery in series with 500 ohms. Therefore, even if the transistor were to act as a dead short, only 6 ma could flow. On the other hand, the minimum current flow is zero. No mat-

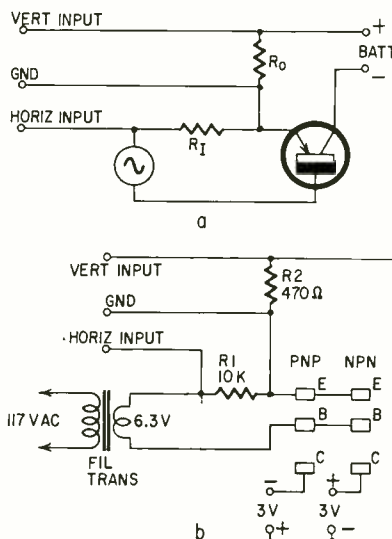

Fig. 1—You'll need this adapter to display a transistor's characteristic curve on your scope. a—basic circuit. b—Working circuit you can use.

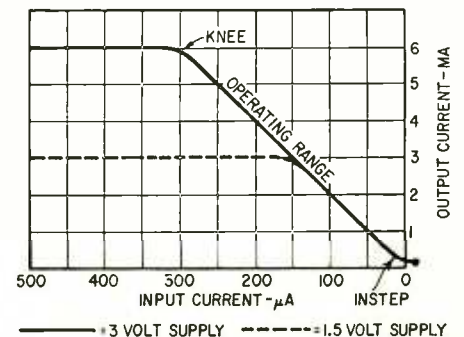

Fig. 2—Characteristic of typical p-n-p transistor.

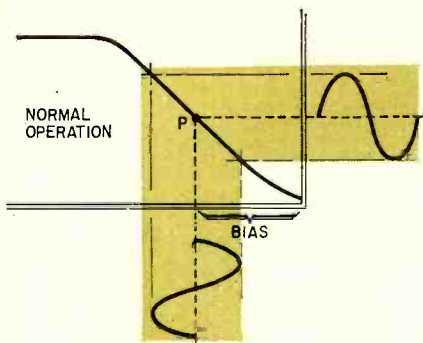

Fig. 3—Characteristic showing normal transistor operation.

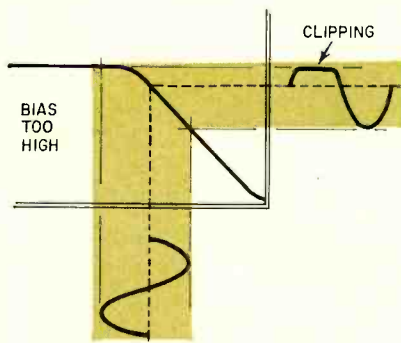

Fig. 4—You get this pattern when bias is too high.

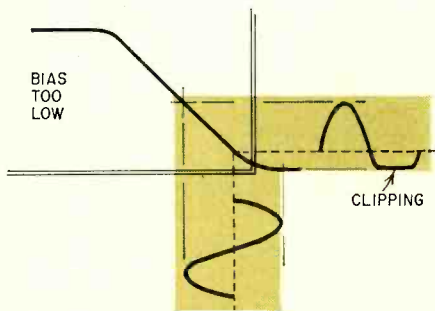

Fig. 5—Clipping caused by low bias.

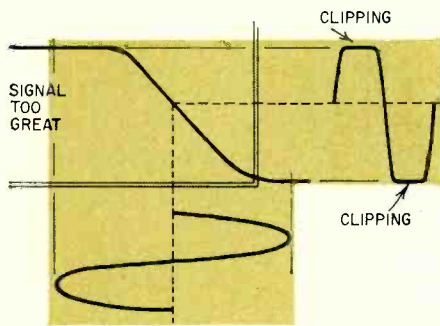

Fig. 6—Clipping caused by too much signal.

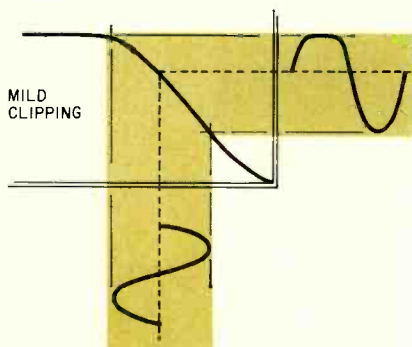

Fig. 7—Clipping is not always sharp. Pattern shows output badly distorted.

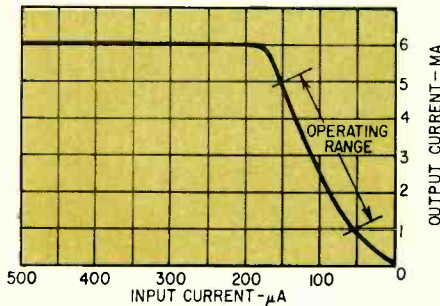

Fig. 8—Curve of high-gain p-n-p transistor. This transistor will cause distortion. Operating curve is not straight.

ter what the transistor does, it cannot reverse current flow.

Therefore, the curve has two limits set by the external circuit and not by the transistor—the output current can never exceed 6 ma nor become less than zero.

The amount of current flowing in the output circuit depends, except for this limiting effect, on the input current only. For the transistor in the example, an input of 100 μ a always produces an output of 2 ma, regardless of the battery and resistor (provided, of course, that the battery and resistor can deliver 2 ma).

In Fig. 2 the dotted line shows the effect of reducing the battery voltage to 1.5. Now the maximum current flow is only 3 ma, but below that limit the curve is just the same.

The last two paragraphs should be qualified a bit. If output current were completely independent of the power supply, the curve would be a perfectly

straight rising line to the upper limit, and there would be a sharp corner instead of the slightly curved knee. In some transistors, the knee is sharp, in others, curved. This knee indicates how independent output is of the power supply.

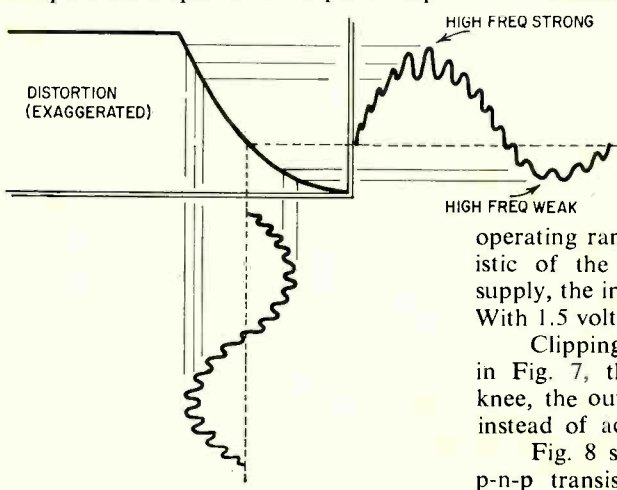

Fig. 9—How the transistor of Fig. 8 causes distortion.

ply. For practical purposes, however, the curve's variations with power supply are much too small to worry about, except in the knee region.

At the other end of the curve we find the instep. Again, the curve may be gentle or sharp. Beyond the instep, where input current is negative, the output current remains zero. However, because of the diode action of the base, very little current can flow in the reverse direction.

(Since our tester's input is ac, the spot remains in this position—small input, small output—for half the cycle, resulting in a bright spot of light at the lower right-hand end of the trace.)

The shape of this curve explains the need for bias. We want to use the straight, even part of the curve. Therefore, we have to have a battery or equivalent power supply arranged to deliver some current even when there is no input. The effect of the input is to increase or decrease this current, so that current to the transistor varies around a fixed value.

Fig. 3 shows this normal operation. The fixed bias produces a fixed, steady output. The input swings around the bias; the output around its corresponding fixed value. The output is exactly similar to the input, except, of course, that it is 20 times as great.

In Fig. 3, the bias has been set so fixed operating point P is near the middle of the operating range. This is important. If the bias is too high, as in Fig. 4, the input will drive the transistor into the knee region. The result is that output will be "clipped" off at 6 ma. On the other hand, if the bias is too low, the input will drive the transistor into the instep region (Fig. 5), clipping the output at the bottom.

If the signal is too great, clipping may occur regardless of bias (Fig. 6). The signal here is greater than the operating range of the curve. Clipping occurs at top and bottom, as the signal drives the transistor into knee and instep.

Referring to Fig. 2, we see that the

operating range is not a fixed characteristic of the transistor. With a 3-volt supply, the input range is nearly 300 μ a. With 1.5 volts, it is only 150 μ a.

Clipping is not always sharp. If, as in Fig. 7, the transistor has a gentle knee, the output will be badly distorted instead of actually being clipped.

Fig. 8 shows the curve of another p-n-p transistor. This one has higher

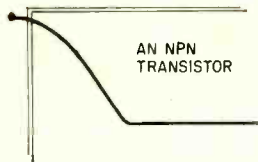

Fig. 10—Curve of n-p-n transistor.

gain—100- μ a change in input produces a 4-ma change in output, a gain of 40. But notice that the operating range is curved instead of being nearly straight. (This drawing is exaggerated.) Indeed, the gain varies at different parts of the curve. Near the knee, small input changes produce large output changes—the gain is nearly 60. As we approach the instep, the gain goes down until it is barely 20.

Such a transistor will produce distortion (Fig. 9). Suppose, for example, that a signal consisting of a high-frequency low-amplitude wave were superimposed on a low-frequency high-amplitude wave. The low-frequency wave carries the high-frequency wave up and down, into regions of greater and lesser gain. Consequently, in the output, the strength of the high-frequency wave varies—it is modulated by the low-frequency wave. Note, too, that the low-frequency wave itself is grossly distorted.

In high-fidelity terms, this is called

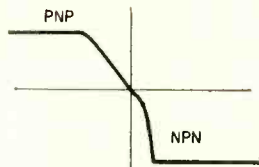

Fig. 11—Simultaneous display of p-n-p and n-p-n transistors shows they are not matched.

intermodulation distortion. The signals modulate each other, resulting in blurry reproduction that is very fatiguing to listen to. This is highly undesirable.

On the other hand, this effect can be useful. Suppose the high-frequency wave is a radio frequency. This is one way to get amplitude modulation. Or suppose the low-frequency signal is dc controlled by a potentiometer—we have a variable-gain amplifier for small signals. The avc in a radio depends on this effect.

Going through your stock of transistors will reveal great variations in their characteristic curves. This is especially true of experimenter's cheap transistors, which are not quality controlled. It might be a good idea to make some sort of label for each transistor, noting the kind of curve it has. Units with very straight characteristics could be set aside for meter amplifiers and the like,—high-

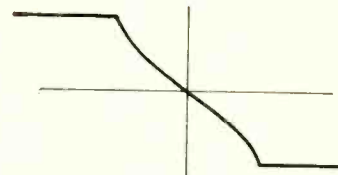

Fig. 12—This kind of display shows n-p-n (lower right quadrant) and p-n-p (upper left quadrant) transistors are matched.

gain units for preamps, curved characteristics for rf applications, sharp knees and insteps for clippers, and so on.

Used in transistor testing, this circuit and your scope provide the most basic test there is. Plug in a transistor. If it is good, it must amplify, and you will see this immediately. You will also see at a glance if gain is low or high, or if the curve is too strong.

An n-p-n transistor will yield a similar curve, except that it is reversed (Fig. 10).

The tester is especially valuable for matching p-n-p and n-p-n transistors. Plug them in simultaneously. The tester will trace a combined curve, showing the p-n-p on one half of the cycle, the n-p-n on the other. For good matching, they should not only have equal gain, but their curves should be similar (Figs. 11 and 12). END

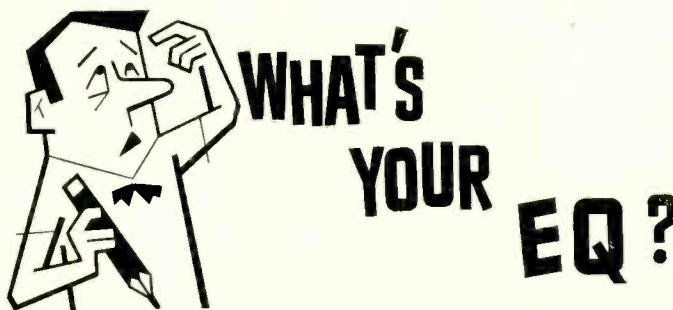

Three puzzlers for the student, theoretician and practical man. They may look simple, but double-check your answers before you say you've solved them. If you've got an interesting or unusual answer send it to us. We are especially interested in service stinkers or engineering stumbers on actual electronic equipment. We are getting so many letters we can't answer individual ones, but we'll print the more interesting solutions (the ones the original authors never thought of). We will pay \$10 and up for each one accepted. Write EQ Editor, Radio-Electronics, 154 West 14th St., New York, N. Y.

Answers for this month's puzzlers are on page 68.

Constant Current

Current flow in the circuit here is 732 ma. When C is shorted, the cur-

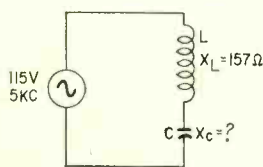

rent remains at 732 ma. Find X_C .—*S. K. Allen*

Four-way Switch

"Three-way switches" are used when it is desired to operate a device (such as a light on a stairway) that can be turned on or off with either of two switches. Here we have a problem in which it is desired to turn the light on or off with any one of three switches.

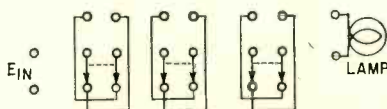

The three switches are dpdt, hooked up as reversing switches, as shown. How are they to be wired so that the light can be turned on or off by switching any one of them?—*John E. Glasner*

Rectified Voltage

What is the rectified voltage across R_L with both tubes connected, as shown in the above circuit? The indicated plate

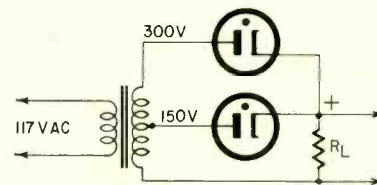

voltages are peak voltages, and the voltage drop across each mercury-vapor rectifier tube is considered to be constant at 15 volts when the tube is conducting.—*Paul F. Brown* END

Ignition Analyzer for hobbyist or pro

Use it to keep your car in top running order

WHEN SERVICING AUTOMOBILE AND IN-board marine engines, symptoms such as hard starting, missing under rapid acceleration or heavy load and frequent stalling are time-consuming to localize and eliminate without an ignition analyzer. Until the recent introduction of the Lafayette TE-40, the only instrument of its general type within the reach of the experimenter, automobile hobbyist and amateur mechanic was a special-purpose oscilloscope. (See "Ignition Analyzer Checks Car Trouble Electronically," RADIO-ELECTRONICS, September, 1957.)

The scope type analyzer is an excellent tool in the hands of an experienced operator and is more versatile than the TE-40, to be described, but has disadvantages. The operator must learn to interpret what he sees on the scope screen. It is ac-operated so it is impractical to use in the field, on boats, at drag strips, race pits and so on.

On the other hand, the battery-powered TE-40 makes most of the qualitative tests provided by the scope and indicates ignition performance as simple direct readings on a large multi-scale meter. It checks plugs, coil, condenser, points and wiring about as fast as you can move the pickup probe from one ignition lead to another and take a reading. A special loading circuit can be switched across the coil's primary to simulate heavy engine loading such as occurs with high-speed driving, rapid

acceleration and hill climbing. It checks coils for reserve power and plugs for ability to fire at lower than normal ignition voltages.

The circuit

Basically, the TE-40 is a vtvm especially adapted for ignition servicing. Its circuit is shown in the diagram. The tube complement consists of a pair of 12DL8's—a twin diode-power tetrode designed to operate directly from 12-volt dc supplies. The voltage probe is a flat metal capacitive pickup, resembling a large spring-type paper clip, that is clamped around the various ignition leads. A sample of the ignition voltage pulse is applied across a 122-megohm voltage divider. A semiconductor diode shorts out negative-going portions of the voltage pulse. The positive portions of the pulses are rectified by a diode section of one of the 12DL8's and applied to the bridge-type vtvm through the voltage divider. Two ranges for coil and ignition voltages are selected by switching shunts across the meter network.

The adjustable LOAD control is shunted across the coil's primary to simulate heavy engine loading to check the

plug's ability to fire with reduced voltage and to check coil reserve capacity.

Using the analyzer

The red lead of the power cable is connected to the positive battery terminal and the black to the negative. The two black leads on the load cable go across the coil's primary terminals. With the FUNCTION switch in the IGNITION position and the motor idling, the capacitive pickup is clipped on the plug cables one by one. A good plug shows a reading above 5 kv in the NORMAL or HIGH sectors of the upper scale. A reading between 2.5 and 5 kv falls in the LOW sector and indicates the possibility of defective points or condenser. A reading below 2.5 kv indicates a bad or fouled plug. A plug that is not firing shows a voltage well above normal.

The coil is checked with the pickup clamped to the lead between the center of the distributor and the coil. The switch is placed in the COIL position and the LOAD control is set to the center of its range. The voltage reading should be between 23 and 30 kv. A weak coil delivers from 15 to 23 kv and a bad one has less than 15 kv output.

The load is then switched in and the LOAD control advanced while comparing voltage readings obtained with the load out of the circuit. The higher the setting of the load control at the point where the engine starts to stall, the greater the reserve power in the coil.

To check out the TE-40, we set up several test spark plugs with gaps ranging from a complete short to about five times normal spacing. With a tachometer to set various engine speeds, we were able to observe the effects of various gappings and to correlate engine rpm's, meter readings and engine performance. At a local drag strip, the TE-40 detected insulation breakdown on one of the spark-plug leads in one dragster and spotted a weak coil that had just been installed on another. Next to a good set of wrenches and a timing light, the TE-40 can be a mechanic's most useful tool.

END

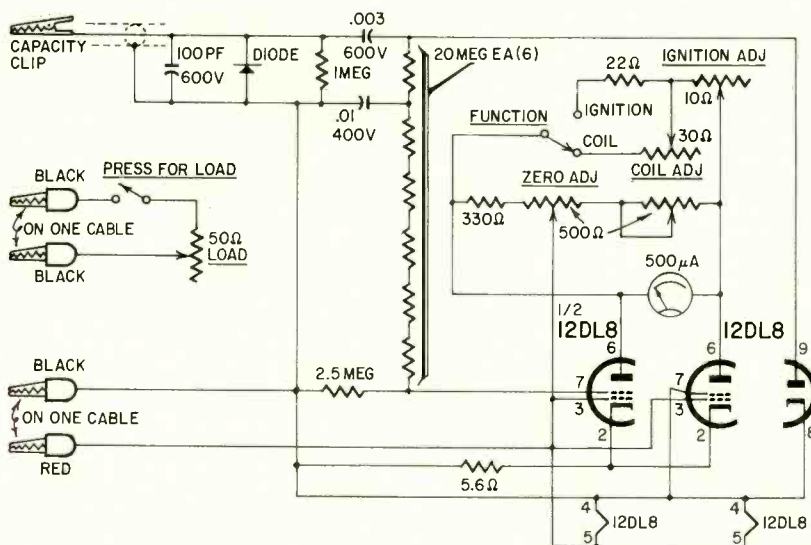

Circuit of the Lafayette TE-40 ignition analyzer. The unit comes wired.



EICO HFT-90



Harman-Kardon Citation III-X



H. H. Scott 350-B



Bogen TP-250

FM TUNERS \$29.50 and up and UP and UP

Why such a price spread?

By LEONARD FELDMAN

FM RADIO, LONG THE STEPCHILD OF THE broadcasting industry, is becoming a most important contender in the home entertainment market. AM has become primarily a source of news and "background music" of limited fidelity and has taken a role secondary to TV. Stereophonic music on records and tape has created great interest in FM stereo—the only means of broadcasting stereo currently approved by the FCC. Finally, FM stations, in general, emphasize good music broadcasting and often serve the needs of their community far better than

consumer item in America. The listing, of course, does not include complete radiophonographs, or even AM-FM combination tuners. To do so would complicate the question and we would start comparing apples and bananas. Even limiting the analysis to straight FM tuners, the spread of price is great indeed. Why should this be so? Can the average hi-fi enthusiast actually tell the difference in sound between a \$29.95 special and a "studio" quality \$300 tuner? How much of the difference lies in circuit refinements, and what do these

refinements mean to the end user?

Why the spread?

Tube complement might serve as one indication of costliness of an FM tuner. It is possible to construct a superhet FM tuner with only four tubes (actually three if one uses a pair of semiconductors for detectors) and achieve acceptable performance *under certain conditions*. A block diagram of such an elementary FM tuner is shown in Fig. 1, and will be analyzed in detail later.

The block diagram of Fig. 2 illustrates the tube complement and general circuit layout of what might best be described as an "average" high-fidelity FM tuner, with seven (in some cases, eight) vacuum tubes. This configuration closely resembles most of the current FM tuner designs.

At the upper end of FM tuner de-

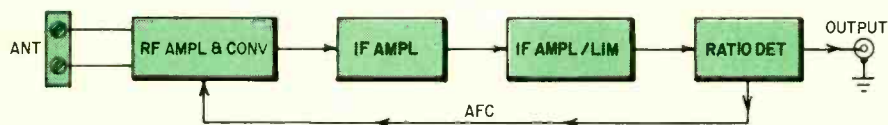

Fig. 1—Least expensive arrangement (excluding superregenerative types). Needs three or four tubes plus rectifier.

network-bound AM outlets could hope to do.

As one examines the listings in the table, a glaring fact becomes obvious: FM tuner prices spread over a greater range from the least expensive to the most expensive than almost any other

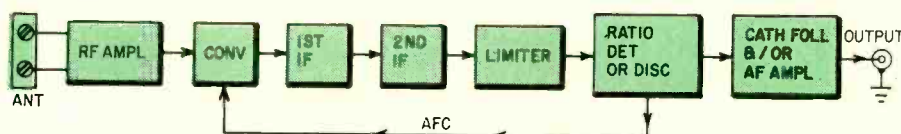

Fig. 2—"Average" kind of FM tuner in the medium price range—seven or eight tubes.

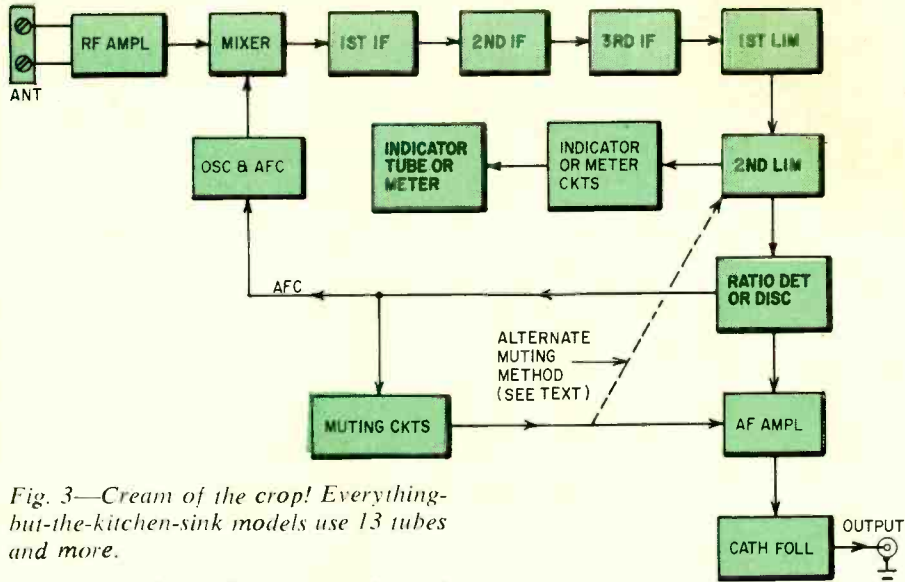

Fig. 3—Cream of the crop! Everything-but-the-kitchen-sink models use 13 tubes and more.

sign we might find a set constructed along the lines of Fig. 3. Here "no expense has been spared." The result is a tuner containing thirteen or more tubes. The fact that thousands upon thousands of such costly tuners are sold yearly suggests that the refinements in this type of design must be worth paying for—again, under certain conditions.

Rf amplifiers

By far the most economical rf and conversion circuit used in modern FM tuners is the so-called "reflex converter" arrangement shown in schematic form in Fig. 4. The circuit, originally developed in Europe, utilizes controlled regeneration to increase gain. Its obvious advantage is that rf amplifier, local oscillator, and converter to intermediate frequencies are all combined in a single tube (a twin triode).

The simplicity of the circuit makes it practical to package the front end separately. Many manufacturers, in fact, no longer produce this portion of the circuit themselves but prefer to buy it, ready-made, from companies specializing in just this type of construction.

Of course, there are negative aspects. The maximum amplification possible with this circuit falls short of that attainable with more conventional two- and three-tube front ends. While the bandwidth of this circuit is good, its ability to reject image signals is extremely poor. So it is not completely accurate to state that such tuners are well suited to strong signal areas only. While this is true in terms of the front end's gain and quieting ability, a particularly strong local station may often interfere with stations at several points on the FM dial.

Fig. 5 is a partial schematic of a grounded-grid rf amplifier which might be found in circuits typical of the block diagram of Fig. 2. A grounded-grid triode amplifier has low noise, and the method of coupling the signal pro-

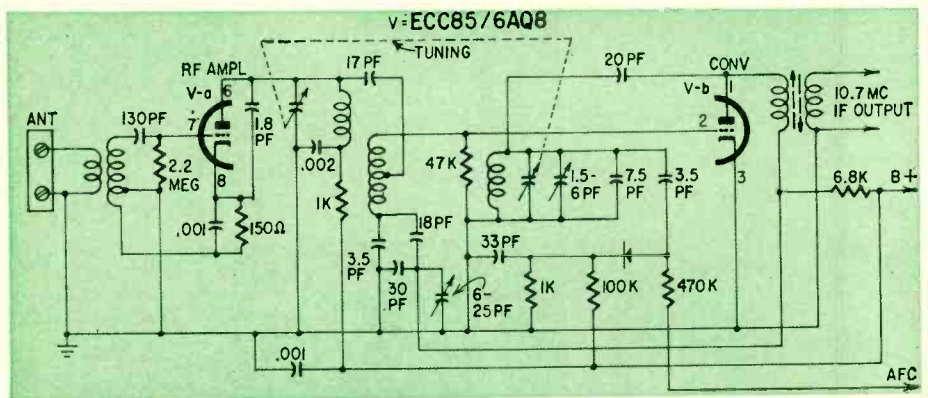

Fig. 4—Low- to medium-priced tuners use this ingenious single-tube rf amplifier and reflex converter front end.

vides a ready impedance match between antenna and input. Separate rf amplifiers, be they triodes or pentodes, in conjunction with separate oscillators or converters, constitute the next major rf stage improvement. Improved oscillator stability and conversion sensitivity are direct results of this more expensive arrangement.

In general, the most expensive sets have a cascode rf amplifier, a simplified schematic of which is shown in Fig. 6. While triodes have low noise, a factor in their favor, they also have less gain than pentodes. The cascode circuit combines the best features of each, by hooking up two triodes in series to achieve high gain and low-noise performance.

Of course, such a circuit must use two triodes (usually a twin triode in a single envelope) for rf alone. Furthermore, the tubes suitable for this application are fairly expensive compared to more conventional triodes or pentodes. This circuit, almost without exception, will be superior to the previous two in sensitivity, selectivity, and image rejection. Users who have a weak-signal area problem would do well to consider such a tuner.

I.f. circuit variations

A quick comparison of Figs. 1, 2 and 3 shows that the all-important i.f.

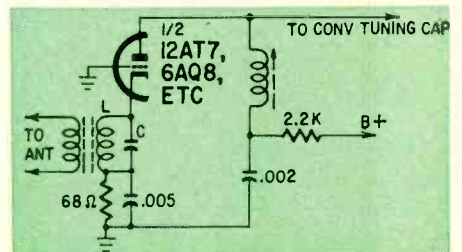

Fig. 5—Typical grounded-grid triode input stage in medium-priced tuners. L and C can be broadly tuned around the center of the FM band.

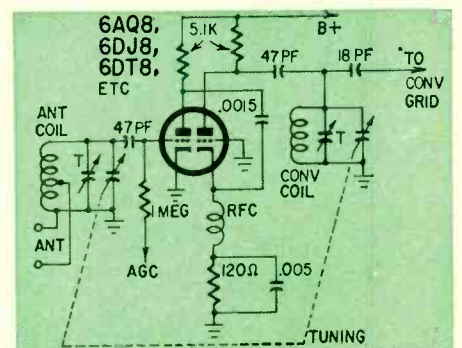

Fig. 6—Example of high-gain, low-noise cascode rf amplifier used in higher-priced tuners.

SOME REPRESENTATIVE TUNERS IN DIFFERENT PRICE GROUPS

No attempt has been made to make a comprehensive list of FM tuners in the table below; it is intended simply to illustrate the wide range of price and complexity in FM tuners. Most manufacturers who have equipment in one price bracket, for example, also have tuners in one or more of the others. Those whose equipment is listed as mono also can supply stereo equipment in most cases, and mono tuners can be obtained from almost any manufacturer listed below.

Manufacturer	Model	Diodes ¹	Tubes	I.f.'s ²	Lim ²	Cath fol or af amp	Mpx
Under \$100							
Radio Shack (Realistic)	HK204 ³	2	3	1	1	no	no
Trutone (Teeco)	289	0	5	1	1	no	no
Eico	HFT-90 ³	0	7	2	1	yes	no
Paco	ST-25MX ³	1 (afc)	7	2	1	no	yes
Daystrom	DA-287 ³	0	5	2	1	yes	no
Knight	KN14IM ³	0	9	2	0	no	yes
\$100-\$200							
Grommes	1018M	7	9	2	1	no	yes
Dynaco	FM-3A ³	6	11	2	2	yes	yes
Bogen	TP250	5	12	2	1	yes	yes
Pilot	280B	6	6	1	0	no	yes
Sherwood	S3000IV	5	11	2	1	yes	yes
Lafayette	LT-700	2	12	2	2	yes	yes
\$200-\$300							
H. H. Scott	350B ³	11	9	2	1	yes	yes
Karg	FMX-9	2	9	3	1	yes	yes
\$300-\$500							
Harman- Kardon	Cit. III-X ³	9	12	2	2	yes	yes
Fisher	FM-1000	15	15	4	2	yes	yes
Altec	314-A	5	11	2	1	yes	yes
McIntosh	MR65B	13	14	4	2	yes	yes

¹ Signal diodes only—does not include rectifiers.

² For honest comparison, i.f.'s and limiters are listed separately. That is, although one tube often can be an amplifier and a limiter (depending on signal strength), it is not considered as both at once.

³ This model—or a near equivalent—can also be obtained in kit form.

by sacrificing bandwidth, as shown in curve B.

Had lower-Q circuits been used, bandwidth (for 3-db-down points) would increase from a scant 150 kc (minimum required to receive fully modulated FM carriers with reasonable freedom from distortion) to over 300 kc. The approach used in circuits of Fig. 2 is to add at least another i.f. stage, operating each stage at somewhat re-

duced gain but increased bandwidth. Not only does limiting begin at lower inputs, but tuning becomes less critical.

This technique can be further extended (within reasonable limits) to three or even four i.f. stages (Fig. 3). Resultant bandwidth is often as great as 1 mc.

Limiters and detectors

Limiters and the way they are cou-

pled to their associated FM detectors, account in great part for the "staticless" performance of FM. By driving these stages into saturation and cutoff, AM noise, riding at the crest of the i.f. signal, is "sliced off" and only the FM variations of the incoming signal are fed to the ratio detector or discriminator.

Here, of course, distance from signal source (or, more accurately, signal strength at the receiver terminals) directly determines the requirements of the set. It is safe to say that a 1,000- μ v FM signal will cause effective limiting in all three categories of design. As signal strength is reduced below 100 μ v, the circuit of Fig. 1 will fall by the wayside. A signal below 20 or 30 μ v will rule out circuits of the type shown in Fig. 2, leaving the "expensive" design for truly difficult signal areas.

It is extremely important to realize that difficult signal areas are not determined by distance from the transmitter alone. You may well have a good outdoor antenna installation hooked to your FM tuner and pull in a fairly distant station with over 1,000 μ v of signal, whereas your neighbor, using the proverbial "hank of wire," may receive the same station with only 100 μ v or less at the antenna terminals of his set. Enough said on that score.

Detectors

The battle of discriminator vs ratio detector is an old one. Perhaps we can end it right here. A properly designed ratio detector, preceded by an adequate limiter circuit, will perform as well as the older discriminator circuit.¹ In fact, the ratio detector has certain advantages for FM stereo reception, since its output impedance is lower than that of the discriminator and there is less tendency for high-frequency subcarrier components of the FM stereo signal to be attenuated by stray and cable capacitances. (We hasten to add, however, that either circuit, when coupled to a multiplex stereo decoding circuit designed for it, will work well.)

Speaking of FM stereo, may we digress for a moment and strongly recommend that the prospective buyer of an FM tuner make certain that FM stereo is built in. The complexities of mating an adapter to your old tuner are many, and if you're in the market for a new tuner—make it an all-in-one, with FM stereo included.

Audio output circuits

Once the signal leaves the detector, not too much can happen to it in the way of deterioration of quality. The desirability of a stage of audio amplification is determined strictly by the needs of the rest of your system. Obviously, if your amplifier requires 1 volt input for full power output and the tuner you examine recovers only 0.5 volt of audio

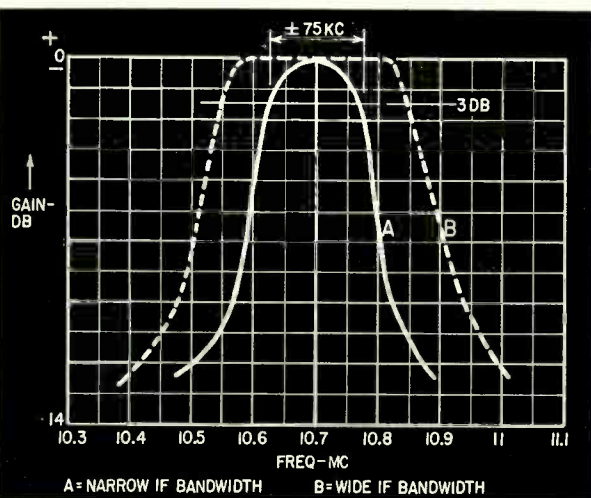

Fig. 7-a—Cheap tuners will sacrifice bandwidth for maximum gain with minimum stages. The 150-kc bandwidth is barely enough for good mono reception, impossible for stereo. b—Wider, flat-topped curve comes with more and lower-gain i.f. stages.

under 100% modulation, you'd be better off selecting a tuner with more audio gain ahead of its output jack.

Cathode-follower circuits are another matter entirely. If your amplifier is to be located at some distance from the tuner, a cathode-follower stage is a must. It transforms the output signal from a high to a low impedance, reducing possible hum and high-frequency attenuation.

Extra features

The last items to be discussed concerning our low-medium-high triumvirate of circuit types are in a category apart from audible performance. They are the so-called special features—all of them nice to have if you can afford them—none of them vital to good, clean distortion-free reception. In general, however, the more sophisticated of these features are to be found in the higher priced units.

Tuning meters and tuning eyes are a very real aid in properly setting the tuner dial for exact center-of-channel reception. Surprisingly, this is often more important in an expensive, wide-band tuner than in tuners of more restricted bandwidth. In the latter types, usually only one precise spot on the dial sounds undistorted for a given station. You tune to that precise spot as accurately as you can and hope that no drift takes place while you listen.

In wide-band sets, the tuning action is "softer". That is, a station sounds quite clean over a considerable movement of the dial pointer. Inadvertently tuning to the edge of the channel during a moment of low modulation might result in distortion later, as louder passages of music or speech are transmitted. The tuning meter or eye serves, therefore, to determine the exact channel center, yielding the greatest amount of plus-and-minus channel width.

A schematic of a tuning-eye type of indicator is shown in Fig. 8. The voltage fed to the grid of this device is taken from the agc voltage (usually at a limiter stage). When this voltage is maximum, the tuning eye closes. This setting corresponds to center-of-channel tuning. Tuning meters operate in much the same way. In some cases, a second tuning meter is used to indicate exact "balanced" setting of the discriminator voltages. Such meters are of the zero-center type, and therefore somewhat easier to use, since indication does not vary with signal strength, as does the agc-actuated meter or tuning eye.

Flywheel tuning imparts a smooth overall "feel" to the tuning knob and enables the user to get from one end of the dial to the other with one or two good spins of the knob. It is certainly more functional than, say, the chrome

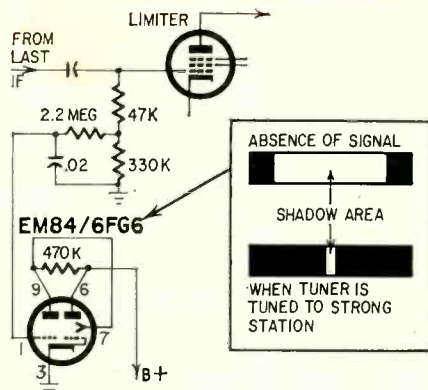

Fig. 8—Popular tuning eye tube and circuit. Shadow narrows with increasing negative bias (−20 volts closes "eye" completely).

on an automobile, so why not look for it if you can afford the luxury!

Many of the better tuners have one or more circuits that do nothing more than silence the tuner between stations. As any FM listener knows, this interstation noise can be annoying, particularly when the listener departs from one station in search of another with his volume control set fairly high before starting his quest. Usually some form of gating circuit is employed, in which an audio tube is cut off by fixed voltages until a 10.7-mc voltage (caused by an incoming station signal) opens the gate by being rectified, filtered and applied in a polarity opposite to the cutoff voltage.

Some tuners cut off an i.f. or limiter instead. Such muting circuits are generally variable, permitting the reception of very weak signals which might not normally cancel the muting feature if it were left full on at all times.

Automatic frequency control

Afc is, fortunately, found in all three classes of FM tuners. [Automatic

frequency control should never be thought of as a remedy for drift. An unstable FM local oscillator will drift whether afc is applied or not—it will just take longer to drift off station (and into distortion) with the afc applied.] Afc, on the other hand, is useful for accurate tuning. Even if the listener does not set the dial to the precise center of the channel, afc will pull the oscillator toward that precise center, reducing the possibility of distorted reception. Some of the best manufacturers, however, reject afc, even in their highest-priced tuners. They believe that wide-band detectors produce superior results, and make tuning less critical.

Refinements in afc include a defeat switch, which enables the user to first tune in the station without afc for best setting and then apply afc to lock in that setting. A further refinement of this circuitry in more expensive sets is *variable* afc. This feature enables the listener to set the "pulling power" of the afc circuit. It is useful in listening to a fairly weak station adjacent to a stronger one. With full afc applied, the tuner might pull in the stronger station only, completely excluding the desired weaker one. If afc is reduced under these conditions (usually with a front-panel or chassis potentiometer), its advantages are still present to a lesser extent.

If you have been patiently awaiting a profound and decisive conclusion, there is, unfortunately, none to be had. There will always be manufacturers who cater to those of moderate means; there will be those who seek the common denominator, and there will be a brave few who will engineer the best they know how, regardless of cost. It is our hope, however, that the pointers in this article may enable you to decide which tuner is for you: the \$29.95 model, or up, or *way up!* END

It's for the Birds

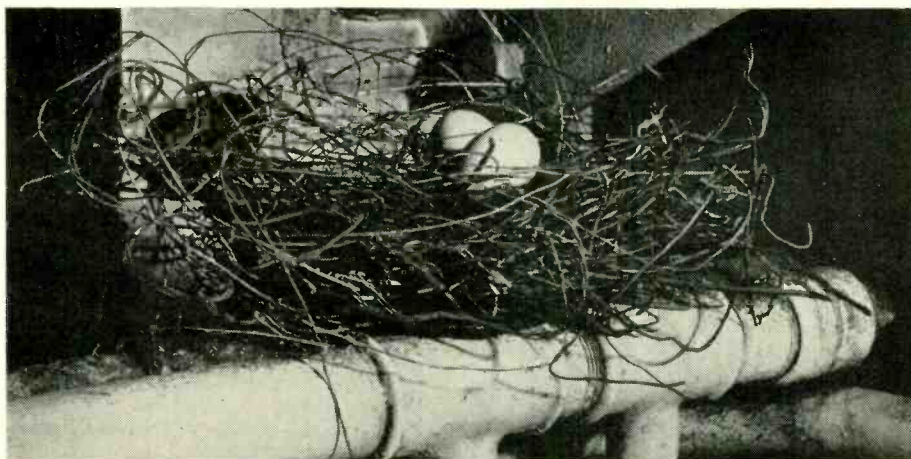

Adaptation of even the birds to the electronic age is shown in this pigeon nest, found in the rafters of an old building at the North Woolwich (England) plant of Standard Telephones and Cables, Limited, British affiliate of ITT. The pigeons, who normally build a rough nest of small twigs, have constructed their home entirely of scraps of wire, using only two small sticks (probably for decorative purposes).

¹"Limiter Discriminator versus Ratio Detector," by H. K. Milward and R. W. Hallows. *Radio-Electronics*, November 1949, page 20ff.

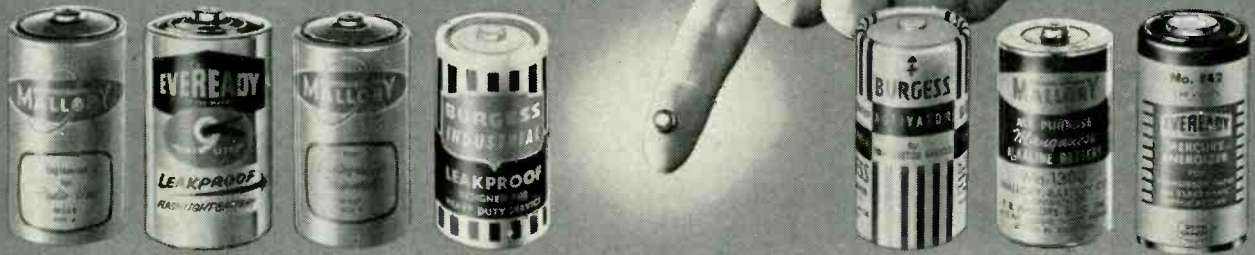

Dry cells can look alike but be very different inside. Left to right, size-D cells for: radio use, flashlights, photography, heavy-duty service, transistor radios, all-purpose (manganese) and a mercury transistor battery. In the center, of course, the familiar little hearing-aid or miniature-radio mercury cell.

INSIDE THE DRY CELL

What is the difference between a zinc-carbon and an alkaline cell? How do they both differ from a mercury cell? And what does it mean to the service technician or battery user?

By GORDON E. KAYE*

NO UNIVERSAL BATTERY EXISTS FOR every application in today's electronics. The user must consider what he needs from a battery system. Then he can choose the battery on the basis of elec-

* Applications engineer, Mallory Battery Co.

trical characteristics and physical dimensions.

First, we have to ask: What is a dry cell? We hear such titles as "energizer" and "activator", and even "alkaline energizer", and we all know that there is a mercury battery. How do these cells differ, and why?

Dry primary (nonrechargeable) cells and batteries convert chemical energy into electrical energy, on periodic or continuous demand, over a long storage period. They are "dry" only because their liquid acid or alkali electrolyte is held in a leak-resistant container.

All commercially available dry cells produce their electrical energy by oxidizing or corroding an active metal, such as zinc, in an electrolytic solution. Zinc is the *negative* terminal and is called the *anode*. The oxygen which corrodes it comes from an oxide of mercury (HgO) or of manganese (MnO₂). These oxides form the *positive* terminal or *cathode*. (Note well that the carbon "positive pole" of a dry cell takes no part in the reaction—it is simply a convenient conductor.) The cathode is also called the depolarizer since its oxygen depolarizes or reacts with the hydrogen formed at the anode. This removes a cause of high internal resistance at this terminal.

We will stay with the three types of commercially available primary dry cells generally found in electronic devices. These are the Leclanché, or zinc-carbon, the manganese-alkaline-zinc and the mercury cell.

Zinc-carbon (Leclanche) cell

The Leclanché cell provides an average of 20 watt-hours per pound in most applications. It is inefficient at heavy loads and will probably provide about 10 watt-hours per pound in heavy-duty service. At very light loads, 25 watt-hours per pound is available.

A typical cell is shown in Fig. 1. Chemically this cell consists of *manganese dioxide* (MnO₂) as the active cath-

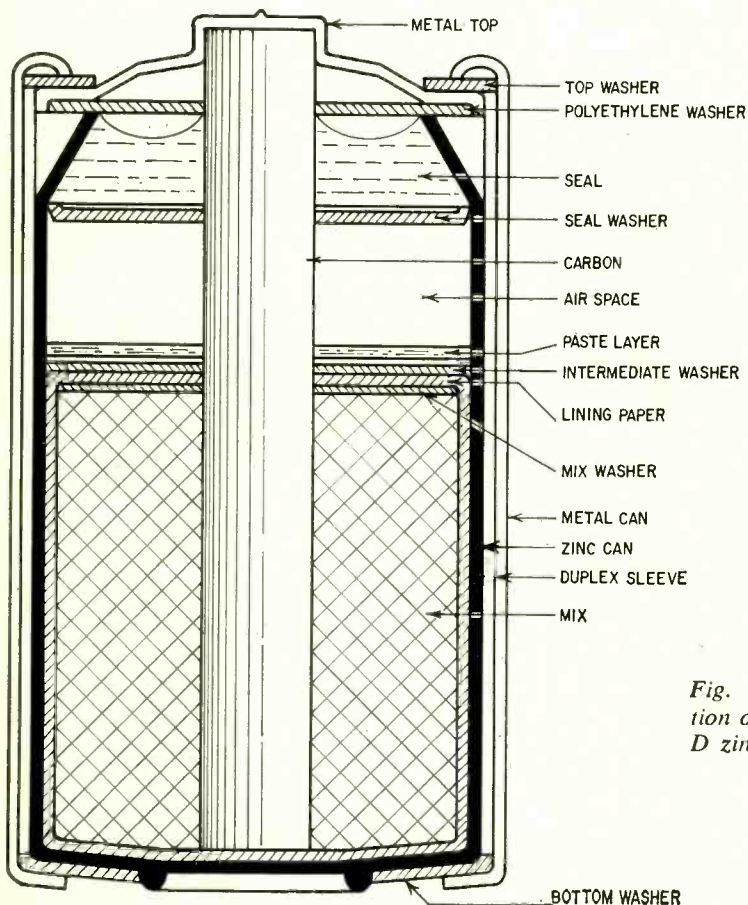

Fig. 1—Cross-section of typical size-D zinc-carbon cell.

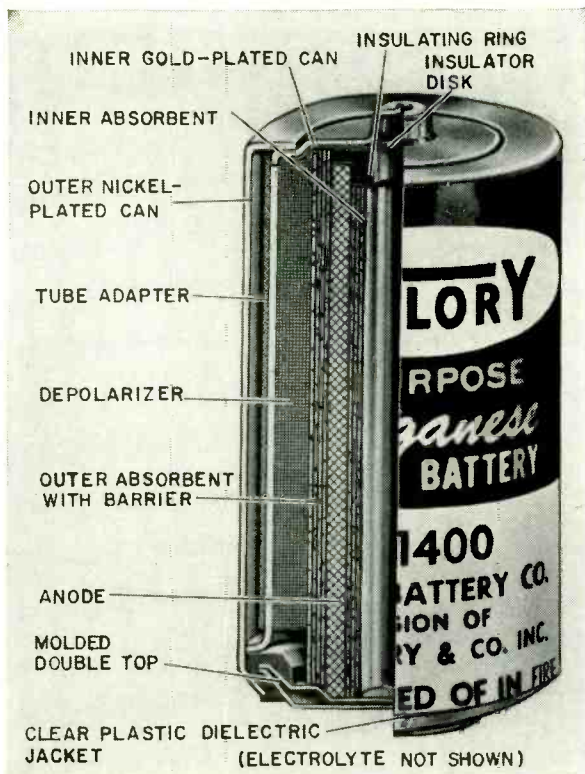

Fig. 2 (left)—*A manganese-alkaline-zinc cell. Electrolyte is not shown.*

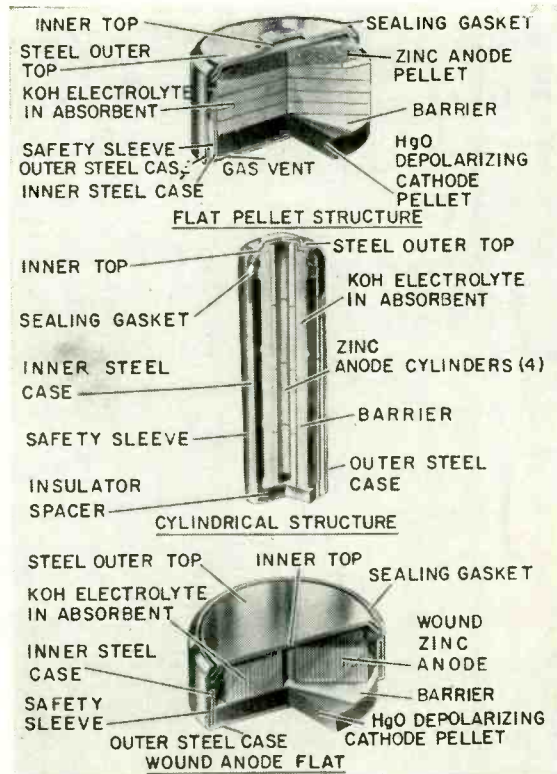

Fig. 3 (right)—*Cutaway views of cylindrical, flat-pellet and wound-anode mercury cells.*

ode and depolarizer, *sal ammoniac* (ammonium chloride) as an electrolyte, with additions of *zinc chloride* and *mercuric chloride* in water. These are blended with graphite or carbon black in a mix. This carbon black actually takes no part in the reaction, but is used to improve current-carrying capacity in the partially conductive MnO_2 depolarizer, and to serve as an absorbent for the electrolyte. The inert, porous carbon rod down the center acts both as a positive terminal and a gas vent. An extruded zinc container serves as an anode.

The relatively impure, low-cost MnO_2 is a cause of poor shelf life. The impurities in this natural ore cause side reactions which in time degrade the cell.

A very pure synthetic MnO_2 has been developed to provide a more efficient oxygen-bearing material. When blended with natural ore, this *electro-ore* can improve battery performance.

The Leclanché cell requires constant venting to relieve internal pressure. However, venting lets water vapor escape from the cell at higher temperatures. This in turn raises the internal resistance by drying out the electrolyte. The overall low shelf life of the zinc-carbon system is partly due to these slow internal losses, and in smaller cells the problems become aggravated.

The MnO_2 depolarizer gives up only 30–50% of its available oxygen. It is rapidly converted to Mn_2O_3 , a compound much less conductive than the original. This accounts for the sharp drop in voltage with discharge time.

The Leclanché cell suffers from oxygen starvation during the latter part of its life. Since there is some re-

maining zinc in the can, the chemical reaction continues and hydrogen accumulates when the load is left on the cell. The pressure developed by the hydrogen distorts the can or bursts it so its corrosive contents spill out. Steel-jacketed cells are preferable in preventing equipment damage.

The Leclanché cell, under heavy loads, should be used intermittently. Poor depolarizer efficiency allows hydrogen gas to accumulate. It appears as an internal resistance in series with the load, so it must be given time to dissipate. (No extra energy is gained during the rest period. You can't get more out of a battery than was built into it.)

Because of the wide range of applications and drain rates, four grades of cells are supplied. They are listed in the table. Most battery manufacturers make the four types and list applications on the label.

While the carbon content is greater in the photoflash mix, the cell capacity is reduced accordingly. Flash bulbs need heavy current but little total energy per flash. The opposite is true of radios, where drains are light and many hours are needed. Capacity is increased by using electro-ore in the mix.

The zinc-carbon cell is the workhorse of the battery industry. It combines low initial cost with availability in many sizes and shapes. It has been much improved in efficiency and design since it first appeared in 1868.

Manganese-alkaline-zinc cell

This system was developed jointly by Ruben Laboratories and P. R. Mallory & Co. The cell in Fig. 2 will deliver

30 to 40 watt-hours per pound at good rates with high overall efficiency. The depolarizer or cathode is electro-ore with a small percentage of graphite. Density is made high by forming the oxide pellets under many tons of pressure, improving conductivity and making a maximum of oxygen available. Due partly to the large amount of depolarizer, the alkaline cell does not leak or burst if left in a discharged state. The alkali electrolyte is 40% *potassium hydroxide* (KOH) solution, presaturated with zinc so the zinc anode will not dissolve during normal shelf stand or storage.

The negative zinc anode is pressed from a highly purified zinc powder amalgamated with pure mercury to minimize adverse local action. The anode is placed *inside* the cell and is not used as a container. Some cells are built with anodes in a gel structure holding the electrolyte and a dispersed zinc powder. This increases anode surface area and results in high conductivity.

Mercuric-alkaline-zinc cell

This cell, shown in its three structural types in Fig. 3, is considered the best commercially available dry cell today. It was developed in 1942 by Dr. Samuel Ruben. It packs 45 watt-hours per pound and 6 watt-hours per cubic inch—with high efficiency and excellent voltage regulation.

The mercury cell doesn't need a rest between loads because of the ease with which available oxygen is released from the *mercuric oxide*. This takes place in a simple conversion with 100% efficiency. Another factor is the low in-

COMPOSITION OF LECLANCHE CELLS

Applications	Average Current Ratings	Duty	Average Component Ratios			
			MnO ₂	Carbon	All Electrolyte Components	
Radio	10-60 ma	Long continuous use	56%	1/2 natural ore 1/2 electro-ore	10%	34%
General-purpose Flashlight	200-300 ma	Highly intermittent heavy drain.	57%	natural ore	10%	33%
Photoflash	Amperes	Instant current burst (milliseconds)	38%	natural ore	17%	45%
Heavy-duty Industrial	200-500 ma	Long continuous use Very heavy drain	57%	all electro-ore	10%	33%

ternal resistance of these cells, even in small sizes. Interrupted or continuous loads have little effect on the total energy delivered.

Electrochemistry of a typical mercury cell is illustrated in Fig. 4. If no resistor or other load were in the circuit, the no-load voltage of the cell would be the net sum of the electrochemical reactions of zinc and mercuric oxide with respect to the alkaline electrolyte. The zinc, dissolving or ionizing in the electrolyte, leaves electrons behind and leaves the zinc anode with a negative charge. Likewise, positive charges accumulate at the mercuric oxide cathode.

With the load resistor across the cell, the cell voltage forces the accumulated electrons at the anode to flow in the direction shown. Reducing the anode charge causes the electrochemical balance to be upset, and the zinc again starts going into solution as zinc ions (Zn⁺⁺). At the cathode, the mercuric oxide combines with water to form Hg(OH)₂. This separates into mercury ions (Hg⁺⁺) and two hydroxyl ions, 2(OH)⁻. The hydroxyl ions react with the zinc to form zinc oxide (a blue-white paste) and water (H₂O). There is no net loss of water in this cell system.

When the electrons pass through the resistor, they give up their energy and end up at the cathode. The mercury ions (Hg⁺⁺) grab two electrons each and become free mercury. This is seen in a disassembled expanded cell as glob-

ules of quicksilver in an inert graphite slurry.

The above reactions take place through a permeable barrier (usually a special high-grade paper or porous plastic material. The barrier passes ions but prevents solid particles from migrating and causing internal short circuits.

The inert, plated steel container is one of the reasons for the high reliability of the mercury system. It is not eroded away or weakened by chemical action, so it does not swell or leak if left on load after complete discharge. These features appear also in Mn-alkaline systems. Including excess depolarizer prevents hydrogen formation at the end of life.

The shelf life of the mercury battery is excellent. Shelf stands of 8 years at room temperature showed 65% to 70% remaining capacity. Cells 12 to 13 years old showed 25% to 40% remaining at room temperature. In both the mercury and manganese-alkaline systems, the high-temperature storage problem is improved. At a continuous 120° F, these batteries show about 25% of their room-temperature capacity in a year, without serious leakage. Good-quality mercury or manganese cells are suitable where 3 to 5 years delayed service in normal environments is expected.

Another article will compare the three common types in ordinary applications, showing which battery should be used for given jobs and the reasons for the choice. END

Fig. 4—Electrochemical action in typical mercury cell.

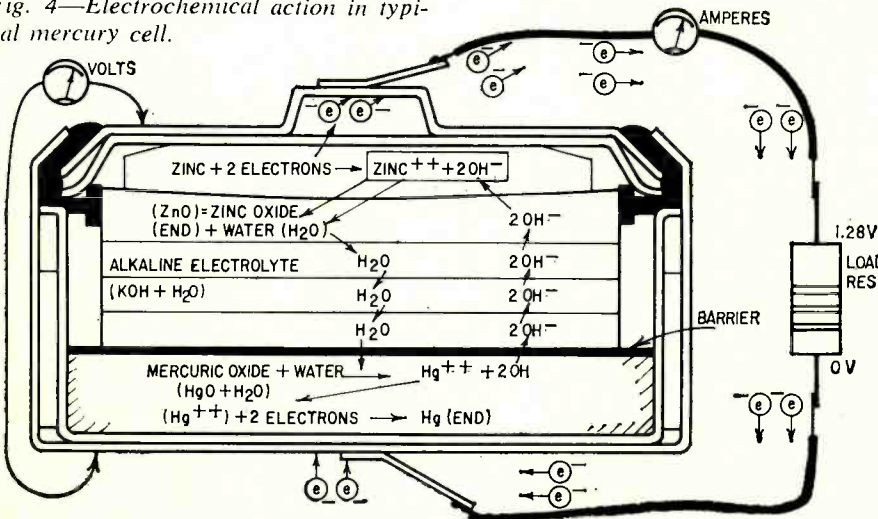

Polish That Faceplate Yourself

YOU DO NOT HAVE TO BUY A NEW PLASTIC faceplate for that portable TV simply because it is scratched or smudged. Now you can polish it.

You can get the materials you will need at most automotive supply stores. First is Dupont No. 7 Rubbing Compound, and second is Johnson's Carplate Automobile Cleaner. A can of each provides enough material to finish many sets and the total cost is less than \$3.

To use, simply keep your fingertips wet with water and apply a small amount of Dupont Compound to the affected area, rubbing very lightly with a circular motion. Continue rubbing for 2 or 3 minutes. Do not rub too hard or you may scratch the surface deeper. Wipe clean with a wet soft cloth and dry with a soft cloth.

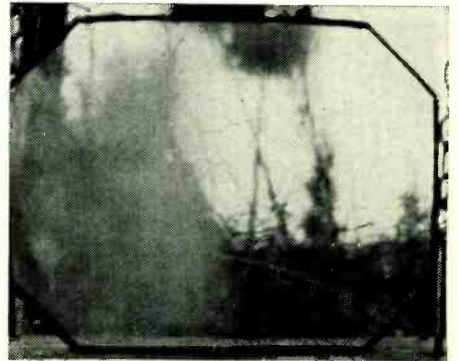

Next, with a very soft cloth, apply the Carplate cleaner and again rub with a circular motion for several minutes. Allow to dry and lightly dust off and polish with a soft cloth.

Repeat both steps, if necessary, to obtain the desired results. With a little practice, you can polish the faceplate to a high shine. If it is lightly smudged or smeared, Carplate alone will often restore the finish.

Rough, deep scratches cannot be removed, but you can shine up the faceplate so they are not noticed. The photograph shows what can be done. The right side was polished while the left was untouched.—Harry D. Parker

UHF Within 10% of VHF

The FCC reports that performance of uhf TV channel 31 gave results approximately 90% as good as those of channels 2 and 7. The report was the outcome of exhaustive tests made in the New York City area with a uhf station built expressly for the tests.

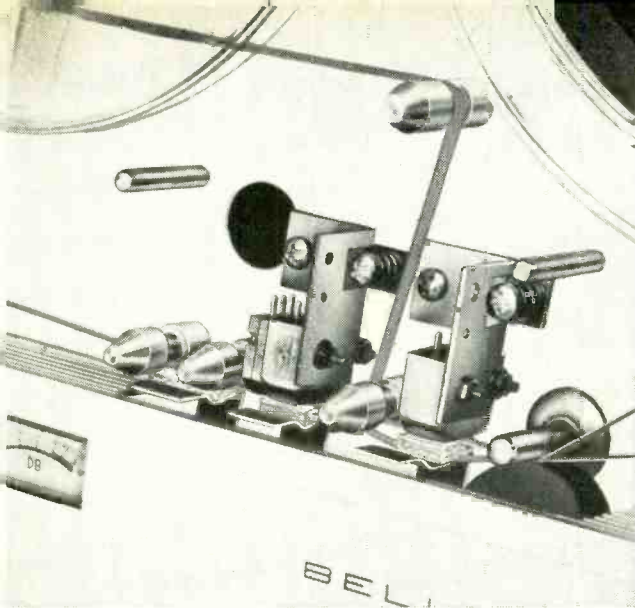

NEW "WAFFLE IRON" HIGH-SPEED MEMORY DEVICE uses base of high-permeability ferrite with grid of slots, leaving regular array of rectangular posts—like a waffle iron. Read-write and digit-sense wiring is preprinted and overlaid. Information is stored in the overlay material between posts. One experimental model of this Bell Labs device has a read-write cycle of 200 nano-seconds and is extremely compact.

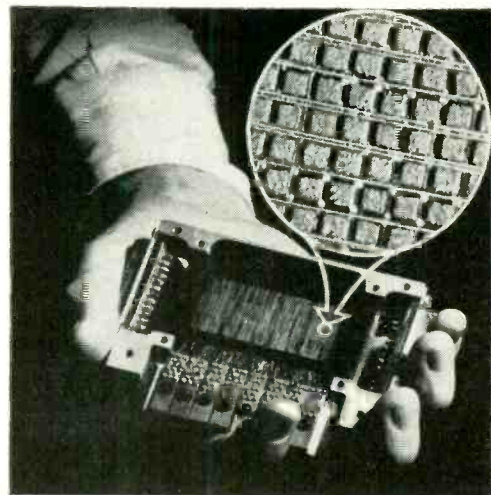

NEW TAPE RECORDER DUPLICATES TAPES as well as recording and playing them in normal fashion. An unusual head and threading arrangement plus accessory motorized adapters make copying possible. Blank tape is set up on onboard adapters and threaded through head slot but held away from playback head. Both tapes are pulled by the same capstan and roller. Recorder is made by Bell Sound Division of Thompson Ramo Wooldridge.

What's New

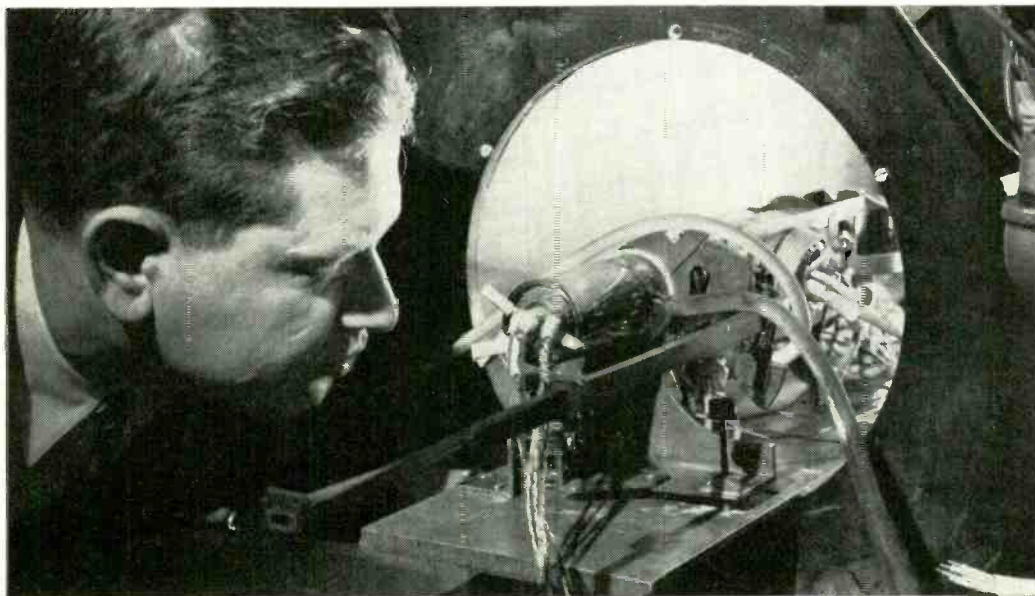

BEAM PLASMA TUBE WORKS NEAR INFRARED RANGE—23 gigacycles—by using pulsating electron beam with cesium plasma. As beam moves toward collector, it passes through signal-carrying helix which modulates and "bunches" it. Electron bunches enter plasma (ionized-gas) chamber and cause plasma electrons to resonate with signal. This reinforces input "bunches", which now pass through another helix—the output element. New tube is less critical to make, has longer life and higher power capability than former methods for amplifying such frequencies. According to RCA, who developed the tube, it may open new communications and radar channels near infrared frequencies.

NEW INSTRUMENT LOW-APPROACH SYSTEM stands about 1,000 feet beyond the far end of the runway at Bournemouth, England. Built by Standard Telephones & Cables, Ltd., British Associate of International Telephone & Telegraph (ITT), the guidance system's antenna radiates a sharp, stable beam to tell a plane's automatic pilot how to bring the craft down for a landing. With its radio beam only 4° wide, there is no chance for misleading ghost reflections. The system works even in zero visibility.

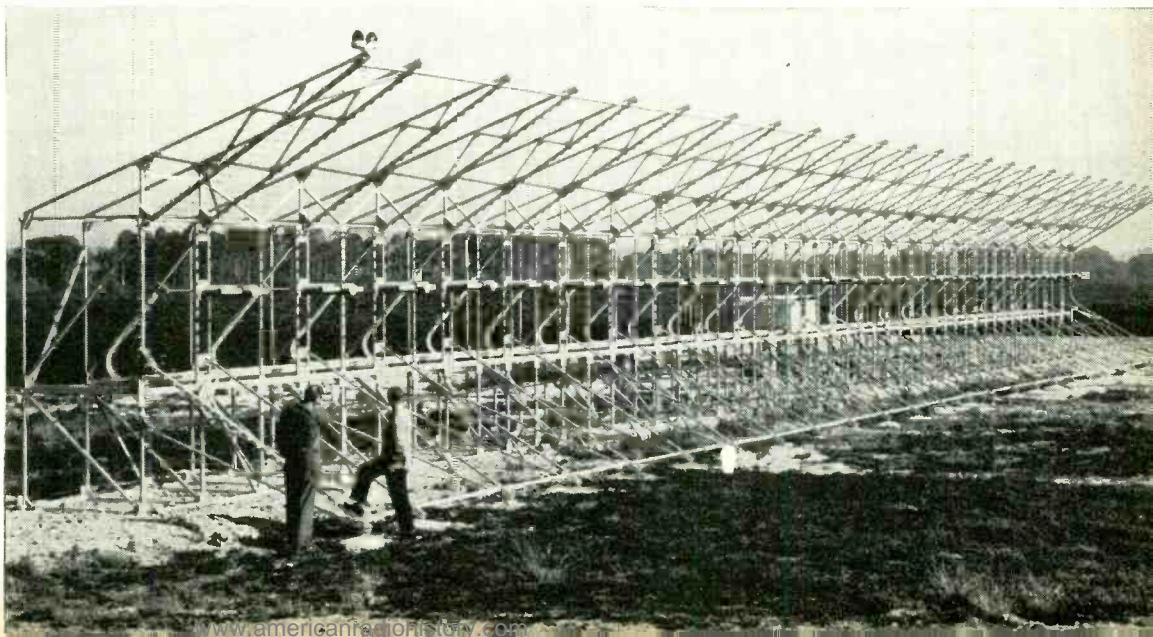

8 transistors

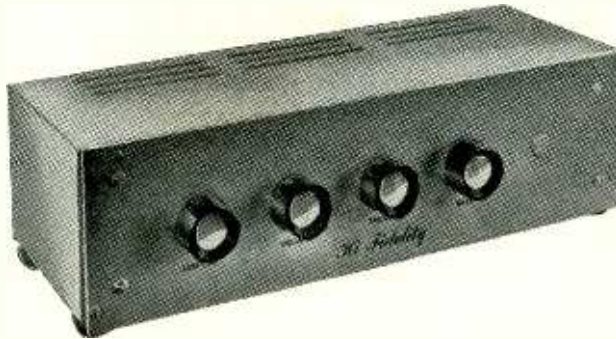

10 watts of hi-fi

Excellent amplifier for mono or stereo

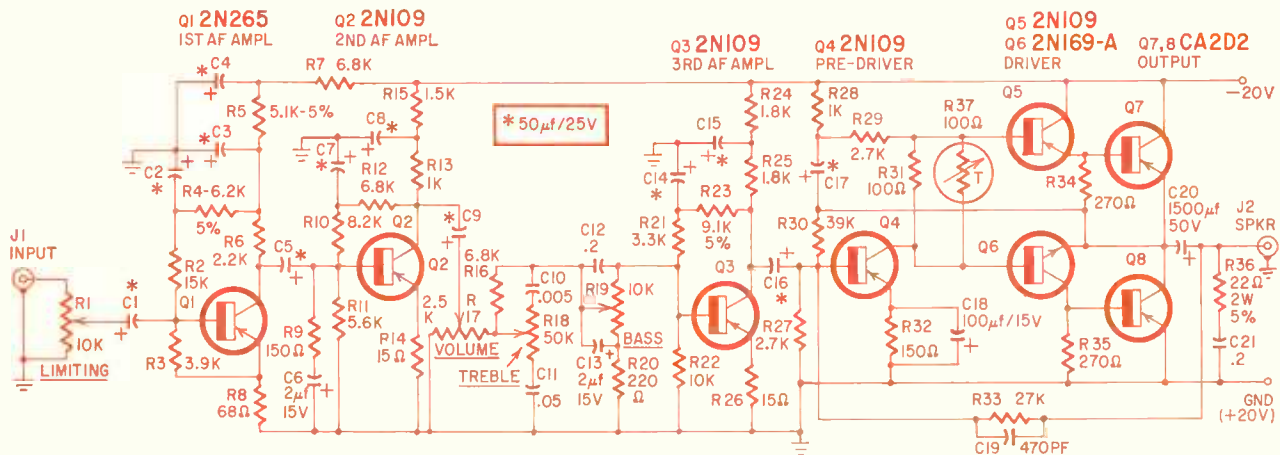

Fig. 1—Complete circuit.

This hot little amplifier can be the central part of any mono or stereo hi-fi system. The 10-watt output is clean with only 0.1% harmonic distortion and 1% intermodulation distortion. Response is flat within 1 db from 10 to 30,000 cycles. A single-channel unit is described here, but for stereo simply build two and use dual pots for the volume, bass and treble controls. The amplifier can be powered from any 20- to 25-volt supply (preferably regulated). It uses no transformers, and only inexpensive, widely available transistors and parts.

The amplifier is a modified and improved version of an experimental circuit developed by RCA Laboratories of Princeton, N. J., and described in an article by H. C. Lin in *Electronics* magazine a few years back.

The circuit of the amplifier is Fig. 1. Eight transistors (seven p-n-p and one n-p-n) are used in six stages of amplification.

The input resistance of the first preamplifier is 6,800 ohms, which matches the impedance of a magnetic cartridge. It will also match output impedances of many AM and FM tuners. Since the gain of this stage is high, a LIMITING control at the input cuts down the voltage from high-output cartridges and tuners to prevent overdrive and distortion.

If you need a higher input resistance to match crystal or ceramic cartridges, use the high-input resistance emitter-follower stage shown in Fig. 2.

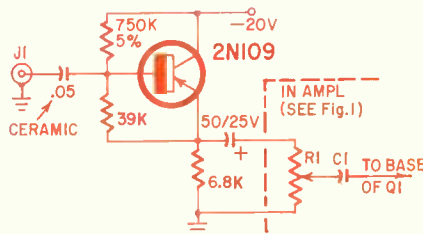

Fig. 2—Circuit of emitter-follower stage for use with high-impedance cartridges.

Its input impedance is 475,000 ohms.

Maximum input voltage to the emitter follower should be limited to 200 mv. Higher voltages will overload the stage and produce unwanted distortion.

[A 2-megohm potentiometer, connected from input to ground, with its slider to the .05- μ f base blocking capacitor, can be adjusted to prevent overload with high-output crystal and ceramic cartridges.—*Editor*]

VOLUME, TREBLE and BASS controls are between the second and third preamps. Low-frequency equalization is the duty of an R-C low-pass filter (R9 and C6). To keep noise at an absolute minimum and prevent overloading at the high frequencies, the filter is placed between the first and second preamp stages. The rate of attenuation increases at 6 db per octave and remains constant at all frequencies above 500 cycles.

A quasi-complementary symmetry circuit is used in the driver output stages. It completely eliminates the need

- R1, R19—pot, 10,000 ohms, linear taper
- R2—15,000 ohms
- R3—3,900 ohms
- R4—6,200 ohms, 5%
- R5—5,100 ohms, 5%
- R6—2,200 ohms
- R7, R12, R16—6,800 ohms
- R8—68 ohms
- R9, R32—150 ohms
- R10—8,200 ohms
- R11—5,600 ohms
- R13, R28—1,000 ohms
- R14, R26—15 ohms
- R15—1,500 ohms
- R17—pot, 2,500 ohms, audio taper
- R18—pot, 50,000 ohms, linear taper
- R20—220 ohms
- R21—3,300 ohms
- R22—10,000 ohms
- R23—9,100 ohms, 5%
- R24, R25—1,800 ohms
- R27, R29—2,700 ohms
- R30—39,000 ohms
- R31—100 ohms
- R33—27,000 ohms
- R34, R35—270 ohms
- R36—22 ohms, 2 watts, 5%
- R37—thermistor, 100 ohms \pm 10%, Temp Coeff/°C 4.4% (Glennite No. 21TD1) Available from Lafayette Radio
- All resistors 1/2-watt 10% unless noted
- C1, C2, C3, C4, C5, C7, C8, C9, C14, C15, C16, C17—50 μ f, 25 volts, subminiature electrolytics (Lafayette CF-144 or equivalent)
- C6, C13—2 μ f, 15 volts, subminiature electrolytics (Lafayette CF-120 or equivalent)
- C10—.005 μ f, miniature ceramic (Lafayette C-611 or equivalent)
- C11—.05 μ f, miniature ceramic (Lafayette C-614 or equivalent)
- C12—.02 μ f, miniature ceramic (Lafayette C-616 or equivalent)
- C18—100 μ f, 15 volts, subminiature electrolytic (Lafayette CF-126 or equivalent)
- C19—470 pf, mica
- C20—1500 μ f, 50 volts, electrolytic
- C21—.02 μ f, 200 volts, paper
- J1, J2—miniature phono jacks
- Q1—2N265
- Q2, Q3, Q4, Q5—2N109
- Q6—2N169-A
- Q7, Q8—8CA2D2 (Can be ordered direct from Minneapolis Honeywell, Union, N. J., at \$1.50 each)
- Chassis, to suit
- Heat sinks for Q7 and Q8
- Miscellaneous hardware

for interstage, driver and output transformers. It also eliminates the distortion caused by such transformers.

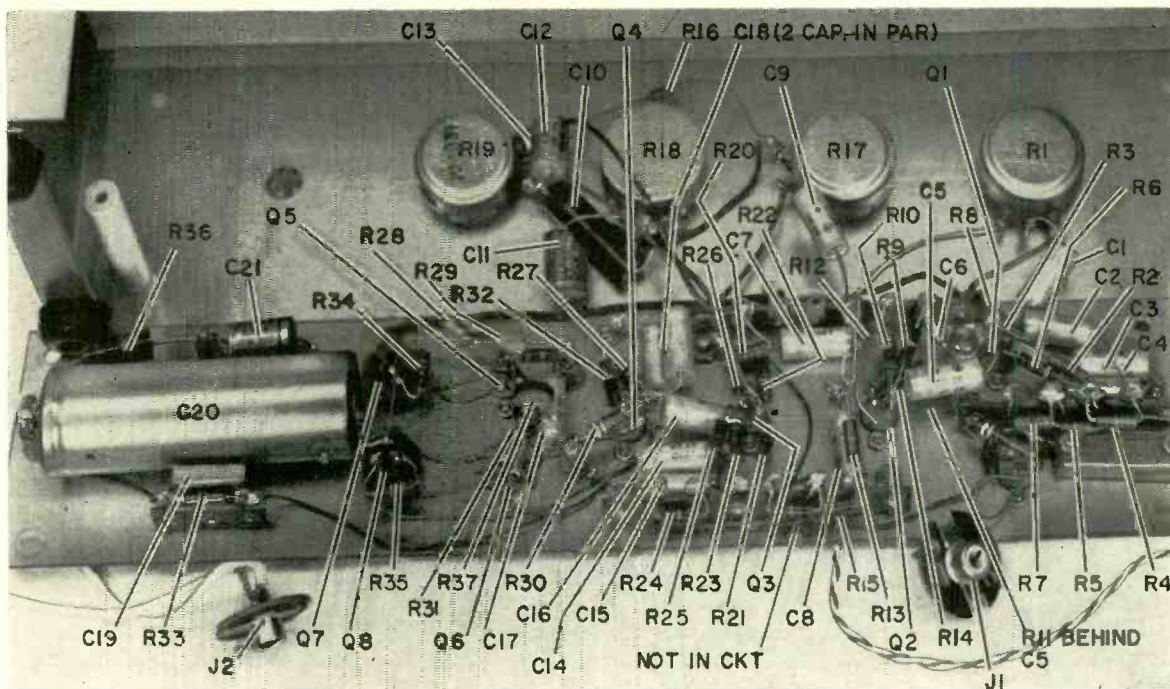

Plenty of room for wiring. Transistor socket, Trimpot and unmarked resistor (lower right corner) are part of high-impedance input stage like the one in Fig. 2. If C20 is unavailable in lead-mounting form, use can type (insulate from chassis) or 2,000- μ f 15-volt tubular unit (made by Cornell-Dubilier).

The speaker voice coil is connected to the junction of the two power transistors through a capacitor, so a single power supply can be used. This capacitor is large enough to pass the lower audio frequencies. It and the voice coil form a tuned circuit resonant at subaudio frequencies.

Feedback

Negative feedback is used between the output stage and the predriver. It is applied from the hot side of the speaker voice coil to the base of the predriver through R30 and R33. C19, in parallel with R33, stabilizes the feedback loop. This loop reduces the total harmonic distortion.

R34 and R35 in the base circuits of the power transistors stabilize the bias. The flow of current through R31, which is part of Q4's collector load resistance, creates a forward bias for the two driver transistors. This eliminates crossover distortion.

Power supply

A power supply delivering 20–25 volts at 800 ma is needed to power the amplifier. It should have low ripple content and good regulation. Variations in supply voltage as load current varies produces high distortion in the output. This is caused by the shifting of the dc operating points of the transistors with varying supply voltage.

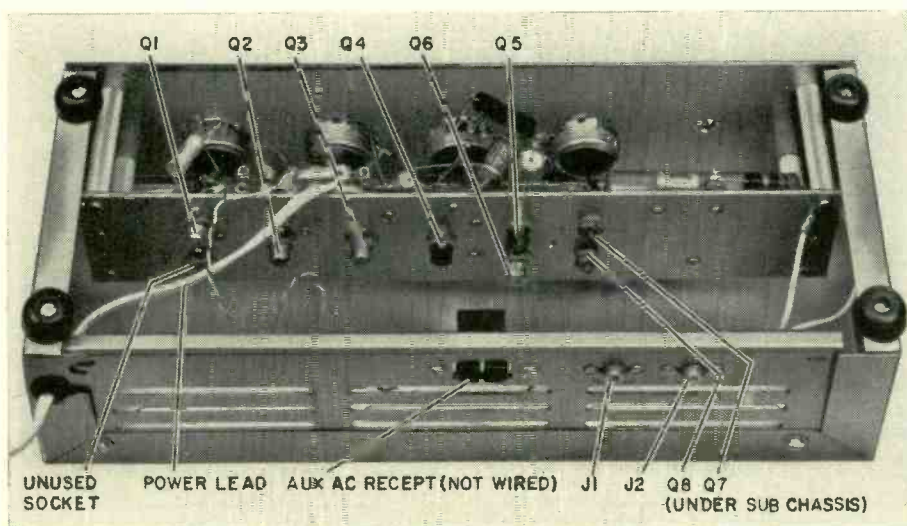

Bottom view of the complete amplifier. Of Q7 and Q8 (output transistors), only the mounting studs show; the transistors themselves are under the subchassis, which serves as a heat sink.

BENCH



TESTED

Unit works well, but requires a regulated dc supply. The two graphs show the distortion and frequency response characteristics of the amplifier. The specification table lists all measured characteristics of the amplifier.

Specifications

Power output	10 w, 50–15,000 cycles into 8 ohms
Sensitivity	10 mv for 10 w
Frequency response	± 1 db, 10–30,000 cycles
Total harmonic distortion (10 w)	.03%, 50–10,000 cycles; 0.1% at 20,000 cycles
1M distortion at full output	1%, using 60 and 7,000 cycles mixed 4:1
Crossover distortion	Invisible on scope at any frequency or power
Noise and hum	80 db below full output
Nominal load impedance	8 ohms (produces more distortion and less power at other loads)
Output (source) impedance	1 ohm at low frequencies, lower at higher frequencies
Input resistance	6,800 ohms (475,000 ohms with emitter-follower input stage)
Power consumption	15 watts peak
Efficiency	70% average

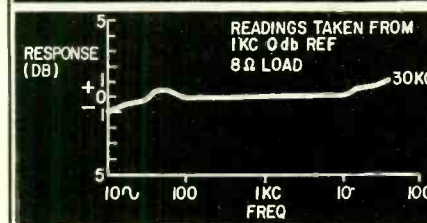
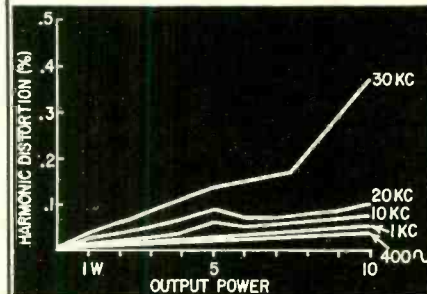

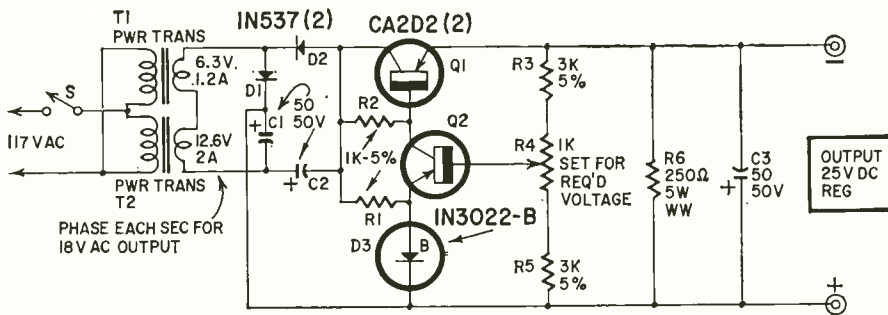

Fig. 3—Recommended regulated power supply for the amplifier.

The recommended power supply shown in Fig. 3 meets all necessary requirements. Regulation is held to 0.5% over a load current variation of 0 to 800 ma. Maximum ac ripple at maximum load current is 5 mv.

Construction

The amplifier is built on a 2 x 10 x 1/16-inch aluminum strip which serves as the chassis. It is mounted in a metal case on ceramic standoffs.

Layout and general construction are not critical and can be varied to suit

your requirements. Standard practices should be followed in assembly and wiring—keep all leads short, provide adequate separation between input and output leads, and avoid ground loops. The neatest-looking arrangement would, by far, be to use a printed-circuit board.

Mount the power transistor on a heat sink. Note that the collectors of the power transistors are bonded to the case for efficient heat dissipation. Therefore, the case must be electrically insulated from the heat sink. Use mica washers or other heat conducting electrical insula-

- PARTS LIST (Fig. 3)**
 R1, R2—1,000 ohms, 1/2 watt, 5%
 R3, R5—3,000 ohms, 1/2 watt, 5%
 R4—pot, 1,000 ohms, linear taper
 R6—250 ohms, 5 watts, wirewound
 C1, C2, C3—50 μf, 50 volts, electrolytic
 D1, D2—1N537
 D3—Zener diode, 1N3022B (Motorola)
 T1—transformer (filament-type), 6.3 vac, 1.2 amps
 T2—transformer (filament-type), 12.6 vac, 2 amps
 Q1, Q2—CA2D2 (Order direct from Minneapolis Honeywell, Union, N. J., at \$1.50 each)
 Chassis, to suit
 Miscellaneous hardware

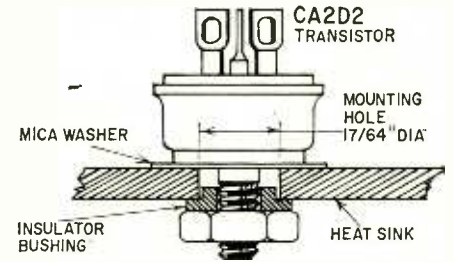

Fig. 4—Mounting details for the CA2D2 power transistors.

tors between the case and the heat sink. Details for mounting the power transistors are in Fig. 4. After mounting, check the transistor case with an ohmmeter to be certain that it is not shorted to the heat sink. END

NOVEL DC-TO-DC SUPPLY

WHENEVER IT IS NECESSARY TO INCREASE the value of a dc voltage, it must first be changed to ac. It can then be stepped up to any desired value by using a transformer. There are several ways to change dc to ac. Probably the most common method, once used in all automobile radios, is to use a vibrator to interrupt the dc, thus creating alternating current. Then there are rotary converters that consist of a dc motor and an ac generator in the same housing. Of course, the latest method is the transistor blocking oscillator used with a stepup transformer. All these methods are good and will undoubtedly be used for many years.

During an experiment with a miniature electric motor, it occurred to me that the commutator in a dc motor



interrupts the dc each time a different commutator bar contacts a brush. Here in our dc motor we have a source of alternating current that we can step up or down by using a transformer in series with the motor and battery. The change in current amplitude will induce a voltage into the secondary of the transformer. This changing voltage isn't a sine wave, a square wave or even a sawtooth. On an oscilloscope it shows up as the worst-looking wave I have ever seen. The waveform is ragged and has high spikes and deep valleys. A waveform such as this will be more efficiently stepped up or down by an audio transformer than by a 60-cycle power transformer.

We used this scheme to build a small power supply that could be used to

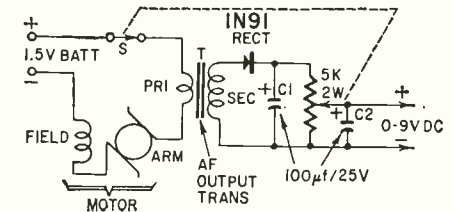

operate transistor circuits (see diagram). We used the small battery-operated Japanese-made motor that the original experiment was performed with. A small audio output transformer was connected backward; that is, the output side was used as the primary, to step up the 1.5 volts put out by the battery. Almost any kind of rectifier can be used. We had a 1N91 on hand so we used it. To improve the regulation of the power supply, which wasn't too good, a 5,000-ohm wirewound potentiometer was used as a bleeder resistor. By connecting the positive binding post to the contact arm on the potentiometer, a variable voltage of 0 to 9 volts can be obtained. Two 100-μf 25-volt filter capacitors will do an adequate job of filtering.

This experimental power supply isn't presented as an addition to your test facility or experimental workshop, but it is intended as a challenge to your ingenuity in devising equipment in which it would be useful. For example, you might try a mobile power supply using something like an automobile heater motor. It is even possible that the fan could perform its intended function and also be used as the chopper up of the battery voltage for the power supply.—James A. Fred



HANDLING THE COLOR-TV CUSTOMER

By WALTER R. McCARTY*



Answer his questions and show him how to tune in a color show

How to deal with the color TV set owner is perhaps the most difficult part of color TV service. When you install a set, he is a particular problem. He will ask many questions and expect accurate, understandable answers. He will also have to be shown how to use the color set. As a practicing service technician, this is your problem and here is how you can take care of it.

Most customers are actually interested in your work and will naturally ask, "Why are you doing that?" (This almost always happens when you are swinging the degaussing coil around.)

Have a reasonable answer for each anticipated question the customer will ask, but be brief. For instance, to the degaussing coil question, you can answer, "I'm demagnetizing the picture tube. It is sensitive to the earth's magnetism and to its surroundings. But this is generally needed only when the set is installed." It does no good to bring up the matter of moving the set or convergence drift. If the customer does move the set, it may not be affected. If it is, he will call you. Remember, the more you point out deficiencies, the more trouble the customer will look for.

Your stock answers might include:

Q. How good is color TV now?

A. Excellent, and the black-and-white picture on a color set is sharper and better, too.

Q. Is there enough color programming to make a set worth while?

A. Depending upon local availability (the technician should have this information). From 50% to 55% of the programs on NBC are in color. The two other networks will probably have color soon.

Q. Are color picture tubes still so expensive?

A. Yes, they still cost considerably more than black-and-white tubes, although they have been reduced recently. Actually, their higher quality construction results in fewer defects and less failure.

Q. I've heard you can't move the set around, is this true?

A. Moving the set will not damage it; however, for best results it should be returned to its original position. If permanently moved to another position, some adjustments may be needed. This can easily be made by our technicians.

Q. What are the dots for?

A. On color sets it is necessary to get the best possible black-and-white picture. These dots aid in adjusting that.

We have found that no matter what the question, any reasonable answer will usually be enough. *But remember—have an answer.*

Customer instruction

For some technicians this is the most difficult part of the installation. To explain without confusion how to adjust a new color set for a good color picture is particularly difficult when it must be done without a color broadcast in progress. This may happen when a set is delivered in the afternoon, and there is no possibility of sending a technician to explain during a color broadcast.

An efficient method of customer instruction requires planning and rehearsal. It should include answers to anticipated questions and some allowance for customer inquiries beyond the scope of your instruction. Above all: *rehearse.*

As soon as you have finished the setup and have a good black-and-white picture on the screen, announce that you would like to explain how to adjust

the set. There is likely to be some discussion as to who will be operating it:

"It was your idea, so you learn."

"I bought it for her, so teach her."

To this merely say, "It's really so simple you can both (or all) learn." You will generally receive the utmost attention of all present, regardless of their somewhat self-conscious protests.

An effective approach is:

"First of all, this is a black-and-white set, similar in most ways to your old one, with circuits added to receive color. The on-off switch is here [demonstrate]. It is also the volume control. The channel selector operates just like the one on your old set, but the fine tuning is slightly different and more important to correct color reception—I'll explain later. This is the brightness control [indicate location] and down here are the horizontal, vertical, contrast and tone controls. [Show the effect of each control while talking. Point out the extreme range of the horizontal hold control and its correct adjustment; it may save a call-back.]

"For good color you must have a good black-and-white picture. You should accustom yourselves to these adjustments just as you did with your first TV set. This instruction booklet will help you—it shows all the adjustments I have just explained. I would suggest you read it thoroughly and go over the adjustments at your leisure; your picture will be no better than your adjustments.

"During your first few color programs, until you get accustomed to the proper adjustments, try tuning in color this way: When you know a color show is on, turn the color control, here, [indicate location] about halfway up. Color should appear in the picture. If it doesn't, try adjusting the fine tuning

*TV service manager Balie Griffith Firestone, Odessa, Tex.

slightly until it does. Now, with color in the picture, turn the color control so that the colors are displayed at the right intensity. This is usually a matter of personal preference, but since colors in nature are not vivid, keep your colors somewhat subdued and as natural as you can get them. You'll enjoy it more and have less picture distortion.

"Finally, adjust the tint control, here, until flesh tones are most natural. That's all there is to it—just these two additional controls and maybe another slight adjustment of the fine tuning. Are there any questions? [If there is a color show on, let the customer try his hand.]

"Again, I suggest you practice making adjustments on several color shows. They are important to insure good color pictures. If you get stuck, remember the instruction book. If that doesn't help, call us; we'll be glad to



Say, "thank you" and depart

help you. Before I leave, I'd like to call your attention to this circuit-breaker button on the back of the set. If the sound and picture fail to come on or go off during a program, push in on the button momentarily and operation should again be restored. If it isn't, turn the set off and call us. We'll send a technician to restore operation as soon as possible. Thank you and I hope you will enjoy your new color set." [DEPART!]

I say "depart" because it is very easy to get tied up for another half-hour in a useless question-and-answer session with the customer, if you permit it. The idea is to get out of the house so the customer will begin to get accustomed to the adjustments of his set. Normally, a customer will not touch the set while you're there. His only reason for more questions is the insecure feeling he expects to have at being left alone with his new and (to him) complicated toy. It is for his own good that you leave quickly after you have finished your setup and explanation. Soon he will muster the courage to try his hand at a few adjustments and quite likely will be surprised to find how simple they really are. END

Continuity Checker

Simple unit gives accurate go-no-go test of continuity in resistances as high as 75 megohms

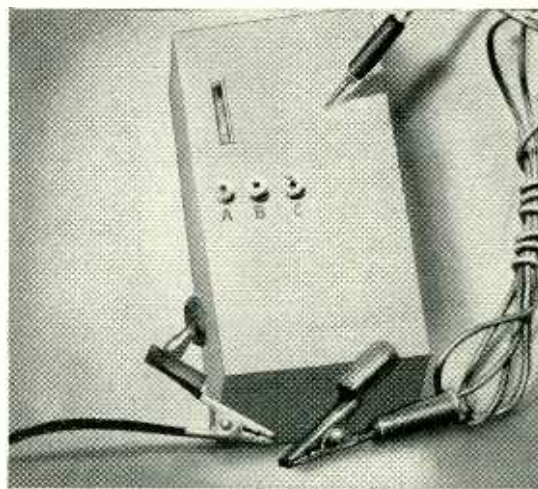

By QUTAIBA BASSIM
EL-DHUWAIB

THE CONTINUITY OF A HIGH-RESISTANCE circuit can be checked by applying a high voltage across it and reading the current with an ammeter or microammeter. Another possibility is to use a high-resistance voltmeter in series with the resistance. In the May 1961 issue of RADIO-ELECTRONICS a continuity checker that uses a neon lamp to indicate continuity was described. But none of these is entirely satisfactory.

I use a subminiature optical indicator—a tuning-eye indicator—such as the DM70, DM71 or 1M3. The circuit is in Fig. 1. To test a resistor, connect it between the two prods. If it is good (shows continuity), a negative voltage through the resistor is applied to the indicator tube's grid, the tube is cut off and the indicator goes out. This is fine for checking continuity of low-

Also, the voltage applied to the grid of the indicator should never be much higher than the extinction voltage (—10 volts). When a resistance is tested, connect it across A and B. The grid bias voltage drops, because of current flow through R3, and the indicator lights. Using jacks B and C you can check continuity in resistances up to 75 megohms.

How to build one

My checker is built into a 4¼ x 2¼ x 1¼-inch bakelite case, which is large enough to house the few components. The indicator tube is inserted into a cutout in a block of wood and mounted behind the front panel. Of course, an opening is cut in the panel first so the tube can be seen.

The 1.5-volt battery is mounted between two brass clips which are wired into the circuit. Another clip holds the batteries against one wall of the instrument. The on-off switch and the prod jacks are mounted next. Then the circuit is wired as in Fig. 2.

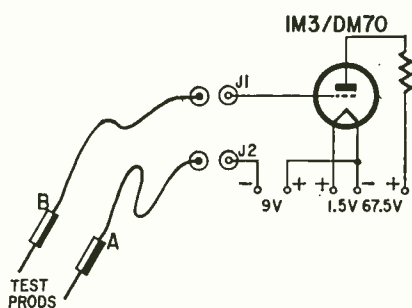

Fig. 1—Basic checker circuit.

value resistors, but will not measure leakage in a capacitor unless the capacitor is charged before testing. Also, when checking high-value resistances, the battery voltage (the one between ground and J2) must be increased.

To overcome these difficulties, I use the circuit of Fig. 2. In this circuit, various values can be used for R3, but do not let its value exceed 25 megohms.

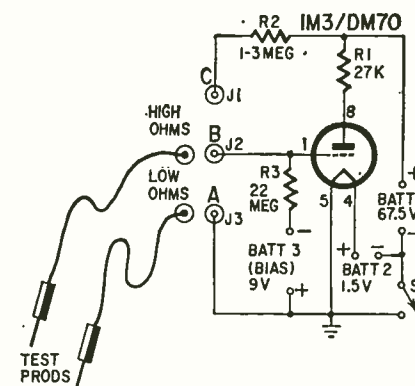

Fig. 2—Two-range instrument requires few components.

After the unit is finished, turn it on and touch prods A and B together. The indicator should light brightly. To check prods B and C, connect a resistor between them. *Never* short B and C. If you do, you may damage the indicator tube.

END

By JOSEPH MARSHALL

Improving the hi-fi

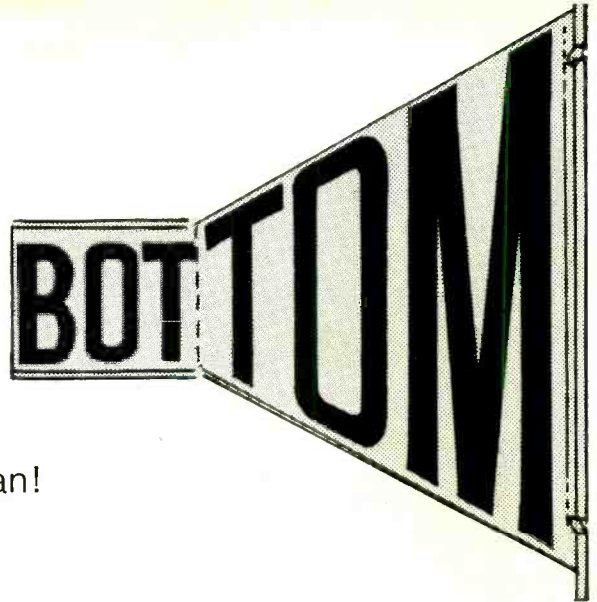

Make an organ sound like an organ!

SPEAKER MANUFACTURERS HAVE DONE A remarkable job in designing and supplying compact stereo speaker systems which take very little backtalk from the big bass-reflex, infinite-baffle and even horn type speakers. But the effect all too often falls short of equaling the awesomeness of the bass from real "live" bass drums, double basses and organ pedals. The drums do not sound as big or as "low-down," the double basses growl but do not roar, and the organ pedal tones rattle rather than rumble.

If all a system lacks is a good bottom, it can be corrected by adding a super-woofer to cover only the bottom two octaves. There are a number of

suitable high-compliance speakers in cone sizes ranging from 8 to 15 inches with resonance in free space between 15 and 25 cycles. Weathers offers a unique variable-mass woofer which, in an enclosure only some 17 x 17 x 8 inches, gets down below 30 cycles, and at the very moderate price of \$70 for speaker and enclosure. Electro-Voice is producing a woofer no less than 30 inches in diameter.

The conventional way of adding a woofer, through an L-C crossover network in the amplifier output, presents difficult technical problems. But there is a way that presents no technical problems of any consequence and can match just about any woofer to just about any speaker system, stereo or monophonic. It can be done for an investment ranging from \$100 to \$300. Finally, a combination can be worked out that meets just about any limitation in space. The Weathers woofer, for example, is small enough to fit in any room and can be placed in such useless spaces as under or behind a davenport or chair. Even the 30-inch woofer can find room in many homes without depriving anybody of breathing space.

Woofers are ordinarily used with complex L-C crossover networks in combination with two or three other speakers. The attempt to add a woofer to a system this way is tricky business. The efficiency of the woofer has to match, within reason, the efficiency of the other speakers. Furthermore, the crossover network can be pretty complex and would require an individual solution for each case. This, in turn, would require considerable engineering and, very likely, hard-to-obtain crossover elements.

All these complications can be removed at one fell swoop by borrowing a good idea from Paul Weathers—the simple expedient of feeding the super-woofer with a separate amplifier, preceded by a simple and inexpensive R-C filter network.

Common bass

The bass of a stereo system can be

extended with a single woofer and a single amplifier by using a common-bass configuration with a crossover at around 80 cycles. There may well be justifiable reservation about common-bass systems that cross over at 300 or even 250 cycles. However, these do not hold with equal force for a system in which the common bass is restricted to frequencies below 80 cycles. I have been experimenting with this for more than a year and my experience is that there is no degradation of directionality if the common bass is limited to the bottom two octaves.

This system is simple and can be used to match just about any woofer to just about any present speaker system. It has several other advantages. We can use an inexpensive R-C filter with a steeper slope than is obtainable from the simpler L-C crossover network in the amplifier output. In this way we can concentrate the improvement entirely in the bottom two octaves where speaker efficiency is poorest. We can also boost the response in these bottom octaves to a degree not possible with the loudness or bass controls on preamplifiers, and do it without muddying up the middle octaves as most loudness and bass-boost controls do if they are set to obtain maximum boost.

By placing the largest part of the bass boost in the super-woofer amplifier, we can operate the main-channel amplifiers at lower average levels for the same bass output with a consequent reduction of distortion and improvement in clarity and reserve power.

Finally, by confining the super-woofer to frequencies below 80 cycles, we simplify the problem of providing a space-saving enclosure for the super-woofer. If any dimension of a totally closed enclosure approaches a half-wavelength of any frequency fed to the speaker, resonance is set up. Since most woofers ordinarily cover frequencies up to 150 or 200 cycles or even higher, this means that we have to avoid columns as short as 4 or even 3 feet. The only way to do this and still obtain a box with a volume of 20 or more cubic feet

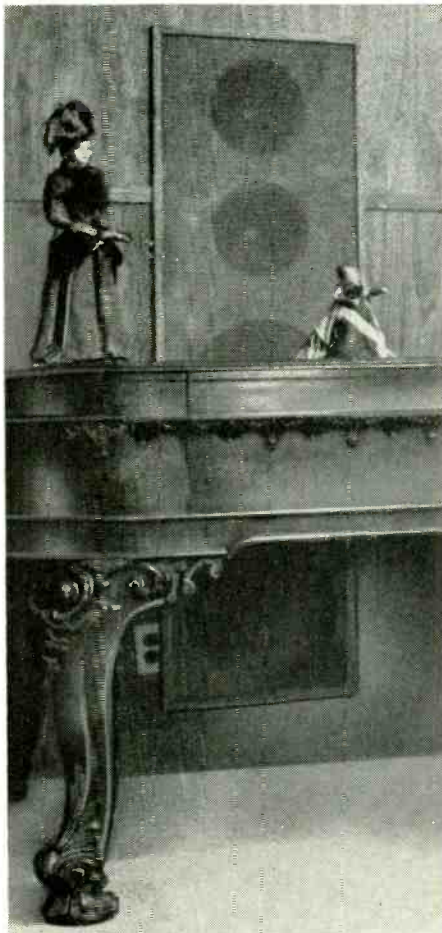

Four speakers set inconspicuously into wall in author's home.

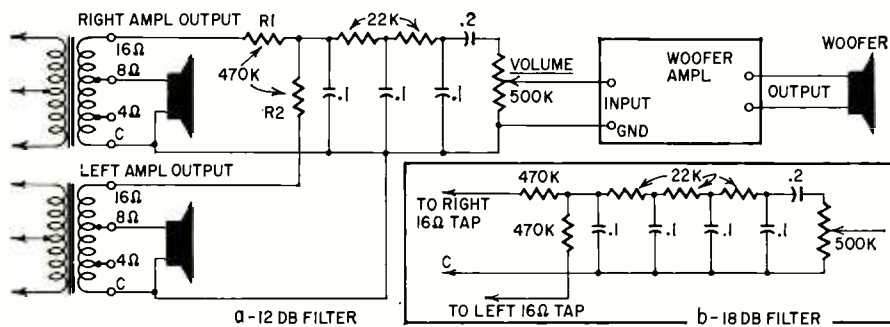

Fig. 1—(a)—12-db-per-octave low-pass filter and connections to system. (b)—18-db-per-octave version. If amplifier has center-channel output jack, omit R1 and R2 and connect "top" of network directly to jack. On amplifiers (such as recent Fisher models) with power center channel but no voltage center-channel output, use connection of Fig. 2. Do not use the power center output.

is to use a more-or-less cubic shape—4 x 3 x 2 feet, for example—which is very wasteful of floor space.

If we do not feed the speaker with anything significant above 80 cycles, we have considerably more leeway. A half-wave at 80 cycles is approximately 7 feet and we can avoid resonances by keeping any single dimension to less than 7 feet. A box 6 x 2 x 2 has the same volume as the 4 x 3 x 2-foot box but, if stood on end, occupies only 4 square feet of floor space instead of 6. It is just as bulky, but the bulk consumes less usable room space. In any event, for any size or shape of enclosure, the use of the low crossover minimizes enclosure resonances.

The filter network is a simple R-C low-pass network. Fig. 1 gives two versions, the first with a 12-db-per-octave slope (approximately), and the second about 18-db-per-octave. The 12-db filter is recommended with most systems; the 18-db where it is desired to obtain the biggest boost in the lowest octave without affecting the mid-frequencies. This network is designed to be fed from the 16-ohm tap of the amplifier or the two amplifiers. The network can also be fed by the "center-channel" output that some preamps and power amplifiers provide. Fig. 2 shows an alternate arrangement for amplifiers with direct power center-channel output. [The extra 0.1- μ f capacitor at the input of each network provides a rolloff with a different time constant, rounding the "knee" slightly. This value was selected empirically for best sound, and thus the networks are not exactly 12 and 18 db per octave.—Editor]

Though rumble is not a problem with ordinary speakers, which have no significant response below 40 or 35 cycles, a super-woofer may well be bothered by them. In that case, the capacitor just before the volume control should be reduced to .05 or even .02 μ f. This will attenuate the rumble without much effect on the musical material.

Most woofers are quite efficient and can be driven to just about any tol-

erable output with amplifiers of between 20 and 25 watts. Be sure the amplifier delivers its full output down to 20 cycles with less than 2% distortion. After all, the only power we have any use for in this application is that between 16 and 80 cycles.

You have to move a lot of air to produce any sound below 40 cycles and for that there is no substitute for a large piston area. The 30-inch woofer has enough as it stands, and the 15-inch woofers will also do a good job singly, though they will be far more efficient if used in pairs. The 12- and 8-inch speakers must be used in pairs or, better yet, in a group of four if you want really significant improvement below 40 cycles.

The simplest and, in many ways, the best way to use the woofers is in a wall type infinite baffle. This maintains the free-space cone resonance whereas an enclosure of any practical size will raise the resonance. Also, wall mounting will consume little if any usable space. The speaker or speakers can be mounted in a wall between two rooms or a room and a closet or stairwell. The photograph shows a bank of four speakers mounted in the wall of our living room. Since walls are usually about 4 inches thick, and these speakers have depths ranging from 6 to 13 inches, the backs will extend into the space on the other side of the wall. If this happens to be a closet or stairwell, there is no problem. But if it is another room, you will have to hide and protect the speaker. A simple four-sided box can be constructed of $\frac{3}{4}$ -inch plywood, and the opening covered with grille cloth. The front, of course, can also be framed and covered with grille cloth.

The location of the super-woofer is not at all critical. Since it will be handling only the two lowest octaves and since these have little directionality, the super-woofer can be located anywhere in the room or even in an adjoining alcove. The location should be chosen so that the shortest distance from front to back of the cone, through any doors,

areaways or whatever, is at least 22 feet. However, if this cannot be achieved in any one direction, the result will not be serious.

The smaller woofers, and possibly even the 30W, can be mounted in the ceiling with the rear radiation absorbed by the attic space. I have done this with 12- and 15-inch speakers, and a pair of the Jim Lansing LE-8's is especially easy to mount in the space between two rafters. Corner mounting, especially near floor or ceiling, will greatly improve the efficiency.

Most recently built homes are framed on 16-inch centers and all of the smaller woofers, including the 15-inch ones, can be mounted between two studs or rafters. For some 15-inch speakers it may be necessary to chisel away a part of both studs to permit the speaker frame to slide in. When pairs are used, they should be mounted as close to each other as practicable. A spacing of 4 to 8 inches will be fine and will still maintain good rigidity in the mounting board. For the 30-inch woofer it will be necessary to remove a portion of one stud or, in a ceiling mount, one joist. Fig. 3 shows the recommended construction.

Mount the speaker on a piece of

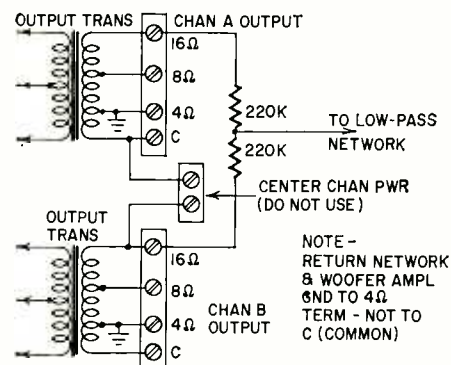

Fig. 2—Modified connections for amplifiers with direct power center-channel output. Note 4-ohm terminal is grounded, not one marked "C".

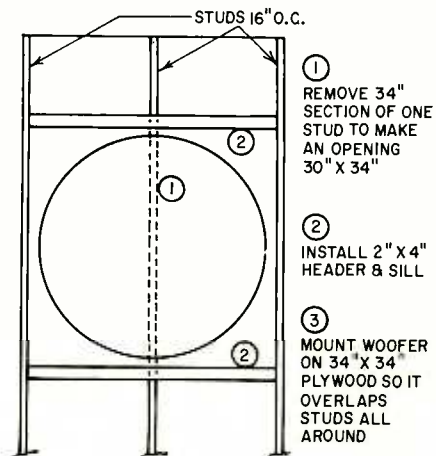

Fig. 3—How to set E-V 30W into wall. With dimension changes, method can be used with any speaker.



30 inches of woofer in wall of Marshall's laboratory. Back wave is absorbed in unused attic.

$\frac{3}{4}$ - or 1-inch plywood 34 inches square. The plywood can be covered with grille

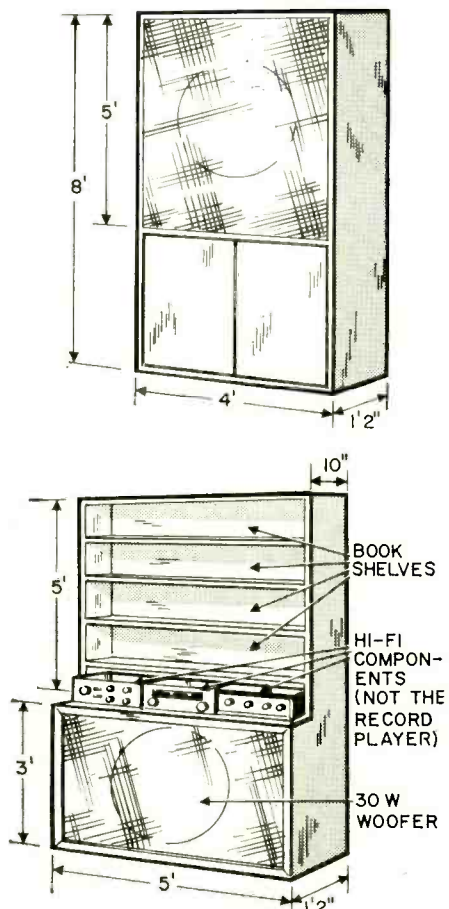

Fig. 4—Further suggestions for hiding a superwoofer.

cloth—the cane type is especially decorative and rigid enough to stretch firmly over the 30-inch opening. Obtain from an auto parts supplier 4 yards of sponge-rubber weatherstripping $\frac{1}{2}$ to 1 inch wide and $\frac{1}{4}$ inch thick and stick it to the back of the baffle board on the very edge or within an inch of the edge all around. Be sure you leave no air holes in the corners where the pieces join. This will provide a good seal between the baffle and the wall to prevent leakage of air and minimize the transfer of vibration from baffle to wall which would have the effect of robbing power to shake the walls. Fasten the baffle to the studs with plenty of $1\frac{1}{2}$ - or 2-inch screws.

Attractive as wall mounting may be from the standpoint of space-saving and performance, it will not be equally appealing to all home owners, landlords or wives. Where wall mounting is not possible, use an infinite-baffle box of at least 15 and preferably more than 20 cubic feet. These enclosures will raise the resonance of the speakers to some degree. A 15-cubic-foot enclosure, for example, raises the resonance of the 30-inch woofer to around 40 cycles. However, though efficiency below resonance falls off, there is still appreciable output to well below 30 cycles.

You can make a simple enclosure that looks like a wall mounting and approaches its performance by using a 4 x 8-foot piece of $\frac{3}{4}$ - or 1-inch plywood for the front, and a 4 x 8-foot sheet of $\frac{1}{2}$ -inch Celotex for the back, joined with plywood sides from 12 to 14

SOME SUGGESTED WOOFERS

Make and Model	Size (in.)	Free-space resonance (cycles)
Electro-Voice 15W	15	25-35
Jensen P15LF	15	16
University C-15HC	15	15
University C-15W	15	25
Jensen C12NF	12	20
University C-12HC	12	18

Other suitable speakers: Electro-Voice 30W, Hartley 216, Jim Lansing LE-8, Weathers Hide-Away.

inches wide, depending on the depth of the woofer. This will provide a volume of more than 30 cubic feet and can be set in the corner of a room to provide what appears to be a built-in offset of the wall. The same sort of enclosure could also be used as a room divider, or combined with adjoining bookshelves to fill one end of a room (Fig. 4).

Whatever the size of the enclosure, use plenty of interior bracing. If the floor can stand it, you could borrow a leaf from Mr. Briggs' book, making the enclosure of a sandwich of two $\frac{1}{2}$ -inch sheets of plywood separated by $\frac{1}{2}$ to 1 inch and filling the space with sand. Also, à la Briggs, you could make the enclosure of brick. Since the enclosure will not be handling any higher frequencies it does not have to be padded.

Since you will end up with a pretty big box whatever speakers you use, I can assure you that the result will justify the bulk and cost. The super-woofer adds a solidity to the bottom that is both subtle and spectacular. The effect is very different from that of merely boosting the bass with the bass control. Boominess is replaced by a more realistic "thudiness." The apparent pitch of the bass is lowered because the fundamental of the lowest bass notes is reproduced in proper amplitude and dominance. There is added also that vibration of the environment that is characteristic of live deep bass tones. The cannons of the *1812 Overture* and Beethoven's *Wellington's Victory* not only sound less like firecrackers but fade away into that floor-shaking thunderlike roll characteristic of cannon fire. You will even find instruments in certain recordings you did not suspect were there. You may not need all this to enjoy the music but, if it is realism you aim for, this can bring you many steps closer to it. END

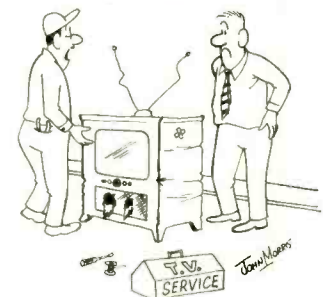

"Let's put it this way: If your set were a building, it would be condemned."

SERVICE CLINIC

Conducted by JACK DARR
SERVICE EDITOR



This column is for your service problems—TV, radio, audio or general and industrial electronics. We answer all questions individually by mail, free of charge, and the more interesting ones will be printed here.

If you're really stuck, write us. We'll do our best to help you. Don't forget to enclose a stamped, self-addressed envelope. Write: Service Editor, Radio-Electronics, 154 West 14th Street, New York 11, N.Y.

WITH AUDIO GAINS GOING HIGHER AND higher, rf pickup on the input grid can become a problem. In fact, many sound technicians check out PA systems and hi-fi amplifiers by connecting an outside antenna to the input. A TV antenna is fine for this: one side to ground and the other to input, and you have (usually) a closed-loop antenna that won't hum (Fig. 1). (If the system won't "detect," add a diode in series and it will. You need a fairly strong rf signal; we do it with about 3,000 μv from a 250-watter about a mile away, though.)

This rf can be troublesome. Even a strong FM transmitter, while it won't make intelligible speech, can cause severe distortion by overloading the input grid. The remedy is simple: short out the rf before it gets to the grid.

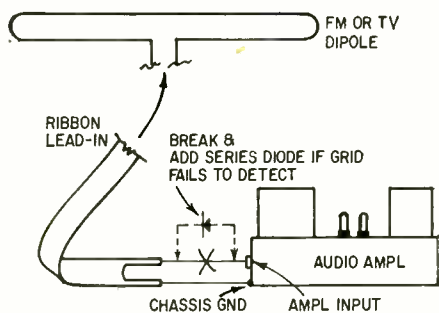

Fig. 1—Connecting some kind of closed-loop antenna to an amplifier often picks up enough signal from a local AM station to give a good test source of voice and music.

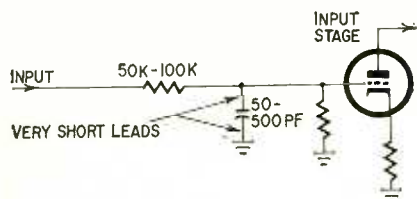

Fig. 2—A series resistor and shunt capacitor help attenuate rf. Keep leads short, and wire resistor as near grid pin as possible.

In most cases, a series resistor and very small bypass capacitor will do it, as in Fig. 2. The resistor can be between 50,000 and 100,000 ohms, and the bypass from 50 to 500 pf. This capacitor has such a low reactance at very high frequencies that it shunts the rf to ground, and won't let it develop any annoying signal voltage at the grid. (Use the smallest capacitor that does the job.)

Good shielding is a big help, too. Adding an earth ground to the input shielding sometimes helps a lot. The power line is a frequent cause of trouble. Be sure that it is bypassed with a pair of capacitors of about .02-.05 μf , one from each side to ground.

In extremely bad cases, try adding a tuned trap to the input circuit, outside the chassis. Mount this in a shielded box on the side of the chassis or rear apron. Tune it for maximum attenuation of the interfering signal, as in Fig. 3.

We still remember one case around our place. The Young Ham was running a "full gallon" in the back room. It was so hot that every pilot light on the bench lit up when he went on the air, even though the instruments were turned off! The local movie theatre, only a block away, received him many decibels above S9, and well above the level of the sound from the film!

The transmitter was operating entirely within legal limits. In such cases,

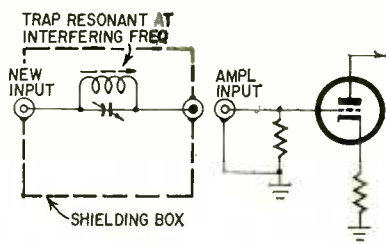

Fig. 3—For serious cases, a resonant trap usually helps. It must be completely enclosed in a shield box grounded to the amplifier chassis.

interference is not the responsibility of the ham, but of the operator of the audio equipment! (In fact, this sound system picked up the local 1/4-kilowatt broadcast station over a mile away, too.)

At any rate, the Young Ham obligingly went off the air until we could work something out. Bypassing grids, shielding and such did no good at all. We were most puzzled. To make a long story short, I eventually discovered that the rf pickup was getting into the amplifier on the cathode of the input tube! For some reason, the designer of this equipment had run the ground lead all the way around three sides of the chassis to a "common ground" point! The lead was almost 24 inches long! When we grounded it at the socket, the rf pickup disappeared. There was no hum, either.

So, to locate the cause of rf pickup, go ahead and ground grids, but don't overlook the cathode, especially if it's got a long wire on it!

Unusual horizontal hold

A small metal-cased Firestone ac-dc TV set is on the bench. All other labels, marking, etc., have been removed! Now, I've got multiple images, horizontally, and can't get rid of them. I have no schematic or information of any kind on this set, so I am fairly well at a loss.—F. W., Hollywood, Calif.

This is a Raytheon M-1750. The schematic for it is in Sams *Photofacts* 261-3. You'll find the same chassis under quite a few names, and even in a 21-inch model, exactly the same except for the larger cabinet.

This has a somewhat unusual horizontal hold circuit. It uses the "coarse" horizontal hold circuit, with an extra potentiometer in series with the horizontal hold pot, also a ringing coil. This control is on the back of the vertical chassis, beside and slightly below the ringing coil, which is near the horizontal oscillator, a 12AU7. Set the horizontal hold in center, and adjust the coarse control. After you get a single picture, set the ringing coil.

Replacement flyback connections

I have a Truetone 2D2047 on the bench, with no flyback. I bought a Merit HVO-6 flyback and MWC-1 width coil, but I am having trouble figuring out the wiring. The dc resistance readings are all different! Can you help me out on this?—J. C., Lincoln, Neb.

Somebody has snatched something out of the box on you. All Merit (and other) replacement flyback transformers should have a connection diagram packed in the box with them, showing you how to connect the unit for any set for which it is listed as a replacement.

There are a few general rules on

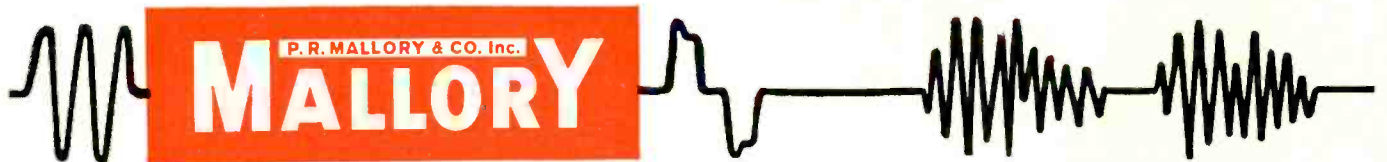

Tips for Technicians

Mallory Distributor Products Company
P. O. Box 1558, Indianapolis 6, Indiana
a division of P. R. Mallory & Co. Inc.

Why some filter capacitors develop hum... and some don't

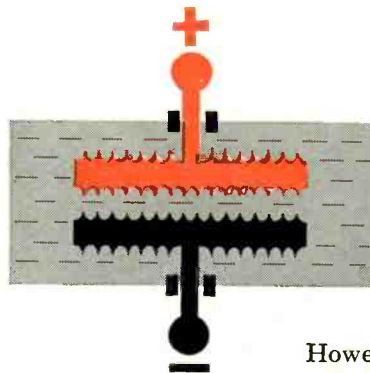

Aluminum electrolytic capacitors are widely used as filters in DC Power Supplies. This is because of their large capacitance in relatively small size. All in all, they do an efficient job of reducing ripple (hum) to acceptable levels.

However, all electrolytic capacitors are not alike. This is often why some types seem to allow hum to rise to objectionable levels more quickly than do others. In order to understand why, we must investigate actual construction methods.

As you know, electrolytics are basically made by depositing a film of aluminum oxide on aluminum foil to form the positive anode. The oxide is the dielectric. A semi-liquid electrolyte surrounds the anode and is actually the negative cathode. In order to connect this semi-liquid cathode to a terminal, a second piece of aluminum foil is used. This is often called the cathode, but it is not. It is actually only the *cathodic connection*. (The preceding describes a "polarized" electrolytic capacitor.)

When high ripple currents are applied to polarized electrolytics, a thin oxide film forms on the so-called "cathode". It begins to assume the characteristics of a second anode. This in turn, has the same effect as placing two capacitors in series. Consequently, overall capacitance is reduced. Inevitably hum increases.

This action is especially noticeable in electrolytics which use plain foil as the "cathode". This is simply because the oxide builds up over a relatively small area.

Mallory avoids this problem by etching the "cathode" on electrolytics. As a result, oxide build-up is spread over a vastly increased area. Therefore, ripple currents are maintained at very low levels for very long time periods.

Of course etched "cathodes" cost a lot more to make. But you get them from Mallory at *no extra cost*. There's much more to the Mallory capacitor story, but we'll leave that to another TIP.

Meanwhile, see your local Franchised Mallory Distributor for capacitors, resistors, controls, switches, semiconductors, and batteries. In fact, he's the man to see for *all* of your electronic component requirements.



NOW! PHOTOFACT®—BETTER THAN EVER—

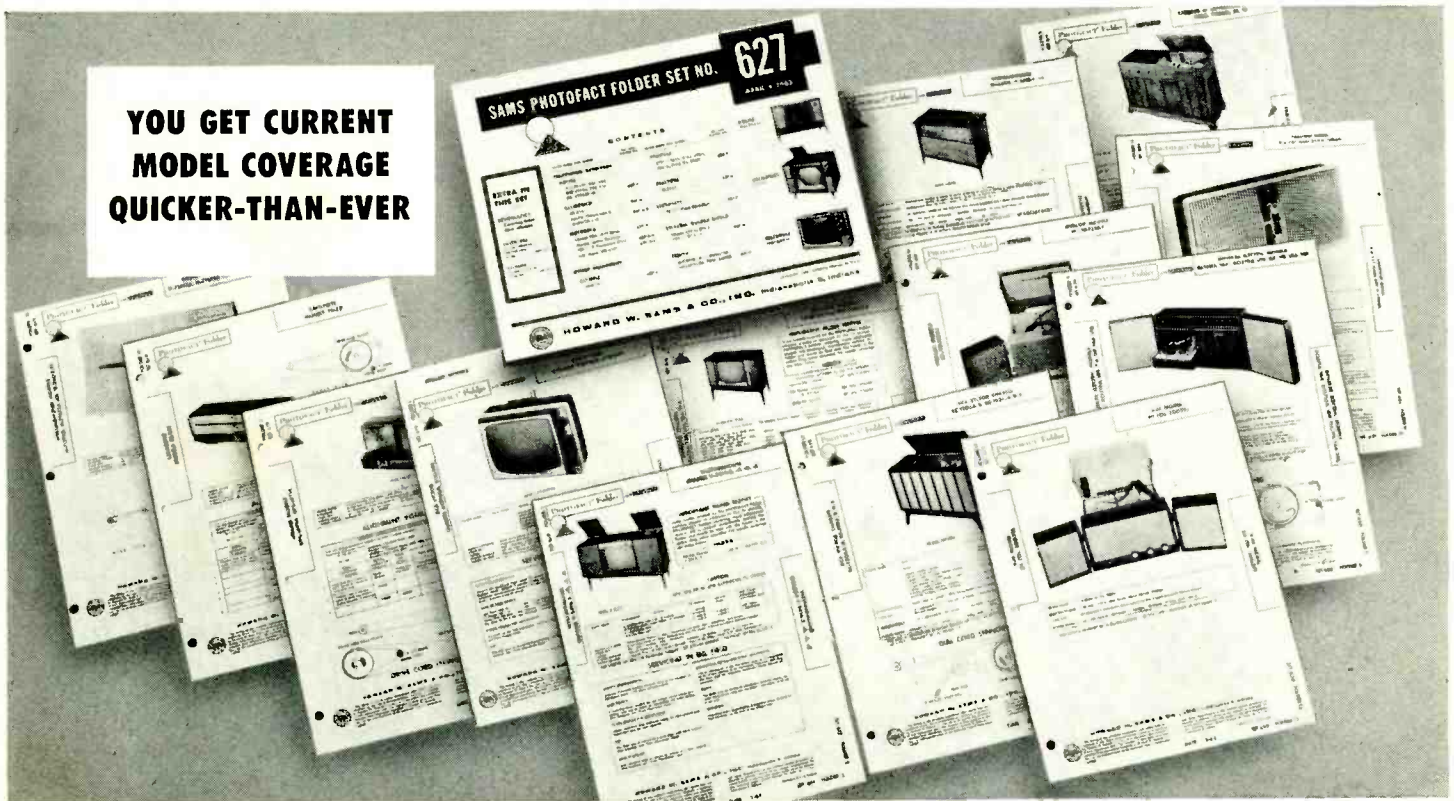

**YOU GET CURRENT
MODEL COVERAGE
QUICKER-THAN-EVER**

Now! More TV Coverage in Every PHOTOFACT Set More coverage of the type of equipment you service most!

- MORE TV COVERAGE
- MORE AC-DC COVERAGE
- MORE AM-FM COVERAGE
- MORE HI-FI COMBINATIONS
- MORE RECORD CHANGER COVERAGE
- MORE PHONOGRAPH COVERAGE

**SEND
COUPON**

UP-TO-THE-MINUTE COVERAGE KEEPS YOU AHEAD

Here it is—beginning with April releases—quicker service data coverage for more of the kind of equipment you most frequently repair. And it's the same famous PHOTOFACT time-saving, troubleshooting help—*everything* you need to earn more daily. You get: Exclusive Standard Notation Schematics packed with all the service details you need; full photo coverage of all chassis views; complete replacement parts lists, tube placement diagrams; actual waveform photos; CircuiTrace® for printed boards; alternate tuner data; terminal identification and connections; disassembly instructions; field servicing notes; dial cord stringing diagrams—plus dozens of other great features. Take the *right* step to time-saving, profit-building servicing—see your Sams Distributor for details on an Easy-Buy PHOTOFACT Library and Standing Order Subscription—or send coupon today!

HOWARD W. SAMS & CO., INC.

Howard W. Sams & Co., Inc., Dept. 6- E3
4300 W. 62nd St., Indianapolis 6, Indiana

- Enter my Photofact Standing Order Subscription
 Send full information on money-saving Easy-Buy Plan

My Distributor is: _____

Shop Name _____

Attn. _____

Address _____

City _____ Zone _____ State _____

**SAVE 30¢
PER SET!**

SIGN UP TODAY FOR A MONEY-SAVING PHOTOFACT STANDING ORDER SUBSCRIPTION!

With a Standing Order Subscription to receive PHOTOFACT regularly each month as issued, you pay only \$1.95 per Set instead of the regular \$2.25 price. You save 30¢ per Set—and you keep right up with the rapidly-increasing current model output! You enjoy the same 30¢ per Set savings when you purchase an Easy-Buy PHOTOFACT Library. Take advantage of substantial savings—sign up for a Standing Order Subscription or Easy-Buy Library with your Sams Distributor, or send coupon now for full details.

SAVE WITH A STANDING ORDER SUBSCRIPTION!

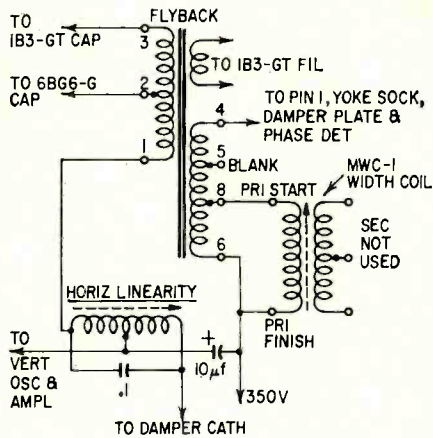

Fig. 4—Truetone TV replacement flyback connections.

replacement flybacks which I should go over here. You'll seldom find a replacement flyback which will *exactly* match the original dc resistance values of the various windings! This is due to differences in manufacture, changes in wire size, etc. However, a flyback listed by any of the major manufacturers as a replacement for a given set will always work in it if connected properly. There is a certain amount of tolerance as to the inductance values, but they will always be within this tolerance.

In the case of your Truetone, the HVO-6 will connect up like Fig. 4. The width coil will be connected as shown.

Worms in color pix

We have just installed a Zenith 29C120 color TV. The color is good, but I have trouble getting the fine tuning to work as it should. I can't tune the "worms" out of the picture without losing the color, or making it too "close"; it pops in and out.— F. S., Plainfield, N. J.

This is most likely a very slight misalignment. Check the setting of the 3.58-mc trap, and the input sound trap, L6. If these are slightly off frequency, they will reduce the color burst amplitude. Also, be sure to check the setting of the "Fringe-Lock" control. Excess clipping here can also cause the same symptoms.

Intermittent sound

The sound in a Westinghouse H-637T14 TV fades out or disappears while the picture stays on. Sometimes it comes back by itself, sometimes if you tap the chassis or vary the fine tuning.

I've tested and substituted all rf, i.f. and sound tubes with no effect. I also cleaned the tuner contacts without result.—B. S., Baltimore, Md.

This trouble is going to be in the sound circuits themselves rather than in the tuner or video i.f. In this chassis, the sound is taken off at the grid of the video amplifier, fed through a 1.5-pf capacitor to the sound i.f. (Fig. 5). It is

CHECKS AND REJUVENATES ALL PICTURE TUBES WITHOUT ADAPTORS OR ACCIDENTAL TUBE DAMAGE



\$69⁹⁵

the all NEW

Featuring Automatic Controlled Rejuvenation

SENCORE

CR125 CATHODE RAY TUBE TESTER

From SENCORE, designers of the famous Mighty Mite Tube Tester and other valuable time savers, comes another industry best. An all new method of testing and rejuvenating picture tubes. Although the method is new, the tests performed are standard, correlating directly with set-up information from the RCA and GE manuals.

Check these outstanding features and you will see why this money making instrument belongs on top of your purchasing list for both monochrome and color TV testing.

Checks all picture tubes thoroughly and carefully; checks for inter-element shorts, cathode emission, control grid cut-off capabilities, gas, and life test.

Automatic controlled rejuvenation. A Sencore first, preventing the operator from over-rejuvenating or damaging a tube. An RC timing circuit controls the rejuvenation time thus applying just the right amount of voltage for a regulated interval. With the flick of a switch, the RC timer converts to a capacity type welder for welding open cathodes. New rejuvenation or welding voltage can be re-applied only when the rejuvenate button is released and depressed again.

Uses DC on all tests. Unlike other CRT testers that use straight AC, the CR125 uses well filtered DC on all tests. This enables Sencore to use standard recommended checks and to provide a more accurate check on control grid capabilities. This is very important in color.

No interpretation chart. Two "easy view" neon lights clearly indicate shorts between any element. A chart is included for interpretation of shorts, if desirable. This chart is not necessary for normal testing on the CR125.

No adaptor sockets. One neat test cable with all six sockets for testing any CRT. No messy adaptors, reference charts or up-dating is required. The Sencore CR125 is the only tester with both color sockets. (Some have no color sockets, others have only the older type color socket.)

No draggy leads. A neat, oversized compartment, in the lower portion of the CR125 allows you to neatly "tuck away" the cable and line cord after each check in the home.



All six sockets, including latest color socket, on one neat cable.

SENCORE, INC.

426 S. WESTGATE DRIVE
ADDISON, ILLINOIS

SPECIAL INTRODUCTORY OFFER WORTH \$5.00

Most SENCORE products are sold by recommendation. So that you will be first in your area to buy and recommend the CR125, this coupon is worth \$5.00 on the purchase of the CR125 when presented to your parts distributor.

Why not save \$5.00 now?

Herb Bowden
President

The pure sound of Grommes. For the truly discerning... for those who appreciate the finer things in life. Hi-fidelity stereo of incomparable quality—sensibly priced.

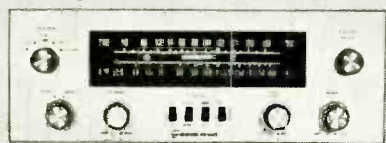

Model 502M 30 watt FM-AM stereo receiver. Integrated multiplex tuner—stereo amplifiers—magic bar indicator..... \$239.95

Model 500M 70 watt FM-AM stereo receiver with exclusive Stereo Sentry to indicate stereo broadcasts (pictured below)..... \$299.95

Write GROMMES

Division of Precision Electronics, Inc.,
9101 King St., Franklin Park, Ill.

Grommes
sets the
scene...

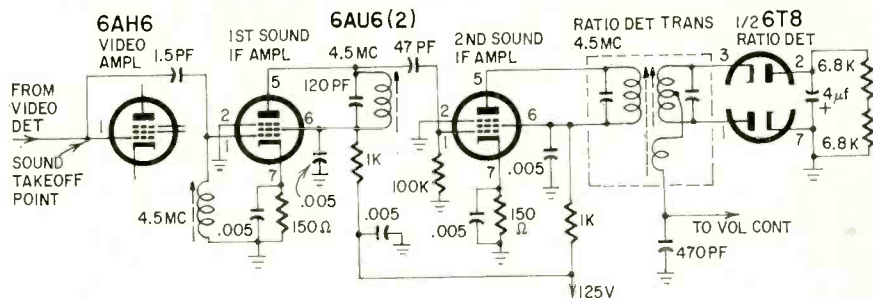

Fig. 5—There are several points to check in sound i.f. strip.

also coupled from there to the second sound i.f. amplifier through a 47-pf capacitor. An intermittent open or leakage in either of these could cause the trouble.

A more likely suspect would be an intermittent connection (or leakage) in the input or second sound i.f. transformers, or in the ratio detector transformer. Try making a signal injection test. Feed a sound i.f. signal into the grid of the first sound i.f. and check it through the whole sound circuit. Use a scope or ac vtm on the sound output.

Using a very fine tip, resolder all connections on the sound i.f. transformers and especially that ratio detector transformer. This last has caused a lot of similar troubles in practically all makes of TV. It might be worth while replacing it for a test.

Color fringing

In an RCA 21CT660U, I can't get enough range of adjustments on the convergence. I can't get the color fringing out over the entire screen. I've had this trouble in a couple of these chassis.

I've been told that the CTC7 chassis has a superior convergence circuit. What would you think of trying to rebuild the convergence circuit to match the CTC7?—R. S., Redstone Arsenal, Ala.

Very little, to be frank! This would involve a major redesign job, always a serious problem. I'd say. From my own experience with this chassis (which has been extensive, to say the least) I have found that magnetization seems to cause more convergence troubles than anything else.

So, degauss the tube and chassis thoroughly, being careful to retract the rim magnets. Keep the degaussing coil away from the neck of the tube at all times, to prevent demagnetizing the convergence magnets there. Then run purity adjustments, screen temperature, and then converge, using a fairly thick line in your crosshatch pattern. I have had some difficulty in trying to converge these old soldiers on very thin-line patterns. However, if you can get reasonably good convergence on a line about 1/4 inch wide, you'll find that there is no noticeable color fringing at even fairly close viewing distances. As a rule, it is

not possible to attain 100% convergence on this chassis; you'll always have a wee bit of fringing at the extreme edges. This will seldom be noticeable in the picture, so don't worry about it.

Make frequent "picture checks" during convergence, to see when the black-and-white picture has reached an "acceptable" stage, and it will be much easier.

Trouble in the agc circuit

I have a peculiar agc trouble in an RCA KCS-136 chassis. It seems to be wanting to go into overload all the time, but won't quite make it!—H. H., Memphis, Tenn.

Check the voltage-divider resistors in the cathode circuit of the 6GY6 agc tube. This is R544 and R545 on RCA schematics and R74 and R73 on Photofact circuits. These resistors are 4,700 and 5,600 ohms, respectively. They are a part of a voltage divider which sets the sync clipper bias, and also, of course, regulates the bias on the 6GY6 agc tube itself. If these increase in size, they will cause the symptoms you have.

Tuner replacement

I would like to change the tuner on a Raytheon 20AY21 TV chassis to a Standard Coil Neurode or cascode type. Is such a change practical?—D. N., Ravenna, Ohio.

Yes, indeed. The only trouble you'll have will be the physical mounting of the new tuner in this series. The original tuner used here is a pretty-good-size job, so you'll have plenty of room for the new one.

Connect the i.f. output of the new tuner directly to the grid of the first video i.f. through a short piece of coaxial cable—ground the shield as close to the socket as possible. The first video i.f. transformer is in the tuner, just as the original was, and is tuned to the same frequency, 26.25 mc.

In all conversion jobs of this kind, which involve any modifications about the i.f. or tuner, it is a good idea to give the whole video i.f. and tuner a complete sweep alignment after the conversion is completed.

Audio reflex circuit

I got an Admiral 17XP3 after someone had tinkered with it, tearing

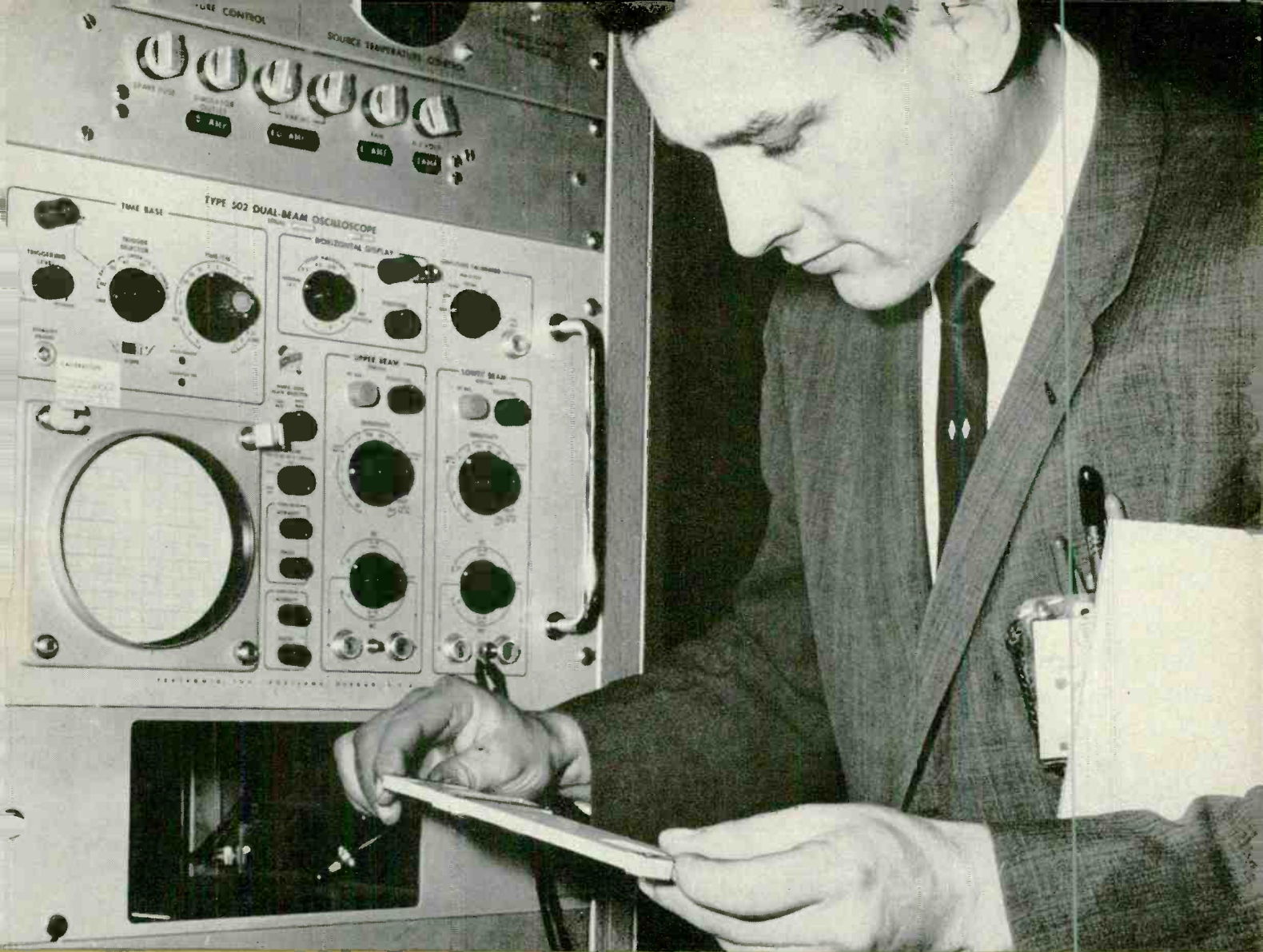

A CREI Program helped Edward W. Yeagle advance to project engineer at Barnes Engineering Co., Stamford, Conn.

Are you standing still in electronics while this man advances?

Find out why and do something about it if you have the ambition to want a career instead of just a job

Experience alone is no guarantee of success in electronics today. In this rapidly changing, increasingly complex field, employers demand advanced, up-to-date technical knowledge and this can't be learned on the job. Success comes to men who back up their experience with advanced education in modern electronics. CREI provides this education through industry-recognized home study programs that emphasize immediate application of knowledge acquired. The material a CREI man studies *today* will help him *tomorrow*—as well as in the years ahead.

If you are working in electronics, send for Free 58-page book. It explains how CREI Programs can help you as they have Edward W. Yeagle and thousands of other CREI men in every phase of electronics. Use coupon or write: CREI, Dept. 1405-A, 3224 Sixteenth St., N.W., Washington 10, D. C.

Send for free 58-page book



Founded 1927
Accredited Member
of the National
Home Study Council

The Capitol Radio Engineering Institute
Dept. 1405-A, 3224 Sixteenth St., N.W., Washington 10, D.C.

Please send me FREE book describing career opportunities and CREI Programs in advanced electronics. I am employed in electronics and have a high school education.

Name Age

Address

City Zone, State

Employed by

Type of Present Work

Check: Home Study Residence School G. I. Bill

47



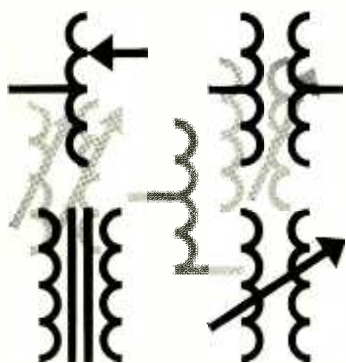

TRIAD THE COMPLETE LINE OF QUALITY TRANSFORMERS

Triad makes transformers of all types for home, laboratory, or service shop. Industrial and amateur types include audio, chokes, filament, instrumentation, modulation, output, and transistor. For television replacement needs, there are yokes, flybacks, and powers to fit nearly every make and model. Specifications and prices are listed in Triad's Industrial Transformer Catalog and Replacement Transformer Catalog. To obtain a copy of either one, see your distributor or write Triad Distributor Division, 305 North Briant Street, Huntington, Indiana.

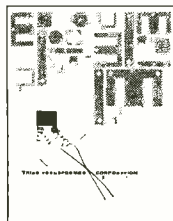

TRIAD DISTRIBUTOR DIVISION
A DIVISION OF LITTON INDUSTRIES

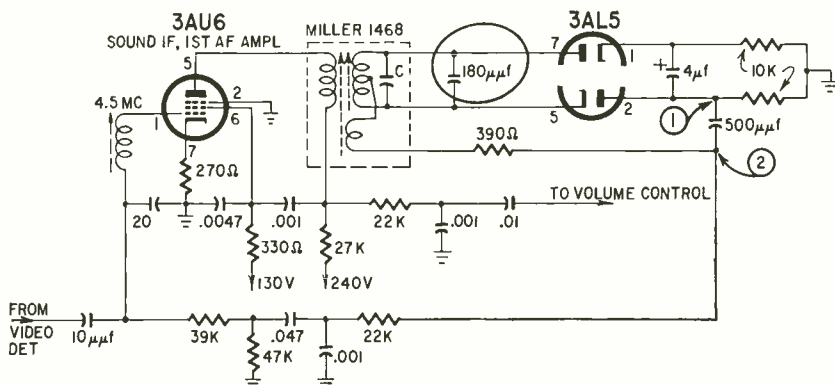

Fig. 6—Admiral sound i.f. circuit, with audio reflexed through it. Capacitor from bottom of 4.5-mc coil to ground is 20 μ f.

up the ratio detector coils, video i.f., etc. I've got the i.f.'s working again, but I can't get any sound. I don't know whether it's something in that sound i.f. stage or whether the new transformer I put in is defective. No zero on the secondary.—R. T., Eagle Mills, Ark.

This little set uses a reflex circuit in the sound i.f. (Fig. 6). While this was fairly common away back when, we don't see much of it any more. However, the stage amplifies the 4.5-mc sound i.f. signal, then the detected audio passes through it again and is amplified. We can do this because the two signals are so far apart in frequency.

You replaced the damaged ratio-detector transformer with a Miller 1468, which is the correct replacement. But there are two things you still have to do. First, remove the 180- μ f capacitor circled in Fig. 6. The Miller transformer has this capacitor inside the can. Its added capacitance across the secondary throws the winding far below the proper resonant frequency. Second, the top adjustment on the Miller can is the secondary. This is the reverse of the original Admiral transformer. So, mark this on the chassis (or schematic) or remember it, so you can adjust this circuit properly.

Feed an unmodulated, accurate 4.5-mc signal into the video detector, set your vtvm on a low dc range and connect it to point 1 in Fig. 6. Adjust the 4.5-mc coil in the 3AU6 grid, and the primary (bottom) adjustment of the ratio-detector transformer for maximum reading.

Move the vtvm to point 2. Set the meter on zero center, if possible. If not, adjust the secondary for zero voltage, with equal positive and negative swings each side, and the alignment is over.

Half a picture

The right side of the picture in an RCA KCS-104A chassis is very poor. It pulls, tears and falls out of sync (the whole picture, that is). The left side of the picture is OK at times.—W. J., Little Rock, Ark.

This trouble is probably caused by a faulty electrolytic capacitor somewhere in the horizontal output circuit. Check the cathode bypass on the 6DQ6, the screen bypass, and especially the filter between B-plus and boost. Check the B-plus lines with a low-capacitance probe on the scope for signs of horizontal-frequency hash or even 60-cycle hash.

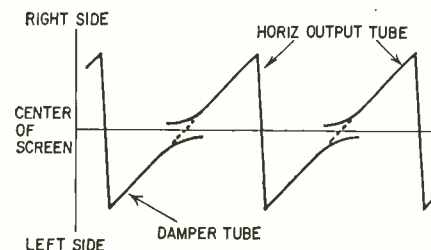
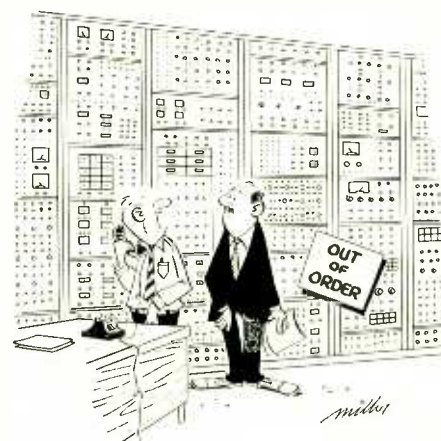

Fig. 7—Horizontal output tube affects right side of picture; the damper the left side.

If shunting a given electrolytic helps the trouble but doesn't stop it, disconnect the capacitor and replace it temporarily. A lot of trouble such as this is caused by leakage between sections of a multiple electrolytic.

Fig. 7 shows where the 6DQ6 conduction starts and the damper stops. Since this affects the right side, the trouble is probably somewhere in the 6DQ6 circuitry. END



"They say they're quite busy now and could we bring it down to the shop."

NEW FROM HEATHKIT

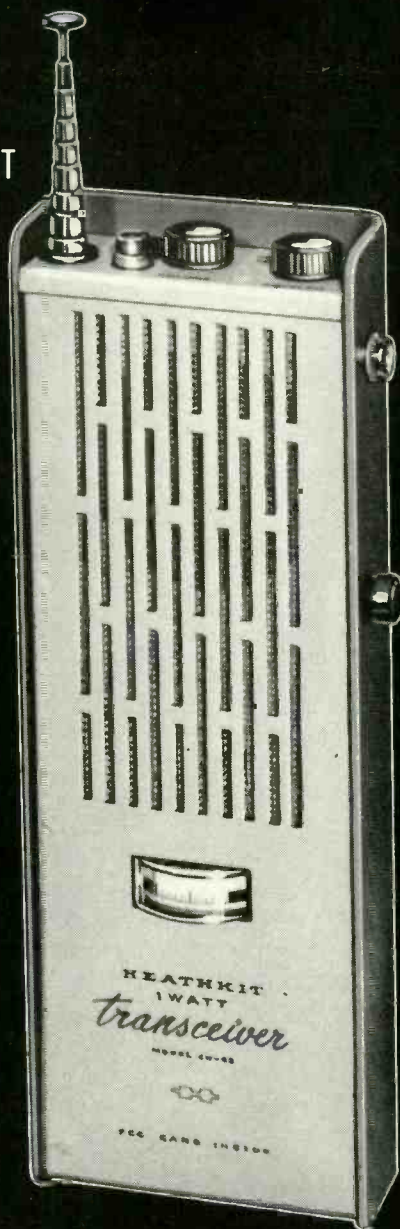

1 WATT WALKIE- TALKIE

ONLY \$74.95
ea.
includes \$20 heavy-duty
rechargeable battery!
Order a pair and save!
Only \$139.95

Attention CB fans! Here is a tremendous new value in a portable two-way radio transceiver! . . . the new Heathkit GW-52. Nowhere will you find a transceiver of such outstanding quality, with so many high performance features at so low a price! Designed for rugged duty and reliable two-way radio communications over extended ranges, the new Heathkit GW-52 features a powerful 10-transistor, 2-diode circuit . . . long-range transmitter with 1-watt input . . . sensitive superheterodyne receiver with 1/4 microvolt sensitivity for 10 db signal-to-noise ratio . . . crystal-controlled transmitter and receiver . . . built-in squelch and automatic noise limiter for crisp, clear communications . . . a heavy-duty 10-cell rechargeable nickel-cadmium battery with 500 milliampere-hour rating that will outlast conventional batteries many times over . . . built-in battery condition meter . . . built-in battery charger and many more! "Solid" communications may be established at ranges of three to five miles between units and even more when used with Class "D" CB stations or external antenna. Batteries may be charged from 117 VAC source with built-in charger or from 12 volt car battery. Battery life is 1500 hours minimum (90% receive, 10% transmit duty cycle) and life expectancy is as high as 5000 hours (over two years in normal workday use) . . . a tremendous savings in operating costs! Easy circuit board assembly. Complete with two-tone aluminum case, shoulder and elastic hand straps, crystals for one channel (specify), rechargeable battery, power cords, earphone, FCC license pack and instructions. Order a pair and save!

Kit GW-52, 4 lbs. no money down, \$8 mo. \$74.95 ea. Kit GW-52-2 (pair) 8 lbs., \$13 mo. \$139.95



a subsidiary of Daystrom

HEATH COMPANY
BENTON HARBOR 20, MICHIGAN

Please Send My Free Heathkit Catalog

Name _____

Address _____

City _____ Zone _____ State _____

Prices & specifications subject to change without notice. Dealer & export prices slightly higher.



FREE 1963 HEATHKIT CATA-03
100 pages, over 250 easy-to-build kits to fit your hobby, to give you better equipment at 50% savings. Send for your free copy today.

STANCOR PRESENTS

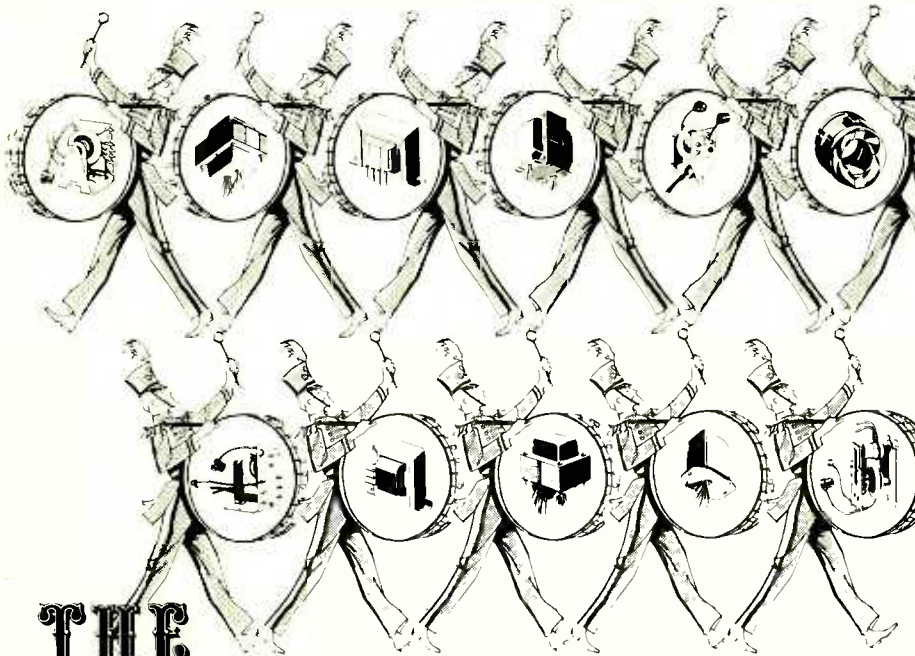

THE PARADE OF PARTS

Over 40 new yokes, flybacks, powers, and vertical output transformers have been added to the Stancor line *so far in 1963* — and that's just the beginning. We're continually marching toward our goal of complete replacement coverage of all major manufacturers' TV sets.

The 1963 Stancor Parade of Parts assures you that there's an *exact replacement* transformer available for your needs through your electronic parts distributor.

You can rely on him . . . and on

STANCOR
ELECTRONICS, INC.
3501E W. ADDISON, CHICAGO 18, ILL.

INDUSTRIAL-SPECIAL PURPOSE TV-RADIO AND HI-FI TUBES

Largest Diversified Stock in U.S.A.

Quality Tubes at savings to distributors, dealers and servicemen. Check with BARRY *first!* Quotations answered same day . . . We also BUY tubes (Name brands, unused only). Write:

BARRY ELECTRONICS® 512 Broadway, New York 12, N. Y.
Phone: 212-Walker 5-7000

Tube Inventory for CB Service

By JIM KYLE, KEG-3382*

IF YOU'RE PLANNING SERIOUSLY TO GO into the servicing of Citizens-Band transceivers, one of your first questions will be "What tube stock do I need?"

The accompanying inventory chart shows the types and quantities of tubes needed to handle the dozen most popular sets. If you're in TV repair, you probably will find many of the tubes already in your caddy. The chart lists 86 tubes, of 52 types.

A brief note on the quantities listed: I assumed, for stocking purposes, that it might be necessary to replace most of the tubes in any one set which might come in. The tube complements of the dozen most popular units were compiled; if from one to three tubes of a type appeared on the finished list, one of this type is specified in the inventory. If from four to six appeared, three are specified. If seven or more appeared, five are specified.

Type	Quantity	Type	Quantity	Type	Quantity
5Y3-GT	1	6BZ6	1	12AQ5	3
6AL5	5	6C4	1	12AT7	3
6AK6	1	6CL6	1	12AU6	1
6AN8	1	6CL8	1	12AU7	1
6AQ5	5	6CM6	1	12AX7	3
6AU6	1	6CM8	1	12BA6	5
6AU8	1	6CS6	1	12BE6	1
6AW8	1	6CX8	1	12BH7	1
6AV6	1	6DC6	1	12BR7	1
6BA6	5	6E5	1	12BW4	1
6BE6	3	6EA8/ 6U8/ 7687*	5	12BY7	1
6BH6	3	6EM5	1	12CR6	1
6BJ6	5	6FM8	1	12X4	1
6BJ7	1	6J6	1	7054	1
6BQ5	1	6K6-GT	1	7061	1
6BS8	1	6T8	1	400-piv	
6BW4	1	6V6-GT	1	silicon	
6BY6	1	12AB5	1	rectifiers	5
		12AL5	1		

*6EA8 is direct substitute for other two types; some manufacturers use them interchangeably.

Most CB sets use 400-piv silicon rectifiers. These are usually used in voltage-doubler circuits, but sometimes in a bridge arrangement. Only a few sets cling to tube rectifiers. No particular diode type is specified; any will be satisfactory. END

*Technical editor, *CB Horizons* Magazine.

NEW!

INTERNATIONAL EXECUTIVE TRANSCEIVER Model 1500



1

Designed for the Hobbyist . . . Complies with FCC Part 15 (no license) requirements

Here is International's new Model 1500 Executive transceiver for radio communication within the 27 mc frequency range. Designed and engineered for phone and cw (code), you can talk from 1 to 10 miles with other Part 15 stations depending on the height of the antenna. You are also permitted to work skip signals 1,000 miles or more with other Part 15 stations when a band opening occurs. And . . . no FCC license is required.

This feature packed transceiver puts the maximum RF power into the antenna by combining the transmitter and antenna for rooftop mounting. A second unit houses a supersensitive receiver and exciter, while a preamplifier at the antenna boosts weak signals for better reception. Other features include a special crystal filter for reducing interference from adjacent channel Class D two-way radios.

- 100 milliwatts input / 60" antenna
- 115 vac operation
- Phone and CW
- Eight channels . . . crystal controlled
- 27 mc frequency range

A complete, "ready to go", package. 1 receiver/exciter complete with 8 sets of crystals, 2 transmitter/antenna assembly, 3 antenna mount, 4 5 foot mast, 5 100 feet of control cable, 6 microphone, 7 key for (CW)

Model 1500 transceiver complete.....\$299.50*

See the Model 1500 transceiver at your International dealer.

* other models from \$80.00

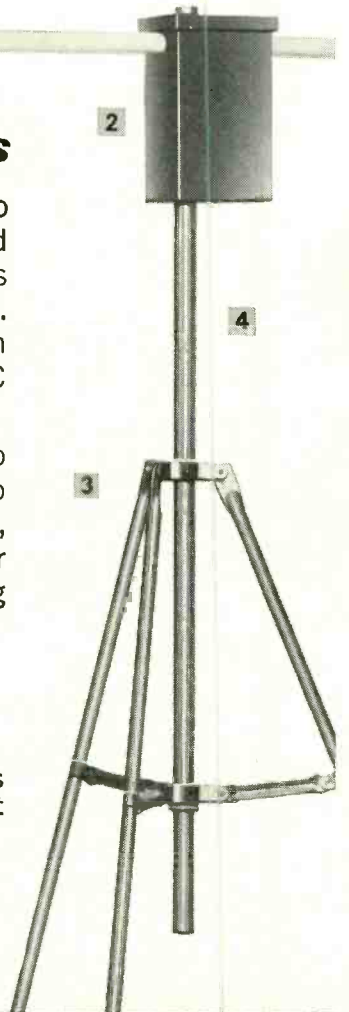

**INTERNATIONAL
CRYSTAL MFG. CO., INC.**

18 NORTH LEE • OKLAHOMA CITY, OKLA.

Write today for International's 1963 catalog.

MAY, 1963

61

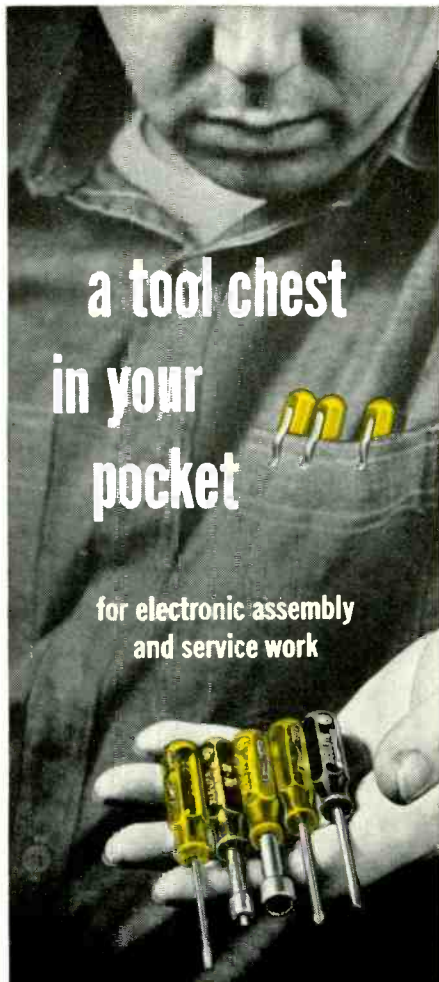

**a tool chest
in your
pocket**

for electronic assembly
and service work

Stockproof (UL), breakproof,
plastic handles with clips

ROUND BLADE SCREWDRIVERS
3/8" and 1/2" x 2", 3", and
4" blades

PHILLIPS SCREWDRIVER
Point size #0, 2" blade

BERYLLIUM-COPPER SCREWDRIVER
Non-magnetic, non-sparking
3/8" x 2" blade

NUTDRIVERS
10 Hex sizes from 3/32" to 3/8"
1 1/4" blades
Color coded handles

TERMINAL WRENCHES
Fit 1/4" and 3/8" O.D. spanner nuts
on external antenna and phone
jacks of transistor radios

WRITE FOR LITERATURE

XCELITE
**PROFESSIONAL
POCKET TOOLS**

XCELITE, INC., 10 Bank St., Orchard Park N. Y.
Canada: Charles W. Pointon, Ltd., Toronto, Ont.

Make diode rectifiers last longer

Protect against transients that can kill a whole string of rectifiers

By E. H. MARRINER

WHEN NEW COMPONENTS ARE TESTED in the field over a long period of time, improvements in reliability often prove necessary. Diode rectifiers in high-voltage power supplies are no exception. These diodes go bad after transient pulses are repeatedly impressed upon them. Many failures of this type require a power supply design change to correct the difficulty.

When the primary circuit of a power transformer is either closed or opened, a high transient voltage occurs as the transformer core flux suddenly changes. This transient voltage often exceeds the peak inverse rating of the diode rectifiers (Fig. 1) used in series with each other, and may blow one of them out. In turn, all the diodes in series with the blown one may be damaged.

In addition to the transient voltage, the piv (peak-inverse-voltage) rating of each of the series diodes may differ from the others because of manufacturing imperfections. Such differences must be equalized.

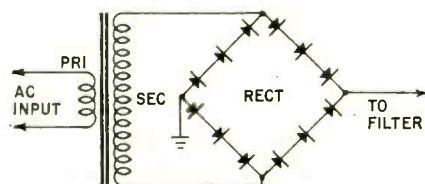
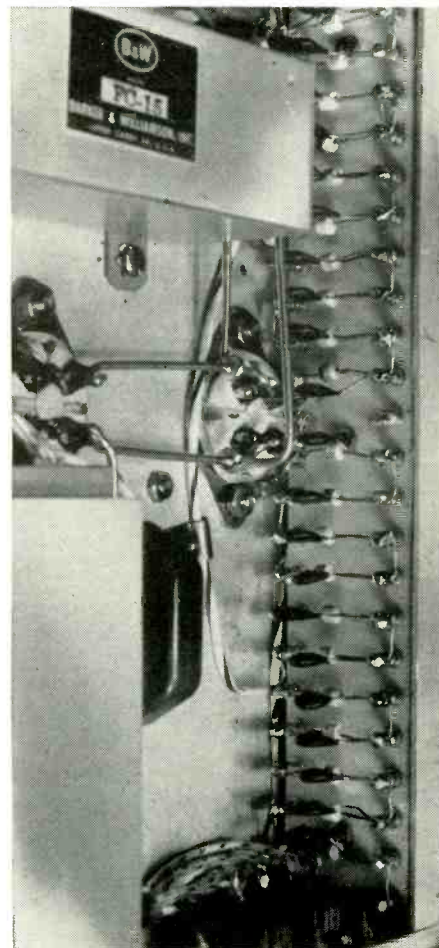

Fig. 1—Standard bridge rectifier circuit using diodes in series.



Small ceramic capacitor is connected across each diode.

When diode rectifiers used in high-voltage power supplies are transferring from a nonconducting to a conducting state, there is an indefinite time element called "charge recovery time." If one of the diodes in the series string does not recover to a nonconducting state as rapidly as the other diodes in series with it, and continues in a low-impedance state, the other diodes must carry the piv load. If one or more diodes fail in this manner, the additional inverse voltage distributed across the rest of the diodes may be large enough to cause the whole series of diodes in that arm of the bridge circuit to break down and fail.

The solution to the problem lies in distributing the peak inverse voltage. The inverse voltage across each individual diode may be more equally distributed by shunting each diode with a .002- μ f 1,200-volt disc ceramic capacitor (Fig. 2).

Now, during the charge recovery time, the capacitance presents a similar low impedance to the transient voltage and sets up an equal voltage across each diode.

To solve the problem of transient voltage across the transformer secondary, place a .005- μ f disc ceramic

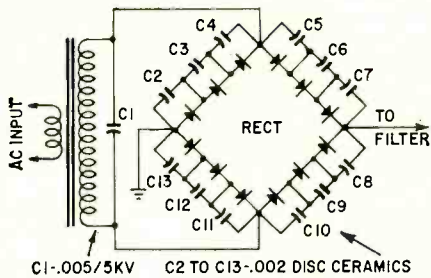

Fig. 2—Capacitors across diodes and transformer secondary protect against transients.

across the entire winding to present a low impedance to the transient pulse and limit it to a safe value. The pulse will not now damage the diode rectifier. The capacitor must withstand the peak voltage across the entire transformer secondary. For a 2,000-volt rms secondary, a 5,000-volt capacitor is needed.

Using these precautions, the inexpensive disc ceramic capacitors will prolong the life of the diode rectifiers indefinitely. Give it a try if you have had trouble. END

Calibrated Potentiometers

A variable but known value of resistance is often handy for servicing; it is a necessity for the lab technician and experimenter. Good-quality potentiometers with a linear taper are best—they are usually dust-tight and remain noise-free for longer periods of time—but any pot will do. Locking pots are usually more compact than the variety that requires a knob.

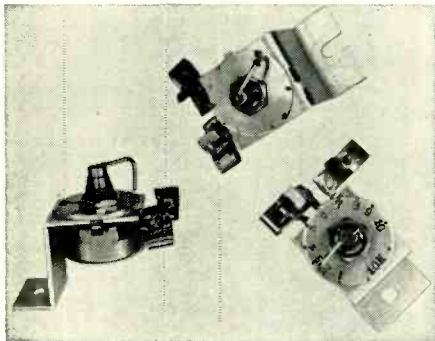

Mount a bracket on the shaft bushing and attach a pointer or knob temporarily, to make calibration easier. Use an accurate ohmmeter—a bridge is *not* necessary as subsequent resetting of values cannot be that accurate. The disc is marked with the point of a scribe at the 10's, 100's or 1,000's etc., around the circumference of the pointer's travel. The disc is then removed and the scribe dots deepened with a sharp center punch. These punch marks can be filled with EIA color-coded paint dots or number punches can be used to identify the calibrations numerically. Fahnestock clips are used as solderless connectors. —E. C. Carlson

MAY, 1963

most RELIABLE TRANSISTOR antenna AMPLIFIER



Low cost too
ONLY \$29⁹⁵

WINEGARD'S RED HEAD

Red Head is one transistor amplifier that does what it's supposed to do . . . boosts those weak signals right out of the snow, gives brighter contrast to your pictures without trouble and call-backs.

Red Head has a lightning-protected circuit—no transistor burnout due to lightning flashes, static precipitation or power line surges. Built-in high pass filter rejects interference from Citizen's Band, hams, etc. Unlike other transistor amplifiers, it can't cause smear or graininess in picture from phase distortion . . . has linear frequency response, no suck-outs or roll-offs at end of bands. You get clear, bright picture detail on color and black and white.

OTHER ADVANTAGES OF WINEGARD'S RED HEAD—has newest type four-lead transistor . . . is AC powered, no corrosion at terminals, no polarity problems—has built-in 2-set coupler in power supply—mounts easily on antenna, mast or wall—powerful enough to drive 6 sets, can be remoted up to 1500 feet using 300 ohm twin lead or ladder line. New eye-catching bright red amplifier housing—gives lasting product identity.

Red Head is your *best* transistor antenna amplifier buy. Try a few and see for yourself. Write for technical data or ask your Winegard distributor.

There's a Winegard Quality Antenna for Every Reception Need

 COLORTRON AMPLIFIER \$39.95	 COLORTRON ANTENNA Model C-44—Gold Anodized \$64.95	 COLORTRON ANTENNA Model C-43—Gold Anodized \$51.90	 COLORTRON ANTENNA Model C-42—Gold Anodized \$34.95	 COLORTRON ANTENNA Model C-41—Gold Anodized \$24.95
---	---	--	---	---



YOU GET AN EXTRA BONUS OF QUALITY AND VALUE FROM WINEGARD

Winegard ANTENNA SYSTEMS

WINEGARD COMPANY • 3013-5A KIRKWOOD BLVD. • BURLINGTON, IOWA

Because you've got to
SEE it - to BELIEVE it
... we will send you
a FREE sample!!!

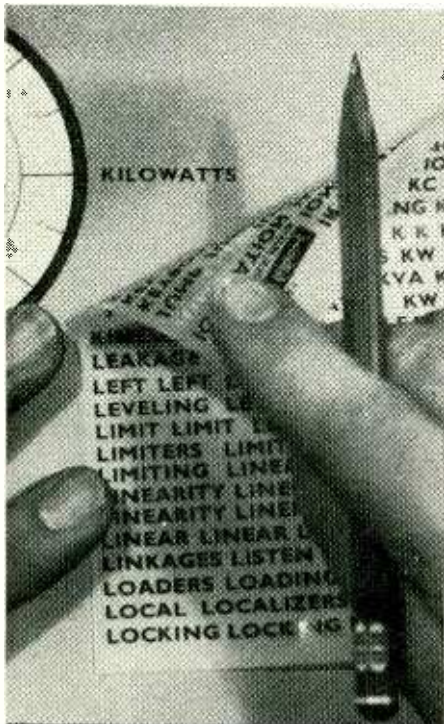

instant lettering

DRY TRANSFER TITLES FOR PROTOTYPES AND ELECTRONIC PANELS

Imagine lettering that transfers DRY to almost any surface — paper, wood, glass, metal, plastic — with just a quick, light pressure! Not just any lettering but the finest, most meticulous lettering in the world transfers from the carrying sheet to your prototypes, electronic panels, or engineering drawings.

**NOT A DECAL—NO WATER—NO TAPES
NO SCREENS — GOES ON INSTANTLY
JUST PRESS AND IT'S THERE
MAKES PROTOTYPES LOOK LIKE
FINISHED EQUIPMENT!**

Complete "Instant Lettering" Title Sets contain 24 sheets with thousands of pre-set words and phrases researched to give you the greatest variety and flexibility.

No. 958—Black\$4.95
No. 959—White 4.95

Now in stock at Allied, Lafayette, Newark, Harvey Radio and other selected electronic distributors.

WRITE - WIRE - PHONE FOR FREE SAMPLE!

THE DATAK CORPORATION

63 71st STREET GUTTENBERG, N. J.
N. J. 201—UN 4-6555 N. Y. 212—LA 4-0346

EQUIPMENT REPORT

3-inch Wide-band Scope

(Sencore PS120)

and

Tunnel Dipper

(Heathkit HM-10A)

WE ARE PRETTY SURE THAT THIS NEW scope is going to find its way into a lot of service shops. It weighs only 12 lbs, hardly more than the average vtm, and takes up less space on the bench than a 9-inch-high pile of RADIO-ELECTRONICS. Frequency response is within ½ db from 20 cycles to 5.5 mc, down only 3 db at 7 mc. This is more than ample for all black-and-white or color TV servicing.

The size of the scope tube is 3 inches, but the whole face area of the nearly flat 3RPI is used along with an oversize calibrated graph.

The controls are organized for convenience of operation. The two main ones, VERTICAL COARSE and FINE, and HORIZONTAL COARSE and FINE, are dual concentric controls with an inner and outer knob. Other less used controls are grouped across the middle of the panel just below the tube. The knurled shafts of the controls act as knobs.

A particularly interesting feature of the VERTICAL COARSE and FINE con-

trols (attenuators) is the direct readout of peak-to-peak voltages. All there is to reading the voltage is to set the trace height for 1 inch (two lines on the calibrated graph) and read the voltage directly from the position of the vertical attenuator knobs (see Fig. 1). In this case, the peak-to-peak voltage is 35 ($10 \times 3\frac{1}{2}$). When the low-capacitance probe is used, multiply the readings by 10.

The scope is ac-coupled. This minimizes trace bounce, so there is no wait for the trace to recenter itself when probing into a circuit.

Horizontal blanking eliminates re-traces that would sometimes make the forward trace hard to interpret. Also, a pulse from the horizontal circuit is available from the horizontal input jack in all positions of the sweep switch except EXT INPUT. This pulse can be used to test transformers and coils for shorted turns, as explained in the instruction book and in RADIO-ELECTRONICS, July 1962, page 59.

The vertical input cable is permanently attached to the scope, but an auxiliary vertical input jack can be selected by a slide switch for using other probes or an open lead where extreme frequency response and low loss are necessary.

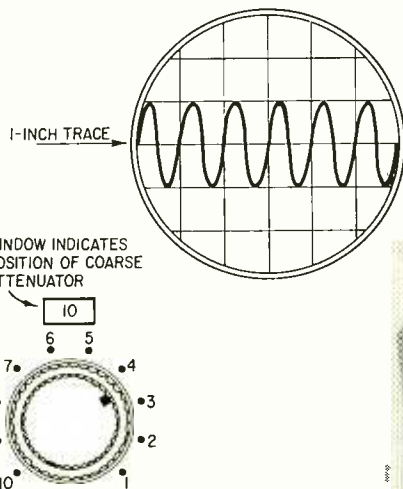
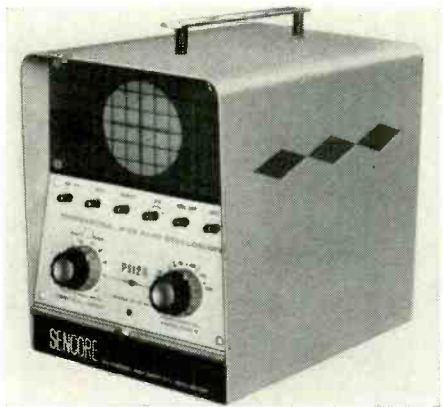

Fig. 1—The vertical attenuators are calibrated for peak-to-peak measurements.



Above-chassis view of the scope. Note the clean, uncluttered appearance.

RADIO-ELECTRONICS



Three-quarter view of Sencore PS120.

All cables fit into a concealed compartment behind a door at the bottom of the front panel.

How the circuit works

Vertical Amplifier: The signal from the input cable or vertical auxiliary input is fed through a four-position frequency-compensated attenuator switch to the control grid of the triode section of a 6GH8 connected as a cathode follower. The output is further amplified through the pentode section of the 6GH8 and a 6GM6. The wide frequency response is maintained throughout the vertical circuitry by large coupling capacitors, low-value plate resistors and special peaking coils. The signal then is fed to the first triode grid of a 12AV7 push-pull stage.

Cathodes of the dual-triode 12AV7 are effectively connected together so that the second triode functions as a grounded-grid amplifier. However, a small signal is taken from the cathode

Frequency Response

Vertical Amplifier—Flat within 1/2 db from 20 cycles to 5.5 mc; down 3 db at 7.5 mc.

Horizontal Amplifier—Flat within 3 db from 45 cycles to 330 kc; within 6 db from 20 cycles to 500 kc.

Deflection Sensitivity (for 1-inch height)

Vertical Input Cable or Aux. Jack—0.035 volt rms.

Low-Capacitance Probe—0.35 volt rms.

Horizontal Amplifier—0.51 volts rms for 1 inch width.

Input Resistance and Capacitance

At Vertical Input Cable—2.7 megohms shunted by approximately 99 pf.

At Aux. Input Jack—2.7 megohms shunted by approximately 27 pf.

Through Low-Capacitance Probe—27 megohms shunted by 9 pf.

At Horizontal Input—40k to 200k shunted by 80 pf.

Horizontal Sweep Oscillator

Frequency ranges continuously adjustable from 15 cycles to 150 kc. Sync range to 7.5 mc.

Maximum Ac Input Voltages

Vertical—1,000 volts peak-to-peak with 600 vdc.

Horizontal—Approximately 15 volts peak-to-peak with 400 vdc.

Size

8 1/2 inches high, 7 inches wide, 11 inches long. Weighs 12 pounds.

Price \$124.50 wired. \$74.50 kit.

\$13.50 plus enclosure: a speaker system that sounds like a million



NEW SONOTONE 8" COAX

Put the new 8-inch Sonotone "WR8-BH" into a good stiff infinite baffle or base reflex cabinet, and hear sound that'll make you think someone misplaced the decimal point in the price. It looks just like any other 8" speaker. The Alnico V magnet is about the same weight as you'd expect to find in a good 8" speaker — the cone and suspension material appears to be the same. The difference? The design. The material used is not half as important as *how* it is used.

One difference you're bound to see. That's the unique high frequency cone radiator, instead of the usual spherical tweeter. Just that little element extends the range clear out to 20,000 cycles. And with a properly matched enclosure, she'll go down to 50, 40 and even 30 cycles, under ideal conditions.

Sound incredible for \$13.50? Wait until you hear how smooth and clean the response is over the entire frequency range. If there is any distortion, you'd have to measure it — you can't hear it. Further, there's no perceptible dip in the vicinity of the 6 KC crossover frequency. The result: A very satisfying sense of "presence" in the mid-range — lacking in so many coaxial speakers.

The WR8-BH handles 20 watts average program material and peaks to 40 watts. Highly efficient, it requires less power input for a given acoustical output, which makes it very desirable for use in low-efficiency bookshelf enclosures. Terminals of the WR8-BH are color coded to simplify correct phasing in multiple speaker and stereo systems. Nominal impedance is 8 ohms. The magnetic structure is completely enclosed, eliminating dust.

The same combination of quality at a sensible price, embodied in the new Sonotone "WR8-BH," is evident in the rest of the Sonotone speaker line. The "CA-12A" coaxial provides clean, smooth response 35 to 20,000 cycles. List \$31.00. The "W-12" woofer produces natural bass for 3-speaker stereo systems or multi-speaker mono systems. List \$19.00. And the elliptically shaped "T-64" tweeter reaches from 2000 to 20,000 cycles. List \$12.00.

Sonotone speakers can put new life into your high fidelity music system. Hear them today.

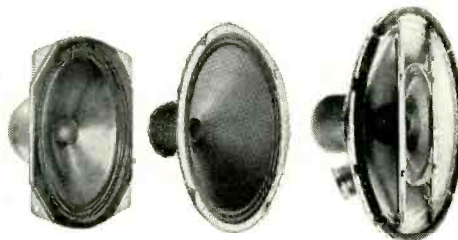

SONOTONE® CORPORATION

ELECTRONIC APPLICATIONS DIVISION • ELMSFORD, N. Y.
In Canada: Atlas Radio Corp., Ltd., Toronto • Cartridges • Speakers • Tape Heads • Microphones • Electron Tubes • Batteries • Hearing Aids • Headphones

of the 6GM6 and fed to the 2nd grid of the 12AV7 to balance the triode outputs. The out-of-phase signals from the 12AV7 are now fed to the deflection plates of the 3RP1 CRT.

Horizontal Circuit: The horizontal sweep oscillator, a 12AU7, is a cathode-coupled multivibrator, somewhat similar to the horizontal multivibrator used in many TV sets, but designed for a wide range of frequencies.

Power Supply: The power supply is a fairly conventional scope design. A 1V2 half-wave rectifier provides a negative output while a 6V4 full-wave rectifier gives positive output.

A STANDBY position is provided on the on-off slide switch. Keeping the scope on standby, when not in use, increases the life of the CRT and other components. Current consumption on standby is 10 watts.

Heathkit HM-10A

THE DIP METER IS STILL NOT A COMMON test instrument outside of ham circles, but is rapidly increasing in popularity as service technicians learn of its special features. At least two dipmeters are now commercially available in the test instrument field (see RADIO-ELEC-

TRONICS, December, 1962, page 60).

Since the dipmeter is an oscillator producing its own signal, it can be used wherever a signal is to be injected. Its meter indicates whenever that signal is being picked up by a resonant circuit, and can be used for quick alignment of traps, etc. With the oscillator switched out of circuit, the instrument becomes a wavemeter, and can check frequencies of other oscillators.

The Heathkit tunnel dipper is especially useful and interesting because of its tunnel diode oscillator. It covers a range 3 to 260 mc in six bands, and appears to work better as the frequency is increased. Beside the tunnel diode, the HM-10A has a diode rectifier as well as a three-transistor amplifier.

The kit offered no assembly problems, though its compactness called for care and a small soldering iron. In operation, it is excellent, making one wonder why one didn't try a dipmeter before.

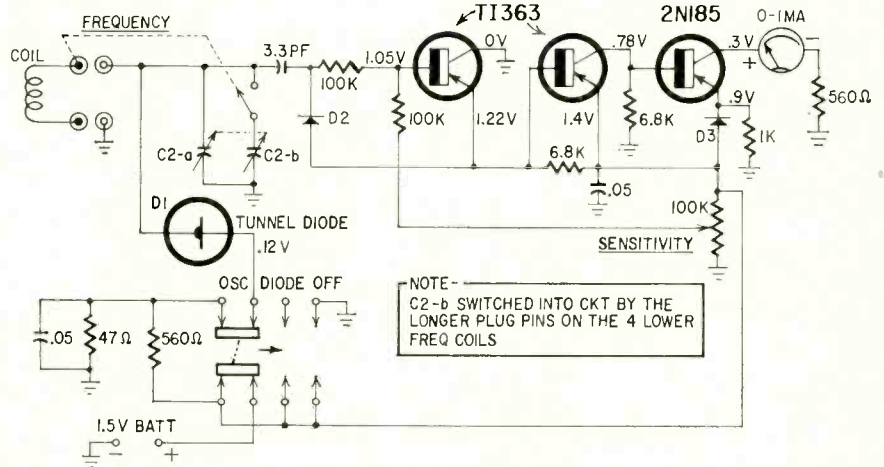

Circuit of the HM-10A

NEW! Winegard TV-FM Signal Outlets!

Look better, offer greater convenience and versatility—Easy to install!

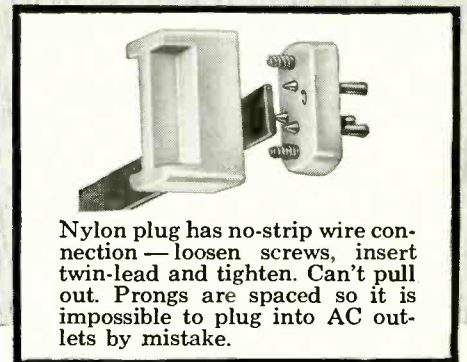
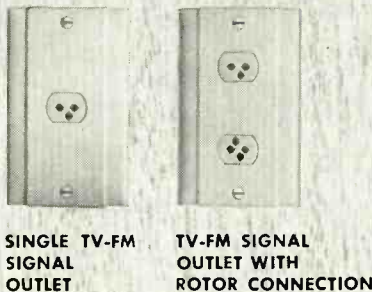

Winegard now offers a complete line of TV-FM wall outlets with plug. They are available with 117V AC electric power connections *plus* a TV-FM signal connection in various combinations. Or they can be bought as single TV-FM outlets, with or without rotor con-

nection. All Winegard TV-FM outlets are "fast connect", require no wire stripping—are available for both 75 and 300 ohm hook-up. Provides isolation between sets preventing set interaction.

On your next home TV-FM system, try Winegard signal outlets.



At your distributor or write for spec. sheets and prices.

Winegard

ANTENNA SYSTEMS
3013-5B Kirkwood • Burlington, Iowa
RADIO-ELECTRONICS

There's an extra bonus of quality and performance in every Winegard product.



HM-10A is just hand-size. Long, narrow coils probe easily in tight spots.

The sensitivity adjustment is rather critical, due to the characteristics of tunnel diode oscillators, but can be set to give a half-scale reading at any point on the six ranges. **END**

Unique Audio Takeoff

THIS CIRCUIT USED IN THE 1963 LINE of Motorola TV receivers is claimed to be more efficient than previous circuits. In the audio takeoff circuitry between the video amplifier plate and the audio i.f. grid (see diagram), C115 and L12 are series-resonant to 4.5 mc. Hence, the 4.5-mc impedance to ground at point A is very low, so very little 4.5-mc voltage is passed on to the CRT. Since C115 and L12 are in series resonance, maximum resonant frequency voltage (the 4.5-mc signal) is developed

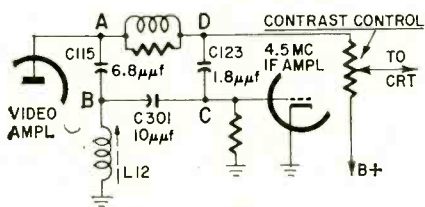

at point B. This voltage is coupled through C301 to the grid of the 4.5-mc amplifier and on to the audio system.

Any 4.5-mc signal that appears at point A is cancelled at point D. This occurs because C123 couples a 4.5-mc voltage to point D, which is always 180° out of phase with any 4.5-mc voltage that reaches point D from point A. So this little circuit acts as a 4.5-mc trap as far as the CRT is concerned, and a 4.5-mc takeoff for the audio system.

L12 is tuned for minimum 4.5 mc in the video to set the circuit for both maximum audio to the audio system and minimum audio to the video system.—Warren Roy

MAY, 1963

she's
listening
to the
specifications
of the



NEW SONOTONE SONO/COM[®]

This pretty lass is no engineer, but she does know what her ears tell her about the new Sonotone Sono/Com[®] Headphone/Microphone. She hears every word sharply, clearly. (Engineering specs say: Frequency response of headphone, flat from 50 to 10,000 cps.) When listening to a recording of the way she pronounces a foreign language, she can easily recognize if her accent is correct — (specs say: boom mike is famed Sonotone Ceramike with high sensitivity, -53db and wide frequency response, 80 to 9,500 cps.)

They're comfortable, too — her hair is never mussed or fussed. Even when she wears glasses, the Sonotone Sono/Com[®] is comfortable. (Specs read: Only 13 ounces; polyurethane foam ear cushions that snap out for easy cleaning.)

By accident, she has also discovered they're rugged. She dropped them and they still continued to perform perfectly (specs say: Ceramic transducer in boom mike will withstand shock, moisture.) She knows, too, that the instructor can listen in to her recording on the spot (swivel permits either earphone to rotate 90°.)

Finally, she feels like learning, because she feels important and modern. Spec sheet says these attractive headsets are available in attractive suntan, spruce green, coral and black). Small wonder, the Sono/Com is the Student's Favorite—Teacher's Pet.

What our pretty friend doesn't know is that the high impedance output of the Sono/Com makes it easily adaptable for installation in any system. (Specs say 50K ohm impedance.)

The Sono/Com[®] is available three ways: Model SHM-1000, headphone/boom mike combination. SH-2000, headset only. Model SB-3000, the Ceramike boom microphone, which fits not only the Sono/Com but other headphones, is available separately. A magnetic microphone will be available shortly. Other Sonotone products for language lab applications include Sonotone "CERAMIKES," a group of top-quality, sensibly-priced microphones.

On your next A-V installation — specify Sonotone Sono/Com headphones and Sonotone Ceramikes.

SONOTONE[®] CORPORATION

ELECTRONIC APPLICATIONS DIVISION • ELMSFORD, N. Y.
In Canada: Atlas Radio Corp., Ltd., Toronto • Cartridges • Speakers • Tape
Heads • Microphones • Electron Tubes • Batteries • Hearing Aids • Headphones



IT PAYS TO USE AEROVOX!

Aerovox Type BE Bi-Electric® Mylar Paper Bypass Capacitors combine the advantages of an exclusive Polycap® case from end-to-end, and process controlled end fills to provide complete sealed protection for every service job! Tests prove this superior construction eliminates cracking and chipping problems common with conventional dipped bypass capacitors... even when the Bi-Electrics are used for axial lead installations.

□ Aerovox Type V84C-V161 Aero-film® Mylar Capacitors are extremely stable axial lead units offering exceptional protection of Polycap case and epoxy end-seals which will not flow, soften or melt at any operating temperature. □ Protect your reputation and profits—ask for Aerovox!

AEROVOX MYLAR® BYPASS CAPACITORS PROVIDE SUPERIOR PROTECTION FOR EVERY SERVICE JOB!

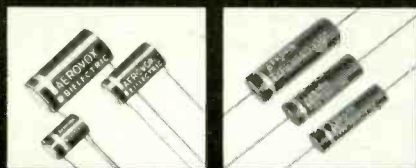

Registered DuPont trademark

AEROVOX CORPORATION
DISTRIBUTOR DIVISION, NEW BEDFORD, MASS.
Technical Leadership—Manufacturing Excellence

WHAT'S YOUR EQ?

These are the answers.
Puzzles are on page 34.

Constant Current

There are two possible answers. The first is that C is shorted, and X_C is therefore zero. Putting another short across C would then have no effect on the circuit. The second answer is, since 732 ma flows in the circuit, the total opposition must be 157 ohms. Since X_L and X_C are in 180° opposition to each other, we can find our answer by simple subtraction. Subtracting X_C from X_L , we find X_C equal to zero. Subtracting X_L from X_C to get 157 ohms, X_C must be equal to 314 ohms. Thus, shorting it out leaves the 157 ohms in circuit.

Note that with X_C in circuit, we have a capacitive circuit, the current leading the voltage by 90°; but when X_C is shorted out, while the ohmage remains the same, the current now lags the voltage by 90°.

Four-Way Switch

The switches are hooked together as shown, so that the light can be turned on or off with any one of the three

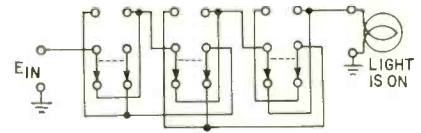

switches. Note that the wiring is repetitive—any number of switches could be connected to the circuit.

Rectified voltage

If the lower tube only is used in the circuit, the voltage across R_L is $150 - 15$, or 135 volts. If the upper tube only is used, the voltage across R_L is $300 - 15$, or 285 volts. The top of R_L connected to the cathode is positive, of course, in both cases. If both tubes are inserted at the same time, the top of R_L is 285 volts (positive) while the plate of the lower tube is 150 volts (positive). Therefore the lower plate voltage is $285 - 150$, or 135 negative, with respect to its cathode potential, and the lower tube does not function as a rectifier. The situation remains the same as if the upper tube alone were inserted.

ONLY \$9.95 EACH

FUN-TO-BUILD knight-kit®

WALKIE-TALKIE

C-100 ALL-TRANSISTOR 2-WAY TRANSCIEVER KIT

Now! Enjoy real on-the-go communication between two or more stations up to 1/4 mile! Just press the button and you're "on-the-air." No license or exam required, no age limit. Operates up to 75 hours on low-cost battery. Handsome blue case, only 5 3/8 x 2 7/8 x 1 3/4"; telescoping 40" antenna. A breeze to build. Includes all parts, solder, easy wiring instructions (less battery). Wt., 9 ozs.

83 Y 804EP. Walkie-Talkie Kit. \$9.95
Each only.....
83 Y 013. Leatherette Carrying Case....98¢
83 Y 002. 9-Volt Battery.....21¢

ALLIED RADIO-ORDER TODAY

100 N. Western Ave., Chicago 80, Ill.

Ship me: Walkie-Talkie Kit(s) 83 Y 804EP,
 Carrying Case(s) 83 Y 013
 9 V. Battery(ies) 83 Y 002
 enclosed check money order

Name _____
PLEASE PRINT
Address _____
City _____ Zone _____ State _____

NOW YOU CAN AFFORD THE ELECTRONIC ORGAN OF YOUR DREAMS!



Completely transistorized PANTRONIC organ kits are easy to assemble, and you make the middleman's profit.

The Model 8000AK, pictured above, is only \$350.00 delivered to your home anywhere in the continental United States. This price includes bench and a beautifully hand finished console.

Consoles, keyboards, and individual electronic subassemblies are available separately.

For information write: Dept. RE-2
PANTRONIC, INC.

10555 Magnolia Avenue, Arlington, California

RADIO-ELECTRONICS

NOTEWORTHY CIRCUITS

Transistor Vibrato for Guitar Amplifier

From time to time, readers ask for a vibrato circuit that can be added to an amplifier used with an electrified guitar. Here is a vibrato and tone control circuit that can be used ahead of many transistor and vacuum-tube power amplifiers. The circuit was adapted

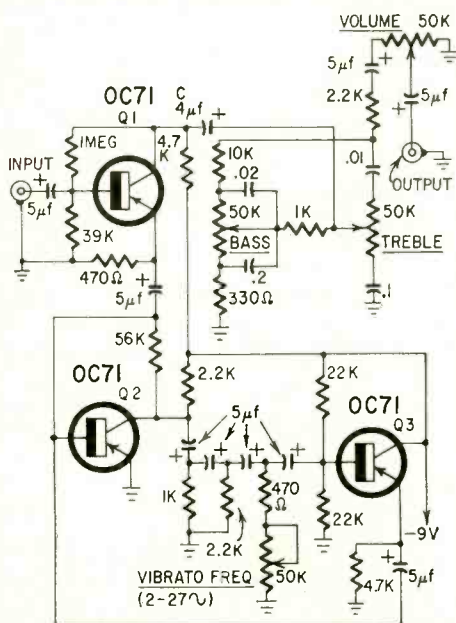

from a transistor guitar amplifier in *Le Haut-Parleur* (Paris, France).

Q1 is a common-emitter amplifier inserted between the instrument pickup and the input to the amplifier. The phase-shift oscillator (Q2 and Q3) generates a vibrato frequency variable from about 2 to 27 cycles. The vibrato signal is fed to Q1's emitter where it modulates the signal from the pickup.

The tone and volume controls can be eliminated by connecting the output jack directly to the positive side of capacitor C.

60-Cycle Hum Attenuator

This attenuator is a handy item to have when making audio voltage measurements. Usually (due to pickup or poor shielding) the measurements made are erroneous because of 60-cycle modulation of the signal frequency.

Inserting the attenuator between the voltage to be measured and a vtvm or scope attenuates the 60-cycle volt-

*the key to
over 1,200
profitable
cartridge
replacements*

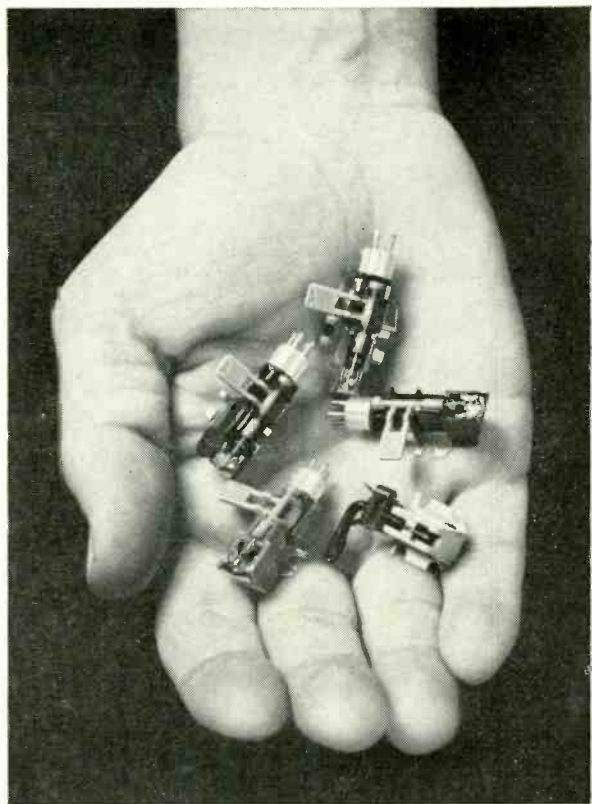

SONOTONE CARTRIDGES

When you rely on Sonotone cartridges, you're always in the best position to increase your replacement profits.

1. You tie up less capital in inventory, because fewer cartridges replace more models.
2. You always have the right replacement. Sonotone cartridges have been specified as original equipment in more than 14,000,000 phonographs — that's the number of genuine direct replacements you can make with Sonotone.
3. You have more satisfied customers. Replace with Sonotone and the improvement in performance is dramatic. Sonotone cartridges feature ceramic transducers—no problem from magnetically induced hum. They're designed to track at the optimum tracking forces for record changers. Needles can be replaced with ease thanks to unbreakable nylon, snap-in-snap-out type needle assembly.

5 new Sonotone cartridges—excellent replacements for more than 1,200 phonograph models

Model "2TA." Ceramic mono cartridge, an improved version of the famous Sonotone "2T Series." New needle assembly, plus increased compliance and lower tracking force, make it ideal for both stereo and mono records.

MODEL "916-TA." This low cost stereo ceramic cartridge employs some of the basic design features of the audiophile-accepted Velocitone Series. New universal tonearm terminal plug for easy replacement in quality models.

MODEL "9TA." Ceramic stereo/mono cartridge features low stylus mass and high compliance. New universal tonearm terminal plug for fast easy replacement. For deluxe models.

MODELS "16T-A" AND "18T-A." Two budget priced stereo cartridges with wide channel separation and smooth flat response over the high fidelity range. New universal terminal plug for fast replacements.

Your most profitable cartridge replacement is Sonotone. Call your distributor today.

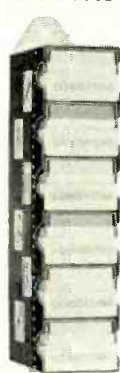

SONOTONE CORPORATION

ELECTRONIC APPLICATIONS DIVISION • ELMSFORD, N. Y.

In Canada: Atlas Radio Corp., Ltd., Toronto • Cartridges • Speakers • Tape Heads • Microphones • Electron Tubes • Batteries • Hearing Aids • Headphones

age 45 db. This means that the 60-cycle component is now 175 times less than the measured voltage at the output terminals of the attenuator.

Although the attenuator was de-

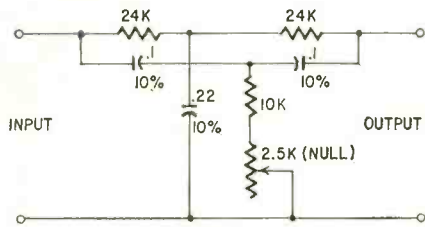

Fig.1

signed for 60-cycle use, any frequency can be attenuated by proper choice of components. The schematic is shown in Fig. 1. The entire circuit can be built into a small box or permanently into any audio system. The potentiometer is

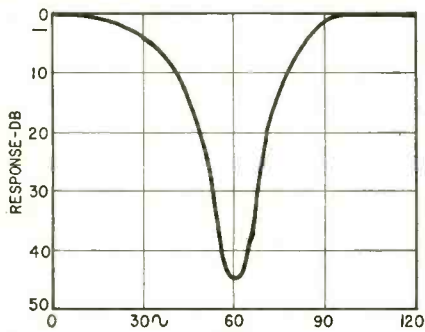

Fig.2

used to null out the attenuated frequency (60 cycles in this case). The frequency response curve of the attenuator is shown in Fig. 2.—Leonard J. D'Airol

Diode Curve Tracer

It is common practice to test diodes by measuring their forward and reverse resistance with an ohmmeter. This method, however, gives only a rough approximation of condition. A much better method is to compare the characteristic curve of the diode under test with the curve for a normal one.

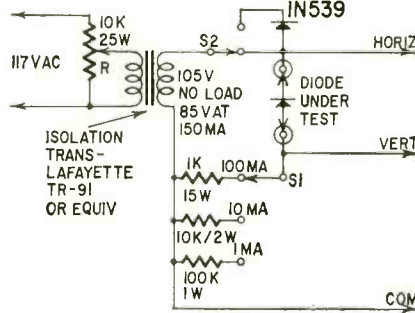

Fig.1

The unit described will do exactly that.

The schematic of the diode curve tracer is shown in Fig. 1, while Fig. 2 shows a typical diode curve. Potentiometer R controls the voltage applied to the diode under test, and is adjusted until the complete curve is obtained. S1 is then set for the current range de-

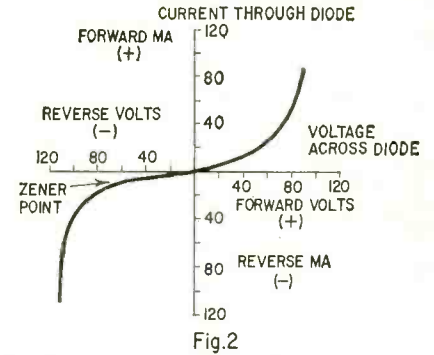

Fig.2

sired. As the ac voltage from the transformer rises from zero to its maximum positive value, the diode is forward-biased, and the right-hand side of the curve is traced. When the ac rises to its maximum negative value, there is little increase in current until the avalanche, or breakdown, point is reached. Then a large amount of current begins to flow. This point is the Zener breakdown point. When viewing this point for extended periods of time, diode D1 should be switched in by S2 to prevent excessive current flow through the diode under test on the positive swing of the ac sweep voltage.

Reproducing the curves can be simplified by preparing a plastic disc (Fig. 3) for the scope screen. To calibrate the scope so that the scales on the plastic disc correspond to the actual diode voltages, first apply 100 volts

MERIT CATALOG NOW AVAILABLE



Contains 20,000 "easy to find" Merit equivalents to manufacturer's part numbers. Merit's exact replacements means fewer call backs... easy installation... minimum field returns.

Form 830
1963-64

Most Complete Catalog & Replacement Guide

Order Your Merit Catalog & Replacement Guide Now.

Name _____ Position _____

Firm _____

Address _____

City _____ Zone _____ State _____

MERIT COIL & TRANSFORMER CORPORATION
Merit Plaza Hollywood, Florida

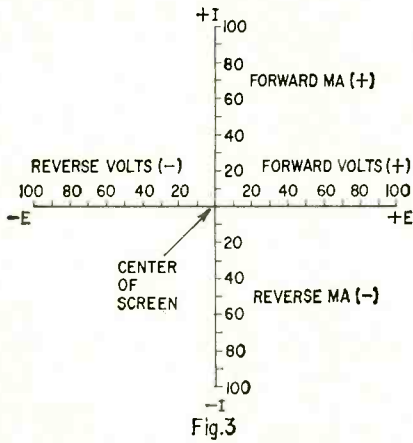

peak-to-peak ac to the vertical input of the scope and adjust the vertical gain control so that deflection occurs from -100 to +100 ma. The other vertical current ranges will be calibrated then—they're multiples of 10.

Calibrate the horizontal voltage scale by applying the 100-volt peak-to-peak signal to the horizontal amplifier and adjusting the horizontal gain control for a deflection that occurs from -100 to +100 volts.

Now connect the curve tracer to the calibrated scope, plug in the diode to be checked and run the curve.—*Irwin Math, WA2NIM*

Bfo for SSB Reception

The bfo's in many communications and all-wave receivers are adequate for CW reception and for zero-beating frequency standards and incoming signals but they are seldom stable enough for SSB work. If the set's local oscillator is reasonably stable, you can simplify SSB reception by installing this crystal-controlled bfo, described in *The Short Wave Magazine* (London, England).

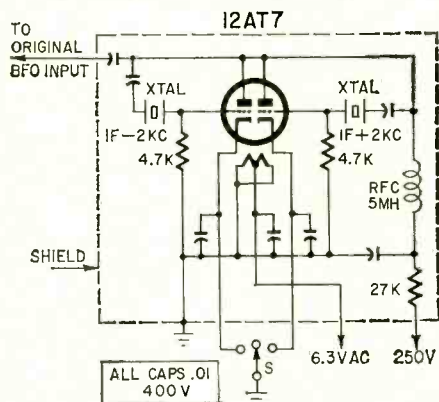

The circuit consists of a 12AT7 with both triodes connected as Pierce oscillators. One crystal is 2 kc above the set's i.f. and the other 2 kc below. The desired sideband is selected by the switch in the cathode circuits. The complete oscillator should be shielded with all heater, B-plus and switch leads bypassed at point of entry into the shield. The output is taken through shielded cable to the same bfo injection point as used by the original bfo. END

MAY, 1963

*that
something
extra that
makes a big
difference in
performance*

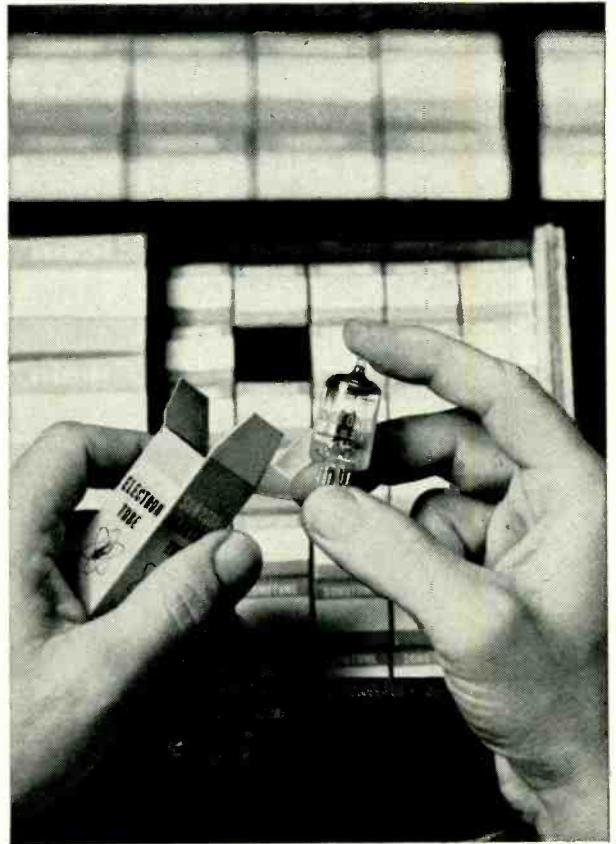

SONOTONE TUBES

When tube deterioration causes fuzzy TV pictures, mars the beauty of the music in a hi-fi system, robs communication gear of crisp, clear reception or transmission — the choice of the right tube replacement can make a world of difference. Let's take a look at some Sonotone tubes and see why they offer that something extra that contributes to better performance.

Take the 12AX7A. Its unique damper mica and coiled heater assure low hum and low microphonics. While we're discussing audio tubes, the Sonotone EL34 and EL84, available in custom matched pairs for push-pull applications, have been chosen to protect the quality of amplifiers made by leading hi-fi manufacturers. If they are good enough for selection by quality-conscious hi-fi manufacturers, they certainly will make excellent replacements.

Then there's the bread-and-butter TV tube types — 1B3GT, 1G3GT, 1X2B, 3BZ6, 5U4GB, 6AL5, 6AQ5A, 6AU6, 6BZ6, 6CB6A, 6DQ6, 12AU7, to name a few. Each is 100% tested — short and continuity, heater current, noise. No noisy or gassy tubes, just sparkling TV pictures and crisp clear sound when you replace with Sonotone.

In critical UHF — the Sonotone 6AF4A and 6DZ4 employs a coiled heater rather than the less expensive folded heater found in other tubes. This means lower hum or hum modulation, lower microphonics.

For every replacement, Sonotone tubes offer extra performance. Replace with Sonotone!

For complete list of tubes, write

SONOTONE® CORPORATION

ELECTRONIC APPLICATIONS DIVISION • ELMSFORD, N. Y.
In Canada: Atlas Radio Corp., Ltd., Toronto • Cartridges • Speakers • Tape
Heads • Microphones • Electron Tubes • Batteries • Hearing Aids • Headphones



NEW PRODUCTS

FUEL-VAPOR INDICATOR, Model M1-41, for gasoline-powered boats. Combustible gas fumes shown on "safe-dangerous-explosive," meter scale. Connection for external alarm device.

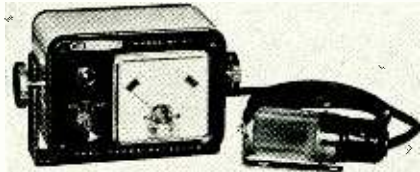

Transistorized. 12 volts dc, current 1.0 amp. Temperature range -20°C to 80°C . 5 x 3-7/16 x 3 3/8 in. Heath Co., Benton Harbor, Mich.

MINIATURE TERMINAL-STRIP ASSEMBLIES. Configurations similar to standard-size types. Strips of XP laminated phenolic 3/64 in.

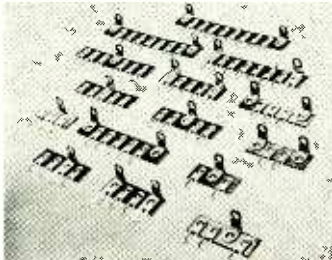

thick, 5/16-in. wide. End lugs spaced 5/32 in. from center of lug to end of strip.—Waldom Electronics, 4625 W. 53 St., Chicago 32, Ill.

DUAL JACK BLOCK, series 2300, for telephone or military type long-frame jacks. Mounted on 5/8-in. centers to block, for rack panel mounting singly or in multiples. Complete jack circuit coverage in 2 or 3 conductors; single break or make to make-make, break-break circuits.—Switchcraft, Inc., 5555 N. Elston Ave., Chicago 30, Ill.

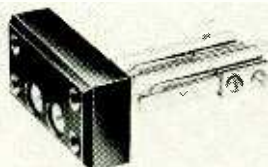

EDGEWISE METERS. Ranges in 2% dc meters, 2% ac meters, 5% dc indicators. Horizontal and vertical models. Cross-arm balance, jeweled bearings, fadeproof printed dials, ultra-sensitive

high-torque movement, high overload capacity. Bezel, mounting hardware.—Hoyt Electrical Instrument Works, Inc., Burton-Rogers, Co., Sales Div., 42 Carleton St., Cambridge 42, Mass.

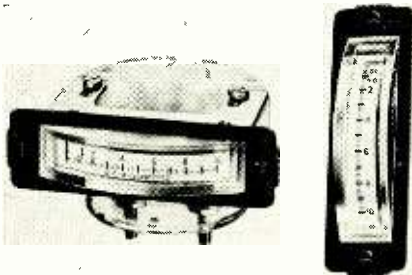

PANEL METERS. Tau-band suspension. Moving element suspended on two metal bands—

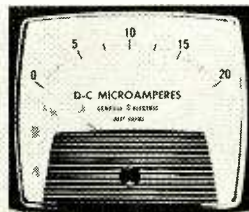

no springs, pivots, jewels. 100° scale, accuracy 2% of full scale. For power supplies, engine-generator sets, control panels, process-control equipment.—Gregory Ellis, General Electric, Schenectady, 5, N. Y.

OHM/CAPACITANCE METER, Model 601. Direct-resistance measurements to .001 ohm; direct-capacitance measurements to 0.3 farad. Line-powered, no batteries; power supply 100-130 volts, 60 cycles, approx. 1 watt. Ranges: 0-0.2, 0-20, 0-10,000 ohms; 100-3,000 μf , .01-0.3 farad. Range



selection by jacks and shorting bar. Power dissipation in measured circuit 10 mw max.—Conant Labs, Box 3997, Bethany Station, Lincoln, Neb.

TRANSISTORIZED AC/DC MULTIMETER. Cordless, portable, powered by flashlight cells. 4-inch meter. Dc voltage 0-1,000 in 4 ranges, 92,000 ohms-9.2 megs input resistance. Ac voltage 0-1,000 in 4 ranges, 650,000 ohms-1.85 megs input resistance, response ± 1.5 db, 10 cycles-500 kc.



Resistance: Calibration 2 ohms-10 megs in 4 ranges. Dc 0-50/0-500 μa , 0-5/0-50 ma; current range extendable with accessory shunts. Wired or kit.—DeVry Technical Institute, 4141 Belmont Ave., Chicago 41, Ill.

VTVM KIT, Model 1M-13, for bench, shelf, wall mounting. 6-in. 200- μa meter tilts to any



angle. Vernier action zero and ohms adjust controls. Dc input 11 megs. Single ac/ohms/dc test probe with switch. 1% voltage-divider resistors, db calibrations in 10-db steps, separate 1.5- and 5-volt ac scales. Ohmmeter measures 1 ohm-1,000 megs with internal battery. Ac input impedance 1 meg shunted by 40 μf . Balanced-bridge circuit using twin triodes. Frequency response ± 1 db 25 cycles to 1 mc from 600-ohm source. Accuracy: dc $\pm 3\%$; ac $\pm 5\%$.—Heath Co., Benton Harbor, Mich.

TUNING-FORK OSCILLATOR, model T/f-0. With plug to fit standard RETMA socket. B+, common, output connections. All-transistor, self-

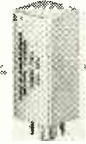

contained circuit internally regulated, temperature-compensated, hermetically sealed. Frequency range 400-8,600 cycles. Accuracy $\pm 0.005\%$ from $+23^{\circ}\text{C}$ to $+27^{\circ}\text{C}$. Stability $\pm 0.075\%$ -20°C to $+75^{\circ}\text{C}$. Voltage coefficient $\pm 0.005\%$ for 10% supply voltage variation. Supply voltage 12-, 18-, 24-, 28 vdc, $\pm 10\%$ at 5 ma or less. Output 5-12 volts peak-to-peak into 10,000-ohm load, depending on supply voltage.—Time & Frequency, 127 S. Batavia Ave., Batavia, Ill.

RANDOM-NOISE GENERATOR, model 420. Calibrated white noise source for general lab ap-



plications; normal amplitude distribution, constant amplitude per root cycle output frequency. For calibrating noise-measuring equipment and as random-noise source to extremely low frequencies for vibration and strain analysis. With scanning equipment, provides data on amplitude and frequency of amplifiers, filters, etc. Output voltage continuously variable .01-1,000 μv per root cycle. Output frequency "white" from dc to 100 kc. Logarithmic output meter with scale calibrated 0.1-1.0. Output dc offset less than 10 mv at maximum output. 600-ohm constant-impedance ladder type attenuator with switch for internal or external termination. 117/234 volts at approx. 10 watts.—Quantech Labs, Inc., Boonton, N. J.

TRANSISTORIZED POWER SUPPLY, model RPS-2. Constant voltage over wide load fluctuations. Adjustable output 0-25, up to 100 ma.



Separate on-off switch controls bias tap output, 0-12 1/2 volts. Operates on 105-130 vac, 60 cycles. With set of 24-in. test leads.—Seco Electronics, Inc., Dept. 164, 1201 S. Clover Dr., Minneapolis 20, Minn.

BENT-NOSE PLIER, No. D338-5-1/2C, reaches into small space, coil spring keeps jaws

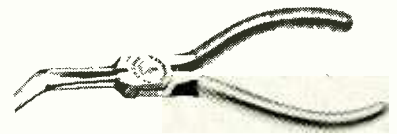

open. Handles coated with firm-grip plastisol. Overall length 5 in.—Mathias Klein & Sons, Inc., 7200 McCormick Rd., Skokie, Chicago 45, Ill.

STORAGE/PROCESSING RACK, TDS UNI-RAK, for circuitboards or similar items. Immersible, unaffected by acids, cleaning solutions, normal oven-drying temperatures. 1 x 6 x

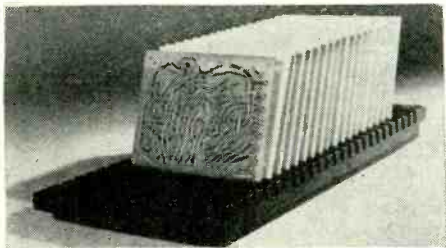

14 1/4 in., 25-3/16 x 5/16-in. slots. With rack only or 2 removable 12-inch stainless steel dipping handles.—Manutronics Co., Box 312, Wayne, N. J.

SUBMINIATURE THIN PLATE CAPACITORS, type TPNPO. Slim, rectangular, for high circuit component density. Gold-plated dumet weldable leads. Power factor max. at 1 kc. 0.1%. Temperature coefficient: with 0 voltage, -55°C to

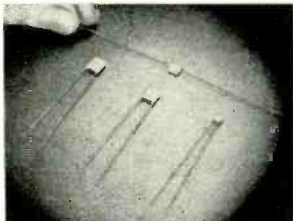

+125°C or, rated voltage applied, -55°C to +125°C, 0 ±30 ppm/°C. Capacitance tolerance to ±5%. Type TP25: intermediate stability range. Type TP89: general-purpose; for bypass, coupling, filtering, blocking circuits. Rated at 50 vdcw at 80°C. Derated 50% at 125°C.—Aerovox Corp. Distributor Div., New Bedford, Mass.

PHONE-ANSWERING DEVICE, model KH85, AnsaFone. Transistorized, portable. Rests under phone, automatically answers, records messages. Plugs into any ac outlet. Monitoring attachment for listening to callers without their

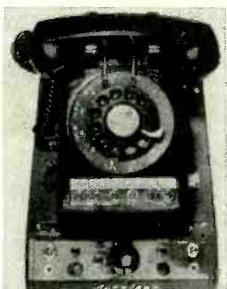

knowing it; others in room can hear conversations if desired. Snap-in amplifier board with printed circuit, 8 transistors. 2 sets double-track record heads, capstan drive. Tape cartridge records 40 messages, automatically shuts off. Monitor jack, extension speaker jack. Fused circuit operates on 117 vac only.—Mind-a-Fone Corp., 254 W. 31 St., New York 1, N. Y.

WHISPER AMPLIFIER. Portable. Amplifies impaired voices 100 times (20 db). 5 transistors. Push-pull; power supply two 7.4-volt batteries.



With speaker in 7 x 5 x 2-in. carrying case. 2 lb. 3-foot thin cable connects amplifier to hand-held or throat mike. 1/5-watt output.—Abilities, Inc., Albertain, N. Y.

WALKIE TALKIE KIT, model KG-4000. 1-watt rf input, crystal-controlled transceiver 5-mile range. Superhet receiver: automatic noise limiter, variable squelch. Plug-in crystal sockets, distance-local call switch, avc. Weather-protected

*a selection
of 7 quality
microphones
for natural,
life-like
tape
recordings*



SONOTONE CERAMIKES

Whether you're a professional or a home recordist, there's a Sonotone "Ceramide"® to bring out the best in your tape recording equipment. So sensitive they pick up all the beauty of the original performance — so selective they screen out unwelcome intrusions — so rugged they withstand almost any abuse, even accidental dropping, and continue to provide topflight performance. The heart of every Ceramide is a rugged rubber-encased ceramic transducer — immune to extremes of temperature and humidity.

7 sonotone ceramikes for tape recording

SONOTONE CERAMIKE "CMT-10A" MATCHED TWINS. Ideal for stereo applications. Each set is a selected matched pair exhibiting similar coloration, frequency response and output characteristics to within ± 2 db. Frequency response: 50 to 11,000 cps. Sensitivity: -56 db ± 2 db. 7' shielded cable and phone plug. List \$35.50 per pair.

SONOTONE CERAMIKE "CMT-11A" MATCHED TWINS. Where greater sensitivity is desired. Same specifications as CMT-10A except—Frequency response: 80 to 9000 cps. Sensitivity: -53 db ± 2 db. List \$35.50 per pair.

SONOTONE CERAMIKE "CM-10A." Natural clean reproduction over the full audible range—50 to 11,000 cps. Sensitivity: -56db ± 2db. 7' shielded cable with phone plug. List \$17.50.

SONOTONE CERAMIKE "CM-11A." Where greater sensitivity is desired. Same specifications as CM-10A except—Frequency response: 80 to 9000 cps. Sensitivity: 53db ± 2db. List \$17.50.

MATCHING TABLE STANDS. Available with 5/8" No. 27 thread for floor stand mounting. List \$5.00.

SONOTONE CERAMIKE "CM-32." Ideal low cost microphone for tape recording. Frequency response: 80 to 9500 cps. Sensitivity: -53db ± 2db. Standard plug and phone jack. List \$12.50.

SONOTONE CERAMIKES "CM-40" & "CM-41." Low price ceramic mikes in high impact plastic case. Unique swing type stand sits upright for table use. Response: 40 to 8000 cps. Sensitivity -50db for both models. Model CM-41 has push-to-talk switch. CM-40 List \$9.90; CM-41 List \$11.90.

Next time you're ready for a tape recording session, think of Sonotone Ceramikes and select the one that will bring greater pleasure to you.

SONOTONE® CORPORATION

ELECTRONIC APPLICATIONS DIVISION • ELMSFORD, N. Y.

In Canada: Atlas Radio Corp., Ltd., Toronto • Cartridges • Speakers • Tape Heads • Microphones • Electron Tubes • Batteries • Hearing Aids • Headphones

ARE YOU GETTING THE MOST VALUE FROM YOUR MEASUREMENT DOLLAR? ... Compare all

features and you'll agree, BEST BUY IS EMC!



EMC'S NEW MODEL 212 TRANSISTOR ANALYZER... Checks DC current gain in 3 ranges to 200. Tests for leakage. Checks all transistors as

oscillators both in and out of circuit. Can be used to signal trace AF, IF or RF circuits. Checks condition of diodes. Tests battery voltage on 0-12 scale. Checks DC current drain on 0-80 ma scale. Supplied with complete instruction manual, transistor listing and pair of test leads.

Model 212 \$18.50 Wired
Model 212 Kit \$13.50



EMC'S NEW MODEL 213 TUBE TESTER... Completely modern! Completely flexible! Completely new! Checks all the new 12 prong (Compactron),

Nuvistor, Novar, and 10 prong tubes, in addition to octal, toctal, miniature, and 9 prong tubes. Tests each tube for shorts, leakages, intermittents, opens, as well as for quality. Each section of multi-purpose tube is checked separately. Magic eye, Voltage Regulator and HI-FI tubes are also tested. Unique switching arrangement makes the checker obsolescent proof. Supplementary tube listings supplied periodically at no cost to keep instrument up to date. It comes complete with instructions and tube charts in ring bound manual.

Model 213 (in bakelite case with strap) \$28.50 Wired
Model 213 Kit \$18.90
Model 213P (in wood carrying case) \$32.25 Wired
Model 213P Kit \$21.90

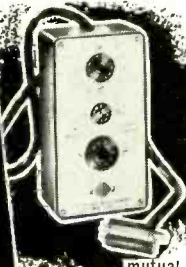

EMC'S NEW MODEL SA SOCKET ADAPTOR... Enables user to check 12 pin Compactron, Nuvistor, Novar and 10 pin tubes with any type tube tester including mutual conductance type.

Model SA \$9.45 Wired
Model SA Kit \$4.95

Yes, tell me more, send me **FREE** a detailed catalog of the Complete EMC Line. Dept RE-563

NAME
STREET
CITY STATE

EMC Electronic Measurements Corp.
625 B'way, New York 12, N. Y.
Ex. Dept., Pan-Mar Corp., 1270 B'way, New York 1, N. Y.

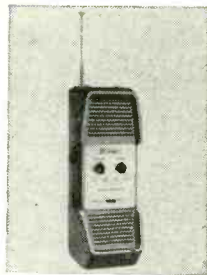

built-in mike and speaker. Relative rf output indicator, 52-inch telescoping whip antenna, external antenna jack, jack for earphone or external speaker. 9 transistors, 3 diodes, powered by 8 size-C flashlight cells or rechargeable nickel cadmium cell. 50 hours operation. Provision for operation from external 12-volt dc source. Receiver: Sensitivity 1 μ v for 10-db signal-to-noise ratio; selectivity 6 db at 6 1/2 kc; image rejection 12 db; adjacent channel, 30 db down; audio output 750 mw class-B push-pull. Transmitter: dc input 1 watt, rf output 0.5 watt.—**Allied Radio Corp.**, 100 N. Western Ave., Chicago 80, Ill.

30-WATT PA AMP, model KN-3230M. Mobile, operates from 12-volt dc source. 4.5 amps at full rated power. Frequency response \pm 3 db, 100-10,000 cycles. Hum and noise 67 db down.



Inputs: 1 mike, 1 phono. Controls: mike volume, phono volume, master tone, on-off, trumpet protector switch. Impedances 4, 8, 16 ohms.—**Allied Radio Corp.**, 100 N. Western Ave., Chicago 80, Ill.

DOUBLE-CONVERSION MONITOR RECEIVERS. Crystal-controlled, fixed-frequency su-

perhet FM communications units: narrow-band (\pm 5-kc deviation) and wide-band (\pm 15-kc deviation); single- and multi-channel. Front-panel selection up to 6 channels. For public monitoring, or as satellite receivers in mobile radio systems.



For 144-174 mc, model **MR50-X**, narrow band; **MR51-X** wide band. For 25-54 mc, **MR60-X**, narrow band; **MR61-X** wide band. 115 vac.—**Hammarlund Mfg. Co., Inc.**, 53 W. 23 St., New York 10, N. Y.

3-WAY HI-FI SPEAKER SYSTEM, KN-2250. 6 7/8 in. deep assembled. 12-inch woofer, 6-in. closed-back mid-range unit, dome-lens compression tweeter. High-compliance thick foam-type cone, 1-lb ceramic magnet. Frequency response 35-19,000 cycles; power capacity 45 watts. Capacitor-type crossover. 5,000 cycles. Impedance, 8 ohms; high-frequency level control. Kit, factory-assem-

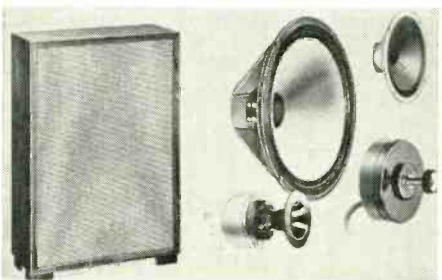

GREGORY ELECTRONICS

SPRING SPECIALS



MOTOROLA

30-50mc

T-41GGV or T-41GIA

6/12v 25-30 watts Tx narrow banded. Complete with all accessories, less crystal and antenna. **\$198**

Same unit tuned to your frequency including brand new antenna, ready for installation. **\$238**

(This unit may also be bought without accessories for \$168)

LINK 2365 FM 25-50mc WIDE BAND TRANSCEIVER

12 volts \$49 6 volts \$39
30 watts 30 watts

Complete with all accessories, less crystals and antenna.

Add \$15 for crystals and tuning of receiver only. Makes an ideal mobile monitor receiver.

Tremendous Selections and Savings!

GUARANTEED RECONDITIONED FM 2-WAY MOBILE RADIOS

G-E, RCA, Motorola and Others! Low, High and UHF Bands. Write for 1963 Catalog.

WE BUY FOR CASH!

Late model 2-way radio equipment. State price, condition and quality.



GREGORY ELECTRONICS CORPORATION

112 Route 46 Saddle Brook, N. J.

Phone PR 3-7550

PHOTOGRAPHS

RADIO-ELECTRONICS can use good photographs of service benches, service shops, high-fidelity audio layouts, and any other interesting and original radio-electronic devices. We will pay \$10 each for good professional photos or equivalent, suitable for reproduction.

Full information on subject photographed will increase their acceptability.

The Editor

RADIO-ELECTRONICS

154 West 14th St.
New York 11, N. Y.

bled or with speaker components only, less enclosure. Kit supplied with 4 enclosure sides assembled and prefinished, speaker mounted on baffle. Cable supplied as harness, wires color-coded.—**Allied Radio Corp.**, 100 N. Western Ave., Chicago 80, Ill.

SLIM-LINE SPEAKER SYSTEM, model *CH-2 Challenger*. 18 x 12 x 3½ in., for wall mounting. Two 6 x 9-in. speakers. 4-in. closed-back

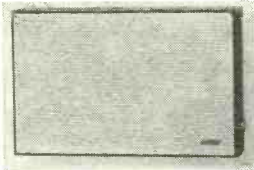

tweeter with electrical crossover. Peak power 15 watts. Hi-fi, stereo, FM multiplex. Extension speaker system for record players, radio or TV. Volume control for remote regulation.—**Mercury Electronics Corp.**, 111 Roosevelt Ave., Mineola, N. Y.

SHALLOW SPEAKERS. 8-inch round, total depth 2-3/16-in. PA model *PA8TD*: 8-ohm voice

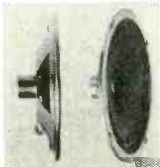

coil. Micro-Gap replacement model *SP8TD*: 3.2-ohm voice coil. 6 x 9-in. model *SP69TD*: total depth 2¼ in. All models ¾-in. voice coils, 2.15-ounce Alnico V magnets.—**Utah Electronics Corp.**, 1124 E. Franklin St., Huntington, Ind.

PAGING SPEAKER, model *EC-10*: Weatherproof, 6-watt speaker, horn assembly of acrylic plastic, adjustable steel mounting bracket. 8 or 45 ohms. Length 6¾ in., bell diam. 6¼ in. 2 lbs.



Model *T-4*: weatherproof line-matching transformer for multiple-speaker installations.—**Atlas Sound**, Div. American Trading & Production Corp., 1419-51 39th St., Brooklyn 18, N. Y.

TRANSISTORIZED BULL HORN, model *PA-271*. Voice amplifier, sound detector and amplifier. 6 standard C-flashlight batteries (not in-



cluded). Talk power range to 2,000 feet. Grip type handle, trigger switch for one-hand operation.—**Lafayette Radio Electronics Corp.**, 111 Jericho Turnpike, Syosset, N. Y.

DYNAMIC SPEAKER HEADSETS. Stereo master control panel. Mono/stereo switch, two-channel control. Volume adjustable for each ear.

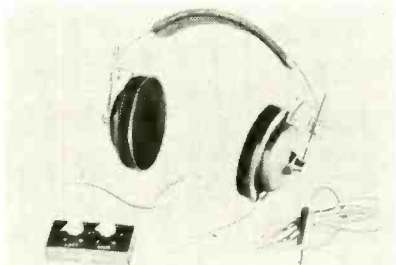

Earpiece headbands padded with sponge rubber. Headsets monitor recordings by plugging into stereo output panel jack.—**Roberts Electronics, Inc.**, 5920 Bowcroft St., Los Angeles, Calif.

HEADSET AND MIKE, model *SHM-1000 Sono/Com*, for classrooms. Universal boom mike



*ask the
music lover
who owns one*

VELOCITONE CARTRIDGES

While the famed Velocitone series has received acclaim from leading high fidelity critics and editors, we're sure the comments by owners of Sonotone Velocitone cartridges are of greater significance to you. To wit:

"... without doubt the best cartridge buy for the money—excellent. Am well pleased."

"Bass response better than (present cartridge). Has crisp, clear sound. I like it."

"Sonotone cartridge produces very noticeable improvement . . . certainly worth the price."

"Bravo!"

"Sounds smoother than my old cartridge, which had irritating peaks . . . main advantage seems to be its ability to track at 2 grams and still be an inexpensive cartridge."

"Am very pleased with the reproduction . . ."

"Separation is unbelievable . . ."

"I am very pleased with this cartridge—it has very clear response."

"I am well satisfied with it . . . your separate equalizers are a very good idea."

"As soon as I plugged in my Velocitone, I noticed an instantaneous and vast superiority to (present cartridge)."

The Mark III is the newest in the Velocitone series. It represents the latest advance in cartridge design. Try it yourself and become a satisfied music lover—Velocitone Mark III, dual diamond styli, \$22.25; diamond sapphire, \$19.25; dual sapphire, \$14.75.

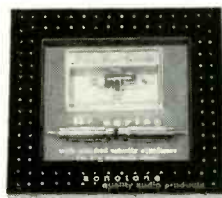

SONOTONE® CORPORATION

ELECTRONIC APPLICATIONS DIVISION • ELMSFORD, N. Y.

In Canada: Atlas Radio Corp., Ltd., Toronto • Cartridges • Speakers • Tape Heads • Microphones • Electron Tubes • Batteries • Hearing Aids • Headphones

Television RADIO-ELECTRONICS Electricity ELECTRONICS IN NEW SHOP-LABS OF **COYNE**

TRAIN QUICKLY! OLDEST, BEST EQUIPPED SCHOOL of ITS KIND in U.S.

Get practical training in New Shop-Labs of Coyne. Prepare for a better job and a successful future in a top opportunity field. Advanced education or previous experience not needed. Employment service to graduates.

Enroll NOW—Pay Later

Finance Plan and Easy Payment Plan. Also Part Time Employment help for students.

FREE BOOK Clip coupon or write for Free Illustrated Book "Your Opportunities in Electronics"—Describes all training offered. No obligation and No Salesman Will Call. Act NOW

B. W. Cooke, President

**CHARTERED
NOT FOR PROFIT
Established 1899**
1501 W. Congress Pkwy.
Chicago, Dept. 53-N

COYNE
ELECTRICAL SCHOOL

COYNE Electrical School
1501 W. Congress Pkwy., Chicago 7, Ill.
Dept. 53-N

Send FREE book "Your Opportunities in Electronics" and details of all training you offer

NAME.....

ADDRESS.....

CITY.....STATE.....

NATIONALLY ADV. BRAND

20 WATT STEREO AMPLIFIER



SALE
\$19⁹⁵

Surplus Run at Fractional Price. 20 watt max.—5U4—12AX7—2 6BQ5, 20 to 20 M. Response. Stereo & Tone & Volume Control Included. ORDER AT ONCE—WHILE THEY LAST FREE CATALOG

GM PHOTOELECTRONICS

623 So. Gay Street Knoxville 2, Tenn.



INJECTORALL

THE NEEDLE DOES THE JOB!



**TUNER CLEANER
AND LUBRICANT**
with...
INJECTOR NEEDLE

The leak-proof steel Injectorall Needle lubricates where you need it... you can reach hard-to-get at Wafers without pulling Tuners apart, or even removing Chassis.

The **BEST CLEANER** on the market today!

INJECTORALL CO. Brooklyn 14, New York

FAST SHIPMENTS

RECORDERS • TAPES

COMPONENTS • KITS

• BEST-BY-COMPARISON PRICES
VISIT OUR STORE • SEND FOR "QUOTES" ON PACKAGE DEALS AND SAVE MORE

WRITE FOR MONTHLY SPECIALS



CARSTON Studios

125-R East 88 St., New York 28, N. Y.



fits other headsets. Ceramic mike element neoprene-encased. Headset transducer assembly has piezoelectric element. Moisture-resistant, shock-mounted. Headset and mike available separately.—Sonotone Corp., Dept. SAH-62, Electronic Applications Div., Elmsford, N. Y.

MIKE/HEADSET COMBO, for language labs. Earphone frequency response 30-20,000



cycles. Dynamic microphone. Stainless steel and high-impact plastic. Removable, washable foam rubber or vinyl polyurethane foam cushions. 180° cup rotation. 15 oz. with cord; may be worn over glasses.—Telex Communications Accessories Div., 3054 Excelsior Blvd., Minneapolis 16, Minn.

BATTERY-POWERED TAPE RECORDER, Sony model 801A. Transistorized, portable. Push-button operation; built-in mike and speaker. VU meter; variable back-spacing lever. Power require-



ments: ac, 2 watts, 110 or 220 volts, 50/60 cycles; dc, 1.5 watts, 9 volts (6 size-D flashlight batteries). Dual-track up to 5-inch reels, plays 3 3/4 and 1 7/8 ips. Frequency response at 3 3/4 ips 90-9,500 cycles. 3 x 5-in. permanent dynamic speaker; impedance 8 ohms. Earphone input jack, built-in mike, impedance 15 ohms. Auxiliary input jack for radio, pickup, etc., -10 db at 100,000 ohms; external microphone jack, -55 db at 10,000 ohms.—Superscope, Inc., 8150 Vineland Ave., Sun Valley, Calif.

STEREOPHONIC CONTROL CENTER, model CB-1. Left and right volume controls, speaker on-off switch, 2 phone jacks. Blend con-



trol mixes 2 input signals from full separation to mono output. Doubles as low-impedance audio mixer.—Sharpe Instruments, Inc., 965 Maryvale Dr., Buffalo 25, N. Y.

FM STEREO SIGNAL LIGHT, model 55, flashes when stereo broadcast. Updates manufac-

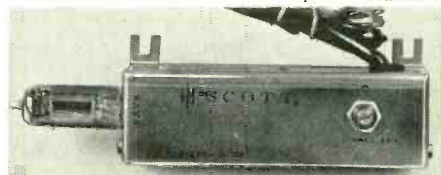

GUARANTEED!



FEATURES AND SPECIFICATIONS

24" wide, 10" high, 9" deep, 8" high compliance woofer; 3" hardened tweeter cone; coaxial wound 1 1/2" voice coil; silicone treated edge allows for 3/8" cone displacement; Alcomax III 1-lb. 5-oz. magnet; 10,000 gauss flux density; 8 ohm impedance; zero external magnetic field; 40-18,000 cps; up to 30 watts power capacity; 1450 cubic inch volume; Fibreglass acoustic dampening; matched for stereo. Solid wood—not a composite.

ORDER NOW to insure prompt delivery! This remarkable speaker is probably the best investment you'll ever make in hi-fi equipment! Price \$19.95 F.O.B. factory. Shipping weight 18 pounds.

- Outperforms speakers costing five times more
- Three year warranty against manufacturing defects
- Complete satisfaction or your money back

the **KENT** **\$19⁹⁵**
all new...all wood
only

Anglo American Acoustics Ltd. RE 5-63
129 Maryland Ave., Freeport, New York
Gentlemen: Enclosed is my check for \$.....
Please ship me..... "Kent" natural wood cabinet speaker(s) at \$19.95 each.

I UNDERSTAND THAT THESE SPEAKER SYSTEMS ARE GUARANTEED AND IF I AM NOT COMPLETELY SATISFIED I MAY RETURN FOR A FULL REFUND WITHIN TEN DAYS AFTER RECEIPT.

NAME.....
ADDRESS.....
CITY.....ZONE.....STATE.....



Quality...
IN EVERY DETAIL

It's not just a lot of sales ballyhoo—you can actually see the quality in every Clarostat potentiometer. Take a good close look at the finish, the construction, and then compare. Clarostat builds potentiometers for the most critical military and industrial applications, and the same careful attention to details—inside and outside—is found in every product of the company whether it is for the most expensive computer, or for replacement of a television control.

Do right by yourself and your customer.
Insist on the best—Clarostat.

DISTRIBUTOR SALES DIVISION



 **CLAROSTAT**

CLAROSTAT MFG. CO., INC. DOVER, NEW HAMPSHIRE



CREI can open new career opportunities for you in ATOMIC ENERGY

Exciting applications of isotopes and atomic power are creating unlimited opportunities for qualified technical personnel—particularly in such areas as nuclear instrumentation, reactor technology and health physics. CREI's free 58-page book describes these career opportunities and tells you how you can prepare to take advantage of them through a unique home study program developed by CREI.

YOU CAN QUALIFY if you have a technical background and are a high school graduate. For details, mail coupon or write: CREI, Dept. X1805-A, 3224 Sixteenth St., N.W., Washington 10, D. C.

FREE BOOK

CREI ATOMICS

A Div. of The Capitol Radio Engineering Institute
Dept. X1805-A, 3224 Sixteenth St., N.W.
Washington 10, D. C.

Please send me details of CREI Home Study Programs and Free Book, "Your Future in Electronics and Nuclear Engineering Technology." I have a technical background and a high school education.

Name _____ Age _____

Address _____

City _____ Zone _____ State _____

42

tuner's model LT-110 FM stereo tuner kit, 350 FM stereo tuners, LM-35 and 335 multiplex adapters. Mounts on top of chassis, does not hinder installation of unit in cases.—**H. H. Scott, Inc.**, 111 Powdermill Rd., Dept. P, Maynard, Mass.

STEREO FM TUNER, model 315A *Empress Royale* for FM and stereo multiplex. Automatic multiplex switching circuitry, stereo indicator light,

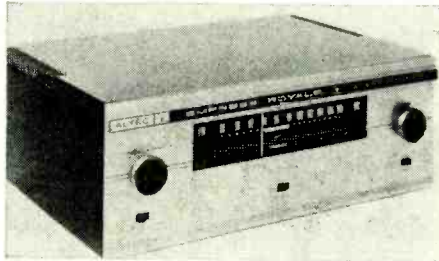

afc, special multiplex noise filter. Frequency response 20-20,000 cycles.—**Altec Lansing Corp.**, 1515 S. Manchester Ave., Anaheim, Calif.

FM ANTENNA SYSTEM, model *FMS-101*. Portable, nondirectional. 110 vac. 60 cycles, 1 watt. Preamp gain at 98 mc. 16.5 db. Antenna system passband: 86-110 mc, preset at factory. Overall antenna system gain, compared to reference dipole

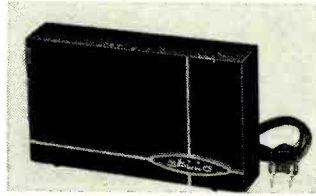

cut to 98 mc, nominal 21 db. Output: coax cable, 60 in., spade-lug terminated. Nominal impedance 75 ohms.—**Gallo Electronics Corp.**, 12 Potter Ave., New Rochelle, N. Y.

TRANSISTOR ANTENNA AMPLIFIER, *Red Head*, model *RD-300*. Eliminates transistor popout due to lightning flashes, precipitation static, power-line surges. Highpass interference filter,



INSIST ON

"NO NOISE"

- **VOLUME CONTROL** and Contact Restorer
- **TUNER-TONIC** for ALL tuners including wafer type
- **FORMULA EC-44** for ALL electrical contacts

FREE with ALL No-Noise Products
5" Plastic Extender Push-button Assembly for pin-point applications. Does not cause shorts!

14 Years of Recognized Leadership

ELECTRONIC CHEMICAL CORP.
813 Communipaw Ave., Jersey City 4, N. J.

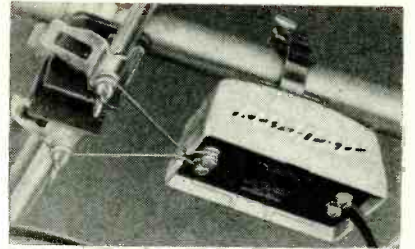

built-in 2-set coupler. Ac-operated. For areas where all signals less than 20,000 μ v.—**Winegard Co.**, Burlington, Iowa.

MOTORCYCLE ANTENNA, model *LW-40 Mark Heliwhip*. Fiberglass linear 2-way communications antenna, vibration-resistant. 50 inches long for 40- and 152-mc bands. Adaptable for various motorcycle installations.—**Mark Products Div.**, Dynascan Corp., 5439 W. Fargo Ave., Skokie, Ill.

SCREEN REFLECTOR YAGI ANTENNAS. 31 units cover 100-470 mc. Heavy-duty welded construction, gain up to 15.2 db over isotropic source. Horizontal or vertical polarization, tower mounting. Direct coaxial input eliminates need for

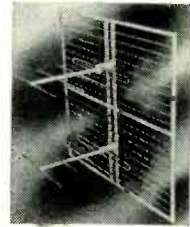

external baluns. Gas-expanded foam plastic within antenna lead system prevents moisture accumulation. *Series SY-41*, single 4-element Yagi on screen reflector. Elements 1/2-in. diam 6061T6 aluminum alloy, 5/8-in. diam. reinforcing sleeves. Reflector 1/4-in. aluminum frame, 3/8-in. diam. reflecting rods.—**TACO**, Technical Appliance Corp., Sherburne, N. Y.

CLASSROOM TV CAMERA, *Observer-2*. Vidicon pickup tube, 8-inch viewfinder screen. Automatic light compensator, range 2,000-1. Oper-

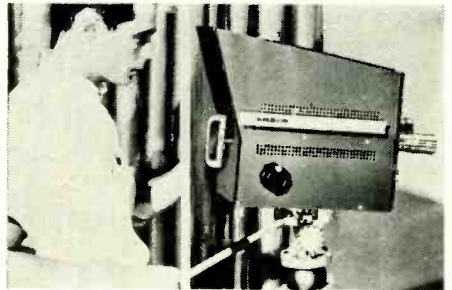

ating controls: focus and built-in 4-position turret. *Model EVL-1*: video output; *EVL-(2-6)*: rf output; *EVL-SNR*, studio net model.—**Blonder-Tongue Labs, Inc.**, 9 Alling St., Newark 2, N. J.

53-AMP ALTERNATOR, *6200 Series*. Delivers 15 amps at engine idle. For 12-volt auto battery-charging systems, positive or negative ground, heavy-duty installations. Positive and negative output terminals, sealed anti-friction bearings, replaceable built-in silicon rectifier diodes,

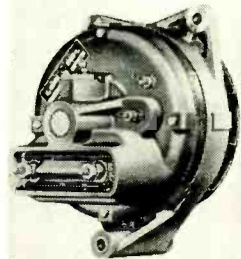

fully shielded slipring assembly, splash-proof construction, protected windings, fully reversible operation. Self-load-limiting. Positive- and negative-polarity regulators available for use with battery charge light or ammeter.—**Leece-Neville Co.**, 1374 E. 51 St., Cleveland 3, Ohio. END

All specifications from manufacturers data

RADIO-ELECTRONICS

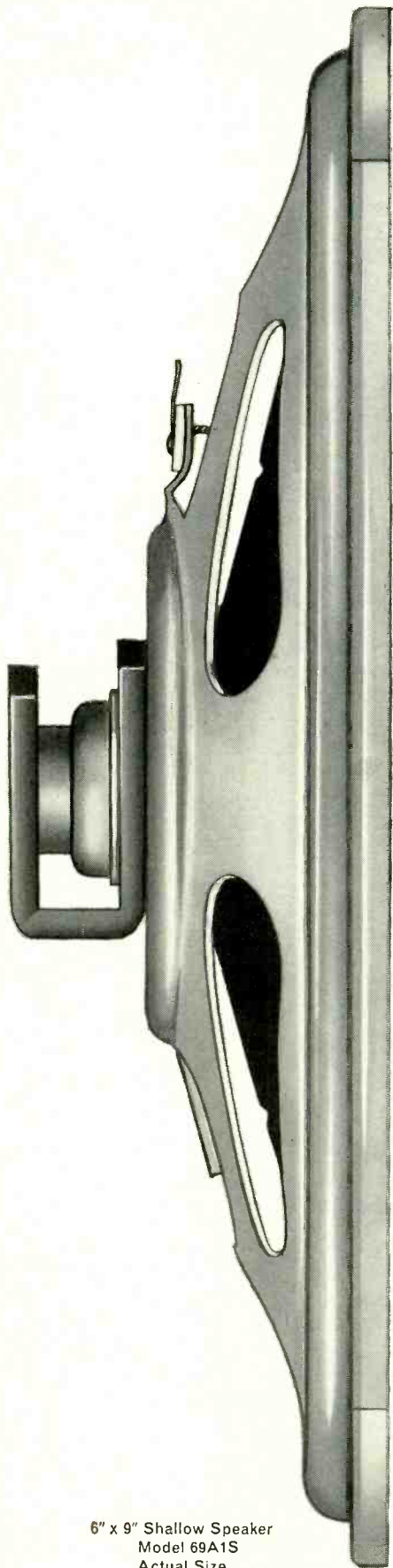

6" x 9" Shallow Speaker
Model 69A1S
Actual Size

For those special applications choose a Quam speaker

When you need a 2 $\frac{1}{4}$ " unit for a transistor radio—or a shallow 6" x 9" for a Thunderbird replacement—Quam has it!

When you need a special voice coil impedance or special field resistance—Quam has it!

Quam gives you the widest selection and the highest quality in the entire speaker industry! Ask for Quam, the Quality line, for all your speaker needs.

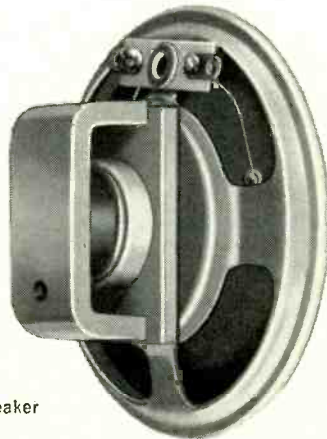

2 $\frac{1}{4}$ " Transistor Radio Speaker
Model 22A06Z8
Actual Size

QUAM

QUAM-NICHOLS COMPANY
238E East Marquette Road
Chicago 37, Illinois

NEW SAMS BOOKS

JUST OUT! Enlarged 6th Edition of the famous Howard W. Sams

Tube Substitution Handbook

Still Biggest and Best—Over 1000 New Substitutions
—New Section on Communications Tubes!

Still Only \$1.50!

Completely updated—now lists over 8,800 direct substitutions—over 1000 more than in Vol. 5! Expanded Receiving Tube Directory now includes over 2,100 types, listing 5,152 substitutions. Picture Tube Section lists 537 types, with 1,835 recommended substitutions. Other Sections list over 370 subminiature types with recommended substitutions, industrial and foreign substitutes for American receiving tubes, and American receiving tube substitutes for foreign types. A "must" for tube caddy and bench. 128 pages; 5½ x 8½". **\$1.50**
Order **TUB-6**, still only.....

Amateur Radio Station Manual

Nothing else like it—a complete log book designed the way radio amateurs want it! Consists of 10 Sections, separated by heavy-stock index dividers, providing log sheets for entering complete information on all transmissions, frequently worked stations, operating records for WAS, WAC, WAZ, DX, special schedules, network data, and equipment. Includes complete prefix listings for countries all over the world. Generous log space permits entries for over 1,000 transmissions. 128 pages; 8½ x 11"; comb binding. Order **ASM-1**, only..... **\$3.95**

Practical TV Tuner Repairs

by Robert G. Middleton. Here, at last, is a "shirt-sleeves" book to help you solve those front end servicing troubles. Explains how you can quickly determine if a tuner is at fault; gives step-by-step procedures for isolating troubles to specific circuits and components. Illustrations and check charts guide you through preliminary analysis, test and measurement techniques, and practical repair and alignment procedures. Shows you how to evaluate test data, make complete tuner replacements, etc. 128 pages; 5½ x 8½". Order **TUN-1**, only..... **\$2.50**

Understanding Electronic Components

by Earl J. Waters. A basic understanding of components is the key to understanding electronics. This book thoroughly explains the physical structure and electronic principles, operation, and application of all major components. Chapters cover: Introduction to Electronic Theory; Resistors; Capacitors; Inductors; Transformers; Electron Tubes; Semiconductors; Transducers; Switches & Relays; Antennas; Conductors; Miscellaneous Components. 160 pages; 5½ x 8½". Order **UEC-1**, only..... **\$2.95**

Computer Circuit Projects You Can Build

by Lee Boschen. Beginning with a simple flip-flop circuit, this book details the construction of 13 basic computer-circuit projects. The theory and applications of each circuit are fully explained. The end result is a working knowledge of fundamental computer circuitry found in modern digital or analog types, as well as the construction of useful devices. Each chapter explains the use of the circuit in a computer, its operation, and how to construct it. 128 pages; 5½ x 8½". Order **BOC-1**, only..... **\$2.95**

ABC's of Electricity

Another of the famous SAMS basic books for beginners. Explains in simple terms the nature of electricity, its characteristics, effects and "how it works." Describes simple battery circuits, explains Ohm's Law, electro-magnetism, development of alternating current, conductors and insulators, electrical components, etc. Complete; easily understandable. 96 pages; 5½ x 8½". Order **LEK-1**, only..... **\$1.95**

Electronics Data Handbook

A valuable selection of articles from *Aerovox Research Worker*, offering technical information of vital interest to technicians, engineers, experimenters, and students. Subject areas include: Receiver circuits, components, tests and measurements, circuits for specialized design applications. Special section on filter design includes a 9-part series covering constant-K and M-derived circuits. 128 pages; 8½ x 11". Order **ERA-3**, only..... **\$2.95**

HOWARD W. SAMS & CO., INC.

Order from your Sams Distributor today, or mail to Howard W. Sams & Co., Inc., Dept. E-23
4300 W. 62nd Street, Indianapolis 6, Ind.

Send me the following books:

TUB-6 TUN-1 BOC-1 ERA-3
 ASM-1 UEC-1 LEK-1

\$_____ enclosed. Send FREE Booklist

Name _____

Address _____

City _____ Zone _____ State _____

IN CANADA: A. C. Simmonds & Sons, Ltd., Toronto 7

NEW SEMI-CONDUCTORS & TUBES

2N2723, -24, -25

These are each made of two n-p-n silicon transistors compound-connected and packaged in a four-lead TO-18 case. They are designed for amplifier circuits requiring very high gain, high input impedance and low noise. The transistors operate at junction temperatures up to 200°C.

Essential characteristics:

	2N2723, -24	2N2725
V _{CBO}	80	45 volts
V _{CEO}	60	45 volts
V _{EBO}	12	10 volts
I _c	40	30 ma

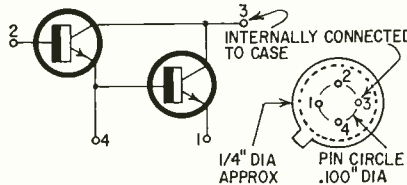

2N2723, 24, 25

Dc current gain:

I_c = 10 ma, V_{CE} = 5 v:
2N2723, 2,000 min, 10,000 max
2N2724, 7,000 min, 50,000 max
I_c = 100 μa, V_{CE} = 5 v:
2N2725, 2,000 min, 10,000 max.

Output capacitance of all three types is 10 pf maximum. All have low leakage current. They are made by Sperry Semiconductor.

15KY8

This tube contains a high-μ triode and a beam power tube in one envelope with a novar base. It is intended for vertical oscillator and amplifier serv-

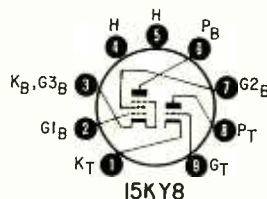

ice in black-and-white sets with relatively low B-plus voltages. The heater has a controlled warmup time.

Maximum ratings:

	Triode	Beam	
E _b	330	300	volts
I _p	22	—	ma
I _k	—	60	ma
Plate dissipation	1.5	12	watts

The triode's amplification factor is 64; its transconductance, 1,600 μmhos. The

beam section's transconductance is 8,400 μmhos. RCA makes it.

22JG6

The 22JG6 is a high-perveance beam-power tube made for horizontal amplifier service in low-B-plus black-and-white sets. It has a novar base,

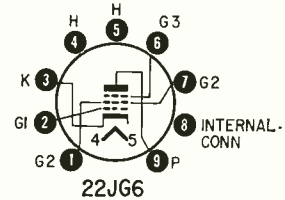

dark heater and controlled warmup time. Its major feature, according to RCA, its maker, is a plate structure that minimizes secondary emission, giving a sharp "knee" to the characteristic curve and reducing "snivets". The tube's transconductance is 10,000 μmhos.

Maximum ratings:

E _b	770 volts
Peak pos. pulse on plate	6,500 volts
E _{g2}	220 volts
E _{g3}	75 volts (pos)
E _{g1}	—55 volts
Plate dissipation	17 watts

Grid 3 has a separate pin connection, so that a positive bias can be applied for further "snivet" reduction.

½-watt microdiodes

The photograph shows six of a new line of microdiodes threading a needle (the giant bulb is for drama). They're rated at 500 mw dissipation, but dissipations up to 800 mw have been measured. Soft, pure-silver ribbons are used

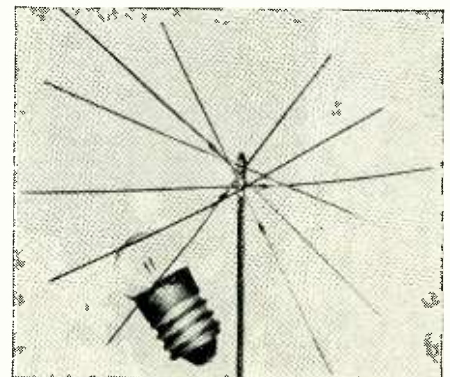

as leads to help raise the dissipation and to reduce the possibility of damaging the diodes by stresses in the leads. The leads can be bent right next to the body without popping the junction.

Made by Delta Semiconductors, Inc., the new diodes come in switching, power rectifier and zener types at up to 600 piv. Diode bridge assemblies are also available in the microdiode line.

2N663

This is a germanium p-n-p power transistor for general switching and au-

See Only the Scale You Want...in the Exact Range You Want

just set the range switch
and the correct scale appears
AUTOMATICALLY

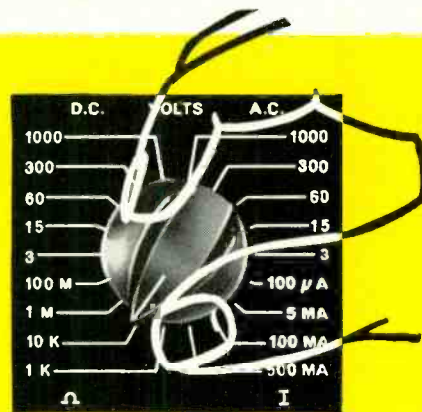

in the new **B&K**
VOM and VTVM

V O M A T I C 360

AUTOMATIC VOLT-OHM MILLIAMMETER



Greatly simplifies your VOM use. Individual full-size scale for each range—and only one scale visible at any one time, automatically. Once you set the range switch, it is impossible to read the wrong scale. Reading in the range you want is amazingly easy—and direct. No reading difficulties, no multiplying, no errors.

Sensitivity 20,000 ohms per volt DC; 5000 ohms per volt AC. **Accuracy** $\pm 3\%$ DC; $\pm 5\%$ AC; (full scale). **DC Volts** in 6 ranges 0-6000. **AC Volts** in 6 ranges 0-6000. **AF (Output)** in 4 ranges 0-300 volts. **DC Current** in 5 ranges 0-10 amps. **Resistance** in 4 ranges 0-100 megohms. Supplemental ranges also provided on external overlay meter scales. Meter protected against extreme overload and burn-out. Polarity reversing switch. Automatic ohms-adjust control. Mirrored scale. Complete with 1½-volt and 9-volt batteries, test leads, and easy-viewing stand. **Net, \$5995**



DYNAMATIC 375

AUTOMATIC VACUUM-TUBE VOLTMETER

Once you set the range switch, you automatically see only the scale you want and read the exact answer directly. Saves time, eliminates calculation, avoids errors. Individual full-size direct-reading scale for each range. Simplifies true reading of peak-to-peak voltages of complex wave forms in video, sync and deflection circuits, pulse circuits, radar systems, etc. Includes DC current ranges, too.

Accuracy $\pm 3\%$ full scale AC and DC. **Sensitive** 100 microampere meter movement. **DC Volts** in 7 ranges 0-1500. **AC Volts (rms)** in 7 ranges 0-1500. **AC Volts (peak-to-peak)** in 7 ranges 0-1500. **DC Current** in 3 ranges 0-500 ma. **Ohms** in 7 ranges 0-1000 megohms. Utilizes single DA-AC ohms probe and anti-parallax mirror. Swivel stand converts to carry-handle. Includes 1½ volt battery. Operates on 117 volts 50-60 cycle AC. **Net, \$8995**

Ask Your B&K Distributor
for Demonstration, or
Write for Catalog AP20-E



B & K MANUFACTURING CO.
DIVISION OF DYNASCAN CORP.
1801 W. BELLE PLAINE AVE • CHICAGO 13, ILL.
Canada: Atlas Radio Corp., 50 Wingold, Toronto 19, Ont.
Export: Empire Exporters, 253 Broadway, New York 7, U.S.A.

NEWEST RCA SENIOR VOLTOHMYST®

NOW AVAILABLE AS A KIT FOR ONLY \$57.95*

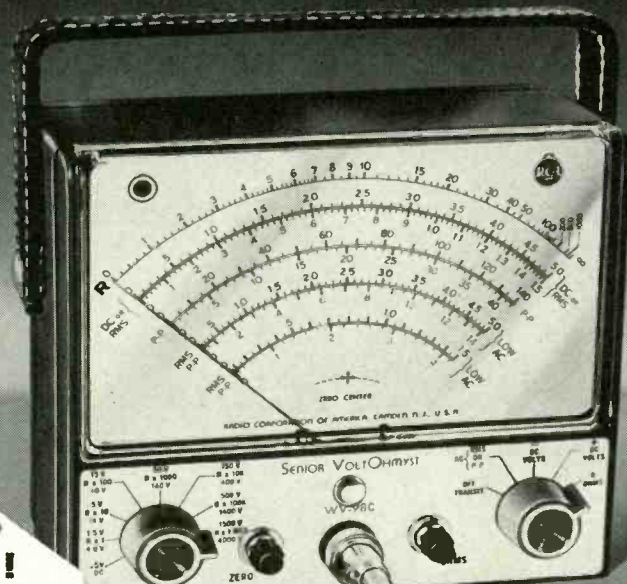

NEW!

0.5-volt full-scale DC range for more accurate measurements of low voltages used in transistor circuits.

EXTRA!

Pre-assembled, factory tested probe (WG-299D) is included with every kit.

SAVE MONEY with this kit version of the RCA WV-98C, the newest improved model of the popular RCA SENIOR VOLTOHMYST. Even with its added features for extra versatility, this new kit still costs less than prior models.

This rugged precision instrument measures **AC voltages** (0.2 to 4200 volts peak-to-peak and 0.1 to 1500 volts rms); **DC voltages** (0.005 to 1500

volts DC); and **resistances** (0.2 ohms to 1000 megohms). Accurate to $\pm 3\%$ full-scale on both AC and DC ($\pm 5\%$ on the 1.5 and 5-volt AC ranges). Less than 1% tracking error.

Scales are separately color-coded to differentiate peak-to-peak and rms voltage readings. Its big meter, 6½ inches wide—electronically protected against burnout—is one of the most readable ever designed into a VTVM.

RCA WV-98C

\$57.95*
KIT

\$79.50*
WIRED

For more information, ask your Authorized RCA Test Equipment Distributor.

*User Price (Optional)

RCA ELECTRON TUBE DIVISION, HARRISON, N. J.



THE MOST TRUSTED NAME IN ELECTRONICS

dio use with a 12-volt supply. It is priced around \$1.00, making it a good low-cost experimental and "workhorse" device. Maximum collector-to-emitter voltage is 25, collector current is 4 amps.

Rise, storage and fall times in switching circuits are specified as 10 μ sec each, at 3 amps collector current. Current gain at 500-ma collector current is 25 minimum, 75 maximum. Cut-off frequency at 2 amps collector current is 15 kc. The 2N663, which comes in a TO-3 package, is made by Delco.

RW-100

Looking a little like a lighthouse or an old stove, the RW-100 is a noise source. (Aren't all tubes?) This one makes noise as a specialty, at 2% minimum efficiency over a range of 50 to 200 mc. It puts out a minimum integrated noise power of 1 watt. Except for



power, the unit is completely self-contained, and the output is brought to a standard 50-ohm BNC-type coax connector. Output capacitance is 4 pf. The tube is made by Warnecke Electron Tubes, Inc.

Its heater requires 4.2 volts at 6 amps; its anodes, 1,200 volts and 2,000 volts at 30 ma each.

Projected lifetime: 1,000 hours.

END



JACK SCHMIDT

"Here's a prescription."

RADIO-ELECTRONICS

RAD-TEL

You Get MORE For Your Money!

RAD-TEL'S QUALITY BRAND NEW TUBES FOR TV, RADIO AND HI-FI 1-YEAR GUARANTEE

UP TO **75% OFF**

1-DAY SERVICE • Over 500 Types in Stock



SERVICEMEN:
RAD-TEL HAS THE LATEST TUBE TYPES.

THE SIGN OF RAD-TEL'S RELIABILITY FOR OVER 15 YEARS

Manufacturers Suggested List Price

EACH TUBE ATTRACTIVELY BOXED & BRANDED RAD-TEL

Qty.	Type	Price	Qty.	Type	Price	Qty.	Type	Price	Qty.	Type	Price
—	0Z4	.79	—	6AU8	.87	—	6K6	.63	—	12CU5	.58
—	1AX2	.62	—	6AV6	.41	—	6S4	.52	—	12CU6	1.06
—	1B3	.79	—	6AW8	.90	—	6SA7GT	.99	—	12CX6	.54
—	1DN5	.55	—	6AX4	.66	—	6SH7	1.02	—	12D4	.69
—	1G3	.79	—	6AX5	.74	—	6SJ7	.88	—	12DE8	.83
—	1J3	.79	—	6BAS	.50	—	6SK7GT	.95	—	12DL8	.88
—	1K3	.79	—	6BC5	.61	—	6SL7GT	.84	—	12DQ6	1.04
—	1R5	.77	—	6BC8	1.04	—	6SN7	.65	—	12DS7	.84
—	1S5	.75	—	6BE6	.55	—	6SQ7GT	.94	—	12DT5	.76
—	1T4	.72	—	6BF5	.90	—	6T4	.99	—	12DT7	.79
—	1U5	.65	—	6BF6	.44	—	6T8	.85	—	12DT8	.78
—	1X2B	.82	—	6BG6	1.70	—	6U8	.83	—	12DW8	.89
—	2AF4	.96	—	6BH8	.98	—	6V6GT	.54	—	12DZ6	.62
—	3AL5	.46	—	6BJ6	.65	—	6W4	.61	—	12ED5	.62
—	3AU6	.54	—	6BJ7	.79	—	6W6	.71	—	12EG6	.62
—	3AV6	.42	—	6BK7	.85	—	6X4	.41	—	12EK6	.62
—	3BC5	.63	—	6BL7	1.09	—	6X8	.80	—	12EL6	.50
—	3BN6	.75	—	6BN6	.74	—	7A8	.68	—	12EZ6	.57
—	3BU8	.78	—	6BQ6	1.12	—	7AU7	.65	—	12F8	.66
—	3BY6	.58	—	6BQ7	1.00	—	7EY6	.75	—	12FA6	.79
—	3BZ6	.56	—	6BU8	.70	—	7Y4	.69	—	12FM6	.50
—	3CB6	.56	—	6BX7	1.11	—	8AU8	.90	—	12FR8	.97
—	3CS6	.58	—	6BZ6	.55	—	8AW8	.93	—	12FX8	.90
—	3DG4	.85	—	6BZ7	1.03	—	8BQ5	.60	—	12GC6	1.06
—	3DK6	.60	—	6C4	.45	—	8CC7	.63	—	12J8	.84
—	3DT6	.54	—	6CB6	.55	—	8CM7	.70	—	12K5	.75
—	3GK5	.99	—	6CD6	1.51	—	8CN7	.97	—	12L6	.73
—	3Q4	.63	—	6CG7	.61	—	8CS7	.74	—	12SF7	.69
—	3S4	.75	—	6CG8	.80	—	8EB8	.94	—	12SK7GT	.95
—	3V4	.63	—	6CL8	.79	—	8FQ7	.56	—	12SL7	.80
—	4BQ7	1.01	—	6CM7	.69	—	9CL8	.79	—	12SN7	.67
—	4CS6	.61	—	6CN7	.70	—	11CY7	.75	—	12SQ7GT	.91
—	4DT6	.55	—	6CQ8	.92	—	12A4	.60	—	12U7	.62
—	4GM6	.60	—	6CR6	.60	—	12AB5	.60	—	12V6	.63
—	5AM8	.79	—	6CS6	.57	—	12AC6	.55	—	12W6	.71
—	5AN8	.90	—	6CS7	.69	—	12AD6	.57	—	12X4	.47

RAD-TEL TUBE CO. NOT AFFILIATED WITH ANY OTHER MAIL ORDER TUBE COMPANY

—	5AQ5	.54	—	6CU5	.58	—	12AE6	.50	—	17AX4	.67
—	5AT8	.83	—	6CU6	1.08	—	12AE7	.94	—	17DQ6	1.06
—	5BK7	.86	—	6CY5	.70	—	12AF3	.73	—	18FW6	.49
—	5BQ7	1.01	—	6CY7	.71	—	12AF6	.67	—	18FX6	.53
—	5BR8	.83	—	6DA4	.68	—	12AJ6	.62	—	18FY6	.50
—	5CG8	.81	—	6DE6	.61	—	12AL5	.47	—	19AU4	.87
—	5CL8	.76	—	6DG6	.62	—	12AL8	.95	—	19BG6	1.39
—	5CQ8	.84	—	6DJ8	1.21	—	12AQ5	.60	—	19EA8	.79
—	5EA8	.80	—	6DK6	.59	—	12AT6	.50	—	19T8	.85
—	5EU8	.80	—	6DN6	1.55	—	12AT7	.76	—	21EX6	1.49
—	5J6	.72	—	6DQ6	1.10	—	12AU6	.51	—	25AX4	.70
—	5T8	.86	—	6DT5	.81	—	12AU7	.61	—	25C5	.53
—	5U4	.60	—	6DT6	.53	—	12AV6	.41	—	25CA5	.59
—	5U8	.84	—	6DT8	.94	—	12AV7	.82	—	25CD6	1.52
—	5V6	.56	—	6EA8	.79	—	12AX4	.67	—	25CU6	1.11
—	5X8	.82	—	6EB5	.73	—	12AX7	.63	—	25DN6	1.42
—	5Y3	.46	—	6EB8	.94	—	12AY7	1.44	—	25EH5	.55
—	6AB4	.46	—	6EM5	.77	—	12AZ7	.86	—	25L6	.57
—	6AC7	.96	—	6EM7	.82	—	12B4	.68	—	25W4	.68
—	6AF4	1.01	—	6EU8	.79	—	12BD6	.50	—	32ET5	.55
—	6AG5	.70	—	6EV5	.75	—	12BE6	.53	—	35C5	.51
—	6AH4	.81	—	6EW6	.57	—	12BF6	.60	—	35L6	.60
—	6AH6	1.10	—	6EY6	.75	—	12BH7	.77	—	35W4	.42
—	6AK5	.95	—	6FG7	.69	—	12BK5	1.00	—	35Z5	.60
—	6AL5	.47	—	6FV8	.79	—	12BL6	.56	—	36AM3	.36
—	6AMB	.78	—	6GH8	.80	—	12BQ6	1.16	—	50B5	.69
—	6AQ5	.53	—	6GK5	.61	—	12BR7	.74	—	50C5	.53
—	6AS5	.60	—	6GK6	.79	—	12BV7	.76	—	50EH5	.55
—	6AT6	.49	—	6GN8	.94	—	12BY7	.77	—	50L6	.61
—	6AT8	.86	—	6H6	.58	—	12BZ7	.86	—	70L7	.97
—	6AU4	.85	—	6J5GT	.51	—	12CN5	.56	—	117Z3	.85
—	6AUG	.52	—	6J6	.71	—	12CR6	.67	—	807	.75

ORDER FORM MAIL TODAY

RAD-TEL Tube Co. Total Tubes \$ _____
Dept. RE-5 Total Part(s) \$ _____
55 Chambers Street Postage \$ _____
Newark 5, New Jersey Grand Total \$ _____

ENCLOSED IS \$ _____ Please rush order.

SEND: _____ Book(s) Be Your Own TV Repairman @ \$1.00 ea. #170
_____ Cheater Cord 29c ea. Lots of 3 - 25c ea. #154

Orders under \$5.00 - Add \$1.00 handling charge - plus postage.

FREE! Send FREE Tube and Parts Catalog
 Send FREE Trouble Shooting Guide

NAME _____

ADDRESS _____

CITY _____ ZONE _____ STATE _____



Be your own TELEVISION REPAIRMAN

The Original NOW YOU CAN FIX YOUR OWN TV SET BOOK

You can fix your own TV if you have TV Fixit Book . . . because 80% of troubles are caused by tubes. This book explains, illustrates trouble and what tubes cause this trouble. Pinpoints in over 3000 layouts by model number, position and type tube causing trouble.

\$1.00

No. 170



CHEATER CORD

Easy to work on set while panel is off.

6 ft., No. 154. **29¢ ea.** Lots of 3 - **25¢ ea.**



RAD-TEL TUBE CO. TV, RADIO AND HI-FI

DEPT. RE-5 55 CHAMBERS STREET, NEWARK 5, NEW JERSEY

TERMS: 25% deposit must accompany all orders, balance C.O.D. Orders under \$5: add \$1 handling charge plus postage. Orders over \$5: plus postage. Approx. 8 tubes per 1 lb. Subject to prior sale. No C.O.D.'s outside continental U.S.A.

carries a whisper
 . . . yet cuts out
 background noise

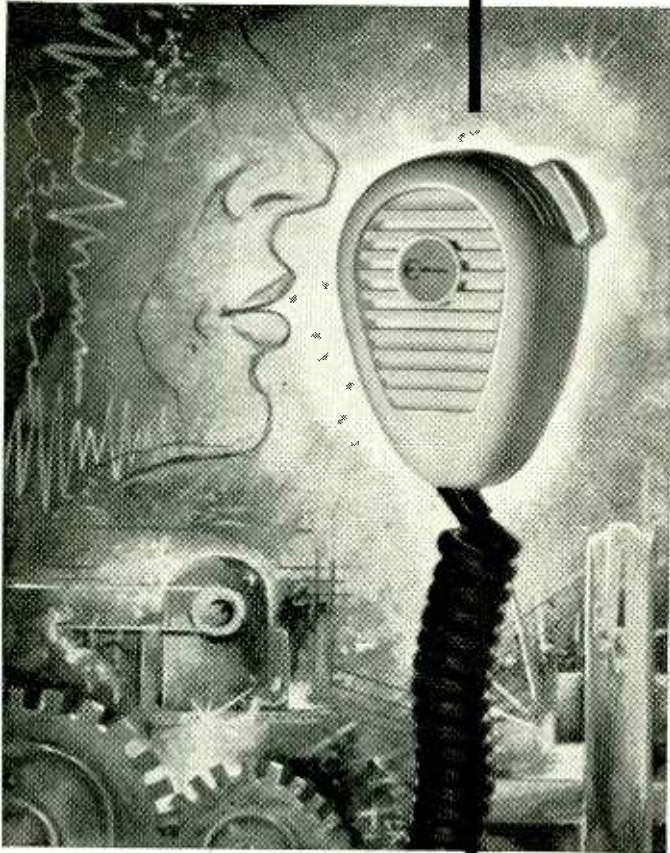

the exciting new
Hot Head

The new Hot Head is the highest output ceramic microphone available. Transmits voice sharply and clearly in the noisiest areas where other microphones fail. Average level: -48 DB, twice the output of conventional ceramic mikes. Response: 300-4000 cps. Polar Pattern, differential to 600 cps; cardioid, 600-4000 cps. Covers a host of applications: CB, Ham, Radio, Marine and Commercial. Heavy duty, DBDT push-to-talk switch can be re-wired for special applications. Has Cylolac, hi-impact, take-apart case. With nickel-plated brass hardware, 3-conductor neoprene coil cord and spring hang-up clip.
Model C47D Hot Head List Price **\$16.00**

EUPHONICS C47 MICROPHONE

A new general-purpose ceramic mike, same as the C47D except for noise-cancelling feature. Polar Pattern, essentially non-directional. Provides high level response curve for maximum intelligibility in all voice communication.

Model C47 Hot Head

List Price **\$14.00**



Manufacturers of
 Quality Microphones
 and Phono Cartridges

For complete details see your distributor or write Dept. RE-5
Euphonics
 CORPORATION
 ALL PRODUCTS AMERICAN MADE
 GUAYNABO, PUERTO RICO, U.S.A.



TV Interference

The majority of TVI problems emanating from hams, CB, commercial and similar services close to the TV set often results from the interfering signal finding an easy path into the TV tuner, even though the interfering signal is operating way below the TV channel assignments in the vhf and uhf bands.

The cure is to install a high-pass filter. When the inter-

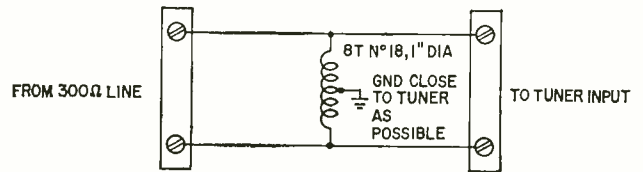

Fig. 1

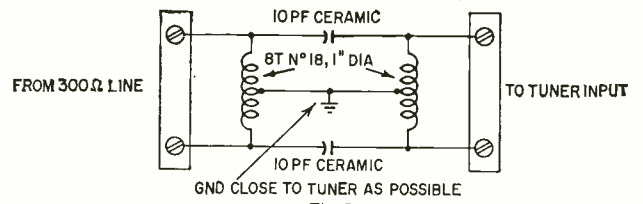

Fig. 2

ference is not too severe, the simple filter in Fig. 1 will do the job, and for severe cases try the filter in Fig. 2. For utmost effectiveness, mount the filter as close to the TV tuner as possible.—George P. Oberto

Westinghouse H148

The old 3E6 used as i.f. amplifier in these portables is hard to get. You can replace it very satisfactorily with a 1LN5, but the difference in filament voltage means that you'll have to insert a 33-ohm 1/2-watt resistor in the lead to pin 8 of the tube socket. Works fine.—William Porter

Philco Sync Control

We had a Philco portable chassis 11H25U that didn't have any control over vertical or horizontal sync. But if the set was left on for 30 minutes it would start working normally. With the help of a TV analyzer, a sync signal was injected at the plate of the 6CG8 sync separator and the sync would lock in. The sync signal was inserted at the grid of the same tube and had no effect on sync. The tube had been replaced and was good. Cathode pin 3 went to ground and this connection was good.

The trouble seemed to be in the module that went to the printed-circuit chassis board. Each resistor was checked,

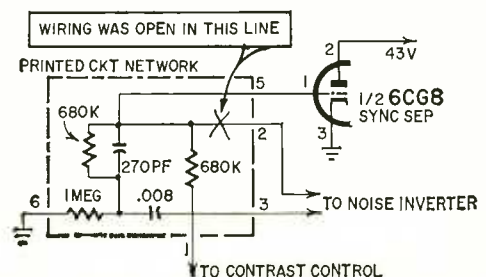

and all were near normal on resistance measurements. The continuity of pins was checked on the printed modular unit and we found that the wiring was open between pins 5 and 2. A piece of hookup wire was soldered from pin 2 to pin 5 and the receiver was normal again.—Homer L. Davidson

RCA KSC 82

The brightness control would not regulate brightness and the picture was out of focus. Voltages at the picture tube were near normal.

Since the picture was a little weak and distorted, the video output tube was checked next. There was very little

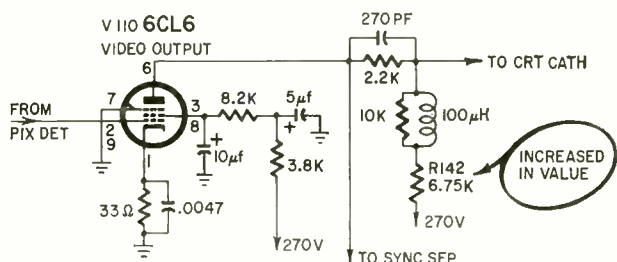

voltage at the plate. R142's resistance had increased so much that there was practically no plate voltage. The 6,750-ohm resistor was replaced, and the picture returned to normal.—L. H. Davies

Thyratron Motor Controls

A large number of expensive type 105 thyratron tubes were changed while troubleshooting motor controls in an effort to find the cause of an intermittent low torque condition in several machines. The trouble was later traced to defective bakelite tube sockets. The high operating temperature of the tubes plus age had caused the sockets to deteriorate and develop leakage between contacts. Replacing the old sockets with a new ceramic type ended the trouble.

Old motor control panels using large-current thyratron tubes should have these bakelite sockets inspected periodically to avoid a production shutdown to replace a bad socket.—F. G. Lewis

Industravox Intercom Amplifier

Failure to get reception from any of the other intercom stations in systems using the EIDB-10B amplifier has been traced to a defective relay. The relay is a dpdt type. One set of contacts keeps B-plus off the tube plates until a station-selector switch is pushed; the other set shorts the local speaker while talking. The latter contacts are the trouble source. As shown in the diagram, an imperfect make of

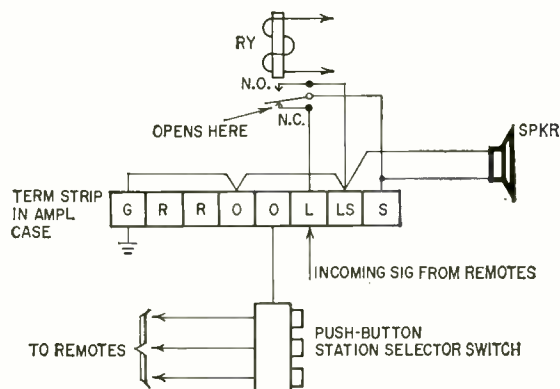

the N.C. position will result in an open circuit to the speaker. As a temporary cure, clean the contactors with a burnishing tool. The best procedure is to install a new relay. Use an Advance type K1504 or equivalent. The relay is mounted on the amplifier chassis, and is held in place with one stud.—G. F. Loomis

END

BECOME A RADIO TECHNICIAN
for only \$26.95

BUILD 20 RADIO

CIRCUITS AT HOME
with the New Progressive
RADIO "EDU-KIT"® Reg. U.S. Pat. Off.

All Guaranteed to Work!

PRACTICAL HOME RADIO COURSE only \$26.95

NOW INCLUDES

- ★ 12 RECEIVERS
- ★ 3 TRANSMITTERS
- ★ SQ. WAVE GENERATOR
- ★ AMPLIFIER
- ★ SIGNAL TRACER
- ★ SIGNAL INJECTOR
- ★ CODE OSCILLATOR

TRAINING ELECTRONICS TECHNICIANS SINCE 1946

- ★ No Knowledge of Radio Necessary
- ★ No Additional Parts or Tools needed
- ★ Excellent Background for TV
- ★ School Inquiries Invited
- ★ Attractively Gift Packed

FREE EXTRAS

- SET OF TOOLS • RADIO & ELECTRONICS TESTER • ELECTRIC SOLDERING IRON • TESTER INSTRUCTION MANUAL • MEMBERSHIP IN RADIO-TV CLUB • CONSULTATION SERVICE • HI-FI GUIDE
- QUIZZES • TV BOOK • FCC AMATEUR LICENSE TRAINING
- RADIO BOOK • PRINTED CIRCUITRY • PLIERS-CUTTERS
- ALIGNMENT TOOL • WRENCH SET • CERTIFICATE OF MERIT
- VALUABLE DISCOUNT CARD

WHAT THE "EDU-KIT" OFFERS YOU

The "Edu-Kit" offers you an outstanding PRACTICAL HOME RADIO COURSE at a rock-bottom price. Our kit is designed to train Radio & Electronics Technicians, making use of the most modern methods of home training. You will learn radio theory, construction, servicing, basic Hi-Fi and TV repairs, code, FCC amateur license requirements.

You will learn how to identify radio symbols, how to read and interpret schematics, how to mount and lay out radio parts, how to wire and solder, how to operate electronic equipment, how to build radios. Today it is no longer necessary to spend hundreds of dollars for a radio course. You will receive a basic education in radio, worth many times the small price you pay, only \$26.95 complete.

THE KIT FOR EVERYONE

The Progressive Radio "Edu-Kit" was specifically prepared for any person who has a desire to learn Radio. The "Edu-Kit" has been used successfully by young and old in all parts of the world, by many Radio Schools and Clubs in this country and abroad. It is used for training and rehabilitation of Armed Forces Personnel and Veterans throughout the world.

The Progressive Radio "Edu-Kit" requires no instructor. All instructions are included. Every step is carefully explained. You cannot make a mistake.

PROGRESSIVE TEACHING METHOD

The Progressive Radio "Edu-Kit" is the foremost educational radio kit in the world, and is universally accepted as the standard in the field of electronics training. The "Edu-Kit" uses the modern educational principle of "Learn by Doing." Therefore, you will construct radio circuits, perform jobs and conduct experiments to illustrate the principles which you learn.

You begin by examining the various radio parts included in the "Edu-Kit." You then learn the function, theory and wiring of these parts. Then you build a simple radio. With this first set, you will enjoy listening to regular construction stations, learn theory, practice testing and troubleshooting. Then you build a more advanced radio, learn more advanced theory and techniques. Gradually, in a progressive manner, and at your own pace, you will find yourself constructing more advanced multi-tube radio circuits, and doing work like a professional Radio Technician.

The "Edu-Kit" course are twenty Receiver, Transmitter, Code Oscillator, Signal Tracer, Signal Injector, Square Wave Generator and Amplifier Circuits. These are not unprofessional "breadboard" experiments, but genuine radio circuits, constructed by means of professional wiring and soldering on metal chassis, plus the new method of radio construction known as "Printed Circuitry." These circuits operate on your regular AC or DC house current.

In order to provide a thorough, well-integrated and easily-learned radio course, the "Edu-Kit" includes practical work as well as theory; troubleshooting in addition to construction; training for all, whether your purpose in learning radio be for hobby, business or job; progressively-arranged material, ranging from simple circuits to well-advanced. Your studies will be further aided by Quiz materials and our well-known FREE Consultation Service.

THE "EDU-KIT" IS COMPLETE

You will receive all parts and instructions necessary to build 20 different radio and electronics circuits, each guaranteed to operate. Our Kits contain tubes, tube sockets, variable, electrolytic, mica, ceramic and paper dielectric condensers, resistors, tie strips, coils, hardware, tubing, punched metal chassis, Instruction Manuals, hookup wire, solder, selenium rectifiers, volume controls, switches, knobs, etc.

In addition, you receive Printed Circuit materials, Printed Circuit chassis, special tube sockets, hardware and instructions. You also receive a useful set of tools, a professional electric soldering iron, and a self-powered Dynamic Radio & Electronics Tester. The "Edu-Kit" also includes Code Instructions and the Progressive Code Oscillator, in addition to the F.C.C.-type Questions and Answers for Radio Amateur License training. You will also receive lessons for servicing with the Progressive Signal Tracer and the Progressive Signal Injector, and a High Fidelity Guide and Quiz Book. Everything is yours to keep.

J. Statulis, of 25 Poplar Pl., Waterbury, Conn., writes: "I have repaired several sets for my friends, and made money. The 'Edu-Kit' paid for itself. I was ready to spend \$240 for a Course, but I found your ad and sent for your Kit."

UNCONDITIONAL MONEY-BACK GUARANTEE

The Progressive Radio "Edu-Kit" has been sold to many thousands of individuals, schools and organizations, public and private, throughout the world. It is recognized as the ideal radio course.

By popular demand the Progressive Radio "Edu-Kit" is now available in Spanish as well as English.

It is understood and agreed that should the Progressive Radio "Edu-Kit" be returned to Progressive "Edu-Kits" Inc. for any reason whatever, the purchase price will be refunded in full, without quibble or question, and without delay.

The high recognition which Progressive "Edu-Kits" Inc. has earned through its many years of service to the public is due to its unconditional insistence upon the maintenance of perfect engineering, the highest construction standards, and 100% adherence to its Unconditional Money-Back Guarantee. As a result, we do not have a single dissatisfied customer throughout the entire world.

ORDER FROM AD—RECEIVE FREE BONUS RESISTOR AND CONDENSER KITS WORTH \$7.00

Send "Edu-Kit" Postpaid. I enclose full payment of \$26.95.

Send "Edu-Kit" C.O.D. I will pay \$26.95 plus postage.

Send me FREE additional information describing "Edu-Kit."

Name:

Address:

Progressive "EDU-KITS" Inc. 1186 Broadway, Dept. 208G
Hewlett, N. Y.

PLAID STAMPS FREE WITH ALL ORDERS

FABULOUS GIFT BROCHURE & 10% DISCOUNT—ON ORDERS OF \$10 OR OVER

- \$15.00 RADIO PARTS "JACK-POT" handy assortment \$1
- 20—ASST. ROTARY SWITCHES all popular types over \$20 value \$1
- 1—LB SPOOL ROSIN-CORE SOLDER 40/60 \$1
- 6—TRANS. RADIO BATTERIES 9 volt, same as Eveready #216 \$1
- 1—EMERGENCY AUTO LAMP Red dome blinker, incl Battery \$1
- 1—5" PM SPEAKER Alnico #5 magnet \$1
- 1—4" PM SPEAKER Alnico #5 magnet \$1
- 3—AUDIO OUTPUT TRANSFORMERS 50L6 type \$1
- 3—AUDIO OUTPUT TRANSFORMERS 6K6 or 6V6 type \$1
- 3—I.F. COIL TRANSFORMERS 456kc, most popular type \$1
- 15—RADIO OSCILLATOR COILS standard 456kc \$1
- 3—I.F. COIL TRANSFORMERS 10.7mc for FM \$1
- 2—G.E. #RTL-143 I.F. COIL TRNSFRMRS 456kc w/Range \$1
- 3—I.F. COIL TRANSFORMERS 262kc for Auto Radios \$1
- 3—LOOPSTICK ANTENNAS hi-gain, ferrite, adjustable \$1
- 3—1/2 MEG VOLUME CONTROLS w/tn switch, 3" shaft \$1
- 5—1/2 MEG VOLUME CONTROLS less switch \$1
- 10—ASSORTED VOLUME CONTROLS less switch \$1
- 5—ASSORTED VOLUME CONTROLS with switch \$1
- 10—SURE-GRIP ALLIGATOR CLIPS 2" plated \$1
- 10—SETS PHONO PLUGS & PIN JACKS RCA type \$1
- 20—ASST. PILOT LIGHTS #44, 46, 47, 51, etc. \$1
- 50—ASSORTED TERMINAL STRIPS 1, 2, 3, 4 lugs \$1
- 100—FINEST NYLON DIAL CORD best size, .028 gauge .. \$1
- 50—ASST. RADIO KNOBS screw and push-on types \$1
- 8—ASST. LUCITE CASES hinged cover, handy for parts \$1

- 100—ASSORTED 1/2 WATT RESISTORS some in 5% \$1
- 70—ASSORTED 1 WATT RESISTORS some in 5% \$1
- 35—ASSORTED 2 WATT RESISTORS some in 5% \$1
- 20—ASST. DIODE CRYSTALS fine assortment. Latest types .. \$1
- 2—SYLVANIA EPOXY SILICON RECTIFIERS 750ma-400 piv \$1
- 20—ASST'D WIREWOUND RESISTORS 5, 10, 20 watt \$1
- 10—ASST. RADIO ELECTROLYTIC CONDENSERS \$1
- 5—ASST. TV ELECTROLYTIC CONDENSERS \$1
- 50—ASST MOLDED CONDENSERS short leads \$1
- 20—GOODALL TUBULAR CONDENSERS .047-600v \$1
- 300—ASST. 1/2 W RESISTORS Top Brand, Short leads, excellent \$1
- 10—6' ELECTRIC LINE CORDS with plug \$1
- 4—50' SPOOLS HOOK-UP WIRE 4 different colors \$1
- 50—STRIPS ASSORTED SPAGHETTI handy sizes \$1
- 100—ASSORTED RUBBER GROMMETS best sizes \$1
- 200'—BUSS WIRE #20 tinned for hookups, special circuits, etc. \$1
- 250—ASST. SOLDERING LUGS best types and sizes \$1
- 250—ASST. SELF TAPPING SCREWS #6, #8, etc. \$1
- 150—ASST. 6/32 SCREWS and 150 6/32 HEX NUTS \$1
- 150—ASST. 8/32 SCREWS and 150—8/32 HEX NUTS .. \$1
- 150—6/32 HEX NUTS and 150—8/32 HEX NUTS ... \$1
- 4—TOGGLE SWITCHES SPST, SPDT, DPST, DPDT \$1
- 10—ASSORTED SLIDE SWITCHES SPST, DPDT, etc. \$1
- 100—ASST RUBBER & FELT FEET FOR CABINETS best sizes \$1
- 50—ASST. MICA CONDENSERS some in 5% \$1
- 50—ASST. DISC CERAMIC CONDENSERS popular numbers \$1

- \$15.00 TELEVISION PARTS "JACKPOT" best buy ever .. \$1
- 90° TV DEFLECTION YOKE wired network, schematic diag. \$1
- 90° FLYBACK TRANSFORMER schematic shows many uses ... \$1
- 70° TV DEFLECTION YOKE wired network, long leads \$1
- 50—ASSORTED TV COILS I.F. video, sound, ratio, etc. ... \$1
- 1—INDOOR TV ANTENNA Hi-gain, 3 section, tiltproof .. \$1
- 5—TV CHEATER CORDS with hota plugs \$1
- 3—ELECTROLYTIC CONDENSERS 50/30-150v \$1
- 3—ELECTROLYTIC CONDENSERS 60/50/30/20-150v \$1
- 100'—TWIN TV LEAD-IN WIRE 300 ohm, heavy duty .. \$1
- 50'—FLAT 4-CONDUCTOR WIRE many purposes \$1
- 20—ASSORTED TV KNOBS ESCUTCHEONS etc. \$20 value \$1
- 6—ASSORTED STANDARD TUNER UHF STRIPS \$1
- 10—ASSORTED STANDARD TUNER VHF STRIPS \$1
- 50—ASST. CERAMIC CONDENSERS some in 5% \$1
- WEBSTER STEREO CARTRIDGE #80-2, standard for all pickups \$1
- 6—TV ALIGNMENT TOOLS \$1
- 2—RATIO DETECTOR COILS 4.5mc or 10.7mc \$1
- 20—ASSORTED GRID CAPS for 1B3, 1X2, 6BG6, 6BQ6, etc. \$1
- 50—ASSORTED TV PEAKING COILS all popular types \$1
- 4—ASST. TV ION TRAPS for all type TV Receivers \$1
- 10—TV PICTURE TUBE SOCKETS wired with 20" leads \$1
- 5—TV HI-VOLT ANODE LEADS 20" length \$1
- 10—DIODE CRYSTALS 1N34 \$1
- 10—ASST. DIODE CRYSTALS 5—1N60 and 5—1N64 \$1
- 3—SILICON RECTIFIERS Top Hat 500ma-400 PIV \$1
- 50'—INSULATED SHIELDED WIRE #20 braided metal jacket \$1
- 32'—TEST PROD WIRE deluxe quality, red or black .. \$1
- 50'—HI-VOLTAGE WIRE for TV, special circuits, etc. \$1
- STANDARD BRAND TUBES 02A, 1B3, 1X2, 5U4, 5Y3, 6AC7, 6AU6, 6AX4, 6CB6, 6CG7, 6J6, 6K6, 6SN7, 6U8, 6X8, 12AT7, 12AU7, 12AX4, 50C5, 50L6 Each Tube \$1

MARKET SCOOP COLUMN

- 1000—ASST. HARDWARE KIT \$1 screws, nuts, washers, rivets, etc. \$1
- 1000—SOLID BRASS SCREWS #2/56, 3/8" long, flat head .. \$1
- 1000—BLACK NICKEL SCREWS #6/40, 1/2" long, fillister head \$1
- 2—IBM COMPUTER SECTIONS loaded with valuable parts \$1
- 3—IBM 25L6 TUBES \$1
- 1—CHAPT ZU DI MITZIA "JACKPOT" double your money back if not completely satisfied \$1
- 100—PRECISION RESISTORS asst. list price \$50.00 less 98% \$1
- 100'—STANDARD ZIP CORD 2 conductor #18 white or brown \$1
- 50—G.E. FLASHLIGHT BULBS #PR-9, 2.7 volts, 15A \$1
- 2—TELEX RADIO EAR SETS standard 3.2 () incl. cond., ear loop & Plug. Value \$8
- 50—PILOT LIGHT SOCKETS bayonet type, wired \$1
- 25—BALL POINT PENS retractable, assorted colors ... \$1
- 10—BALL POINT PEN FILLERS black fine-line for drafting and offset, fits 95% of all pens made \$1
- 1—HEARING AID AMPLIFIER incl 3 Tubes, Mike, Etc. (as is) \$1
- 3—3" RECORDER TAPES quality acetate, 150 feet \$1
- 10—3" RECORDER TAPE REELS \$1
- 1—SQ. YARD GRILLE CLOTH most popular brown & gold design \$1
- 500'—CHOICE HOOKUP WIRE asst colors cut in handy lengths some stripped and tinned \$1
- 100—ASST TUBULAR CONDENSERS .001 to .47 to 600v \$1
- 50—RADIO & TV SOCKETS asst 7 pin, 8 pin and 9 pin ... \$1
- 100—ASSORTED FUSES 3AG and other popular sizes .. \$1
- 10—ASSORTED TUBES Radio, Television and Industrial \$1
- 1—STANDARD 1AX2 TUBE and 1 STANDARD 35W4 TUBE \$1
- 10—RCA #12L8 TUBES \$1
- 3—STANDARD 35W4 TUBES \$1
- 3—STANDARD 12AT6 TUBES \$1
- 5—RCA #1U4 TUBES also serves as a 1T4 Tube \$1
- JENSEN 15" PM SPEAKER Deluxe concert type, full range, ceramic 10 oz magnet for only \$9

A TELEPHONE  in every room

with

PORTABLE—PHONE JACK & PLUG

- Western Electric Specifications
- Fits all Telephones & Intercoms
- Saves—Time, Steps and Money
- Assembles in a few minutes

PHONE JACK & PLUG SET
with 50' Extension Cord and easy-to-follow Instructions **\$3.98**

3 - SETS.....\$ 9.94
6 - SETS.....\$17.69

PHONE JACK (only) \$1.75
PHONE PLUG (only) 1.50



\$200 HEARING AID—Your Price \$2

We Scouted the Market on 15000 of these HEARING AIDS from one of the Leading Manufacturers (name withheld) who switched to the Transistor Type.

Each HEARING AID INSTRUMENT is a Complete AUDIO AMPLIFIER and includes—a CRYSTAL MICROPHONE, 3 SUBMINIATURE TUBES and a Superb Beige CABINET.

Indeed a TOP ITEM for the Experimenter—can be modified and converted to: RADIOS—INTERCOMS—TRANS. MITTERS—SECRET LISTENING DEVICES—MICROPHONE for Tape Recorders—PRE-AMP & MICROPHONE COMBINATION—Etc.

5" x 2 1/2" x 1"—Shipping Weight 1 lb. **\$2**

Complete as illustrated—incl. detailed informative SCHEMATIC DIAGRAM (less Earphone & Battery)

Sold without limit or reserve! Order as many as you want!



BROOKS RADIO & TV CORP., 84 Vesey St., Dept. A, New York 7, N.Y. TELEPHONE
CORtland 7-2359

TECHNICIANS'

NEWS



PFTRSA Plans Education

Harrisburg, Pa.—The Pennsylvania Federation of Television & Radio Service Associations recently approved an education program to bring increased business to independent service technicians.

The federation hopes that the plan will help get independent service out of the "television and radio repair rut." It plans to offer training programs and speakers at the local level.

TESA-Wis. Group Insurance Raised

Sheboygan, Wis.—TESA (Television & Electronic Service Association) of Wisconsin recently adopted a new \$10,000 major-medical expense plan plus a weekly disability program.

The group insurance provides, in addition to the full coverage of medical expenses, other benefits, such as reimbursement for loss of time due to illness or accident—up to \$30 a week. Psychiatric care is also covered; not a bad idea, maybe, with color TV as complicated as it is.

CSEA Meets in Los Angeles

Los Angeles—The California State Electronics Association, at their recent dealer-service workshop, heard Dr. Willard Geer, vice president of Video Color Corp., describe a 3-inch flat TV picture tube his company is producing for military use. The tube, with its 3-by-5-inch screen, was invented by Dr. Ross Aiken, also a vice president of Video Color.

Dr. Geer also mentioned a two-color (red and green) 4-by-8 tube, a larger black-and-white tube, and a three-color tube to be brought out in September. All are for military use.

Robert Mott, trade practice consultant with the Los Angeles Better Business Bureau, told the CSEA that television repair remains at the top of the list of complaints in 42 categories handled by the BBB. A special problem of the BBB was "setnapping"—the giving of a moderate in-home estimate for repairs on a TV receiver, then removing it to the shop and holding it for "ransom", or a charge much higher than the estimate.

Fewer than 20 companies in the Los Angeles and Orange Counties, Mr. Mott said, were responsible for a ma-

Tarzian offers
**FAST, DEPENDABLE
TUNER REPAIR
SERVICE (ALL
MAKES)**

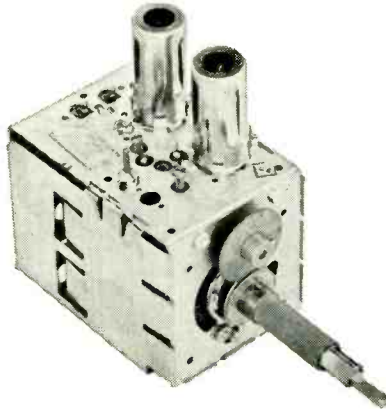

It just makes sense that a manufacturer of tuners should be better-qualified, better-equipped to offer the most dependable tuner repair and overhaul service.

Sarkes Tarzian, Inc. pioneer in the tuner business, maintains two complete, well-equipped Factory Service Centers—assisted by Engineering personnel—and staffed by specialized technicians who handle ONLY tuner repairs on ALL makes and models.

Tarzian-made tuners received one day will be repaired and shipped out the next. Allow a little more time for service on other than Tarzian-made tuners.

Tarzian offers a 12-month guarantee against defective workmanship and parts failure due to normal usage. And, compare our cost of \$9.50 and \$15 for UV combinations. There is absolutely no additional, hidden charge, for ANY parts except tubes. You pay shipping costs. Replacements on tuners beyond practical repair are available at low cost.

Ⓢ Tarzian-made tuners are identified by this stamping.

When inquiring about service on other tuners, always give TV make, chassis and Model number. All tuners repaired on approved, open accounts. Check with your local distributor for Sarkes Tarzian replacement tuners, replacement parts, or repair service.

SARKES TARZIAN, INC.
Bloomington, Indiana

MANUFACTURERS OF TUNERS . . . SEMICONDUCTORS . . . AIR TRIMMERS . . . FM RADIOS . . . AM/FM RADIOS . . . AUDIO TAPE . . . BROADCAST EQUIPMENT

ONLY
\$9.50
INCLUDING

ALL PARTS
(except tubes)
and LABOR

**24-HOUR SERVICE
1-YEAR WARRANTY**

**TWO SERVICE CENTERS
TO SERVE YOU BETTER**

See your distributor, or use the address nearest you for fast factory repair service

537 South Walnut St.
Bloomington, Indiana
Tel: 332-6055

10654 Magnolia Blvd.
North Hollywood, Calif.
Tel: 769-2720

CONVERT TO COLOR TV

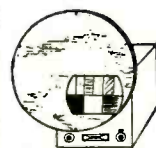

COLORDAPTOR—A simple 10-tube circuit and rotating color wheel converts any size B & W TV to receive compatible color.

COLORDAPTOR — Easily attached to any TV set, does not affect normal operation, often built from parts experimenters have on hand. **BRILLIANT COLOR!**

Complete booklet—gives theory of operation, all construction details, schematic, and sample color filters. **\$195**

Essential Parts Kit—Includes all special parts—coils, delay line, crystal, color filters. Add \$1.00 for sets over 16". **\$19.95**

COLORDAPTOR 1798 Santa Cruz, Menlo Park, Calif.

fix **ELECTRIC APPLIANCES**
\$3 TO \$5 AN HOUR

FREE BOOK tells about it. Our complete, easy profitable spare-time or full-time business that pays \$3-\$5 hour—right at home! **400 MILLION** Appliances now in use. People need them fixed. **YOU** make good money doing **NOW**. Our complete, easy course trains you for top earnings. At no extra charge you get time-saving Appliance Tester. Get **FREE** Appliance Tester. **FREE** Sample Lesson! Mail coupon

NATIONAL RADIO INSTITUTE, Appliance Div.
Dept. FE-3 Washington 16, D.C.
Send **FREE** Book, **FREE** Appliance Repair Course Lesson.
Name.....
Address.....
City..... Zone..... State.....



- Tests TV and Radio Tubes —both old and new
- Tests all Novars
- Tests Nuvistors, 10-pin Tubes, and 12-pin Compactrons
- Tests Voltage Regulators, Thyratrons, Auto Radio Hybrid Tubes, European Hi-Fi Tubes, and Many Industrial Types

B&K PROFESSIONAL QUALITY AT LOW COST

Model 600 Compact Portable Dyna-Quik Makes Tube Testing Quick, Accurate, Profitable!

It's amazing how quickly you can accurately check out tubes on every call—sell more replacements, and make more money—with this up-to-date, low-cost professional quality tube tester.

Checks for all shorts, grid emission, leakage, and gas. Checks each section of multi-section tubes separately. Checks tube capability under simulated load conditions. Rejects bad tubes, not good tubes. Quickly reveals tube condition, saves customers, stops call backs, increases servicing profit.

Exclusive adjustable grid emission test. Sensitivity to over 100 megohms. Phosphor-bronze socket contacts.

Complete tube listing in handy reference index.

Handsome, sturdy leatherette-covered carry-case.

Size 8½" x 11" x 4½". Net, \$74.95

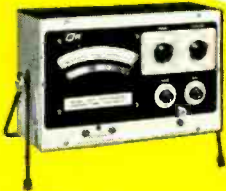

**QUICK, DIRECT, ERROR-FREE
READINGS WITHOUT MULTIPLYING**

Model 375
VTVM
Net, \$89.95

Model 360
V O Matic
Net, \$59.95



See Your B&K
Distributor
or Write for
Catalog
AP20-E



B & K MANUFACTURING CO.

Division of DYNASCAN CORPORATION

1801 W. BELLE PLAINE • CHICAGO 13, ILL.

Canada: Atlas Radio Corp., 50 Wingold, Toronto 19, Ont.

Export: Empire Exporters, 253 Broadway, New York 7, U.S.A.

RADIO-ELECTRONICS pays \$5.00 for good cartoon ideas and \$25 and up for finished work.

Radio-Electronics
154 West 14th Street
New York 11, N. Y.

majority of the complaints. There was some discussion about the advisability of publishing the names of the offending companies, and it was stated that they would be furnished to consumers upon individual request.

Keith Kerstein, executive director of CSEA, reported progress on an upcoming bill to license TV service technicians in California. He told the meeting that the bill is sponsored by the state's Attorney General and consumer council office.

Line-Voltage Variations Can Cost You \$\$

Line voltage has been found to vary between 103 and 131 in different sections of a large city, says *Modern Electronic Service Dealer*, organ of the California State Electronics Association. Daily variations at one location were as great as 8 or 10 volts. Clearly, a major source of callbacks becomes obvious if your shop line voltage is at one end of the range, and the customer's at the other.

The problem is compounded by the scarcity of good ac meters. A common tolerance figure for ac voltmeters is 5%. But this is often not achieved. A volt-ohmmeter's accuracy may change with time: a recent check of vom's (none more than 3 years old) showed readings from 93 to 160 volts from a known 117-volt line!

Is there an answer? CSEA says yes.

1. Consider an accurate expanded-scale type ac panel meter for reference and calibration in your shop.

2. When you buy a new vom or vtvm, pay attention to ac specifications and tolerance as well as dc and resistance.

3. Promote a "calibration session" in connection with one of your association meetings. Expanded-scale meters have an accuracy of ½%, and often meter manufacturers or a local lab will be glad to cooperate. Get in touch with them and see. Once you have access to accurate meters, encourage association members to bring in the vom's, vtvm's and check them against the standard.

Key to Future: Service

Chicago—Servicing holds the key to future business gains, said Raymond W. Saxon of RCA at the annual meeting of the National Appliance and Radio-TV Dealers Association here. Yet, he added, "the service aspect of our business today is undoubtedly the most neglected selling tool that a retailer has at his disposal."

Saxon feels that extended warranties are not in the best interest of independent service technicians or dealers. "A warranty alone," he said, "was never intended to be a merchandising tool."

Reminding service technicians of their tremendous importance to both

dealers and consumers, Saxon said that full consumer satisfaction with our industry's products "will depend on a vigorous and healthy independent service industry".

Competition Keeps TV Repairs Costs Down

Reports from around the nation show that fierce competition has kept TV repair costs down in most areas, but some areas show a slow rise. Los Angeles shows the greatest rise. Ralph Johannot, vice president of the California State Electronics Association, said, "Increased operating costs are reflected in higher repair rates which now average \$5 and better." Bench rates, he added, are up to \$10 an hour now.

Larger Chicago firms have raised their prices somewhat and, although increases have been spotty, independent shops are seriously considering price hikes. Frank Moch, executive director of NATESA, feels the independent service charge will soon approach \$6.

In Pittsburgh, service dealers are doubtful about raising prices because of severe competition. They would like to raise the \$5 house call to \$6 or \$6.50, but the consensus is bench rates will probably go up sooner than house calls.

In St. Louis, Philadelphia and Detroit, competition is so tough that service shops may have a hard time even

keeping current prices. St. Louis has had layoffs because of the difficulty in getting enough service work.

Indianapolis reports a creeping price advance among firms outside state and local associations, but no deliberate trend. Washington and Boston shops report no definite trend, but believe price rises are forthcoming.

Costs seem to be stable in San Francisco, Atlanta and Dallas.

Points for Shop Owners

Indianapolis, Ind.—The Indianapolis Television Technicians Association offers a concise list of suggestions to help service dealers including:

1. Consider carrying related or accessory items (tape, needles, batteries).
2. Never send a customer to a distributor to pick up a part or for little odds and ends you don't stock.
3. Watch your *shop appearance*. Dirty windows, sloppy signs, peeling paint send customers away.
4. Watch your *personal appearance*.
5. Watch your *vehicle appearance*.
6. Get together with your employees occasionally to make sure that they have the shop's interest at heart.
7. Suggest an accessory to a customer while on a service call.
8. Watch how your business phone is answered.

END

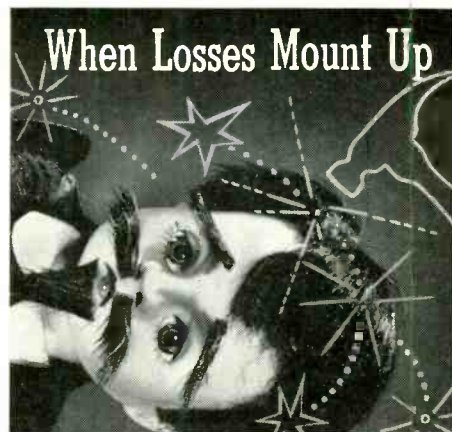

When Losses Mount Up Take DUOTONE For INSTANT RELIEF!

We recommend Duotone needles for the well being of all phonograph records. Losses in high fidelity reproduction can be so easily cured with a simple Duotone needle replacement. They're tipped with genuine diamonds, the finest prescription made, synthetic sapphires and osmium. Diagnosis: A worn needle makes worn records. Prognosis: Take one new Duotone needle and your headache is over.



Write for Free 1963 Duotone Needle Wall Chart.

DUOTONE[®]
COMPANY, INC. KEYPORT, N.J.

TV-RADIO Servicemen or Beginners..

2 WEEKS FREE TRIAL!

Just Send name for

Coyne's

Seven Volume

Job-Training Library!



The First Practical TV-RADIO-ELECTRONICS Shop Library!

Answers ALL Servicing Problems QUICKLY...
Makes You Worth More On The Job!

Put money-making, time-saving TV-RADIO-ELECTRONICS know-how at your fingertips—examine Coyne's all-new 7-Volume TV-RADIO-ELECTRONICS Reference Set for TWO WEEKS at our expense! Shows you the way to easier TV-Radio repair—time saving, practical working knowledge that helps you get the BIG money! How to install, service and align ALL radio and TV sets, even color-TV, UHF, FM and transistorized equipment. New photo-instruction shows you what makes equipment "tick." No complicated math or theory—just practical facts you can put to use immediately. Over 3,000 pages; 1200 diagrams; 10,000 facts! Ready to use in shop or home.

SEND NO MONEY! Just mail coupon for 7-Volume TV-Radio Set on FREE BOOK below. If you keep the set, pay only \$3 after TWO WEEKS and \$3 per month until \$27.25 plus postage is paid. Cash price only \$24.95. Or return set at our expense in TWO WEEKS and owe nothing. Offer limited, so act NOW!

"LEARNED MORE FROM THEM THAN FROM 5 YEARS WORK!"

"Learned more from your first two volumes than from 5 years work."
—Guy Bliss, New York

"Swell set for either the serviceman or the beginner. Every service bench should have one."
—Melvin Masbruch, Iowa.

KEEP FREE DIAGRAM BOOK EVEN IF YOU RETURN THE SET

We'll send you this big book, "150 Radio-Television Picture Patterns and Diagrams Explained" ABSOLUTELY FREE just for examining 7-Volume Shop Library on TWO WEEKS FREE TRIAL! Shows how to cut servicing time by reading picture-patterns, plus schematic diagrams for many TV and radio sets. Yours to keep FREE even if you return the 7-Volume Set! Mail coupon TODAY!



Like Having An Electronics Expert Right At Your Side!

ALL 7 BOOKS HAVE WASHABLE, VINYL CLOTH COVERS

VOL. 1—EVERYTHING ON TV-RADIO PRINCIPLES! 300 pages of practical explanations; hundreds of illustrations.

VOL. 2—EVERYTHING ON TV-RADIO-FM RECEIVERS! 403 pages; fully illustrated.

VOL. 3—EVERYTHING ON TV-RADIO CIRCUITS! 336 pages; hundreds of pictures and circuits.

VOL. 4—EVERYTHING ON SERVICING INSTRUMENTS! How they work, how to use them. 368 pages; illustrated.

VOL. 5—EVERYTHING ON TV TROUBLESHOOTING! Covers all types of sets, 437 pages; illustrations, diagrams.

VOL. 6—TV CYCLOPEDIA! Quick and concise answers to TV problems in alphabetical order, including UHF, Color TV and Transistors; 868 pages.

VOL. 7—TRANSISTOR CIRCUIT HANDBOOK! Practical Reference Transistor Applications; over 200 Circuit Diagrams; 472 pages.

FREE BOOK—FREE TRIAL COUPON!

COYNE SCHOOL PUBLICATIONS, Dept. 53-RE
1455 W. Congress Parkway, Chicago 7, Illinois

Yes! Send me COYNE'S 7-Volume Applied Practical TV-RADIO-ELECTRONICS Set for TWO WEEKS FREE TRIAL. Include "Patterns & Diagrams" book FREE!

Name _____ Age _____

Address _____

City _____ Zone _____ State _____

Check here if you are sending \$24.95 in full payment. Same TWO WEEK Money-Back Guarantee applies.

Coyne

SCHOOL PUBLICATIONS

Dept. 53-RE, 1455 W. Congress Parkway, Chicago 7, Ill.

you
can play
your records



manually



or automatically

and enjoy the same quality you associate with turntables that can only be played manually.

The Benjamin-Miracord is fundamentally a quality instrument—designed and constructed to highest quality standards. Its components are those characteristic of the finest record players: solid, die-cast, dynamically balanced, 12-inch turntable; precision-machined, mass-balanced transcription arm; and choice of either high-torque, 4-pole induction motor or the famous Papst hysteresis motor.

Yet, the Miracord can play single records automatically as well as manually, or you can play up to 10 records in automatic sequence. The automatic action of the arm is actually more precise and more gentle than by hand. See and hear the Benjamin-Miracord perform at your hi-fi dealer. Model 10 with 4-pole induction motor, \$89.50; Model 10H with Papst hysteresis motor, \$99.50 (complete with arm but less cartridge and base). For catalog, write to:

BENJAMIN ELECTRONIC SOUND CORP.
80 Swalm Street, Westbury, L.I., New York
Sole U.S. Distributor of Electroacoustic® Record Playing Components



**BENJAMIN
MIRACORD**

NEW LITERATURE

CATALOGS • BOOKLETS • CHARTS

ELECTRONIC COMPONENTS presented in 32-page 1963 catalog. Lists components of all major manufacturers, features industrial tubes, sel-syns, motors, missile and test equipment, precision potentiometers, meters, accelerometers, transducers, gyro test tables, computers. Special sections on relays and technical books. Illustrated with photos, drawings, diagrams.—**American Relays, Electronic Div.**, 39 Lispenard St., New York 13, N. Y.

EDUCATIONAL TV BOOKLET. Illustrated 6-page brochure describes broadcasting, on-air closed-circuit, cable closed-circuit and microwave techniques.—**Industrial Products Div., Adler Electronics, Inc.**, 1 LeFevre Lane, New Rochelle, N. Y.

CONTACT STRIPS AND RINGS offered in 16-page *Catalog E-109*. Shows typical beryllium copper standard contact rings for electron tubes, grounding and contact strips, tube shields and strips, flat stampings, intricate formed parts. Dimensional drawings, electrical, physical, chemical tabulations.—**Braun Tool & Instrument Co., Inc.**, 140 5th Ave., Hawthorne, N. J.

GLASS COLOR FILTERS described in 4-page illustrated pamphlet. Gives advantages of color filters, discusses use for electronic switching, pilot and indicator lights, split-screen color projection, 2- to 4-color switching.—**Corning Glass Works**, Corning, N. Y.

INSTRUMENTATION MODULES FOR DATA ACQUISITION SYSTEMS described in 12-page catalog. Applications and specs for instrumentation amplifiers, signal conditioning modules and standard assemblies for custom timing systems; brief coverage of servo-analyzers, data acquisition and processing systems. Many photos.—**Astrodata, Inc.**, 240 E. Palais Rd., Anaheim, Calif.

AUDIO ACCESSORIES in 32-page 1963 catalog. Includes amplifiers, cartridges, needles, phonograph and tape accessories, rack card items. Features five new amplifiers, line of crystal and ceramic cartridges and arms.—**Qualitone Industries, Inc.**, Tuckahoe, N. Y.

SEMICONDUCTORS presented in 24-page 1963 Condensed Catalog. Charts, drawings, photos describe full line of germanium and silicon, miniature and subminiature transistors and diodes, silicon rectifiers, plus Circuit-Pak and Weld-Pak circuit modules.—**Raytheon Co.**, Semiconductor Div., 350 Ellis St., Mountain View, Calif.

SOUND-LEVEL METER detailed in technical bulletin. Specs, photo and operation data on *Type ELZT* self-contained, 30-120-db sound-level meter.—**Rohde & Schwarz**, 111 Lexington Ave., Passaic, N. J.

ELECTRONIC PARTS offered in 160-page Spring Sale Catalog No. 128. Features *Realistic* line components and test equipment, plus radios, phonos, electrical accessories. Many photos.—**Radio Shack Corp.**, 730 Commonwealth Ave., Boston 17, Mass.

PANEL METERS. 12-page Catalog 21-1 describes 30 models, with photos and full specs. Features slimline and edgewise meters; includes sales data, accessory equipment, meter construction information.—**Triplett Electrical Instrument Co.**, Bluffton, Ohio.

RECTIFIER INTERCHANGEABILITY LIST. Covers three E series "Powercomp" rectifier lines, listed by JEDEC type and mfr's type. Rectifier specs and ratings available in *Bulletins E101, E102, E103*.—**Power Components, Inc.**, P.O. Box 421, Scottsdale, Pa.

VHF POWER AMPLIFIERS. 9-page article by commercial engineer, for amateur radio devotees. Tells how components in vhf amplifiers are affected by stray capacitance, self-inductance, etc., how side-effects are eliminated. Five vhf amplifier tubes detailed, with circuit drawings.—**Dept. TP, Tung-Sol Electric Inc.**, 1 Summer Ave., Newark, N. J.

RANDY, THE TRANSISTOR RADIO, 24-

page hard-cover book for 6-10-year-old readers, illustrated in full color. Tells how a transistor radio is made, how to care for it.—**Ira Morais, Sony Corp. of America**, 580 5th Ave., New York, N. Y.

ELECTRONIC PARTS offered in 384-page 1963 Catalog. Products from approximately 200 manufacturers include amateur supplies, audio equipment, antennas, electronic components, microphones, test equipment, wire and cable, many others. Photos, drawings, complete specs.—**Federated Purchaser**, 155 U. S. Route 22, Springfield, N. J.

PURCHASING AGENTS ELECTRON TUBE GUIDE. 10-page booklet lists all mfr's tubes except TV picture tubes, by type and classification.—**Sylvania Electric Products, Inc.**, 730 3rd Ave., New York 17, N. Y.

FILTERS AND DELAY LINES, 1 cycle to 50 mc, explained in 6-page foldup leaflet. Photos and graphs show complete lines L-C filters, magnetostriction filters, electromagnetic delay lines in lumped-constant and distributed-parameter types.—**Raytheon Co.**, Industrial Components Div., 55 Chapel St., Newton 58, Mass.

POCKET TOOL KIT shown in illustrated Bulletin N163. Photos, complete specs.—**Xcelite, Inc.**, Orchard Park, N. Y.

LIGHT MEASURING INSTRUMENTS displayed in 4-page Circular 06-400, Revised. Photos and specs of sightmeters, illumination meters, foot-candle meters, foot-lambert meters, specialized instruments for measurement of TV studio illumination.—**Weston Instruments & Electronics Div.** of Daystrom, Inc., 614 Frelinghuysen Ave., Newark 14, N. J.

HEAT DISSIPATION DEVICES, 6-page, illustrated folder shows how to select proper heat dissipator for given semiconductor application. Describes Thermo-Flags, Thermo-Vanes, Thermo-Sinks, contains type selection chart based on class of service and air speed.—**Staver Co., Inc.**, Bay Shore, N. Y.

THE SEALED NICKEL-CADMIUM BATTERY CELL. 12-page reprint of technical paper, BA-112. Drawings and specs show detailed cross-section views, physical and electrical characteristics, operational curves.—**Sonotone Corp.**, Battery Div., Elmsford, N. Y.

DC POWER SUPPLIES and ac line regulators presented in 32-page *Designer's Handbook and Catalog*. Single modules, power supplies and assemblies, built-to-order units, with photos and complete specs.—**Dressen/Barnes Electronics Corp.**, 250 N. Vinedo Ave., Pasadena, Calif.

FM ANTENNAS pictured and described in 6-page foldup leaflet. Features Stereo-Cone omnidirectional unit, twin-driven Yagi, Transis-Tenna amplifier, plus turnstile antenna kits.—**JFD Electronics Corp.**, 6101 16th Ave., Brooklyn 4, N. Y.

HANDBOOK OF VOLTAGE CONTROL WITH THE VARIAC AUTOTRANSFORMER. 40-page booklet includes principles of autotransformers, descriptions and diagrams of Variac circuits, data on use of autotransformers for incandescent and fluorescent dimming, maintaining color temperature in photography, and lab, heating, motor speed applications. Over 80 circuit diagrams, charts, photos.—**General Radio Co.**, West Concord, Mass.

END

Any or all of these catalogs, bulletins, or periodicals are available to you on request direct to the manufacturers, whose addresses are listed at the end of each item. Use your letterhead—do not use postcards. To facilitate identification, mention the issue and page of RADIO-ELECTRONICS on which the item appears. UNLESS OTHERWISE STATED, ALL ITEMS ARE GRATIS. ALL LITERATURE OFFERS ARE VOID AFTER SIX MONTHS.

new PATENTS

Selective Infrared Detector

PATENT No. 2,994,053

Russell D. DeWaard, Old Greenwich, Conn. (Assigned to Barnes Engineering Co., Stamford, Conn.)

This thermistor responds instantly to a narrow band of radiation. A thin semiconductor film is immersed within a germanium lens. Because of its tiny dimensions, the thermistor heats and cools

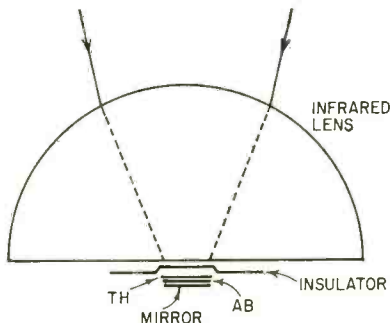

rapidly, so it can detect chopped (intermittent) radiation. In such a case the output is ac, which is easily amplified.

Radiation focused by the lens falls on transparent thermistor TH. It passes through AB, a layer which passes some wavelengths and absorbs others, and is reflected through AB. Thus the radiation returns through AB. Heat is generated when radiation is absorbed, so the thermistor is heated only by the desired wavelengths.

Fast Switching

PATENT No. 2,995,637

Alexander Feiner, Whippany; Clarence A. Lovell, Summit; Terrell N. Lowry, Boonton; Philip G. Ridinger, Boonton, N.J. (Assigned to Bell Telephone Lab., Inc., New York, N.Y.)

This fast-acting switch can be closed by a pulse of current. The magnetic system comprises two vertical bars of ferrite. E1 energizes one bar

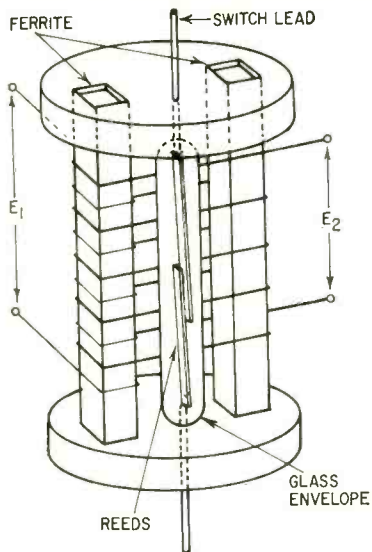

alone, while E2 energizes both. The switch contacts are flat reeds sealed within an envelope.

Ferrite is easily driven into saturation by a magnetic field. It retains its magnetism after the field is removed. A reverse field will saturate the ferrite to the opposite polarity.

In the diagram shown here, a pulse from E2 will saturate both bars in the same direction. This

MAY, 1963

IF YOU SELL, SERVICE OR GIVE ORDERS, YOU NEED SONAR BUSINESS RADIO

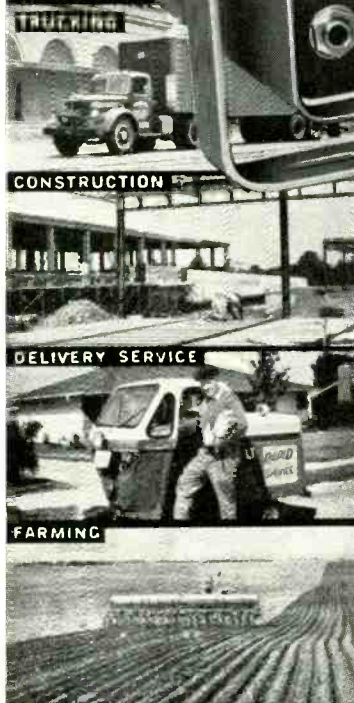

A complete power-packed dependable performer!

Quality designed and engineered for years of service and dependability • Compact and lightweight • Easily installed in smallest vehicles • Smartly styled for office use • Greater range because of Voice-Power designed circuitry • Unexcelled reception • Noise-free squelch • Heavy-gauge aluminum construction • Easily serviced • Wired for instant use of the "Sonar-Call" selective calling system • Wired for Sonar High Power Linear Amplifier operation • 1 year warranty • 12 VDC or 117 VAC and 6 VDC or 117 VAC operation • Size: 11¼" L x 9½" W x 4¾" H • Weight: 10 lbs.

BR-20 Business Radio complete with mike, 2 crystals and 2 power cables

\$229.50

SONAR RADIO CORPORATION

73 Wortman Ave., Brooklyn 7, N. Y.

Please send me complete information on Business Radio BR-20

Name _____

Address _____

City _____ Zone _____ State _____

Dept. 238

100 and 1 uses in every type of industry and business

- Delivery services
- Garage
- Motor Carrier
- Construction
- Road building
- Farm
- Doctor
- Telephone maintenance
- Security guards

QUICK and LASTING

When You Use HUSH®

Chemically-Electronically, engineered for Tuners and Switching Mechanisms.

When New HUSH is applied it will wash-away that dirt, leaving clean and positive contacts protected by a lasting lubricant. New HUSH is made from the finest solvents and it contains Electro-Silicone oils.

6 oz. Spray can. Also available 2 oz., 8 oz., 32 oz. containers
FREE 6" Plastic Extender With Every Can

EVER-QUIET®

Since 1949

VOLUME CONTROL AND CONTACT RESTORER

EVER-QUIET is a free-flowing liquid that leaves no powder residue. Scientifically designed to seep around the shaft and penetrate the control or potentiometer, cleaning the contacts and leaving a safe protecting film. Harmless to metals, wire or carbon.

2 oz. Bottle & dispenser. Also available—6 oz. Spray can



CHEMICAL ELECTRONIC ENGINEERING, INC., Matawan, New Jersey

The world's smallest watch, \$3000
 Courtesy of Vacheron & Constantin-LeCoultre Watches, Inc.

Swiss precision makes the difference



THORENS

TD-124 TRANSCRIPTION TURNTABLE

CRAFTSMANSHIP — unique in its precision — superlative in its design and style. These are the marks of a fine Swiss watch; on these qualities the Swiss firm of Thorens has built its reputation.

No one surpasses the Swiss in precision manufacturing. And no one has surpassed the precision-crafted Thorens TD-124 either . . . with its built-in versatility, its more conveniences, more features than any other turntable available.

A mere glance beneath the table tells you why: Machined parts, precision balanced, polished to mirror-like finishes — no mere metal stampings these! The finest features of a belt drive . . . plus idler wheel . . . plus an 11½ pound, machine-balanced table!

Visit a franchised dealer, and see the TD-124 and all the family of fine Thorens turntables . . . compare with any other! Or write us for full specifications. Dept. RE-5

Guaranteed for One Full Year.

TD-124—\$125 net BASES from \$10 to \$35



Thorens TD-121
 \$85 net

. . . a new Swiss-precision Thorens for those requiring only 33½ rpm or other single speed.



ELPA MARKETING INDUSTRIES, Inc.
 THORENS DIVISION • New Hyde Park, N. Y.

In Canada: Tri-Tel Associates Ltd., Willowdale, Ont.

sets up a strong field that will pull the contacts together. If a reverse pulse is applied by E1, its bar will be oppositely saturated. We now have two opposite fields which cancel, and the contacts open.

Dual Power Supply

PATENT No. 3,053,991

(May be manufactured or used by the U.S. Government without payment of royalties)

Two separate outputs are available from the same transformer. Rectified output from V1 is filtered by a conventional choke-input filter to provide E1. It is also passed through V2 for capaci-

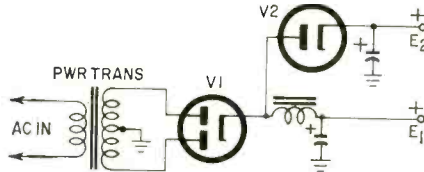

tor-input filtering to provide E2. E2 is about 40% higher (at low drains) than E1.

Note that the piv rating of V2 need be only half the peak rating of the transformer.

Improved Clamping Device

PATENT No. 2,980,806

Donald L. Ort, Los Angeles, Calif. (Assigned to Litton Systems, Inc., Beverly Hills, Calif.)

A simple square-wave generator can be made with a pair of diodes. When a signal (sine wave, for example) appears across a diode, the diode conducts when the voltage is high enough. The result is a flattened wave. If both alternations are flattened well down on the "straight" portions, the result is a square wave.

Actually, a diode has appreciable resistance even during conduction. Furthermore, its resistance varies with signal strength, so the resulting wave is not exactly square.

Clamping can be made better with half of a transistor (see the figure). Each transistor clips one peak. The drop between emitter and base is

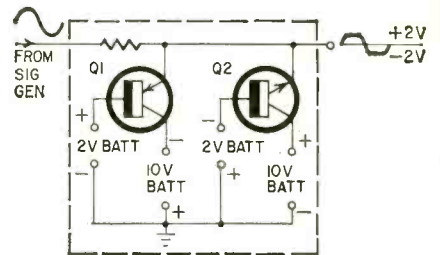

negligible because base current is always small. In addition, the narrow base region of a transistor eliminates transient delay time, which may be troublesome in a diode at high frequencies. END



"The shop downtown repaired it for nothing? Care to step over here and repeat that?"

PROFESSIONAL technicians

USE
Dave Rice's
 OFFICIAL
 ORDER BOOKS

for every
 TV-RADIO
 service
 call



This is the businesslike approach to service record keeping. Triuplicate forms serve as order form, invoice and office record, with spaces for complete information on every job. Separate listings for receiving tubes, pix tube, parts, serial numbers, labor and tax charges, signatures, etc. 75c a book, \$6.50 for dust-proof box of 10. In stock at your distributor.

FREE

Write for your free folder describing Dave Rice's OFFICIAL ORDER BOOKS, including an actual size sample copy of the handy order form.

ELECTRONIC PUBLISHING CO., INC.
 133 N. JEFFERSON ST.
 CHICAGO 6, ILLINOIS

FREE Catalog OF THE WORLD'S FINEST ELECTRONIC GOV'T SURPLUS BARGAINS



HUNDREDS OF TOP QUALITY ITEMS— Receivers, Transmitters, Microphones, Inverters, Power Supplies, Meters, Phones, Antennas, Indicators, Filters, Transformers, Amplifiers, Headsets, Converters, Control Boxes, Dynamotors, Test Equipment, Motors, Blowers, Cable, Keys, Chokes, Handsets, Switches, etc., etc. Send for Free Catalog—Dept. RE.

FAIR RADIO SALES
 2133 ELIDA RD. • Box 1105 • LIMA, OHIO

Please mention
RADIO-ELECTRONICS
 when answering advertisements

TV CAMERA \$99.50



Basic
 Parts
 Kit

Details:
 FREE FLYER
 No. 771

DENSON ELECTRONICS CORP.
 Rockville, Connecticut

RADIO-ELECTRONICS



Corner Case for Electronics

There are corner enclosures for speakers, women's jewelry boxes, and tuckaway bins of all sorts, but this space-saving idea seems to have been overlooked on the workbench where the clutter of test instruments is notorious.

Here is an instrument built in a corner case to show how it can be done. This case was made from heavy cardboard, since shielding was not needed and we have no equipment for forming sheet metal neatly. It fits snugly into the wall-corner end of the bench and can be read and adjusted with no trouble. In fact, it really *faces* the operator who is sitting downbench from it. Don't you ordinarily have to turn a far instrument

at just such an angle to read it without moving?

The instrument uses the transistorized voltmeter circuit shown on page 110 of Gernsback Library's Book No. 63, *Transistor Circuits*, with the top

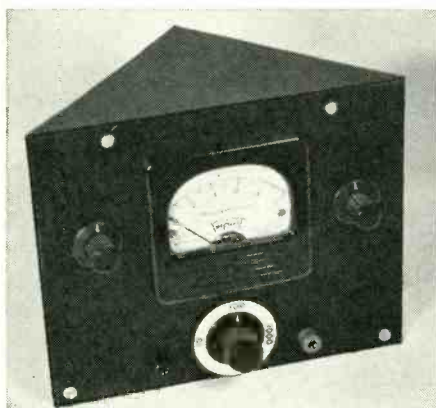

range changed to 1,000 volts and a separate ON-OFF switch (upper left) added.—*Rufus P. Turner*

Printed-Circuit Service Aid

It is easier to locate a particular solder connection in a maze of printed-circuit wiring when you use a jumper made by soldering two small pee-wee clips (such as Mueller No. 88) to the ends of a 2-inch length of thin flexible wire. For most purposes it is best to insulate as much of the clip as possible

TRANSISTORIZED POWER CONVERTER

12 VOLT DC to 117 VOLT AC

FOR ONLY \$ **29.95** DEALER NET

POWERFUL 125 WATT CONTINUOUS DUTY. PROVIDES 117 VOLT 60 CYCLE AC BY PLUGGING INTO CAR OR BOAT 12 VOLT CIGARETTE LIGHTER RECEPTACLE.

PLUGS INTO CIGAR LIGHTER



MODEL BX125

MADE IN U.S.A.

ASK YOUR ELECTRONIC PARTS DISTRIBUTOR FOR

TRANSVERTER

Designed and Manufactured by:

WORKMAN *Electronic*
SARASOTA, FLORIDA PRODUCTS, INC.

ELECTRONIC TECHNICIANS

STATESIDE & OVERSEAS POSITIONS

Openings for men trained or experienced in military electronics to maintain or instruct in the following:

**COMMUNICATIONS
RADAR
COMPUTERS**

Let us review YOUR BACKGROUND NOW so that we may arrange for a personal interview with you in or near your home city. Save time and S-P-E-E-D your answer. Fill in the coupon below and mail to:

PHILCO TECHREP DIVISION

A Subsidiary of Ford Motor Company
P.O. BOX 4730—PHILADELPHIA 34, PA.

Please Mail This Coupon To The Above Address
c/o Department 804

MY NAME IS

ADDRESS

CITY PHONE

Discharge Rate or Rank

Branch of Service

Military or Commercial Electronic Exp.

.....

Educational Background

.....

An Equal Opportunity Employer

Superior's New Model 820

TUBE TESTER

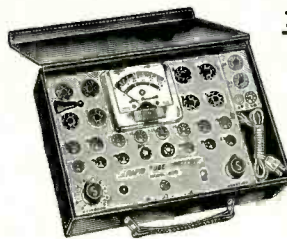

TESTS ALL MODERN TUBES
INCLUDING THE NEW

- ✓ NOVARS
- ✓ NUVISTORS
- ✓ 10 PINS
- ✓ 12 PIN COMPACTRONS

- Employs new improved emission circuit.
- Tests over 850 tube types.
- Tests 0Z4 and other gas filled tubes.
- Employs new 4" meter with sealed air-damping chamber resulting in accurate vibrationless readings.
- Use of 26 sockets permits testing all popular tube types.
- Dual Scale meter permits testing of low current tubes.
- 7 and 9 pin straighteners mounted on panel.
- All sections of multi-element tubes tested simultaneously.
- Ultra-sensitive leakage test circuit will indicate leakage up to 5 megohms.

Model 820 comes complete with tube charts and instructions; housed in handsome, portable, Saddle-Stitched Texon case. Only **\$3850**

SHIPPED ON APPROVAL
NO MONEY WITH ORDER — NO C. O. D.

Try it for 15 days before you buy. If completely satisfied then send \$5.00 and pay balance at rate of \$5.00 per month until total price of \$38.50 (plus postage) is paid — No Interest or Finance Charges Added! If not completely satisfied, return to us, no explanation necessary.

MOSS ELECTRONIC, INC.
DEPT. D-9583849 Tenth Ave., New York 34, N.Y.
Please rush Model 820. If satisfactory, I will pay on terms specified. Otherwise I will return tester.

Name

Address

City Zone State

All prices net. F.O.B. N.Y.C.

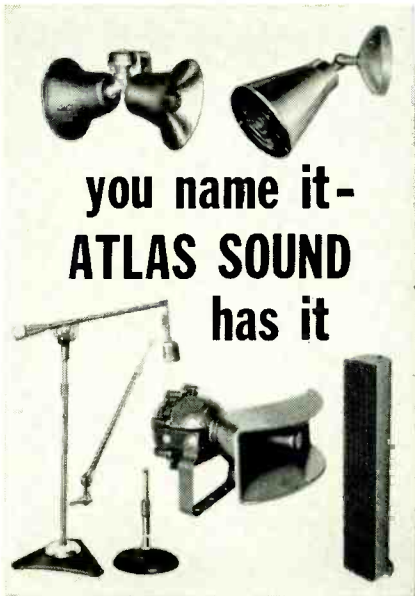

you name it-
ATLAS SOUND
has it

**CHOOSE FROM A FULL
LINE OF P.A. SPEAKERS
AND MIKE STANDS**

There's an Atlas Sound speaker and accessory just right for any job. From horn projectors to sound columns to support stands—all engineered for the application, priced for your profit, and supplied to serve all your needs. Atlas Sound quarter-century leadership is your best guarantee of satisfaction.

And, as it is with speakers, so it is with mike stands, boom stands, desk stands—support accessories, fittings and hardware—they're built better to last longer. Only Atlas Sound offers such a complete line. For the well-engineered, professional sound installation—turn to Atlas Sound.



Breakthrough
In Design, Materials,
Performance

**ATLAS SOUND EC-10
ALL-NEW
PAGING SPEAKER**

\$23.75 list

Every way you look at it, this compact, weather-proof, American-made speaker is 100% NEW. It's a powerhouse of crisp, articulate sound for a wide variety of uses. Precision-molded Implex* horn assures vibration-free, resonance-free output. Improved magnetic circuit features new ceramic magnet. Handsome 2-tone colors blend with any decor. Adjustable, versatile bracket.

Specs: 6 watts; 8 ohms (also 45 ohms); Length 6 3/8"; Bell Diameter 6 1/4"; Weight 2 lbs. Special Model T-4 line matching transformer available.

*t.m. Rohm & Haas — new, tough, all-weather plastic.



Write for full details and latest catalog
ATLAS SOUND

Division of
American Trading and Production Corporation
1419-51 39th Street, Brooklyn 18, N. Y.
In Canada: Atlas Radio Corp. Ltd., Toronto

with an insulating sleeve.

The jumper is used, for example, to short out a mounted tubular capacitor. Use probes, from a meter set to the low-ohms range, to locate the zero reading (across the shorted capacitor) and mark the underside of the circuit board. This shorting out of components and checking for zero readings saves much time when compared with the normal hunt-and-pick method.—*A. von Zook*

0-2-volt Range on EICO 221

You can very easily add a 0-2-volt dc range to your EICO 221 vtvm; it'll be useful for measuring transistor bias voltages, for instance. Simply make another dc probe similar to the existing one, but omit the 15-megohm resistor. Use shielded wire for making the probe and lead. Make readings on the vtvm's 0-10-volt scale and multiply the reading by 0.2.—*James C. Letzelter*

**Socket Adapter Fixes
CRT Shorts**

The octal base from a discarded vacuum tube can be used to obtain high voltage for burning out interelement shorts in CRT's on transformer-powered chassis.

Pin jacks wired to base pins 4 and 6 will allow the transformer secondary

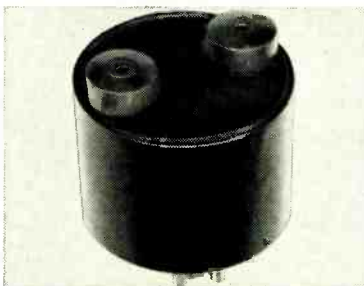

high-voltage ac to be conveniently applied to the CRT base pins with ordinary pin-tipped test leads. The socket base is plugged into the rectifier tube socket.

WARNING: Peak voltages of nearly 1,000 volts may be found across these pin jacks and anything plugged into them—half that much to the chassis. Use alligator clips to connect to the CRT base pins. Turn on the power after the clips are hooked on.

For additional safety, a CRT socket with 3-foot leads (terminated in pin tips) would allow base-pin selection, and contact with hot wires would not be necessary.

The base of the octal tube should be filled with some insulating compound. Tar or wax will do. Any of the semi-rigid plastic casting compounds will work, too.—*E. C. Carlson*

**Converting 3-Speed Players
for 16-rpm Records**

Many 33-, 45- and 78-rpm turntables can be converted to play 16-rpm records. Remove the turntable and locate

**NEW 1963 TWO WAY RADIO
5 TRANSISTOR TRANSCIVER**

CITIZENS BAND

Hams, Hunters, Rangers, Construction, Farmers, Boating, Sportsmen. It's a genuine rugged 5 transistor factory-wired walkie-talkie at a pleasantly low price. Has sensitive super-regenerative receiver and crystal-controlled transmitter with maximum legal power citizens band transceivers, built in 2 1/2" speaker. Removable whip antenna, 5 sections, extends to 30". Attractive durable steel case 6 x 2 3/4 x 1 1/4". Compact hand held unit. Fully guaranteed. Shipping weight 15 oz. Mfg. in U.S.A.



**Specially
Priced at
\$10.75 Ea.**

With 9V Battery, plus 75 cents for shipping and handling

WARREN ELECTRONICS CO.
89 Chambers St., Dept. A, New York 7, N.Y. WO 2-5727
No C.O.D. Send Check or Money Order

**SILICON
TOP HATS
OR DIODES**



**750 MA
LOWEST PRICES
GUARANTEED**

LOW LEAKAGE NEWEST TYPE

PIV/RMS 50/35 .05 ea.	PIV/RMS 100/70 .09 ea.	PIV/RMS 200/140 .12 ea.	PIV/RMS 300/210 .18 ea.
PIV/RMS 400/280 .23 ea.	PIV/RMS 500/350 .28 ea.	PIV/RMS 600/420 .38 ea.	PIV/RMS 700/490 .50 ea.
PIV/RMS 800/560 .58 ea.	PIV/RMS 900/630 .68 ea.	PIV/RMS 1000/700 .78 ea.	PIV/RMS 1100/770 .88 ea.

ALL TESTS! AC & DC FVD!
ALSO TESTED ON LOAD
100 Dif. Pre. Res. 1/2, 1, 2 WATT-1% Tol. \$1.25
G.E. IN91 Diode-10 for \$1.00, 100 for \$8.00
Special 8 Amp. 400 V Sil. Stud Rect. 10 for \$9.50

SILICON POWER DIODE STUDS

Amps	Piv	Sale	Amps	Piv	Sale
3	50	\$0.15	35	50	\$1.30
3	100	.30	35	100	1.55
3	200	.40	35	200	2.00
3	400	.65	35	400	3.00
3	600	.75	50	50	2.25
3	50	.60	50	100	3.25
12	100	.80	50	200	4.00
12	200	1.00	100	50	2.75
12	400	1.50	100	100	3.50
12	600	2.00	100	300	4.00

All material guaranteed. \$2.00 min. order. Orders F.O.B. NYC. Include check or money order. Shpg. charges plus. C.O.D. orders 25% down.

WARREN ELECTRONICS CO.
NYC 7, NY 87 Chambers St. WO 2-5727

IF YOU CHANGE YOUR ADDRESS...

PLEASE NOTIFY US

For most efficient service, send us the actual address label pasted on the lower right corner of the front cover. If not possible, send your name and new address with all numbers appearing on label. Include postal zone of the new address, if any.

IMPORTANT: Don't delay. Tell us your new address as soon as you know it so that you receive Radio-Electronics without interruption.

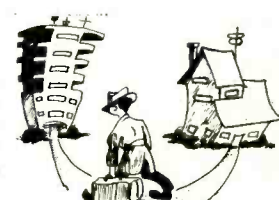

Send data to:

RADIO-ELECTRONICS

SUBSCRIBER SERVICE

154 West 14th Street, New York 11, N. Y.

RADIO-ELECTRONICS

the stepped three-speed drive spindle. On some models it is possible to loosen the setscrews of the stepped drive enough to let the motor shaft make contact with the turntable idler wheel. Replace the turntable and check the new motor speed with a stroboscopic disc.

If the turntable speed is still faster than 16-rpm, the diameter of the motor shaft can be reduced, using the motor, in effect, as its own lathe. This is done by removing the idler wheel and holding a fine-cutting flat file against the top section of the motor shaft as it turns. Reduce the shaft diameter slowly, checking with the strobe disc on the assembled turntable until 16-rpm is obtained.

It is still possible to play 78-rpm records—just raise the three-step drive into its original position.—*Alfred J. Elboz*

Bottles Are Low-Loss Coil Forms

Experimenters and builders who wind their own coils will find that empty plastic bottles that once contained dish-washing detergent or similar liquid are made to order for their needs. Such a coil can be mounted on a chassis panel

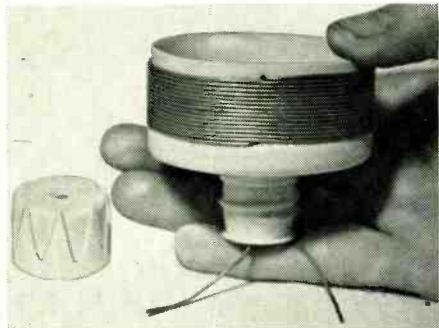

by drilling a hole to accept the bottle's neck and using the lid (on the other side of the panel) as a "nut" to mount the coil upright. If the form is too long, you can trim it down to length very easily with a sharp knife. Drill a hole in the lid if you have to feed the wires down through.—*John A. Comstock*

Setting Up a New Shop? Try a Filling Station

The radio technician seeking a location for his business will do well to look into gasoline service stations that have been relinquished by their operators.

They frequently make ideal locations. For example, they can become drive-in spots for radio servicing. They have ample parking room on their driveways, and they're usually strategically located. You can pull cars into the lubrication bay or wash rack for indoor service in bad weather and you can keep a service truck or two sheltered there, and with the cut-throat competition that characterizes gas stations, they're available in about every area.—*Henry Josephs, Sr.*

END

ELECTRONICS

Engineering-Technicians

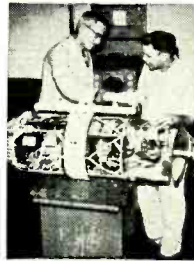

Heald's Microwave and Radar Laboratory Equipment.

The Nation's increased demand for Engineers, Electronic Technicians, Radio TV Technicians is at an all time high. Heald Graduates are in demand for Preferred High Paying Salaries. Train Now for a lucrative, satisfying lifetime career.

Bachelor of Science Degree, 30 Months
Save Two Years' Time

- Radio-Television Plus Color Technician (12 Months)
- Electronics Engineering Technology (15 Months)
- Electronics Engineering (B.S. Degree)
- Electrical Engineering (B.S. Degree)
- Mechanical Engineering (B.S. Degree)
- Civil Engineering (B.S. Degree)
- Architecture (B.S. Degree)

Approved for Veterans
DAY AND EVENING CLASSES

Write for Catalog and Registration Application,
New Term Starting Soon.

HEALD'S ENGINEERING COLLEGE

Established 1863

Van Ness at Post, RE
San Francisco, Calif.

Your Name _____
Address _____
City _____
State _____



TOO HIGH?

Mail us your list of components for a Price-Crushing quote on your stereo hi-fi needs!

Write too for our valuable audio discount catalog A-17.

KEY ELECTRONICS CO.
120 Liberty St. New York 6, N. Y.



Convert any television to sensitive, **BIG-SCREEN OSCILLOSCOPE** with minor, inexpensive changes. Ingenious circuit. No electronic experience needed to follow our clearly illustrated plans. **TECHNICIANS, HAMs, EXPERIMENTERS, BROADCASTERS.** Use in shop, school, lab. Any size—any size screen.

FULL PLANS \$2
RELCO, Dept. RE-5, Box 10563, Houston 18, Tex.

"TAB", SILICON 750MA* DIODES

*NEWEST TYPE! LOW LEAKAGE!			
Piv/Rms	Piv/Rms	Piv/Rms	Piv/Rms
50/35	100/70	200/140	300/210
.05 ea.	10 ea.	14 ea.	20 ea.
400/280	500/350	600/420	700/490
.25 ea.	.30 ea.	.40 ea.	.52 ea.
800/560	900/630	1000/700	1100/770
.60 ea.	.70 ea.	.80 ea.	.90 ea.

All Tests! AC & DC & FWD! Load!

Kit Zener Diodes up to 400MV.....3 for \$1
Kit Stabistor Diodes up to 1 Watt.....4 for \$1
Kit Photo Sun Cells, Ass'd Sizes.....4 for \$1
Weston Std Voltac Cell \$4 @. 3/\$10

Silicon Power Diode Studs				
D.C. Amps	50Piv 35Rms	100Piv 70Rms	150Piv 105Rms	200Piv 140Rms
3	.25	.35	.45	.55
12	.70	.95	1.20	1.45
35	1.40	1.65	1.85	2.15
100	2.90	3.60	3.80	4.15
240	4.50	5.70	6.90	8.40
D.C. Amps	300Piv 210Rms	400Piv 280Rms	500Piv 350Rms	600Piv 420Rms
3	.70	.85	1.20	1.40
12	1.65	1.90	2.70	3.69
35	2.90	3.90	5.20	6.60
100	4.50	5.70	6.90	8.40

Send for Data Write for Quantity
240 16.50 24.50 Export & O.E.M. Prices

GTD! Octal Silicon—SU4G—Tube Replacement
1120Rms 1600Piv \$4 @. 2 for \$6; 4 for \$10
5R4 Silicon 1900 2800Piv \$4
866A Silicon 5000 10400Piv \$9
O24 Silicon \$1.50 @. 4 for \$5

"TAB" FOR TRANSISTORS & DIODES!!!!

Full Leads Factory Tested & Gtd! U.S.A. Mfg.
PNP 50Watt/15Amp H. Power TO38 Pkg!
2N441, 442, 277, 278, D5501 up to
50 volts VCB0 1 @. 12 for \$10 up to
2N278 443, 174 up to 80V VCB0 \$3 @. 4 for \$10
PN/10Watt/3A-2N155, 156, 235, 242, 254,
255, 256, 257, 301, 351 ea. @. 5 for \$2
PNP/2N107, 123, 218, 223, 1191, 1265, GT222,
TR722 & CK722 c25 @. 5 for \$4
NPN/2N55, 94, 194, 213, 214, 216, 228, 233,
292, 293, 306, 516, 517, 1101 c39 @. 3 for \$1.
100 for \$30
PNP 2N670/300M c50 @. 10 for \$4, 100 for \$35
PNP 2N671/1Watt c75 @. 10 for \$6, 100 for \$50
Silicon PNP/T05 & T018 Pkg! 2N327A, 33208
2N474 to 9, 480, 541 to 3, 935 to 7 & 1276 to 9
c59 @. 8 for \$4, 25 for \$10
Round or Diamond Base Mica Mtd Kit c30 @.
Power Heat Sink Fins 80 \$4 \$1.39 \$2 Min. order
Kit Glass Diodes equiv. 1N34A, 46, 48, 51,
12 for \$1, 100 for \$6, 1000 for \$50

D.C. POWER SUPPLY 115V/60to800Cvs Imp.
330x165VDC up to 150MA. CASED! SPECIAL \$5

"TAB" TERMS: Money Back Guarantee!
Our 188¢ year \$2 Min. order
F.O.B. N.Y.C. Add ship charges
or for C.O.D. 25% Dep. Prices
shown subject to change.
111-RE Liberty St., N. Y. 6, N. Y.
Send 25¢ Phone: RECTOR 2-6245 for Catalog



AMAZING OFFER

RADIO & TV SERVICE DATA
Your best, complete source for all needed RADIO and TV diagrams and helpful servicing data. Most amazing values. Only \$2.50 and \$3 per giant volume. Cover all important makes, models of all periods. Use this entire ad as your no-risk order form.

NO-RISK ORDER COUPON

TELEVISION SERVICE MANUALS

Supreme TV manuals are best for faster, easier TV repairs. Lowest priced. Factory data on practically all sets. Complete circuits, all needed alignment facts, wiring board views, waveforms, voltages, production changes, and double-page schematics. Only \$3 per large annual manual. Check volumes wanted, send entire advertisement as your order form.

RADIO DIAGRAM MANUALS

Here are low-priced radio manuals that simplify repairing. Cover everything from most recent 1963 radios to pre-war old-timers; home radios, stereo, combinations, transistor portables, FM, and auto sets. Large schematics, all needed alignment facts, printed boards, voltages, dial stringing, hints. Volumes are big, 8 1/2 x 11", about 190 pages, each.

\$2.50

- 1963, 1962, 1961, 1960, 1959, 1958,
- 1957, 1956, 1955, 1954, 1953, 1952,
- 1951, 1950, 1949, 1948, 1947, 1946,
- 1942, 1941, 1940, 1926-38, EACH, \$2.50

SUPREME PUBLICATIONS

1760 Balsam Road, Highland Park, ILL.

Rush today TV and Radio manuals checked in no-risk order form of this ad. Send postpaid, I am enclosing full price. You guarantee my complete satisfaction or my money back.

Name: _____
Address: _____
City: _____ State: _____

R-E**Classified****ADS**

Rates—55¢ per word (name of city, each abbreviation, each set of characters as in key counts as one word; zone number free.) Minimum ad 10 words. Payment must accompany all ads except those placed by accredited advertising agencies. Misleading or objectionable ads not accepted. Copy for July issue must reach us before May 10, 1963 RADIO-ELECTRONICS, 154 West 14 St., New York 11, N. Y.

SERVICES

METERS—MULTIMETERS REPAIRED and calibrated. **BIGELOW ELECTRONICS**, Box 71-B, Bluffton, Ohio.

PATENT SEARCHES, \$6.00! Free "Invention Record"/Information.—**MISS HAYWARD**, 1029 Vermont, N.W., Washington 5, D.C.

TRANSISTORIZED products dealers catalog, \$1. **INTERMARKET**, CPO 1717, Tokyo, Japan.

ALL MAKES OF ELECTRICAL INSTRUMENTS AND TESTING equipment repaired. **HAZELTON INSTRUMENT CO.**, 128 Liberty St., New York, N.Y.

SPEAKER RECONING. Satisfaction Guaranteed. **C & M RECONE CO.**, 18 E. Trenton Ave., Morrisville, Pa.

TV Tuners—rebuilt or exchanged, \$9.95. Fast, Guaranteed. Complete crystal control alignment. **VALLEY TUNER SERVICE**, 5641 Cahuenga, North Hollywood, Calif.

TV TUNERS REBUILT AND ALIGNED Per manufacturer's specification. Only \$9.50. Any make UHF or VHF. We ship COD. 90-day written guarantee. Ship complete with tubes or write for free mailing kit and dealer brochure. **J. W. ELECTRONICS**, Box 51D, Bloomington, Ind.

SPANISH TRANSLATIONS by Electronics Engineer. **L. SICHEL**, 311 St. Marks Place, Staten Island, N. Y.

WANTED

CASH PAID! Sell your surplus electronic tubes. Want unused, clean radio and TV receiving, transmitting, special purpose, Magnetrons, Klystrons, broadcast types, etc. Want military & commercial lab/test and communications equipment such as G.R., H.P. AN/UPM prefix. Also want commercial receivers and transmitters. For a fair deal write **BARRY**, 512 Broadway, New York 12, N.Y. WALKER 5-7000.

G-R, H-P, L&N, etc., Tubes, manuals, military electronics. **ENGINEERING ASSOCIATES**, 434 Patterson Road, Dayton 19, Ohio.

**EDUCATION/
INSTRUCTION**

LEARN WHILE ASLEEP. Hypnotize with your recorder, phonograph or amazing new Electronic Educator endless tape recorder. Catalog, details free. **SLEEP-LEARNING ASSOCIATION**, Box 24-RD, Olympia, Wash.

NEW CONCEPT OF LEARNING SELF-HYPNOSIS! Now on tape or record! Free Literature. **McKINLEY-SMITH CO.**, Dept. T5, Box 3038, San Bernardino, Calif.

FCC LICENSE in 6 weeks, First Class Radio Telephone. Results Guaranteed. **ELKINS RADIO SCHOOL**, 2603E Inwood, Dallas, Tex.

LEARN ELECTRONIC ORGAN SERVICING. New Home Study courses covering all makes electronic organ including transistors. Experimental kits—schematics—troubleshooting. Accredited NHSC-GI Approved. Write for free booklet. **NILES BRYANT SCHOOL**, 3631 Stockton Blvd., Dept. F. Sacramento 20, Calif.

LEARN HYPNOSIS. Free illustrated catalogue. Write: **HYPNOTIST**, 8721 Sunset, Los Angeles 69RE, Calif.

COLLEGE HOME Study Courses from leading universities. Full credit towards Bachelor's or Master's degree. 5,000 course directory \$2.00. **COLLEGE RESEARCH**, North Highlands 14, Calif.

PIANO TECHNIC Simplified. \$1.25. **WALTER KAZAKS**, 234 E. 58th St., New York 22, N.Y.

FOR SALE**General**

FREE INSTRUCTION MANUAL with purchase of 10 scale slide rule—\$4.00. Illustrative, Self-Teaching Course—\$2.00. Save! Combination only \$4.95 postpaid. No COD. **ALSYNCO**, Dept. RE-3, 171 So. Main, Natick, Mass.

SOLDERING-IRON CORD SWITCH \$1.00. Gives two heats for better soldering. Unusual electrical devices catalog 25¢. **WELLSCO**, Box 3443, Granada Hills, Calif.

BEFORE You Buy Receiving Tubes, Test Equipment, Hi-Fi Components, Kits, Parts, etc. . . . send for your Giant Free Zalytron Current Catalog, featuring all STANDARD BRAND TUBES all Brand New Premium Individually Boxed, One Year Guarantee—all at BIGGEST DISCOUNTS in America! We serve professional servicemen, hobbyists, experimenters, engineers, technicians, WHY PAY MORE? **ZALYTRON TUBE CORP.**, 461 Jericho Turnpike, Mineola, N. Y.

FREE CATALOG—name-brand tubes 65% discount, phono needles 80% or more discount, phono cartridges, picture tubes 75¢ inch, parts, parts kits, silicon and selenium rectifiers, transmitting tubes, 7" TV test tube \$6.99, imported batteries, tube testers etc. Want to swap or sell tube inventory? Send us your offering. **ARC-TURUS ELECTRONICS CORP.**—Dept. R.E., 502 22nd St. Union City, N. J.

Electronics

PRINTED CIRCUIT BOARDS—Hams, Experimenters. Board for Garage Door Opener, January issue RADIO-ELECTRONICS. \$1.50—Free Catalog. **P/M ELECTRONICS**, Box 6288, Seattle 88, Wash.

FREE LITERATURE keeping you informed on the latest work-saving, money-making test equipment. Learn how Easy Budget Payment Plan lets you pay out of increased earnings. Top engineered test instruments are priced for tremendous value. Write today. **CENTURY ELECTRONICS**, 352 Maple Ave., Westbury, N.Y.

15 DISTANCE ONE-TUBE plans—25¢; One-tube Handbook—50¢. Includes Transistor experiments, catalog. **LABORATORIES**, 1131-B Valota, Redwood City, Calif.

TRANS-NITION Electronic Ignition parts kit, Negative ground \$25. Coil, Manual SPECIAL \$8.50. Manual \$2. **ANDERSON ENGINEERING**, Wrentham, Mass.

GOVERNMENT SURPLUS. Jeeps—\$223.83, Transmitters—\$6.18, Receivers—\$5.65, Typewriters—\$4.15, Oscilloscopes, Multimeters, Speakers, Walkie-Talkies. Typical Government Surplus prices. Exciting details FREE. **N.Y. ENTERPRISES**, Box 402-F15, Jamaica 30, N.Y.

CB TRANSMITTERS \$6.00. Other bargains, send 10¢ for list. **VANGUARD**, 190-48—99th Ave., Hollis 23, N.Y.

RADAR: Largest surplus stock in the world. **RADIO RESEARCH INSTRUMENT CO.**, 550 Fifth Avenue, New York 36, N.Y.

SCHEMATICS FOR TV, RADIO. \$1.00. **DEES ELECTRONICS**, 5945 Beverly Lane, RR #2, Middletown, Ohio.

SAVE DOLLARS on radio, TV tubes, parts at less than manufacturer's cost. 100% guaranteed! No rebrand, pulls. Request Bargain Bulletin. **UNITED RADIO**, 1000-R, Newark, N.J.

DIAGRAMS for TV, \$2.50; for radio, \$1.25. **HIETT DIAGRAMS**, Box 816, Laredo, Tex.

PROFESSIONAL ELECTRONICS PROJECTS—Organs, Timers, Computers, etc.—\$1 each. List free. **PARKS**, Box 1665, Lake City, Seattle 55, Wash.

SUPERSENSITIVE DIRECTIONAL MICROPHONE picks up faint sounds at 300 feet. Detects sound through ordinary walls. Easily built for \$7.00. No electronic experience necessary. Illustrated plans, \$2.00. **DEE CO.**, Box 7263-A, Houston 8, Tex.

CONVERT ANY TELEVISION TO SENSITIVE, Big-screen oscilloscope. Only minor changes necessary. Plans \$1.95. **RELCO**, Box 10563, Houston 18, Tex.

PRECISION RESISTORS, carbon-deposit. Guaranteed 1% accuracy. Millions in stock. 1/2 watt, 8¢. 1-watt, 12¢. 2-watt, 15¢. Leading manufacturers. **ROCK DISTRIBUTING CO.**, 902 Corwin Rd., Rochester 10, N.Y.

DIAGRAMS FOR REPAIRING RADIOS, \$1.25; television \$2.50. Give make and model. **DIAGRAM SERVICE**, Box 672 E1, Hartford 1, Conn.

WALKIE-TALKIE RADIOS: Citizens Band equip; Intercoms; Radio-TV parts. FREE Catalogue. **ALLEN ELECTRONICS**, 41-42C Main, Flushing 55, N.Y.

RADIO-ELECTRONICS

WEBSTER ELECTRIC INTERCOMS! Amateur Equipment! Marine Electronics! All Select Bargains! 10¢ Any list! SUPPLIERS, 187 Miraloma, Miraloma, Calif.

Audio—Hi-fi

8-INCH PM SPEAKERS. 3.16-Ounce: \$3.95. 6.8-Ounce: \$4.25. **T. J. SOUND STUDIOS**, 139 Pugsley, Bronx 72, N.Y.

INTERESTED IN NEW ELECTRONIC MUSICAL INSTRUMENTS? Send for free copy of "MoogMusic" to **R. A. MOOG CO.**, Dept. J, Box 263, Ithaca, N.Y.

TAPE recorders, Hi-Fi components, Sleep-learning equipment, Tapes, Unusual values. Free catalog. **DRESSNER**, 1523 Jericho Turnpike, New Hyde Park 5, N.Y.

RENT STEREO TAPES—over 2,500 different—all major labels—free catalog. **STEREO-PARTI**, 811-RE, Centinela Ave., Inglewood 3, Calif.

SALE ITEMS—tapes—recorders—component quotes. **BAYLA**, Box 131-RE, Wantagh, N. Y.

4/TR STEREO TAPES—bought, sold, rented, traded! Bargain closeouts! Catalog/**COLUMBIA**, 9651 Foxbury, Rivera, Calif.

STEREO TAPES FOR RENT. Write **NATIONAL TAPES**, 71 Dey St., New York 7, N.Y.

HI-FI COMPONENTS, tape recorders at guaranteed "We Will Not Be Undersold" prices. All brands in stock. 15-day money-back guarantee. 2-year warranty. Write your requirements for quotation. No catalog. **HI-FIDELITY CENTER**, 1797D 1st. Ave., New York 28, N.Y.

MISCELLANEOUS

EXOTIC EARRINGS! Details free. Pair, \$1.00. **OHGA**, RA-443, Sigakenkusatu, Japan.

\$100 WEEKLY POSSIBLE. Compile mailing lists and address envelopes for advertisers. Home-spare time. Particulars free. **NATIONAL SERVICE**, 81 Knickerbocker Station, New York, N. Y.

MAKE \$25-\$50 WEEK CLIPPING newspaper items for publishers. Some clippings worth \$5.00 each. Particulars free. **NATIONAL**, 81 Knickerbocker Station, New York N. Y.

HUNDREDS Moneymaking Opportunities. Free Copy. **POPULAR MECHANICS**, 740-CV Rush, Chicago 11, Ill.

PRINTING PRESSES, Type, Supplies. Lists 5¢. **TURNBAUGH SERVICE**, Mechanicsburg, Pa.

LOCATE ANY BOOK. No Obligation. **BOOK-FINDERS**, Box 668-RE, San Diego 12, Calif.

BUSINESS AIDS

BUSINESS CARDS, LABELS, RUBBER STAMPS. Send for free descriptive literature, **HEIGHTS INDUSTRIES**, 6121 C Street, Capitol Heights 27, Md.

1,000 Business Cards, "Raised Letters" \$3.75 postpaid. Samples. **ROUTH**, RE-5, 3910 Kipling, Greensboro, N. C.

MAY, 1963

new BOOKS

ABC'S OF MAGNETISM, by Barron Kemp and Imperio Azteca. Howard W. Sams & Co., Inc., 1720 E. 38 St., Indianapolis, Ind. 5 1/2 x 8 1/2 in. 96 pp. Paper, \$1.95.

A fundamental book for the beginner.

MOST OFTEN NEEDED 1963 RADIO DIAGRAMS (Volume R-23). Compiled by M. N. Beitman. Supreme Publications, 1760 Balsam Rd., Highland Park, Ill. 8 1/2 x 11 in., 192 pp. Paper, \$2.50.

Compilation of manufacturers' schematic diagrams and other servicing data, including voltage and resistance tables, alignment data and dial-stringing diagrams for radio sets, record changers and stereo amplifiers of all major manufacturers.

TROUBLESHOOTING WITH VOM AND VTVM, by Robert G. Middleton. Howard W. Sams & Co., Inc., 1720 E. 38 St., Indianapolis 6, Ind. 5 1/2 x 8 1/2 in., 160 pp. Paper, \$2.50

How these test instruments are used for TV service.

THE CONTROLLED RECTIFIER (2 Vols). International Rectifier Corp., El Segundo, Calif. 6 x 9 in., 132 pp. Paper, \$2.50 each.

Vol. I discusses characteristics, testing and cooling methods, and Vol. II covers applications. Diagrams and charts help to obtain optimum results from this power switch.

ELECTRONIC EQUIPMENT MADE EASY FOR THE BOAT OWNER, by John D. Lenk. John F. Rider Publisher, Inc., 116 W. 14 St., New York, N. Y. 5 1/2 x 8 1/2 in. 200 pp. Cloth, \$5.95.

This book takes the mystery out of small-boat electronics—a subject often confusing to the nontechnical boat owner.

WORLD RADIO TV HANDBOOK, 17th ed. Published by O. Lund Johansen, Ltd. Obtainable in the United States from Gilfer Associates, Box 239, Park Ridge, N.J. 6 1/2 x 8 1/2 in., 246 pp. Paper, \$3.25.

The latest edition of the short-wave listener's bible has 246 pages crammed with data: identifying stations, listings by country and by frequency, standard frequencies, world TV, call signs and articles of general interest to listeners.

ELECTRONIC TEST INSTRUMENT HANDBOOK by Joseph A. Risse. Howard W. Sams & Co., Inc., 1720 E. 38 St., Indianapolis 6, Ind. 5 1/2 x 8 1/2 in., 288 pp. Paper, \$4.95.

A guide to the use of meters, scopes, testers and other lab and shop equipment, written for the practical technician.

ELECTRONICS FOR SCIENTISTS, by H. V. Malmstadt, C. G. Enke and E. C. Toren Jr., W. A.

SAVE MONEY

HI-FI COMPONENTS
TAPE RECORDERS
SLEEP LEARN KITS

MERITAPE low cost, high quality recording tape, in boxes or cans

DRESSNER FREE 1963 CATALOG

1523 JERICHO TPKE
NEW HYDE PARK 17, N.Y.

Look what U get with \$10

DOUBLE BONUS

\$25⁰⁰

BONUS

\$1⁰⁰

BONUS

PLUS

WORTH OF

- TRANSISTORS
- DIODES
- COILS
- KNOBS
- RESISTORS
- ETC. ETC.

ADD 25¢ FOR HANDLING

CHOOSE ANY \$1 ITEM LISTED BELOW FREE

BOTH FREE WITH EVERY \$10.00 ORDER
POLY PAKS WORTH \$3.00 TO \$50.00

WORLD'S BEST "DOLLAR" BUYS

- | | |
|--|--|
| <ul style="list-style-type: none"> <input type="checkbox"/> 10 TOGGLE SWITCHES, asst types, all 115VAC \$1 <input type="checkbox"/> 10 PANEL SWITCHES, micro, toggle, rotary \$1 <input type="checkbox"/> 60 SOCKETS, plugs, receptacles, pwr, tube \$1 <input type="checkbox"/> 50 TERMINAL STRIPS, 1 to 8 screw & lug types, asst \$1 <input type="checkbox"/> 100 PARTS SURPRISE, worth \$50 \$1 <input type="checkbox"/> 3 HI-Q FERRITE LOOPSTICK ANTENNAS \$1 <input type="checkbox"/> 7 25-ft. ROLLS, sub-mini wire ±20 to ±32 \$1 <input type="checkbox"/> 1500-PC. HARDWARE KIT, screws, etc. \$1 <input type="checkbox"/> 10 TRANSISTOR ELECTROLYTICS, for PNP-NPNs \$1 <input type="checkbox"/> 20 'TINY' SWITCHES GE, like micro 115VAC \$1 <input type="checkbox"/> 3 OUTPUT TRANSFORMERS, 50L6, 50C5 \$1 <input type="checkbox"/> 10 RCA PLUG 'N' JACK sets, Phonos, amps \$1 | <ul style="list-style-type: none"> <input type="checkbox"/> 8 ROLLS ELEC. TRICAL TAPE, black \$1 <input type="checkbox"/> 2 WORLDS SMALLEST IFs, 455 kHz, 3/4" sq. \$1 <input type="checkbox"/> 4 TRANSISTOR OSCILLATOR COILS \$1 <input type="checkbox"/> 15 PRINTED CIRCUITS \$1 <input type="checkbox"/> SIGMA RELAY, sensitive, 12K ohms, SPST \$1 <input type="checkbox"/> \$25 SURPRISE, has transistors, diodes, etc. \$1 <input type="checkbox"/> 100 PRINTED CIRCUIT RADIO PARTS \$1 <input type="checkbox"/> 4 TRANSISTOR TRANSFORMERS, worth \$24 \$1 <input type="checkbox"/> 300-ft. HOOKUP WIRE, asst colors \$1 <input type="checkbox"/> 50 COILS 'N' CHOKES 1/4, osc, if, peaking, etc. \$1 <input type="checkbox"/> 50 KNOBS, radio 'n' tv asst colors, sizes \$1 <input type="checkbox"/> 8 POCKET 'SPIN' STRAIGHTENERS, 7 & 9 prong tubes \$1 <input type="checkbox"/> 5 'HI' Q MAGNETS, Alnico V; worth 50¢ ea. \$1 |
|--|--|

CONDENSERS

- | | |
|--|--|
| <ul style="list-style-type: none"> <input type="checkbox"/> 10 TUBULAR ELEC-TROLYTICS to 450V \$1 <input type="checkbox"/> 10 TRANSISTOR ELECTROLYTICS, ASST \$1 <input type="checkbox"/> 40 ASST DISCS, 27mmf to .05 to 6KV \$1 <input type="checkbox"/> 35 SILVER MICAS, "red" cased, hi stability \$1 <input type="checkbox"/> 10 ELECTROLYTICS to 600V, F5s & tubular \$1 <input type="checkbox"/> 50 MICAS, 5mmf to .01 mf; silvers too \$1 <input type="checkbox"/> 50-PC. SURPRISE, discs, tubulars, moldeds, electro, oil, ceramics \$1 | <ul style="list-style-type: none"> <input type="checkbox"/> 40 TEMPERATURE COMPENSATING CERAMICS, npo's, N750s \$1 <input type="checkbox"/> 60 TUBULARS, .0002mf to .5mf to 800V \$1 <input type="checkbox"/> 100 CERAMICS, tubular, asst values \$1 <input type="checkbox"/> 30 PLASTIC-PORCE-LAIN CAPACITORS, asst \$1 <input type="checkbox"/> 40 SUBMINIATURES, .0002 to .05 mf \$1 <input type="checkbox"/> 30 MYLAR SQUARES, .01 to .05 mf \$1 <input type="checkbox"/> 60 CERAMICS, discs, npo's, etc. to .05 mf \$1 |
|--|--|

RESISTORS

- | | |
|---|---|
| <ul style="list-style-type: none"> <input type="checkbox"/> 30 CORNING "LOW NOISE" for hi-fi ckt's \$1 <input type="checkbox"/> 60 CARBONS, 1/2, 1, 2W; A-B, 5% too \$1 <input type="checkbox"/> 30 PRECISIONS, 1/2, 1, 2W, 1% and better \$1 <input type="checkbox"/> 10 VOLUME CONTROLS to 1 meg, sw. too \$1 | <ul style="list-style-type: none"> <input type="checkbox"/> 6 POPULAR SWITCH TYPE VOL. CONTROLS \$1 <input type="checkbox"/> 15 HALF PERCENT-ERS, 1/2, 1, 2W \$1 <input type="checkbox"/> 20 POWERS, 5-50W, to 7K ohms, vitreous, etc. \$1 <input type="checkbox"/> 40 WORLDS SMALLEST, A-B, 5% too \$1 |
|---|---|

TRANSISTORS

- | | |
|---|--|
| <p>(TESTED)</p> <ul style="list-style-type: none"> <input type="checkbox"/> 4 2N35s, NPN \$1 <input type="checkbox"/> 4 2N107s, PNP \$1 <input type="checkbox"/> 4 2N170, PNP, RF \$1 <input type="checkbox"/> 2 OSCILLATORS, PNP \$1 <input type="checkbox"/> 5 2N377, NPN, RF \$1 <input type="checkbox"/> 25-amp CAR IGNITION, TO3 case \$1 <input type="checkbox"/> 6 PRINTED CIRCUIT TYPES worth \$15 \$1 | <p>(UNTESTED)</p> <ul style="list-style-type: none"> <input type="checkbox"/> 15 NPNs, asstd. case \$1 <input type="checkbox"/> 15 PNP, assorted case \$1 <input type="checkbox"/> 15 CK722, PNP \$1 <input type="checkbox"/> 2 40-WATTERS, 2N174 case, stud \$1 <input type="checkbox"/> 10-PC. SET, 5 PNP and 5 NPN \$1 <input type="checkbox"/> TEN 100mc PNP, Surface barrier \$1 <input type="checkbox"/> 5 POWERS, 2N155, TO3 chrome case \$1 |
|---|--|

SEMI-KON-DUCTORS

- | | |
|---|---|
| <p>(TESTED)</p> <ul style="list-style-type: none"> <input type="checkbox"/> 30 "KILIP" IN DIODES, 450V 1N119 \$1 <input type="checkbox"/> 15 GERMANIUM DIODES like 1N34 \$1 <input type="checkbox"/> ONE WATT ZENER, Choose 3 to 30V \$1 <input type="checkbox"/> 4 SUN BATTERIES to 1 1/2" sizes \$1 | <p>(UNTESTED)</p> <ul style="list-style-type: none"> <input type="checkbox"/> 20 TOP HAT RECTIFIERS, to 750 ma \$1 <input type="checkbox"/> 15 SILICON DIODES, to 750 ma, epoxy \$1 <input type="checkbox"/> 10 2-amp POWER RECTIFIERS, silicon \$1 <input type="checkbox"/> 25 DIODES, RECTIFIERS, TRANSISTORS \$1 |
|---|---|

Send 10¢ for Bargain Mail Order Flyers
 Semiconductors Poly Paks Parts

POLY PAKS

TERMS: include postage, check, money order, EXPORT ORDERS INVITED. Wt. per pak 1-lb.

P. O. BOX 942R
S. LYNNFIELD, MASS.

World's Largest Supplier of Pre-Packed Assortments

LEARN

electronics theory this easy way.
No previous technical knowledge required.

BUILD

the finest professional quality TV Set
on a practical "pay-as-you-wire" plan.

SAVE

up to 1/2 on cost of equivalent
educational course plus TV set.

Build the Transvision "Professional" TV Kit
described below and get this complete course
of study for \$7.95 (available only to
Transvision Kit builders.)

Requires no previous technical knowledge.
Prepared by experts in teaching novices
about electronics.

YOU LEARN: About block diagrams... How to read and follow electronic circuits... How to use basic measuring instruments... Theory and operation of basic electronic circuits... How to service TV, Radio, and other types of electronic equipment.

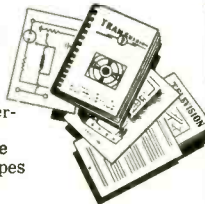

Prices range
from \$119 to \$199.



The Transvision
"Professional" TV Kit

Choice of 19", 23", or 27"
Picture Tube... Easy "Pay as
You Wire" Terms... Only \$15
for the Starting Package.



A few of the Professional Quality Features
of Transvision TV Kits:

Choice of push-pull 10-watt audio or output to
your Hi-Fi System... D.C. restoration... Ultra-
linear sweep circuits... Standard Coil Model
PKO Automatic Tuner... Super-sensitivity for
fringe areas... Complete line of Accessories for
Custom Installations.

U. S. Armed Services and over 4000 schools and
colleges have selected Transvision Receivers for
educational television.

ASSEMBLY MANUAL—\$2.00

See how easy it is to assemble the Transvision
Kit. Cost of Manual refunded on purchase of Kit.



Grey Oaks Ave.
Yonkers, N. Y.
YO 5-6900

START NOW—MAIL THIS COUPON

TRANSVISION ELECTRONICS, Grey Oaks Ave.,
Yonkers, N. Y., Dept. REL-5

Send FREE 12-page Catalog... I enclose \$2 for Assembly
Manual, refundable on purchase of Kit.

I enclose \$15 for Starting Pkg. on pay-as-you-wire plan.
(Complete Kits range from \$119 to \$199.)

Name _____

Address _____

City _____ Zone _____ State _____

Benjamin, Inc., 2465 Broadway, New York 25,
N. Y. 6 x 9 in. 619 pp. Cloth, \$10.75.

A fundamental book on electronics,
written for persons with a technical ap-
proach, rather than for the beginner. An
excellent refresher for the service technician
whose theory has become rusty, or for
engineers in non-electronic fields, medical
researchers, musicians, etc., whose work re-
quires more knowledge of electronics than
they have. The authors have developed
equipment (supplied by the Heath Co.)
suitable for performing the experiments
given in the book and for constructing an
electronic laboratory.

ELECTRIC MOTOR AND GENERATOR REPAIR,
by L. Donald Payne. Howard W. Sams & Co.,
Inc., 1720 E. 38 St., Indianapolis 6, Ind. 5 1/2
x 8 1/2 in., 254 pp. Paper, \$4.95

This comprehensive book shows how
to test, wind and repair all types.

**ASPECTS OF THE THEORY OF ARTIFICIAL IN-
TELLIGENCE**, The Proceedings of the First Inter-
national Symposium on Biosimulation, Locarno,
June 29-July 5, 1960, Ed. by C. A. Muses. Pergamon
Press, Inc., 227 W. 17 St., New York 11, N. Y.
6 x 9 in. 283 pp. Cloth, \$10.00.

One of the first books in the new
science of bionics, this is a collection of ten
papers by leaders in the various branches of
the field. Ranges from apparatus-angled
subjects (self-reproducing systems, micro-
electric components, inter-connections and
system fabrication) to experiments on
artificial teaching and learning and studies
of brain processes.

**ELEMENTARY INDUSTRIAL ELECTRONICS (2
Vols.)**, by Leonard C. Lane. John F. Rider Pub-
lisher, Inc., 116 W. 14th St., New York 11, N.Y.

5 1/2 x 8 1/2 in., 325 pp. (both volumes) Paper, \$3.25
set.

These volumes provide an insight into
modern equipment and processes, and the
opportunities they offer to electronic tech-
nicians.

THERMAL CONDUCTION IN SEMICONDUCTORS,
by J. R. Drabble and H. D. Goldsmid. Pergamon
Press, Inc., 122 E. 55th St., New York 22, N.Y.
6 x 9 in., 235 pp. Cloth, \$10.

Advanced theory of conduction and its
measurement, for semiconductor physicists.

END

50 Years Ago

In Gernsback Publications

HUGO GERNSBACK, Founder

Modern Electrics	1908
Wireless Association of America	1908
Electrical Experimenter	1913
Radio News	1919
Science & Invention	1920
Practical Electronics	1921
Television	1927
Radio-Craft	1929
Short-Wave Craft	1930
Television News	1931

Some larger libraries still have copies of Modern Electrics
on file for interested readers.

In May, 1913, The Electrical Experimenter
A Treatise on Wireless Telegraphy, by H.
Gernsback.

Quenched Spark Gap, by H. Winfield Secor.
How to Make a Loud Speaking Telephone.
Novel Show-Window Attraction.

Pocket Battery Set.

Vacuum Detector, by H. Winfield Secor.
Stippling Drawings with an Electric Buzzer.
Odd Static Generator.

Building Large Spark Coils, by H. Gerns-
back.

CORNELL

1 YR. GUARANTEED

Mutual Conductance Lab-tested, Individually
Boxed, Branded and Code Dated

RADIO & TV TUBES

33¢

PER TUBE

100 TUBES OR MORE:
30¢ PER TUBE

OZ4	6AU4	6CG7	6Q7	7A7	12BF6
1B3	6AU5	6CG8	6S4	7B6	12BH7
1L4	6AU6	6CM7	6SA7	7B8	12BL6
1T4	6AU8	6CX8	6SC7	7C5	12BQ6
1U4	6AV6	6CZ5	6SH7	7Y4	12BY7
1X2	6AW8	6D6	6SJ7	12AD6	12C5
2A5	6AX4	6DA4	6SK7	12AE6	12CA5
3CB6	6BA6				12DQ6
3Q5	6BC5				12SN7
5U4	6BD6				12SQ7
5Y4	6BG6				25L6
5Y3	6BH6				25Z6
5Z3	6BJ6				35W4
6A6	6BL7				35Y4
6A8	6BN4				35Z5
6AB4	6BN6	6DE6	6SL7	12AF6	50L6
6AC7	6BQ6	6DQ6	6SN7	12AT7	117Z6
6AG5	6BQ7	6F6	6S07	12AU7	27
6AL5	6BX7	6H6	6U8	12AX4	41
6AN8	6BZ6	6J5	6V6	12AX7	45
6AQ5	6C4	6J6	6W4	12B4	47
6A55	6CB6	6K6	6W6	12BA6	75
6AT6	6CD6	6K7	6X4	12BD6	80
6AT8	6CF6	6L6	6X5	12BE6	84/6Z4

If not shipped in 24 hrs.
**YOUR ORDER
FREE!**

Special!
With every \$10 Order
25¢
per tube

(No Limit) from this list.

6AG5 6CG7 6SN7
6AL5 6J6 6V6
6AU6 6K6 6W4

Other tubes and CRT's at low prices—send for free list

LIVE IN THE EAST?

WAITED MONTHS FOR DELIVERY FROM OTHERS?

AIR MAIL AN ORDER TO CORNELL

AND RECEIVE DELIVERY TO THE EAST COAST

IN AS LITTLE AS 72 HOURS!!!

NO SUBSTITUTIONS WITHOUT YOUR PERMISSION

Tubes are new, seconds or used and so marked.

TERMS: All Pre-Paid Orders over \$5.00 postage free. Under
\$5.00 add 50¢ for handling. Send 25% deposit on all CDD
orders. Canadian and Foreign orders, send approximate postage.
All orders subject to prior sale. 5-DAY MONEY BACK OFFER!

CORNELL ELECTRONICS CO.

Dept. RE5 4217 University Ave., San Diego 5, Calif. • Phone: AT 1-9792

WANT RESULTS



You'll get
them with

**CLASSIFIED
ADVERTISING**

in
**RADIO-
ELECTRONICS**

Classified

ADS

Only 55¢ a word

SEE DETAILS
ON PAGE 96

ADVERTISING INDEX

Aerovox Corp.	68	Jerrold Electronics Corp. a Subsidiary of	15
Allied Radio Corp.	68	The Jerrold Corp.	3
Amperex Electronic Corp.	2nd Cover	JFD Electronics Corp.	95
Anglo American Acoustics Ltd.	76	Key Electronics Co.	100
Atlas Sound Div. of American Trading & Production Corp.	94	Lafayette Radio	53
B & K Manufacturing Co. Div. of Dynascan Corp.	81	(P. R.) Mallory Co., Inc.	18
Barry Electronics	90	Mercury Electronics	70
Benjamin Electronic Sound Corp.	60	Merit Coil & Transformer Corp.	93
Brooks Radio & TV Corp.	86	Moss Electronics Inc.	19-20
Capitol Radio Engineering Institute	57	National Radio Institute	5
CREI Atomics (Div. of Capitol Radio Engineering Institute)	78	National Technical Schools	68
Carston	76	Pantronic, Inc.	8
Castle TV Tuner Service	10	Perma-Power Co.	93
Chemical Electronic Engineering Co.	91	Philco Corp. (TechRep. Div.)	97
Clarostat Mfg. Co., Inc.	77	Polypaks	85
CLASSIFIED ADS	96-97	Progressive Edu-Kits Inc.	79
Cleveland Institute of Electronics	9	Quam-Nichols Co.	99
Colordaptor	87	Quietrole Co.	82, Back Cover
Colorgrams, Inc. Subsidiary of TV Development Corp.	12-13	RCA (Tube Div.)	16-17
Cornell Electronics Co.	98	RCA Institutes	83
Coyne Electrical School	76	Rad-Tel Tube Co.	3rd Cover
Coyne School Publications	89	Reeves Soundcraft Corp.	95
The Data Corp.	64	Relco	54, 80
Denson Electronics Corp.	92	(Howard W.) Sams & Co., Inc.	55
DeVry Technical Institute	7	Sencore	91
Dressner	97	Sonar Radio Corp.	75
Duotone Co., Inc.	89	Sonotone Corp.	21
EICO Electronic Instrument Co.	22	Sprague	60
Electronic Chemical Corp.	78	Stancor Electronics Inc.	95
Electronic Measurement Corp. (EMC)	74	Supreme Publications	95
Electronic Publishing Co., Inc.	92	T A B	15
Elpa Marketing (Florens)	92	TACO (see Jerrold Electronics Corp.)	87
Euphonics Corp.	84	(Sarkes) Tarzian Inc. (Tuner Div.)	98
Fair Radio Sales	92	Transvision	58
GM Photoelectronics	76	Triad Distributor Div.	94
Grantham School of Electronics	11	Warren Electronics Co.	63, 66
Gregory Electronics Corp.	74	Winegard Co.	93
Grommies Div. of Precision Electronics	56	Workman Electronics Products Inc.	62
Hallicrafters	14	Xcelite Inc.	62
Heald's Engineering College	95	SCHOOL DIRECTORY	page 99
Heath Company	59	Electronic Technical Institute	
Injectorall Co.	76	Indiana Institute of Technology	
International Crystal Mfg. Co., Inc.	61	Milwaukee School of Engineering	
		Northrop Institute of Technology	
		Pacific International College of Arts & Sciences	
		Tri-State College	
		Valparaiso Technical Institute	
		Printed in USA.	

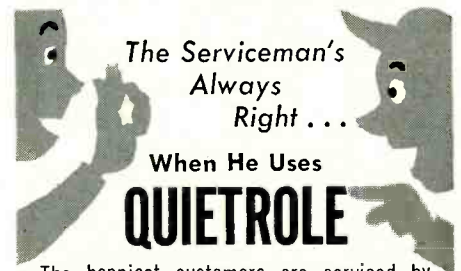

The happiest customers are serviced by repairmen who use Quietrole... the amazing lubricant that so effectively silences pesky, noisy controls and switches on radios, TV sets and electronic instruments. If you want to leave your customers smiling, you'll do what good servicemen do everywhere... **USE QUIETROLE!**



manufactured by
QUIETROLE COMPANY
Spartanburg, South Carolina
In Canada: CROSS CANADA ELECTRONICS
12 Laurel Street, Waterloo, Ontario

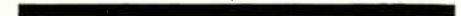

ETI Engineering Technician
A.S. Degree—2 Years
Electronics Engineer
B.S. Degree
Evening Courses Available
ELECTRONIC TECHNICAL INSTITUTE
970 W. Manchester Ave., Inglewood, Calif.
4863 El Cajon Blvd., San Diego, Calif.

ENGINEERING DEGREES
Electronics, Mechanical,
Also in Liberal Arts &
Major in Accounting
earned by
HOME STUDY
Resident Classes Also
Available if Desired
Specify course preferred
PACIFIC INTERNATIONAL COLLEGE OF ARTS & SCIENCES
Primarily a correspondence school
Chartered 1935
5719-M Santa Monica Blvd. Hollywood 38, Calif.

GET INTO ELECTRONICS
V.T.I. training leads to success as technicians, field engineers, specialists in communications, guided missiles, computers, radar and automation. Basic & advanced courses in theory & laboratory. Electronic Engineering Technology, an ECPD accredited Technical Institute curriculum. Assoc. degree in 29 mos. B.S. also obtainable. G.I. approved. Graduates in all branches of electronics with major companies. Start Sept., Feb. Dorms, campus. High school graduate or equivalent. Catalog.
VALPARAISO TECHNICAL INSTITUTE
Department C, Valparaiso, Indiana

School Directory
ENGINEERING B.S. DEGREE IN 36 MOS. SCIENCE MATH
U.S. NEEDS 50,000 NEW ENGINEERS A YEAR! EARN ACCREDITED B.S. DEGREE in Science or Engineering in 36 months—year-round program optional. 27-month engineering diploma also available. Classes start June, Sept., Jan., March. **QUALITY EDUCATION.** Graduates employed throughout the U. S. and abroad. Government approved for veteran training. Students from 50 states, 40 countries. 20 buildings, dorms, gym, Campus. New library and laboratories. Employment help provided. **SAVE TIME AND MONEY.** Write for catalog. 1616 E. Washington Boulevard, Fort Wayne 2, Indiana
Indiana Institute of Technology
formerly Indiana Technical College

engineering degree in 27 months
Become an Electronics Engineer. College graduates enjoy higher income & advancement. Major corporations visit us regularly to interview and employ seniors. **BACHELOR OF SCIENCE DEGREE IN 27 MONTHS** in Electrical (Electronics or Power major), Aeronautical, Chemical, Mechanical, Civil Engineering. **IN 36 MONTHS** a B.S. Degree in Business Administration. One-year Drafting-Design Certificate Program. Small classes. Well-equipped labs. Campus. Dorms. New library. **Moderate Costs.** Enter June, Sept., Jan., Mar. Founded 1884. Write J. G. McCarthy for Catalog and "Your Career in Engineering and Commerce" Book.
TRI-STATE COLLEGE
2453 College Avenue • Angola, Ind.

ENGINEERING EDUCATION for the Space Age
NORTHROP INSTITUTE of Technology
is a privately endowed, nonprofit college of engineering offering a complete Bachelor of Science Degree Program and **TWO-YEAR** accredited technical institute curricula. Students from 50 states, many foreign countries. Outstandingly successful graduates employed in aeronautics, electronics, and space technology. Write today for catalog—no obligation.
NORTHROP INSTITUTE OF TECHNOLOGY
1181 West Arbor Vitae Street, Inglewood 1, California

FREE CAREER BOOKLET
to guide you to a successful future in Engineering and Engineering Technology
Write for your copy! **MSOE**

MILWAUKEE SCHOOL OF ENGINEERING
Dept. RE-563,
1025 N. Milwaukee St., Milwaukee, Wis.
Tell me about an engineering career through residence study in:
 Electrical Mechanical
Name.....Age.....
Address.....
City.....State.....
MS-204

FREE! FOR

'63

LAFAYETTE RADIO ELECTRONICS

1963 CATALOG NO. 630
388 GIANT-SIZE PAGES —
The Largest Catalog in Our 42-Year History

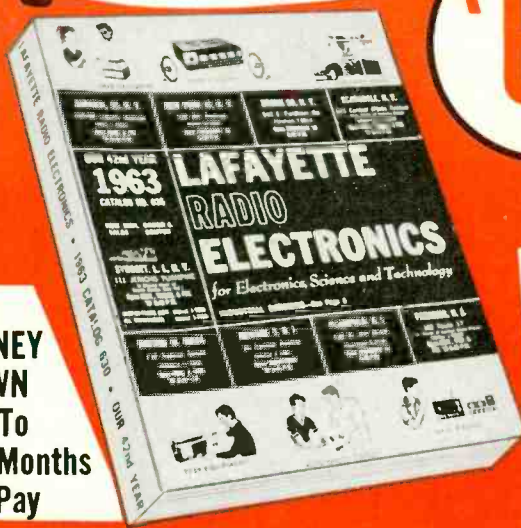

NO MONEY DOWN
Up To
24 Months
To Pay

from the
"WORLD'S
HI-FI
&
ELECTRONICS
SHOPPING
CENTER"

WHEN YOU BUY AT LAFAYETTE, YOU GET THESE EXCLUSIVE BENEFITS

- ★ OUTSTANDING LAFAYETTE KITS
- ★ LOWEST PRICES
- ★ 24-HOUR SERVICE

- SATISFACTION GUARANTEED OR MONEY REFUNDED. Use Lafayette's 30-Day FREE Home Trial.
- LARGEST STOCK SELECTION. If it's in Hi-Fi or Electronics, it's in the Lafayette Catalog.
- NO MONEY DOWN. Buy on time with Lafayette's Easy Pay Credit Plan, up to 24 months to pay.

TRUE, CUSTOM MATCHED STEREO COSTS LESS AT LAFAYETTE

NEW LAFAYETTE DELUXE PROFESSIONAL QUALITY 4-TRACK STEREO TAPE DECK

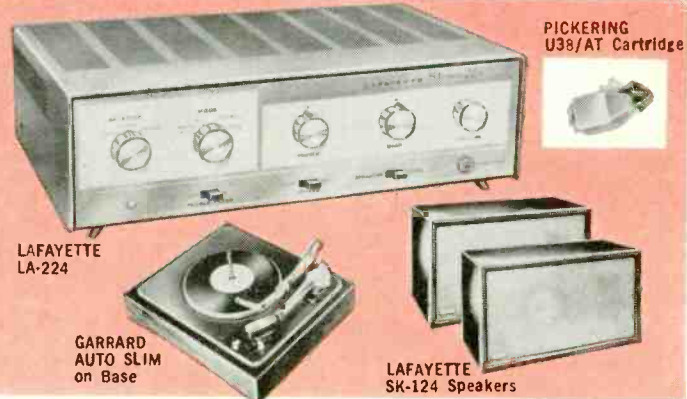

Records Sound-on-Sound
Built-in Transistorized
Stereo Record/Play Preamps

Shown with optional case

99⁵⁰

NO MONEY DOWN

Only at Lafayette could you find an outstanding, custom-matched stereo system at such an amazing low price. System includes: a powerful Lafayette LA-224 24-watt stereo amplifier with complete stereo controls; a 4-speed Garrard Autoslim automatic/manual record changer with a Pickering U/38AT cartridge and 2 Lafayette SK-124 2-way speaker systems for gigantic full size performance. Compare components, compare price — you'll choose Lafayette.

LS-225WXM specify: Pickering cartridge; wood base finish (walnut, Mhg. or Blonde); Speaker system finish (walnut or Mhg.). Shpg. wt., 64 lbs. Net 129.50

COMPLETE SYSTEM
ONLY
129⁵⁰
NO MONEY DOWN

A truly outstanding tape recorder/reproducer. Superb electronics, smooth, dependable tape transport. Plugs into your hi-fi system.

- Plays: 4-track & 2 track stereo; 4-track, 2-track and full track mono;
- Records: 4-track stereo or mono;
- Sound-on-Sound;
- Freq. response 40-18,000 cps @ 7½ ips;
- Complete with cables and empty reel.

RK-143WX as above but with carrying case Net 114.50

MAIL THIS COUPON TODAY for YOUR FREE LAFAYETTE 630 CATALOG

Get One for a Friend Too

LAFAYETTE RADIO ELECTRONICS
Dept. JE-3, P.O. Box 10, Syosset, L.I., N.Y.

- Rush my FREE 388-page giant-size Lafayette Catalog
- Send me #....., Shipping charges collect.

I am enclosing

Name

Address

City Zone State

Friend's Name

Address

City Zone State



LAFAYETTE'S MAIL ORDER and SALES CENTER SYOSSET, L. I., NEW YORK 111 Jericho Turnpike

OTHER LOCATIONS		
NEW YORK, NEW YORK 100 6th Avenue	SCARSDALE, NEW YORK 691 Central (Park) Ave.	PARAMUS, NEW JERSEY 182 Route 17
JAMAICA, NEW YORK 165-08 Liberty Avenue	PLAINFIELD, NEW JERSEY 139 W. 2nd Street	BOSTON, MASS. 110 Federal Street
BRONX, NEW YORK 542 E. Fordham Rd.	NEWARK, NEW JERSEY 24 Central Avenue	NATICK, MASS. 1400 Worcester Street

A NEW LOW-PRINT MASTERING TAPE WITH NO SACRIFICE IN OUTPUT!

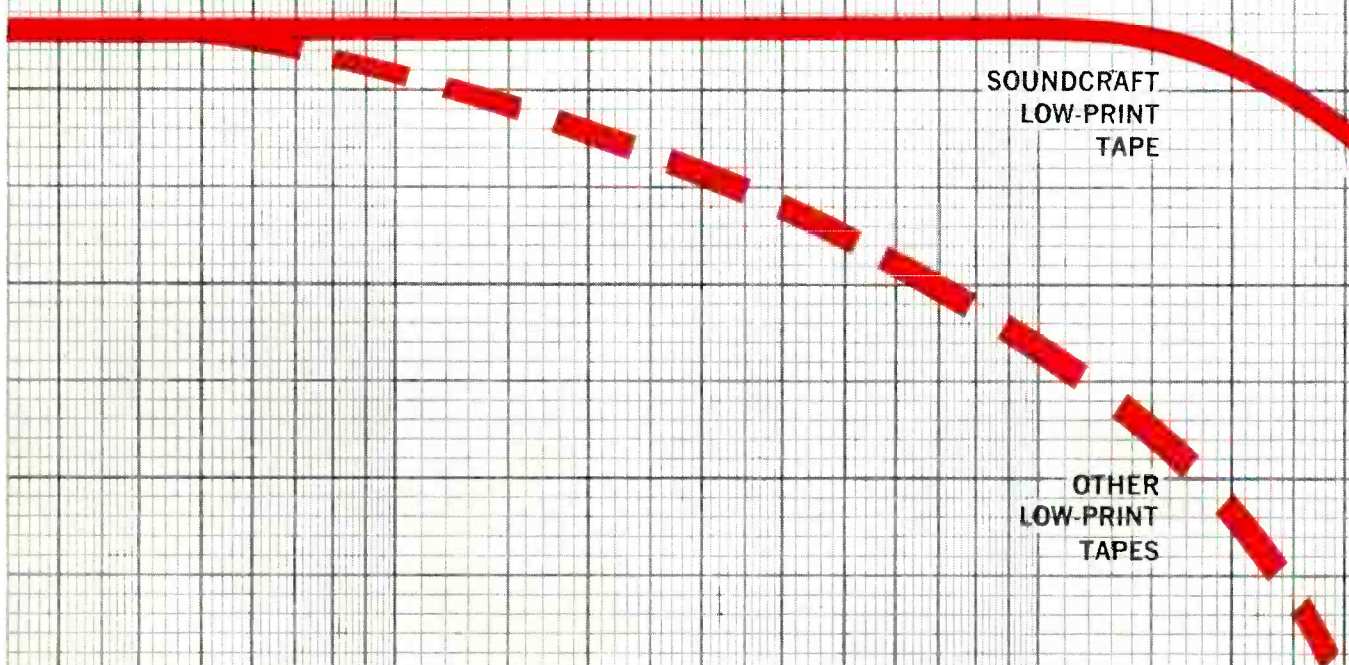

SOUNDCRAFT
LOW-PRINT
TAPE

OTHER
LOW-PRINT
TAPES

Gives you a bonus of 5 db greater high frequency output than any other low-print tape!



Now, for the first time — a professional low-print mastering tape you can intersplice with standard mastering tapes because **its output characteristics match these tapes!** To achieve this, Soundcraft has provided this tape with a high frequency boost . . . 5 db more output than other competitive low-print tapes . . . to assure you of master recordings with lower background noise and wider dynamic range. All this, in a tape that offers 8 db better print-through than standard mastering tapes. No static noise, no editing squeal. Exclusive Soundcraft manufacturing processes help to produce a physically perfect tape — among these:

- Micropolishing® for mirror-smooth defect free surface, perfect high frequency response without break-up.
- Precision-slitting for complete absence of edge burrs and skew.
- Chemical balance of base material and oxide coating to prevent cupping.



And two more Professional Tapes to improve your recordings:

SOUNDCRAFT HIGH OUTPUT MASTERING TAPE — Provides optimum combination of high output, high signal to noise and low distortion characteristics — resulting in wider dynamic range for your critical master recordings.

SOUNDCRAFT DUPLICATING TAPE — Has 25% greater high frequency output and 7 db better signal to noise ratio than conventional duplicating tapes. Used throughout the industry when quality reproduction is required.

Write for your free "Guide to Soundcraft Professional Recording Products".

REEVES **SOUNDCRAFT** CORP.

Main Office: Great Pasture Road, Danbury, Connecticut • New York: 10 E. 52nd Street • Chicago: 28 E. Jackson Blvd. • Los Angeles: 342 N. La Brea • Canadian Reps.: Toronto, Vancouver



Let RCA put your name in lights

Put a bright new face on your store front with a striking illuminated outdoor hanging RCA business sign. Through Authorized RCA Tube Distributors, RCA offers you a choice of two new double-faced illuminated shop signs imprinted with your business name. Made of weather-proof translucent plastic, RCA business signs:

- Brighten your entire shop front
- Give your business a smart, modern, efficient appearance
- Focus attention on your services
- Fix your shop location in the minds of potential customers
- Associate your business with the prestige and customer acceptance of RCA—the most trusted name in electronics



SIGNS IN TWO POPULAR SIZES

3' x 5' Double-Faced Illuminated Hanging Sign—1A1341

2' x 5' Double-Faced Illuminated Hanging Sign—1A1340



Find out now how you can get yours. Your participating Authorized RCA Electron Tube Distributor has all the facts. Call him today.

RCA ELECTRON TUBE DIVISION, HARRISON, N. J.



The Most Trusted Name in Electronics