

**Electronic Ignition
For Your Car**

**Boat Electronics
—What's New**

**Servicing Those
Color Circuits**

**Highway Radar
Nabs Speeders**

JULY

Radio-Electronics

TELEVISION • SERVICING • HIGH FIDELITY

HUGO GERNSBACK, Editor-in-chief



Hand-Held Radar for the Foot Soldier

See page 4

50c

A L PRIDDY 6-63
BOX 133 BRANCH RD RT 1
BELLE WEST VIRGINIA



6" x 9" Shallow Speaker
Model 69A1S
Actual Size

For those special applications choose a Quam speaker

When you need a 2 $\frac{1}{4}$ " unit for a transistor radio—or a shallow 6" x 9" for a Thunderbird replacement—Quam has it!

When you need a special voice coil impedance or special field resistance—Quam has it!

Quam gives you the widest selection and the highest quality in the entire speaker industry! Ask for Quam, the Quality line, for all your speaker needs.



2 $\frac{1}{4}$ " Transistor Radio Speaker
Model 22A06Z8
Actual Size

QUAM

QUAM-NICHOLS COMPANY
234 East Marquette Road
Chicago 37, Illinois

LK-72 80 WATT AMPLIFIER

"... no effort has been spared to make the building job simple, a lot of fun, and yet have the builder end up with a unit that looks and works like factory-built equipment... Whizzed through the complete construction in only about 11 1/2 hours. A conservatively designed, versatile, integrated stereo amplifier that should be a pleasure to build and a pleasure to use."

Electronics World

LT-110 FM MULTIPLEX TUNER

"... a fine stereo tuner and an unusually easy kit to build..."

Audio, April, 1962

"... If you have hesitated to go into stereo FM because of imagined complexities... fear no more. The LT-110 shows you how to enjoy stereo FM the easy way..."

Electronics Illustrated, July, 1962

"... The drift was the least I have ever measured on an FM tuner. Less than 2 or 3 kilocycles from a cold start..."

Hi-Fi/Stereo Review, June, 1962

LK-150 POWER AMPLIFIER

"... Checking my notebook for my feelings about the music capabilities — I find only two words, "immaculate sound"... This unit belongs to that very small group of components which allow you to "see" past the equipment into the performance itself..."

American Record Guide, April 1962

LC-21 PREAMPLIFIER

"Noise is totally inaudible under any listening conditions... Listening to music with the LC-21 proves to be as rewarding as it was with the power amplifier. It imparts nothing of itself on the performance while providing positive control... Both kits go together with no fuss at all. About a week's worth of evening work will provide a superb electronic control center..."

American Record Guide, April, 1962

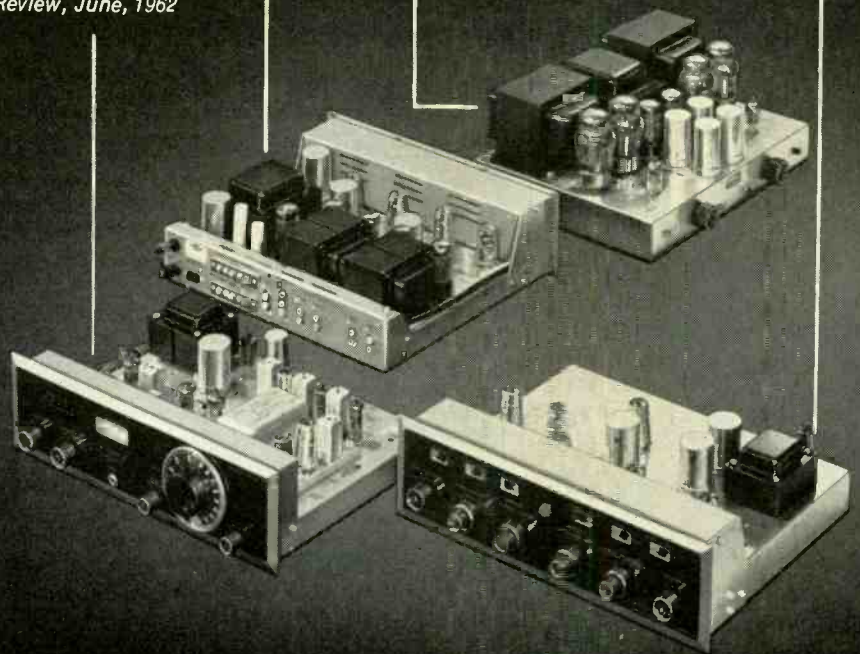

Scott Kits win
rave reviews
from leading
Hi-Fi experts

"The packaging and instruction manual for the Scott LK-72 kit help make the assembly and wiring of this amplifier painless and even pleasurable. Each stage of the work is carefully explained, with text and illustrations that leave little or no room for error, and which were obviously prepared with more than a passing sense of humor. There are no outside "blowups" to hang on the wall, but rather meticulously detailed drawings, in color, of each stage of the work, and all contained in the manual in the normal sequence of steps used by the builder. The instructions are prefaced with helpful hints on how to unpack the kit, what tools to select, correct soldering procedures, and so on. For those who are interested, there also is a section explaining how the amplifier operates, stage by stage. All told, this is a neat, attractive, very well-designed kit, and one which gives every assurance of successful completion even in the hands of the inexperienced or first-time builder."

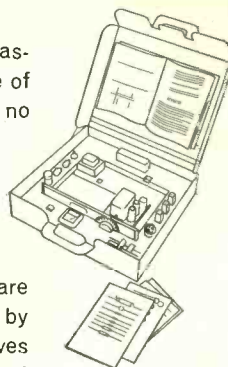

H. H. Scott, Inc., 111 Powdermill Rd.,
Maynard, Mass. Dept. 570-07

Export: Morhan Exporting Corp., 458 Broadway, N. Y. C.
Canada: Atlas Radio Corp., 50 Wingold Ave., Toronto

Rush me your new full-color folder
showing the complete line of Scott
Kits.

Name

Address

City.....State.....



Radio-Electronics

JULY 1962
VOL. XXXIII No. 7

Formerly RADIO CRAFT—Incorporating SHORT WAVE CRAFT—TELEVISION NEWS—RADIO & TELEVISION*

editorial

- Hugo Gernsback 29 Sleeplearning
Ben Miessner 81 Our Patent Problem—A Proposed Solution

test instruments

- 37 Silicon Diode Checker
Albert H. Taylor 47 Low-Amplitude Linear Oscillator
Jeffrey F. Raskin 57 Simple Random-Noise Generator
(How do you think it works)
E. L. Deschambault 59 Oscilloscope Checks Flybacks
Larry Steckler 71 Two Bench Supplies
(Equipment Report: a variable ac supply and a battery eliminator)
Leonard J. D'Airo 76 Portable Precision Frequency Standard
(Try this interesting construction job)

electronics

- Don Dudley 30 Radar on the Highways
(“But officer—your cavity oscillator was malfunctioning”)
33 Radar in a 10-lb Package
(Cover Feature)
Harry W. Lawson 34 Put Electronic Ignition in Your Car
(It will run better)
Elbert Robberson 42 Boat Electronics—What’s New
(Boating means electronics today)
51 What’s New
(Pictorial reports of new developments)
60 What’s Your EQ?
(Answers to last month’s puzzles on page 70)
Rufus P. Turner 80 Handling the Metric Prefixes

television

- Robert G. Middleton 38 Chroma Circuit Servicing
(How to handle the special parts of a color set)
Larry Steckler 55 Tube Layouts in TV Sets
(Westinghouse 1961-1962)
Conducted by Jack Darr 62 Service Clinic
(Identify that TV chassis)

radio

- Stanley Leinwoll 41 SW Propagation Forecast
(June 15-July 15)
Jean Provost 58 How to Hold Up a Broadcast
(Delay-tape keeps listeners’ comments pure and pointed)
Enoch J. Hicks 74 Ground-Plane Antenna for Citizens Radio

audio—high fidelity—stereo

- Johan Van Leer 46 OTL Stereo Amplifier
(Compact unit delivers 10 watts per channel)
Norman H. Crowhurst 48 More Circuits for FM Stereo
Earl E. Snader 66 Bias Oscillator Circuits
(Eight circuits in use today)

industrial

- Harold Reed 50 Adapting a Recorder for Language Training
Robert G. Middleton 52 Industrial Handyman—The Scope
(Differential scopes and other things)

the departments

- | | | | |
|-------------------|--|------------------------|-----------------|
| 92 Corrections | 86 Business Getters and New Literature | 6 News Briefs | 89 Technotes |
| 18 Correspondence | 82 New Patents | 95 Noteworthy Circuits | 87 Try This One |
| 98 New Books | 83 New Products | 93 Technicians’ News | 88 50 Years Ago |
| | 91 New Tubes & Semiconductors | | |

Over 50 Years of Electronic Publishing

EDITOR-IN-CHIEF AND PUBLISHER
Hugo Gernsback

EDITOR
M. Harvey Gernsback

MANAGING EDITOR
Fred Shunaman

TECHNICAL EDITOR
Robert F. Scott, W2PWG

ASSOCIATE EDITOR
Larry Steckler

EDITORIAL ASSOCIATE
I. Queen

SERVICE EDITOR
Jack Darr

TECH. ILLUSTRATION DIRECTOR
Wm. Lyon McLaughlin

ART ASSOCIATE
Fred Neinast

DIRECTOR OF PRODUCTION
Elizabeth Stalcup

DIRECTOR, ADVERTISING SALES
Lee Robinson

EASTERN SALES MANAGER
John J. Lamson

CIRCULATION MANAGER
G. Aliquo

DIRECTOR, NEWSSTAND SALES
Joseph L. Bund



Average Paid Circulation
Over 160,000

—on the cover—

(Story on page 33)

Is anything going there?
This combat radar answers
yes or no. It spots and identi-
fies moving objects with an
audio readout and gives their
range on a 3-inch CRT.

Signal Corps Photo

Gernsback Publications, Inc.
EXECUTIVE, EDITORIAL, ADVERTISING OFFICES

154 W. 14 St., New York 11, N.Y.
Telephone AL 5-7755

CHAIRMAN OF THE BOARD
Hugo Gernsback

PRESIDENT
M. Harvey Gernsback

SECRETARY
G. Aliquo



Radio-Electronics is indexed in
Applied Science & Technology Index
(Formerly Industrial Arts Index)

*Trademark registered U. S. Pat. Office

GET YOUR ELECTRONICS-TV-RADIO HOME TRAINING FROM N.T.S. RESIDENT SCHOOL

BREAK THROUGH TO HIGHER PAY, GREATER JOB SECURITY

START NOW! Break through the Earning Barrier that stops "half-trained" men. N.T.S. "All-Phase" Training prepares you . . . at home in spare time . . . for a high-paying CAREER as a

MASTER TECHNICIAN in Electronics — TV — Radio. One Master Course at One Low Tuition trains you for unlimited opportunities in All Phases: Servicing, Communications, Preparation for F.C.C. License, Broadcasting, Manufacturing, Automation, Radar and Micro-Waves, Missile and Rocket Projects.

A MORE REWARDING JOB . . . a secure future . . . a richer, fuller life can be yours! As an N.T.S.

MASTER TECHNICIAN you can go straight to the top in industry . . . or open your own profitable business.

Over 1 City Block of Modern School Facilities, Laboratories and Shops Housing Over 1,000 Students.

50,000 Graduates — all over the World — since 1905

BETTER . . . MORE COMPLETE . . . LOWER COST . . . WITH NATIONAL SCHOOLS' SHOP-METHOD HOME TRAINING!

BETTER . . . Training that is proved and tested in N.T.S. Resident School shops and laboratories, by a School that is the **OLDEST** and **LARGEST** of its kind in the world.

MORE COMPLETE . . . You learn **ALL PHASES OF** Television — Radio — Electronics.

LOWER COST . . . Other schools make several courses out of the material in our **ONE MASTER COURSE . . .** and you pay more for less training than you get in our course at **ONE LOW TUITION!**

NATIONAL TECHNICAL SCHOOLS
WORLD-WIDE TRAINING SINCE 1905

THE SCHOOL BEHIND YOUR HOME-STUDY TRAINING



In these modern School Headquarters your Home Training is: Classroom-Developed, Lab-Studio Planned, Shop-Tested, Industry-Approved, Home Study-Designed.

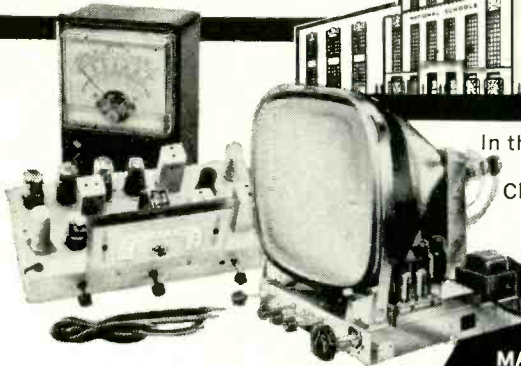

TRAIN AT HOME IN YOUR SPARE TIME . . . AT YOUR OWN PACE!

19 BIG KITS YOURS TO KEEP

- Friendly Instruction and Guidance
- Graduate Advisory Service
- Unlimited Consultation
- Diploma Recognized by Industry
- **EVERYTHING YOU NEED FOR SUCCESS**

N.T.S. IS NOT JUST A MAILING ADDRESS ON A COUPON

N.T.S. is a real school . . . a world famous training center since 1905. Thousands of men from all over the world come to train in our shops, labs, studios and classrooms.

You learn quickly and easily the N.T.S. Shop-Tested way. You get lessons, manuals, job projects, personal consultation from instructors as you progress. You build a Short-Wave, Long-Wave Superhet Receiver plus a large screen TV set from the ground up with parts we send you at no additional cost. You also get a Professional Multimeter for your practical job projects. The Multimeter will become one of your most valuable instruments in spare-time work while training, and afterwards, too. Many students pay for their entire tuition with spare time work. You can, too . . . we show you how.

SEND FOR INFORMATION NOW . . . TODAY!
IT COSTS YOU NOTHING TO INVESTIGATE

After you graduate you can open your own TV-Radio repair business or go into high paying jobs like these: Communications Technicians, Hi-Fi Stereo and Sound Recording Specialists, TV-Radio Broadcasting Technician, Technician in Computers & Missiles, Electronics Field Technician, Specialist in Micro-Waves and Servomechanisms, Expert Trouble Shooter, All-Phase Master Technician, TV-Radio Sales, Service and Repair.

RESIDENT TRAINING AT LOS ANGELES
If you wish to take your Electronics-TV-Radio training in our famous Resident School in Los Angeles — the oldest and largest school of its kind in the world — write for special Resident School catalog and information, or check special box in coupon.

MAIL COUPON NOW FOR FREE BOOK & ACTUAL LESSON

No obligation.
No salesman will call.



NATIONAL TECHNICAL SCHOOLS
WORLD-WIDE TRAINING SINCE 1905

Mail Now To
National Technical Schools, Dept. RG-72
4000 S. Figueroa St., Los Angeles 37, Calif.
Please rush **FREE** Electronics-TV-Radio "Opportunity" Book and Actual Lesson.

Name _____ Age _____
Address _____
City _____ Zone _____ State _____

Check here if interested ONLY in Resident Training at Los Angeles.
VETERANS: Give date of discharge _____



ACCREDITED MEMBER

NATIONAL TECHNICAL SCHOOLS
WORLD-WIDE TRAINING SINCE 1905

4000 SO. FIGUEROA ST., LOS ANGELES 37, CALIF., U.S.A.

News Briefs

Computers in Education

Electronics in education is not confined to television, according to the students and teachers of the Collingswood, N. J., High School. The regular March report cards of that school were processed by computer rather than being marked by the teachers, and were mailed to the students from the RCA Educational Services of nearby Cherry Hill instead of being handed out in class. According to Dr. James Mason, superintendent of Collingswood schools, the teachers need spend, to prepare data, only 25% of the time for the electronic processing system than would be needed to make out report cards in full. This will result in a considerable saving of teacher time.

Slow-Scan Television Works on Phone Lines

A low-budget TV system, designed to transmit still images rather than moving figures, was demonstrated recently by Westinghouse Electric Corp. The system uses a new slow-scan vidicon TV camera tube type 7290. The camera produces one frame every 8 seconds, turning the video information into audio frequencies. This picture can be recorded with an ordinary tape record-

er, sent over standard phone lines, or transmitted by any radio capable of transmitting voice. With it, televised pictures for education, business purposes or newspaper work can be transmitted at low cost, with a minimum of equipment and installation work.

The camera's lens focuses the live image on the vidicon screen. An electronic shutter then freezes the image, which is scanned at the 8-second rate. At the end of the scan, another frame is frozen on the screen.

New Power Supply Regulates with Pulses

A new, heavy-duty regulated power supply converts line ac immediately to dc, eliminating the usual 60-cycle transformer. A dc chopper then converts the dc to high-frequency bidirectional pulses, the voltage of which is stepped up or down, as desired, by a high-frequency transformer. Silicon controlled rectifiers produce the high-frequency pulses at variable widths, thus regulating the voltage. The wider the pulses, the higher the output voltage will be. The system is efficient only for load power ratings above about 2 kw. This new approach to power conversion was described by Dr. Victor

Wouk, chairman of the Subcommittee on Power Supplies of the IRE. Supplies of this type are being manufactured by Dr. Wouk's company, Electronic Energy Conversion Corp., Bethpage, N. Y.

Molybdenum a Superconductor

Pure molybdenum has been discovered by Bell Laboratories Researchers to be a superconducting element (a material that loses all its electrical resistance as its temperature approaches absolute zero). Molybdenum is the 24th element found to be superconducting.

The report, which appeared in the April 15 issue of *Physical Review Letters*, states that a very pure sample of molybdenum was studied. The study also suggests that, as extremely pure samples become available, studies should be conducted on other metals previously thought of as non-superconducting.

Conelrad Abandoned

The Defense Dept. has notified the FCC that restricting broadcasting to 640 and 1240 kc during defense emergencies no longer is necessary and that the system will be changed to "insure more effective presidential and civil defense communication with the public in the event of a national emergency." While modernization is in progress, the old system will, however, continue in effect.

Under the proposed new system, according to FCC Commissioner Bartley, some stations might still be shut down or required to stand by to reduce interference; stations may receive fallout protection surveys and emergency power equipment from the Defense Dept.; state defense-network FM stations will have top priority in getting such assistance; the FM defense network



Advertising Representatives: Los Angeles: Harker-Husted-Coughlin, 408 1/2 South Alvarado St., Tel. DUmkirk 7-2328. San Francisco: Harker-Husted-Coughlin, 444 Market St., Tel. GARfield 1-0151. Atlanta: J. Sidney Crane & Associates, 22 Eighth St., N.E., Tel. TRinity 2-6720. Florida: Neff Associates, 15 Castle Harbor Isle, Fort Lauderdale, Fla. United Kingdom: Publishing & Distributing Co., Ltd., Mitre House, 177 Regent St., London, W. 1, England.
Foreign Agents: Great Britain: Atlas Publishing and Distributing Co., Ltd., 18 Bride Lane, London E.C. 4.
Subscription Service Address form 3579 and correspondence to Radio-Electronics, Subscriber Service, 154 West 14th St., New York 11, N.Y. When requesting a change of address, please furnish an address label from a recent issue. Allow one month for change of address.

LET DeVRY TECH PREPARE YOU TO

Profit! Prosper!

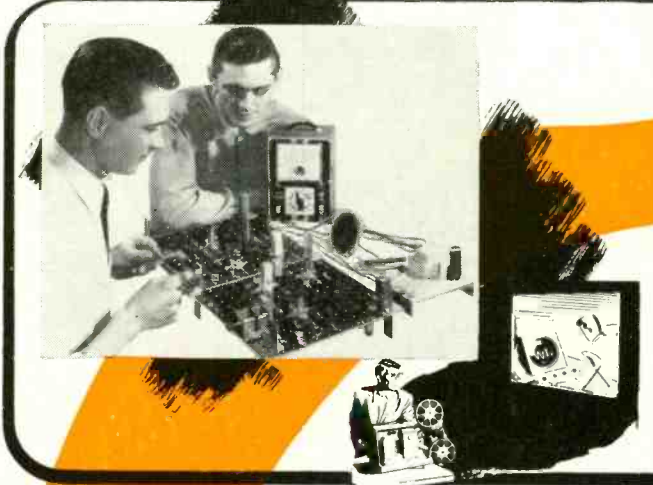

In the Big Job Opportunity Field of **Electronics!**

DeVRY'S MODERN METHODS HELP YOU LEARN FASTER . . . AT HOME!

**MEN
17 to 55
Eligible**

**NO
ADVANCED
EDUCATION
NEEDED!**

**PREPARE
FOR JOBS
FROM RADIO TO
GUIDED MISSILE
CONTROL**

**NO EXTRA
CHARGE FOR
EFFECTIVE
EMPLOYMENT
SERVICE**

**TIP FOR
MEN WHO FACE
MILITARY SERVICE
—Mail Coupon
today!**

**Prepare
At HOME or
in our CHICAGO
or TORONTO
Laboratories**

DeVry Tech training with its many time-saving features is designed to get you to the big opportunity field of Electronics well trained, in a minimum of time.

Our home training movies save hours of reading, show you electronics "in action," help you to learn faster. DeVry's patented home laboratory system helps you work practical experiments quicker with little soldering to slow you down.

We KNOW the value of good training . . . and understand that a man wants to start in a good job as soon as he can. That's why DeVry Tech provides everything you need to learn quickly at home: up-to-date texts, movie projector, reels of film and 16 shipments of Electronic equipment.

The same holds true in our well-equipped training centers in Chicago and Toronto, where you learn with the help of fine instructors and use modern equipment similar to that you can use later in the industry.

Send coupon for full facts today. Let DeVry Tech help you get ready for a job that pays REAL money. Do it in record time if you wish.

Accredited member of National Home Study Council

SEND FOR 2 FREE BOOKLETS MAIL COUPON TODAY!

DeVRY TECHNICAL INSTITUTE
4141 Belmont Ave, Chicago 41, Ill., Dept. RE-7-S
Please give me your two free booklets, "Pocket Guide to Real Earnings" and "Electronics in Space Travel"; also include details on how to prepare for a career in Electronics. I am interested in the following opportunity fields (check one or more):

- | | |
|---|--|
| <input type="checkbox"/> Guided Missile Control | <input type="checkbox"/> Communications |
| <input type="checkbox"/> Television and Radio | <input type="checkbox"/> Computers |
| <input type="checkbox"/> Microwaves | <input type="checkbox"/> Broadcasting |
| <input type="checkbox"/> Radar | <input type="checkbox"/> Industrial Electronics |
| <input type="checkbox"/> Automation Electronics | <input type="checkbox"/> Special "Short Courses" |

Name _____ Age _____

Address _____ PLEASE PRINT Apt. _____

City _____ Zone _____ State _____

Check here if you face military service.
Canadian residents: Write DeVry Tech of Canada, Ltd.,
2079 970 Lawrence Avenue West, Toronto 19, Ontario

**DeVRY TECHNICAL
INSTITUTE
CHICAGO • TORONTO**

BUY THIS

GET THIS FREE

MASTER CARTRIDGE SUBSTITUTION GUIDEBOOK

by JACK STRONG

RIDER publication

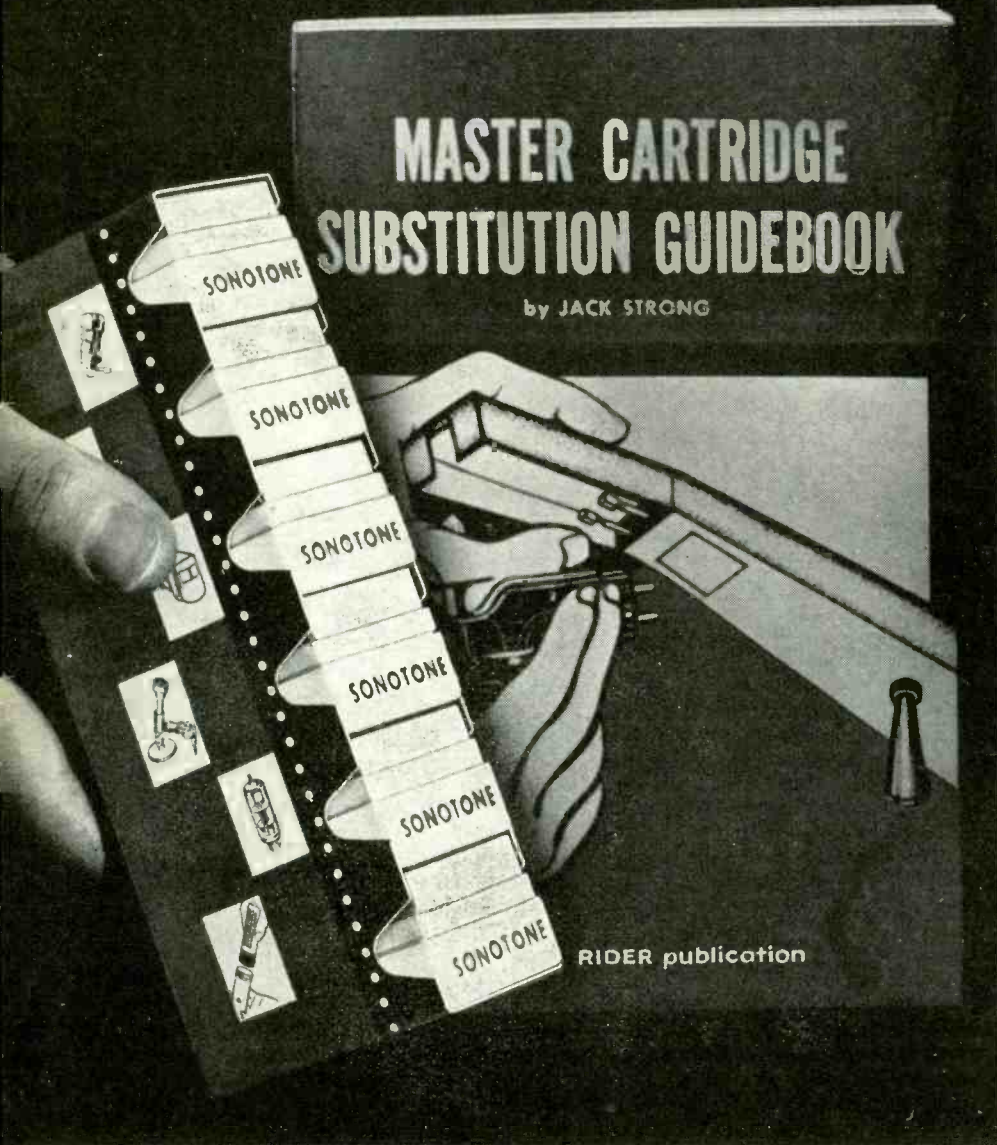

POWERFUL PROFIT-PRODUCING COMBINATION—YOURS FROM SONOTONE

What a profit-making combination — the industry's finest replacement cartridges in the new, handy Sonotone 6-PAK plus the new Rider "Master Cartridge Substitution Guidebook" (regularly \$2.00), for the price of the cartridges alone. This guidebook, world's greatest source of cartridge replacement data, enables you to locate the exact or equivalent replacement for nearly every record player manufactured since 1930.

HERE'S HOW TO GET YOUR FREE GUIDEBOOK — Visit your distributor and select any 6 Sonotone cartridges. Or choose one of the pre-selected 6-PAK combinations that include the most needed cartridges for the most frequent replacements. With your purchase, your distributor will

give you a valuable coupon — one for every six Sonotone cartridges. Mail the coupon to Sonotone Corp., Electronic Applications Division, Elmsford, New York. You'll receive your free Rider "Master Cartridge Substitution Guidebook" by return mail. It will make your stock of Sonotone cartridges more valuable than ever before.

Visit your parts distributor today. Order a Sonotone 6-PAK — and receive your valuable "Cartridge Substitution Guidebook" Coupon. (This offer expires Aug. 15, 1962).

**ELECTRONIC APPLICATIONS DIVISION
SONOTONE® CORPORATION**

Elmsford, New York • Canada: Atlas Radio Corp., Ltd., Toronto
Cartridges • Speakers • Tape Heads • Microphones
• Electron Tubes • Batteries • Hearing Aids

might be expanded to a national network.

Japanese Satellites To Report 1964 Olympics

The Nippon Electric Co., Ltd., hopes to orbit three or four Japanese-made communications satellites to relay news of the 1964 Olympic Games at Tokyo, if their research on a 105-pound satellite, equipped with solar batteries, is successful.

The satellite will be orbited by the United States National Aeronautics and Space Administration. It is expected to minimize the cost to Japan of getting the satellites into outer space. It is hoped to orbit the satellites at an altitude of 22,380 miles above the earth, where their velocity

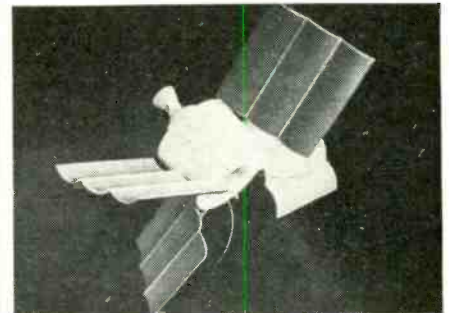

The satellite, with its four banks of solar cells.

would tend to keep them stationary over a given point. Four satellites would then give complete mobile coverage.

Two other companies, Mitsubishi Shipbuilding & Engineering Co. and Mitsubishi Electric Co., are cooperating with Nippon Electric, designing respectively tracking systems and telemeters. The satellite is planned as an active repeater, containing its own receiver and transmitter.

TV's Most Distant "Echo"

The admittedly Class-B picture shown was the first TV image to be transmitted and received by satellite relay. Sent from the Massachusetts Institute of Technology field station near San Francisco, it was bounced off Echo I and received at the Millstone Hill Laboratory in Massachusetts. The distance on earth



RADIO-ELECTRONICS

another ***knight-kit***® first



all-in-one KU-45 stereo receiver

MULTIPLEX FM, AM, 32-WATT AMPLIFIER "AUDIO CENTER" KIT

ONLY **\$129⁹⁵**
(less case)

SEND NO MONEY

only \$7 per month

PROOF OF SUPERIOR VALUE

• Built-in multiplex stereo FM circuit • Dynamic Sideband Regulation (DSR) for distortionless FM • Ratio detector wideband FM tuning circuit • 2½ µv usable IHFM sensitivity • AFC for driftless FM reception • Tuning eye indicator to pinpoint FM and AM tuning • Flywheel tuning for effortless station selection • AM wide or narrow band • Center channel output for a third stereo or extension speaker • Input facilities for stereo record player • Tape recorder inputs and outputs • 32 watts of continuous sine wave power output • Push-button "on-off" switch to eliminate volume resetting once unit is "on" • AM loopstick; FM folded dipole antenna • Pre-assembled, aligned front end—no further adjustments • With all parts, tubes, wire, solder and famous Knight-Kit step-by-step instructions. Less case. Beautiful anodized satin-gold and mocha control panel. 4¼ x 16½ x 13". For 110-125 v, 60 cycle AC. 39 lbs.

*Typical of the quality and value of
over 100 other great KNIGHT-KITS*

**ALLIED RADIO
KNIGHT ELECTRONICS DIVISION**

*first time ever...complete Stereo-Tuner-Amplifier Kit...
latest Multiplex Stereo circuitry...lowest price ever...*

There's no other kit like it—three units on a single compact chassis for *complete* listening enjoyment—at a tremendous saving! Just add speakers and changers and you have a superb system. Yes, you get a powerful 32-watt stereo amplifier; dual preamps with a full set of controls; extremely sensitive FM-AM tuner, PLUS the latest built-in stereo FM Multiplex circuit for dazzling, full-depth stereo sound. You save in a big way because you get the components all-in-one and you do the easy assembly yourself. You get space-saving advantages, too. There's nothing like the KU-45—nothing to equal the value or the quality. Order it today—*no money down* (just check coupon). **\$129⁹⁵**
An incomparable value at only (less case)

(Metal case for KU-45, only \$7.95)

(less case)

Satisfaction guaranteed or your money back

**SEND NO
MONEY**
order today

ALLIED RADIO

100 N. Western Ave., Chicago 80, Ill.

Ship me the following:

- Knight-Kit KU-45 All-In-One Stereo Receiver 83 YU 993AS
 Metal Case for KU-45, 5 lbs. 83 YX 646
 Ship No Money Down on Allied's Credit Fund Plan

Name _____
PLEASE PRINT

Address _____

City _____ Zone _____ State _____



ARCO · ELMENCO

CAPACITOR

SERVICENTER

**CAPACITOR
KIT
NO. 144**

Available Now! Arco-Elmenco's **CAPACITOR SERVICENTER** complete with the most popular assortment of dp dipped mylar-paper, VCM high voltage silvered mica and CCD disc ceramic capacitors.

Each value is stocked in its own separate section of a 15-drawer **FREE Akro-Mils cabinet**. Each drawer is clearly labelled to show the contents. The **SERVICENTER** is easy to use, easy to re-stock and actually helps you keep a proper inventory.

CONTENTS:

71 dp DIPPED MYLAR-PAPER	20 VALUES	600 VDCW $\pm 10\%$	\$30.40
41 VCM SILVERED MICAS	15 VALUES	1000 VDCW $\pm 5\%$	\$26.60
32 CCD DISC CERAMICS	9 VALUES	1000 VDCW $\pm 10\%$	\$ 8.50
144 CAPACITORS	44 VALUES	TOTAL LIST PRICE	\$65.50

PLUS FREE AKRO-MILS CABINET LIST \$4.95 **\$29⁹⁵**

SPECIAL DEALER NET

ARCO electronics inc.

Community Drive, Great Neck, New York • HUnter 7-0500

BRANCHES:

LOS ANGELES
ARCO CAPACITORS INC.
1548 So. Robertson Blvd.,
Los Angeles 35, Calif.
CRestview 1-1151

DALLAS
ARCO ELECTRONICS INC.
1339 Crampton St., Dallas 7, Texas
MElrose 1-0270

between the two points is 2,700 miles. The signal's course was considerably longer, Echo I being 1,000 miles above the earth at the time.

Calendar of Events

IRE Spring Conference on Broadcast and TV Receivers, June 18-19, O'Hare Inn, Chicago.

1962 Music Industry Trade Show, June 24-28, Hotel New Yorker & New York Trade Show Building, New York, N. Y.

IRE National Convention on Military Electronics, June 25-27, Shoreham Hotel, Washington, D.C.

Symposium on Electromagnetic Theory & Antennas, June 25-30, Technical University of Denmark, Copenhagen.

IRE, AIEE, ISA, ASME, AICHE Joint Automatic Control Conference, June 27-29, New York University, New York, N. Y.

IRE National Symposium on Radio Frequency Interference, June 28-29, Town House Hotel, San Francisco, Calif.

Mobile Civil Emergency Unit (MCEU) National Jamboree, July 6-8, State Fair Grounds, Syracuse, N. Y.

National Bureau of Standards Course in Radio Propagation, July 16-Aug. 3, Boulder Labs, Boulder, Colo.

Wabash Valley CB Jamboree, July 15, Turkey Run State Park, Marshall, Ind.

Western Electric Show and Convention (Wescon), Aug. 21-24, Sports Arena, Los Angeles, Calif.

Rubber-Stamped Circuit Boards

Precision rubber stamps are being used by the Electronics Div. of the Martin Co., Baltimore, for printing identifications in critically tight spaces on the circuit side of the printed-circuit boards used in missile and space vehicle assemblies. Silk-screen printing does not work on surfaces close to the conductors as the screen is lifted away from the board at these points by the height of the conductor.

Japanese Portable TV's Said to Be World's Smallest

An all-transistor TV with a 5-inch picture tube has been introduced on the Japanese market by Sony Corp. The new TV is 7 $\frac{5}{8}$ inches long x 4 $\frac{1}{4}$ inches high x 7 $\frac{1}{4}$ inches deep.

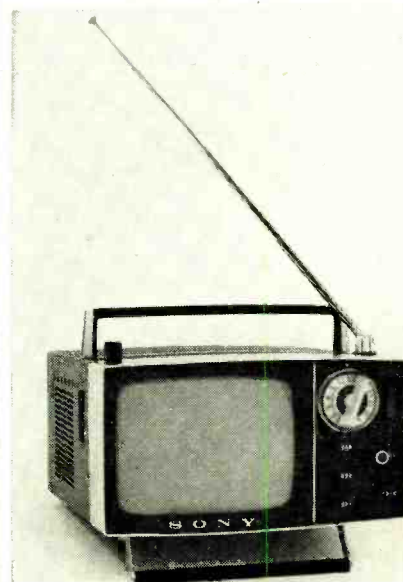

The new TV, only 7 $\frac{5}{8}$ inches long x 4 $\frac{1}{4}$ inches high.

RADIO-ELECTRONICS

Are You Fully Qualified For An Unlimited Career In Electronics?

What's your answer? Do you know *enough* about electronics to take advantage of the tremendous opportunities in the world's fastest growing industry? If there's *any* doubt in your mind, consider this:

It takes more than desire or the "breaks" to get the top jobs in electronics. The primary requirement is a thorough understanding of advanced electronic theory and math plus the ability to apply this knowledge in such exciting fields as Computers . . . Servomechanisms . . . Magnetic Amplifiers . . . AC Circuit Analysis . . . Pulse Circuitry . . . Radar . . . Advanced Measuring Techniques . . . Industrial Electronics . . . Instrumentation . . . Automation . . . Radio Telemetry . . . Semiconductors. Cleveland Institute Home Study can provide this knowledge and combined with your natural desire to get ahead, will let you make your own breaks . . . get the high paid, more challenging jobs that are available right now to men who are fully qualified.

CIE's Exclusive Guarantee of Electronics Training Effectiveness . . . A Commercial FCC License or Your Money Back

Many schools offer home study electronics training. But of all of these, you'll find only one . . . Cleveland Institute of Electronics . . . makes this exclusive guarantee:

Completion of our Master Course (both sections) prepares you for an FCC First Class Commercial Radio Telephone License with a Radar Endorsement. If you fail the FCC examination for this license after successfully completing the Master Course, you will receive a full refund of all tuition payments. This guarantee is valid for the entire duration of your enrollment period.

Cleveland Institute of Electronics

1776 E. 17th St., Desk RE-678B,
Cleveland 14, Ohio

Accredited by the National Home Study Council



Three More Ways In Which CIE Helps Its Students Get Ahead In Electronics

Once you've enrolled with Cleveland Institute, you automatically get these important "extras" . . . *free*:

Job Service . . . every month, throughout your training, CIE will supply you with a listing of hundreds of job opportunities. High paying, interesting jobs . . . with top companies throughout the world. See how CIE training opens a whole new world in electronics opportunity.

Electron Bulletin . . . every month, every student receives a free copy of this informative bulletin that will keep you up to date on what's going on in the world of electronics.

And, for when you graduate — PLACEMENT ASSISTANCE . . .

For every graduate, we will prepare and print 200 letters of recommendation and 200 resumés of your qualifications. As hundreds of our graduates can tell you, this valuable service lets you take immediate advantage of your new skill and knowledge and begin your trip to the top in electronics.



This free booklet will give you complete details on Cleveland Institute Home Study Training and how it can qualify you for an *unlimited* future in electronics. Don't miss this opportunity. Send the coupon *today*.



Get This Handy Pocket Electronics Data Guide Free . . .

Conversion factors, formulas, tables and color codes at your fingertips. Yours without obligation, simply for responding NOW to this opportunity to improve your future.

I want to know more about your electronics home study training program. Please send me your free booklet described above plus your handy pocket Electronics Data Guide. I understand there is no obligation. I have had training or experience in electronics as indicated.

—Clip Here and Mail Coupon To—

Cleveland Institute of Electronics
1776 E. 17th St., Desk RE-67B Cleveland 14, Ohio

- | | |
|---|---|
| <input type="checkbox"/> Military | <input type="checkbox"/> Amateur Radio |
| <input type="checkbox"/> Radio-TV Servicing | <input type="checkbox"/> Broadcasting |
| <input type="checkbox"/> Manufacturing | <input type="checkbox"/> Home Experimenting |
| <input type="checkbox"/> Communications | <input type="checkbox"/> Other |

I'm now working in _____

I want to know about the following branches of electronics —

(please print)

Name _____ Age _____

Address _____

City _____ Zone _____ State _____

RE-67B

NEW 4-WAY POCKET TOOL

a real "working partner"
for removing backs of TV sets
and installing antennas



1 It's a 1/4" nut driver!
Fits Parker-Kalon screws.

Genuine Xcelite
plastic handle—
shaped and
balanced for
working ease.
Equipped with
pocket clip.

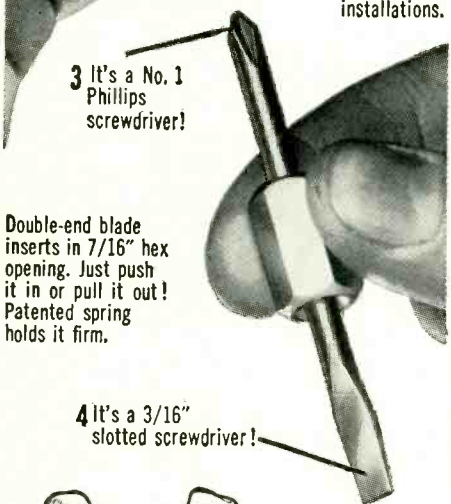

2 It's a 7/16"
nut driver!
Ideal for
antenna
installations.

3 It's a No. 1
Phillips
screwdriver!

Double-end blade
inserts in 7/16" hex
opening. Just push
it in or pull it out!
Patented spring
holds it firm.

4 It's a 3/16"
slotted screwdriver!



Ask to see
"No. 600"
next time you
pick up parts...

XCELITE

XCELITE, INC. • ORCHARD PARK, N.Y.
Canada: Charles W. Pointon, Ltd., Toronto, Ont.

Weight is 8 lbs. This set uses 24 transistors, including 5 silicon types, and 20 diodes. The 5-inch picture tube is a 70° deflection metal-back type. The set will operate on 117 volts ac or 12 volts dc. Hardly had Sony's report reached the newspapers when Mitsubishi announced perfection of a 6-lb. set with 23 transistors and a 90° picture tube. Sony may or may not export sets to the United States in the future. A Mitsubishi spokesman stated that their production, scheduled to start in October, would be "channeled mainly to the export market."

TV Education Better

More than 20% of the students receiving TV instruction learned more from TV than from conventional teaching. Unfortunately, 14% learned less, while 65% showed no significant difference. These facts were brought out in a study by Stanford University, "Educational Television, the Next 10 Years." According to the study, every major school in the United States will probably have its own educational TV system in the next 10 years, and as many as 50% of the college degree programs will be available on TV.

Radio System Controls Turnpike Warning Signs

The New Jersey Turnpike has installed a radio control system that can turn on any or all the warning signs along its 131 miles of highway. These signs warn drivers of snow, ice, fogs or accidents on the road ahead. The system uses both microwave and vhf at the turnpike headquarters. The highway signs are divided into nine groups. Any single sign or any group can be turned on

with a single button. Or, if desired, only the northbound or southbound signs in a section or sections can be actuated.

Pressing a button on the control-board gates signals from a number of tone generators to the microwave transmitter at Turnpike Headquarters, which sends the signal to one of five vhf stations along the turnpike. Automatic means provide that the station nearest the sign transmits the message. The actual message consists of six tones. Four of these are a combination that actuates only one of the receivers in the area. The other two cause relays to light the appropriate warning on the sign.

The whole system is transistorized, more than 1,000 transistors being used in the headquarters equipment alone, the largest number of them in flip-flop circuits.

The new system is expected to give motorists earlier warning of road conditions, as well as save time for the highway patrol troopers who used to operate the signs manually. In accidents, it was often necessary for all available troopers to go to the scene of the accident, and the sign could be lit only later. Under the present system, the sign can warn drivers within 5 seconds after an accident. Obviously, the system also saves valuable time for troopers.

Brief brief

Lasers can cut diamonds, report General Electric Co. scientists. The powerful light beam produced by the laser (optical maser) was focused on a diamond in an experiment at Schenectady. It disintegrated the diamond where it was focused, creating an explosive sound and producing a blue-white jet similar to the flame of an intensely hot gas. END

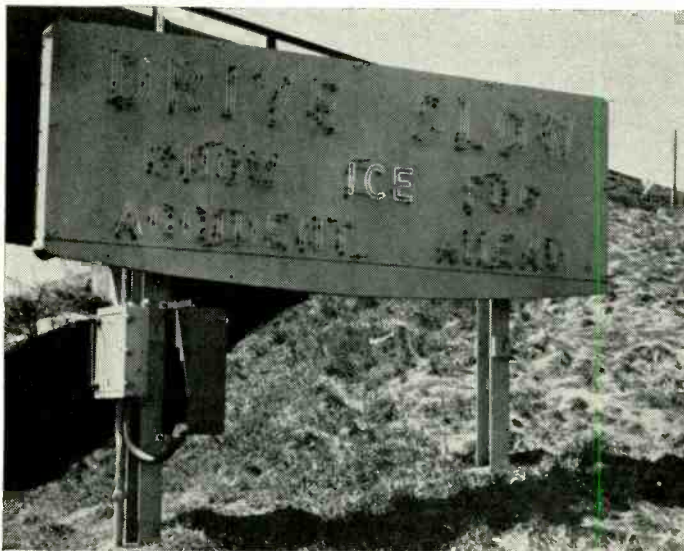

One of the automatically controlled signs on the Jersey Turnpike. The larger dark box on the post contains transistor vhf receiver and system of relays for turning warnings on and off.

The Same School That Originated The RTS BUSINESS PLAN

...NOW
Proudly
Presents...

A SPECIAL COMPACT COURSE COVERING ALL THREE PHASES OF **ELECTRONICS**

The Entire Course Is Made
Up Of The Following:

- 35 LESSONS COVERING BASIC AND INTERMEDIATE ELECTRONICS
- 9 EQUIPMENT KITS COMPLETE WITH TUBES AND BATTERIES
- SOLDERING IRON
- 25 LESSONS COVERING THESE ADVANCED ELECTRONIC SUBJECTS:
 - Thyratron Tubes • Semiconductors • Electronic Symbols and Drawings • Voltage-Regulators • Electronic-Timers • Control Systems • X-Rays • Photoelectric Devices • Dielectric Heating • Geiger Counters • Pulse Circuitry • Clippers and Limiters • Multivibrators • Electronic Counters • Radar • Magnetic Amplifiers • Analog-Computers • DC Amplifiers • Digital Computers • Storage Systems • Input and Output Devices • Servomechanisms • Telemetering
- 60 EXAMINATIONS
- UNLIMITED CONSULTATION SERVICE
- KIT MANUALS
- DIPLOMA UPON GRADUATION

AND MUCH MORE...

BASIC • INTERMEDIATE • ADVANCED

DESIGNED FOR THE BUSY MAN OF TODAY

This is MODERN training for the MODERN man. You'll find no "horse and buggy" methods here. Every page of this streamlined course is devoted to important Electronics principles and practical projects. You'll be amazed how fast you grasp Basic Electronics the RTS way. RTS has combined modern THEORY and PRACTICE to make this the finest training program of its kind available!

SATISFIES NOVICE, TECHNICIAN OR HOBBYIST

Whether you're new to Electronics or an old "pro," chances are you'll find this to be the ideal course for you. The novice will appreciate the completeness of the training. It starts with the most basic considerations, covering each important point thoroughly, yet concisely. The technician will enjoy the practical review of fundamentals and profit from the 25 advanced subjects covered.

RTS GIVES YOU "TOP MILEAGE" FOR YOUR TRAINING DOLLAR

The price quoted below buys EVERYTHING — there are no extras to pay for. RTS has gone "all out" to give you the best training value in America. Why pay hundreds of dollars for training such as we offer when it's available for this LOW PRICE? If you can find a better training bargain... BUY IT!

CAN BE COMPLETED IN MONTHS INSTEAD OF YEARS

Some students will complete this course with "Jet-Like" speed but we allow up to two years if your circumstances require it. You study at your own rate. You are ENCOURAGED but not pushed. You'll find the lessons professionally written. LET US SEND YOU ONE OF THESE LESSONS ALONG WITH YOUR CAREER BOOKLET SO YOU CAN SEE FOR YOURSELF. NO OBLIGATION!

COMPLETE
COST...
INCLUDES ALL KITS,
TUBES, BATTERIES, ETC.
\$125.00*

* TERMS ALSO AVAILABLE
AS LITTLE AS

\$5.00 DOWN \$5.00 PER MONTH

**SAVE TIME — SEND
\$5.00 WITH COUPON**
YOUR FIRST LESSONS AND
KIT WILL BE RUSHED TO YOU
THE SAME DAY THEY ARE RECEIVED!

RTS' Membership in
The Association of
Home Study Schools
is your assurance of
Reliability, Integrity and
Quality of Training.



RTS ELECTRONICS DIVISION
815 E. ROSECRANS AVENUE
LOS ANGELES 59, CALIFORNIA

Est. 1922



L 201 D



**Rush
Coupon**

**NO
SALESMAN
WILL
CALL!**

DON'T LOSE OUT — FIND OUT!

RTS ELECTRONICS DIVISION Dept. 72
815 E. ROSECRANS AVENUE LOS ANGELES 59, CALIFORNIA
Rush me full information by return mail. (Please Print)

Name _____ Age _____

Address _____

City _____ Zone _____ State _____

ENROLL ME NOW **SEND MORE FACTS**

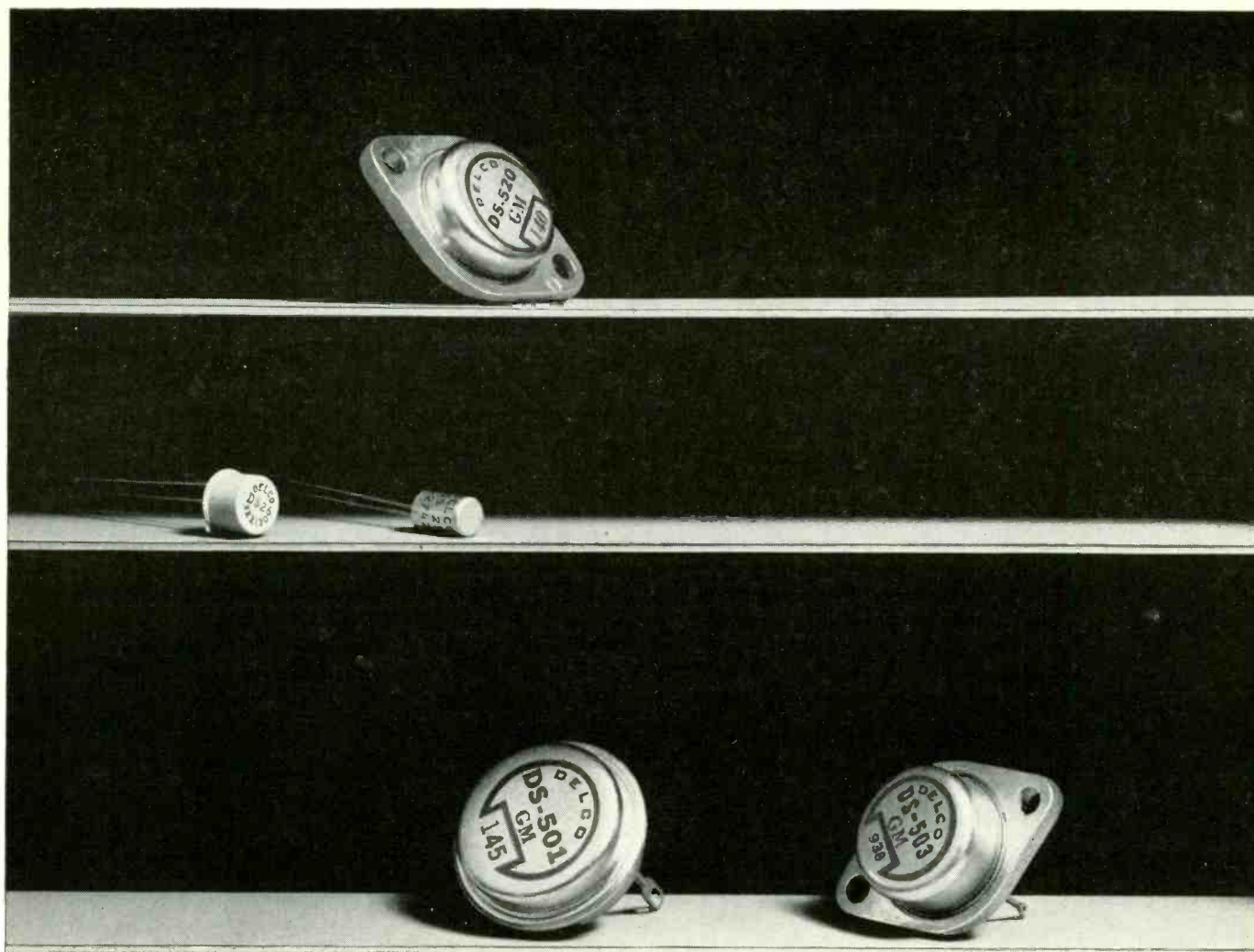

**YOU'RE LOOKING AT ALL THE TRANSISTOR INVENTORY YOU NEED
TO SERVICE EVERY TRANSISTOR CAR RADIO ON THE ROAD!**

simply say **Delco**

There are millions of transistors in car radios today . . . and with just five Delco numbers in stock, you're ready to service this entire replacement market. Simply say Delco and get these advantages!

- Five transistor numbers service all PNP Transistor Auto Radios!
- Delco's DS-25 and DS-26 cover small signal transistor needs in all Delco radios!
- Delco's DS-501 and DS-503 cover audio output transistor needs in all Delco radios!
- Delco's DS-520 fits all non-Delco radios—actually improves performance (up to 1.5 watts)!
- DS-25 and DS-26 replace practically every PNP transistor used in *portable* radios!
- Application and cross reference charts are packaged with your Delco transistors!
- All these advantages are yours at a low cost!

Cash in now on the coverage you get from top-quality **Delco Radio** Automotive Radio Service Parts and Electro-Mechanical devices, distributed nationally through **United Delco**.

DELCO RADIO, Division of General Motors, Kokomo, Indiana



ARE YOU "ON TARGET?"

Test Yourself.....

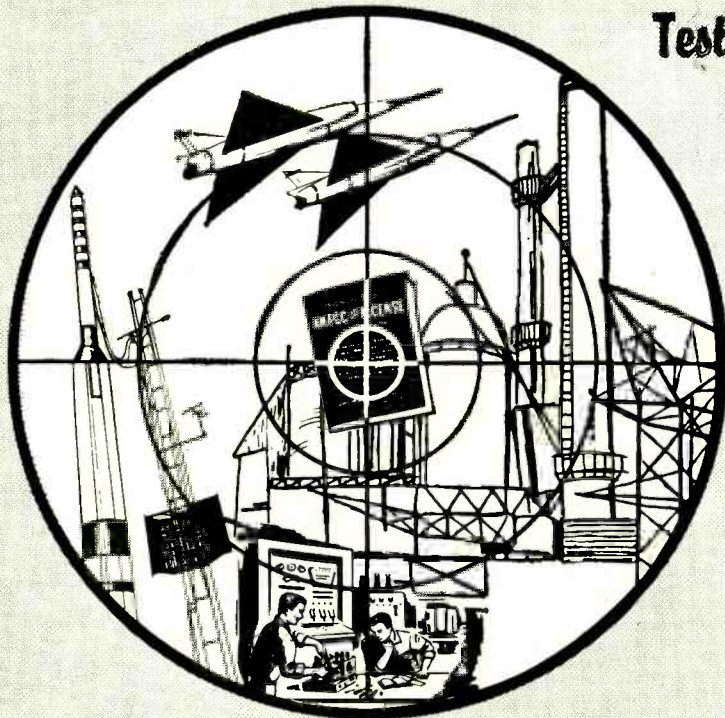

ANSWER THESE QUESTIONS:

- DO YOU want to get into ELECTRONICS?
- Do you have a SPECIFIC OBJECTIVE in mind ... Are you shooting at a particular target (such as an FCC License)?
- Do you want the kind of training that will take you straight to this objective QUICKLY... without wasting valuable time on non-essentials?

The Grantham Communications Electronics Course prepares you for your first class commercial

F.C.C. LICENSE QUICKLY!

CORRESPONDENCE OR RESIDENCE CLASSES

Is Grantham Training for You?

CHECK THESE FEATURES:

- Grantham teaches the *theory* of electronics. Every basic concept of electronics fundamentals is covered in the Grantham course... whether you take it in resident classes or by home study, Grantham training "makes electronics yours."
- You can get your First Class FCC license IN ONLY 12 WEEKS in Grantham resident classes (or, in a correspondingly short time in the Grantham home-study program). THINK OF IT! A *commercial* U. S. Government license... PROOF OF YOUR qualifications in meeting these U.S. Government requirements as an electronics communications technician... a nationally recognized certificate. By preparing you for this license in only 12 WEEKS, Grantham conserves YOUR TIME!
- Mature men select Grantham Schools for electronics training. (The average age of Grantham Students is 28.8 years.) MATURE MEN want a definite objective (not a pot of gold at the end of the rainbow). Grantham training has this specific objective: To prepare you for your First Class FCC license and greater earning capability. The Grantham Course is for mature men who know what they want.

- Grantham Schools' tuition rates are low, yet the instructional service is not equalled by many of the *most expensive schools!* Grantham can do this because of highly efficient instructional methods and because Grantham has a sincere desire to out-do all others in service rendered per tuition-dollar. Grantham has established *reasonable* tuition rates. And, the percentage of students who successfully complete the Grantham course — and who get their FCC licenses — is one of the highest in the nation.
- YOU GAIN RESPECT by showing your Grantham diploma, once you earn it. YOU GAIN RESPECT by showing and posting your First Class FCC License — a nationally recognized certification of your electronics knowledge. Many companies which employ industrial electronics technicians require them to have this license. YOU CAN GET IT IN ONLY 12 WEEKS. Let Grantham show you how!

HERE'S PROOF: Here is a list of a few of our recent graduates, the class of license they got, and how long it took them:

	License	Weeks
James C. Bailey, 217 Behrends Ave., Juneau, Alaska	1st	12
Edward R. Barber, 907 S. Winnifred, Tacoma, Wash.	1st	20
M. A. Dill, Jr., 20 Cherry St., Gardiner, Maine	1st	12
Bernhard G. Fokken, Route 2, Canby, Minn.	1st	12
Kenneth F. Foltz, Broad St., Middletown, Md.	1st	12
James C. Greer, Mound City, Kansas	1st	12

Get your First Class Commercial F.C.C. License Quickly by training at



GRANTHAM SCHOOL OF ELECTRONICS

Accredited by the National Home Study Council

1505 N. Western Ave. 408 Marion Street 3123 Gillham Road 821-19th Street, N.W.
 Los Angeles 27, Calif. Seattle 4, Wash. Kansas City 9, Mo. Washington 6, D. C.
 (Phone: HO 7-7727) (Phone: MA 2-7227) (Phone: JE 1-6320) (Phone: ST 3-3614)

MAIL COUPON NOW — NO SALESMAN WILL CALL →

(Mail in envelope or paste on postal card)

TO: GRANTHAM SCHOOL OF ELECTRONICS

1505 N. Western • 408 Marion • 3123 Gillham Rd. • 821-19th, NW
 Los Angeles • Seattle • Kansas City • Washington

Gentlemen:

Please send me your free booklet telling how I can get my commercial F.C.C. license quickly. I understand there is no obligation and no salesman will call.

Name _____ Age _____

Address _____

City _____ State _____

Interested in: Home Study, Resident Classes 24-K



Tips for Technicians

Distributor Division, P. R. Mallory & Co. Inc.
P. O. Box 1558, Indianapolis 6, Indiana

The new generation of batteries ... how to use them

You may not realize it, but dry batteries used in modern electronic circuits are as different from old style dry cells as 1962 autos are from the Model T.

Of primary interest to you as a technician is the mercury battery. Instead of the ordinary combination of zinc, carbon, and electrolytic compounds, Mercury batteries use mercuric oxide and a zinc amalgam in combination with an alkaline electrolyte. This chemical system produces a dry battery uniquely matched to solid-state electronic circuits. For example, Mercury batteries have about four times the milliampere-hour capacity of ordinary batteries of the same physical size.

Not only do mercury batteries contain more actual power, they hold this power for long periods of time. Ordinary batteries start to lose power from the instant they are assembled *whether used or not*. On the other hand the storage life of a mercury battery is amazing. We've had some on storage test for more than nine years . . . AND THEY'RE STILL ALIVE.

Perhaps the best thing about mercury batteries is their steady output voltage. It stays nearly constant throughout the entire life of the battery (see chart). Ordinary battery voltage drops steadily. Constant voltage is important in solid state circuits . . . it means constant gain and linearity.

Terminal voltage on a mercury cell is 1.35 volts $\pm 1/2\%$! This is so accurate there's a special multi-voltage reference battery (Pt. No. 303113) that's widely used as a secondary voltage standard. It's excellent for setting scopes, meters, etc., and all sorts of lab work. We'll be happy to send complete information. Just ask.

Mercury batteries are a Mallory development. We like to think we're experts on them. But we know there are jobs a mercury battery shouldn't do. Jobs where very high surge drains or continuous heavy drains are required . . . flash cameras, flashlights, movie cameras, etc. So we developed the Mallory Manganese Battery. It's the king of heavy drain batteries . . . with excellent storage life and moderate price.

There are literally dozens of other battery systems available from Mallory. We simply don't have space to go into them here. But if you're interested in rechargeable batteries, or ultra low temperature types, or extreme low or high voltage types, or other exotic types, write to Dept. 762. We'll send the information.

Meanwhile, when you need a battery for a grid bias circuit, or a portable instrument, or a transistor radio, use a Mallory Mercury Battery. For flashlights and similar applications use Mallory Manganese Batteries. You can get them from your Mallory Distributor. He's the man to see for Mallory capacitors, controls, switches, semiconductors, and vibrators . . . and for all your electronic requirements.

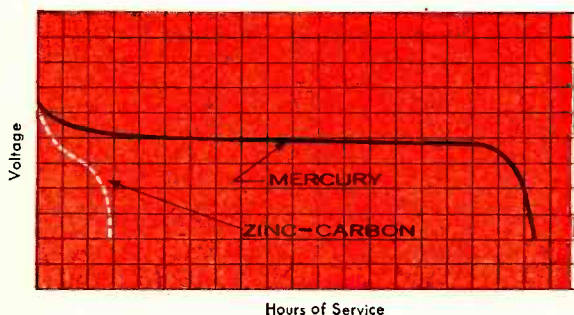
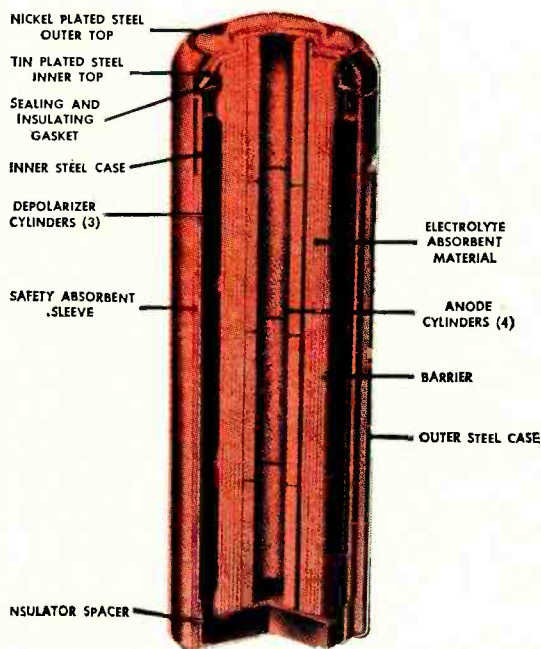

Free!

LATEST SAMS INDEX TO PHOTOFACT[®] FOLDER SETS

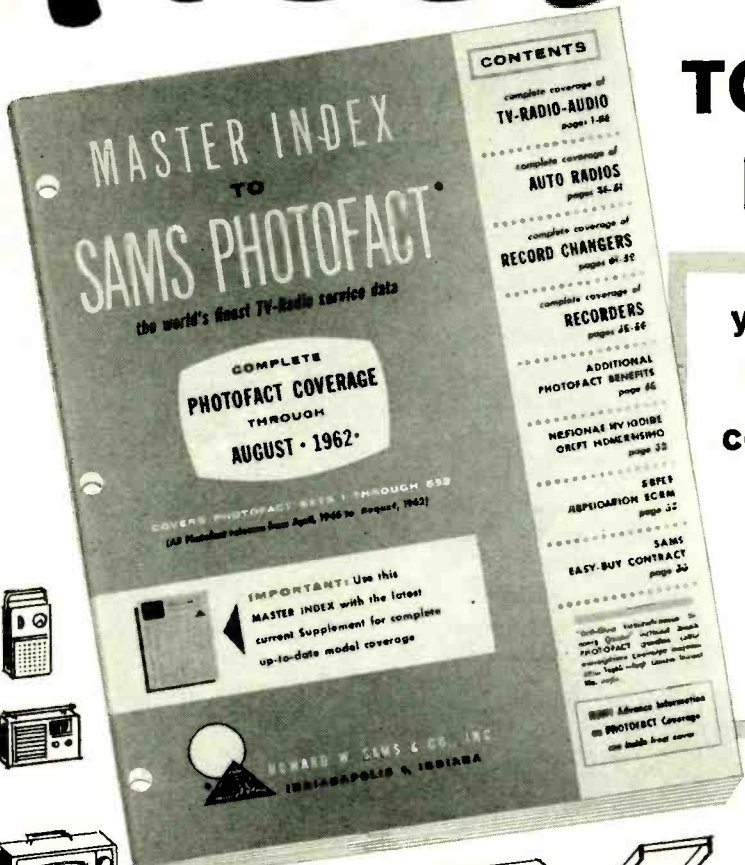

your handy quick guide to the world's finest service data covering **53,000** listings

**TV, HOME & AUTO RADIOS,
HI-FI & PHONOGRAPHS,
RECORD CHANGERS &
TAPE RECORDERS
CITIZENS BAND RADIOS**

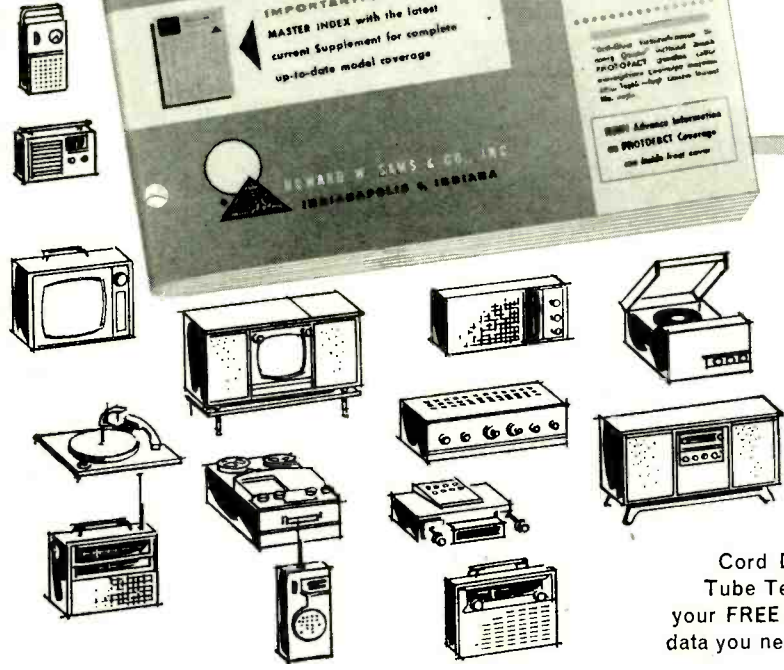

Here is your invaluable 60-page guide covering virtually every model of home-entertainment electronic equipment produced since 1946! Helps you locate the proper PHOTOFACT Folder to quickly solve any service problem in any model. PHOTOFACT provides *everything* you need in complete, uniform style for quick, effective repairs: Famous Standard Notation Schematics packed with the service details you need; Full Photo Coverage of all chassis views; Complete Replacement Parts Lists; Tube Placement Diagrams; Alignment Instructions; CircuiTrace[®] for printed boards; Disassembly Instructions; Dial Cord Diagrams; Changer and Recorder "Exploded Views"; Tube Test data—plus dozens of other great features. Send for your FREE copy of the latest PHOTOFACT Index to the service data you need!

**OVER 53,000 LISTINGS COVERED BY
PHOTOFACT FOLDERS—EACH EASY TO LOCATE
FROM THE INDEX—SEND FOR YOUR FREE COPY!**

**TAKE THE RIGHT STEP TO TIME-SAVING
PROFIT-BUILDING SERVICING—see your
Sams Distributor for details on an Easy-Buy
PHOTOFACT Library or Standing Order
Subscription!**

MAIL COUPON TODAY! **Send for FREE INDEX**

HOWARD W. SAMS & CO., INC.

Howard W. Sams & Co., Inc., Dept. 5-G2
4300 W. 62nd St., Indianapolis 6, Ind.

Send FREE Photofact Index

I am a Service Technician: _____ full time, _____ part time

Other: (specify) _____

Shop Name _____

Attn: _____

Address _____

City _____ Zone _____ State _____

Correspondence



Pathfinder Change Won't Work

Dear Editor:

W. Chakeres' electronic pathfinder modification (May 1962, page 26) won't work the way it is drawn. Once the headlights have been turned on (manual switch), the heater of the time delay relay has 15 volts on it. Thus, 180 seconds later, the contacts would open and the pathfinder would be useless.

A high-power diode (25 amps) in the feed to the headlights would make the circuit operational. However, it is better to connect the headlamp feed to a separate pole of the relay. Also, by

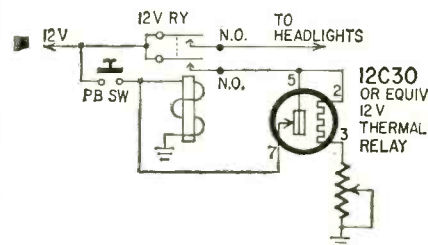

using a 30-second thermal relay and a rheostat you can vary the time delay. **IMPORTANT:** Before selecting a value for the rheostat, make sure its maximum value will allow enough heater current to turn the headlamps off when battery voltage is 10 to 11 volts.

R. M. HICKS

Anderson, Ind.

Vidicon a Problem

Dear Editor:

I was most interested in the article on the closed-circuit TV camera in the May 1962 issue until I found the current price for the 6198 vidicon at \$220. Let's have construction articles that are down to earth and not such fabulously priced duds.

In addition, I think an editor's note on this type of article listing prices of this sort of tube or semiconductors would forewarn the constructor.

CHARLES D. HAUPT

Wichita, Kans.

[We investigated carefully the prices of 6198 vidicons, deflection units, etc. before publishing the article. While we did not quote the price, we did give a source for these tubes. It is our understanding that new 6198 vidicons are no longer obtainable, so it is quite possible that you quoted from an older catalog.

The source we quoted offers

RADIO-ELECTRONICS

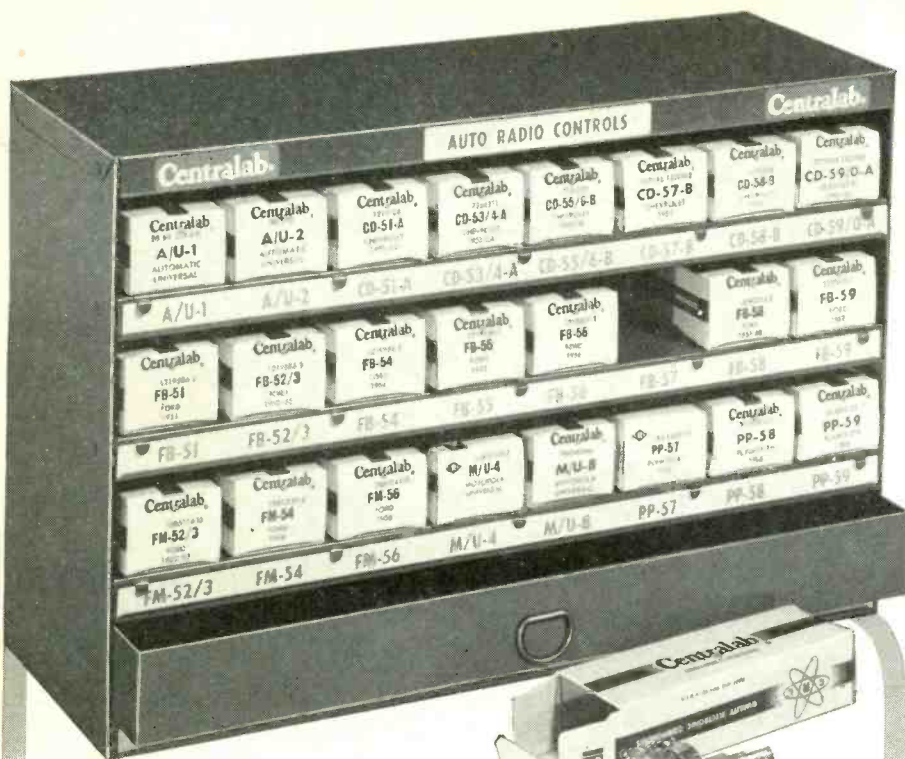

FREE ROLLER SKATES

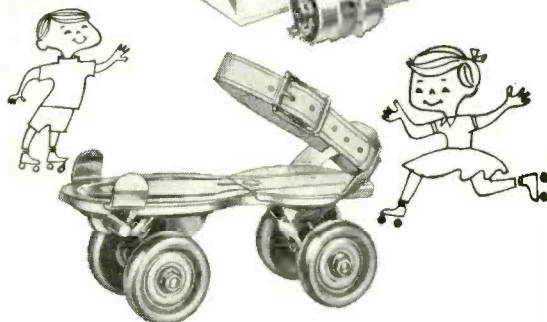

with each Centralab ACK-100

AUTO RADIO CONTROL KIT

YOU GET:

24 of today's fastest movers

PLUS

- free sturdy steel cabinet

PLUS

- auto-radio control cross reference

PLUS

- free roller skates

ONLY **\$49.95** THE PRICE OF THE CONTROLS ALONE!

See your distributor now!—Offer will be withdrawn when supplies are exhausted.

Centralab controls are listed in Sams' TV & Auto-Radio Control Replacement Guide.



THE ELECTRONICS DIVISION OF GLOBE-UNION INC.
9226 EAST KEEFE AVENUE • MILWAUKEE 1, WISCONSIN
In Canada: Centralab Canada Ltd., P.O. Box 400, Ajax, Ontario

B-6227S

PICK THE CAREER YOU WANT IN THE WONDERFUL FIELD OF ELECTRONICS TRAIN AT HOME WITH THE LEADER

Higher earnings and rapid advancement plus a growing need for trained technicians . . . these are the reasons why so many men are training for careers in Electronics with NRI. Right now, four-to-seven technicians are needed for every graduate engineer—but you must be *trained to qualify*. So to assure advancement, or to turn your hobby into a new and profitable career, investigate the Electronics courses offered by NRI, the oldest and largest home-study school of its kind. NRI training is the time-proved way to get into the fast-growing industry of the 1960's.

INDUSTRIAL ELECTRONICS



Prepare for a career as an Electronic Technician in industry, business, government, the military, with this NRI course in Electronics — Principles, Practices, Maintenance. Computers, telemetry, automation, missiles, rockets all employ the same basic principles . . . and that is what this NRI course stresses with illustrated lessons, special training equipment.

FCC COMMERCIAL LICENSE



This course is for men with Radio-TV experience who want to operate or service transmitting equipment used in broadcasting, aviation, marine, microwave, facsimile or mobile communications. A Service Technician is *required by law* to have an FCC License to work on C-Band and other transmitting equipment. This new NRI course trains you quickly for your Government exams.

TELEVISION-RADIO SERVICING

(INCLUDES COLOR TV)

NRI's time-tested course in Servicing not only trains you to fix radios, stereo hi-fi, black & white TV, etc., but also prepares you for profit opportunities in the growing field of Color TV. NRI training shows how to earn spare-time money starting soon after you enroll. Prepare for a spare-time or full-time business or a good job as a Service Technician. Special training equipment included.

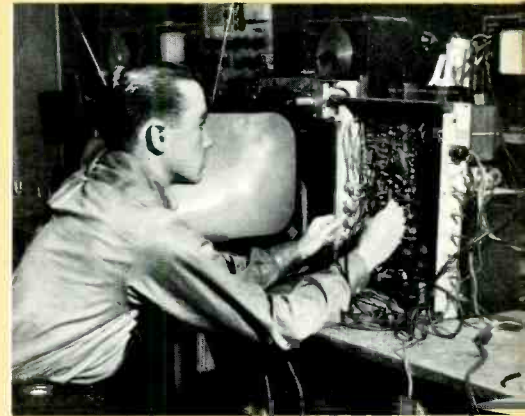

TV-RADIO COMMUNICATIONS

Get actual experience as NRI prepares you for your choice of Communications fields and an FCC License. Commercial methods and techniques of Radio and TV Broadcasting; teletype; facsimile; microwave; radar; mobile and marine radio; navigation devices; FM stereo multiplexing are some of the subjects covered. You work with special training equipment NRI furnishes.



Job Counsellors Recommend—TURN PAGE 

Mail Postage-Free Card 

Cut Out and Mail—No Stamp Needed



NATIONAL RADIO INSTITUTE
WASHINGTON 16, D. C. RG

Please send me your Electronic, Radio-TV catalog without cost or obligation. I am interested in the course checked below. (No salesman will call PLEASE PRINT.)

- INDUSTRIAL ELECTRONICS FCC LICENSE
 RADIO-TV SERVICING COMMUNICATIONS

Name _____ Age _____

Address _____

City _____ Zone _____ State _____

ACCREDITED MEMBER NATIONAL HOME STUDY COUNCIL

Approved for Veteran's under Korean GI Bill

The Amazing
Field of
Electronics



**ELECTRONICS NEEDS
4 TO 7
QUALIFIED TECHNICIANS**

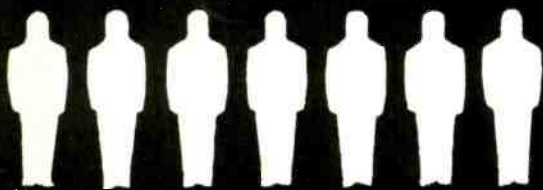

FOR EVERY ENGINEER



Join The Thousands Who Trained For Advancement With NRI

Thousands of NRI graduates throughout the U. S. and Canada are proof that it is practical to train at home. NRI graduates are in every kind of Electronics work: inspectors, maintenance men, lab technicians, testers, broadcasting and mobile communications operators, Radio-TV service technicians, or in essential military and government posts. Catalog tells more about what NRI graduates do and earn. Mail postage-free card.

"Learn-by-Doing" with Special NRI Training Equipment



As part of your training (in all but the FCC License Course) NRI sends you specially-developed training kits that give actual practice, make NRI training come to life in an exciting, practical, easy-to-understand manner. You perform dozens of "home lab" experiments with high-quality, scientifically designed electronic components, like those used in commercially-made instruments. You keep all the equipment you get. It is yours at no extra cost . . . to use in your new career. See and read about this special training equipment, as well as other course details, information about the growing Electronics field, data on amazing new developments, job opportunities and the NRI trial plan in FREE 64-page Catalog. No obligation. No salesman will call on you. Just mail postage-free card below.

As part of your training (in all but the FCC License Course) NRI sends you specially-developed training kits that give actual practice, make NRI training come to life in an exciting, practical, easy-to-understand manner. You perform dozens of "home lab" experiments with high-quality, scientifically designed electronic components, like those used in commercially-made instruments. You keep all the equipment you get. It is yours at no extra cost . . . to use in your new career. See and read about this special training equipment, as well as other course details, information about the growing Electronics field, data on amazing new developments, job opportunities and the NRI trial plan in FREE 64-page Catalog. No obligation. No salesman will call on you. Just mail postage-free card below.

SEE OTHER SIDE



"THE FINEST JOB I EVER HAD" is what Thomas Bilak, Jr., Cayuga, N. Y., says of his position with the G. E. Advanced Electronic Center at Cornell University. He writes, "Thanks to NRI, I have a job which I enjoy and which also pays well."



BUILDING ELECTRONIC CIRCUITS on specially-designed plug-in type chassis, is the work of Robert H. Laurens, Hammonton, N. J. He is an Electronic-Technician working on the "Univac" computer. Laurens says, "My NRI training helped me to pass the test to obtain this position."



"I OWE MY SUCCESS TO NRI" says Cecil E. Wallace, Dallas, Texas. He holds a First Class FCC Radio-telephone License and works as a Recording Engineer with KRLD-TV.



MARINE RADIO OPERATOR is the job of E. P. Searcy, Jr. of New Orleans, La. He works for Alcoa Steamship Company, has also worked as a TV transmitter engineer. He says, "I can recommend NRI training very highly."



FROM FACTORY LABORER TO HIS OWN BUSINESS that rang up sales of \$158,000 in one year. That's the success William F. Kline of Cincinnati, Ohio, has had since taking NRI training. "The course got me started on the road," he says.

NRI IS OLDEST, LARGEST SCHOOL OF ITS KIND

Helping men to succeed through Home Study training has been NRI's only business for nearly half a century. Thousands of NRI graduates from coast to coast are proof that NRI home study methods lead to profitable, respected careers. *Act Now.*



MAIL POSTAGE-FREE CARD NOW!

FIRST CLASS
PERMIT
NO. 20-R
(Sec. 34.9, P.L.&R.)
Washington, D.C.

BUSINESS REPLY MAIL
NO POSTAGE STAMP NECESSARY IF MAILED IN THE UNITED STATES

POSTAGE WILL BE PAID BY



National Radio Institute

**3939 Wisconsin Ave.
Washington 16, D.C.**

grade-A vidicons at \$100. However, the same source advertises grade B's at \$34.50.

Listing the prices of components in electronic projects is a difficult problem. It would be to our advantage to quote figures but, whenever we have done so, we have been challenged by readers for underquoting or overquoting. Prices vary widely between sources and in different sections of the country. A New York City reader, for instance, can shop around on Cortlandt St. and get a surplus item for less than in, say, Lake City, S. C.—*Editor*]

Back with the Baffle

Dear Editor:

I was interested to see Walt Wheelock's "New Life for Console Radios" in the March issue. Bofflizing an old console is a good idea. My original article on the Baffle, "Building a Baffle," February 1956, produced a spate of letters from readers who had used it with various speakers, and they reported that it really did work.

I would like to make a few comments on the present article with a view to helping your readers. The text says it, but the picture doesn't—the carpet felt *must* be carried around the wooden frame. There must be a jam-tight fit in the cabinet to prevent the cabinet sides from resonating.

Five screens are certainly better than none, but as many frames as possible should be inserted in the cabinet. Even then, the space that is unoccupied will have "air-column resonance," and all the vacant air space should be filled with teased-out cotton waste.

Finally, each and every internal surface should have felt glued to it, not only to damp out resonance of the sides, but to prevent reflection of the back sound waves from the speaker.

I feel remiss at not having made any contributions to the art during the past few years. The truth is that I had nothing to write about. I have been doing a lot of research into fundamental high-fidelity problems and hope to come out with something interesting in the near future. Meanwhile it is encouraging to note that some of my past work has some merit. I wish it could have had more.

H. A. HARTLEY

London, England

Is Reverberation Valid?

Dear Editor:

Several publications have been concerned with the effects and value of devices such as headsets and artificial reverberation for stereo music systems.

In my own experience, some recordings fare better than others in headset use, and vice versa. Obvious shortcomings of headsets are bass dis-

(Continued on page 24)

JULY, 1962



Personal two-way radio
is serious business. Wherever
you plan to use it, your only
important measures of performance
are ruggedness, reliability
and range. This was our target
in designing the CB-4.
No gadgets, no gingerbread.
Just an extremely dependable 27 Mc.
portable communications system.

littlefone
CB-4
\$89.95

Power input: 100 MW • Receiver sensitivity: 1 microvolt • Plug-in crystals and transistors for easy channel changeover and service • Shatter-proof, vinyl-clad aluminum cabinet • Fully transistorized • Mercury-type battery (not included).



the new ideas
in communications
are born at ...



hallicrafters

Chicago 24, Illinois

No FCC license required

Dealers: A limited number of Authorized Hallicrafters Dealerships are available in some territories. See your Hallicrafters distributor, representative, or write to: The Hallicrafters Co., 4401 W. Fifth Ave., Chicago 24, Ill.

ATTENTION

- Service Technicians' Associations
- Club Members
- Student Groups

Special subscription rates to RADIO-ELECTRONICS are available to associations, clubs, schools, employee groups, etc. For information write— G. Aliquo

Radio-Electronics 154 West 14th St., New York 11, N. Y.

New Heavy Duty RFI Suppression Kit For Mobile Radio



RADIO HAMs, fleet owners, and CB operators can now enjoy clearer, more readable, less tiring mobile communications at longer effective ranges.

Sprague's new Type SK-1 SUPPRESSIKIT provides effective R-F Interference suppression—at moderate cost—up through 400 megacycles. Designed for easy installation on automobile, truck, or boat engines with either 6-volt or 12-volt generators, the Suppressikit makes possible high frequency interference control by means of Sprague's new, extended range, Thru-pass[®] capacitors.

The components in the SK-1 Suppressikit are neatly marked and packaged, complete with easy-to-follow installation instructions. All capacitors are especially designed for quick, simple installation.

The generator capacitor is a heavy-duty unit rated at 60 amperes, and will operate at temperatures to 125°C (257°F). This means you'll have no trouble with an SK-1 installation in the terrific temperatures found "under the hood" on a hot summer's day. There's no chance of generator failures from capacitor "short outs," as with general purpose capacitors. The Thru-pass capacitors for use on voltage regulators are also rated at a full 60 amperes.

The Deluxe Suppressikit is furnished complete with an 8-foot shielded lead on the generator capacitor which can be trimmed to necessary length for any car or small truck, preventing R-F radiation from armature and field leads.

Containing only 5 easy-to-install capacitors, the Deluxe Suppressikit is a well-engineered kit. The net price is a little higher than that of many thrown-together kits, but it saves you so much time and aggravation it's well worth the slight extra cost.

For additional information on the Type SK-1 Suppressikit, see your Sprague Electronic Parts Distributor.

**Sprague TWIST-LOK[®] Capacitors give you
2 tremendous advantages over
all other twist-prong electrolytics**



1

**The right size,
the right rating, for
EVERY replacement job**

No need to compromise or improvise...the TWIST-LOK Line includes over 1690 different capacitors . . . It's the industry's most complete selection of twist-prong type capacitors, bar none!

2

**Exclusive, improved
cover design for
greater dependability**

Type TVL Twist-Lok Capacitors are now more dependable than ever! Sprague's new cover design provides a truly leak-proof seal and permits capacitors to withstand higher ripple currents.

Compare internal construction of TWIST-LOK to ordinary 'Lyctic!

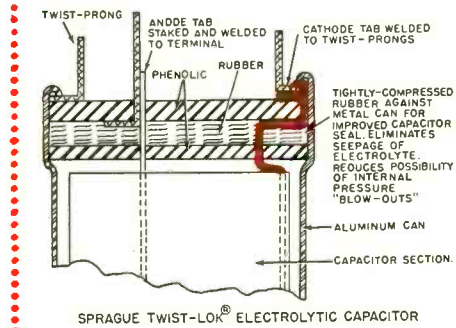
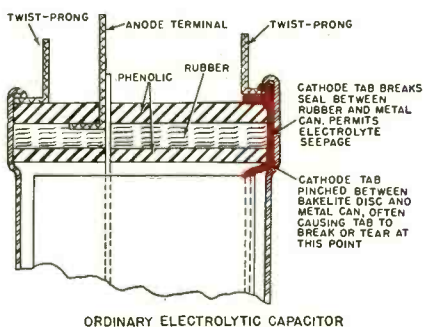

Complete listings are shown in handy Wall Catalog C-457. Get your copy from any Sprague Distributor, or write to Sprague Products Company, 81 Marshall St., North Adams, Mass.

**WORLD'S LARGEST
MANUFACTURER OF CAPACITORS**



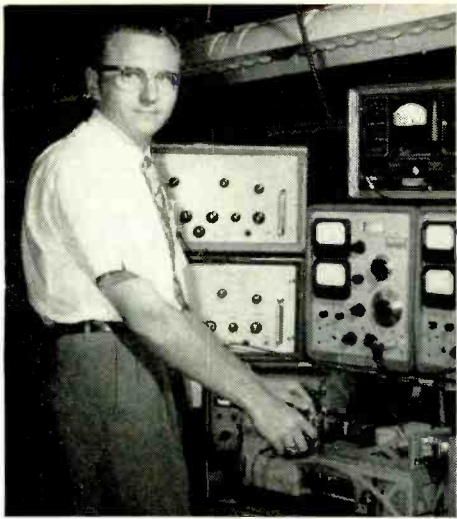

RICHARD S. CONWAY (CREI grad 1960) is Supervisor, Electronic Test Department Wilcox Electric Co., Kansas City, Mo.

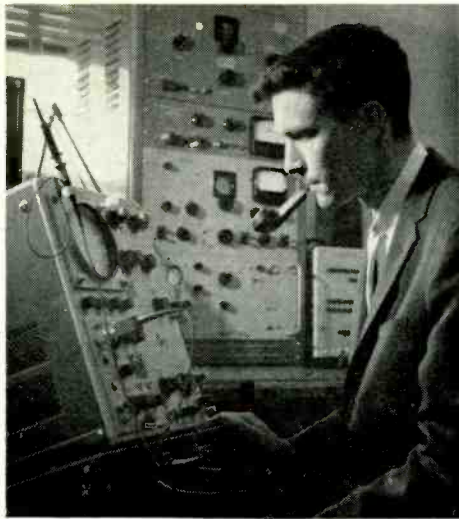

ROBERT T. BLANKS (CREI grad 1960) is Engineer, Research & Study Div., Vitro Labs., Division of Vitro Corp. of America, Silver Spring, Md.

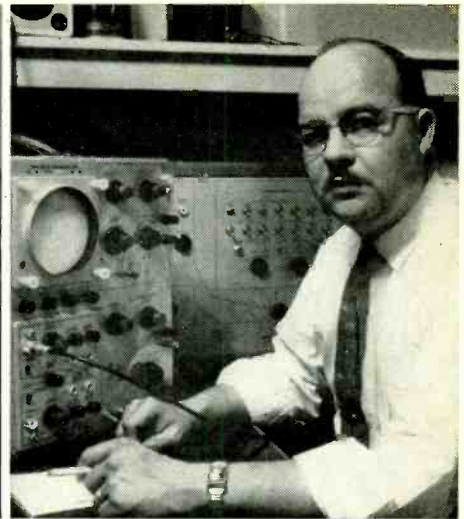

MEARL MARTIN, Jr. (CREI grad 1956) is a Senior Engineer and Field Support Manager, Tektronix, Inc., Portland, Oregon.

Why do these men now enjoy profitable careers in electronics that others still dream about?

SUCCESS IS NO ACCIDENT. There is a reason why some men move ahead in electronics while others stand still, year after year, in routine, low-paid jobs. Responsible, rewarding positions in electronics require advanced technical knowledge. Without such knowledge, you cannot hope for success no matter how bright and ambitious you are.

THE THREE MEN SHOWN ABOVE realized that career opportunities would open up for them only if they gained the practical knowledge of electronic engineering technology demanded by industry. They gained this knowledge through CREI Home Study Programs and achieved the success they desired.

YOU HAVE THE SAME OPPORTUNITY. Through CREI Home Study Programs, you can acquire the practical working knowledge of advanced and up to date electronic engineering technology that will put you on the level of specialization where men are most in demand.

YOU WILL FOLLOW THE FOOTSTEPS of the thousands of CREI men who hold positions as associate engineers, engineering aides, field engineers, project engineers and technical representatives. They work in every area of electronics, from manufacturing to the space program.

WHEN YOU ENROLL IN A CREI HOME STUDY PROGRAM, you study courses to which a number of leading engineers and scientists have made substantial contributions. You are guided and assisted by CREI's staff of experienced instructors.

YOU HAVE A CHOICE OF PROGRAMS covering every field of electronics:

RADAR • COMPUTERS • SERVOMECHANISMS • INSTRUMENTATION • AERONAUTICAL AND NAVIGATIONAL • COMMUNICATION • TELEVISION • AUTOMATION AND INDUSTRIAL ENGINEERING TECHNOLOGY • NUCLEAR ENGINEERING TECHNOLOGY

CREI EDUCATION IS RECOGNIZED by many large corporations such as National Broadcasting Company, Pan American Airways, Federal Electric Corporation, The Martin Company, Canadian Broadcasting Co., Mackay Radio, and many others. These companies often pay all or part of CREI tuition for their employees.

CREI HAS 35 YEARS OF EXPERIENCE in advanced technical education through home study. CREI has de-

veloped electronics courses for the Army Signal Corps, special radio technician courses for the Navy, and group training programs for leading aviation and electronics companies. CREI also maintains a Residence School in Washington, D. C.

YOU CAN QUALIFY for a CREI Program, if you have basic knowledge of radio or electronics and are a high school graduate or the equivalent. If you meet these qualifications, write for FREE 58-page book describing CREI Programs and career opportunities in advanced electronic engineering technology. Mail coupon or write to: The Capitol Radio Engineering Institute, Dept. 1407-K, 3224 Sixteenth St., N.W., Washington 10, D. C.

Mail coupon today for FREE 58-page book



THE CAPITOL RADIO ENGINEERING INSTITUTE

Founded 1927

Dept. 1407-K, 3224 Sixteenth St., N.W., Washington 10, D.C.

Please send me details of CREI Home Study Programs and Free Book, "Your Future in Electronics and Nuclear Engineering Technology." My qualifications are noted to obtain immediate service.

CHECK FIELD OF GREATEST INTEREST:

- Electronic Engineering Technology Nuclear Engineering Technology
 Servo and Computer Engineering Technology Automation and Industrial Electronic Engineering Technology
 Aero and Navigational Engineering Technology

Name Age

Address

City Zone State

Employed by

Type of present work

Education: Years High School Other

Electronics Experience

Check: Home Study Residence School G.I. Bill





**FOR ALL
BLACK & WHITE
PICTURE TUBES**

2 volt / 4 volt / 6 volt / 8 volt
series or parallel
electrostatic or electromagnetic

Perma-Power

INTRODUCES THE

2-Brite

**IF THE BASE
IS RIGHT
THE BOOST
IS RIGHT**

7 POWER RATINGS

VOLTS	AMPS
2.34	.600
2.68	.450
4.70	.300
6.30	.300
6.30	.450
6.30	.600
8.40	.450

MODEL C202
for duodecal
base sets



MODEL C212
for 110°
button base
sets
(RCA type)



MODEL C222
for 110° shell
base sets
(Sylvania-
Dumont type)

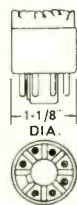

A Britener with a slide switch for series or parallel wiring is nothing new—but those previously available could only be used on picture tubes with heater ratings of 6.3 volts, .600 amps. For all other heater ratings, a single-purpose auto-former has been necessary.

Now Perma-Power has developed a truly universal series/parallel Britener—one that can be used on ANY set without endangering the delicate filaments through too much boost. Only Perma-Power—the leader—offers you this convenience.

You can brighten any TV picture with Perma-Power's 2-Brite. If the base is right, the boost is right! You don't even have to take the time to consult a Britener Selector Guide. Just choose the right base style—and install with confidence.

List Price \$3.75

Perma-Power COMPANY

3106 N. ELSTON AVE. • CHICAGO 18, ILL.

**COMING UP IN
Radio-Electronics**

- Protect Your Meters with a Circuit Breaker
- Survey of Sweep Generators
- All About Radiation Detection and Measurement
- Increase Your Multimeter Sensitivity
- Build a Transistor FM Tuner
- Simple Electronic Metal Detector
- Construct a Professional Quality Stereo Preamp
- Shooting Trouble with the Color Bar Generator
- Electronic Starting Aid for Your Car

SUBSCRIPTION RATES: 1 Year \$5, 2 Years \$9, 3 Years \$12

RADIO-ELECTRONICS 54 W. 14th St. New York 11, N.Y.

tortion and, with some recordings, an oppressive feeling of over-imminence of the signal source. There is also something of an impression of the music coming from a point at the center of the head rather than the sought-for spaciousness. However, for the most part I prefer headset listening because of the effect of greater vividness, and the better representation of the original reverberation conditions.

When I do listen via speakers, in addition to two facing speakers, I set up two more *behind* me, fed by an auxiliary stereo amplifier plus reverberation. The result is a far more convincing illusion. Clean monaural records feel more "spacious" and "transparent" than ungimmicked stereo records of similar quality. A little judicious juggling of the tone controls to feed more highs or lows to one or the other leg of the system enhances the effect, of course. "Pseudo-stereo," you may say, but a reasonable illusion is all that we can hope for in any event. "Authorities" who deprecate this sort of gimmickry in favor of a more "authentic" realism are suffering from *delusions!*

My reaction concerning reverberation devices is that they must do until something better comes along. The fact that the delay is done with springs is rather embarrassingly apparent, as can be observed on isolated record clicks. These, not being masked by following material, sound for all the world like a plucked spring twanging. The vibration of the coil springs is all too obviously just that. However, this should not dissuade the prospective purchaser, as I have found even these crude makeshifts valuable when intelligently used.

CURTIS D. JANKE

Sheboygan, Wis.

Rigged Sets

Dear Editor:

Three cheers for Mr. M. C. McCombs' letter in the March issue (page 22). This is the first sensible item I have ever read about the "rigged set" racket. [Try reading "Pedro and the Impeded Double Cross," January 1949, page 54. —*Editor*] I would like to watch a couple of these guys repairing a set someone else had rigged.

In 1935 I bought a duplicate billing machine and every customer gets an itemized bill. If it takes me 4 hours to find a 30-cent defective part and replace it, the bill reads: resistor 30¢, labor \$16.00. (If I feel I should have found the trouble in less time, the labor is priced accordingly.)

I feel that most radio-TV service technicians are as well qualified as anyone else for their work and are entitled to a fair day's pay.

JACK WATT

Ontonagon, Mich.

END

See Only the Scale You Want...in the Exact Range You Want

just set the range switch
and the correct scale appears
AUTOMATICALLY

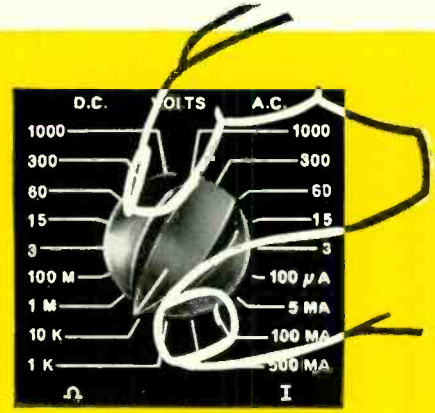

in the new **B&K**
VOM and VTVM

V O M A T I C 360

AUTOMATIC VOLT-OHM MILLIAMMETER

WITH
BURN-OUT PROOF
METER

Greatly simplifies your VOM use. Individual full-size scale for each range—and only one scale visible at any one time, automatically. Once you set the range switch, it is impossible to read the wrong scale. Reading in the range you want is amazingly easy—and direct. No reading difficulties, no multiplying, no errors.

Sensitivity 20,000 ohms per volt DC; 5000 ohms per volt AC. **Accuracy** $\pm 3\%$ DC; $\pm 5\%$ AC; (full scale). **DC Volts** in 6 ranges 0-6000. **AC Volts** in 6 ranges 0-6000. **AF (Output)** in 4 ranges 0-300 volts. **DC Current** in 5 ranges 0-10 amps. **Resistance** in 4 ranges 0-100 megohms. Supplemental ranges also provided on external overlay meter scales. Meter protected against extreme overload and burn-out. Polarity reversing switch. Automatic ohms-adjust control. Mirrored scale. Complete with 1½-volt and 9-volt batteries, test leads, and easy-viewing stand. Net, \$5995



DYNAMATIC 375

AUTOMATIC VACUUM-TUBE VOLTMETER

Once you set the range switch, you automatically see only the scale you want and read the exact answer directly. Saves time, eliminates calculation, avoids errors. Individual full-size direct-reading scale for each range. Simplifies true reading of peak-to-peak voltages of complex wave forms in video, sync and deflection circuits, pulse circuits, radar systems, etc. Includes DC current ranges, too.

Accuracy $\pm 3\%$ full scale AC and DC. **Sensitive** 100 microampere meter movement. **DC Volts** in 7 ranges 0-1500. **AC Volts (rms)** in 7 ranges 0-1500. **AC Volts (peak-to-peak)** in 7 ranges 0-1500. **DC Current** in 3 ranges 0-500 ma. **Ohms** in 7 ranges 0-1000 megohms. Utilizes single DA-AC ohms probe and anti-parallax mirror. Swivel stand converts to carry-handle. Includes 1½ volt battery. Operates on 117 volts 50-60 cycle AC. Net, \$8995

Ask Your B&K Distributor
for Demonstration, or
Write for Catalog AP20-E



B & K MANUFACTURING CO.
DIVISION OF DYNASCAN CORP.

1801 W. BELLE PLAINE AVE • CHICAGO 13, ILL.
Canada: Atlas Radio Corp., 50 Wingold, Toronto 19, Ont.
Export: Empire Exporters, 277 Broadway, New York 7, U.S.A.

Now Sylvania puts more "silver" in SILVER SCREEN 85 Picture Tubes [the kind you can spend]

Tube for tube, type for type, famous SILVER SCREEN 85* picture tubes have never meant more to your profit...any way you figure it.

Cold cash? That's mighty important these days. From border to border, coast to coast—now Sylvania offers the industry's best quality and performance at more competitive prices. New distribution and a realistic universal replacement program are the big reasons.

It's good business to make a good profit, and to deal with a manufacturer who protects your profit with consistent quality and is there to support you when occasional adjustments are necessary.

Go solid on Sylvania—be solid with Sylvania. Remember—there's now more "silver" in SILVER SCREEN 85. Next time, ask your distributor for SILVER SCREEN 85 by name.

SILVER SCREEN 85 Picture Tubes are made only from new parts and materials except for the envelopes which, prior to reuse, are inspected and tested to the same standards as new envelopes.

*Trade Mark

RADIO-ELECTRONICS



SYLVANIA

SUBSIDIARY OF
GENERAL TELEPHONE & ELECTRONICS



JULY, 1962

27

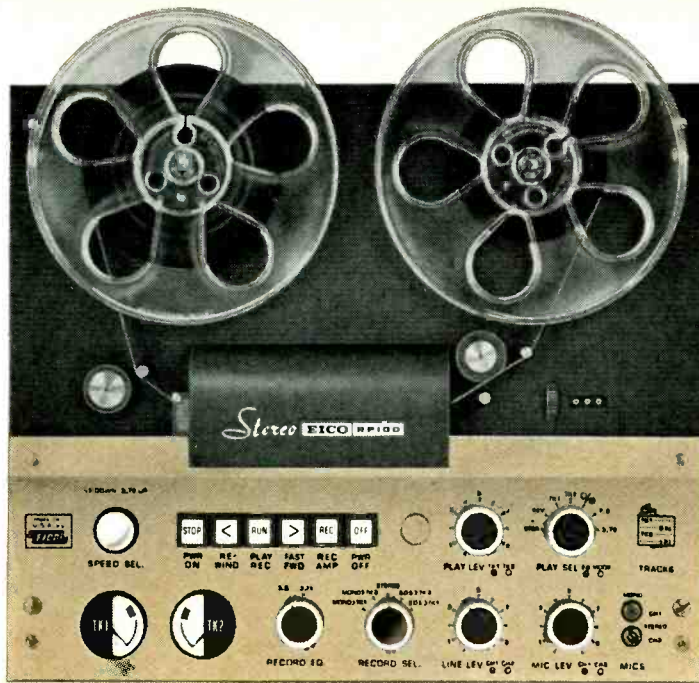

9 New Features Now In The New 1962 EICO RP100 Transistorized Stereo/Mono 4-Track Tape Deck

A great tape recorder made greater:

1. New professional studio recording hysteresis-synchronous capstan motor: 24 stator slots for ultra-smooth drive, ultra-quiet and vibrationless professional bearing system.
2. Two new take-up and rewind reel motors, both extra-powered for effortless operation.
3. New cored-out steel capstan flywheel with all the mass concentrated at the rim for improved flutter filtering.
4. New optimally designed capstan drive belt brings wow down to negligibility.
5. New relay provides instantaneous extra power to the take-up reel motor at start to minimize tape bounce. Provides near-perfect stop-and-go operation and eliminates any risk of tape spillage when starting with a nearly full take-up reel.
6. New automatic end-of-tape stop switch cuts off take-up reel motor power. Also permits professional editing techniques, whereby tape being edited out runs off the machine while you are listening to it.
7. Playback preamps remain "on" during stop-standby mode to permit cueing.
8. Recording level adjustment during stop-standby.
9. Shock-absorbent helical spring tape lifters practically eliminate tape bounce at start of fast winding.

And All These Well-known RP-100 Features:

Separate stereo 1/4 track record and playback heads permitting off-the-tape monitor and true sound-on-sound recording; separate transistor stereo record and stereo playback amplifiers meeting true high fidelity standards; monaural recording on 4 tracks; digital turns counter; electrodynamic braking (no mechanical brakes to wear out or loosen); all-electric push-button transport control (separate solenoids actuate pinch-roller and tape lifters); unequalled electronic control facilities such as mixing mic and line controls, two recording level meters, sound-on-sound recording selected on panel, playback mode selector, etc. Modular plug-in construction.

Wow and flutter: under 0.15% RMS at 7 1/2 IPS; under 0.2% RMS at 3 3/4 IPS. **Timing Accuracy:** ± 0.15% (±3 seconds in 30 minutes). **Frequency Response:** ± 2db 30-15,000 cps at 7 1/2 IPS, 55db signal-to-noise ratio; ± 2db 30-10,000 cps at 3 3/4 IPS, 50db signal-to-noise ratio. **Line Inputs Sensitivity:** 100mv. **Mike Inputs Sensitivity:** 0.5mv.

Semikit: Tape transport assembled and tested; electronics in kit form \$299.95
Factory-assembled: Handwired throughout by skilled American craftsmen \$399.95

An original, exclusive EICO product designed and manufactured in the U.S.A. (Patents Pending)

Carrying Case \$29.95
Rack Mount \$9.95



FM-AM Stereo Tuner ST96
Kit \$89.95 Wired \$129.95
Includes Metal Cover and FET



70-Watt Integrated Stereo Amplifier ST70
Kit \$99.95 Wired \$149.95
Includes Metal Cover
40-Watt Integrated Stereo Amplifier ST40
Kit \$79.95 Wired \$129.95
Includes Metal Cover



FM MULTIPLEX AUTODAPTOR MX99 (Patent Pending)
Kit \$39.95 Wired \$64.95 Cover Optional \$2.95

An original EICO contribution to the art of FM-Multiplex reception

The MX-99 employs the EICO-originated method of zero phase-shift filterless detection of FM Stereo signals (patent pending) described in the January 1962 issue of AUDIO Magazine (reprints available). This method prevents loss of channel separation due to phase shift of the L-R sub-channel before detection and matrixing with the L+R channel signal. In addition, the oscillator synchronizing circuit is phase-locked at all amplitudes of incoming 19kc pilot carrier, as well as extremely sensitive for fringe-area reception. This circuit also operates a neon lamp indicator, whenever pilot carrier is present, to indicate that a stereo program is in progress. The type of detection employed inherently prevents SCA background music interference or any significant amount of 38kc carrier from appearing in the output. However, very sharp L-C low pass filters are provided in the cathode-follower audio output circuit to reduce to practical extinction any 19kc pilot carrier, any slight amounts of 38kc sub-carrier or harmonics thereof, and any undesired detection products. This can prove very important when tape recording stereo broadcasts. The MX-99 is self-powered and is completely factory pre-aligned. A very high quality printed board is provided to assure laboratory performance from every kit. The MX-99 is designed for all EICO FM equipment (ST96, HFT90, HFT92) and component quality, wide-band FM equipment.

©1962 EICO Electronic Instrument Co. Inc.
3300 Northern Boulevard, L. I. C., J. N. Y.

EICO, 3300-N. Blvd., L.I.C. 1, N.Y. C-7

Send free 32-page catalog & dealer's name

Send new 36-page Guidebook to HI-FI for which I enclose 25¢ for postage & handling.

Name _____

Address _____

City _____ Zone _____ State _____

Over 2 MILLION EICO Instruments in use. Most EICO Dealers offer budget terms. Add 5% in West.

Listen to the EICO Hour, WABC-FM, N. Y. 95.5 MC, Mon.-Fri., 7:15-8 P.M. Export Dept., Roburn Agencies Inc., 431 Greenwich St., New York 13

SLEEPLEARNING

... A Resumé of Various Methods of the Art ...

FOR ages, scientists, writers and inventors have contemplated and pondered the biological fact that over one-third of the human life span is taken up by sleep. What could be done, they wondered, to use the "unproductive" sleep period and impart knowledge to the sleeper when his mind is resting? Even in the days of the ancient Egyptians, priests recited the scriptures to sleeping subjects in the hope that they would retain such information after awakening. Not much came of this, although some modern writers believe that "light" sleepers can be thus influenced. Others found that during the so-called "threshold sleep period" some knowledge could be so imparted which could be remembered after awakening.

According to qualified scientists, no actual work with audio or other instrumentation in this sphere was attempted before 1911. Sleeplearning was first described in detail in the writer's science-fiction novel *Ralph 124C 41+*. This novel was serialized in *Modern Electrics*, the world's first radio magazine. The installment describing the *Hypnobioscope* (the learn-while-you-sleep instrument) appeared in June 1911. (Circulation at that time was near 100,000.)

Some excerpts describing the method used follow:

"He [Ralph] attached a double leather head-band to his head; at each end of the band was attached a round metal disc which pressed closely on the temples. From each metal disc an insulated wire led to a small square box, the *Menograph*, or mind-writer.

"After a few minutes' reflection he pressed the button, and immediately a wave line, traced in ink, appeared on a narrow white fabric band.

"In the evening he worked for some hours in the laboratory, and retired at midnight. Before he fell asleep he attached to his head a double leather head-band with metal temple plates, similar to the one used in connection with the *Menograph*.

"He then called for his faithful butler and told him to 'put on' Homer's *Odyssey* for the night.

"It remained for 124C 41+ to invent the *Hypnobioscope*, which transmits words direct to the sleeping brain in such a manner that everything can be remembered in detail the next morning.

"Peter, the butler, placed the reel containing the film in a rack and introduced the end of the film into the *Hypnobioscope*. This instrument, invented by Ralph 124C 41+, transmitted the impulses of the wave line direct to the brain of the sleeping inventor, who thus was made to 'dream' the *Odyssey*."

"All books are read while one sleeps. *Most of the studying is done while one sleeps*. Some people have mastered 10 languages, which they have learned during their sleep-life."

While the above gives the barest outline of the "learn-while-you-sleep" method, the original text contains much additional information. Incidentally—for the record—the 1911 *Menograph* accurately forecast the future electroencephalograph. It became an actuality 17 years later, in 1928, when the German physiologist Hans Berger first demonstrated his *elektrenkephalograms*, exactly as the writer had conceived them in 1911.

It is interesting to note that nowhere in the writer's "learn-while-you-sleep" forecast was an *audio* instrument ever mentioned. He always spoke of a "head-band (attached) to his head" with "a round metal disc, which pressed closely on the temples" . . . "the (electrical) impulses" thus went "direct to the brain of the sleeping inventor." The writer finds it necessary to repeat these passages for emphasis, in the light of what follows.

Much later, certain enterprising individuals who had read *Ralph 124C 41+* came to conclusions of their own regarding sleeplearning and acted upon them.

Thus an article describing how the original learn-while-you-sleep theory was first put into practice ran in the author's *Radio News* magazine for October 1923, under the title "Learn While You Sleep." (Circulation at that time was 400,000 copies.) In this article, Chief Radioman J. N. Phinney, US Navy, relates his work with the method at the Navy Training School at Pensacola, Fla., in 1922. Students were successfully taught Continental Code while they slept. A photograph in the article shows a number of sleeping men on benches. Each wore a special helmet inside of which were close-fitting earphones. Long cords connected to a code machine. Telegraphic code on records was transmitted over and over to the men during the night.

Chief Radioman Phinney reported that he had read an article on sleeplearning in the writer's magazine, *Science and Invention*, in the December 1921 issue. Trying to teach the telegraphic code to his men, he found that a certain percentage could not learn code. It was these men whom he selected to teach the code while they slept. Here is the summary of Phinney's lengthy report:

"Seventeen students volunteered for this experiment with the following results next day.

"(1) One of the seventeen copied five words faster than he had ever been able to copy previously. (2) Four copied three words faster and one nearly three words faster. (3) Four copied two words faster, and one nearly two words faster. (4) Three copied one word faster and one only half a word faster."

This then was the first experimental record of an *audio* sleep-learning method, which the writer had never contemplated.

Navyman Phinney's well publicized report generated an avalanche of similar audio methods over the years. In 1932 (21 years after the publication of *Ralph 124C 41+*) Aldous Huxley, in his novel *Brave New World*, also used the audio "learn-while-you-sleep" method, of which he claimed to be the originator.

In the late 1930's, sleeplearning finally went commercial in many countries. Various entrepreneurs began selling a variety of phonograph records with machines and attachments to teach languages and various other courses. The attachments—even today—usually consist of a telephone receiver placed under the pillow or beside the ear. This is probably the worst method imaginable because the sound is too far from the ear; the other ear—or both—are open to too many extraneous noises; the audio method, at least for the spoken word, so far seems worthless.

Yet, since the early Thirties, the learn-while-you-sleep method has been investigated seriously by men of science on both sides of the Atlantic. Various institutions of learning have issued scientific papers and the US Armed Forces became very interested as well. As a result, in the early Fifties, the US Air Force commissioned one of the country's foremost research organizations to investigate the sleeplearning method in all its scientific aspects. These the well-known Rand Corp. of Santa Monica, Calif., undertook to explore exhaustively. It is quite impractical here to list the vast amount of research performed by Rand in its professional sleep laboratories. Let us mention only two of the voluminous reports:

"Considerations for Research in a Sleep-Learning Program," by Charles W. Simon and William H. Emmons, No. P-565, Sept. 13, 1954, 69 pages. (NOTE: This volume lists 76 authors and their papers on sleeplearning. The present author's is listed the earliest one, June 1911.)

"Responses to Material Presented During Various Levels of Sleep," by the same authors, No. RM-1442, Dec. 27, 1954, 55 pages.

In their summary, Drs. Simon and Emmons conclude:

"With the exception of items heard and sometimes recalled

(Continued on page 64)

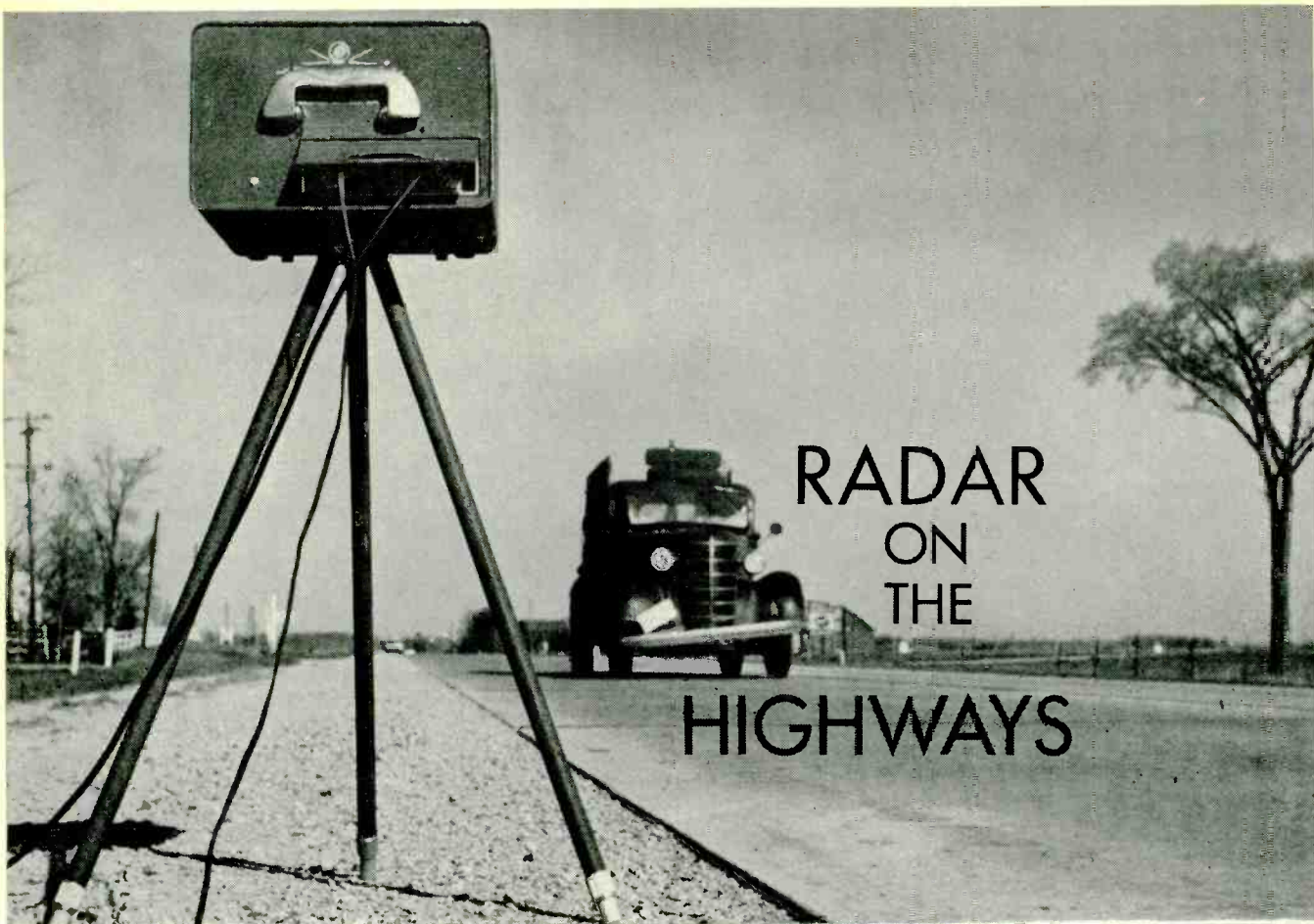

how radar traps
the speeder — some
hints on its
installation and
maintenance

*Highway patrol
officer watches
the speed meter.
He radios officer
farther up the
road to stop any
violators.*



By **DON DUDLEY**

THE MOTORIST, NO MATTER WHERE HE travels, is constantly confronted with signs reading **SPEED CHECKED BY RADAR**. Despite the contention by a few individuals that the use of radar is not quite "sporting" of the traffic patrol, radar will be with us as long as there is death on the highways.

Radar is a contraction of the words radio direction and ranging. By bouncing radio signals off an object and analyzing the returning signal we can determine direction, height and speed of the target. The little black box used on the highway tells us only the *speed* of the approaching vehicle.

The speed indicated by the meter is measured by the Doppler radar in the black box. The classic example of Doppler effect is the whistle of a train. The pitch of the whistle changes, rising as the train approaches and thunders on

by, then falling as it moves away from you. The apparent frequency of the whistle has changed in direct proportion to the speed of the train. It is this change in frequency that is measured, by subtracting the outgoing signal from the incoming signal, to determine the speed of the object that the transmitted signal hits. This is done when the vehicle is approaching. If it is going away from the radar, the incoming signal is subtracted from the outgoing signal. Those of you who have tracked satellites on your radios have seen this effect in action, and possibly used it to measure the satellite's distance.

Two basic radar frequencies are in use today—2,455 and 10,525 mc. Although the 10,525-mc radar is becoming more popular, there's a load of 2,455-mc equipment around.

A block diagram of a highway

radar is shown in Fig. 1. The antenna is an eight-element dipole behind a non-metallic cover. The oscillator output is coupled through a directional mixer to this antenna. Half the power from the oscillator is thus transmitted. In the directional mixer, the incoming signal is mixed with the outgoing signal to give the difference frequency.

A wavelength at 2,455 mc is about 5.1 inches long. The low-frequency radar uses a cavity oscillator to adjust the frequency. The tube (a lighthouse type) is moved up or down in the cavity to shorten or lengthen the tuned circuit, which consists of a cathode sleeve and a grid cylinder that slide on the tube. The complete unit then fits in a holder through which B-plus is applied. Sliding the tube in and out of the holder adjusts the radar's frequency. The oscillator is then set to 2,455 mc. It has a high in-

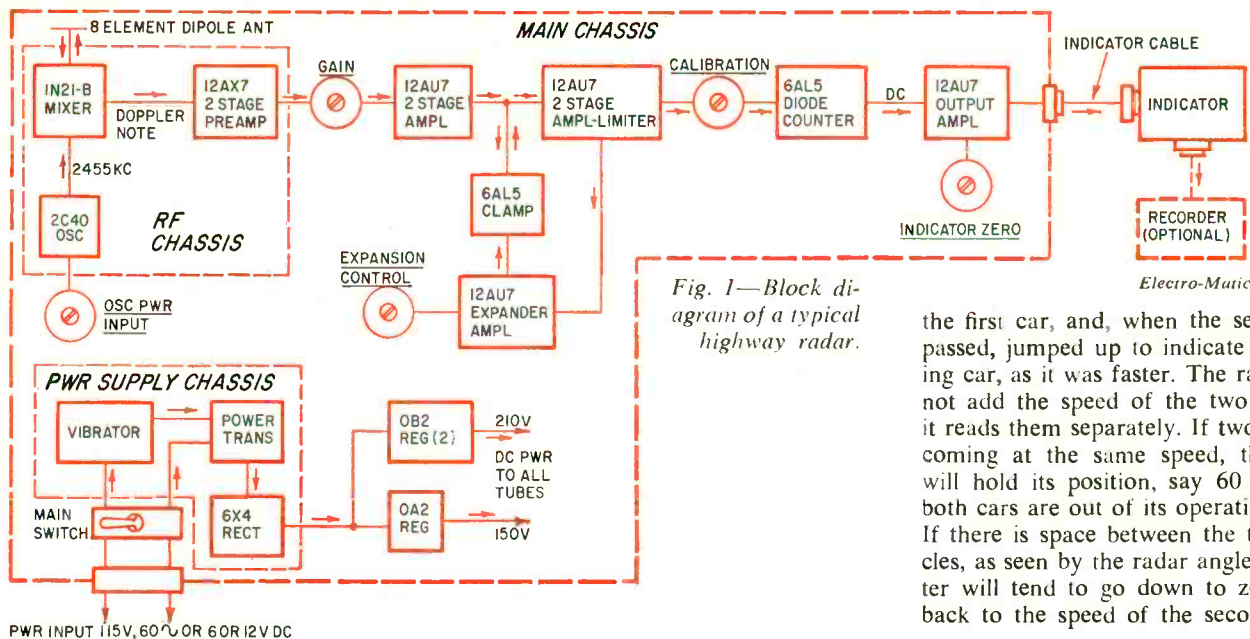

Fig. 1—Block diagram of a typical highway radar.

Electro-Matic

the first car, and, when the second car passed, jumped up to indicate the passing car, as it was faster. The radar does not add the speed of the two vehicles, it reads them separately. If two cars are coming at the same speed, say 60 mph, till both cars are out of its operating range. If there is space between the two vehicles, as seen by the radar angle, the meter will tend to go down to zero, then back to the speed of the second car.

Can radar be fooled?

You may have heard stories of jurists jingling keys in front of the radar and throwing the case out of court. The jingling keys indicates only that the set is working. The beam hits the keys and then is reflected to the set. As stated before, the radar units are designed to pick up movements, and that includes waving your hand in front of the radar set. What we read is the speed of the keys as they are waved in front of the set, not the sound of the keys as they are jingled. You can blow your horn in the beam of radar and not affect the radar meter.

Another illusion the motorist may have is that placing tin foil in the hub caps of his vehicle will fool the radar. This idea may have been started by the fact that bomber crews often dropped aluminum foil to confuse the enemy radar. Radar couldn't tell the difference between the airplanes and the foil floating down to earth. The principle here is not the same and the amateur radar jammers are always disappointed by the lack of results. (Possibly if they sprayed the tinfoil out in front

herent stability of about 0.1%. It quits oscillating if it wanders beyond this range.

The 10,525-mc radar illustrated is manufactured by Muni Quip Corp. of Ill. It has two types of antennas. One is the "rabbit ear" shown in the photo along with the radar. One ear is for receiving and the other is the transmitting antenna. The receiving antenna is slightly smaller than the other. These antennas are made of a type of plastic waveguide and the signal actually travels inside the plastic antennas, trapped by the walls. A control between the two antennas adjusts the amount of power coupled between the two—the amount passed into the receiver. The second antenna is a parabolic unit shaped to resemble a spotlight. The operating frequency for both antennas is the same, about 10,525 mc, and at this frequency, the wavelength is about 1.2 inches long.

The 10,525-mc radar uses a reflex klystron that costs about \$200, so be careful handling it. The oscillator is a fixed reflex klystron. Its inherent stability is 0.1%, like the low-frequency radar. The physical characteristics of oscillation are predetermined at the factory. By adjusting the voltage on the repeller, the klystron frequency can be changed. But as the oscillator circuit is fixed, mixer crystal current will be maximum only at the frequency of the circuit. Therefore, peaking the mixer current will put the radar on the correct frequency.

The motorist stopped by a radar patrol is understandably quite concerned about the accuracy of the radar set. Both these radar units are claimed by the manufacturers to be accurate within 2 mph over the whole range of the meter. If the meter reads 60 mph, your real speed could vary from 58 to 62 mph.

Setting up the radar

The radar operator is careful not to set up where signals are reflected to the set from any moving objects other than cars, such as trees, swaying fences and etc. Picking up such signals is normal for radar as radar is designed to detect moving objects. These reflections would cause the meter to read their movement. However, if a vehicle enters the radar beam, the radar will read the true speed of the vehicle, regardless of the meter reading from these other sources. The radar can read only one thing at a time, and that is the speed of the fastest moving object. One reason for caution in setting up is that readings are often recorded on a graph and should be unequivocal when presented in court. Also those unwanted signals sometimes mask the desired signal, making readings on the approaching vehicles hard to distinguish and identify.

In operation, I have seen two cars coming toward the radar and, while in the operating zone of the unit, one car passed the other. The meter indicated

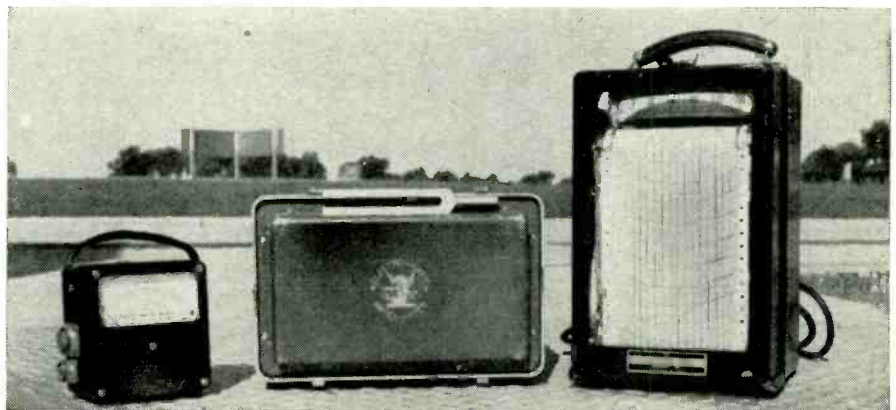

This speed radar uses a chart recorder.

Electro-Matic

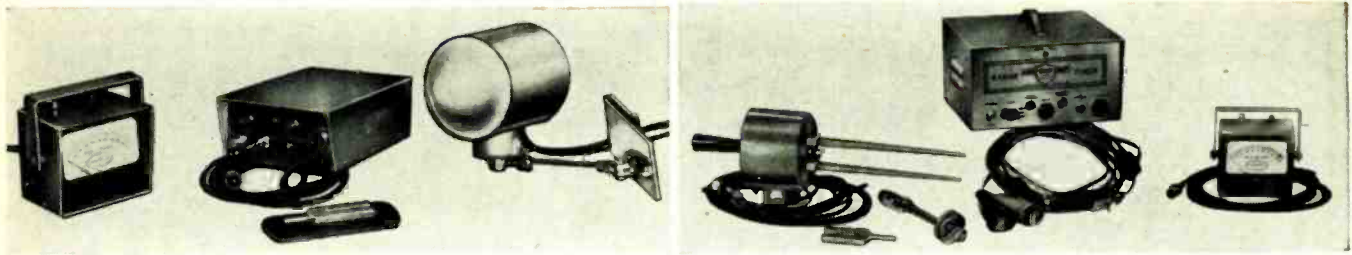

Muni-Quip

Two highway radar units. The one with the spotlight-type antenna is transistorized.

of the vehicles it might work.)

Accuracy

The accuracy of the radar unit is not determined by the accuracy of the operating frequency. The speed-meter reading is obtained by subtracting the transmitted signal from the returning signal, which is the transmitted signal changed in frequency. So even if the frequency of the transmitted signal changes, the difference between the two remains the same, and the indicated speed will still read true, no matter what happened to the frequency—unless, of course, it drifted beyond the 0.1% inherent stability. Then the unit would quit oscillating and be sent back to the shop for repairs. The importance of setting the operating frequency correctly is to improve the operating efficiency. The more it's off frequency the more standing waves are in evidence, thus reducing the working range of the radar. (If the sensitivity of a unit has decreased, this could be the cause.)

When a radar arrest turns into a jury trial, defense attorneys have the nasty habit of asking questions such as, "When was the frequency checked last?" If there is any discrepancy in the radar set, a non-technical jury will tend to distrust the radar reading. Actually, if it was off frequency, or some other thing was wrong, the speed indicated by the radar might be slightly *lower than the true speed*. Most defects in the radar unit will reduce the speed meter reading—though not appreciably—from the true ones.

How it works

With the radar unit placed beside the road approaching vehicles reflect the signal to the radar set. This reflected signal, which is increased in frequency by the approaching car, enters the radar set through the same antenna that transmitted it. In the 2,455-mc model. In the 10,525-mc radar there are separate receiving and transmitting antennas, the receiving antenna being slightly smaller than the transmitting antenna. The reflected signal is then mixed with the outgoing signal. The difference signal is sent through an amplifier to increase the signal level. After amplification, it is fed into a limiter which clips the signal, reducing amplitude modulation to a minimum. The

limiter works in conjunction with a clamp circuit. This lets only signals of a predetermined strength through, stopping any low-level extraneous signals. The limited signal is then frequency-detected and set to operate a form of voltmeter. This meter is the output indicator, a meter calibrated directly in miles per hour, or a graph recorder. Both could be used together and sometimes are, if recorded evidence is required by the traffic court.

Installation is simple. With the 10,525-mc set, the box containing the power supply and tubes is set alongside the seat or on the floor of the car. The antenna is then attached to the spotlight bracket, or some other suitable place if it's to be a permanent installation. For a temporary installation a bracket could be made for mounting to the front edge of the car door or to a half-rolled-up window. The antenna could be mounted inside of the vehicle, and beamed through the window. A slight reduction in range might be encountered in that case. In the 2,455 mcs radar, the antenna is located in the same box as the power supply and tubes. The whole unit must be placed out on the roadside on a tripod. Two cables are used, one to carry the battery voltage, the other for the indicator located in the radar car. In most cases the radar is set up about 100 feet from the radar car. Any violation noted by the officer in the radar car will be radioed to another officer to stop the speeder.

Speed radars have a power output of less than 0.5 watt. Vehicle detection is effective within a zone of approximately 20° throughout a range of about 400 feet. The radar beam must be properly aimed down the highway. If it's

aimed directly across the road, the approaching vehicles will not be in the beam long enough to be read.

As a car approaches the radar beam, the indicator swings up to the speed of the vehicle and remains there till the car is out of the beam. If it's aimed too far down the road the vehicle will be out of the radar beam when it's within range. The setting-up procedure for some of the traffic patrols: They let the radar set warm up for 20 minutes. Then they check the set with a tuning fork. A squad with a calibrated speedometer is run through the radar several times; this will determine if the angle is right. At the end of their duty, they repeat the procedure. If the set is operated for several hours, the tuning fork is used periodically for continual checking.

Periodic checks will assure proper operation. Such checks should include the tubes, sensitivity, and accuracy of the radar. A metered audio signal injected into the amplifier input checks sensitivity. The oscillator and the mixer crystal are bypassed for this check. This metered signal is fed into the amplifier through a pad (Fig. 2). In low frequency radars, the gate control is adjusted to open for 6 volts of audio. The higher-frequency radar has no specification like this, and no gate control. The gate circuit is preset, but the action will be the same. When the signal reaches a predetermined level, the indicator swings up to speed. By using this method with a good high-frequency radar, a standard may be developed to go by.

To set the speed or accuracy of the radar, as read on the meter, a calibrated audio signal is fed into the input of the amplifier. Any frequency between 73.1 to 731 cycles maybe used for the 2,455-mc radar, and 314 to 3,140 cycles for the 10,525-mc radar. This represents the transmitted signal subtracted from the reflected signal. These frequencies correspond to 10 to 100 mph. The accuracy of the audio generator used must be 1% or better. The actual speed as read on the output indicator will be set by the audio generator and must be as accurate as possible. An adjustment in the amplifier box of the 2,455-mc unit which is used to set the speed. This control is in the frequency-determining circuit. It can be adjusted only on the bench. In the 10,525-mc unit adjust-

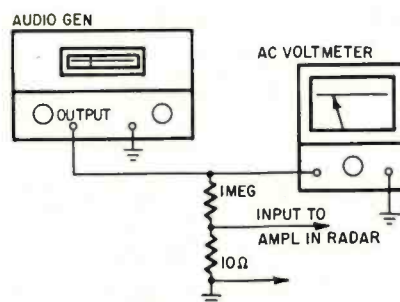

Fig. 2—Monitored voltage is fed to amplifier in radar through a pad to check unit's sensitivity.

ment is in reach of the operator. This control is located in the output circuit—it's called METER CALIBRATE. The operator adjusts it with a tuning fork. These tuning forks, by the way, have an accuracy of 1% or better and can be purchased in any speed.

If generator accuracy is less than 1%, it can still be used, if a scope is available (Fig. 3). Set the scope for internal 60-cycle line sweep. Then feed the audio generator into the vertical input of the scope. We shall pick the audio frequency of 480 cycles, for it is a convenient multiple 60 cycles and corresponds to 65.6 mph (this is for the 2,455-mc radar). Now adjust the audio generator for eight loops of the Lissajous patterns on the scope— 8×60 equals 480. On the 10,525-mc radar, 480 cycles corresponds to 15.2 mph.

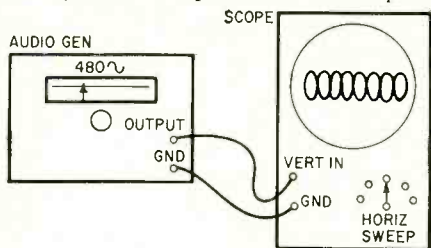

Fig. 3—Oscilloscope is used to set audio generator frequency. Generator checks the radar speed reading accuracy.

If the radar zero is erratic when in use, but not on the bench, look for moving objects in the transmitter field—swaying billboards, waving trees, etc. Neon or arc lights can have the same effect too. If it's erratic with nothing in sight, check for a defective crystal. A shorted or noisy crystal can cause this. Another thing to check is the coupling between the transmitter and the receiver. This can cause trouble if coupling has increased. Tubes could be at fault too.

If the radar operator complains that the unit's range has decreased, a weak amplifier tube could be the trouble. Reduced oscillator output could also be at fault. Another possibility is low mixer current in the 10,525-mc set and by a bolometer bridge in the 2,455-mc unit. If you're lucky enough to have a bolometer, use it on the 10,525-mc unit. Of course, be sure that it's peaked to frequency.

In my experience, the most frequent troubles in the 2,455-mc unit were in the cables. They were repaired more often than the unit itself. In the 10,525-mc radar, the most usual complaint was a burnt out mixer crystal. If the radar operator aims the antenna at a metal object within 6 feet of the antenna, the mixer crystal will burn out.

Rain or fog will not affect the accuracy of the radar. It is an accurate machine requiring little maintenance. So if you get caught, by one of these don't say I haven't warned you. **END**

**COVER
STORY**



radar in a 10-lb package

One-man equipment is complete radar station

THE DEVICE ON OUR COVER IS A TRUE miniature combat radar—and the smallest of its kind. It weighs only 10 pounds—can be held and aimed like a submachine gun to spot moving targets a mile or more away. Developed by Harold Tate, electrical engineer at the Army Signal Research and Development Laboratory, Fort Monmouth, N. J., it produces an audible signal when a rapidly moving object passes through its invisible beam.

Working on the Doppler principle, the radar portable ignores all stationary features of the landscape, and picks out only moving objects. The shape, size, speed and characteristics of the object's motion produce a characteristic sound that in many cases enables a skilled operator to identify his target. Thus a tank can be detected by its two-pitched note, caused by the separate motions of the vehicle body and the turning tracks. The radar signal from a jeep or truck is a sin-

gle whine, which varies with speed, and soldiers, marching with arms swinging freely, produce a characteristic "thump-thump" sound.

Besides indicating its targets by sound, the hand-held radar has a standard type-A display, producing blips on a 1 x 3-inch C-R tube screen. The cathode ray tube is one of three tubes in the set. The other two are a small beacon magnetron transmitter and a klystron local oscillator. All other active elements are solid-state. Printed circuits are employed throughout.

Major emphasis, according to the designer, has been placed on low power drain. The 4-pound belt battery lasts through 12 hours of continuous operation. The rf assembly uses a waveguide, but some consideration has been given to the use of strip-line techniques for the high-frequency plumbing. This would reduce the weight of the equipment still further. **END**

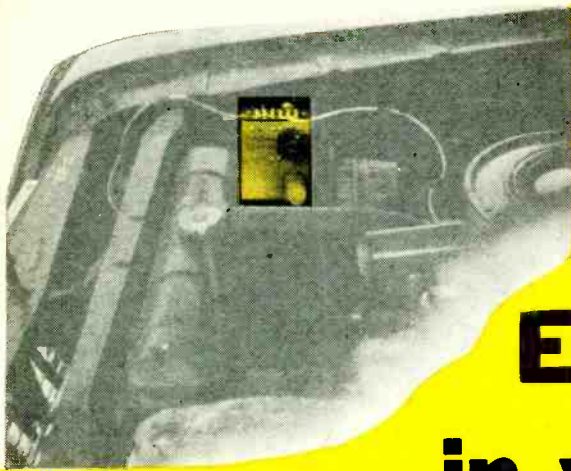

put Electronic Ignition in your car . . . All solid-state

system improves pickup, saves gas, reduces point and plug wear

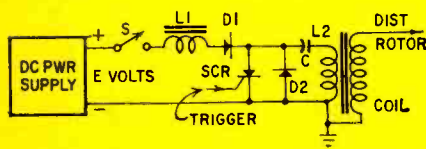

Fig. 1—Simplified diagram of the ignition system.

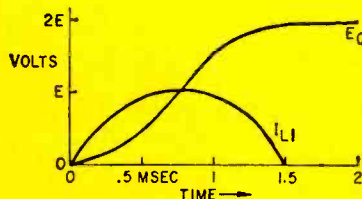

Fig. 2—Waveform produced when switch S in Fig. 1 closes.

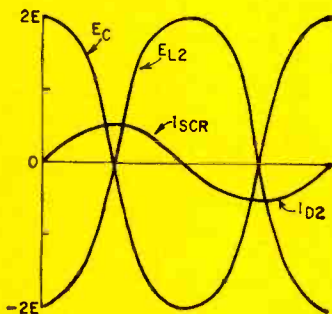

Fig. 3—Waveform when capacitor C discharges through silicon controlled rectifier.

BENCH



TESTED

This unit was tested for 2 weeks, not long enough for an accurate measurement of its full capabilities, but long enough to determine how well the unit works.

Installation (in a 1960 Ford Falcon) was fairly simple though time consuming. Operation with the electronic system in

place was excellent. The engine started just as easily as it always had. On the road, the car seemed to run more smoothly, specially at higher speeds. Gas consumption on a total of 500 miles of driving showed a 2 to 3 mpg improvement. Pickup was definitely improved—seemed as though a better grade of gas was being used.

Overall impression—this system is well worth building.

By HARRY W. LAWSON

Want a good solid-state electronic ignition system you can build and install yourself? If you do, try the unit described in this article. Construction is easy, and the system offers extremely long point life, increased gas mileage (particularly at high speeds) and markedly improved acceleration at speeds above 40 mph.

A silicon controlled rectifier (SCR) makes this system possible. This 3-terminal device is the semiconductor analog of the thyatron. Its advantages over a thyatron include no warmup time, no sensitivity to light, no need for bias normally, and extremely small physical size per kilowatt of switched power.

Before we look at the ignition system, let's make one point very clear. The system is complex when compared to modern mechanical systems, and complexity can reduce reliability. But if you want optimum automotive performance and are willing to try something new, electronic ignition is for you.

Fig. 1 is a simplified diagram of the electronic system. Note the two oscillatory networks. The first is the charging circuit made up of L1, D1 and C. It determines the maximum repetition rate, therefore the maximum rpm. When switch S is closed, C is charged via D1 and L1 and its voltage rises from zero to a point approaching twice the supply voltage (Fig. 2). It does this in half the period of oscillation of L1 and C, whose resonant frequency is about 333 cycles. This makes the maximum repetition rate 666 cycles, which corresponds to 10,000 rpm for an 8-cylinder engine.

With the capacitor charged, if a trigger pulse is fed to the SCR, the positive side of the capacitor is instantaneously shorted and discharges via the SCR and coil primary (Fig. 3). Now, L1's inductance comes into play since it is the only isolation between the SCR effective short circuit and the supply.

The second resonant circuit, C and L2, is now in operation. Its resonant frequency is initially 2,500 cycles, although this shifts upward during the cycle, as soon as the short-circuiting effect of the completed secondary spark reflects a lower primary inductance.

During a discharge cycle, capacitor C rids itself of its charge in about a quarter of the cycle. At this time all its energy has been stored in the coil primary inductance, which tends to maintain current flow in the same direction for the next quarter cycle, thus forcing the capacitor to reverse its charge polarity completely. Current flow in the SCR has ceased at this time and all energy (minus losses) is re-stored in the capacitor. C immediately discharges again through the coil primary in the reverse direction via D2. The drop across D2 ensures complete turnoff of the SCR. Actually, during repetitive operation, the capacitor is charged to the forward primed condition by the power supply via L1, D1 and the reverse half cycle of the firing wave via D2.

Circuit operation

Fig. 4 shows the complete ignition system. The power supply is a dc-to-dc converter that provides about 200 volts dc at 400 ma at filter capacitor C3-a. The supply shown is much heavier than necessary and, if you wish to economize, a supply with a 100-ma current rating will do. R3 and Zener diode D9 maintain supply voltage at 150 dc. This insures that the peak charging voltage does not exceed the forward breakover rating of the SCR and maintains constant-amplitude capacitor charging current pulses.

In my circuit, the power supply is the most expensive portion of the system. To cut costs, a very simple vibrator supply with a center-tapped 6.3- or 12.6-volt filament transformer could be used, provided the output voltage does not exceed 150. This can be controlled with a 10-watt Zener diode (1N3011)

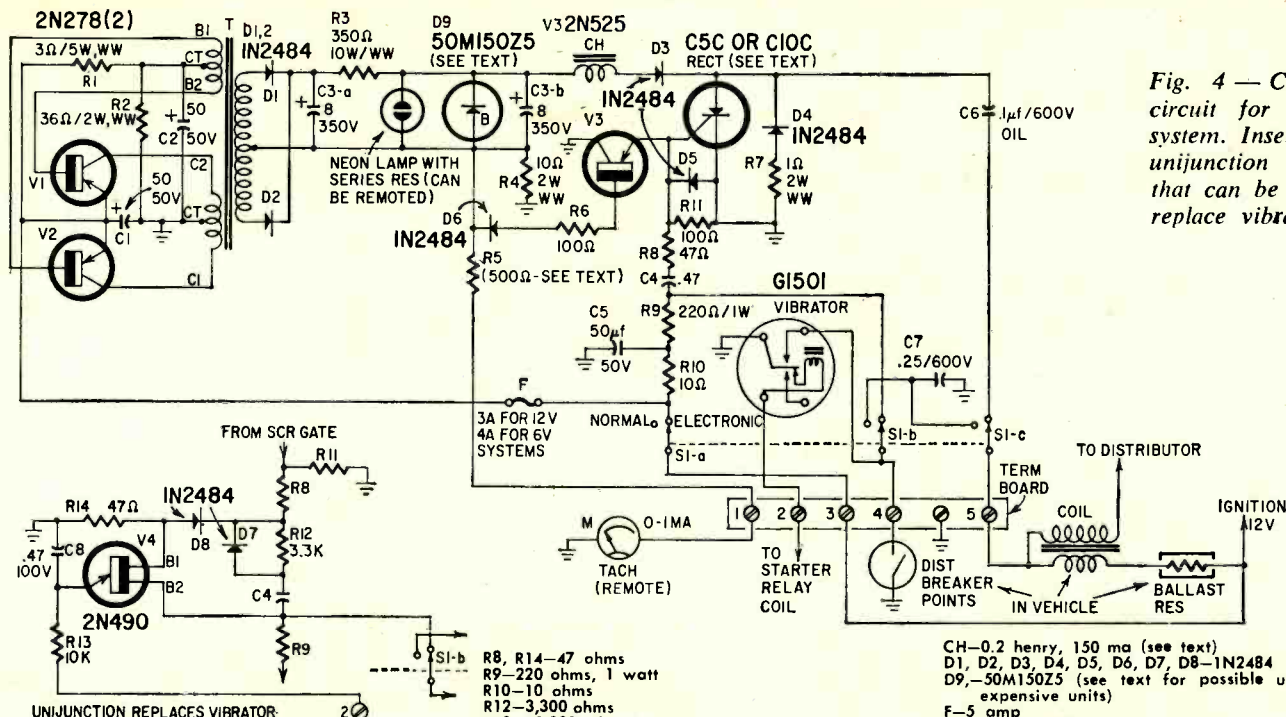

Fig. 4 — Complete circuit for ignition system. Inset shows unijunction circuit that can be used to replace vibrator.

- R1—3 ohms, 5 watts, wirewound
- R2—36 ohms, 2 watts, wirewound
- R3—350 ohms, 10 watts, wirewound
- R4—10 ohms, 2 watts, wirewound
- R5—meter multiplier, approx 500 ohms (see text)
- R6, R11—100 ohms
- R7—1 ohm, 2 watts, wirewound
- R8, R14—47 ohms
- R9—220 ohms, 1 watt
- R10—10 ohms
- R12—3,300 ohms
- R13—10,000 ohms

- All resistors 1/2-watt 10% unless noted
- C1, C2, C5—50 μ f, 50 volts, electrolytic
- C3—8 μ f, 350 volts, electrolytic (use two separate single-section units to keep size down)
- C4—0.47 μ f, 100 volts, paper
- C6—0.1 μ f, 600 volts, oil filled
- C7—0.25 μ f, 600 volts, paper
- C8—0.47 μ f, 100 volts, molded paper
- CH—0.2 henry, 150 ma (see text)
- D1, D2, D3, D4, D5, D6, D7, D8—1N2484
- D9—50M150Z5 (see text for possible use of less expensive units)
- F—5 amp
- M—0.1 ma millimeter
- RECT—C5C or C10C (see text)
- T—Triad TY-715 or equivalent
- V1, V2—2N278
- V3—2N525
- V4—2N490
- Vibrator, Mallory G1501 or equivalent
- Case—4 x 5 x 6 inches
- Miscellaneous hardware

or an OD3/VR150 used as a voltage limiter rather than a regulator.

C3-b provides a stiff source of charging current when battery cranking voltage is low. The negative power supply return is grounded via R4, across which the charging-current waveform appears.

The tachometer circuit consists of a simple voltmeter and multiplier resistor. The multiplier is selected to give a full-scale meter reading at 5,000 rpm.

Switch S1, shown in the electronic position, reinserts the normal ignition system, should the electronic system fail. The pilot light indicates the presence of high voltage and can be removed on the dash. CH is the charging choke. It is connected to discharge capacitor C6 via charging diode D3. To simplify coil switching, only the normal distributor side is switched, primary current completing its circuit through the vehicle's ignition primary wiring. That makes the first high-voltage wave to the spark plug positive-going. (This has been considered incorrect by some although I found no noticeable effects.) The SCR and inverse diode D4 are placed in the circuit in normal fashion. R7, originally added for current waveform observation, was retained as an additional source of inverse voltage to ensure SCR turnoff.

The firing circuit is made up of R9, C4, R8 and D5. Filter network R10—C5 attenuates any unwanted signals from the vehicle's primary electrical

system. Initially C4 has no charge and the distributor points are closed, resulting in full battery voltage being dropped across R9. When the points open, capacitor C4 charges via R9, R8 and the SCR gate. The current rises very rapidly and decays exponentially as a function of C4's capacitance and circuit resistance. This current rise through the SCR gate turns it on. When the points close, C4 discharges through them via R8 and D5 to essentially zero, ready for the next opening. Peak gate firing current is essentially determined by R9 with peak discharge current through the points limited to a nominal value by R8. Any silicon controlled rectifier with a 300-volt rating can be used in this circuit. The difference will be in the required trigger current, determined by R9, which can be decreased for those requiring higher gate signal.

The vibrator serves a unique purpose in both the electronic and conventional mode of operation. It is energized by the starter circuit and places an additional, parallel set of vibrating contacts across the distributor points. Thus a continuous series of firings at a 115-cycle rate is available whenever the distributor points are open and the starter is engaged, enhancing the ignition of the mixture under poor starting conditions.

Transistor V3 is the heart of the lockout system. The emitter impedance of a saturated transistor is very low (on the order of 1 ohm). Since V3's emitter

is connected directly to the SCR gate with the collector grounded, a base current of anything over 1.0 ma is enough to short completely any positive trigger approaching the SCR gate via R8. Thus it is desirable to turn on and saturate V3 whenever charging current flows in choke L1. Since the power supply end of R4 drops below ground during each charging cycle, this point is the ideal signal source for V3's base. R6 serves only as a current-limiting resistor. D6 provides a form of cutoff bias for V3 when the voltage across R4 is zero and the circuit is primed for firing.

Construction

The unit is built into a 4 x 5 x 6-inch aluminum box. C6, located under the component boards, is made up of two 0.5- μ f bathtub units in parallel. Both power supply transistors (V1 and V2) are on the one heat sink and Zener diode Z is mounted on its individual sink. No separate heat sink is needed for the SCR. Although not indicated on the schematic and not absolutely necessary, rf filters were used on all leads except those going to the distributor and coil, which must not be filtered by any appreciable shunt capacitance to ground. In line with minimizing rfi, the lead from the unit to the coil primary should be a short run of coax with both ends of the shield grounded. This and a large Sprague Hypass capacitor on the ballast-resistor side of the coil does the good job of

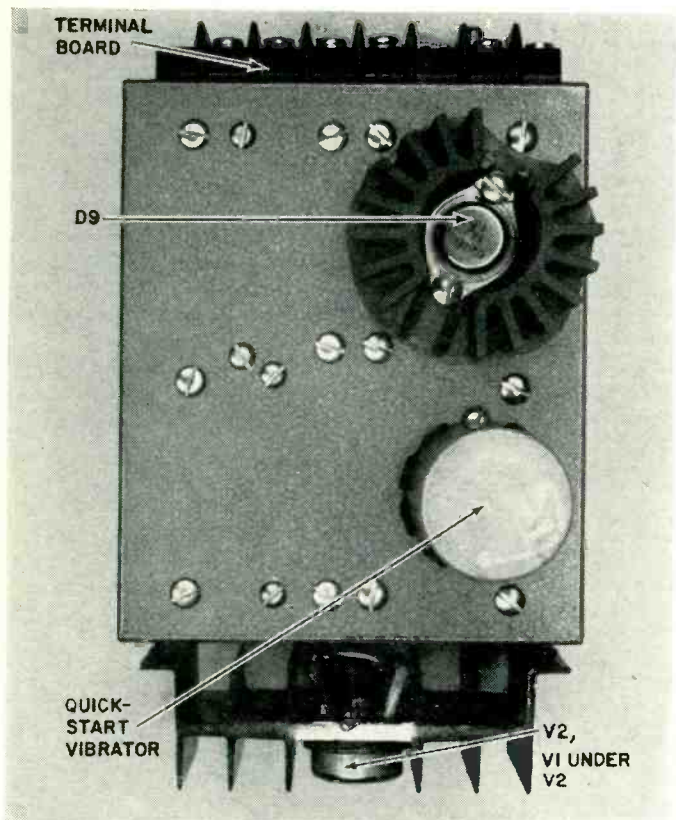

Looking straight down we can see the vibrator and Zener diode on top of the case.

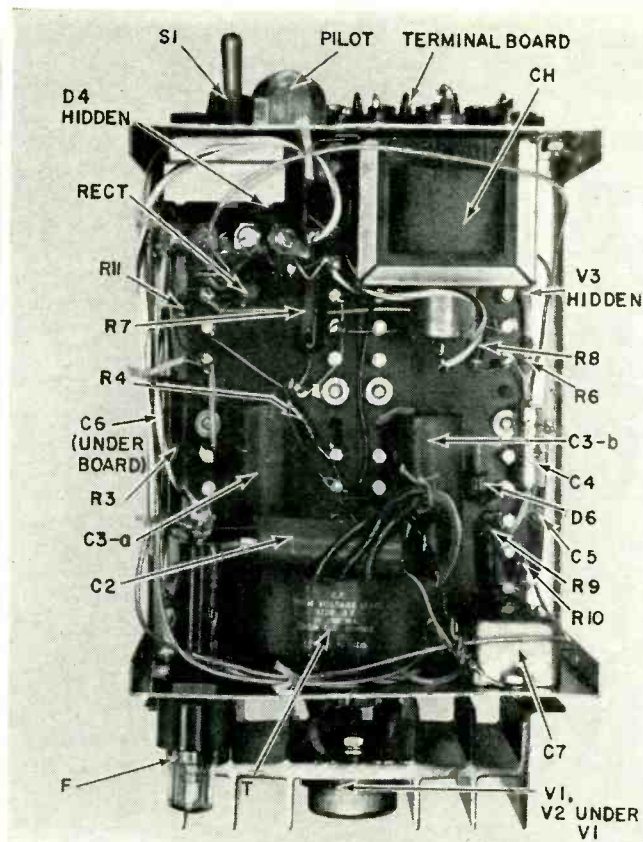

Phenolic chassis and terminal lugs help make unit sturdy enough for any mobile equipment.

rfl reduction desirable in such a fast waveform system.

The problem of SCR type, rating and cost will influence many design modifications. Silicon controlled rectifiers are available in several current ratings which govern physical size. Each size is also available in several voltage ratings from 25 to 400. I used a type C5C rated at 300 volts. It has a gate-current sensitivity much greater than necessary (200 μ a maximum) and is relatively costly at present (\$54 each). Resistor R11 is used solely to decrease the gate sensitivity and can be eliminated when using other, less-sensitive types such as the C10C, which presently is the least expensive (\$34) SCR with a 300-volt rating suitable for use in the system. The much cheaper C15 series brought out for the appliance market is presently available only as the C15B, which has a 200-volt rating and costs \$10. This can be used with a 100-volt (maximum) power supply, preferably Zener-regulated. However, a coil such as the Mallory F-12T with a somewhat higher turns ratio might be needed. Conventional operation would be possible only by also keeping the original coil for this purpose with appropriate switch changes.

A better arrangement that retains the original coil requires only the addition of a low-cost filament transformer. Connect a Stancor P8191 6.3-volt to 6.3-volt filament isolation transformer

as a stepup autotransformer with its primary connected to discharge capacitor C6, secondary to the original in-car coil primary. Thus a 400-volt coil primary pulse is derived from a 200-volt charging system. To maintain discharge energy, increase C6 to between 1 and 4 μ f.

Construction is based on ruggedness and long-time reliability. Use quality components and good construction techniques so the device will endure the vibration, temperature and humidity encountered under the hood. Give such things as exhaust manifolds a wide berth when mounting the equipment.

You will have to make L1 yourself. Pick up a filter choke such as the Stancor C2343 which has an inductance of 0.75 henry and connect it in the test circuit shown in Fig. 5. The tuning capacitor can be made up of any combination of paralleled, oil-filled capacitors totaling 35 μ f.

Pry the mounting channel bracket off the choke. You will see that the coil

is wound on the E-core laminations, and paper gap shims appear between this and the stack of I-laminations. (Heating the unit to 250°F in an oven will soften the varnish and wax to make for easier disassembly.) Once the gap has been exposed, insert additional paper shims to widen the gap, clamp the core together again with a C-clamp and place in the test circuit. Repeat this procedure until the circular display on the scope approaches a straight line at 45°, indicating that the choke is resonant with the 35- μ f capacitor at 60 cycles, giving an adjusted inductance of 0.2 henry. Once obtained, refasten the mounting bracket to the core to hold everything firmly in position. This method is preferred to removing turns since it provides a charging inductance that will not saturate the iron during the charging cycle.

Component layout is not at all critical other than to keep the trigger-circuit components somewhat isolated from other high-current leads to prevent any possibility of false triggering. High-current leads are present in the power supply primary and all oscillatory circuits.

Test before using

Bench-testing the completed unit is a must since debugging a complex unit in a hot engine compartment isn't very easy. As it stands, the circuit provides its own built-in testing circuit in the form of the vibrator normally used for

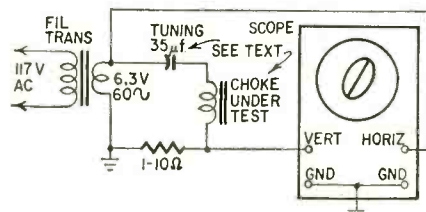

Fig. 5—How to make sure your choke has the right inductance.

starting only. This also lets you adjust tachometer multiplier R5. A 12-volt battery eliminator capable of delivering 5 amps is an ideal source since low battery cranking voltages can be simulated. A 12-volt storage battery, of course, is also another possibility. Remember to observe correct polarity, and connect +12 volts to supply input terminal 3. Connect the negative supply lead to the case of the unit. Connect the primary distributor side terminal of a standard ignition coil to terminal 5 of the circuit with the coil primary battery terminal solidly grounded to the case.

A coil nominally rated at either 6 or 12 volts may be used for bench-testing since there is little difference between them. Be sure to provide a gap of about 1/2 inch in series with the lead from the high-voltage coil terminal to ground. Do not attempt to run the unit without this or you may damage the high-voltage secondary insulation.

Place S1 in the electronic position and apply the primary 12 volts dc. The pilot lamp should light immediately, indicating the power supply is operating. Measure the voltage across the Zener diode or power supply output to make sure it is delivering 150 volts and no more. The dc voltage across C3-a with the power supply shown should be about 187 volts. Now connect a jumper from terminal 3 to terminal 2. This applies 12 volts to the vibrator, which synthesizes a set of distributor points operating at 115 cycles per second, the standard frequency of a radio vibrator. The high-voltage gap described should immediately form a continuous discharge of a healthy blue color. The 115-cycle operation represents 1,725 rpm on an 8-cylinder car, 2,300 rpm for 6-cylinders, and 3,450 for a 4-cylinder engine. With a vibrating set of contacts other than a radio vibrator the relationships are:

8-cylinder rpm = 15f
6-cylinder rpm = 20f
4-cylinder rpm = 30f

where f is the contact frequency in cycles per second.

Now R5 can be adjusted so the tachometer scale reads properly. A 0-1-ma meter will require around 500 ohms. Since this is essentially a voltmeter measuring the voltage across R4, resistor R5 is not an awkward low-resistance but rather a standard composition resistor adjusted for proper scale reading. Start with a 1-watt composition type of a stock value that gives a slightly high reading on the tach scale. Then file a notch through the body of the resistor (perpendicular to the long dimension) until the reading is acceptable. Seal the notch with model cement. Now you're ready to install the unit in your car.

For 6-volt cars

Those who wish to make a 6-volt installation will find little difficulty in

making this circuit work. Most of the dc converter transformers on the market are suitable for 6 volts with, of course, half-voltage output. Enough information for doing this usually accompanies them. The only other components you would have to change are the vibrator, and perhaps reduce R9 to 150 ohms.

The distributor requires no modification other than removing the capacitor. It would be helpful to start out with a fresh set of points. Install them carefully, double checking for proper gap and breaker-arm tension to avoid contact bounce when closing, since this could fire the SCR again. Point gap is no longer a function of electrical system parameters so it should be possible to decrease it to very small proportions, thereby improving the mechanical point-bounce problem at very high speed. Gap decrease (dwell increase) could make some timing-advance adjustment necessary. However, normal operation would be adversely affected, so do not make this adjustment until the reliability of your particular installation has proved itself and very high-speed operation is required.

Positive-ground systems

Vehicles with positive-ground batteries, either 6 or 12 volts, require two circuit changes. The power supply pri-

mary-circuit ground point must be the emitters of V1 and V2, and the -12 volts is applied to the now ungrounded collector-winding center tap. Vibrator type supplies are unaffected. The other change is in the firing circuit. Remove C4 and insert the primary of a very small 6.3-volt filament transformer in series with the lead going from R9 to S1-b. Ground one end of the secondary and connect the other end via R8 (increased to about 220 ohms) to the SCR gate lead. Proper phasing of this trigger transformer must be determined by bench testing, but remember that contact opening must deliver a positive-going gate signal to the ungrounded secondary lead to fire the SCR.

Since the vibrator for quick starting produces a continuous series of sparks during engine cranking, some engine bucking may be caused by the distributor rotor not confining the secondary high voltage to one cylinder at a time, but sharing it with the next one in the firing order. Round off the leading edge of the rotor-arm metal slightly to confine the arc off the trailing edge to the proper cylinder and put an end to the bucking.

What has been described here is certainly not the last word in automotive ignition, but it is a good practical reliable electronic ignition system that you will enjoy building and using. Happy motoring. END

Silicon Diode Checker

THIS SIMPLE TESTER PERFORMS QUICK qualitative tests on silicon rectifiers rated at 250 ma or more. The condition of the diode is shown by one of three indicator lamps.

With an open diode or no connection across the test terminals, PL1 is lit by current flow through D1, R1 and R2. The voltage drop across R2, positive at the top end, is too low to light PL3. PL2 does not light because D2 is back-biased by the positive voltage developed by D1.

If a good diode is connected across the test terminals with polarity as shown, PL1 is shorted out and does not light. PL2 does not light because D2 is now back-biased by voltage developed by the diode under test. C1 charges, permitting PL3 to light and indicate that the diode is good.

A shorted diode shorts out PL1 and allows full ac to appear across R2. D2 conducts on negative half-cycles and lights PL2. Ac appears across R4, R5, PL3 C1 and C2. The capacitors appear as a low-reactance shunt across R5 and PL3 so PL3 does not light. Thus, PL2 is the only one lighted to indicate that the diode is shorted.

All lamps light when a good diode is connected to the test terminals with polarity reversed. D1 conducts on positive half-cycles so PL1 lights. The test diode conducts on negative half-cycles and develops a dc voltage across R2 with the upper end negative. D2 conducts and PL2 lights. C2 charges and permits PL3 to light.—*Tech Tips from Westinghouse*

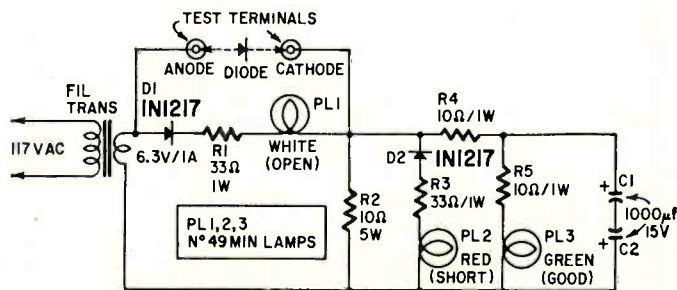

chroma circuit servicing

How to tend the heart of the color TV receiver

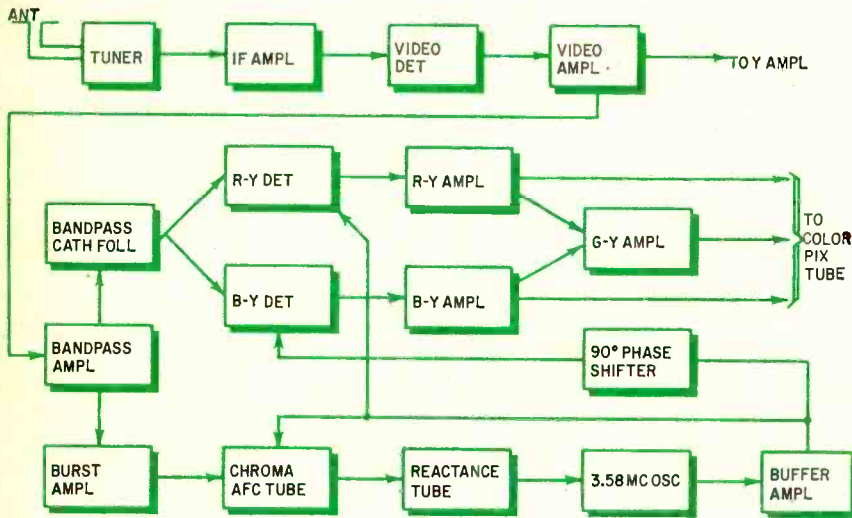

Fig. 1—Chroma signal is processed in these sections of the color receiver.

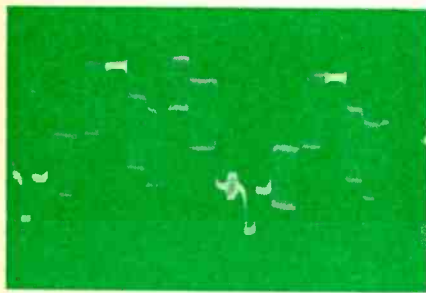

Fig. 2—The video modulating signal from a color bar generator.

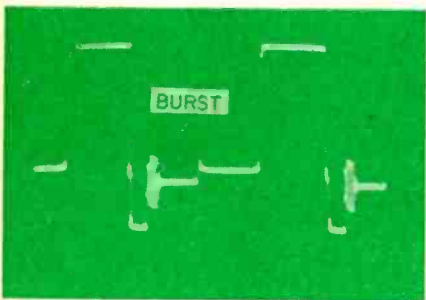

Fig. 3—Y-signal with color burst.

By ROBERT G. MIDDLETON

Every day color-TV servicing becomes a more important business activity. Some of us are still a little leery about the complexities of chroma circuits. However, the difficulties are more apparent than real. Remember how we soon put aside our fears when we "graduated" from radio to black-and-white TV servicing? In this article we'll examine the color circuits in a color set and see how they work.

It is helpful to keep a chroma-signal flow chart in mind. Fig. 1 is a block diagram for a color TV receiver, with the black-and-white sections eliminated. The arrows show the distribution of the 3.58-mc signal. Next, let us note the significant characteristics of the processing circuits.

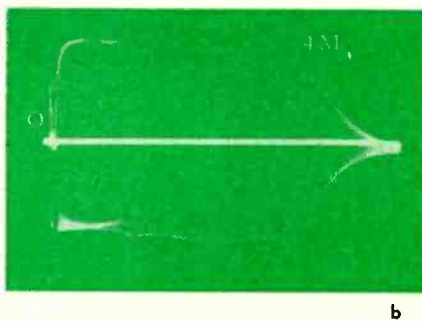

Fig. 4-a—Setup for checking a scope's frequency response. b—Frequency response of a scope suitable for color TV servicing.

If we are receiving a color test pattern via the antenna, or feeding a color bar generator signal into the front end, the video modulating signal appears as in Fig. 2. If we are operating on channel 3, for example, the signal amplitude-modulates a 61.25-mc rf carrier. The "shaded" blocks in the Fig. 2 waveform contain the chroma information, and each block consists of a 3.58-mc sine wave. The only difference between consecutive blocks is a phase difference.

Reference phase for the entire chroma system is established by the burst phase. Fig. 3 shows a simple Y-signal plus burst. This burst signal has a frequency of 3.579545 mc (commonly rounded off to 3.58 mc) and consists of a minimum of eight sine-wave cycles. To check the burst signal, we must use a scope which has a flat frequency response out to at least 3.58 mc.

Which scope?

TV technicians often ask whether a particular scope is suited for chroma work. The best way to answer this question is to feed the output from a video-frequency sweep generator into the vertical input terminals of the scope, as in Fig. 4-a. An undemodulated FM waveform appears on the screen (Fig. 4-b). The best scopes have a very flat response through the burst frequency. If a scope has some attenuation of high frequencies (Fig. 5), it is still usable. However, the height of the burst display is reduced in proportion to the attenuation in the vertical amplifier—experienced technicians can take this into account in analyzing chroma waveforms.

Of course, any scope with good 60-cycle square-wave response can be used in sweep-alignment tests. If a question arises concerning the frequency response of the front end, check it with an rf sweep test (Fig. 6). The chief consideration here is that the response curve should have full response at 3.58

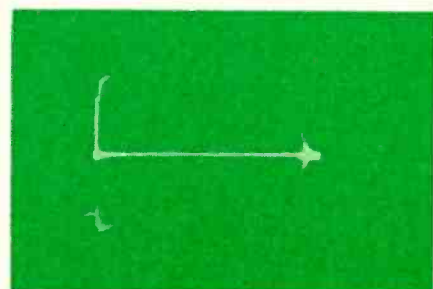
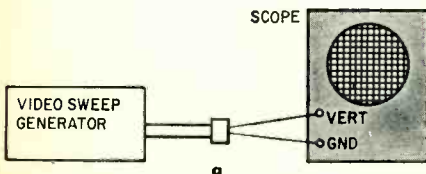

Fig. 5—This frequency response is also usable.



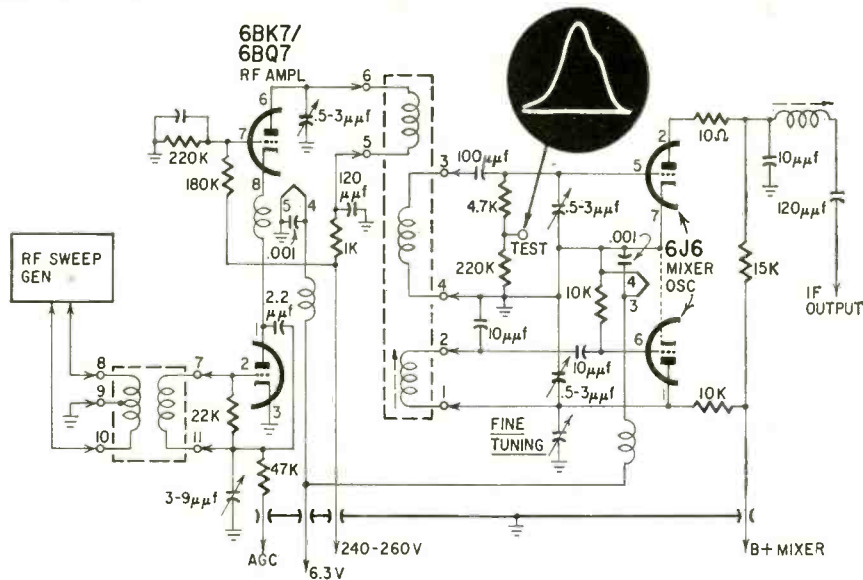

Fig. 6—If a question arises concerning front-end response, check it with a sweep-generator test.

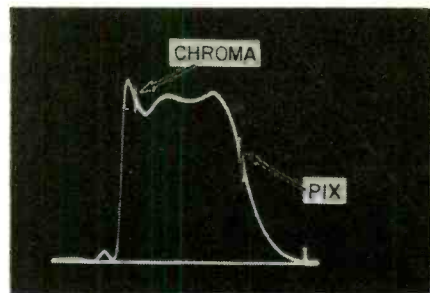

Fig. 7—Chroma-if response at 100%.

mc. We locate the picture-carrier and the chroma-subcarrier points on the curve with a marker generator. In the front end, we should find both the picture carrier and the chroma subcarrier very near the top section of the curve. Otherwise, rf alignment procedures are in order.

Using ordinary service instruments, we will first see the video modulating signal (Fig. 2) at the output of the picture detector. The chroma information in Fig. 2 is attenuated almost 6 db. Now, this may or may not indicate the need for rf or if realignment. It all depends upon the type of receiver on the bench. One kind of color receiver is designed to pass the chroma subcarrier at the top of the if response curve (Fig. 7). In this case, unattenuated chroma information passes through the picture detector.

On the other hand, the other type of color receiver comprises an if amplifier normally aligned for vestigial-sideband chroma reception. This simply means that the chroma subcarrier does not fall on the top of the if response curve, but instead is found 50% up the far side of the curve (sound-carrier side). Hence, the chroma signal is attenuated by half in passage through the if amplifier, and the burst, with all chroma bars, has half the usual amplitude at the picture-detector output. Note that in this type of receiver the bandpass amplifier has a compensating frequency response to restore the chroma amplitude.

We check the frequency response of a chroma bandpass amplifier as in Fig. 8. Procedure is conventional, with the exception of a demodulator probe used in series with the vertical input cable to the scope. We use this probe because, unlike an if amplifier, a chroma amplifier is not followed by an AM detector. Hence, to display a conventional response pattern, we supply an AM detector in the form of a demodulator probe. Again, the scope used in this test need have only good 60-cycle square-wave response.

The bandpass response curve shown in Fig. 9 is that of an if amplifier

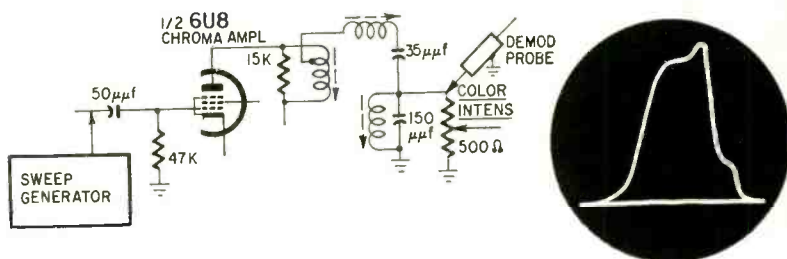

Fig. 8—Checking the chroma bandpass amplifier.

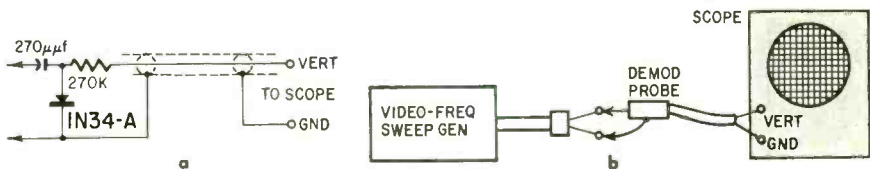
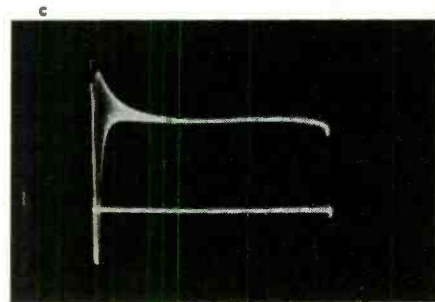

Fig. 9—At low rf, the demodulator probe permits feedthrough of ac signal voltage. a—Demodulator probe. b—Sweep generator setup. c—Typical scope pattern obtained in test.



having the color subcarrier located at the top of the if curve. Hence, the bandpass curve also has an essentially flat-topped response. On the other hand, when the if amplifier has vestigial chroma-sideband response, the bandpass curve will have a sloping top, with twice as much amplitude at the high end. Bandpass frequency limits are determined with the aid of a marker generator, in the usual manner.

Returning to the picture detector, consider the problem of attenuated chroma-signal response, in the event that we suspect the scope's frequency response to be inadequate and the video sweep generator to have attenuated high-frequency output. In this situation, we need some method of checking the video sweep generator. This can be done as in Fig. 9. We eliminate the scope from the problem by connecting a demodulator probe in series with the scope's vertical input. Now, with the generator sweeping from zero to 4 mc,

we should see a flat-topped pattern. Otherwise, the generator is inadequate for chroma-circuit sweeping. Note in Fig. 9 that a large "marker" appears in the vicinity of zero frequency. This is normal. It is caused by the inability of simple demodulator probes completely to demodulate and filter very low video frequencies.

Check chroma action

How can we make a quick check of chroma-detector action? A vectorgram provides the maximum information in a single pattern (Fig. 10). To display a vectorgram on the scope screen, connect the output from the (R - Y) detector to the vertical input terminal, and the

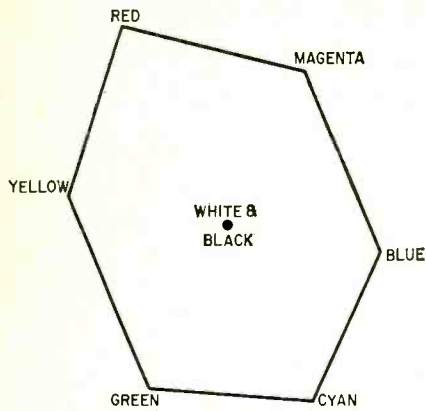

Fig. 10—Vectorgram from chroma detectors.

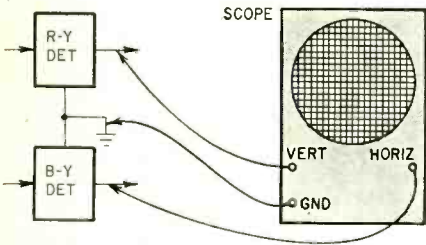

Fig. 11—Test setup to display a vectorgram.

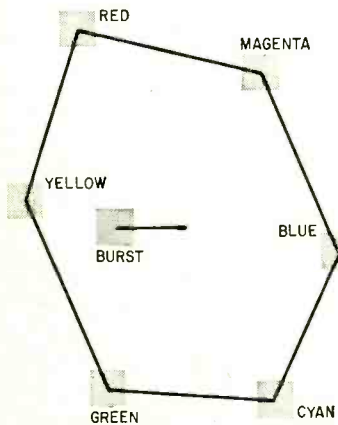

Fig. 12—Vectorgram graticule.

output from the (B — Y) detector to the scope's horizontal input terminal (Fig. 11). The receiver is driven by a color bar generator. The generator should supply the primaries and complementaries (green, yellow, red, magenta, cyan and blue). If receiver operation is normal through the color detectors, we see the vectorgram pattern of Fig. 10.

A scope used for vectorgram displays should have good 150-kc square-wave response. This requirement is imposed on both the vertical and the horizontal amplifiers. Otherwise, there will be distortion in the display. Note that quite a few scopes with satisfactory vertical-amplifier response may have limited horizontal-amplifier response. The busy color TV shop will find it advantageous to obtain or draw up a vectorgram graticule for the scope. They are used in all color TV broadcast stations to monitor the transmitted signal periodically. The graticule layout is

Symptoms	Tubes to Check
Normal raster and black-and-white picture. No color.	Bandpass amplifier and cathode follower; 3.58-mc buffer; (R — Y) and (B — Y) demodulators; (R — Y) and (B — Y) amplifiers; 3.58-mc oscillator and reactance tube; rf amplifier; mixer-oscillator; first, second and third if tubes.
Normal raster, normal black-and-white picture, color out of sync. Color information falls off to side, similar to out-of-horizontal sync.	Bandpass cathode follower; 3.58-mc buffer; burst amplifier; (G — Y) matrix amplifier; color afc tube; 3.58-mc oscillator and reactance tube.
Normal raster and black-and-white picture. Poor color tone and balance on color portion of picture.	Burst amplifier and (G — Y) matrix tube; (R — Y) and (B — Y) demodulators; (R — Y) and (B — Y) amplifiers; picture tube.
Tinted raster (entire raster tinted evenly).	Picture tube—make visual check first to see if all three heaters are glowing; burst amplifier and (G — Y) matrix tube; (R — Y) and (B — Y) demodulators; (R — Y) and (B — Y) amplifiers.
Excessive 920-kc beat interference in picture.	Rf amplifier; oscillator-mixer; first, second and third if amplifiers; sync and video amplifiers; agc detector and amplifier; brightness amplifier.
Picture size changes excessively with adjustment of brightness control.	High-voltage regulator tube.
Tinted raster (one or more sections tinted, usually in the outer areas).	Picture tube.
Color fringing.	Picture tube.
Sound OK; no picture. (Receivers using separate sound detector).	Last if amplifier, picture detector tube.
No sound, no color; black and white picture OK. (Receivers using separate Y detector.)	Chroma-and-sound detector tube.
Picture blooms badly, with varying dynamic convergence as brightness control is advanced.	Regulator tube. (Some receivers utilize a triode regulator—others use a corona bleeder tube). If corona tube is used, weak high-voltage rectifier tubes may reduce the high voltage below the striking level of the regulator.
Color hum bars in picture.	Heater-cathode leakage in color detector tubes, or color amplifier tubes.
Blues and greens only are present in the color picture.	(R — Y) detector, or amplifier.
Reds and greens only are present in color picture.	(B — Y) detector, or amplifier.

Fig. 13—Chroma troubleshooting chart (from *Servicing Color TV*, Gernsback Library).

similar to that shown in Fig. 12. The small squares indicate the limits of phase error for each color. Whether we will see a burst indication when testing chroma detectors depends on the receiver design. Quite a few color receivers trap out the burst ahead of chroma detection.

Preliminary troubleshooting

When a color receiver is tackled, first we make sure that the tubes are OK. In general, symptoms of defective tubes in the black-and-white section are readily recognized. On the other hand, newcomers to color servicing can be baffled by tube symptoms in the chroma section. Common symptoms caused by faulty tubes in the chroma section are in Fig. 13.

Obviously, preliminary troubleshooting is enormously simplified by driving the receiver from a color bar generator, instead of using a color program signal. The bars displayed on the picture-tube screen and the color signals observed on a scope screen are pure and saturated when a bar generator is used. *A good color bar generator is a must for the serious color TV technician.*

Practical servicing follows. Measure dc voltages and resistances in suspected chroma circuits. Standard service data provide these values for color receivers, just as for black-and-white sets. Hence, the second *must* is a schematic of the receiver. Although many operating defects can be traced to the offending component by dc voltage and resistance measurements, some faults show

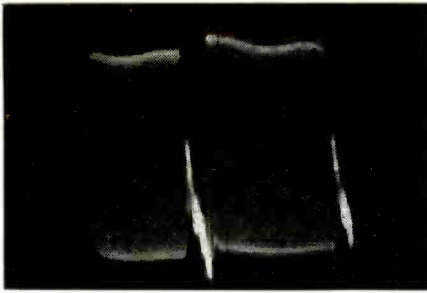

Fig. 14—Output from a bandpass amplifier.

up clearly only in scope tests.

Within its limitations, the color picture tube is a scope, when the receiver is driven by a color bar generator. On the other hand, pattern analysis is of no avail when the color signal is killed somewhere ahead of the picture tube. In this case, we can save much wasted effort by using the scope as a *chroma signal tracer* to find out where the chroma signal stops in the circuits. If we find normal chroma output from the picture detector, we can check the output from the bandpass amplifier. With a 3.58-mc signal modulating the picture carrier, we should see the typical bandpass output signal of Fig. 14. The breaks in the 3.58-mc signal are caused by the keying pulse. Many bandpass amplifiers are keyed off during the burst interval, to accommodate subsequent chroma circuitry.

Trouble in the keyer circuit often results in the bandpass amplifier being biased off continuously, which kills the chroma output. By the same token, a fault in the color-killer circuit can render the bandpass amplifier inoperative. In either case, waveform checks in these two circuits will localize the trouble or clear the control circuits. A practical note here is to use a low-capacitance probe with the scope when making chroma-circuit tests. At 3.58 mc, instrument loading can easily lead to false conclusions. If you do not have a low-capacitance probe—get one!

Even when the chroma signal is getting through to the picture tube in a defective color receiver, it is often difficult or impossible to localize the trouble by picture-screen analysis. We see that the colors are distorted or weak, but we can't tell whether the distortion is in the high-frequency circuits, in the bandpass amplifier, in the chroma detectors or amplifiers, or possibly in the color-sync section. Complete loss of color sync causes rainbows to appear on the picture-tube screen, but drifting or pulling in the color-sync circuits can distort the colors while still holding the bars in sync.

Chroma signal tracing, followed by analysis of vectorgram (or partial vectorgram) displays, accordingly provides the easiest practical approach. It might appear to the beginner that practical procedures would require only a multimeter to run down chroma trouble. This is an oversimplification. The competent technician must be prepared to include a wide-band scope in his bench gear. Otherwise, he will find himself "hunting with a bow and arrow." **END**

SW PROPAGATION FORECAST

June 15—July 15

By STANLEY LEINWOLL*

During the summer there is a significant increase in the formation of sporadic-E (E_s) clouds in the ionosphere. These clouds, or patches of extremely high ionization density, permit reflection from the ionosphere of frequencies much higher than those normally reflected by the F-layers of the ionosphere.

Last summer a record number of serious TVI cases due to E_s -propagated TV signals, were reported on the lower channels, 2 and 3 in particular. There is evidence this summer will be just as bad; recent studies indicate sporadic-E occurrence may be more frequent during years of minimum sunspot activity.

To use the tables, select the one most suitable for your location, read down the left side to the region in which you are interested, then follow the line to the right until you are under the appropriate time. (Time is given at the top of each table in 2-hour intervals from midnight to 10 pm, in your local standard time.) The figure thus obtained is the optimum working frequency, in mc. The best band for any particular service is the one nearest the optimum working frequency.

The tables are a general guide; day-to-day variations in receiving conditions can be considerable. At certain hours, propagation over some of the paths given may be extremely difficult, or impossible. This will depend on the type of service, antenna characteristics, radiated power of the station, etc. The curves from which the data in the tables are derived are based on an effective radiated power of 10 kw.

In general, circuits passing through the northern auroral zone will be more difficult than those over more southerly paths; in addition, circuits lying entirely in daylight or darkness will be better than those passing from daylight to darkness, or vice versa.

*Radio-frequency and propagation manager, Radio Free Europe.

EASTERN US to:

	Mid	2	4	6	8	10	Noon	2	4	6	8	10
West Europe	8	8	10	10	14	14	14	14	15	14	12	10
East Europe	8	8	8	10	10	14	14	15	15	11	10	8
Central America	13	10	11	16	17	18	18	18	19	18	15	13
South America	14	14	14	14	14	14	14	14	14	14	14	14
Near East	8	8	8	10	10	11	14	14	15	15	11	9
North Africa	10	10	10	12	14	14	14	14	15	15	15	11
South & Central Africa	9	10	12	14	16	16	16	17	17	15	11	9
Far East	11	11	11	11	11	14	14	14	15	15	15	11
Australia & New Zealand	10	10	10	10	8	8	9	21	21	21	20	14

CENTRAL US to:

	Mid	2	4	6	8	10	Noon	2	4	6	8	10
West Europe	10	10	10	10	14	14	14	14	15	11	10	10
East Europe	8	8	10	10	11	13	14	15	11	11	10	10
Central America	13	11	10	15	17	18	18	18	18	18	15	13
South America	13	11	10	13	15	15	15	15	15	15	15	14
Near East	10	10	11	11	13	14	15	15	14	11	10	10
North Africa	10	10	11	13	14	14	15	15	14	14	11	10
South & Central Africa	10	10	11	13	15	16	16	16	17	17	15	10
Far East	10	10	11	11	13	11	13	13	14	14	14	14
Australia & New Zealand	11	11	10	10	10	10	13	20	20	20	16	13

WESTERN US to:

	Mid	2	4	6	8	10	Noon	2	4	6	8	10
West Europe	8	8	10	10	13	14	14	15	15	11	10	10
East Europe	10	8	8	10	10	13	15	11	11	11	10	10
Central America	10	9	10	12	14	14	14	14	14	14	12	10
South America	13	10	9	13	14	15	15	15	15	15	15	13
North Africa	8	8	10	11	13	14	15	15	15	11	10	10
South & Central Africa	10	10	11	14	15	16	16	17	11	9	8	8
Far East	14	11	9	10	13	14	14	15	15	15	17	16
South Asia	15	11	8	10	14	14	14	15	15	15	14	14
Australia & New Zealand	15	15	10	10	10	14	20	20	20	20	20	16



boat elec- tronics —what's new

Judging from the amount of equipment available, water must be conducive to electronics

By **ELBERT ROBBERTSON**

JUST A FEW SLEEPS OVER 20 YEARS AGO, I saw my first yacht marine radiotelephone. My job was converting the radio equipment on vessels taken over by the Army Transport Service to operate on military frequencies. This yacht had been commandeered to serve as a general's command post, or whatever it is that generals do with yachts. The radiotelephone, a custom rack-and-panel job, occupied an entire closet. The door knob on the closet shone like gold. Maybe it *was* gold. In those days, you had to be able to afford gold door knobs to have a radiotelephone on your boat.

Today, in 1962, you can have a radiotelephone on your boat for about the cost of insurance coverage. And that's fair enough because a radiotelephone *is* insurance.

In addition, you can have other equipment that just a few years ago hadn't even been thought of, and some that was thought of, but only behind guarded doors.

Echo sounders

(20 manufacturers)

At first, small-craft "marine elec-

UPI

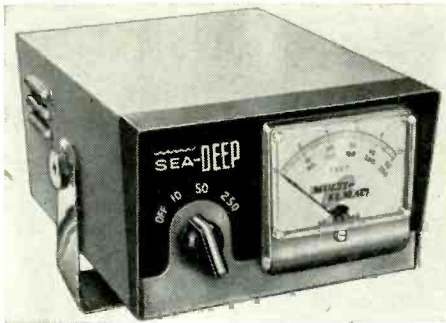

Multi-Products Sea-Deep echo sounder shows depth on a meter.

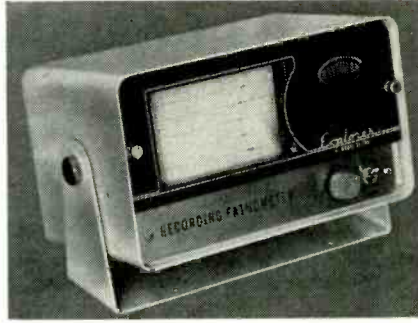

Recording Fathometer by Raytheon continuously charts bottom contour.

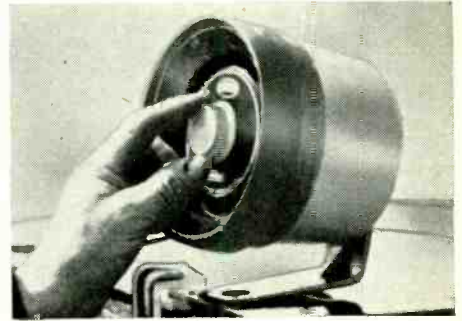

Flashing light type of sounder indicator is used in this Paytheon Fathometer.

tronics" was practically synonymous with "radiotelephone." There wasn't much else. But I have just completed a survey covering all the manufacturers I could find in the marine electronics field. It shows that, from one specialty, they have developed about 20—all items of interest and use to boatmen. And, except for Citizens-band equipment (a field that practically everyone with a spare production line has jumped into), what kind of gear do you think has attracted more manufacturers than any other? The echo sounder, or electronic depth finder. This means that boating interest is heavy here. Otherwise, the market-analysis boys wouldn't have pointed to this particular area and told their people, "Dig here!"

The echo sounder fills a universal need. You can't tell, by just looking, how far down it is to the bottom; and when the bottom gets too close to the top, a boatman is in trouble. The old way of sounding, slinging a chunk of lead over the side and checking off the marks as the line skinned through your hand was tiresome, messy and often very inconvenient. An echo sounder tells you painlessly, automatically and continuously just how much water is under the keel.

The first echo-sounding device I ever saw took up a room in the bowels of the ship. A trained "sound man" sat before a very-low-frequency transmitter and receiver connected to a monstrous quartz-crystal transducer set in the hull. He started a stopwatch, pressed a telegraph key, sent a squirt of 50-kc rf to the transducer, exciting the mosaic of crystals to make a 50-kc squeak of sound. When the echo came back from the bottom, it hit the crystals, jarred them into making a 50-kc squirt of rf that the sound man heard in the receiver. The stopwatch told him how long the round trip had taken. A table told him the water's depth. Not very good for shallow water. Not very good for a small boat, either. But the principle was OK—it is still used today.

Modern echo sounders still tell the depth by the time it takes for a sound to hit bottom and return, but the "clock" is calibrated in feet or fathoms instead of

time, and it operates automatically. There are two forms: mechanical and electronic. The mechanical instruments are further broken down into indicators and recorders. The indicators show the depth on a dial; recorders plot the depth on a moving strip of graph paper. Electronic indicators point out depth on a meter calibrated in feet.

The heart of the mechanical indicator is a revolving arm with a neon lamp on the end. The arm turns rapidly at a constant speed, sweeping the lamp past figures for depth marked on a transparent scale. When the lamp is at the zero point, a pulse of sound is sent out and the lamp flashes. The returning echo causes the lamp to flash again, this time opposite the figure for the depth.

Indicators have an electric stylus on the end of the arm, sweeping over a moving graph paper. The "signals" cause the stylus to mark the graph paper. Some indicators use a stylus on a vertically moving belt instead of a rotating arm, to get a straight-line picture instead of a curved one, but the principle is the same.

Electronic indicators show depth on a meter. At the instant the sound pulse is sent down, current in the meter circuit starts rising linearly, at an accurate rate. The returning echo cuts off the current rise. The amount the current has risen depends upon the time elapsed and, hence, the depth. Pulses are sent out several times a second, so inertia keeps the meter needle hovering at the depth figure.

Modern transducers are small streamlined units that you can install on the bottom of the boat, on the transom or even extend over the side on a portable support.

Sound frequencies range from tens of thousands of cycles to hundreds of kilocycles. The low frequencies have greatest range and penetration, while the higher frequencies have better resolution and the ability to pick up small objects. The latter feature is often used to find fish.

Recent developments include transistor circuits—some of them units that will operate from a few flashlight batteries. Era Dynamics Corp. (67 Fac-

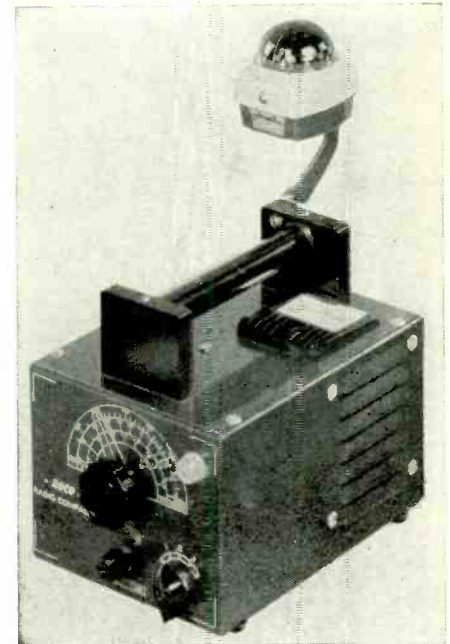

Robinson 3-band RDF has compass to give magnetic bearings.

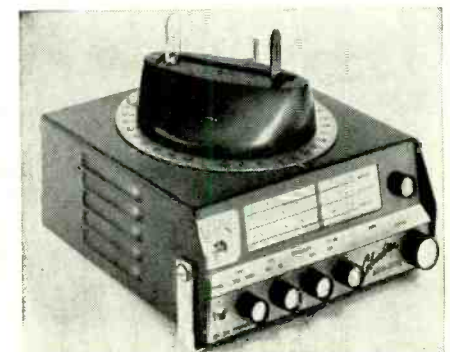

Columbian Hydrosonics' RDF with attached pelorus for taking visual bearings.

tory Place, Cedar Grove, N. J.) manufactures a sounder that shows the distance to the bottom ahead of the boat as well as directly underneath, and which also probes horizontally forward to detect obstructions in front of the boat. Their dual-beam transducer may also be adapted to certain other makes of depth finders.

The least expensive echo sounders have a range of 100 or 200 feet over a hard bottom—less if the bottom is like soup. With some practice, you can fig-



RCA Cruisphone 25 can be mounted on shelf, bulkhead, or overhead.

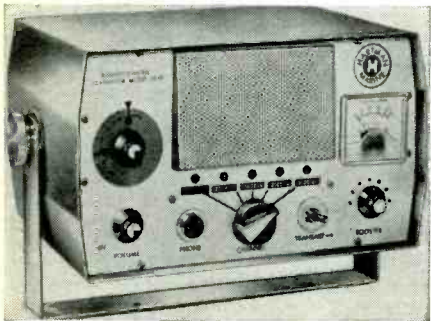

Package 30-watt radiotelephone made by Hartman Marine. It includes crystals, antenna and installation hardware as well as the radiotelephone.

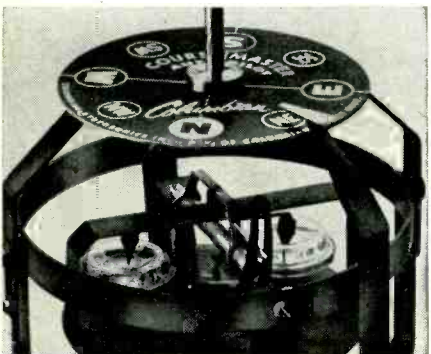

Coursemaster automatic pilot by Columbian Hydrosonics uses north-seeking bar-magnet control. When boat falls off course, carbon tips contact the port or starboard mercury switch, actuating the steering motor.

ure out what the signal is bouncing from by the echo indication.

The price of indicator echo sounders starts under \$100 (there are even kits by Heath Co. and Paco Electronics); recorders start at about \$200.

Direction finders (18 manufacturers)

By the same yardstick—the number of manufacturers in the field—the radio direction finder (RDF) comes next. Like the echo sounder, the instrument has benefitted vastly from transistor circuitry—also the development of

ferrite antennas. Just a few years ago, an RDF contained a long string of vacuum tubes and was topped by a large loop antenna. Today's models are very little different in appearance and operation from a portable broadcast receiver—just a small cabinet with a rotatable ferrite-rod loop antenna and a compass scale for bearings. Many have a null meter as well as a loudspeaker. The days of guessing at bearings by the noise in a headset are gone.

The most simple sets tune one band—the low-frequency range between about 200 and 400 kc—in which the marine and aircraft radio beacons lie. Other sets have three-band coverage—200 to 400 kc. standard broadcast and a high-frequency band covering the marine radiotelephone channels. Robinson & Co. (731 W. 129 St., Gardena, Calif.) makes a compact set that has from four to six channels, crystal-tuned to the stations you want to navigate by. The DF-O-Matic, made by Allen-Bradford Inc. (3181 N. Elston Ave., Chicago 18, Ill.) has a visual homing indicator—a meter that tells automatically if you are to the right or left of the course toward the radio station.

With conventional direction finders, accuracy depends largely upon the skill of the operator, and the unskilled beginner can get some erratic results.

Automatic direction finders automatically and instantaneously show the bearings of stations as soon as they are tuned in. You don't have to interpret by ear or try to adjust the loop setting to the center of a no-signal sector. Bendix-Pacific Div.'s Marine Dept. (North Hollywood, Calif.) manufactures the ADF-100, which shows bearings by a trace on an oscilloscope tube. Frontier Electronics (Sky Harbor Airport, Phoenix 34, Ariz.) makes the ADF-200 with stroboscopic light readout.

You can visualize how these sets operate by imagining a rotating loop antenna. The loop antenna has a figure-8 response pattern, so, when a signal is tuned in, the loop output will vary twice to maximum and twice to minimum in one rotation. Now, visualize a cathode-ray tube that has a circular trace and radial deflection going around in sync with the loop antenna. With no signal input, the tube face shows just a spot in the center. Signal input deflects the spot radially toward the rim of the tube. Now, if the loop output were coupled to the scope tube, a signal would make a figure-8 pattern on the screen, like the loop directional pattern. The orientation of the pattern on the tube would correspond to the station bearing.

The actual RDF's contain many variations and refinements, some of which the manufacturers keep strictly under their hats, but the above simple comparison gives the basic idea.

Direction-finder prices start at a little over \$100, with a Heathkit three-band job selling at \$109.95. ADF prices range upward from \$689.

Marine radiotelephones (17 manufacturers)

From a room full of gear, the marine radiotelephone has been squeezed down to a package smaller than ½ cubic foot. The price has also shrunk drastically. And, while early units gobbled current greedily, the combination of transistors and low-drain tubes has resulted in current consumption so reasonable that even the batteries of electric-starting outboard motors have reserve for considerable talking time.

Standard marine channels lie between 2 and 3 mc. The International Calling and Distress frequency is 2.182 mc. All stations monitor this channel for possible distress calls. There are two ship-to-ship channels: 2.638 and 2.738 mc. The Coast Guard channel, 2.670 mc, is also available for talking directly to Coast Guard stations and vessels. In addition, commercial telephone companies maintain a nationwide network of stations to enable boats to place calls through shore-telephone lines and to be called from shore in return. Special high frequencies are also assigned for long-haul work on the high seas, and over difficult inland stretches, such as the Great Lakes and the Mississippi River.

Marine radiotelephones are made to operate on at least four channels to permit communication on the International Calling and Distress frequency, and a combination of the other available channels chosen by the buyer. The receivers often tune the broadcast band as well as marine frequencies. Channels are crystal-controlled, and are tuned automatically by a panel switch. Some telephones have automatic noise limiters and squelch to reduce noise, and all of them have harmonic reduction and modulation peak-limiting circuits to minimize interference to other services.

For a long time radiotelephone installation was strictly a job for specialists. Now, you can buy "package" telephones that include a special "loaded" antenna and other installation necessities. A good many owners have found it possible to do most of the work themselves. Final tuning and adjusting must be by a technician with a Second-Class or higher Commercial license.

The talking range of these sets depends upon the transmitter power, antenna system and, of course, conditions at the time. Very roughly you should get at least 1 mile per watt of transmitter power, and you can usually reach much farther. Transmitter power starts at 15 watts; prices at about \$225.

Some boatmen, especially in areas not served by regular marine radiotele-

phone facilities, use Citizens-band equipment on their boats. It is also useful for short-range communications such as managing regattas. However, as with land use of CB channels, no public facilities are set up. Boatmen must provide their own contacts.

Professional and business (and sometimes just plain men and women) users of radiotelephone have often objected to the lack of privacy. Of course, the FCC rules are intended to preserve privacy as far as possible, but they still don't prevent others from listening to every word you say on the air. Delcon Corp. (943 Industrial Ave., Palo Alto, Calif.) can furnish a transistorized speech scrambler that will make your speech gibberish to everyone but the person with a matching unscrambler.

Automatic pilots (10 manufacturers)

Operating a boat for a little while is great fun. But when you have to steer for hours on end you can get a crick in your back and bug-eyed from watching the pips on the compass. And, every time your mind wanders, so does your course. It is for these reasons that big ships have automatic pilots, known as an "Iron Mike." You can get one that works just about the same for a small boat.

An automatic pilot consists of a compass with an electrical contactor, or a magnetic, electrostatic or photoelectric sensing and control device that operates a steering motor to keep the boat on course. Both magnetic and gyro compasses are used. You set the course you wish to steer on a dial. As long as you remain on course, nothing happens. When the boat wanders off, the compass closes a contact or changes a magnetic or electric field, or the amount of light picked up by a photoelectric cell, in the sensor and a command goes to the steering motor to set you back on course. The sensitivity of the sensor can be adjusted to suit sea conditions.

Automatic pilots can also be fitted with a pushbutton hand control on a cord so that you could sit on top of the mast to steer through a rocky channel, toward a school of fish or just for the heck of it.

Auto-pilot prices start around \$330. Some machine work may be necessary to couple the steering unit to the boat's helm, but it is a simple installation.

Radar (4 manufacturers)

When I first heard this word, the people talking looked around before they said it to see if anyone were listening. When I went up into the mountains to make a repair, there were pass-words and guys with tommy guns at every turn. The equipment occupied vans and buildings and towers, and you couldn't get it for any price. Now, 35-

foot boats at the marina are radar equipped.

Indicators are about the size of a portable TV, while the rotary antennas are compact and light enough to be installed on the boat's mast or cabin top without needing extra support. Equipment is made to operate from 12, 24, 32, or 110 volts dc or 117 volts ac. Prices start at about \$2,000.

Loran (2 manufacturers)

Deep-sea navigators are no longer dependent upon the vagaries of weather and their ability to get a sextant shot at the sun while balancing on one leg and holding onto a shroud with the other. Loran makes finding your position at sea a simple matter of matching pips on the face of a scope, then reading a time-difference figure on a dial and looking up the corresponding line of position in a table or chart. Loran stations blanket the navigable waters of the globe.

Shipboard loran equipment consists of a special receiver that tunes the loran frequencies in the neighborhood of 1.8 mc, and an oscilloscope on which signals are displayed. Pulse signals from pairs of transmitting stations on shore are tuned in, and the difference in the time of reception (in microseconds) of pairs of pulses is measured by aligning the pulses on the scope.

Loran receivers are available that consume less than 50 watts, and prices start at around \$1,500.

Consolan

Consolan and Consol are developments of the "Sonnen" navigational system originated by the Germans in World War II. There are three stations in the United States: at Nantucket, Miami and San Francisco. The only practical difference between Consolan and Consol is that the former stations have an antenna system using two towers, and Consol stations three towers.

Consol and Consolan stations operate between 190 and 194 kc. Transmission from the towers is phased so that a pattern of dot and dash sectors is laid down around the station. You can tell your bearing from the station by the number of dots and dashes you hear, and by referring to a Consol chart or set of tables.

To use Consolan stations for navigation, all you need is a receiver that will tune to the above frequencies and the tables. The receiver must have a bfo. Most of the direction finders now being produced can be used for Consolan reception.

Electro-Nuclear Apparatus Co. (Box 6890, Baltimore 4, Md.) has developed a digital Consol reader receiver that automatically counts the dots and dashes received and indicates the number on glow transfer tubes. The re-

ceiver operates from 12 volts dc or 117 volts ac, and costs \$650.

Miscellaneous

Electronic inverters make it possible for boatmen to operate just about every kind of ac equipment that they normally use in the home. Changing battery voltage to 117 volts ac, they provide enough power for razors, tape recorders, record players, TV and FM radio. Other knickknacks operate from their own self-contained batteries, usually with the benefit of transistors. These include intercoms, "bull horns" and even automatic fog-horn timers to sound the boat's horn.

The water is no barrier to the use of electronic equipment. It is, in fact, the other way around. The problems of boat operation need the sort of things that only electronics can furnish and equipment is being developed at an increasing rate to fill the need. END



Electro-Nuclear D-X Navigator gives Loran system delay time in μ sec.

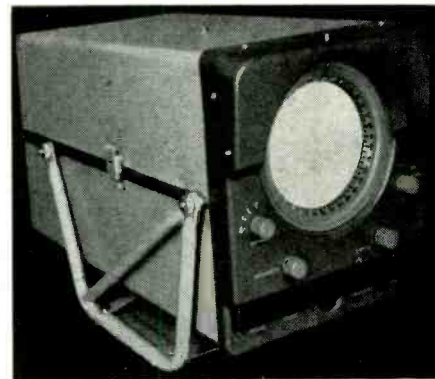

Raytheon small-boat radar has 1/2-, 2-, 6-, 12-mile ranges.



Consol dot-dash count automatically displayed by glow-tube indicators in Electro-Nuclear Consol Reader.

OTL stereo amplifier

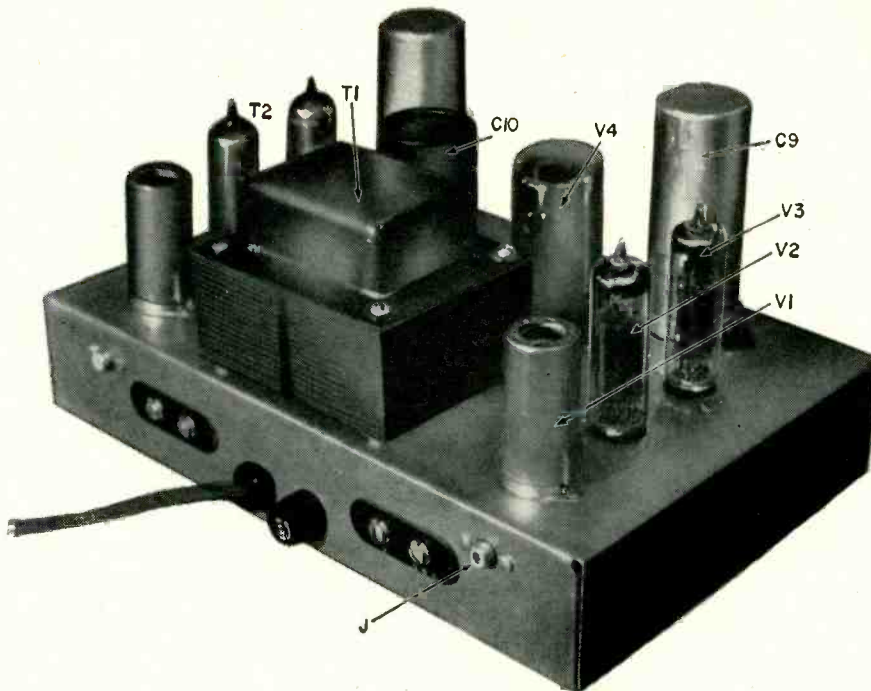

Dual 10-watt unit dispenses with output transformers

By JOHAN VAN LEER

HERE IS A HIGH-QUALITY, DUAL 10-WATT amplifier that is not extremely costly. One of the biggest factors in reducing the price is that it needs no output transformers. Frequency response at full output (10 watts) is down 1 db at 20 and 40,000 cycles. Maximum distortion is 0.5%. Hum and noise are 80 db down and a 0.6-volt input will produce 10 watts output.

I got the idea for this amplifier from a presentation by J. Rodriguez De Miranda at the 1957 AES annual meeting in New York. Building the amplifier and getting it into operation is not tricky and the circuit should work well when completed and without any mess-

ing around adjusting one component or another.

A 12AX7 is used as a voltage amplifier and phase inverter. Besides allowing the amplifier to operate at lower signal inputs, it gives us a way to include feedback loops. Including feedback to improve performance has the usual drawback of reduced gain. But because the entire amplifier has no coupling or output transformers, phase shift between input and output is very low. Because of this, positive feedback can be used to regain some of the sensitivity loss. This is one bonus obtained by eliminating the output transformer. The hot end of the 12AX7 common cathode resistor (R2) con-

BENCH



TESTED

This amplifier was tested by Sigma Electric Co., New York, N. Y., for: frequency response, power response, input sensitivity for full output, harmonic distortion at full output, and square wave response. The equipment was found satisfactory and in accordance with the author's specifications.

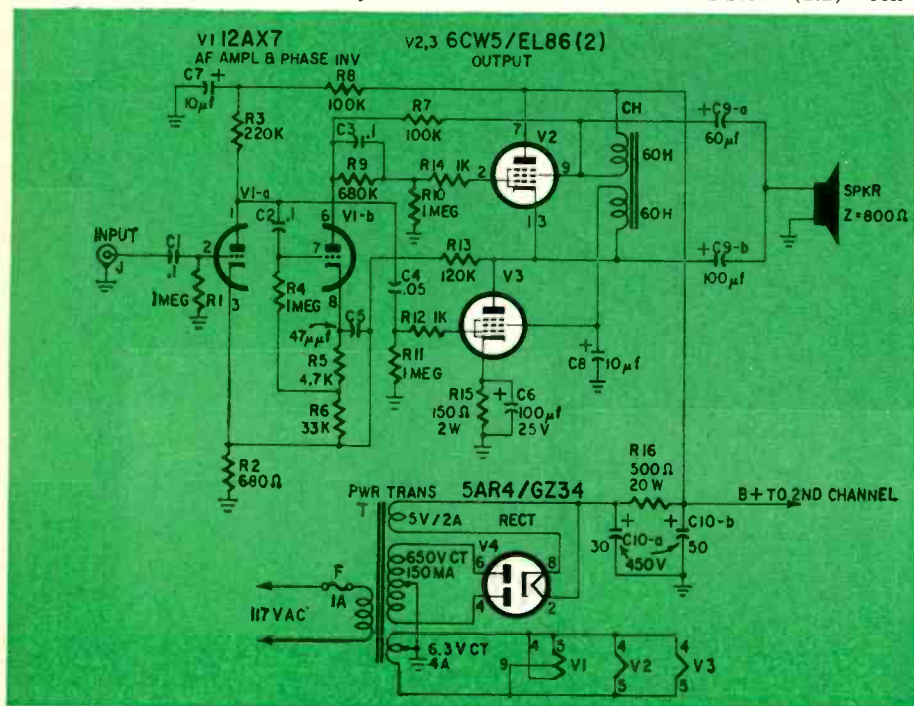

- R1, R4, R10, R11—1 megohm
 R2—680 ohms
 R3—220,000 ohms
 R5—4,700 ohms
 R6—33,000 ohms
 R7, R8—100,000 ohms
 R9—680,000 ohms
 R12, R14—1,000 ohms
 R13—120,000 ohms
 R15—150 ohms, 2 watts
 R16—500 ohms, 20 watts, wire wound
 All resistors 1/2 watt, 10% unless noted
 C1, C2, C3—0.1 μ f, 400 volts, molded paper
 C4—0.05 μ f, 400 volts, molded paper
 C5—47 μ f, 400 volts, disc ceramic
 C6—100 μ f, 25 volts, electrolytic
 C7, C8—10 μ f, 350 volts, electrolytic
 C9—60—100 μ f, 350 volts, electrolytic
 C10—30—50 μ f, 450 volts, electrolytic
 CH—2 x 60 henries double choke (Philips AD-9025 available from Norelco Electronic Products, 100 E. 42 St., New York 17, N.Y. for approximately \$3.50)
 J—phono jack
 F—fuse, 1 amp, slow blow
 T—power transformer: primary, 117 volts; secondary, 650 volts, ct, 150 ma; 5 volts, 3 amps; 6 volts, 5 amps (Knigh t 61 G 471 or equivalent)
 V1—12AX7
 V2, V3—EL86
 V4—5AR4
 Speaker—800 ohms (Norelco 9710-AM—8-inch 10-watt costs approximately \$24. Norelco AD-3800-AM—8-inch 6-watt costs approximately \$10. Both are available from Norelco Electronic Products, 100 E. 42 St., New York 17, N. Y.)
 Chassis to suit
 Miscellaneous hardware
 Note: Except for components in the power supply (T, V4, C10 and R16) you need two of each part specified — one of each per channel.

Circuit of the amplifier. Only one channel and the power supply is shown here.

nects to the output through a 120,000-ohm resistor to furnish negative feedback. The same common cathode resistor to ground also provides some positive feedback.

Performance figures

Actual distortion measurements gave the following results:

OUTPUT	FREQUENCY		
	30 cycles	1,000 cycles	10,000 cycles
1 watt	0.15%	0.21%	0.21%
5 watts	0.35%	0.32%	0.3%
10 watts	0.5%	0.43%	0.5%

At 10 watts frequency response was down 1 db at 20 and 40,000 cycles.

For full 10 watts output, a 0.6-volt input signal is needed. Hum and noise products are 80 db below 10 watts.

Speakers

The speakers used have special voice coils which are made to look like 800 ohms over the operating range. With such a constant impedance, the amplifier sees an ideal load. Absence of an output transformer eliminates the losses in that element so we get the full theoretical power of the output tubes.

Building the amplifier and getting it into operation is not tricky. I got excellent results immediately upon turning it on without adjustments or de-bugging.

How the circuit operates

The push-pull output stage is in series across the dc supply—V2 and V3

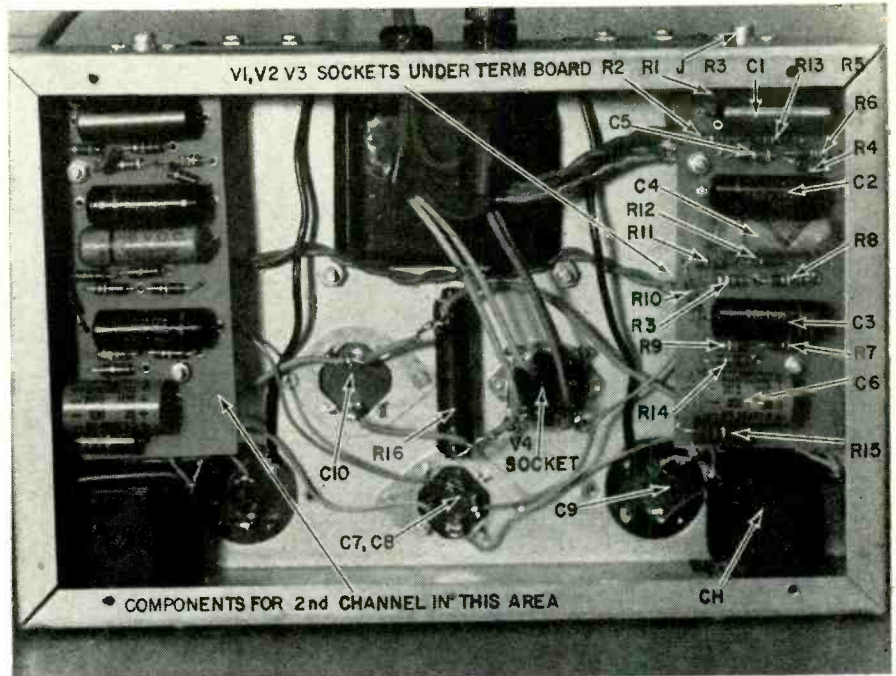

Under the chassis. Note that many of the smaller components are mounted on phenolic boards—one per channel.

each operate with plate-to-cathode voltage equal to half the dc supply. The tubes are in parallel for ac so the load impedance they work into is only one-quarter that required by the same tubes in a conventional push-pull circuit.

The af amplifier drives the grid of phase inverter V1-b and output tube V3. The phase inverter drives the grid of V2. The phase inverter is arranged so equal voltages 180° out of phase are applied between grid and cathode of V2 and V3. The dc voltage at the junction of V2's cathode and V3's plate

varies at an audio rate and the resulting audio signal is capacitance-coupled to the speaker.

The correct operation of the pentodes in the output stage requires that the screens operate at approximately the same dc potential as the plates but must be at cathode potential for ac. A 60-henry choke is connected between each plate and screen. V2's screen is returned to the cathode through C9-a and C9-b. V3's screen returns to the cathode through C8 and C6. END

low-amplitude linear oscillator

A SIGNAL GENERATOR MUST HAVE A stable oscillator with constant amplitude over the tuning range. A beat-frequency oscillator requires very stable rf oscillators, the weaker of which must have constant amplitude and very pure waveform if the output is used for critical audio distortion measurements.

These requirements are met by an oscillator using the negative mutual conductance from grid 4 to grid 2 of a pentagrid converter, and limiting amplitude not by grid current but by avc on grid 1. In the diagram, the two-terminal tank circuit (L-C3) is in grid 2 of V1, and the feedback without phase reversal is to grid 4 through the capacitive voltage divider formed by C2 and C4. C1 is added to reduce feedback if desired. L and C3 are selected for the desired, non-crystal-controlled frequency. If C3 is a variable, you will have a band of frequencies available.

Optionally, a crystal on grid 4 would oscillate with only a resistor in grid 2, C4 being kept small enough to avoid spurious oscillations. Its value ranges from 30 μmf with a 100-kc crystal to 5 μmf with a 6.2-kc rock.

Electron-coupled output for external use is taken from V1's plate, preferably via a cathode follower (not shown). The plate signal also drives V2, a video type avc amplifier whose output is rectified and biases grid 1. Grid 4 is biased to the most linear region at the points of inflection of the I_{b2} and I_p vs E_{g4} curves, and the avc limits the amplitude to a small part of this region, so that grid 4 and plate signals are as low as .05 volt rms if desired.

The amplified avc holds the amplitude very constant and at low amplitude.

Even the signal from V1's untuned plate has low distortion. For still lower distortion, output could be taken from the tank circuit itself via a linear buffer stage. The oscillator can be amplitude-modulated by audio in series with grid 1.

Component values are not critical, but amplitude may flutter if V2's gain is high and the avc time constant is too long for the frequency of the tuned circuit. Resistor values are adjusted for the best working point. Typical values are shown in the diagram.—Albert H. Taylor

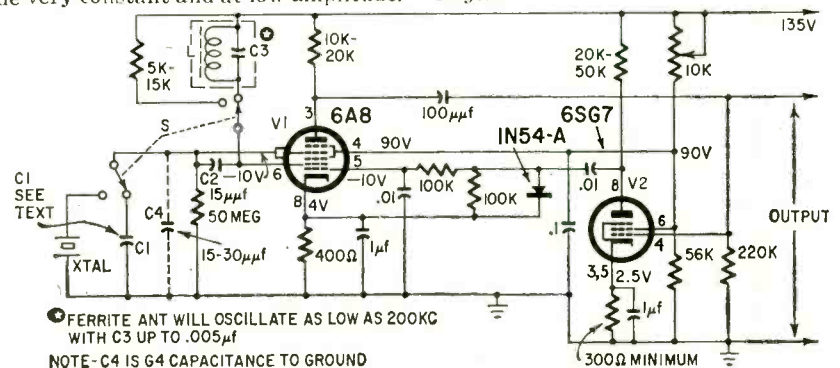

more circuits for FM STEREO

By NORMAN H. CROWHURST

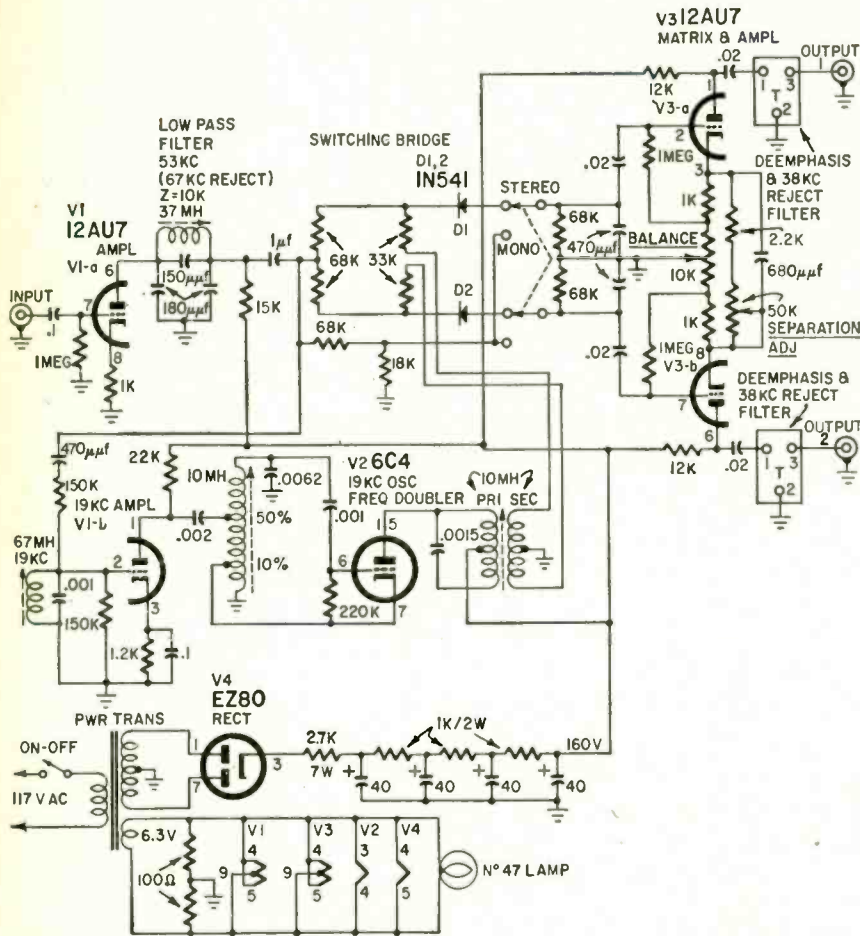

THE REVISED CROSBY CIRCUIT first amplifies the signal with a stage giving an input impedance of 1 megohm (the input resistor) and then passes it through a 53-kc low-pass filter with 67-kc reject, to eliminate SCA. The output from this feeds two circuits: (1) through the 68,000-ohm resistors to the matrixing bridge and (2) through the 470- μ mf capacitor and 150,000-ohm resistor to the 19-kc tuned circuit and amplifier, which synchronizes the 19-kc oscillator. The plate circuit of the cathode-coupled oscillator is tuned to 38 kc to pick off a frequency-doubled signal. The 38-kc tuned transformer has a center-tapped secondary to feed into the bridge, thus phase-reversing the carrier, rather than the L - R. This eliminates the need for separating L + R and L - R, and makes the detection method similar to envelope detection in this respect. The output from these diodes feeds twin-triode amplifiers, whose cathode circuits provide balance adjustment and cross-feed for separation adjustment. The plate circuits feed through filters that provide de-emphasis and 38-kc rejection. For mono reception, the output triodes are switched to a tap on the output from the input stage (after the SCA filter) that equalizes gain, so there is no drastic change in level when this switch is operated.

IN THE ZENITH MULTIPLEX circuit, when there is no 19-kc pilot, the pentode section of the 6AW8-A is biased just to cutoff and the bias on the 6BN8 diodes (27,000- and 68,000-ohm resistors in series across B-plus) renders them conducting all the time. Thus the only signal path is through the triode section of the 6BN8 through the right hand part of the matrix to the left and right outputs. When a 19-kc pilot of usable amplitude appears at the grid of the 6AW8-A pentode, it is amplified and frequency-doubled by the 103-34 diodes to produce 38 kc to feed to the triode section grid, also a positive voltage for the grid bias of the pentode section, rapidly bringing the latter to full gain. Amplitude of the 38 kc is then limited by clipping in the 6AW8-A triode section. The plate transformer cleans up the waveform to a sinusoid. Composite signal, fed through the 67-kc reject circuit, goes to the 6BN8 triode. Amplified, it is fed into the

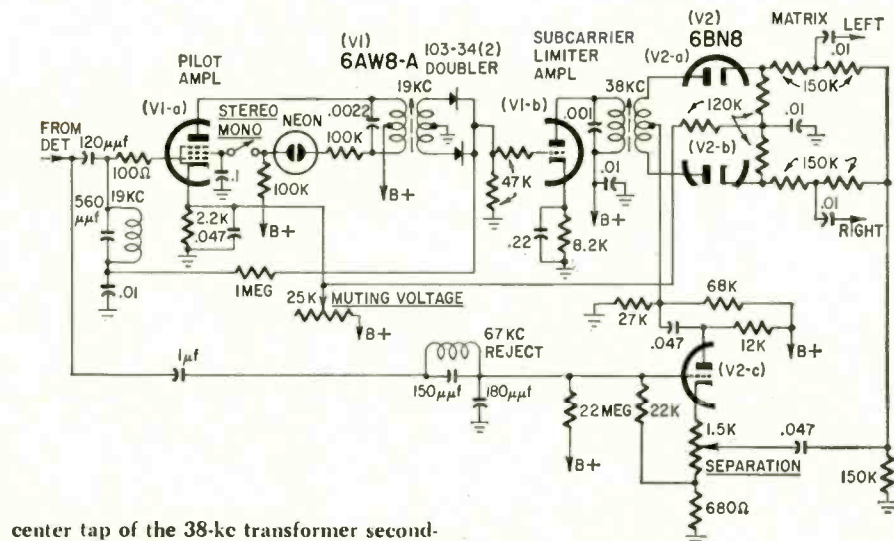

center tap of the 38-kc transformer secondary, so the 6BN8 diodes conduct on opposite peaks of the 38 kc, and "follow" L - R and R - L respectively. These are matrixed with L + R from the cathode, with the 1,500-ohm SEPARATION control, to produce L and R outputs. Current through the 100,000-ohm screen feed resistor of the 6AW8-A pentode produces a voltage

drop that lights the neon lamp to indicate that stereo is being received. At cutoff there is no voltage drop. Also, opening the STEREO-MONO switch disconnects this screen feed, thus disabling the stereo.

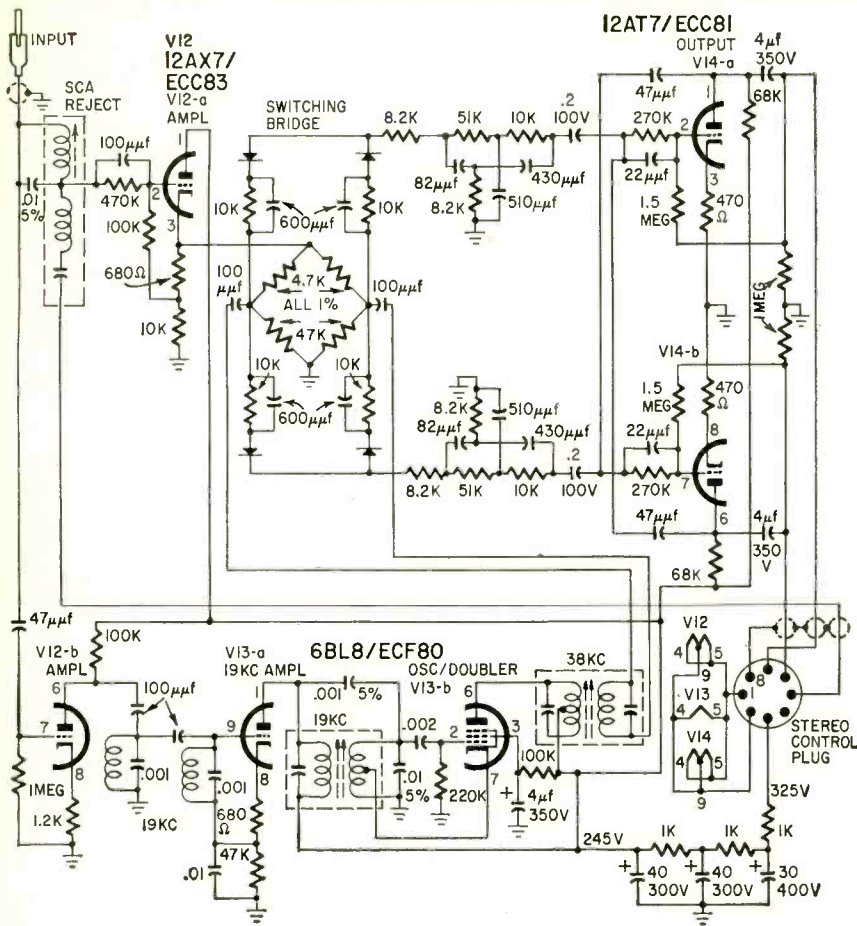

THE HARMAN-KARDON UNIT, PART of the Citation III-X assembly, gets rid of the SCA subcarrier right at the input, with a two-coil filter. Directly from the input, a resistance-coupled stage feeds the double-tuned 19-kc filter. A further stage of amplification couples into the pentode oscillator section, which has a double-tuned 38-kc transformer in its plate. The secondary of this transformer is floating across two diagonals of the detection bridge. Following the SCA filter, a cathode follower, with high-frequency compensation in its grid circuit, feeds the "top" of this bridge, whose bottom is grounded. Alternate reversals of the 38 kc cause the pairs of diodes above and below the bridge to conduct and block alternately, thus "connecting" the cathode-follower output alternately to the feeds leading to left and right outputs—it is a form of switching circuit. De-emphasis and 38-kc reject filters lead to the feed-back output stages. END

adapting a recorder for language training

TAPE RECORDERS ARE USED EXTENSIVELY in language training. They are excellent for this work, but a standard tape recorder not designed for language training lacks certain desirable features. This modification, made on a PT63-J Magnecorder, permits the teacher to comment when playing a tape during a teaching session with students wearing earphones.

Several methods were considered. One was to connect the commentary microphone to the input of one of the playback amplifier stages. This did not work out since commentary voice level was entirely too low. A preamp would have overcome this but would require another piece of equipment, plus additional expense. Finally, a very simple and comparatively inexpensive solution to the problem was found. It requires nothing but a spdt switch and a few simple wiring changes!

Enough of the recorder diagram is shown in the figure to explain the modification. The lead from C18, the coupling capacitor from the second record amplifier stage, is disconnected from the grid of the following tube V8 and connected to the arm of the new switch S. A lead is then connected from the grid, pin 2, of V8 to the normally closed contact of S. Another wire is run from the normally open contact of S to pin 1 of tube V3, in the playback circuit, and that's all

the wiring required. The changes are shown in dashed lines on the diagram.

Any type switch may be used but it is best to employ a push-to-talk type. It automatically returns the record amplifier circuitry to normal.

In use, the teacher's commentary microphone is connected to the input of the record amplifier. Switch S when pushed mixes the output of the second stage, V7, of the record amplifier with

the output of V3 of the playback amplifier. The teacher's voice level can be adjusted by the regular record amplifier volume control R33, which is in the grid circuit of the stage at which the transfer switch S is installed.

Although this modification is given for a specific tape recorder, the technician engaged in work of this nature can apply the idea equally well to other recorders.—*Harold Reed*

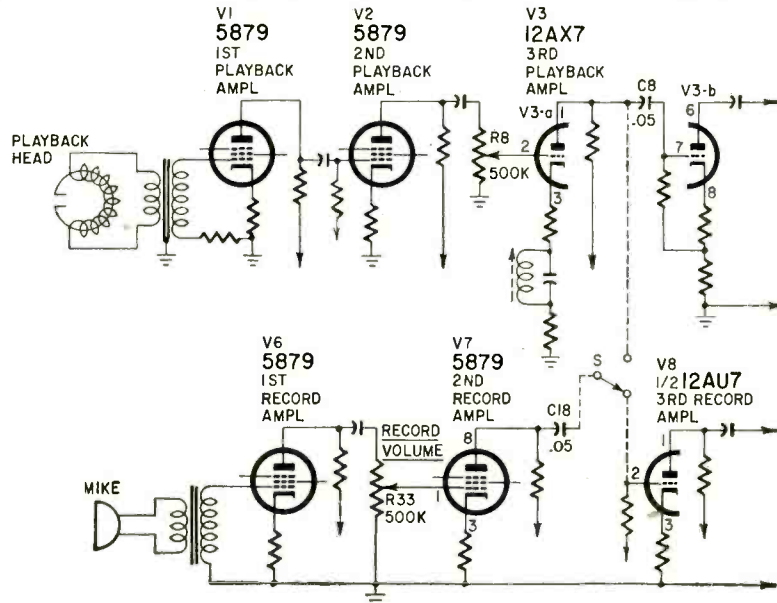

IT'S A TUBE! Not from your TV, but it works like those in your set. The tweezer-held object is two tiny titanium wafers separated by a ceramic spacer, with a vacuum in the middle. It is designed for operation at high temperatures (580°C) and is highly resistant to nuclear radiation. If 200 of these G-E tubes were used to build a computer they could be stacked in a space the size of a deck of playing cards.

CB RADIO CAN BE A PART OF YOUR CAR when you buy a new Ford, Mercury or Lincoln passenger car or a Ford truck. The optional unit is a 5-channel Raytheon Raytel transmitter-receiver that operates from either 6- or 12-volt batteries. It can also be used as a 117-volt set.

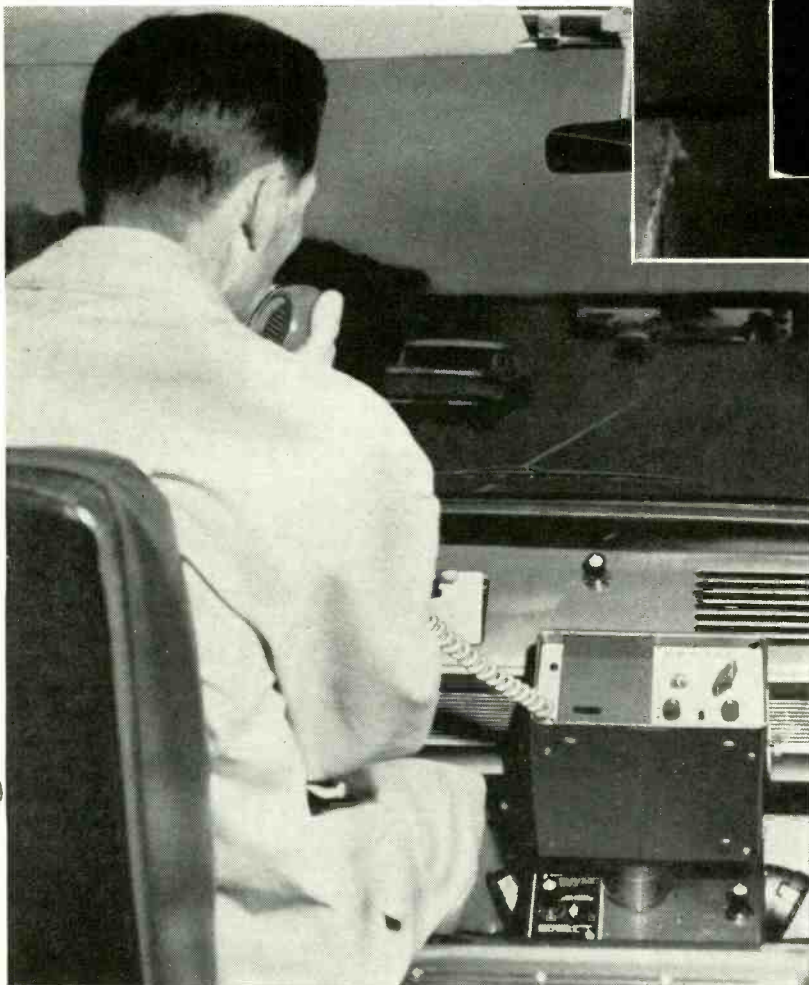

What's New

HIGH-INTENSITY RADIATION can be measured with a special solar cell and a milliammeter according to studies conducted by Dr. Walter Rosenzweig of Bell Telephone Labs. All you do is connect the cell to the meter. The current produced is the direct measure of radiation intensity. The solar cell is 10 to 15 times more resistant to radiation than ordinary types.

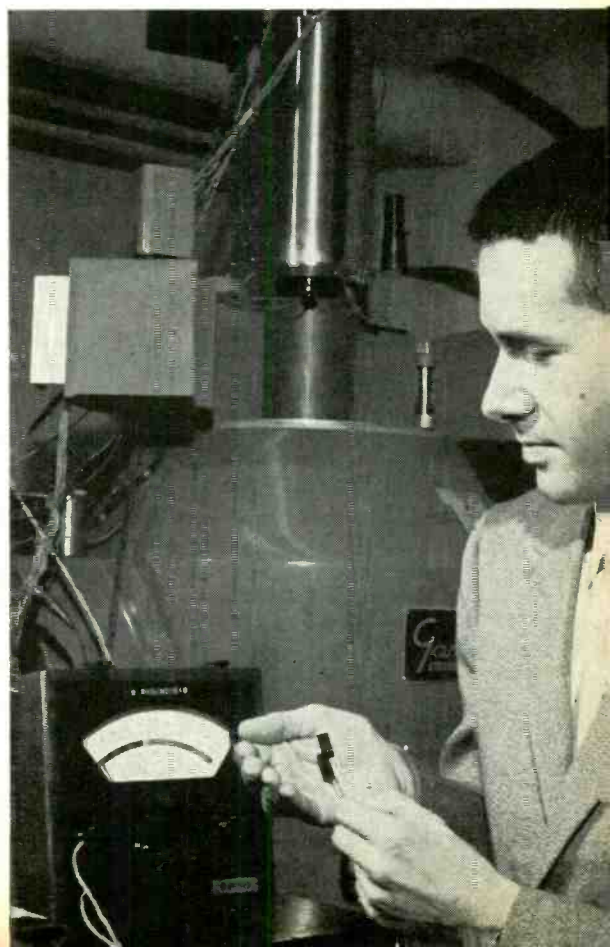

industrial handyman— the oscilloscope

By ROBERT G. MIDDLETON

Differential scopes, cyclograms and dc waveforms

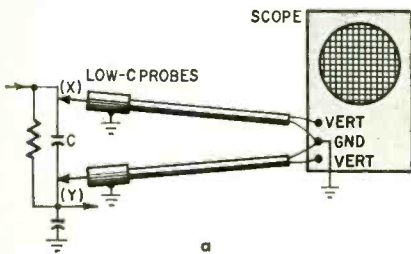
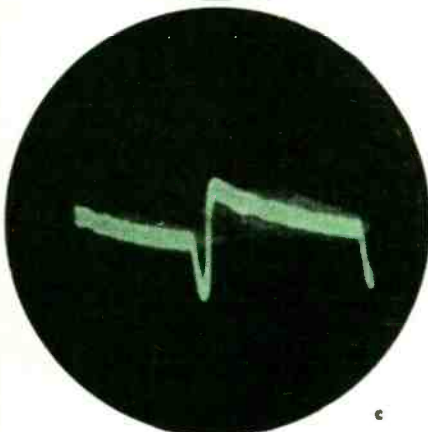
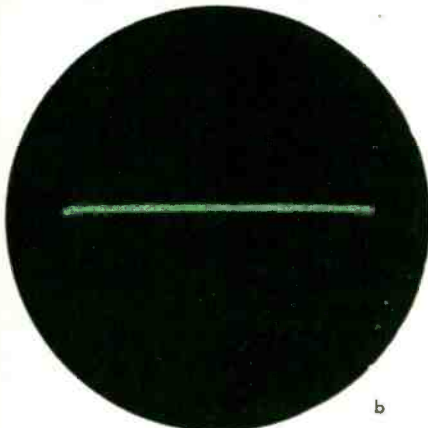

Fig. 1-a—Test setup to check ac voltage drop across capacitor C. b—When both probes are connected to X, a horizontal line is displayed on the scope screen. c—With one probe at X and the other at Y, the screen pattern shows the ac voltage drop across the capacitor.



THE DIFFERENTIAL SCOPE IS A WONDERFUL device for getting a picture of circuit action concerning a particular component. This is subject of the first part of this article. Then we go on to some cyclograms and show how they can be extremely valuable when servicing an electronic circuit. To wrap up the story we take a close look at dc waveforms and what they can tell us.

Differential-input scope patterns

Do not confuse cyclogram patterns with the patterns displayed by a differential-input scope. Cyclogram patterns are obtained by applying different input signals to the vertical and horizontal amplifiers of the scope. On the other hand, conventional patterns are obtained when different input signals are applied to the two vertical terminals of a differential-input scope (Fig. 1).

The only feature in common is that both types of patterns are developed by a pair of signal voltages. The basic difference is that a cyclogram is obtained by sweeping one signal voltage against another, while a differential pattern is obtained by displaying the difference between two signal voltages on a sawtooth time base.

Fig. 2—Scope test is made at cathode of tube. a—Normal cathode waveform. b—Waveform is distorted when capacitor is open.

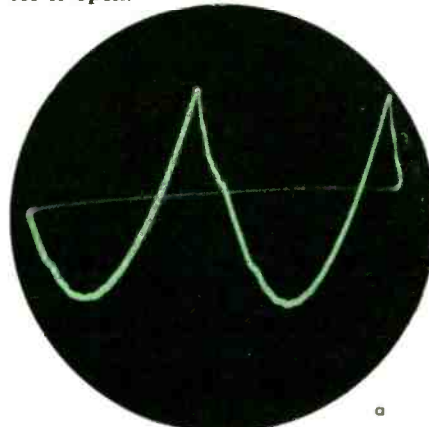

Just as a waveform has a fine structure which has practical importance, it has also a general structure that is equally important. Both considerations must be taken into account in practical waveform analysis. Note the two waveforms in Fig. 2. When the cathode-bypass capacitor operates normally, we see a parabolic type waveform at X in Fig. 2. If the bypass capacitor is open, a sawtooth type waveform is displayed.

The basic waveshape changes because the bypass capacitor has an integrating action in the circuit. It is an incomplete bypass. When a sawtooth wave is integrated, it is changed into a parabola. The tube's cathode is nearer ac ground when the bypass capacitor is normal. Thus, we find that the ac voltage at X triples when the capacitor is open.

Turning to the detail in the waveform, we see that there are small irregularities in the normal waveform (Fig. 2-a). They are caused by a ringing tendency in the plate circuit. The cathode supplies plate current, screen

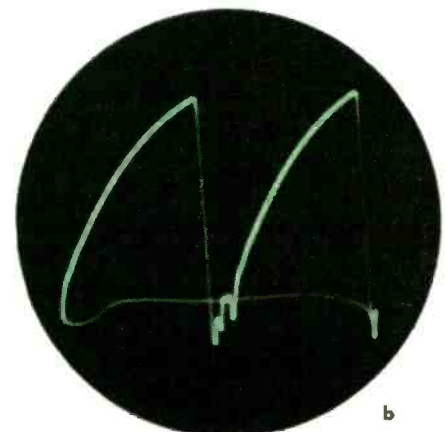
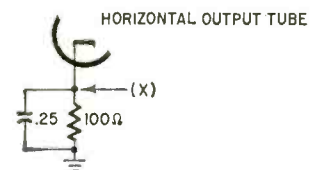



Fig. 3-a—Cyclogram with two basic excursions. b—Input waveform associated with cyclogram.

current and a small amount of control-grid current. Hence, if there is a residual ringing in the plate circuit, we will see it reflected in the cathode waveform. When the bypass capacitor is open, the circuit becomes more degenerative (has more negative feedback). In turn, the picture loses width, and the residual ringing in the plate circuit is largely suppressed (Fig. 2-b).

All forms of scope patterns have significant structure. We sometimes find cyclogram patterns which have two chief excursions (Fig. 3). One portion of the pattern partially or completely encloses the other. These patterns are made by input signals with different

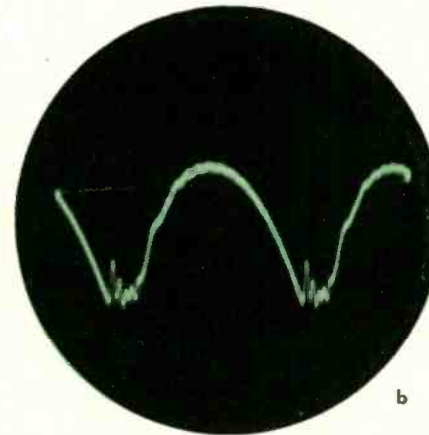
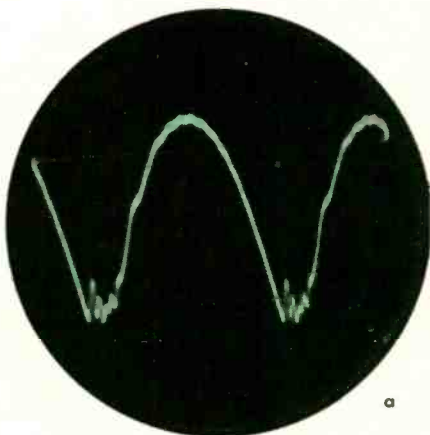

Fig. 4-a—Normal waveform across booster capacitor. b—Waveform when capacitor is leaky.

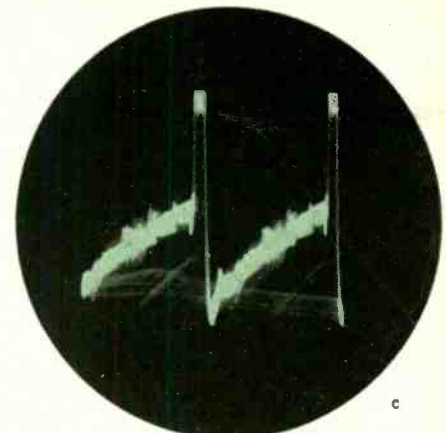
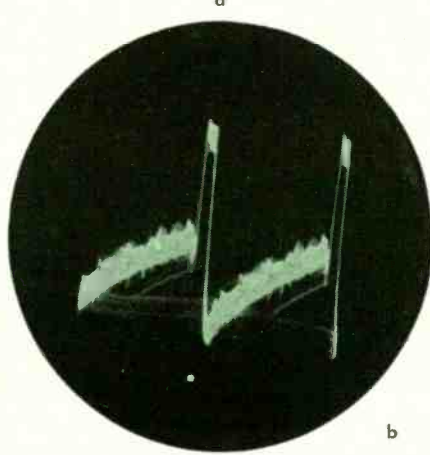
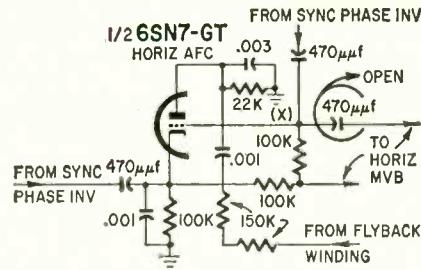

Fig. 5-a—Partial diagram of afc circuit. b—Normal waveform at X (grid of 6SN7) measures 4 volts, peak to peak. c—Abnormal waveform at X measures 8 volts peak to peak. The vertical gain control was reset to keep the pattern on the screen.

repetition intervals, or with an input signal which has successively different amplitudes.

The amplitude of a waveform is just as important as the waveshape. In some tests, it is the most important characteristic. Fig. 4-a shows the waveform across a normal capacitor in the booster circuit of a TV receiver compared with the waveform displayed when the capacitor is leaky (Fig. 4-b). The waveshape is practically the same, but the amplitude is reduced.

Fig. 5 is another practical example of waveform amplitudes. An open coupling capacitor to the horizontal multivibrator causes a very slight change in waveshape, but a large change in amplitude. This amplitude change is enough to disturb seriously the operation of the afc circuit. Thus we must never assume that waveshapes are more important than amplitudes.

We know that the peak-to-peak amplitude of a waveform is equal to the positive-peak amplitude plus the negative-peak amplitude. In complex waves, positive and negative peak am-

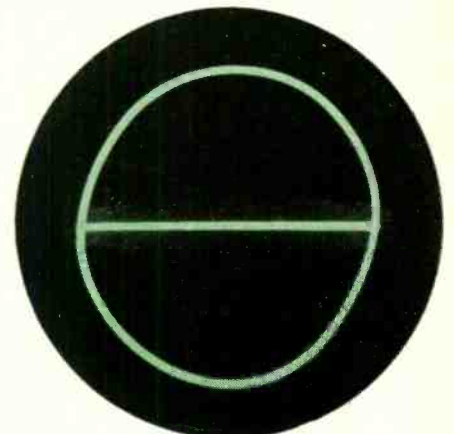

Fig. 6—The positive-peak voltage in the cyclogram equals the positive-peak voltage of the vertical-input signal.

plitudes are usually different. What is the situation in the case of a cyclogram pattern? Fig. 6 shows a simple cyclogram, with the beam-resting level indicated in the pattern. The positive-peak amplitude of the cyclogram is equal to the positive-peak voltage of the vertical-input signal. Likewise, the negative-peak amplitude of the cyclogram is equal to the negative-peak voltage of the vertical input signal.

The same principle can be used to measure the positive-peak and the negative-peak voltages of the horizontal-input signal if we locate the beam-resting position with the horizontal-input signal disconnected. In general, of course, we are more concerned with peak-to-peak amplitudes than with peak amplitudes.

DC waveforms

Till now, all the waveforms illustrated were ac waveforms. Any dc voltage at the test point was not represented in the scope pattern. We know that if we connect a battery across the vertical input terminals of an ac scope, the beam-resting position is unaltered. On the other hand, if we connect a positive dc voltage across the vertical input terminals of a dc scope, the beam-rest-

FOR YOUR VACATION-TIME

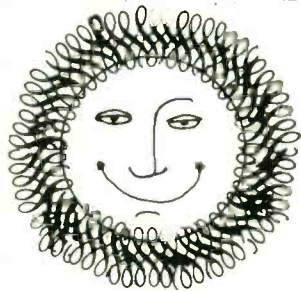

Building Crossover Networks

Build a speaker system or two for yourself with the help of simple crossover networks described in this article. You are provided with a practical example and all necessary calculations for various speaker impedances and crossover frequencies that makes the project easy.

Pilot: Where Am I?

Electronic Aid: Here!

Through a new Doppler navigation system, transoceanic air pilots are now instantly informed of their plane's location. The system cuts navigation problems, increases air travel safety.

An Electronic Vacation Suggestion

A description of a four-channel transmitter, companion to the R/C receiver described in the June issue. Four-tube circuit gives range and reliability to the transmitter, ideally suited for outdoor radio models.

Summer Reading Assignment

Ten tips to speed transistor servicing. How to apply old servicing tricks—and a few new ones. Keep on top of that American best-seller: the transistor radio. The article emphasizes practical ways to help you find transistor troubles faster.

Radio-Electronics

SPECIAL VACATION ISSUE
August Issue On Sale July 19

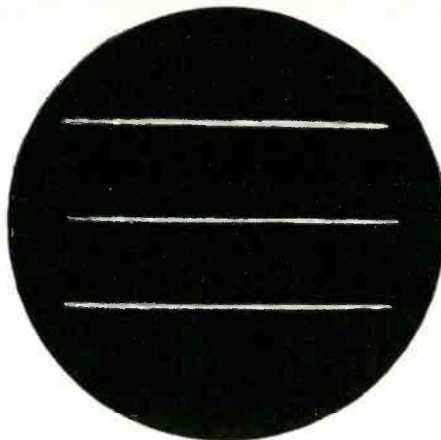

Fig. 7—The beam-resting level shifts if a dc voltage is applied to the input terminals of a dc scope.

ing position moves up (Fig. 7). If we connect a negative dc voltage, the beam-resting position moves down.

We find that there is a direct relationship between dc and peak-to-peak voltages. This is shown in Fig. 8. To put it another way, 1 volt dc causes the same shift in beam level as the spot excursion when a 1-volt peak-to-peak ac signal is applied. Thus, it is easy to calibrate a dc scope because a battery and dc voltmeter serve as an accurate calibrating source.

Suppose we check the output signal from a picture detector when the video signal is black? A dc scope shows a succession of sync pulses at black level, as in Fig. 9. However, the pulse pattern is *not* centered at the zero-volt level as with an ac scope. The dc scope displays a pattern which shifts vertically from the zero-volt level by an amount equal to the peak carrier voltage.

In other words, a dc scope can be used to measure the percentage modulation of an if signal, or rf signal. A dc scope is also very useful for checking clamp circuits (dc restorers) in radar or computer equipment. Some puzzling cases of sync buzz can be localized quickly by testing the ratio-detector circuits with a dc scope. A dc scope is also useful for setting up the service con-

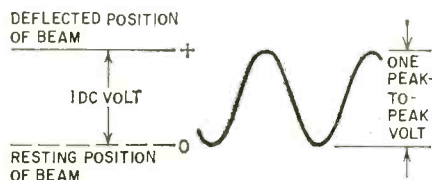

Fig. 8—Dc and peak-to-peak voltages are equivalent.

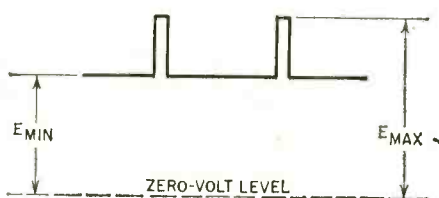

Fig. 9—Vertical shift of pulse pattern on dc scope screen shows peak carrier voltage and percentage of modulation (black video signal).

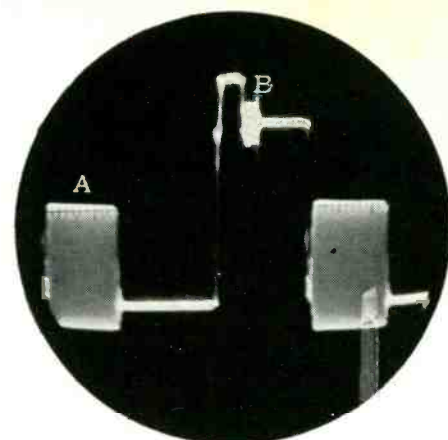

Fig. 10—The blue video signal output from one type of NTSC color-bar generator.

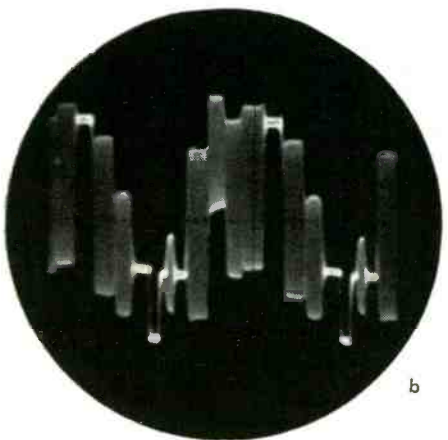
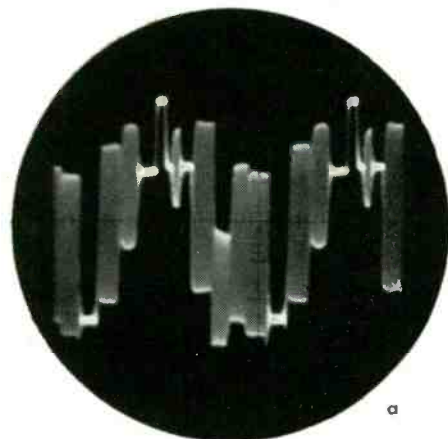
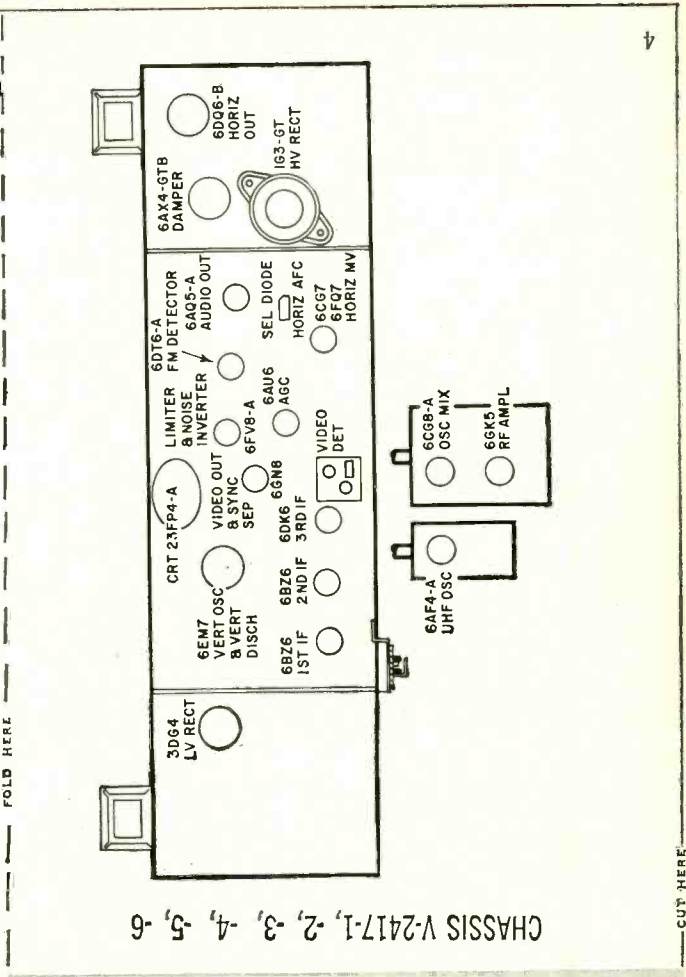
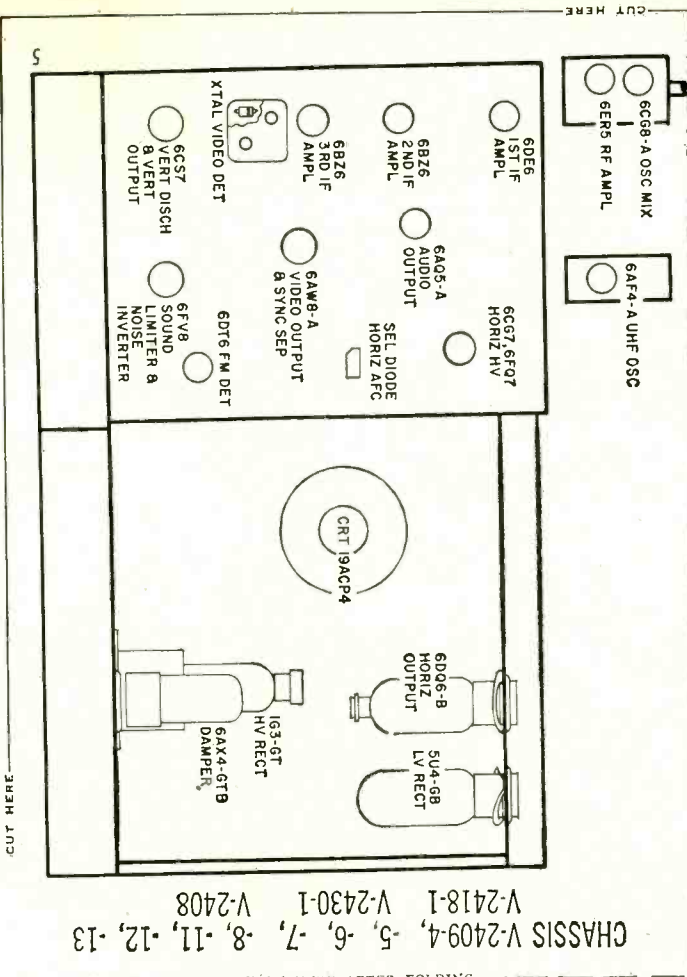

Fig. 11—Simultaneous video color-bar patterns in different polarities.

trols of color bar generators and test-pattern generators.

Fig. 10 shows the output from an NTSC type of color bar generator designed to supply one color bar or color-difference bar at a time. A is a color-bar signal (blue), and B is the burst signal. On the other hand, we see a simultaneous color-bar signal in Fig. 11. Fig. 11-a has positive-going sync, and Fig. 11-b has negative-going sync. A polarity switch in this type of generator switches signal polarity. This makes it possible to inject the video signal into any point of a Y amplifier or video amplifier. **END**



Mr. Service-Dealer:
 When You Install this TV
 Why do Half a Job...
 At Half the Profits?

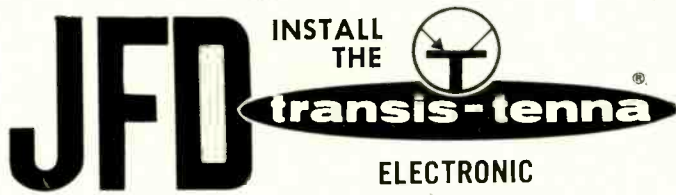

TV ANTENNA- AMPLIFIER-DISTRIBUTION SYSTEM!

- Delivers 800% more picture power to single set—black and white or color... FM, too.
 - Provides equal power to 2, 3 or 4 sets at highest signal-to-noise ratio.
- See the difference ... bank the difference in your profits.

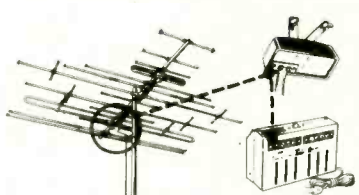

16 Transis-tenna systems to choose from assure you premium performance that suits any location. Write for Form #250. Better yet, see your JFD distributor today.

THE BRAND THAT PUTS YOU IN COMMAND OF THE MARKET
JFD ELECTRONICS CORPORATION
 6101 Sixteenth Avenue, Brooklyn 4, N.Y.

JULY, 1962

Radio-Electronics
**TUBE LAYOUTS
 IN TV SETS**

Compiled by Larry Steckler, Associate Editor

WESTINGHOUSE
 1961-1962

**HOW
 TO
 FOLD**

Fold the top down and back, keeping the cover facing you. Then trim the right and left edges. Now staple the booklet along the vertical center fold, about 3/4 inch from the top and bottom. Now fold from left to right, keeping the cover facing you. Trim a fraction of an inch off the top and trim the bottom to size and you're finished. You now have another useful piece of service data, exclusive with RADIO-ELECTRONICS.

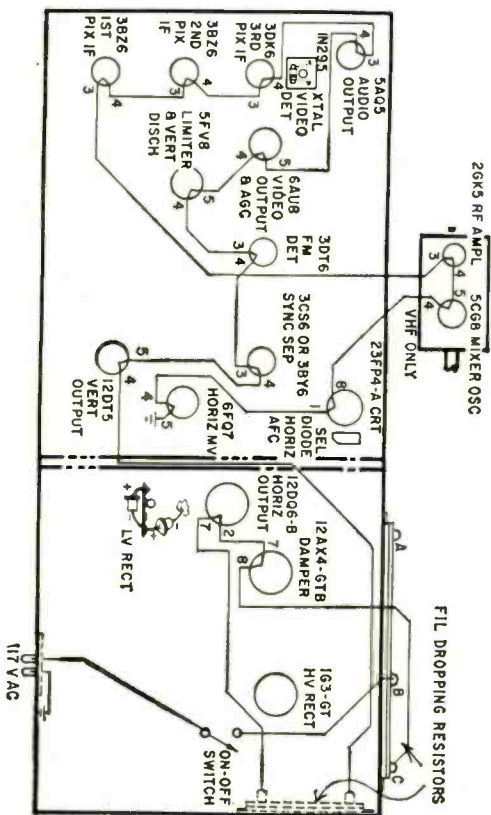

CHASSIS V-2414-3, 4

CHASSIS V-2414-3, 4

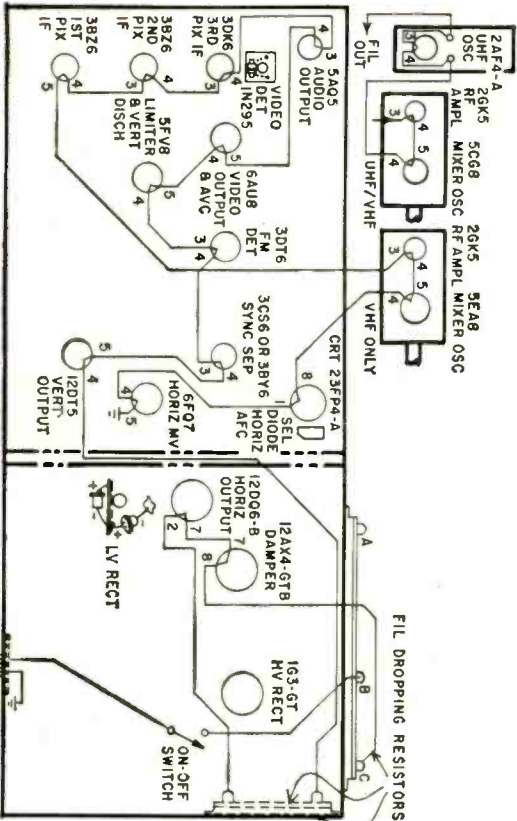

CHASSIS V-2416-1, 2, 3, 4, 5, 6, 7, 8, 9, 11, 12

CHASSIS V-2416-1, 2, 3, 4, 5, 6, 7, 8, 9, 11, 12

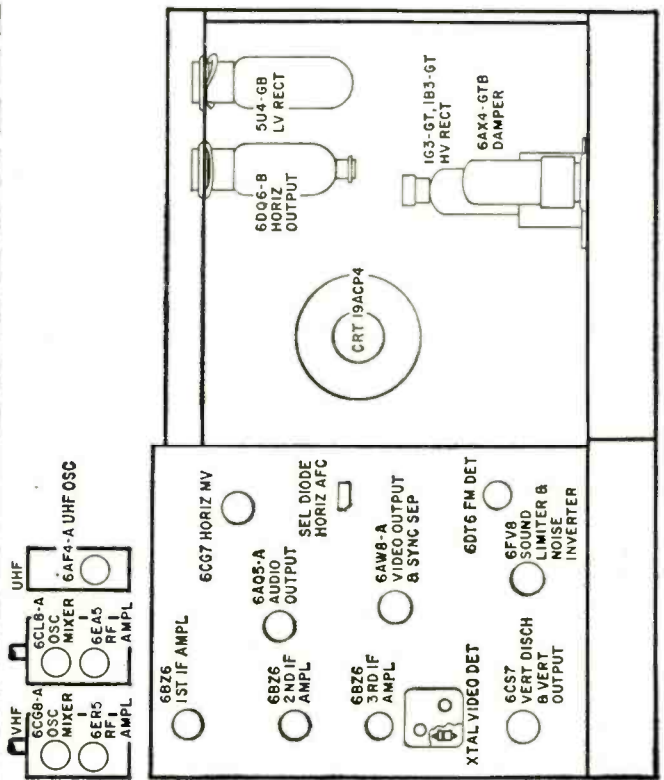

simple random-noise generator

You only need a capacitor, resistor and battery; but the capacitor is kind of special

By JEFFREY F. RASKIN

Simplicity has always been prized in electronics. Combining an Ultra-Kap capacitor, a resistor and a low-voltage dc source to get a random noise generator is simplicity in its most basic form. And the generator is extremely stable, is quite small, and requires little power. It produces frequencies throughout the audio spectrum at an average output level of 10 mv while the device draws only 1 ma at 4.5 volts.

Most of the work the electronic technician does with noise is with a view to eliminating it. So why should anyone want a noise generator? The answer is clear-cut. Noise is used in modern industry to test frequency response and wide-band characteristics of amplifiers and bandpass stages, to determine meter response parameters, and to find optimum levels for transmission in communications circuits. Other uses include cross-talk and intermodulation tests, reverberation testing of speaker enclosures, and simulating telephone line and interference noise.

After being amplified and fed to a suitable transducer, noise can be used to test attenuation of speaker enclosures, walls, and ducts; to examine other acoustic properties of materials and spaces, and for demonstration purposes. At really high levels, noise can

Fig. 1—Basic relaxation oscillator uses a neon lamp.
Fig. 2—Equivalent circuit of Ultra-Kap.

Fig. 3—Ultra-Kap random noise generator.
Fig. 4—Add a simple 1-transistor amplifier and you can hook up phones and listen to the noise generator at work.

be used for a structural testing (fatigue and other tests dependent upon vibration).

In the January 1961 issue of RADIO-ELECTRONICS, an article "Do You Know the Ultra-Kap?" appeared. The device is a tiny low-voltage miniature capacitor available in high capacitances. It is manufactured by Centralab. These components couldn't be tested with too high a voltage, because the leakage resistance drops drastically just above the working voltage. (At that time 3 or 10 volts; they've recently put out a 20-volt unit which has not been tested in noise-generator service.) A little experimenting showed resistance fell off slowly with increasing applied voltage and then became unstable just above rated working voltage. Any further voltage increase merely heats the component, making it unsuitable for further experiment.

The noise generator uses both the capacitance and high leakage properties of the Ultra-Kap simultaneously. Let's look at the circuit of Fig. 1, a neon-tube oscillator. The voltage builds up across capacitor C until it reaches the tube's firing voltage, E_f , at which point the lamp glows and conducts. The voltage (E_c) across the now shorted capacitor drops, and the process starts anew. This simplest of relaxation oscillators operates at some particular frequency because the lamp fires at the same time each cycle. If we could use a lamp whose firing voltage varied at random, we would have a noise generator.

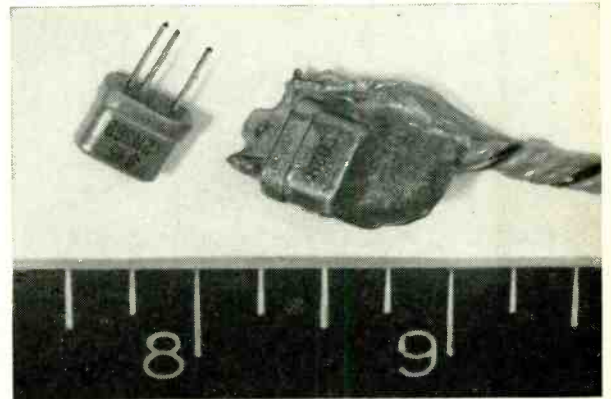

The completed generator with its transistor amplifier is tiny indeed.

Fig. 2 is the equivalent circuit for the Ultra-Kap. R1 is the series resistance; C, the marked capacitance; R2, the leakage resistance, which varies with voltage E_c . E_c rises until it reaches the firing voltage (E_f). Then R2 (which has been slowly decreasing) drops off rapidly. The voltage begins to build up until it again reaches an E_f , but not necessarily the same voltage as before. This causes the frequency of oscillation to vary. The amplitude of the resultant wave also varies.

Fig. 3 is the actual circuit. A wide range of resistance values will work for R. Try a 500,000-ohm pot for the 3-volt units and a 50,000-ohm pot for the 10-volt ones. If you want to listen to the noise, hook up a preamplifier such as that used with magnetic cartridges or build the simple device shown in Fig. 4.

We didn't run the generator's output through a wave analyzer, but on a wide-band scope it looked just like the output from a white-noise generator. We noticed that some units provided flatter output than others.

If components can be manufactured that have a stable resistance-applied-voltage characteristic or a fixed E_c , we should be seeing inexpensive and highly reliable voltage regulators and oscillators in the near future. It is occasionally possible (especially when the signal is fed into a tank circuit) to get the generator to oscillate at a fixed frequency, but much more work is required in this line. END

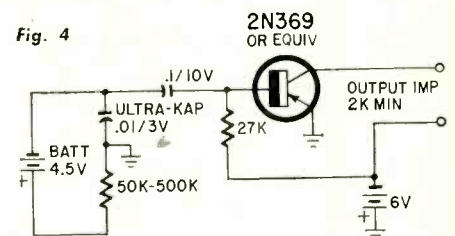
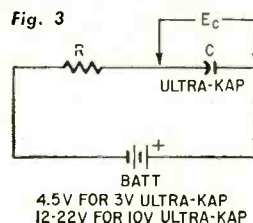
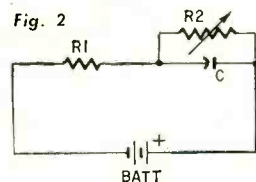
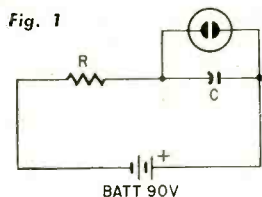

HOW TO HOLD UP A BROADCAST

Radio CJMS inserts a 6-second time delay in an audience-participation program.

By JEAN PROVOST*

CJMS RADIO MONTREAL DECIDED SOME time ago to let its listening audience comment on the station's daily editorials. The first few nights the program was on, it was indeed quite lively; in fact, much too lively for the peace of mind of the station's management. Some colorful listeners appeared more ready to use the program for humorous and other comments than for a serious and responsible discussion of the subject on the agenda. It was clearly necessary to be able to exercise some control over the opinions voiced over the telephone by listeners, before these opinions were transmitted. Yet the station was anxious to preserve the program's spontaneity and liveliness.

What was required, therefore, was a system which would give the program's moderator enough time to censor un-broadcastable off-taste and irrelevant comments before they went on the air, but which would not at the same time interfere with the telephone calls, and with handling them efficiently and systematically.

The problem was also somewhat sharpened by the fact that the studio operations at CJMS are fully automated, with the announcer entirely in charge of the console and of all the phases of broadcasting the program. In other words, there could not be any question of a system which would have required the announcer to rewind or rethread the mechanism, particularly in view of the length of the program, which could last up to 2 hours.

Finally, a 6-second-delay tape loop was tried on an Ampex with much success, without undue expenditure and without further difficulties either on the technical side or on the "censorship" level.

The following explanations are for the user of an Ampex 350 or 351 but, with minor modifications, can be adapted to any machine that uses independent heads for recording, erasing and reproducing.

Fig. 1 shows the machine in operation. It consists essentially of a loop which imposes no limit as to the time it can turn, and still leave enough tape for a supplementary period. The Ampex

operates at the slow, or $7\frac{1}{2}$ -ips, speed.

The main task involves the transposition of all the heads. In its original construction, an Ampex 350 (or its more recent development, Ampex 351) had its heads in the order shown in Fig. 2-a. From left to right, looking at the machine from the front as in Fig. 1, they are the erase, record and reproduce heads. To use the loop and form a 6-second time delay between the recording and the reproducing, the heads have to be placed as in Fig. 2-b. Starting from left to right again, they are found to be the reproduce, erase and record heads. This means complete realignment of all the heads.

The instruments needed are a few tools, an audio signal generator, a vtvm, a standard alignment tape and a tape with a tone recorded on a machine which was previously aligned. A noise and distortion analyzer is not necessary.

The cables and heads have to be

moved to their positions as in Fig. 2-b. This will require disconnecting the cables from the heads and then reconnecting them after the move has been made. The casing has to be moved along with the playback head on account of the shielding, which is important for that head. We suggest substituting the outer casings only, placing them in their new location upside down. This will allow free movement of the tape as before. New holes will have to be made to fix the casing in place. The old ones can be filled.

The proper heads are then placed in position, trying to have the tape follow the same path as before. This path was adopted by Ampex after the years of experience they are known for and surely gives the best results. The pressure and stability of the tape on the heads are obtained without pressure pads. Then, using a standard alignment tape, align the playback head by varying the depth, height and azimuth.

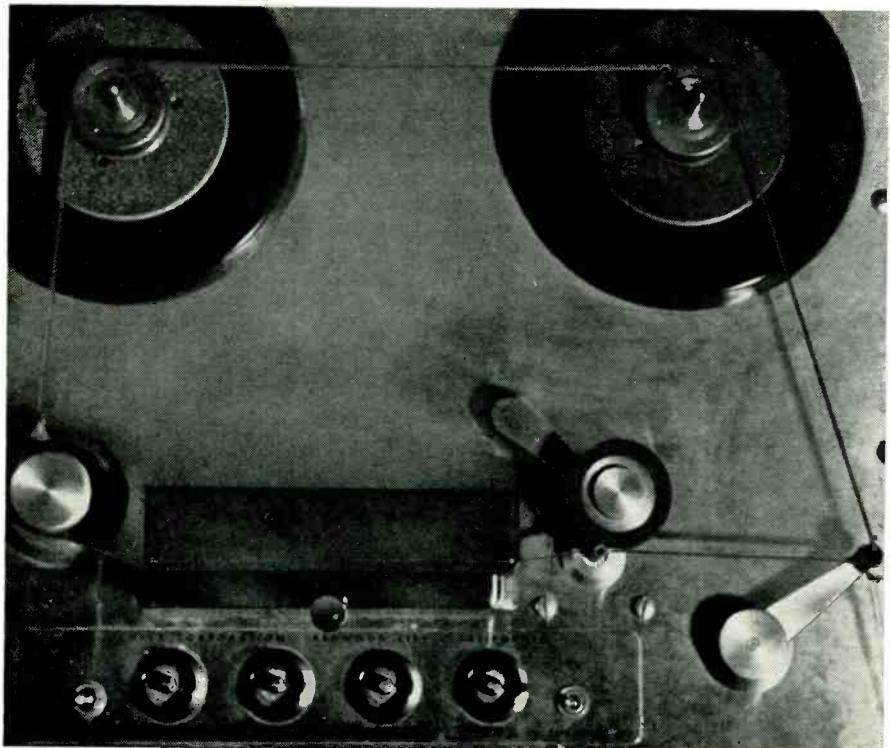
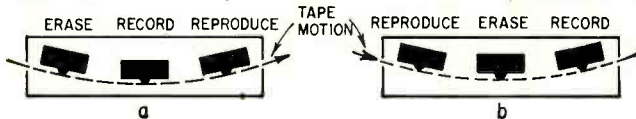

Fig 1—The 6-second time-delay loop in place.

*Engineer-in-chief, CJMS Radio, Montreal, Canada.

Fig. 2—How heads are rearranged for delay.



A standard alignment tape has different tones recorded to give known levels at reproduction. Those levels are given on the tape itself, and are obtained only when the playback head is perfectly aligned. The depth of the head affects the level and frequency response.

To align the erase head, place the previously recorded tape on the machine in the recording mode with the vtm connected at the output, the output switch being in the playback position. After having erased a known length, you have to rewind the tape and place the machine in the play mode to read the remaining signal on the vtm. Unfortunately, this head is not as easy to work on as the others but is not as critical. It is adjusted by varying its depth and height to read minimum noise on the vtm. For maximum results, the height must be made as uniform as possible along the head, as no azimuth adjustment is provided. An attenuation of 60 db between the signal and the remaining trace after erasing is very good as it includes also the noise of the instrument itself. This noise depends on the age of the tape.

Before starting to align the recording head, we need to work on the machine a little further. First, with an spst switch, cancel the voltage to the rewind and takeup motors as shown in Fig. 3. With these motors inactive, and brake solenoids energized in the PLAY mode, it becomes possible to loop the tape on regular reel hubs because the friction in the motion of the motors is very negligible. At CJMS Radio, we used a special type of ball bearing instead of the hubs, as minimum friction was desired.

The next step is a mechanical adjustment. Having no takeup or rewind tension, we needed a way to obtain the proper pressure of the tape on the heads. This was done by fastening a spring between a part adjacent to the tape deck and the takeup tension arm to pull the tape the required amount. This can be seen in Fig. 4. We now make a loop with a good splice and go on with the record-head alignment. Of course, this alignment doesn't go as fast as that on a regular machine on account of the delay. You align the recording head by varying the depth, height and azimuth, just like the playback head. This is done in the usual way, by observing the offset of the adjustment on the VU meter set in the playback position while having the machine in the recording mode. You have to remember, though, that these effects will be noted on the VU meter only 6 seconds after this adjustment is completed.

Fig. 3—Switch in dashed circle deactivates rewind and takeup motors.

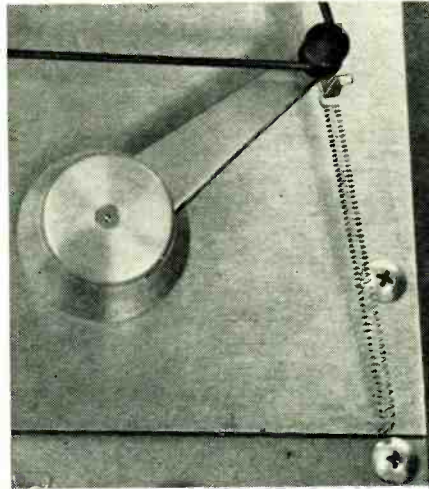
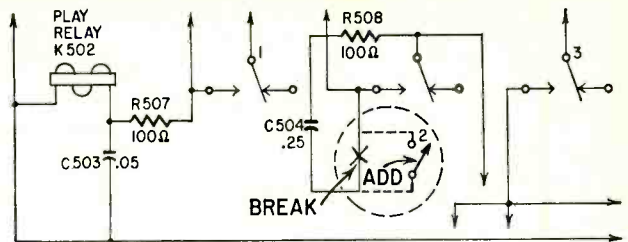

Fig. 4—Spring is adjusted to provide tape tension for proper pressure on head.

Once this is done, you have a machine which will give you a 6-second time delay between recording and playback when using a loop as in Fig. 1. By closing the spst switch, getting the spring off the takeup tension arm and threading a tape the regular way, the machine can be used for recording and reproducing just as before. The only difference in the operation is the fact that, while recording, the output in the playback position doesn't reproduce the recording being made but rather the previous recording on the tape, if any.

We have found it desirable at CJMS to start the machine some 5 minutes before and to stop it a little after the program. We have so far no record of a breakdown of this machine since the program started last October, although the program is heard 5 days a week for 2 hours each day. END

Oscilloscope Checks Flybacks

Shorted windings in flybacks, yokes and output transformers are easy to check with your scope. You need a sharp high-amplitude pulse to shock-excite the inductance under test. In the Heathkit IO-30, tap the pulse voltage off the plate of the retrace blanking amplifier (pin 6 or V5-b). Connect a 10- μ f 1,600-volt capacitor from pin 6 to an insulated terminal installed on the front panel, as shown in dashed lines in Fig. 1.

On scopes that do not have a retrace blanking amplifier, you can try the voltage at the plate of the horizontal oscillator. This works out well in the Heathkit OM-3 and Knight-Kit general-purpose 5-in scope. The 10- μ f capacitor goes to pin 5 of the 6AU6 horizontal oscillator (V3) in the Knight scope and to pin 1 of the 12AX7 in the OM-3.

To use the scope as an inductance or transformer checker, connect a jumper between the added insulated terminal (one end of the 10- μ f capacitor) and the scope's vertical input terminal. Connect the component under test between the vertical input and ground terminals on the scope. (For in-circuit tests, pull the receiver's ac plug from the line before connecting the scope.) Adjust the scope's horizontal frequency and horizontal and vertical gain controls to dis-

play a damped wave on the screen. The component is good if the waveform resembles Fig. 2-a; it is defective if the pattern looks like Fig. 2-b, and is completely shorted if you get a horizontal line as in Fig. 2-c.

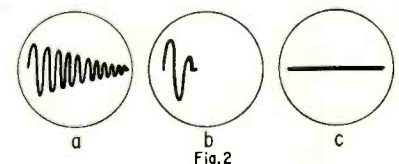
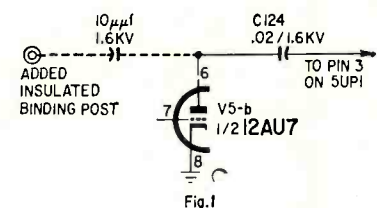

You can check the horizontal deflection system by removing the plate cap from the horizontal output tube. connect a probe from the vertical input terminal to the plate cap and another from the scope's ground to the set's B-minus bus. Patterns as in Fig. 2-b or -c indicate a short in the flyback, width coil or yoke.—E. L. Deschambault

CLASSROOM TRAINING COURSES IN
LOS ANGELES AND NEW YORK CITY

START YOUR CAREER IN ELECTRONICS NOW AT RCA INSTITUTES...

Choose from this list

	Course	Qualifications	Length of Course
A	Electronics Technology (T-3)	High School Grad, with Algebra, Geometry, Physics or Science	Day 2¼ yrs. (N.Y., L.A.) Eve. 6¾ yrs. (N.Y.)
B	Industrial and Communications Electronics (V-7)	2 yrs. High School with Algebra, Physics or Science	Day 1½ yrs. (N.Y., L.A.) Eve. 4½ yrs. (N.Y.) Eve. 3 yrs. (L.A.)
C	Electronics and Television Receivers (V-3)	2 yrs. High School with Algebra, Physics or Science	Day 9 mos. (N.Y., L.A.) Eve. 2¼ yrs. (N.Y.) Eve. 1½ yrs. (L.A.)
D	Radio Telegraph Operating (V-5)	2 yrs. High School with Algebra, Physics or Science	Day 9 mos. (N.Y.) Eve. 2¼ yrs. (N.Y.)
E	Electronic Drafting (V-11, V-12)	2 yrs. High School with Algebra, Physics or Science	Eve. Basic: 1 yr. (N.Y.) Advanced: 2 yrs. (N.Y.)
F	Automation Electronics (V-14)	Radio Receiver and Transistor Background	Sat. 44 wks. (N.Y.) Eve. 9 mos. (N.Y.)
G	Digital Computer Electronics (V-15)	Radio Receiver and Transistor Background	Sat. 32 wks. (N.Y.) Eve. 6 mos. (N.Y.)
H	Computer Programming (C-1)	College Grad. or Industry Sponsored	Sat. 32 wks. (N.Y.) Eve. 6 mos. (N.Y.)
I	Computer Programming (C-2)	Programming Experience	Sat. 16 wks. (N.Y.) Eve. 3 mos. (N.Y.)
J	Color Television	Television Background	Eve. 3 mos. (N.Y., L.A.)
K	Transistors	Radio Background	Eve. 3 mos. (N.Y., L.A.)
L	Technical Writing	Electronics Background	Eve. 3 mos. (N.Y.)
M	Technical Writing (V-10)	High School Graduate	Eve. 1½ yrs. (L.A.)
N	Preparatory (P-1)	1 yr. High School	Day 3 or 6 mos. (N.Y.) Day 3 mos. (L.A.)
O	Preparatory Mathematics (P-OA)	1 yr. High School	Eve. 3 mos. (N.Y.)

RCA Institutes is one of the largest technical institutes in the United States devoted exclusively to electronics. Free Placement Service. Applications now being accepted for next term classes in Los Angeles and New York.



The Most Trusted Name
in Electronics
RADIO CORPORATION OF AMERICA



Send to the school nearest you -

RCA Institutes, Inc. Dept. RER-72

Pacific Electric Building 350 West Fourth Street
610 S. Main St., L.A. 14, Calif. New York 14, New York

Please send me your FREE catalog. I am interested in the courses circled below.

A B C D E F G H I J K L M N O

Name _____ (please print)

Address _____

City _____ Zone _____ State _____

For Home Study Courses See Ad On Opposite Page

WHAT'S YOUR EQ?

It's stumper time again. Here are three little beauties that will give you a run for the money. They may look simple, but double-check your answers before you say you've solved them. For those that get stuck, or think that it just can't be done, see the answers next month. If you've got an interesting or unusual answer send it to us. We are getting so many letters we can't answer individual ones, but we'll print the more interesting solutions (the ones the original authors never thought of). Also, we're in the market for puzzles and will pay \$10 and up for each one accepted. Write EQ Editor, Radio-Electronics, 154 West 14th St., New York, N. Y.

For answers to last month's puzzle see page 70.

Delayed Switching

A high-power audio amplifier has separate power and standby switches. The problem is to devise a circuit using two pilot lights—no tubes, relays or other moving parts—to indicate when the filaments are hot enough to switch on the plus-B. (The pilot lights used were neons.)

—Juan L. Guthman

A Series Circuit

In the simple series circuit shown, a vtvm connected from ground to point A measures 86 volts. An ammeter with an internal resistance of 10 ohms reads 3 amperes when connected from ground to the same point. What is the ohmage of each resistor?—Sgt. R. M. Rasch

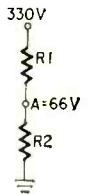

Resistance Network

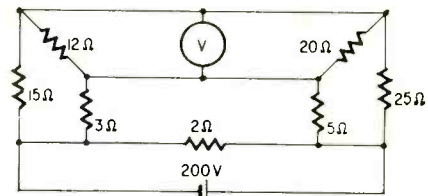

What does the voltmeter read?—John Capobianco



"Oops, sorry, Chief."

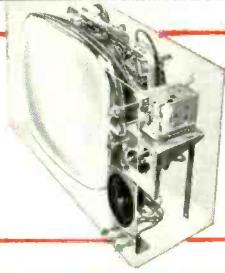

**TELEVISION
SERVICING**

**COLOR
TELEVISION**

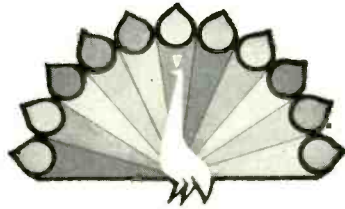

ELECTRONIC FUNDAMENTALS

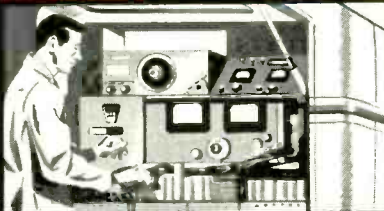

**COMMUNICATIONS
ELECTRONICS**

**RCA INSTITUTES
OFFERS A COMPLETE
SELECTION OF
HOME TRAINING
COURSES IN
ELECTRONICS**

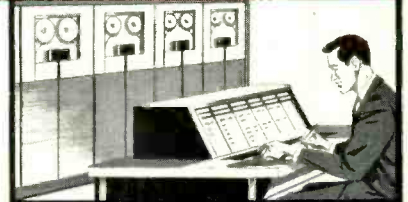

**COMPUTER
PROGRAMMING**



TRANSISTORS

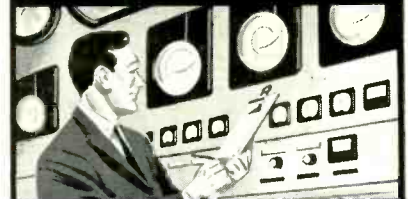

**AUTOMATION
ELECTRONICS**

Prepare yourself for an exciting and profitable career in electronics. You need no special technical background to start your training. Even if you do not have high school training, you can start your training at home under the guidance of RCA Institutes. Choose from RCA Institutes' wide selection of courses including Electronic Fundamentals, TV Servicing, Color TV, Communications Electronics, Automation Electronics, Computer Programming, Transistors. Practical work starts with the very first lesson. You get

prime quality equipment that you keep and can later use on the job. You never have to take apart one piece of equipment to build another. Perhaps most important, RCA's liberal Voluntary Tuition Plan is the most economical home study method because you pay only for lessons as you order them. If you should interrupt your training at any time, you do not owe one cent. No other obligations. No installment payments required! Licensed by the New York State Department of Education. Approved for Veterans.

Act today! Send for this 64-page career book FREE!

CLASSROOM TRAINING

Classroom Training in New York City and Los Angeles. Day and Evening Classes start four times a year. In addition, Radio Corporation of America offers a limited number of basic courses in Chicago, Philadelphia, and Cherry Hill, N. J. (near Camden). Detailed information on request.

To save time, paste coupon on postcard

RCA INSTITUTES, INC. Dept. RE-72

A Service of the Radio Corporation of America
350 West 4th St., New York 14, N. Y.

Please rush me your FREE illustrated 64-page book describing your home training programs. No obligation. No salesman will call.

Name _____ Age _____
(please print)

Address _____

City _____ Zone _____ State _____

CANADIANS—Take advantage of these same RCA courses at no additional cost. No postage, no customs, no delay. Send coupon to: RCA Victor Company, Ltd., 5581 Royalmount Ave., Montreal 9, Quebec

RCA INSTITUTES, INC. Dept. RE-72

A Service of the Radio Corporation of America
350 W. 4th Street, New York 14, N. Y.
610 S. Main St., Los Angeles 14, Calif.



The Most Trusted Name in Electronics

SERVICE CLINIC

By JACK DARR
SERVICE EDITOR

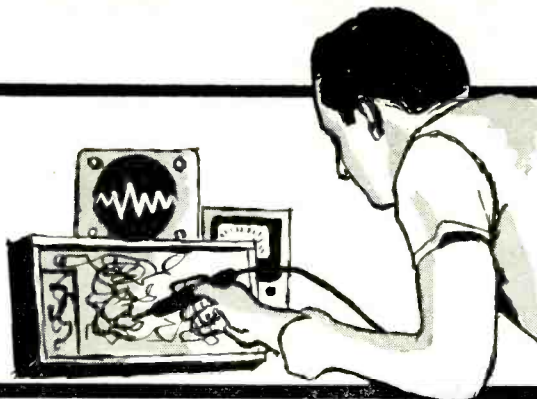

This column is for your service questions. We answer them free of charge and your name and address will be kept confidential if you wish. The main purpose is to help those working in electronics with their problems.

We've changed our target a little and are no longer restricted to TV. Radio, audio and industrial electronics problems are also grist for the mill. All letters get a prompt individual answer and the more interesting ones will be printed here. So if you have a service problem, send it here. We'll do our very best to help you solve it.

WE CAN USE SEVERAL TRICKS TO IDENTIFY that orphan TV set—the one with no name (or one we never heard of), no model number and no label. Somebody made the thing, *somewhere*, and we must have run across the same set in the past under another name.

So, the first thing we do is look for part numbers on the larger components—flyback, tuner, vertical output transformer, power transformer, speaker. The characteristics of the part numbers will often give us a good clue. Most manufacturers tend to keep the same system of part numbering for many years. One will tend to use long numbers, with as many as 10 or 12 digits. Others use a couple of numbers, then a couple of letters, then more numbers. Others use a key prefix.

Most of these troublesome-to-identify chassis were made by some well known manufacturer for a sales outlet under its name, not his own. However, the part numbering usually stays the same.

The most helpful thing you can have is an assortment of catalogs. You can get them, free, at your distributor's store—transformer catalogs, volume-control catalogs, flyback catalogs, and on and on. Get the ones which list as many parts as possible, all in a row under a given model or chassis number. These will give the original part number, with the replacement part number below it in the same box.

So, to check out your orphan, make an educated guess as to what make or makes it could be, and start looking through the catalog for part numbers on one large part, say, the flyback. When you find this, start checking the rest of the parts numbers against those given for that chassis. When you get about a 75% agreement, you're getting close. In severe cases, you can often look up this set, and find the circuit you need, say the horizontal or vertical output, even though the rest of the set

won't match up. Circuits, especially those named, tend to be carried over from year to year, especially in the older models.

Good hunting!

Record out the scratch

I have a large collection of 78-rpm records, including some irreplaceable music. I'd like to transfer these to tape,

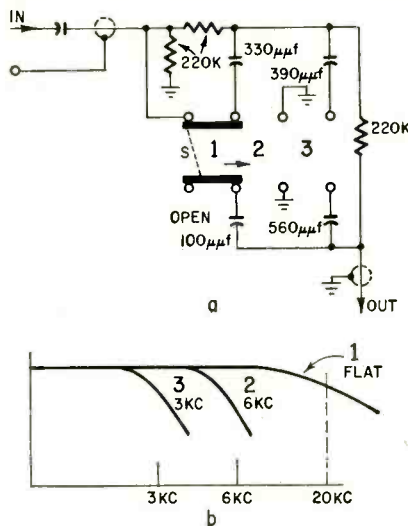

Fig. 1—When taping old 78-rpm discs with a lot of surface noise, you may find this filter handy.

to save the records and the music too. While doing this, I'd like to do something to reduce the surface noise and scratch.—W. L.—Chicago, Ill.

This should be fairly easy. Simply feed the output of your 78-rpm cartridge or a very good hi-fi amplifier into the input of a tape recorder. You can feed the "tape output" signal into the high-impedance input of the tape recorder, or, if the recorder happens to have a 500-ohm input (for low-impedance microphones), feed the 500-ohm output of the amplifier directly to this.

You can eliminate the scratch with a "high-cut" filter. Many hi-fi amplifiers have a high-cut tone control which will give good results. Or you

can hook up the circuit shown in Fig. 1, shield it with a tin can, and connect it between the cartridge and amplifier, or between amplifier and tape recorder. It will take out most of the scratch. In many cases, you can re-record and get a slight reduction in scratch each time. The recording companies have done this on some of their old shellac records and wound up with a very clean recording for LP's.

Vertical instability

An old Zenith, model 24H21, is resisting all my efforts toward getting vertical stability. All tubes have been replaced, also the integrator and all capacitors around the vertical oscillator.—E. J., Long Island City, N. Y.

This is a chassis with the picture-size switch which increased the size of the picture vertically. I believe you're going to find this trouble somewhere around that switch. We had quite a bit of trouble with it along that line. Leakage across the switch contacts and dirty contacts gave the same trouble. If the switch is bad, it can be cut out of the circuit entirely.

Also, you'll note the extra transformer (an inductor, really) between the vertical output transformer and the yoke. Check both this and the vertical output transformer for electrolytic damage, such as high, intermittent leakage to ground from the windings.

As an additional check, use a scope on the B-plus lines feeding the vertical oscillator. Look for signs of vertical pulses. If they are there, add capacitance until they disappear.

Too much signal

My service area is pretty close to two powerful stations. I have quite a bit of trouble with color sets in getting the picture to stay in color, and so on. Some of them develop sound buzz (both black-and-white and color) and things like that.—J. B.—Oak Park, Mich.

Your main trouble here is *too much* signal. A very strong signal can cause distortion or even cancellation of color, buzz and a lot of other things. Your only cure is to reduce the signal level applied to the tuner input. The easiest way to do this is with simple resistive pads. Fig. 2 shows some typical values.

If the set is really close—that is,

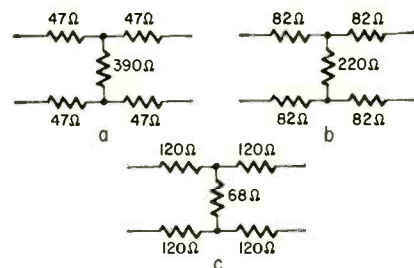

Fig. 2—Three pads for use when the incoming TV signal is too strong: a—6-db attenuation; half of voltage input at output. b—10-db attenuation; a third of voltage input at output. c—20 db attenuation; a tenth of voltage input at output.

within a couple of miles of a 100-kw station, you may even have to eliminate the antenna altogether. Try a short piece of Twin-Lead or even a piece of single wire. Another suggestion that has helped in similar cases is using shielded 300-ohm Twin-Lead between the pad and the tuner input. Build the pad inside a small shield can to reduce pickup. Any kind of tin can will do, as long as it's not too small.

Audio distortion

As the volume control of a Sentinel U74-02AA TV is advanced, the audio gets more and more distorted. The voltage on plate and screen of the 12L6 audio output is 40 volts low; on the grid, it's high. Everything else seems to be about normal.—M. J. K., Evansville, Ind.

This trouble is common, not to this set alone, but to all sets using this particular circuit. Look at Fig. 3. Notice that the source of the 135-volt line is the cathode of the 12L6 audio output tube. Any upsetting of the

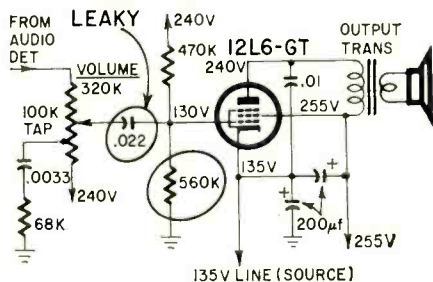

Fig. 3—This circuit produced increasing audio distortion as the volume control was turned up.

operating voltages would not only cause audio trouble, but many other difficulties as well, by upsetting the 135-volt line.

Here it looks as if you've got just a slight leakage in the coupling capacitor, the .022- μ f between the volume control and the 12L6 grid. I say this because your voltage readings show the grid to be more positive than it should be.

Note the voltage divider in the grid circuit of the 12L6. I have drawn it this way for clarity. Change in value of either the 560,000-ohm or the 470,000-ohm resistor will also cause trouble here as the grid bias depends on the ratio of these two resistors. If the 560,000-ohm unit to ground opens completely, you'll get some very peculiar results, too.

So check those capacitors and resistors, and you'll probably pin it down somewhere in that circuit. It would also be wise to check the two 200- μ f electrolytics between the 255-volt line, cathode and ground.

Horizontal pulling

There is just enough horizontal pulling in a G-E TV set to be annoying. The set uses a Hartley oscillator, with a reactance tube and triode afc. It is definitely picture pulling and not raster pulling. I think it's in the video amplifier, but everything checks out OK.—G. B., Hoisington, Kans.

Although you neglected to give me the model number of this set, from the

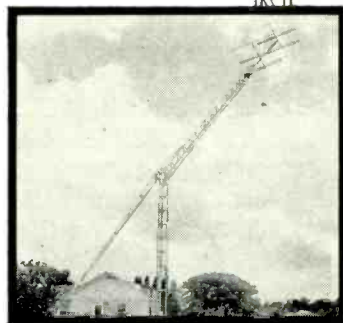
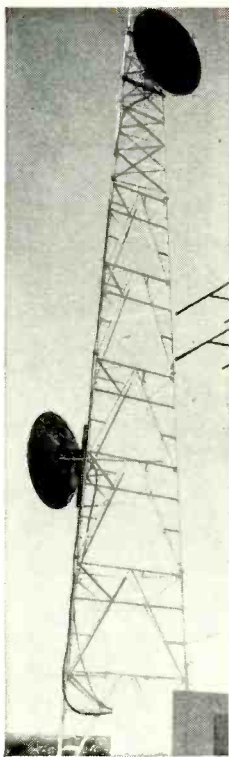

The most Famous Name in TOWERS of ALL KINDS!

Here are the advantages you get when you insist on ROHN TOWERS

LARGEST FULL RANGE OF TOWERS—you can get anything from home TV and amateur radio towers to heavy-duty communication and micro-wave towers. Included are 170 foot self-supporting towers, 1,000 foot guyed towers, and "fold-over" towers. Regardless of your needs, ROHN can supply it.

UNQUESTIONED LEADERSHIP IN DESIGN AND MANUFACTURE—you get the latest in advanced tower engineering. All communication towers are engineered to EIA specifications, and are proved by thousands of installations. No other manufacturer can surpass the quality and fine reputation of ROHN.

QUALITY MATERIALS AND WORKMANSHIP—Only highest quality steel is used which fully meets the specifications for the job. ROHN towers are hot-dipped galvanized after fabrication—a feature ROHN pioneered!

SERVICE WHEREVER YOU WANT IT—ROHN representatives are world-wide. Complete erection service for communication systems, broadcasting, micro-wave, and other needs is available; also competent engineering service to help you.

Settle for the **BEST** in TOWERS—ROHN—today the world's largest, exclusive manufacturer of towers of all kinds!

For your needs, contact your local ROHN salesman, distributor or dealer; or write direct for information.

SEND THE HANDY COUPON INDICATING YOUR NEEDS

ROHN
Manufacturing
Company
BOX 2000
PEORIA, ILLINOIS

ROHN Manufacturing Company
Box 2000
Peoria, Illinois

Send me complete literature on the following ROHN Products:

- | | |
|---|--|
| <input type="checkbox"/> Home TV Towers | <input type="checkbox"/> Amateur Towers |
| <input type="checkbox"/> Communication Towers | <input type="checkbox"/> AM-FM Broadcasting Towers |
| <input type="checkbox"/> Micro-Wave Towers | <input type="checkbox"/> Government |

Name _____
Firm _____
Address _____
City _____ State _____

GM-JR. EXECUTIVE 4 TRANSISTOR MINIATURE TAPE RECORDER

- Quality Engineered for Peak Performance
- Single Knob Operation
- Operates Anywhere Open or Closed

COMPLETE OUT-FIT: Microphone, Earphone, Batteries, Tape Reels, Carry Strap.
New Low Price
\$29.95

600' reel of tape for double recording time
Postage paid in continental U.S.

\$1.49

Write for FREE Catalog Dept. 19F-RE

GM PHOTOELECTRONICS
623 So. Gay Street Knoxville 2, Tenn.

fix ELECTRIC APPLIANCES \$3 TO \$5 AN HOUR

FREE BOOK tells about it. Our complete, easy profitable spare-time or course trains you for top full-time business that earnings. At no extra pays \$3-\$5 hour—right at charge you get time-sav- home! 400 MILLION Ap- ing Appliance Tester. Get- pliances now in use. Peo- FREE Book, FREE Sam- ple need them fixed. YOU ple Lesson! Mail coupon make good money doing NOW.

NATIONAL RADIO INSTITUTE, Appliance Div.
Dept. FG-2, Washington 16, D.C.

Send FREE Book, FREE Appliance Repair Course Lesson.

Name _____
Address _____
City _____ Zone _____ State _____

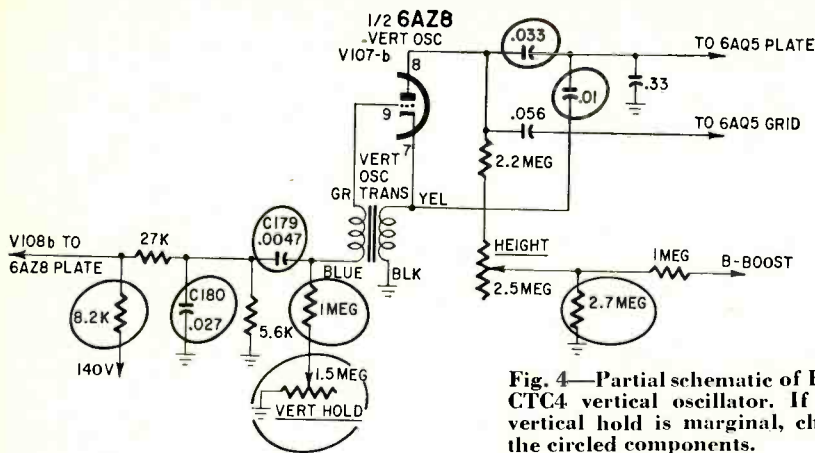

Fig. 4—Partial schematic of RCA CTC4 vertical oscillator. If the vertical hold is marginal, check the circled components.

circuit description it should be somewhere along about the old E-series.

Most of this trouble comes from defective electrolytic capacitors and I believe that's where you'll find this one. Use your scope on the B-plus lines around the horizontal oscillator. See if there is any trace of horizontal pulse energy on them. If there is, check all electrolytics anywhere near that point.

Another frequent cause of this is drift in the value of resistors in the horizontal oscillator and afc circuits. This is especially true of plate load resistors in the horizontal oscillator. If they drift, they cause the time constant of the R-C network to change.

Vertical roll

I'm having trouble with an RCA color TV set, a CTC4. The vertical hold is very weak. It will hold momentarily, but a change in picture or a commercial will start it rolling again. All tubes have been changed and the capacitors in the vertical oscillator circuits checked. Any suggestions would be appreciated.—J. B., Pennsauken, N. J.

The vertical hold in this chassis is normally weak. The picture does not have the decided snap that some others do. However, it will hold a picture steady if it is in good shape.

You might try changing the first video if-vertical oscillator 6AZ8 again. Some of these tubes are slightly critical in this circuit. Check the amplitude of the vertical sync pulses on the oscillator input, the blue wire. Also, measure the 1-megohm resistor and the vertical hold control. Both of these have given trouble in the past (Fig. 4).

Check the plate load resistors on the triode section of the 6AZ8 too. Also, if the .027- μ f C180 or the .0047- μ f C179 is even slightly leaky, it will play hob with your vertical sync.

One more possibility (This is a frequent occurrence): Check the settings of the noise-canceller control. It's part of a dual pot. I've had trouble with its inside shaft turning when the outer shaft (the color killer) is turned. If the canceller control should happen to be moved down to the point where it is just barely clipping sync, you've got troubles.

The same thing can happen to the age control. If it turns when it shouldn't, you'll lose contrast and, to

some extent sync. While you are around there, check the plate load resistors, coupling capacitors, and the tube on the noise canceller. All can cause trouble along the same line. Check the action of the canceller by turning the control to see if it reacts normally. It should clip sync and cause the picture to fall out somewhere near the middle of its range.

Disappearing raster

I have a problem with a Packard-Bell 88S1 TV. The complaint is loss of raster, with a loud singing sound from the flyback, after the set has been on for about an hour. It can be cured by turning the set off for a minute.

The same symptoms can be induced by turning the horizontal frequency slug all the way out, by shorting the coil momentarily, or by grounding the grid of the 6CG7.—T. L., Compton, Calif.

Your trouble here is due to marginal operation of the horizontal oscillator. Its adjustments are probably set right on the edge of its operating range, instead of centered. Thus, normal thermal drift pulls the oscillator frequency, and it falls out at a sudden shock of any kind. Of course, you could also have a heat-sensitive component in some of the R-C networks or the transformer itself. Try heating some of the resistors with a soldering iron to see if they cause a change in frequency. Run a complete realignment of the horizontal oscillator, being careful to set the adjustments in the center of their range and try it again.

5Y3 furnaces

I am working on a Philco 50-T1632. Problem: no sound, no picture. First thing I noticed was a blown fuse. A replacement did not last long. A larger fuse made the 5Y3 rectifiers glow like small furnaces. The filter chokes got too hot to touch and the parasitic suppressor melted its wax.

When the yoke and focus-coil plug is pulled, the sound returns and the chokes cool off.—E. J. A., Villa Park, Ill.

From the description, I'd say you have a big fat short somewhere. This will be in the B-plus circuit and past the yoke plug. Removing the plug clears the short as the focus coil is in the negative leg of the B-supply.

Make a careful ohmmeter check from the yoke plug onward. If this fails to show anything, disconnect the various components (yoke, focus coil, etc.) one at a time until the short is cleared.

A likely location for this trouble, if I remember this series correctly, is in or around the damper tube and its circuits. A 5V4 damper is used with an insulated heater winding on the transformer. A heater-cathode short in the tube would have no effect as they are tied together. However, if the heater winding on the transformer develops a leakage to ground, it would blow the fuse.

One important thing on this type of trouble is the time constant of the short. If the rectifier tubes show red (on their plates) just as soon as the B-plus voltage comes up to normal (?), the trouble is in the B-plus circuit. If the short takes quite a while to show up (that is, several seconds after the B-plus voltage has come up), then it is most likely to be somewhere past the horizontal output tube—in the damper, yoke and associated circuits. The 5Y3's heat much faster than the damper, horizontal output, oscillator, etc. If your B-plus rises to normal value, then drops rapidly, check for a grounded yoke, shorted damper tube, shorted capacitor in or around the boost circuit, grounded damper heater winding or a short between windings in the yoke. Inasmuch as you can get sound when the yoke is disconnected, I'd be inclined to predict that this one will be found somewhere in the boost circuit. END

Sleeplearning

(Continued from page 29)

when particular EEG (electroencephalograph) patterns associated with arousal occurred, the few remaining items answered correctly could be explained on the basis of reminiscence, correct guessing, and possible EEG misclassification. Data is presented to support this. Learning during real sleep is concluded to be impractical and probably impossible. The possibility of utilizing the drowsy state where material is retained is discussed."

It should be noted here that the Rand researchers investigated only audio sleep-learning. What other methods are there? There may be many others in the future.

The author revealed a plausible one in his editorial, "Superception," in the April 1960 issue of RADIO-ELECTRONICS. It reports the work done at the University of California at Los Angeles in which electric currents were induced in the brain, just as they are induced in regulation transformer coils. Such brain conductivity had been noted by Norwegian technicians. They "saw" bluish-white flickerings whenever they were near large choke coils at their plant. If the correct current impulses and intensities can now be impressed inductively on the brain, it becomes possible to transmit radio and TV programs directly to our audio and optical nerve centers via superception, while we are awake or asleep.

—H. G.

LAFAYETTE

AMERICA'S VALUE LEADER

HI-FI · AMATEUR · CB · RADIO

"WORLD FAMOUS" HE-29B 10-TRANSISTOR CITIZENS BAND

"WALKIE TALKIE"



39⁹⁵

NO MONEY DOWN

SET OF 2 78.88

- Transmits & Receives up to 2 miles
- Crystal Controlled on Both Transmit & Receive
- Push-to-Talk Operation
- 46" Telescoping Antenna
- Earphone For Personal Listening
- Leather Case with Shoulder Strap

Ideal for Sportsmen — Boating — Fishing — Camping

Now Lafayette has done it again. The world Famous HE-29 has been further improved. Packed with power, 10 handpicked transistors plus 1 diode extend the range of the HE-29B up to two miles under average conditions i.e., no intervening obstructions.

No license or permit required. Compact, pocket size unit provides complete portable two way communications. Transmitter section is crystal controlled. Crisp, clear reception is furnished by the efficient superheterodyne receiver. Power is supplied by 8 miniature standard penlight batteries with a life expectancy of up to 50 hours.

Housed in a handsome black and chrome case. Supplied with leather carrying case w/shoulder strap, earphone, antenna, batteries and crystals for channel 10. Size: 6 $\frac{3}{8}$ x3 $\frac{3}{4}$ x1 $\frac{1}{2}$ ". Shpg. wt., 3 lbs.

HE-29B1 Net 39.95
Set of 2 Net 78.88

NEW! LAFAYETTE HE-20C CLASS D Deluxe CITIZENS BAND TRANSCEIVER



109⁵⁰

NO MONEY DOWN

NOW WITH These ADDED FEATURES

- 8 Crystal — Control Receive Positions
- 8 Crystal — Control Transmit Positions
- Built-in 12 Volt Power Supply
- Efficient Pi-Network
- Improved Series Gate — Noise Limiter
- 14 Tube Performance — 3 Diodes
- Complete with crystals for Channel 9

Quality engineering, design, and features give this Deluxe transceiver a place all-its-own in the Citizens Band Field. Operating within the limits prescribed by the FCC, the HE-20B supplies you with a highly efficient 2-way radio-telephone communications system from your office, truck, auto, boat, store, home, etc. Size 12x5x8 $\frac{1}{2}$ ". Shpg. wt., 14 lbs.

HE-20CW 109.50

NEW LAFAYETTE 2-SPEED STEREO PLAYBACK TAPE DECK



59⁵⁰

NO MONEY DOWN

- Dual NARTB Equalized Transistor Preamps
- Frequency Response: 50-15,000 CPS @ 7 $\frac{1}{2}$ ips
- Plays back: $\frac{1}{4}$ & $\frac{1}{2}$ Track Stereo; $\frac{1}{2}$ Track & Full Track Monaural

Now you can enjoy the superlative reproduction and fidelity of prerecorded tape at the price you'd expect to pay for a record changer. Precision engineered, the RK-141 is equipped with its own 6-transistor stereo preamplifiers designed to play back $\frac{1}{4}$ track and $\frac{1}{2}$ track stereo plus $\frac{1}{2}$ track and full track monaural tape with true NARTB hi-fi tape equalization. Its tape handling mechanisms and heads are of a type found in costlier units. Accepts all size reels to 7". Measures 10 $\frac{3}{8}$ Dx14 $\frac{3}{8}$ Wx5"H. Complete with cables. Shpg. wt., 17 lbs.

RK-141WX Net 59.50
RK-148W Furniture Grade Walnut Base. Wt., 4 lbs. Net 6.95
RK-147W Portable Carrying Case. Wt., 5 lbs. Net 9.95

NEW! LAFAYETTE STEREO FM MULTIPLEX ADAPTER KIT

- Less Than 1% Distortion
- Self-Powered
- Noise Filter (switchable)
- Prealigned Coils
- Stereo Separation — 30 db @ 400 cps
- 3 Tubes — 2 Dual, 1 Triple-Purpose Tube + Silicon Rectifier
- Ideal For Any Tuner With Multiplex Output Jack

19⁵⁰



Enjoy thrilling FM Stereophonic sound from any recent Lafayette Tuner or any other quality wide-band FM or FM-AM tuner with multiplex jacks. Hear the full range of audio frequencies in all the realism and magnificence of stereo sound by simply adding this low-cost Lafayette Multiplex adaptor Kit. Engineered for anyone to build and operate, the KT-220 is easily connected to your tuner.

The KT-220 Multiplex adaptor is supplied complete with shielded cable for input and output connections; metal case and all parts plus the famous Lafayette detailed kit instruction manual. Front panel is finished in beige and ivory trim with contrasting beige and brown cabinet. Size 8 $\frac{1}{2}$ Wx4 $\frac{3}{8}$ Dx4 $\frac{3}{8}$ H. For 110-125 volts, 60 cycle AC. Shpg. wt., 4 lbs.

KT-220 Net 19.50

FAMOUS "MIGHTY 9"TM. 9 TRANSISTOR PERSONAL PORTABLE

NOW ONLY

19⁹⁵

REG. 25.88

- 9 Transistors, 2 Diodes,
- 1 Thermistor
- Lightweight, Shirt Pocket Size
- 4 Audio Stages
- Full Tone Speaker
- Complete with Leather Carrying Case, Batteries and Earphone



Lafayette's "Mighty-9" portable, the most powerful transistor radio, is the answer for those who want the best, without spending the most. Compare this portable with others selling for much more — compare feature for feature and you'll see why the Lafayette "Mighty-9" is your best buy. Size: 4 $\frac{1}{2}$ Hx3Wx1 $\frac{1}{4}$ "D. Shpg. wt., 2 lbs.

FS-91L 19.95

LAFAYETTE'S

NEW MAIL ORDER HEADQUARTERS
111 JERICHO TURNPIKE
(2 Blocks West of South Oyster Bay Rd.)

SYOSSET
LONG ISLAND, NEW YORK



LAFAYETTE RADIO DEPT. JG-2
P.O. BOX 10, SYOSSET, L. I., N. Y.

FREE!

- Rush my FREE Lafayette Summer Catalog Supplement
 - Please send me # _____, Shipping Charges Collect
- I am enclosing \$ _____



Name _____
Address _____
City _____ Zone _____ State _____

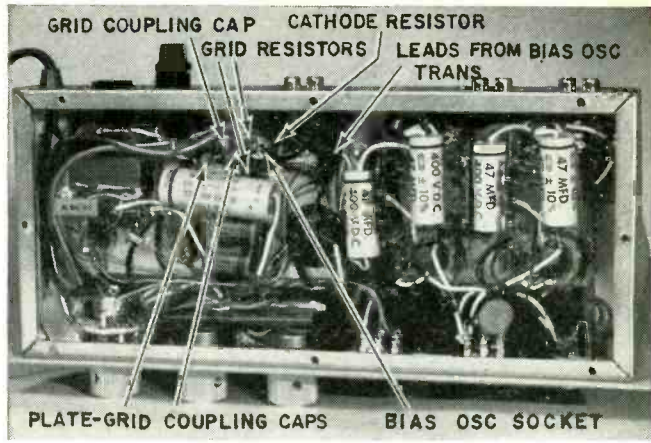
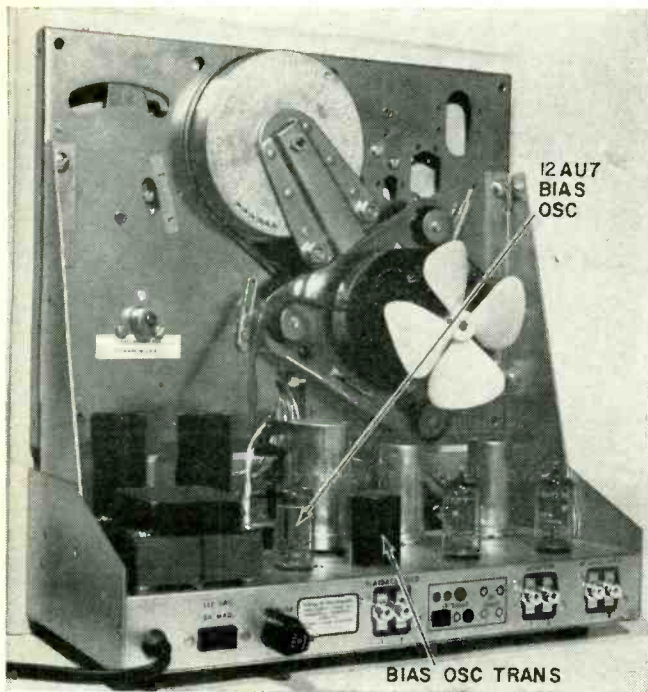

Underchassis view, showing bias oscillator components.

Compact recorder showing bias oscillator tube and transformer.

bias oscillator circuits

In this second article of a series we examine 8 different kinds of circuits used in modern tape recorders

By EARL E. SNADER*

THE BIAS OSCILLATOR IS A SEPARATE SECTION in some recorders, while in others it doubles as an audio amplifier during playback.

Most tape recorders use conventional oscillator circuits that are readily recognized because of their similarity to the oscillators in radio and TV receivers and signal generators. The circuitry of a number of typical bias oscillators is shown in Figs. 1 through 8.

*Customer service, Viking of Minneapolis.

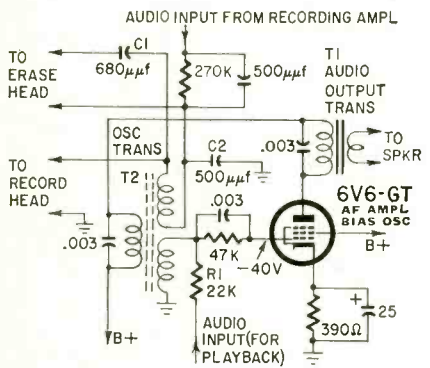

Fig. 1—Audio output stage which doubles as a bias oscillator for recording.

Most of these circuits ordinarily include switches. They have been omitted here for the sake of clarity.

Bias oscillator—audio amplifier

Fig. 1 shows how a 6V6 audio power output stage doubles as a bias oscillator. Audio comes in to the grid, when it is functioning as a power amplifier, through R1.

The primary of audio output transformer T1 and the primary of oscillator transformer T2 are connected in series in the plate circuit of the tube. One of the secondary windings on the oscillator transformer is connected to the grid, and is disconnected from ground by a switch (not shown) when the 6V6 is used as an audio amplifier. When the record-playback switch is set for recording, the ground circuit is completed and the 6V6 becomes a tickler feedback oscillator.

A third winding on T2 is connected direct to the record head and to the erase head through capacitor C1. The audio signal for recording is series-fed through this winding, and across C2, which is between the lower end of the winding and ground.

Hartley type oscillator

Fig. 2 shows a variation of the

basic Hartley oscillator widely used in the local oscillator section of superhet radio receivers. A separate 12AU7 is used; its two triode sections are connected in parallel. The current for the erase and record heads is taken from the grid end of the oscillator coil and coupled through individual capacitors to each head. Varying the value of these capacitors changes the amount of current supplied to each head, and also affects the bias oscillator frequency somewhat.

If you replace the erase or record head on a recorder with this kind of a bias oscillator, the replacement heads must have the same electrical characteristics as the original ones. The lead length between the bias oscillator and

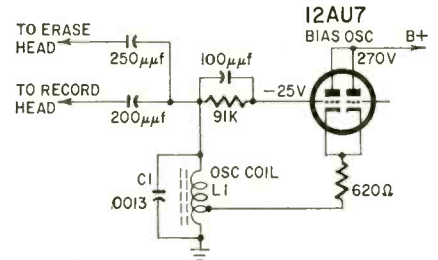

Fig. 2 — Hartley circuit as a bias oscillator.

the heads should not be changed either. Both heads, in this particular case, will probably be relatively high-impedance units.

The normal operating frequency of the oscillator shown in Fig. 2 is determined mostly by the resonant frequency of the tuned circuit consisting of C1 and L1.

Tapped-coil circuit

The bias oscillator shown in Fig. 3 also uses a tapped coil, but here it has been placed between the grid and the plate of the 12AU7. The coil carries the full dc plate potential of the tube, and is coupled to the grid through C2. The main frequency-determining elements are C1 and L1. They are both variable, for precise oscillator frequency adjustment.

The bias oscillator output is coupled to the erase head through C3, and to the record head through C3 and C4 in series. Erase current is adjusted by changing the capacitance of C3; recording bias current is adjusted by changing that of C4. Any change in one of these capacitors may call for a change in the other.

The heads, as well as the value of the coupling capacitors, affect the frequency of this oscillator. Heads in tape recorders with this type of oscillator are likely to be medium- or high-impedance types.

Feedback oscillator

Fig. 4 shows a tickler feedback type oscillator similar to Fig. 1. However, in this the erase head is connected to the same oscillator transformer secondary as the grid of the oscillator tube. It is likely that an erase head connected to the bias oscillator in this way will be a low- or medium-impedance unit. There is no simple way of adjusting the erase current in this circuit.

The oscillator frequency is determined by the tuned circuit that forms the primary of the oscillator transformer. The plate circuit in this feedback oscillator is tuned instead of the

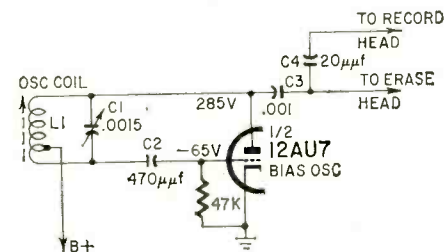

Fig. 3—Here the tapped coil is between the plate and grid.

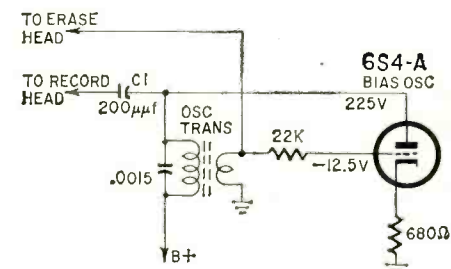
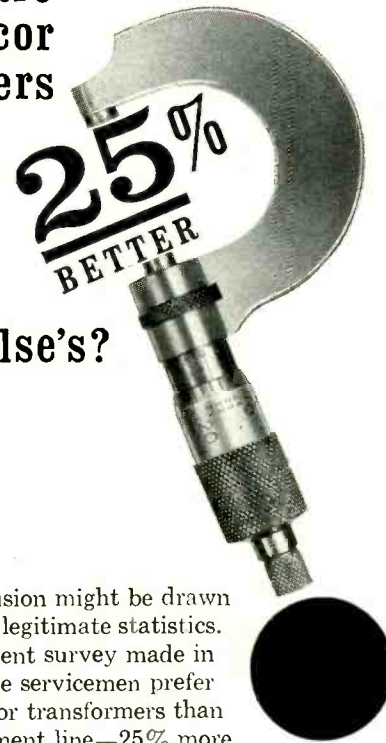

Fig. 4—Tickler feedback-type bias oscillator.

JULY, 1962

are
Stancor
transformers

than anybody else's?



An illegitimate conclusion might be drawn from a set of strictly legitimate statistics. An impartial independent survey made in 1961 shows that more servicemen prefer Stancor transformers than any other replacement line—25% more than the next most popular brand.*

Of course, this preference does not of itself prove anything about relative quality—but it does show that a lot of professional servicemen feel that they get more for their money from Stancor.

And who are we to argue with them?

STANCOR
ELECTRONICS, INC.

(formerly Chicago Standard Transformer Corporation)
3501 WEST ADDISON STREET • CHICAGO 18, ILLINOIS

*According to Brand Name Survey, Chicago, Illinois, May, 1961. This survey has been made annually since 1954—and Stancor has come out first every time.

JOHN DOE 7-64
154 WEST 14TH ST SU 322
NEW YORK 11 N Y

MOVING?

Please send us your old address as it appears on the latest copy of the magazine. Include the numbers shown beside your name. If possible send the actual address label pasted on the lower right hand corner of the front cover. Be sure to include postal zone number (if any) with your new address. If we receive this information before the 20th of the month, you will continue to get Radio-Electronics without interruption.

Please send data to RADIO-ELECTRONICS Subscriber Service, 154 West 14th Street, New York 11, N. Y.

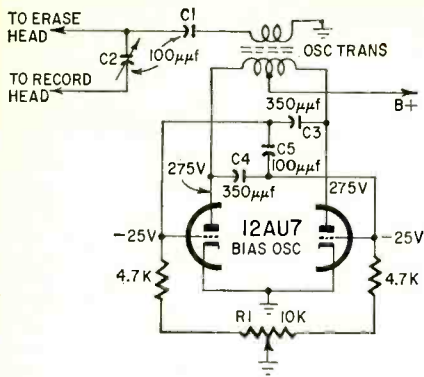

Fig. 5 — Balanced multivibrator also makes a bias oscillator.

grid. Bias current to the record head is taken through C1. The amount of recording bias current can be adjusted by changing the value of this coupling capacitor. Medium- or high-impedance record heads can be expected with this kind of bias oscillator. The record head and C1 will have an effect on the bias oscillator frequency. The length of the leads to the record head should not be changed.

Balanced multivibrator

The oscillator in Fig. 5 is a balanced multivibrator that can supply relatively high output without distortion. The oscillator transformer has a center-tapped primary. Half of the primary winding is in the plate circuit of each tube. Each plate is coupled to the grid of the opposite section of the twin triode, in conventional multivibrator fashion. C3, C4 and C5 determine the operating frequency, along with the inductance of the center-tapped primary winding of the transformer. The two plate coupling capacitors must be matched for good balance and low distortion. If the value of one capacitor is changed to adjust the oscillator frequency, the other should be changed also.

R1 is a balancing adjustment. Low distortion in the bias oscillator waveform is particularly important in professional and high-fidelity recording applications where background noise must be kept at a minimum. A distorted bias oscillator waveform causes higher background noise in the recording. A bias oscillator of this kind is often used in tape recorders for critical applications, because it is possible to keep the circuit balanced and distortion low.

The main function of the transformer secondary is to provide output for driving the erase head and supplying bias to the record head. The erase head is coupled to the secondary through C1. The record head is coupled through C1 and C2 in series.

Erase current can be adjusted by changing the value of C1, recording bias current can be adjusted by changing that of C2. There is a certain amount of interaction between these two capacitors. Any change in one may require a change in the other to maintain recommended erase and recording bias currents to the heads.

The transformer sometimes has

more than one secondary winding. When it does, the erase head is fed independently of the record head. The secondary windings can be designed to match low-, medium-, or high-impedance heads.

There is excellent isolation between the oscillator and the heads, because of the transformer type output. The heads have no appreciable effect on the oscillator frequency. This circuit is often used in recording amplifiers intended for use with the tape deck in a "component" high-fidelity system.

Another tapped coil

The oscillator circuit in Fig. 6 is similar to the one in Fig. 3, but with the coil tap connected to ground instead of to the high-voltage dc. Also, there are capacitors between the ends of the coil and the tube grid and plate. The oscillator acts as a low-level exciter and is coupled to the input of a bias amplifier rather than direct to the erase and rec-

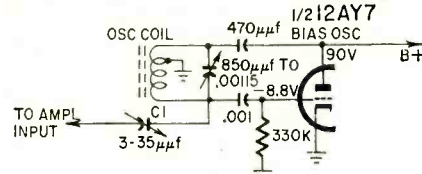

Fig. 6—This bias oscillator is designed to drive a bias amplifier.

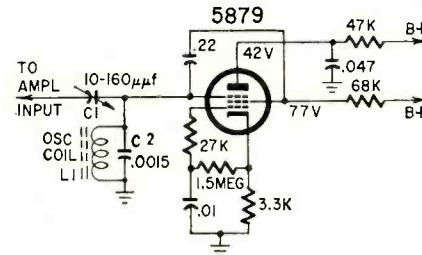

Fig. 7—Pentode playback preamp doubles as bias oscillator for recording.

ord heads. Output coupling capacitor C1 can be adjusted to provide the right amount of excitation to the bias amplifier. A test point will often be included in the circuit, to permit accurate bias checking. The manufacturers service literature usually gives specific information concerning the proper use of such test points.

Preamp-oscillator

Fig. 7 shows how a pentode playback preamp is sometimes arranged to act as a negative-resistance oscillator when the recorder is used for recording. This is a "two-terminal" oscillator circuit. The frequency is determined by the parallel-tuned circuit (C2 and L1). The output is taken from the grid end of this tuned circuit and fed to the input of a bias amplifier through variable coupling capacitor C1. It is an exciter-type bias oscillator which performs the same function as the one in Fig. 6.

Dual function

The bias amplifier in Fig. 8 uses a 6AQ5 as a conventional audio power output for playback and a bias amplifier for recording. Variable capacitor C1 in

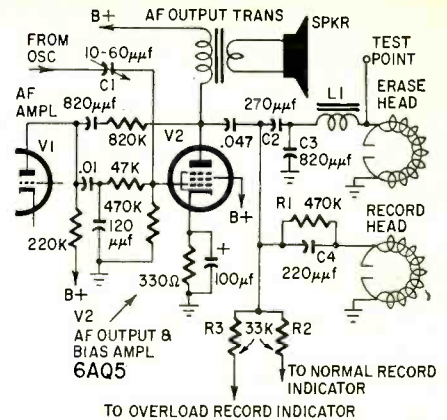

Fig. 8—Another audio output stage that doubles as a bias oscillator.

this circuit is the same as the output coupling capacitors C1 in Fig. 6 and C1 in Fig. 7.

An audio output transformer is connected in the plate circuit of the 6AQ5 in the usual way. In addition, the plate is coupled to the erase and record heads. A discriminating network consisting of C2, C3 and L1 feeds the high-frequency bias to the erase head while the audio frequencies, plus a certain amount of the bias current, are fed to the record head through the resistive-capacitive network R1-C4. The ratio between the erase current and the recording bias current is determined by C2 and R1-C4. R2 and R3 go to neon type recording indicators.

Bias current in recorders which use a circuit such as this is adjusted for a correct reading at the test point, according to the manufacturer's recommendations. The test-point reading is reliable only as long as the original erase and record heads are used, unless any replacement heads that have been installed are identical replacements. If heads with different electrical characteristics are used, the value of some of the components in the feed system from the plate of the amplifier tube will probably have to be changed and the reading at the test point may change too.

Coupling circuits

Fig. 9 shows two typical arrangements for coupling the output of the

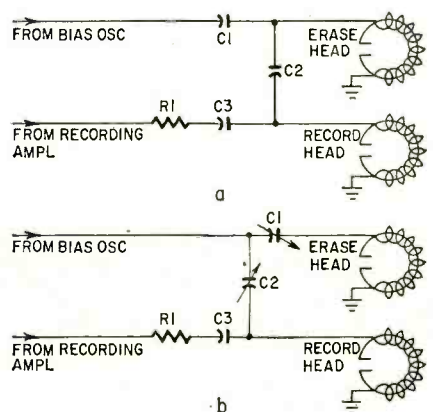

Fig. 9—Two circuits for coupling erase and record heads to the bias oscillator.

EVERYTHING IS A-OK--GO!



PHILCO STAR BRIGHT 20/20 PICTURE TUBES

Starlight, STAR BRIGHT . . . here's the finest tube you'll see tonight! Philco Star Bright 20/20 Picture Tubes are not exactly intended to sail through space to the moon, but we couldn't be more particular about how they are made if our lives depended on them.

Everything that goes into* a Philco Star Bright 20/20 Picture Tube is new! That means you need only open the carton . . . and install. Everything will be A-OK . . . no need to worry about checking, testing . . . or callbacks, either. Each Philco Star Bright 20/20 Picture Tube gets the same careful attention that we at Philco give to everything we make or sell . . . whether it is Philco equipment that rides the rockets to the moon . . . or Philco Star Bright 20/20 Picture Tubes to help you make more satisfied customers for your business.

*Except the envelope which, prior to re-use, is inspected and tested to the same standards as a new envelope.

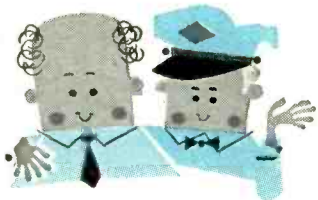

Depend on Your **PHILCO** Distributor
for **Quality Replacements** that
Match Original Parts.



PHILCO
Long Life Tested
Receiving Tubes

A complete line of receiving tubes and numbers, manufactured under exacting quality standards, thoroughly tested and inspected. And each one bears the name PHILCO . . . a name your customers know and trust.

PARTS & SERVICE OPERATIONS

PHILCO
A SUBSIDIARY OF *Ford Motor Company*

HIGH SPEED
PERFORMANCE
UNLIMITED... with the

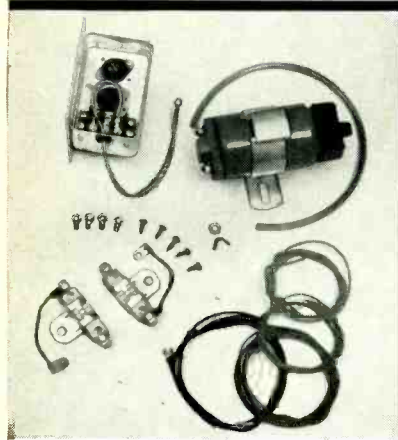

SLEPTRONIC
TWO TRANSISTOR
IGNITION SYSTEM

Assure the best performance for your engine with this amazing new two transistor ignition system which completely eliminates high-speed voltage fall-off and increases speeds 10 to 30%. Two transistors combined with our specially designed, 250:1 turns ratio, F-12T Coil acts as a transistor amplifier... addition of this Transistor Amplifier to your ignition system relieves the contacts of high current loads and greatly reduces the voltage transit across them.

Our TS-14 Transistor System was designed, after 5 years of engineering, to give you the very finest Heavy-Duty Transistorized Electronic Ignition System. TS-14 is economical, maintenance-free and can be installed in 30 minutes on any six or 12 volt, negative or positive ground imported or American sports car.

- THE "SLEPTRONIC" TS-14**
- Eliminates High-Speed Voltage Fall-Off up to 20,000 RPM
 - Increases Speed 10 to 30%
 - Extends Point and Plug Life to 100,000 Miles
 - Increases Gas Mileage
 - Starts Instantly in Any Weather
 - Eliminates Overheating at Low Speeds
 - Increases Acceleration at Low or High Speeds
 - Eliminates Condenser Breakdown
 - Eliminates Mis-Firing
 - Has a 250:1 Coil Turns Ratio compared to 100:1 in other systems
 - Gives you all the advantages of a magneto system at less cost and with more convenience
 - All parts made in U. S. A.
 - Perfect for rallies

SATISFACTION GUARANTEED
OR YOUR MONEY REFUNDED

TS-14 Transistorized Ignition System, complete with F-12T Coil and all Mounting Hardware for all 6 or 12 volt sports cars.

For Negative Grounding, specify 6 or 12 volt\$44.95
 Special F-12T, 250:1 Turns Ratio Coil for Electronic Builders\$16.50

BILL SLEP COMPANY Automotive Electronics
 P.O. Box 178-E Ellenton, Florida

Please send me postage prepaid: TS-14 for Neg. Ground TS-14 for Pos. Ground Special F-12T Coil Free Color Brochure. My Car is a 6 volt 12 volt.

Name _____
 Address _____
 City _____ State _____

What's Your EQ? June Solutions

Control-board problem

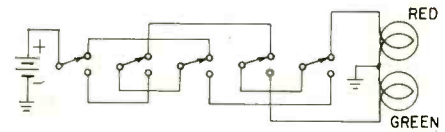

The circuit is as shown. A similar but slightly more complex hookup can be made for an even number of valves, six for instance.

Shapely problem

The simplest circuit is a shorted 0.5-microsecond delay line across the shaper input terminals. The 2-microsecond trigger would then be reduced

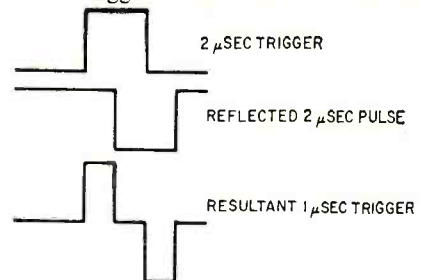

to 1 microsecond as the negative reflection returning from the delay line cancelled the second half of the original pulse. See sketch.

What's the Output?

An ac generator supplies voltage to a voltage divider network, as indicated in Fig. 1. At first glance the out-

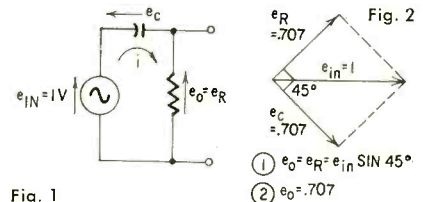

Fig. 1

put might seem to be 0.5 volt. It is actually roughly .7 volt, since $e_{in} = \sqrt{e_c^2 + e_r^2}$. See the vector diagram (Fig. 2).

Bias Oscillator Circuits (continued)

recording amplifier to the record head along with separate coupling from the bias oscillator to the head. The audio is coupled to the head through C3, which may have a value anywhere from 0.1 to 0.5 μ f. The bias is coupled to the record head through C2, which is much lower in value than C3. Typical values for C2 are anywhere from as low as 60 to 500 μ f. Capacitors in this range have a low reactance at the bias frequency and high reactance at audio frequencies. Therefore, they can couple the bias into the record head without loading the audio amplifier output.

R1 is a swamping resistor to equalize the impedance the record head

presents to the recording amplifier output at different audio frequencies. Typical values for R1 are around 50,000 ohms for medium- and high-impedance record heads.

The circuit in Fig. 9-b has been rearranged so the coupling capacitor between the bias oscillator and the erase head can be adjusted more precisely, to form a series-resonant circuit with the inductance of the erase head. The way in which C2 and C3 feed bias and audio, respectively, to the record head is the same as for Fig. 9-a.

Sometimes a resistor is used in place of C2 to feed a portion of the bias oscillator output to the record head.

Usually this is done only when the output of the bias oscillator is high so a fairly large resistor can be used. A typical value is about 68,000 ohms.

If a low-impedance erase head is used, the voltage to the erase head will be so low it would be impossible to feed enough bias to the record head through a resistor without loading down the output from the recording amplifier.

The adjustments of C1 and C2 in Fig. 9 affect one another. Any time the recording bias adjustment is changed (C2) check the erase current. A method for checking erase and bias currents will be discussed in the next article of this series.

END

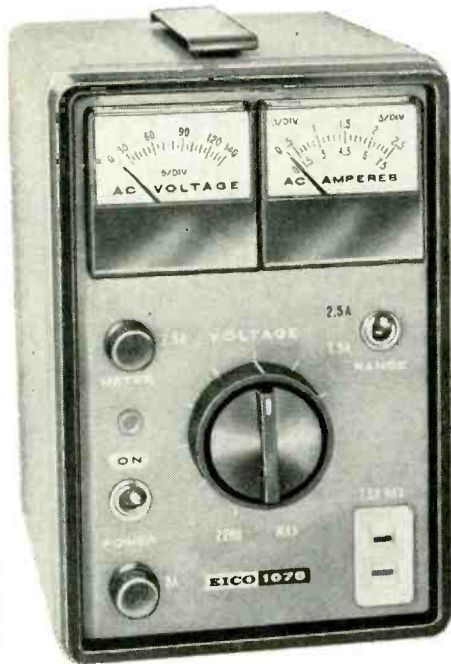

Eico 1078 metered variable-ac bench supply.

By **LARRY STECKLER**
ASSOCIATE EDITOR

There are two power supplies that every electronic technician is bound to have a use for at one time or another. One is a variable ac supply, the second a low-ripple battery eliminator.

The variable ac supply is excellent for keeping line voltage constant while checking equipment on the bench. It also makes it possible to study equipment operation at higher and lower than ordinary voltages. Overvoltage is often useful for locating intermittents. Under the higher than normal rating they may break down once and for all.

Where to use the battery eliminator is obvious—wherever and whenever you want to operate a piece of battery-powered equipment off the ac line. The classic example is the auto radio. Any technician who intends to do any amount of auto radio servicing will find this unit a must. The large number of transistor radios that now reach the service bench also make a battery eliminator a necessity. It is also vital in serv-

two bench supplies



Eico 1064 battery eliminator and charger.

icing much Citizens-band equipment and other mobile radios.

The Eico 1078

The circuit of the 1078 variable ac supply is comparatively simple. (See Fig. 1). The heart of the unit is a rather

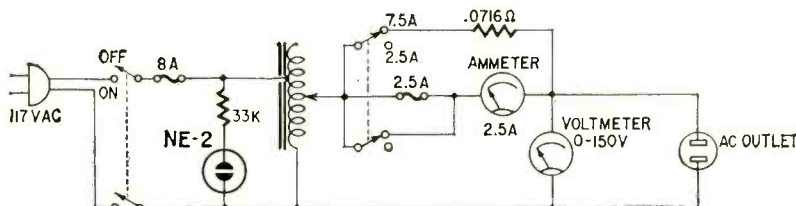

Fig. 1—Circuit of ac supply. Note that an autotransformer is used. The ac output receptacle is polarized, but not all ac equipment has polarized plugs.

ARE YOU GETTING THE MOST VALUE FROM YOUR MEASUREMENT DOLLAR? ... Compare all



features and you'll agree, **BEST BUY IS EMC!**



EMC'S NEW MODEL 212 TRANSISTOR ANALYZER... Checks DC current gain in 3 ranges to 200. Tests for leakage. Checks all transistors as oscillators both in and out of circuit. Can be used to signal trace AF, IF or RF circuits. Checks condition of diodes. Tests battery voltage on 0-12 scale. Checks DC current drain on 0-80 ma scale. Supplied with complete instruction manual, transistor listing and pair of test leads. Model 212 **\$18.50 Wired** Model 212 Kit **\$13.50**



EMC'S NEW MODEL 213 TUBE TESTER... Completely modern! Completely flexible! Completely new! Checks all the new 12 prong (Compactron), Nuvistor, Novar, and 10 prong tubes, in addition to octal, loctal, miniature, and 9 prong tubes. Tests each tube for shorts, leakages, intermittents, opens, as well as for quality. Each section of multi-purpose tube is checked separately. Magic eye, Voltage Regulator and Hi-Fi tubes are also tested. Unique switching arrangement makes the checker obsolescent proof. Supplementary tube listings supplied periodically at no cost to keep instrument up to date. It comes complete with instructions and tube charts in ring bound manual. Model 213 (in bakelite case with strap) **\$28.50 Wired** Model 213 Kit **\$18.90** Model 213P (in wood carrying case) **\$32.25 Wired** Model 213P Kit **\$21.90**



EMC'S NEW MODEL SA SOCKET ADAPTOR... Enables user to check 12 pin Compactron, Nuvistor, Novar and 10 pin tubes with any type tube tester including mutual conductance type. Model SA **\$9.45 Wired** Model SA Kit **\$4.95**

Yes, tell me more, send me **FREE** a detailed catalog of the Complete EMC Line. Dept. 1262

NAME _____
STREET _____
CITY _____ STATE _____

EMC Electronic Measurements Corp.
625 B'way, New York 12, N. Y.
Ex. Dept., Pan-Mar Corp., 1270 B'way, New York 1, N. Y.

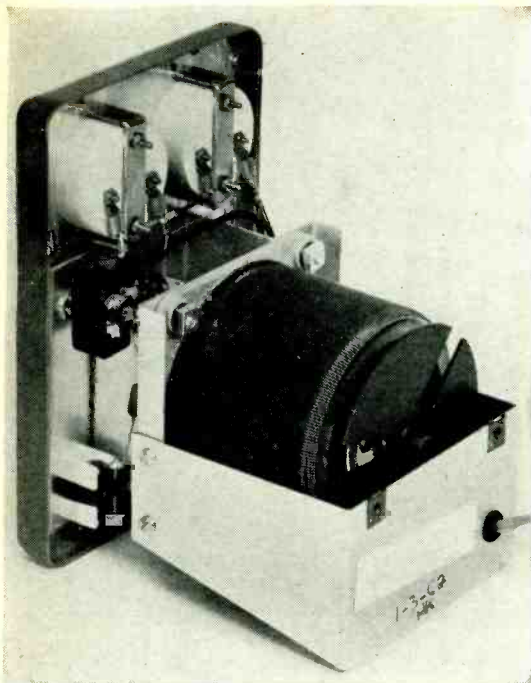

Model 1078
variable ac
supply

power source:
117 vac

output:
0-140 vac @ 0-7.5 amps
Output fully metered by ac volt- and
ammeters

size:
8½ x 5¼ x 7 in.

weight:
13 lb

price:
\$42.95 kit, \$54.95 wired

Massive autotransformer dominates ac supply.

large autotransformer with a variable tap. An ammeter in series and a voltmeter in parallel with the output monitor the voltage and the load.

Two ammeter ranges are provided. One reads 0-2.5 amps; the other, 0-7.5 amps. In the 7.5-amp position, the meter is shunted by a .0716-ohm resistor. In the 2.5-amp position, it is protected by a 2.5-amp fuse in series. The fuse can be replaced from the front panel of the instrument should it become necessary.

Remember one caution when using this unit: an autotransformer is used. Therefore, the output voltage is not isolated from the line, except when power is off. When power is off, the dpdt on-off switch disconnects both sides of the line. (This is just the kind of thing that would be nice to see in a few radio and TV receivers.)

The autotransformer is protected by an 8-ampere slow-blow fuse. It, like the meter fuse, can be replaced from the front panel. To help avoid blowing many of these fuses, it is a good idea to make a few simple resistance checks before hooking up the equipment to be tested. You'll also find it handy to tape a box of Buss MDL and a box of Buss AGC fuses to the top of the instrument. Then you'll always have the correct replacement on hand, should you need one.

The 1064 dc supply

This unit is a bit more complex than the ac supply. It uses an isolation type transformer, so there is no danger of hot chassis and the like. The transformer (Fig. 2) has dual secondaries. An adjustable arm contacts each secondary. These arms are connected electrically

and ganged physically.

When the instrument is set to provide voltages in its 0 to 8-volt range (selector switch in 6-volt position), these contacts become the center tap of a full-wave rectifier using diodes D1 and D2 of the bridge. The tap is connected to the positive output jack. When the

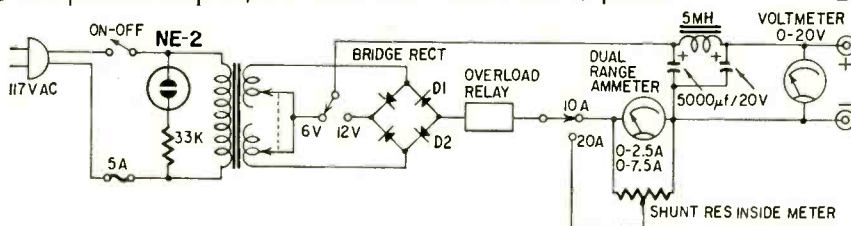

Fig. 2—Circuit of battery eliminator, a dual range unit.

Battery eliminator with case removed. Note how overload relay is outboard-mounted on selenium rectifier.

Model 1064
battery eliminator
& charger

power source:
117 vac

outputs:
0-8 vdc @
10 amps continuous
20 amps intermittent
0-16 vdc @
6 amps continuous
10 amps intermittent

ripple:
0.25% @ 1 amp, 0.6% @ 5 amps,
1.5% at 10 amps
Output fully metered by dc volt- and
ammeters

size:
8½ x 5¼ x 7½ in.

weight:
16 lb

price:
\$43.95 kit, \$52.95 wired

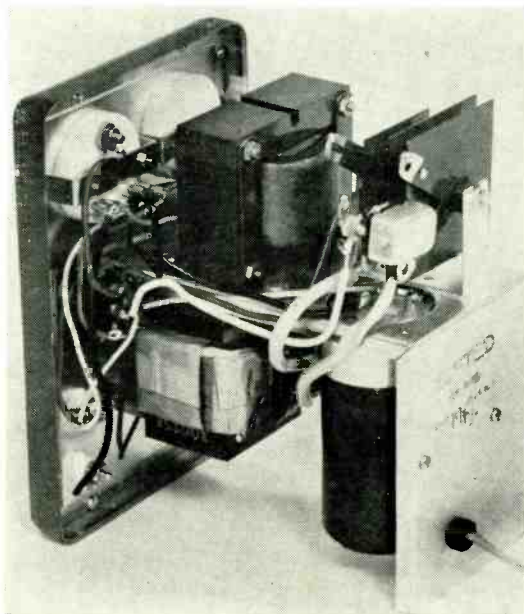

unit is switched to its 0-16-volt range, the rectifier-transformer arrangement is changed to a full-wave bridge rectifier (all four rectifier sections are used).

On both ranges, the raw dc is smoothed by a heavy filter consisting of two 5,000-µf 20-volt capacitors and a 5-mh choke. The ripple figure remains about the same for either voltage range. The determining factor is the amount of current being drawn. Ripple is 0.25% at 1 ampere and even lower at the 200 or 300 ma drawn by the average transistor portable.

The output is carefully metered by a 0-20-volt meter across the output and a dual-range 10-20-amp meter in series with the output. The voltmeter needs no protection as the unit cannot produce enough output to damage it. The ammeter is protected by an overload relay. It opens if too much current is drawn and automatically resets when the overload is removed. The power transformer primary has a 5-amp fuse in series for protection. It can be replaced from the front panel.

Only one warning goes along with this instrument and that applies only when charging batteries: **Charge batteries only in a well ventilated room.** The fumes liberated during the charging process are toxic and combustible. Also, loosen or remove the battery caps while charging, or you can blow the occasional cell to pieces. END

NEW, MODERN, PORTABLE... FOR THE MAN ON THE GO...

as easy to use as a voltmeter

- A new 3 inch Extended View Portable Scope with New Features and Performance Unmatched by even the most Costly 5 inch Oscilloscopes



NEW

SENCORE PS120 PROFESSIONAL WIDE BAND OSCILLOSCOPE

Lowest priced
Wide Band 3 inch Scope
anywhere. All hand wired.

Only 124⁵⁰ net

Here it is, the scope that technicians, engineers and servicemen from coast to coast have been demanding. A portable wide band scope that can be used on the job anywhere, yet has the highest laboratory specifications for shop or lab. Cumbersome color TV sets, remote audio and organ installations and computers are just a few of the jobs that make owning a scope of this type so essential. Why consider a narrow band scope, when for only a few dollars more, this professional wide band sensitive scope equips you for any job.

- The PS120 provides features never before offered. Only two major controls make the PS120 as easy to use as a voltmeter. Even its smart good looks were designed for functional efficiency. New forward thrust design, creating its own shadow mask, and full width calibrated graph increase sharpness of wave form patterns. A permanent chromed steel carrying handle instead of untidy leather strap and a concealed compartment under panel for leads, jacks and AC

line cord make the PS120 the first truly portable scope combining neatness with top efficiency.

- Electrical specifications and operational ease will surpass your fondest expectations. Imagine a wide band scope that accurately reproduces any waveform from 20 cycles to 12 megacycles. And the PS120 is as sensitive as narrow band scopes... all the way. Vertical amplifier sensitivity is .035 volts RMS. The PS120 has no narrow band positions which cause other scopes to register erroneous waveforms unexpectedly. Another Sencore first is the Automatic Range Indication on Vertical Input Control which enables the direct reading of peak-to-peak voltages. Simply adjust to one inch height and read P-to-P volts present. Standby position on power switch, another first, adds hours of life to CRT and other tubes. A sensitive wide band oscilloscope like the PS120 has become an absolute necessity for trouble shooting Color TV and other modern circuits and no other scope is as fast or easy to use.

SPECIFICATIONS

WIDE FREQUENCY RESPONSE:

Vertical Amplifier—flat within ½ DB from 20 cycles to 5.5 MC, down—3 DB at 7.5 MC, usable up to 12 MC.
Horizontal Amplifier—flat within —3 DB from 45 cycles to 330 KC, flat within —6 DB from 20 cycles to 500 KC.

HIGH DEFLECTION SENSITIVITY:

	RMS	P/P
Vertical Amplifier—Vert. input cable	.035V/IN.	0.1V/IN.
Aux. vert. jack	.035V/IN.	0.1V/IN.
Through Lo-Cap. probe	.35V/IN.	1.0V/IN.
Horizontal Amplifier—	.51V/IN.	1.44V/IN.

HIGH INPUT RESISTANCE AND LOW CAPACITY:

Vert. input cable	2.7 Meg. shunted by approx. 99 MMF
Aux. vert. input jack	2.7 Meg. shunted by approx. 25 MMF
Through low cap. probe	27 Meg. shunted by 9 MMF
Horiz. input jack	330 K to 4 Meg.

HORIZONTAL SWEEP OSCILLATOR:

Frequency range— 4 ranges, 15 cycles—150 KC
Sync Range— 15 cycles to 8 MC—usable to 12 MC

MAXIMUM AC INPUT VOLTAGE:

Vertical input cable—	} 1000 VPP (in presence of 600 VDC)
Aux. vert. jack—	
Lo-Cap. probe—	
Horiz. input jack—	approx. 15 VPP (in presence of 400 VDC)

POWER REQUIREMENTS:

Voltage— 105-125 volts, 50-60 cycle
Power consumption— On pos. 82 watts
Stby. pos. 10 watts

SIZE: 7" wide x 9" high x 11¼" deep—weight 12 lbs.

The PS120 is a must for color TV servicing. For example, with its extended vertical amplifier frequency response, 3.58 MC signals can be seen individually.



SENCORE

ADDISON 2, ILLINOIS



Fig. 1

By ENOCH J. HICKS, 6W0360

WANT TO INCREASE THE RANGE OF YOUR class-D base station? Here is a simple, inexpensive, but very effective ground-plane antenna that can be constructed in one evening.

My model was constructed from materials I bought at a local electrical supply house and hardware store. The only tools required are hacksaw, screwdriver, pliers, electric drill and some means of bending the tubing used. The necessary parts are listed at the right of Fig. 2.

Using a $\frac{3}{4}$ -inch floor flange as a guide, drill three $\frac{1}{4}$ -inch holes in the bottom of the 4-inch outlet box. (Do not drill through the knockout plugs.) Mount the $\frac{3}{4}$ -inch floor flange to the outside of the box with three $\frac{1}{4} \times \frac{3}{4}$ -inch flat-head machine screws, lock washers and nuts. Lay this assembly aside.

Using the cover plate from the outlet box as a guide, drill two $\frac{1}{4}$ -inch holes in opposite corners of the insulating block. Countersink these holes to a depth of $\frac{3}{4}$ inch (Fig. 1). These holes will be used when the block is fastened to the box. Next, using the $\frac{1}{2}$ -inch floor flange as a guide, drill three $\frac{1}{4}$ -inch holes through the same insulating block. Countersink these holes $\frac{3}{4}$ -inch also, but on the opposite side from the ones previously mentioned. Mount the $\frac{1}{2}$ -inch floor flange to the block, using three $\frac{1}{4} \times 1\frac{1}{2}$ -inch round-head machine screws, lock washers and nuts. Drill a $\frac{1}{8}$ -inch hole in one side of the outlet box. Press out the four side knockout plugs.

Cut all five sections of the aluminum tubing to 102 inches. Bend four sections of this tubing to a 90° angle. Begin 3 inches from the cut end of the tube and bend on a 10-inch radius. Fasten these four sections to the box, using one

ground-plane antenna for Citizens Radio

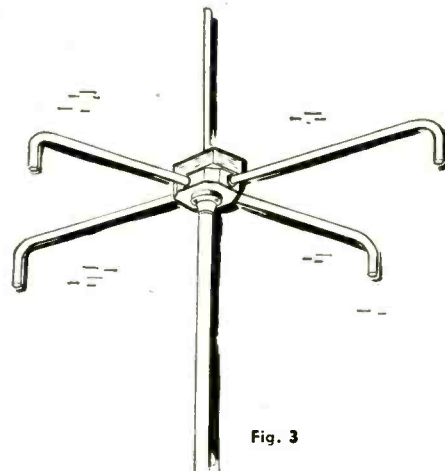

Fig. 3

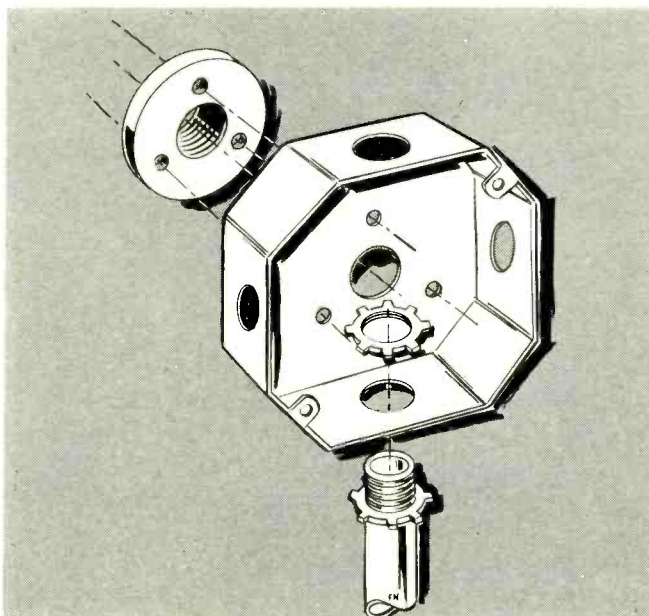

Fig. 2

Parts needed to assemble the antenna:

- 1 Floor flange, $\frac{3}{4}$ inch
- 1 Octagon outlet box, 4-inch, with $\frac{1}{2}$ -inch knockouts on four sides
- 1 Insulating block, 4 x 4 x $1\frac{3}{4}$ inches
- 5 Pieces aluminum conduit tubing, $\frac{1}{2}$ inch diam, 8 feet long.
- 1 Floor flange, $\frac{1}{2}$ inch
- HARDWARE:
- 3 flat-head machine screws with lock washers and nuts, $\frac{1}{4} \times 1\frac{1}{2}$ inches
- 3 round-head machine screws with lock washers and nuts, $\frac{1}{4} \times 1\frac{1}{2}$ inches
- 2 round head stove bolts, $\frac{3}{16} \times 1\frac{1}{4}$ inches
- 5 snap-in plugs, $\frac{1}{2}$ inch

thin pipe-thread nut outside and one inside the box (Fig. 2). Make sure all ends are turned down.

Fasten the insulating block to the cover-plate mounting studs of the box, using two $\frac{3}{16} \times 1\frac{1}{4}$ -inch round-head stove bolts. Screw the remaining piece of 102 x $\frac{1}{2}$ -inch tubing into the flange on the insulating block. Seal the ends of all tubes with the $\frac{1}{2}$ -inch snap-in plugs.

Fasten the lead-in cable to the radiating portion of the antenna under one bolt of the floor flange. Fasten the ground to the box with a self-tapping screw in the $\frac{1}{8}$ -inch hole previously drilled.

The finished antenna (Fig. 3) may be mounted on a $\frac{3}{4}$ -inch mast, or a $\frac{3}{4}$ inch by 2-foot section of pipe may be used to fasten the antenna to an existing structure. END



Think, man! Try to remember what you did to it!

RCA—PIONEER OF COLOR TV—BRINGS YOU

ALL YOU
NEED FOR

COLOR-TV SERVICING



WR-6-A



WO-91A



WR-70A



WR-69A



WR-99A

RCA Color-Bar/Dot/ Crosshatch Generator

Low-cost, lightweight, portable instrument that provides all essential Color-TV test patterns. Simple to operate: only 3 controls. RF output leads connect directly to antenna terminals of receiver; no external sync leads required. Crystal-controlled signals assure rock-steady patterns, free from "jitter" and "crawl." Extra-wide-range chroma control. Generates:

- **Color-bar pattern:** ten bars of color, including R-Y, B-Y, G-Y, I and Q signals spaced at 30° phase intervals for checking phase and matrixing, and for automatic frequency and phase alignment. Permits accurate alignment of the "X" and "Z" demodulators which are used extensively in RCA Victor and many other makes of color TV receivers
 - **Crosshatch pattern:** a grid-like pattern of thin sharp lines for adjusting vertical and horizontal linearity, raster size, and overscan
 - **Dot pattern:** a pattern of small sized dots facilitating accurate color convergence adjustments
- \$189.50* with output cables.

RCA 5-Inch Oscilloscope for Color-TV

A wideband scope excellent for checking colorburst signals and general troubleshooting of wideband color circuits and other electronic equipment. Mult-scale calibrated graph screen makes measurement of peak-to-peak voltage as easy as with a VTVM.

- New 2-stage sync separator assures stable horizontal sweep lock-in on composite TV signals
 - Dual bandwidth: 4.5 Mc at 0.053 volt rms/in. sensitivity. 1.5 Mc at 0.018 volt rms/in. sensitivity
 - Continuously adjustable sweep frequency range: 10 cps to 100 Kc
 - 3-to-1 voltage-calibrated, frequency-compensated step attenuator for "V" amplifier
 - Simplified, semi-automatic voltage calibration for simultaneous voltage measurement and wave-shape display
 - Vertical-polarity reversal switch for "upright" or "inverted" trace display
- \$249.50*, including direct/low capacitance probe and cable, ground cable, and insulated clip.

RCA Television FM Sweep Generator

Specifically designed for visual alignment and troubleshooting of color and black-and-white TV receivers, and FM receivers. The RCA WR-69A has pre-set switch positions for all VHF TV channels, FM broadcast band, and TV video, chrominance, and IF frequencies. The WR-69A has these important features:

- IF/Video output frequency continuously tunable from 50 Kc to 50 Mc
 - Sweep-frequency bandwidth continuously adjustable from 50 Kc to 20 Mc on IF/Video and FM; 12 Mc on TV channels
 - Output level—0.1 volt or more
 - Attenuation range: TV channels, 60 db IF/Video, 70 db FM, 60 db
 - Return-trace blanking
 - Two adjustable bias voltages on front panel
- \$295.00* including all necessary cables.

RCA RF/VF/IF Marker Adder

Designed for use with a marker generator (such as RCA's WR-99A) and a sweep generator (such as RCA's WR-69A), this instrument is used for RF, IF, and VF sweep alignment in both color and black-and-white TV receivers. In visual alignment techniques, it eliminates distortion of sweep response pattern.

Important features:

- Choice of four different marker shapes provided by front panel switch for different types of sweep-response curves and for positive and negative sweep traces
 - Provides very high-Q markers of high-amplitude and narrow bandwidth
 - Complete front panel control of marker shape, marker amplitude, marker polarity, sweep amplitude, and sweep-trace polarity
- \$74.50* complete with cables.

RCA Crystal-Calibrated Marker Generator

Supplies a fundamental frequency RF carrier of crystal accuracy for aligning and troubleshooting color and B&W TV receivers, FM receivers and other electronic equipment in the 19-260 Mc range. Combines functions of multiple-marker generator, re-broadcast transmitter, and heterodyne frequency meter.

- Highly stable output
 - May be calibrated at 240 separate crystal check points—accurate calibration provided at 1-Mc and 10-Mc intervals
 - Matched-impedance pad-type attenuator and double shielding of the oscillator provide effective attenuation of all frequencies
 - Most-used IF and RF frequencies are specially indicated on the dial scale
 - Sound and picture carrier markers available simultaneously
- \$242.50* complete with output cable and phone tip.

RCA ELECTRON TUBE DIVISION, Harrison, N. J.



The Most Trusted Name in Electronics

*User Price (Optional)

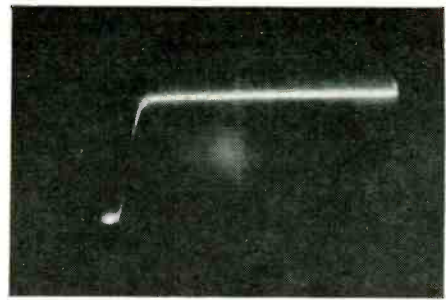
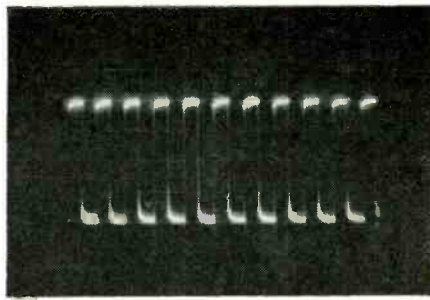
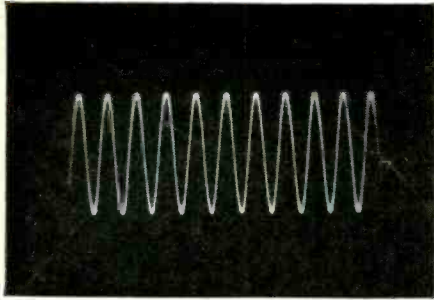

Fig. 1—(a) 100-kc oscillator output; (b) 100-kc output from pulse generator.

Fig. 2—100-kc output from the unit showing .03- μ sec rise time.

portable precision frequency standard

6-transistor unit is the ultimate in a home-made standard

By **LEONARD J. D'AIRO***

A frequency standard is just as important and necessary a tool in aligning and calibrating communications equipment as an rf signal generator. It makes it possible to calibrate a receiver to a fairly high degree of accuracy, and adjust a transmitter's operating frequency to within the required operating limits. The unit described here is designed for efficiency, accuracy and stability at the lowest possible cost. It is completely transistorized and self-contained. Power is supplied by a single 9-volt mercury battery, with a maximum total current drain of 12 ma. Output

frequencies are 100 kc, 10 kc, and 100 mc with 10-kc markers. They are selected with a rotary switch. Both high- and low-impedance output terminals are provided. Output at the low-impedance terminal is 250 mv maximum (for direct connection to the receiver antenna terminals), while the high-impedance terminal provides a maximum output of 6.5 volts.

The standard uses a 2N409 (or 2N410) as the 100-kc crystal-controlled oscillator. The oscillator circuit was designed around an International Crystal FO-8 100-kc crystal. This crystal is accurate and stable to a very high degree.

C1 (see schematic) tunes the tank circuit. Its setting depends upon the actual capacitance of C2 and the inductance of RFC2. Although this setting is

not particularly critical, the transistor used in the circuit should be chosen so that, with C1 set at mid-point, the oscillator should start under load. Adjusting C1 lets you adjust the oscillator frequency to zero-beat with a known rf standard such as the National Bureau of Standards radio station WWV (2.5, 5, 10 mc, etc.)

The oscillator is coupled to a pulse-generating circuit. A transistorized version of the Schmitt trigger circuit, it is used to change the sine-wave output of the oscillator (Fig. 1-a) to a square wave (Fig. 1-b). The har-

*Project Engineer, Harman-Kardon, Inc., Plainview, N.Y.

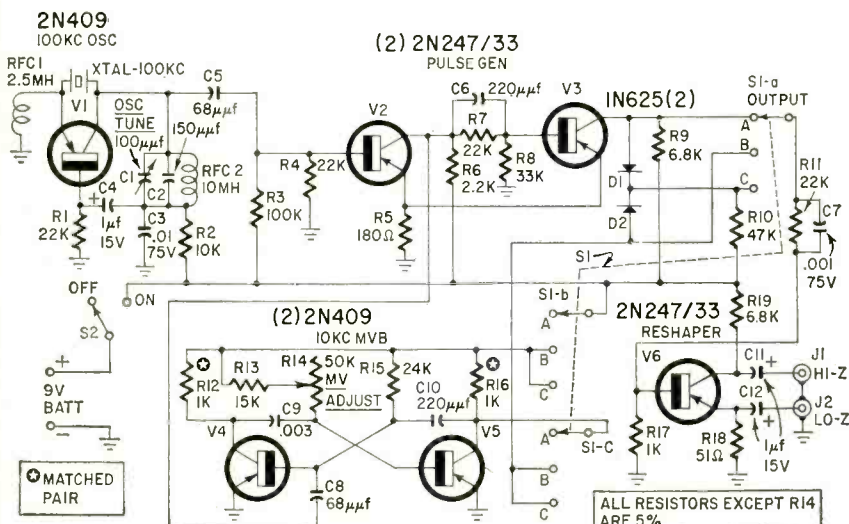

Circuit of the frequency standard.

- R1, R4, R7, R11—22,000 ohms
 - R2—10,000 ohms
 - R3—100,000 ohms
 - R5—180 ohms
 - R6—2,200 ohms
 - R8—33,000 ohms
 - R9, R19—6,800 ohms
 - R10—47,000 ohms
 - R12, R16—1,000 ohms, matched pair
 - R13—15,000 ohms
 - R14—pot, 50,000 ohms, linear taper
 - R15—24,000 ohms
 - R17—1,000 ohms
 - R18—51 ohms
- All resistors except R14 are 1/2-watt 5% units
- C1—100 μ f, variable (Hammarlund HF-100 or equivalent)
 - C2—150 μ f, silver mica
 - C3—.01 μ f, 75 volts, miniature ceramic (Lafayette C-612 or equivalent)
 - C4, C11, C12—1 μ f, 15 volts, miniature electrolytic (Lafayette CF-128 or equivalent)
 - C5, C8—68 μ f, mica
 - C6, C10—220 μ f, mica
 - C7—.001 μ f, 75 volts, miniature ceramic (Lafayette C-609 or equivalent)
 - C9—.003 μ f, silver mica
- BATT—9 volts, mercury (RCA VS300A or equivalent)
 - D1, D2—1N625
 - J1, J2—coaxial connectors
 - RFC 1—2.5 mh
 - RFC 2—10 mh
 - SI—3-pole 3-position rotary
 - S2—sps toggle
 - V1, V4, V5—2N409
 - V2, V3, V6—2N247/33
 - XTAL—100-kc crystal (International Crystal FO-8)
 - Xtal socket (1)
 - Transistor sockets (6)
 - Battery holder (1)
 - Case, 4 x 4 x 2-inch utility cabinet
 - Chassis, 3 3/8 x 1 3/4 inches
 - Miscellaneous hardware

monic content of a sine wave is practically nil while a square wave is rich in these harmonics. Therefore, the square-wave output of the pulse generator allows reception of the fundamental 100-kc signal well into the vhf region.

The harmonic content of this square wave depends mainly upon the rise time of the leading edge of the pulse—how fast the pulse rises from zero to its maximum voltage. The faster this rise time, the greater the number of harmonic frequencies in the output and the greater their overall strength.

Two 2N247/33 transistors are used in the circuit. They provide a measured rise time of .03 μ sec (Fig. 2). This means that the harmonic content of the pulse is such that the 100-kc signal is received at the same level at 30 mc as it is at 100 kc. This level starts to fall off above 30 mc, but the signal can still be received up to 150 mc.

Output from the pulse generator is then coupled to a reshaper amplifier through the output selector switch. At the same time, a synchronizing pulse taken from V2 drives an asymmetrical 10-kc multivibrator that uses a conventional cross-coupled circuit. The collector load resistors, R12 and R16, should be matched. They may require some change in value with individual transistors for proper 10-kc operation. Capacitors C9 and C10 have different values to provide an output pulse of the proper width for mixing with the 100-kc signal (Fig. 3). If the 10-kc pulse is too wide, it would blank out some of the 100-kc pulses during mixing and cause improper frequency marking in the receiver.

So we can adjust the multivibrator output frequency for exact 10-kc operation, the base resistor (R14) of one transistor is made variable. It allows a frequency range of 4.8 to 20 kc, so the multivibrator can be synchronized on frequencies other than 10 kc. When varying the frequency, the width of the output pulse remains constant. Output from the multivibrator is also coupled to the reshaper amplifier through the output selector switch.

With S1 in position A, we get 100-kc output. The 10-kc multivibrator is disabled in this position to prevent 10-kc leak-through. In position B, the multivibrator is turned on, and we get only 10-kc output. The 100-kc signal is bypassed. The oscillator and pulse generator are not turned off because the 100-kc pulses are required to sync the multivibrator. In position C, all circuits are on and output from the pulse generator and the multivibrator are mixed in a diode mixing circuit to provide a 100-kc signal with 10-kc markers. Two diodes in the mixing circuit prevent interaction between the 100- and 10-kc signals.

Because of the wiring, S1 and the mixer diode capacitances, the rise time of the output pulse decays slightly. It is compensated for by the 2N247/33 reshaper amplifier. This amplifier is also used to provide the high and low output impedances.

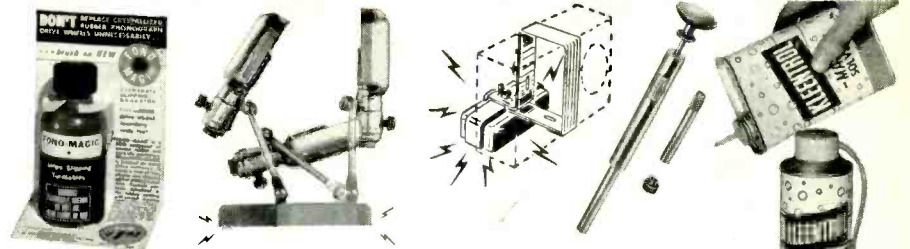

SHORT CUTS FOR SERVICE PROFITS!

FONO-MAGIC—a liquid compound of Special Rubber and precious carbide particles forms a live rubber coating on metal phono drive parts . . . stops slipping and dragging caused by crystallized rubber drive wheels. Contents are equivalent to the replacement of 100 idler wheels; will not wear off. dealer net . . . **\$1.95**

MAGNA-LITE—superpowerful magnet clamps light to chassis, transformers, brackets, etc. Does away with flashlight servicing. 3-way swivel action puts light exactly where needed. net . . . **\$5.95**

CARDIO MASTER—super powerful magnetic device, designed to hold a portable transistor radio in the area of a car's windshield and make it operate as a car radio. List Price **\$4.95**. dealer net **\$2.97**

TROLMASTER—cleans and lubricates TV-Radio controls in 60 seconds from the front of set without removing chassis or back from cabinet. Solid brass construction. dealer net . . . **\$3.59**

KLEENTROL MAGIC SOLVENT—approved by C.A.A.; contains no Carbon-Tet: non-flammable; will not harm finishes of wood, metal, or acetate parts. net (5-oz. spray can incl. injector tube) **\$1.25** pint size . . . **\$1.95 net.**

METAL STROBE—handy all metal speed determining tool that lasts a lifetime; 4 speed design. dealer net . . . **\$9**

NU-SHAFT—repairs broken clock-radio shafts without removing set from cabinet. Kit includes 7 Nu-Shafts and 21 replacement knobs of asst. colors. net . . . **\$1.95**

HUMI-KUP 2 SET COUPLERS—hermetically sealed for outdoor installation; all inductive circuitry; skin packaged for self service sales. List **\$3.95**. Dealer net **\$1.95**

Sold at better jobbers everywhere—Detailed literature upon request. Write Dept. P-10

R-COLUMBIA PROD. CO., INC.

2008 St. Johns Ave., Highland Park, Ill.

NEW!

MA-300 only **\$34.95** list

WINEGARD Transistor TV-FM TENNA-BOOST

Mounts on Any Antenna!

19 D.B. GAIN! CUTS SNOW. BOOSTS SIGNAL

Make any TV or FM Antenna work better by amplifying signals with the new Winegard Tenna-Boost.

19 DB gain—no peaks and valleys. Linear frequency response—extremely low VSWR. All AC power supply.

Because of its extra power, the Winegard Tenna-Boost can be used to operate up to 6 TV sets from one antenna. Works perfectly for black and white and color . . . plus FM and FM stereo.

There's a big difference in antenna amplifiers! Ask your distributor or write for technical bulletin.



Winegard

3013-7 Scotten, Burlington, Iowa

Television
RADIO-ELECTRONICS

Electricity
ELECTRONICS

IN NEW SHOP-LABS OF **COYNE**

TRAIN QUICKLY! OLDEST, BEST EQUIPPED SCHOOL OF ITS KIND in U.S.

Get practical training in New Shop-Labs of Coyne. Prepare for a better job and a successful future in a top opportunity field. Advanced education or previous experience not needed. Employment service to graduates.

Enroll NOW—Pay Later

Finance Plan and Easy Payment Plan. Also Part Time Employment help for students.

FREE BOOK Clip coupon or write to address below for Free Illustrated Book "Guide to Careers"—Describes all training offered. No obligation and No Salesman Will Call. Act NOW.

B. W. Cooke, Jr., President

CHARTERED NOT FOR PROFIT ESTABLISHED 1899 1501 W. Congress Pkwy., Chicago, Dept. B2-N

COYNE
ELECTRICAL SCHOOL

COYNE Electrical School
1501 W. Congress Pkwy., Chicago 7, Ill.
Dept. B2-N

Send FREE book "Guide to Careers" and details of all training you offer. However, I am especially interested in:

ELECTRICITY TELEVISION BOTH FIELDS

NAME.....

ADDRESS.....

CITY.....STATE.....

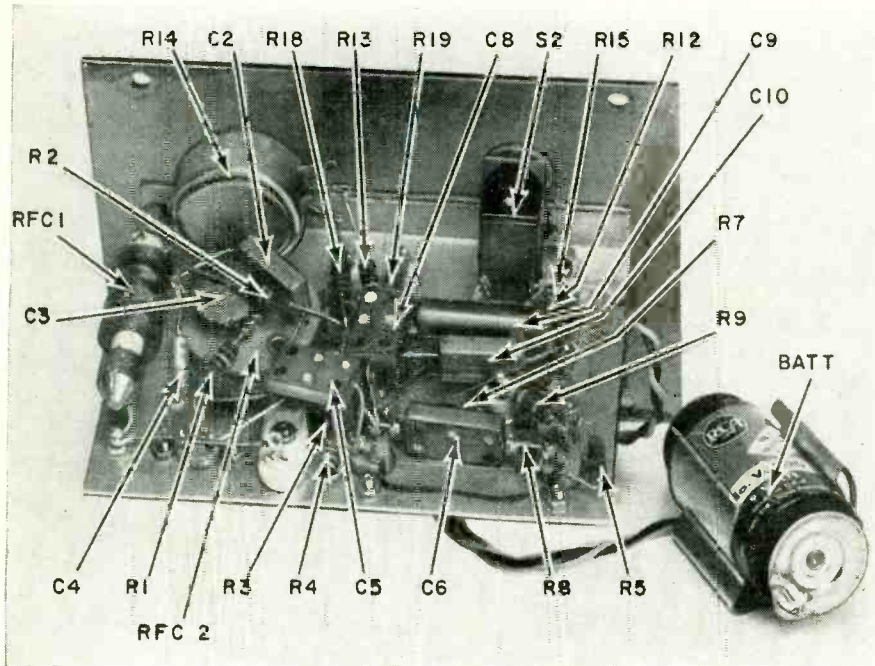

Underchassis of the instrument.

too much decay in the output pulse.

Two UG-290/U BNC connectors are used for the output terminals and are mounted on one of the 4-inch sides of the cabinet. Although BNC's were used, just about any low-loss terminal can be used.

Calibration is easy

After the unit is completed and all wiring checked, insert a 2N409 into the oscillator socket. Connect an oscilloscope between output and ground, and apply power to the oscillator. The circuit should oscillate at once, regardless of the setting of C2. If it does not, or if it oscillates only with C2 fully meshed, try another 2N409. If the same thing happens, the lead from the oscilloscope may be loading the circuit. If this happens, insert a 47- μ f mica capacitor in series with the lead.

Once the oscillator is working properly, insert the two 2N247/33's in their sockets and touch the scope probe to V3's collector. An asymmetrical square wave should be seen. If there is no output, either the circuit has not been

Construction tips

The unit is built into a 4 x 4 x 2-inch utility cabinet. All components except the controls, battery and diodes are on a 3/8 x 1 1/4-inch aluminum chassis mounted on one of the removable case panels.

Transistor sockets are used to facilitate wiring and keep leads as short as possible. Although layout is not critical, standard practices should be followed when wiring rf circuits. All connections and interconnections should be direct. This is required to keep wiring capacitances at a minimum and prevent

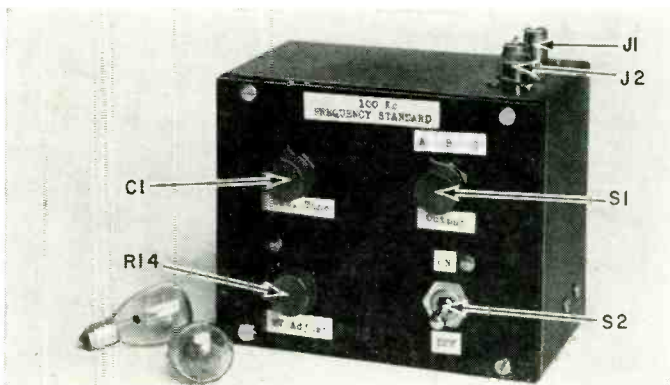

Completed unit is small enough to fit in a tool case.

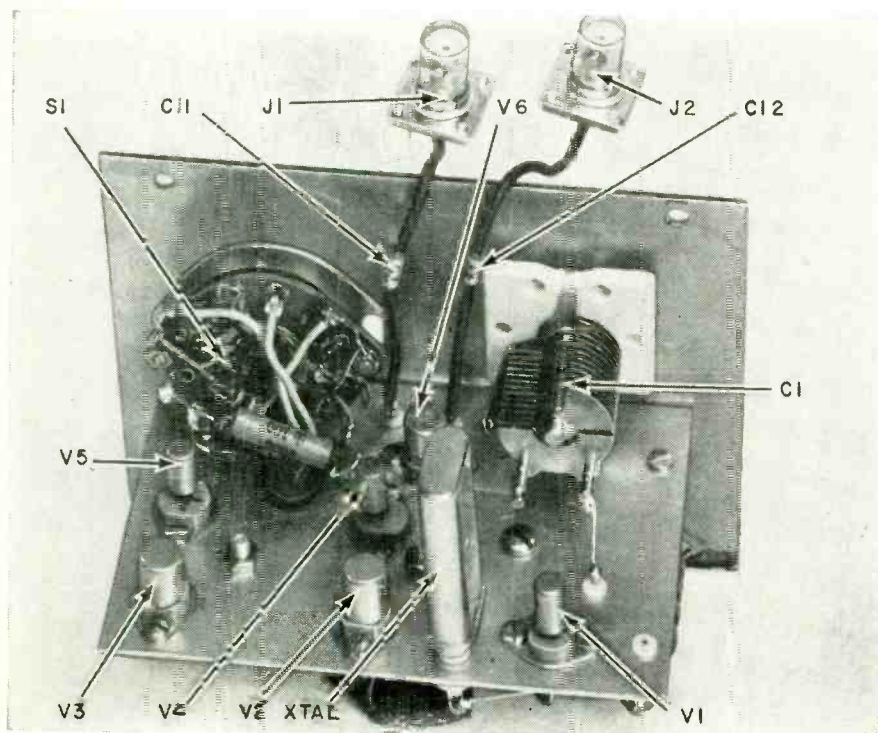

Top-chassis view inside the instrument.

wired correctly or the transistors may be defective. Try different transistor combinations to determine if the transistors are at fault. (The oscillator should be functioning at all times.) Next, insert the two 2N409's. Connect the scope between V5's collector and ground. Place S1 in position B. An output pulse, similar to Fig. 3, should be seen. Vary the MV ADJUST control. The spacing between pulses should change while the width of the pulse remains constant. No output from this circuit means either incorrect wiring or a defective transistor.

After these circuits have been checked and are operating, connect the

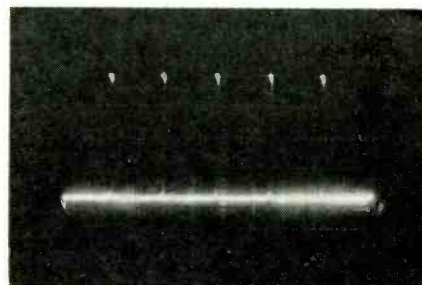
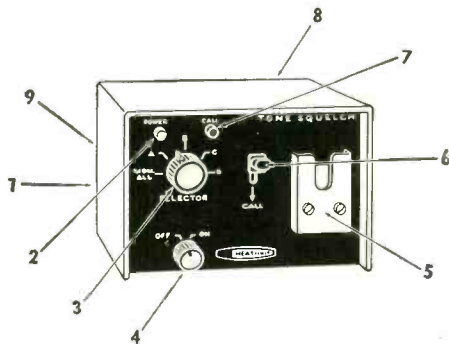

Fig. 3—10-ke multivibrator output.

First new concept in citizen's band equipment in two years! . . . Heathkit 4-Position Selective-Call kit



*an exclusive with
Heath, this inexpensive
unit converts your
CB station from
"party line" confusion
to "private line" calling
convenience*



FEATURES

(1) squelch time-delay control, (2) power indicator, (3) tone selector switch (4 tones plus "monitor all" position), (4) tone squelch "defeat" switch for normal operation (5) "lift-to-operate" microphone bracket, (6) "call" lever (7) "call" indicator, (8) external alarm contacts to signal received call, (9) input and output level controls.

Here's welcome news for the serious user of Citizen's Band two-way radio. Heath's new Selective-Call Kit with tone squelch makes it possible for you to enjoy the calm of a CB station that is completely silent, yet ever alert for a personal call . . . makes it possible for you to call your choice of four specific units in your system at the touch of a button.

Using a unique new method, Heath's Selective-Call Kit features an *exclusive* 4-position rotary selected resonant-reed relay which responds only to calls transmitted by similarly equipped units using the same tone frequency. Upon receipt of the proper tone, your unit will automatically "come to life" permitting you to hear the call letters transmitted . . . you reply by merely lifting the microphone and acknowledging. At all other times, your station is peacefully quiet, allowing you to perform your job without one ear "cocked", for this unit does your listening for you.

To call another unit, just select the correct one of four tone frequencies, press the lever, and the called station will be waiting for you. Nothing could be simpler or more convenient. A "defeat" switch allows normal transceiver operation at any time. Equip all your CB units now with this economical new advance in communication ease . . . instructions included for installation with most popular CB transceivers using PTT.

Kit GD-162A (AC), no money down, \$5 mo. \$33.95; Kit GD-162D (DC) \$37.95



GW-11 3-channel transceiver from \$69.95



GW-12 Single channel all crystal controlled transceiver from \$39.95



GW-31 Low Cost "Walkie-Talkie" from \$24.95



GW-21 Superhet "Walkie-Talkie" from \$44.95



HEATH COMPANY
Benton Harbor 20, Michigan

Ordering instructions: Fill out the order blank, include charges for parcel post according to weights shown. Express orders shipped delivery charges collect. All prices F. O. B. Benton Harbor, Mich. A 20% deposit is required on all C.O.D. orders. Prices subject to change without notice. Dealer and export prices slightly higher.

Enclosed is \$ _____; send _____

Name _____

Address _____

City _____ Zone _____ State _____

Handling The Metric Prefixes

By RUFUS P. TURNER

Whether we are concerned with large or small quantities, the metric prefixes save a lot of time, breath, and printer's ink. Most of these have been around a long time, and electronic men use a few of them very often (centi-, kilo-, mega-, micro-, and milli-).

We have gone on to compound them to express the very large and the very

small (thus, *kilomegacycle*, *micromicro-watt*, etc.) and the thing got out of hand a long time ago. Now we have four new prefixes which do away with such mouthfuls. Instead of 1 millimicrosecond, we can now say 1 *nanosecond*; instead of 10 micromicrofarads, 10 *pico-farads*; and instead of 2 kilomegacycles, 2 *gigacycles*.

The accompanying table will be con-

venient for converting metric quantities of one order of magnitude to those of another order. Simple multipliers are given. Thus, to convert *microfarads* into *picofarads*, multiply by 10^6 (which is 1,000,000); to convert *kilocycles* into *megacycles*, multiply by 0.001; to convert *nanoseconds* into *microseconds*, multiply by 0.001. Clip this table and paste it in your notebook. END

TO CONVERT THESE TO THESE, MULTIPLY BY THE FIGURES BELOW

	Pico—	Nano—	Micro—	Milli—	Centi—	Deci—	Units	Deka—	Hekto—	Kilo—	Myria—	Mega—	Giga—	Tera—
Pico—		0.001	10^{-6}	10^{-9}	10^{-10}	10^{-11}	10^{-12}	10^{-13}	10^{-14}	10^{-15}	10^{-16}	10^{-18}	10^{-21}	10^{-24}
Nano—	1000		0.001	10^{-6}	10^{-7}	10^{-8}	10^{-9}	10^{-11}	10^{-11}	10^{-12}	10^{-17}	10^{-15}	10^{-18}	10^{-21}
Micro—	10^6	1000		0.001	0.0001	10^{-5}	10^{-6}	10^{-7}	10^{-6}	10^{-9}	10^{-10}	10^{-12}	10^{-15}	10^{-18}
Milli—	10^9	10^6	1000		0.1	0.01	0.001	0.0001	10^{-5}	10^{-6}	10^{-7}	10^{-9}	10^{-12}	10^{-15}
Centi—	10^{10}	10^7	10,000	10		0.1	0.01	0.001	0.0001	10^{-5}	10^{-6}	10^{-8}	10^{-11}	10^{-14}
Deci—	10^{11}	10^8	10^5	100	10		0.1	0.01	0.001	0.0001	10^{-5}	10^{-7}	10^{-10}	10^{-13}
Units	10^9	10^6	10^6	1000	100	10		0.1	0.01	0.001	0.0001	10^{-6}	10^{-9}	10^{-12}
Deka—	10^{13}	10^{10}	10^7	10,000	1000	100	10		0.1	0.01	0.001	10^{-5}	10^{-8}	10^{-11}
Hekto—	10^{14}	10^{11}	10^8	10^5	10,000	1000	100	10		0.1	0.01	0.0001	10^{-7}	10^{-10}
Kilo—	10^{15}	10^{12}	10^9	10^6	10^5	10,000	1000	100	10		0.1	0.001	10^{-6}	10^{-9}
Myria—	10^{16}	10^{13}	10^{10}	10^7	10^6	10^5	10,000	1000	100	10		0.01	10^{-5}	10^{-8}
Mega—	10^{18}	10^{15}	10^{12}	10^9	10^8	10^7	10^6	10^5	10,000	1000	100		0.001	10^{-6}
Giga—	10^{21}	10^{18}	10^{15}	10^{12}	10^{11}	10^{10}	10^9	10^8	10^7	10^6	10^5	1000		0.001
Tera—	10^{24}	10^{21}	10^{18}	10^{15}	10^{14}	10^{13}	10^{12}	10^{11}	10^{10}	10^9	10^8	10^6	1000	

portable precision frequency standard

(continued)

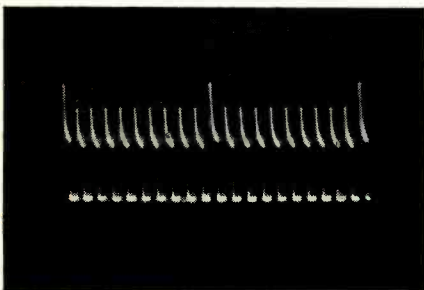

Fig. 4—100-kc output shown with 10-kc markers.

scope leads to the high-impedance output terminal and ground. Place S2 in position A. The output signal should be the same as in Fig. 1-b. Switch to position B. The output should match Fig. 3.

Switch to position C. A mixed signal should be seen with the 10-kc pulses of slightly larger amplitude than the 100-kc pulses. Adjust R14 until there are exactly nine small pulses between the larger pulses, as in Fig. 4.

Return S1 to position A, and couple the standard to a communications receiver. Tune the receiver to WWV (2.5, 5, 10 mc, etc.) and adjust C1 until the 100-kc signal zero-beats with WWV.

Switch to position B. The 10-kc signal should also zero-beat with WWV. Detuning the receiver should produce a squeal or hash on either side of zero beat.

The standard is now calibrated and ready for use. C1 should require no further adjustment and may be locked in place, although for precise measurements it should be checked with WWV prior to use.

As stated earlier, supply is 9 volts. Though not critical (the standard will operate on as little as 5 volts), the voltage should be kept within $\pm 5\%$ for optimum results. END

LEARN

electronics theory this easy way.
No previous technical knowledge required.

BUILD

the finest professional quality TV Set
on a practical "pay-as-you-wire" plan.

SAVE

up to 1/2 on cost of equivalent
educational course plus TV set.

Build the Transvision "Professional" TV Kit
described below and get this complete course
of study for \$7.95 (available only to
Transvision Kit builders.)

Requires no previous technical knowledge.
Prepared by experts in teaching novices
about electronics.

YOU LEARN: About block diagrams... How to read and follow electronic circuits... How to use basic measuring instruments... Theory and operation of basic electronic circuits... How to service TV, Radio, and other types of electronic equipment.

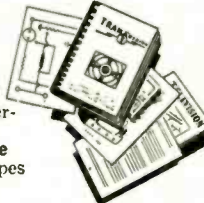

Prices range
from \$119 to \$199.



The Transvision "Professional" TV Kit

Choice of 19", 23", or 27"
Picture Tube... Easy "Pay as
You Wire" Terms... Only \$15
for the Starting Package.

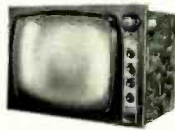

A few of the Professional Quality Features
of Transvision TV Kits:

Choice of push-pull 10-watt audio or output to
your Hi-Fi System... D.C. restoration... Ultra-
linear sweep circuits... Standard Coil Model
PKO Automatic Tuner... Super-sensitivity for
fringe areas... Complete line of Accessories for
Custom Installations.

U. S. Armed Services and over 4000 schools and
colleges have selected Transvision Receivers for
educational television.

ASSEMBLY MANUAL—\$2.00

See how easy it is to assemble the Transvision
Kit. Cost of Manual refunded on purchase of Kit.



Grey Oaks Ave.
Yonkers, N. Y.
YO 5-6900

START NOW—MAIL THIS COUPON

TRANSVISION ELECTRONICS, Grey Oaks Ave.,
Yonkers, N. Y., RE-L7

- Send FREE 12-page Catalog... I enclose \$2 for Assembly
Manual, refundable on purchase of Kit.
 I enclose \$15 for Starting Pkg. on pay-as-you-wire plan.
(Complete Kits range from \$119 to \$199.)

Name _____
Address _____
City _____ Zone _____ State _____

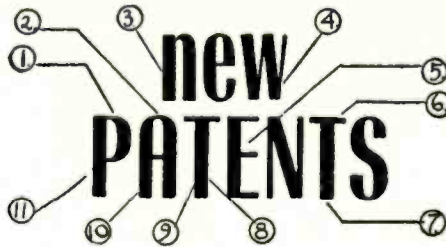

STEPLESS POTENTIOMETER

Patent No. 3,008,111

Loebe Julie, c/o Julie Research Labs, Inc., 603
W. 130th St., New York 27, N.Y.

A wirewound potentiometer can be varied
only in steps, as each turn enters and leaves
the circuit. This new device permits finer varia-
tion. The wiper is made of relatively high-resis-
tance material and it contacts several turns at
the same time.

For clarity, only two turns are shown in
the diagram. The wiper is drawn as a resistor
with a conductive lead at its center. At a par-

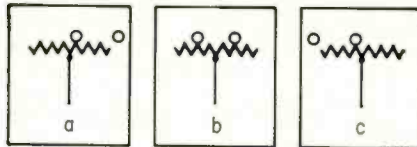

ticular instant (a) the wiper is centered at one
turn. Consequently, the output potential must
be that of the turn. At a later instant (b) the
wiper has moved to the right, and now it acts
as a center tap between the turns. Finally (c)
the output lead has the same potential as the
second turn.

If the wiper resistance is properly chosen,
it is clear that output potential will vary uni-
formly and slowly as the wiper is moved through
very short distances.

FREQUENCY DIVIDER

Patent No. 2,981,899

Alwin Hahnel, Rochester, N.Y. (Assigned to United
States of America as represented by the Secretary
of the Army)

This invention describes a simple fre-
quency divider, but lists no component values
or transistor type.

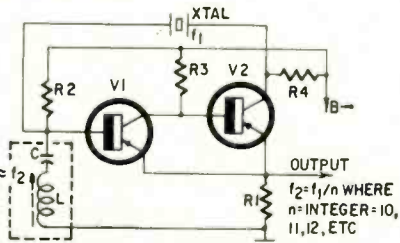

The two-transistor circuit provides regen-
eration at the L-C frequency. Due to the crystal
control, subharmonics will have the same stabili-
ty as the crystal itself.

BROAD-BAND AMPLIFIER

Patent No. 3,015,071

Robert V. Goodman, Summit, N.J. (Assigned to
Bell Telephone Labs, Inc., New York, N.Y.)

The common-base connection is best for
frequency response but not for maximum gain.
Here a tube adds its gain to that of a transistor.

For example, assume a positive signal at
the emitter. V1 passes more current through R
and network A. The greater voltage drop across
A means a positive signal at the grid, so the
cathode current increases. Since tube electron
flow cancels transistor hole flow, the signal cur-
rent is reduced. For a given output current,
the input is much less due to tube action. There-
fore the gain has increased.

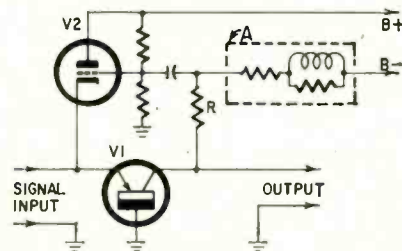

A improves the wide-band response as
follows: The grid signal is the product of col-
lector current and impedance of A.

The network is designed for a rising fre-
quency characteristic to counteract the falling
frequency characteristic of V1. Therefore the
grid signal remains constant (with respect to
frequency) over a broad band.

DC-AC VOLTMETER

Patent No. 2,970,268

Bernard E. Lenehan, Bloomfield, N.J. (Assigned to
Westinghouse Electric Corp.)

This moving-vane meter is designed to elim-
inate vibration when measuring ac. It consists
of three stators and a moving vane or rotor,
all made of soft iron. Current through the coil
sets up magnetic poles in the iron elements.

Either dc or ac may be fed into the coil.
When the instantaneous direction of the flow is
as shown by the arrows on the coil, north (N)
and south (S) poles will be induced. Stators
1 and 3 will attract the rotor. Since the tapers
of stators 1 and 3 grow wider in a clockwise
direction (viewed from the top), the rotor tends

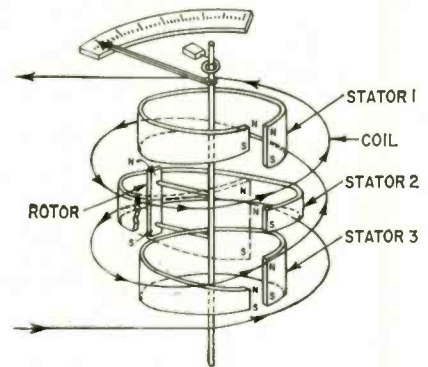

to move clockwise to get closer to these stators.
On the other hand, stator 2 will repel the rotor.
Since stator 2's taper grows narrower, the rotor
will again be forced clockwise because of
repulsion of like poles.

Due to the balanced forces of the top and
bottom stators, there is no tendency for the
rotor to vibrate longitudinally. Also, the calibra-
tion will be linear. Shielding and other mechan-
ical details are also described by the inventor.

TUBE-TRANSISTOR AMPLIFIER

Patent No. 3,015,070

Louis W. Erath, Houston, Tex. (Assigned to Dres-
ser Industries, Inc., Dallas, Tex.)

Transistors are capable of high gain, but
their low input impedance is often a disadvan-
tage. In this amplifier, the signal is impressed
across the very high impedance of an electro-

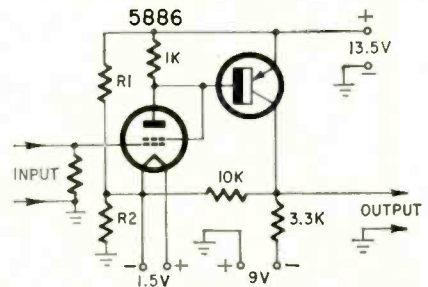

meter type tube. The small plate resistor per-
mits good high-frequency response.

The tube output biases the transistor,
which provides further gain. Part of the output
is fed back for degeneration. When the signal
increases, the filament goes more positive to cut
gain.

R1-R2 form a voltage divider to bias
the grid to about 0.5 volts and keep the input
impedance high.

our patent problem—

a proposed solution

During correspondence with inventor Benjamin Miessner concerning his recent contribution "Credit to War-time Inventors," the following letter was received. RADIO-ELECTRONICS believes the technical public will be very much interested in the practical solutions it proposes for a number of our patent weaknesses.

Dear Hugo:

My thanks for your recent letter relative to our patent system. It occurs to me that no better time could *ever* be found for constructive improvement suggestions. The patent system has been much in the news lately, and American Patent System Week should bring it into sharp focus all over the country.

I have read your letter several times. With much of it I agree; with some I do not for reasons I will explain:

1. Patent Office's application log jam.

There are two reasons why application processing has fallen so far behind. The first is that modern technology has grown so complicated, and the search area for relevant prior art has so greatly increased that only those examiner-specialists of long experience and knowledge of their subjects can deal effectively with new advances in their fields.

The second is that, once a young examiner becomes proficient in his field, he is lured away by private industry with higher pay inducements. Thus trained at taxpayers' expense, private industry gets the benefit.

For the first trouble I would suggest that computer techniques could be used for storing and quick retrieval of all the bits of prior art. If the FBI can find, among many millions, a particular fingerprint; if the Internal Revenue Department can find among many other millions particular facts concerning one individual taxpayer's financial details, and if the registrar of prospectors' claims or the real property tax department of any large city can find who owns each bit of land within its environs, all merely by pushing the appropriate button, then the Patent Office should be able to find very quickly what it needs to know in processing patent applications.

For the second trouble I would suggest either one or both of the following remedies:

a. That universities establish courses for graduate engineers and physicists in patent engineering in all of the established fields of technology specialization. These must first know their field's technology and its history; then they must know patent law, search methods and claim analysis. This is the

beginning only. At present, an engineer with only a smattering of knowledge in a specialized field, and no knowledge at all of patent law, enters the Patent Office as an assistant examiner—like a shop apprentice. Or he may be a young lawyer, with a smattering of patent law and *no* knowledge of technology.

There his every action must be supervised, in this training process, by senior examiners and division chiefs. A great many of the processing "actions" by these trainees are utterly worthless both to the Patent Office and to the patent applicant.

b. On entering the patent office these beginners should be *put under contract* for, say, 5 or 10 years, with a modest starting salary and steady advances year by year, as in the defense services. That scale of salaries should equal that in private industry to stimulate his choice of this field in the first place.

It must be remembered that a good examiner must know a particular field of technology intimately, and he must also know patent law equally intimately. He cannot acquire all of this knowledge in any university curriculum, any more than a brain surgeon can in a school of medicine. Only in the hospital or the Patent Office can these novitiates fully learn their profession. If this is learned at taxpayers' expense, as in our military academies, by training in the Patent Office, the young would-be examiner should be required to stick with his job long enough for the taxpayers to enjoy the fruits of that training. As it is now, private industry reaps these benefits.

The French registration system is utterly worthless, and its "Sans Garantie du Gouvernement" is not one whit different from our own.

The German system is infinitely better than our own. The caliber of their examiners is very much higher. Albert Einstein, for example, was once one of their examiners. Their prior-art searchers are very thorough and competent. Once satisfied that an applicant is entitled to the claims he seeks, the German Patent Office publishes his disclosure and claims and by this asks all and sundry to present valid objections based on previously unnoted prior art. This

is much like our own marriage ceremony wherein the officiating officer asks any one who has valid objections to the marriage to stand up and present them, or "forever hold his peace."

Unless such valid objections to the issuance of a patent are presented within a reasonable time (a month or two, as I remember), the patent is issued and stands against any later contentions by others. Such a patent can be no "invitation to a law suit" as are US patents.

I have, in a letter to Mr. Todd of the Patent Office, emphasized other ills of our patent system. I must re-emphasize the shortness of the 17-year patent term. Copyrights run 56 years, and now recommended is an increase to *76 years!* A great many of our most important patents expire before going into use, and the inventor gets nothing for his creative pains, yet private industry and the public receive the benefits far into the future.

[Mr. Miessner holds more than 100 American and many foreign patents, and is president of the Patent Equity Association, a non-profit organization dedicated to reviving and protecting the American patent system.]

BEN MIESSNER



"... Well, last year I took mine on Thursday."

NEW PRODUCTS

FM MULTIPLEX GENERATOR, model 725. Aligns receivers or adapters, doubles as floor demonstrator of FM stereo. Complete FM multiplex signal. Composite output: L + R generated by 2 stable, self-contained oscillators 400 cycles and 1,200 cycles; L - R produced by double-balanced modulator; L - R sidebands of suppressed 38-kc

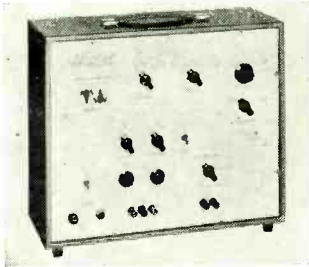

subcarrier; 19-kc pilot carrier. RF output tunable over FM band, modulated with composite stereo signal, variable from 2-1,000 μ v. Generator modulated by external signal source, fully compensated for correct L - R vs L + R delay.—**Hickok Electrical Instrument Co.**, 10514 Dupont Ave., Cleveland 8, Ohio.

MULTIESTER, Micronta. 31-range precision 30,000-ohms/volt unit has 9 dc volt ranges, built-in buzzer for continuity check, 1% precision resistors. Dc volts to 1,000 at 30,000 ohms/volt; ac to 1,000



at 13,000 ohms/volt; -20 to +56 db in 6 ranges. Output 0 to 1,000 volts, 2-color, full-view 4-inch meter.—**Radio Shack Corp.**, 730 Commonwealth Ave., Boston 17, Mass.

POWER SUPPLY/BATTERY ELIMINATOR, model 36-562, for extended operation of units without batteries. Dc, 0-24-volt unit checks current drain; large capacitor filter provides less than 1% ripple. Full-wave rectification with 2

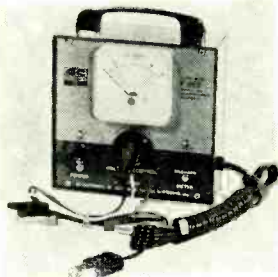

silicon rectifiers. Meter ranges: 0-24 vdc, 0-100 ma dc. Dpst on-off switch shuts off ac, disconnects meter, works on 110-125 vac, 50-60 cycles. Recharges nickel-cadmium batteries. Built-in leads: common, B+ variable, 1.5 volts. Leads equipped with insulated miniature clips, 5 x 5 x 1 1/8 in.—**GC Electronics Co.**, 400 S. Wyman St., Rockford, Ill.

TRANSISTORIZED CRYSTAL CALIBRATORS, Model TE-27 (illus.) 2 crystal-controlled transistor oscillators, harmonics, sufficient for accurate markers every 1 mc through 54 mc. In 100-kc position, tones produced to 54 mc. **Model TE-29:**



100-kc harmonics to 54 mc. Both calibrate and align receivers and vfo's, mark receiver band edges. Can be beat against WWV for accurate calibration.—**Lafayette Radio Electronics Corp.**, 111 Jericho Turnpike, Syosset, N. Y.

WIDE-BAND SCOPE, model PS120. Reproduces waveforms 20 cycles to 12 mc. Automatic range indicator on vertical input control for direct



reading of peak-to-peak voltages. Standby position on power switch. Full-width calibrated graph.—**Sencore, Inc.**, 426 S. Westgate Dr., Addison, Ill.

ALL-TRANSISTOR POWER SUPPLY, model P612. Converts 110-volt ac to 0-16 volts dc. Use bench power supply in auto radio repair. Operates any auto radio including automatic-tuning and all-transistor types. Rated output 8 amps continuous at 6 volts, 5 amps continuous at 12 volts, .01% ripple at rated load. Electronic filter-



ing, 20 amps instantaneous output. Dc equivalent output capacitance 1.5 farads, operates Wonder Bar radio with 16-amp solenoid at 12-v input. With proper polarity, recharges batteries.—**Delco Radio Div.**, General Motors Corp., Kokomo, Ind.

VTVM KIT, model 211. Full-view 6-in. meter with flat scales. Special circuit protects meter against overloads and vibration damage. 1% precision resistors, 36- μ f shunting capacitance. Cali-

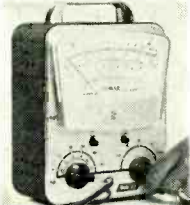

bration simple and stable; transformer power supply with selenium rectifier. Assembled or kit.—**Conar Instruments**, 3939 Wisconsin Ave., Washington 16, D. C.

TUBE TESTER, model 885S. For in-shop, do-it-yourself testing. Checks all new tubes including 9-pin Novars, 12-pin compactrons, 10-pin tubes and nuvistors, plus all previous popular TV tube types and modern radio tubes and hybrids. Grid circuit test; cathode emission test using low im-

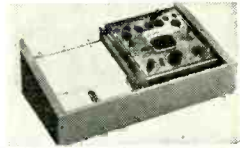

pedance, low test voltage circuit and vacuum-tube meter; filament continuity and open element tests. 12AU7 2-stage dc amplifier, selenium rectifier power supply. Single 5-ma meter shows grid circuit and tube test results, rotary and lever switches for pin isolation and transposition.—**Seco Electronics, Inc.**, 5015 Penn. Ave. So., Minneapolis 19, Minn.

INDICATING FUSE/HOLDER. Transparent holder knob shows indicating pin on open GBA fuse. Pin identifies open circuit with power on or

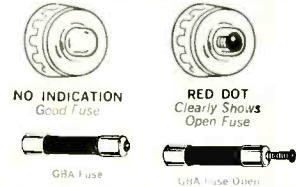

off. Molded phenolic body, held mechanically and by solder.—**McGraw-Edison Co.**, Busman Mfg. Div., University at Jefferson, St. Louis 7, Mo.

BULLDRIVER. Fluted handle of Amberly

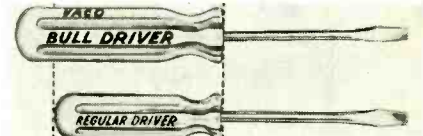

plastic. No. 6150 chrome vanadium steel blade. Six sizes.—**Vaco Products Co.**, 317 E. Ontario St., Chicago 11, Ill.

PRODUCTION TOOL, model 7104. Adjustment ends match manufacturer's trimmers. Metal ferrule guides tool to position, prevents slippage,



provides wear-resistance. Plastic cylindrical handle may be covered by knurled aluminum slip-on when making precision adjustments.—**JFD Electronics Corp.**, 6101 16th Ave., Brooklyn 4, N. Y.

LIQUID CLEANER KIT, Contacore II. Cleans and protects TV tuner contacts. Nonflam-



mable solution, lint-free cloth, nonevaporating channel-contact lubricant.—**Standard Kollsman Industries, Inc.**, 2085 N. Hawthorne Ave., Melrose Park, Ill.

SOLDERING TOOL, Mark V. Plier action holds pieces while heat is applied. 250-watt dual-

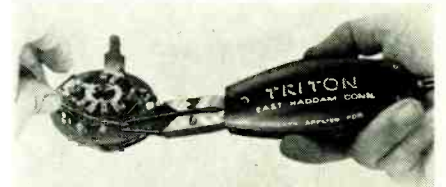

heat transformer. Interchangeable tapered carbon tips and metal tips.—**Triton Mfg. Co.**, 1229 Town St., East Haddam, Conn.

BOOKSHELF SPEAKER SYSTEM, model SH4-W. 5-in. deep, 2-way unit. Bass-reflex type cabinet with tuned port, 8-in. woofer, 3 1/2-in. tweeter and electrical crossover network. Shelf or

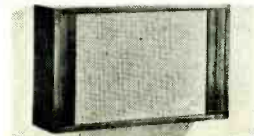

wall mounting.—**Utah Electronics Corp.**, 1124 E. Franklin St., Huntington, Ind.

SPEAKER ENCLOSURE, model EN-1215-C, new version of *Debonaire*. High-compliance loading duct, baffle-board cutouts and adapters allow 36

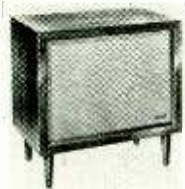

speaker combinations. Uses phase inversion and direct radiation principles. 27 $\frac{3}{8}$ x 16 x 25 $\frac{3}{8}$ in.—**University Loudspeakers, Inc.**, 80 S. Kensico Ave., White Plains, N. Y.

AUDIO COMPRESSOR AMPLIFIER. *Speak-easy*. For mobile and base CB radio transceivers. Amplifies softer modulated sounds, maintains louder ones, thus increasing average modulation



and range of transmitter without overmodulating. Built-in modulation meter or 100% modulation-indicating lamp, both with in-out and modulation controls. For 115-12 or 115-6 volts.—**Communications, Inc.**, 33 Danbury Rd., Wilton, Conn.

DYNAMIC MICROPHONES, general purpose, indoor-outdoor. Model 633 (illustrated) for use on stand, model 634 with gooseneck or boom.



Both non-directional, becoming directional at high frequencies. For fixed-station applications. Output level -57 db, frequency response 70-10,000 cycles. High impedance or 150-ohm impedance.—**Electro-Voice, Inc.**, Buchanan, Mich.

TONE ARM, model 200, for $\frac{1}{2}$ -gram tracking of stereo records. Single pivot bearing, built-in arm rest, calibrated stylus force adjustment over

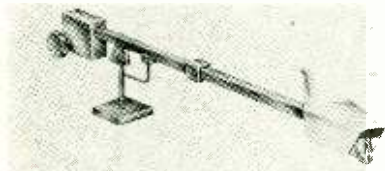

$\frac{1}{2}$ -2-gram range. Moving assembly 6 oz. Color-coded connecting leads. Overall 11 $\frac{3}{8}$ in.—**Pickering & Co., Inc.**, Sunnyside Blvd., Plainview, N. Y.

PORTABLE TAPE RECORD/PLAYBACK, *Stereorecorder* model 464-CS. 4 tracks. Belt-free, idler wheel drive mechanism. Dynamically balanced capstan-flywheel assembly. Wow and flutter less



than 0.2% at 7 $\frac{1}{2}$ ips. Pushbutton channel selection, separate volume controls, master volume control for playback, playback tone control, built-in channel integrator for sound-on-sound, 2 high-level line

inputs for recording FM stereo, stereo line outputs for connecting external amplifiers, auxiliary speaker outputs. 2 F-7 dynamic mikes.—**Superscope, Inc.** 8150 Vineland Ave., Sun Valley, Calif.

HEADSETS, Type A. For language labs, audio analgesia, aircraft, military, music listening. Porous ear cushions secured by pressure-sensitive

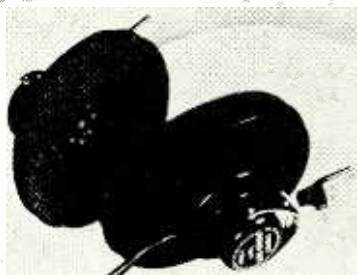

adhesive. Dynamic drivers, range 30-15,000 cycles, impedances 8-2,000 ohms monaural or stereo. 7 oz.—**R-Columbia Products Co., Inc.**, 2008 St. Johns Ave., Highland Park, Ill.

COMMUNICATION TOWERS, Rigid Tube. Triangular-designed, all-bolted construction, variable sized steel tubing. For antennas to 600 ft.,



most microwave and other communication equipment. Assembled or knocked-down.—**Rohn Mfg. Co.**, Box 2000, Peoria, Ill.

FM ANTENNA, Mark Stereo 7. 7 horizontally polarized aluminum elements. No insulators. 30 x

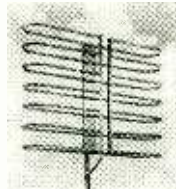

22 x 5 $\frac{1}{2}$ in. Mounting hardware.—**B & K Mfg. Co.**, Div. Dynascan Corp., 1801 W. Belle Plaine, Chicago 13, Ill.

FM ANTENNA KIT, model KG626-A, Ad-A-Kit. Omnidirectional, for mounting on existing TV

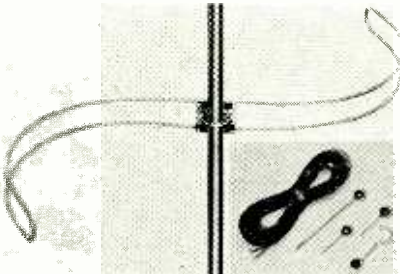

antenna mast. *Lark* S-type FM antenna, 50-ft lead-in, woodscrew and mast type standoffs.—**TACO, Technical Appliance Corp.**, Sherburne, N. Y.

BOOSTER COUPLER, model IT-4. Matched input and antenna impedance, amplifies antenna

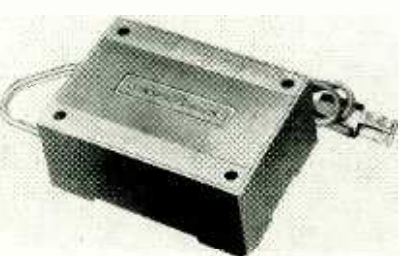

signals for all vhf channels, including color TV, and FM. Stripless terminals, transistor circuit. Average gain: channel 2, 18 db; channel 6, 14 db; channel 7-13 and FM band, 13 db. 300-ohm balanced input and output, 1, 2, 3 or 4 TV and/or FM sets. Power: 117 volts, 60-cycle, power consumption negligible. 2 $\frac{7}{8}$ x 4 x 1 $\frac{1}{8}$ in.—**Blonder Tongue Labs, Inc.**, 9 Alling St., Newark, N. J.

STEREO TUNER, model LT-78. For FM, AM, FM multiplex. Superhet AM circuit: 3 i.f. stages, avc, 8-kc bandwidth, level control. FM circuit: 200-kc bandwidth, Foster-Seeley discriminator, response 20-20,000 cycles \pm 2 db, hum level 60



db, image rejection 40 db. Variable afc. Built-in multiplex circuit: stereo separation 30 db at 400 cycles, less than 1% distortion. Rear-panel stereo dimension control, front-panel noise filter slide switch, flywheel tuning.—**Lafayette Radio Electronics Corp.**, 111 Jericho Turnpike, Syoset, N.Y.

FM TUNER/AMPLIFIER, model 340. 60 watts. Sonic-Monitor tells listener when stereo is on air. Multiplex section: 4 tubes, 9 diodes; silver-

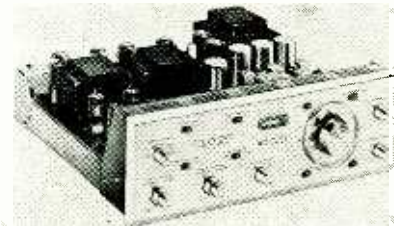

plated front end, IHFM sensitivity 2.5 μ v. Pickup selector switch for choice between phono and tape deck; subchannel noise filter; inputs for tape recorder, phono cartridge, TV and tape deck.—**H. H. Scott, Inc.**, Dept. P, 111 Powdermill Rd., Maynard, Mass.

STEREO AMPLIFIER KIT, model A50K, for novices. 50-watt unit in tool box form with removable chassis. Each package of components color-coded to section of instruction manual. Battery-operated continuity probe for stage-by-stage



checking during construction. D'Arsonval meter on tuner for proper alignment, tube sockets and terminal strips riveted to chassis. Wires stripped and precut.—**Harman-Kardon, Inc.**, Ames Court, Plainview, N. Y.

FM STEREO MULTIPLEX INDUCTORS, 5 types. For construction or replacement on multiplex adapters. *RTC-9270*, low-pass filter; *RTC-9280*, bandpass filter series element; *RTC-9281*,

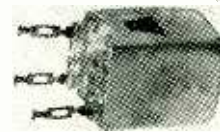

bandpass filter shunt element; *RTC-9282*, 19-kc locked-oscillator; *RTC-9283*, 38-kc output transformer.—**Stancor Electronics, Inc.**, 3501 W. Addison St., Chicago 18, Ill.

MULTIPLEX ADAPTER, model FMX-3, complements manufacturer's FM-1 tuner. Fits all Dynatuners, wholly contained on chassis. Identical mono signals from both channels or 30-db separation stereo. Complete suppression SCA (subsidiary communications allocation) subcarriers; 38-kc rejection filter, dual volume control. Push-pull envelope detection system requires no matrixing or

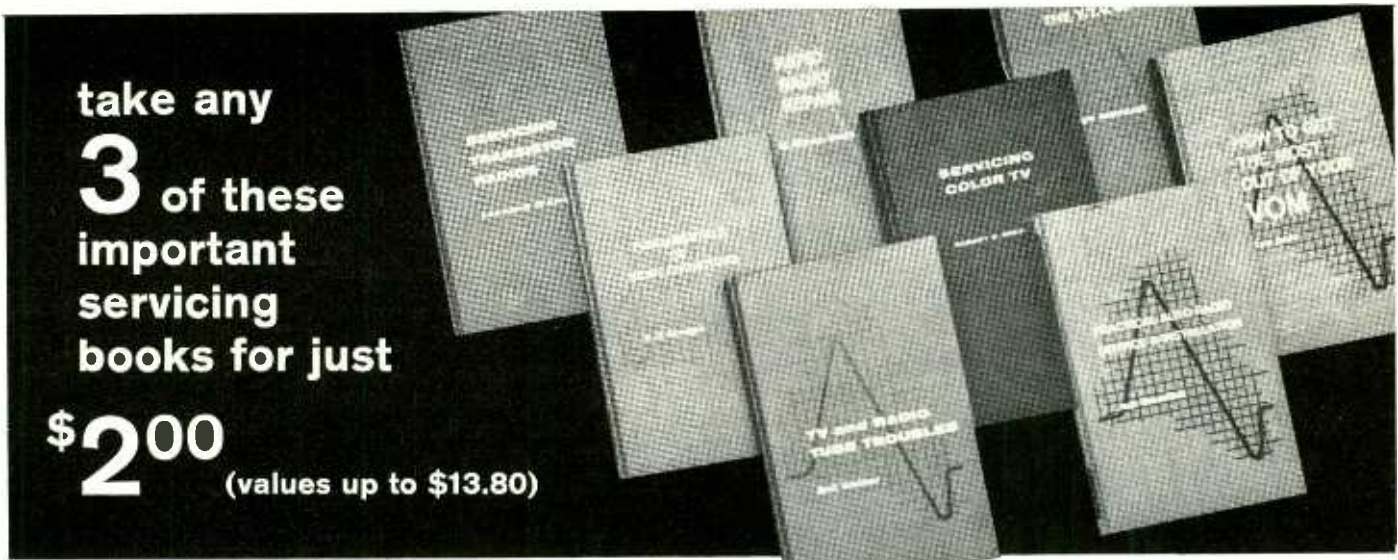

take any
3 of these
 important
 servicing
 books for just
\$2.00
 (values up to \$13.80)

and watch your membership in G/L Technician's Book Club really pay off!

Keep 'way ahead of your competition in electronics servicing! Get all the technical information you've got to have. Get it fast, get it right, *get it at lower cost.* Get it by joining the Gernsback Library Service Technician's Book Club.

This book club was set up for men like you, who must have up-to-the-minute servicing data at their fingertips. Short-cuts, time-savers, important details of new theories, and fundamentals. Practical technical know-how that means more business for you—right now! So practical you'll probably put it right to use on your very next job.

And the G/L Technician's Book Club can get ALL this vital, money-making

information to you at big special discounts. The latest books, written by qualified experts in the field in clear and easy-to-read language that tells you just what you want to know... what you NEED to know to build your profitable reputation as the service technician who can be relied on, whatever the problem!

THIS IS WHAT YOU GET BY JOINING THE G/L TECHNICIAN'S BOOK CLUB

- Generous monthly choice of selections picked from the most important new electronics books published by leading technical book publishers
- Tremendous savings of up to 27% on each volume at our special club rate

- Monthly news bulletins to keep you informed on the latest books in all branches of electronics
- Opportunities to get technical books not available through regular retail stores
- No obligation to buy more than four books a year to keep your membership

Just fill in and mail the coupon and we'll send you any three of these fact-filled books as your special new-member package. We'll bill you later for just \$2 plus postage. And, if you don't agree that these books are worth their weight in tax deductions*, return them within 10 days and we'll freely cancel your membership.

*Books purchased for professional use are tax-deductible

Choose the 3 books you want below for only \$2.00

RAPID TV REPAIR. By G. Warren Heath—Lists hundreds of tough TV problems alphabetically for quick and easy reference. Tells how to find'em and fix'em in minutes. Save servicing time with troubleshooting charts.

THE VTVM. By Rhys Samuel—Tells how the VTVM works, describes meter scales, probes, alignment, servicing. Offers dozens of new ideas on using the VTVM.

TV & RADIO TUBE TROUBLES. By Sol Heller—This new sure-fire symptom analysis method helps you trace any TV tube trouble to the source in minutes. A great servicing time saver.

PRACTICAL AUTO RADIO SERVICE. By Jack Greenfield—Covers transistor, hybrid FM and AM models. Compares auto with home radio servicing. Covers removal, installation, troubleshooting, power supplies, interference, suppression, tuner theory, etc.

FUNDAMENTALS OF SEMICONDUCTORS. By M. G. Scroggie—Thorough rundown on theory and practical applications of all kinds of semicon-

ductors—transistors, diodes, photocells, solar generators, Hall effect devices, and others. Application of principles in practical devices.

SERVICING TRANSISTOR RADIOS. By Leonard D'Airo—Ins and outs of the specialized knowledge needed to handle these tricky sets. Theory, instruments to use, pit-falls to avoid, alignment, hints on how to handle transistors.

RAPID RADIO REPAIR. By G. Warren Heath—An alphabetized "instant" guide to finding tough troubles in FM, transistor, hybrid auto sets and other modern receivers.

SERVICING COLOR TV. By Robert G. Middleton—Get ready for the color breakthrough! This book answers all your questions about chroma circuits, matrix testing, the flyback system test equipment. Contains numerous troubleshooting charts.

HOW TO GET THE MOST OUT OF YOUR VOM. By Tom Jaski—Get more mileage out of this versatile instrument. How to choose, build, work with and extend the use of the VOM.

ONLY 3 BOOKS TO A MEMBER PLEASE

TECHNICIAN'S BOOK CLUB
 Gernsback Library Dept. 72A
 154 West 14th Street, New York 11, N. Y.

Enroll me as a member of the G/L Technician's Book Club. Start my membership with the 3 books I've checked for only \$2.00 plus a few cents postage. Each month send me a brochure describing the current selections which I may purchase at special discount prices if I wish. I understand that my only obligation is to purchase 4 additional books within the next 12 months. I may cancel anytime thereafter. I may also cancel immediately by returning the first 3 books within 10 days.

I enclose \$2.00 plus 24¢ postage Bill me later

NAME _____

ADDRESS _____

CITY _____ ZONE _____ STATE _____



balancing. Wired or kit.—**Dynaco, Inc.**, 3912 Powelton Ave., Philadelphia 4, Pa.

KARADIOS. Models to fit most American cars and imports, including compacts and trucks. Transistor or tube-operated hand-wired sets, no

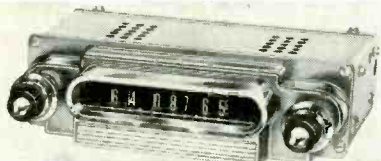

printed circuitry. Fingertip tone control, automatic volume control, equivalent 8-tube performance. Complete with car speaker.—**ATR Electronics, Inc.**, 300 E. 4th St., St. Paul 1, Minn.

MINIATURE PAGING SPEAKER, model PA7. Power handling capacity 7½ watts over 400-



13,000 cycle range; 120° coverage. Cyclocat horn housing, weatherproof design, ring diaphragm. 6¾ x 6 in.—**Electro-Voice, Inc.**, Buchanan, Mich.

AM/FM RADIO-INTERCOM, model 5500. Master and up to 9 remotes. Afc with afc off-switch. Master and any remote may call each other; pre-switching at master unit enables one re-

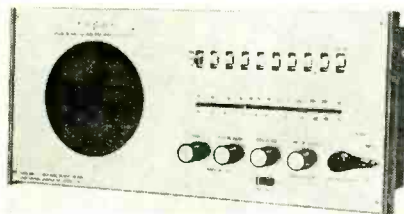

more to talk directly to another. Remotes have 5-in. speakers, individual volume controls.—**Fanon Electronic Industries, Inc.**, 439 Frelinghuysen Ave., Newark 14, N. J.

TWO-WAY INDUSTRIAL RADIO, Messenger 202. Transmits and receives on 25-50 mc, operates 12 to 20 miles from base station. 10-tube, crystal-controlled transceiver, superhet receiver, noise limiter, plug-in selective calling system.

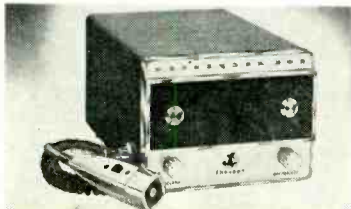

Squelch control, ceramic mike with push-to-talk switch and plug-in cord. Includes avc, automatic modulation limiter, and automatic transmit indicator. 7 x 5½ x 11¾ in.—**E. F. Johnson Co.**, Waseca, Minn.

CB TRANSCEIVER, model C-75. Portable, 1.2-watt unit operates over 5-mile range. Fully transistorized.—**Cadre Industries Corp.**, 20 Valley St., Endicott, N. Y.



DEPTH SOUNDER, model MI-11. 5 transistors. Shows depth to 200 ft. on hard bottom, 100 ft. on soft bottom. Powered by internal or external



batteries. Tuned amplifiers, 2-conductor transducer cable for extra shielding. Provision for powering from boat's 12-volt battery.—**Heath Co.**, Benton Harbor, Mich.

MODULAR SILICON RECTIFIERS. Cooling-fin heat sink increases standard convection-cooled current ratings 50%. 3 series: single-phase bridge assemblies, 12 amps; 3-phase bridge assem-



blies, 15 and 26 amps. 6 units in each series cover range 100-600 volts. Use individually as open bridges, or in variety of circuit combinations.—**Sarkes Tarzian, Inc.**, Semiconductor Div., 415 N. College, Bloomington, Ind.

MINIATURE FOIL CAPACITORS. Tantalum electrolytics, 450-volt; 5 case sizes; 0.15-6 µf, -55°C-85°C. 375-volt in 7 case sizes; 0.2-17 µf, 85°C. Tubular, for filter and bypass circuits, energy storage, etc. Capacitance tolerance ±15%, capacitance 90% rated value after 2,000 hours operation.—**General Electric Co.**, Electronic Components Div., Owensboro, Ky.

All specifications are from manufacturers' data

NEW BUSINESS GETTERS

NEW LITERATURE

Any or all of these catalogs, bulletins, or periodicals are available to you on request direct to the manufacturers, whose addresses are listed at the end of each item. Use your letterhead—do not use postcards. To facilitate identification, mention the issue and page of RADIO-ELECTRONICS on which the item appears. UNLESS OTHERWISE STATED, ALL ITEMS ARE GRATIS. ALL LITERATURE OFFERS ARE VOID AFTER SIX MONTHS.



NEW PACKAGING surrounds Electro-Voice equipment. High visibility, easy identification of parts. Flexible design fits all sizes of cartons.—**Electro-Voice Co.**, Buchanan, Mich.

SPEAKER DISPLAY for counter-top use. Each hook holds 6 Thin-Drive speakers, mounted in plastic bubbles and heat-sealed to display cards.



Base 15 x 15 in., triangular portion rotates.—**Utah Electronics Corp.**, 1124 E. Franklin St., Huntington, Ind.

MOBILE EQUIPMENT in 4-page leaflet, with description, photos, specs and line drawings of new 25- and 75-watt high-band, plus 35- and 100-watt Fleetcom low-band mobile unit.—**Communications Co., Inc.**, 300 Greco Ave., Coral Gables, Fla.

LONG RANGE ANTENNA TEST SITE, for industrial or military use, described in 4-page brochure, with photos, line drawings, description of facilities at Earlville, N. Y. site.—**TACO, Technical Appliance Corp.**, Defense and Industrial Div., Sherburne, N. Y.

PHONOGRAPH CARTRIDGES listed in revised *Replacement Manual SAC-17*. Manufacturer's models shown as replacements for 1,200 cartridges of 33 manufacturers.—**Sonotone Corp.**, Elmsford, N. Y.

SEMICONDUCTOR DEVICES described in 12-page *Bulletin SR 3099*, include silicon planar epitaxial and germanium transistors, silicon and germanium diodes, silicon nanocircuits and Zener diodes. Technical data, dimensional diagrams, application information, plus performance specs.—**General Instrument Semiconductor Div.**, 65 Gouverneur St., Newark 4, N. J.

TAPE TIPS offered in 16-page leaflet *How to Make Quality Tape Recordings at Home*. Tells how to improve technique, select the right tape for specific purpose, how to edit. Provides chart of playing times for all tape thicknesses, reel sizes and recording speeds.—**Triton Electronics, Inc.**, 62-05 30th Ave., Woodside 77, L. I., N. Y. 10e.

FM STEREO, its history and operation, detailed in 24-page booklet, *A Discussion of Stereo FM Broadcasting*. Illustrated with 18 schematics.—**Motorola Consumer Products Inc.**, 9401 W. Grand Ave., Franklin Park, Ill. 50g.

SEMICONDUCTOR PRODUCTS, 18-page condensed catalog, covers manufacturer's line standard industrial and MIL type products. Gives major electrical specifications on transistors, Zener diodes, rectifiers; provides mechanical characteristics and outline drawings for 2,500 semiconductor devices, including new high-frequency silicon planar and mesa transistors.—**Technical Information Center, Motorola Semiconductor Products, Inc.**, 5005 E. McDowell Rd., Phoenix 8, Ariz.

TERMINAL BLOCKS AND KITS in 16-page, 2-color catalog. Gives specifications and blueprints of parts and complete blocks, including fully insulated feed-through and track types.—**Curtis Development & Manufacturing Co.**, 3266 N. 33 St., Milwaukee 16, Wis.

AC POWER SOURCES detailed in 14-page, 2-color catalog. Includes power amplifiers 10-180-kw output; electronic generators with single, two and three-phase outputs, rack-bench and console models; stroboscopes, megohm meters, other test equipment. Complete specifications, dimensional illustrations.—**Communication Measurements Lab, Inc.**, 350 Leland Ave., Plainfield, N. J.

PISTON TRIMMER CAPACITORS described and illustrated in 32-page *Catalog C-62*, with electrical and mechanical engineering data on 13 types of glass and quartz capacitors. Special section lists adjustment tools and test fixtures.—**JFD Electronics Corp.**, 6101 16th Ave., Brooklyn 4, N. Y.

NEEDLE REPLACEMENT GUIDE. 48-page catalog includes cross-reference index by needle numbers; record speed and needle number in diamond, jewel or osmium; illustrations of needle replacements, plus manufacturer's line of accessories.—**Duotone Co.**, Keyport, N. J.

PRACTICAL RADIO MATHEMATICS. Tells how practical radio problems can be simplified by use of arithmetic and algebraic principles. Sections include resistors, coils and transformers; capacitors; L, C and R; combined circuits, and decibels.—**Supreme Publications**, 1760 Balsam Rd., Highland Park, Ill. 25e.

END

ELECTRONICS

Engineering-Technicians

Bachelor of Science Degree, 30 Months
Save Two Years' Time

- Radio-Television Plus Color Technician (12 Months)
- Electronics Engineering Technology (15 Months)
- Electronics Engineering (B.S. Degree)
- Electrical Engineering (B.S. Degree)
- Mechanical Engineering (B.S. Degree)
- Civil Engineering (B.S. Degree)
- Architecture (B.S. Degree)

Approved for Veterans
DAY AND EVENING CLASSES

Write for Catalog and Registration Application.
New Term Starting Soon.

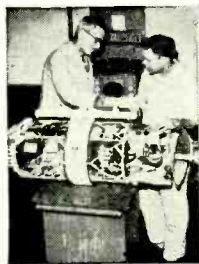

Heald's Microwave and Radar Laboratory Equipment.

HEALD'S ENGINEERING COLLEGE

Established 1863
Van Ness at Post, RE
San Francisco, Calif.

Your Name _____
Address _____
City _____
State _____



CIRCLE CUTTING MADE EASY

The experimenter often needs to cut a circle or half-circle for dial scales, and cutting it out with scissors is a frustrating job, since you know in advance it will look exactly as if it were cut out by hand.

If you have or can borrow a paper cutter or photographer's print trimmer, you can cut circles quickly, easily and with enough precision that no one not armed with a micrometer can spot the inaccuracy.

Mark on your paper or lightweight cardboard the *radius* (half the diameter) of your circle. Stick a thumb tack through the inner mark; then push the tack into the wooden base of the trimmer so that your outer mark (the outside of your circle) comes just under the trimming blade.

Now revolve your sheet of paper on its thumb-tack axis, taking short cuts with the blade as you do. As you keep turning and cutting, its polyhedron shape rapidly turns into a perfect circle—but be careful not to tear the paper around the thumb tack or you'll wind up with an uncertain ellipsoid. Now if you need a half circle, use the trimmer to cut your completed circle in two.—
R. C. Sandison

HANDY MIKE CLAMP

Nonprofessional users of small microphones often need a quickly detachable mike clamp to fit units for tape recorders or amplifiers. Such a clamp should also work with a neck loop. For this purpose nothing beats the spring

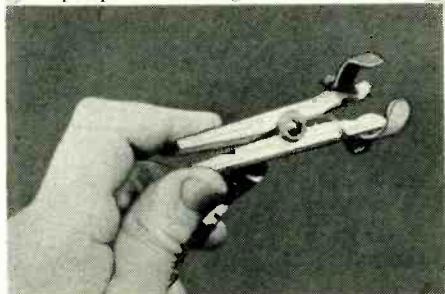

type clothespin. This is the basic piece, and to it you need add only a pair of pipe clips you can pick up at any hardware store. Trim the two clips with file or grinder and fasten them to the jaws of the clothespin with small machine bolts, the nuts to the outside of each clamp tightened against the pipe clip. Both clips should be fastened to the jaws at approximately right angles,

Now... Tomorrow and for years to come!

Sonar CITIZENS BAND RADIO

- 8 Channels, crystal controlled transmitter and receiver
- Tunable receiver for 22 channels
- Transmitter 100% Class B modulated
- Adjustable squelch
- Automatic noise limiter
- R. F. Power indicator
- 1 Year guarantee
- Easy to install. Ideal for home, boat, car or business. Weighs only 9 lbs. . . 4¾ x 9½ x 11¼
- FCC Type accepted*

*in preference to only certification

with 1 pair of crystals, microphone and power cables

\$179⁵⁰



Sonar RADIO CORPORATION

73 Wortman Avenue • Brooklyn 7, N.Y.

Please send me complete information on Model "E" CB Radio.

Dept. 140

NAME _____
ADDRESS _____
CITY _____
STATE _____

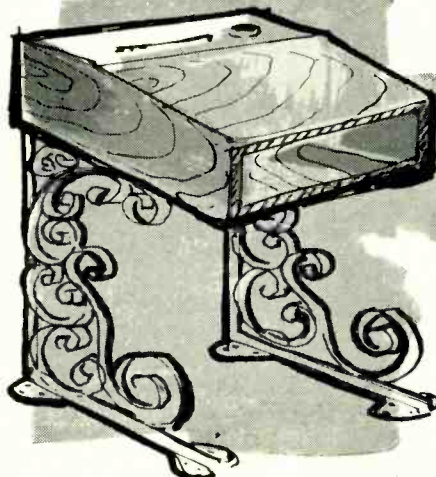

RADIO-ELECTRONICS IN THE CLASSROOM

An excellent teaching aid and supplementary reading source for technical students.

Write for special educational group rates.

MR. G. ALIQUO

RADIO-ELECTRONICS

154 West 14th Street, New York 11, N. Y.

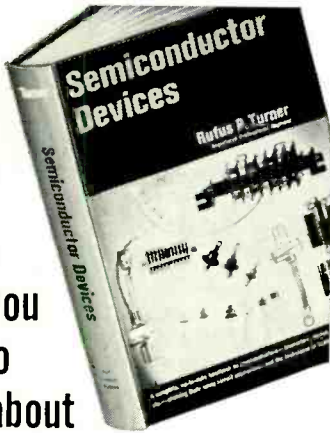

Here's what you need to know about

SEMI-CONDUCTORS!

- DIODES • TRANSISTORS
- THERMISTORS • VARISTORS
- Power and controlled RECTIFIERS
- ZENER DIODES • PHOTO CELLS
- PARAMETRIC and MAGNETIC DEVICES, etc.

plus using, testing and measuring semiconductors

Here at last is a down-to-earth 278-page book that gives you a practical working knowledge of semiconductors—from transistors to diodes, power and controlled rectifiers, ZENER diodes, varistors, thermistors, photo cells, parametric and magnetic devices and all the rest! It answers your questions about these remarkable little devices—equips you with the complete know how of their types, construction, circuit applications, testing and use.

No other field of electronics in recent years has experienced such remarkable growth. SEMICONDUCTOR DEVICES by Rufus Turner gives you a clear understanding of the entire subject—and does it without a lot of complicated mathematics. It has been specifically written for electronic technicians, servicemen, experimenters who are finding it increasingly important to have more than just a casual knowledge of these little devices which are literally revolutionizing electronic circuitry and design.

Standard and special-purpose types and their uses are fully explained. Over 250 illustrations demonstrating semiconductor circuitry and operational and construction features greatly simplify your understanding of the subject. Of particular importance, methods of testing and measuring semiconductor devices are spelled out in detail. Price \$7.50 on 10-day money-back guarantee basis.

.....10-DAY FREE EXAMINATION..... #623900

Department RE-72
HOLT, RINEHART and WINSTON
 P.O. Box 2334, Grand Central Station
 New York 17, New York

Send Turner's big, 278-page SEMICONDUCTOR DEVICES Manual for 10-day free examination. If I decide to keep book, I will then promptly send you \$7.50 in full payment. If not, I will return book postpaid and owe nothing. #709063

(SAVE! Send \$7.50 with order and we pay postage. Same 10-day return privilege with money promptly refunded.)

Name _____
 Address _____
 City, Zone State _____

OUTSIDE U.S.A. \$8.00. Cash only.
 (Above offer expires March 30, 1963)

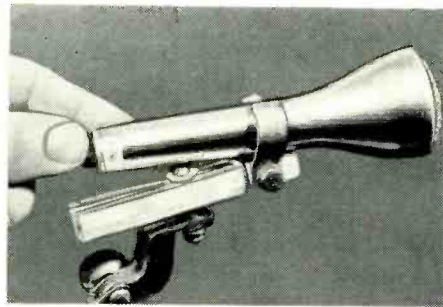

1/2 inch from the ends. When attached in this way, the regular jaw ends of the clothespin can be used for other types of small microphones.

To complete the mike holder, insert a long thin bolt through the eye of the clothespin spring, using small fibre washers against the bolt head and the nut. This provides a single bolt for attaching the holder to any suitable bracket. Some clothespins have larger spring eyes than others. Select one with a large spring eye so the bolt will pass through it freely.

If desired, pad the inside of the pipe clips with bits of felt. When this clamp is used with a neck loop, reverse the position of the mike—if cylindrical in shape, as illustrated—and attach the cord to the clamp in the most convenient way possible.—Glen F. Stillwell

CONTROLS AND THE REAR COVER

Ever have trouble getting those darned little plastic tubes used to turn controls on the back of a set back through their holes in the cover? Usually they'll swarm on you. By the time you get one threaded, the rest have escaped.

Everyone has a bunch of long thin

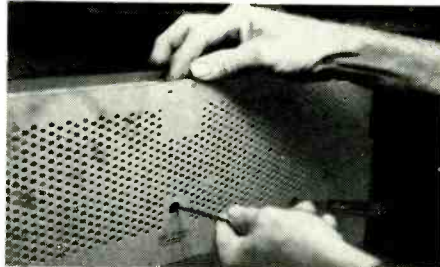

screwdrivers lying around the bench. Put one screwdriver through the hole in the cover and into each tube. Push the back cover up almost in place, then "wiggle" the tubes into place by moving the screwdrivers. (Note: no screwdrivers? Make up three or four rods out of an old coat hanger and bend a 1-inch loop on one end!)—Jack Darr

PENCIL-TIP TIGHTENING

After a soldering pencil has been in use for a period of time, the socket sometimes comes loose and the screw-in



tip element wiggles when you are using the pencil. Tighten up such a socket with some epoxy cement (Duro Liquid Steel or Plastic Aluminum).—John A. Comstock

TAPE TUBE LABELS

When tube numbers approach illegibility, give the tubes new labels of Magic Mending Tape. Write the tube



number on the label with pen or soft-lead pencil. If the tubes are handled much (as in experimenting), a second piece of tape over the first will protect the numbers.—Joe C. Allen

50 Years Ago

In Gernsback Publications

HUGO GERNSBACK, Founder

Modern Electronics	1908
Wireless Association of America	1908
Electrical Experimenter	1913
Radio News	1919
Science & Invention	1920
Practical Electronics	1921
Television	1927
Radio-Craft	1929
Short-Wave Craft	1930
Television News	1931

Some larger libraries still have copies of Modern Electrics on file for interested readers.

In July, 1912, Modern Electrics

- Wireless Telegraphy.
- Position Finding by Wireless.
- Generator for High Frequency Current.
- Wireless in Space, by Moore Stuart.
- Practical Rotary Spark Gap, by Benj. Du Mez.
- A New Inductive Tuner, by R. Treweeke.
- Compact Portable Receiving Set, by N. Clinton Youngstrom.
- Formation of Imitation Crystals by Electric Current, by Stanley E. Hyde.
- Improved Forms of Detectors, by P. Mertz.
- Rotating Helix, by Galen Hieronymus.

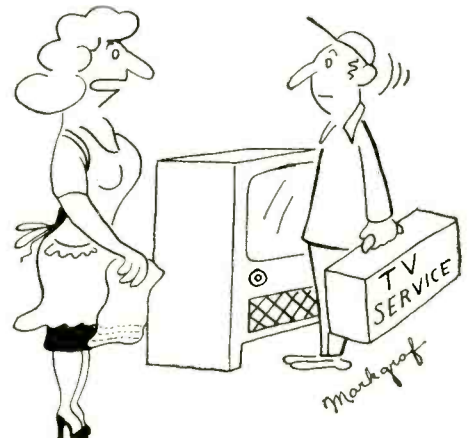

Some sound fights through—but only during commercials.



WESTINGHOUSE V-2208

The set started blooming on wet days. The humidity element in the complaint helped identify the trouble as high

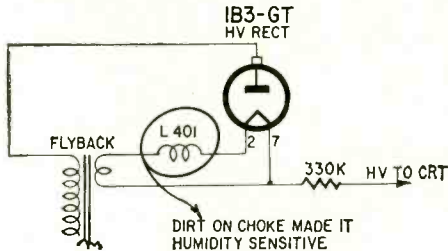

leakage with high humidity. Monitoring the B-plus revealed no irregularity. The next step was to check the high voltage.

Monitoring with a high-voltage probe revealed a change in high voltage whenever an atomizer was squirted

near the high-voltage rectifier tube. When accumulated fuzz and dirt were brushed off filament choke L-408 located on the high-voltage rectifier, the trouble disappeared.—Warren Roy

RCA KCS-102, 107, 109, 111 and 113

The FM sound detector used in these sets has a tuned coil in the suppressor grid circuit of the sound detector tube. If for any reason this coil is not properly tuned, the set's audio output may be distorted. Should a set come into your shop with this trouble, tune in the station whose sound is most seriously distorted. Note the position of the tuning slugs, and slowly tune the coil. You should get the correct sound setting without having to turn the slug more than half a turn. Beware of one thing—there are two peaks when turning this slug. The correct one is the one which gives maximum gain as well as clearer sound. If adjusting this coil does not correct the distorted sound, standard alignment procedure must be followed; or there may be component defects. In this case, return the slug to its original position, and proceed with your normal troubleshooting steps.—RCA Television Service Tips.

DuMONT RA-306

The complaint was a loud intercarrier buzz on strong stations. Routine adjustment of the sound detector transformer and shunting the 5- μ f limiting capacitor C291 did not help. We noted that detuning L208 cured the trouble as far as strong stations are concerned, but performance on weaker channels was impaired.

JULY IS HOT BUT THIS SALE IS HOTTER

\$200 HEARING AID—Your Price \$2



We Scooped the Market on 15000 of these HEARING AIDS from one of the Leading Manufacturers (name withheld) who switched to the Transistor Type.

Each HEARING AID INSTRUMENT is a Complete AUDIO AMPLIFIER and includes—a CRYSTAL MICROPHONE, 3 SUB-MINIATURE TUBES and a Superb Beige CABINET.

Indeed a TOP ITEM for the Experimenter—can be modified and converted to: RADIOS—INTERCOMS—TRANSMITTERS—SECRET LISTENING DEVICES—MICROPHONE for Tape Recorders—PRE-AMP & MICROPHONE COMBINATION—Etc.
5" x 2 1/2" x 1"—Shipping Weight 1 lb.

Complete as illustrated—including detailed informative SCHEMATIC DIAGRAM (less Earphone and Battery) \$2

Sold without limit or reserve! Order as many as you want!

- | | | |
|--|--|--|
| <input type="checkbox"/> 20—SMALL SCREWDRIVERS handy for pocket, toolbag, shop \$1 | <input type="checkbox"/> 100—ASSORTED 1/2 WATT RESISTORS some in 5% \$1 | <input type="checkbox"/> 1000—ASST. HARDWARE KIT screws, nuts, washers, rivets, etc. \$1 |
| <input type="checkbox"/> 10—5/16" I.D. HEX NEUTRALIZING WRENCHES \$1 | <input type="checkbox"/> 70—ASSORTED 1 WATT RESISTORS some in 5% \$1 | <input type="checkbox"/> 300—ASST. 1/2W RESISTORS AB, IRC, short leads, excellent \$1 |
| <input type="checkbox"/> 20—SPLINE TOOLS blade 1" long, tip 1/16" square \$1 | <input type="checkbox"/> 35—ASSORTED 2 WATT RESISTORS some in 5% \$1 | <input type="checkbox"/> 50—ASSORTED TV COILS sync, peaking, width, ratio, etc. \$1 |
| <input type="checkbox"/> 2—WIRE STRIPPERS/CUTTERS adjusts for all insulation sizes \$1 | <input type="checkbox"/> 40—ASST. PRECISION RESISTORS in 1 percenters \$1 | <input type="checkbox"/> \$15.00 TELEVISION PARTS "JACKPOT" best buy ever \$1 |
| <input type="checkbox"/> 30—PILOT LIGHT SOCKETS bayonet type, wired, long leads \$1 | <input type="checkbox"/> 20—ASST'D WIREWOUND RESISTORS 5 and 10 watt \$1 | <input type="checkbox"/> 10—21" TV PLASTIC MASKS gray, std. type, 18" x 22 1/2" \$1 |
| <input type="checkbox"/> 30—ASST. PILOT LIGHTS 244, 46, 47, 51, etc. \$1 | <input type="checkbox"/> 50 — ASSORTED TUBULAR CONDENSERS .001 to .47 \$1 | <input type="checkbox"/> 1—TV SAFETY GLASS standard type, 17 7/8 x 21 7/8 \$1 |
| <input type="checkbox"/> 1—6" x 9" OVAL PM SPEAKER (one to a customer) \$1 | <input type="checkbox"/> 50—ASST. CERAMIC CONDENSERS some in 5% \$1 | <input type="checkbox"/> 1—S10 INDOOR TV ANTENNA hi-gain, 3 section, tiltproof \$1 |
| <input type="checkbox"/> 4—456KC I. F. TRANSFORMERS assorted types and sizes \$1 | <input type="checkbox"/> 50—ASSORTED MICA CONDENSERS some in 5% \$1 | <input type="checkbox"/> 5—6' TV CHEATER CORDS with both plugs \$1 |
| <input type="checkbox"/> 1—5 1/2" PM SPEAKER 1.47 mag w/ output transformer \$1 | <input type="checkbox"/> 4—ELECTROLYTIC CONDENSERS 20/20-450v, 125-50v \$1 | <input type="checkbox"/> 100'—TWIN TV LEAD-IN WIRE 300 ohm, heavy duty \$1 |
| <input type="checkbox"/> 3—1/2 MEG VOLUME CONTROLS with switch, 3" shaft \$1 | <input type="checkbox"/> 7—SPRAGUE ELECTROLYTIC CONDENSERS 50-150v \$1 | <input type="checkbox"/> 2—TV CRT BRIGHTENERS restores brilliance & contrast \$1 |
| <input type="checkbox"/> 3—AUDIO OUTPUT TRANSFORMERS 25L6 push-pull \$1 | <input type="checkbox"/> 25—GOODALL CONDENSERS .193-600v \$1 | <input type="checkbox"/> 40—ASSORTED TV KNOBS ESCUTCHEONS, \$20 value \$1 |
| <input type="checkbox"/> 10—ASSORTED VOLUME CONTROLS less switch \$1 | <input type="checkbox"/> 30—TUBULAR CONDENSERS .02-200v \$1 | <input type="checkbox"/> 6 — ASSORTED STANDARD TUNER UHF STRIPS \$1 |
| <input type="checkbox"/> 5—ASSORTED VOLUME CONTROLS with switch \$1 | <input type="checkbox"/> 30—TUBULAR CONDENSERS .003-600v \$1 | <input type="checkbox"/> 1—70" FLYBACK TRANSFORMER incl. Schematic Diagram \$1 |
| <input type="checkbox"/> 50—ASSORTED TERMINAL STRIPS 1, 2, 3, 4 lugs \$1 | <input type="checkbox"/> 4—ELECTROLYTIC CONDENSERS 40/40/10-300v \$1 | <input type="checkbox"/> 1—90" FLYBACK TRANSFORMER incl. Schematic Diagram \$1 |
| <input type="checkbox"/> 50—ASST. RADIO KNOBS screw and push-on types \$1 | <input type="checkbox"/> 25—WIREWOUND RESISTORS 50 ohm, 10 watt \$1 | <input type="checkbox"/> 2—TV RATIO DETECTOR COILS 4.5mc or 10.7mc \$1 |
| | <input type="checkbox"/> 25—WIREWOUND RESISTORS 15000 ohm, 10 watt \$1 | <input type="checkbox"/> 2—TV SOUND I.F. COILS 4.5mc or 21.2mc \$1 |
| | | <input type="checkbox"/> 50—ASSORTED TV PEAKING COILS all popular types \$1 |
| | | <input type="checkbox"/> 2—SILICON RECTIFIERS 500ma, 400PIV \$1 |
| | | <input type="checkbox"/> 5 — TV HI-VOLT ANODE LEADS 20" length \$1 |
| | | <input type="checkbox"/> 10—PICTURE TUBE SOCKETS wired, long 20" leads \$1 |
| | | <input type="checkbox"/> 6—TV CENTERING RINGS fits on neck of picture tube \$1 |
| | | <input type="checkbox"/> 3—TV ALIGNMENT TOOLS Assortment #1 \$1 |
| | | <input type="checkbox"/> 3—TV ALIGNMENT TOOLS Assortment #2 \$1 |
| | | <input type="checkbox"/> 3—TV ALIGNMENT TOOLS Assortment #3 \$1 |
| | | <input type="checkbox"/> 3—TV ALIGNMENT TOOLS Assortment #4 \$1 |
| | | <input type="checkbox"/> 100—ASSORTED SOCKETS all types 7 pin, 8 pin, 9 pin \$1 |
| | | <input type="checkbox"/> 100—ASSORTED FUSES popular sizes 3AG, 4AG, etc. \$1 |
| | | <input type="checkbox"/> 10—ASSORTED TUBES Radio, TV, Industrial \$1 |
| | | <input type="checkbox"/> \$15.00 RADIO PARTS "JACKPOT" handy assortment \$1 |
| | | <input type="checkbox"/> 3—SYLVANIA 35W4 TUBES factory cartoned \$1 |
| | | <input type="checkbox"/> 2 — WESTINGHOUSE 3AV6 TUBES in factory cartons \$1 |
| | | <input type="checkbox"/> 2 — WESTINGHOUSE 6AV6 TUBES in factory cartons \$1 |
| | | <input type="checkbox"/> 15 — ASSORTED ROTARY SWITCHES regular \$15 value \$1 |
| | | <input type="checkbox"/> 10—6' ELECTRIC LINE CORDS with plug \$1 |
| | | <input type="checkbox"/> 4—50' SPOOLS HOOK-UP WIRE 4 different colors \$1 |
| | | <input type="checkbox"/> 25'—INSULATED SHIELDED WIRE #20 braided metal jacket \$1 |
| | | <input type="checkbox"/> 32'—TEST PROD WIRE deluxe quality, red or black \$1 |
| | | <input type="checkbox"/> 50—STRIPS ASSORTED SPAGHETTI handy sizes \$1 |
| | | <input type="checkbox"/> 100 — ASSORTED RUBBER GROMMETS best sizes \$1 |
| | | <input type="checkbox"/> 50'—HI-VOLTAGE WIRE for TV, special circuits, etc. \$1 |
| | | <input type="checkbox"/> 200'—BUSS WIRE #20 tinned for hookups, special circuits, etc. \$1 |
| | | <input type="checkbox"/> 250—ASST. SOLDERING LUGS best types and sizes \$1 |
| | | <input type="checkbox"/> 1—LB SPOOL ROSIN-CORE SOLDER 40/60 \$1 |
| | | <input type="checkbox"/> 200—ASST. SELF TAPPING SCREWS #6, #8, etc. \$1 |
| | | <input type="checkbox"/> 150—ASST. 6/32 SCREWS & 150—6/32 HEX NUTS \$1 |
| | | <input type="checkbox"/> 150—ASST. 8/32 SCREWS & 150—8/32 HEX NUTS \$1 |
| | | <input type="checkbox"/> 100—ASST. RUBBER FEET FOR CABINETS best sizes \$1 |
| | | <input type="checkbox"/> 8—ASST. LUCITE CASES hinged cover, handy for parts \$1 |
| | | <input type="checkbox"/> 4—ASST. TOGGLE SWITCHES SPST, SPDT, DPST, DPDT \$1 |
| | | <input type="checkbox"/> 6—ASSORTED SLIDE SWITCHES SPST, DPDT, etc. \$1 |
| | | <input type="checkbox"/> 200'—CHOICE HOOK UP WIRE des. lengths, asst. colors \$1 |

BROOKS RADIO & TV CORP., 84 Vesey St., Dept. A, New York 7, N. Y. TELEPHONE COrtland 7-2359



Turn ON the QUIET
Turn OFF the NOISE

with **QUIETROLE...**

The quality, proved lubricant for effective silencing of noisy controls and switches on TV, radio and electronics instruments. And the FREE EXTENDER TUBE makes those once pesky places easy to reach. Put quality QUIETROLE in your repair kit and see how quickly and easily you satisfy more of your customers.



6 Oz. SPRAY PACK CAN
(with FREE Extender Tube)



2, 4, 8 oz. Bottles
(with Dropper)



Product of

QUIETROLE COMPANY

Spartanburg, South Carolina
in Canada: CROSS CANADA ELECTRONICS
12 Laurel Street, Waterloo, Ontario

TO CURE MORE—GIVE MORE
AMERICAN CANCER SOCIETY

Superior's New Model 820

TUBE TESTER

TESTS ALL MODERN TUBES
INCLUDING THE NEW



- ✓ NOVARS
- ✓ NUVISTORS
- ✓ 10 PINS
- ✓ 12 PIN COMPACTRONS

- Employs new improved emission circuit.
- Tests over 850 tube types.
- Tests OZ4 and other gas filled tubes.
- Employs new 4" meter with sealed air-damping chamber resulting in accurate vibrationless readings.
- Use of 26 sockets permits testing all popular tube types.
- Dual Scale meter permits testing of low current tubes.
- 7 and 9 pin straighteners mounted on panel.
- All sections of multi-element tubes tested simultaneously.
- Ultra-sensitive leakage test circuit will indicate leakage up to 5 megohms.

Model 820 comes complete with tube charts and instructions; \$3850 housed in handsome, portable, Saddle-Stitched Texon case. Only

**SHIPPED ON APPROVAL
NO MONEY WITH ORDER—NO C. O. D.**

Try it for 15 days before you buy. If completely satisfied then send \$5.00 and pay balance at rate of \$5.00 per month until total price of \$38.50 (plus postage) is paid—No Interest or Finance Charges Added! If not completely satisfied, return to us, no explanation necessary.

MOSS ELECTRONIC, INC.
DEPT. D-985, 3849 Tenth Ave., New York 34, N.Y.
Please rush Model 820. If satisfactory, I will pay on terms specified. Otherwise I will return tester.

Name _____
Address _____
City _____ Zone _____ State _____

All prices net, F.O.B., N.Y.C.

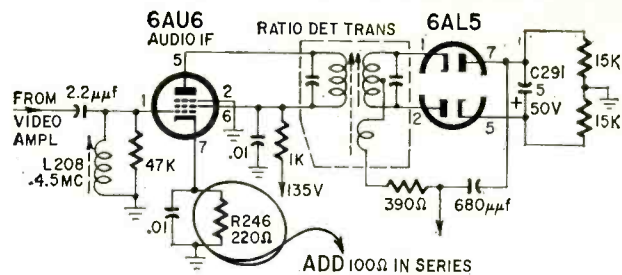

To cure this trouble, we added a 100-ohm resistor in series with 220-ohm cathode resistor R246 when we found shunting this resistor aggravated the condition.—Mark Sturgeon

RCA SHP-7

Howl caused by acoustic feedback in this unit can be stopped by adding a 1-megohm, ½-watt resistor between the red (hot) lead coming from the phono pickup and the

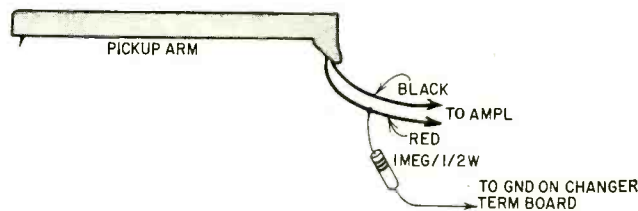

ground on the record changer terminal board. A similar trouble appears in other models of this series. The cure is the same.—Warren Roy

RECURRING 1B3 BURNOUT

A 1954 Philco with a D-191 deflection chassis kept burning out one 1B3 after another. The receiver was taken to the shop. We discovered that reducing the width prolonged 1B3 life. As soon as the width control (in the screen

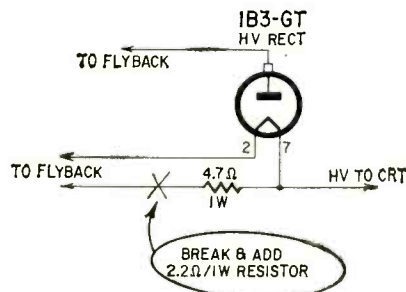

of the output tube) was turned up, the 1B3 gave up the ghost. To cure the trouble we added a 2-ohm resistor in series with the existing filament resistor. After this, the 1B3 stayed put with normal width and drive.—Chester S. Lawrence

RCA 8BT-10K

When this set came into the shop, it looked like we were going to have trouble. The sound was intermittent. Heat and moisture had no effect, but jiggling the set would make the sound come and go. A check through the receiver, shaking

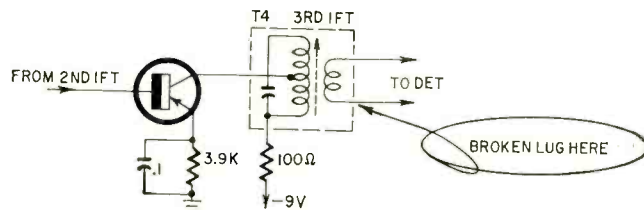

one component or connection at a time, revealed a broken lug on transformer T4, the third if transformer. As we couldn't repair the break, we replaced the transformer to repair the set.—M. L. Leonard

END

NEW TUBES and SEMI-CONDUCTORS

DIVERSITY IS OUR WORD FOR THE MONTH and we go from high-speed switching transistors, to flying-spot scanners, to TV pentode-triodes, to silicon-controlled rectifiers to prove it.

2N846-A

A p-n-p germanium micro alloy diffused-base transistor for very high speed switching applications. Reliable operation at 20 mc has been possible with this unit. The transistor's very thin base region makes the unit highly resistant to radiation.

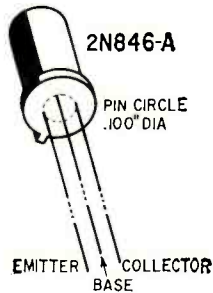

Maximum ratings for the Philco 2N846-A are:

V_{CB}	15
V_{CES}	15
I_C (ma)	100
P_{total} (mw)	60

Typical electrical characteristics are:

C_{out} (output capacitance, μmf)	1.9
C_{in} (input capacitance, μmf)	6.0
f_T (gain bandwidth products, mc)	450
t_r (rise time, nsec)	13
t_f (fall time, nsec)	10

5DKP15, 5DKP16

These are two flying-spot scanners. They have 5-inch round glass faces,



aluminized screens, magnetic deflection, magnetic focus and high resolution. The Sylvania 5DKP— can be supplied with other phosphors, including P4, P11 and

P24. The tubes are designed to operate at a typical anode voltage of 8,000 volts dc.

6KA8, 8KA8

A pair of 9-pin miniatures containing a high- μ triode and a sharp-cutoff pentode. They are intended for use in black-and-white and color TV receivers where the pentode can be used in gated age amplifier and noise inverter circuits. The triode section is excellent for sync-separator circuits. The 6-volt tube is for sets with parallel heaters; the 8-volt tube is for series heater sets. Except for their heater ratings both tubes are identical.

Maximum ratings for the RCA 'KA8 pentode unit in gated-age-amplifier and noise inverter service are:

V_{p}	300
(peak positive-pulse)	600
V_{G3} (pos bias value)	0
(neg bias value)	100
V_{G2} (supply)	300
V_{G1} (pos bias value)	0
(neg bias value)	50
P_p (watts)	2
G2 input (watts for V_{G2} 150)	1.1
R_{G3} (k ohms)	680
R_{G1} (k ohms for fixed bias)	500
(megohms for cathode bias)	1

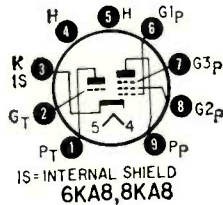

Maximum ratings for the triode section when used as a class A1 amplifier are:

V_{p}	300
V_G (pos bias value)	0
(neg bias value)	50
P_p (watts)	1.1
R_G (k ohms for fixed bias)	250
(megohms for cathode bias)	1

3TCR, 5TCR

These two series of Sarkes Tarzian silicon controlled rectifiers are rated at 3 and 5 amps respectively with break-over voltages from 25 to 400. They are

2 NEW G/L BOOKS

Get a complete grasp of
RADIO and TV

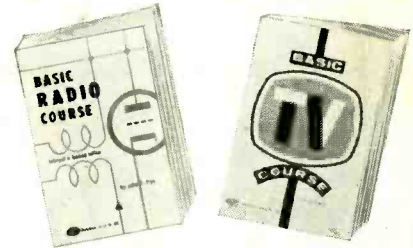

BASIC RADIO COURSE

Revised and greatly enlarged

By John T. Frye No. 104—224 pages. \$4.10 (cloth bound, \$5.75)

The original book sold out completely through eight reprints! Now here's the spanking new revised edition bulging with lots of new circuits and information with all the dated stuff dropped. And the author's good-humored style remains the same. Learning—from Ohm's law right up to advanced techniques—is fun.

Must reading for anyone serious about radio.

Some of the contents

Ohm's Law • Resistance • Induction • Capacitance • Reactance • Impedance • Phase • Resonance • Vacuum tubes • Power supplies • Sound and Speakers • Amplifiers • Demodulation • Selectivity • Converter Stage • Oscillators • Signals in Space • Transistor Radio • Instruments and Tools • Servicing Techniques

BASIC TV COURSE

By George Kravitz No. 105—264 pages. \$4.10 (cloth bound, \$5.75)

The up-to-date TV book on today's TV receivers. Throws out old schematics and concentrates on what makes modern sets tick. All straight facts in light, readable style from a bench man's point of view.

Some of the highlights covered

Forming the Picture • How the Picture Tube Works • The TV Signal • The TV Receiver • Antennas and Tuners • How the Video IF Works • Video Detector and AGC • Video Amplifier at Work • How the Sync Section Works • How the Sweep Section Works • How the Sound Section Works • Low Voltage Supply • Horizontal Output and High Voltage Supply • Transistor Portable TV • Review

See your distributor—Or mail this coupon

GERNSBACK LIBRARY, INC., Dept. 72X
154 West 14th St.
New York 11, N. Y.

Please send me the books checked

Basic Radio paperback cloth cover
 Basic TV paperback cloth cover

NAME _____

STREET _____

CITY _____ ZONE _____ STATE _____

PROFESSIONAL
technicians
use
Dave Rice's
OFFICIAL
ORDER BOOKS
for every
TV-RADIO
service
call



This is the businesslike approach to service record keeping. TriPLICATE forms serve as order form, invoice and office record, with spaces for complete information on every job. Separate listings for receiving tubes, pix tube, parts, serial numbers, labor and tax charges, signatures, etc. 75c a book, \$6.50 for dust-proof box of 10. In stock at your distributor.

Write for your free folder describing Dave Rice's OFFICIAL ORDER BOOKS, including an actual size sample copy of the handy order form.

For customer's prices on every replacement part, plus flat rate and hourly service charge data, regional and national, Dave Rice's OFFICIAL PRICING DIGEST, listing over 63,000 items. \$2.50.

ELECTRONIC PUBLISHING CO., INC.
133 N. JEFFERSON ST.
CHICAGO 6, ILLINOIS

Ask By Name For
GENUINE
"NO NOISE"
PRODUCTS

your assurance
of brand name
quality

NO-NOISE
Volume Control
and
CONTACT RESTORER
• Lubricates
• Restores
• 6 oz.
• Spray Can
\$2.25
Net to Servicemen



Not a Carbon Tet Solution

NO-NOISE
TUNER-TONIC
with **PERMA-FILM**
• Cleans, lubricates, restores all
• Tuners, including wafer type.
• Non-toxic, non-inflammable.
• For TV, radio and FM use.
• Economical—a little does a lot.
• 6 oz.
• Aerosol Can
\$3.25
Net to Servicemen



FREE
with each can of
ELECTRONIC
CHEMICAL
products—
5" PLASTIC
EXTENDER
• Push Button
• Assembly
• For Pin Point
• Applications
• Does Not
• Cause Shorts



Electronic
Chemical
new
formula
EC-44
Lubricates, con-
ditions, cleans
all electrical
contacts. Eco-
nomical... a
little does a lot!

6 oz.
spray
can
\$3.50
Net To Servicemen.

ELECTRONIC CHEMICAL CORP.

813 Communipaw Avenue Jersey City 4, N. J.

intended for use in both industrial and consumer products. Typical applications include light dimmers, motor speed

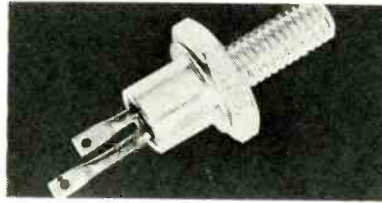

controls and numerous switching and inverter applications.

RD250

A "universal diode" designed to replace more than 80 general-purpose and high-voltage silicon diodes has been announced by Raytheon. Maximum rat-

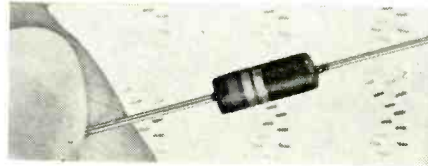

ings include: peak rectified current, 200 ma; average rectified current 63 ma; 1-second surge current of 1,000 ma and 250 mw power dissipation.

The new diode meets all test and specifications of the following diodes:

- | | |
|-----------------------|---------------------|
| 1N456 through 1N459-A | 1N681 |
| 1N461 through 1N464-A | 1N683 |
| 1N482 through 1N488 | 1N685 |
| 1N676 | 1N687 |
| 1N678 | 1N850 |
| 1N851 | 1N883 |
| 1N861 | 1N884 |
| 1N862 | 1N846 through 1N849 |
| 1N872 | 1N857 through 1N860 |
| 1N873 | 1N868 through 1N871 |
| | 1N878 through 1N882 |

2N2386

This transistor is said to be the only silicon diffused planar field-effect device being made. It has an input impedance of 1 megohm at 1,000 cycles; g_m of 1,000 μ mhos minimum. A departure from traditional transistor concepts, the Texas Instruments 2N2386 uses the most desirable features of vacuum tubes—voltage amplification, high input impedance and low noise—with the advantages of transistors—small size, ruggedness, long life, and low power consumption. This unit can be used to replace vacuum tubes and standard transistors in most small-signal applications.

2N1865

A hermetically sealed germanium p-n-p micro-alloy diffused-base trans-

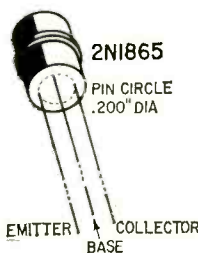

tor designed for AM/FM i.f. amplifiers in 6-volt auto and 6- to 9-volt home radios. The 10.7-mc power gain (typically 28 db) is controlled by testing. An h_{FE} specification also insures interchangeability at the lower intermediate frequencies.

Maximum ratings for the Philco 2N1865 are:

V_{CB}	20
V_{CES}	20
V_{EB}	20.5
I_C (ma)	50
P_{TOTAL} (mw)	60

Typical electrical characteristics are:

h_{re} (current amplification factor)	70
h_{ie} (input impedance, k ohms)	2
PG (at 10.7 mc, db)	28
3-db bandwidth (kc)	750

1N2611 to 1N2617

A series of low-current flangeless silicon rectifiers, featuring long life, reliability and stability. Available in ratings up to 1,000 volts these Electronic

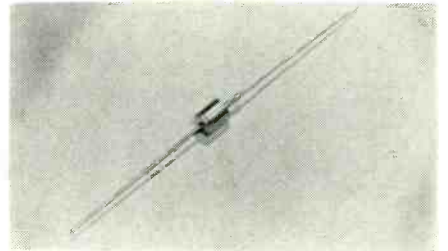

Devices diodes carry a maximum 0.3 ma full-cycle reverse current at the rated piv. Maximum 1-cycle surge is 35 amperes. Maximum rectified forward current is 850 ma. END

Corrections

Sprague Electric Company points out that the part number given for C1 is incorrect in the parts list for the ohm-dwell tachometer (June, page 34). The number specified by the author is probably part of a MIL spec number. The correct number for this 0.1- μ f, 100-volt subminiature metal-clad paper capacitor is 196P10491S2. They add that the type 2WF-P10 film-wrap capacitor is less expensive and more readily available from most distributors.

The type number for C2 is also incomplete. The designation for this subminiature electrolytic is TE-1128.

There is an error in the article "Power Measurements with Your Scope" in the May issue. In the hypothetical power problem on the inside column of page 47, the reactive power is given as 25 watts. This figure should be 66.1 volt-amperes.

We thank Terry Wright of Saskatoon, Sask., for calling this to our attention.

**WE
WANT TO BUY
CERTAIN TYPES
OF
UNUSED TUBES
AND
ELECTRONIC EQUIPMENT**

BARRY ELECTRONICS
CORPORATION

512 BROADWAY, NEW YORK 12, NEW YORK Walker 5-7000

ORGAN SERVICING

End sticking keys, leaky condensers and rust—with electric DAMPP-CHASER® Organ Dehumidifier. Write for Dealer prices and specs. on letterhead. Damp-Chaser, Inc., Box 1641, Hendersonville, N. C.

TV CAMERAS - COMPONENTS

6198 Vidicons \$34.50

Denson Electronics Corp.

Box 85 Rockville, Conn.



OUT OF SPACE?

You bet we'd be... if we were to tell you all about AUDION's 'Out of this World Hi Fi Values.'

Write for free Catalog

audion
25-E Oxford Road
Massapequa, New York

HI-FI RECORDING TAPE

Splice Free (except 2400') Freq. Resp.: 20, 20,000 cps. 15 day money-back guarantee

	3-11	12-23	24+
1200' 7" Acetate	\$1.29	\$1.17	99¢
1800' 7" Acetate	1.79	1.59	1.45
1800' 7" Mylar	1.99	1.95	1.85
2400' 7" mylar	2.69	2.59	2.49
2400' 7" tensilized mylar	2.99	2.95	2.90

Can Be Assorted. Add 15¢ Postage Per Reel 10¢ for 24+ Lot Orders

HI-FI COMPONENTS, TAPE RECORDERS
Same day shipments • Best-by-comparison prices • Factory sealed cartons • Send for "Quotes" on package deals and save more. Write for monthly specials.

125-RD East 88 St., New York 28, N. Y.



TAPE RECORDERS



**HI-FI COMPONENTS
SLEEP LEARN KITS**

Unusual Values
Free 1962
Catalog
DRESSNER,

MERITAPE
Low cost, high
quality recording
tape. In boxes or cans.
1523RE Jericho Tpke, New Hyde Park, N. Y.

FREE Catalog

**OF THE WORLD'S FINEST
ELECTRONIC GOV'T
SURPLUS BARGAINS**



**HUNDREDS OF TOP QUALITY
ITEMS—** Receivers, Transmitters, Microphones, Inverters, Power Supplies, Meters, Phones, Antennas, Indicators, Filters, Transformers, Amplifiers, Headsets, Converters, Control Boxes, Dynamometers, Test Equipment, Motors, Blowers, Cams, Keys, Chokes, Handsets, Switches, etc., etc. Send for Free Catalog—Dept. RE.

FAIR RADIO SALES
2133 ELIDA RD. • Box 1105 • LIMA, OHIO

TECHNICIANS'

NEWS



Examining Board Appointed

South Bend, Ind.—The City Council and Mayor Bruggner announced their appointments to the examining board for licensing TV technicians.

The mayor's appointees are: John Frick, Frick Electric & TV Service Inc., as the sales representative, and Russell Bill of Bill's Radio & TV Sales & Service, representing the technicians.

Council appointees are Eugene Ferrin of River Park TV, representing technicians; Steve A. Molenda of S. A. Molenda Antenna Installers, representing the installers, and Joseph Badjek, a wholesale grocer, representing the general public. Frick, Bill and Molenda are members of ARTS—St. Joseph Valley.

IESA Membership Meeting

Indianapolis, Ind.—Directors and delegates from all over the state attended the Indiana Electronic Service Association's 7th Annual Membership Meeting. Three new associations (RT SA-Muncie, RETA-Richmond, and WESA-Whitley County) were sworn in as new members. Licensing provoked a great deal of interest and Ferril Rensing, executive vice president of the Indiana Real Estate Association, explained how licensing affects a trade or profession.

Elections made Leon Howland new IESA Chairman. Other officials elected were: Charles F. Wilhelm, vice chairman; Frank J. Teskey, secretary, and James W. Baker, Treasurer.

**BRATSG—New
Technicians' Group**

Brooklyn, N. Y.—The Brooklyn Radio & Television Service Guild joins the growing ranks of service associations. At the moment they list 9 chapters—each limited to a maximum membership of about 30. This keeps individual groups small enough to prompt every member to take an active part.

To become a member you must possess either a business certificate or a retail tax number and be approved by your local chapter. Part-timers are not eligible. At present, only shop owners are members. Provisions for technician members will be made in the future.

Aims of the group are to stop the trend of service shops discounting them-

new books for
the technician
experimenter
hobbyist
who likes to

**GET
THINGS DONE**

**HINTS & KINKS FOR RADIO,
TV & AUDIO**

Edited by Martin Clifford

Gernsback Library Book No. 103
128 pages \$2.35



A unique and helpful selection of tips on how to use all sorts of gadgets and gimmicks like paper clips, drinking straws, grommets, corkscrews, tape and dozens of other everyday items as helps and timesavers in your servicing or experimenting be it TV, Radio, Audio—or just plain electronic tinkering. Editor Clifford selected the best from thousands of hints and kinks sent in to Radio-Electronics magazine by ingenious readers. This book is really priceless. Any one of these 280 suggestions may be worth hundreds of dollars to you in time and effort saved or in work more easily done.

JUST A FEW OF THE COLLECTION OF 280
HINTS & KINKS

Test prods. • Test lead storage • Fuse puller • Sticky yokes • Reduce nuisance calls • Toothpaste-tube knob • Boost fringe reception • Servicing aids • Transistor lifesaver • Kit-building kink • Audio test rig • Soldering tip • Gun carries own sander • Novelty blinker • Spaghetti for miniature circuits • Tube tapper and wire pusher • Wing nut driver • Plus 263 more practical shortcuts, timesavers and bench helpers.

RADIO-CONTROL HANDBOOK

By Howard G. McEntee

Revised and greatly
enlarged edition

Gernsback Library Book No. 93
304 pages \$4.95



Enough R/C material to fill two books. The book bulges with practical information with emphasis on how to do it, not why it happens. The original edition sold out completely after eight printings. This big second edition is completely updated—obsolescent material has been dropped, new developments added. Offers scores of new ideas, circuits and construction details on receivers, transmitters, servos, pulsers, escapements, controls, relays plus inside tips on installation, adjustments, testing and building of complete systems.

ORDER TODAY FROM YOUR DISTRIBUTOR

or use this coupon
Gernsback Library, Inc. 72Y
154 West 14th St.
New York 11, N. Y.

Please send me the books indicated postpaid
My remittance of \$_____ is enclosed

please list books selected by number

NAME _____
STREET _____
CITY _____ ZONE _____ STATE _____

AEROVOX ELECTROLYTIC CAPACITORS PROVIDE TOP QUALITY IN EVERY EXACT REPLACEMENT TYPE YOU NEED

PRODUCT
NEWS
FROM



AFH twist-prong 'lytics feature 85°C operation, improved sealing, high-purity aluminum foil construction throughout, ruggedized prongs and mounting terminals.

PR

for exact replacements in TV receivers and antenna rotating devices. Available in singles, duals, triples, quads, and quintos for 0-65°C operation.

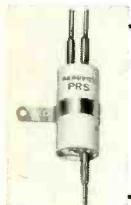

PRS compact "Dandee" units for trouble-free repair of series-string TV and AC-DC table radios. Made in singles, duals, and triples, as well as AC rated and non-polarized units.

SRE

... "Bantam" metal tubular 'lytics hermetically-sealed in aluminum cans with cardboard insulating sleeves. Smaller than the PRS but capable of handling full size loads to 85°C.



PTT-PWE miniaturized tubular 'lytics for repair of personal transistor radios, portable TV sets, and all space-tight requirements. Feature "Polycap"® plastic cases with exceptional humidity resistance.

BCD

upright mounting 'lytics for replacement in printed circuits, transistorized and auto radios. "Polycap" case and epoxy seal offer excellent moisture barrier to protect against drying out or leakage.



HCB

...high-capacity-low voltage 'lytics designed especially for applications such as motion picture sound equipment, electric fence controls and other low voltage applications.



Remember—it pays to use Aerovox!



Ask your Aerovox Distributor for a free Electrolytic Guide AFG-370 and AFH Twist-Prong 'Lytic Booklet AFH-461.

AEROVOX CORPORATION
DISTRIBUTOR DIVISION
NEW BEDFORD, MASS.

Technical Leadership - Manufacturing Excellence

selves out of business. According to Charles R. Edwards, president of BRATSG, "When everyone has a 50%-off sign in his window, who has the advantage?" The group may also try and pool purchases to give members a better price break.

Officers of the guild are: Charles R. Edwards, president; Walter Weisburd, first vice president; Bernard Block, second vice president; Morris Weiner, treasurer; Phillip Fisher, corresponding secretary; Joe Witlin, recording secretary; Bernard Avner, sergeant-at-arms.

ESDA Dropped From NATESA

Chicago, Ill.—ESDA (Electronic Service Dealers Association, Pittsburgh) has been dropped from NATESA, according to Frank Moch, executive director of the National Alliance of Television & Electronic Service Associations. A new local group has been formed from former members of ESDA. This new group has asked for NATESA affiliation as TESA-Pittsburgh.

Licensing In Louisiana

Among the papers presented before the National Association of Broadcasters was one titled "The Successful License Law for TV and Radio Service Technicians in Louisiana." Offered by J. D. Bloom, director of engineering, WWL-TV, New Orleans, La., it gave the history behind the license law.

In 1958, the Louisiana State Legislature passed a law requiring the licensing of all persons engaged in radio and TV maintenance and service on home receivers in cities of over 20,000 population. In 1960, the bill was amended to include all electronic technicians in the state. Only individual technicians are licensed, not the shop or shopowner.

Results in the intervening years are interesting. The licensing board has the power to revoke licenses, and violators are subject to a fine of not less than \$50 or more than \$300, or imprisonment for 90 days, or both.

In practice, the board has taken the stand that it is not in a position to punish anyone unless the person is a deliberate multiple offender. In most cases, once the technician realized he was being policed, he was more than willing to make good his error and promise not to let it happen again.

Additionally, the board started a public relations program aimed at raising the technician's image in the eye of the public.

Action by the board has shown that several licenses have been revoked and some technicians have left the state to avoid prosecution.

A secondary purpose of the licensing board is the educating and upgrading of the service technician. Before it was operating for even 6 months,

schools were set up throughout the state in cooperation with the Louisiana Department of Education. Most schools are operated as extension classes of existing trade schools. The response to these classes was overwhelming.

How does it work out? The technician has been upgraded. Service costs no more than before licensing. The public has more confidence in the work done. And the technician is no longer a "shady individual."

Wisconsin Roundup

Indianhead—First of three meetings on color TV. Sponsored by Howard Sams, the meeting included a lecture, slides and handout material.

Milwaukee—Inauguration saw Frank Moch, NATESA executive director, present the new TESA officers. After the business portion of the meeting, Frank Moch addressed the group and answered questions on many phases of the service industry.

Sheboygan County—Educational TV and licensing fund raising were the discussion topics at a recent meeting. Later the program committee and its new chairman, Jerry Vollbrecht, looked into the possibility of obtaining technical films for association meetings.

ARTSD Meets

Columbus, Ohio—Transistor manufacturing, transistor principles, transistorized remote control, and FM multiplex were on the agenda at a recent meeting of Associated Radio Television Service Dealers. Bob Rice of Westinghouse gave a talk, illustrated with slides, on these subjects. It was enjoyed by all who were present.

The Ethics Committee reported that it had one complaint on a member but, before the member could be contacted, the customer had been approached and the complaint settled to the customer's satisfaction.

Pop Those CRT Heaters

Continued investigations reveal that unscrupulous marginal CRT rebuilders continue to "reflash," "boom cathodes" and use other gimmicks to permit them to salvage dud picture tubes without replacing the electron gun.

If you turn in a single dud without first "popping" the heater by applying 117 volts ac by way of your cheater cord, don't complain if cut-rate CRT ads make your life miserable by presenting prices you can't meet.—*NATESA Scope*

Techs Favor Licensing

McMinnville, Ore.—Every service shop in the state received a postcard ballot from the Oregon Television Service Association. Out of the first group of replies (112), 76 favored a state licensing law, 33 were against and 3 were neutral.

END

NOTEWORTHY CIRCUITS

Low-Current Ac Generator

Here is an experimenter's general-purpose ac generator that develops up to 110 volts open circuit. For a novice this is ideal, for he can learn to handle and use these voltages without fear of a dangerous shock. The uses to which it might be applied are numerous and two of these will be discussed later.

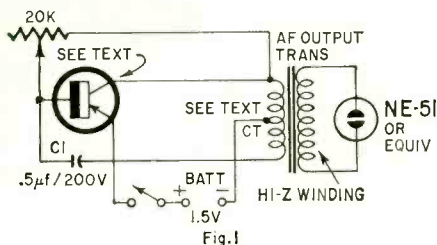

The transistor circuit is built around a conventional output transformer. First remove the complete transformer from the frame, knock off the bar of laminations from the top, and pry off the winding. If it's hard to get the winding off the core, heat the core with a soldering iron to soften the impregnation and make removal easy. Now unwind the primary winding and fold in two. Twist the wire at the folded end to serve as the center tap. Rewind, tape and assemble the transformer. Wire the circuit as in Fig. 1. Either a p-n-p or n-p-n power-type transistor may be used. Reverse battery for n-p-n type. The 20K pot adjusts the output voltage, and should be turned very slowly when adjusting for maximum voltage. If the instrument is to be used for maximum voltage, it can be a fixed resistor. When adjusting the pot, you will come to a point where the neon bulb will glow brightest; going beyond this point will stop the generator from oscillating, and if left at this point, there is danger of damaging the transistor.

One use of this generator is to provide current to a neon lamp used as a pilot. The advantage is that the current drain is less than half of what would be normally required to light a type 48 or 49 panel lamp, the lowest listed drain for panel lamps. For a nice brisk neon glow, the drain is approximately 20 ma; the 48 and 49 draw 60 ma.

Another and perhaps more serviceable use is in conjunction with a neon-tube parts checker as described in *The*

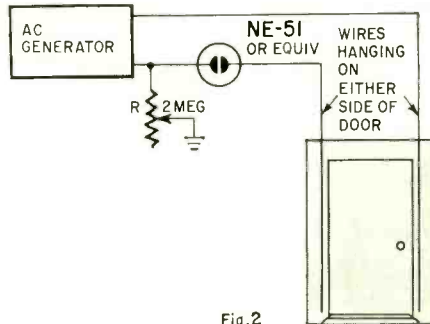

Radio Amateur's Handbook, page 400, 1942; or, *QST*, October, 1942. These checkers measure resistances up to 500,000 ohms and capacitances from 250 μf to 4 μf . The advantage is that this generator is free from line fluctuations which might render some resistance and capacitance readings inaccurate. Furthermore, it eliminates entirely the ever present shock hazard.

A third and novel use is as a body-capacitance detector. Set up the generator as shown in Fig. 2. Any person walking through the door will cause the neon lamp to glow. Set R to a point where the neon lamp begins to flutter, then turn back very slightly. The effect is quite novel.—*Martin H. Patrick*

Monitoring Automatic Controls

A modern automatic industrial machine is often equipped with a number of safety devices that protect its various components during a malfunction. When something goes wrong, we want to monitor the setup to see just which element is shutting down the conveyor, sounding the alarm or whatever.

The sketches show two simple ways I have found to connect indicator lights to one or more of almost any combination of relays, limit switches, manual-hold switches and "black boxes." Fig. 1 is for parallel switching

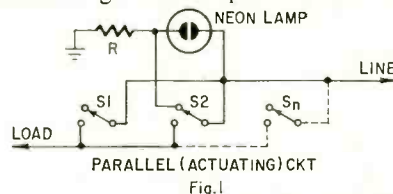

devices, such as operate latch-release coils, solenoid valves, etc., when one side of the switch is not being used. If

NEW SAMS BOOKS



Understanding Transformers and Coils

Ed Buckstein's new book fully describes transformers and coils—basic components found in practically all electronics equipment. A knowledge of their characteristics is all-important to a clear understanding of circuitry. Fully explains fundamental principles of inductance in terms anyone can easily comprehend. Important mathematical relationships and formulas are covered completely and clearly, along with the theory, construction, application and testing of transformers and coils. Includes a complete glossary and transformer color code guide. 96 pages, 5 1/2 x 8 1/4". Only \$1.95

CB Radio Antenna Guidebook

The first and only book devoted entirely to Citizens Band antennas. Authoritatively written by David E. Hicks to guide those who plan to buy CB equipment or want to improve their present gear. Explains importance of a good antenna system, characteristics of radio waves and how they affect antenna design, how antennas operate, and problems encountered. Describes range to expect, methods for improving existing antenna systems, base station and mobile antenna installations; tells how to check and service antennas. 128 pages; 5 1/2 x 8 1/4". Only \$2.50

Servicing Electronic Organs

Written by Gene Oliver and Carl Pittman. A practical guide for those seriously interested in servicing electronic organs. Explains the operation of all types of electronic organ circuits. Eleven chapters include: Introduction; Tone Generators; Pedal Generators; Vibrato and Tremolo; Keyswitches; Percussion; Sustain; Voicing; Amplifiers and Power Supplies; Check-out and Adjustment Procedures and Servicing Tips; Accessories; Glossary. Only book of its kind. 224 pages plus 26-p. schematic fold out section; 5 1/2 x 8 1/4". Only \$4.95

Having Fun With Transistors

This fascinating new book by Len Buckwalter provides the hobbyist with with numerous fun-filled and useful construction projects using simple transistor circuits. All projects are laid out in easy-to-follow pictures and drawings along with a clear explanation of how each device works. Chapters include: Construction Hints; The Radiomobile; Transistor Telephone; Lemon-Juice Oscillators; Sending Code on Your House Wires; Sherlock Ohms; Electronic Eyeball; Home Broadcaster; Musical Oatmeal Box; the Flip-Flop; Radio "Clock"; Toddler's "Tooter"; Speaker Mike; "Boris"; The Talking Skull. 128 pages; 5 1/2 x 8 1/4". Only \$2.50

ABC's of Radio Navigation

Allan Lytel explains the principles of many navigational techniques now in use, from the familiar two-way radio to the more complex air-traffic control system. Describes shipboard as well as airborne units—invaluable for owners of boats or planes. Exceptionally useful to the service technician. Chapters: Electronic Navigation; Radar; Loran; Other Long-Range Systems; Direction Finders; Radio Ranges; Instrument Landing Systems. 96 pages; 5 1/2 x 8 1/4". Only \$1.95

NEW! VOL. 15 AUTO RADIO MANUAL!

Just out...coverage of 42 popular models produced in 1960-61. Complete Photofact® data on each model. 160 p., 8 1/2 x 11", only \$2.95

HOWARD W. SAMS & CO., INC.

Order from your Sams Distributor today, or mail to Howard W. Sams & Co., Inc., Dept. G-22, 4300 W. 62nd St., Indianapolis 6, Ind.

- Send me the following books:
- Understanding Transformers & Coils (TAC-1)
 - CB Radio Antenna Guidebook (CAH-1)
 - Servicing Electronic Organs (ORG-1)
 - Having Fun With Transistors (THF-1)
 - ABC's of Radionavigation (ARN-1)
 - Auto Radio Manual, Vol. 15 (AR-15)

\$.....enclosed. Send Free Book List

Name.....

Address.....

City..... Zone..... State.....

IN CANADA: A. C. Simmonds & Sons, Ltd., Toronto 7 (outside U.S.A. prices slightly higher)

R-E**Classified****ADS**

Rates—50¢ per word (including name, address and initials). Minimum ad 10 words. Payment must accompany all ads except those placed by accredited agencies. Discount, 10% for 12 consecutive issues. Misleading or objectionable ads not accepted. Copy for September issue must reach us before July 12, 1962.

RADIO-ELECTRONICS, 154 West 14 St., New York 11, N. Y.

SERVICES

TV TUNERS—rebuilt or exchanged, \$9.95 complete—all types—fast, guaranteed service. Send tuner with all parts to: **L. A. TUNER EXCHANGE**, 4611 W. Jefferson Blvd., Los Angeles 16, Calif.

TRANSISTORIZED products dealers catalog, \$1. **INTERMARKET**, CPO 1717, Tokyo, Japan

ALL MAKES OF ELECTRICAL INSTRUMENTS AND TESTING equipment repaired. New and used instruments bought, sold, exchanged. **HAZELTON INSTRUMENT CO.**, 128 Liberty St., New York, N.Y.

DEALERS — WHOLESALE TRANSISTOR RADIO SERVICING. Guaranteed. Fast. Write for details. **WAYNE ELECTRONICS**, Public Square, Buffalo, Mo.

TV Tuners—rebuilt or exchanged, \$9.95. Most tuners shipped same day received. **VALLEY TUNER SERVICE**, 18530 Parthenia, Northridge, Calif.

FOR SALE

Electronics

POCKET-SIZED, low-impedance, square-wave generator. Variable frequency, 200 to 4000 cycles. Build it yourself for \$9. Send \$1.00 and stamped envelope for schematic to **ACE**, 11500-K NW 7th Ave., Miami 50, Fla.

TRANSISTOR IGNITION COIL and construction manual. **SPECIAL**—\$8.50. **ANDERSON ENGINEERING**, 16 Williams, Wrentham, Mass.

FREE LIST. Do-it-yourself circuits for building many economical miniaturized shop equipment items. Voice relays, signal generators, etc. Send stamped addressed envelope. **DEPT-2T**, 11500 NW 7th Ave., Miami 50, Fla.

SCOPEMATE: Display characteristic curves of solid-state devices on your own oscilloscope. Use for Transistors, Diodes, Zener Diodes, Tunnel Diodes, Rectifiers. Also gives I_{CO} , I_{CEO} , Alpha, Beta. \$29.50. **D-J ENTERPRISES**, Rocky Hill, N.J.

15 DISTANCE ONE-TUBE plans—25¢; One-tube Handbook—50¢, including Transistor experiments, catalog. **LABORATORIES**, 1131-B Valota, Redwood City, Calif.

ELECTRONIC SURPLUS CATALOG, 5,000 items. Send 10¢. **BILL SLEP CO.**, Drawer 178R, Ellenton, Fla.

TRANSISTORIZED IGNITION REPORT and schematic, \$1.50. Mallory F-12-T coil, \$16.95. Complete negative ground system, \$69.95. **PROFESSIONAL ELECTRONIC TECHNICIANS**, 6601 Park Ave., Room 4, Allen Park, Mich.

FREE BRAND-NEW FAMOUS-BRAND TUBES CATALOG. Discounts to 75% from list. Picture tubes at 75¢ inch up; parts, kits at 1/10 original cost. Phono needles, tube testers, silicones, seleniums, 7" TV bench test tube—\$6.99—and more. **ARCTURUS ELECTRONICS CORP.** RE, 502 22nd St., Union City, N.J.

INVESTIGATORS, write for free brochure on latest subminiature electronic listening devices. **DEPT. 7C**, 11500 NW 7th Ave., Miami 50, Fla.

PRECISION RESISTORS, carbon-deposit. Guaranteed 1% accuracy. Millions in stock. ½ watt, 8¢. 1-watt, 12¢. 2-watt, 15¢. Leading manufacturers. **ROCK DISTRIBUTING CO.**, 902 Corwin Rd., Rochester 10, N.Y.

SHORT CIRCUITS pinpointed within 5 feet or your \$4.50 back. Own a patented pocket-size Dynamic Short Locator. **DYNAMICO**, 11370 SW 60th Terr., Miami 43, Fla.

2" MONISCOPE TUBE, RCA Type 1698 Electrostatic Deflection, \$5.00 plus PR. 931 Photocells \$4.00, 6198 \$50.00 (Grade B). Many other types of industrial tubes in stock. Write your requirements. **SPERA ELECTRONICS**, 37-10 33 St., Long Island City, N.Y.

BEFORE YOU BUY Receiving Tubes or Hi-Fi Components send now for your giant **FREE Zalytron** current catalog—featuring nationally known Zalytron First Quality TV-Radio Tubes, Hi-Fi Stereo Systems, Kits, Parts, etc. All priced to Save You Plenty—Why Pay More? **ZALYTRON TUBE CORP.**, 220 W. 42nd St., N.Y.C.

CONVERT ANY TELEVISION TO SENSITIVE, Big-screen oscilloscope. Only minor changes necessary. Plans \$1.95. **RELCO**, Box 10563, Houston 18, Texas.

SAVE DOLLARS on Radio, TV-Tubes. Brand new. Parts at less than manufacturer's cost. 100% Guaranteed. No re-brands or pulls! Request bargain bulletin. **UNITED RADIO**, Box 1000-R, Newark, N.J.

BUILD AMAZINGLY SENSITIVE TRANSISTORIZED TREASURE FINDER. Locate deep buried, sunken metals. No electronic experience necessary. Inexpensive. Simple, illustrated plans, details. \$2. **DEEKITS**, Box 7263-E, Houston 8, Texas.

TV CAMERA PARTS available for Camera described in May & June issues of this magazine. **SPERA ELECTRONICS**, 37-10 33 St., Long Island City, N.Y.

MONEY-BACK GUARANTEE. Pocketable hi-fi six-transistor radio \$9.95. Powerful extended-range five-transistor transceiver, \$16.95; pair \$29.95. All postpaid! Money order to **TECHSERVICES**, CPO Box 849, Tokyo, Japan.

PROFESSIONAL ELECTRONIC PROJECTS—Organs, Timers, Computers, etc.—\$1 each. List free. **PARKS**, Box 1665, Lake City, Seattle 55, Wash.

Audio—Hi-fi

TAPE recorders, Hi-Fi components, Sleep-learning equipment, Tapes, Unusual values. Free catalog. **DRESSNER**, 1523R Jericho Turnpike, New Hyde Park, N.Y.

SAVE 30%. Stereophonic music on tape. Request tape, recorder Catalog R-1. **SAXITONE TAPE SALES**, 1776 Columbia Rd., Washington 9, D.C.

RENT STEREO TAPES—over 2,500 different—all major labels—free catalog. **STEREO-PARTI**, 811-RE, Centinela Ave., Inglewood 3, Calif.

STELLITE HI-FI enclosure. Sixteen 5-inch Hi-Fi speakers—construction prints—only \$24.95 postpaid. Money order to: **TECHSERVICES**, C.P.O. Box 849, Tokyo, Japan.

HIGH FIDELITY DEALERS, SERVICE-MEN. Increase your income. Keep clients satisfied. Write for full story. No obligation. **WILLIAM N. GREER ASSOCIATES**, Consulting Engineers, 511 Impartial Building, San Juan, Puerto Rico.

HUMLESS amplifiers need dc filament power! 6.3V 1.5ADC full-wave bridge rectifier, sample with data \$2.00 postpaid. **ENGINEERING ASSOCIATES**, Dayton 19, Ohio.

SPEAKERS. Quality hi-fi 12" woofer only \$8.98, also 12" PM Twin-Cone full-range hi-fi \$17.93. Have 3½" tweeters, stiff cone, only \$1.49 each. Include shipping charges, excess amount refunded. **GENERAL ELECTRONICS**, 620 Eggert Rd., Buffalo, 15, N.Y.

DON'T BUY HI-FI COMPONENTS, Kits, Tape, Tape Recorders until you get our low, low return mail quotes. "We Guarantee Not To Be Undersold." Wholesale Catalog Free. Easy Time Payments Plan, 10% down—up to 24 months to pay. **HI-FIDELITY CENTER**, 220 RC E 23 St., New York 10, N.Y.

the normally closed contacts are used in the load circuit, of course the connections would be reversed from those shown. The value of R and the type of neon indicator lamp depend on the line voltage, anything from 56,000 to 200,000 ohms, 1/2 to 1 watt with an NE-2 or NE-51 bulb works on 100 to 250 volts, ac or dc. Use higher resistance values for higher voltage.

When both sides of a switch feed low-impedance loads, or when switches are in series, as in a relay holding circuit, the connections in Fig. 2 can be used. This is an old hookup to many, and is used, not only across switches in a series string, but across single switches

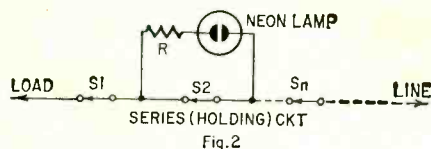

and fuses. Any of the neon bulbs or sockets with built-in resistors can be used within their voltage ratings in this circuit. When used in the feed to a relatively low-impedance load at common power voltages, most of the voltage drop will be across the neon bulb and its resistor, so there is no shock hazard while the load remains in the circuit.—
Homer E. McCoon END

SALE ITEMS. Component quotes. Bulk tapes. **BAYLA CO.**, Box 131-RE, Wantagh, N.Y.

MISCELLANEOUS

MODEL RELEASES, Forms 100—\$1.00. **STUDIO,** Box 1143-F, Santa Barbara, Calif.

PRINTING PRESSES, type, supplies. List 4¢. **TURNBAUGH SERVICE,** Mechanicsburg, Pa.

BOOK 200 Electric Stunts \$1.00. CUTT-RADO, 875 Arastradero, Palo Alto, Calif. **DO SECRET INVESTIGATIVE WORK** with supersensitive, directional microphone. Detects a whisper at great distances. Easily constructed for \$7. Step-by-step plans \$1.95. **DEE COMPANY,** Box 7263-A, Houston 8, Tex.

HOMEBREWING! . . . Beers . . . Wines. Complete Instruction Manual, \$1.00 (guaranteed!). **CRYSTAL'S 28-BRK3,** Millburn, N.J.

TELEPHONE homework information, \$1.00. **WALTER KAZAKS,** 234 E. 58th St., New York 22, N.Y.

General

FREE confidential electronics catalog, unbeatable. **KNAPP CO.** 3174 8th Ave. SW., Largo, Fla.

TRANSISTORIZED PRODUCTS replacement parts catalog, \$1.00, money-order. Custom orders for transistorized equipment or components. Write **TECHSERVICES,** C.P.O. Box 849, Tokyo, Japan.

DISC CERAMIC CAPACITORS. New, unused. Leading manufacturer. Most popular capacitance. Assortment of 30 capacitors for only \$1.00. **ROCK DISTRIBUTING CO.,** 902 Corwin Rd., Rochester 10, N.Y.

FREE GIANT WHOLESALE CATALOG Electronics, HiFi, Tools, Tubes, Radios, Imports, Housewares, Photos, Optics, Appliances, Survival Products. Write **LEKTRON,** 241 Everett Ave., Chelsea, Mass.

TRANSFIRE IGNITION. Transistor electronic. Save gas, tune-ups. Points, plugs last 50,000-100,000 miles. Improved cold-starting high-speed performance. Parts, complete conversions, kits from \$34.95. **PALMER ELECTRONICS, RE-1,** Carlisle, Mass.

COMMUNICATIONS, Teletype, unusual surplus bargains. Free Flyer. **MDC,** 923 W. Schiller, Philadelphia 40, Pa.

BUSINESS AIDS

BUSINESS CARDS, LABELS, RUBBER STAMPS. Send for free descriptive literature, **HEIGHTS INDUSTRIES,** 6121 C Street, Capitol Heights 27, Md.

BUSINESS CARDS, 1000, \$3.99. Rubber Stamps, 10 words, \$1.00. Catalog Free. **ALCO,** Box 244-R, Urbana, Ill.

EDUCATION/INSTRUCTION

AUTOMATION and COMPUTER TECHNIQUES. Study as you desire. No contracts to sign. Evaluation exam 25¢. **ENGINEERING,** Box 945, Fern Park, Fla.

LEARN WHILE ASLEEP, Hypnotize with your recorder, phonograph or amazing new Electronic Educator endless tape recorder. Catalog, details fee. **SLEEP-LEARNING ASSOCIATION,** Box 24-RD, Olympia, Wash.

NEW CONCEPT OF LEARNING SELF-HYPNOSIS! Now on tape or record! Free Literature. **McKINLEY-SMITH CO.,** Dept. T5, Box 3038, San Bernardino, Calif.

HYPNOTIZE: Practical Instruction Course \$1.00 (guaranteed). **CRYSTAL'S, KRK3,** Millburn, N.J.

WANTED

CASH PAID! Sell your surplus electronic tubes. Want unused, clean radio and TV receiving, transmitting, special purpose, Magnetrons, Klystrons, broadcast types, etc. Want military & commercial lab/test and communications equipment such as G.R., H.P., AN/UPM prefix. Also want commercial receivers and transmitters. For a fair deal write **BARRY,** 512 Broadway, New York 12, N.Y. WALKER 5-7000.

WANTED: Tubes, Diodes, Transistors, Military, Commercial Lab-Grade Test Equipment, Components, PRC, GRC Equipment, Aircraft Equipment by Collins. **TOP PRICES.** Write details, **BOB SA-NETT, W6REX, V & H Radio Electronics,** 2053 Venice Blvd., Los Angeles 6, Calif.

SCHOOL DIRECTORY

FREE! ELECTRONICS CAREER KIT

If you're interested in breaking into a good-paying job in Radio-TV-Electronics, I.C.S. will send you absolutely free a famous Career Kit with 3 famous booklets that have helped thousands of others—just like yourself—on the road to real success. Includes:

- 1 "HOW TO SUCCEED" Career Guide—36-page gold mine of career tips and information.
- 2 "JOB CATALOG" of opportunities in your field of interest.
- 3 "SAMPLE LESSON" (math) to demonstrate the famous I.C.S. method.

Send today for your free I.C.S. Career Kit with these 3 famous booklets. There's no obligation. This may be the big break you've been waiting for. Mark and mail the coupon today.

INTERNATIONAL CORRESPONDENCE SCHOOLS

Dept. W7420F, Scranton 15, Penna.

Please send free Career Kit with 3 famous booklets

- | | | |
|---|--|---|
| <input type="checkbox"/> General Electronics | <input type="checkbox"/> Radio-TV Serv'g | <input type="checkbox"/> Practical Electrician |
| <input type="checkbox"/> Industrial Electronics | <input type="checkbox"/> Sound Equip't. Serv'g | <input type="checkbox"/> Profess'l Eng. (Elec.) |
| <input type="checkbox"/> Radio-TV Eng'g | <input type="checkbox"/> Electrical Eng'g | <input type="checkbox"/> Electrical Drafting |
| <input type="checkbox"/> Electronic Servicing | <input type="checkbox"/> Electrical Tech. | <input type="checkbox"/> Other _____ |

Name _____ Age _____

Address _____

City _____ State _____

GET INTO ELECTRONICS

V.T.I. training leads to success as technicians, field engineers, specialists in communications, guided missiles, computers, radar and automation. Basic & advanced courses in theory & laboratory. Electronic Engineering Technology an ECPEP accredited Technical Institute curriculum. Assoc. degree in 20 mos. B.S. also obtainable. G.I. approved. Graduates in all branches of electronics with major companies. Start Sept., Feb. Dorms, campus. High school graduate or equivalent. Catalog.

VALPARAISO TECHNICAL INSTITUTE

Dept. C Valparaiso, Indiana



ENGINEERING EDUCATION for the Space Age

NORTHROP INSTITUTE of Technology is a privately endowed, nonprofit college of engineering offering a complete Bachelor of Science Degree Program and TWO-YEAR accredited technical institute curricula. Students from 50 states, many foreign countries. Outstandingly successful graduates employed in aeronautics, electronics, and space technology. Write today for catalog—no obligation.

NORTHROP INSTITUTE OF TECHNOLOGY
1181 West Arbor Vitae Street, Inglewood 1, California

B. S. DEGREE IN 36 MONTHS

INDUSTRY & GOVERNMENT NEED 50,000 NEW ENGINEERS A YEAR! Accelerated year-round program puts you in the job-market a whole year early! Also B.E. degree in 27 mos. Aero., Chemical, Civil, Electrical, Mechanical, Electronics, Math., Chemistry, Physics. Quality instruction: widely recognized. Graduates employed from coast to coast. Self-help program. Modest rate. Start June, July, Sept., Jan., March. Catalog: 1772 E. Washington Blvd., Ft. Wayne 2, Ind.

INDIANA TECHNICAL COLLEGE

BUILD 10-20 RADIO CIRCUITS AT HOME

with the New **PROGRESSIVE RADIO "EDU-KIT"®**

only **\$14.95** up
Reg. U.S. Pat. Off.

ALL Guaranteed to Work!

A Complete Home Radio Course

- BUILD**
- Receivers
 - Transmitters
 - Signal Tracers
 - Signal Injector
 - Code Oscillator
 - Sq. Wave Generator
 - Amplifier
 - No Knowledge of Radio Necessary
 - No Additional Parts or Tools Needed
 - Excellent Background for TV
 - School Inquiries Invited



WHAT THE "EDU-KIT" OFFERS YOU

The "Edu-Kit" offers you an outstanding PRACTICAL HOME RADIO COURSE at a rock-bottom price. You will learn radio theory, construction and servicing. You will learn how to build radios, using regular schematics; how to solder and wire in a professional manner; how to service and trouble-shoot radios. You will learn how to work with punched metal chassis as well as the new Printed Circuit chassis. You will learn the principles of RF and AF amplifiers and oscillators, detectors, rectifiers, test equipment. You will learn and practice code, using the Progressive Code Oscillator. In brief, you will receive a basic education in Electronics and Radio, worth many times the small price you pay.

PROGRESSIVE TEACHING METHOD

The Progressive Radio "Edu-Kit" is the foremost educational radio kit in the world, and is universally accepted as the standard in the field of electronics training. The "Edu-Kit" uses the modern educational principle of "Learn by Doing." You begin by building a simple radio. Gradually, in a progressive manner, and at your own rate, you construct more advanced multi-tube radio circuits, learn more advanced theory and techniques, and do work like a professional radio technician. These circuits operate on your regular AC or DC house current.

THE KIT FOR EVERYONE

You do not need the slightest background in radio or science. The "Edu-Kit" is used by young and old, schools and clubs, by Armed Forces Personnel and Veterans Administration for training and rehabilitation. One of the most important aspects of the "Edu-Kit" is the Consultation Service which we provide. We welcome students to send us their problems, whether related to any of the material covered in the "Edu-Kit" course, or encountered in other experiences in the field of electronics.

THE "EDU-KIT" IS COMPLETE

You will receive all parts and instructions necessary to build several different radio and electronic circuits, each guaranteed to operate. Our kits contain tubes, tube sockets, variable, electrolytic, mica, ceramic and paper dielectric condensers, resistors, tie strips, coils, hardware, tubing, punched metal chassis, Instruction Manuals, hook-up wire, solder, selenium rectifiers, volume controls, switches, etc. In addition, you receive Printed Circuit materials, including Printed Circuit Chassis, special tube sockets, hardware and instructions. You also receive a useful set of tools, pliers, cutters, an alignment tool, professional electric soldering iron, wrench set, and self-powered, dynamic Radio and Electronics Tester. The "Edu-Kit" also includes Code Instructions and the Progressive Code Oscillator. You will also receive lessons for servicing with the Progressive Signal Tracer and the Progressive Signal Injector, a High Fidelity Guide, FCC Amateur License Training Book, and a Quiz Book.

TROUBLE-SHOOTING LESSONS

You will learn to trouble-shoot and service radios, using the professional Signal Tracer, the unique Signal Injector and the dynamic Radio and Electronics Tester. Our Consultation Service will help you with any technical problems.

J. Stasaltis, 25 Poplar St., Waterbury, Conn., writes: "I have repaired several sets for my friends, and made money. The "Edu-Kit" paid for itself. I was ready to spend \$240 for a course, but I found your ad and sent for your kit."

FREE EXTRAS

- Set of Tools • Radio Book • Radio and Electronics Tester • Electric Soldering Iron • Pliers-Cutters
- Alignment Tool • Tester Instruction Book • Hi-Fi Book • TV Book • Quiz Book • Membership in Radio-TV Club • Consultation Service • FCC Amateur License Training • Printed Circuitry • Certificate of Merit • Valuable Discount Card • Wrench Set

Choose From These Popular "Edu-Kit" Models

- #10A: 10 Circuits \$14.95
- #15A: 15 Circuits \$19.95
- #16A: 16 Circuits (includes Printed Circuitry) \$22.95
- #20A: 20 Circuits (includes Printed Circuitry and 4 Advanced Circuits) \$26.95

UNCONDITIONAL MONEY-BACK GUARANTEE

Please RUSH my Progressive Radio "Edu-Kit" to me. BE SURE TO INCLUDE all the FREE EXTRAS and BONUS RESISTOR and CONDENSER KITS WORTH \$7.00.

- MODEL desired Price
- Send "Edu-Kit" postpaid. I enclose remittance in full.
 - Send "Edu-Kit" C.O.D. I will pay postage.
 - Send me FREE additional information describing "Edu-Kits."

Name.....
Address.....

Progressive "EDU-KITS" Inc.

1186 Broadway Dept. 199G Hewlett, N.Y.



new BOOKS

ELECTRONICS MADE EASY, by Lothar Stern. A Popular Mechanics Press book. Hawthorn Books, Inc., 70 Fifth Ave., New York 11, N. Y. 6 x 9 in. 220 pp. \$4.95.

Starts with fundamentals and goes through to hi-fi, with 25 do-it-yourself projects, "written so you can understand it."

INDUSTRIAL TRANSISTOR AND SEMICONDUCTOR HANDBOOK, by Robert B. Tomer. Howard M. Sams & Co. Inc., 1720 E. 38 St., Indianapolis, Ind., 5 1/2 x 8 1/2 in. 254 pp. \$4.95.

Design and application of control and measuring devices and circuits.

THE THINKING MACHINE by John Pfeiffer. J. B. Lippincott Co., East Washington Square, Philadelphia 5, Pa. 6 x 8 1/2 in. 343 pp. \$5.95.

Introduction to computers and what they do in today's world.

THE BRITISH TRANSISTOR DIODE AND SEMICONDUCTOR DEVICES DATA MANUAL, 1962-63, edited by G. W. A. Dummer and J. Mackenzie Robertson. Pergamon Press Inc., 122 E. 55 St., New York 22, N. Y. 8 1/2 x 11 in. 935 pp. \$25.

This monumental work contains listings, specifications, basing diagrams and other information on a wide range of British transistors, diodes and other semiconductor devices (4-layer transistors, tunnel diodes, reference elements, photocells, sili-

con controlled rectifiers, cadmium sulphide cells, temperature-sensing resistors, etc.).

BENCH SERVICING MADE EASY, by Robert G. Middleton. Howard W. Sams & Co. Inc., 1720 E. 38 St., Indianapolis 6, Ind. 5 1/2 x 8 1/2 in. 160 pp. \$2.95.

Locates and eliminates TV troubles quickly with the aid of charts and waveform patterns.

BASIC PRINCIPLES AND APPLICATIONS OF RELAYS, by Harvey Pollack. John F. Rider Publisher, Inc., 116 W. 14th St., New York, N.Y. 5 1/2 x 8 1/2 in. 104 pp. \$2.90.

The proper use of mechanical and electronic relays is explained with the help of diagrams and numerical examples.

AUTOMATIC CONTROL SYSTEMS, by Benjamin C Kuo. Prentice-Hall Inc., Englewood Cliffs, N. J. 6 x 9 in., 560 pp. \$16.

A college-level text providing a thorough coverage of feedback theory and its application to the analysis and design of feedback control systems.

FOUNDATIONS OF FUTURE ELECTRONICS Edited by David B. Langmuir and W. D. Hershberger. McGraw-Hill Book Co., 330 W. 42 St., New York 36, N. Y. 6 x 9 in. 514 pp. \$10.75.

Modern trends in electronics and physics, described by top specialists, for engineers and scientists.

PRACTICAL TELEVISION SERVICING, by J. Richard Johnson. Holt, Rinehart & Winston, Inc. 383 Madison Ave., New York 17, N. Y. 6 1/4 x 9 1/2 in., 423 pp. \$7.95.

Slanted toward the practicing TV technician, the book begins with a comprehensive review of receiver circuitry plus antennas and their installation. It then covers TV defects, troubleshooting and alignment.

INERTIAL GUIDANCE, edited by George R. Pitman, Jr. John Wiley & Sons Inc., 440 Park Ave. So., New York 16, N. Y. 6 x 9 in. 473 pp. \$18.50.

A compendium by fourteen authors. Covers the theory and principles of operation of inertial sensing devices, design, construction, analysis and testing of instruments for surface and air cruise vessels and for rocket-propelled vehicles in the atmosphere and space.

THE RADIO AMATEUR'S HANDBOOK (39th Edition), by Headquarters Staff, American Radio Relay League, West Hartford, Conn. 6 1/2 x 9 1/2 in. 586 pp. \$3.50.

The standard manual of the radio amateur, experimenter, student and communications engineer. Completely revised and brought up to date to cover the latest advances in theory, material and equipment. Chapter on vacuum tubes and their characteristics includes specifications and base diagrams on more than 500 tubes.

SERVICING TRANSISTOR RADIOS (Vols. VIII, IX and X). Howard W. Sams Inc., 1720 E. 38 St., Indianapolis 6, Ind. 8 1/2 x 11 in. 160 ea., \$2.95 ea.

Compilations of Sams Photofact folders covering transistor radios. Such servicing data as schematic diagrams, dialcord stringing arrangements, alignment data and parts lists are included for each set. Vol. VIII covers 51 models of 22

YOU SAVE MONEY!

RUSH US YOUR LIST OF HI-FI COMPONENTS FOR A SPECIAL QUOTATION

WRITE FOR FREE AUDIO DISCOUNT CATALOG A-15

New low prices on amplifiers, tuners, tape recorders, speakers, etc.

KEY

ELECTRONICS CO.
120 LIBERTY ST.
NEW YORK 6, N.Y.

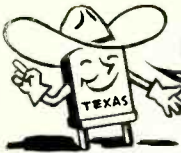

Send for NEW FREE CATALOG #961 with oscillator circuits

Citizen Band Class "D" Crystals \$2.95 EACH



CITIZEN BAND CLASS "D" CRYSTALS 3rd overtone — .005% tolerance — to meet all FCC requirements. Hermetically sealed HCB/U holders. 1/2" pin spacing. .050 pins. (Add 15c per crystal for .093 pins).

All 22 megacycle frequencies in stock: 26.965, 26.975, 26.985, 27.005, 27.015, 27.025, 27.035, 27.055, 27.065, 27.075, 27.085, 27.105, 27.115, 27.125, 27.135, 27.155, 27.165, 27.175, 27.185, 27.205, 27.215, 27.225. Matched crystal sets for ALL CB units (Specify equipment make and model numbers) \$5.90 per set

RADIO CONTROL CRYSTALS in HCB/U HOLDERS—SIX FREQUENCIES

In stock for immediate delivery (frequencies listed in megacycles); tolerance—.005%; 1/2" pin spacing. .070 pin diameter. .093 pins available, add 15c per crystal.) Specify frequency desired. 26.995, 27.045, 27.095, 27.145, 27.195, 27.255. \$2.95 EACH (add 5c per crystal for postage-handling)

ENGINEERING SAMPLES and small quantities for prototypes now made at either Chicago or Fort Myers plants with 24 hour service. IN CHICAGO, PHONE GLADSTONE 3-8555

IF YOUR PARTS DEALER DOESN'T STOCK Texas Crystals, order direct and send us his name.

RUSH YOUR ORDER NOW TO

TEXAS CRYSTALS

1000 Crystal Drive, Fort Myers, Florida

Dept. RE Phone WE 6-2100

FOR SHIPMENT VIA FIRST CLASS MAIL AT NO EXTRA COST ATTACH THIS ADVT. TO YOUR ORDER!

CONVERT TO COLOR TV

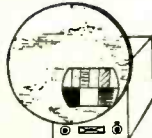

COLORDAPTOR—A simple 10-tube circuit and rotating color wheel converts any size B & W TV to receive compatible color.

COLORDAPTOR — Easily attached to any TV set, does not affect normal operation, often built from parts experimenters have on hand, BRILLIANT COLOR!

Complete booklet—gives theory of operation, all construction details, schematic, and sample color filters. \$1.95

Essential Parts Kit—Includes all special parts—coils, delay line, crystal, color filters. Add \$1.00 for sets over 16". \$19.95

COLORDAPTOR 1798 Santa Cruz, Menlo Park, Calif.

AUDIO unlimited

Specializes in SAVING YOU MONEY

- ✓ FACTORY FRESH COMPONENTS
- ✓ LOWEST POSSIBLE QUOTATIONS
- ✓ FAST DELIVERY

We are FRANCHISED DEALERS for most Hi-Fi lines. Most orders SHIPPED PROMPTLY from stock. RECORDING TAPE at LOWEST PRICES. FREE 95 page STEREO CATALOG 190-R Lex. Ave., Cor. 32 St., New York 16, N. Y. Visit Our Showroom

ENGINEERING DEGREE IN SCIENCE 27 or 36 MOS. MATH



B.S. degree—36 mos. • B.E. degree—27 mos. Accelerated year-round program prepares for early employment in fields of Science and Engineering. Regular 4-year program for B.S. Degree completed in 36 months, special engineering degree program in 27. Classes start June, July, September, January, March. Quality education. Graduates employed from coast to coast. Government approved for veteran training. Students from 50 states, 40 countries. 20 buildings; dorms, gym. Campus. Save time and money. Earn board. Write for catalog, 1772 E. Washington Boulevard, Fort Wayne 2, Indiana

INDIANA TECHNICAL COLLEGE

makes, Vol. IX 47 models of 22 makes and Vol. X 57 models of 24 brands.

MOST OFTEN NEEDED 1926-1938 RADIO DIAGRAMS, compiled by M. N. Beitman. Supreme Publications, 1760 Balsam Rd., Highland Park, Ill. 8 1/2 x 11 in. 240 pp. \$2.50.

Diagrams covering the most famous of the old-time radios, ranging from early RCA's, Atwater Kents and Majestics to some of the multiband sets put out by Philco, Zenith and others in the late 30's. Especially useful for restoring old-time radios. END

ADVERTISING INDEX

Radio-Electronics does not assume responsibility for any errors appearing in the index below.

Allied Radio	9
Aerovox Corp.	94
Arco Electronic Supply Co.	10
Audio Devices	Inside Back Cover
Audio Unlimited Inc.	99
Audion	93
B&K Mfg. Co., Div of Dynascan Corp.	25
Barry Electronics Corp.	93
Brooks Radio & TV Corp.	89
Capitol Radio Engineering Institute	23
Carlson	93
Centralab. Div. of Globe-Union	18
CLASSIFIED ADS	96, 97
Cleveland Institute of Electronics	11
Colordaptor	99
Coyne Electrical School	77
Damp-Chaser Inc.	93
Delco Div. of General Motors	14
Denson Electronics Corp.	93
DeVry Technical Institute	7
Dressner	93
Dynascan Corp., B&K Mfg. Co. Div.	25
Electronic Chemical Corp.	92
EICO Electronic Instrument Co.	28
Electronic Measurement Corp.	71
Electronic Publishing Co.	92
Fair Radio Sales	93
GM PhotoElectronics	63
Gernsbach Library	85, 91,
Grantham School of Electronics	15
Hallcrafters	21
Heald's Engineering College	87
Heath Co.	79
Holt, Rinehart & Winston Inc.	88
Indiana Technical College	99
JFD Electronics Corp.	55
Key Electronics Co.	98
Lafayette Radio	65
Mallory (P. R.) Co.	16
Moss Electronic Inc.	90
National Radio Institute	19-20,
National Technical Schools	63
Perma-Power Co.	5
Philco Corp.	69
Progressive Edu-Kits Inc.	98
Quam-Nichols	Inside Front Cover
Quietrole	90
RCA Electron Tube	Back Cover
RCA Institutes	60, 61
RCA Test Equipment	75
R-Columbia Products Co. Inc.	77
Rad-Tel Tube	100
Rohn Mfg. Co.	63
RTS Electronics Div.	13
Sams (Howard W.) & Co. Inc.	17, 95
Scott (H. H.) Inc.	3
Score	73
Slep (Bill) Co.	70
Sonar Radio Corp.	87
Sonotone Corp.	8
Sprague	22
Stancor Electronics Inc.	67
Sylvania Products Inc.	26, 27
TAB	99
Texas Crystals	99
Transvision	82
Winegard Co.	77
Xcelite Inc.	12

SCHOOL DIRECTORY PAGE 97

Indiana Technical College
International Correspondence School
Northrop Institute of Technology
Valparaiso Technical Institute
Printed in USA

"TAB" TUBES

Six Months Guarantee! No Rejects! NEW & Used Gov't & Mfrs. Surplus!

Orders \$10 or more. Receiving types only ppd. 48 states

0A2	.80	8B3B	.69	12A7A	.69	1A51	1.00
0B3	.65	6B87	.99	12A7B	.84	1175B	1.10
0C3	.69	8B17	1.25	12A7C	.84	4A5A	16.00
0D3	.35	6B86	.98	12A7D	.69	20J1	2/81
0E4	.59	6B02A	1.19	12A7E	.79	30Z3	5.85
1A3	.78	6C84	1.25	12A7F	.69	717A	2/81
1B3	.78	6C83	.69	12A7G	.99	4-125	29.00
1S4	.78	6C82	.69	12B06	.59	4-250	33.50
1T4	.78	6C84	1.49	12B07	.59	4127	7.00
				12B08	.59	4986G	29.50

Send 25¢ for Catalog!

1U5	.73	6H6	5/81	12B07	.69	4K250	35.00
1X2A	1.99	6J5	.52	12B07	.69	4K500	38.00
3B3	.68	6A8	.48	12B07	.59	589A	Query
3S4	.68	6K6	.59	12C08	1.45	25T	4.00
3V4	.83	6L6	1.19	12S07	.94	100T	7.00
5R4	.98	6V6	.99	12SH7	.89	316A	5/81
5U4	.69	6SA7	.69	12SQ7	.75	388A	3/81
5V4	.89	6B7	1.19	12SQ7	.84	416B	4.00

Wanted Test Equipment from schools & U

5Y3	.59	6507	.89	1996G	2.15	450T	42.00
6AC7	.70	6507	.79	25B06	1.59	607	1.00
6AG7	.89	6517	.69	23A	.69	866A	1.89
6AK5	2/81	65K7	.72	23W4	.77	811	4.40
6AL5	.63	65L7	.89	25Z5	.63	814	3.45
6AQ5	3.00	65N7	2/81	23Z6	.75	815	2.75
6AT6	.49	6A8	.98	33A4	.69	827S	8.00

Wanted 811, 812, 813, and 304 1/2 tube! Top 1 1/2 Paid

4AU4	1.10	6U8	.98	35W4	.49	832A	7.00
4AU5	1.19	6V6GT	.70	25Z5	.63	873A	3/50
4AU6	.69	6WA	.79	30A3	.69	1625	2.51
4B4	.78	6X4	2/81	30B3	.69	144A	4.50
68A6	.59	6A8	.98	30B3	.69	3879	2/50
68D6	.69	6A3	.49	30C5	.69	3881	2.71
68E4	.78	6A8	.98	30L6	.69	6350	3.00
68G6	1.50	6T6	.97	30L6	.69	6350	3.00
68H6	.72	7N7	.89	40	.59	5654	1.90

TUBES WANTED! WE BUY! SELL AND TRADE!

TWO 866A's and FILAMENT XPMB 10 60 (and SPECIAL!) \$6

SILICON POWER DIODE STUDS*

Operation Up to 125° C Case Temp.

D.C. Amps	50 Piv 35 Rms	100 Piv 74 Rms	150 Piv 103 Rms	200 Piv 140 Rms
2	.25	.34	.42	.49
3	.40	.45	1.10	1.25
4	.70	.95	1.13	1.40
12	.85	1.15	1.25	1.60
35	1.80	2.20	2.50	3.25
70	3.75	4.50	5.00	8.40
240	4.50	5.40	7.70	9.00

D.C. Amps	300 Piv 210 Rms	400 Piv 280 Rms	500 Piv 350 Rms	600 Piv 420 Rms
2	.60	.84	1.30	1.85
3	1.50	1.80	2.10	2.65
4	1.68	1.95	2.70	3.20
12	1.83	2.07	2.50	2.85
35	4.90	4.10	5.00	5.80
70	8.50	9.00	9.50	10.50
240	7.0	7.50	8.00	8.50

*Derate 20% for Battery or Capacitive Load or D.C. Blocking! *Stud mounted on Heat-sink.

112D: Oval Silicon—3U4G—Tube Replacement
112D: Round Silicon—3U4G—2 for \$1, 4 for \$1.50
68A Silicon 5000/10400 Piv \$9

TRANSISTOR POWER CONVERTER
12VDC to 500VDC up to 300MA
100 Wm. Top at 25VDC
D8500 \$33

12VDC to 250VDC up to 150MA
Type C12238 \$30

PC200 POWER 200 WATT AC CONVERTER 12VDC input, AC:117V/60 cps. \$32.
CASED SPECIAL \$3

"TAB" FOR TRANSISTORS & DIODES!!!

Full Length Leads U.S.A. Mfg.

Factory Tested and Guaranteed!

PNP Hi Power 15 Amp. TO3 & TO3A Pkg.
2N4413 2N277 \$1.25 4 for \$4; 2N4422 2N278 \$3 @ 2 for \$5; 2N4443 2N174 \$4 @ 2 for \$7; 2N677 \$1 @ 12 for \$10; 2N677A \$2 @ 4 for \$10; 2N677B \$3 @ 4 for \$10; 2N677C \$3 @ 2 for \$5; 2N132 2N107 CK72 2 4 for \$1; 23 for \$5; 2N132 2N293 PNP2N234 C30 @ 12 for \$4; 100 for \$52; PNP2N670/300W C40 @ 20 for \$7; PNP2N717/W C40 @ 10 for \$5; 2N597 2N594 2N599 PNP \$1.30 @ 4 for \$5.
\$10 or more this month POSTPAID U.S.A.

Round or Diamond Base Micro Mixer C30 @ Power Heat Sink Pins \$0.50 \$1.50
Kit Diodes equip. 1N34A, 46, 48, 51, 12 for \$1, 100 for \$4, 1000 for \$50.

KIT ZENER DIODES up to 400W SINGLE AND DOUBLE ENDED ZENER DIODES 3 for \$1

"TAB", SILICON 750MA* DIODES

NEWEST TYPE! LOW LEAKAGE!

D.C. or Battery Derate 20%

rms/piv	rms/piv	rms/piv	rms/piv
35/50	70/100	140/200	210/300
280/400	350/500	420/600	490/700
.34	.44	.53	.69
560/800	630/900	700/1000	770/1100
.83	.94	1.10	1.30

Diode order \$10 shipped Post free

LOW PRICED 1300 SILICON DIODES
Rated 400 pvt/280 rms @ 300 Ma @ 100° C
.25 each; 30 for \$7; 100 for \$20; 500 for \$90

SEMICONDUCTOR KITS (NO OPENS OR SHORTS)
SILICON PNP DIODES AS120, 2 & 4 Amp. 4 for \$1; TRANSISTORS TO GERMANIUM PNP, 4 for \$1; TRANSISTORS SILICON up to 400W/PNP, 3 for \$1; SILICON DIODES up to 750 MA, 18 for \$1; ZENER DIODES up to 10 Watts, 4 for \$1; \$10 or more this item, we pay P.P./U.S.A.

"TAB" TERMS: Money Back Guarantee! Our 18th year. \$2. min. order F.O.B. N.Y.C. Add shipping charges or for C.O.D. 25% Dep. Prices shown subject to change.

111 GJ Liberty Street • New York 6 N.Y.

Send 25¢ for Catalog PHONE: RECTOR 2-6245

RAD-TEL



WHY PAY MORE!

RAD-TEL'S QUALITY BRAND NEW TUBES 1 YEAR GUARANTEE

TUBES FOR TV, RADIO, AND HI-FI

UP TO 75% OFF*

1-DAY SERVICE

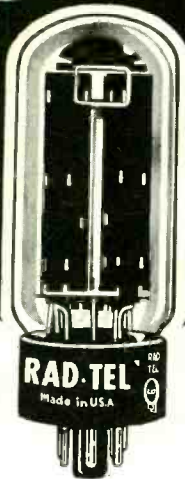

OVER 500 TYPES IN STOCK

*Manufacturers Suggested List Price

FREE!

Send For New Tube & Parts Catalog
& Trouble Shooting Guide

CAM-DWELL DISTRIBUTOR POINT INDICATOR

FOR CARS, TRUCKS, ENGINES, ETC.



No. A2.....\$3.95

Now, anyone can set distributor points. It's done electronically and automatically. No other equipment needed, no outlet. You don't have to remove the distributor. Pocket-sized, precision-engineered, high quality testing instrument for use on cars, trucks, marine engines, industrial equipment, tractors, farm machinery and road equipment. It's accurate. It's portable. It's LOW priced!



RAD-TEL TUBE CO.

TV, RADIO AND HI-FI

Dept. RE-7 55 CHAMBERS STREET, NEWARK 5, NEW JERSEY

TERMS: 25% deposit must accompany all orders, balance COD. Orders under \$5: add \$1 handling charge plus postage. Orders over \$5: plus postage. Approx. 8 tubes per 1 lb. Subject to prior sale. No COD's outside continental USA.

EACH TUBE INDIVIDUALLY & ATTRACTIVELY BOXED & BRANDED RAD-TEL

Qty.	Type	Price	Qty.	Type	Price	Qty.	Type	Price	Qty.	Type	Price
—	0Z4	.79	—	6AU4	.82	—	6J6	.67	—	12CX6	.54
—	1AX2	.62	—	6AU6	.52	—	6K6	.63	—	12D4*	.69
—	1B3	.79	—	6AU7	.61	—	6C6	1.06	—	12DB5	.69
—	1DN5	.55	—	6AU8	.87	—	6N7	.98	—	12DE8	.75
—	1G3	.79	—	6AV6	.41	—	6S4	.51	—	12DL8	.85
—	1J3	.79	—	6AW8	.90	—	6SA7GT	.76	—	12DQ6	1.04
—	1K3	.79	—	6AX4	.66	—	6SG7GT	.41	—	12DS7	.79
—	1R5	.62	—	6AX5	.74	—	6SH7GT	.49	—	12DT5	.76
—	1S4	.59	—	6AX7	.64	—	6SJ7	.88	—	12DT7	.79
—	1S5	.51	—	6AX8	.92	—	6SK7GT	.74	—	12DT8	.79
—	1T4	.58	—	6BA6	.50	—	6SL7GT	.80	—	12DU7	1.01
—	1U4	.57	—	6BA8	.88	—	6SN7GT	.65	—	12DW8	.89
—	1U5	.50	—	6BC5	.61	—	6SQ7	.73	—	12DZ6	.56
—	1X2B	.82	—	6BC7	.94	—	6T4	.99	—	12ED5	.69
—	2AF4	.96	—	6BC8	.97	—	6T8	.85	—	12EG6	.54
—	2BN4	.64	—	6BD5	1.25	—	6U8	.83	—	12EK6	.56
—	2EN5	.45	—	6BE6	.55	—	6VG6T	.54	—	12EL6	.50

—	3AL5	.42	—	6BF5	.90	—	6W4	.60	—	12EM6	.79
—	3AU6	.51	—	6BF6	.44	—	6W6	.71	—	12EN6	.78
—	3AV6	.41	—	6BG6	1.66	—	6X4	.39	—	12EZ6	.53
—	3BA6	.51	—	6BH6	.65	—	6X5GT	.53	—	12F8	.66
—	3BC5	.54	—	6BH8	.87	—	6X8	.80	—	12FA6	.79
—	3BE6	.52	—	6BJ6	.62	—	7A8	.68	—	12FM6	.43
—	3BN6	.76	—	6BJ7	.79	—	7AU7	.61	—	12FR8	.91
—	3BU8	.78	—	6BK7	.85	—	7B6	.69	—	12FX8	.85
—	3BY6	.55	—	6BL7	1.00	—	7EY8	.73	—	12GC6	1.06
—	3BZ6	.55	—	6BN4	.57	—	7F8	.90	—	12J8	.84
—	3CB6	.54	—	6BN6	.74	—	7N7	.90	—	12K5	.65
—	3CS6	.52	—	6BQ6	1.05	—	7S7	1.01	—	12L6	.58
—	3DG4	.85	—	6BQ7	1.00	—	7Y4	.69	—	12SA7	.92
—	3DK6	.60	—	6BS8	.90	—	8AU8	.83	—	12SF7	.69
—	3DT6	.50	—	6BU8	.70	—	8AW8	.93	—	12SH7	.49
—	3Q4	.63	—	6BX7	1.02	—	8BQ5	.60	—	12S17	.67
—	3Q5	.80	—	6BY5	1.15	—	8CG7	.62	—	12SK7	.74

RAD-TEL TUBE CO. NOT AFFILIATED WITH ANY OTHER MAIL ORDER TUBE COMPANY

—	3S4	.61	—	6BY6	.54	—	8CM7	.68	—	12SL7	.80
—	3V4	.58	—	6BY8	.66	—	8CN7	.97	—	12SN7	.67
—	4BQ7	1.01	—	6BZ6	.55	—	8CS7	.74	—	12SQ7	.78
—	4BZ7	.96	—	6BZ7	1.01	—	8CX8	.93	—	12U7	.62
—	4BZ8	1.10	—	6BZ8	1.09	—	8EB8	.94	—	12V6	.53
—	4CS6	.61	—	6C4	.43	—	8SN7	.66	—	12W6	.69
—	4DT6	.55	—	6CB6	.55	—	9CL8	.79	—	12X4	.38
—	5AM8	.79	—	6CD6	1.42	—	11CY7	.75	—	17AX4	.67
—	5AN8	.86	—	6CE5	.57	—	12A4	.60	—	17BQ6	1.09
—	5AQ5	.52	—	6CF6	.64	—	12AB5	.55	—	17DQ6	1.06
—	5AS8	.86	—	6CG7	.61	—	12AC6	.49	—	17W6	.70
—	5AT8	.80	—	6CG8	.77	—	12AD6	.57	—	18FW6	.49
—	5AV8	1.01	—	6CK4	.70	—	12AE6	.43	—	18FY6	.50
—	5BC8	.79	—	6CL8	.79	—	12AE7	.94	—	18FX6	.53
—	5BE8	.83	—	6CM6	.64	—	12AF3	.73	—	19AU4	.83
—	5BK7	.82	—	6CM7	.66	—	12AF6	.49	—	19BG6	1.39
—	5BQ7	.97	—	6CM8	.90	—	12AJ6	.46	—	19C8	1.14

—	5BR8	.79	—	6CN7	.65	—	12AL5	.45	—	19T8	.80
—	5BT8	.83	—	6CQ8	.84	—	12AL8	.95	—	21EX6	1.49
—	5CG8	.76	—	6CR6	.51	—	12AQ5	.60	—	25AV5	.83
—	5CL8	.76	—	6CS6	.57	—	12AT6	.43	—	25AX4	.70
—	5CM8	.90	—	6CS7	.69	—	12AT7	.76	—	25BK5	.91
—	5CQ8	.84	—	6CU5	.58	—	12AU6	.51	—	25BQ6	1.11
—	5CZ5	.72	—	6CV6	1.08	—	12AU7	.60	—	25C5	.53
—	5EA8	.80	—	6CY5	.70	—	12AV6	.41	—	25CA5	.59
—	5EU8	.80	—	6CY7	.71	—	12AV7	.75	—	25CD6	1.44
—	5J6	.68	—	6DA4	.68	—	12AX4	.67	—	25CU6	1.11
—	5T8	.81	—	6DB5	.69	—	12AX7	.63	—	25DN6	1.42
—	5U4	.60	—	6DB6	.51	—	12AY7	1.44	—	25EH5	.55
—	5U8	.81	—	6DE6	.58	—	12AZ7	.86	—	25L6	.57
—	5V3	.90	—	6DG6	.59	—	12B4	.63	—	25W4	.68
—	5V6	.56	—	6DK6	.59	—	12BA7	.84	—	32ET5	.55
—	5X8	.78	—	6DN6	1.55	—	12BD6	.50	—	32L7	.90
—	5Y3	.46	—	6DQ6	1.10	—	12BE6	.53	—	35B5	.60

—	6A8G	1.20	—	6DT6	.53	—	12BF6	.44	—	35C5	.51
—	6AB4	.46	—	6DT8	.79	—	12BK7	.77	—	35L6	.57
—	6AC7	.96	—	6EA8	.79	—	12BK5	1.00	—	35W4	.42
—	6AF3	.73	—	6EB5	.72	—	12BL6	.56	—	35Z5	.60
—	6AF4	.97	—	6EB8	.94	—	12BQ6	1.06	—	36AM3	.36
—	6AG5	.68	—	6EM5	.76	—	12BR7	.74	—	50B5	.60
—	6AH4	.81	—	6EM7	.82	—	12BV7	.78	—	50C5	.53
—	6AH6	.99	—	6EU8	.79	—	12BY7	.77	—	50EH5	.55
—	6AK5	.95	—	6EW6	.57	—	12BZ7	.75	—	50L6	.61
—	6AL5	.47	—	6EY6	.75	—	12C5	.56	—	70L7	.97
—	6AM8	.78	—	6F5GT	.39	—	12CN5	.56	—	70Z5	.69
—	6AQ5	.53	—	6FE8	.75	—	12CR6	.54	—	807	.70
—	6AR5	.55	—	6GH8	.80	—	12CU5	.58	—	117Z3	.61
—	6AS5	.60	—	6GK6	.79	—	12CU6	1.06	—		
—	6AS6	.80	—	6GN8	.94						
—	6AT6	.43	—	6H6	.58						
—	6AT8	.79	—	6J5GT	.51						

BIG SAVINGS ON PARTS IN CATALOG



Pardon us while we change our face

Some say that only women are privileged to change their minds, and their faces, whenever they choose. We disagree. And we have the courage of our convictions, because—from this day forward—Audiotape will be wearing a bright new face you've never seen before.

We think you'll like the new Audiotape look, not only because it's fresh, clean and attractive but because it will now be easier than ever to select the type of Audiotape you need. We've assigned a distinct, highly visible color to each of the eight types so that you can locate your favorite immediately. We've also printed a description of the contents on every package—brief, simple and in large, clear letters. (No matter which Audiotape you favor, you're getting the tape that quality made famous.)

Look for the new family of Audiotape packages. They're well worth your attention.

audiotape
TRADE MARK

AUDIO DEVICES INC., 444 Madison Ave., New York
Offices in Los Angeles, Chicago, Washington, D. C.

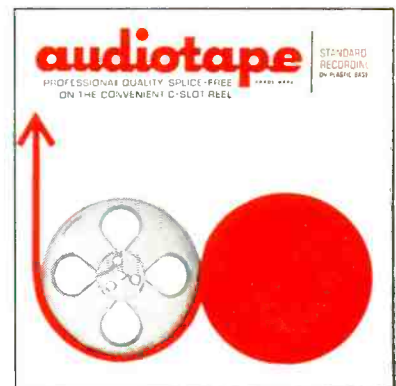

NOW!!! ONLY 4 PICTURE TUBES CAN FILL 50% OF TV REPLACEMENT NEEDS*



RCA 21CBP4A, 21AMP4A, 21ZP4B and 21YP4A Universal Silverama® Picture Tubes Replace 33 Industry Types

Now, four—*only four* RCA Universal Silverama types can take care of *half* your picture tube replacements. Think of what this means to you in terms of simplicity, economy and efficiency:

- **Fewer trips to the distributor.**
You can keep these four types in your shop, knowing that you will quickly have use for them.
- **Faster service.**
For half your picture tube replacements, you have the right tube on hand, in the shop. Saves hours of time picking up the proper tube or waiting for it to be delivered. The time saved gives you a competitive edge!
- **Picture tube replacements from your service truck.**
It's simple to carry one of each of these Universal types on your service truck so you can make half of your picture tube replacements *right on the spot*.
- **Fewer types to take care of.**
Think of the headaches and extra bookkeeping this simplification saves.

These four types are part of a growing family of RCA Universal Picture Tubes designed to help you fill the maximum number of sockets with the minimum number of types.

RCA Universal Silverama Picture Tube types are made with an all-new electron gun, the finest parts and materials and a high-quality envelope that has been thoroughly inspected, cleaned and rescreened prior to reuse.

Start now to simplify your picture tube replacement problems. See your authorized RCA Distributor this week about RCA Universal Silverama Picture Tubes.

*Based on EIA figures for the national movement of the picture tube types below.

RCA Silverama "Universal" Type	Replacing		
21CBP4A	21ALP4	21ANP4A	21CBP4B
	21ALP4A	21BTP4	
	21ALP4B	21CBP4	21CMP4
	21ANP4	21CBP4A	
	21ATP4	21BAP4	21CWP4
	21ATP4A	21BNP4	21DNP4
21AMP4A	21ATP4B	21CVP4	21FLP4
	21ACP4	21AMP4A	21BSP4
	21ACP4A	21AQP4	21CUP4
21ZP4B	21AMP4	21AQP4A	
	21ZP4	21ZP4A	21ZP4B
21YP4A	21YP4	21YP4A	21AFP4

RCA Electron Tube Division, Harrison, N. J.



THE MOST TRUSTED NAME IN ELECTRONICS