

Radio-Electronics

TELEVISION • SERVICING • HIGH FIDELITY

HUGO GERNEBACK, Editor-in-chief

ELECTRONIC IGNITION SYSTEM FOR YOUR CAR

Save gas and improve engine performance with this two-transistor, one-thyratron system. Easy to build and get working.

INDUSTRIAL SOUND

SYSTEMS Sound installations in schools and industry have their own kinks and problems. This article tells you how to maintain and service them.

TALK ON A LIGHT BEAM

A few pieces of cardboard tubing, some lenses from a \$1 surplus kit, a flashlight bulb and a photocell make a practical light phone.

HANDLING VERTICAL

FOLDOVER Wayne Lemons reveals the four causes of vertical foldover in a TV set; shows how to find and fix the trouble.

5-Transistor Receiver IN AN EARPHONE

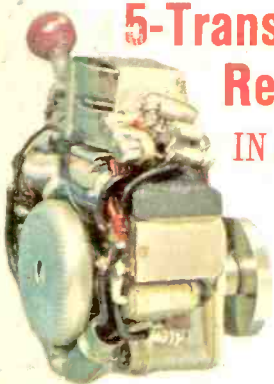

SEE PAGE 4

You can build this little job entirely in a headphone earpiece. Receives stations to at least 25 miles with excellent quality.

94
119
117

50c

JAMES D MC NEAL 2-65
40 MIDDLETOWN AVE
NORTH HAVEN CONN

SYLVANIA'S

BIG 9

covers the line!



New Sylvania 9-transistor kit provides replacement for over 300 NPN and PNP types.

You Save Money—reduce inventory requirements—eliminate slow-moving stock that can tie up your cash. You simply stock the new Sylvania kit of 9 fast-moving SYL types instead of more than 300 different types.

You Save Time—with only 9 types to choose from, *plus* the new Quik-Pik-Pak, you speed up servicing work, cut down bench time.



Free Coupon Worth \$12.50 toward the purchase of the famous \$25 twelve-lesson Sylvania/RTTA "Transistor Servicing" course is included. Kit pays for itself immediately.



Free Replacement Guide, listing the more than 300 transistor types for which Sylvania's BIG 9 can be substituted, is included in every kit. Handy size for pocket carry or wall mounting. Your distributor has extra copies, too. Ask for one.

TYPE NUMBER	JOB DESCRIPTION	REPLACEMENT FOR
SYL 101	NPN, conv., mixer, osc.	18 types
SYL 102	NPN, if-amplifier	24 types
SYL 103	NPN, af-amplifier driver	21 types
SYL 104	NPN, af-power amplifier	12 types
SYL 105	PNP, conv., mixer, osc.	30 types
SYL 106	PNP, if-amplifier	40 types
SYL 107	PNP, af-amplifier driver	60 types
SYL 108	PNP, af-amplifier output	65 types
SYL 109	PNP, af-amplifier pwr output (popular auto radio type)	54 types

AT YOUR SYLVANIA TUBE DISTRIBUTOR'S...NOW!

SYLVANIA

SUBSIDIARY OF

GENERAL TELEPHONE & ELECTRONICS



Every Essential Term in Physics and Electronics—15,000 of Them

—now in one giant dictionary!

Send today for **FREE EXAMINATION** of this new second edition, 1,400-page reference work. Used in homes, offices, schools and laboratories.

THE NEW, completely revised INTERNATIONAL DICTIONARY OF PHYSICS AND ELECTRONICS is the only book that gives you definitions, equations, principles and detailed explanations of every important term in all — even the newest — fields of physics and electronics.

Over 15,000 laws, relationships, equations, basic principles, instruments, apparatus and techniques are described in over a half-million words. You'll find everything from alphatopic, band and cybotaxis to Wronksian, ylem and Zwitterion.

Combines 16 Reference Books — AND MORE

You've never seen so much useful information in one volume. It takes the place of a whole library of reference books on:

Electronics	General Principles
Meteorology	Units & Dimensions
Mechanics	Heat & Thermodynamics
Gases	Atomic & Nuclear Physics
Liquids	Mathematical Physics
Solids	Quantum Mechanics
Acoustics	Electricity
Optics	Relativity

Updated coverage of all these fields . . . plus **BRAND NEW MATERIAL** on latest thermonuclear and magnetohydrodynamics research, space physics, astrophysics . . . IRE definitions in networks, computers, etc. Also new review of physics: from Newton to non-conservation of parity and strange particles.

Ends hunting from book to book . . . wading through long texts to get needed information. Everything you need can be found simply and quickly in this one handy volume.

Answers Your Questions in Seconds

Unique cross-referencing system locates information instantly. "Pyramided" articles start with concise definitions, progressing to more detailed information. Boldface "word signals" refer you to related articles. You get needed answers in a hurry!

HELPFUL FOUR-LANGUAGE INDEX

By popular request, this revised edition contains a special 4-language Index which lists all Russian, German, French and Spanish terms with precise English equivalents.

AVOID COSTLY ERRORS—You'll use this giant, 1,400-page reference work dozens of times a day — to recheck work, to clarify technical articles or engineering data, to increase your understanding of complex physics and electronics. You won't have to trust your memory . . . with the INTERNATIONAL DICTIONARY OF PHYSICS AND ELECTRONICS you get answers you can be sure of. Pays for itself many times over in just one avoided error!

Use It FREE for 10 Days — Send No Money Now!

So you can fully appreciate the usefulness of this mammoth volume (over 3" thick with lifetime binding) — we invite you to actually use it FREE for ten days. If you do not find it one of the most valuable books you have ever owned, simply return it and pay nothing. Otherwise, remit payment on easy terms indicated in coupon. You take no risk! Send coupon now to **D. Van Nostrand Company, Inc., Dept. 189, 120 Alexander St., Princeton, N. J. (Established 1848).**

NOTE: Cost of book is tax deductible if used in your work.

Acclaimed by Major Journals in Every Field of Science

"Unique. Useful. Presents a wide variety of terms."
—SCIENTIFIC AMERICAN

"Remarkably complete. Highly useful. Provides definite and concise answers to a myriad of questions."
—PHYSICS TODAY

"Will undoubtedly make a

well-deserved place for itself."
—SCIENCE

"There has been a real need for such a work."
—ELECTRONICS

"Recommended for all that do any reference work in physics."
—LIBRARY JOURNAL

"Unique in its field and exceptionally clear in its typography. It should prove a most useful reference."
—NUCLEONICS

"The best book of definitions available on the market today. Highly recommended."
—TELE-TECH

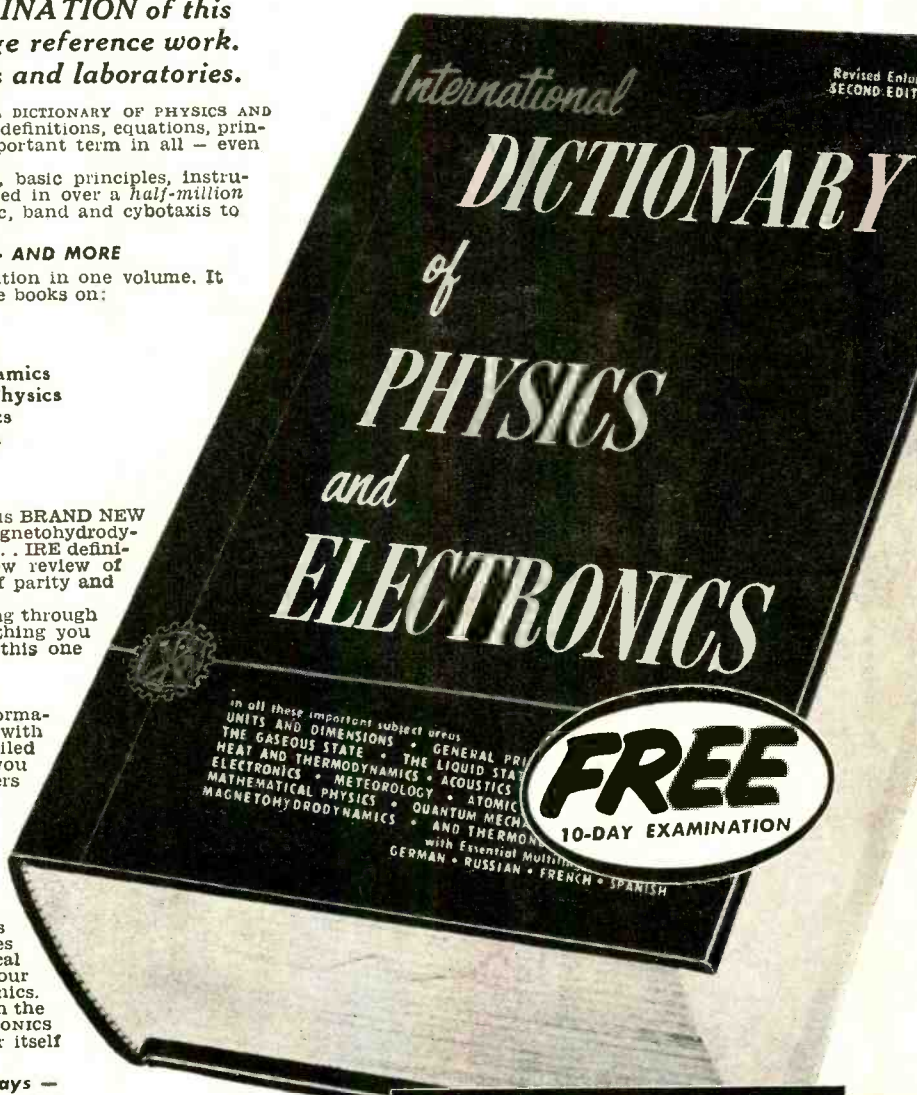

in all these important subject areas:
UNITS AND DIMENSIONS • GENERAL PRINCIPLES
THE GASEOUS STATE • THE LIQUID STATE
HEAT AND THERMODYNAMICS • ACOUSTICS
ELECTRONICS • METEOROLOGY • ATOMIC
MATHEMATICAL PHYSICS • QUANTUM MECHANICS
MAGNETOHYDRODYNAMICS • AND THERMODYNAMICS
with Essential Multilingual
GERMAN • RUSSIAN • FRENCH • SPANISH

FREE
10-DAY EXAMINATION

MAIL FREE-EXAMINATION COUPON TODAY

**D. Van Nostrand Company, Inc., Dept. 189
120 Alexander Street, Princeton, N. J.**

Please send me — for 10 days' FREE use — the "International Dictionary of Physics and Electronics" thumb-indexed edition. If not completely satisfied, I may return it and owe nothing. Otherwise I will remit \$6.85 plus small shipping cost, and \$7 a month for 3 months.

Name.....
Address.....
City..... Zone..... State.....

Save! Enclose full payment (\$27.85) and shipping costs will be prepaid. Money back if not delighted.

In Canada: Order from D. Van Nostrand Co., Ltd., 25 Hollinger Road, Toronto 16, Canada. (Price slightly higher) Foreign and A.P.O. please send \$27.85 with coupon.

RADIO-ELECTRONICS published monthly at Mt. Morris, Ill., by Gernsback Publications Inc. Second-class postage paid at Mt. Morris, Ill. Copyright © 1961, by Gernsback Publications Inc. All rights reserved under Universal, International and Pan-American Copyright Conventions. SUBSCRIPTION RATES: US and possessions, Canada: \$5 for 1, \$9 for 2, \$12 for 3 years. Pan-American countries: \$6 for 1, \$11 for 2, \$15 for 3 years. Other countries: \$6.50 for 1, \$12 for 2, \$16.50 for 3 years.

Formerly RADIO CRAFT — Incorporating SHORT WAVE CRAFT— TELEVISION NEWS— RADIO & TELEVISION*

editorial

Hugo Gernsback 33 Lee de Forest, Father of Radio, 1873-1961

radio

- Philip de la Roza 44 Superhet in a Headphone (Cover Story)
Build this tiny 5-transistor receiver
- Fred Shunaman 47 What Did de Forest Really Invent?
- Stanley Leinwoll 51 Short-Wave Dx Forecast for Aug. 15-Sept. 15
- Robert F. Scott 52 Guide to Low-Power CB Transceivers
Complete directory of 100-mw equipment
- George D. Philpott 57 Autodyne Converter Troubles
- Joseph Marshall 61 Practical Alignment of Hi-Fi FM Tuners
How to work without special instruments

audio-high fidelity

- 40 3,000 Watts of Audio
- Jack Darr 58 All About Tape Recorders
Part V—(Conclusion) Brakes and pressure pads
- Dave Stone 68 Tape-Speed Test Loop
- Larry Steckler 82 New Ideas in Kits
Scott FM tuner and stereo amplifier
- J. W. Korte 92 Add Percussion to Your Organ
One-tube amplifier does the job

electronics

- Cmdr. Thurman E. Smithey 34 Electronic Ignition for Your Car
Transistorized system you can build
- E. H. Marriner 43 Electronic Flasher
- 49 What's Your EQ? (Answers to August puzzles on page 89)
- R. L. Winklepleck 50 Electronic Pathlighter Is Easy to Build
Let your car light you to the door
- R. E. Pittet, Jr. 56 Talk on a Light Beam
Build a visible-light telephone

test instruments

- Barron Kemp 41 Full Value From Your Multimeter
Good technique can double its usefulness
- J. Scheckley 46 Add a Scope Pilot Light
- 66 In-Circuit Transistor Testing
Two new instruments test them in the set

industrial electronics

- Yvon O. Johnson 38 Sound Systems in Schools and Industry
Do you know how to maintain and service them?
- Ed Bukstein 72 Industrial Electronics Dictionary
Carrier current to differential amplifier
- Matthew Mandl 94 Variation Control in Automation
How some important controls work

television

- C. H. Citron 52 Antenna Coil or Rf Amplifier?
- Wayne Lemons 54 Vertical Foldover Problems
What are foldover's four causes?
- 55 Watchdog Television
- Wayne Lemons 76 Cy and Lucky Whip an Intermittent
How to short out difficulties
- Jack Darr 84 TV Service Clinic
Tuner cleaning

the departments

121 Business and People
124 Correction
22 Correspondence
125 New Books

123 New Literature
120 New Patents
101 New Products
112 New Tubes & Semiconductors

6 News Briefs
116 Noteworthy Circuits
110 Technicians' News

114 Technotes
118 Try This One
119 50 Years Ago

Over 50 Years of Electronic Publishing

EDITOR-IN-CHIEF AND PUBLISHER
Hugo Gernsback

EDITOR

M. Harvey Gernsback

MANAGING EDITOR

Fred Shunaman

TECHNICAL EDITOR

Robert F. Scott, W2PWG

ASSOCIATE EDITOR

Larry Steckler

EDITORIAL ASSOCIATE

I. Queen

SERVICE EDITOR

Jack Darr

ART DIRECTOR

Harry Schlack

TECH. ILLUSTRATION DIRECTOR

Wm. Lyon McLaughlin

ART ASSOCIATE

Fred Neinast

PRODUCTION MANAGER

Elizabeth Stalcup

DIRECTOR, ADVERTISING SALES

Lee Robinson

EASTERN SALES MANAGER

John J. Lamson

CIRCULATION MANAGER

G. Aliquo

DIRECTOR, NEWSSTAND SALES

Adam J. Smith

PROMOTION MANAGER

Robert Fallath

Average Paid Circulation
Over 157,000

—on the cover—

(Story on page 44)

Good things come in small packages. If you doubt it, you haven't taken a close look at the miniature 5-transistor superhet the girl on the cover is wearing over her right ear.

Color original
by Irving Kaufman

Gernsback Publications, Inc.

EXECUTIVE, EDITORIAL, ADVERTISING OFFICES

154 W. 14 St., New York 11, N.Y.
Telephone AL 5-7755

CHAIRMAN OF THE BOARD

Hugo Gernsback

PRESIDENT

M. Harvey Gernsback

SECRETARY

G. Aliquo



Radio-Electronics is indexed in
Applied Science & Technology Index
(Formerly Industrial Arts Index)

*Trademark registered U. S. Pat. Office

GET YOUR ELECTRONICS-TV-RADIO HOME TRAINING FROM N.T.S. RESIDENT SCHOOL

BREAK THROUGH TO HIGHER PAY, GREATER JOB SECURITY

START NOW! Break through the Earning Barrier that stops "half-trained" men. N.T.S. "All-Phase" Training prepares you . . . at home in spare time . . . for a high-paying CAREER as a **MASTER TECHNICIAN** in Electronics — TV — Radio. One Master Course at One Low Tuition trains you for unlimited opportunities in All Phases: Servicing, Communications, Preparation for F.C.C. License, Broadcasting, Manufacturing, Automation, Radar and Micro-Waves, Missile and Rocket Projects.

A MORE REWARDING JOB . . . a secure future . . . a richer, fuller life can be yours! As an N.T.S.

MASTER TECHNICIAN you can go straight to the top in industry . . . or open your own profitable business.

Over 1 City Block of Modern School Facilities, Laboratories and Shops Housing Over 1,000 Students.

50,000 Graduates — all over the World — since 1905

BETTER . . . MORE COMPLETE . . . LOWER COST . . . WITH NATIONAL SCHOOLS' SHOP-METHOD HOME TRAINING!

BETTER . . . Training that is proved and tested in N.T.S. Resident School shops and laboratories, by a School that is the **OLDEST** and **LARGEST** of its kind in the world.

MORE COMPLETE . . . You learn **ALL PHASES OF** Television — Radio — Electronics.

LOWER COST . . . Other schools make several courses out of the material in our **ONE MASTER COURSE . . .** and you pay more for less training than you get in our course at **ONE LOW TUITION!**

NATIONAL TECHNICAL SCHOOLS
WORLD-WIDE TRAINING SINCE 1905

THE SCHOOL BEHIND YOUR HOME-STUDY TRAINING

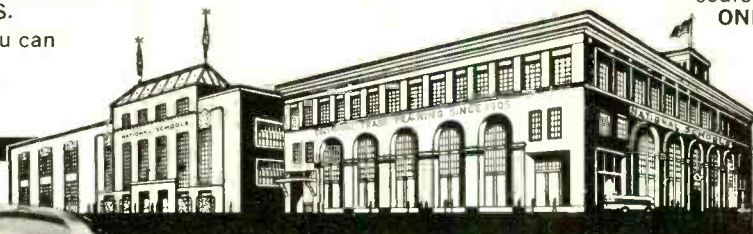

In these modern School Headquarters your Home Training is: Classroom-Developed, Lab-Studio Planned, Shop-Tested, Industry-Approved, Home Study-Designed.

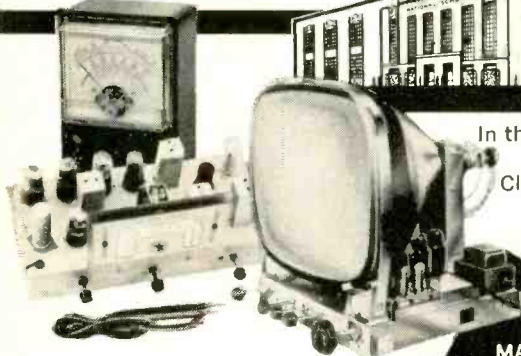

TRAIN AT HOME IN YOUR SPARE TIME . . . AT YOUR OWN PACE!

19 BIG KITS YOURS TO KEEP

- Friendly Instruction and Guidance
- Graduate Advisory Service
- Unlimited Consultation
- Diploma Recognized by Industry
- **EVERYTHING YOU NEED FOR SUCCESS**

N.T.S. IS NOT JUST A MAILING ADDRESS ON A COUPON
N.T.S. is a real school . . . a world famous training center since 1905. Thousands of men from all over the world come to train in our shops, labs, studios and classrooms.

You learn quickly and easily the **N.T.S. Shop-Tested** way. You get lessons, manuals, job projects, personal consultation from instructors as you progress. You build a **Short-Wave, Long-Wave Superhe- Receiver** plus a large screen TV set from the ground up with parts we send you at no additional cost. You also get a **Professional Multitester** for your practical job projects. The Multitester will become one of your most valuable instruments in spare time work while training, and afterwards, too. Many students pay for their entire tuition with spare time work. You can, too . . . we show you how.

SEND FOR INFORMATION NOW . . . TODAY!
IT COSTS YOU NOTHING TO INVESTIGATE

After you graduate you can open your own TV-Radio repair business or go into high paying jobs like these: Communications Technicians, Hi-Fi, Stereo and Sound Recording Specialists, TV-Radio Broadcasting Technician, Technician in Computers & Missiles, Electronics Field Technician, Specialist in Micro-Waves and Servomechanisms, Expert Trouble Shooter, All-Phase Master Technician, TV-Radio Sales, Service and Repair.

RESIDENT TRAINING AT LOS ANGELES
If you wish to take your Electronics-TV-Radio training in our famous Resident School in Los Angeles — the oldest and largest school of its kind in the world — write for special Resident School catalog and information, or check special box in coupon.

MAIL COUPON NOW FOR FREE BOOK & ACTUAL LESSON

No obligation.
No salesman will call.

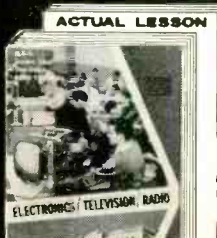

ACCREDITED MEMBER

NATIONAL TECHNICAL SCHOOLS

WORLD-WIDE TRAINING SINCE 1905

4000 SO. FIGUEROA ST., LOS ANGELES 37, CALIF., U. S. A.

NATIONAL TECHNICAL SCHOOLS
WORLD-WIDE TRAINING SINCE 1905

Mail Now To
National Technical Schools, Dept. RG91
4000 S. Figueroa St., Los Angeles 37, Calif.
Please rush **FREE** Electronics-TV-Radio "Opportunity" Book and Actual Lesson.

Name _____ Age _____
Address _____
City _____ Zone _____ State _____

Check here if interested **ONLY** in Resident Training at Los Angeles.
VETERANS: Give date of discharge _____

News Briefs

Pay TV Test Postponed

The RKO Phonevision Co. has asked the FCC to permit it to reschedule the date for starting pay television tests from Aug. 23, 1961, to July 1, 1962. The tests were to have been made in the Hartford area, from WHCT. The company reports that work is definitely going ahead, that station coding equipment will be installed by the end of 1961, and that 2,000 decoders have been ordered and that other arrangements of both a mechanical and organizational nature are being made to assure a successful test with a reasonable number of good programs "before asking the first member of the Hartford public to sign up as a subscriber."

Ultraminiature Transistors

Thin-film transistors are so small that up to 20,000 of them can fit on a postage stamp. This new device, which comes from RCA's David Sarnoff Research Center, is made by depositing thin films of semiconductor materials on an insulating base. Each finished device is only a few ten-thousandths of an inch thick. Using such transistors, it will be possible to shrink the basic circuitry of a computer to the size of a book page.

The active material used in the semiconductors is cadmium sulfide. In making thin-film transistors, an evaporation process is used to deposit successive thin layers of cadmium sulfide and metal on a glass plate. In the evaporation process, the cadmium sulfide crystals and the metal are heated in successive steps in a vacuum, turning to vapor that is collected by condensation on a glass plate. By using a special mask to cover portions of the plate during the process, the metal layers are



deposited in a pattern that forms the electrical contacts needed to operate the transistor. The masking process can also be used to produce various patterns of connections among many transistors to complete a desired circuit at the same time the transistors are being made.

The completed transistor is not only very tiny, but also incorporates an important operating feature not now used in commercial transistors. In conventional transistors having comparable functions, electrons flow more or less freely through the semiconductor material between two of the contacts, and the third element provides control by reducing the flow in varying degrees. The operating principle of the experimental thin-film units is exactly the opposite. The insulating properties of the cadmium sulfide hamper the flow of electrons between the two electrodes, and the third element provides control by increasing the flow in varying degrees.

The photograph shows an enlarged laboratory test unit containing three thin-film transistors made in special elongated form on a glass base.

FCC Proposes FM Rule Changes

FM proposal recently issued by the FCC is aimed at simplifying station allocations. It sets up definite spacings for FM stations, as is now done in TV, and avoids the complex considerations used to calculate an AM transmitter's service area.

Three classes of commercial FM stations are proposed: class A, with an effective radiated power of 1 kw and 250-foot mast (the formula permits more power if the mast is lower or limits it for a higher mast); class B, 20 kw and 500-foot tower; class C, 100 kw and 2,000-foot antenna (above average terrain). Spacing of class-A stations would be 115 miles; class-B, 190 miles; class-C, 300 miles.

Two classes of educational stations are proposed: class D, 10 watts and 100 feet; class E, "same as for maximum commercial station at the same location."

Comments were asked on polarization of FM signals. The commission noted the growing number of FM auto radios, whose vertical antennas can receive a vertically polarized signal best. FM is now horizontally polarized, though circular polarization is permitted.

The question of duplication of AM

and FM programs was also raised, with comments invited "as to whether complete or partial duplication should be allowed for any FM station."

Electronics Engineer Becomes Miss Universe

The 1961 Miss Universe is an electronics engineer who expects to return to the job as soon as her tour as Miss Universe is completed.



Marlene Schmidt of Stuttgart, Germany, is electronics' answer to Marilyn Monroe. She was crowned this summer at Miami, Fla., in competition with beauties from all parts of the world. A year of travel and guest appearances is one of the prizes. "But when the year is over, I will return to the job," says Miss Schmidt, who has been given a leave of absence by her employer. "Engineering is my career. I've been interested in technical subjects since I was 5." Anyone for engineering?

Kerosene Thermogenerator Powers Transistor Radio

A portable thermoelectric generator that can supply power for a transistor radio, and which runs for 24 hours on a pint of kerosene has been announced by Minnesota Mining & Manufacturing.

The kerosene lamp heats six thermocouples in the generator to produce about 1/2 watt of power at 0.75 volt. A built-in transistor converter steps this up to the voltage required to operate the radio (3 to 9 volts). The converter, according to 3M, will be sold at less than the price of a good transistor radio. Its chief use will be as an emergency and Civil Defense power source.

Work over
300
projects
with your wonderful
**HOME
LABORATORY**

Use and keep
ALL
these units to
get all-important
**PRACTICAL
EXPERIENCE**

COLOR TV
DeVry Tech's program
also includes training in
Color Television

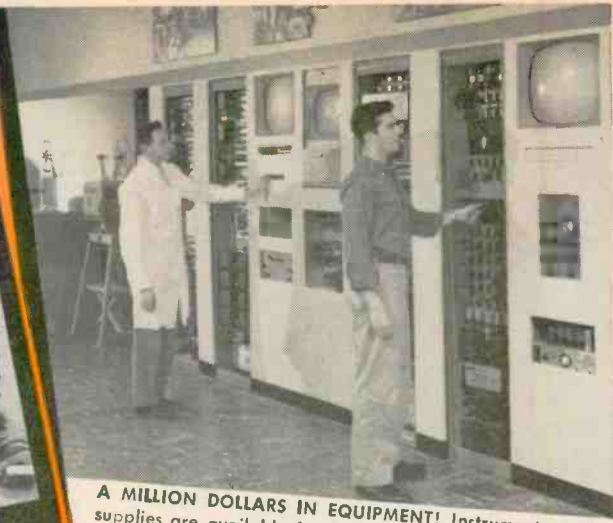

A MILLION DOLLARS IN EQUIPMENT! Instruments, tools, supplies are available for DeVry Tech students in our Chicago and Toronto Laboratories. Above is shown a Closed Circuit TV station in our Chicago Laboratories.



**NEW!
NEW!
NEW!**

Shown above is the valuable new combination oscilloscope and volt-meter which DeVry Tech men build during the new training program. But that's not all! New movies, new experimental projects—all prepare you thoroughly in this latest and greatest DeVry Tech training program.



**Exclusive
HOME
MOVIES**
help you grasp
important points
**FASTER . . .
EASIER . . .
BETTER. A
tremendous
advantage!**

**NOW...at home...get DeVry Tech's
amazing effective training in**

ELECTRONICS

RADIO-TELEVISION! Nothing else like it for providing real LABORATORY-TYPE training at home. Get the kind of thorough, practical experience YOU NEED for the kind of progress YOU WANT in today's tremendous field of Television, Radio and Electronics. Qualify yourself for real money . . . interesting work . . . a wonderfully promising future. And when you finish, DeVry Technical Institute's active Employment Service HELPS YOU GET STARTED! Or open your own profitable Television-Radio Service Business.

THOUSANDS OF SUCCESSFUL GRADUATES

Why has DeVry Technical Institute become one of the largest training organizations of its kind? Because it provides EVERY MAJOR HOME TRAINING AID to help make the subject EASIER to learn . . . EASIER to remember—the kind of training so helpful for REAL PROGRESS. Students get thorough, up-to-date, practical training that TAKES ADVANTAGE of new and improved training developments. Study the ADVANTAGES shown on this page. Think what they can mean to YOU . . . to YOUR FUTURE! Or come to DeVry Tech's modern Training Laboratories in Chicago or Toronto. MAIL COUPON TODAY for complete facts—including 2 valuable free booklets, "Pocket Guide to Real Earnings" and "Electronics in Space Travel". Also, valuable information for men subject to MILITARY SERVICE.

Accredited member of
National Home Study Council



**SEND FOR 2 FREE BOOKLETS
MAIL COUPON TODAY!**

DEVRY TECHNICAL INSTITUTE
4141 Belmont Avenue, Chicago 41, Ill., Dept. RE-9R
Please give me your two free booklets, "Pocket Guide to Real Earnings" and "Electronics in Space Travel"; also include details on how to prepare for a career in Electronics. I am interested in the following opportunity fields (check one or more):

- | | |
|--|--|
| <input type="checkbox"/> Space & Missile Electronics | <input type="checkbox"/> Communications |
| <input type="checkbox"/> Television and Radio | <input type="checkbox"/> Computers |
| <input type="checkbox"/> Microwaves | <input type="checkbox"/> Broadcasting |
| <input type="checkbox"/> Radar | <input type="checkbox"/> Industrial Electronics |
| <input type="checkbox"/> Automation Electronics | <input type="checkbox"/> Special "Short Courses" |

Name _____ Age _____
Address _____ Apt. _____
City _____ Zone _____ State _____
1001 Check here if you face military service.
Canadian residents: Write DeVry Tech of Canada, Ltd.,
970 Lawrence Avenue West, Toronto 19, Ontario

NEW! ALL NEW!

**Now Prepare For
SPACE AND MISSILE
Electronics At Home**

DeVry Tech now also makes available their highly effective SPACE and MISSILE ELECTRONICS Program. Now a man can train at home for a job in "outer space"—and not only "keep his feet on the ground": he can keep his present job while he is training. DeVry opens a wider range of job opportunities to a wider range of men 17-55.



**DeVRY TECHNICAL
INSTITUTE**
CHICAGO • TORONTO



Centralab L&T PAD ATTENUATORS

offer these advantages
in any
sound installation

SMALL SIZE...

less than $1\frac{3}{16}$ " deep from mounting surface, these units fit into any standard junction or switch box with room to spare... diameter is only $1\frac{3}{32}$ ".

HIGH WATTAGE...

conservatively rated at 20 watts audio, 5 watts D.C. yet they are no larger than units rated at 2 watts D.C. One size takes care of all your 2, 3, 4, and 5 watt requirements. Centralab's exclusive "thermo-pass" insulation combines fast heat transfer with a high dielectric constant to achieve this high rating.

ANTI-BACKLASH CONSTRUCTION...

the "play" frequently found in dual controls is eliminated. The wiper contacts move in unison, assuring that there will be no alteration in frequency response due to variations in wiper position on the resistance tracks.

B-6124

Centralab

THE ELECTRONICS DIVISION OF GLOBE-UNION INC.
9221 EAST KEEFE AVENUE • MILWAUKEE 1, WISCONSIN
In Canada: Centralab Canada Ltd., P.O. Box 400, Ajax, Ontario

ELECTRONIC SWITCHES • VARIABLE RESISTORS • CERAMIC CAPACITORS
PACKAGED ELECTRONIC CIRCUITS • ENGINEERED CERAMICS

New "Solid-State" IFT

A new type of ceramic coupling unit announced by the U. S. Sonics Corp. of Cambridge, Mass., is expected to show some advantages over crystal and magnetostrictive filters, especially in price.

The new and very small device consists of two discs of a modified zir-

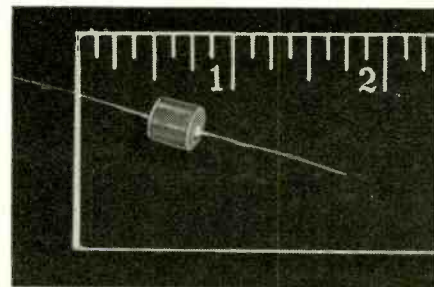

conate compound, approximately $\frac{1}{4}$ -inch in diameter. These are in contact, and the coupling between them is acoustic. Input and output leads are to the outside centers of the two discs, and the common lead to a point on the inside circumference of both.

Two types were reported available, both at 455 kc. The transistor type is rated at 10 kilohms input, 1 kilohm output; the input impedance of the tube type is 25 kilohms and the output 200 kilohms. Insertion loss for both types is in the order of 1 db, and the bandwidth at 3 db down is 6 kc for the transistor type, 2 kc for the tube type.

Now—a Maser for Sound

The principle of stimulated emission has been successfully applied to sound waves, reports Dr. Guy Suits, head of the General Electric Research Laboratory. This is the first time, he states, that stimulated emission has been used successfully to amplify energy other than electromagnetic energy. While no immediate commercial application is visible, the maser technique may assist in the study of sound waves in many physical phenomena. It may also make possible an oscillator that can generate sound (ultrasonic) waves of higher frequency than now possible.

The equipment resembles that of the ruby light maser described in the May issue of RADIO-ELECTRONICS. As in the light maser, electrons are raised to a higher energy state than normal. Dropping back to their original state, they give out energy.

There is also interaction between the vibrations of the atoms in the crystal lattice and the energy states of the electrons, due to the electric fields of the atoms in the lattice. As the atoms vibrate, the electric fields acting on the electrons vary and this affects their energy levels. This interaction is what makes the *phonon maser* possible.

**do you know
what an FCC License**

Really Can
do for you in electronics

1. If you want to get into electronics...

2. If you are now employed in electronics...

See what this leading employer **Burroughs Corporation** has to say:

"An FCC License is a job asset ...

to any man looking to enhance his career in the field of electronics. At Burroughs Corporation, a licensed man is well regarded because an FCC license attests to his knowledge of electronic theory. The licensed man at Burroughs will be called upon to handle many challenging assignments."

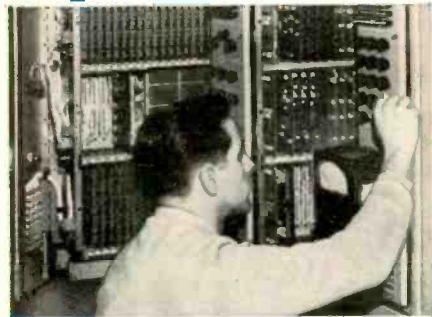

Employers are good judges of the value of an FCC License.

FREE!

find out how ...

1. You can get job security. Specialized education is the road to higher salary and important jobs in the growing field of electronics.
2. You can solve the problems that stump other technicians. Problems in electronics are becoming more complex. Your ability to solve problems will help you get ahead in your field.
3. You can handle new electronic devices. Every day, advances are being made in electronics. Only through education can you find out how to keep up with these developments and how to use the new devices.

GET ALL 3 VALUABLE BOOKLETS



**JUST MAIL THE
COUPON BELOW**

Accredited By The National Home Study Council

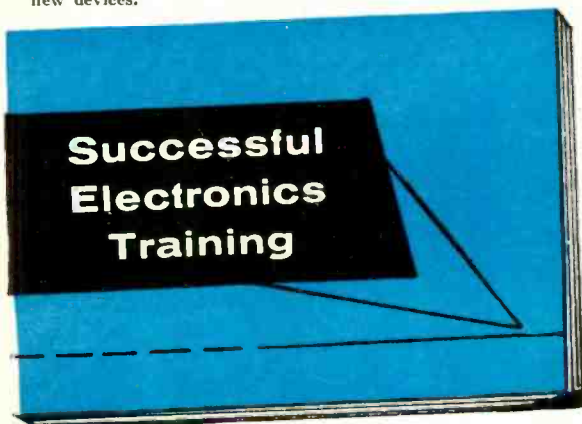

Sorry—Not For Beginners

Please inquire only if you really want to get ahead and to add to what you have already learned in school, in the service, or on the job. Some previous schooling or experience in electronics, electricity, or related fields is necessary for success in Cleveland Institute programs.

Cleveland Institute of Electronics

Desk RE 57-B

1776 E. 17th Street

Cleveland 14, Ohio

SEPTEMBER, 1961

Cleveland Institute of Electronics

Desk RE 57B, 1776 E. 17th Street, Cleveland 14, Ohio

Please send Free Career Information Material prepared to help me get ahead in Electronics. I have had training or experience in Electronics as indicated below.

- | | |
|---|---|
| <input type="checkbox"/> Military | <input type="checkbox"/> Broadcasting |
| <input type="checkbox"/> Radio-TV Servicing | <input type="checkbox"/> Home Experimenting |
| <input type="checkbox"/> Manufacturing | <input type="checkbox"/> Telephone Company |
| <input type="checkbox"/> Amateur-Radio | <input type="checkbox"/> Other |

In what kind of work are you now engaged? _____

In what branch of Electronics are you interested? _____

Name _____ Age _____

Address _____

City _____ Zone _____ State _____

RES7B

Quality you can count on **EVERY SINGLE TIME!**

In "Just What You Need" **HANDY KITS**

- Eliminate costly delays
- Increase your profits

Transistor Radio Electrolytic Capacitor Kit AK-510

Stock the most popular values of miniature electrolytic tubulars for repair of personal transistor radios, portable TV sets, and all space tight applications with this new Aerovox kit. Contains 18 miniature Type PTT-PWE plastic-cased units covering over 90% of all replacement requirements for transistor radios.

A \$23.65 value
for only
\$14.20



Series-String TV & AC-DC Radio Tubular Capacitor Kit AK-500

A \$13.70 value
for only
\$8.22

Designed for trouble-free repair of series-string TV and AC-DC table radios, this handy kit contains 6 Type PRS "Dandee" electrolytic tubular units in the fastest moving values. A "must" for the busy technician.

Both of these new Aerovox kits, packaged in reusable plastic boxes, are now available from your local Aerovox Distributor. See him for complete details or write direct... today. **Remember—it pays to use Aerovox!**

AEROVOX CORPORATION

DISTRIBUTOR DIVISION

NEW BEDFORD, MASSACHUSETTS

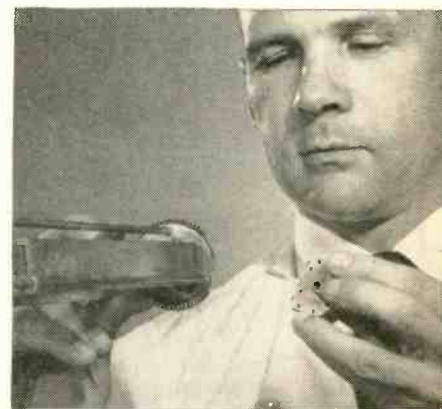

Dr. Edmund Tucker of General Electric inserts ruby rod into phonon maser.

lower frequency is introduced, stimulated emission occurs.

The phonon amplification is about 12% per centimeter of ruby. This is probably enough to overcome losses from crystal imperfections and deviations of the ends of the crystal from perfect flatness and parallelism. For high amplification, the waves must be reflected back and forth through the crystal many times, being amplified a little each time. The ends must be flat and parallel, or the waves reflect unevenly and interfere with each other. The ruby crystal is kept at a temperature of about 1.5° above absolute zero to minimize the effects of thermal vibrations.

Reliability the Keynote In New Transistor Plant

A semiconductor plant recently opened by Raytheon in Lewiston, Me., is "designed to produce transistors with 10 times higher reliability than presently available devices," according to Raytheon's president, Richard E. Krafve. Secret of the extremely high level of quality and reliability aimed at, company engineers explained, is a "continuous-flow" technique of quality control at all points in the process of manufacture, beginning with careful measurements and continuing with inspection of each step of the process, to the final checks on the finished transistor.

Flat Color TV Needed?

Protesting against present color TV set designs, Motorola demonstrated to its distributors an advanced design color TV receiver in a standard-size black-and-white TV cabinet. A special 23-inch 90° rectangular three-gun picture developed in the Motorola laboratory was used
(Continued on page 14)

The Same School That Originated The RTS BUSINESS PLAN

...NOW
Proudly
Presents...

A SPECIAL **COMPACT** COURSE COVERING ALL THREE PHASES OF **ELECTRONICS**

The Entire Course Is Made
Up Of The Following:

- 35 LESSONS COVERING BASIC AND INTERMEDIATE ELECTRONICS
- 9 EQUIPMENT KITS COMPLETE WITH TUBES AND BATTERIES
- SOLDERING IRON
- 25 LESSONS COVERING THESE ADVANCED ELECTRONIC SUBJECTS:
 - Thyratron Tubes • Semiconductors • Electronic Symbols and Drawings • Voltage-Regulators • Electronic-Timers • Control Systems • X-Rays • Photoelectric Devices • Dielectric Heating • Geiger Counters • Pulse Circuitry • Clippers and Limiters • Multivibrators • Electronic Counters • Radar • Magnetic Amplifiers • Analog-Computers • DC Amplifiers • Digital Computers • Storage Systems • Input and Output Devices • Servomechanisms • Telemetering
- 60 EXAMINATIONS
- UNLIMITED CONSULTATION SERVICE
- KIT MANUALS
- DIPLOMA UPON GRADUATION

AND MUCH MORE...

RTS' Membership in The Association of Home Study Schools is your assurance of Reliability, Integrity and Quality of Training.



RTS ELECTRONICS DIVISION
815 E. ROSECRANS AVENUE
LOS ANGELES 59, CALIFORNIA

Est. 1922



L 202

BASIC • INTERMEDIATE • ADVANCED
DESIGNED FOR THE BUSY MAN OF TODAY

This is MODERN training for the MODERN man. You'll find no "horse and buggy" methods here. Every page of this streamlined course is devoted to important Electronics principles and practical projects. You'll be amazed how fast you grasp Electronics the RTS way. RTS has combined modern THEORY and PRACTICE to make this the finest training program of its kind available!

SATISFIES NOVICE, TECHNICIAN OR HOBBYIST

Whether you're new to Electronics or an old "pro," chances are you'll find this to be the ideal course for you. The novice will appreciate the completeness of the training. It starts with the most basic considerations, covering each important point thoroughly, yet concisely. The technician will enjoy the practical review of fundamentals and profit from the 25 advanced subjects covered.

RTS GIVES YOU "TOP MILEAGE" FOR YOUR TRAINING DOLLAR

The price quoted below buys EVERYTHING — there are no extras to pay for. RTS has gone "all out" to give you the best training value in America. Why pay hundreds of dollars for training such as we offer when it's available for this LOW PRICE? If you can find a better training bargain... BUY IT!

CAN BE COMPLETED IN MONTHS INSTEAD OF YEARS

Some students will complete this course with "Jet-Like" speed but we allow up to two years if your circumstances require it. You study at your own rate. You are ENCOURAGED, but not pushed. You'll find the lessons professionally written but easy to understand. LET US SEND YOU ONE OF THESE LESSONS ALONG WITH YOUR CAREER BOOKLET SO YOU CAN SEE FOR YOURSELF. NO OBLIGATION!

**LOWEST
COST
AND
TERMS**

**ALL KITS ARE SENT TO
YOU COMPLETE. TUBES AND
BATTERIES ARE INCLUDED
AT NO EXTRA COST**

**No Kit Deposits Required.
THE FIRST TRAINING KIT IS SENT
IMMEDIATELY UPON ENROLLMENT**

DON'T LOSE OUT — FIND OUT!

RTS ELECTRONICS DIVISION Dept. RE91
815 E. ROSECRANS AVENUE LOS ANGELES 59, CALIFORNIA

Rush me full information by return mail. (Please Print)

Name _____ Age _____

Address _____

City _____ Zone _____ State _____

**Rush
Coupon
for FREE
FACTS!**

NO SALESMAN WILL CALL ON YOU!

news from hallicrafters



littlefone

CB-3 TRANSCEIVER

Only Hallicrafters offers 8-channel convenience and all these quality performance features.

The transmitter . . . output circuit matches 25 to 75 ohm antenna systems. Standardized CR23/U crystals (3rd overtone, series resonant) readily available. Output amplifier adjustable for max. legal input. 100% modulation on positive peaks. Series-tuned 2nd harmonic trap for excellent TV suppression.

The receiver . . . sensitivity less than 1.0 UV for 10 db. signal-to-noise ratio. Electronic squelch works on less than 6 db. signal strength change. 6 kc. selectivity. Image rej. 40 db. min. Audio output over 2 watts. Auto. noise limiter series and shunt diodes.

\$14950

citizens band

Before you choose from the countless brands of CB equipment available, consider this fact: Nowhere in the field of communications is a manufacturer's experience, integrity and record of achievement more critical to performance and reliability than in citizen's band. Hallicrafters has produced about 1,000,000 communications units in the past 27 years.

the new ideas in communications are born at . . .

h hallicrafters

CHICAGO 24, ILLINOIS

Export Sales: International Div., Raytheon Mfg. Co., Waltham, Mass.

Canada: Gould Sales Co., Montreal, P.Q.

ARE YOU "ON TARGET?"

Test Yourself.....

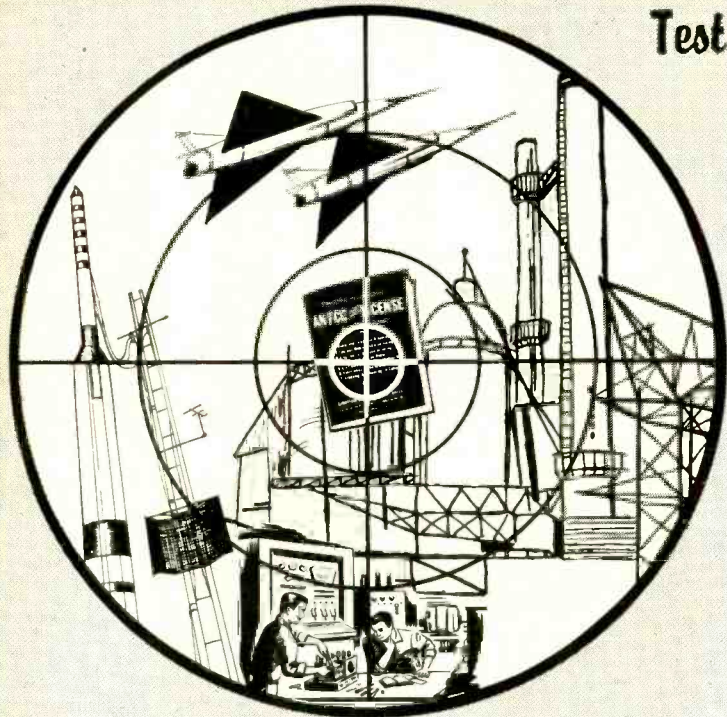

ANSWER THESE QUESTIONS:

- DO YOU want to get into **ELECTRONICS**?
- Do you have a **SPECIFIC OBJECTIVE** in mind ... Are you shooting at a particular target (such as an FCC License)?

NOTE: The First Class Commercial FCC License is a nationally recognized certification of electronics knowledge... PROOF of qualifications in meeting U. S. Government requirements for certain jobs. Many companies which employ industrial electronics technicians require them to have this license. If you want a job in electronics, set your sights on an FCC License as your No. 1 objective.

- Do you want the kind of training that will take you straight to this objective **QUICKLY**... without wasting valuable time on non-essentials?

Is Grantham Training for You?

CHECK THESE FEATURES:

- Grantham teaches the *theory* of electronics. Every basic concept of electronics fundamentals is covered in the Grantham course... whether you take it in resident classes or by home study. Grantham training "makes electronics yours."
- You can get your First Class FCC license **IN ONLY 12 WEEKS** in Grantham resident classes (or, in a correspondingly short time in the Grantham home-study program). **THINK OF IT!** A *commercial* U. S. Government license... **PROOF OF YOUR** qualifications in meeting these U. S. Government requirements as an electronics communications technician... a nationally recognized certificate. By preparing you for this license in only 12 WEEKS, Grantham conserves **YOUR TIME!**
- Mature men select Grantham Schools for electronics training. (The average age of Grantham Students is 28.8 years.) **MATURE MEN** want a definite objective (not a pot of gold at the end of the rainbow). Grantham training has this specific objective: To prepare you for your First Class FCC license and greater earning capability. The Grantham Course is for mature men *who know what they want.*

- Grantham Schools' tuition rates are low, yet the instructional service is not equalled by many of the *most expensive schools!* Grantham can do this because of highly efficient instructional methods and because Grantham has a sincere desire to out-do all others in service rendered per tuition-dollar. Grantham has established *reasonable* tuition rates. And, the percentage of students who successfully complete the Grantham course — and who get their FCC licenses — is one of the highest in the nation.
- YOU GAIN RESPECT** by showing your Grantham diploma, once you earn it. **YOU GAIN RESPECT** by showing and posting your First Class FCC License — a nationally recognized certification of your electronics knowledge. Many companies which employ industrial electronics technicians require them to have this license. **YOU CAN GET IT IN ONLY 12 WEEKS.** Let Grantham show you how!

HERE'S PROOF: Here is a list of a few of our recent graduates, the class of license they got, and how long it took them:

	License	Weeks
Thomas Schutte, 736 Clinton, Hamilton, Ohio	1st	12
Louis W. Pavak, 838 Page St., Berkeley 10, Calif.	1st	16
William F. Bratton, Jr., 435 Etna Street, Russell, Ky.	1st	12
Darrell E. Cloce, 25 E. 32nd St., Kansas City, Mo.	1st	12
P. B. Jernigan, Route 2, Benson, North Carolina	1st	12
Claude Franklin White, Jr., c/o Radio Sta. WJMA, Orange, Va.	1st	12
John M. Morgan, c/o KIRI-TV, 1530 Queen Anne Ave., Seattle, Wash.	1st	9½

Get your First Class Commercial F. C. C. License Quickly by training at



GRANTHAM SCHOOL OF ELECTRONICS

1505 N. Western Ave. Hollywood 27, Calif. (Phone: HO 7-7727) 408 Marion Street Seattle 4, Wash. (Phone: MA 2-7227) 3123 Gillham Road Kansas City 9, Mo. (Phone: JE 1-6320) 821 - 19th Street, N.W. Washington 6, D. C. (Phone: ST 3-3614)

MAIL COUPON NOW — NO SALESMAN WILL CALL →

(Mail in envelope or paste on postal card)

TO: GRANTHAM SCHOOL OF ELECTRONICS
 1505 N. Western Hollywood 408 Marion Seattle 3123 Gillham Rd. Kansas City 821 19th, NW Washington

Please send me your free booklet telling how I can get my commercial F.C.C. license quickly. I understand there is no obligation and no salesman will call.

Name _____ Age _____
 Address _____
 City _____ State _____

I am interested in: Home Study, Seattle classes
 Hollywood classes, Kansas City classes, Washington classes

14-P

11 down-to-earth ways to sell high-profit sound:

Sonotone ceramic and crystal cartridges

One line of cartridges to meet virtually every service or replacement need, at a price that allows you excellent profits... that's what Sonotone offers you today. There are Sonotone ceramic cartridges for any sound system... and equalizers to convert any magnetic input for ceramic cartridge use. 70 phonograph manufacturers use Sonotone as original equipment. And more than 12,000,000 satisfied users make up a "pre-sold" market for your future service or sales profits. For full profit opportunity, stock the full Sonotone Cartridge line!

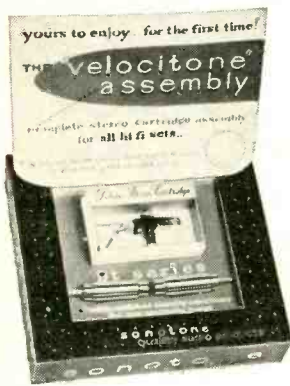

Stereo:

Velocitone Assembly DeLuxe "9T" cartridge plus matched equalizers for improved sound through any magnetic input system. Response: Flat $\pm 1/2$ db from 20 to 6,000 cps, 1 db to 17,000 cps with deliberate rolloff to 20,000 cps.



"9T"—Superb quality for even the most advanced audiophile.

Response: Flat ± 1 db from 20 to 17,000 cps, with deliberate rolloff to 20,000 cps.



"10T"—A budget-priced ceramic cartridge for inexpensive phonographs.

Response: Flat from 20 to 15,000 cps ± 2.5 db.



"12T"—Crystal cartridge offering clear stereo sound at budget price. Response: Flat ± 2.0 db to 10,000 cps, smooth rolloff to 15,000 cps.



"T1" Tonearm assembly complete with "12T" stereo cartridge for the best possible sound anywhere near the price.



"8TA"—Fine economical replacement to achieve well-balanced reproduction from most popular systems.

Response: Flat ± 2.5 db from 20 to 15,000 cps, with gradual rolloff to 20,000 cps.



"16T"—Ideal cartridges combining top quality with moderate price... now original equipment on most leading phonographs.

Response: Flat ± 1 db from 20 to 10,000 cps, with smooth rolloff to 12,000 cps.

"18T"—Companion to the 16T with slightly greater output voltage, moderately priced and now original equipment with most phonograph manufacturers.

Response: Flat ± 1 db from 20 to 10,000 cps, with smooth rolloff to 12,000 cps.



"3T"—Crisp, clear highs...full authoritative lows. Outperforms expensive magnetic cartridges.

Response: smooth 20 to 20,000 cps, flat to 15,000 with gradual rolloff beyond.



"2T"—Wide spectrum response... ideal for monophonic replacement at less cost.

Response: smooth 20 to 20,000 cps, flat to 12,000 with gradual rolloff beyond.

Monaural:

"1P"—Improves performance of even simplest record players.

Response: smooth 20 to 20,000 cps, flat to 12,000 with gradual rolloff beyond.

Sonotone

REG. U.S. PAT. & TM. OFF. ELECTRONIC APPLICATIONS DIVISION, DEPT. C2-91, ELMSTOWN, N.Y. In Canada, contact Atlas Radio Corp., Ltd., Toronto

Leading Makers of Cartridges • Speakers • Tape Heads • Mikes • Electronic Tubes • Batteries

(Continued from page 10)

in the set. Reducing the front-to-back distance by several inches, it adds 20-odd square inches to the viewing area.

Motorola's vice president Ed Taylor told the distributors that the new set was not an indication that Motorola was going into color. It meant that Motorola would not go into color until it could sell a set comparable to that on display. Information on the new tube is available to tube manufacturers, he said, and he "would like to see all the manufacturers in this industry put as much of their time and effort into advancing the color art in their laboratories as is being put into the marketing of receivers that are too large for the average-size American living room.

Molecular Radios Coming?

Radios in which the components will consist of thin films and dots on a piece of ceramic may be on the market "substantially before 1965," according to Westinghouse vice president Chris J. Witting. One Westinghouse molecular block contains the equivalent of two stages of amplification—two transistors, several resistors and capacitors—on a "functional block" $1/4$ inch long, $1/8$ inch wide and .03 inch thick. Three of these blocks stacked one on top of each other might contain the equivalent of all but the tuning circuitry and speaker of a six-transistor radio—on a "chassis" that could be dropped into the cap of a mechanical pencil.

Several companies have reported and demonstrated molecular components, and it is likely that others will be announcing their units in the near future.

"Citizens Band" for Canada

Following the US lead, Canada is to have a General Service band, roughly equivalent to the US Citizens band. Provisional specifications have been drawn up by the Canadian Department of Transport and forwarded to the Canadian Radio Technical Planning Board for comments. It is expected that either FM or AM will be permitted on the band, which will consist of 19 discrete frequencies in the 27-mc region. Radiation figures are being held within stringent limits, and there is some question as to whether kit-built equipment will be able to meet the specs. Power limit is 5 watts. No superregenerative receivers will be permitted. Starting date for the new service is next April, according to present proposals.

Flat Speakers Near

Flat but nonelectrostatic speakers appear to be just around the corner, from a number of reports. The Israeli speaker announced nearly 2

(Continued on page 20)



Special Training Equipment Included

Pick the field of your choice—and train at home with the leader—NRI. In addition to Industrial Electronics and FCC License training explained at the right, NRI offers comprehensive courses in Radio-TV Servicing and Radio-TV Communications. Except for the FCC course, all NRI courses include—at no extra cost—special training equipment for actual practice at home, building circuits and working experiments. Makes theory you learn come to life in an interesting, easy-to-grasp manner.

Multiplexing, FM Stereo Broadcasting Included

NRI training keeps up with the times. New, additional profit opportunities exist for the Technician who understands the latest technical advances. Course material now covers FM Stereo Broadcasting, tells you about Multiplexing equipment, other recent developments.

Learn More to Earn More

Act now. The catalog NRI sends you gives more facts about the field of your choice, shows equipment you get and keep. No obligation. Cost of NRI training is low. Monthly payments. 60-Day Trial Plan. Mail postage-free card today. **NATIONAL RADIO INSTITUTE, Washington 16, D.C.**

Send for
64-Page
CATALOG
FREE

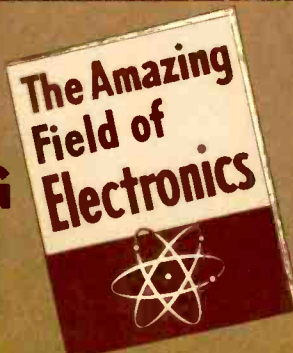

NRI—Oldest and Largest Radio Television School Now Offers NEW HOME STUDY TRAINING IN INDUSTRIAL ELECTRONICS & MILITARY ELECTRONICS

This is the age of Electronics. Rapidly expanding uses for Electronic Equipment in industry, business, the military demands more trained men. Prepare now for a career as an Electronic Technician to assure advancement or to profit from your hobby. NRI now offers a complete course in **ELECTRONICS—Principles, Practices, Maintenance.** Computers, telemetry, automation, avionics are changing our world, yet all employ the same basic principles . . . and that is what this NRI course stresses with illustrated lessons and special training equipment. Mail card below.



NEW HOME STUDY TRAINING FOR YOUR FCC LICENSE



An FCC Commercial License combined with NRI time-tested training can be the keys to a better future for you with higher pay, interesting work, more rapid advancement as the rewards. Prepare at home *quickly* for your FCC examinations through NRI's new, low-cost, special training. Like other NRI-trained men, you can be monitoring TV shows, radio broadcasts, operating shipboard and aviation radio, or holding down other important jobs. Get full details—mail the card below.

FOR MORE INFORMATION-TURN PAGE

Cut Out and Mail—No Stamp Needed



**NATIONAL RADIO INSTITUTE
WASHINGTON 16, D.C.**

Send me your Electronic, Radio-TV catalog without cost or obligation. I am interested in the course checked below: (No representative will call. Please PRINT.)

- INDUSTRIAL ELECTRONICS COMMUNICATIONS
 FCC LICENSE SERVICING **WX**

Name _____ Age _____

Address _____

City _____ Zone _____ State _____

ACCREDITED MEMBER NATIONAL HOME STUDY COUNCIL

**ELECTRONICS NEEDS
4 TO 7
QUALIFIED TECHNICIANS**

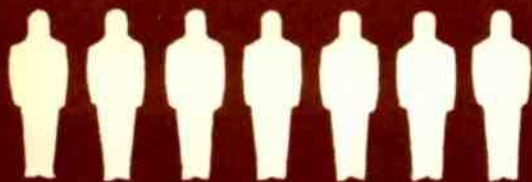

FOR EVERY ENGINEER



Choose from 4 Courses

- 1 INDUSTRIAL ELECTRONICS**
Learn Principles, Practices, Maintenance of Electronic equipment used today by business, industry, military, government. Covers computers, servos, telemetry, multiplexing, many other subjects.
- 2 FCC LICENSE**
Every communications station must have one or more FCC-licensed operators. New NRI course is designed to prepare you for your First Class FCC exams. You learn quickly, training at home in your spare time.
- 3 COMMUNICATIONS**
Training for men who want to operate and maintain radio and TV stations; police, marine, aviation, mobile radio, etc. Includes FM Stereo broadcasting. Course also prepares you for your FCC license exam.
- 4 SERVICING**
Learn to service and maintain AM-FM Radios, TV sets, Stereo Hi-Fi, PA systems, etc. A profitable, interesting field for a spare-time or full-time business of your own.

SEE OTHER SIDE

**Join The Thousands
Who Trained For
Advancement With NRI**

Thousands of NRI graduates throughout the U. S. and Canada are proof that it is practical to train at home. NRI graduates are in every kind of Electronics work: inspectors, maintenance men, lab technicians, testers, broadcasting and mobile communications operators, Radio-TV service technicians, or in essential military and government posts. Catalog tells more about what NRI graduates do and earn. Mail postage free card.



"THE FINEST JOB I EVER HAD" is what Thomas Bilak, Jr., Cayuga, N. Y., says of his position with The G. E. Advanced Electronic Center at Cornell University. He writes, "Thanks to NRI, I have a job which I enjoy and which also pays well."



BUILDING ELECTRONIC CIRCUITS on specially-designed plug-in type chassis, is the work of Robert H. Laurens, Hammonton, N. J. He is an Electronic Technician working on the "Univac" computer. Laurens says, "My NRI training helped me to pass the test to obtain this position."



"I OWE MY SUCCESS TO NRI" says Cecil E. Wallace, Dallas, Texas. He holds a First Class FCC Radio-telephone License and works as a Recording Engineer with KRLD-TV.



MARINE RADIO OPERATOR is the job of E. P. Searcy, Jr., of New Orleans, La. He works for Alcoa Steamship Company, has also worked as a TV transmitter engineer. He says, "I can recommend NRI training very highly."



FROM FACTORY LABORER TO HIS OWN BUSINESS that rang up sales of \$158,000 in one year. That's the success William F. Kline of Cincinnati, Ohio, has had since taking NRI training. "The course got me started on the road," he says.

FIRST CLASS
PERMIT
NO. 20-R
(Sec. 34.9, P.L.&R.)
Washington, D.C.

BUSINESS REPLY MAIL
NO POSTAGE STAMP NECESSARY IF MAILED IN THE UNITED STATES

POSTAGE WILL BE PAID BY



National Radio Institute
3939 Wisconsin Avenue
Washington 16, D.C.



**NRI IS OLDEST—LARGEST
SCHOOL OF ITS KIND**

Training men to succeed by home study has been the National Radio Institute's only business for over 45 years. NRI is America's oldest and largest Electronics home-study school. Don't delay. Cut out and mail POSTAGE-FREE CARD.



MAIL POSTAGE-FREE CARD

FREE!!

LAFAYETTE RADIO ELECTRONICS



Your Complete
"Electronics
& Hi-Fi" Catalog
featuring
"The Best Buys
in the Business"

340 PAGES

1962 Catalog 620



10,000
OHMS-PER-VOLT
MULTITESTER
TE-10 9.95



9-TRANSISTOR
CITIZENS BAND
"WALKIE TALKIE"
HE-29A each 35.95
2-for 78.88

SUPERHETERODYNE
COMMUNICATIONS RECEIVER
KT-200, HB \$4.50
HE-10, Wired 79.95



FM STEREO
MULTIPLEX TUNER
LT-700 129.50



COMPLETELY WIRED,
FULL SIZE TUBE TESTER
TE-15 19.95

- Stereophonic Hi-Fi
- Citizens Band
- Ham and Amateur
- Audio, Radio & TV Parts
- Optics
- Industrial



TRANSISTORIZED
PORTABLE TAPE RECORDER
RK-125 29.95

Audiophile, Experimenter, Hobbyist, Technician, Engineer, Student, Serviceman — you'll find what you want in this latest Lafayette catalog. All the name brands plus hundreds of Lafayette "exclusives" including the famous Lafayette Kits — the best value for your money today.

Detach and mail **TODAY**

Mail Coupon today for your **FREE** copy of Lafayette's 1962 catalog.

SATISFACTION GUARANTEED OR MONEY REFUNDED

Lafayette's **NEW Easy-Pay Plan.**

NO MONEY DOWN, up to 24 months to pay.

LAFAYETTE RADIO

165-08 LIBERTY AVENUE, JAMAICA 33, N. Y.

NEW YORK, N. Y.
100 6th Avenue

NEWARK, N. J.
24 Central Avenue

BROX, N. Y.
542 E. Fordham Rd.

PARAMUS, N. J.
182 Route 17

BOSTON, MASS.
110 Federal Street

PLAINFIELD, N. J.
139 W. 2nd Street

LAFAYETTE RADIO, Dept. J11-1
P. O. Box 190, Jamaica 31, N. Y.

- Rush my **FREE** Lafayette 1962 Catalog 620
 Please send me # _____, shipping charges collect.

I am enclosing \$ _____



340 PAGES

Name _____
Address _____
City _____ Zone _____ State _____

INTERNATIONAL'S

NEW SERIES

Executive

for SUPERIOR Citizens band communication . . .

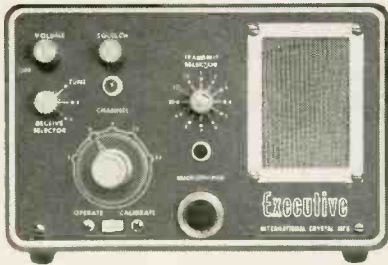

MODEL 100

The ultimate in Executive Citizens transceivers. Advanced features and design make the Model 100 an exceptional value. **New** crystal filter which minimizes adjacent channel interference in the receiver. **New** built-in receiver calibration circuit. **New** International NR squelch. **New** 12 position crystal control transmit channel selector. **New** front panel microphone jack. **New** provision for connecting external speaker and S/meter. Dual conversion superheterodyne receiver. Push-to-talk operation. Three way power supply for 6/12 vdc, and 115 vac. Handsomely packaged with new attractive control panel. Full five watts plate input. Certified tolerance .005%. Size 5½" x 8½" x 9" deep. Engineered to provide maximum operating efficiency. **Complete with 1 transmit crystal, 1 receive crystal, new style ceramic microphone and coil cord.**

\$199.50*



MODEL 10

International's exciting **New** Compact transceiver for the Citizens licensee who desires quality workmanship and engineering plus the best possible circuit for the money invested. Field tested full 5 watt transmitter contained in the higher price Executives. Certified tolerance .005%. Tunable superheterodyne receiver covering all 23 channels. Three position crystal control transmit channel selector. Manual transmit-receive control. Noise limiter. Available accessories include four separate power supplies — 6 vdc, 12 vdc, 24 vdc or 115 vac, push-to-talk relay kit, squelch kit, and 12 position transmit channel selector. **Complete with 1 transmit crystal, matching microphone and external speaker, but less power supply.**

\$59.50*

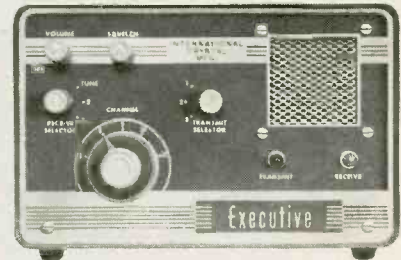

MODEL 50

A precision engineered transceiver featuring push-to-talk operation. Three position crystal control transmit channel selector. Dual conversion superheterodyne receiver tuning all 23 channels. Full five watts plate input. Crisp and clear modulation. Certified tolerance .005%. Series Gated automatic noise limiter. **New** International NR squelch. Three way power supply for 6/12 vdc, and 115 vac. The Model 50 Executive is a rugged yet handsome piece of communication gear equally at home in the office, service truck or field. Inside the Model 50 and every International Executive you'll find the latest circuitry, careful craftsmanship and quality components. Additional features of the Model 100 Executive may be added at any time. **Complete with 1 transmit crystal and matching microphone.**

\$149.50*

*Suggested Price

SEE THE EXECUTIVE SERIES AT YOUR AUTHORIZED INTERNATIONAL DEALER



INTERNATIONAL CRYSTAL MANUFACTURING CO., INC.

18 NORTH LEE • OKLAHOMA CITY, OKLAHOMA

THIS SHOP IS MAKING MONEY



with **CLAROSTAT** RTV controls

Radio and television repair shops in all parts of the country are increasing their profits with Clarostat RTV controls—the controls that are *right* for the job, *right* from the carton.

RTV controls are manufactured as matched replacements under rigid quality control standards at the factory. Clarostat offers the direct replacement for practically every radio and TV set control ever produced. RTV controls can save you many hours per man per week, raising your output and multiplying your profits.

Always ask for CLAROSTAT!



GET THE COMPLETE DETAILS ON RTV CONTROLS FROM YOUR DISTRIBUTOR

CLAROSTAT MFG. CO., INC.

DOVER, NEW HAMPSHIRE

In Canada: CANADIAN MARCONI CO., LTD., Toronto 17, Ont.



NEW KITS FROM H. H. SCOTT!



Massive 130 Watt Power Amplifier, Feature-Packed Control Center use radical ways to simplify Kit building

Exciting News for Kit-Builders! Now, for the first time, H. H. Scott engineering leadership, H. H. Scott quality, and H. H. Scott experience are available to the kit-builder in a massive 130 watt power amplifier kit and a feature-packed stereo pre-amplifier kit.

These new kits utilize the time-saving, labor-saving, techniques pioneered by H. H. Scott in their famous LT-10 FM tuner and LK-72 complete amplifier. To speed assembly time and reduce errors all wires are pre-stripped and cut to proper length; mechanical parts are already riveted in place; each electronic component is mounted on special part charts, easy-to-follow instruction books are in full color.

The new H. H. Scott LC-21 Pre-Amplifier and LK-160 Power Amplifier kits are completely professional units in looks... in design... in specifications. You'll be proud to show and demonstrate them to your friends.



Unique time and labor-saving features of H. H. Scott kits:

1. All mechanical parts pre-riveted in place.
2. All wires pre-cut, pre-stripped.
3. Unique Part-Charts** provide positive identification of parts.
4. Full-color instruction book.
5. Kit-Pak** container opens to convenient work table, folds out of sight when not in use.

** Mass. Trade-Mark Reg.
No. 19043, 19044

Outstanding Features and Technical Specifications of These New Kits

LK-160 POWER AMPLIFIER KIT — Output rated at 65 watts music power per channel (60 watts steady state). Famous 6550 matched-pair output tubes, rated at 100 watts. Unique output circuitry assures top performance without external laboratory equipment. IHFM power band from far below 19 cps to more than 25,000 cps (limits of laboratory test equipment). Total Harmonic Distortion less than 0.5% at full power. IM distortion less than 0.5% at full output. Damping factor adjustable to either 16:1 or 8:1 to compensate for differences between some efficient and inefficient loudspeakers. Switchable subsonic noise filter. Amplifier absolutely stable even without load. 15" W x 6½" H x 11¼" D. \$169.95*

LC-21 PRE-AMPLIFIER KIT —

Five pairs of stereo inputs, derived center channel output and stereo tape recorder outputs. 16 front panel controls including equalization provisions for microphone, tape head, or RIAA; scratch and rumble filters; magnetic pickup selector; phase reverse; tape monitor; derived center channel level control. Unique power supply shielding, DC tube heaters, and aluminum chassis permit unusually low — 80 db hum level. Distortion less than 0.1% at 2.5 volts output. Can be wired for home or laboratory use where response below 10 cps is required. Frequency response 8 cps to 50,000 cps ± 1 db. 15½" W x 5¼" H x 13¼" D. \$99.95*

*Cage or case extra. Slightly higher west of Rockies



H. H. Scott Inc., Dept. 570-09, 111 Powdermill Road, Maynard, Mass.

Send me complete specifications on your new Kits, and information on your entire factory-built line.

Name _____

Address _____

City _____ Zone _____ State _____

Export: Morhan Exporting Corp., 458 Broadway, N. Y. C.

(Continued from page 14)

years ago (or one very much like it) is being manufactured in France under the name Orthophase. Emerson also demonstrated a model, for which they have obtained American rights from the Weizmann Institute in Israel. At about the same time, Bogen and Rich of Yonkers, N. Y., announced a speaker system containing a flat middle- and high-range unit that consists of a voice coil attached to a flat sheet between two sets of permanent magnets. (In the Israeli speaker, the voice coil is on ridges on a flat sheet, with magnets so placed that if the sheet excursions were large the magnets would enter troughs between the ridges.)

Calendar of Events

- NATESA Convention**, Aug. 17-20, Pick-Congress Hotel, Chicago.
- Western Electronics Show and Convention (WESCON)**, Aug. 22-25, Cow Palace, San Francisco, Calif.
- Chicago High Fidelity Show**, Aug. 25-26, Hotel Sherman, Chicago.
- German Radio, Television and Phonographic Industries Exhibition**, Aug. 25-Sept. 3, Berlin, Germany.
- Danish RMA Radio & TV Show**, Sept. 1-10, The Forum, Copenhagen, Denmark.
- Conference of the Association for Computing Machinery and International Data Processing Exhibit**, Sept. 5-8, Statler Hilton Hotel, Los Angeles, Calif.
- IRE Symposium on Space Electronics and Telemetry**, Sept. 6-8, Albuquerque, New Mexico.
- IRE-AIEE-ASEE International Conference on Electrical Engineering Education**, Sept. 6-13, Sagamore Conference Center, Syracuse University, Adirondacks, New York.
- ISA Instrument Automation Conference and Exhibit**, Sept. 11-15, Los Angeles Memorial Sports Arena, Los Angeles, Calif.
- EIA Fall Conference**, Sept. 12-14, Biltmore Hotel, New York, N.Y.
- IHFH High Fidelity Show**, Sept. 13-17, Trade Show Building, New York, N.Y.
- AIEE-IRE Engineering Management Conference**, Sept. 14-15, Roosevelt Hotel, New York, N.Y.
- IRE Symposium on Engineering Writing and Speech**, Sept. 14-15, Bellevue-Stratford Hotel, Philadelphia, Pa.
- National Exhibition of Radio and TV**, set for Sept. 14-25, Parc Des Expositions, Paris, France.
- Instrument Society of America-AIEE-IRE Industrial Electronics Symposium**, Sept. 20-21, Bradford Hotel, Boston, Mass.
- IRE National Communications Symposium**, Oct. 2-4, Utica, N.Y.
- IRE Canadian Electronics Conference**, Oct. 2-4, Automotive Bldg., Exhibition Park, Toronto, Canada.
- IRE Annual Broadcast Symposium**, Oct. 6-7, Willard Hotel, Washington, D.C.
- IRE-AIEE National Electronics Conference**, Oct. 9-11, International Amphitheatre, Chicago, Ill.
- Audio Engineering Society Fall Convention and Technical Exhibit**, Oct. 10-12, Hotel New Yorker, New York.

Stereo FM for Canada?

The Canadian Radio Technical Planning Board, representing the Canadian radio industry, has submitted proposals to the Department of Transport, Ottawa, for FM multiplex stereo broadcasting. (Radio in Canada comes under the jurisdiction of the Department of Transport.) The department is stated to be studying the matter, and it is expected that stereo broadcasting will be permitted. **END**

PHOTOFACT world's finest electronic service data now greater than ever!

with dozens of exclusive new features for fastest, easiest, more profitable servicing

OVER 50,000 LISTINGS: Only service data of its kind—prepared from analysis of the actual equipment. Complete, uniform, accurate. Over 21,000,000 PHOTOFACT Sets now in use! If you're not using PHOTOFACT, you're not realizing your full earning power. So get the proof—try PHOTOFACT on any job—see how much time you save, how much more you can earn daily! Your Parts Distributor has the PHOTOFACT Folder Sets you need. Have *all* the help you'll ever want for greater servicing success and bigger earnings!



EXCLUSIVE IN PHOTOFACT



COVERS:
 Black & White TV
 Color TV
 AM Radios
 FM Radios
 Transistor Radios
 Auto Radios
 Amplifiers, Tuners
 Recorder Changers
 Tape Recorders

FAMOUS "STANDARD NOTATION" SCHEMATICS

- Uniform symbols in each schematic; same circuit layout form each time

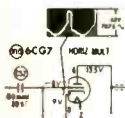

- Voltages at tube pins and test points
- Waveforms at appropriate points on TV schematics
- "CircuiTrace" identification numbers for printed circuits

- Schematic items keyed to chassis photos and parts lists
- Special capacitor and resistor ratings
- Coil and transformer color codes or terminal identification

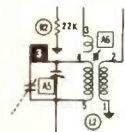

- Test points labeled
- Special currents shown (B+, horizontal output cathode, horizontal output screen)

- Alignment adjustments and test points labeled
- Tube functions shown
- Control and switch functions shown
- Switch sequence indicated
- Power supply "sources" shown
- Fuse ratings indicated
- Coil resistance over 1 ohm shown
- Coding of electrolytic capacitors shown

REPLACEMENT PARTS LISTS



- Lists standard, locally available replacement parts
- Includes notes for special installation or other considerations
- Includes ratings and/or measured values for assisting in selection of replacement parts
- All parts keyed to chassis photos and schematics for quick reference

TUBE PLACEMENT DIAGRAMS



- Shows tube types and functions; top and bottom views shown
- Includes filament connections on series string
- Indicates TV sound and sync paths
- Tube failure check charts included
- Shows blank pin or locating key on each tube
- Includes fuse locations and ratings.

ALIGNMENT INSTRUCTIONS



- Gives step-by-step easy-to-follow alignment data
- Procedure makes use of standard service-type equipment
- Alignment frequencies are shown on chassis photos near adjustment number—adjustments are keyed to schematic and photos

"CIRCUITRACE" FEATURE



- Invaluable printed board servicing aid—indicates points on board photo and schematic for quick, easy measurement of components, or test locations

FULL PHOTO COVERAGE



- All chassis views are shown in actual photographs
- All parts are numbered and keyed to the schematic and parts lists
- Test and alignment points indicated

FIELD SERVICE NOTES

- Outlines procedure for "in the home" adjustments
- Gives hints on quick access to pertinent adjustments, safety glass removal, etc.

"BONUS" FEATURES

- Disassembly instructions
- Dial cord diagrams
- Record changer and tape recorder "exploded views" for easy mechanical parts replacement or service

"PLUS" ADVANTAGES

- ★ Citizens Band Radio coverage
- ★ Tube Test data—provides setting for testing new tubes
- ★ Color TV Course "Bonus" beginning in Set No. 541
- ★ Eligibility for membership in "PEET" with ownership of a PHOTOFACT Library

SEND FOR YOUR PHOTOFACT INDEX NOW!

FREE

FREE!

VALUABLE PHOTOFACT INDEX

YOUR GUIDE TO OVER 50,000 TV, Radio, Electronic Listings! Send for it today! Your guide to virtually every model produced since 1946. Helps you locate the proper PHOTOFACT Folder you need to solve any service problem in any model. Send the coupon today for your FREE copy of the latest PHOTOFACT Index to the service data you need!

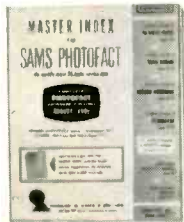

HOWARD W. SAMS & CO., INC.

Howard W. Sams & Co., Inc., Dept. 6J1
 1724 E. 38th St., Indianapolis 6, Ind.

- Send FREE Photofact Cumulative Index
- Send full information on: Easy Buy Plan Standing Order Subscription "Peet" Program

Shop Name _____
 Attn.: _____
 Address _____
 City _____ Zone _____ State _____

Special Combination Offer

SAVES \$244



Weller® Instant Heat Gun PLUS Solder Dispenser Tool

New, money-saving Weller combination assures faster, better soldered connections. Gun tip heats instantly when trigger is pulled—cools immediately when trigger is released. Spotlight illuminates work. Tip made of copper for maximum heat transfer, iron-plated for long life. Weller-Kormat Dispenser saves time—particularly in difficult-to-reach spots. It eliminates manual handling of the solder, and resulting contamination that causes faulty connections. It also reduces solder waste and prevents finger burns.



100 Watt Soldering Gun
Guaranteed 1 year.
Model 8100B. Reg. list price..... **\$6.44**

Weller-Kormat Dispenser
for wire solder from .028 to .074". Reg. list price.. **\$5.95**
Reg. list price value.... **\$12.39**

COMBINATION PRICE..... \$9.95
list

AT YOUR ELECTRONIC PARTS DISTRIBUTOR

WELLER ELECTRIC CORP., EASTON, PA.

Correspondence



X = TRANS

Dear Editor:

Xmitter = Transmitter
Xformer = Transformer
So why doesn't
Xistor = Transistor?

NATE SILVERMAN

Los Angeles 26, Calif.

[Perhaps one day when transistors have been around as long as transmitters and transformers Xistor will be an applicable abbreviation. At present the abbreviation does not Xist, as far as we know. But then again, Xistor might turn out to be an actual device by that time and couldn't be used as an abbreviation for transistor.—Editor]

ALTERNATE TEST CIRCUIT FOR ZENER DIODES

Dear Editor:

Mr. Donald L. Stoner's circuit for checking the Zener voltage of diodes in the January issue is very good with one exception. The 1-megohm resistor will form a voltage-dividing circuit with the internal resistance of the oscilloscope's horizontal input. This can range from 100,000 ohms to several megohms and can introduce an appreciable error when using the ac voltmeter. It may also seriously attenuate the voltage, making it impossible to Zener the diode.

The best approach is to calibrate the horizontal amplifier to read 10 volts per centimeter and then add a multiplier resistor which is nine times the input impedance of the amplifier (see diagram). This will reduce the voltage in the scope to a safe value and each centimeter will represent 100 volts. It will also reduce the voltage attenuation to a minimum.

The Variac and voltmeter are not necessary with this setup. I used a 1,000-volt transformer with a push-button to apply the voltage. In testing

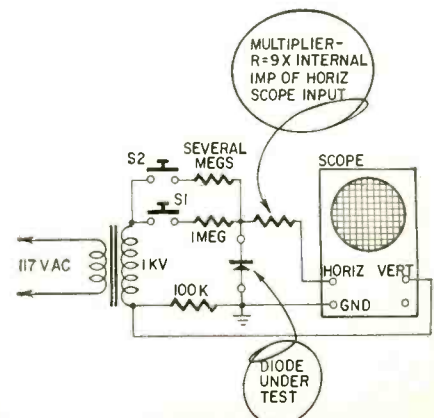

UTAH ANNOUNCES

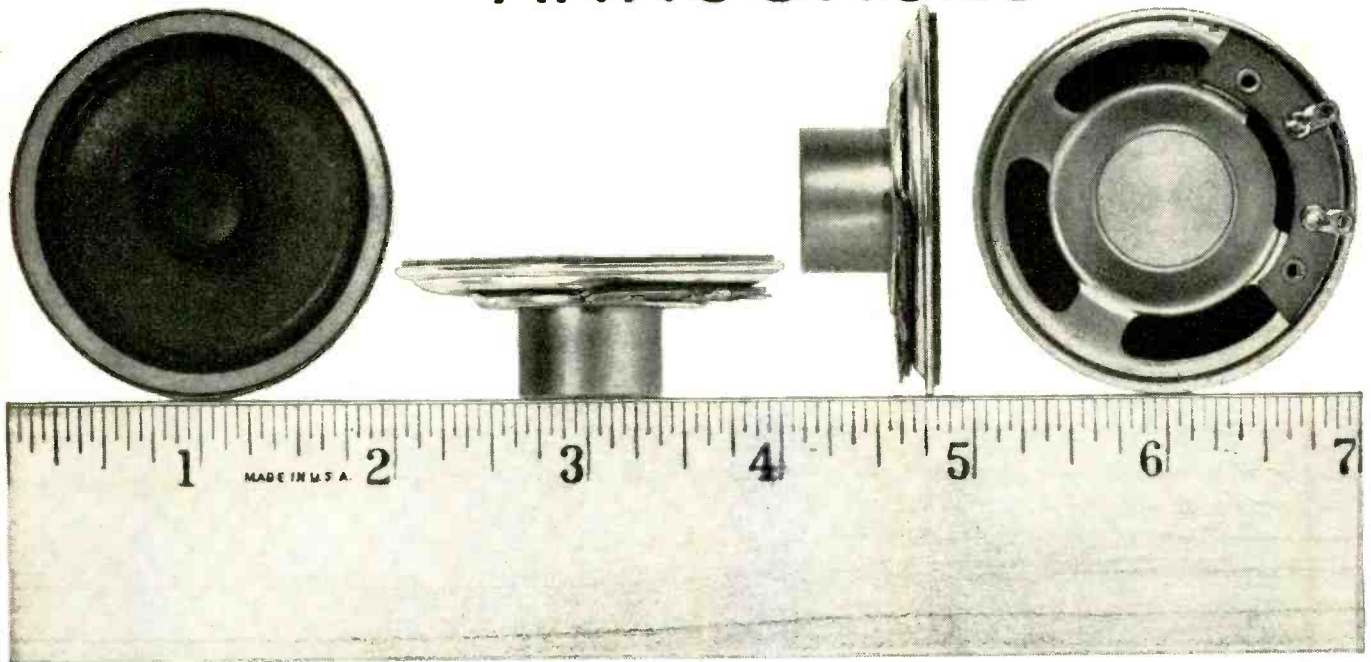

... the first complete line of all-American-made replacement speakers for transistor radios!

Hardly surprising that Utah becomes the first domestic source for transistor radio replacement speakers. A pioneer in developing electronic and acoustical products, Utah uses only 100% American labor and 100% American parts in building these miniature speakers. Seven basic speaker models fit both imported and domestic sets. Performance equals or betters that of original equipment speakers. Compare these features and you'll see why it pays to buy and replace with all-American-made speakers from Utah!

- extra shallow baskets for clearance in crowded cases
- special terminal strips keep basket depth wafer-thin
- deeper models (SP25A, SP27A) for larger domestic sets will handle more power
- all steel surfaces cadmium plated
- voice coil impedance 12 ohms (correct value for most sets)

Model No.	SP2T	SP22T	SP25A	SP25T	SP27T	SP27A	SP3T
Size and Description	2" round	2¼" round	2½" square	2½" round	2¾" round	2¾" round	3" round
Total diameter	2"	2¼"	2½" sq.	2½"	2¾"	2¾"	3"
Basket Depth	⅞"	¼"	½"	⅜"	1½"	1¾"	1½"
Total Depth	1¼"	¾"	1¾"	2½"	1¾"	1¾"	1¾"

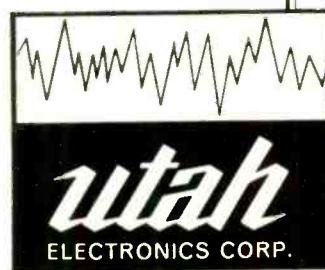
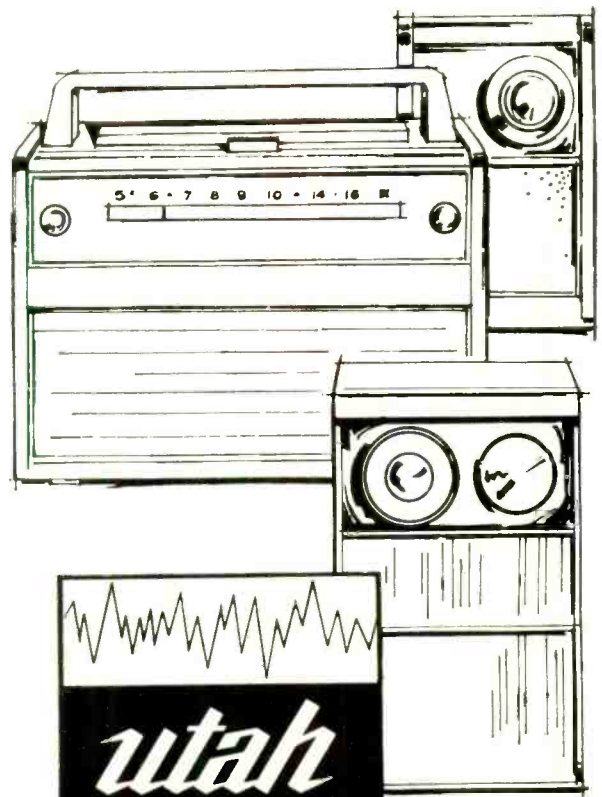

Huntington, Indiana

ORDER NOW! Write direct for full specifications and prices.

There are 2 Kinds of Radio-TV Servicemen-

Those who use
QUAM
replacement loudspeakers

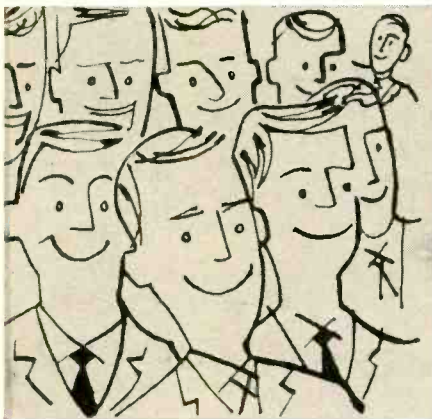

We're proud to say that
this group is bigger*

- * According to the findings of Brand Name Surveys, Chicago, Illinois in March and April 1961, more servicemen prefer Quam speakers than all other replacement brands combined. Major reasons stated for the preference: Quality! Availability! Performance!

QUAM-NICHOLS COMPANY

238 East Marquette Road, Chicago 37, Illinois

Those who use
other brands of
replacement loudspeakers

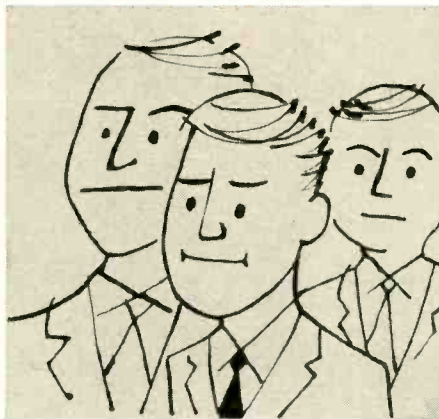

more than 100 diodes, two broke down under test. These were probably weak to begin with. A second current-limiting resistor of appropriate value could be added for delicate diodes and could be controlled by a second pushbutton if desired.

R. G. ANDERSON
Field Service Supervisor
Friden, Inc.
Philadelphia, Pa.

90-DAY WARRANTY OK?

Dear Editor:

From what I have read in your magazine about this 90-day parts and labor business, I have come to one conclusion: that the service technicians should go to a school which will teach them how to think.

When a factory recommends a particular service shop, it is giving the shop a free plug. After the 90 days the shop charges its normal fee and has the customers who were referred to it by the company. It is obvious that a customer would much rather do business with a shop that is authorized by the factory, because he feels that they are specialists in repairing his piece of equipment.

As for the fee, this is a matter that should be left up to the firm and the shop and not be abused in a magazine.

I would like to conclude by stating that any loss on the shop's part is its fault. I have found that, when a customer brings his set in on a warranty, the service shop kicks the set around, throws parts together without the least bit of concern as to whether they installed the part correctly, misadjusts or does not adjust the adjustments, and then wonders why the customer does not come back when the warranty is over. They then complain that factory authorization does not bring them permanent customers.

I know of one man who brought his record changer in to be serviced with the complaint that the changer made a great deal of noise on the 78 speed. When he got it back, he found the noise was gone, but in its place the tone arm did not track properly and, when he shut the changer off, the entire changer started to vibrate violently. (I found later when checking his set, that there was a misadjustment in the idler-wheel lever which caused it to disengage and then re-engage the motor pulley. So he returned the changer to the shop for repair and, when he got his set back again, he found that the vibration was still present and the changing mechanism was no longer activated by the pickup arm when it reached the end of the record. It is rather obvious that he never returned to that shop and they lost a customer.

HERBERT A. KATZ

Brooklyn, N. Y.

[You have passed very rapidly over the heart of this problem—what the technician should receive for doing a warranty repair. Obviously, his fee should be exactly the same as for the same job performed for a regular customer. If he gets less, he is losing money. As far as kicking a set around goes, this is not done by any reputable techni-

COMING UP IN Radio-Electronics

- Ionosphere—Invisible Radio Mirror
- Build a Kit or Build from Scratch?
- Industrial Infrared Radiometers
- Automobile Interference Suppression
- Crossover Networks—a Practical Approach

SUBSCRIPTION RATES

1 year \$5 2 years \$9 3 years \$12

154 West 14th Street

New York 11, N.Y.

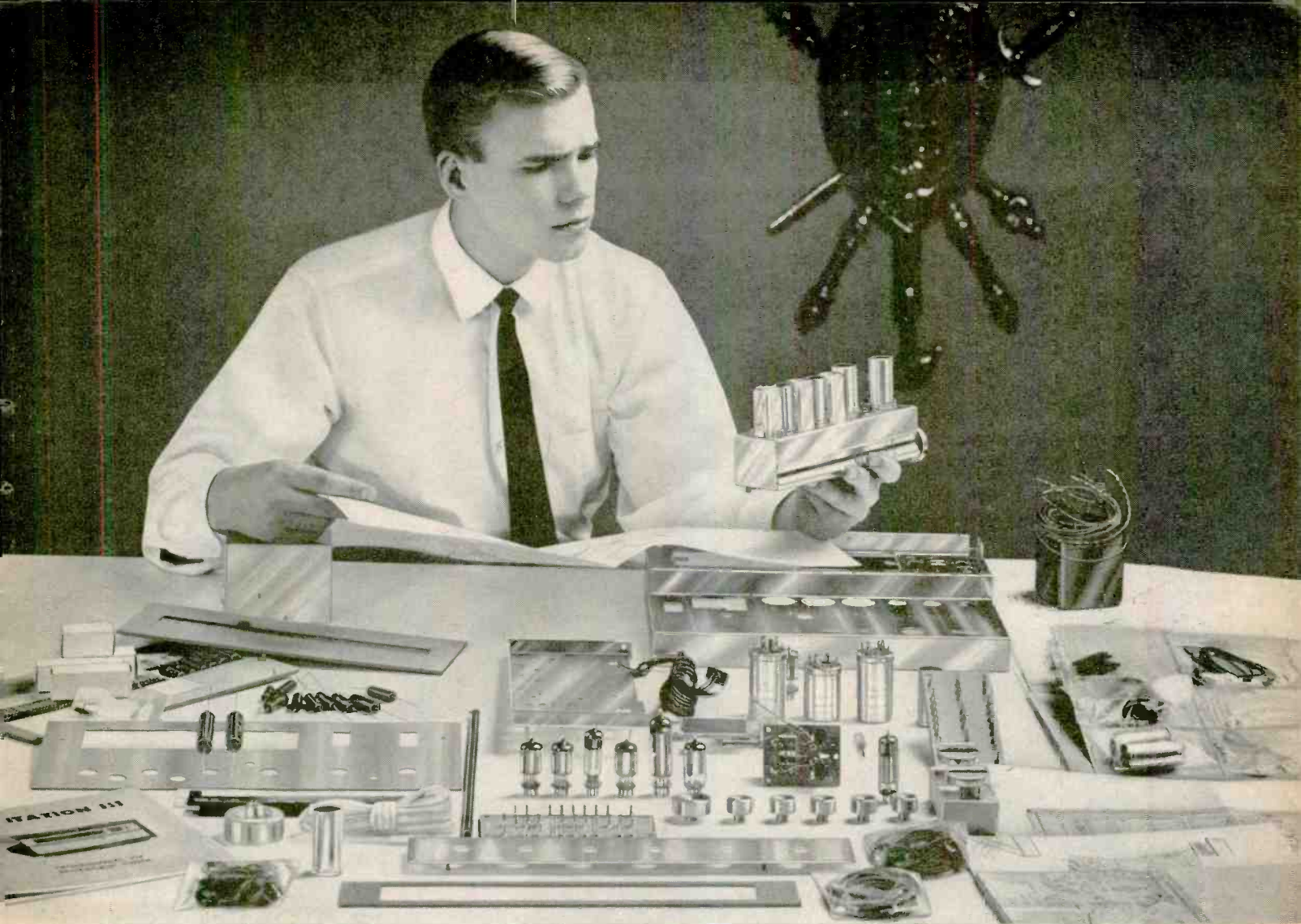

Can You Afford 15 Hours to Build The World's Best FM/Multiplex Tuner?

Fifteen hours. That's all it takes to build the world's best FM/Multiplex tuner.

Citation has the "specs" to back the claim but numbers alone can't tell the story. On its real measure, *the way it sounds*, Citation III is unsurpassed. And with good reason.

After years of intensive listening tests, Stew Hegeman, director of engineering of the Citation Kit Division, discovered that the performance of any instrument in the audible range is strongly influenced by its response in the non-audible range. Consistent with this basic design philosophy—the Citation III has a *frequency response three octaves above and below the normal range of hearing*. The result: unmeasurable distortion and the incomparable "Citation Sound."

The qualities that make Citation III the world's best FM tuner also make it the world's best FM/Multiplex tuner. The multiplex section has been engineered to provide wideband response, exceptional sensitivity and absolute oscillator stability. It mounts right on the chassis and the front panel accommodates the adapter controls.

What makes Citation III even *more* remarkable is that it can be built in 15 hours without reliance upon external equipment.

To meet the special requirements of Citation III, a new FM cartridge was developed which embodies every critical tuner element in one compact unit. It is completely assembled at the factory, totally shielded and perfectly aligned. With the cartridge as a standard and the two D'Arsonval tuning meters, the

problem of IF alignment and oscillator adjustment are eliminated.

Citation III is the *only* kit to employ military-type construction. Rigid terminal boards are provided for mounting components. Once mounted, components are suspended tightly between turret lugs. Lead length is sharply defined. Overall stability of the instrument is thus assured. Other special aids include packaging of small hardware in separate plastic envelopes and mounting of resistors and condensers on special component cards.

For complete information on all Citation kits, including reprints of independent laboratory test reports, write Dept. RE-9, Citation Kit Division, Harman-Kardon, Inc., Plainview, N. Y.

The Citation III FM tuner—kit, \$149.95; wired, \$229.95. The Citation III MA multiplex adapter—factory wired only, \$89.95. The Citation III X integrated multiplex tuner—factory wired, \$319.90. All prices slightly higher in the West.



Build the Very Best **CITATION KITS** by

harman kardon

NEW!

Dynamic Beta®

IN-CIRCUIT Transistor Tester



Only
\$129.50
Net

THE

HICKOK

**MODEL 890 Measures AC Beta
or out
IN-CIRCUIT...with 5% Accuracy!**

With the new Model 890, you can measure AC Beta—in circuit—with unmatched accuracy. The key to this new accuracy standard is the unique HICKOK-developed (patent-applied-for) method of neutralizing circuit impedance before tests are made. This effectively nullifies the loading effects of external circuit impedances and thereby eliminates the inaccuracies inherent in other methods.

The Model 890 also measures these other in-circuit parameters: R_{in} (transistor input resistance), Z Ohms (base-emitter circuit impedance), and I_c . Out-of-circuit measurements include AC Beta, I_c and I_{cbo} .

The Model 890 is an ideal maintenance, service and production line instrument for use in applications requiring measurement of soldered-in transistors.

Ask Your HICKOK Distributor For An **890** Demonstration!

The **HICKOK** Electrical Instrument Co.

10531 Dupont Ave. • Cleveland 8, Ohio

cian, warranty or no warranty! If you enlarge your investigation to include more than just the one case you describe, you will find you have described the exception and not the rule.—Editor]

ELECTRONIC IGNITION IS FOR ME

Dear Editor:

I built an all-transistor voltage regulator for my car after the February 1960 issue. It is installed in my 1961 Buick Special equipped with a Delco electrical system employing a 12-volt negative ground.

The regulator works exceedingly well. However, it has been in use too short a time to evaluate its durability and freedom from bugs.

I changed the value used for resistors R1, R2 and R3 shown in Fig. 3-a of the original article to improve the bias arrangement of V1. I use 6,800 ohms for R1; a 250-ohm wirewound pot for R2 and a 270-ohm resistor for R3.

I keep the current limiter in the stock regulator and suggest that anyone using this circuit do the same. This can be done by merely placing a piece of insulating material between the points of the stock regulator and running a lead from the current limiter to the transistorized voltage regulator much in the manner shown in Fig. 3-a. To avoid errors consult a diagram of the stock voltage regulator before making any changes. WILLIAM B. FRASER
San Francisco, Calif.

[Don't miss the electronic ignition system described in this issue. If you liked the regulator, you'll love this set-up.—Editor]

USE A SHOCK SINK

Dear Editor:

On page 28 of the July issue, it was stated that transistors are not as sensitive to heat as has often been harped about. But don't throw away the long-nosed pliers because they're still useful as shock absorbers.

It is true that I have yet to ruin a transistor by soldering it into a circuit without using a heat sink, but it is also true that I destroyed an unknown number of transistors before I discovered that cutting the leads off with diagonal pliers may transmit a powerful shock into the device, thus separating the delicate connections inside. I found the failure rate to be as high as 5% in one test where I checked the transistors before and after clipping.

There are several precautions which will minimize this type of damage:

1. Use long-nose pliers at clipping time to absorb any shock.
2. Cut only one lead at a time to minimize total shock.
3. Cut with the back of the cutter jaw to reduce shock.
4. Sharpen your dikes for this purpose, removing the bevel edge on face.
5. A nice wire cutter is on the market. It looks like a miniature pair of tin-snips. Unlike diagonal cutters, the shock from the clipper (if any) appears at right angles to the lead being cut.

RICHARD L. SHAMM
Albuquerque, N. M. END

Earn Extra Money Soon

.. while training at home for high-pay career or business of your own!

AMAZING PLAN FOR YOUR SUCCESS IN RADIO-TV-APPLIANCES and ELECTRONICS

Central will show you how to start making money soon . . . servicing AM-FM radios and television sets . . . repairing electrical appliances . . . building and installing electronic equipment in homes, factories, and business offices. Step-by-step, you'll learn how to get started in spare time at minimum cost; how to prepare for a bright future in servicing, audio, communications, broadcasting, or the gigantic electronic industry. Complete FCC license preparation included. High income, prestige, security, prosperity . . . all can be yours!

NO EXPERIENCE NEEDED!

You don't need high school diploma or previous knowledge of electronics to get started. Quick, low-cost home training for young and old. New illustrated lessons make learning easy. We supply equipment and *know how* you need to start making money soon. You learn by *doing*. You assemble useful, practical electronic projects—no incomplete "student" radios and testers—our kits meet commercial standards. Also recommended for citizen band and amateur radio operators, hi-fi and stereo enthusiasts, hobbyists, etc. Your personal pleasure and the savings you can make on home installations and repairs alone, make this course a profitable adventure. Keep your present job—set your own pace—add to your income—and find out how much fun Electronics can be!

New Frontiers Need You!



Cash in on growing demand for technicians in hundreds of exciting space-age fields: guided missiles, rocketry, outer space research and development, automation, nuclear power, computers, microwaves, radar, communications, oil field exploration, air traffic control, civil service, armed forces, etc. *Start now.* Get facts—mail coupon today for two FREE books!

NEW KITS!



You will build and keep this handy "transistorized" electronic and appliance tester that you'll use soon to start earning spare-time money. Many other practical and profitable electronic projects to choose from: 4 transistor portable radio—code oscillator—solar cell switch—RF signal generator—CB converter—oscilloscope—others! Fully described in our FREE 64-page catalog.



Central grad GLEN LEIRER, shown here, earned an attractive income from part-time Radio-TV Servicing. Now he's employed as a Computer Technician for RCA Service Co., Camden, N. J.

Over 50,000 Successful Graduates Since 1931!



"I averaged between \$60 and \$70 a month servicing radios and TV's part-time while taking your home study course. Plan to open my own shop soon." Student THEODOR SCHMIDT, Peshastin, Wash.



Central grads HOWARD EDMONDS & FLOYD CONKRIGHT are joint owners of EDCO FACTORY TV SERVICE CO., K. C., Mo., and RANCH MART TV & STEREO, Leawood, Kansas, have three service trucks, seven full-time employees.

Grad FRANK LEENKNECHT works in missile field for Convair Astronautics, San Diego, Calif., and as Transmitter Engineer for Station KDEO as a sideline.



RESIDENT TRAINING—Central also offers a full-time ECPD-Accredited Technical Institute program at its resident school in Kansas City, Mo., for qualified high school graduates. Details in FREE catalog.

FREE

FCC PREP BOOK

Profits from Electronics

We'll mail you FREE FCC License Prep Handbook that prepares you to pass the 3rd Class FCC Radiotelephone examination, and to qualify to operate radiotelephone transmitting stations used by airlines, police, railroads, emergency services, etc. You get FREE FCC Prep Book plus FREE 64-page catalog with facts about Central's practical electronics home study course.

NO OBLIGATION

TRADE THIS COUPON FOR 2 FREE BOOKS!

Central Technical Institute
1644 Wyandotte, Dept. RE91A,
Kansas City 8, Mo.

(PLEASE PRINT)

NAME

ADDRESS

CITY

ZONE STATE



Accredited Member
National Home Study Council

Central Technical Institute

Free **ALLIED**

444-PAGE ELECTRONICS CATALOG

WORLD'S BIGGEST • MOST COMPLETE

*best buys
for 1962*

EVERYTHING IN
ELECTRONICS
including exclusive
products & special
values available
only from
ALLIED

Send
for it
today!

ALLIED
ELECTRONICS
for everyone

1962
OUR 41st YEAR

CATALOG 210
INDEX: PAGE 361

ALLIED RADIO
100 N. WESTERN AVENUE • CHICAGO 90, ILLINOIS • HAYMARKET 1-8900

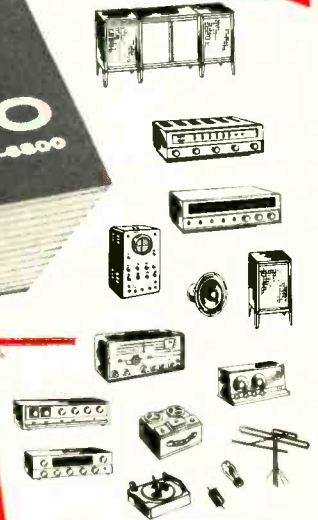

**SAVE
MOST
ON EVERYTHING IN ELECTRONICS**

- New Stereo Hi-Fi Systems—Everything in Hi-Fi Components
- New Multiplex Stereo FM • All-Transistor Stereo Hi-Fi
- Money-Saving Build-Your-Own KNIGHT-KITS® for Every Need
- Best Buys in Tape Recorders, Tape, and Supplies
- Citizens Band 2-Way Radios • Short-Wave Receivers
- Amateur Receivers, Transmitters, and Station Gear
- Latest Public Address Systems, Paging and Intercom Equipment
- TV Tubes, Antennas, Accessories • Batteries, Wire and Cable
- Test and Laboratory Instruments • Tools, Hardware
- Huge Listings of Parts, Tubes, Transistors, Technical Books

**NEW Multiplex Stereo FM
All-Transistor Stereo Hi-Fi**

exclusive money-saving KNIGHT® products
SAVE MOST on famous KNIGHT Stereo Hi-Fi—comparable to the best in quality, styling and performance, yet priced far lower. Select super-value KNIGHT components or complete systems (including latest Multiplex Stereo and All-Transistor hi-fi) and save most. KNIGHT products are acclaimed by all those who recognize integrity in design and manufacture and who appreciate value.

NO MONEY DOWN
new on Allied's new Credit Fund Plan
Now—easiest terms ever—see our 1962 Catalog for the simple details.

SEND FOR 444-PAGE CATALOG TODAY!

Satisfaction Guaranteed or Your Money Back

ALLIED



BIG PLUS!
in your 1962
ALLIED
CATALOG

includes complete catalog featuring over 70 exciting

knight-kits[®] 
A PRODUCT OF ALLIED RADIO

NEW for '62 and simply great!
available only from **ALLIED**

new



ALL-TRANSISTOR
2-Band AM-Shortwave
DX-er Radio Kit. \$19.95



Amazing 100-In-1 Electronic
Science Lab Kit..... \$29.95

new
MULTIPLEX STEREO



MULTIPLEX
Adapter Kit for
Stereo FM re-
ception. \$19.95

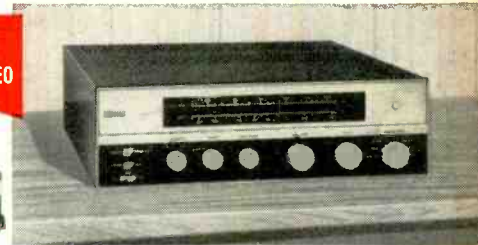

All-In-One FM-AM Tuner-Amplifier Kit
with built-in **MULTIPLEX** Stereo FM...



TRANSISTORIZED
Electronic Tachometer
Kit..... \$24.95



ALL-TRANSISTOR Wireless
Intercom System Kit..... \$45.00



Deluxe Stereo FM-AM Tuner
Kit with built-in **MULTIPLEX**
Stereo FM..... \$99.95



ALL-TRANSISTOR
40-Watt Stereo Ampli-
fier Kit, less case, \$79.95

**building a Knight-Kit is the
most satisfying do-it-yourself
experience in the world!**

5 BIG REASONS WHY:

- **Convenience Designed**—makes you a kit-building expert—even the very first time!
- **Wonderful to Build**—you'll marvel at the sheer ease of assembly with the exclusive "show-how" manual guiding you like a good instructor.
- **You Own the Best**—you'll enjoy with pride a true custom-built product, professional in its engineering, styling and performance.
- **You Save So Much**—because you buy direct from Allied at our money-saving volume prices—and because you do the easy assembly yourself.
- **Easiest to Buy**—NO MONEY DOWN on Allied's new Credit Fund Plan—easiest terms ever!

MONEY BACK GUARANTEE: Buy any Knight-Kit. Build it! Use it! You must be satisfied or you get your money back!

see more than 60 other KNIGHT-KITS!

HI-FI KITS

- FM & FM-AM Tuners
- 70-W Amplifier
- 40-W Amplifier
- 32-W Amplifier
- 20-W Amplifier
- Stereo Preamp
- Record-Playback Preamp

INSTRUMENT KITS

- Lab AC VTVM
- VOM's
- 5" Scopes
- Tube Testers
- Signal Tracer
- Audio Generator
- Sweep Generators, etc.

HOBBYIST KITS

- "Span Master" Receiver
- "Space Spanner" Radio
- Transistor Radios
- 2-Way Intercoms
- Electronic Lab Kits
- plus many others

AMATEUR KITS

- R-100 Amateur Receiver
- R-55 SW Receiver
- Self-Powered VFO
- Grid Dip Oscillator
- 100 kc Crystal Calibrator
- Code Practice Oscillator

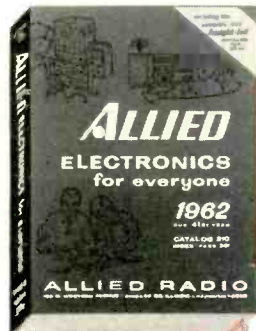

Send for it today!

new



Phone and CW 60-Watt
Ham Transmitter Kit. \$49.95

new



Mutual Conductance
Tube Tester Kit. \$99.50

KNIGHT-KITS
also available
in Canada

- World's Largest Stocks • Lowest Money-Saving Prices
- Fastest Shipment • Expert Help • Easiest-Pay Terms
- Satisfaction Guaranteed or Your Money Back

send for the world's biggest
electronics catalog!

Free

ALLIED RADIO, Dept. 76-J1
100 N. Western Ave., Chicago 80, Ill.

Send FREE 1962 ALLIED 444-page Catalog

Name _____
PLEASE PRINT

Address _____

City _____ Zone _____ State _____

RADIO  **World's Largest
Electronic
Supply House**

FM Multiplex Stereo broadcasting has arrived!

A top quality stereo tape recorder will permit you to build a stereo tape library of your favorite music at low cost. As your musical interests change, you may record the new music that interests you at no additional cost. See your EICO dealer now for a demonstration of the EICO RP-100.

dedicated to perfection



TRANSISTORIZED 4-TRACK STEREO TAPE DECK

MODEL RP-100W
Completely assembled, wired and tested. **\$399.95**

MODEL RP-100K
Semi-kit includes a completely assembled and tested transport, electronics in kit form. **\$299.95**

Perfected 4-track stereo/mono recording, 4 & 2 track playback. True high fidelity transistor electronics, individual for record & playback, plus separate record & playback heads permitting off-the-tape monitor. 2 recording level meters, mixing, mic & level controls, switched sound-on-sound recording. Electro-dynamically braked supply & take-up reel motors; hysteresis synchronous capstan motor. Individual solenoids for pinch-roller & tape lifters. All-electric, interlocked push-button transport control & interlocked safety "record" pushbutton. Precision tape guidance & sweep loading — no pressure pads. No sturring or tape bounce problems. Digital turns counter. Vertical or horizontal mounting. Modular plug-in construction. An original, exclusive EICO product designed & manufactured in U. S. A. (patents pending).

NEW SUPERB SERIES.....

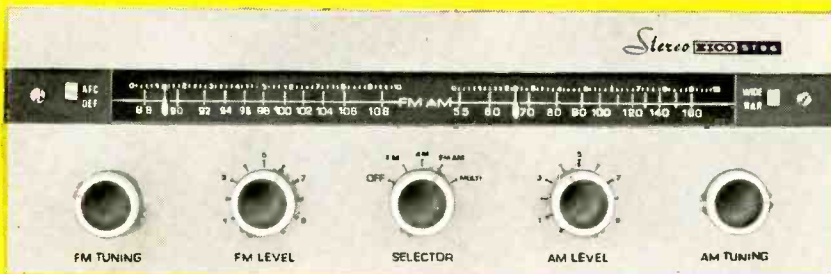

FM-AM STEREO TUNER ST96

Kit **\$89.95** Includes Metal Cover and FET Wired **\$129.95**

FM and AM stereo tuners on one compact chassis. Easy-to-assemble; prewired, prealigned RF and IF stages for AM and FM. Exclusive precision prewired EYE-TRONIC® tuning on both AM and FM.

FM TUNER

Switched AFC (Automatic Frequency Control). Sensitivity: 1.5uv for 20db quieting. Frequency Response: 20-15,000 cps ± 1db.

AM TUNER

Switched "wide" and "narrow" bandpass. High Q filter eliminates 10 kc whistle. Sensitivity: 3uv for 1.0V output at 20db S/N ratio. Frequency Response: 20-9,000 cps ("wide"); 20-4,500 cps ("narrow").

OF EICO STEREO.....



70-WATT INTEGRATED STEREO AMPLIFIER ST70

Kit **\$94.95** Includes Metal Cover Wired **\$149.95**

40-WATT INTEGRATED STEREO AMPLIFIER ST40

Kit **\$79.95** Includes Metal Cover Wired **\$129.95**

BOTH AMPLIFIERS: Complete stereo centers plus two excellent power amplifiers. Accept, control, and amplify signals from any stereo or mono source.

ST70: Cathode-coupled phase inverter circuitry preceded by a direct-coupled voltage amplifier. Harmonic Distortion: less than 1% from 25-20,000 cps within 1db of 70 watts. Frequency Response: ±½db 10-50,000 cps.

ST40: Highly stable Williamson-type power amplifiers. Harmonic Distortion: less than 1% from 40-20,000 cps within 1 db of 40 watts. Frequency Response: ±½db 12-25,000 cps.

Over 2 MILLION EICO instruments in use.

Most EICO Dealers offer budget terms.

Add 5% in West.



C-9

EICO, 3300 N. Blvd., L.I.C. 1, N. Y.
 Send free 32-page catalog & dealer's name
 Send new 36-page Guidebook to HI-FI for which I enclose 25¢ for postage & handling.

Name
Address
City Zone State

Listen to the EICO Hour, WABC-FM, N. Y., 95.5 MC, Mon.-Fri., 7:15-8 P.M.

Export Dept., Roburn Agencies Inc., 431 Greenwich St., New York 13, N. Y.

© 1961 by EICO, 3300 N. Blvd., L. I. C. 1, N. Y.

FM MULTIPLEX ADAPTOR MX-99 —
Kit **\$39.95** Wired **\$64.95**

An original EICO contribution to the art of FM Multiplex reception



The new EICO MX-99 Multiplex Adaptor incorporates the best features of both the matrixing and sampling techniques. It is free of phase-distorting filters and provides the required, or better-than-required, suppression of all spurious signals including SCA (67kc) background music carrier, re-inserted 38kc sub-carrier, 19kc pilot carrier and all harmonics thereof. This is very important for high quality tape recording, where spurious signals can beat against the tape recorder bias oscillator and result in audible spurious tones in a recording. This adaptor will synchronize with any usable output from the FM tuner and will demodulate, without significant distortion, tuner outputs as high as 10 volts peak-to-peak (3½ volts RMS). The MX-99 is self-powered and provides entirely automatic stereo/mono operation. A separation of 35 db between channels is typical across the entire audio spectrum. Low impedance cathode follower outputs permit long lines. The MX-99 is designed for all EICO FM equipment (HFT-90, HFT-92, ST-96), and component quality, ratio detector FM equipment provided with a multiplex output.

See us at New York Hi-Fi Show, Booth #424, Sept. 13-17

Lee de Forest

FATHER OF RADIO

1873-1961

LEE DE FOREST, ILLUSTRIOUS inventor of the Audion tube, died on June 30 from a heart attack, at his home in Hollywood, Calif. He was almost totally incapacitated since 1959 by an illness that kept him bedridden and that was to last almost 2 years. His legion of friends will be comforted that he died without suffering and in peace. His last signed letter to the present writer—one of hundreds—was dated June 6, 1959.

So passes a great historic era which ushered in not only radio but electronics as well. It was Dr. de Forest's vacuum tube—the Audion—that lifted the whispering wireless-crystal-detector age into the radio-loudspeaker age, where it has remained ever since. No one doubts that the electronic age began in 1906 with his stupendous invention, which in turn gave us amplification, regeneration and oscillation, making possible the radiotelephone, broadcasting, radar, television and the host of other incredible electronic wonders already here, with new ones still in the future.

Because his Audion—the first practical detector-amplifier—was one of the most brilliant and far-reaching inventions ever made, it fell to de Forest's unenviable lot to be constantly immersed in a long, fierce and costly series of patent litigations. So much was involved, not only in the US but in other countries as well, that everybody wanted to get into the act and share in the fabulous profits. The vacuum-tube gold rush was on.

First of the contenders was Dr. J. A. Fleming of England with his two-element valve, which could neither amplify or regenerate. He had not even invented it, but had lifted it—without credit—in toto from the real inventor. Edison had observed in 1883 the famed "Edison effect" which made it possible to send an electric current between a cold conductor and a hot filament in a vacuum. (To the credit of English scientists, Fleming a few years back was officially disowned as the inventor of the three-element de Forest vacuum tube, despite the long patent battle.)

Then there were patent suits in behalf of German and French contenders, plus a long list of American litigants, among whom were Maj. Edwin H. Armstrong, inventor of the superheterodyne circuit as well as super-regeneration and the FM system now in increasing use and Dr. Irving Langmuir for the General Electric Co.

The expensive, decades-long patent suits finally ended in 1934 in the US Supreme Court in a full victory for de Forest, who by that time had gone through at least four fortunes running into millions of dollars. In 1936, he went into personal bankruptcy, with considerable liabilities and assets of only \$390.

As is true of many inventors, de Forest had the misfortune of being associated with too many unscrupulous

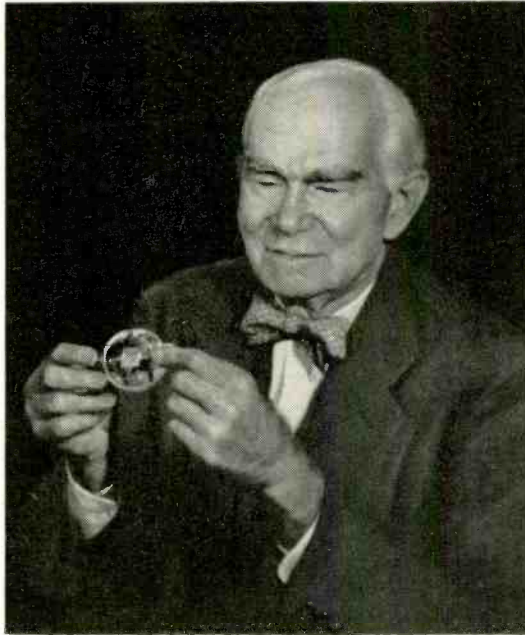

business managers and associates who looked out for themselves but not for him. Nor was he over much interested in business or money. His great urge in life was inventing.

A prolific originator and inventor, he had well over 300 patents. Aside from his Audion and numerous vacuum-tube circuit patents, here are a few of the more outstanding ones: a tubeless (dynamic) amplifier, a gaseous microphone, a diffraction microphone, a subterranean signaling system, a cautery high-frequency surgery device (he was operated on with one several years before his death), a telegraphone. De Forest was intensely interested in loudspeakers—he invented many different types of various principles; a thermionic pickup; talking-picture devices; a thermophone, a diaphragmless speaker. A television sign operated by remote control and various television patents, including stereoscopic vision, large picture size and others, were also among his achievements.

While de Forest, during his long and eventful life, had been honored with some eleven outstanding medals and decorations, including the recently awarded Cross of the Legion of Honor from the French Government, he was much disappointed that he never had been awarded the Nobel Prize. In private talks with this writer, the great inventor could not understand why Marconi should have been awarded the coveted prize while he, de Forest, with a much greater contribution in the arts, should not have been so honored.

Accordingly, in March 1955, RADIO-ELECTRONICS and the undersigned started a widespread campaign, petitioning the Nobel Fund, through the Swedish Academy of Science, in de Forest's behalf. Yet after the usual deliberation of the Fund, the result was negative. We were given to understand that the Nobel Prize in Science (physics) nowadays is given only for pure science, rarely for an invention. Unofficially we learned that there was not a sufficient number of votes for de Forest; certain individuals did not wish to vote because of their industrial affiliations in their respective countries. It became known, nevertheless, that the final voting was stormy. De Forest was heartbroken and stated so in a communication to us.

The celebrated scientist-inventor, who saw his Audion blossom into a world-wide, multibillion dollar business, died in very modest circumstances after a long protracted illness that consumed all his life savings.

As the undersigned stated in the January 1947, de Forest Anniversary Issue of this magazine, in a paraphrase of Winston Churchill:

"Verily, never in the history of the world has so much been owed by so many to one man—Lee de Forest."
—Hugo Gernsback

ELECTRONIC IGNITION FOR YOUR CAR

Build this transistorized electronic ignition system;
it needs no critical adjustments

THIS CIRCUIT FEATURES A TRANSISTOR power supply with silicon rectifiers, a light to indicate system warmup, a tachometer, a quick-start auxiliary device, and an emergency switch which instantly restores conventional operation in the unlikely event of failure in the electronic system.

The idea of an electronic ignition system is rather old.^{1, 2, 3} But an electronic ignition system which you can build and expect to work reliably *without any adjustments* on any automobile with a 12-volt electrical system may well be considered new.

In a conventional ignition system, the spark impulse is produced by interrupting the current in the primary of the ignition coil. (The "coil" is actually a two-winding transformer.) The collapsing magnetic field produces a high voltage in the coil secondary, which causes current to jump the gap in the spark plug. In the electronic ignition system, the spark impulse is produced by discharging a charged capacitor through the coil primary.

One advantage of this system is that operation is significantly faster, so the amount of charge placed on the capacitor is essentially the same regardless of engine rpm. This means that the energy in each spark is the same, regardless of rpm, and that ignition timing need not be noticeably retarded at

high rpm due to large ignition-system time constants, as in conventional systems.

Fig. 1 is a simplified diagram of the electronic ignition system. Assume C2 is charged and that the distributor points are closed. The voltage at point A is zero. V's grid is biased negatively so that the tube does not conduct. At the instant a spark is required, the points open. Point A rises abruptly to 180 volts, in square-wave fashion. This abrupt rise of voltage at point A is coupled to point B through C1 as a positive voltage spike, since C1 and the

combination of R2 and R3 form a differentiator circuit. The spike amplitude is large compared to the bias voltage, so V conducts. C2 then discharges through the coil primary and C3 in series with V as the switch. This discharge produces a spark across the spark gap at the desired instant. The transient induced in the coil primary is damped by RECT 2 and most of its energy recaptured to replace the charge removed from C3 during the pulse.

V, in its function as a switch, opens as soon as C2 is discharged. CH is important here. At the beginning of the

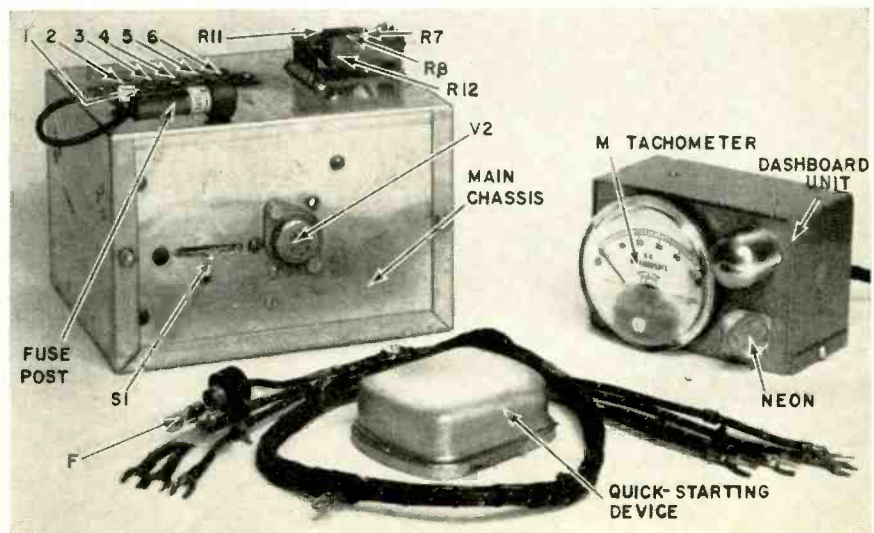

The three basic units of the ignition system.

pulse, the current through CH was zero. After C2 discharged through V, the current through CH could not start flowing rapidly enough to maintain ionization of V. Therefore, V extinguishes and becomes the open switch it was just before the pulse started. Current builds up through CH which, with C2, forms a resonant charging circuit. The effect of this circuit is that C2 is charged to about 700 volts from a total supply of 360 volts, and the system is ready for the next pulse. RECT 1 prevents the excess voltage on C2 from flowing back into the power supply. R5 carries the dc component of the current through C3.

Circuit details

Let's examine Fig. 2, the detailed schematic of the practical ignition system.

Note first that a thermal delay relay has been added to the circuit of Fig. 1. It prevents plate voltage being applied to V3 before the cathode has warmed up. Applying plate voltage sooner would injure the 2D21 and occasionally cause the thyatron to conduct continuously upon first warming up, preventing the proper conditions for pulse operation from ever being established. The nominal delay is 20 seconds.

Early in the work on this system this few seconds' waiting for system warmup, coupled with not knowing just when warmup was complete, prompted the installation of a neon indicating light and the network C3, R4, R5. The light flashes when the ignition system is turned on and stops flashing when

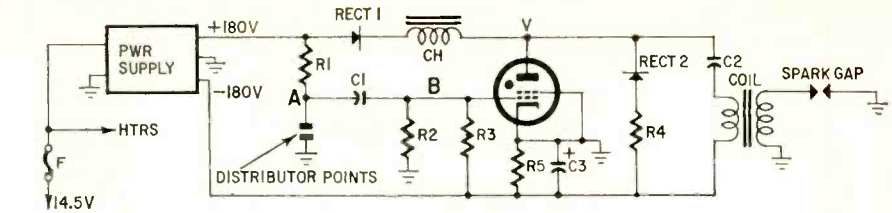

Fig. 1—Basic circuit of the electronic system.

the relay closes, indicating that the system is warmed up.

Before the system was reduced to its present form, I was somewhat reluctant to commit myself to the open road with mobility dependent on an unknown quantity. Switch S1 was installed as a safeguard. C7 is the original distributor capacitor. Remove it from the distributor and mount it inside the case of the electronic system. When S1 is thrown to the "emergency" position, the conventional ignition system is completely re-established with the exceptions that a fuse and S1 are in the circuit. In addition, C4 shunts the distributor during emergency operation, but C4 is small compared to C7 in parallel with it.

This switch also proved handy when leaving the car in the hands of a parking lot or service station attendant. A lot of explanation regarding the warm-up time can be avoided by merely throwing the switch. It also adds to the reliability of the overall system. As good as the electronic system is from a reliability standpoint, it still is undeniably more complex. Therefore, a

simple backup system as provided by S1 is good to have. S1 is not designed to switch heavy currents, so always turn the ignition system off before changing the switch position in either direction.

A meter is connected in the circuit to read the average charging current through CH. This current is proportional to rpm so we have a convenient tachometer.

In practice the tachometer is linear, provided input voltage is constant, to only about 200 pps (pulses per second) (3,000 rpm on an 8-cylinder engine). The nonlinearity at higher pulsing rates is due primarily to drops in the power supply voltages.

Construction

The photographs show parts layout. Spacing and size of individual components are very critical in such a small cabinet (6 x 5 x 4 inches). If there is room, it would be wiser to use a larger case to simplify construction. R7, R8, R11 and R12 are mounted outside the cabinet for better heat dissipation. After this is done, the main

PARTS LIST (Fig. 2)

- R1—82 ohms, 2 watts
- R2, R3—33 ohms, 1 watt
- R4—2.2 megohms
- R5—1 megohm
- R6—100,000 ohms, 2 watts
- R7, R8—12,000 ohms, 2 watts
- R9—270,000 ohms
- R10—100,000 ohms
- R11—100 ohms, 2 watts
- R12—15 ohms, 5 watts
- All resistors 1/2 watt 10% unless noted
- C1, C2—10 μ f, 450 volts, electrolytics
- C3—0.5 μ f, 200 volts, paper

- C4, C5—.001 μ f, 400 volts, paper
- C6—1 μ f, 1,000 volts, oil filled
- C7—removed from distributor
- CH—choke, modified Stancor C2326 (see text)
- F—9 amps, 32 volts
- M—0-50 ma, milliammeter (Triplet 221-PL)
- RECT 1, RECT 2, RECT 3, RECT 4, RECT 5, RECT 6—silicon rectifiers, 150 ma, 130 volts (Sarkes Tarzian M-150 or equivalent)
- RECT 7, RECT 8—silicon rectifiers, 500 ma, 130 volts (Sarkes Tarzian M-500 or equivalent)
- RY—thermal delay relay, 20-second delay (Amperite 6N020T)
- S1—4-pole double-throw lever switch (Centralab

- 1458 or equivalent)
- T—toroidal power oscillator transformer (Triad TY-695)
- TS—terminal strip, 6 screw terminals
- V1, V2—2N554 (Motorola)
- V3—2D21W
- Tube socket, Vector turret, for V3
- Pilot-light assembly (Drake 105 Postlite modified as per text)
- Case to suit
- Tube holddown for 2D21, Mini-Spring 21-A or equiv.
- Tube holddown for Amperite relay, Mini-Spring 68-A or equiv.
- Miscellaneous hardware

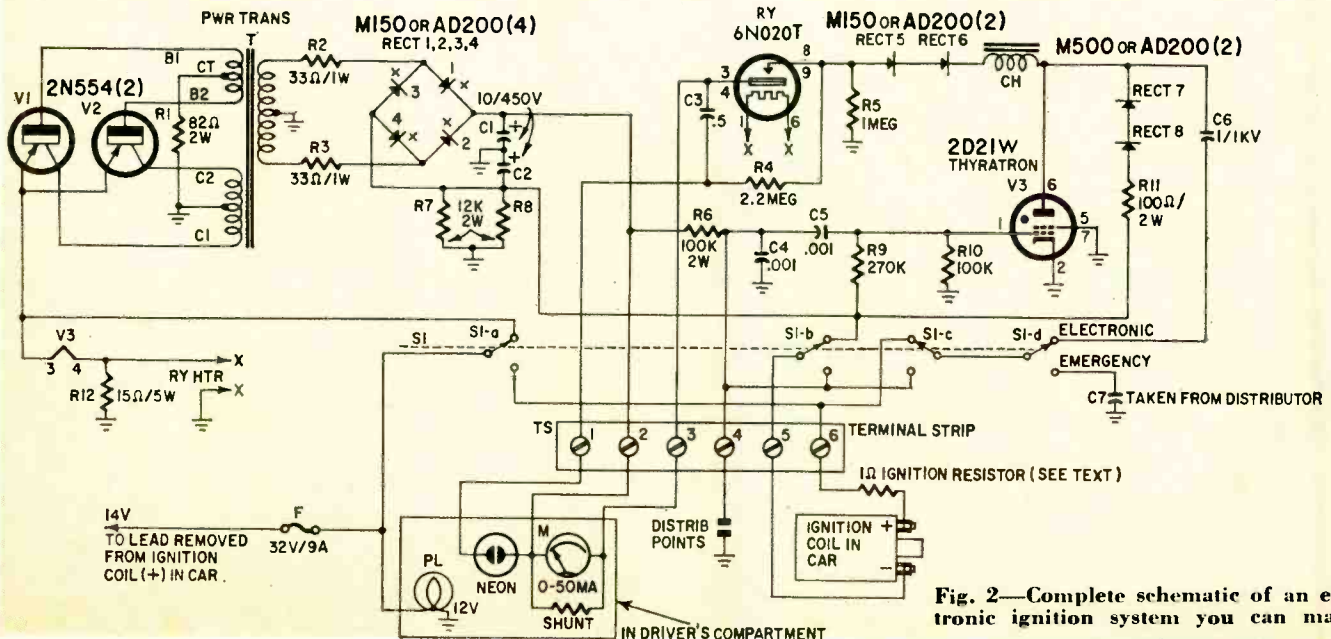
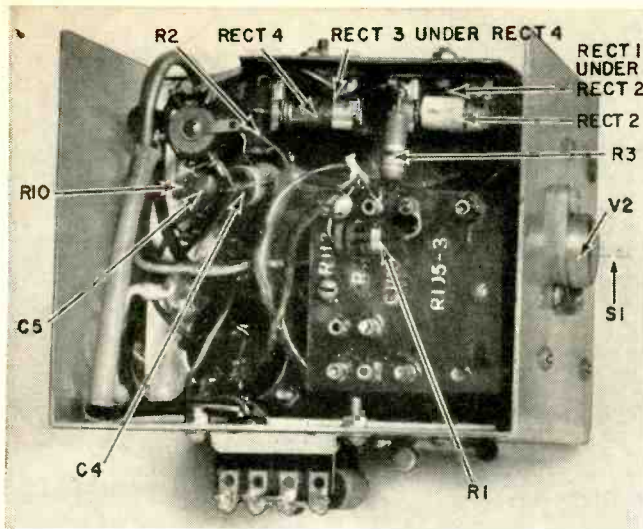
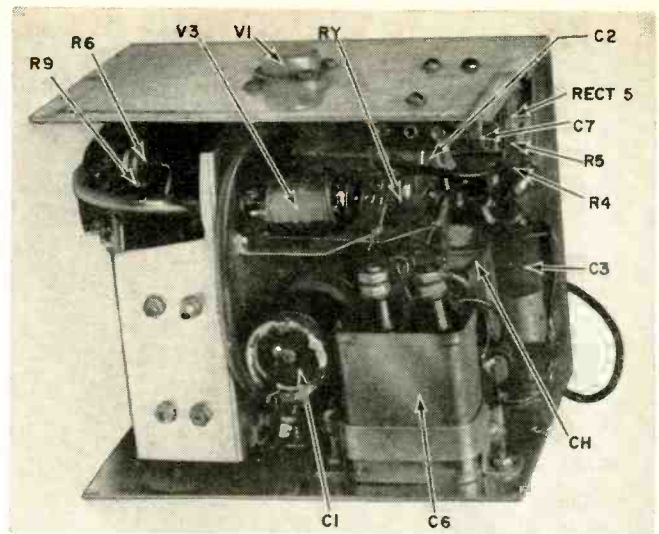

Fig. 2—Complete schematic of an electronic ignition system you can make.



Parts layout inside the main chassis.



Another view of the main chassis interior.

heat producers inside the cabinet are the heaters of the thermal delay relay and V3.

No leads require shielding. The usual good construction practices should, of course, be followed and the highest-grade components used. Remember, the unit will be subjected to extremes of heat, moisture and vibration in use. The failure of any component, connection or solder joint can put it out of commission. Build the unit ruggedly and clamp or tie down anything that can vibrate, such as long leads and heavy components. Use cambric spaghetti over hookup wire, and bundle small leads together inside pieces of large insulating tubing for protection.

Two components are modified before use. The indicator lamp is a Drake 105 Postlite which incorporates a base resistance. Use a soldering pencil to melt a hole in the base so you can get at the resistor, then short it with a jumper. An NE-2 neon lamp is a satisfactory electrical substitute, but presents mounting problems.

Choke CH must have about seven layers of its winding removed. Dc resistance of the units measured 42 ohms before wire removal and 27 ohms afterward. The choke must be carefully taped and reassembled for good reliability.

Both the transistors and the transformer in the power supply operate beyond their normal ratings at the higher rpm's. However, nothing has failed in many thousands of miles of high- and low-speed driving, so the overload cannot be serious. Power tran-

sistors other than the 2N554 have been tried in the circuit and have failed to oscillate, although by modifying the oscillator circuit it could certainly be made to work.

Transformer T is a commercial unit, but some constructors may wish to wind their own¹.

Testing the completed unit

Initial tests can be conducted using any source of well filtered dc capable of delivering up to 5 amperes somewhere between 12 and 15 volts. A fully charged 12-volt automobile battery is adequate and a metered battery eliminator with fully controllable voltage is ideal. Remove V3 from its socket and apply input power. Check for positive and negative voltages of 150 to 180 at C1 and C2, respectively, and about 50 volts negative at pin 1 of V3. The neon indicator light, if connected, should blink continuously. When these checks are satisfactory, you are ready for the first operational test.

A quick check may be made on the car you're going to use with the unit. Connect the coil low-tension terminals to terminals 5 and 6 on the ignition system. Connect either a tachometer meter between 2 and 3, or short these terminals with a jumper. Remove one spark plug. Remove the coil high-tension lead from the center of the distributor cap and connect to the removed plug. Place the plug where its case is grounded and its electrodes are visible. With power applied, ground and unground terminal 4, using a short length of wire. At each ungrounding, a spark should be seen at the plug electrodes.

When the unit has been checked out, it is ready for tachometer calibration if one is used. Since the tachometer calibration is very sensitive to input voltage variation, it is best to calibrate the meter with the system installed on the automobile on which it is to be used.

You will probably find a 1-ohm resistor somewhere in your conventional ignition system. If convenient, leave this resistor in the coil circuit as shown

in Fig. 2, or between terminal 4 and distributor points. For electronic operation its effect is insignificant, but it is needed when conventional operation is restored with S1. The points burn very quickly if this resistor is not in the circuit. If physically inconvenient to incorporate it as shown, remove this little resistor from the circuit entirely but reinsert it if any extended conventional operation becomes necessary.

CAUTION: Make sure no other leads or radio noise-suppression capacitors are connected to the coil. Some automobiles incorporate a system for shorting out the resistor during starter cranking, and connections for this may be made at the coil. Such leads must be removed or starting will be impossible on electronic operation.

The input power lead should be connected to the lead from the ignition switch. Connect the other leads as indicated in Fig. 2. Observe the polarity markings on the coil and connect as shown. Remove the capacitor from inside the distributor and mount it inside the electronic system case. Connect the tachometer and start the engine.

Adjust an oscilloscope's horizontal sweep frequency to approximately 60 cycles. Connect the vertical amplifier to terminal 6 on the ignition unit through the network of Fig. 3. Adjust the 10,000-ohm potentiometer so the 60-cycle amplitude is about 1/4 inch when the terminal 6 waveform is about 2 inches high. The pattern will now be steady only when the prf (pulse repe-

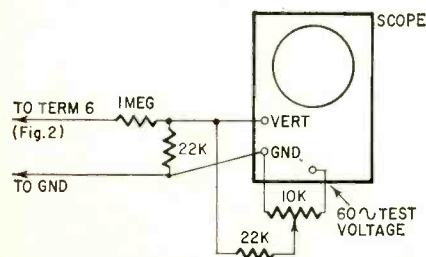

Fig. 3—Oscilloscope hookup for tachometer calibration.

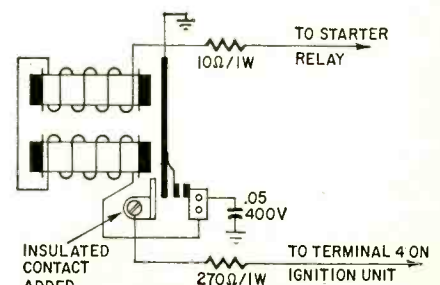
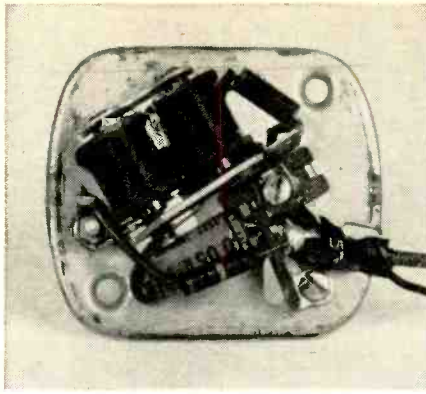

Fig. 4—Modified doorbell buzzer insures a quick start.



Inside view of the little quick starter.

tion frequency) is exactly a multiple of 60 cycles. This will provide conveniently spaced rpm calibration check points, as follows:

No.	6-Cyl Rpm	8-Cyl Rpm
1	60	1,200
2	120	2,400
3	180	3,600
4	240	4,800
5	300	6,000

I chose a 0-50-ma meter for the tachometer because the scale was readily adaptable for reading 0-5,000 rpm and the requirements on the necessary external shunt were not very severe. A satisfactory shunt was made from a length of the wire removed from CH. With the oscilloscope setup of Fig. 3, adjust the shunt till the meter reads correctly for 3,600 rpm on a 6-cylinder engine or 2,700 rpm on an 8-cylinder engine since these numbers represent calibration points near the top of the linear range of the tachometer in each case. The wire length will turn out to be about 30 feet for the 6-cylinder engine and about 22 feet for the 8-cylinder. When the exact length is determined, coil the wire and tape it to the back of the meter.

Quick-starting aid

You may have some trouble starting the engine when using the electronic system. I don't know the exact reason for this, but it's rather easy to cure. What is needed is a series of sparks in the firing cylinder during each compression stroke instead of only one as is normally provided. The system can provide the addition sparks, if it gets proper firing signals. The signals are supplied by a doorbell buzzer modified as shown in Fig. 4. I used a Rodale 6- to 8-volt ac doorbell buzzer. Somewhat different values from the 10-ohm series resistor and .05- μ f capacitor may be required if another type of buzzer is used. The auto electrical system voltage is usually between 9 and 12 during starter cranking, so tests on the buzzer should be carried out in this range of voltages. A good value of series resistance is that which will just permit starting the buzzer at 9 volts. The best capacitor size is the one that gives minimum sparking at the points.

After these components have been determined and installed, add the addi-

tional contact and the 270-ohm resistor. Make the new contact from a small angle of any convenient metal stock which will not deform under the beating of the buzzer armature. This contact must be insulated from the buzzer case. Spacing between the new contact and the armature is not critical. The buzzer will do its job as long as some contact, even a high-resistance one, is made and then broken on each stroke of the armature.

The 270-ohm resistor isolates the buzzer from the distributor points when operating on the conventional system. If you leave it out, the added contact would be burned during starter cranking if S1 of Fig. 2 were positioned for emergency operation on the conventional system.

When the buzzer is completed, connect it as indicated in Fig. 4. It operates only when the starter relay is energized. Since the added contact is in parallel with the distributor points, the buzzer can have no effect when the distributor points are closed, even though it operates continuously. When the distributor points are open, however, the buzzer provides the electronic system with a series of firing signals in addition to the one provided by the distributor points. One of them is certain to fire the mixture on each compression, and quick starting is assured.

NEXT MONTH

DIRECTORY OF FM STEREO MULTIPLEX EQUIPMENT

An exhaustive and topical listing of receivers and adapters giving important characteristics and differences between the various units. See it in the October issue—

on sale September 14.

One difficulty may be encountered in using the buzzer. Some distributor caps are small, and plug wire contacts are closely spaced inside the cap. In one instance, the distributor rotor moved far enough during the time the points were open that one of the later sparks in each series was firing the plug ahead of the one intended. This left no unburned mixture in that cylinder to fire at its proper time, so the engine merely bucked the starter and would not start. The remedy was to round off the leading corner of the conducting part of the distributor rotor with a file. This confined the sparks to the desired plugs, and the trouble disappeared.

There is no reason for considering

the buzzer a separate or auxiliary unit. If space permits, it should be mounted inside the main system box, adding one more terminal for the lead from the starter relay. In my case, the buzzer was developed after the box was already full. A 12-volt auto radio vibrator might make an admirable substitute for the buzzer, but has not been investigated.

Performance

Why, then, an electronic ignition system? Remember how well your car ran just after you had it tuned up last time? It will run like that all the time (as far as the ignition system is concerned) with an electronic system. Points can't burn—they just polish themselves. Spark-plug electrodes are not eroded as much because the spark duration is shorter. They should last much longer before requiring replacement.

Then there is the matter of speed. If you need ignition in a high-speed engine, a requirement that would normally dictate dual points or a magneto such as in racing cars or hydroplanes, this system is for you. Put in a heavier power supply and shave down on the charging inductance a bit, and you can run any 8-cylinder engine so fast it will fly apart before you exceed the capabilities of the electronic ignition system. This presupposes a set of points that can open and close properly at high speeds.

I have used the unit described in this article in a 1956 Ford V-8 and a 1960 Valiant. The Ford was driven about 5,000 miles with the electronic system. The Valiant has just been driven on a cross-country trip of nearly 4,000 miles using the electronic system. The 2D21 thyatron has been the only component to fail in either installation. It seems to require replacement about every 4,000 to 5,000 miles. END

References

- ¹ *Radio and Television News*, July, 1955, page 62. "Electronic Ignition System," by Harry W. Lawson, Jr.
- ² *Ibid.* September, 1955, page 182. "Added Notes on 'Electronic Ignition System'."
- ³ *Ibid.* June, 1956, page 106. "More Notes on Electronic Ignition System," by Charles Erwin Cohn
- ⁴ *RADIO-ELECTRONICS*, October, 1960, page 55. "Winding a Transistor-Power-Supply Transformer," by R. L. Winklepleck

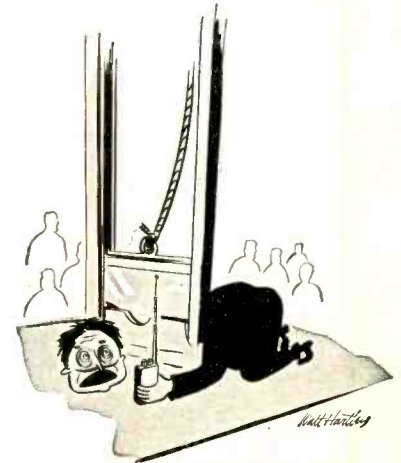

Help!"

SOUND SYSTEMS IN SCHOOLS AND INDUSTRY

What they are and how they work

By YVON O. JOHNSON*

Many schools and industrial plants have complete sound systems. You as a service technician may suddenly find yourself called upon to repair one. This article will show you what such systems consist of, how they work, and how they can be serviced.

Schools have sound systems in auditoriums, gyms, stadiums, offices and classrooms. These may be simple amplifiers with one microphone and one or two speakers, or may be elaborate consoles like the Bogen Series III, which has 33 inputs! Consoles include mixers, preamplifiers, power amplifiers, AM-FM tuners, record players, provision for tape playback, remote-line input, tone oscillators and switch panels for program distribution or communication to one or more than a hundred rooms.

Schools and plants present profitable opportunities to the technician who goes after and gets that business. These markets also give the technician an opportunity to work on well designed and well built equipment. Space is usually not at a premium. Tubes and parts are readily accessible.

Let's look at the difference between

*Audio-visual building coordinator, Herbert Hoover JHS, San Francisco, Calif.

The model FC100 compound horn permits directional control of highs and lows.

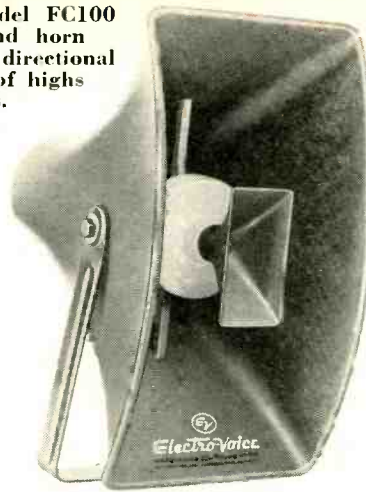

The AC100 is an 80° coverage speaker.



Jensen VR-11 gives 360° coverage in horizontal plane.



Shallow depth speaker makes in-wall mounting possible.

commercial and home systems.

Electronics or electricity?

You are standing on the border between electronics and electricity. One step this way and you might have to be a state-licensed contractor; a step in the other direction, you need not be.

Your state may have a category of "specialized contractor" which permits you to install the 25- and 70-volt audio lines (more about these later) generally used in schools and industrial applications. Local codes may require running the 70-volt system through conduit. State codes may require grounding any electrical apparatus containing a motor through three-way connectors. A city code may go even further and state that all sound systems in schools must be grounded, motors or no motors.

Servicing and maintaining existing equipment does not require a licensed contractor unless there is a licensing law in your locality. It is a moot point, however, whether modifications—such as installing an additional speaker line—would be considered maintenance or installation!

The logical procedure for an electronics technician or firm that wants to specialize in this field would be to start at the maintenance end. This would give time to check into installation licensing while getting familiar with the equipment.

Constant-voltage systems

You'll get your first surprise—if you have worked previously only on home hi-fi equipment—when you discover that the output connections on the power amplifier have, in addition to the familiar 4-, 8- and 16-ohm taps (and possibly a 500-ohm tap), two other taps labeled 25 volts and 70 volts.

These two constant-voltage outputs are the ones generally used in school and relatively low-powered industrial applications. The 70-volt (70.7 volts to be exact) is usually used in installations that do not provide for intercommunication. Or the 25-volt system may be used—especially with intercommunication without callback or with high-level callback. (However, 25 volts is common in schools because the Los Angeles school system pioneered it.) Local electrical codes may have a bearing on which system is used: the 70-volt line may have to be installed in conduit, making it more expensive.

Some industrial sound installations use 100- or 140-volt systems, but most equipment you will come across will be 25- or 70-volt output. Intercoms usually have 45-50-ohm outputs.

What is "constant"?

The first point to clear up is that a constant-voltage system of, say, 25 volts does not necessarily always have 25 volts of audio across the 25-volt terminals. It should appear when the amplifier is supplying its *rated power* into its *rated load impedance*. In other words, the voltage across the output terminals would vary with volume level, frequency and load.

The output voltage is a *mathematical constant*, even though it isn't constant under operating conditions. Calculations for speaker matching assume that the amplifier is always delivering its full output voltage. Therefore, in solving for impedance or power, *E* in the formula is either a constant 25 or 70 volts.

Commercial installations use constant-voltage lines with matching transformers rather than direct connection to speakers (using the 4-, 8- or 16-ohm taps) or the constant-impedance system employing 250- or 500-ohm taps.

Direct connection to speakers is not practical for long runs because the power loss in the lines is excessive. It is somewhat more difficult to calculate the power distribution to the speakers in the constant-impedance system, but its main drawback arises when more speakers and a more powerful amplifier are added to an existing system.

Constant-voltage lines are sometimes balanced to minimize crosstalk with other outputs. This is done by connecting the amplifier ground to the voltage center tap (12.5 volts for a 25-volt line; 35 volts for a 70-volt line) instead of the "common" terminal.

Let's see how easy it is to match speakers to an amplifier when we use a constant-voltage system.

Power equals power

The designer first determines the total amount of audio power required. If he decides, as in Fig. 1, that he needs 15 watts delivered to one speaker, 10 watts to another, and 5 watts to the third and last, he needs an amplifier with a nominal power of 30 watts. (It would have a higher maximum power, but he is interested in the rated power for normal operation.) So the total power consumed in the system should be equal to or slightly less than the normal power output of the amplifier—never more.

The designer is not concerned with the fact that two 4-ohm speakers in series equal 8 ohms, or that two 1,000-ohm line-matching transformers in parallel equal 500 ohms. He needs to know only the amount of power he wants for a given speaker and the voice-coil impedance of that speaker.

Likewise, you need know only those two items to match a speaker properly to a constant-voltage line—assuming, of course, you know the rated voltage of that line.

Simply select a line-matching transformer designed for the voltage of that line and amplifier. If you have a transformer with a tapped primary (Fig. 2-a), choose the required power level terminals. Connect the speaker to the secondary terminals that match its voice coil. A check of catalogs will show the range of power that can be selected by these line-matching transformers.

Jensen lists 70-volt transformers covering, in the total line of transformers, 1/8 to 30 watts. Each transformer covers a part of that range. Electro-Voice also has a series of tapped primary transformers.

The line-matching transformers of

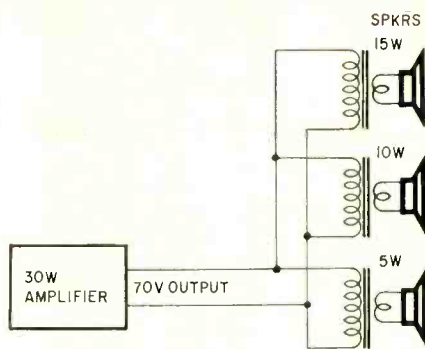

Fig. 1—Total power used to drive speakers equals amplifier power.

the Bogen series shown in Fig. 2-b are slightly different. The power level is selected by the connections to the tapped secondary. The primary is not tapped.

As stated previously, it's not as convenient, but you *could* use a constant-impedance transformer. Calculate the primary impedance by dividing the desired speaker power level into the square of the voltage. Also consider power rating, frequency response, mounting and weatherproofing. This goes for the speaker, too.

Proving it works

If the constant-voltage line-matching procedure seems too simple or contrary to all you know about impedance matching, let's take a look at Ohm's law formulas and prove that there is a perfect match between the amplifier and the speakers of our 30-watt 70-volt system. Its amplifier output impedance is:

$$\begin{aligned} (1) Z &= \frac{E^2}{P} \\ &= \frac{70.7^2}{30} \\ &= \frac{5,000}{30} \\ &= 167 \Omega \end{aligned}$$

So our 30-watt amplifier has a 167-ohm output impedance across the 70-volt terminals. (A 50-watt amplifier would be 100 ohms at 70 volts, and so on.)

According to basic amplifier theory, we should present a load of the same



Electro-Voice model TH waterproof transformer housing.

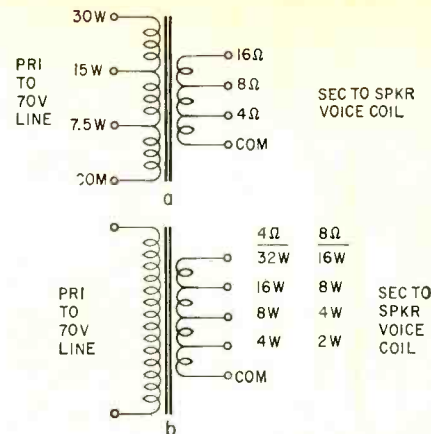

Fig. 2—Constant-voltage line-matching transformer: a—primary tapped for power; b—secondary tapped for power.

impedance to the amplifier for maximum undistorted power output. Let's see if our three speakers driven at 15, 10 and 5 watts, respectively, do present a total of 167 ohms to the amplifier:

$$\begin{aligned} (2) Z &= \frac{E^2}{P} \\ &= \frac{70.7^2}{15} \\ &= \frac{5,000}{15} \\ &= 333 \Omega \\ (3) Z &= \frac{5,000}{10} \\ &= 500 \Omega \\ (4) Z &= \frac{5,000}{5} \\ &= 1,000 \Omega \end{aligned}$$

So far we find that the 15-watt speaker and its transformer present a load of 333 ohms; the 10-watt speaker and transformer, 500 ohms; the 5-watt speaker and transformer, 1,000 ohms. Since the transformer primaries are in parallel, let's combine them according to the usual formula:

$$\begin{aligned} (5) \frac{1}{Z_t} &= \frac{1}{Z_1} + \frac{1}{Z_2} + \frac{1}{Z_3} \\ &= \frac{1}{333} + \frac{1}{500} + \frac{1}{1,000} \\ &= \frac{6}{1,000} \\ Z_t &= 167 \Omega \end{aligned}$$

So we find that matching by power

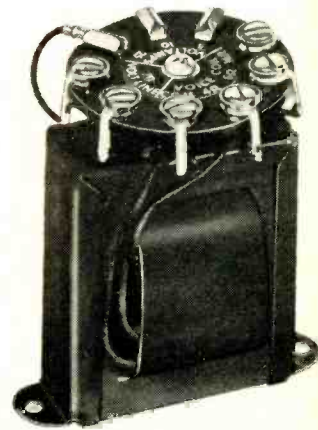

Jensen constant-voltage line-matching transformer.



Bogen Series III is a complete multi-channel sound-system console.

One-channel system with 30-watt amplifier for intercom or program is the TM 40 by Bogen.

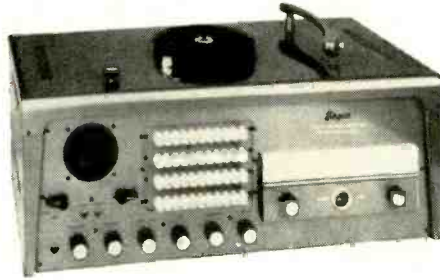

in a constant-voltage system results in a proper impedance match when we use the full rated power output of the amplifier.

But in many systems, speakers are selected at the switch panel and only when they are all "on" is the amplifier working into the precise match of our example. Without all speakers on, we get a mismatch that results in a power loss. But we do not need the full rated power output since we are not using all the speakers.

Since the load impedance increases as we delete speakers and their transformers, the mismatch is in an upward direction which decreases the plate current of the output tubes. Switching on all speakers in a properly designed system merely results in a perfect match. The amplifier will never work into a downward mismatch which would cause excessive plate current unless more speakers were added or taps incorrectly selected.

If additional speakers are added, it is necessary only to replace the old amplifier with a new one capable of supplying the new total power to all speakers. Taps on the old line-matching transformers would not have to be changed. This is one of the major advantages of the constant-voltage system. Both amplifiers supply the same voltage (say, 70 volts) but the power increases and the output impedance decreases when the new amplifier is substituted.

Amplifier servicing

If the amplifier is new to you, read control labels, infer tube function by type and location, try various inputs to isolate the fault. You might even find a schematic inside the bottom plate.

Many troubles are mechanical or caused by abuse. I've seen an amplifier with a burnt-out output transformer because someone plugged leads from the output terminals into the 117-volt ac line! You'll find broken controls because someone insisted that there must be a switch on the control. You'll find broken keys in key-operated switches.

Large, jeweled, high-intensity indicator lights are often used to indicate that the power is on. Sometimes the indicator light is a neon glow lamp for

longevity. Unfortunately, some pieces of equipment have the light behind a door on the equipment. In backstage installations, you may find the indicator light mounted on a nearby wall as part of the 117-volt ac circuit to the amplifier.

Don't assume the output line is connected to the proper tap—it may not be! Unfortunately, output terminal strips are often too accessible to the wrong persons. You may have to do detective work to determine how the system was originally set. For example, inspect line-matching transformers to find the line voltage rating.

Microphones

Amplifiers usually come from the factory with high-impedance microphone inputs. High-impedance microphones work fine with a 25-foot or shorter cable. You are familiar with these crystal, ceramic and, sometimes, dynamic units from ham work and Citizens-band, tape-recording and small portable PA systems.

In runs of more than 25 feet, you'll find low-impedance microphones of 30

to 50 ohms and (sometimes called "medium" impedance) 150 to 250 ohms. The amplifier's input must be changed to match the particular low impedance used. To do so, insert the manufacturer's plug-in transformer designed to match that mike. On some amplifiers you'll have to clip wires on the input transformer socket too.

High-impedance mike cables commonly are a single conductor within the shield while low-impedance mike cables are two conductors within the shield.

Some dynamic microphones such as the Astatic 77 and the Shure 55S have a built-in switch to give you a choice of 35 or 50 ohms, 150 or 250 ohms or high impedance. The Electro-Voice 636 can be either 150 ohms or high impedance, depending on which connector contacts you select. (Make up two cables: one for low-impedance input of the amplifier; another for the high-impedance input of a tape recorder.)

Not only do service opportunities abound in broken mike cables and damaged connectors, but there are sales opportunities for specialized microphones and accessories.

Mechanical know-how

If you contemplate working in this field, you must have, in addition to electronic experience and knowledge, quite a bit of mechanical aptitude. The mechanical portions of the equipment often break down before the electronic.

You also need a knowledge of wire and connectors beyond that required in TV servicing. Many otherwise good technicians are inept when it comes to handling shielded cables and connectors.

This interesting field can lead to profitable and pleasant work if you have the technical and business know-how. Schools and industry are willing to pay for competent and fast servicing—time is often of the essence. END

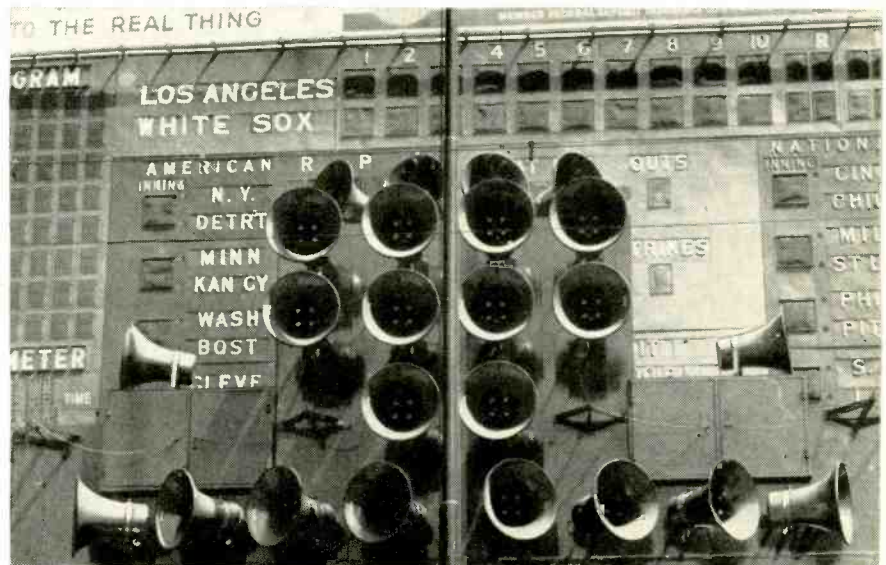

3,000 WATTS OF AUDIO give a big voice to baseball scoreboard at Comiskey Park, home of Chicago White Sox. Separate 100-watt amplifier feeds each of 30 speakers (24 are shown here). The complete system was built by Dukane Corp., St. Charles, Ill.

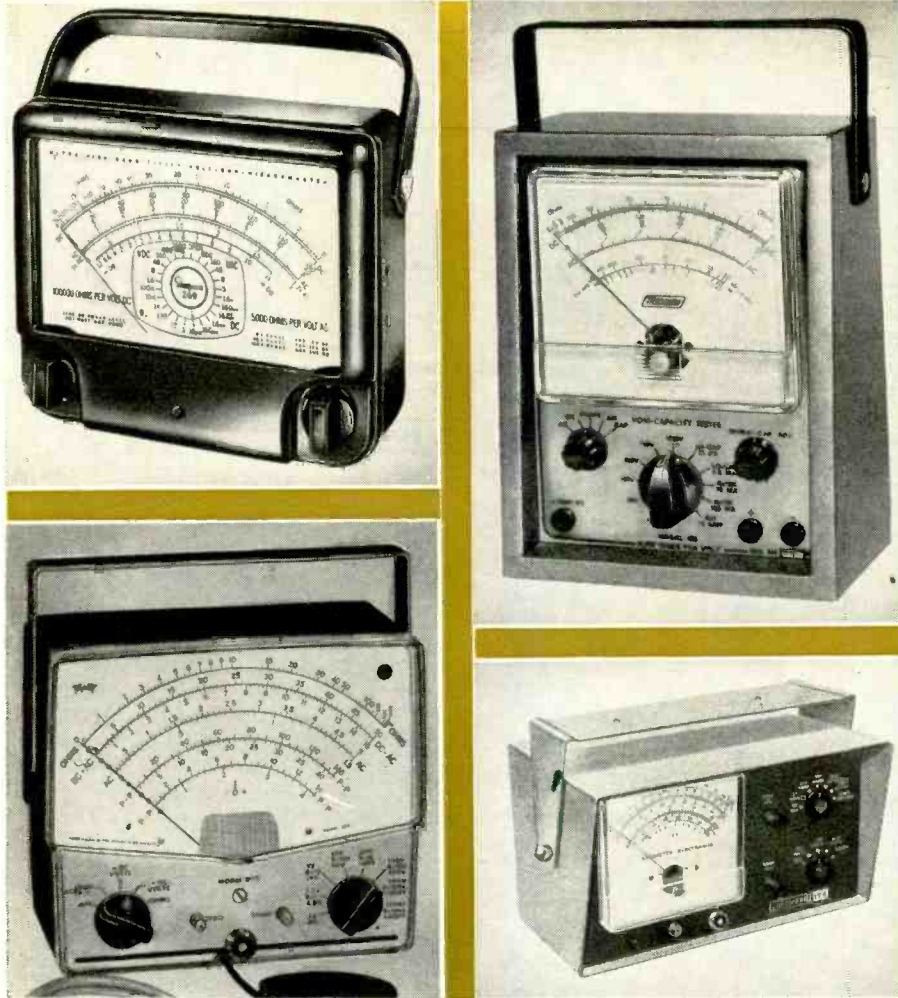

FULL VALUE FROM YOUR MULTIMETER

Servicing can be quicker and safer if you use your meter right.

By **BARRON KEMP**

EVEN though we seldom think about it, the multimeter is the most valuable tool in the shop. A basic and most useful instrument, it is used for troubleshooting, making ac, dc and resistance measurements, voltage and continuity checks.

First: Use your multimeter correctly! Errors can be expensive. Carelessness in making resistance measurements probably accounts for the greatest number of damaged multimeters. When we forget to set the voltage selector switch to the highest range before measuring unknown volt-

ages in a circuit or forget to switch from resistance or current when measuring voltage, the meter suffers. In the minority but still adding to the injuries of our uncomplaining servant, are mishandling, jarring and dropping.

Measuring resistance

One of the most important uses of your multimeter is troubleshooting by measuring resistance. With ordinary care, there is not much chance of damaging the meter on these measurements. But be sure always to discharge all high values of capacitance before making resistance or continuity measurements! If you don't, voltage remain-

ing in the capacitor may throw the needle of the meter against the stop pin, either ruining the meter or bending the needle. And don't measure resistances with the power on—you may find yourself measuring high voltage instead!

It is often difficult to check the resistance of individual parts and circuits because they are shunted by other parts in a circuit. Disconnect one terminal of the part or circuit from the rest to get accurate readings. *Keep your hot little fingers off the test prods!* They can louse up high-resistance readings because your body resistance is in parallel with the circuit being measured.

When you're through measuring resistance, set the selector switch to OFF or to the highest voltage range. This protects the meter against possible damage if you later use it for measuring voltage without first checking the setting. If you're going on vacation and won't be using the multimeter for some time, remove the battery.

Measuring current

When making current measurements, the circuit must be opened to insert the meter. Connect the meter with special care. It can easily be ruined if you set it to a low-current scale and connect it into a high-current circuit. The important thing to remember is that the meter must be in series with the circuit, and the current range you use must be high enough to pass the current. Also, you must watch meter polarity. When the meter is in the positive leg of the supply, as when measuring plate or screen current, the positive terminal goes to the source and the negative terminal to the load. Measure grid current with the negative terminal toward the grid and the positive terminal toward the bias source or ground.

Measuring voltages

Before measuring voltages check the circuit to see whether it's ac or dc; then set the meter accordingly. If the switch is set for dc and you connect the meter ac, it may be damaged. On dc, watch polarity too. When the voltage is positive with respect to the chassis, connect the negative test lead (black) to the chassis or other reference point first, then the positive lead (red) to the point being measured. If you're measuring a negative voltage, reverse the red and black leads, or throw the voltage reversing switch found on some multimeters.

A 60-cycle ac line voltage will cause the needle to quiver on dc meter settings. This can be destructive because the violent motion of the needle can shake the meter movement out of balance.

Unless your multimeter is designed to read peak voltages, only sine-wave voltages will give accurate indications on the ac scales. The ac scales of most meters used with multimeters are calibrated to read 0.707 times the peak value of the sine-wave voltage (the rms voltage). The meter indication multiplied by 1.414 will give you the peak voltage.

Rf voltages

Sometimes you'll find it necessary to measure rf voltages with a vtm and rf probe. When measuring rf, a few precautions will prevent false readings. First, leave the tip of the probe as it is; do not extend it with a piece of wire for convenience. Such an extension causes erroneous readings at higher frequencies because the extension picks up stray radiated rf energy. Also, it's good practice not to grasp the probe too firmly or too close to the tip, or body capacitance may introduce addi-

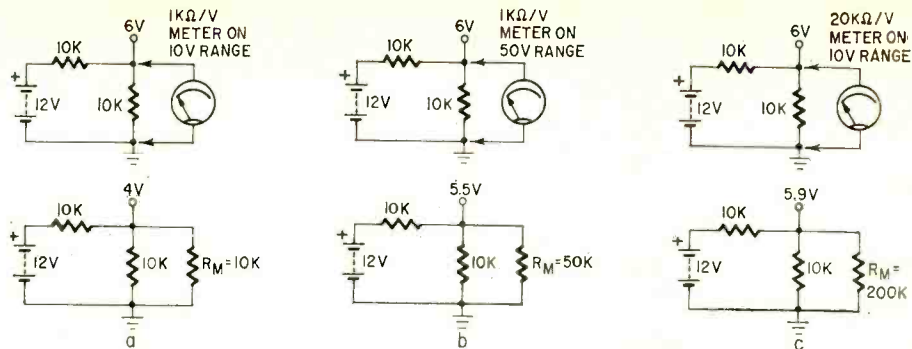

Fig. 1—Loading effect of voltmeter on circuit being tested: a—how low-sensitivity meter loads circuit. b—Circuit loading can be reduced by using a high voltage range c—Loading is minimized by using high-sensitivity voltmeter or vtvm.

tional errors. Another cause for erroneous readings when using a probe is a faulty ground connection or ground leads that are too long. One sign of a poor probe ground is the inability to repeat a voltage reading when the ground connection is shifted to another point.

Circuit loading

When a voltmeter is connected between two points in a circuit, the resistance of the meter is added to the circuit resistance and can change the circuit voltages. The meter "loads" the circuit. The amount of loading depends upon the meter's internal resistance. Since such loading results in a voltage reading lower than the actual circuit voltage, you should be aware of this and learn to allow for it.

Loading is a problem in both ac and dc circuits. In either case, the meter resistance or impedance should be many times the resistance between the meter and the point being measured. When the circuit has little or no series resistance, as in a power supply or battery, the meter drain is so small compared to the available current that loading is no problem. The loading effect of voltmeters is illustrated in Fig. 1.

To minimize circuit loading effects use a high-resistance voltmeter. For negligible loading when making voltage readings, the resistance of the meter should be at least 20 times that of the circuit being measured. Use the highest practical range which will allow an accurate reading. The higher the range used, the higher the total meter resistance and the lower the circuit loading. Use a vtvm if you have one. Measure the voltage on two or more ranges. If you don't get the same reading on all ranges, the meter is loading the circuit.

Extending meter range

Sometimes you'll have to measure a voltage that is beyond the range of your meter. Some meters have a high-voltage probe especially designed to extend their range, but maybe you don't have one of these contraptions. Don't be discouraged; there is a way to measure the voltage. Just add an extra multiplier resistor in series with the meter lead to increase the range of the meter (Fig. 2). You must know the meter

sensitivity if using a nonelectronic meter, or the input resistance if using your vtvm.

It's convenient to increase the meter range by a factor of 10. Since the meter will now indicate 10,000 volts full scale, all readings must be multiplied by 10 to find the value of the measured voltage. For instance, if you're going to check a 7,500-volt circuit and have a 5,000-ohms-per-volt meter with a top range of 1,000 volts, first determine the total resistance required for measuring 10,000 volts full scale. Do this by multiplying the sensitivity of the meter by the desired full-scale voltage: that is, 5,000 ohms per volt multiplied by 10,000 volts, or 50 megohms. However, since the 1,000-volt range already has a 5-megohm multiplier resistor, only 45 megohms additional resistance is required in series with the meter lead for the meter to indicate 10,000 volts at full-scale deflection.

If your vtvm has a 20-megohm input resistance and a maximum voltage range of 1,000, add sufficient resistance to form a 10-to-1 voltage multiplier. In this case, the added resistance must be 9 times as great as the meter resistance, or 180 megohms. Since you probably don't have this value resistor around the shop, use a number of smaller ones in series to get the 180-megohm total resistance.

Isolating the meter

The capacitive effect of the test leads used to measure dc voltages cause a similar type of loading when rf is present. This type of circuit loading is noticeable mostly when the test leads are connected across a tuned circuit because the capacitance between the test leads can be large enough to detune the circuit. For example, when you try to measure grid bias in the local oscillator of a superhet, the loading can cause the oscillator frequency to change

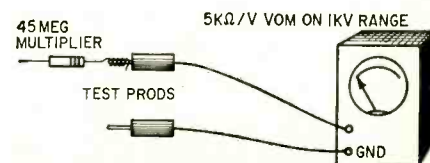

Fig. 2—Extending vom range by using multiplier resistor in series with internal resistance of the meter.

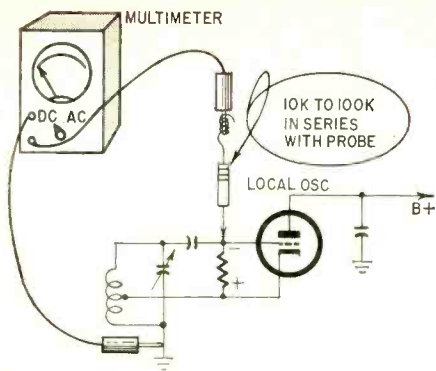

Fig. 3—Measure oscillator bias by using an isolating resistor to minimize circuit loading.

while the test leads are connected across the circuit.

To minimize this type of loading, isolate the circuit from the multimeter as much as possible by inserting a large resistor in series with your vtvm probe. This effectively separates the capacitance of the test leads from the circuit. Although the measured dc voltage is decreased slightly, this is unimportant.

An indication that low-powered rf circuits are working can be obtained with a low-sensitivity multimeter. Measure the grid bias, using a high value of resistance (10,000 to 100,000 ohms). The resistor can be clipped temporarily to the test point or may be wrapped around the test prod (Fig. 3). Although the voltage indicated on the meter will be influenced by the voltage-divider action of the isolation resistor and meter resistance, you know that an oscillator is working if there is bias voltage at the grid. Another indication of oscillation is that the needle of the meter will show a quick kick as the test prod is attached to the grid, then returned to zero.

Power level and db

The output of an audio amplifier

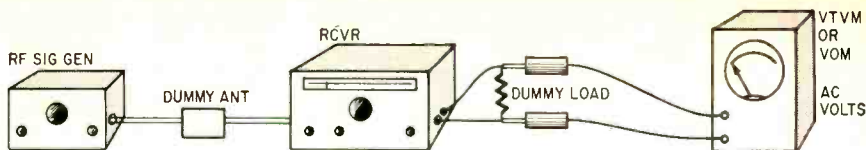

Fig. 4—Checking receiver sensitivity by measuring output power.

must sometimes be measured to determine whether the equipment is operating properly. This requires an output meter. This kind of ac voltmeter usually has a selection of standard resistance loads which can be connected to the equipment being tested, and is calibrated in decibels.

An ac voltmeter and a resistive load can be used if you have no output meter. The normal loudspeaker load is not suitable for accurate power measurement since it does not have the same impedance at all frequencies. More uniform results can be obtained by using a resistive load. It must have the same value as the impedance of the amplifier output and have a power rating at least as great as that of the amplifier.

Since the meter can indicate only the ac voltage across the resistive load, you'll have to compute the power. Fig. 4 shows the setup for checking the sensitivity of a receiver. The receiver output should be a certain value when a standard modulated rf signal is applied to the antenna terminals. If the load resistance is 600 ohms and the minimum power output required is 100 mw, the voltmeter should indicate 7.75 volts or more. The exact value can be found from the standard power formulas, $E = \sqrt{PR}$, $P = E^2/R$. Since P is in watts, the answer will be in terms of watts—100 mw would be expressed as 0.1 watt.

Ac voltmeters intended for use with audio frequencies usually have a db scale in addition to voltage scales. This

makes it convenient to make power measurements when the power level is in db. The voltmeter uses a linear scale for ac voltage measurements and a nonlinear one for dc measurement.

The scale of my meter (a Simpson 270) is calibrated to read directly in db when the meter switch is set to the 2.5-volt ac range and the meter is connected across a 600-ohm load resistance. The standard reference (0 db) measurement is 1 mw across a 600-ohm load. This corresponds to 0.775 volt. A correction factor must be added to or subtracted from the reading to obtain the true db level of 600 ohms. This correction factor is marked on the meter panel opposite the setting of the selector switch at each range and the figures are added algebraically. Different meters use different correction scales.

If the db meter is calibrated for 1 mw across 600 ohms and is used to make measurements across a load that is not 600 ohms, the db readings must be corrected to give the true value. A correction factor to add or subtract from the meter indication is calculated from the formula: db correction to be added = $10 \log_{10} 600/Z$, where Z is the impedance of the circuit being tested.

To increase the usefulness of your multimeter further, adapters are available which permit using the multimeter for measurements not incorporated into its basic design (see "Test Adapters," July 1960, page 40). With these adapters, the multimeter can be used as a battery tester, transistor beta tester, ac ammeter and audio wattmeter. END

Electronic Flasher

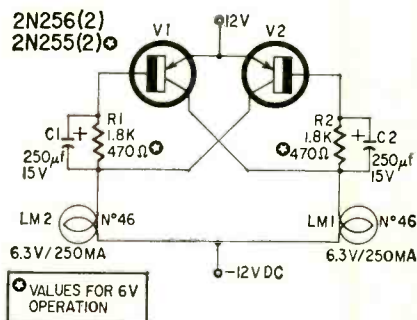
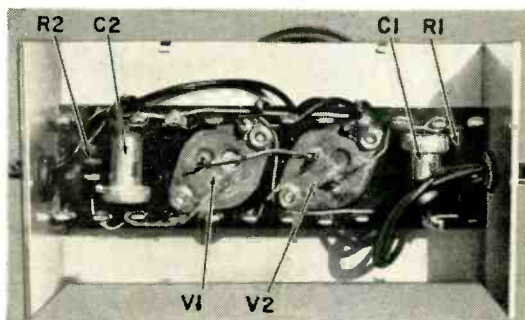

Here's a nifty little two-lamp flasher that's an easy one-evening project. It uses two transistors in a multivibrator circuit. If you want to amuse the kids, build three of these circuits into one box, each with a different flash rate (adjusted by changing the value of the series resistors). Paint the lamps different colors, put a few toggle switches on top of the box and turn it over to

the little ones. It's sure to keep them busy. It will also draw attention to store displays.

The lamps are connected in the collector circuit of the multivibrator transistors so when V1 conducts LM1 lights and when V2 conducts LM2 lights. A 12-volt battery powers the circuit. If you would rather use 6 volts as the power source, use 2N255 transistors

and 470-ohm resistors. The photo shows the parts arrangement of one flasher. The lamps are connected externally. They could be mounted on the box.

If the lamps do not alternate properly, the transistors may be badly mismatched. Check by connecting a milliammeter in each leg to see if the currents balance. If not, adjust the resistors until they do.—E. H. Marriner

**COVER
STORY**

SUPERHET IN A HEADPHONE

Tiny 5-transistor set covers
the broadcast band — and
it's not hard
to make



The radio is
worn like
a headphone.

BY PHILIP DE LA ROZA*

The availability of subminiature components makes very compact radios possible. The five-transistor superhet described here fits into an headphone case. The set performs well. Even indoors, strong local stations come in clearly. Battery life is about 25 hours with a 4-ma drain. If a 2-foot length

of wire is connected to the antenna lead going to the tuning capacitor, many weaker stations can also be received.

Although this type of three-dimensional construction takes a bit of patience, it is not too difficult to solder components in place with a little practice. I used a pencil iron rated 23 watts, with a 1/8-inch tip. A pair of tweezers, small diagonal cutters and a small pattern file are the only other tools needed to assemble the radio. A pair

*Technical Consultant, Allied Radio Corp.

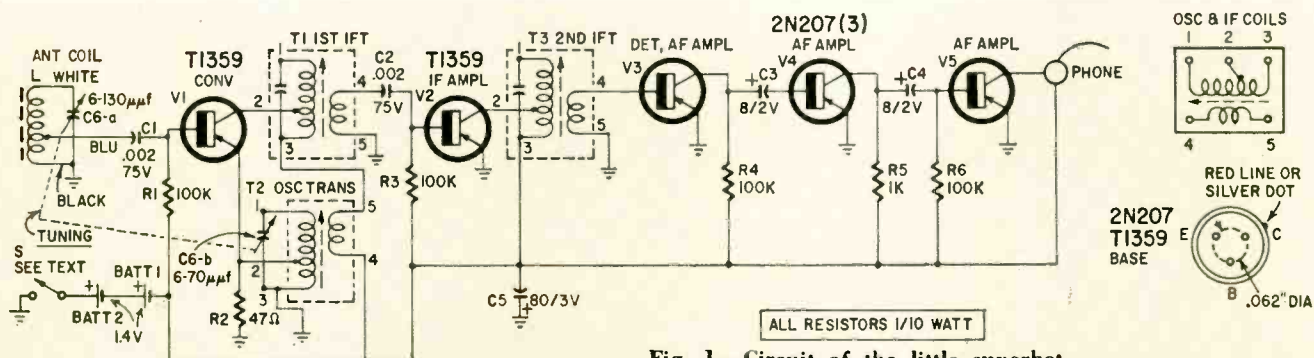

Fig. 1—Circuit of the little superhet.

R1, R3, R4, R6—100,000 ohms, 1/10 watt, 10%
R2—47 ohms, 1/10 watt, 10%
R5—1,000 ohms, 1/10 watt, 10%
C1, C2—.002 μ f, 75 volts, ceramic subminiature
(Allied 78 L 716 or equivalent)
C3, C4—8 μ f, 2 volts, subminiature electrolytic
(Allied 19 L 830 or equivalent)
C5—80 μ f, 3 volts, subminiature electrolytic (Allied
or 18 L 959 or equivalent)
*C6—tuning capacitor; osc, 6-70 μ f; ant, 6-130 μ f

BATT 1, BATT 2—1.4 volts, mercury cell (Mallory
RM-675 or equivalent)
*L—antenna coil, ferrite core, cut down to 1 1/2 inches
S—see text
*T1—if transformer:
*T2—oscillator transformer:
*T3—if transformer:
V1, V2—T1359 (Philco)
V3, V4, V5—2N207

Earpiece, 2,000 ohms, miniature (Allied 59 J 119 or
equivalent)
Phono hookup cable, 10 feet (Allied 49 T 614 or
equivalent)
Epoxy cement
Headphone, single earpiece, 1 1/2-inch inside diam-
eter, 3/4 inch deep (Allied 59 J 112 or equivalent)
Miscellaneous hardware
*These components are all part of a coil kit sold by
Allied Radio under the stock number 60 H 074

of cuticle nippers are handy, because of their narrow tip, for cutting fine wire in tight corners.

The circuit, using only six capacitors and six resistors, was designed to eliminate as many components as possible to reduce the size and amount of wiring involved. The schematic follows conventional transistor circuitry with few variations. Resistor R2 reduces feedback in the oscillator circuit for better stability. (With a real "hot" transistor for V1 you may have to reduce R2's resistance for optimum stability. R2 is 15 ohms in one version of this circuit.) Capacitor C1 affects stability too. V3's bias circuit rectifies the if output, and the amplified audio signal appears at the collector. Load resistor R4 was made larger than usual to reduce the audio gain slightly as there is no volume control. Tiny 1/10-watt resistors, very small ceramic capacitors rated at only 75 volts and subminiature tantalum capacitors originally designed for hearing aids make this compact circuitry feasible.

How to build it

Cement all large components together with an epoxy cement. Use thin phono pickup cable for wiring and insulate transistor leads with insulation pulled from ordinary hookup wire.

The best method of soldering, I found, was to hold the leads together, melt a little solder and flux on the iron and quickly apply it to the work. Hold the iron in place for only a second and snip or file off any excess solder left on the leads.

Choose an earphone case deep enough to accommodate the combined thickness of the tuning capacitor and small earphone. You'll have to file the flange on the front of the phone flush and possibly trim off part of the plastic housing. Cut away part of the back to expose the terminals and solder short leads to them.

Drill a hole in the case for the tuning capacitor shaft and position the if transformers, antenna and tuning capacitor as shown. Trim the antenna's ferrite core to fit the inside diameter of the case. It is best to cement the capacitor and antenna together first, and add the coils later. Center the antenna coil midway on the core. Let the epoxy cement harden for about half an hour under a light bulb. More heat will shorten the drying time but may overheat the parts. Do not cement the earphone in place until after alignment is finished. It may be necessary to cut away a little of the inside of the case to get a loose fit.

The battery bracket and switch plate are made from sheet brass. The heaviest gauge of automobile shim brass would be suitable. Solder a No. 2 or No. 3 nut to the plate over the hole and solder the plate to the battery bracket. Notice that a small piece of flexible plastic insulates the two mercury cells and also makes battery removal easier. When fastening the plastic strip to the bracket, cut a small hole in the plastic so the cement bonds

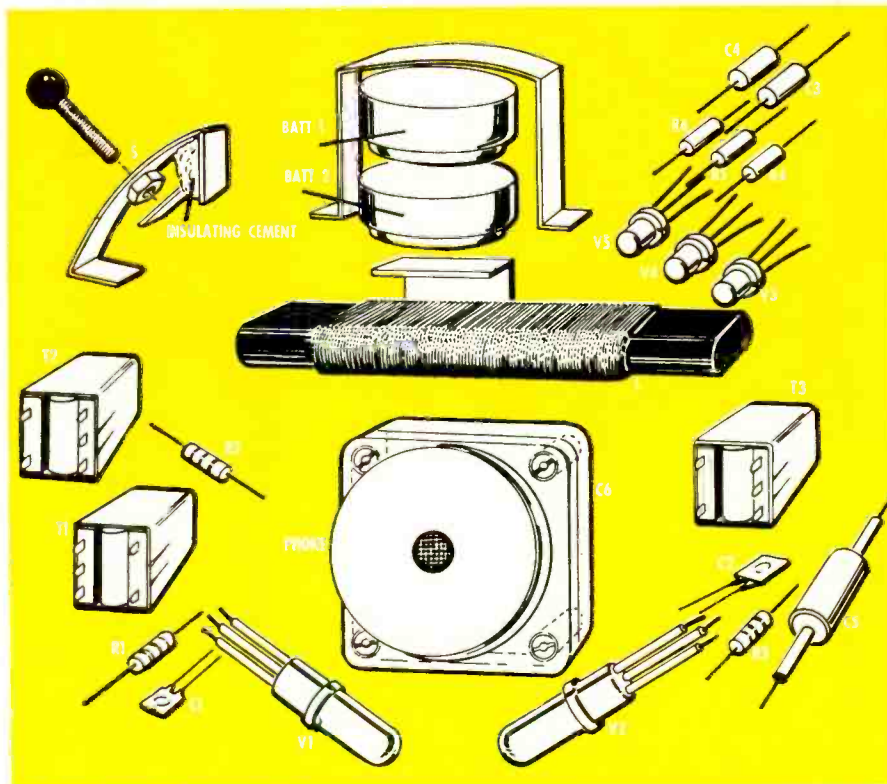
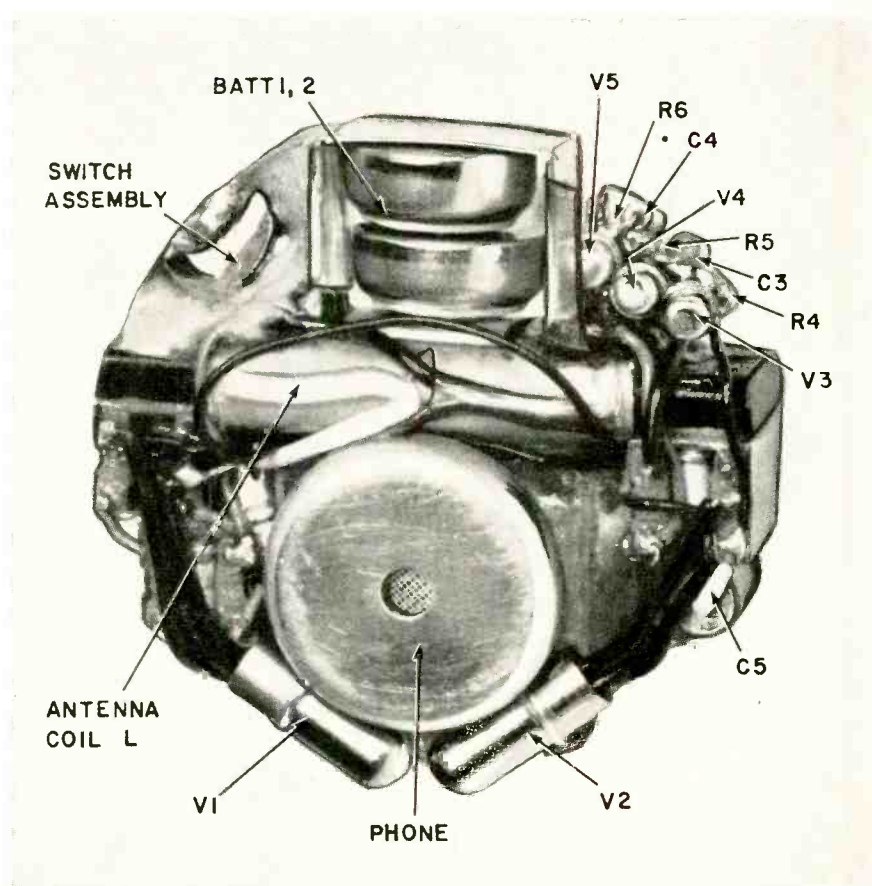

Fig. 2—Parts location detail with reference to interior photos.



Earpiece side of the radio, showing parts layout.

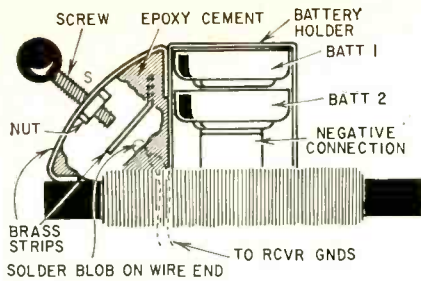

Fig. 3—Details of switch assembly construction

with the metal. After the bracket has been fastened in place, cement the negative terminal to the side of the antenna. The outer cases of these cells are positive, so the bracket becomes the positive terminal when the cells are inserted.

To complete the switch, form a small bead of solder on the end of a piece of light hookup wire and partially imbed it in glue underneath the screw which forms the other contact of the switch. A blob of cement on the head of the screw serves as the knob. Drill a hole in the side of the case large enough for the screw.

The three-stage audio amplifier is assembled separately and then wired into the radio. Don't use too much solder, and position all leads to avoid shorts. Spot cement the amplifier in place after making certain it will fit into the case, and finish wiring.

The radio was designed to be completely self-contained so it would be very rugged and could be removed from its case easily.

Alignment

To align the set, tune in the strongest local station. Use a wire strung around the room if extra pickup is needed. Adjust the if transformers

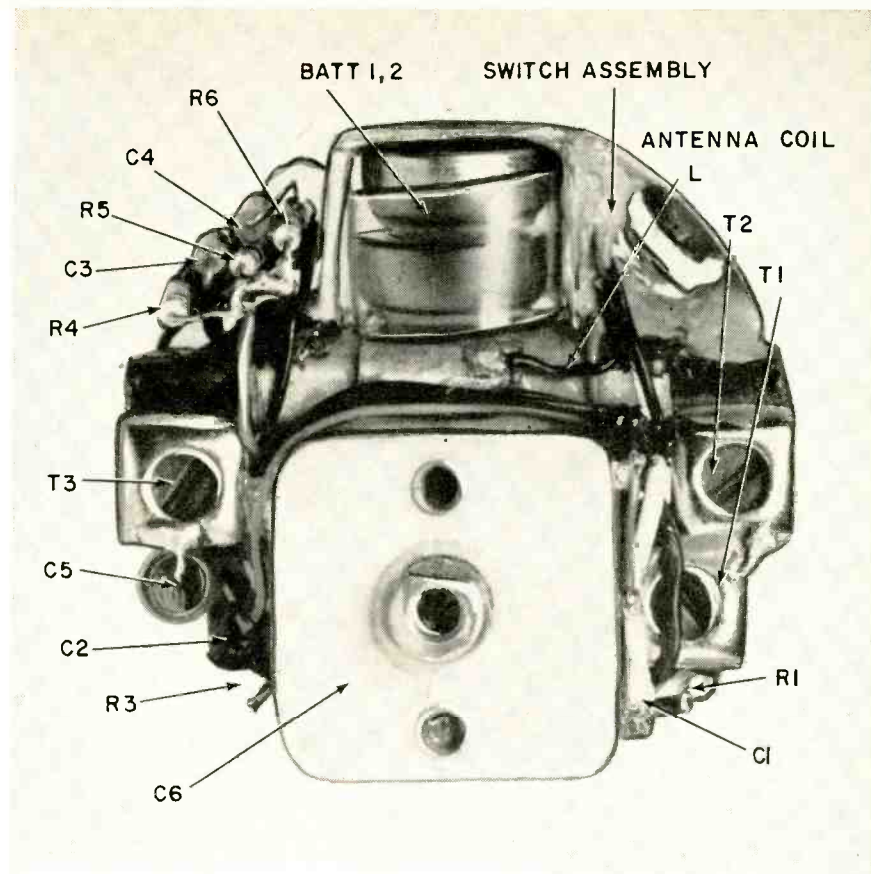

The tuning capacitor is on this side of the tiny set.

for the maximum volume. Now tune in a station near the low end of the band and adjust the oscillator slug. Set the tuning capacitor at several positions, near the low end of the band, and readjust the oscillator to determine which setting of the capacitor gives maximum volume on the same station. Repeat the if's and tune in a station around 1400

kc. Adjust the trimmers on the tuning capacitor, recheck the low end and the alignment is complete.

I was worried that the compact construction would cause feedback problems, but no serious effect resulted. I did notice a slight tendency to howl on strong stations, but a slight adjustment of the if's cured it. END

Add a scope pilot light

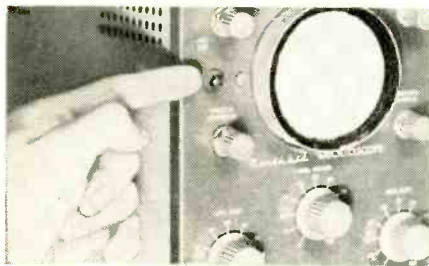

Two views of the pilot-light installation

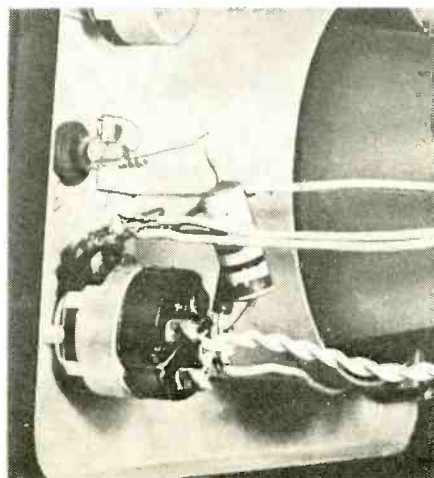

Some of the less expensive oscilloscopes don't have a pilot light. What is doubtlessly an economy measure for the manufacturer can be a nuisance for the scope owner. When the intensity control is turned down to dim or eliminate the trace, it's easy to forget the scope is on and leave it running for hours.

A simple and convenient pilot-lamp installation can be made at the point indicated in the photo. Drill a hole in the scope's front panel close to the intensity control and mount a miniature neon pilot-lamp assembly. An alternative method is to press-fit an NE-2 through a rubber grommet mounted on the panel. After mounting the bulb or pilot assembly, run one of its leads to a convenient ground point. Connect the other lead to a 4.7-megohm 1/2-watt resistor. The free resistor lead goes to either of the two outside terminals of the intensity control, and the job is finished.—*J. Scheckley*

By **FRED SHUNAMAN**
MANAGING EDITOR

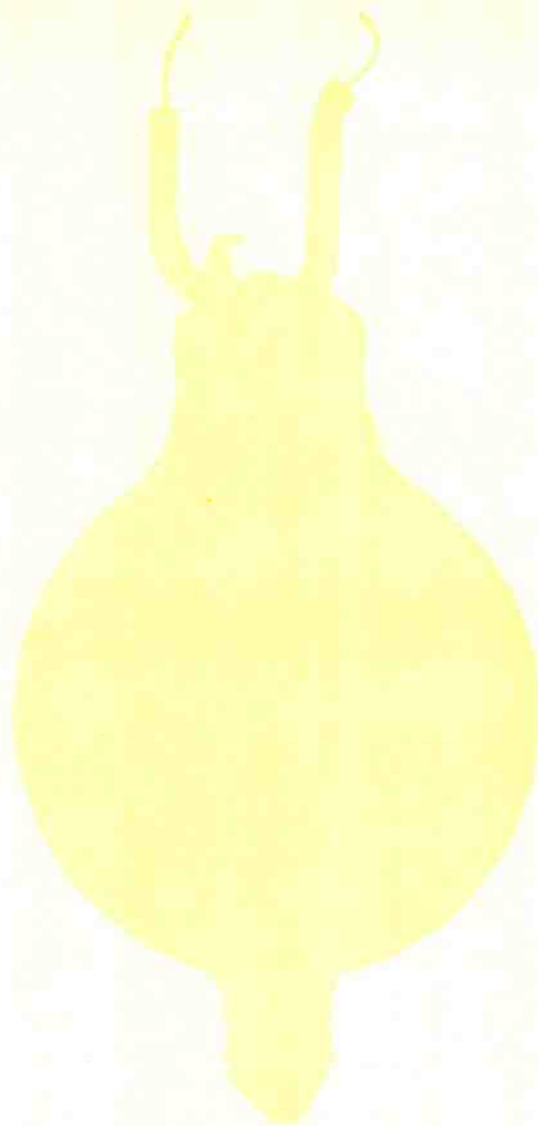

What did de Forest really Invent?

A PROFOUND MISCONCEPTION ABOUT THE nature of de Forest's fundamental invention has prevented many from appreciating the full importance of his contribution to communications and electronic science. Indeed, if he had simply "interposed a grid between the cathode and anode of a two-element vacuum tube" as some seem to think, he would have no claim to the title "Father of Radio" which he has borne without challenge for several decades.

Yet, in spite of their superficial resemblances, the de Forest Audion and the Fleming valve do not belong in the same family of detection devices. De Forest started out with the *Responder*, an electrolytic detector. A steady current from a local battery flowed through it. Arrival of a radio signal reduced the conductivity of the solution and interrupted the current. Thus it was, like the Branley coherer, a *relay*, in which very small amounts of radio-frequency power controlled much larger quantities of power supplied by a local source. The *Responder* was the subject of de Forest's first patent.

De Forest did not "add a grid to the diode": he developed an entirely new electronic device

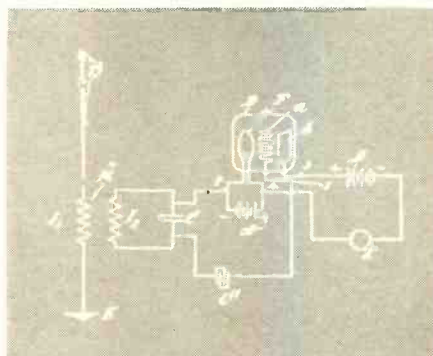

This early patent drawing may be the first of the grid Audion and its circuit.

While working with the *Responder*, de Forest was led by an accident into the study of flame or hot gases as a means of detecting wireless signals. The Audion was the last of a long series of heat-operated devices. All of them used a local or B-battery (de Forest's term—abbreviated from "booster battery"). The leads from this battery terminated in two electrodes, placed in different parts of a flame (in the earlier models). The battery current was to be controlled by the wireless signal, picked up by an antenna attached to one of the electrodes of the device, which in its simplest form is shown in Fig. 1. Another electrode was grounded, to complete the antenna circuit. The telephones were in the battery circuit.

Several of these devices, using a Bunsen burner as the chief element in the detector, and with different types of elements variously positioned, were patented by de Forest.

But the inventor realized that his flame detector, though improving with each new model, was fundamentally unsuited for practical work, especially on



Dr. de Forest inspects the newly invented transistor while Dr. Shockley, who directed the team responsible for its invention, holds one of the early Audions.

shipboard. A breath of air or slight list of the craft could change the relative positions of flame and electrodes, making the detector intermittently useless. "So," he said, "I thought of other means of heating the gases." After trying and abandoning a small arc, he had a number of small lamps—with the essential elements built in—constructed (Fig. 2).

It would be naive to suppose that Fleming's valve might not have given him a suggestion. On the other hand, he might have got his inspiration from an ordinary electric light bulb. In any case, the elements sealed into those earlier tubes—and most especially the circuitry surrounding them—were definitely those of the de Forest gaseous detectors. (Even the final grid Audion is reminiscent of a much earlier device which used a number of rings in a Bunsen burner flame.)

De Forest argued that the arrangement of Fig. 2 was imperfect "because it permitted part of the high-frequency energy to pass to earth through the telephone and B-battery circuit, instead of concentrating it upon the ions between the plate and filament." He there-



De Forest and Sarnoff before the plaque erected at the site of the invention of the vacuum tube.

fore tried attaching the antenna to a piece of tinfoil wrapped around the glass of the lamp. The next step was to insert it in the tube, at first as an additional plate or "wing" on the opposite side of the filament from the plate.

The new model was "a further distinct improvement" on previous detectors, and work was intensified to find the best shape and position for the new element. The Audion was practically invented. Already a system was in existence that isolated the signal and local circuit, and finding the ideal placement of the control element was a matter of a few experiments. De Forest was convinced that it would have the greatest effect on the conductive stream (of ions, as he envisioned them) if placed between cathode and "wing" or plate. The plate was perforated as a first experiment, then de Forest handed tube maker McCandless a piece of wire, bent in zig-zag fashion into the shape of a grid about $\frac{5}{8}$ inch square. Instructions were to put this grid between the wing and filament, and "as close to the filament as possible."

The new tube, delivered with a batch of others of different forms, had a life of barely 3 minutes. Yet that was long enough to prove a device of an entirely

new order of sensitivity was born. Thus the Audion, which differed from all previous detectors of electric waves in that it could *amplify*, was born.

In contrast, the Fleming valve was a simple rectifier. It is related to the crystal diode or the imperfect-contact type of detector rather than to the family of the coherer. Putting a third electrode in it—while retaining its method of operation—would simply make it "a rectifier with one too many electrodes." It could never have advanced electronics beyond the crystal-diode stage.

In recent years even the British—who tended to defend Fleming during his lifetime—have pretty well recognized de Forest as the inventor of a new device. De Forest's own attitude, which the British considered sporting, was partly responsible for the swing in his favor. Fleming consistently attacked de Forest as a charlatan and cheat, while he took a far more tolerant attitude toward his British colleague. According to one British author, de Forest went so far as to remark that "Fleming went to his death convinced that he was the inventor of the vacuum tube."

Now that both great pioneers of radio are dead, and personalities no longer enter into the problem, it is clear that

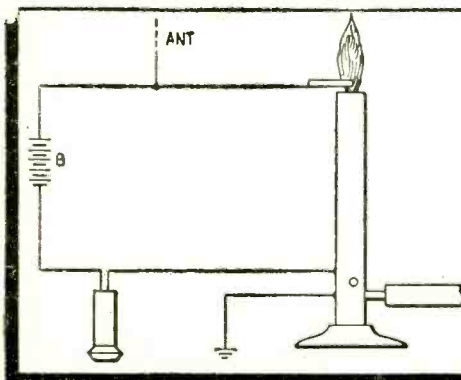

Fig. 1—The earliest model of the flame or heat-operated detector.

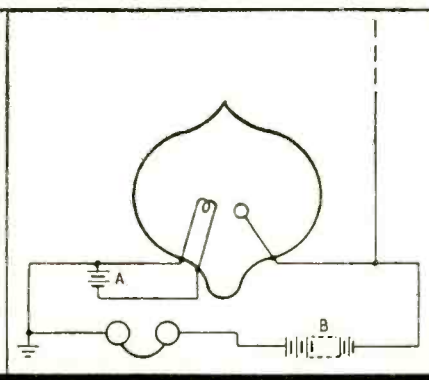

Fig. 2—Elements of the flame detector of Fig. 1 sealed in a glass envelope.

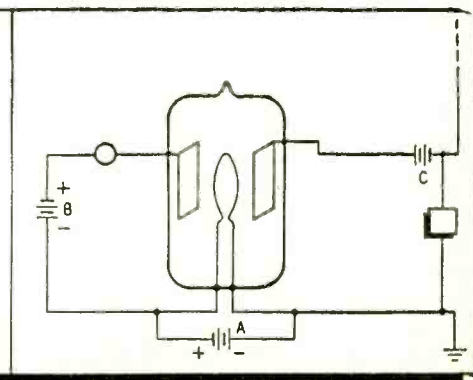

Fig. 3—A near-Audion. Signal circuit connects to a separate electrode.

what de Forest invented was not just another and more efficient "oscillation detector" but a revolutionary new device, a thermionic relay in which a very small electric charge can be made to control the flow of much larger charges, in short a device that can amplify. It is this ability to amplify all types of electric signals, from direct current to the kilomegacycles, without changing their form, that made the Audion and its descendants creators of the Electronic Age. De Forest's confidence in the relay principle and the "booster battery", which could supply large amounts of power, was justified and helped him to invent the device on which depends not only modern radio, but television, radar, countless control devices, including those that make modern aviation possible, our great new computers and data-processing devices and a host of other equipment and apparatus. The term "Father of Radio" dates from a day when the potentialities of his invention could not be realized or imagined. Today he may more correctly be hailed as the Father of the Electronic Age. END



In 1946, editor Hugo Gernsback asked permission to have de Forest's hands photographed. De Forest, in a letter to Gernsback, objected to this because he thought "it was not dignified." We convinced him that the picture was necessary for a historical record. The photograph above is printed here for the first time; it shows the hands that fashioned the Audion, which ushered in the electronic age.

Dr. de Forest's picture appearing on page 33 was taken from an oil painting by Geo. L. Camarero in 1952. It now hangs in the home of H. Gernsback.

WHAT'S YOUR EQ?

Series-Parallel Capacitors

Five paper capacitors are connected as shown. The capacitances are given in microfarads. Now, what is the capacitance between points A and B?—*T. A. Varhelyi*

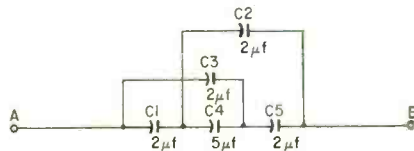

Over the River

Here is a puzzle that should increase aspirin sales:

You have a cable containing 100 wires running under a river. None of the wires are color-coded. The problem is to identify (using numbered labels or

cable markers) the corresponding wires on both sides of the river. Only one round trip across the river is permitted and the only piece of equipment that may be used is a continuity checker (not an ohmmeter).—*Ronald J. Draus*

Black Box No. 3

In the figure, note that at the left, one cell identical to the two cells at the right is used to power the black box. Further, note that the current drain of the black box in both cases is the same.

Question: What's in the black box?—*George R. Wisner*

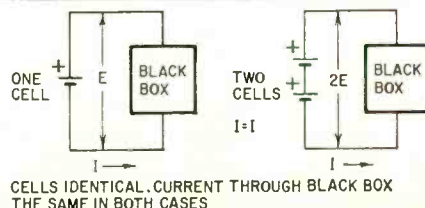

Here we go again. Sharpen up your pencils, put on that thinking cap and settle down to some interesting puzzles.

If you've got one of your own that will stump our readers, especially if it's on an engineering level, send it to us. We pay \$10 and up for each one accepted. Write to EQ editor, RADIO-ELECTRONICS, 154 W. 14 St., New York 11, N. Y. Answers to July puzzles are on page 89. Answers to this month's puzzles appear next month.

Automated Voting

To solve the usual office problem of whether to have music or not, one boss installed a double-pole switch on his own desk and single-pole switches on the desks of each of his three men, John, Dick and Harry, as shown in the figure. When anyone wants music, he votes for it by closing the switch at his desk. Closing the boss' switch counts as two votes, while closing any of the other three switches counts as one vote. When there are three or more votes for music, the radio comes on.

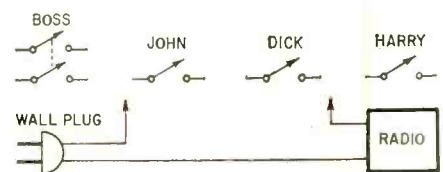

Wire up the circuit. No additional parts are needed, and the switches need not be altered. Before deciding you have done the job right, check to make sure the radio will come on for any combination of three or more votes, and never for any combination of less than three votes.—*Darrell L. Geiger*

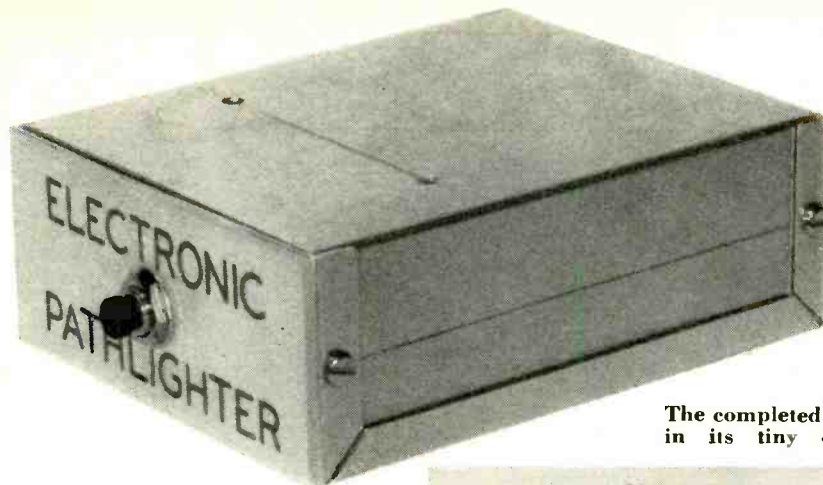

The completed unit in its tiny case.

ELECTRONIC PATHLIGHTER

is easy to build

TWO-TRANSISTOR UNIT TURNS OUT YOUR CAR'S HEADLIGHTS AFTER YOU'VE MADE IT SAFELY TO YOUR FRONT DOOR

By R. L. WINKLEPLECK

DO YOU remember just last week when you came home late from a meeting, pulled up in the driveway, doused the car lights and made a dash for the house in darkness blacker than black, completely unaware of the tri-cycle lying in your path? And the week before when you nearly hung yourself on the clothesline which hadn't been taken down after the wash had dried. Next week could be worse—but it won't be if you build the Pathlighter.

This simple little transistor-operated gadget, which can be mounted unobtrusively under the edge of the automobile dash, permits you to leave the auto lights on to light your path while you saunter casually into the house. A couple of minutes later, after you've made it safely into your home, the car's lights automatically go out and all is secure.

The Pathlighter can be easily assembled and installed in one evening. The only moving parts are the pushbutton and the relay. The unit should outlast several cars and is so easily installed that it can be quickly transferred whenever you switch to a new car. Once you've enjoyed its convenience, it will be as indispensable as the turn indicator or the windshield washer. It'll be just as dependable, too.

The two bulky components are the relay, which must have heavy-duty contacts to handle the amperage of the headlights, and the capacitor, which must store enough electrical energy to keep the relay closed for the desired interval. Together with the switch, transistors and resistors, they can be housed without crowding in a small aluminum box mounted conveniently beneath the dash.

A glance at the schematic shows that the circuit couldn't be simpler. When the pushbutton is depressed, C is charged with the battery voltage. This charge is then dissipated slowly through current-limiting resistor R1 and V1's base-emitter circuit. As long as the current flows, V1 is biased to conduction. This in turn biases power transistor V2 to conduction with a current flow great enough to close the power relay and turn on the lights. When the flow of current from C1 decreases, the conduction of the transistors decreases and the relay opens, turning off the car lights. S1-b and the upper contacts of the relay connect the unit to the car battery while it is being used and disconnect it when the lights go out. Otherwise, there would be a constant transistor leakage current which, while insignificant in view of the big battery from which it is being drawn, is best eliminated.

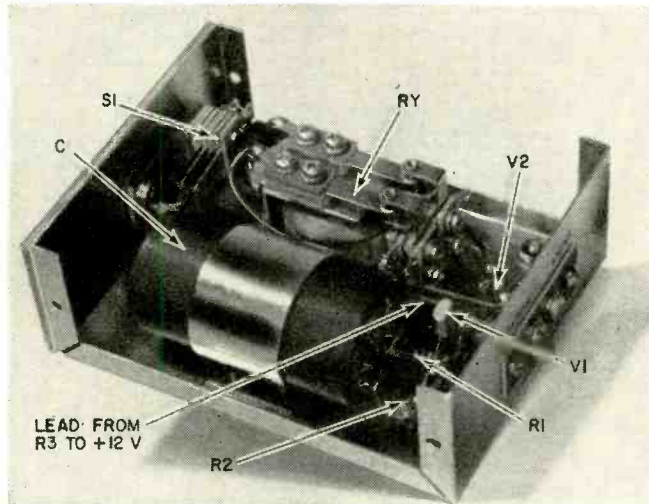

Two main components (size-wise) inside Pathlighter are the relay and electrolytic capacitor.

The unit illustrated is built into a 3 x 4 x 5-inch case which was cut down to 1 3/4 inches high. It is designed for an automobile with a 12-volt system and negative ground. Thus, power transistor V2, (its case is the collector) is mounted directly on the aluminum case which is attached to the grounded dash of the auto. Resistor R2 biases V1's emitter to prevent possible thermal runaway. Resistor R3 limits the flow of current in V2's emitter-collector circuit to a safe value. The circuit is essentially a two-stage, complementary-symmetry transistor amplifier. The delay, with the components shown, is approximately 1 1/2 minutes.

Construction hints

There is nothing complicated or time-consuming about the wiring. Just be careful, as always, not to overheat the transistors while soldering. Be sure not to confuse the transistor leads, and watch the polarity of the electrolytic capacitor. The box is the negative battery connection when it's mounted to the metal auto dash. The positive battery and headlight connections can be made to a two-terminal composition strip on the end of the box opposite the pushbutton. Transistor V1 is mounted on a tie strip as illustrated. This transistor, its two resistors and the short lead to V2's base, can all be

soldered to the strip before installing it in the box. The capacitor can be securely fastened in place with a piece of scrap aluminum.

Installation is even quicker and easier than the wiring. Mount the box somewhere around the dash as dictated by convenience and appearance. The light lead goes to the light-switch terminal that connects to the headlights. This terminal can be quickly located with a voltmeter or even by close observation. The positive battery lead may be connected at a number of points, but there is also a positive terminal on the light switch, so this is probably the most convenient location.

All kinds of modifications of the physical layout are possible to fit specific mounting requirements or to suit the builder's preferences. If the unit is installed in a car with a positive ground, V2 must be mounted on a thin sheet of insulating material. Composition shoulder washers should be used with the mounting screws to isolate the transistor collector. Also all connections shown grounded in the schematic must be brought to one of the terminals on the insulated strip on the back of the box which becomes the negative connection. Positive connections are then made to the box. If the unit is to be used with a 6-volt electrical system, R3 may be eliminated and R1 reduced to 20,000 ohms. The delay with a 6-volt input will be slightly shorter. To increase the delay with either a 6- or 12-volt supply, use a larger-value electrolytic capacitor. Conversely, the delay can be shortened by using a smaller one. (Electrolytic capacitors are customarily made to wide tolerances and this factor, plus wide variations in their leakage characteristics, makes it difficult to predict the amount of delay accurately.) Thus, the builder may prefer to use a 2,000- μ f unit. If the delay is too long, the capacitor can be shunted with a resistor whose value will shorten the delay period to the desired amount. A potentiometer could be connected across the capacitor to provide an adjustable delay.

This project should be enjoyable to build and you'll be working with the assurance that your path through the dark of night will always be lighted. END

R1—39,000 ohms, 1/2 watt
 R2—100 ohms, 1/2 watt
 R3—10 ohms, 5 watts
 C—1,000 μ f, 15 volts, electrolytic
 RY—6 volts dc, dpdt (Advance PC/2C/6VD or equivalent)
 S1—dpst pushbutton
 V1—2N35
 V2—2N256
 Case, 3 x 4 x 5 (see text)
 Miscellaneous hardware

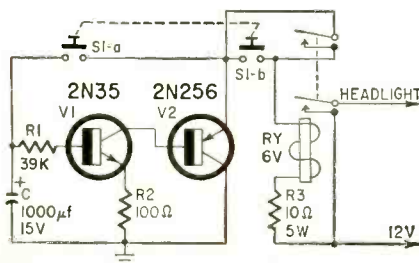

Circuit of simple instrument.

SHORT-WAVE FORECAST

Aug. 15–Sept. 15

By STANLEY LEINWOLL†

THE GENEVA RADIO REGULATIONS OF 1959 REQUIRE THE WORLD'S HIGH-FREQUENCY broadcasters to make four major schedule changes annually. These occur in March, May, September and November, and are intended to take seasonal changes in radio propagation conditions into account.

The schedule change for the fall 1961 season will take place on Sept. 3 and remain in effect until early November, when the winter schedule will go into effect. Daytime frequencies will be higher than during the summer months, and the lower frequencies will be used more during the evening and nighttime hours.

The tables show the optimum broadcast band, in megacycles, for propagation of programs between the locations shown during the time periods indicated.

To use the tables, the listener selects the one most suitable for his location, reads down the left side to the region he wishes to hear, then follows the line to the right until he is under the appropriate time. (Time is given at the top of each table in 2-hour intervals from midnight to 10 pm, in your local standard time.) The figure thus obtained is the short-wave band (in megacycles) nearest to the optimum working frequency.

For example, a listener in Chicago would use the Central USA table. He would be most likely to hear broadcasts from Western Europe in the 15-mc band at noon and the 11-mc band at 8 pm, Central Standard Time.

The tables are designed to serve primarily as a general guide, since day-to-day variations in receiving conditions can be large.

At certain hours, propagation over some of the paths given in the tables may be extremely difficult, or impossible. These are shown with an asterisk (*).

†Radio Frequency and Propagation Manager, RADIO FREE EUROPE

EASTERN US to:

	Mid	2	4	6	8	10	Noon	2	4	6	8	10
West Europe	9	7	9	11	15	17	17	17	15	15	11	9
East Europe	9*	7*	9*	11	15	15	15	15	15	11	11	9*
Northern Latin America	15	11	11	11	15	15	15	15	15	15	15	15
Southern Latin America	15	11	9	9	15	15	15	15	15	15	15	15
Near East	9	7*	9*	11	15	17	17	17	15	15	9	9
North Africa	9	7	9	9	15	17	17	17	17	15	11	11
South & Central Africa	11	9	9*	15	15	17	17	21	15	11	11	7
Far East	11	9	9*	9*	11	11	11*	11*	15	17	17	15
Australia & New Zealand	11	11	11	9	11	11*	11*	15	15	17	17	17

CENTRAL US to:

West Europe	9*	7*	9	11	15	15	15	17	15	11	11	9*
East Europe	9	9	9	11	15	15	15	15*	11*	11*	11	11
Northern Latin America	11	9	9	15	15	15	15	15	15	15	15	11
Southern Latin America	11	9	9	15	15	15	15	15	15	15	15	15
Near East	9*	9*	11*	11	17	17	17	17	15*	11*	11	11
North Africa	9	7	9*	11	15	15	15	17	15	15	11	9
South & Central Africa	11	11*	11	15	15	15	15	15	15	11	11	11
Far East	11	9	9*	9*	11	11*	11*	15	15	17	17	17
Australia & New Zealand	11	11	9	9	11	11*	11	15	15	17	17	17

WESTERN US to:

West Europe	9	9*	9*	11	15	15	15	17	15*	11*	11	11
East Europe	9	9*	9*	11	15	15	15	11*	11*	11*	11	11
Northern Latin America	9	9	9	11	15	15	15	15	15	15	15	11
Southern Latin America	11	9	9	15	15	15	15	15	15	15	15	15
North Africa	9	7*	9*	11	17	15	15	15	15	11	11	11
South & Central Africa	9	7*	9*	15	15	17	17	15	11	11	11	9
Far East	15	11	9	9	11	15	15	15	15	15	17	17
South Asia	9	9	9*	9	11	15	15	15*	15	17	17	17
Australia & New Zealand	15	15	11	9	9	11	15	15	17	21	17	17

Antenna Coil or RF Amplifier?

By C. H. CITRON

The test-adaptor "stage-jumping" method described here determines whether a snowy TV picture is being caused by a defective antenna coil or a defective rf stage. And you don't have to disconnect any coil leads.

Suppose the symptom is a weak, snowy picture. Pull the rf tube and plug in the proper socket adapter. If the picture improves (or at best is no worse), the trouble is in the rf stage. However, if the picture becomes even weaker and more snowy or goes out entirely, then the trouble is between the antenna and the rf grid—probably the antenna coil itself.



Seven-pin socket adapter plugged into TV tuner. Note single capacitor connected from grid to plate pins.

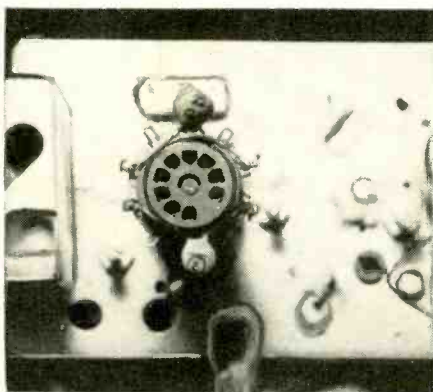

Nine-pin adapter calls for two capacitors across socket.

Two socket adapters, one seven- and one nine-pin, are all you need. The seven-pin unit is for pentode, tetrode and triode rf stages, the nine-pin for cascode types. Two capacitors are used with the nine-pin socket so it will act as a stage jumper regardless of which triode is used for the input stage. The capacitors are connected between pins 1 and 7 and between pins 2 and 6. Only one capacitor is used with the seven-pin adapter, between pins 1 and 5.

Capacitor value is not too critical; anything between 5 and 50 μf seems to work well.

One last point: on series-string sets, connect the proper heater pins with a length of hookup wire. END

GUIDE TO

LOW-POWER CB TRANSCEIVERS

Pick the unit that suits you best

By **ROBERT F. SCOTT**

TECHNICAL EDITOR

Hand-held Citizens-band transceivers are selling like ice in the Sahara desert. These units have innumerable uses in industry, business, agriculture, sporting activities and for personal use. All but two can be used license-free under Part 15 of the Rules and need not be licensed unless they are used in a net with licensed CB stations.

Selecting the low-power transceiver best suited for your needs can pose a number of problems. Even though many manufacturers are making these units, dealers and distributors rarely carry more than two or three models. Also, the technical information available on the units the dealer has is hardly adequate for an intelligent comparison. All have power inputs of about 100 milliwatts (except the 1-watt Ray Jefferson Spokesman 700), built-in telescopic antennas and crystal-controlled receivers

and are powered by inexpensive dry cells or rechargeable nickel-cadmium batteries.

From this point on, the transceivers divide into two classes. One group consists of relatively inexpensive units designed mainly for personal use and light business and industrial applications. The second group is generally more expensive and is aimed at industrial and specialized applications. These sets include many extras—lapel microphones, dual-conversion superhet receivers with automatic noise limiters and adjustable squelch, rechargeable batteries, jacks for mobile and other antennas not longer than 60 inches, and ground straps for optimum performance.

The chart lists pertinent characteristics and features. It will help you evaluate the many units available and select the equipment that is best suited to your needs. END

PERSONAL TYPE TRANSCEIVERS FOR CB AND LICENSE-FREE OPERATION

Manufacturer	Model No.	Certificate FCC Rules Part 15-19	RECEIVER					TRANSMITTER					Batt. type No. (NEDA)	Dimensions (H x W x D)	Ant. (In.)	Weight (oz.)	Accessories and features	
			Type	Xtal control	Ext. tuning	ANL	Squelch	Type	Pwr. input to final (mw)	Transistors	Diodes	Channel supplied						Batt. Volts
Allied Radio 100 N. Western Ave. Chicago 80, Ill.	Lincoln L-271D	15	Superhet	Yes	No	No	No	MOPA	90	9	1	7	9	15	6 5/8 x 2 1/2 x 1 1/2	57	24 without batt	1, 3, 8
Cadre Industries Endicott, N.-Y.	Cadre 100	Both	Superhet	Yes	No	No	No	Mod. Osc.	100	7	1	Your choice	12	Mercury TR-169	6-9/32 x 2-23/32 x 1-9/16	42	16 with batt	
Dorsal Electronics, Inc. 1412 Broadway New York, N. Y.	Walk 'n Talk RT-101	19 Note C	Superhet	Yes	No ¹⁷	No	No	MOPA	100	9	1	9	9	15	6 1/2 x 3 x 1 1/2	56	18 with batt	1, 3, 5, 8, 17, 18, 19
Electronic Instrument Corp. 3300 Northern Blvd. Long Island City 1, N. Y.	740	Both	Superhet	Yes	No	No	No	MOPA	100	9	1	16	9.6	Ni Cad	7 1/8 x 2 5/8 x 1 5/8	41	19 with batt	1, 7, 10
Electro-Voice Buchanan, Mich.	RME 4304	Both	Superhet	Yes	No	No	No	Mod. Osc.	90	7	1	3, 6, 11, 16	12	1810M	7 1/2 x 3 1/4 x 2	35	21 with batt	1, 7
Globe Div. GC Electronics Rockford Ill.	Pocket-phone	Both	Superhet	Yes	No	No	No	MOPA	100	9	1	7, 11, 15	9	N. Cad	6 1/4 x 2 3/8 x 1 5/8	less than 60	13 with batt	3, 7, 8, 16
	Silent phone	15	Dual Superhet	Yes	No	Yes	No	MOPA	100	11	0	7, 11, 15	9	Ni Cad		18	32 with batt	22
Heath Company Benton Harbor, Mich.	GW-30, DM-278	Both	Superregen	No	No	No	No	Mod. Osc.	100	4	0	Note A	9	1602	6 1/2 x 3 1/2 x 2 1/2	40	40 with batt	2
	GW-31	Both	Superregen	No	No	No	No	Mod. Osc.	100	4	0	Note A	9	1602	5 7/8 x 3 x 1 1/2	36	20 with batt	
International Communications, 1929 Wilshire Blvd. Santa Monica, Calif.	Herald Mark 1	Both	Superhet	Yes	No	No	No	MOPA	95	9	1	10	12	15	6 x 3-1/16 x 1 1/2	52	19 with batt	3
Ray-Jefferson, Inc. 4312 Main St. Philadelphia 27, Pa.	Spokesman 700	19 Note C	Superhet	Yes	No	Yes	No	Mod. Osc.	1 watt	8	2	6	13.5	14	3 x 4 x 12	50	36 with batt	2, 4, 5, 6
E. F. Johnson Co. Waseca, Minn.	Personal Messenger	Both	Superhet	Yes	No	Yes	Yes	MOPA	100	11	4	5, 7, 11, 18, 22	12	Ni Cad	8 x 3 1/2 x 1 3/4	35	24 with batt	1, 4, 6, 7
Kaar Engineering Corp. 2995 Middlefield Rd. Englewood, Calif.	Hand-Phone TR 330	Both	Superhet	Yes	No	Yes	Yes	Mod. Osc.	100	9	3	10, 13, 20	12	15, 15-A Ni Cad	10 x 2 7/8 x 2 1/2	41	24 without batt	1, 7, 8, 9
Keltner Electronics 1045 W. Hampden Englewood, Colo.	HT-1	Both	Superregen	No	No	No	No	Mod. Osc.	90	7	0	7	9	216	4 x 2 x 1 5/8	47	11 with batt	
Lafayette Radio Electronics 165-08 Liberty Ave. Jamaica 33, N. Y.	HE-29	Both	Superhet	Yes	No	No	No	MOPA	100	9	1	10	12	15	6 3/8 x 3 1/4 x 1 5/8	46	18	1, 8, 10
Morrow Radio Mfg. Co. 2794 Market Street Salem, Ore.	VP-100	Both	Superhet	Yes	No	No	Yes	MOPA	100	12	1	Your choice	9	1604	6 x 3 x 1 1/8	27	18 without batt	1, 6, 10, 11
Osborne Electronic Sales 13105 S. Crenshaw Blvd. Hawthorne, Calif.	Duo-Com 100	15	Dual Superhet	Yes	No	No	No	MOPA	100	10	3	10	12	910	1 5/8 x 4 x 7 3/4	60	20 with batt	1, 3, 6, 11, 12, 13, 14
	Duo-Com 100S	15	Dual Superhet	Yes	No	No	Yes	MOPA	100	11	4	10	12	910	1 5/8 x 4 x 7 3/4	60	20 with batt	1, 3, 6, 11, 12, 13, 14
Radio Corp. of America Special Products Dept. Telecommunication Center, Meadow Lands, Pa.	Personal-Com	Both	Superhet	Yes	No	No	No	Mod. Osc.	100	7	1	7	11	1810M	7 3/4 x 3 1/2 x 2 1/4	35	24 with batt	2, 8, 10
	Personal-Com 300	Both	Superhet	Yes	No	No	No	Mod. Osc.	100 ²²	9	2	7	11	RCA VS320	7 5/8 x 2 7/8 x 1 7/8	40	16 with batt	8, 10, 23, 24, 25
Radio Shack Corp. 730 Commonwealth Ave. Boston 17, Mass.	Realist-phone	Both	Superhet	Yes	No	No	No	MOPA	100	9	1	11	9	216	6 x 2 3/4 x 1 1/2	36	12 with batt	1, 8, 10, 16
Raytheon Co. 411 Providence Turnpike Westwood, Mass.	Rayette Super	Both	Superhet	Yes	No	Yes	Yes	MOPA	100	10	1	11	9	Ni Cad	5 1/4 x 2 3/4 x 1-3/16	46	15 with batt	1, 7, 8, 9
	Rayette Regal	Both	Superregen	No	No	No	Yes	MOPA	100	5	0	11	9	Ni Cad	5 1/4 x 2 3/4 x 1-3/16	46	14 with batt	1, 7, 8, 9
Ross Laboratories, Inc. 124 Lakeside Ave. Seattle 2, Wash.	Pocket Talkie	Both	Superregen	No	No	No	No	MOPA	50	5	0	9	9	1604	5 1/8 x 2 1/4 x 1 1/2	42	9 with batt	1
	Pocket Phone	Both	Superhet	Yes	No	Yes	Yes	MOPA	100	12	2	9	6	15	6 1/2 x 3 1/8 x 1 1/2	42	23 with batt	1, 15
Seiscor Communications Section Box 1590, Tulsa, Okla.	Telepath PM-A	15	Superhet	Yes	No	No	No	MOPA	100	9	1	11, 18	9	1600	5 3/4 x 3 x 1 3/8	42	12 with batt	1, 8, 10
Sonar Radio Corp. 3050 W. 21st St. Brooklyn 24, N. Y.	Sonarcom CBP	Both	Superhet	Yes	Yes	No	No	Mod. Osc.	100	8	1	11	12	1403	3 x 3 1/2 x 8 1/4	53	40 with batt	3
Webcor, Inc. 5610 W. Bloomingdale Ave. Chicago 29, Ill.	Micro 350	Both	Superhet	Yes	No	Yes	No	MOPA	100	9	2	14	9	1604	5 3/8 x 3 3/8 x 1 3/8	44	13 without batt	2, 16
Wightman Electronics, Inc. 9 West St. Easton, Md.	WE Phone	Both See note B	Superhet	Yes	No	Yes	No	MOPA	100 ¹⁰	10	1	22	12	14	9 3/4 x 3 1/2 x 2 3/4	48	40 with batt	2, 9, 21

- 1—Phone jack
- 2—Shoulder strap
- 3—Leather case and strap
- 4—12-volt auto battery adapter
- 5—117-volt ac adapter
- 6—Jack for external antenna
- 7—Battery charger
- 8—Earpiece
- 9—Hand strap
- 10—Leather case
- 11—Lapel microphone
- 12—Headset

- 13—External mobile and fixed antenna (less than 60 in.)
- 14—Ceramic filter if
- 15—Jack for external microphone
- 16—When used with radio paging system the whip need not be extended. Extend to full length for longer range reception or to transmit.
- 17—Includes AM broadcast receiver with 6-transistor circuitry
- 18—Leather antenna case
- 19—Leather earpiece case
- 20—500-mw input under Part 10 (See Note B)
- 21—Earphone, flexible antenna and throat mike available on 30-50-mc version.

- 22—Transceiver built into headgear for use in high-noise areas such as airports, factories and at sporting events. Fits under size 6 1/2 to 8 1/2 hard hat.
- 23—May be factory-modified with plug-in module to increase transmitter power input to 350 mw. 350-mw unit has MOPA transmitter, 12 transistors and weighs 17 1/2 oz with NiCad battery.
- 24—Center-loaded 19 1/2-inch antenna available.
- 25—Battery chargers available for 1 and 2 NiCad batteries.
- A—As ordered or random
- B—Also licensed under Part 10 (Public Safety Radio Services) for use by police, fire and emergency communications in the 30-50-mc band.
- C—Approved for licensed CB operation only.

VERTICAL FOLDOVER PROBLEMS

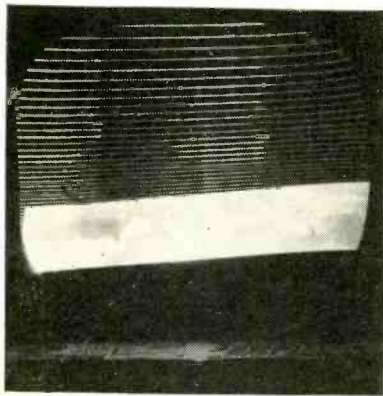

In this severe case of foldover wedge of picture near bottom of screen is upside down.

Yes, vertical foldover has 4 major causes. Do you know what they are and how they can be located?

By WAYNE LEMONS

VERTICAL foldover is caused by a defect in the vertical output stage almost every time! This simple but all-important fact seems to elude us, unhappily right when we need it most—when we have a vertical foldover problem. Oscillator defects causing foldover are scarce as hen's teeth. What, then, are the causes and cures for foldover?

Foldover is always caused by one or more of four conditions: improper bias, low plate voltage, inadequate bypassing or mismatch. This is true regardless of the circuit.

First, look at a conventional (if such a thing exists) output stage as used in many models of Admiral receivers 5 or

6 years ago. The output stage uses a 6S4 triode. Plate voltage comes from the boost circuit through a 1,200-ohm resistor, bypassed by a 20- μ f decoupling capacitor in series with 100- μ f cathode bypass. The 6S4 bias is adjusted by a 3,000-ohm vertical linearity control in the cathode circuit.

In this circuit (Fig. 1) improper bias can be caused by a defective tube, leaky coupling capacitor (C1) or defective cathode resistors (R2 and R3). Low plate voltage is due to a weak low-voltage rectifier or damper tube, changed-value decoupling resistor (R1) or leaky decoupling capacitor (C2). Inadequate bypassing is the result of an open decoupling capacitor (C2) or an open cathode bypass capacitor (C3). Mismatch is caused either by a defective transformer or yoke. (Generally you should be suspicious of these only if either has been replaced.)

Fig. 2 is a pentode vertical output stage. Only 120 volts is used on the plate of the 12W6 in this Arvin circuit. A negative feedback circuit (R4, R5, C4 and C5) from the plate to the grid tends to improve overall linearity. Trouble spots are identical to the circuit of Fig. 1 except for the feedback network. Here, C5 may short and burn R5, reducing the plate voltage and causing foldover.

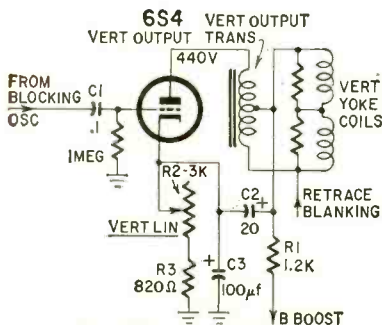

Fig. 1—Typical triode vertical output stage.

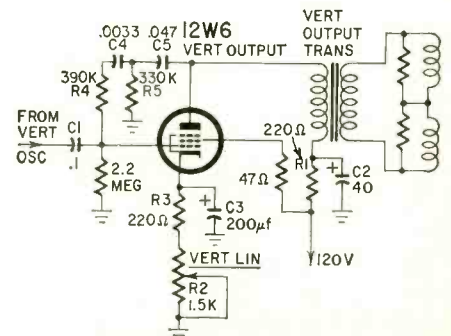

Fig. 2—Low-voltage pentode vertical output stage.

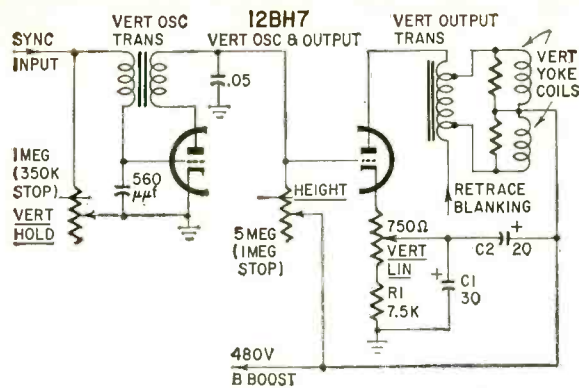

Fig. 3 — Direct-coupled vertical oscillator output circuit.

The most common defect in this circuit (in addition to electrolytic capacitors C1 and C2) is the 7,500-ohm resistor (R1, sometimes 8,200 ohms). When this resistor changes value or opens, a variety of symptoms may occur, depending upon the condition of the 12BH7 and just how much the resistor changes value. The most common symptoms are inadequate height and severe foldover. In every case, of course, the vertical deflection is seriously affected or even nonexistent.

Fig. 4 is a G-E circuit. It is the output feedback or oscillator-output multivibrator circuit used almost universally in today's TV sets, in a multitude of forms. It is the hardest type of vertical circuit to troubleshoot; so many of its functions interact. But like all the others, foldover is almost always caused by a defect in the output stage. This circuit, like many of its type, obtains a negative voltage from the grid of the input stage for biasing the output stage. The voltage is tapped off R1 and fed through R2 and R3 to the grid

of the 12R5. C1 is a decoupling capacitor to prevent pulse voltages in the two parts of the circuit from interacting. One of the common causes for foldover is leakage in C1. Often the leakage is much more severe after the set has been on for a while. This produces what might be called creeping foldover, and it's difficult to troubleshoot. It's best to replace both C1 and C2 when you encounter this condition; this nearly always cures the trouble.

Summary

Remember, even though circuits

differ, foldover is nearly always caused by a defect in the output stage. Remember, too, the four primary causes of vertical foldover in any circuit:

- ▶ Improper bias.
- ▶ Low plate voltage.
- ▶ Inadequate bypassing.
- ▶ Mismatch.

Biasing and voltage defects can be detected with any good meter, preferably a vtvm. Inadequate bypassing can be detected by shunting a suspected capacitor with a good one or by measuring the peak-to-peak voltage across it with a scope. Mismatch is best determined by replacing the suspected part temporarily with the correct output transformer or yoke. Or you might use one of the new "universal" vertical output transformers, selecting the proper tap to match the yoke used.

Whatever the problem causing foldover at the bottom of the picture, you'll find it lurking somewhere in the output stage! END

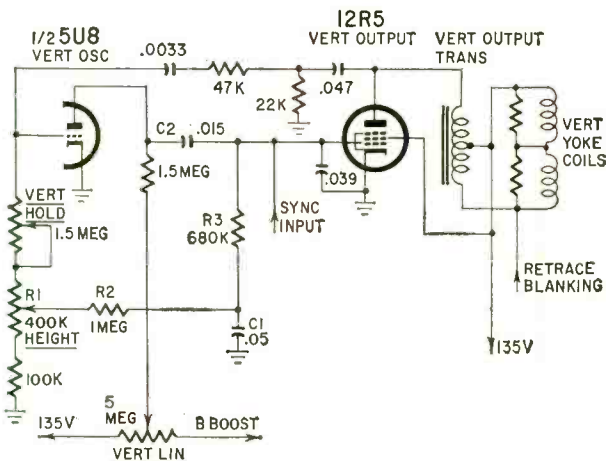

Fig. 4—Oscillator output multivibrator. Height and linearity controls may seem to be labeled incorrectly, but this is the way the set manufacturer (G-E) does it.

Watchdog Television

lets tenants in new apartment houses see who's downstairs before letting them through the main door. Closed-circuit TV camera and monitor are mounted at entrances, and each apartment has its own receiver. The system is made by Bell Television Inc. and has been installed in a new apartment house in Brooklyn, N.Y.



THINKING

about industrial servicing?

TEST EQUIPMENT FOR INDUSTRY

How it's like radio-TV servicing gear—and how it differs. Some new pieces the radio/TV man will have to understand and use in industrial work. A comprehensive article by old timer Matt Mandl. Another good reason for buying next month's issue—

on sale September 14.



TALK ON A LIGHT BEAM



Put light to work and forge a visible communications link

By R. E. PITTET JR.

Here is a delightful little gadget for talking via light waves. Uncomplicated, it needs few parts and can be easily assembled. As a source of fun and amusement it will be hard to beat.

The transmitter combines a light source, a modulating membrane with a reflector mounted on it and a simple optical focusing system. The receiver uses a phototube and lens to receive the light beam and detect the modulation envelope, plus an audio amplifier to boost the signal to listening level (Fig. 1).

To build the transmitter, first collect three pieces of cardboard tubing each about 12 inches long. The two larger pieces should be about 1½ and 1¼ inches, respectively, in diameter so that the smaller one will telescope snugly into the larger one. The third piece of tubing should be about ⅝ inch in diameter so it can accommodate a flashlight bulb. The diameters of the two larger tubes are not too important although the largest should be big enough to talk into comfortably.

The Edmund Scientific Co., Barrington, N. J., sells a set of telescoping cardboard tubes that is just right for this project with lots left over for future optical experiments. The stock number is 80,043 and the price \$4.50. I used these tubes to build my unit.

Next, get a small piece (2 x 2 inches) of Saran Wrap or other very thin, transparent wrapping plastic and a small piece (½ x ½ inch) of aluminum foil. Some fast-drying cement, a few

odd pieces of cardboard, hand tools, scissors, ruler and some flat black paint complete almost everything needed except the lenses. They can be taken out of a child's toy binocular or from Edmund Scientific Co.'s beginner's lens kit, stock No. 2 (\$1). There are 10 different lenses in the kit. One is 30 mm in diameter and has a 153-mm focal length. (This is equivalent to about 1-3/16 inches in diameter and a 6-inch focal length.) The focal length is important and helps determine the length of the two tubes. I used the 30-mm x 153-mm lens. Note in Fig. 2 how dimension line A plus dimension line B equals a little more than the 6-inch focal length, thereby determining the length of tube II.

Cut the tubes to size with a hacksaw. Follow the dimensions in Fig. 3 and paint the insides with flat black paint. The drilled hole is larger in tube I so the light beam can be manually centered on the aluminum reflector mounted in the center of the plastic membrane after the unit is assembled. Cement the small piece of aluminum foil to the center of the plastic membrane with the shiny side up. Then cement the membrane over the angled cut on tube II so the aluminum is centered and its shiny side faces down. Solder two wires to a flashlight bulb and mount it in tube III, but don't cement it in place yet. Shape tube III with a razor blade to make it fit snugly over the hole in tube I and cement into place. After that cement the lens to the front end of tube II.

Next, assemble the unit and line it up optically by connecting the bulb to

a battery, sighting through the front end and adjusting tube II into tube I until the light from the bulb appears the brightest on the aluminum-foil reflector. Then cement tube II in place. Next, point the light beam at a light-colored wall in a dark room. The range should be about 10 feet. Slide the bulb in and out of tube III until the projected light beam is sharply focused on the wall, then cement the bulb in place. A series of vent holes are recommended in tube I over the membrane which is inside and mounted on tube II. These holes will allow your breath to escape as you talk and also allow the sound waves to travel down the tube, strike the membrane and dissipate themselves.

If possible, get a small ¼ x ¼-inch square of very thin glass to use in

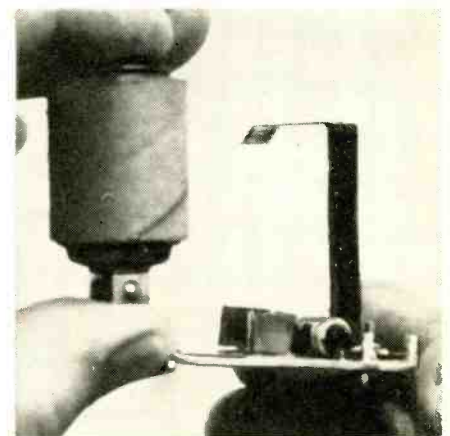

Close-up look at receiver. Phototube unit is left.

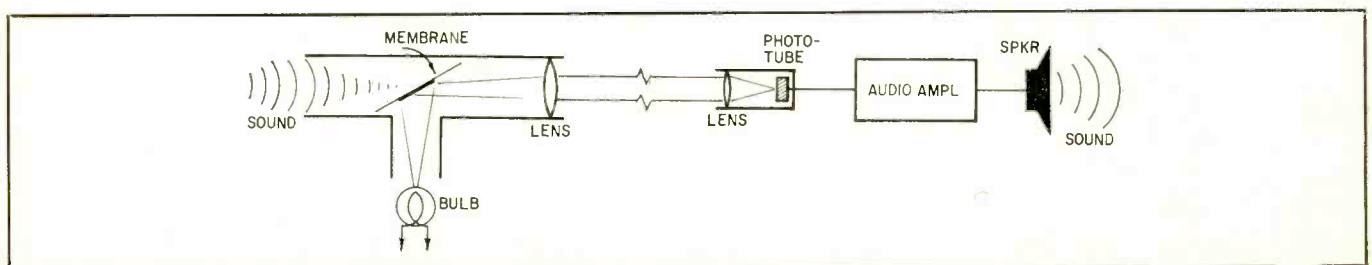

Fig. 1—Light communications arrangement.

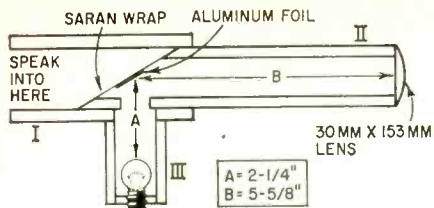

Fig. 2—Transmitter setup.

place of aluminum foil for your reflector. It will improve the operation of the device tremendously. A cover glass for microscope slides is ideal because of its light weight. Coat the back with aluminum paint.

As a final touch, paint the outside of the transmitter a flat black.

Receiver construction

The receiver is reasonably simple and only requires a phototube, one resistor, one capacitor, a battery, some miscellaneous mounting hardware and cardboard tubing. The electronic circuit was built according to Fig. 4 and fed into the crystal-mike input of a tape recorder, using it as a public-address set. The "phono input" on a radio or TV set should do just as well.

As shown in Fig. 5, fit the 921 phototube into a cardboard tube that has a small window cut into it. Over this window attach another tube containing a focusing lens. Mount this on a piece of fiberboard and connect it to the electronic circuitry. The whole receiver assembly should be mounted inside a metal container. Connect the container to the shield of a length of coax which connects the unit to an audio amplifier. An empty soup can with one end cut



Aluminum-foil diaphragm is cemented to center of Saran wrap.

out provided the necessary shielding.

Now try it out

Check the transmitter first. Point its lighted end toward a light surface in a darkened room and talk into it. You should notice a decided variation in the focus of the light beam as you speak. Next hook up the phototube receiver and plug it into an amplifier. Point it toward an ac light or table lamp. You should hear a heavy 120-cycle hum. This will cease as you cover the phototube with your hand. Now you are ready to start.

If possible, mount the transmitter on a tripod and align it with the receiver. Talk into the rear of the transmitter and your voice will come out of the speaker of the amplifier with a surprising amount of volume. Keep moving the transmitter away from the receiver until you lose contact entirely. This maximum distance depends completely on the accuracy of the alignment of the

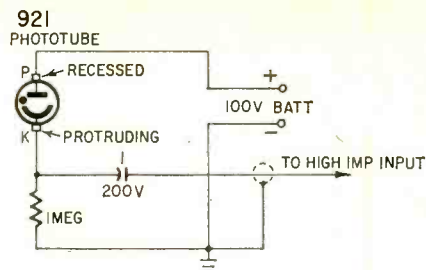

Fig. 4—Receiver circuit.

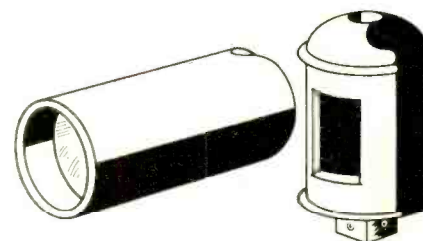
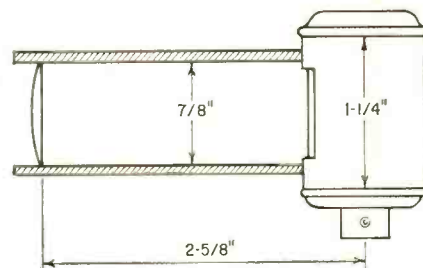

Fig. 5—Physical setup for receiver.

optical system and on the brightness of the bulb in the transmitter. END

- Set of cardboard tubes (Edmund Scientific Co., Barrington, N. J. No. 80,043 or equivalent)
- Flashlight bulb, No. 42
- Set of lenses (Edmund Scientific Co. No. 2 or equivalent)
- Type 921 phototube
- 1- μ f, 200-volt paper capacitor
- 1-megohm, 1/2-watt resistor
- Battery, 100 volts
- Miscellaneous hardware, wire, cement, black paint, aluminum foil, wrapping plastic, etc.

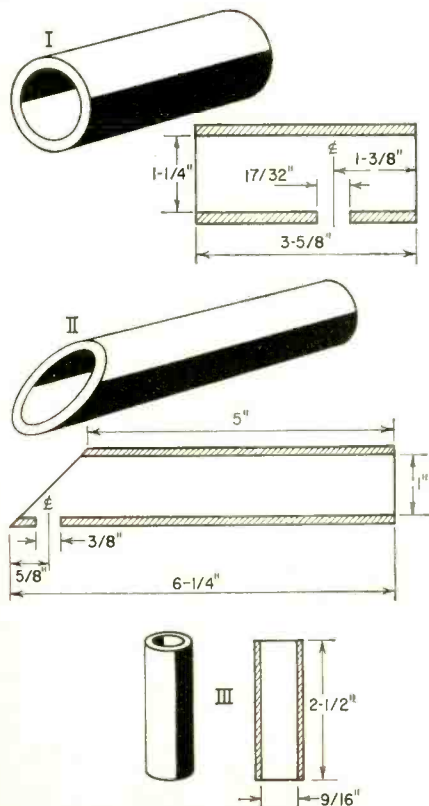

Fig. 3—These three tubes are used to build the transmitter.

Autodyne Converter Troubles

Many technicians will recognize the popular autodyne converter circuit (as shown, or with certain variations) incorporating a 12AU6 pentode, combined local oscillator, mixer, and if amplifier. The following circuit defect is not so apparent, however.

Symptom: Local oscillator refuses to oscillate.

Cause: Fixed-trimmer capacitor in the if transformer base—open!

Why it happened:

Random circuit noise is amplified by the 12AU6 and this alternating current is returned by the resonant if circuit to the grounded-grid configuration imposed at the cathode, inductively coupled to the "Meissner tank" which is tuned to a desired oscillator frequency. Properly phased, this feedback is regenerative and when strong enough will sustain oscillation at the correct difference frequency between an incoming signal and that of the oscillator.

If the if L-C network is defective, however, this regenerative feedback voltage is not high enough to sustain

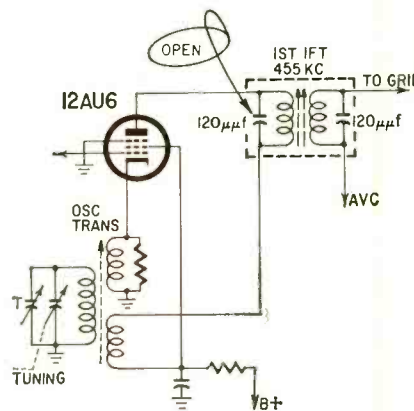

oscillation in the cathode circuit and the receiver stops working. The circuit defect is doubly evasive since the if transformer apparently resonates when a 455-kc rf signal is applied to the 12AU6 signal grid, because the coil slug appears to be reaching a peak as it passes through the coil center!—George D. Philpott

ALL ABOUT TAPE RECORDERS

PART V—BRAKES AND PRESSURE PADS

By JACK DARR

THIS IS THE CONCLUDING SECTION OF this series of articles on tape recorder repairs. It covers two very important sections of the tape recorder, brakes and pressure pads. If the brakes don't work properly, the tape may break or spill out and tangle. If pressure pads are off, the recorder may not play or may distort the sound of the recorded material.

The brakes are just as important as those on a car and have the same effect. If they get too loose, the result is a spill. Of course, the spill is only tape and not people, but it's annoying.

Recorder brakes have a dual function. While the machine is playing or recording, the brake on the feed reel drags just enough to keep the tape at the right tension. When rewinding (or running fast

forward), the brakes must stop the reels as soon as possible. Like car brakes, they must take hold smoothly. If they grab on a full stop, the tape will break.

They're actually simple. The brake is just a small felt pad which contacts a smooth drum under the reel hub (Fig. 1). Special cams on the actuating arms give the reel brakes two positions—one for recording and playback in which the brake pad is held lightly against the surface of the drum to provide just the right amount of drag, and the other, a fairly heavy tension, applied when the mechanism is set to the stop position. This tension is regulated by a spring. Actually, the spring tension must be set on the full-stop position, as this is the only time that its full effect is felt. During play, a stop on the brake arm prevents the full force of the spring from being applied.

There are two ways to adjust the brakes. Using the first one, set the brake arm stop for play position. This is usually an adjustable lance. Alternately, you can adjust the spring tension. Watch out for too heavy springs here. They make brakes grab. Service data for each machine usually give the proper procedure for setting them.

There is a very useful rule of thumb for brake adjustments: Run the machine at full speed, then stop it. If the tape stops smoothly, without jerking or

running free allowing a loop of slack to form in the tape between reels, it is OK. If slack appears between reels when stopping, the feed-reel brake isn't taking hold quickly enough. This brake should hold slightly harder and actually furnish the major part of the braking force. Let me hit that one again; it's important. **The reel from which the tape is being unwound should furnish the braking, or most of it, to keep the tape taut after a stop.** Check brake tension by trying to turn the empty reels with the machine stopped. Ideally the spindles should move about twice as hard in the direction in which they unwind as that in which they wind.

Pressure pads

Similar to brakes, although they have

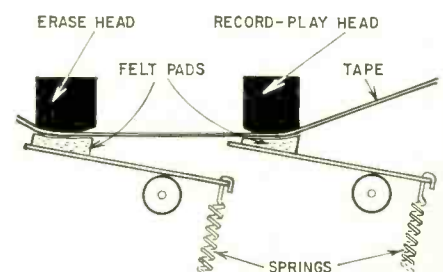

Fig. 2—Pressure pads hold the tape closely against recording and erase heads.

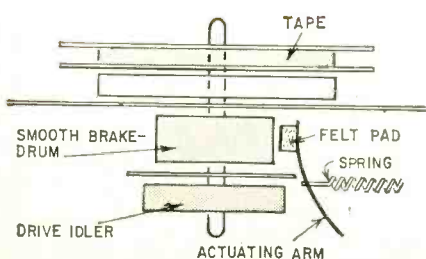

Fig. 1—Typical position of reel brake.

a completely different function, are the pressure pads (Fig. 2). They are small felt pads that hold the tape snugly against the record and erase heads. During rewind or fast forward, the pressure pads are released to let the tape run past the heads without making contact. This reduces head wear, and reduces the familiar "Donald Duck" gabble heard while running tape backward through a recorder.

The pressure-pad actuating arms are usually brass or some nonmagnetic material as they work very close to the recording heads. They are moved into place by another arm and spring arrangement usually actuated by the familiar cam or lever on the pushbuttons, or sometimes by a heavy solenoid. The pressure applied to the heads by the pads is usually determined by the spring tension, although some rare machines have direct-drive types, which must be adjusted by bending a tab on the actuating arm.

If the pads press too tightly on the head, the tape is slowed up and wow may result. Too little pressure will cause "dull" recordings.

Clutches and tape tension

The amount of tape tension is regulated by several things, mostly the combined tension exerted by the feed-reel brake drag and the takeup-reel drive. Of course, as we said before, the capstan determines the tape speed. But it can be affected by excessive drag or binding in any part of the tape-transport mechanism—too much pressure on the pressure pads, for example.

At this point, we run into a feature of all machines which deserves discussion—controlled slippage. All tape recorder drives must have a certain amount of slip. When we put a full reel of tape on the feed reel and an empty reel on the takeup, the two hubs must turn at different speeds. To do this, we arrange the drives on each so the driving mechanisms can slip. When separate reeling motors are used, slip is electrical. In idler or belt-driven machines, some type of clutch will be the rule. Some fabric belts are set to have enough slack to allow the necessary slippage.

Some makers use a felt-faced clutch between the reel spindle and the drive (Fig. 3). Here, the reel hub floats completely free from the drive. It rests on a felt-faced disc, which in turn rests on a smooth metal disc, driven by the idler. Therefore, if the tape jams or suddenly gets too tight, there is enough slippage to keep the tape from breaking.

If these felt-faced clutches get oil, grease or dirt on them, they may slip too much or bind unevenly. If this kind of trouble shows up, replace the clutch. If no spare is available, as a stop-gap, wash them with a grease solvent and dry carefully.

Fig. 3 also shows a rather common method of supporting reel spindles and other rotating shafts. The shaft is ground to a point which rests in a cup on the end of an adjusting bolt. This arrangement is often used in setups where the amount of end play on a

given shaft must be adjusted. To set up an arrangement like this correctly, loosen the lock-nut, run the bolt up until the shaft begins to bind, then loosen the bolt about a quarter turn, and retighten the lock-nut.

Wow and flutter

One of the worst problems in tape recorders is caused by drive troubles. It is variations in the speed of the tape as it passes the recording head. Slippage anywhere in the capstan drive mechanism will make the tape run below its rated speed, and everything will sound low-pitched.

A periodic variation in speed is called wow or flutter, for reasons which will be immediately apparent once you hear it.

This trouble is always caused by a drive defect. Most of it originates in dirty, greasy or wornout drive idlers. Excessive drag on feed-reel brakes or takeup clutches can also cause it. Grease spots on rubber idlers can cause wow. The slick surface of the drive shaft spins momentarily, causing a sudden

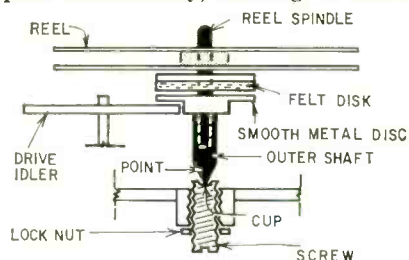
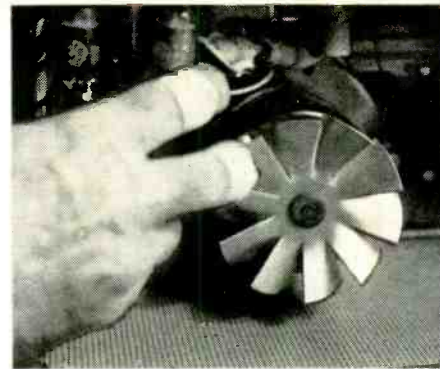

Fig. 3—Felt-faced clutch keeps enough driving tension on reel, but still allows for necessary slippage.

variation in the speed of the mechanism.

The best check for this is to play a tape with a continuous tone, somewhere around 3,000 cycles. Any tendency toward wow will immediately be heard. Make certain that you become familiar with the way a 3,000-cycle tone should sound on a home recorder that is operating properly before using this test. On no home recorder will the tone sound as steady as the original.

First step when trying to get rid of



Remove that fan before doing any servicing. It can gash fingers badly.

wow is a thorough cleaning of all rubber drives. Wash them with alcohol or xylene, using a clean rag or cotton swab or new pipe cleaner to apply it. Keep your fingers off the rubber surfaces or the metal drives afterward. Even the cleanest human skin carries enough oil to cause trouble.

If the rubber drive is fairly old, its contact surface may develop a glaze from constant friction against the smooth metal drive shafts. These should be replaced. If replacements are not available, the idler can be resurfaced with fine sandpaper or handier still, an emery board sold in the cosmetic department of drug stores. When resurfacing, remove all rubber dust from the mechanism and cover bearings to protect them.

Dents in the rubber drive of an idler also cause wow. If the machine is stored or left idle for long periods in hot weather, the drive shaft resting against the soft rubber drive will cause a dent (Fig. 4). If the dent isn't too deep, it can sometimes be removed by running the machine for a long time to knead the drive idler enough to remove the dent. Don't try to sand it off. This is useless. The voice of experience!

Another obscure cause of wow is a bent or off-center capstan. This is the result of dropping the machine or other abuse. The degree of wobble which can be tolerated in the capstan is very small and may be undetectable by the naked

Inside a tape recorder. Note the belt drive.

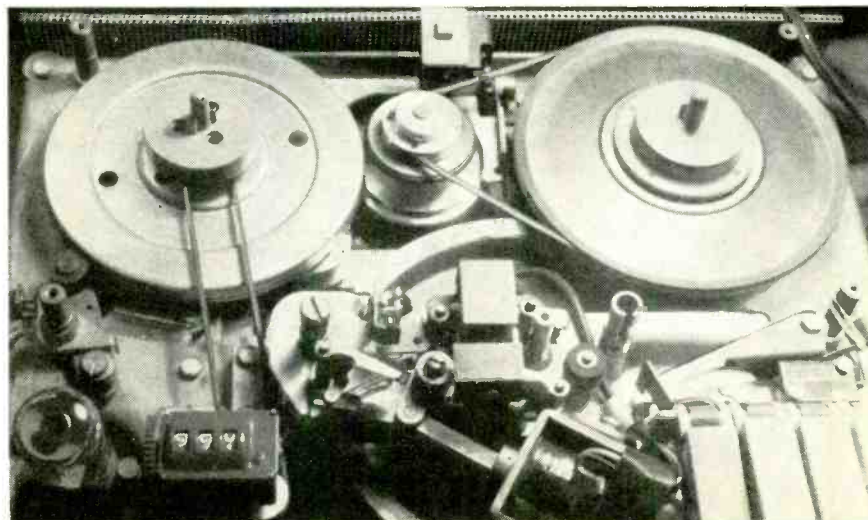

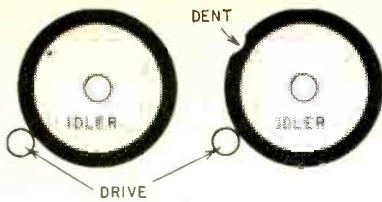

Fig. 4—Dents in idlers are often caused by a drive being left engaged when not in use. The dents cause wow.

eye. Run the machine and hold a sharp-pointed object like a pencil very close to the capstan, watching it through a magnifying glass or jeweler's loupe. If necessary, clamp the pencil or pointer to the top of the machine to get it steady enough. Wobble can be detected in this way. If the capstan is badly off center, the pencil will touch only one side, leaving a mark which can be seen when the machine is stopped.

Incidentally, a bent spindle in one of the tape reels can cause the same symptom, so watch out for this, too. Sometimes, you can spot this quickly by observing the reel as it turns. If the spindle is off center, the reel will wobble up and down. However, try several different reels just to be sure. A plastic reel will often wobble naturally from being stored in hot places.

Checking tape speed

There are several ways to check tape speed. The quickest is with a stroboscope. Several firms make this instrument. One very small one is placed on top of the capstan idler. Another is a strobe disc, about the same general dimensions as the familiar strobe disc used to check record changer speeds.

Mounted on a handle, it is held against the tape while it is running. A special endless-loop strobe tape is also available. It is placed on the machine and illuminated by a neon or fluorescent light, just like the others.

One word of caution here. **Never attempt to check tape speed by placing a strobe disc on the reels themselves.** As we explained before, the reel speed is always proportional to the amount of tape left on it, and only if the amount of tape on each reel was exactly equal would this be a valid measurement. So no matter what method you use, be sure to apply the measuring device directly to the tape itself, preferably at a point where it passes over the capstan or one of the tape guides.

General service hints

The driving motors of these machines normally have small metal fans to keep them cool. Stamped out of sheet metal, they have very sharp corners. So, to avoid being called Stubby for the rest of your life, remove the fan before attempting any service work underneath the machine.

Also watch out for tricks in design. Now and then, you'll run into some very unusual things. I recently ran

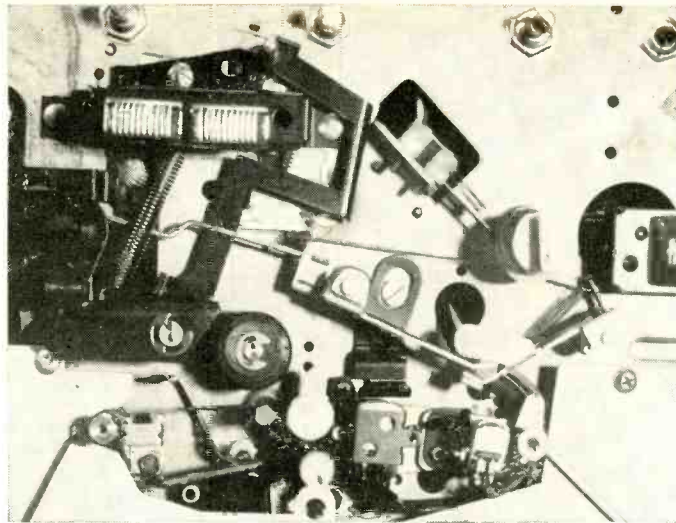

Part of the mechanism of a 4-track stereo tape recorder.

into trouble while repairing a Bell & Howell 785 recorder. The complaint was no recordings. A quick check with a scope disclosed that there was no bias. Tracing the bias oscillator circuit, I found the plate supply running through what appeared to be a standard dpdt slide switch. Ohmmeter tests showed the switch bad.

A frantic examination of 47 switches finally turned up one that was an exact duplicate. Removing the old switch, I saw that one of the little metal contacts in the fiber disc was completely gone. No wonder it wouldn't work.

The switch was replaced, all the wires soldered very carefully back to where they came from. (Three green wires went to the top right contact, two yellow wires to the top left.) (By the way, these were voice-coil wires, and the schematic we had on this machine showed this as a muting switch, with the voice-coil leads broken by it.) The red B-plus leads went to the bottom terminals.

So I happily turned the machine on, and punched the record button. Scope check showed lots of bias now. But only one small defect still remained. Before, the machine had played back beautifully, but wouldn't record. Now,

it wouldn't do anything! No playback, no record, no nothing!

Hmmm. Go back, check the wires on the switch. Even according to the service information, they were OK. To make a *very* long, painful story a lot shorter, about 10 hours of detailed checking later, I finally removed the switch and took off the top contacts, leaving the red wires (to the bias oscillator). The machine played perfectly.

After I had cooled down somewhat, I reached the obvious conclusion. This was not a standard dpdt switch. The missing contact was not accidentally lost, but had been removed deliberately. The two top contacts on the switch were merely being used as tie points to hold the voice-coil leads. When I installed a dpdt switch, the voice coil was firmly shorted out whenever I switched the machine to either play or record.

Watch out for such tricks. Fortunately, they are rare.

Well, we've come to the end of the road. The tape recorder has been covered from top to bottom. I wish there were more service hints that I could offer, but you'll just have to learn the rest by experience. **END**

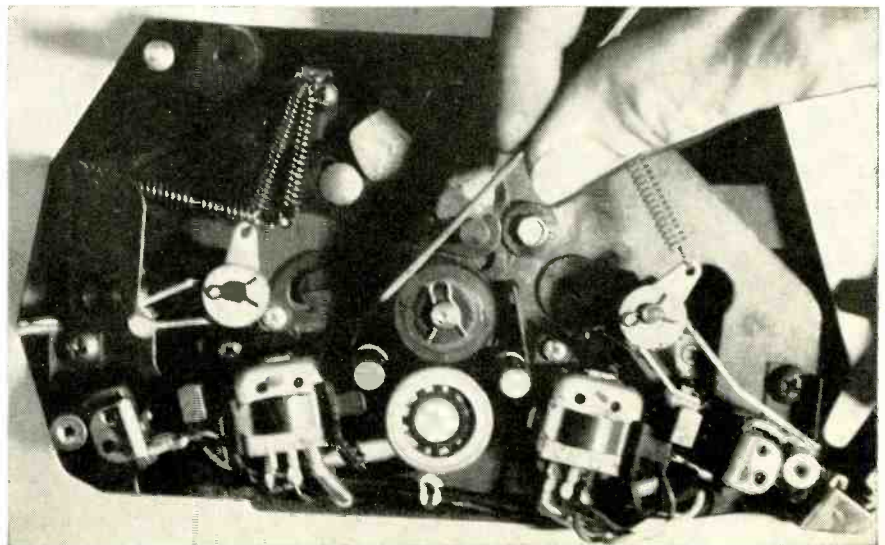

Sanding glaze off rubber drive-idlers with an emery board.

Practical alignment of Hi-Fi FM TUNERS



The Fisher FM-100 tuner.

*Forget about that sweep generator and oscilloscope;
use your vtvm and signal generator*

Every service technician "knows" that the only "proper" way to align an FM tuner is with a sweep generator and oscilloscope. Yet, the majority of shops use a signal generator—or the signal of an FM station—and a vtvm, or just the tuning meter on the tuner. This article describes a simple but accurate alignment method that eliminates the need for the scope and sweep generator, yet results in accurate alignment. For those who insist on the ultimate—an absolute minimum of distortion—a second method, using an FM generator and a distortion meter, will be described next month.

As nearly as I can determine, all current tuners—and most of those made after 1955—use loaded transformers and have a single-peaked response curve. Overcoupled transformers with their double-humped curves are rare. A tuner with this single-peaked curve can be aligned at least as accurately by peaking with a signal generator (or station signal) and vtvm or tuning meter as with the visual method. And, the signal-generator-plus-vtvm method is not only far simpler to use but requires less expensive instruments and a relatively simple alignment procedure and setup.

Let me make clear that this does not mean that visual alignment should not be used. It has its share of advantages as well as disadvantages. On the other hand, don't apologize if you use the generator-plus-vtvm approach. Furthermore, if you have been afraid to undertake FM tuner alignment because you did not have the right equipment for visual alignment, you can put your fears at rest. Simpler methods can do a good job.

Is realignment necessary?

Most tuner alignment instructions assume that a complete realignment job is necessary. They detail a rather complicated procedure which takes considerable time and equipment. Actually

the need for realigning good FM tuners is greatly exaggerated. A really significant departure from the design frequency and response curve is likely to occur only when there is a breakdown in one of the circuit components. The small drift due to aging is made pretty harmless by the wide-band detectors found in most modern tuners. So if a tuner has not been touched since leaving the factory, it is likely that the if and detector stages are peaked well enough to provide high performance even after 2 or 3 years of use.

Misalignment is far more likely in the rf and converter stages. You will probably get greater improvement from realigning these.

Alignment procedure

Most of the time the following technique will be both adequate and efficient: Always start by letting the tuner warm up at least a half hour, to stabilize its operation. If you tune in a station and connect the tuner to an amplifier and speaker, you can, while doing another job, check for drift and effectiveness of the automatic frequency control by listening with one ear.

When the tuner is warmed up, check the sensitivity. The most elegant and objective way to do this is with an FM generator with calibrated voltage output like the Measurements 78-FM or 210-A. Unfortunately, these instruments are rather expensive and only a shop that handles a great deal of tuner work is justified buying one. A simple alternative is available to everyone. In every location there are weak or marginal stations that can be used to estimate tuner sensitivity. If you are familiar with the stations receivable in your location with your antenna, you can get an excellent estimate of a tuner's sensitivity in one or two sweeps of the band. Note the deflection on the tuning indicator or the degree of noise suppression on the weakest stations.

Check the tubes, and replace any that

do not meet normal standards. Check sensitivity again to see if there has been a significant improvement. I have found that a change in tubes makes the greatest single improvement in performance.

Peaking the front end

While checking sensitivity, watch to see how the tuner is tracking in relation to the dial calibrations. Do this, of course, with the afc disabled. FM stations whose frequencies are known to you are by far the best standards for this purpose. The chances are that there will be some departure from accurate tracking in any tuner that has been in use a year or more. If it is serious—a megacycle or more—you have good grounds for suspecting that the tuner has been misaligned and you can at this point do a complete realignment job, using the procedure recommended in the service manual.

In a great majority of cases, you will find only a small departure, which will indicate that the if amplifier is still peaked pretty close to its original frequency. Tracking can be restored by adjusting the oscillator trimmer at the high end of the band. The signal of an FM station in the region between 105 and 108 mc is again best for this purpose. The low end can be tracked by squeezing coils. Work back and forth between the low and high end.

The next step is to peak the rf and converter stages with their trimmers. You can use a relatively weak station anywhere above 100 mc as the signal source, and the tuning meter on the tuner as indicator. Or you can peak for maximum noise at a point around 105 mc where there is no signal and only receiver noise is audible. Although it is usual to peak at the high-frequency end, in fringe areas it may be preferable to peak the front end on the signal of the weakest station. This provides maximum gain at the most needed point. Some sets have interaction be-

tween oscillator and mixer trimmers (pulling). This is one job where a sweep generator and scope are lovely.

Checking if response

You can now get a pretty good idea of the shape and symmetry of the if response curve, still using the signal of an FM station and the tuning meter on the tuner. Carefully tune in a station of moderate strength—one that gives a good indication on the meter but does not saturate it. Detune the station by about 100 kc on each side of resonance. Considering the vagueness of modern dial markings, this will involve some educated guessing on your part.

With a station of moderate strength, the signal should be audible for at least 100 kc on each side of resonance. (Of course, the afc is disabled throughout this process.) The tuning should be about the same whether you tune in the station from the upper or the lower side. If it seems sharper from one side than the other, the response curve is not symmetrical and a complete realignment of the if is justified.

Very sharp tuning indicates regeneration. This calls for a close look at the tubes and components of the individual if stages. A new tube that is

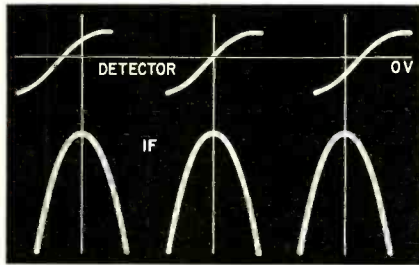

Fig. 1—Detector is properly tuned when center of detector response coincides with peak of if response curve.

exceptionally "hot" may be responsible. Cathode resistors and capacitors, plate and screen decoupling resistors and capacitors, and transformer loading resistors should be checked and replaced if their value is more than 25% off the marked value or that specified in the wiring diagram.

The detector

In the great majority of cases the tuner will pass this check, showing a broad enough response and a reasonably symmetrical one. The detector alignment can be checked next. If the tuner uses a ratio detector, the procedure is:

▶ Carefully tune in a station of moderate strength (one that produces a 50% deflection on the indicator) to maximum swing on the tuning meter or indicator.

▶ Take an electric drill, turn it on and hold it close to the tuner.

▶ A ratio detector provides maximum noise suppression when the input signal is in the center of the detector band-pass. Therefore, when the center of the detector response coincides with the peak of the if response curve, you get maximum noise suppression (Fig. 1). If

you get a complete null, you can assume the detector is properly aligned. If you get some noise, detune the tuner slightly on each side of resonance to see if you get less noise to one side or another of the if peak. If this happens align the detector.

▶ Again carefully tune in the station for maximum swing of the tuning indicator. Detune the secondary of the detector transformer so the noise of the drill is plainly audible. Turn the primary slug for maximum noise, then the secondary slug for minimum noise. The primary tunes fairly broadly. Set it for the center of its peak. The secondary is more critical. Adjust it very carefully, rocking the tuning slug to one side and the other to make sure that you get it set at the exact minimum-noise point.

You can also make this adjustment slightly more accurately by injecting a signal into the tuner, anywhere in the FM band, from your AM signal generator. Tune the tuner carefully to resonance as above. Turn on the amplitude modulation and connect an ac vtm or the ac range of a service vtm across the tuner output. Detune the secondary of the detector transformer so the amplitude modulation produces a reading on the meter. Now adjust the primary for maximum meter reading, and the secondary for minimum meter reading.

For a discriminator detector, the procedure is:

▶ Again carefully tune in a station of moderate strength to exact resonance.

▶ Connect a dc vtm (M1) across the detector output load. The simplest connection is across the two cathodes of the detector double diode (Fig. 2). One of them is grounded. A discriminator is properly aligned when the center of the discriminator curve coincides with the peak of the if response curve. At this point, there is zero dc voltage across the detector output.

Therefore, if the vtm shows a zero reading when you have connected it in this way, the detector is properly aligned. You can check by detuning to one side or the other. If the vtm gives a zero reading when the tuner is slightly detuned, the detector should be aligned. Retune the signal to exact resonance on the tuning meter. Turn the secondary slug of the detector transformer slowly in the direction that brings the reading on the vtm closer to zero and adjust it for exactly zero reading. Now move the vtm across either of the two detector output load resistors (M2 in Fig. 2) and adjust the primary slug for maximum swing on the vtm. (The swing may be in the negative direction. If it is, change the vtm polarity.)

With the meter still in this position, peak the slugs of the transformer between the two limiters.

Practically all current high-fidelity tuners, whatever the type of detector, now use a maximum-swing tuning meter or indicator. Some older and one or two current tuners use a zero-center type of meter connected across the detector output to indicate the null point

when the signal is properly centered on the detector curve. A couple of deluxe tuners have both a maximum-swing "carrier-strength" indicator and a zero-center type of tuning meter. If the tuner has two meters or indicators, the alignment is very simple. The zero null on the tuning meter should coincide with the maximum-swing peak on the carrier-strength meter. If they do not coincide, tune the tuner for maximum swing on the carrier-strength meter. Now adjust the secondary of the detector transformer for the zero-voltage null on the tuning meter. The primary is best adjusted by connecting a vtm across one of the load resistors as detailed previously. However, it is possible to adjust it by turning the slug to the point which gives both a zero reading on the tuning meter and the loudest output.

If the tuner has only a zero-center type of tuning indicator, connect a vtm across the grid-return resistor of the first limiter. Now adjust the tuner for maximum swing on the vtm. This should coincide with the zero null on the tuning meter. If it does, detector alignment is OK. If the tuning meter does not show zero voltage, adjust the detector secondary for the zero reading. Then shift the vtm to the detector load resistor and adjust the primary for maximum swing as detailed earlier.

The question arises: Which is the primary and which the secondary slug? This is a good one and ought to, but does not, have a categorical answer. It ought to be standardized and, in my own view, the secondary slug should always be the bottom one—so that it will be less likely to be disturbed by an owner with more itch to use his screwdriver than knowledge and skill in employing it. However, there is no standard. More often than not, the secondary is the bottom slug, and the odds are in favor of assuming this. Of course, the safest thing to do is to check the service manual. Sam's *Photofacts* folders do indicate which slug is which. In other cases, you can deduce it from the alignment instructions.

With a little experience, you will soon learn which is which by the audible effect of a slight change in slug position. The secondary slug usually has a far more violent effect on the quality of the sound or on the noise. Primary-slug tuning is usually much broader and

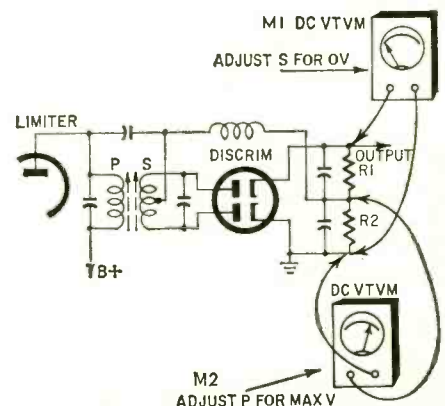
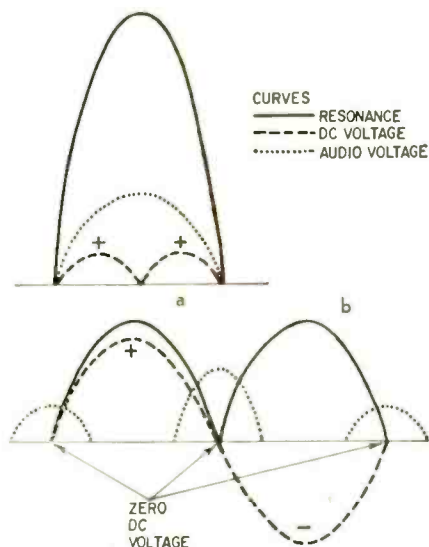

Fig. 2—Connections for discriminator alignment.

tends merely to increase or decrease the volume of sound or noise. Secondary tuning produces a very marked difference in the noise level, the loudness of the modulation or the distortion or all three.

Suppose you're working on a ratio detector with electric-drill noise or a signal generator with AM modulation. Try the bottom slug first and turn it a half turn or so in each direction. Within this one-turn range you should find a point where you get a very definite, sharp null in the noise or AM modulation. If you do, it's the secondary all right, and you adjust the slug for the minimum output point. On the other hand, if instead of a sharp null, you find a peak in the noise with a gradual reduction on each side, you definitely have the primary slug. Tune it for the maximum output point, and then tune the other slug for the minimum output.



If you're working on a discriminator detector with the vtvm across the detector diodes and an FM station as the signal source, again try the bottom slug first and turn it in both directions slightly. One way will produce a reduced reading on the meter and at the same time increased loudness in the audio output; the other way will produce an increased reading on the meter and a decrease in audio output or an increase in distortion. Turn the slug in the direction that gives the lower voltage and adjust it for zero voltage. Now detune the slug about a turn in each direction.

If you do *not* find another point where you get the combination of zero voltage and loud sound, you are actually tuning the primary. On the other hand, if you do find another or possibly two other points where you get the meter null and loud peak, you definitely have the secondary. In that case, adjust for the middle null or, if there are only two points of null, for the one that produces the least distorted sound. Then adjust the primary again as detailed previously.

It may help to keep in mind a picture



Sherwood S-3000 II FM tuner.

of the way the resonant curves of the primary and secondary affect both the dc voltage and the audio at the output of the detector. In Fig. 3-a we have the curves for the primary and in Fig. 3-b the curves for the secondary. The solid curves are the resonance curves, the broken curves represent the dc voltage developed across the detector output, and the dotted curves are the audio voltage developed at the output of the detector.

You will note that in the primary (Fig. 3-a) there are three points at which you can get a zero voltage but only one point at which you get *both zero dc and an audio peak*. On the other hand, in the secondary you can get the combination of zero dc and an audio peak at three points. In the ratio detector, the primary peaks the noise but does not null it. The secondary produces some noise suppression at all three points, but a null only at the middle peak. In a discriminator, there is only one audio peak when the primary is tuned, but three peaks when the secondary is tuned. The right one is always the middle one and is recognizable because it is the least distorted.

In a narrow-band detector the three peaks show up in a few turns of the secondary slug. But it is possible to get confused in a wide-band detector because the additional peaks may not show up in the plus or minus one turn of the slug. Fortunately, you don't need to worry about this because a wide-band detector will almost certainly pass the detector test and give you no justification for trying to align it. Wide-band detectors have enough leeway so that with normal aging they will give the required zero-voltage null even when the coincidence between the centers of the if response curve and the detector curve is not perfect. In the vast majority of cases, the very slight misalignment that may exist because of aging will not significantly affect performance.

If you have trouble distinguishing between primary and secondary, it's a good bet you're dealing with a wide-band detector. In that case, adjust both slugs for the point within the range of about one turn of the original position that yields both a dc null and an audio peak.

If you run into a wide-band detector that is badly misaligned, the safest thing is to obtain the service manual and align the detector as recommended. If you have an FM generator and dis-

tortion meter, you can align it with perfect confidence by the method outlined in a later section. However, you'll be pretty safe if you sweep the range of the secondary slug to find the three audio peaks and dc nulls and adjust for the middle one. On some wide-band discriminators you may find only two peaks. In that case, choose the one which produces the cleanest sound.

Peaking the if

Whatever the type of detector, when you have finished adjusting it, leave the tuner dial (and generator if used) exactly as they were when you completed the detector alignment—in other words, in the position that gave you the meter null. If you have the meter connected to the discriminator output leave it in. Peak the if slugs carefully for maximum swing on the tuning indicator without disturbing the dial (or generator) at any time. If you should disturb the dial setting, reset for the null in the vtvm across the discriminator output and start again.

When you have finished, you can check the symmetry of the response curve and also the coincidence of the if peak with the detector output null. If the voltage or noise null of the detector coincides with the peak of the if response curve, you know the job is done properly.

That winds up FM alignment without a scope or sweep generator. There is another FM alignment method. If you follow it you need an FM generator and a distortion meter. As this is a separate procedure, we will not cover it here. It will appear as an article in next month's issue. END

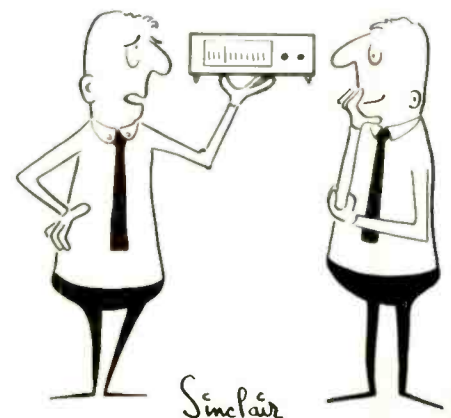

"It's the new deluxe kit—all I have to do is put the knobs on."

for the Newest Kits, the Finest Quality,
the Greatest Values . . . look to Heathkit,
the world's shopping center for Electronic Kits



NEW STYLING



Deluxe . . . tops in Heathkit stereo/hi-fi styling with luggage-tan vinyl-clad cabinets, plastic fronts, refracted lighting. Choose matching tuner and amplifier. Left: **AA-100** 50 watt stereo amplifier. 31 lbs. **\$84.95**

Everything is

NEW



20 New Stereo Hi-Fi Kits . . . Tuners, Multiplex, Amps., Speakers, from \$16.88 up! Above: **AA-11** Deluxe Stereo Preamp., 19 lbs. . . . **\$84.95**



New "Walkie-Talkies" . . . Deluxe Superhet. 9-Trans. & Economy 4-Trans. Regen. Both in handsome styling. Above: "Deluxe" **GW-21** 3 lbs. **\$44.95**



Short Wave Listeners Radio . . . Circuit board; beige, aqua steel cab.; four bands, 550 kc—30 mc; lighted meter & dial. **GR-91** 9 lbs. . . . **\$42.50**



8 New Test Instruments . . . Capacitor Checker, "Handy-Lab," Transistor Tester, Scope. kit & wired VTVM's. Above: **IM-20** "Handy-Lab," 2 lbs. **\$14.95**

NEW GUARANTEE

We guarantee that you can build any Heathkit!

The Heath Company *unconditionally guarantees* that you can build any Heathkit product and that it will perform in accordance with our published specifications, by simply following and completing our check-by-step instructions, or your purchase price will be cheerfully refunded.

This Heathkit guarantee, unprecedented in the industry, is made possible by our millions of satisfied customers who have proved that building a Heathkit requires no special background, experience, skills or training.

NEW NO-MONEY DOWN TERMS

It's easiest to buy Heathkit! With these new *no-money down* terms you can order the Heathkits of your choice . . . send no down payment . . . and take as long as 18 months to pay! These new, relaxed terms, coupled with our guarantee that you can build any Heathkit, are your assurance of complete satisfaction with your purchase. Any order for \$25.00 to \$600.00 worth of Heathkit equipment is eligible for these new easy time-pay terms; write for details on orders over \$600.00. See the order blank in the new 1962 Heathkit catalog or send for application forms.

NEW is the key word this fall at Heath! NEW KITS . . . in every product line . . . *forty* new kits, bringing the total to over 250 to choose from . . . the world's largest selection of electronic kits! NEW STYLING . . . three new styling concepts for stereo /hi-fi, completely coordinated . . . new test instrument styling . . . newly styled citizen's band equipment . . . new variations on the Heathkit amateur radio theme. NEW GUARANTEE . . . assures your kit building success, regardless of your background or experience. NEW NO-MONEY DOWN TERMS . . . easier than ever to buy . . . your assurance of complete satisfaction. NEW FREE CATALOG . . . 100 pages . . . the world's biggest kit catalog . . . better, too, with larger photos, complete descriptions and specifications, and now with kit schematics for your complete buying information. Look to Heathkit for the NEW!

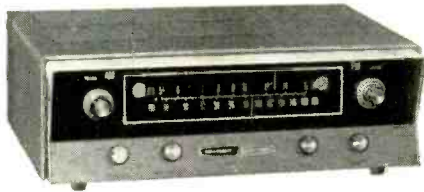

Mid-Range . . . styling combines deluxe and popular motifs; tan vinyl-clad cabs., charcoal-grey fronts, for tuner and amps.
Left: **AJ-11** AM/FM Tuner.
19 lbs. . . . **\$69.95**



Popular . . . striking charcoal grey steel cabinets with ivory accents. Choose tuners and amplifiers.
Left: **AA-161** 14 watt monophonic amp-pre-amp.
15 lbs. . . . **\$33.54**

at HEATH



5 New Amateur Radio Kits . . . VFO, Tunnel-Diode "Dip" Meter, Basic Receiver, "Q" Multiplier, CW Transmitter.
Above: **HG-10** VFO.
2 lbs. . . . **\$34.95**

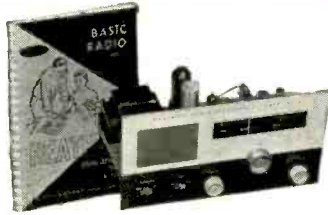

Another New Educational Kit . . . Two-Part Basic Radio Course (EK-2A & 2B). Each has authoritative textbook and parts for radio receiver.
6 lbs. . . . **\$19.95**

NEW KITS

NEW FREE CATALOG

The World's Shopping Center for Electronic Kits

Send for your FREE copy of the 1962 Heathkit catalog . . . the world's biggest kit catalog . . . 100 pages packed with over 250 kits . . . big new page size, big photos, complete descriptions, specs., schematics . . . we'll be glad to send your friends a copy too!



HEATH COMPANY
Benton Harbor 20, Michigan

a subsidiary of
DAYSTROM

Please send Free Heathkit catalog.

NAME

ADDRESS

CITY

ZONE

STATE



The Sencore model TR110 in-circuit transistor checker.

Transistors *do* go bad under normal use, in spite of the wealth of scientific "proof" to the contrary. Since they are usually wired into the circuit and hard to remove for testing, manufacturers have developed in-circuit testers. Two separate approaches to the problems of in-circuit testing are presented here.

Both are interesting and well worth considering. Both require that the input circuit impedance be more than about 150 ohms at 1,000 cycles for accurate testing. For this reason, volume controls should be set about halfway when testing audio driver transistors (Fig. 1). Note that either position *a* or *c* will reduce the input impedance of the circuit. A few if circuits similar to Fig. 2-a will have too little impedance for in-circuit testing because the 10- μ f capacitor has less than 20 ohms reactance at 1,000 cycles. However, the circuit in Fig. 2-b can be tested since the emitter resistor is larger than 150 ohms (the reactance of the .05- μ f emitter bypass is more than 3,000 ohms at 1,000 cycles). The circuit in Fig. 2-c can also be tested since an electrolytic is not used to bypass the lower end of the if input circuit.

Some other circuits, such as direct p-n-p, n-p-n-coupled, etc., may give erroneous results on in-circuit tests. Nevertheless, probably more than 90% of the circuits used today will respond to in-circuit tests. If the transistor checks OK in-circuit, you can assume

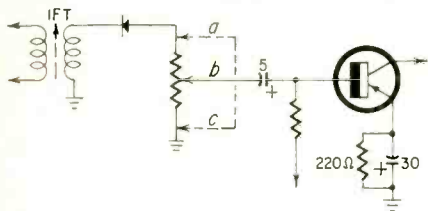

Fig. 1—When testing audio driver transistors in circuit, set volume control halfway (position *b*). Position *a* or *c* will lower the input impedance and make in-circuit testing difficult or impossible.

Two new instruments let you test transistors without unsoldering them from the circuit



The Hickok model 890 in-circuit transistor checker.

In-Circuit Transistor Testing

it is a good transistor. If it checks bad in-circuit, always make an out-of-circuit test for final verification. The circuit itself may be shorted!

One big advantage of in-circuit testing is that by determining which transistors are good, you can concentrate on just the portion of the circuit that tests bad.

Sencore Transi-Master

This new Sencore instrument (the TR110) makes both in-circuit and out-of-circuit tests. The in-circuit test determines the ability of the transistor to oscillate as a blocking oscillator. The out-of-circuit check determines leakage and dc beta (gain).

The simplified in-circuit check for a p-n-p transistor is shown in Fig. 3. (N-p-n transistors are checked identically except polarities are reversed by a front panel switch.) Note that the impedances represented by the blocking oscillator windings are quite low in both

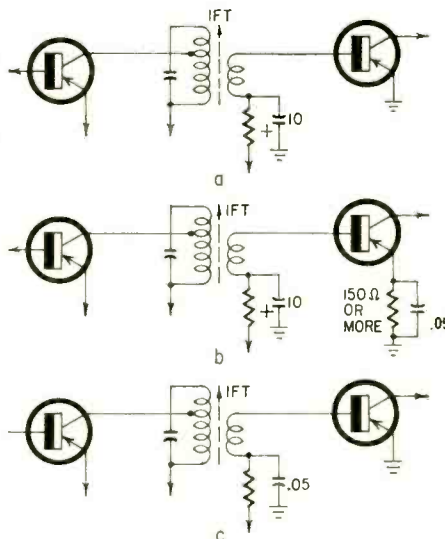

Fig. 2—The circuit at *a* has less than 150 ohms input impedance. However, both *b* and *c* have more than 150 ohms input impedance and transistors can be tested with in-circuit checkers.

the input and output circuit so any external circuitry is pretty well swamped.

The BIAS SET control is set for the PNP (OR NPN) BIAS LINE position so that the transistor is forward-biased. A good transistor will oscillate under these conditions. The meter indicates oscillation since it is connected between the collector and emitter to read the ac output of the circuit.

The Sencore unit does not claim to make an in-circuit gain check but only to indicate whether or not the transistor is operative. For this reason, the meter reading will be approximately the same for all transistors. If a transistor fails to respond, remove it from the circuit and test again. This is necessary because there may be a fault in the circuit itself or the natural impedance of the circuit may be so low that oscillations cannot start.

The TR110 tests transistors out of circuit too (Fig. 4). Set the function switch to OUT OF CIRCUIT. Adjust BIAS SET as indicated by the setup chart. Leakage from emitter to collector with base open is read automatically. Leakage should not exceed that indicated on the chart. Depressing the TEST switch inserts the base into the circuit and forward-biases the transistor. The meter reads collector current. This current is equivalent to dc gain (beta).

For high-power transistors, the 22,000-ohm limiting resistor in the base circuit is shorted out to lower the

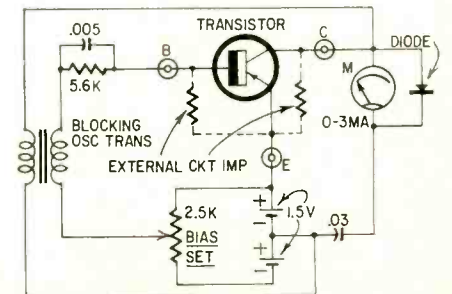
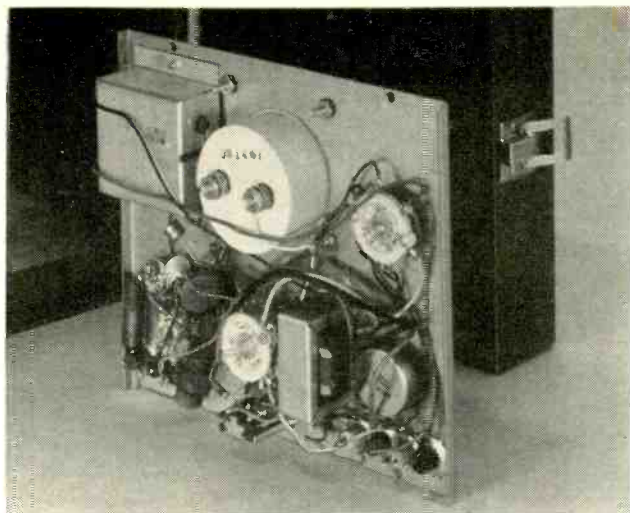

Fig. 3—In-circuit test used in Sencore model TR110.



Inside the Sencore tester. All components are mounted on the back of the front panel.

Sencore Transi-Master Model TR110

Power Requirements: (2) 1.5-volt type-C cells.

Functions: Out-of-circuit test for I_{CBO} leakage and dc beta (gain) for low- and high-power transistors. In-circuit test for transistor's ability to oscillate. Volts dc 0-12. Ma dc 0-50. Audio and harmonic generator.

Size: $7\frac{1}{2} \times 8 \times 3$ inches, lid closed.

Meter Size: $3 \times 3\frac{1}{2}$ inches, 0-3 ma.

Construction: All metal, mirror in lid.

Price: \$49.50

input impedance and, since collector current will be higher, a 33-ohm resistor is shunted across the meter.

In addition to testing transistors, the Sencore instrument includes a harmonic generator (Fig. 5). It is used for signal-tracing transistor radios through rf, if and audio stages. In the AUDIO position, the output is essentially a sine wave. In the RF-IF position the output is rich in harmonics up through the broadcast band. The meter indicates that the generator is putting out.

The meter can also be used to measure

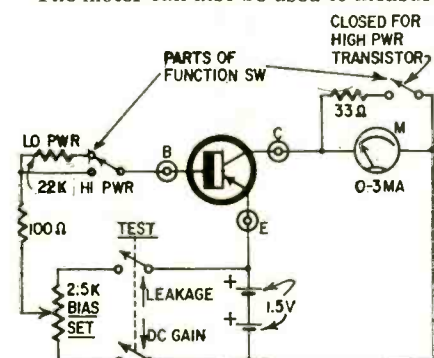

Fig. 4—The TR110 uses this dc leakage-gain test.

battery voltage (0-12 volts) and current (0-50 ma). The current scale is especially useful for aligning transistor radios since, for most radios, there will be maximum current drain with maximum signal.

A special test lead set is included with the instrument. It slips between the battery and its connector to make it easy to check battery current. Another 3-wire test lead set is said to make it easier to connect to the terminals of the transistor in-circuit.

Another method of getting onto the terminals of the printed board is to "ball up" a bit of solder on each of

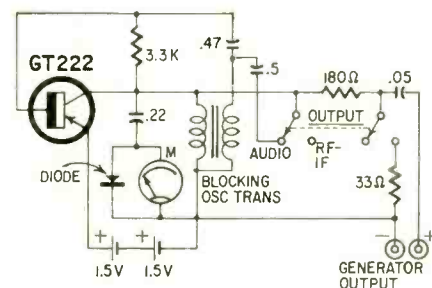

Fig. 5—Harmonic and audio generator in the TR110.

the transistor terminals.

Hickok Model 890

This in-circuit tester measures the dynamic (ac) beta of a transistor by using an ingenious bridge circuit to balance the external input impedance of the transistor circuit out completely. The output impedance is swamped during the test with a 1-ohm resistor. The circuit impedance (at 1,000 cycles) can be read directly on the calibrated potentiometers of the bridge circuit. Another is calibrated so you can read the dynamic input impedance of the transistor itself.

First, the I_C (collector current) control is set to take control of transistor

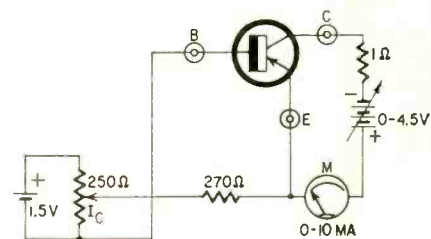
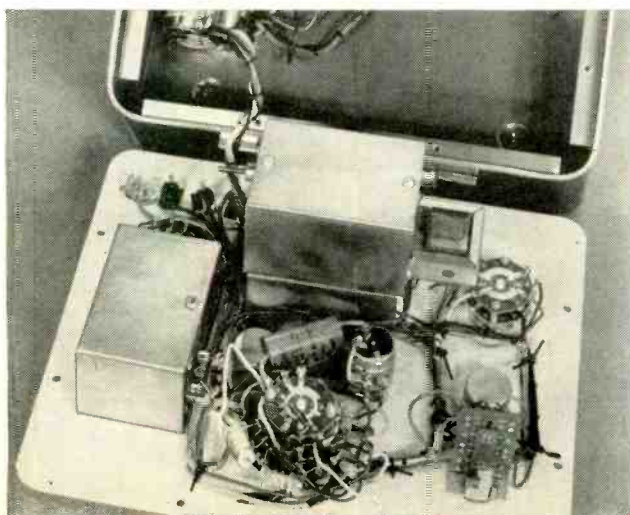

Fig 6—Basic I_C test circuit for p-n-p transistor in Hickok model 890.



Inside the Hickok tester. Batteries are mounted inside the bottom of the case.

Hickok In-Circuit Transistor Tester Model 890

Power requirements: (4) 1.5-volt type-C cells. (1) 22.5-volt battery.

Functions: I_{CBO} leakage (out of circuit only). Collector current. External circuit impedance (Z ohms). Dynamic transistor input impedance (R_{IN}). Beta calibrate and ac beta. (All above, in circuit or out of circuit.)

Size: $9 \times 10\frac{1}{4}$ inches.

Meter Size: $3\frac{1}{2} \times 3\frac{1}{2}$ inches, 0-50 μ a.

Cabinet Construction: All metal with sloping front panel.

Price: \$129.50

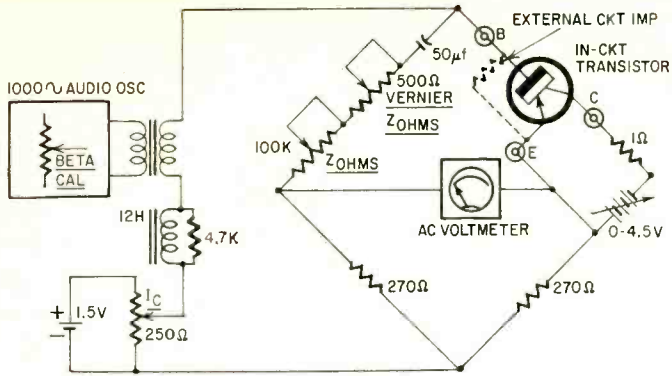

Fig. 7— Z_{OHMS} test circuit in the model 890.

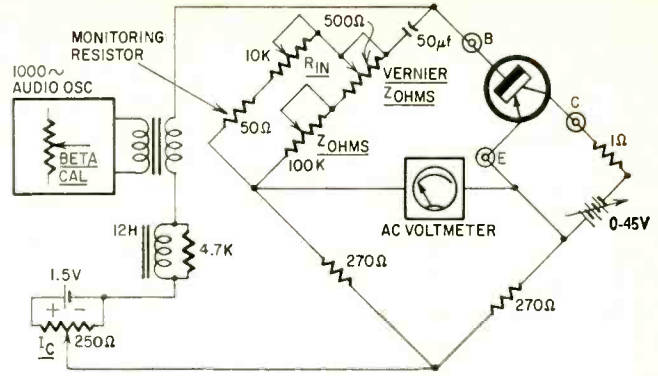

Fig. 8—The 890 uses this R_{IN} test circuit.

currents (Fig. 6). With the I_C control at zero, the meter reads the stray currents in the circuit. These are usually less than 1 ma. The I_C control is then set for an additional 1 ma of collector current. If stray currents are high—3, 4 or 5 ma—the I_C control is set so the collector current is approximately twice the stray-current value.

To test circuit beta accurately, the circuit impedance must be cancelled. This is done by balancing out this impedance in the bridge circuit of the 890, as shown in Fig. 7. The transistor is automatically reverse-biased in this step to prevent its input impedance from affecting the bridge balance.

To balance the bridge, the BETA CAL control is advanced until there is a reading on the meter. Then the Z_{OHMS} controls are rotated until a null (dip in meter reading) occurs. The bridge is now balanced and the circuit impedance effectively cancelled.

There is still one other consideration—the dynamic input impedance of the transistor itself. The R_{IN} potentiometer is switched in parallel with the Z_{OHMS} controls, and the transistor is again forward-biased (Fig. 8). R_{IN} is then set to balance the bridge. Now, with both the circuit impedance and the transistor impedance nulled, we are ready to make the in-circuit beta test.

Ac beta is the current gain of a transistor in a common-emitter circuit. It is the ratio of ac collector current

to ac base current, expressed:

$$\frac{I_C}{I_B}$$

The model 890 measures ac beta as shown in Fig. 9. An ac voltmeter is placed across the 50-ohm monitoring resistor in the bridge circuit. The BETA CAL pot (it adjusts the output of the internal 1,000-cycle transistor oscillator) is set so the meter reads at the CAL position. Next the meter is switched across the 1-ohm resistor in the collector circuit and the ac beta is read directly on the meter.

The 890 can also make out-of-circuit tests and one additional out-circuit test is provided— I_{CBO} (leakage, reverse current from collector to base with emitter

open). Since the external input impedance (Z ohms) would be infinite, this portion of the bridge is switched out for out-of-circuit tests. Otherwise tests are made identically to the in-circuit mode.

Since the 890 uses a 1,000-cycle bridge, it can measure the impedance or quality of other circuit components—speakers, transformers, and the like—by simply connecting their terminals to the base and emitter leads and rotating the Z_{OHMS} controls for a null on the meter. The impedance of the component at 1,000 cycles can then be read directly in ohms on the calibrated dials. Impedances from almost zero to 100,000 ohms can be read in this manner. END

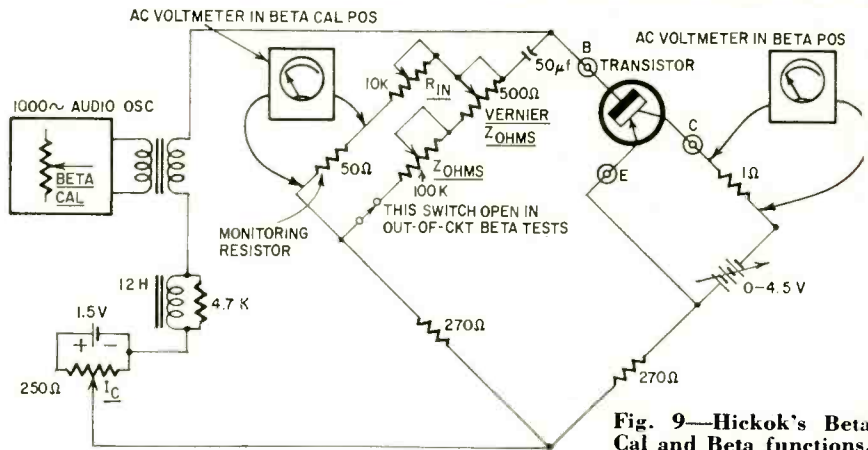

Fig. 9—Hickok's Beta Cal and Beta functions.

DON'T MISS

HORIZONTAL OSCILLATOR DRIFTING

next month

Cut down on call backs! Wayne Lemons shows you how to find and cure drift in different types of horizontal circuits. Save yourself a lot of rough hours. Read this feature in the October issue of Radio-Electronics.

on sale September 14.

Tape-Speed Test Loop

Tape recorder owners and service technicians can make a simple and accurate test tape to check the speed of the tape recorder transport mechanism. Any loss or variation of speed indicates trouble in the drive mechanism caused by worn belts, rubber wheel drives or lack of lubrication.

First, feed a 1,000-cycle tone from an audio oscillator into the tape recorder and record it for a foot or so on good quality tape. Remove the tape, and carefully measure and cut a 1½-inch piece from the recorded section. Then, measure off and cut a 36-inch piece of "clean" nonrecorded tape and splice it to the 1½-inch tone-recorded section.

The net result will be a closed-loop tape exactly 37½ inches long.

When the closed loop is played back on the recorder, a series of "beeps" of tone are heard. The frequency of the beeps, or the time interval between them, depends upon the recorder's tape-speed setting.

At a speed of 1½ ips, the separation between beeps is exactly 20 seconds; at 3¾ ips, beep separation is 10 seconds; at 7½ ips 5 seconds; and at 15 ips the beep is heard every 2½ seconds, or two beeps every 5 seconds. A fairly accurate watch with sweep-second hand and this easy-to-construct test tape provide a useful and accurate aid for checking the tape transport mechanism.—Dave Stone



Feb. 5th:

(Paco ran this ad in The New York Times)



Feb. 27th:

(the Taylor Twins began their duel of kits!)

*Don and Larry Taylor, with twin backgrounds and skills, have competitively built kit after kit, Paco vs. other makes. In one test Don built the Paco, in the next Larry did. Net results: Paco kits proved faster, easier, and better in performance. **For a typical Twin-Test report turn the page.***

PACO DISTRIBUTOR LIST (cont'd.)

OHIO

Columbus Whitehead Radio Co.*
Cincinnati United Radio, Inc.
Dayton Sreco, Inc.
Toledo Lifetime Electronics
Warren Radio Co.
Warren Valley Electronics*
Youngstown Armes Electronics

OKLAHOMA

Oklahoma City Dulaney's†

PENNSYLVANIA

Allentown A. A. Peters, Inc.
Charleroi Barno Radio Co.
Erle Mace Electronics
Harrisburg Electronic Wholesalers, Inc.
Radio Distributing Co.
McKeesport Barno Radio Co.
New Brighton Television Parts Co., Inc.
Pittsburgh House of Audio*
Marks Parts Co.†
Metropolitan Distributors, Inc.
Opus One*
Reading George D. Barbey Co.
State College Alvo Electronics Dist. Inc.*
Tarentum Huston TV Parts Co.
Wilkes-Barre General Radio & Elec. Co.

RHODE ISLAND

Providence Electronic Distributors, Inc.

SOUTH CAROLINA

Columbia Hi-Fi Sound & Records Co.*
Southeastern Radio Parts

SOUTH DAKOTA

Rapid City Dakota Electronics

TENNESSEE

Chattanooga Curle Radio Supply
Columbia Randolph & Williams†
Knoxville Smith Electronics Supply Inc.†
Nashville Electra Distributing Co.*
Randolph & Rice†

TEXAS

Ablene R & R Electronics Co.
Amarillo R & R Electronics Co.
Austin Modern Electronics Co.
Service Electronic Supply
Bay City R. C. & L. F. Hall, Inc.
Baytown R. C. & L. F. Hall, Inc.
Beaumont R. C. & L. F. Hall, Inc.
Conroe R. C. & L. F. Hall, Inc.
Corpus Christi Modern Electronics Co.
Wicks Radio Equipment Co.†
Dallas All State Distributors, Inc.†
Crabtree's Wholesale Radio & TV†
Denison Denison Radio Supply
Freeport R. C. & L. F. Hall, Inc.
Galveston Electrotex
R. C. & L. F. Hall, Inc.
Houston Electrotex
Gilbert Co.
R. C. & L. F. Hall, Inc.
McAllen Rio Radio Supply Co.†
Midland R & R Electronics Co.
Odessa R & R Electronics Co.
Pasadena R. C. & L. F. Hall, Inc.
San Angelo R & R Electronics Co.
San Antonio Modern Electronics Co.
Radio TV Parts Co.†
Sherman Electronics Supply Inc.
Texas City Electrotex
R. C. & L. F. Hall, Inc.
Wichita Falls R & R Electronics Co.

UTAH

Salt Lake City Moore Radio Supply†

VIRGINIA

Norfolk Southern Television Corp.†
Richmond Banner Electronics, Inc.†
Industrial Electronic Tube Corp.†
Roanoke Dixie Appliance Co.†

WASHINGTON

Seattle Empire Electronic Supply Inc.
Northgate Cameras*
Pacific Electronic Sales Co., Inc.
Radio Products Sales Co., Inc.
Spokane E. M. Johnson Co.
Tacoma Branham Hi-Fi*
Sound Center*

WASHINGTON, D. C.

Elec. Wholesalers, Inc.
Rucker Electronic Products Inc.
Arlington, Va., Key Electronics
Rucker Electronic Products Inc.
College Park, Md. Rucker Elec. Prod. Inc.
Silver Spring, Md. Kenyon Elec. Corp.†
Rucker Electronic Products Inc.
Silver Spring Electronic Supply

WISCONSIN

Milwaukee Acme Radio Supply
West Allis Hi-Fi Salon*

WEST VIRGINIA

Beckley Chemcity Electronic Dist. Inc.†

EXPORT:

Morhan Exporting Corp., New York, N. Y.

CANADA:

Atlas Radio Corp., Toronto, Ontario

*Hi-Fidelity Equipment Only
†Test Equipment Only



For free illustrated PACO catalog write:
Paco Electronics, Dept. RE 9
70-31 84th Street, Glendale 27, N. Y.
A subsidiary of PACOTRONICS, INC.

By ED BUKSTEIN*

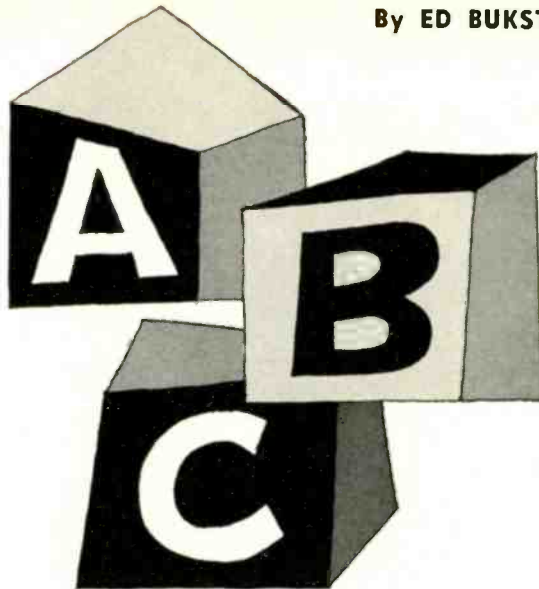

**INDUSTRIAL
ELECTRONIC
DICTIONARY**

Part III: From carrier-current control to differential amplifier.

Carrier-current control: A system of remote control involving a radio transmitter and receiver coupled through power lines. The power lines serve as the transmission line that carries the rf from the transmitter to the receiver. A relay connected to the receiver can be energized by turning on the transmitter at a remote location served by the same power lines.

Chopper amplifier: A circuit used to amplify low-level dc signals (the output of a thermocouple, for example). Direct-coupled amplifiers may be used, but they tend to drift and are very critical with respect to part values and supply-voltage variations. In the chopper amplifier, the dc signal is periodically interrupted by an electro-mechanical chopper somewhat similar to the vibrator of an automobile radio. Once the signal has been chopped, it can be amplified by a conventional R-C or transformer-coupled amplifier, eliminating the need for a direct-coupled

amplifier. After amplification, the signal can be converted to its original form by a demodulator circuit.

Closed loop: An automatic control system in which the output is fed back to control the input. The feedback signal is compared to a reference quantity and the difference (error) is applied as input. This input, after amplification, alters the output in the direction that reduces the error signal to zero.

Color sensitivity: The spectral response of a light-sensitive device. Phototubes, for example, are rated for color sensitivity as an indication of the response of the phototube with respect to the colors of the spectrum.

Control locus: A curve showing the critical value of grid bias of a thyatron. The control locus curve is plotted with respect to the positive half-cycle of plate supply voltage (Fig. 8). If the thyatron bias at any instant is less than the critical value indicated by the locus, the gas ionizes. The critical grid

NEW...Home TV Signal Amplifier



Model AT-6
ONLY
\$34.95
LIST

EXCLUSIVE!
ANTENNA

GAIN CONTROL SWITCH

EXCLUSIVE!
OUTPUT

300 Ω 75 Ω

300 AND 75 Ω OUTPUT

EXCLUSIVE!
117V

AC RECEPTACLE FOR TV

**TRANSISTORIZED
WINEGARD "BOOSTER-PACK"**

**Clears up snow, improves contrast,
adds miles to reception distance!**

Here's the most unusual (and most useful) home TV-FM signal amplifier you've ever seen! Winegard "Booster-Pack" utilizes new low noise, high gain transistor* to give you a flat gain of 16 db on the low band and FM... a flat gain of 14 db on the high band.

Shock-proof... full AC chassis with AC isolation transformer (not AC-DC). Draws only 1.2 watts... cost only 27c per year to operate if left on continuously. No heat radiation. Can be mounted on back of TV set, on baseboard, in basement, attic, etc. Use "Booster-Pack" as a single set booster or as a home system amplifier for up to 6 or 7 sets. (See right)

*Special transistor so new that this amplifier could not have been produced until now.

**No other amplifier under \$80.00
has all these features!**

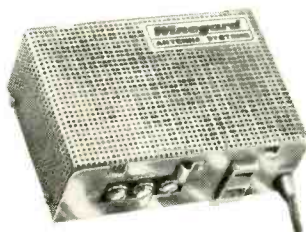

- Drives from 1 to 7 TV/FM sets
- Ideal for color
- Power Consumption: 1.2 watts

- Gain: Low and FM: 16 db.
High: 14 db
- Input: 300 ohm
- Output: 300 ohm and 75 ohm
- Transistor*: Low noise, high gain type
- Power Transformer: AC isolation type
- Gain Control: 3-position switch
- AC Outlet: To receive TV set power plug
- Precision Wiring... finest quality throughout

1 USE IT AS A "SINGLE SET" AMPLIFIER

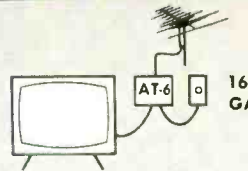

WITH ANY OUTDOOR ANTENNA

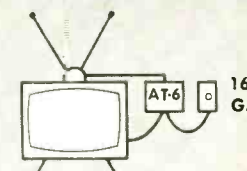

WITH "RABBIT EARS"

2 USE IT AS A "HOME SYSTEM" AMPLIFIER

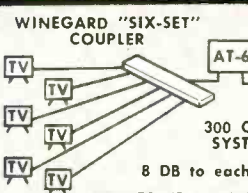

WINEGARD "SIX-SET" COUPLER

300 OHM SYSTEM

8 DB to each set
DRIVES UP TO 6 SETS

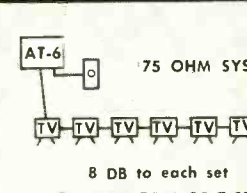

75 OHM SYSTEM

8 DB to each set
DRIVES UP TO 6 OR 7 SETS

New! Winegard "Six-Set" SIX SET TV COUPLER

For connecting up to 6 TV sets to "Booster-Pack" or to Winegard Powertron antenna. 300 ohm input and outputs. Low insertion loss, positive isolation between sets.



Mod. LT-63
\$7.95 List

ASK YOUR DISTRIBUTOR OR WRITE TO:



Winegard
ANTENNA SYSTEMS

WINEGARD CO., 3013-9 Kirkwood Ave., Burlington, Iowa

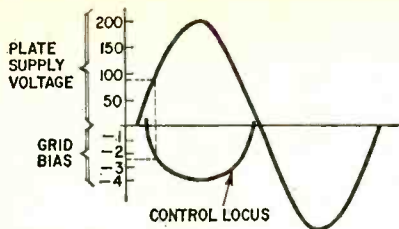

Fig. 8—Control locus curve indicates critical value of grid bias for positive values of plate supply voltage. Dashed line shows that -2.5 volts bias will allow tube to ionize when plate reaches 90 volts.

bias (dotted line in Fig. 8) is -2.5 volts when the plate supply is 90 volts—if the thyatron bias is adjusted to -2.5 volts, the thyatron will ionize when the plate reaches 90 volts during each positive half-cycle of supply voltage.

Control ratio: The ratio of plate voltage to critical grid voltage of a thyatron. A thyatron having a control ratio of 10, for example, will ionize if the plate voltage is at least 10 times as great as the bias voltage. If the grid bias is adjusted to -8 volts, the plate voltage must be at least 80 volts for the tube to fire. The control locus is a graphical representation of the tube's control ratio.

Counting-rate meter: A frequency-measuring circuit commonly used to indicate the pulse rate of Geiger or scintillation counters. Pulses generated by the counter are applied to a diode circuit (Fig. 9). Each input pulse causes diode V2 to conduct and charge capacitor C. During the interval between pulses, some of the charge leaks off through resistor R. If the pulses

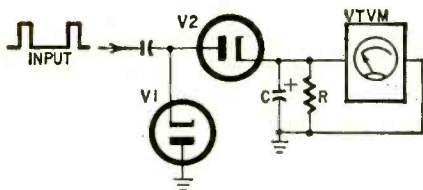

Fig. 9—Counting rate meter indicates frequency of input pulses. Capacitor C charges during input pulse and partially discharges during time between pulses.

occur at a low frequency, there is more time between one pulse and the next and most of the charge leaks off. If the pulses occur at a high frequency, there is less time between one pulse and the next and only a small amount of the charge leaks off. The average charge on C is therefore a measure of the frequency of the input pulses. This charge is read on a vtvm calibrated to read directly in pulses per second or per minute.

D

Dead time: The time, following the application of an input pulse, during which a circuit or component is not receptive to another input pulse. A Geiger tube, for example, will not respond to a second input if the gas is still ionized as a result of a preceding input a short time earlier. Dead time



Computer Measurements Co.

Fig. 10—Pulse counting instrument uses six decade counters in cascade. Neon lamps indicate number of pulses counted.

is also known as *resolving time* and is usually specified in microseconds.

Dead zone: The range of values over which an automatic control system will produce no corrective actions. An automatic temperature-control system, for example, may be designed to apply power to a heating element when furnace temperature drops below 250° , and to disconnect the heating element when temperature rises to 260° . The dead zone in this example is 10° wide (250° to 260°).

A narrow dead zone has the advantage of holding the temperature (or other quantity) at a more nearly constant value. A wider dead zone permits greater deviation of the controlled quantity but reduces the frequency of the on-off corrective actions. This feature is desirable because it increases the life of relay contacts, heating elements and other components. The dead zone is also known as the *neutral zone*.

Decade counter: A pulse-counting circuit that produces 1 output pulse for every 10 input pulses it receives. The decade counter usually consists of a four-stage binary counter to which feedback networks have been added to reduce the counting capacity from 16 to 10 (see Binary counter). The feedback pulses simulate the effect of 6 input pulses, so that only 10 actual input pulses are required to produce an output. Neon lamps or other special tubes are used as front-panel indicators to display the pulse count.

The instrument shown in Fig. 10 uses 6 decade counters in cascade, each of which has 10 neon lamps numbered from 0 through 9. These lamps light up in sequence as input pulses are applied, and each decade feeds a trigger pulse to the next decade when it returns from 9 to 0. The number of pulses applied during a selected time interval are determined simply by reading the lamps that are on.

Densitometer: A photoelectric instrument used to measure optical density (of a photographic negative, for example). The negative is placed between a light source and a phototube so that the amount of light reaching the phototube depends upon the density of the negative. The output of the phototube is amplified and applied to a meter.

Derivative control: A form of automatic control in which the rate of correction is determined by the rate of change of the error. The corrective action is there-

fore more rapid when the error is increasing rapidly.

Dielectric heating: A form of radio-frequency heating used to raise the temperature of nonconducting substances: rubber, wood, plastics, etc. The substance to be heated is placed between a pair of metal plates connected to a high-power rf oscillator. The substance to be heated, now the dielectric of a capacitor, undergoes an increase of temperature due to dielectric losses. This type of heating is used in industry for molding plastics, glue setting, rubber curing, etc.

Differential amplifier: A type of amplifier used for measuring (and recording) the difference of potential between two points, neither of which is grounded and either or both of which may be varying with respect to ground potential. This type of amplifier is particularly useful for low-level signals because it rejects noise and stray pickup. One form of the differential amplifier is shown in Fig. 11. If both input terminals change in potential in the same

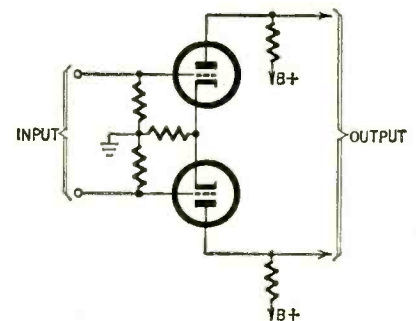

Fig. 11—Differential amplifier responds to difference of potential of input terminals but rejects in-phase interference.

direction and by the same amount (stray pickup, for example), the plate voltages will also change in potential but will still be equal to each other. The circuit, therefore, produces no output in response to in-phase pickup on the two input terminals. If the two input terminals change by different amounts or in different directions, as they would in response to a desired signal, the two plates will differ in potential. This difference is the output of the circuit.

TO BE CONTINUED

INDIVIDUAL
WIDE-VIEW
SCALE FOR
EACH RANGE
GIVES

Quick, Direct, Error-Free Readings *without Multiplying!*



New VTVM DYNAMATIC 375 Automatic Vacuum-Tube Voltmeter

- Individual Full-Size Scale for Each Range
- Range Switch Automatically Sets Correct Scale
- Only One Scale Visible at Any One Time
- All Scales Are Direct Reading
- No Multiplying . . . No False Readings
- Includes DC Current Ranges, too

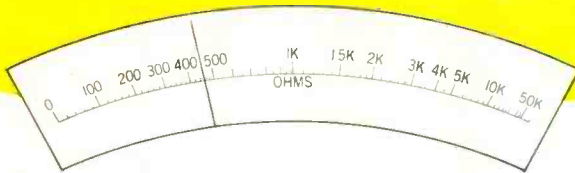

Here's another exciting first by B&K. With direct-reading single scales, this professional automatic VTVM makes it easier, faster than ever to read the exact answer accurately on the correct scale . . . without reading difficulty, calculation, or chance of error. Greatly simplifies true reading of peak-to-peak voltages of complex wave forms in video, sync and deflection circuits, pulse circuits, radar systems, etc.

All scales are direct reading. Every scale is the same full size, and only one scale is visible at any one time. Once you set the range switch properly, it is impossible to read the wrong scale.

The DYNAMATIC 375 utilizes a single DC-AC ohms probe, anti-parallax mirror, and other desired features . . . to make accurate measurements with utmost convenience and reliability in laboratory, factory production, or service shop.

Includes sturdy swivel stand which permits tilting "375" to any desired viewing angle, swings up as convenient carry-handle.

Ranges: DC Volts	0 - 1.5, 5, 15, 50, 150, 500, 1500
AC Volts (rms)	0 - 1.5, 5, 15, 50, 150, 500, 1500
AC Volts (peak-to-peak)	0 - 1.5, 5, 15, 50, 150, 500, 1500
DC Current	0 - 5 ma, 50 ma, 500 ma
Ohms	0 - 500 ohms, 5 k, 50 k, 500 k, 5 meg, 50 meg, 1000 meg

Input Resistance: 11 megohms on all DC ranges
Accuracy: $\pm 3\%$ full scale AC and DC
Meter Movement: Sensitive 100 microampere
Precision Multiplier Resistors with $\pm 1\%$ accuracy
Anti-Parallax Mirrored Scale for precise readings
Easy-to-See Iridescent Knife-Edge Pointer
Single DC-AC Ohms Probe (supplied)
Includes 1½ volt Battery. Operates on 117 volts 50-60 cycle AC
Sturdy, handsome metal case with convenient combination swivel stand and handle. **Size:** 10¾" x 6¾" x 4" deep. **Net wt:** 8 lbs.

Model 375

Net, \$89⁹⁵

See Your B&K
Distributor
or Write for
Catalog API8E

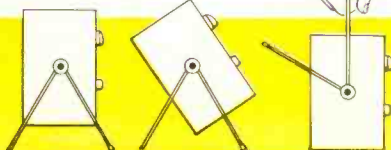

B & K MANUFACTURING CO.
 1801 W. BELLE PLAINE AVE • CHICAGO 13, ILL.
 Canada: Atlas Radio Corp., 50 Wingald, Toronto 19, Ont.
 Export: Empire Exporters, 277 Broadway, New York 7, U.S.A.



**how often
could you
have used...**

**an
Xcelite
"Seizer"?**

Handy as an extra
hand or helper.
Clamps lightly
or tightly ... for
moments or minutes.

two-position
snap-lock

slim, serrated jaws

Outreaches, out-holds needle-nose pliers. Hardly a spot too small for it. Approx. 6" long. Dozens of uses: Holds and positions wires for soldering ... retrieves small parts from inaccessible places ... it's a heat sink. Two-position snap-lock won't slip, yet releases with a twist of the fingers. All stainless steel—precis on machined and tempered for smooth action and years of service.

2 Models: No. 43H curved nose and No. 42H straight — Ask your distributor to show you Xcelite Seizers today.

XCELITE

XCELITE, INC. • ORCHARD PARK, N. Y.
Canada: Charles W. Pointon, Ltd., Toronto, Ont.

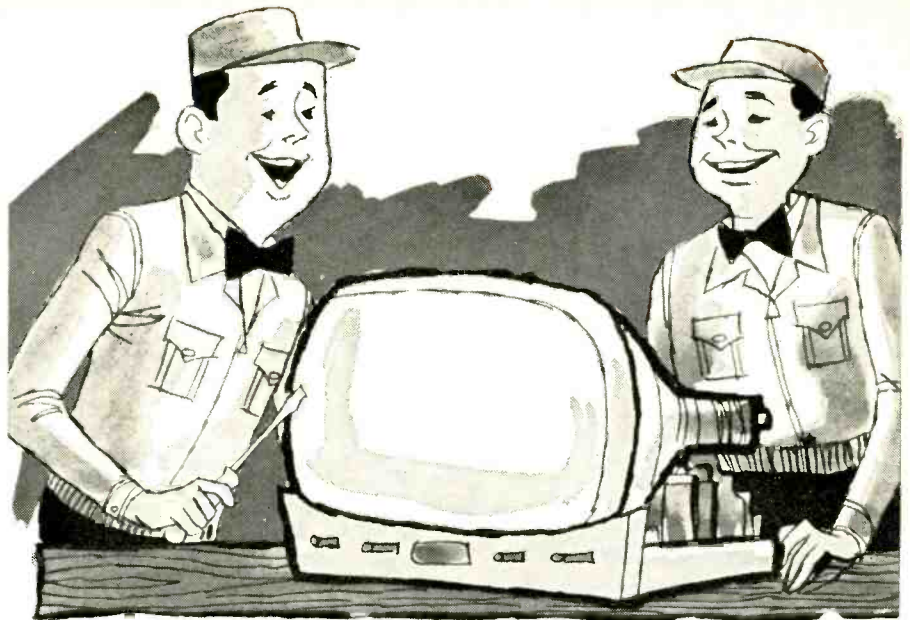

Cy and Lucky whip an intermittent

One vertical dog type trouble that wasn't as bad as it seemed

By **WAYNE LEMONS**

"I'M having trouble," said Lucky, as his boss came in the door. "Mrs. Kendall brought this Admiral in for us to fix. She says it doesn't have any picture; just a little white line across the picture tube."

"Vertical trouble, of course."

"No doubt about that," said Lucky, "but that's not the problem—not by a long shot! When I turned the set on, there sure enough was just a thin white line. So I checked the tubes and they were OK or at least they seemed to be. Well, right away I knew I was going to have to pull the chassis, so I did. But, when I turned the set back on, *AFTER* I got the chassis out of the cabinet, what do you think happened?"

"You'd dropped a spin wrench on the picture tube and broke it?" Cy asked uneasily.

"No, not that!" Lucky said with a trace of disgust in his voice. "The picture was filled out vertically as nice as you please."

"Oh, is that all?" Cy breathed a sigh of relief.

"That all!" exclaimed Lucky, "Isn't that enough? How you gonna fix a set that there ain't nothing wrong with?"

"Well, Lucky, I've had troubles like this before and I've developed some pretty crude but effective ways of finding them. But first, let's see just how much we know about this set. Did you tap the tubes to see if the vertical would go off?"

"With everything but a sledge hammer," said Lucky.

"Then we know that the tubes are probably not at fault. We also know that there was definitely vertical trouble in the set, because you saw it."

"Right."

"Now, we also know that the trouble seemed to cure itself. This means we could have a burnt resistor, a capacitor that is opening up, a broken connection or a poor solder joint."

"Oh, no you don't," said Lucky. "I've gone over this circuit with a fine-tooth comb. There just aren't any obvious troubles. I took the tweezers and moved each capacitor back and forth and jig-

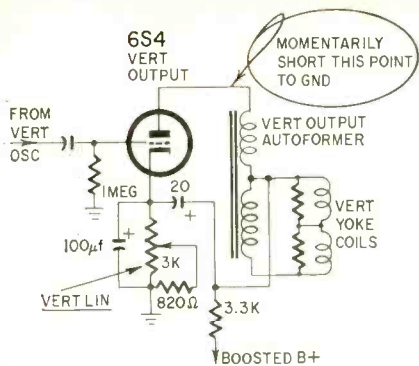

Fig. 1—Vertical output circuit that included the cause of the trouble.

gled every wire and connection in the circuit."

"Fine," said Cy picking up a screwdriver. He studied the circuit a minute, then shorted a point to ground. The vertical collapsed. Cy removed the screwdriver but the vertical deflection did not return.

"What in the world did you do?" asked Lucky.

"Simple, I shorted the plate pin of the vertical output tube to ground." (See Fig. 1.)

"What for?"

"Well, in cases like this, I always suspect transformer trouble. Either the blocking oscillator or the output. When I shorted the plate pin to ground, that placed quite a lot of voltage across the transformer primary."

"I'd say. Over 400."

"Exactly," agreed Cy. "And you

see what happened—the transformer opened up."

"But wouldn't any transformer open up with that much voltage across it?"

"Not a good one," retorted Cy. "Any good transformer would have no trouble passing that much current for a moment or so. Of course, you wouldn't want to short the circuit for very long or you'd probably blow a fuse if the transformer happened to be OK."

"What if it had been the blocking oscillator transformer?" asked Lucky. "It has a pretty good size resistor in series with the primary plus the height control also."

"Good thinking," congratulated Cy. "That's why you have to go a step further when checking the blocking oscillator transformer. You take one of our jumper wires with the insulated clip on each end and jump out the height control and the series resistor. Or if you prefer, you can just connect the jumper to any convenient B-plus point and to the B-plus side of the primary of the blocking oscillator transformer."

"Then you momentarily short out the plate side of the winding?" questioned Lucky. (Fig. 2.)

"Right," Cy replied, "and sometimes when you have transformer trouble, the vertical deflection doesn't collapse all the way. You may have insufficient height or the raster may jiggle and jump vertically even when off channel."

"What happens when you short the transformer then?" asked Lucky.

"Just about every time, if the trans-

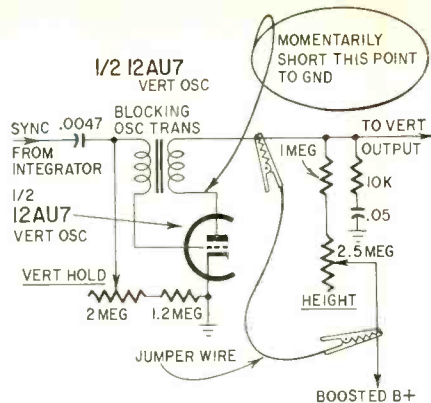

Fig. 2—Handling a set with a blocking oscillator is a little different.

former is defective, the vertical will settle down and fill out the screen. May even stay that way an hour or so."

"I'll bet you could use that method to find a noisy if or rf transformer too," reasoned Lucky.

"You sure can, if it's a case of the winding opening up. Lately with these small ifs though, the problem is one of leakage between primary and secondary, and usually the best way to handle them is to disconnect the secondary and check for a positive voltage on it."

"Well, I had better install this transformer before Mrs. Kendall comes after her set," said Lucky.

"That's the best way," Cy agreed, and smiled broadly at the pained look that crossed Lucky's face. END

MAKE YOUR INTEREST IN ELECTRONICS PAY OFF

Get
Into...

The HIGH PAY—PRESTIGE Field of TECHNICAL WRITING

HERE'S WHAT YOU GET . . .

- 50 Meaty Lessons
- Over 110 pages on Electronics
- Covers ALL Military Specifications
- Real, practical writing projects
- Full consultation privileges
- Many manuals, charts and diagrams
- Low tuition terms
- Employment Assistance
- State Approved Diploma
- Close, personal supervision
- AND MUCH, MUCH MORE . . .

ELECTRONICS WRITERS NEEDED NOW—ATWS will train you at home at low cost for a profitable career in TECHNICAL WRITING. Thousands needed in all areas. Get in on the ground floor of this fascinating new field. ATWS offers training specifically designed for the needs of industry. Course includes everything you need to become a top-notch Tech Writer.

YOU ARE JUST A STEP AWAY FROM TOP PAY—Yes, with your present interest in Electronics, you're just a step from the BIG MONEY. Technical Writing is one of the highest paying fields NOT requiring college training. It's tailor-made for YOU—but you must ACT NOW.

THIS COUPON CAN BE YOUR PASSPORT TO SUCCESS
Fill in your name and address and rush coupon for full information. We will prove to you that we can train you without interfering with your present income or job.

CAREER BOOK AND SAMPLE LESSON

American Technical Writing Schools, Inc. Dept. RE91
5504 Hollywood Blvd., Hollywood 28, Calif.

Please RUSH full particulars.

Name _____ Age _____

Street _____

City _____ Zone _____ State _____

**BOTH
FREE**

NO SALESMAN WILL CALL ON YOU

TRAINING

AMBITIOUS

MEN FOR

INDUSTRY

American Technical Writing Schools, Inc.

5504 Hollywood Blvd.
Hollywood 28, Calif.

A PROPHECY

For men and women with a sincere desire to succeed



"In the years that have passed since my days on the faculty of RCA Institutes, I have become even more firmly convinced that the individual who continues his education . . . particularly his technical education . . . is the individual who profits both as a thinking man and as a working man. Science and industry will reward you for your talents and energy. Out of your efforts may come inventions, new products, processes and services. There is everything good yet to be accomplished in our lives and in our work. What man has done, man can do better."

David Sarnoff

Chairman of the Board,
Radio Corporation of America

RCA Institutes Offers the Finest of Home Study and Resident Training for Your Career in the Rapidly Expanding World of Electronics

RCA Institutes, founded in 1909, is one of the largest technical institutes in the United States devoted exclusively to electronics. A service of Radio Corporation of America, RCA Institutes offers unparalleled facilities for technical instruction . . . tailored to *your* needs. The very name "RCA"

means dependability, integrity, and scientific advance.

RCA Institutes Home Study School, licensed by the New York State Department of Education, offers a complete program of integrated courses for beginners and advanced students rang-

ing from electronic fundamentals to automation. All courses are designed to prepare you for a rewarding career in the rapidly expanding world of electronics. *The caliber of the training you receive is the finest!* And you get top recognition as an RCA Institutes graduate!

HOME STUDY COURSES *in* *Electronic Fundamentals • TV Servicing* *Color TV • Electronics for* *Automation • Transistors*

Voluntary Tuition Plan. The important thing to remember about RCA Institutes Training is the convenient, *no-obligation payment plan*. This plan affords you the most economical possible method of home study training because you pay for each study group only when you order it. If you interrupt your course *at any time, for any reason*, you owe nothing more. You *never* have to pay for the whole course if you don't complete it. No other obligations. No monthly installment payments!



RCA Instruction is Personal. With RCA Home Study training you set *your own pace* in keeping with *your own ability*, finances, and time. The Institutes allows you ample time to complete the course. Your lesson assignments are individually graded by

technically trained personnel, and helpful comments are added where required. You get theory, experiment, and service practice beginning with the very first lesson. All lessons are profusely illustrated. You get a *complete training package* throughout the entire course.

You Get Prime Quality Equipment. All kits furnished with the course are complete in every respect, and the equipment is top grade. You keep all the equipment furnished to you for actual use on the job . . . *and you never have to take apart one piece to build another!*

* * *

RESIDENT SCHOOLS *in* *Los Angeles and* *New York City* train you for any field of *Electronics* you may choose!

No Previous Technical Training Required For Admission. RCA Institutes Resident Schools in Los Angeles and New York City offer training that will prepare you to work in re-

warding positions on research and production projects in fields such as automation, communications, technical writing, television, computers, and other industrial and advanced electronics applications. Even if you did not complete high school, RCA will prepare you for such training with courses specially designed to provide the basic math and physics required for a career in electronics.

Free Placement Service. RCA Institutes graduates are now employed in important jobs at military installations such as Cape Canaveral, with important companies such as IBM, Bell Telephone Labs, General Electric, RCA, and in radio and TV stations all over the country. Many other graduates have opened their own businesses. A recent New York Resident School class had 92.06% of the graduates who used the Free Placement Service accepted by important electronics companies . . . *and had their jobs waiting for them on the day they graduated!*



**SEND POSTCARD FOR FREE
 ILLUSTRATED BOOK TODAY!
 SPECIFY HOME STUDY OR
 RESIDENT SCHOOL**

Coeducational Day and Evening Courses. Day and Evening Courses are available at Resident Schools in New York City and Los Angeles. You can prepare for your career in electronics while continuing your normal full-time or part-time employment. Regular classes start four times each year.

RCA INSTITUTES, INC. A SERVICE OF RADIO CORPORATION OF AMERICA, 350 W. 4th St., New York 14, N. Y., 610 S. Main St., Los Angeles 14, Calif.



The Most Trusted Name in Electronics



STOP!
Demand the finest in Electronic Test Equipment—EMC, of course. You get the most quality per measurement dollar!

NEW! EMC Model 301 Speedi Tube Tester

Checks tubes in seconds. Checks shorts, leakages, and quality. Over 375 tubes, including OZ4, now listed. New listings available. Uses line voltage regulation. Checks and rejuvenates Picture Tubes with Model PTA (Picture Tube Adaptor), at only \$4.50. Model 301P (illustrated),



with 4 1/2" meter & oak Carrying case \$47.50
Kit 33.20
Model 302C, (with 7 1/2" meter) 62.90
Kit 47.90

NEW! EMC Model 108 Handi Tester

The only appliance and auto battery tester in its price class to use a D'Arsonval, instead of an iron vane type meter. Gives exclusive advantages of maximum accuracy and scale length, and minimum battery replacement cost... at no added charge. Complete with test leads and instruction manual.



Wired \$15.95 Kit 12.95

NEW! EMC Model 905-6A Battery Eliminator, Charger, and Vibrator Checker

A MUST for auto radio service. Features continuously variable voltage output—in either 6 or 12 volt operation. Checks all 6 or 12 volt vibrators.



Wired \$67.90 Kit 44.90

NEW! EMC Model 601, Wide Band Oscilloscope for Color & Monochrome TV

Features full 5 mc band with push-pull vertical amplifier with sensitivity .02 volts per inch, retrace blanking amplifier for clearer pictures, and multivibrator sweep from 15 cycles to over 75 kilocycles. Wired and tested ... \$117.90

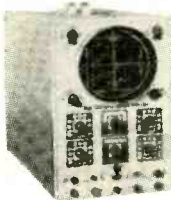

NEW! EMC Model 206P Dynamic Mutual Conductance Tube Tester

The lowest priced mutual conductance tube checker on market. Checks tubes for microhm value and gas content. Completely flexible switching. Your best buy in a quality tube tester. (Hand rubbed Carrying Case)\$83.50

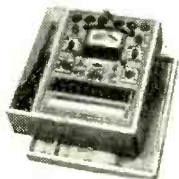

Yes, tell me more, send me **FREE** a detailed catalog of the Complete EMC Line. Dept.RE-961

NAME
STREET
CITY STATE

EMC Electronic Measurements Corp.
625 B'way, New York 12, N. Y.
Ex. Dept., Pan-Mar Corp., 1270 B'way, New York 1, N. Y.

NEW IDEAS IN KITS

A stereo amplifier and an FM tuner.



The LT-10 tuner kit, ready to start wiring.



The completed amplifier and tuner make an attractive matched pair.

By LARRY STECKLER

ASSOCIATE EDITOR

FROM TIME TO TIME WE ALL FIND OURSELVES on a tight budget. Often, at the same time we are interested in a new TV, radio or hi-fi component. When this happens, we look for the least expensive way of getting what we want. One solution is to buy a kit—a package of parts and instructions that will enable us to build the device we want and save the assembly cost. For hi-fi equipment this is ideal, and many manufacturers offer kits that keep costs to a minimum, yet produce a quality instrument.

The crude kits of just a few years ago have little in common with those available today (except that they are all "kits.") There have been many improvements and changes in a very short time. Let's take a look at two of the newest kits to reach the high-fidelity marketplace. One is a stereo control amplifier and power amplifier combination; the other is an FM tuner. Both are made by an old name in the hi-fi business—H. H. Scott.

As soon as you open the box, you find a different approach to kits. The box turns out to be the work table. You just open it up on whatever surface you intend to work on, and do all wiring and assembly right in the packing case. It holds the chassis, parts and instruction book right where you can get at them. And when you're

finished for the day, simply close the lid and put the kit away. No more half-assembled kits sitting around on a table top waiting to be completed. (Incidentally, when the kit is completed, save the box it came in. It makes a handy emergency suitcase when the need arises.)

The instruction book too is a great improvement over earlier types. Each page of assembly instructions has its own pictorial diagram showing the arrangement of *only the particular parts* that are installed in the steps on *that page*. And, the diagram is in color. Red leads are red, yellow ceramic capacitors are yellow and resistors have true-to-life color stripes. It adds up to a big help when trying to check connections of a particular lead or component.

TABLE I

CHARACTERISTICS OF THE SCOTT LT-10 FM TUNER

Sensitivity (1HFM).....	2.5 μ v
Signal-to-noise ratio.....	60 db below 100% modulation
Total harmonic distortion.....	0.8%
Frequency deviation.....	0.2%
Frequency response.....	20-20,000 cycles \pm 1 db
Intermodulation distortion.....	0.3%
Hum.....	66 db below 1 volt
Audio output (100% modulation).....	0.8 to 1.2 volts
Tuning range.....	87 to 109 mc
Output impedance.....	3,000 ohms

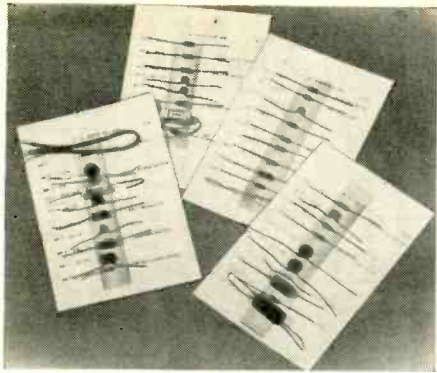

Parts and leads are mounted on cards and arranged in the order in which they are used.

It is also a safety check against placing the wrong part in the wrong place.

As soon as you start assembling the kit, another surprise greets you. Remember when kits were new and all resistors and capacitors were just lumped together in one big envelope? You picked the particular part you needed out of a heap that contained all the resistors and capacitors in the kit. Later on, the resistors and capacitors were separated into envelopes. And recently, resistors and capacitors have been mounted on cards along with their code numbers for identification—R1, R2, R3, etc. Scott takes this last idea one step further. You don't even have to hunt for parts on the cards. All those little resistors, capacitors, even some of the leads (in the tuner kit) are arranged on cards—in the order they are used in the construction process.

For example, on page 15 in the instruction book for the LK-72 amplifier is assembly group BF-5. Step BF5-1 (the first on this page) calls for a 470,000-ohm resistor. At the top of the parts card for this page (also marked BF-5) is a 470,000-ohm resistor marked BF5-1. The next part called for is a 220- μ f ceramic capacitor. It is the second part on the same card. And so on.

An admirable feature is that all sockets and terminal strips are already fastened to that chassis. I like this feature; it eliminates what is the annoying part of kit building to me. I don't mind the wiring and stuff, but the tedious mounting of sockets, only to discover that one is backward or you left off a solder lug, I can do without. Some kit builders feel that since the unit is a kit, they want to do everything and that includes attaching the sockets. Maybe they're right. It might make that particular kit a bit less expensive.

When the kit is completed and you're ready to plug in the tubes, you don't have to consult anything but the chassis of the unit you have built. On that chassis, next to each tube socket is clearly imprinted the tube type. Transformers and electrolytic capacitors are marked in the same manner.

Now that we've seen what makes these kits a pleasure (almost) to build, even for the nonelectronic-minded person, let's see what the kits have to offer

on the electronic and high-fidelity side of the ledger. We'll take the tuner kit first.

The LT-10 FM tuner

The unit uses six tubes and two semiconductor diodes. The front end is a pre-aligned unit incorporating a local oscillator and mixer. Construction time from start to finish was 5 hours, and it won't take an inexperienced builder too much longer.

One thing some audiophiles are going to notice right away is the lack of an afc circuit. The Scott tuner has no afc because it doesn't need it. The front end is designed so that, as it heats up, temperature-compensated components adjust (automatically) for any circuit changes that might otherwise cause the tuner to drift. After using the tuner for several months, I can safely testify to the drift-free reception of this unit.

There are two 6AU6 if amplifiers in a high-selectivity if strip that keeps out all stations but the one you want. A station close to the one you have tuned in won't feed through the if strip and appear in the background as a disturbing murmur. A 6U8 (pentode section) limiter with a wide bandpass (2 mc) removes man-made or electrical interference. The detector uses two semiconductor diodes in a ratio-detector circuit which has some additional limiting action of its own. It too is a wide-band unit with a 2-mc bandpass.

PHOTO FANS

watch for this one next month

BUILD A BETTER LIGHT METER

Easy to build and it will give you accurate readings right down to light levels so low they call for 30 seconds exposure. Not expensive either. Uses a cadmium sulphide cell. October issue.

on sale September 14.

If you're concerned about adding a multiplex adapter now that FM multiplexing has been okayed by the FCC, you've got nothing to worry about. The tuner is designed with multiplex in mind, and is easily adaptable. Originally the multiplex adapter was to go right on the tuner chassis. Unfortunately, things did not work out this way. When the adapter was mounted on the chassis, tuner sensitivity dropped. Now, a small adapter plugs into the tuner and sits behind it out of sight. The adapter controls mount on the front panel of the tuner.

The adapter kit will include a new front panel for the tuner that will be

Maximum power output each channel (music waveform)	36 watts
Total harmonic distortion at rated output	0.8%
Frequency response	20-20,000 cycles \pm 0.5 db
Intermodulation distortion	0.3%
Signal for rated output (tape input)	3 mv
Signal for rated output (magnetic cartridge, low)	3 mv
Signal for rated output (magnetic cartridge, high)	9 mv
Signal for rated output (tuner, extra, playback)	0.5 volt
Hum and noise (low-level inputs)	80 db below rated power
Hum and noise (high-level inputs)	10 μ v
Scratch filter	above 5,000 cycles
Treble boost and cut (at 10 kc)	15 db \pm 2 db
Bass boost and cut (at 50 cycles)	15 db \pm 2 db

properly marked for the adapter. Also, the LT-10 meets the requirements for a multiplex adapter. It offers more than just a jack marked multiplex. It has the necessary if bandwidth (to 150 kc), the signal-to-noise ratio (better than 60 db) and the low distortion needed for satisfactory stereo FM multiplex reception. Table I gives a rapid rundown on the important specifications of this tuner. Using the indoor antenna that comes with the kit, I logged 24 FM stations from a location about 20 miles from New York City.

The LK-72 stereo amplifier

The amplifier half of the hi-fi pair delivers 36 watts of music per channel. It took a flat 12 hours to get it from kit to working amplifier. Eleven tubes and a full-wave selenium rectifier are used. The dual amplifiers are identical so, if we deal with only one channel, we cover both.

The first audio amplifier stage (actually a pre-preamplifier) is a twin-triode 12AX7. Weak signals from magnetic cartridges or tape heads are fed to this stage. To avoid any possibility of hum, this tube along with the 12AX7 amplifier following it have a dc heater supply. Following the pre-preamplifier and first audio amplifier stages is a pentode-triode 7199. It acts as the second audio amplifier and the phase splitter that drives the push-pull out stage. The specially designed phase splitter with matched components eliminates the need for separate ac and dc balance controls.

The output stages use two 7591 pentodes to deliver a 36-watt output. The full 36 watts of output is available over the entire audio-frequency range—from slightly below 20 cycles to slightly above 20,000 cycles.

There are separate bass and treble controls for each channel. The switch-selected volume-loudness control is ganged and adjusts both channels simultaneously. A balance control compensates for minor differences in speakers. A complete listing of the important characteristics of this amplifier are in Table II.

END

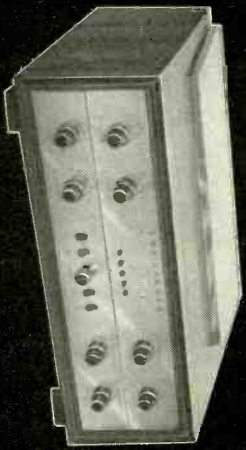

110-Watts

The Fabulous

FISHER

X-1000

Stereo Master

Control-Amplifier

The FISHER X-1000 is the most powerful control-amplifier in existence! Its extremely flexible Master Audio Control is combined with a 110-watt dual-channel amplifier. A special feature is the exclusive Fisher internal switching system that permits the monitoring of tapes and the use of all tone controls and switches during playback without changing cable connections. The Center Channel Speaker Output eliminates the need for a third amplifier. A center channel output is provided for connection to a third amplifier and speaker permitting a remote installation. Precise blending of the two stereo channels is accomplished with the Stereo Dimension Control. The Space-ender Control for operation of a reverberation system. Attractive architectural brass-finish front control panel.

\$329.50
 Walnut (20-DXW) and Mahogany (20-DXM)
 Cabinets for the X-1000 **\$24.95**

USE THIS COUPON
FISHER RADIO CORPORATION
 LONG ISLAND CITY 1, N. Y.

Please rush FREE literature on the following:

- Specifications on the FISHER X-1000
- Complete Catalogues on FISHER equipment
- Illustrated Custom Stereo Installation Guide

Name _____

Address _____

City _____ State _____ RE-5

TV Service CLINIC

conducted by

JACK DARR, SERVICE EDITOR

This is your column in the magazine: the service is absolutely free; there is no charge for answering your questions, and your name and address will be kept confidential if you so wish. The main purpose is to help everyone working in electronics with their unusual problems. Send in your questions; each one gets an immediate personal answer. Later, the more interesting cases are published in the Clinic columns.

Due to the many peculiarities found in commercial TV circuits, you might find a different answer to a question than the one we give, even though the "conductor" of this column is himself a full-time professional TV technician. We would be interested to hear of such cases, as we feel that the more widespread the knowledge of such peculiarities, the better off we'll all be! So, if you have an unusual service job, or one which is giving you trouble from an obscure cause, send in a question on it; we'll answer it promptly and to the best of our ability.

CLEANLINESS IS NEXT TO GODLINESS, AS the old saying goes, and that's never more true than in a TV tuner. Outside of vertical rolling (intermittent, of course), I believe that this is about the most annoying complaint to the customer. The typical symptom: he turns the channel-selector knob to channel 5 and nothing happens! Turning to channel 8, the picture comes in; back to 5 and now he gets a picture. The next thing he gets is a technician!

This trouble is common to all tuners, turret, incremental-inductance or switch types. Even the old continuous jobs such as the Inductuner suffered from it. In the modern tuner, there are a minimum of eight contacts which must be made for each channel.

The switch contacts in practically all tuners are silver-plated over a base of copper, brass, etc. After a certain amount of use and exposure to the atmosphere, these contacts develop a resistive coating. While this is ordinarily called oxidation, it isn't necessarily so. In quite a few cases, this turns out to be sulphation from sulphur-bearing gases in the air. So the coating on the points is a sulphide or sulphate instead of an oxide. Fortunately, the processes for dealing with them are about the same.

The easiest method is to use a spray cleaner. They are packed in pressurized cans and many of them have a long steel needle to allow spraying the cleaner deep inside a tuner without taking it out of the cabinet. (*Keep the set turned off while prodding around inside a tuner with this conductive needle!*)

Many of the later TV chassis have separate tuners, which can be removed for servicing without taking the main chassis out at all. These are simple to clean up, but some of the older ones are

more difficult. The shining example of this, of course, being the old set which had the tuner mounted *under* the chassis, so that the set had to be pulled to change the tuner tubes!

However, most tuners are accessible enough for spraying. Spray the cleaner through any accessible holes on the top and sides, while turning the channel-selector switch.

Continue turning, spraying and checking until all stations come in without having to wiggle the knob to make contact. If it won't do this, you'll have to pull the chassis so you can take the tuner apart.

After the chassis is out, remove the bottom shield to expose the switch contacts. On turret tuners, take out enough of the coils to allow access to the row of contact points. Spray cleaner over all switches, turning the selector while this is going on. A good cleaning compound will evaporate almost entirely, leaving only a very thin lubricating film on the contacts. After quite a bit of experience, we wouldn't recommend using carbon tetrachloride for cleaning tuners. Beside the health hazard, it dissolves *all* lubrication, making detents hard to turn, switches drag, etc.

Any lubrication in a tuner must be sparing. Too much grease or oil will eventually find its way onto the contacts and you've got more troubles. Use only the cream type lubricants on detents and other mechanisms. Because of their higher viscosity they stay in place better than the rest.

For cleaning badly worn or dirty contacts, use something that will dissolve the residue of dirt then polish them with a dry piece of cloth. The rougher the surface of the cloth, the better; something like unbleached muslin, old cotton workshirts and such material is fine. The surface of this

kind of cloth has just about enough abrasive material to give the contacts a high polish. Switch tuners and other inaccessible places can be cleaned like this by wrapping a very small piece of cloth around the end of a matchstick and *very carefully* polishing them. While poking around inside a tuner, be awfully careful not to move any of the coils or wiring or you may find yourself with a tuner realignment job on your hands!

When you're through, see that the tuner contacts are as dry as you can possibly leave them! This is necessary to avoid a rapid buildup of dust, dirt, lint and other material on the tuner contact points. If you think they must be lubricated, put a very small amount of lubricant on your fingertip, rub your fingers together and then over the surface to be oiled. This leaves a very thin film of lubricant and is usually just about the right amount.

Pipe cleaners are very useful in applying solvents or lubricant to inaccessible places, but be sure that no lint is left where it could get between contacts. They're handy for the process just described. Put a tiny dab of lubricant on the end of the pipe cleaner, then try to wipe it as dry as you can by squeezing it between your fingers. This leaves just the right amount on the tip.

In some cases, you'll find that dirty-contact symptoms are actually caused by loose rivets or bent contacts in the

Fig. 1—Circled components show where 60-cycle signal may be getting into vertical circuits.

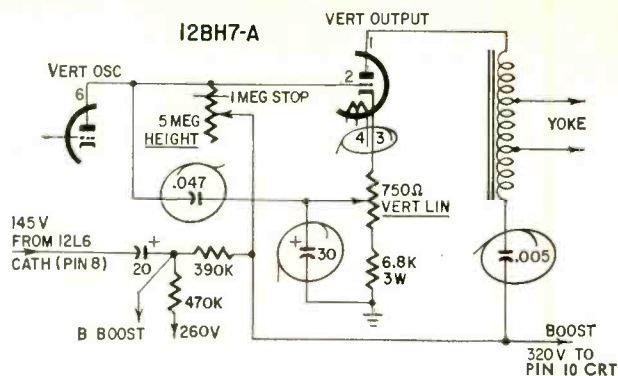

tuner. The rivets can be resoldered. The bent contacts can be straightened with a relay tool—a small metal rod with a split end, used by telephone technicians for adjusting relay points. Often, a soldering aid tool with a split end will do the work, unless the space is too small to allow it to get in there.

One final word, in some tuners the manufacturer placed a special impregnated paper, which was treated with a chemical supposed to prevent sulphation of contacts. The latest word from his service department on this is, and I quote, "Take it out! It didn't work!"

Vertical distortion

I've got a Crosley H-21COWUc in the shop and the vertical linearity is awful! It's stretched at the top from three-quarters of the way up, and the bottom

is compressed. I'm about to give up! Help!—J. F. P., Schenectady, N. Y.

Don't give up; help is on the way. From the symptoms this is probably caused by a good-sized 60-cycle sine wave feeding into the vertical output stage somehow (Fig. 1). Possibilities: heater-cathode leakage in the tube, or a defective electrolytic filter capacitor. The clue here is the excessive stretch at the top and the crowding at the bottom, typical of a vertical sweep which is sinusoidal instead of linear.

Misplaced ion trap?

When is it necessary to misplace the ion-trap magnet to light up a picture tube? I have three sets, and the ion-trap magnets on all of them have to be moved back until they touch the
(Continued on page 88)



HERE'S THE NEW, 2-WAY HAND-HELD TRANSCIVER THAT
OUTPERFORMS 'EM ALL!

PERSONAL Messenger

- No license required—may be used at once!
- Meets FCC requirements for use with licensed Citizens' Band stations, too!

This is the new "Personal Messenger"—a superbly engineered 2-way crystal-controlled transceiver so compact it fits in your hand—so flexible it can be used in thousands of applications! 11 transistors and 4 diodes—superheterodyne receiver with exclusive tuned R.F. amplifier gives you twice the sensitivity and more than 40% more range than units with conventional circuitry! Powerful two-stage transmitter delivers more power output than similar units with the same rated input! Unmatched audio intelligibility and razor-sharp voice reproduction—automatic noise limiter—automatic volume control—positive squelch control—elastic hand strap—operates on penlight or rechargeable nickel-cadmium batteries. **\$109.50**

ILLUSTRATED AT LEFT—The Viking "Messenger"—maximum legal power Citizens' Band crystal-controlled transceiver. Excellent receiver sensitivity and selectivity—highly efficient transmitter punches your signal home! Built-in squelch—AVC—ANL. With tubes, push-to-talk microphone and crystals for 1 channel. **FROM \$134.95**



Delivery or fleet operation



Your own personal use



Construction or Business

FREE
Color Brochure



WRITE TODAY



E. F. JOHNSON COMPANY

911 Tenth Avenue S. W. • Waseca, Minnesota

• Please rush me your full color brochure.

NAME _____

ADDRESS _____

CITY _____ STATE _____

Manufacturers of the world's most widely used personal communications transmitters

LAFAYETTE is America's Citizens Band Headquarters

Complete Portable Communications for Everyone



Ship to Shore



On the Farm



Construction Work

NO LICENSES, TESTS OR AGE LIMITS



HE-29A

PORTABLE—POCKET SIZE Only 6 3/4 x 3 1/4 x 1 5/8"

LAFAYETTE 9 TRANSISTOR CITIZENS BAND "WALKIE TALKIE"



Complete with Leather Carrying Case, Earphone, Antenna, Batteries, and Crystal

39.95
2 for **78.88**
NO MONEY DOWN

- Completely Wired—Ready to Operate • Fully Transistorized—9 Transistors plus 1 Diode • Uses Inexpensive Penlight Batteries
 - No License, Tests or Age Limits • Comes with Leather Carrying Case, Earphone, Antenna, Batteries and Crystals
- As simple and easy to use as the telephone—and twice as handy. Receives and transmits up to 1.5 miles under average conditions. Weighs only 18-oz. and slips into your pocket. Push-to-talk button operates built-in speaker as sensitive microphone.

Deluxe CITIZENS LAFAYETTE HE-20A BAND TRANSCEIVER

ONLY **109.50**
NO MONEY DOWN



Made in U.S.A.

Now With Added Deluxe Features—

- Pi-Network for Greater Power Output • Calibrated "S" Meter
 - 14 Tube Performance, 3 Diodes • Built-in 12 Volt Power Supply for Mobile Use • Complete with Matched Crystals for Channel 9
- A highly efficient 2-way communications system operating over a distance of up to 20 miles or more depending on terrain. Features

4 crystal-controlled transmit positions and 4 crystal-controlled receive positions. Tuneable superhet receiver covers all 23 assigned channels. Other highlights include dependable push-to-talk ceramic mike & relay, adjustable squelch control, automatic series gate noise limiter and illuminated dial.

LAFAYETTE HE-15A

Made in U.S.A.

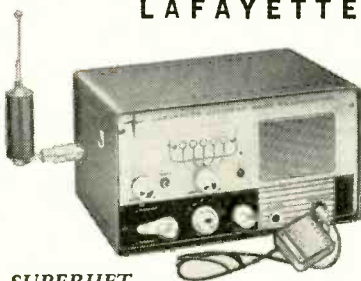

SUPERHET

Citizens Band TRANSCEIVER

- Completely Wired—Not A Kit • 5 Crystal-Controlled Transmitting Positions • Tuneable Receiver Over Full 23 Channels • High Output Ceramic Microphone • Complete with Transmitting Crystal for Channel 9

A compact, precision transmitter and receiver covering up to a 20 mile or more radius, depending upon conditions. The HE-15A features an effective full-wave variable noise limiter, planetary vernier tuning, RF and microphone jack, on front panel. 12 tube performance from 4 dual-function tubes, 2 single-function tubes, 2 rectifiers.

HE-19 Telescoping Whip Antenna	Net 3.95
HE-16 Power Supply for 12 Volts	Net 10.95
HE-18 Power Supply for 6 Volts	Net 10.95

ONLY **59.50**
NO MONEY DOWN

NOT A KIT

LAFAYETTE All-in-One CITIZENS BAND MOBILE ANTENNA

6.95

HE-800WX

- Chrome Swivel Base • Stainless Steel Spring
- 102 1/2" Stainless Steel Whip for Optimum 11-Meter Performance

Chrome swivel ball mount base designed for mounting on any surface. Stainless steel spring holds rod in properly adjusted position and prevents rod damage from shocks and blows. Stainless steel whip for maximum resiliency and strength.



NEW! LAFAYETTE RADIO FIELD INDICATOR

6.95

- Continuously Indicates Transmitter Output • Rugged 200 ua Meter Movement • Requires No Electricity, Batteries or Transmitter Connection

Check the performance of marine, mobile or fixed transmitter. Features a 200 ua meter movement with variable sensitivity control. Earphones can be plugged in for an aural check of output. Antenna extends from 3 1/4" to 10 3/4". Magnet on bottom plate allows easy mounting on car dash or metal surfaces. Size, less antenna, 3 1/8 W, 2 1/4 H, 2" D.



TM-14

LAFAYETTE RADIO

PLEASE INCLUDE SHIPPING CHARGES WITH ORDER

165-08 LIBERTY AVENUE, JAMAICA 33, N. Y. • OTHER LOCATIONS

NEW YORK, N. Y.
100 6th Avenue

NEWARK, N. J.
24 Central Avenue

BRONX, N. Y.
542 E. Fordham Rd.

PARAMUS, N. J.
182 Route 17

BOSTON, MASS.
110 Federal Street

PLAINFIELD, N. J.
139 W. 2nd Street

LAFAYETTE

Engineered To Professional Standards . . . Designed For The Home . . . Dedicated To Music



STEREO HIGH-FIDELITY COMPONENTS

Announcing... The New Lafayette Multiplex Tuner

NEW! LAFAYETTE LT-700 Criterion

FM STEREO MULTIPLEX TUNER

Ready for Stereo and no Adapter Needed . . . opening a new era in stereo, the new Lafayette Criterion FM Stereo Multiplex Tuner is entirely self contained with its own built-in multiplex facilities. Capable of achieving the highest Laboratory Standards, its exceptional selectivity and sensitivity together with drift-free AFC performance insures effective reception of even the weakest multiplex or monaural FM signals.



FACTORY WIRED & TESTED **129.50**



KT-250A 50 WATT INTEGRATED STEREO AMPLIFIER

KT-250A **74.50** LA-250A **99.50**
in Kit Form Completely Wired

- Separate Bass & Treble Controls • 3rd Channel Output
 - Response: 15-40,000 cps \pm .5db (at normal listening level)
 - 50-Watts Monophonically—25 Watts Each Stereo Channel
- Pacesetter quality, performance and design. Features include: unique "Blend" control for continuously variable channel separation—from full monaural to full stereo, 4-position Selector, Mode, Loudness and Phase switches. Also provides outputs for 4, 8, and 16 ohm speakers. Hum-free operation is insured by use of DC on all preamp and tone control tubes. Individual bias and balance controls. Harmonic distortion, less than 0.25%. IM distortion, less than .5%. Hum and noise 77db below full output. 14½Wx-12¾Dx5½"H. Shpg. wt., 28 lbs.

Made in U.S.A.

KT-600A Criterion

PROFESSIONAL STEREO CONTROL CENTER

KT-600A **79.50** LA-600A **134.50**
in Kit Form Completely Wired

- "Null" Balancing System • Response 5-40,000 cps \pm 1 db
- Bridge Control Provides Variable 3rd Channel Output
- Tape Head Playback Equalization for 4-Track Stereo
- Variable Cross Channel Signal Feed Eliminates Hole-In-The-Middle Effects

Sensitivity 2.2 mv for 1 volt out. Dual low impedance "plate follower" outputs 1500 ohms. Less than .03% IM distortion; less than .1% harmonic distortion. Hum and noise 20 db below 2 volts. 14x10¾x4½". Shpg. wt., 16 lbs.



Made in U.S.A.

KT-550 Criterion

100-WATT BASIC STEREO AMPLIFIER

Made in U.S.A.



- Rated at 50-Watts per Channel
- Response from 2-100,000 cps: C-1 db at 1-Watt
- Massive Grain Oriented Silicon Steel Transformer
- Multiple Feedback Loop Design (over 50 db)
- Metered Calibration Control Panel
- Absolutely Stable Under Any Conditions of Load

A new "Laboratory Standard" dual 50-watt amplifier guaranteed to outperform any basic stereo amplifier on the market. Advanced engineering techniques plus the finest components ensure flawless performance. Distortion levels so low they are unmeasurable. Hum and noise better than 90 db below 50-watts. Complete with metal enclosure. 9¾Hx12½"D. Shpg. wt., 60 lbs.

KT-550 **134.50**
in Kit Form

LA-550 **184.50**
Completely Wired

Lafayette's NEW Easy-Pay Plan.
NO MONEY DOWN

FREE!

YOURS FOR THE ASKING —



Lafayette Radio, Dept. J11-2
P. O. Box 190, Jamaica 31, N. Y.

Send FREE 1962 Catalog featuring the complete line of Lafayette Stereo Components.

\$ Enclosed for Stock No.....

Name.....

Address.....

City..... Zone..... State.....

(Continued from page 85)

socket for the brightest picture, and then it's not bright enough.—S. L. O., Duncanville, Tex.

Actually, your ion-trap magnets or beam benders are *not* misplaced. The correct location is where the picture is the brightest. On some tubes, two locations are found—one near the yoke, the other close to the base of the tube. In general, the beam bender should always be set at the location closest to the base. This keeps it from disturbing magnetic fields of the yoke, magnetic focusing devices, etc.

If you are using the original ion-trap magnets on old sets, it is possible that their magnetic strength has fallen off. Try one of the new adjustable types, changing the setting of the shunt bar until the brightest picture is obtained.

To set a beam bender correctly, find the place which gives light on the screen. Then, move the beam bender about this location, back and forth and around the neck, until you get the brightest picture possible. Never adjust the ion-trap magnet to eliminate neck shadows or to position the raster. If the tube uses magnetic positioning and focusing, adjust focus and positioning coils for best results. Then make the final adjustment of the beam bender for *maximum brightness*. This will give best tube life, and avoid ion burns on the CRT screen.

Tuner drift

I have two sets on the bench with the same symptom—frequency drift in the tuner oscillator. This happens after they have been turned on for an hour or so, sometimes not at all.—L. G., Chicago, Ill.

The cure for this is simple. There aren't many parts in the tuned circuits in a TV oscillator! This is obviously a thermal drift. Wrap a piece of heavy wire around the tip of your soldering iron and carefully warm up the small capacitors connected to the *grid* of the oscillator tube. Some sets use capacitors in the plate; check these and any resistors in that circuit too.

Intermittent retrace lines

I have a Packard-Bell 2040 with vertical trouble. It plays, on the bench, for quite a while, then vertical retrace lines show up, and it jitters, then rolls slowly and drifts up and down for 3 or 4 inches.—M. J., Portland, Ore.

This is caused by a weakness somewhere in the vertical oscillator/sync circuits. I'd replace both vertical oscillator and sync tubes first, and check it.

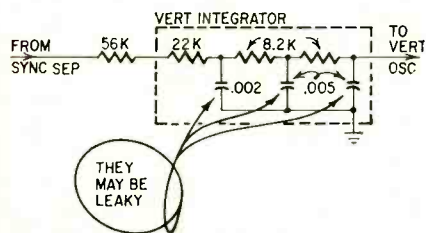

Fig. 2—Leaky capacitors in vertical discriminator may be causing vertical drift.

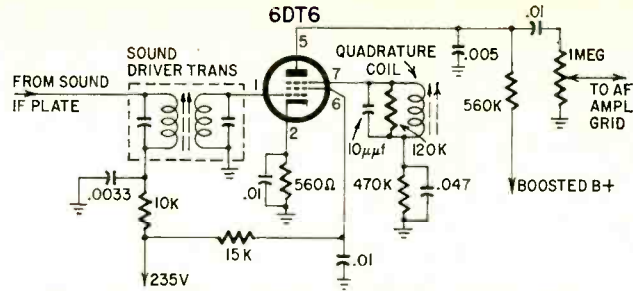

Fig. 3—Check quadrature coil for intermittent sound, also 15,000-ohm screen resistor and all solder joints.

If this doesn't stop the drifting, check operating voltages, especially the plate voltage, around the vertical oscillator and sync separator circuits.

The appearance of retrace lines is just a signal that the set is getting ready to fall out of sync. When they show up, it means that the vertical oscillator is drifting just slightly so as to change the phase of the vertical pulses and you lose cancellation of the retrace lines, and soon she starts rolling.

Trace the sync pulse with a scope. If it isn't high enough, find out why. A plate load resistor in the vertical sync tube rising in value is a common cause of this. Leaky shunt capacitors in the vertical integrator are another common cause (Fig. 2). Check these for leakage, and replace any that show more than just a very slight leakage. Leaky coupling capacitors on the sync input are also good suspects.

Chronic 1X2 breakdown

I have been getting return calls on an RCA CT-1708. The 1X2-B breaks down after a few days. The flyback transformer has been replaced. I also installed a modification suggested by the distributor.—K. A. L., Honey, B. C.

Your trouble is probably caused by excessive filament voltage on the 1X2 tube. When the flyback was replaced, was the 3.3-ohm resistor underneath the 1X2 socket checked? Some versions of this chassis omitted this resistor. If it is not there, add one. This will lower the 1X2's filament temperature and should give longer life.

A test adapter for the 1X2 can be made from a nine-pin socket adapter sold for making voltage measurements on inaccessible sockets. Tack a pilot-light socket to pins 2 and 9, and insert a 1.4-volt flashlight bulb. Plug it into the 1X2 socket and fire the set up. The brightness of the bulb is a surprisingly good way to determine whether an overload exists. If the voltage is too high, install a resistor about 1 ohm higher than the one present.

Intermittent sound

After running an RCA KCS-120 for about an hour, the sound stops suddenly. Picture OK. Sometimes it goes 2 hours, sometimes 3. Banging the chassis or tapping tubes won't bring it back. If I advance the volume control, the sound pops on and then dies out again.—H. S., Chelsea, Mass.

This is most likely to be a defective

quadrature coil in the suppressor grid circuit of the 6DT6 (Fig. 3). That or some standard printed-circuit trouble—a bad solder joint somewhere. The quickest way to find trouble like this is signal tracing. After the sound cuts out, inject a signal into the part where the trouble seems to be centered—a 4.5-mc signal into the input, or an audio signal from the volume control on out. Once trouble has been pinned down to a certain section, resolder all the joints in that circuit. This seems to be the most reliable way to do it.

One last check: several cases of puzzling trouble in this circuit are caused by the screen resistor on the 6DT6. Check it!

Pix-tube query

I'm making a custom installation of a Philharmonic 8820 TV. The 21EP4 tube is bad, and I want to use a 21DQP4 to conserve space in the cabinet. Will this work if I use a Stancor DY-13A yoke? There is about 12 kv at the second anode now.—H. W. L., Minneapolis, Minn.

This conversion should work out all right. There should be sufficient reserve power in this chassis to give you the added deflection with the yoke you mention. Your original yoke had a 8.5-mh horizontal winding, while the new one has a 12.5-mh winding. You may have to add a little capacitance across the damper to get more width, but, in general, I'd say it would be OK.

If you encounter ringing, change the network in the yoke. Because of the unpredictability of the circuit in cases like this, you'll have to cut and try here, but it should be fairly simple. END



"The TV sets in the neighborhood are distorting my diathermy machine."

What's Your EQ August Solutions

Yuletide Effect

The 80- μ f electrolytic capacitor in the output of the B-supply filter is defective. It had an extremely high power factor, coupled with a severe loss of capacitance, although there was no perceptible hum in the sound. This allowed the horizontal oscillator to receive peaks or pulses probably fed back through the boost in some way and caused it to break into sporadic oscillation on each cycle. This broke up the time-constant circuits in the yoke, etc., and stopped the output stage from functioning properly.

A Lighting Problem

The switching is accomplished by an arrangement of rectifying diodes. In position 1, the positive pulse from the ac generator is passed through the single wire into the box with the bulbs. This pulse is accepted only by the rectifier hooked up in the same polarity and blocked by the other rectifier, the resulting current flow lighting the red bulb. In position 2, the opposite occurs and the blue bulb lights. In position 3, pure ac is passed into the first box and both bulbs light, one from the position pulse and the other from the negative pulse.

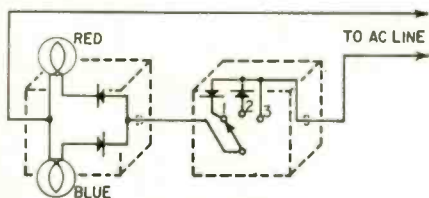

Resistor Mixup

Answer: Actually all the resistors are connected in parallel. Therefore, the effective resistance is 8 ohms.

Ghosts Really Bad

Driving along route 66 near Lebanon, Mo. we spotted this new motel sign. Evidently the neon company failed to mask the F in FREE properly, with an eerie result.—Wayne Lemons



SEPTEMBER, 1961



World's Only 'Portable Recording Studio'...
the all-in-one

Norelco[®]

CONTINENTAL '400'
4-Track Stereo Tape Recorder



A recording studio in a suitcase—that's how Norelco '400' owners describe this most advanced (and most popular) self-contained stereo tape recorder. **VERSATILITY:** 4-track stereo recording and playback, as well as 4-track monophonic recording and playback, at any of its 3 speeds. **FREQUENCY RESPONSE:** at 7½ ips, 50-18,000 cps; at 3¾ ips, 50-14,000 cps; at 1½ ips, 60-7000 cps (yes, its response at 3¾ ips is actually equal to or wider than the response of most other machines at 7½ ips)! **PROFESSIONAL EXTRAS** (at no extra cost): mixing, monitoring, sound-on-sound facilities and the Norelco stereo dynamic microphone. **SIGNAL-TO-NOISE RATIO:** 48 db or better. **WOW AND FLUTTER:** less than .15% at 7½ ips. **CROSSTALK:** 55 db. **HEAD GAP:** .00012". **AUDIO FACILITIES:** completely self-contained, including dual recording and playback pre-amplifiers, dual power amplifiers and two Norelco wide-range, stereo-matched speakers (one in the detachable lid). For complete specifications, write to Norelco. In the meantime, see and hear the '400'. The recording studio you can carry is now available for immediate delivery.

High Fidelity Products Division
NORTH AMERICAN PHILIPS COMPANY, INC. • 230 Duffy Avenue, Hicksville, L. I., N.Y.

When answering ads, please mention
Radio-Electronics

HI-FI RECORDING TAPE

Splice Free (except 2400')
15 day money-back guarantee

	3-	12+	24+
1200' 7" Acetate	\$1.29	\$1.17	99c
1800' 7" acetate	1.79	1.59	1.45
1800' 7" mylar	2.09	1.99	1.85
2400' 7" mylar	2.69	2.59	2.49
2400' 7" tensitized mylar	4.25	3.95	3.75

Can Be Assorted. Add 15c Postage Per Reel.
10c For 24+ Lot Orders.

HI-FI COMPONENTS TAPE RECORDERS available from wide variety of stock and shipped within 24 hours. Write for free wholesale catalogue. *WE WILL NOT BE UNDERSOLD.* Write us and see why.

CARSTON

125-RD East 88 St.
New York, 28, N. Y.

CONVERT TO COLOR TV



COLORDAPTOR—A simple 10-tube circuit and rotating color wheel converts any size B & W TV to receive compatible color TV.
COLODAPTOR—Easily attached to any TV set, does not affect normal operation, often built from parts experimenters have on hand. **BRILLIANT COLOR!**

Complete booklet—gives theory of operation, all construction details, schematic, and sample color filters.

Essential Parts Kit—All Special Parts—Coils, Delay Line, Crystal, Color Filters
Up to 16" **\$19.95** 17" and **\$20.95**
Sets—
Other Kits, Wired Chassis, Motors Available
COLORDAPTOR

1798 Santa Cruz,
Menlo Park, Calif.

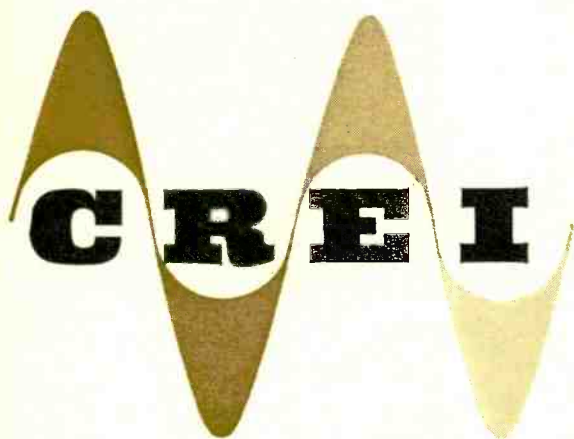

"a CREI home study program helped me become an electronics engineer—

Through a CREI Home Study Program I learned the practical theory and technology I needed to become a fully-qualified engineer—not a 'handbook' engineer either—and I did it while I was on the job."

Robert T. Blanks

*Engineer, Research & Study Division
Vitro Laboratories, Silver Spring, Md.
Division of Vitro Corporation of America*

**INDUSTRY-RECOGNIZED CREI HOME STUDY PROGRAMS
PREPARE YOU FOR INCREASED RESPONSIBILITIES,
CHALLENGING POSITIONS IN ELECTRONICS**

Today thousands of advanced electronics personnel—engineering technicians, engineers, administrators, executives—attribute their present high salaries and positions to their home study of CREI's comprehensive programs in Electronic Engineering Technology. Wherever you go—wherever thorough knowledge of electronic engineering technology is a prime requisite—you'll find CREI Home Study students and alumni welcomed.



HELPS YOU ON THE JOB. *Electronics Engineer Robert T. Blanks applies knowledge learned in his CREI Home Study Program to tough research problems at Vitro Laboratories.*

When you enroll in the CREI Home Study Programs, you join more than 20,500 students who are presently working in almost every phase of electronics in all 50 states and most countries in the free world. You study courses to which a number of today's leading engineers and scientists have made substantial contributions. You are guided and assisted by CREI's staff of experienced instructors. Completion of your CREI Home Study Program depends upon your on-the-job electronics experience, the amount of time you devote to study and the program you choose.

Demand for CREI-prepared men today far exceeds the supply—has exceeded the supply for many years. CREI Home Study Programs are specifically designed to prepare you for responsible positions in the electronics industry. In addition, CREI Home Study Programs are kept up to date to include latest advancements in electronics. We invite you to judge the Programs for yourself. Check the thoroughness and completeness of CREI Home Study Programs in the catalog provided upon request. These Programs include:

INTRODUCTION TO ELECTRONIC ENGINEERING TECHNOLOGY • ELECTRONIC ENGINEERING TECHNOLOGY • SPECIALIZED COMMUNICATIONS ENGINEERING TECHNOLOGY • SPECIALIZED AERONAUTICAL AND NAVIGATIONAL ENGINEERING TECHNOLOGY • SPECIALIZED TELEVISION ENGINEERING TECHNOLOGY • SPECIALIZED SERVOMECHANISMS AND COMPUTER ENGINEERING TECHNOLOGY • SPECIALIZED ENGINEERING MATHEMATICS • AUTOMATION AND INDUSTRIAL ELECTRONICS ENGINEERING TECHNOLOGY • NUCLEAR ENGINEERING TECHNOLOGY

The high calibre of a CREI Home Study education is attested to by America's biggest corporations, where CREI students and alumni attain positions ranging from engineering technicians to



EMPLOYERS ARE QUICK to recognize the value of your enrollment in CREI Home Study Programs—to your company as well as to yourself. Often promotion comes before you complete your studies. Here Engineer Robert Blanks discusses CREI with Director Wayne G. Szaifer of Vitro Laboratories.



YOUR LIVING IS BETTER when you prepare yourself for—and get—desired promotions and advancements through CREI Home Study Programs. CREI alumnus Robert Blanks, shown relaxing on his front lawn with his dog, is understandably proud of his fine home in a comfortable suburban neighborhood.



YOU EARN NEW RESPECT. Your CREI acquired knowledge helps you form new associations, makes you more valuable on the job. Engineer Blanks talks with Technician Robert I. Trunnell, a CREI Home Study alumnus and John H. Scofield Mathematician, a current CREI Home Study student—all of Vitro Laboratories.



YOUR WHOLE FAMILY BENEFITS from your CREI Home Study Program. Everyone in Engineer Blanks' growing family pitched in to provide him with free time at home to pursue his CREI studies. Now they share in his success.

engineers to top officials. Such companies are National Broadcasting Company, Pan American Airways, Federal Electric Corporation, The Martin Company, Northwest Telephone Company, Mackay Radio, Florida Power and Light, and many others. These companies not only recognize CREI Home Study educational qualifications but often pay all or part of CREI tuition for their staff members.

CREI Home Study Programs are the product of 34 years of experience; CREI itself was among the first to have its curricula accredited by the Engineers' Council for Professional Development. Each program has been developed with the same painstaking skill and care that CREI put into its World War II electronics courses for the Army Signal Corps, its special radio courses for the Navy, and its post-war group training programs for leading companies in aviation and electronics. For those who can attend day or evening classes in person, CREI maintains a fully accredited ECPD Technical Institute Residence School Program in Washington, D. C.

REQUIREMENTS FOR ENROLLMENT Pre-requisite is a high school education or equivalent plus basic electronics training and/or practical electronics experience. (Electronics experience and/or training not necessary for Residence School.) If you qualify, send for the latest CREI catalog and full information at no cost. Veterans may apply under the G.I. Bill. If you're doubtful about your qualifications, let us check them for you. Mail coupon to: The Capitol Radio Engineering Institute, Dpt. 1409-H 3224 Sixteenth St., N.W., Washington 10, D. C.



THE CAPITOL RADIO ENGINEERING INSTITUTE
 Founded 1927 • ECPD Accredited
 Technical Institute Curricula
 Dept. 1409-H, 3224 Sixteenth St., N. W.,
 Washington 10, D. C.

I am interested in the opportunities offered by the CREI Home Study Programs in Electronic Engineering Technology.

- I believe my qualifications as listed below meet CREI requirements. Please send me your latest catalog and full information at no cost.
- Please check my qualifications below and let me know if I am eligible for CREI Home Study Programs.

- CHECK FIELD OF GREATEST INTEREST:**
- Servo and Computer Engineering Technology
 - Electronic Engineering Technology
 - Aero and Navigational Engineering Technology
 - Automation and Industrial Electronic Engineering Technology
 - Nuclear Engineering Technology

My educational and electronics experience qualifications are:
 (All information held in strict confidence)

Employed by _____
 Type of present work _____
 Education: Years High School _____ Other _____
 Electronics Experience _____
 Name _____ Age _____
 Address _____
 City _____ Zone _____ State _____
 Check: Home Study Residence School G.I. Bill

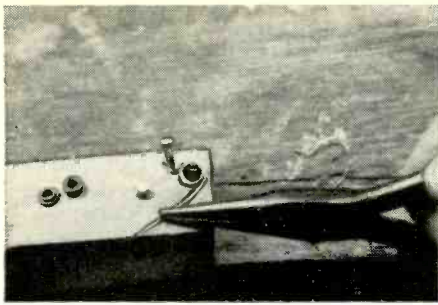

Step in forming contact wire on jig.

Build a simple 1-tube amplifier and add a new dimension to the sound of your electronic organ

ADD PERCUSSION

TO YOUR ELECTRONIC ORGAN

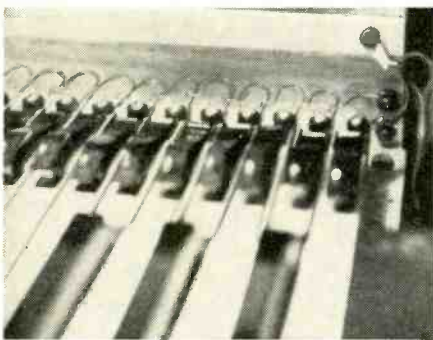

View of contacts mounted in organ.

By J. W. KORTE

THIS unit is adaptable to practically any electronic organ. It is simple to build the one-tube amplifier and add another set of contacts.

The tones produced have the characteristic percussion "plunk" bell-like sound. Perhaps a better way to explain the tone is to say that it sounds as though a hammer was used to hit a tone bar. Any number of notes can be played simultaneously. All keys must be released before the next is played, however. Selective percussion is possible; that is, if the preceding note is held until after the next one is played, no percussion will sound. It is easy to select by striking the keys with ham-

mer-action fingering for the percussion tone, or running the notes together in typical pipe-organ fashion to eliminate the percussion on certain notes.

This unit is easy to build and produces beautiful tones. Any of the regular organ stops can be played along with the new percussion tones, or it can be played separately. A variety of percussion effects can be obtained by having the vibrato on or off, or by using the octave tones separately or together.

Some adaptation of the unit will be necessary, but this should involve changing only the input and output resistors to fit the unit to the signal level of the connecting points on the particular organ. The values shown and the points of connection are for a model K Minshall (Fig. 1). A block diagram is included (Fig. 2) so the arrangement can be compared with other organs.

Basically, the signals are fed to the percussion amplifier from the key buses. These buses generally feed the tone coloring circuits. The signals from the percussion amplifier bypass the tone coloring circuits and are introduced at the point where all the signals combine to enter the preamplifier.

The new key switches are merely a chain of contacts. When any key is depressed, the ground from the end of the string is opened. Then the cathode floats positive, which increases the bias and reduces amplifier gain to produce the percussion effect. The three capacitors and two resistors in the cathode circuit slow the decay to about 2 seconds. When the contacts are all closed again, the time constant is short, however. This restores amplifier gain to normal quickly so the next keys can be played as soon as the preceding ones are released.

If more variety is desired, a slow-fast decay-time switch may be used. This can either switch out the 0.25- μ f capacitor on the end of the string of contacts or switch in a large value. If desired, you can get more tone variety by switching a certain tone coloring "formant" filter in the output of the percussion amplifier. Perhaps some similar to those already used in the particular organ would be most suitable. The

two 50- μ f capacitors in the amplifier emphasize the higher frequencies for a better volume balance between low and high frequencies.

A good physical location for the percussion amplifier is in the tone coloring section of the organ. It should be installed in a shielded location because of the sensitivity to hum pickup. The contacts, however, are not very sensitive to noise or hum pickup.

Any type of key contacts can be used. Those explained here should fit on most organs and are quite easily constructed. They are set to open when the key is depressed about halfway. This provides a lot of "follow" which causes contact wiping and self-cleaning. Contact current flow is small, so many types of 24-gauge springy wire are suitable.

A jig can be made in a few minutes to facilitate making the wire contacts as shown. They are held in place on the back edge of the keys with insulating washers and wood screws. Walsco No. 7824F insulating washers, obtainable at radio supply houses, are suitable. These are pairs of washers, one flat, the other one with an extruded ridge to keep the contact wire from touching the wood screws. A small dab of lubricant on the wires at the point of contact will reduce any tendency for corrosion. General Cement Lube-Rex appears to work well. END

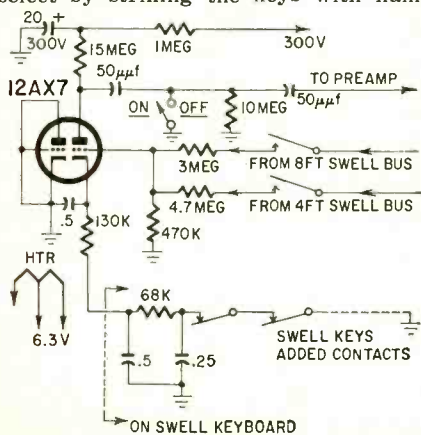

Fig. 1—Circuit of the 1-tube percussion amplifier.

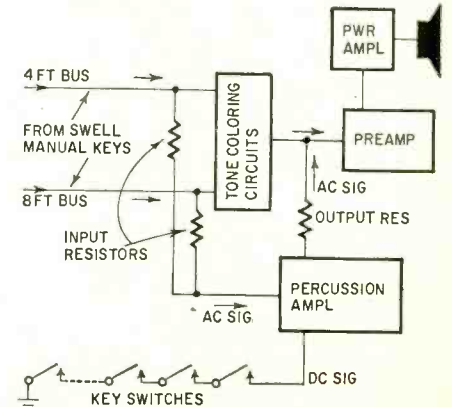

Fig. 2—Block diagram showing how to hook up the percussion amplifier to an electronic organ.

A new standard of broadcast performance from UNIVERSITY NO OTHER PROFESSIONAL MICROPHONE AT ANY PRICE CAN DO WHAT THIS ONE CAN!



Never before has there been a microphone like this . . . and it's just one of *six* professional models that herald the entrance of University into the field of microphones. Each sets a new standard of wide-range, distortion-free performance . . . with frequency response available as low as 30 cps, as high as 20,000 cps. Each offers the years-ahead-of-its-time concept of modular flexibility. Each is styled with clean, uncluttered lines totally adaptable to every environment.

To accomplish all this, University drew upon its more than two decades of leadership in sound, and applied all this vast experience to the challenge of producing a better microphone than had ever been known before. University — the leading manufacturer of speakers — now sets the pace in microphones.

MODULAR FLEXIBILITY . . . a major breakthrough in microphone design . . . gives you total interchangeability between all microphones and all accessories at all times. Need a microphone with a switch and another without . . . or for slide-on and screw-on stands . . . or for cables with and without cannon plugs? Buy just one University microphone plus only the adapters you need, and you've got them all! You don't pay for features you don't need . . . you don't compromise to meet a price. That's *true* modular flexibility, and you get it only from University.

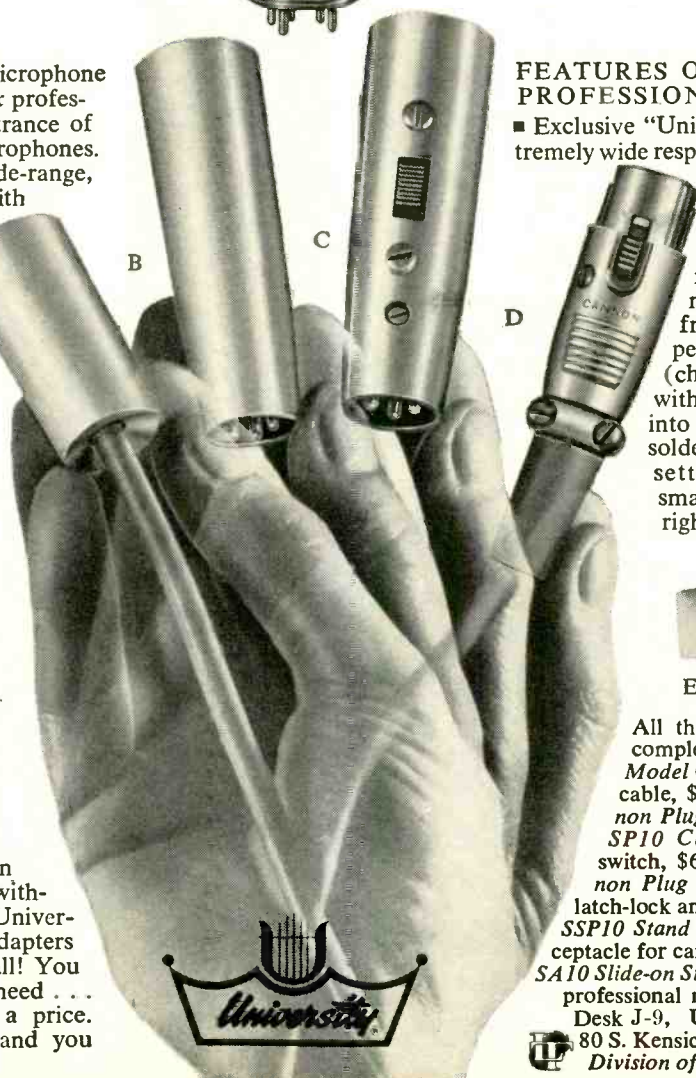

FEATURES OF THE UNIVERSITY PROFESSIONAL MICROPHONES

- Exclusive "Unilar" diaphragm assures extremely wide response range . . . from as low as 30 cps to as high as 20,000 cps. ■ Rugged generating element is indestructible in normal use. Internal elements of shock-mounted models float in vibration-free foam insulations. ■ Impedance matching simplicity (choice of two low, one high) with press-on connectors built into every accessory. No tools, soldering, or rewiring. ■ Trend-setting exterior design with smart modern finishes . . . just right for every application.

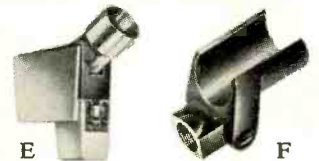

All these accessories available for complete modular flexibility: [A] Model CC10 Cable Adapter with 18' cable, \$6.00. [B] Model PA10 Cannon Plug Adapter, \$6.30. [C] Model SP10 Cannon Plug Adapter with switch, \$6.90. [D] Model CA10 Cannon Plug and Cable with push/action latch-lock and 18' cable, \$6.00. [E] Model SSP10 Stand Adapter with switch and receptacle for cannon plug, \$11.10. [F] Model SA10 Slide-on Stand Adapter \$4.20. All prices professional net. For further details, write Desk J-9, University Loudspeakers, Inc. 80 S. Kensico Ave., White Plains, N. Y. A Division of Ling-Temco Electronics, Inc.

Variation Control For Automation

Self-correcting controls are a vital part of automated systems. How some of them work is our story

By MATTHEW MANDL

AN important aspect of automation is electronic sensing and control of variations or changes in items being processed. Such deviations can be the omission of a particular step, a shift of position of the item on the assembly line or a change in the bulk of the item—a change in thickness or width, or in the case of fluids, of volume.

There are several types of control systems, and the choice depends primarily on whether the variations to be sensed are gradual or abrupt. Initially we'll consider gradual change and show some practical commercial applications. For gradual variations we need a sensing device that will recognize the change as it occurs and then actuate a device to correct it.

One device which will do this is the differential reactor (Fig. 1). It is essentially a coil with a movable plunger acting as an adjustable core, attached to a feeler (or roller) which moves over the material to be tested. The device is basically a transducer—it produces electric signals proportional to physical changes. As the core moves farther into the coil, the coil's opposition to ac (inductive reactance) increases. (Inserting a core into a coil increases permeability and inductance and, as inductance increases, so does reactance.)

To make the device practical, we have to get a dc correction voltage so a change in one direction produces a negative signal while a change in the

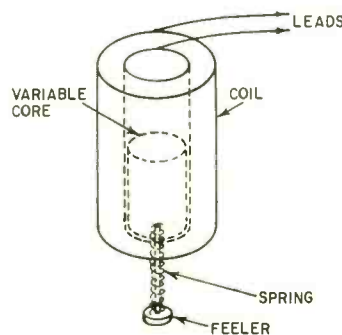

Fig. 1—Basic differential reactor.

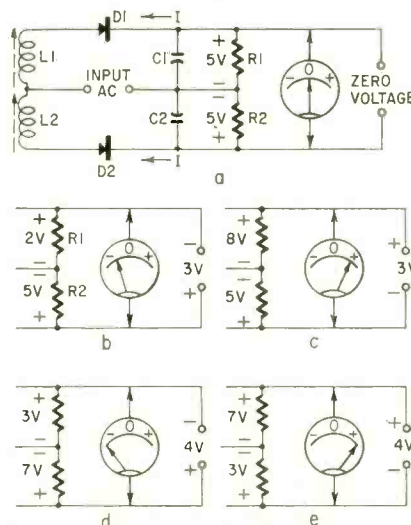

Fig. 2—Null indicator circuit and its possible outputs.

opposite direction produces a positive one. Such variations can be observed on a center-zero meter or applied to a servo motor to correct the deviations as they occur.

The necessary dc correction voltages can be supplied by a bridge type balanced circuit (Fig. 2-a). Two differential reactors are employed, L1 and L2. If L1 is the sensing device, L2 is adjusted for zero output from the circuit. Assume that both cores are midway within their coils and each presents the same amount of reactance. When the diodes D1 and D2 conduct for a positive alternation of the ac, current flow is in the direction shown by the arrows. But, since the circuit is balanced, the voltage drop across R1 is equal (but opposite in polarity) to the voltage drop across R2. The result is zero voltage output.

If the reactance of L1 goes up, less current flows through D1 and the voltage across R1 goes down. If this decrease is from 5 volts to 2, the voltage output would be -3, as shown in Fig. 2-b. If L1's reactance decreases, more current flows through D1 and the output voltage polarity changes as shown in Fig. 2-c (its value depends on the amount of reactance change).

Where both differential reactors are used for sensing, such as above and below a moving sheet of metal, both reactances vary. Assume, for instance, that the sensing devices are set up to indicate curvature. As the material bends upward, L1's core moves farther into the coil, while L2's core moves out of the core. Thus, the reactance of L1



**Model 650
GRID CIRCUIT ANALYZER
TUBE TESTER**

Tests all standard tubes plus 10 pin miniatures, 12 pin Compactrons, 5 and 7 pin Nuvistors, Novar tubes and a wide variety of voltage regulator types, foreign and industrial tubes. Indicates gas current as low as 1 micro-ampere. Leakage sensitivity over 100 megohms.
Net Price: \$69.95



**ADAPTER G-140
MULTI-SOCKET
ADAPTER UNIT**

Modernizes any tube tester for the test of • 10 pin miniatures • 12 pin Compactrons • 5 and 7 pin Nuvistors and Novar tubes.
Net Price: \$12.95



**Model ST-22
RF-AF SIGNAL TRACER**

High gain RF-AF Signal Tracer for AM, FM, TV and audio. Visual and audible signal indication from antenna to speaker. Noise test circuit, test amplifier and Wattmeter also included. Complete with, shielded probe.
Net Price: \$59.95



**Model IC-60
IN-CIRCUIT
CAPACITOR TESTER**

A great time saver! Reveals open or shorted capacitors without removing them from the circuit. Electrolytic dial indicates actual in-circuit electrolytic values from 2 mfd. to 400 mfd.
Net Price: \$32.95



**Model ES-150
5 MC WIDE BAND
OSCILLOSCOPE**

A deluxe, laboratory-type instrument in every sense, the ES-150 oscilloscope covers the entire range between DC and 5 megacycles with outstanding sensitivity and stability.
Net Price: \$149.95



**Model E-75
RF SIGNAL GENERATOR**

A signal generator designed for AM-FM and TV. Frequency ranges from 160 kc. to 240 megs, direct reading in 8 bands. High RF output in excess of 100,000 microvolts. 400 cycle output approximately 15 volts.
Net Price: \$49.95



**Model 48
VACUUM TUBE VOLTMETER**

All-purpose VTVM includes 7 DC (11 megohms input) and 7 AC ranges to 1,500 volts. Measures P-P to 4,000 volts. Resistance in 7 ranges to 1,000 megohms. Three-way probe for voltages and resistance included.
Net Price: \$55.95

NOW! A TOP-QUALITY LINE FROM **PRECISION** THAT EVERY SERVICEMAN CAN AFFORD!

In designing test equipment, Precision has always maintained a firm policy of quality first, price afterwards. Now, thanks to improved manufacturing techniques, we are able to offer a popular priced line which meets the same exacting standards of engineering that have made Precision a leader in the field of over a quarter of a century! This puts Precision Electronic

Test Equipment within the reach of virtually every radio technician, student and engineer. On this page, you'll find apparatus that meets your own specific requirements. And you'll find you can save time and do more jobs when Precision does the trouble-shooting. REMEMBER, ALL PRECISION TEST EQUIPMENT IS GUARANTEED FOR ONE FULL YEAR!

See these and PRECISION'S Industrial Test Instruments at your local electronics distributor.

OTHER TOP ITEMS FROM THE NEW **PRECISION** LINE:

- Model CB-26 Resistance-Capacity-Ratio Bridge Net Price: \$79.95
- Model P-28 Battery Eliminator and Charger With Built-In Low-Ripple L/C Filter \$64.95
- Model RS-24 Regulated Power Supply \$99.95
- Model 1904 Decade Condenser \$29.95
- Model 1601 Decade Resistor/Divider \$29.95
- Model 1803 Condenser Substitution Box \$12.95
- Model 1702 Resistance Substitution Box \$15.95



PRECISION Apparatus Company, Inc., Dept. B
70-31 84th Street, Glendale 27, N. Y.

Please send me more information on the model numbers circled below:

650	ES-150	P-28	1803
G-140	E-75	RS-24	1702
ST-22	48	1904	
IC-60	CB-26	1601	

Name _____

Address _____

City _____ Zone _____ State _____

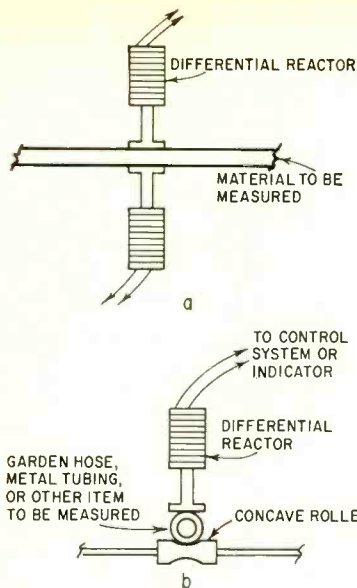

Fig. 3—Two ways of using differential reactors.

increases while that of L2 decreases. Voltages would then have the relationship shown in Fig. 2-d. If the material bends downward to the same degree as it bent upward, the same total output voltage is produced, but of opposite polarity (Fig. 2-e). Thus, the changes in voltage and polarity can be applied to a deviation-correcting device because they give a proportional voltage change for the errors which occur.

Practical application

Placing one reactor above the material, and one below, as in Fig. 3-a can be used to sense differences in thickness. If both are wired as shown earlier, however, a change in thickness will result in both reactances changing identically and no correction voltage will be obtained. To measure thickness, the terminals from one reactor must be reversed. A single reactor can be used also, as in Fig. 3-b. Though less output voltage is obtained, increased amplification will compensate for the difference.

In some commercial installations a lever arm is used (Fig. 4). A typical industrial application of this device is shown in Fig. 5. Here, any sideways variations of the continuously moving sheet of material is sensed by the lever arm of the differential reactor. The voltage variations produced are amplified and used to operate a servo motor that rotates in one direction for one voltage polarity and reverses rotation for an opposite polarity. The motor actuates a hydraulic valve that causes the controlling piston to move in the direction necessary for correction. If the edge of the material pushes the sensing lever to the left, for instance, the piston is made to move to the right until a zero voltage is produced. A balancing reactor is used with the differential reactor to get a zero adjustment for proper placement of the material.

The device can also be used to sense abrupt changes. An inductance is still used but, instead of using a movable core, it senses a change by detecting

Fig. 4—A lever type edge control.

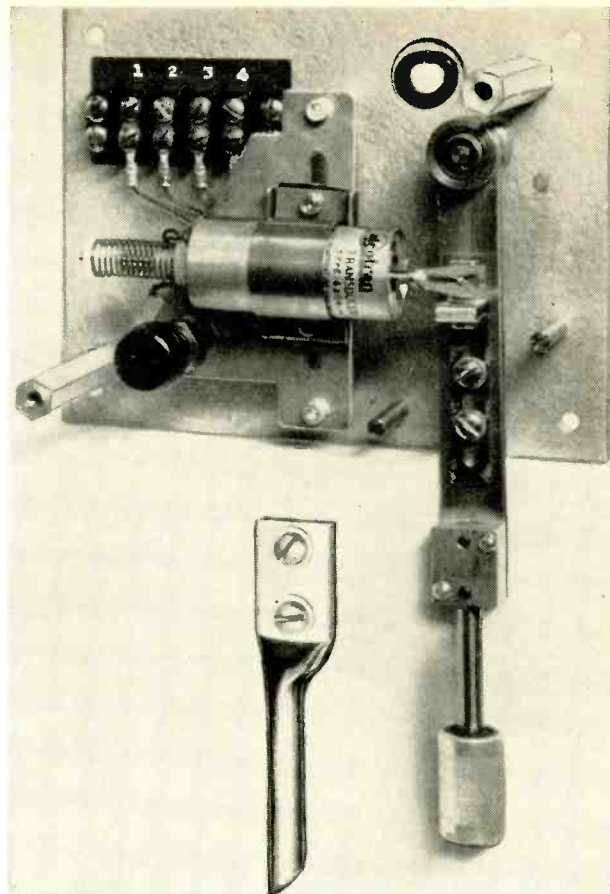

Automatic Timing & Controls Inc.

metal passing beneath it. With ac applied to the reactor, the lines of force are cut each time metal passes under the unit, causing a slight change in the circulating current.

A practical application of this device is shown in Fig. 6, where it senses which bottles were not capped in beverage packing industries. Because a sig-

nal is obtained every time a metal bottle cap passes beneath the proximity-cell reactor, the absence of a cap would produce no signal. From a functional standpoint, the reverse should be true. To do this, the proximity-cell device is paired with a photo cell that generates an opposite voltage to form a "comparator" circuit. To generate a good field

Fig. 5—Edge control system.

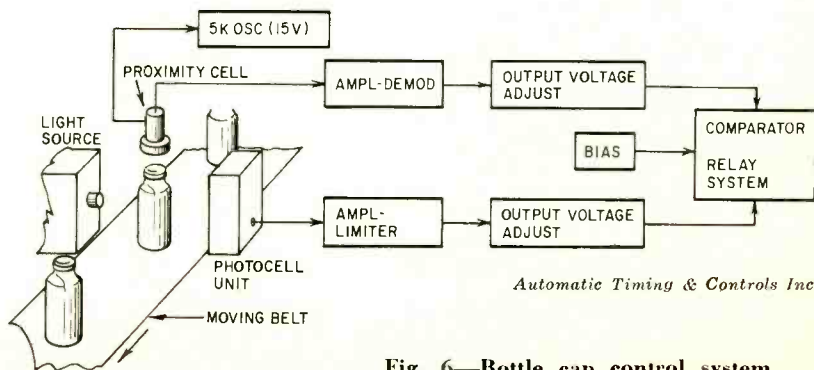
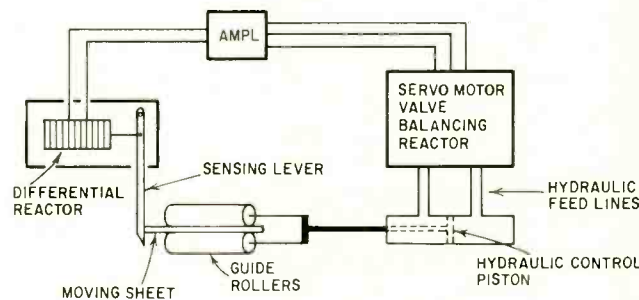

Automatic Timing & Controls Inc.

Fig. 6—Bottle cap control system.

Wake Up



A new day is dawning in electronics. Transistors are here to stay... they are now being used everywhere; in radio, television, Hi-Fi, intercoms, and in nearly all new electronic equipment...

Why put off transistor circuit servicing any longer... there's gold in them thar hills. But you must be equipped to do the job fast and efficiently. Here are the tools that you will need.

NEW SENCORE TRANSI-MASTER

This Tester will analyze the entire circuit in minutes and test transistors in-circuit or out of circuit. Here is how you can pin point troubles step by step.

First, check the batteries with the 0 to 12 voltmeter. If the batteries are O.K., check the current drain with the 0 to 50 milliamp meter. A special probe is provided so that you do not need to break the circuit. Excessive current indicates a short; low current indicates an open stage or cracked board. All PF schematics indicate average current.

If trouble is not located by now, isolate the trouble to a specific stage by touching the output of the harmonic generator to the base of each transistor and note spot where sound from speaker (or scope where no speaker is used) stops or becomes weak. The generator becomes a sine wave generator for audio stages to help find distortion.

If trouble points to a transistor, check it in a jiffy with the exclusive in-circuit power oscillator check provided by the TR110. A special probe is also provided for this.

If the transistor checks bad in-circuit, remove it and give it an out of circuit check with the oscillator check or the more accurate DC check.

The DC check is provided for comparison reasons, experimental or engineering work and to match transistors in audio output stages. Beta (current gain) is read direct or on a good-bad scale for service work.

DEALER NET. ONLY **\$49.50**

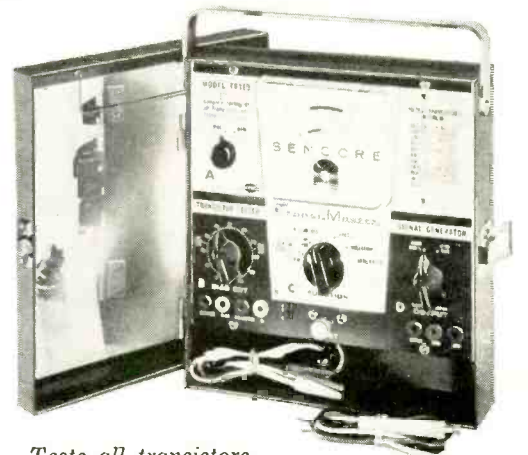

Tests all transistors in-circuit or out-of-circuit

Model TR110

It's a COMPLETE TRANSISTOR TESTER

- SIGNAL TRACER • VOLTMETER
- BATTERY TESTER • MILLIAMMETER

NEW SENCORE TRANSISTOR AND DIODE CHECKER

Here is a low cost tester that has become America's favorite. The TR115 provides the same DC out of circuit checks as the TR110; leakage and current gain. Beta (circuit gain) can also be read direct or as good or bad. Opens or shorts in the transistor are spotted in a minute. The TR115 checks them all from power transistors to the small hearing aid type. Japanese equivalents are listed also. This famous tester is used by such companies as Sears Roebuck, Bell Telephone and Commonwealth Edison. New circuits enable you to make service checks without set-up charts even though charts are provided for critical checks.



Model TR115
Dealer Net
\$19.95

SENCORE BATTERY ELIMINATOR AND TROUBLE SHOOTER

For replacing batteries during repair.

Many servicemen say that they wouldn't service transistor circuits without this power supply. The tried and proven PS103 is a sure fire answer. It can be used to charge the nickel cadmium batteries as well. Dial the desired output from 0 to 24 volts DC and read on meter. Low ripple insures no hum or feedback. Total current drawn can also be read on the PS103 by merely flicking the function switch to milliamps. The PS103 is the only supply that will operate radios with tapped battery supplies such as Philco, Sylvania and Motorola. No other supply has a third lead.

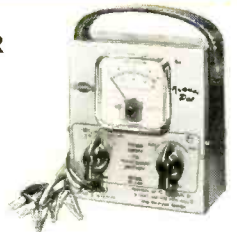

Model PS103
Dealer Net
\$19.95

Now in stock at your Authorized Sencore Distributor



SENCORE

ADDISON, ILLINOIS

"ONE DOLLAR" buys As much as \$15 worth—Everything Brand New and sold to you with a money back guarantee.

DEDUCT 10% ON ANY ORDER OF \$10 OR OVER—Plus a FREE SURPRISE PACKAGE

- | | | | |
|---|---|--|---|
| <ul style="list-style-type: none"> □ 1-5" PM SPEAKERS \$1 □ 1-4" PM SPEAKER \$1 □ 1-3" PM SPEAKER \$1 □ 1-3 1/2" TWEEETER SPEAKER \$1 □ 3-AUDIO OUTPUT TRANS. 50L6 type \$1 □ 2-AUDIO OUTPUT TRANS. 50L6 pushpull \$1 □ 3-AUDIO OUTPUT TRANS. 6K6 or 6V6 \$1 □ 2-AUDIO OUTPUT TRANS. 6K6 push-pull \$1 □ 3-AUDIO OUTPUT TRANS. 3Q4, 3Q5, 3S4 \$1 □ 3-CHOKE TRANS. 520 for Radio or TV \$1 □ 10-CHOKE TRANS. 780, 1 by 100 ma \$1 □ 5-SETS SPEAKER PLUGS wired \$1 □ 3-I.F. COIL TRANS-FORMERS 456 kc \$1 □ 2-I.F. COIL TRANS. G.E. IIT 40, 436kc \$1 □ 3-I.F. COIL TRANS-FORMERS 10.7mc FM \$1 □ 3-I.F. COIL TRANS-FORMERS 202kc (auto) \$1 □ 4-OVAL LOOP ANTENNAS ass't hi-gain \$1 □ 2-LOOPSTICK ANT latest type adjustable \$1 □ 3-VARIABLE COND. super 420/162 mfd \$1 □ 3-ASST. SIZES RADIO CHASSIS PANS \$1 □ 12-RADIO OSCILLATOR COILS 056 kc \$1 □ 3-1/2 MEG. VOLUME CONTROLS w/switch \$1 □ 5-1/2 MEG VOLUME CONTROLS less switch \$1 □ 1 MEG VOLUME CONTROLS less switch \$1 □ 5-SOK VOLUME CON-TROLS less switch \$1 □ 5-ASST. 4 WATT WIREW'D CONTROLS \$1 □ 10-ASST. VOLUME CONTROLS less switch \$1 □ 5-ASST. VOLUME CONTROLS w/switch \$1 □ 100-VOLUME CON-TROL HEX NUTS \$1 □ 10-SURE GRIP ALIGATOR CLIPS \$1 □ 1-GOLD GRILLE CLOTH 14x14or12x18 \$1 □ 10-SETS PHONO PLUGS and PINJACKS \$1 □ 2-52.50 SAPPHIRE NEEDLES 5000 plays \$1 □ 20-ASST. PILOT LIGHTS popular types \$1 □ 10-PILOT LT. SKTS. bayonet type, wired \$1 □ 20-ASST. TERMINAL STRIPS 1, 2, 3, 4 lugs \$1 □ 3-ASSORTED TUBE SHIELDS best sizes \$1 □ 35-ASST. RADIO KNOBS, screw, push-on \$1 □ 100-ASSORTED KNOB SET-SCREWS \$1 □ 25-ASST. RADIO DIAL POINTERS \$1 □ 25-ASS'TED CLOCK RADIO KNOBS \$1 □ 35-ASST. SOCKETS 7 pin, 8 pin, 9 pin \$1 □ 25-ASST. PRINTED CIRCUIT SOCKETS \$1 □ 100'-FINEST NYLON DIAL CORO best size \$1 | <ul style="list-style-type: none"> □ 100-ASST. 1/2 WATT RESISTORS some 5% \$1 □ 70-ASST. 1 WATT RESISTORS some 5% \$1 □ 35-ASST. 2 WATT RESISTORS some 5% \$1 □ 50-ASSORTED FUSES popular sizes \$1 □ 50-ASST. TUBULAR CONDENSERS \$1 □ 20-TUBULAR CONDENSERS .047-600v \$1 □ 15-TUBULAR CONDENSERS .47-400v \$1 □ 25-TUBULAR CONDENSERS .001-600v \$1 □ 20-TUBULAR CONDENSERS .005-600v \$1 □ 20-TUBULAR CONDENSERS .01-600v \$1 □ 15-TUBULAR CONDENSERS .1-600v \$1 □ 15-TUBULAR CONDENSERS .25-600v \$1 □ 10-HV CONDENSERS .007-1600v \$1 □ 3-ELECTROLYTIC COND. 50/30-150v \$1 □ 2-ELECTROLYTIC COND. 40/20-150v \$1 □ 10-ASST. RADIO ELECTROLYTIC COND. \$1 □ 5-ASST. TV ELECTROLYTIC COND. \$1 □ 2-ELECTROLYTIC COND. 40/20-450v \$1 □ 4-ELECTROLYTIC COND. 10-450v \$1 □ 3-ELECTROLYTIC COND. 16/16-450v \$1 □ 3-ELECTROLYTIC COND. 80/80-150v \$1 □ 3-ELECTROLYTIC COND. 80-450v \$1 □ 30-FP CONDENSER MOUNTING WAFERS \$1 □ 2-ELECTROLYTIC COND. 50/50-150v \$1 □ 5-ELECTROLYTIC COND. 25-50v \$1 □ 5-ELECTROLYTIC COND. 100-50v \$1 □ 50-100K 1/2 WATT RESISTORS 10% \$1 □ 50-100K 1/2 WATT RESISTORS 1% \$1 □ 50-470K 1/2 WATT RESISTORS 10% \$1 □ 50-2.2 MEG 1/2 W. RESISTORS 10% \$1 □ 20-ASST. WIREW'ND RES. 3, 5, 10, 20 watt \$1 □ 40-ASST. PRECISION RESISTORS 1% \$1 □ 35-ASST. DISC CERAMICS best numbers \$1 □ 35-DISC CERAMICS 3000 mhm \$1 □ 25-ASSORTED MICA TRIMMER COND. \$1 □ 5-DIODE CRYSTALS 2-1N21 1-1N34 1-1N40 1-1N64 \$1 □ 4-DIODE CRYSTALS 1-1N34 1-1N60 1-1N64 1-1N69 \$1 □ 3-SELENIUM RECT 2-65ma & 1-150ma \$1 □ 3-SELENIUM RECT 2-75ma & 1-100ma \$1 □ 2-SELENIUM RECT. 1-250ma & 1-300ma \$1 □ 2-SELENIUM RECT. 1-150ma & 1-350ma \$1 □ 2-SELENIUM RECT. 1-75ma & 1-450ma \$1 □ 1-SELENIUM RECTI-FIER 500 ma \$1 | <ul style="list-style-type: none"> □ 15-ASST. ROTARY SWITCHES \$15 worth \$1 □ 3-TOGGLE SWITCH-ES spst, dpdt, etc. \$1 □ 6-SLIDE SWITCHES \$1 □ 1-LB. SPOOLS ROSIN CORE SOLDER 40/60 \$1 □ 600-ASST. HDWARE \$1 □ 200-SELF TAPPING SCREWS #8 x 1/2" \$1 □ 200-6/32 HEX NUTS & 200-6/32 BOLTS \$1 □ 8-ASST. LUCITE CASES handy for parts \$1 □ 10-6' ELECTRIC LINE CORDS w/plugs \$1 □ 5-TV CHEATER CORDS w/both plugs \$1 □ 4-5 SPOOLS SPOOK-UP WIRE 4 colors \$1 □ 25'-INSULATED SHIELDED WIRE \$1 □ 75'-MINIATURE ZIP CORD 2 conductor \$1 □ 32-TEST PROD. WIRE \$1 □ 50-STRIPS ASS'TED SPAGHETTI best sizes \$1 □ 100-ASST. RUBBER GROMMETS best sizes \$1 □ 50'-HI-VOLTAGE WIRE top quality \$1 □ 50-ZIP CORD (2-cond) #18 brown or ivory \$1 □ 100'-BUSS WIRE handiest size #20 \$1 □ 200'-HOOK-UP WIRE \$1 □ 500-ASST. SOLDER-ING LUGS best sizes \$1 □ 3-SILICON RECTIFI-ERS 350 ma \$1 □ 50-ASST. MICA CON-DENSERS some in 5% \$1 □ 50-ASST. CERAMIC COND. some in 5% \$1 □ 35-MICA COND. 20-5mmf & 15-25mmf \$1 □ 35-MICA COND. 20-50mmf & 15-68mmf \$1 □ 35-MICA COND. 20-100mmf, 15-270mmf \$1 □ 35-MICA COND. 20-470mmf, 15-680mmf \$1 □ 35-MICA COND. 20-820mmf, 15-1000mmf \$1 □ 35-MICA COND. 20-2200, 15-2400mmf \$1 □ 35-MICA COND. 20-3300, 15-4700 mmf \$1 □ 35-MICA COND. 20-6800, 15-10000mmf \$1 □ 35-CERAMIC COND. 20-25mmf, 15-190mmf \$1 □ 35-CERAMIC COND. 20-25mmf, 15-47mmf \$1 □ 35-CERAMIC COND. 20-56mmf, 15-82mmf \$1 □ 35-CERAMIC COND. 20-100, 15-150 mmf \$1 □ 35-CERAMIC COND. 20-270, 15-470 mmf \$1 □ 35-CERAMIC COND. 20-1000, 15-1500mmf \$1 □ 35-CERAMIC COND. 20-2000, 15-5000mmf \$1 □ 4-RCA 1U4 TUBES also serves as 1T4 \$1 □ 2-GENERAL ELEC. 35W4 TUBES \$1 □ TOP BRAND TUBES-1B3, 1X2B, OZ4, 5U4, 6SN7, 6CB6, 6U8, 6J6, 6V6, 6X4, 6X5, 6X4, 6AC7, 12AT7, 12AU6, Ea. \$1 | <ul style="list-style-type: none"> □ \$15-"JACKPOT" TELEVISION PARTS \$1 □ 1-70' FLYBACK TRANS. incl schematic \$1 □ 1-90' FLYBACK TRANS. incl schematic \$1 □ 3-511 TODD 60° DEFLECTION YOKES \$1 □ 1-57 INDOOR TV ANT. hi-gain 3 sec. \$1 □ 100'-TWIN LEAD-IN WIRE 300# heavy duty \$1 □ 50'-FLAT 4-COND. WIRE many purposes \$1 □ 20-ASST. TV KNOBS, ESCUTCHEONS, etc. \$1 □ 15-ASST. STANDARD TUNER VHF STRIPS \$1 □ 6-ASST. UHF STAND-ARD TUNER STRIPS \$1 □ 25-ASST. PEAKING COILS popular types \$1 □ 2-RCA SYNCHRO-GUIDE COILS #20SR1 \$1 □ 1-RCA SYNCHROLOC COIL #20SR8 \$1 □ 2-STANDARD AGC COILS 1R4AG \$1 □ 2-RATIO DETECTOR COILS 4.5 mc \$1 □ 2-RATIO DETECTOR COILS 10.7 mc \$1 □ 2-TV SOUND I.F. COILS 4.5mc \$1 □ 2-SOUND DISCRIMI-NATOR COILS 10.7mc \$1 □ 1-TV VERTICAL OUT-PUT TRANSFORMER 10 to 1 ratio \$1 □ 1-VERTICAL BLOCK TRANS. standard \$1 □ 4-TV ION TRAPS good for all TV's \$1 □ 4-TV CENTERING RINGS for back of yoke \$1 □ 4-TV CENTERING RINGS fits on neck CRT \$1 □ 15-ASST. TV COILS sync, peaking, width \$1 □ 5-TV CRT. SOCKETS with 18" leads \$1 □ 5-HI-VOLT. ANODE LEADS with 20" leads \$1 □ 3-TV CARTWHEEL CONDENSERS 20 kv \$1 □ 2-TV CARTWHEEL CONDENSERS 30kv \$1 □ 3-HV RECTIFIER SOCKETS 1B3 mounted \$1 □ 3-HV RECTIFIERS SOCKETS 1X2 mounted \$1 □ 1-TV FOCALYZER with any output \$1 □ 2-2 MEGOHM RESIS-TOR 20w for #630 \$1 □ 1-SILICON RECTI-FIER 750 ma 500v \$1 □ 2-SILICON RECTI-FIERS 500 ma \$1 □ 3-TV ALIGNMENT TOOLS assortment #1 \$1 □ 3-TV ALIGNMENT TOOLS assortment #2 \$1 □ 3-TV ALIGNMENT TOOLS assortment #3 \$1 □ 3-TV ALIGNMENT TOOLS assortment #4 \$1 □ 3-TV ALIGNMENT TOOLS assortment #5 \$1 |
|---|---|--|---|

HANDY WAY TO ORDER—Simply pencil mark items wanted (X in square is sufficient), enclose with money order or check. You will receive a new copy of these offers for re-orders.
ON SMALL ORDERS—Include stamps for postage, excess refunded. Larger orders shipped express collect.

BROOKS RADIO & TV CORP., 84 Vesey St., New York 7, N. Y.

RADIO SHACK

FREE ELECTRONICS CATALOGS for 1 full year

RADIO SHACK Corp.
730 Commonwealth Ave., Boston, Mass.

See the greatest line of electronics...
 top quality equipment and parts for "pro," amateur, music lover! Mail coupon and receive Radio Shack's exciting 1961-62 all-new Buying Guide of 336 pages PLUS all value-packed supplements for one full year.

You'll see famous brands and our own private label Stereo, Hi-Fi, Ham Radio, Tapes, Records, 300 pages of easy-to-build kits. Your satisfaction guaranteed.

New No Money Down Credit Terms!
MAIL THIS COUPON TODAY

RADIO SHACK Corp. Dept. 61J10C
 730 Commonwealth Ave., Boston 17, Mass.

Gentlemen:
 Please send me Radio Shack's famous electronics catalogs for the next 12 months, all FREE and POSTPAID.

Name _____
 Address _____
 City & Zone _____ State _____

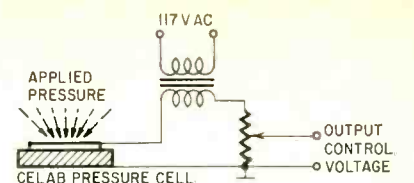

Fig. 7—Typical pressure-cell circuit.



Clark Electronic Labs.

Fig. 8—One type of pressure cell designed to measure liquid pressure.

in the proximity reactor, 5,000-cycle signal is applied, which is amplified and demodulated as shown. As each bottle reaches a position beneath the proximity cell, it also is between the light source and the photo cell, so that both cells produce signals at the same instant.

As shown in the figure, a bias voltage is compared with that produced by the photocell. If there is no signal from the proximity unit (uncapped bottle) a difference voltage is produced. It actuates the relay system that removes the uncapped bottle or stops the conveyor belt. When a capped bottle is sensed, the voltage produced by the proximity cell opposes the difference voltage and prevent the tripping of the reject relay. Thus, uncapped bottles are detected electronically, without any physical contact with the moving items.

High-pressure variations

Variation control is also employed where pressures are high—as in oil lines, gas lines and reactors. Pressure control is a safety factor and, when pressures become excessive, correction consists of closing a valve or controlling check valves that protect the pipe lines.

One commercial sensing device is made from intermetallic resins and rare earths processed with zirconium tetrachloride. Its resistance changes with applied pressure. The cells are available in a variety of mountings and with different characteristics to meet particular requirements. A typical unit is the No. 48 Celab solid-state load cell. It has a resistance of approximately 900,000 ohms at 5 pounds and zero resistance at a pressure slightly over 20 pounds. A typical circuit for the cell is shown in Fig. 7. It will function with dc as well as ac. Fig. 8 shows the housing for the cell where liquid pressure variations are to be sensed.

Overload protection

Simpler switch controls are also used in commercial applications. For exam-

SPRAGUE CERAMIC CAPACITORS

THE Complete LINE THAT OFFERS MORE THAN MERE "CAPACITY"

"Rated" capacitance is not enough . . . *actual* capacitance during operation is equally important. Excessively high or low values as well as capacitance change with temperature can foul up a TV or radio set. Therefore, characteristics such as Capacitance Stability, Capacitance Tolerance, and Temperature Coefficient of Capacitance must be considered in replacement applications.

That's why the Sprague Ceramic Line is varied and broad—it includes capacitors with electrical and mechanical characteristics to meet practically every replacement requirement.

See complete listings in the new Sprague Catalog C-614. Get your copy from any Sprague Distributor, or write to Sprague Products Co., 81 Marshall St., North Adams, Massachusetts.

CERA-MITE® CAPACITORS



Tiny, tough, dependable. Silvered flat-plate construction for high by-pass efficiency, high self-resonant frequency. Available in the following types to meet specific requirements:

- *General Application*, for by-pass and coupling
- *High-K*, for applications requiring guaranteed minimum capacitance values
- *Temperature-Stable*, for minimum capacitance change with temperature
- *Temperature-Compensating*, for applications requiring negative temperature coefficient
- *NPO*, for use where capacitance change with temperature is undesirable
- *AC*, rated at 125 VAC
- *Buffer*, rated at 2000 WVDC
- *Low-voltage*, for by-pass and coupling in transistorized circuitry
- *TV Yoke*, rated at 3000 and 5000 WVDC

HYPERCON® CAPACITORS

Ultra-miniature discs for use in transistorized circuitry. Designed for by-pass and coupling applications in low voltage circuits where high capacitance and low power factor are important considerations. Superior in size and performance to comparably-rated aluminum electrolytic capacitors.



"UNIVERSAL" CAPACITORS



Have multiple leads. Quick-fix capacitors for on-the-spot repairs. By using certain leads for terminals, connecting certain leads together, and removing certain leads, various ratings may be obtained. Available in General Application as well as High-K types.

DOORKNOB CAPACITORS



Available in 20 and 30 KV ratings. Molded guard rings lengthen surface creepage path. Complete with variety of screw-in terminals to meet all replacement requirements.

BUTTONHEAD CAPACITORS



Screw-mounting units with flat disc capacitor elements seated in hexagon head. This series includes feed-thru capacitors for filtering leads through chassis, as well as standoff capacitors for by-pass applications.

BULPLATE® CAPACITORS

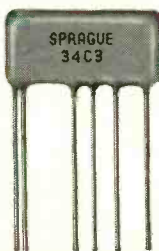

Rugged multiple-section units which combine in one compact assembly all the capacitors used in one or more stages of a radio circuit. These space-saving capacitors are ideal for miniature sets.

SPRAGUE®
THE MARK OF RELIABILITY

WORLD'S LARGEST CAPACITOR MANUFACTURER

**FAST,
ACCURATE TESTERS
FOR C/B INSTALLATION
AND ALIGNMENT BY
SECO**



MODEL 510—complete with all necessary cables and adapters
\$46.95 NET

TRANSMITTER TESTER

Designed especially for citizens band (C/B) and other low power transmitters up to 160 MC. Calibrated for direct percentage reading of amplitude modulation; 0.5 watts RF output; 0-400 ma. RF output. Connection provided for headphones or scope.



MODEL 500—wired and factory tested
\$29.95 NET

2-WAY RADIO TEST SET
Combination Crystal Checker, RF Signal and Field Strength meter—ideal for C/B. 0.50 ma. meter for final amplifier tuning. Use as RF output indicator. Checks activity on third overtone transmitter crystals—checks fundamental and high overtone crystals at fundamental frequency. Powered by two 1.5 c. "C" cells.



MODEL 520—complete with instructions
\$42.95 NET

ANTENNA TESTER
For 50 ohm coaxial transmission line applications. 1000 watt maximum dual air cylinder coupler inserts no error up to 160 MC. Simplified direct reading scales give quick GOOD-POOR results as well as percent. Direct reading of FORWARD POWER and REFLECTED POWER. 0-10, 0-100 and 0-1000 watt ranges



Model 511A—
\$21.50 NET

ATTENU-LOAD
Ten db "T" pad attenuator for reducing power levels by ratio of 10 to 1 . . . fully shielded 50 ohm termination for coaxial cable applications.

SECO TUBE TESTERS

GRID CIRCUIT TUBE TESTER—Tests for Grid Emission, leakage, shorts and gas in one operation! Two new exclusive tests—Cathode Continuity Check and Inter-element Short Test with short identified to pin number. Easy to operate.
MODEL GCT-9 \$32.95 NET

GRID CIRCUIT & TUBE MERIT TESTER—Offer complete TV tube type coverage—Incorporates patented Seco Grid Circuit Test plus reliable Cathode Emission Test—also checks filament continuity and provides open element test.
MODEL 78 \$69.50 NET

DELUXE COMPLETE TUBE TESTER—Three complete tests: Dynamic Mutual Conductance Test on pre-wired chassis—Cathode Emission Test for all tubes by free point selector system—"Good-Bad" meter indicates merit. Nationally accepted Grid Circuit Test.
MODEL 107 \$139.50 NET

DYNAMIC TRANSISTOR CHECKER—checks transistors "in" or "out" of circuit. Permits matching of similar transistor types. No set-up necessary.
MODEL 100 \$19.95 NET

SECO ELECTRONICS INC.
5015 Penn Ave. So.,
Minneapolis 19, Minn.
Please send more information on MODELS . . .

510 500 520 511A GCT-9W 107
 100 78 FREE Selling and Installing Citizens Band Equipment Bulletin

Name _____
Address _____
City _____ State _____

ple, pressure-switch controls are used for overload protection in all phases of industry. Such types are simple in operation and relatively inexpensive. The one shown in Fig. 9 is used to control air, gas or liquid pressure where close on-off deviations must be sensed. This control uses a brass bellows which trig-



United Electric Controls Co.

Fig. 9—Another type of pressure control.

gers a basic single-pole, single-throw switch. Other models have double-throw switches and various pressure ranges.

This pressure control, as well as the other control devices previously described, are adaptable to many control applications. In all instances, however, the basic principles are similar. Initially the variation must be sensed, and

the signal produced by the sensing device is employed either for correction, for a metered display, or both. By using electronic circuits to process the signals, they can be amplified to control motors and valves to make corrections.

All must have provision for adjusting the system to the normal or correct setting. That is, the operator must indicate to the system by proper circuit balancing the normal condition, so the electronic devices can sense variations from it and make the proper corrections. After that, the control and correction processes are automatic and need only be checked occasionally as part of routine maintenance. **END**

THE MAILS ARE SAFER

An FCC inspector boarded a boat in California only to be ordered off by the uncooperative owner. When the inspector stepped off the boat to write his report, the boat owner followed him. In the resulting dispute, the inspector found himself in the water. He had to swim for shore to finish his report. The FCC is taking administrative action against the boat owner, this time by mail, and he is likely to find himself in much warmer water than he is used to navigating.



ORGAN BUILDERS MANUAL

Assemble a Beautiful
Artisan
ORGAN

"20th Century Successor
to the Pipe Organ"

Build an exciting Artisan organ, with either one, two or three manuals. Meets American Guild of Organists specifications.

This 160 page manual gives a wealth of information on this thrilling hobby, plus complete specifications, prices and parts lists. World's largest selection of organ parts and kits. "Horse-shoe" or conventional console.

Housewives, doctors, teen-agers, do-it-yourself fans by the hundreds are now enjoying this creative and rewarding hobby.

Step-by-step instructions are so simple anyone can follow them. If you can handle a soldering iron, you can build your own full size electronic organ and save hundreds of dollars.

SEND \$2.00 with coupon TODAY!

Please send me the Organ Builders Manual
Enclosed \$2.00

Name _____
Address _____
City _____ Zone _____
State _____

Artisan Organ Division,
Dorsett Electronics, Inc.
4949R York Blvd. • Los Angeles 42, Calif.

WALKIE-TALKIE RADIOPHONES

From \$24.98 for electronic chassis Now you can afford the new fully transistorized and portable Springfield TR-28 radiophone kit or the new Vanguard Mark 1 factory assembled radiophone. Both are high quality industrial types and come with a 5 year service guarantee. Available for license free Citizens Band and Amateur Bands. Send for free literature.
Made in U.S.A.
VANGUARD ELECTRONIC LABS., Dept. ER-9
190-48 99 Ave., Hollis 23, N.Y.

FIX ELECTRIC APPLIANCES

PAYS \$3 TO \$5 AN HOUR
Spare Time, Full Time • Learn at Home

FREE BOOK offered below shows how YOU can now have a good-paying business of your own, right in your home. No experience needed, just simple tools. Learn to repair Electric Appliances. Pays \$3-\$5 an hour!

Quick Way To Get Started
For less than 20¢ a day our easy, pictured instruction—backed by 45 years of success in home training—prepares you for top earnings in this booming field. Earl Reid of Thompson, Ohio says: "Made \$510 in one month spare time. NRI course is priceless." At no extra charge you even get all parts for your own Appliance Tester, too. Finds trouble-spots, speeds and checks your work.

Get your **FREE Book** and **FREE Sample Lesson!** Mail coupon below, letter or postcard, now.

FREE BOOK • FREE LESSON

NATIONAL RADIO INSTITUTE, Appliance Division
Dept. FJ1, Washington 16, D. C.
Send **Free Book, Free Appliance Repair Course Lesson.** Am interested in:
 Spare Time Earnings My Own Business
 Better Job

Name _____
Address _____
City _____ Zone _____ State _____
—Accredited Member—National Home Study Council.

new PRODUCTS



CITIZENS-BAND TRANSCEIVER, Littlefone Model CB-3, for office, industrial, farm, home, automobile and leisure-time uses. 8 crystal-controlled channels. Practical range 5 to 10



miles. Self-contained dual power supply for operation on 117 volts ac or 12-volt battery. Power plugs included permit switching from ac to dc.—Hallcrafters Co., 4401 W. 5th Ave., Chicago 24, Ill.

CITIZENS-BAND TRANSCEIVER, HQ-105 TR. All-wave receiver—CB receiver. Receiver combined with crystal-controlled transmitter with 5-watt input. Continuously tunable from 540 kc



to 30 mc. Push-to-talk operation, meter output and tuning indication, separate Q-multiplier and BFO, 11-tube superhet circuit with built-in automatic noise limiter.—Hammarlund Mfg. Co., 460 W. 34th St., New York 1, N. Y.

MOBILE TRANSCEIVER UNIT, Mobilaire. Same circuitry as manufacturer's R-2700 receiver and S-NINE transmitter for Citizens-band operation.



Squelch circuit. Operated on any of 4 preselected channels.—Browning Laboratories Inc., 100 Union Ave., Laconia, N. H.

32-INCH CB MOBILE ANTENNA, Stinger Mobile Whip, for Class D, 27-mc band. 32 in.



long. Installs on roof, fender or trunk through single hole.—International Communications, 26330 S. Western, Lomita, Calif.

TRANSISTORIZED "BULL HORN", PA-271, functions as sound detector and amplifier as well

spend one hour a day with this famous course and prepare yourself for a rewarding future

BASIC ELECTRONICS

by Van Valkenburgh, Nooger & Neville, Inc.

The civilian version of the extremely successful illustrated training course used by the U. S. Navy

The Navy course turned out naval trained technicians in record time. More than 100,000 naval trainees learned basic electronics this easy "picture-book" way. The modern course we offer also presents BASIC ELECTRONICS in a "picture-book" manner that everyone can grasp, regardless of previous education. Only a knowledge of the basics of electricity is necessary. So successful has the Rider published course proven in industry, that the nation's leading firms use it to teach their personnel. And, now you can master the basics of electronics at home with this same "learn-by-pictures" training course! (This course is available only from John F. Rider Publisher, Inc. or its dealers).

HERE'S HOW THIS EASY, ILLUSTRATED COURSE WORKS: Every page covers one complete idea. There's at least one carefully selected illustration on that same page to explain it. Then, at the end of every section, you'll find review pages that highlight the important topics you have just covered. You build a thorough step-by-step knowledge at your own pace—as fast as you yourself want to. The illustrations—more than 800 of them and the text are the perfect combination to make the subject of electronics completely understandable.

BASIC ELECTRONICS COURSE NOW AVAILABLE IN TWO WAYS

BASIC ELECTRONICS 5-VOLUME COURSE AVAILABLE AS HERETOFORE. The 5-volume civilian version of the U. S. Navy course covers vacuum tube diodes and power supplies, amplifiers, oscillators, transmitters, and receivers. This is the same as has been available heretofore.

BASIC ELECTRONICS EXPANDED COURSE. The INTEGRATED EXPANDED COURSE consists of 6 volumes, including the 5-volume course, plus a 6th volume which expands into the areas of semiconductors, transistors, and frequency modulation. Transistors and semiconductors are the most modern devices in electronic technology. Everyone interested in the broad subject of electronics now must have a familiarity with transistors and semiconductors. If you are interested in learning the basics of electronics, this 6-volume course is the best that you can buy. If you are among the great many tens of thousands who have completed the 5-volume course, the 6th volume on semiconductors transistors, and FM is a book which you should own. It can be bought separately.

BASIC ELECTRONICS: #170, set of Vols. I to V in soft covers, \$11.25. #170-H, all 5 vols. in single cloth binding, \$12.75.
BASIC ELECTRONICS EXPANDED course, #170-X, sets of Vols. I to VI in soft covers, \$13.85; #170-XH, 6 volumes in single cloth binding, \$14.85.
BASIC ELECTRONICS Vol. 6 only, #170-6 soft cover, \$2.90; #170-6H cloth, \$3.95.

ALSO AVAILABLE—A 5-VOLUME COURSE ON BASIC ELECTRICITY

For those who wish to master the basics of electricity before they progress in electronics, there is BASIC ELECTRICITY. This is the civilian version of the course on electricity used by the U. S. Navy to turn out trained technicians. (This course is available only from John F. Rider Publisher, Inc. or its dealers.)

More than 900 carefully selected illustrations supported by crystal-clear text make electricity completely understandable. #169, 5 vols. soft covers, \$11.25 per set; #169-H all 5 vols. in single cloth binding, \$12.75.

These and many other Rider titles are available at bookstores, electronic parts distributors, dept. stores or direct. Send for new catalog.

Buy these books today—No matter where you buy these books, we guarantee satisfaction, or your money back within 30 days of purchase.

RE-9

JOHN F. RIDER PUBLISHER, INC., 116 West 14th Street, New York 11, N. Y.

Canada: Chas. W. Pointon, Ltd., 66 Racine Rd., Rexdale, Ont.

Export: Acme Code Company, Inc., 630 9th Ave., N. Y. C.

India: Asia Publishing House, Bombay and other cities

LEKTRON FIRST

NOT \$1.98
NOT \$1.00
FREE POSTAGE
on \$10 orders

NEW KIT KING® KITS

FIRST TIME EVER IN LEKTRON'S HISTORY! BRAND NEW PARTS! ALL MADE IN U.S.A.! \$5 to \$35 VALUES! LEKTRON EXCLUSIVE!

- 10 TOGGLE TYPE SWITCHES: SPST, D.P.D.T., etc. 115VAC... 4 for 66c
 - 3 PNP TRANSISTORS: "golden" value; factory over-runs... 3 for 66c
 - 2 SUN CELLS: 5g sq. unimtd. generv. type; from sun... 30 for 66c
 - 10 MOLDED CONDENSERS: "world's finest" .003 to .25 mfd... 10 for 66c
 - 15 SILVER MICA'S. condensers. 10p (not 15 dif. values)... 15 for 66c
 - 30 CERAMIC CONDENSERS, discs, "dogbones" to .01 mf... 30 for 66c
 - 30 MICA CONDENSERS, incl. "silver" top! 15 dif. values... 30 for 66c
 - 2 PNP Transistors: "golden" value; factory over-runs, etc... 2 for 66c
 - 10 POWER RESISTORS: 5 to 50 watts, 50-750 ohms, all types... 10 for 66c
 - 5 PR. RCA PHONO PLUG & JACK SETS, for amps, tuners, etc... 5 pr. 66c
 - 30 TERMINAL STRIPS, lug & screw types to 9 lugs... 30 for 66c
 - 3 500-MIL SILICON RECTIFIERS, tubular & "top hat"... 3 for 66c
 - POSTAGE CHART—Orders \$5-\$10 add 85c! Orders \$2-\$5 add 55c
 - 15 CRYSTAL DIODES, germanium, unmarked, over-runs, etc... 15 for 66c
 - 10 "MISSILE" PRECISION resistors, 1% only: 1/4" L... 10 values... 10 for 66c
 - 5 TRANSISTOR SOCKETS, low loss case; submini tubes, too... 5 for 66c
 - 30 TUBULAR CONDENSERS, 0.001 to .5 mf to 1600 WV... 30 for 66c
 - "HOOK-UP" WIRE SPECIAL, 150-ft. all types insulation, colors... 66c
 - 30 CARBON RESISTORS, 1/2, 1, 2W.; 1 & 5% too. 10C, Erie, etc... 30 for 66c
 - 30 CERAMIC CONDENSERS, discs too! To .01mf. 15 values... 30 for 66c
 - 15 STANDARD KNOBS, radio-TV hi-l, push, set screw, pointer... 15 for 66c
 - 25 PLUG & RECEPTACLES, audio, battery, hi-l, spkrs, etc. 25 for 66c
 - 5 ELECTROLYTICS, PPs, tubular, singles, to triples, to 450WV... 5 for 66c
 - 25 COILS: r.f. ant, osc., slug-tuned & 1/2 a too!... 25 for 66c
 - 5 VOLUME CONTROLS, to 1/2-meg. submini too; ea. val. diff... 5 for 66c
- How to Order: Check (✓) blocks; send check, cash, or money order. Rated: 30 days.

LEKTRON 241-245 EVERETT AVE. CHELSEA 50, MASS.

**100,000 SAY
"STILL THE BEST"**

Karlson

ENCLOSURES, KITS, "ROCKET" SPEAKER SYSTEM

U.S. Patents 2,816,619 and 2,896,736
After hearing everything else, over 100,000 users are more convinced than ever that the Karlson Enclosures are "Still the best". The thoroughly engineered and patented designs have ALL the essentials for getting the utmost in sound from your speakers. This includes unexcelled bass and transient response PLUS uniform wide angle dispersion with ANY speaker you install making EVERY SEAT A STEREO SEAT.

Convert to **Multiplex** with the best MODELS AVAILABLE in genuine wood veneers, finished in walnut (WX), mahogany (MX) and blonde oak (BX); unfinished assembled and kits in birch exteriors (DeLuxe) and unfinished assembled and kits (Basic) in a high-density particle board.



Karlson '12' for 12" Speakers
Finished Models
12-MX, 12-BX, 12-WX \$99.60
Unfinished:
DeLuxe, 12-U 66.00
Basic, 12-BSC-U 49.50
Kits: DeLuxe, 12-K 42.00
Basic, 12-BSC-K 33.00
Size: 24 1/4 x 16 3/4 x 13 1/4
Ship. Wt.: 45 lbs.

12-U

**Karlson '8' for 8" Speakers
Finished Models**

8-MX, 8-BX, 8-WX \$42.60
Unfinished:
DeLuxe, 8-U 26.70
Basic, 8-BSC-U 21.00
Kits:
DeLuxe, 8-K 18.60
Basic, 8-BSC-K 15.00
Size: 17 1/4 x 11 3/4 x 9 3/4
Ship. Wt.: 14 lbs.



8MX



Karlson '15' for 15" Speakers
Finished Models
15-MX, 15-BX, 15-WX \$129.00
Unfinished:
DeLuxe, 15-U 87.00
Basic, 15-BSC-U 66.00
Kits: DeLuxe, 15-K 57.00
Basic, 15-BSC-K 45.00
Size: 22 1/2 x 33 x 18
Ship. Wt.: 78 lbs.

15-WX

ROCKET SPEAKER SYSTEM

Complete, full-range. Use as satellite, extension, P.A., miniature stereo and reverb speaker. Chameleon Ivory finish. KR-5 5" speaker, 15 1/2" high, 7" sq. at base. Ship. Wt.: 3 lbs.



KR-5

WHERE TO BUY

Buy with confidence where demonstrated and advertised. Consult your Classified Directory, mail order catalogs, or the current Radio Electronic Masters'. Save time—buy direct. Send check or money order: above prices f.o.b. West Hempstead.

Visit our showroom in West Hempstead for a unique demonstration of our new Ultra Panoramic Stereo.

Learn more about stereo. Send for free copy of "StereoSonics by Karlson".

Name _____
Street _____
City _____ State _____

KARLSON ASSOCIATES, Inc.
433-REHempstead Ave., W. Hempstead, N.Y.



as voice amplifier. "Talk power" range up to 2,000 ft. Uses 6 size C flashlight cells. Pistol-grip handle with trigger switch for one-hand operation. 2 1/2 lbs.—Lafayette Radio Electronics Corp., 165-08 Liberty Ave., Jamaica 22, N. Y.

INTERCOM MASTER, Ektacom G series, with single-touch gold-plated self-cleaning leaf type

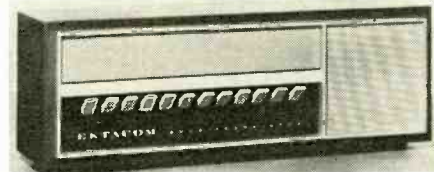

switches.—Fisher Berkeley Corp., Emeryville 8, Calif.

PA SYSTEM, Portable Moving Rostrum in single case. Battery operated. Under 30 lbs. All-transistor 10-watt push-pull amplifier. Low-

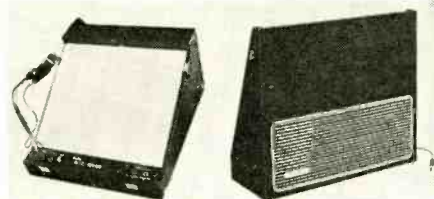

impedance microphone with 60-10,000 cycle response, 2 full-fidelity 6 x 9-in. loudspeakers with 10-oz. ceramic magnets.—Perma-Power Co., 3100 N. Elston Ave., Chicago 18, Ill.

MICROPHONE HEADSET COMBINATION, model 260, 1 cable serves crystal headphones and

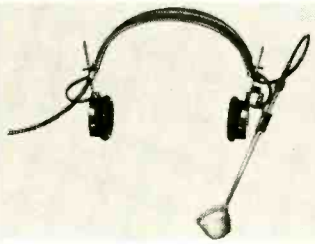

microphone. Dynamic, crystal or ceramic mike elements.—Turner Microphone Co., 909 17th St., N. E. Cedar Rapids, Iowa.

SOLDERGUNS, models 190-02 Single Heat and 192-02 Dual Heat. Alloy tips retinned by wiping

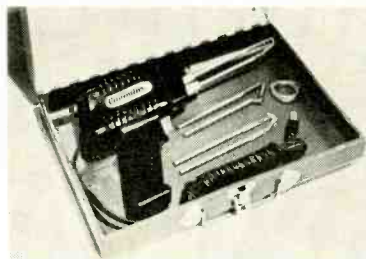

heated tip with damp rag. Built-in shadowless spotlight, roomy handle compartment.—Cummins Portable Tool Co., Div. of John Oster Mfg. Co., 5055 N. Lydell Ave., Milwaukee, Wis.

IN-CIRCUIT TESTER measures in-circuit pa-

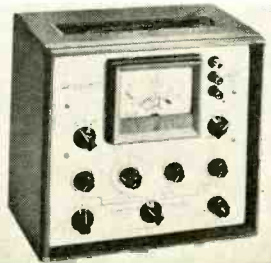

rameters of all low- and medium-power transistors and diodes. I_{co} ranges: 0-5 μ a, 0-500 μ a and 0-5 ma. I_c ranges: 0-1 ma, 0-10 ma and 0-100 ma. Collector voltage variable from 0 to 4.5 in 3 steps. Variable collector current, 0-100 ma. 11 1/4 x 10 3/4 x 7 1/2 in. 17 lb.—Hickok Electrical Instrument Co., 10514 Dupont Ave., Cleveland 8, Ohio.

PICTURE-TUBE BRIGHTENER, 2-Brite, handles C-234-, 2.68-, 4.79-, 6.30- and 8.40-volt tubes. Model

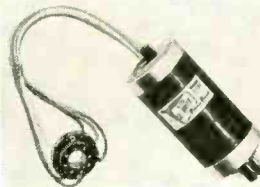

C-202 fits standard (duodecal) base sets; model C-212. 110° button-base sets; model C-222. 110° shell-base sets.—Perma-Power Co., 3100 N. Elston Ave., Chicago 18, Ill.

TUBE TESTER, grid circuit type, model 650, tests all standard radio and TV tubes plus 10-pin



miniatures, 12-pin Compactrons, 5- and 7-pin nuvistors, Novar tubes, wide variety of voltage regulator tubes, foreign and industrial tubes. Complete tube-data listing. 9 x 13 x 4 in. 9 lb.—Precision Apparatus Co. Inc., Pacotronics, Inc., 70-31 84th St., Glendale 27, N. Y.

VOLT-OHM-MILLIAMMETERS models 267 and 268 with 7-inch meter. Low microamp ranges:



0-50 for 267 and 0-60 for 268. Sensitivity of ac voltage ranges to 5,000 ohms per volt.—Simpson Electric Co., 5200 W. Kinzie St., Chicago 44, Ill.

VOLT-OHM-MILLIAMMETER model 630-NARM, 68 ranges, mirror-scaled. Meter protection against overloads. High accuracy on same scale for ac and dc. Frequency compensation from 35 cycles to 20 kc. Temperature compensation ac-

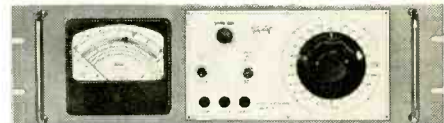

curate within wide range of ambient temperatures. Dc reversing switch.—Triplett Electrical Instrument Co., Bluffton, Ohio.

GARAGE-DOOR OPERATOR, all-transistor, portable. Additional transmitters available where door will regularly be operated from more than



one car. Unit controls garage light which remains on for 2 minutes after door closes. If door strikes object power shuts off and door automatically stops.—Perma-Power, 3100 N. Elston Ave., Chicago 18, Ill.

MINIATURE ROTARY-SWITCH CONSTRUCTION KIT PK-20-S for designing and building switches to exact specifications for prototypes



and lab work. Up to 25 4-section switches possible.—Centralab, Electronics Div. of Globe-Union Inc., 900 E. Keefe Ave., Milwaukee, Wis.

FILAT PLUGS with 0.206-in. diameter fingers. Nylon insulation between tip, ring and sleeve circuits of finger assembly. Commercially inter-

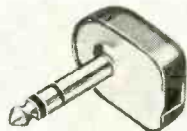

changeable with military type plug PJ-068. Part No. S-235, red plastic handle; Part No. S-230, black plastic handle.—Switchcraft Inc., 5555 N. Elston Ave., Chicago 30, Ill.

NAIL CLIP E-Z Hook type 81-1 drives into wood with hammer. Up to 4 or more wires feed through hook or slip under end. Patented con-

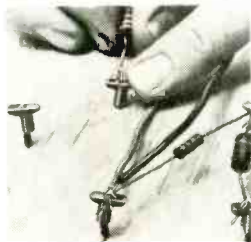

ductor, nylon insulator, special T-shape, large bulk head and stainless steel spring and body.—E-Z Hook Test Products, 1536 Woodburn Ave., Covington, Ky.

ELECTRONIC CONTACT CLEANER LUBRICANT in an aerosol dispenser. Special plastic



extender for hard-to-reach areas. 6- and 16-oz.—Krylon Inc., Norristown, Pa.

TEMPERATURE-STABLE CAPACITORS. Type CE, in values from 150- μ f to .001 μ f, 10% tolerance. Type CF from .0012 μ f to .01 μ f, 10%.

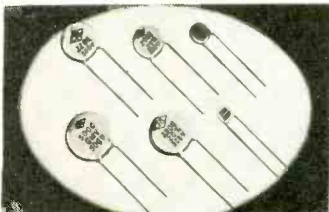

500-vdc working voltage. Over 10,000 megohms initial minimum leakage resistance.—Centralab, Electronics Div. of Globe-Union Inc., 900 E. Keefe Ave., Milwaukee 1, Wis.

SEALED POLYSTYRENE CAPACITORS for (Continued on page 108)



THE INDUSTRY'S STANDARD

Most Widely Used Today
by Professional Servicemen

SAVE CUSTOMERS MAKE MONEY

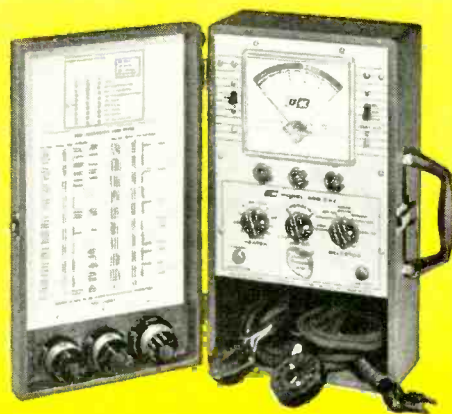

FAMOUS DELUXE



CRT 440



For Black & White and Color

"Most valuable and useful" . . . "Wouldn't be without it" . . . "Pays for itself over and over again" . . . servicemen say. Quickly checks and corrects television picture tube troubles in a few minutes right in the home without removing tube from set. Gives new life to weak or inoperative tubes. Checks for leakage, shorts, open circuits and emission. Removes inter-element shorts and leakage. Repairs open circuits and low emission. Restores emission and brightness. Life Test checks gas content and predicts remaining useful life of picture tube. Makes new tube sales easier. Completely self-contained. Rich leatherette-covered carry-case. Net, \$74.95

TESTS AND REJUVENATES

all picture tubes at correct filament voltage from 1 to 12 volts

TESTS AND REJUVENATES

110° tubes and the new 19" and 23" tubes

TESTS AND REJUVENATES

color picture tubes. Checks each gun of color tube separately

UP-DATE YOUR B&K CRT WITH THESE ACCESSORIES

Subscribe to New Picture Tube Information Service

Model C40 Adapter. For use with previous Models 400 and 350 CRT's—to test and rejuvenate TV color picture tubes and 6.3 volt 110° picture tubes. Net, \$9.95

Model CR48 Adapter. For use with previous Models 400 and 350 CRT's—to test and rejuvenate 110° picture tubes with 2.34, 2.68, and 8.4 volt filaments. Net, \$4.95

See Your B&K Distributor, or Write for Catalog AP18E

B&K MANUFACTURING CO.
1801 W. BELLE PLAINE AVE • CHICAGO 13, ILL.
Canada: Atlas Radia Corp., 50 Wingold, Toronto 19, Ont.
Export: Empire Exporters, 277 Broadway, New York 7, U.S.A.



Please..

mention

RADIO-ELECTRONICS

when answering advertisements

SILICON RECTIFIERS 750 MA TOP-HATS
Factory Direct MFG. PRICES

PIV/RMS 50/35 .15 ea.	PIV/RMS 100/70 .25 ea.	PIV/RMS 200/140 .30 ea.	PIV/RMS 300/210 .40 ea.
PIV/RMS 400/280 .45 ea.	PIV/RMS 500/350 .65 ea.	PIV/RMS 600/420 .75 ea.	PIV/RMS 700/490 .90 ea.
PIV/RMS 800/560 .95 ea.	PIV/RMS 900/630 1.15 ea.	PIV/RMS 1000/700 1.55 ea.	PIV/RMS 1100/770 1.75 ea.

General Purpose 400PIV at 300MA
Special 2 for .75 25 for \$7.50
LOW PRICES! General Electric 1N91 Power Junction Diode—10 for \$1.50; Top Hat Silicon Diode 25PIV/17RMS, 500MA—29 for \$2.00; Hughes 1N67A Crystal Diode Glass Special—10 for \$1.50; Int. Rect. Selenium PIV440/RMS160 DC Current, 10MA—10 for \$2.00
All material guaranteed. \$2.00 min. order. Orders F.O.B. NYC. Include check or money order. Shpg. charges plus. C.O.D. orders 25% down.
WARREN DIST. CO.
NYC 7, NY 87 Chambers St. WO 2-5727

EXAMINE ANY OF THESE TESTERS BEFORE YOU BUY!!

Yes, we offer to ship at our risk one or more of the testers described on these pages.

SUPERIOR'S NEW MODEL 770-A

VOLT-OHM MILLIAMMETER

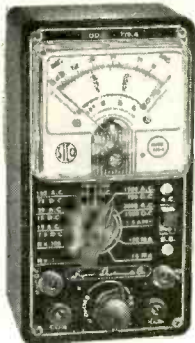

FEATURES:

- Compact—measures 3 1/8" x 5 7/8" x 2 1/4".
- Uses "Full View" 2% accurate 850 Microampere D'Arsonval type meter
- Housed in round-cornered, molded case.

SPECIFICATIONS:

- 6 A.C. VOLTAGE RANGES: 0-15/30/150/300/1500/3000 Volts.
- 6 D.C. VOLTAGE RANGES: 0-7.5/15/75/150/750/1500 Volts.
- 2 RESISTANCE RANGES: 0-10,000 Ohms, 0-1 Megohm.
- 3 D.C. CURRENT RANGES: 0-15/150 Ma., 0-1.5 Amps.
- 3 DECIBEL RANGES: -6 db to +18 db, +14 db to +38 db, +34 db to +58 db.

The Model 770-A comes complete with test leads and operating instructions. Price is \$15.85. Terms: \$3.85 after 10 day trial then \$4.00 monthly for 3 months.

SUPERIOR'S NEW MODEL 79

SUPER-METER

WITH NEW 6" FULL VIEW METER



SPECIFICATIONS:

- D.C. VOLTS: 0 to 7.5/15/75/150/750/1,500.
- A.C. VOLTS: 0 to 15/30/150/300/1,500/3,000.
- D.C. CURRENT: 0 to 1.5/15/150 Ma. 0 to 1.5/15 Amperes.
- RESISTANCE: 0 to 1,000/100,000 Ohms. 0 to 10 Megohms.
- CAPACITY: .001 to 1 Mfd. 1 to 50 Mfd.
- REACTANCE: 50 to 2,500 Ohms, 2,500 Ohms to 2.5 Megohms.
- INDUCTANCE: .15 to 7 Henries, 7 to 7,000 Henries.
- DECIBELS: -6 to +18, +14 to +38, +34 to +58.

The following components are all tested for QUALITY at appropriate test potentials. Two separate BAD-GOOD scales on the meter are used for direct readings.

All Electrolytic Condensers from 1 MFD to 1000 MFD.

All Silicon Rectifiers. All Germanium Diodes.

Model 79 comes complete with operating instructions, test leads and carrying case. Price is \$38.50. Terms: \$8.50 after 10 day trial then \$6.00 monthly for 5 months.

SUPERIOR'S NEW MODEL 77

VACUUM TUBE VOLTMETER

WITH NEW 6" FULL VIEW METER

Compare it to any peak-to-peak V.T.V.M. made by any other manufacturer at any price!

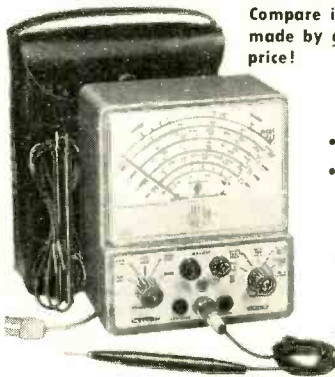

SPECIFICATIONS:

- DC VOLTS—0 to 3/15/75/150/300/750/1500 volts at 11 megohms input resistance.
- AC VOLTS (RMS)—0 to 3/15/75/150/300/750/1500 volts.
- AC VOLTS (Peak to Peak)—0 to 8/40/200/400/800/2000 volts.
- ELECTRONIC OHMMETER—0 to 1000 ohms/10,000 ohms/100,000 ohms/1 megohm/10 megohms/100 megohms/1,000 megohms.
- DECIBELS—10 db to +18 db, +10 db to +38 db, +30 db to +58 db. All based on 0 db = .006 watts (6 mw) into a 500 ohm line (1.73v).
- ZERO CENTER METER—For discriminator alignment with full scale range of 0 to 1.5/7.5/37.5/75/150/375/750 volts at 11 megohms input resistance.

Model 77 comes complete with operating instructions, probe and test leads and carrying case. Price is \$42.50. Terms: \$12.50 after 10 day trial then \$6.00 monthly for 5 months.

SUPERIOR'S NEW MODEL 80

20,000 OHMS PER VOLT ALLMETER



6 INCH FULL-VIEW METER provides large easy-to-read calibrations. No squinting or guessing when you use Model 80.

MIRRORED SCALE permits fine accurate measurements where fractional readings are important.

SPECIFICATIONS:

- 7 D.C. VOLTAGE RANGES: (At a sensitivity of 20,000 Ohms per Volt) 0 to 15/75/150/300/750/1500/7500 Volts.
- 6 A.C. VOLTAGE RANGES: (At a sensitivity of 5,000 Ohms per Volt) 0 to 15/75/150/300/750/1500 Volts.
- 3 RESISTANCE RANGES: 0 to 2,000/200,000 Ohms. 0-20 Megohms.
- 2 CAPACITY RANGES: .00025 Mfd. to .3 Mfd., .05 Mfd. to 30 Mfd.
- 5 D.C. CURRENT RANGES: 0-75 Microamperes, 0 to 7.5/75/750 Milli-amperes, 0 to 15 Amperes.
- 3 DECIBEL RANGES: -6 db to +18 db, +14 db to +38 db, +34 db to +58 db.

NOTE: The line cord is used only for capacity measurements. Resistance ranges operate on self-contained batteries.

Model 80 Allmeter comes complete with operating instructions, test leads and portable carrying case. Price is \$42.50. Terms: \$12.50 after 10 day trial then \$6.00 monthly for 5 months.

SUPERIOR'S NEW MODEL 70 UTILITY TESTER

FOR REPAIRING ALL ELECTRICAL APPLIANCES MOTORS ★ AUTOMOBILES

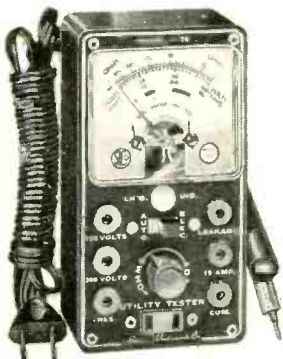

INCLUDED FREE

64 page condensed course in electricity. Profusely illustrated. Written in simple, easy-to-understand style.

As an electrical trouble shooter the Model 70:

- Will test Toasters, Irons, Broilers, Heating Pads, Clocks, Fans, Vacuum Cleaners, Refrigerators, Lamps, Fluorescents, Switches, Thermostats, etc.
- Measures A.C. and D.C. Voltages, A.C. and D.C. Current, Resistances, Leakage, etc.
- Incorporates a sensitive direct-reading resistance range which will measure all resistances commonly used in electrical appliances, motors, etc.
- Leakage detecting circuit will indicate continuity from zero ohms to 5 megohms (5,000,000 ohms).

As an Automotive Tester the Model 70 will test:

- Both 6 Volt and 12 Volt Storage Batteries • Generators • Starters • Distributors • Ignition Coils • Regulators • Relays • Circuit Breakers • Cigarette Lighters • Stop Lights • Condensers • Directional Signal Systems • All Lamps and Bulbs • Fuses • Heating Systems • Horns • Also will locate poor grounds, breaks in wiring, poor connections, etc.

Model 70 comes complete with 64 page book and test leads. Price is \$15.85. Terms: \$3.85 after 10 day trial then \$4.00 monthly for 3 months.

DID YOU EVER?

- ▶ Order merchandise by mail, including deposit or payment in full, then wait and write...wait and write?
- ▶ Purchase anything on time and sign a lengthy complex contract written in small difficult-to-read type?
- ▶ Purchase an item by mail or in a retail store then experience frustrating delay and red tape when you applied for a refund?

Obviously prompt shipment and attention to orders is an essential requirement in our business... We ship at our risk!

NO

CONTRACT TO SIGN

CO-MAKERS

**EMPLOYER
NOTIFICATION**

The simple order authorization included in this offer is all you sign. We ask only that you promise to pay for or return the goods we ship in good faith.

**EXAMINE ANY ITEM YOU SELECT
IN THE PRIVACY OF YOUR OWN HOME**

Then if completely satisfied pay on the interest-free terms plainly specified. When we say interest-free we mean not one penny added for "interest" for "finance" for "credit-checking" or for "carrying charges." The net price of each tester is plainly marked in our ads—that is all you pay except for parcel post or other transportation charges we may prepay.

SUPERIOR'S NEW MODEL 82A

MULTI-SOCKET TYPE

TUBE TESTER

SPECIFICATIONS:

- Tests over 1000 tube types.
- Tests OZ4 and other gas-filled tubes.
- Employs new 4" meter with sealed air-damping chamber resulting in accurate vibrationless readings.
- Use of 22 sockets permits testing all popular tube types and prevents possible obsolescence.
- Dual Scale meter permits testing of low current tubes.
- 7 and 9 pin straighteners mounted on panel.
- All sections of multi-element tubes tested simultaneously.
- Ultra-sensitive leakage test circuit will indicate leakage up to 5 megohms.

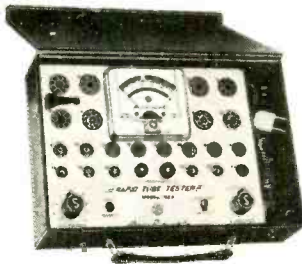

Model 82A comes housed in handsome, portable, saddle-stitched Texon case. Price is \$36.50. Terms: \$6.50 after 10 day trial then \$6.00 monthly for 5 months.

SUPERIOR'S NEW MODEL TW-11

STANDARD PROFESSIONAL

TUBE TESTER



- Uses the new self-cleaning Lever Action Switches for individual element testing. Because all elements are numbered according to pin-number in the RMA base numbering system, the user can instantly identify which element is under test.
- Free-moving built-in roll chart provides complete data for all tubes. All tube listings printed in large-easy-to-read type.
- **NOISE TEST:** Phono-jack on front panel for plugging in either phones or external amplifier will detect microphonic tubes or noise due to faulty elements and loose internal connections.
- **SEPARATE SCALE FOR LOW-CURRENT TUBES**—Previously, on emission type tube testers, it has been standard practice to use one scale for all tubes. As a result, the calibration for low-current types has been restricted to a small portion of the scale. The extra scale used here greatly simplifies testing of low-current types.

The Model TW-11 comes housed in a handsome, portable, saddle-stitched Texon case. Price is \$47.50. Terms: \$11.50 after 10 day trial then \$6.00 monthly for 6 months.

SUPERIOR'S NEW MODEL 83A

C.R.T. TESTER

Tests and Rejuvenates

ALL PICTURE TUBES

ALL BLACK AND WHITE TUBES

From 50 degree to 110 degree types—from 8" to 30" types.

ALL COLOR TUBES

Test ALL picture tubes—in the carton—out of the carton—in the set!

Model 83A provides separate filament operating voltages for the older 6.3 types and the newer 8.4 types.

Model 83A properly tests the red, green and blue sections of color tubes individually—for each section of a color tube contains its own filament, plate, grid and cathode.

Model 83A will detect tubes which are apparently good but require rejuvenation. Such tubes will provide a picture seemingly good but lacking in proper definition, contrast and focus.

Rejuvenation of picture tubes is not simply a matter of applying a high voltage to the filament. Such voltages improperly applied can strip the cathode of the oxide coating essential for proper emission. The Model 83A applies a *selective* low voltage *uniformly* to assure increased life with no danger of cathode damage.

Model 83-A comes housed in handsome portable saddle-stitched Texon case—complete with socket for all black and white tubes and all color tubes. Price is \$38.50. Terms: \$8.50 after 10 day trial then \$6.00 monthly for 5 months.

SUPERIOR'S NEW MODEL TV-50A

GENOMETER 7 Signal Generators in One!



- ✓ R.F. Signal Generator for A.M.
- ✓ R.F. Signal Generator for F.M.
- ✓ Audio Frequency Generator
- ✓ Bar Generator
- ✓ Cross Hatch Generator
- ✓ Color Dot Pattern Generator
- ✓ Marker Generator

A versatile all-inclusive GENERATOR which provides ALL the outputs for servicing:

A.M. Radio • F.M. Radio • Amplifiers • Black and White TV • Color TV

The Model TV-50A comes absolutely complete with shielded leads and operating instructions. Price is \$47.50. Terms: \$11.50 after 10 day trial then \$6.00 monthly for 6 months.

SUPERIOR'S NEW MODEL 85

TRANS-CONDUCTANCE TYPE TUBE TESTER

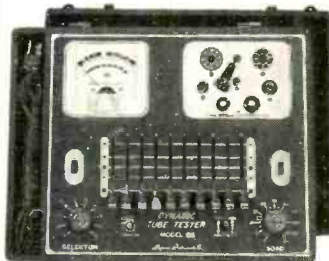

- Employs latest improved TRANS-CONDUCTANCE circuit. Test tubes under "dynamic" (simulated) operating conditions. An in-phase signal is impressed on the input section of a tube and the resultant plate current change is measured as a function of tube quality. This provides the most suitable method of simulating the manner in which tubes actually operate in radio, TV receivers, amplifiers and other circuits. Amplification factor, plate resistance and cathode emission are all correlated in one meter reading.

Model 85 employs time-saving symbols (•, +, •, A, ■) in place of difficult-to-remember letters previously used. Repeated studies proved to us that use of these symbols speeded up the element switching step. As the tube becomes necessary and advantageous.

Model 85 comes complete, housed in a handsome portable cabinet with slip-on cover. Price is \$52.50. Terms: \$12.50 after 10 day trial then \$8.00 monthly for 5 months.

Scientifically selected symbols speeded up the element switching step. As the tube becomes necessary and advantageous.

• "FREE-POINT" LEVER TYPE ELEMENT SWITCH ASSEMBLY marked according to RETMA basing, permits application of test voltages to any of the elements of a tube.

• FREE FIVE (5) YEAR CHART DATA SERVICE. Revised up-to-date subsequent charts will be mailed to all Model 85 purchasers at no charge for a period of five years after date of purchase.

Model 85 comes complete, housed in a handsome portable cabinet with slip-on cover. Price is \$52.50. Terms: \$12.50 after 10 day trial then \$8.00 monthly for 5 months.

SUPERIOR'S NEW MODEL 88

TESTS ALL TRANSISTORS AND TRANSISTOR RADIOS



AS A TRANSISTOR RADIO TESTER

An R.F. Signal source, modulated by an audio tone is injected into the transistor receiver from the antenna through the R.F. stage, past the mixer into the I.F. Amplifier and detector stages and on to the audio amplifier. This injected signal is then followed and traced through the receiver by means of a built-in High Gain Transistorized Signal Tracer until the cause of trouble is located and pinpointed.

AS A TRANSISTOR TESTER

The Model 88 will test all transistors including NPN and PNP, silicon, germanium and the new gallium arsenide types, without referring to characteristic data sheets. The time-saving advantage of this technique is self-evident. A further benefit of this service is that it will enable you to test new transistors as they are released!

Model 88 comes housed in a handsome portable case. Complete with a set of Clip-on Cables for Transistor Testing; an R.F. Diode Probe for R.F. & I.F. Tracing; an Audio Probe for Amplifier Tracing and a Signal Injector Cable. Complete—nothing else to buy! Price is \$38.50. Terms: \$8.50 after 10 day trial then \$6.00 monthly for 5 months.

SEND POSTCARD TODAY

**(NO POSTAGE
NECESSARY)**

Try any of the instruments on this or the facing page for 10 days before you buy. If completely satisfied then send down payment and pay balance as indicated on coupon. No interest or Finance Charges Added! If not completely satisfied return unit to us, no explanation necessary.

MOSS ELECTRONIC, INC., DEPT D-903, 3849 TENTH AVENUE, NEW YORK 34, N.Y.

PHILCO
Computer Division
Willow Grove, Pa.

America's fastest growing computer manufacturer now offers career opportunities to:

- SALESMEN
- PROGRAMMERS
- SYSTEMS ANALYSTS
- INSTRUCTORS
- FIELD ENGINEERS

The above positions are available in major cities throughout U.S.A. Acceptable candidates will receive orientation in the PHILCO 2000 System at company expense at our Willow Grove, Pa. plant. Applicants should be available for occasional travel and/or relocation.

Unique technical opportunities for SENIOR LEVEL ENGINEERS exist in these areas at our Willow Grove Computer Plant:

- CHARACTER RECOGNITION
- CIRCUIT DESIGN
- LOGICAL DESIGN
- ADVANCED SYSTEMS
- MEMORY DEVICES
- ELECTRONIC PACKAGING
- DIGITAL PULSE TECHNIQUES

All qualified applicants will receive consideration for employment without regard to race, creed, color or national origin.

Please submit resume to:
 Mr. John Felos
 Professional Employ. Mgr.

PHILCO
 Famous for Quality the World Over

COMPUTER DIVISION
Willow Grove, Pa.

(Continued from page 103)

long-life applications. Leakage resistance in excess of 500,000 megohms/μf. 25-, 125- and 500-volts dc units available with 2.5%, 5.0%, 10% or 20% tolerances.—Centralab, Electronics Div. of Globe-Union, Inc., 900 E. Keefe Ave., Milwaukee 1, Wis.

POTENTIOMETER, Series 60M Cap-Pot in resistance ranges of 10 to 10,000 ohms. Wirewound, rated at ½ watt at 40°C. Linear taper. Resist-



ance tolerance ±10%. Overall miniaturization, weather- and, explosion-proof.—Clarostat Mfg. Co. Inc., Dover, N. H.

MOLDED CARBON POTENTIOMETER, series 63M, style RV-6, withstands 750 volts rms at sea level, 350 volts rms at 50,000 feet for 1 minute. ½-in. diameter. Rated at ½ watt at 70°C. Re-

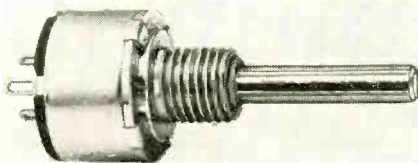

sistance values 100 ohms to 5 megohms. Linear tapers. Resistance tolerance ±10%. Mechanical rotation 295° ±3°.—Clarostat Mfg. Co. Inc., Dover, N. H.

ATTENUATOR-RESISTOR BANK, model 511A Attenu-Load, follows typical T-pad design. Maximum power dissipation rating 50 watts at input



connector. 10-db power reduction ratio represents power stepdown of 10:1.—Seco Electronics Inc., 5015 Penn Ave. S., Minneapolis 19, Minn.

TRANSISTOR ANTENNA-MOUNTED BOOSTER, AB-4 Signal Master. Built-in 4-set coupler. Re-

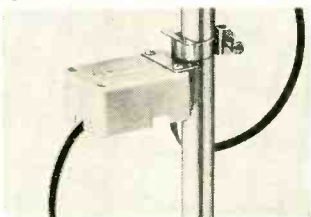

note power supply uses 4 flashlight cells. Noise figure, 3 db on low band, 6.5 db on high.—Blonder-Tongue Labs Inc., 9 Alling St., Newark 2, N. J.

AMPLIFIERS, for public address, Moduline: basic 30-, 60- and 120-watt amplifiers; 4 modules;



front-panel can be used for VU meter or monitor speaker. **Commander series:** 12-, 35- and 100-watt amplifiers; master volume and fader-mixer controls.—Harman-Kardon Inc., Ames Court, Plainview, N. Y.

BROADBAND AMPLIFIER for master TV systems. Up to 35-db gain. Power rating under 50 watts. 2 volts output. Separate inputs for high or low band with link for use with combined



high/low band inputs. Weatherproof container available.—Benco Television Assoc. Ltd., 27 Taber Rd., Rexdale, Ontario, Canada.

AUDIO AMPLIFIER, PK-522, subminiature type, 3 transistors. 2 input leads for use with tape recorder record/playback heads, radio tuner, crystal or ceramic phono cartridge and crystal or ceramic microphone; 2 output leads for 2 to 10-ohm speakers; 2 leads for on-off spst switch;

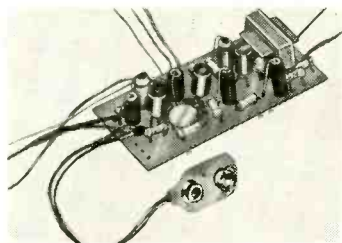

3 leads for volume control; 2 leads terminating in battery clips. 2 13/16 x 1 1/4 x 3 1/4 in. 8 oz.—Lafayette Radio Electronics Corp., 165-08 Liberty Ave., Jamaica 33, N. Y.

PREAMPLIFIER KIT, LC-21. Components arranged on cards and correlated with step-by-step full-color instruction book plus container-storage

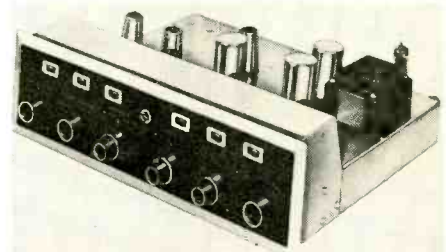

area and work bench. 5 pairs of stereo inputs, derived center-channel output, stereo tape recorder outputs. 14 front-panel controls. 80-db hum level. Distortion 0.1% at 2.5 volts output. Input sensitivity 2.4 mv. Frequency response 8-50,000 cycles ±1 db.—H. H. Scott Inc., Dept. P, 111 Powdermill Rd., Maynard, Mass.

MONOPHONIC TAPE RECORDER model 101. Playing and recording time of over 8 1/2 hours on 1 reel. 1 7/8-, 3 3/4- or 7 1/2-ips tape speed. VU meter,



tape lifters and dynamic microphone.—Super-scope Inc., 8150 Vineland Ave., Sun Valley, Calif.

AUTOMATIC TURNTABLE AND RECORD CHANGER, Miracord Studio H. Synchronous hysteresis motor. One-piece nonferrous turntable



weighs almost 7 lb. Transcription tone arm with adjustable counterbalance and springless construction.—Benjamin Electronic Sound Corp., 97-03 43rd Ave., Corona 68, N. Y.

STEREO CONTROLS from manufacturer's dual concentric controls with use of specially tempered spring that inserts between shafts of

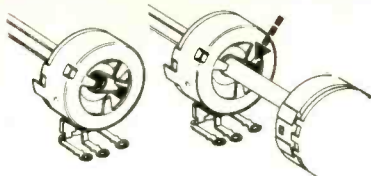

front and rear controls and provides sufficient tension to insure their simultaneous rotation.—Centralab, Electronics Div. of Globe-Union, Inc., 900 E. Keefe Ave., Milwaukee 1, Wis.

STEREO TUNER/AMPLIFIER, KN-300. Separate FM and AM tuner sections, built-in preamps and complete stereo amplifier with 30-watt IHFM



music power output. Amplifier response ± 0.5 db, 15-30,000 cycles. Tuner sensitivity $2\frac{1}{2}$ μ v for 20-db quieting on FM; 15 μ v on A.M.—Allied Radio Corp., 100 N. Western Ave., Chicago, 80, Ill.

STEREO TAPE-HEAD KIT with simple, illustrated mounting directions. Quarter-track record—playback stereo tape head, 3-inch reel of azi-



lignment tape, electrical connector and necessary hardware.—Fidelitone Inc., 6415 Ravenswood Ave., Chicago 26, Ill.

STEREOPHONIC MASTER CONTROL-AMPLIFIER, X-202-B. Combined music power output of 75 watts. Harmonic distortion 0.5% at 70 watts rms. Intermodulation distortion 1% at 70 watts



rms. Overall frequency response (1 watt) 20-20,000 cycles ± 1 db. Power amplifier hum and noise more than 90 db. Stereo channel separation at 1 kc better than 50 db. Output impedance at speaker terminals 4, 8 or 16 ohms. 20 front-panel controls.—Fisher Radio Corp., 21-21 44th Drive, Long Island City 1, N. Y.

STEREO PIANO CONSOLE, GDW-41. 2 full-range, cylindrical, ported enclosures mounted on vertical axes and mechanically linked so can be rotated in opposite directions by equal



amounts. 4-speed automatic stereo record changer with diamond (LP) and sapphire (78) styli, 30-watt amplifier and built-in stereo speaker system. 50 $\frac{1}{2}$ x 31 x 18 inches.—Heath Co., Benton Harbor, Mich.

AM/FM TUNER, AJ-11, with separate tuning indicators for AM and FM. 3-position afc and AM fidelity switches. Individual flywheel tuning



for both AM and FM. Separate terminals for outside AM and FM antennas. Multiple signal output jack.—Heath Co., Benton Harbor, Mich.

FM TUNER KIT, model ST-25. 2 limiter stages coupled with wide-band ratio detector and afc. Sensitivity 1.5 μ v for 20-db quieting; IHFM sensitivity 4 μ v. Signal-to-noise ratio 50 db at

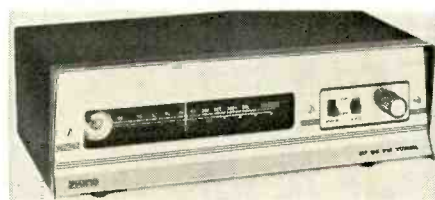

15 μ v, full limiting. Output, 1 volt rms minimum. Maximum distortion 1%. Bandwidth, 250 kc; antenna input, 300 ohms. Main and multiplex outputs. Fully wired and prealigned front end.—Paco Electronics Co. Inc., 70-31 84th St., Glendale 27, N. Y.

BOOKSHELF SYSTEM, model SP-10S, with 30-watt power capacity. Pair of specially designed cone-type tweeters in tuned cabinet ducted with plastic tubing. Foam-suspended woofer. Swedish walnut finish. 23 $\frac{1}{2}$ x 14 x 11 $\frac{1}{4}$ in.—Monarch Electronics International Inc., 7035 Laurel Canyon Blvd., North Hollywood, Calif. END

All Specifications from Manufacturer's data.

TV-RADIO Servicemen or Beginners...

Send for *Coyne's*
7-Volume Job-Training Set
on 7-Day **FREE TRIAL!**



The First
Practical
TV-RADIO-
ELECTRONICS
Shop
Library!

Answers **ALL** Servicing Problems **QUICKLY** . . .
Makes You Worth More On The Job!

Put money-making, time-saving TV-RADIO-ELECTRONICS know-how at your fingertips—examine Coyne's all-new 7-Volume TV-RADIO-ELECTRONICS Reference Set for 7 days at our expense! Shows you the way to easier TV-Radio repair—time saving, practical working knowledge that helps you get the BIG money! How to install, service and align ALL radio and TV sets, even color-TV, UHF, FM and transistorized equipment. New photo-instruction shows you what makes equipment "tick". No complicated math or theory—just practical facts you can put to use immediately right in the shop, or for ready reference at home. Over 3000 pages; 1200 diagrams; 10,000 facts!

SEND NO MONEY! Just mail coupon for 7-Volume TV-Radio Set on 7-Day FREE TRIAL! We'll include the FREE BOOK below. If you keep the set, pay only \$3 in 7 days and \$3 per month until \$27.25 plus postage is paid. Cash price only \$24.95. Or return set at our expense in 7 days and owe nothing. Either way, the FREE BOOK is yours to keep. Offer limited, so act NOW!

"LEARNED MORE FROM THEM THAN FROM 5 YEARS WORK!"

"Learned more from your first two volumes than from 5 years work."
—Guy Bliss, New York

"Swell set for either the serviceman or the beginner. Every service bench should have one."
—Melvin Masbruch, Iowa.

FREE DIAGRAM BOOK!
We'll send you this big book, "150 Radio-Television Picture Patterns and Diagrams Explained" **ABSOLUTELY FREE** just for examining Coyne's 7-Volume Shop Library on 7-Day FREE TRIAL! Shows how to cut servicing time by reading picture-patterns, plus schematic diagrams for many TV and radio sets. Yours FREE whether you keep the 7-Volume Set or not! Mail coupon TODAY!



Like Having An Electronics Expert Right At Your Side!

VOL. 1—EVERYTHING ON TV-RADIO PRINCIPLES! 300 pages of practical explanations; hundreds of illustrations.

VOL. 2—EVERYTHING ON TV-RADIO-FM RECEIVERS; 403 pages; fully illustrated.

VOL. 3—EVERYTHING ON TV-RADIO CIRCUITS! 336 pages; hundreds of illustrations, circuit diagrams.

VOL. 4—EVERYTHING ON SERVICING INSTRUMENTS! How they work, how to use them. 358 pages; illustrated.

VOL. 5—EVERYTHING ON TV TROUBLESHOOTING! Covers all types of sets. 437 pages; illustrations, diagrams.

VOL. 6—TV CYCLOPEDIA! Quick and concise answers to TV problems in alphabetical order, including UHF, Color TV and Transistors; 868 pages.

VOL. 7—TRANSISTOR CIRCUIT HANDBOOK! Practical Reference covering Transistor Applications; over 200 Circuit Diagrams; 410 pages.

ALL 7 BOOKS HAVE BRIGHT, MODERN, VINYL CLOTH WASHABLE COVERS

FREE BOOK—FREE TRIAL COUPON!

Educational Book Publishing Division
COYNE ELECTRICAL SCHOOL

1455 W. Congress Parkway, Dept. 91-RE, Chicago 7, Illinois

Yes! Send me COYNE'S 7-Volume Applied Practical TV-RADIO-ELECTRONICS Set for 7-Days FREE TRIAL per your offer. Include "Patterns & Diagrams" book FREE!

Name _____ Age _____
Address _____

City _____ Zone _____ State _____

Check here if you want Set sent C.O.D. Coyne pays postage on C.O.D. and cash orders. 7-Day Money-Back Guarantee.

Coyne

ELECTRICAL SCHOOL
1455 W. Congress Parkway,
Dept. 91-RE, Chicago 7, Illinois

Professional Technicians Use CASTLE'S Complete

TV TUNER OVERHAUL

ALL MAKES
ONE PRICE

\$9⁹⁵

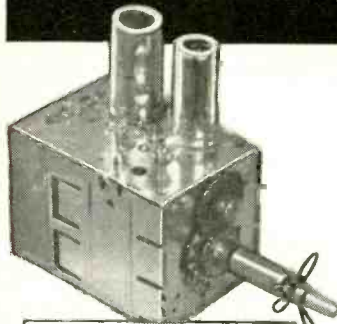

SAME DAY SERVICE!
on Popular Types
48 Hours most Others

VHF TUNERS • UHF TUNERS • UV Combinations*

Castle overhaul charge includes all labor and minor parts and written 90 day warranty. Tubes and major parts are extra at net prices. Tuner to be overhauled should be shipped complete; include tubes, shield cover and any damaged parts. Write down model number and state complaint. Pack well and insure.

NOW ALSO IN THE EAST

Castle pioneered TV Tuner Service almost a decade ago. Overhauling TV Tuners is our only business. *One piece construction. Separate UHF and VHF tuners must be dismantled.



CASTLE TV TUNER SERVICE, INC.

NEW! 653 PALISADE AVE., CLIFFSIDE PARK, NEW JERSEY
• 5710 N. WESTERN AVE., CHICAGO 45, ILLINOIS
• IN CANADA: 136 MAIN ST., TORONTO 13, ONTARIO

TECHNICIANS'

NEWS

TECHNICIAN JAILED

Los Angeles, Calif.—Oscar Singer, an LA TV repairman, is serving 90 days in jail after being found guilty of allegedly phony TV repairs. The charges stated that a total of \$120 in overcharges were collected on repairs of three sets installed in homes of undercover city agents.

MINIMUM PAY

Santa Clara Valley, Calif.—Endorsement by the Santa Clara Valley and Santa Cruz chapters of the California State Electronics Association of a \$3 an hour minimum wage has been announced to their members. The pay rate is for journeyman technicians. The pay rate has been adopted by the apprenticeship committee to determine the pay scale for apprentices in approved shops.

SRTT MEETING

San Fernando Valley, Calif.—About 40 technicians met at the Sky Trails for the first meeting after elections. In his inaugural speech on forthcoming plans of the group, president Dudley Anderson said, "Programming will be geared to more and better technical meetings, with transistors and color television given a high priority. A recent survey has shown a demand for this type of meeting and this we shall have for you."

PARTS BAG

There's a little business builder G-E has made available to technicians through their distributors that can help you. It's a small paper bag to hold defective parts which you have replaced. The bag is given to your customer when you have completed a repair.

The message imprinted on the bag reads: "We have bagged your troubles. Your set has been completely serviced by a qualified technician and all parts and tubes found to be defective have been replaced with first-quality material. We appreciate your confidence and intend to earn and keep your TV-radio service business by providing prompt, reliable service at fair prices."

There is room on the bag to write the name of the customer and the service shop doing the work.

CODE OF ADVERTISING ETHICS

Milwaukee, Wis.—The local TESA in an attempt to eliminate unethical advertising has adopted into its constitution the following 14 points on advertising:

1. Deception: It shall be considered an unfair trade

TELL YOUR FRIENDS ABOUT Radio-Electronics

NEW! Mark II SUPER BEACON with "STATIC SHEATH"

The Ultimate in Citizen Band Base Station Antennas

Improves signal/noise up to 20 DB by eliminating precipitation static

The new MARK II Super Beacon with exclusive "Static Sheath"* is the most efficient, most rugged 27 mc. base station antenna made! 19 feet overall, MARK II places the radiated signal directly on the horizon for maximum contact with mobile units. The "Static Sheath"* is a protective, highly attractive gray plastic covering that virtually eliminates noisy precipitation static... increases receiver sensitivity up to 20 DB! Furnished with launcher-matcher cable and coax connector; eliminates ground radials or shirts. 50 ohm impedance. Easily installed with clamp mounting.

*U.S. Process Patent 2,938,210

Your Electronic Parts Distributor has the MARK II in Stock for Immediate Delivery.

MARK MOBILE, Inc.

Dept. REG, 5441 West Forgo Ave. Skokie, Illinois

Citizen's Band and Amateur Operators INCREASE THE RANGE of your transmitter



Only **\$45⁰⁰**

The New Improved Elenco

POWER GAINER

Audio Compression Amplifier Now Available

- 4 TIMES power gain
- Simple connections to any CB or Amateur AM transmitter
- Can be used mobile or base
- Meets all F.C.C. requirements
- Many CB and Amateur operators report 50% to 100% increase in range.

Write for Details

"Elenco", sold by leading CB and Amateur equipment Dealers everywhere.

ELECTRONIC ENGINEERING CO.
Wabash, Indiana

practice to use advertising of any nature which has the tendency or capacity to confuse or mislead the public regarding the nature of the service provided, or the cost of such service, or in any other respect.

2. *No fix-no pay:* The use of this phrase or any statement of a similar nature shall not be used.
3. *Price:* There shall be no reference to the amount charged for a house call unless the advertisement clearly sets forth the amount of time to be devoted to such call, the labor charge per hour for time in excess of the stated period, and providing the advertising clearly states that parts are extra, if that is a fact.
4. *Identification:* Firm shall have an established shop where the servicing work is performed and the address shall be clearly stated in its advertising. No false address shall be used.
5. No reference shall be made to the number or percentage of sets repaired in the owner's home.
6. *No telephone number* shall be advertised unless there is an existing electronic service shop at that number.
7. *Credit:* When an offer of credit is made in an advertisement, it should be accompanied with the statement "Usual Finance Company Requirements" or the equivalent.
8. *One-hour service:* Advertisements shall not contain such statements as "24-hour service," "Service within one hour," etc.
9. *Free offers:* The word "free" cannot be used if a purchase of any kind is required, except where services are rendered in connection with a new product sale.
10. *Bonded, etc.:* Words such as "bonded," "insured," etc. which suggest protection of any nature shall not be used unless the exact nature of such coverage, or the protection provided, is fully explained, and in no instance unless coverage is in behalf of the set owner.
11. *Engineer:* The term, "engineer," or words or terms having similar connotation shall not be used in advertisements offering radio or television service unless a degree in engineering or the like has been conferred on the principal of the company by a recognized school of engineering.
12. *Authorized:* When the word "authorized," or others of similar connotation, are used in an advertisement offering radio or television service, and which advertisement lists one or more names of manufacturers or makes of television sets, the advertiser must possess and have available for inspection written authorization to perform such service from the manufacturers or franchised distributors of the sets named.
13. *License:* When the word "license," or similar connotation, is used, it must be specifically stated by whom they are licensed.
14. *No secondary fictitious name or prefix* shall be used by an existing shop for the purpose of obtaining advantageous position in the Telephone Directory advertising or in any other media.

LICENSING IN N.C.

Durham, N. C.—A TV service licensing bill has been introduced into the North Carolina State Legislature. If passed, it will create a State Board of Home Electronic Service Certification to certify and regulate the installation of radio and TV receivers and other home electronic devices. The bill would state that those who service and install home electronic equipment should be individuals of proven skill.

The board this bill sets up would consist of five members to be appointed by the Governor. Three would be practicing service technicians, one an instructor of electronics or electronic servicing and one a consumer with no connection with the sale or servicing of home electronic items.

ELECTRONICS COUNCIL MEETS

Yakima, Wash.—On the agenda for the annual meeting of the Washington State Electronics Council was the election of officers. By the time the meeting

was over Dick Brinkerhoff was chairman; Dick Jones, vice chairman; Ansel Heckman, secretary-treasurer. Other business included a report on future plans including methods of encouraging attendance from areas not already represented.

ELECTION NEWS

Indianapolis, Ind.—Delegates from service associations throughout the state associated with the Indiana Electronic Service Association elected their officers for the coming year. LaMar Zimmerman, who served as secretary last year, was elected chairman; Robert Luecke, vice chairman; Clyde Smeltzer, secretary, and Jay Schupbach, treasurer.

Binghamton, N. Y.—At the last meeting of the Empire State Federation of Electronic Technicians Associations, the following officers were elected: Douglas W. Cook, president; Don Roberts, vice president; O. Capitelli, corresponding secretary; Anthony Ferris, recording secretary; Warren Baker, treasurer; Ben DeYoung, segeant at arms.

Vancouver, B. C., Canada—Newly elected officers of the Radio Electronic Technicians Association, Vancouver chapter, are: Julius Cotter, president; Ted Bernard, vice president; Maurice Doyon, secretary; Ray Sarky, treasurer, and A. Curtus, recording secretary.

Gloucester, N. J.—Members of the Allied Electronic Technicians Association of N. J. voted the following officers to head their group: Tony DeFranco, president; Ray Dellinger, vice president; Joseph Papovich, re-elected secretary, and Joseph Eberhardt, re-elected treasurer.

Kansas City, Mo.—At a regular meeting of Team, the electronic association of Missouri, Ralph McClellan was elected president; Jay Oliver Johnson, vice president; P. C. Brink, secretary treasurer; Richard Lagle, recording secretary, and Fred Loeb, sergeant-at-arms. New directors were also elected. They are Ralph McClellan, Joy Oliver Johnson, P. C. Brink, Richard Lagle, Fred Loeb, Joseph Garner, Tather Jones, Manuel Emerick, Earl Davis, Ed Ruttinger and W. W. Miller. END

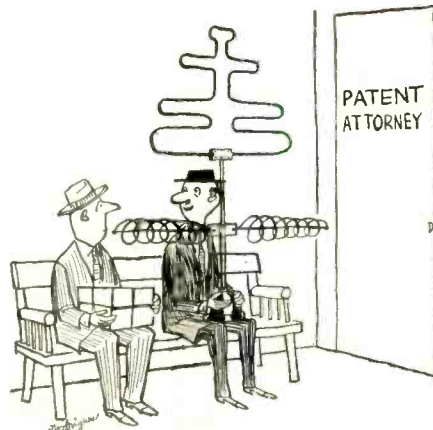

"It'll completely eliminate the need for outdoor antennas."

4 IMPORTANT NEW SAMS BOOKS



Two-Way Mobile Radio Maintenance



Jack Darr comes through with the first practical guidebook on maintenance and installation for 2-way radio technicians. You get field-tested methods, service hints and test procedures. Chapters include: Planning a 2-Way Radio Installation; Receivers; Transmitters; Remote Controls; Towers; Installation of Mobile Units; Noise Elimination; Test Equipment; FCC Tests and Measurements. Includes charts to help you make required calculations without using math; actual photos show proper step-by-step installation and maintenance. Only book of its kind for \$4.95 the technician. 224 pages; 5½ x 8½". Only \$4.95

Troubleshooting Amateur Radio Equipment



Howard S. Pyle, W70E, provides a wonderful guide for all hams who want to repair their own equipment. The most common types of failures are stressed. You learn in detail what is most likely to cause the trouble and how to correct the problem right in the "shack". Includes 9 complete schematic diagrams for the most popular transmitters and receivers. Chapters cover: Receiver Troubles; Transmitter Troubles; the Antenna System; Accessory Equipment; Preventive Maintenance; Mobile Equipment; Component Color Codes; Schematic Symbols. 128 pages; 5½ x 8½". Only \$2.50

Handbook of Electronic Charts and Nomographs

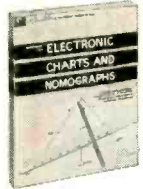

Allan Lytel's important time-saving book—contains 58 electronic charts and nomographs to provide solutions to hundreds of formulas and ratios—in just the time it takes to rule a line. Shows you how to use each nomograph; provides examples. Includes bound-in clear vinyl overlay sheet for positioning over any nomograph; permits ruling in erasable pencil lines connecting appropriate points on the graph scales; can be used repeatedly without injuring the nomograph. Comb-binding; book lies flat with its 8½ x 11" size providing large scales for best accuracy. Special chapter tells how to use nomographs most effectively and how to develop \$4.95 them on your own. 128 pages; 8½ x 11". Only \$4.95

Basic Amplifier Series: Amplifier Circuits



Thomas M. Adams, Captain, U.S.N., completely explains amplifier circuits. This second book in the series also provides dynamic circuit diagrams in FOUR COLORS to enable you to visualize exactly what action takes place every moment during circuit operation. You unmistakably identify each and every electron current in a particular circuit, and you learn in detail the changes each current undergoes for every moment of operation. Chapters include: Basic Vacuum Tube Actions; R-C Coupled AF Voltage Amplifiers; Transformer-Coupled AF Voltage Amplifiers; A-F Power Amplifiers; Audio Phase-Inversion Circuits; Impedance-Coupled AF Voltage Amplifiers; Transformer-Coupled RF Voltage Amplifiers. Here's the one book that helps you understand amplifier \$2.95 circuits. 128 pages; 5½ x 8½". Only \$2.95

HOWARD W. SAMS & CO., INC.

Order from your Sams Distributor today, or mail to Howard W. Sams & Co., Inc., Dept. J-21 1720 E. 38th St., Indianapolis 6, Ind.

- Send me the following books:
- Two-Way Mobile Radio Maintenance (TWD-1)
 - Troubleshooting Amateur Radio Equip. (AMP-1)
 - Handbook of Electronic Charts (NOM-1)
 - Basic Electronics Series: Amplifier Cir. (BEA-1)
- \$..... enclosed. Send Free Book List

Name _____
 Address _____
 City _____ Zone _____ State _____

IN CANADA: A. C. Simmonds & Sons, Ltd., Toronto 7 (outside U.S.A. priced slightly higher)

Columbia

SUPER-FLEX

Ultra Flexible Coaxial Cable

- EXTRA FLEXIBLE CONDUCTOR
- EXTRA FLEXIBLE JACKET
- EXTRA LOW COST

NEW! Super-flexible 52 ohm and 72 ohm Coaxial Cable for Citizens' Band and Multiple Television Systems, etc. Cable jackets are high gloss super-smooth, non-contaminating FLEXLIFE Vinyl that will not become rigid in cold weather. Another First from COLUMBIA.

SUPER-FLEX RG 58A/U

Center Conductor: 19/.0068 Tinned Copper. Jacket: Columbia Black Flexlife Insulation. Dielectric: Low loss Foam Polyethylene.



SUPER-FLEX RG 8/U

Center Conductor: 19/24 Soft Copper. Jacket: Columbia Black Flexlife Insulation. Dielectric: Low loss Foam Polyethylene.



SUPER-FLEX RG 59/U

Center Conductor: 7/31 Soft Copper. Jacket: Columbia Silver Grey Flexlife Insulation. Dielectric: Low loss Foam Polyethylene.



Available thru your local distributor

Columbia

WIRE & SUPPLY CO.

2850 IRVING PARK ROAD
CHICAGO 18, ILLINOIS

"America's Most Complete Wire Line"

NEW TUBES and SEMI-CONDUCTORS

THERE ARE SOME INTERESTING AND REALLY new devices this month. You will find the first group of noval tubes, two 150-watt power transistors, and a different switching device called a Dynaquad.

2N1706

A p-n-p germanium alloy junction transistor intended for use in class-A and class-B audio output stages. It features high reliability, excellent life and environmental characteristics.

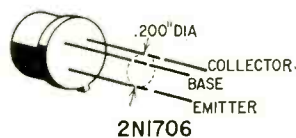

Maximum ratings of the Tung-Sol 2N1706 are:

V_{CB0}	25
V_{EB0}	5
V_{CE} ($R_{BE} = 1 \text{ k}$)	18
P_C (mw)	200
I_C (ma)	400

Electrical characteristics at 25°C are:

f_{sb} (frequency cut off) (typical) (mc) ($V_{CE} = -6 \text{ v}$, $I_C = 1 \text{ ma}$)	3
h_{fe} (current gain) (typical) ($I_C = 10 \text{ ma}$, $V_{CE} = -5 \text{ v}$, $f = 1 \text{ kc}$)	9
h_{FE} (dc current gain) (maximum) ($I_C = 20 \text{ ma}$, $V_{CE} = -1 \text{ v}$)	120

6BH3, 17BH3, 22BH3

A group of half-wave vacuum rectifier tubes designed as damper diodes for black-and-white TV receivers. They are *novar* tubes which have all-glass 9-pin bases but are not to be confused with standard 9-pin miniature tubes. The *novar* tubes have a relatively large pin circle and larger envelopes.

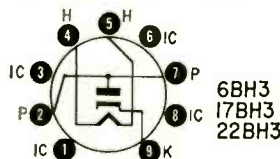

The three tubes are identical except for heater ratings which are: 6.3 volts at 1.6 amps for the 6BH3, 17.0 volts at 600 ma for the 17BH3, and 22.4 volts at 450 ma for the 22BH3. Both the 17BH3 and 22BH3 have controlled warmup for series-string heater arrangements.

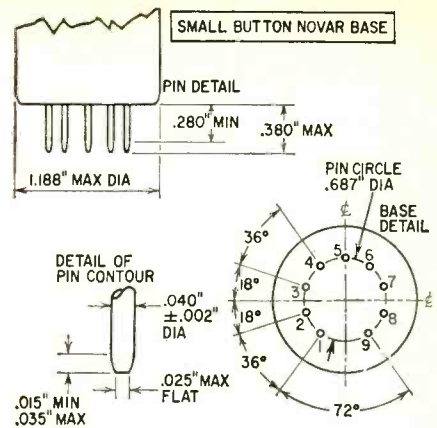

Maximum ratings in damper service for these RCA tubes are:

V_p (piv)	5,500
I_p (peak ma)	1,100
I_p (dc ma)	180
P_p (watts)	6.5
$V_{htr-cath}$ (peak)	
(htr neg with respect to cath)	5,500
(htr pos with respect to cath)	300

2N2015, 2N2016

Two diffused-junction power transistors of the silicon n-p-n type. They have very high power-dissipation capabilities (150 watts) and are intended for a variety of applications in military and industrial equipment. They are particularly useful in power switching circuits of dc-to-dc converters, inverters,

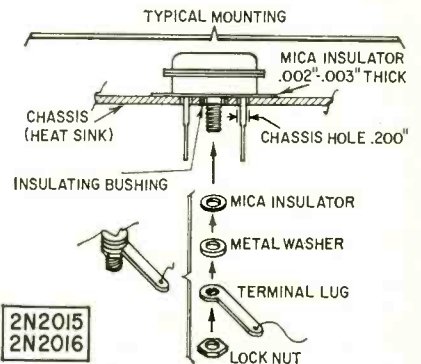
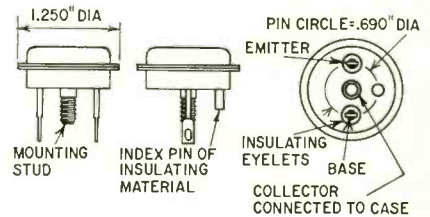

choppers and relay-control equipment. They are also useful in oscillator, regulator and pulse amplifier circuits, and as class-A and -B push-pull amplifiers for audio and servo applications.

Maximum ratings in industrial service for the RCA 2N2015 and 2N2016 are:

	2N2015	2N2016
V_{CB}	100	130
V_{CE0}	50	65
V_{EB}	10	10
I_C (amps)	10	10
I_E (amps)	13	13
I_B (amps)	6	6
P_{Total} (watts)	150	150

Dynaquad

This alloy-junction 4-layer device in-

troduced by Tung-Sol is a natural switch which has both turn-on and turn-off control at its base. The unit is a germanium, 3-terminal p-n-p-n device packaged in a standard transistor case. Basically, it is a 2-position switch that works in the megacycle range with rise times in the order of 0.1 μ sec. Because of its bistable nature, a single Dyna-

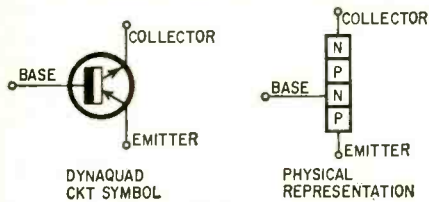

Fig. 1

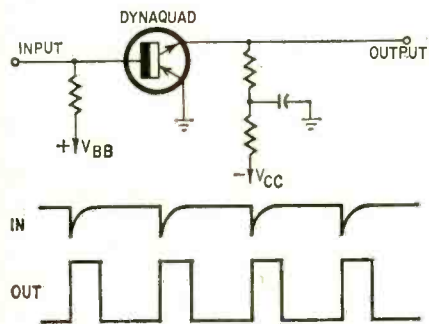

Fig. 2

quad can replace a number of transistors and associated components in many applications, and in simple on-off switching it behaves like a pulse-operated latching relay with no bounce, chatter or sticking contacts.

The construction of and symbol for the Dynaquad are shown in Fig. 1. A circuit showing the device used as a monostable multivibrator is in Fig. 2.

T1925, T1975, T1976

Three germanium tunnel diodes designed for low-level switching and small-signal applications. They have closely controlled peak-point current and low series resistance and inductance. The T1976 has a maximum frequency of oscillation in excess of 950 mc, the T1975 oscillates beyond 1,200 mc, and the T1925 beyond 1,500 mc. All are in hermetically sealed cases. They have two parallel negative electrode leads to reduce inductance and one positive electrode lead.

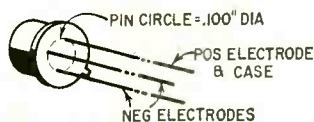

T1925, T1975, T1976

Maximum ratings of these Philco units are:

	T1925	T1975	T1976
Forward current (ma)	3	3	15
Reverse current (ma)	3	3	15
I_p (peak-point current) (typical) (ma)	1	1	5
I_p/I_v (peak-to-valley-point current ratio)	5	8	6
V_p (peak-point voltage) (mv)	55	55	55
V_v (valley-point voltage) (mv)	320	320	320
V'_F (forward voltage) (max mv)	525	525	515

Now... assemble the finest: A Professional Quality CUSTOMIZED TV KIT

ON EASY
"PAY AS YOU WIRE" TERMS *

- ☆ Designed for the perfectionist seeking maximum performance.
- ☆ Easy to assemble; no technical knowledge required.
- ☆ An ideal "Learning" Kit with a complete Course of Study is available.

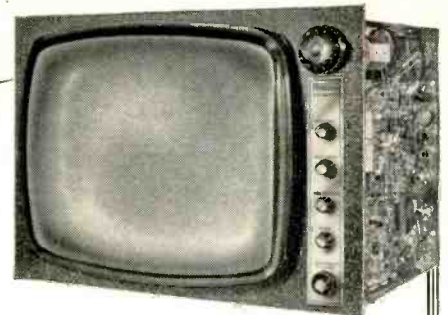

The TRANSVISION
"Professional"

Professional Quality Features

The Transvision "Professional" Model TV Kit (or Assembled Chassis) is designed to satisfy those video-and-audiophiles who seek the best possible performance of which the art is capable. Nevertheless, the kit builder can assemble this chassis for less than the cost of an ordinary receiver.

Note these unique features:

- Hi-Fi Audio (with 2 EL-84 output tubes, oversize audio output transformer, Woofer-Tweeter Speaker System with heavy magnets and crossover; Extended Range Tone Control).
- Ultra-linear sweep circuits; D.C. restoration; Standard Coil Guided Grid Turret Tuner with provisions for UHF and special low noise tubes; 4 megacycle picture bandwidth; 10 microvolt sensitivity.
- Heavy-duty power supply (power transformer, two low voltage rectifier tubes — no silicon rectifiers).

* Only \$15 for the Starting Package!

ALSO AVAILABLE AS AN
ASSEMBLED CHASSIS
for custom installations

- Heavy-duty ruggedized construction, no printed circuits; built to give trouble-free performance for many years.
- Includes newest reflection-free 23" tube with bonded face, or the 24" or 27" CRT.
- Selected because of superior performance for use in Educational TV by over 3000 schools and colleges and U.S. Armed Services.

Interested in Electronics?

Learn the basic principles of electronics from the Complete Course of Study which is available with the Kit.



As a preliminary, order the Assembly Instructions for only \$2.00; to be refunded if you purchase kit.

TRANSVISION NEW ROCHELLE, N. Y.

Pioneers in Television Kits

NEW Rochelle 6-6000

START NOW — MAIL THIS COUPON —

TRANSVISION, New Rochelle, N. Y.

Dept. RE

- Send Free 8-page Catalog Enclosed is \$2. for Assembly Instructions so that I might see how easy it is to assemble the Transvision Kit. I understand that this will be refunded if I purchase a kit.
- Enclosed is \$15 for the Starting Package. I understand that I can buy packages one at a time as I wire. (Models range from \$119 to \$199.)

Name..... Address.....

City..... Zone..... State.....

QUICK and LASTING

When You Use

HUSH®

Chemically-Electronically, engineered for Tuners and Switching Mechanisms.

When New HUSH is applied it will wash-away that dirt, leaving clean and positive contacts protected by a lasting lubricant. New HUSH is made from the finest solvents and it contains Electro-Silicone oils.
6 oz. Spray can. Also available—2 oz., 8 oz., 32 oz. containers

EVER-QUIET®

Since 1949

VOLUME CONTROL AND CONTACT RESTORER

EVER-QUIET is a free-flowing liquid that leaves no powder residue. Scientifically designed to seep around the shaft and penetrate the control or potentiometer, cleaning the contacts and leaving a safe protecting film. Harmless to metals, wire or carbon.

2 oz. Bottle & dispenser. Also available—6 oz. Spray can

FREE 6" Plastic Extender With Every Can



CHEMICAL ELECTRONIC ENGINEERING, INC., Matawan, New Jersey

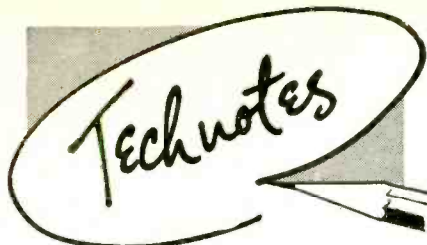

DIS IS FOR DE BOIDS!

If you put up a couple of fine big metal trumpets at the football field a few years ago and they bellowed loud and clear for a mile or so, but you can't hear them so good of late and the announcer keeps turning up the gain of the PA system and complains because the people can't hear him, you'd better look into the speakers. And I mean look into them literally!

This happened to me. Somehow, I took a look into the mouth of one of the horns out on the field and saw telltale pieces of straw sticking out. Taking the speakers down and disassembling them, this is what I found (see photo)! For the last 4 or 5 years, they had been used as a birdhouse, although it must have been pretty hard for the birds to get any sleep on Friday nights during the football season!

They were packed absolutely full of birds' nests! The



sound couldn't get out through feathers and goop. Remedy: clean 'em out, wash off and reassemble, this time placing a heavy screen of hardware cloth (a heavy wire screening) across the bell of each horn.—*Jack Darr*

INOPERATIVE POWERED AUTO ANTENNA

Frequently, checking an inoperative automobile radio antenna reveals that the nylon cord which raises and lowers it is pulled out of the metal ferrule crimped around the cord to attach it to the top section. While the proper repair is a new top section and cord assembly, when they can't be found at the moment you can make a satisfactory repair by inserting a punch of the proper size inside the ferrule. Then tap the outside with a small hammer to remove as much of the crimping as possible.

Next, scrape and sand the cord until it is a push fit into the ferrule. Then drill a hole (using a smaller than 1/16-inch drill) through both ferrule and cord. Now you can insert a small pin through ferrule and cord. Rivet it on both sides, then file smooth to allow entrance into the second antenna section.

This repair will last as long as a new assembly.—*Henry Josephs*

RCA 800 SERIES COLOR SET

Our man brought the set to the shop. Its focus was shot and there was nothing wrong with the focus control. The screen also showed some signs of poor horizontal linearity.

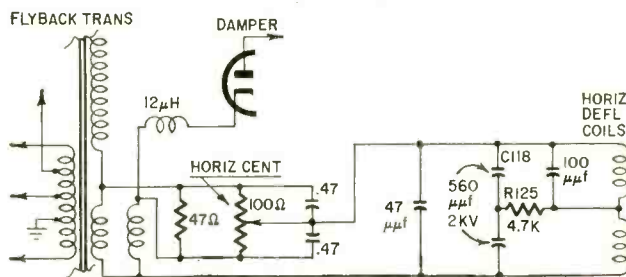

FREE
ELECTRONICS
CATALOGS
for one full year

Coupon below brings you
GIANT BUYING GUIDE plus ALL
Catalog Supplements for 1 year

Don't miss the huge selection, the wonderful values Radio Shack offers you in its exciting free catalogs! 1961-62 Buying Guide, 2/3 bigger than last year, has 336 pages. See over 100,000 items—famous makes and our own private brand electronics equipment:

Stereo, Hi-Fi,
Tapes, Records,
Ham Radio, Parts
and Accessories.
New! 30 pages of
easy-to-build kits.

Radio Shack's better-than-ever catalogs reflect our booming growth—fastest in the field of Electronics! You'll find every item you want in our books—whether you are a "pro," hobbyist, modern "do-it-yourselfer," or music lover.

MAIL THIS COUPON TODAY

RADIO SHACK Corp. Dept. 61J10
730 Commonwealth Ave., Boston 17, Mass.

Gentlemen:
Please send me Radio Shack's famous electronics catalogs for the next 12 months, all FREE and POSTPAID.

Name _____

Address _____

City & Zone _____ State _____



You'll see typical values like these: Our own Realistic 2-speed Tape Recorder at \$54.95. A 10-transistor Radio at \$29.95. Stereo Amplifier kit at \$10.95. New No Money Down Credit Terms with 2 full years to pay. Satisfaction Guaranteed.

RADIO SHACK
Corp.
730 Commonwealth Ave.,
Boston, Mass.

SELF SERVICE TUBE TESTERS FOR YOUR CUSTOMERS USE

Only \$29.95

- 22 Socket, 2 Control Tester Panel
- Large Attention Getting Back Sign
- Tests Over 900 Tubes
- Locked Tube Storage for 600 Tubes
- Green and Yellow Console Cabinet 20" Wide, 18" Deep, 66" High, Weight 55 Lbs.

Used (Tested Before Shipment) . . . \$29.95

Reconditioned . . . \$39.95

Accessory Kit contains 3 fibre tube trays with partitions and suggested inventory sheets plus

2 fluorescent tubes for back sign . . . \$8.95

All Prices F.O.B. Indianapolis, Ind.

25% Deposit on All C.O.D. Orders

Subject to Prior Sale

DELMAR ENGINEERING CO.

3606 DELMAR ROAD
INDIANAPOLIS 20, INDIANA

ENGINEERING DEGREE IN SCIENCE MATH 27 or 36 MOS.



B.S. degree—36 mos. • B.E. degree—27 mos.
Accelerated year-round program prepares for early employment in fields of Science and Engineering. Regular 4-year program for B.S. Degree completed in 36 months, special engineering degree program in 27. Classes start September, January, March, June, July. Quality education. Graduates employed from coast to coast. Government approved for veteran training. Students from 50 states, 40 countries, 20 buildings; dorms; gym. Campus. Save time and money. Earn board. Write for catalog, 1791 E. Washington Boulevard, Fort Wayne 2, Indiana

INDIANA TECHNICAL COLLEGE

WE BUY TECHNOTES

RADIO-ELECTRONICS wants Industrial Technotes. These should cover equipment (including closed-circuit television) actually used in industrial work, or technotes on counters, controls and other apparatus whose uses are largely industrial. Unillustrated Technotes pay \$5; circuit diagrams raise the price to \$9 and acceptable photos are worth \$7 each. Send your technotes from industry to Technote Editor, RADIO-ELECTRONICS, 154 W. 14th St., New York 11, N. Y.

After much careful troubleshooting, we found that resistor R125 in the horizontal section of the yoke was slightly charred, indicating leakage through capacitor C118. We replaced the capacitor, a 560- μ pf 2-kv unit, and the resistor to restore normal operation.—C. S. Lawrence

PHILCO 9L35

There was only about 5 inches of width in the center of the screen with very little brightness. Voltage and waveforms were normal in the horizontal oscillator and output circuit. Transformer and yoke tested OK on yoke tester. Yet the yoke was bad—it would break down and short only under heavy current flow.—W. G. Eslick

CRESTWOOD CP-201 TAPE RECORDER

Complaint: Intermittent and noisy sound on playback. The intermittent condition was more noticeable when the recorder was played back using low volume settings, and at times the sound would become very noisy.

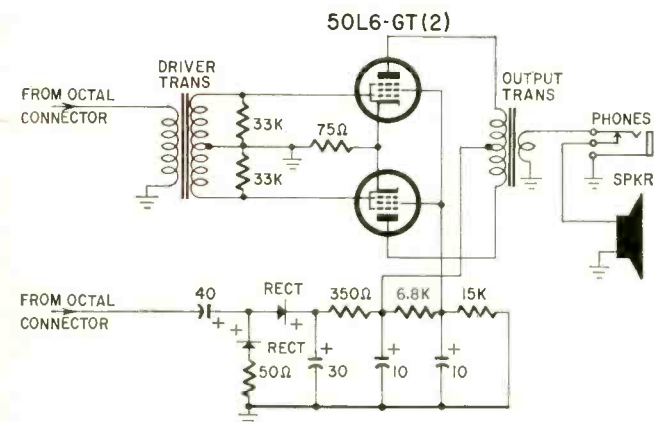

Cure: A scope check was made on the power amplifier chassis, and the trouble was isolated to an intermittent connection in the center tap of the driver transformer. Replacing this transformer cured the trouble.—George P. Oberto

ZENITH 16C20-U

Poor vertical linearity was the complaint. A defective vertical oscillator-amplifier was the cause. But the way this tube caused the trouble was unusual and interesting and could happen in any circuit of a receiver.

On the bench, the set presented a picture stretched so much out of proportion that a man's head resembled a cucumber, legs were stovepipes. All individuals were flat-topped. No adjustment of the vertical height or linearity controls would compensate for the condition. Even the customer's face was long. The 6CY7, vertical tube, checked good in the tube checker. All voltage and resistance checks proved normal. Apparently, this dog had a new trick for the audience to figure out.

A casual, lucky glance at the 6CY7 solved the problem. Although the tube had checked perfect in the tester, half of one triode section of filament was not burning. This loss in electrons in the triode section of the tube was enough to ruin its operating efficiency (under load), but not enough to show in the checker. A new tube corrected the trouble. The linearity controls again worked as they should have and the customer's face came back to normal.—George D. Philpott

END

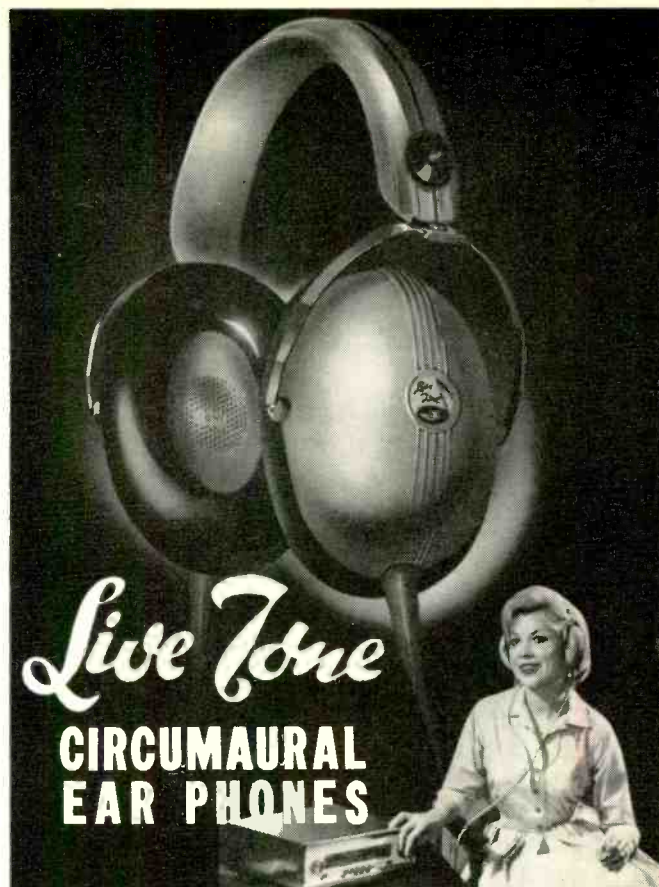

A MAJOR BREAKTHROUGH IN STEREO REPRODUCTION!

Converting electrical energy into faithful sound reproduction is a constant engineering problem involving an array of speaker systems, acoustically prepared rooms, etc., to give that intangible quality called "presence"—the ability to reproduce sound so that it creates a sense of reality to the human ear. Sharpe Live Tone Circumaural Earphones solve these problems and offer you many unique engineering advances—from liquid-seal noise-excluding ear pads which exert no pressure on the ear to built-in acoustical damping.

Live Tone Earphones are tested with a specially designed artificial ear that duplicates the characteristics of the human ear. Thus, when we claim a flat frequency response from 30 to 11,000 cycles \pm 3db, (total response 15 to 20,000 cycles) you can be sure that this is an accurate indication of the live-tone performance sound you will hear from your Live Tone Earphones.

Sharpe Circumaural Earphones meet every requirement in the field of Audio Engineering, Aviation, Language Laboratories, Audio-analgesia, Music Libraries, etc.

A FREQUENCY RESPONSE

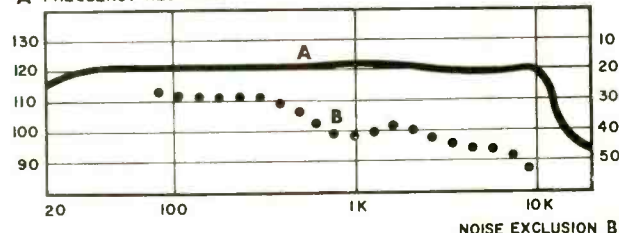

For full information and free brochure, see your nearest dealer or write to

E. J. SHARPE INSTRUMENTS, INC.
965 Maryvale Drive, Buffalo 25, New York
E. J. SHARPE INSTRUMENTS OF CANADA LIMITED
6080 Yonge Street, Willowdale, Ontario

PREPARE NOW FOR A
SECURE AND PROFITABLE CAREER
IN ONE OF THESE GROWING FIELDS
OF ELECTRONICS

LEARN
TRANSISTOR
OR
COMPUTER
TECHNOLOGY
AT
HOME

Learn with proven home study courses from the Philco Technological Center. Get practical knowledge with courses developed by specialists in electronics and training... men who know the kind of knowledge you need.

Choose from five courses:

1. Semiconductors—Transistor Principles and Practices. Learn theory, construction, applications of all types of transistors.
2. Introduction to Analog Computers—Covers theories and fundamentals of analog computers.
3. Analog Computer Systems (Advanced Level)—Covers the analog system concepts and methods.
4. Automatic Digital Computers—Digital computer theory, maintenance, installation, basic programming.
5. Programming for Digital Computers—Covers encoding, set-up and operation.

MAIL COUPON TODAY
FOR **FREE** INFORMATION

R-3

Philco TechRep Division
P.O. Box 4730
Philadelphia 34, Penna.

I'm interested in Semiconductors Analog computers Analog computer systems Digital computers Computer programming. Please send free information to:

Name _____
Address _____
City _____ Zone _____
State _____

PHILCO
TECHNOLOGICAL CENTER
P.O. Box 4730, Philadelphia 34, Pa.

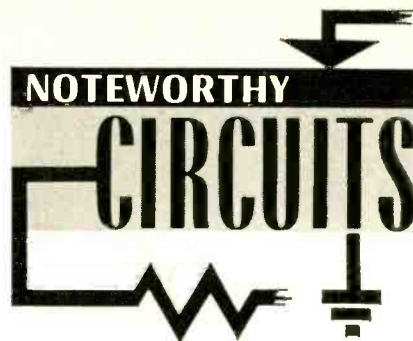

UNUSUAL TONE CONTROL

This four-channel tone control or audio equalizer may well be the start of a trend among audio design engineers. This circuit, used in the Blonder-

boost and 10-db cut at 50 cycles. The LO MIDDLE and HI MIDDLE controls provide a boost of up to 15 db and cuts of 20 db at 300 and 1,600 cycles, respec-

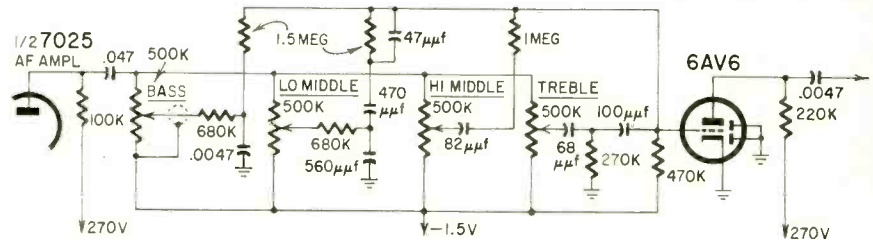

Tongue model A-1 amplifier, breaks the spectrum between 50 and 8,500 cycles into four segments or channels to simplify correcting for deficiencies in recordings and speaker systems and to provide various special sound effects. The BASS control provides a 6-db

tively. The TREBLE control has a maximum boost of 15 db and cut of 6 db at 8.5 kc. Greater boost and cut are obtained by operating more than one control. With the controls in the flat position response is flat within $\pm \frac{1}{2}$ db from 30 cycles to 15 kc.

TRANSISTOR OUTPUT CIRCUIT

The diagram shows the rather unusual output stage in the Roberts (British) RT7 two-band AM transistor port-

lector circuits. This split-load arrangement requires more drive than the conventional collector-loaded push-pull

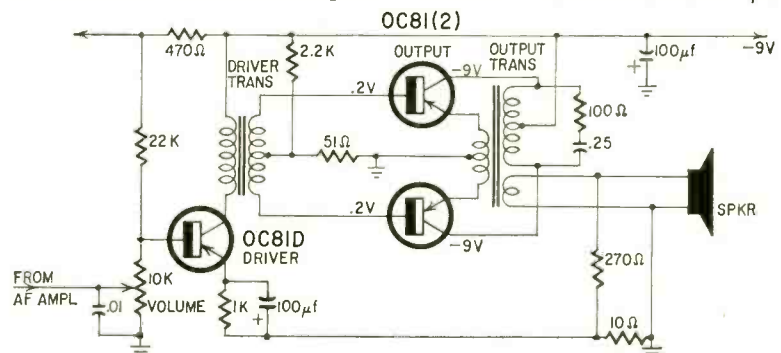

able. The driver is transformer-coupled to the bases of the output transistors. The output stage is operated as a split-load class-B amplifier. A part of the load is in the emitter circuits and the larger portion of the load is in the col-

lector circuit. This split-load arrangement requires more drive than the conventional collector-loaded push-pull amplifier but greatly reduces crossover distortion, which tends to increase as battery voltage drops off. Negative feedback voltage is tapped off a voltage divider across the voice coil and fed to the driver's emitter.

HEADLIGHT REMINDER

Installed on your car, this simple electronic circuit sounds an alarm when the ignition switch is turned off and the light switch is on. The reminder circuit consists of a 2N139 Colpitts oscillator and 2N109 af amplifier.

resistor (about 6 volts) operates the oscillator and amplifier. When the ignition switch is turned on, the resistor and diode are shorted by the two closed switches and the reminder circuit is inoperative. The diode prevents reverse current from flowing through the resistor when the ignition is on and the lights are off.

Note the connections between the reminder and the car's instrument panel. One terminal of the ignition switch goes to the gauges. With the lights on and the ignition off, current flows through the low-resistance gauges, the 1N34 and 4,500-ohm resistor. The drop across the

The speaker is a reproducer or driver unit from an antique horn speaker. Many antique and second-hand shops have a few of these around. If you can't

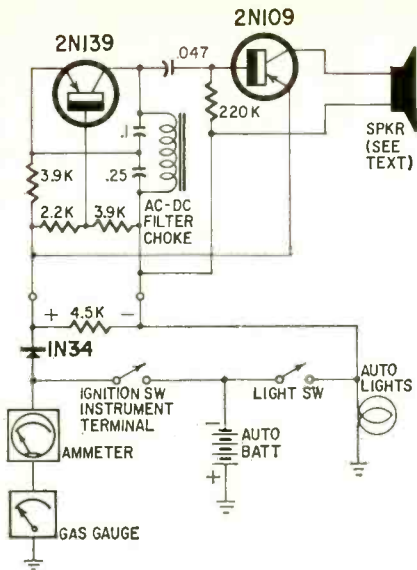

find one, use a large earphone. You can use a standard PM speaker if you build more gain into the amplifier by using transformer coupling between oscillator and amplifier and use an output transformer to match the speaker.

When I installed the reminder on my car, I tapped on to the hot lead to the tail lights for the negative or collector lead and tapped the gauge terminal for the positive lead.—*Robert E. Flanagan*

(Why not use one winding of the interstage transformer in place of the oscillator inductor? The other winding could then be connected to the amplifier's base. Juggle values of the two oscillator tuning capacitors for desired tone and reliable oscillation.—*Editor*)

PHOTOELECTRIC RELAY

Photoelectric relays are used in control circuits, counting devices, monitors, alarms and many other applications in the home, shop and industry. The diagram shows the circuit of a photorelay taken from the RCA data sheet on the 7412 cadmium sulfide photocell.

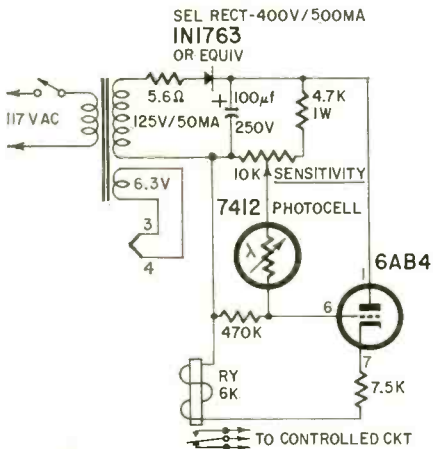

In this circuit, the relay is normally energized when light strikes the photocell. The relay drops out when the light beam is interrupted or when the light level drops below a level set by the potentiometer. The relay may be a Sigma 11F-6000G or equivalent. (The frame of the 11F series relay is at armature potential and must be insulated from the common chassis for safety). END

ATLAS "Job Rated" P. A. SPEAKERS



There is an Atlas Speaker Ideally Suited for Every Job

All Atlas P. A. speakers are highly efficient, especially in the voice frequency range, providing the extra "punch" needed to override high level background noise. Most are 100% weatherproof; aluminum and diecast parts are treated with corrosion inhibitors, then finished in "stone hard" baked enamel. The CJ Cobra-Jector horns are constructed of nonresonant, indestructible fiberglass, and HU and TP speaker horns of aluminum, finished in gun-metal grey. The HU and TP speakers are particularly designed for efficient talkback operations. The peaked characteristics within the voice frequencies increase the sensitivity of these speakers as pickup devices.

All HU and CJ speakers are equipped with versatile "Versalock" . . . This rugged, reliable mounting bracket, completely adjustable both horizontally and vertically, provides positive locking in any position.

The DU-12 and DC-5, Atlas' renowned DeCor projectors, are styled to harmonize with any decor, modern or traditional. Send for free catalog to Dept. RE-9

Model	HU-12N	HU-15N	HU-24N	CJ-14N	CJ-30N	CJ-44	TP-15N	TP-24N	DU-12	DC-5
POWER*	7.5 w	25 w	25 w	7.5 w	25 w	60 w	25 w	25 w	7.5 w	6 w
IMPEDANCE**	8 ohm	8 ohm	8 ohm	8 ohm	8 ohm	16 ohms	8 ohm	8 ohm	8 ohm	8 ohm
FREQUENCY C.P.S.	350-10,000	250-10,000	200-10,000	400-10,000	250-10,000	150-9000	250-10,000	200-10,000	14 in. 10,000	120-7000
LENGTH OVERALL	7 1/4 in.	8 3/4 in.	12 in.	8 in.	1 1/4 in.	23" x 13"	16 1/2 in.	23 in.	14 in.	14 in.
BELL DIAMETER	7 1/2 in.	9 3/4 in.	11 1/4 in.	9 1/2" x 5 1/2"	14" x 6"	19 in.	9 3/4 in.	11 1/4 in.	7 in.	7 in.
NET PRICE	\$16.20	\$20.10	\$22.35	\$18.00	\$24.60	\$43.50	\$31.20	\$34.50	\$19.80	\$13.20

*Input range limited to frequencies above horn cutoff **All models available in 45 ohms at slightly higher prices

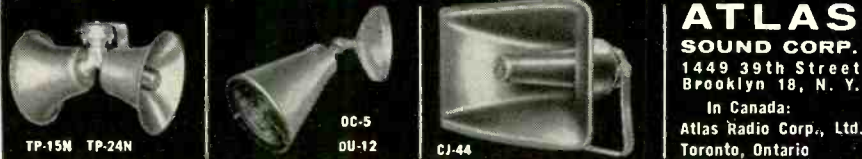

ATLAS SOUND CORP.
1449 39th Street
Brooklyn 18, N. Y.
In Canada:
Atlas Radio Corp., Ltd.,
Toronto, Ontario

the business-like approach to SERVICE CHARGES and RECORD KEEPING



For customer's prices on every replacement part, plus flat rate and hourly service charge data, regional and national. Dave Rice's OFFICIAL PRICING DIGEST, listing over 63,000 items. \$2.50.

AVAILABLE FROM YOUR DISTRIBUTOR

If you want to operate on a professional level, Dave Rice's OFFICIAL ORDER BOOKS give you triplicate forms for order, invoice, and office records . . . spaces for tubes, parts, serial numbers, labor and tax charges, signatures, etc. 75c per book, \$6.50 for dust-proof box of 10. *Dave Rice's*



ELECTRONIC PUBLISHING COMPANY, INC.

133 N. JEFFERSON ST. • CHICAGO 6, ILL.

HANDLE TOUGH SERVICE JOBS

as slick as you do the easy ones!



COMPLETE TRAINING In modern Professional methods

Invaluable step-by-step guides help you troubleshoot in less time—and with a minimum of testing. Each service procedure, from locating troubles to fixing them fast and accurately, is covered in text and by more than 417 how-to-do-it illustrations. Price \$10 for the complete 822-page training.

PRACTICE 10 DAYS . . . FREE!

Dept. RE-91, Technical Division, #623900
HOLT, RINEHART and WINSTON, Inc.
383 Madison Ave., New York 17, N.Y.

Send TROUBLESHOOTING & REPAIR manual for 10-day examination. If I like book, I will then send you \$10 (plus postage) in full payment. Otherwise, I will return book and owe nothing. (Save! Send \$10 with order and we pay the postage. 10-day money-back guarantee.) #708578

Name.....
Address.....
City, Zone, State.....
(Above offer expires May 1, 1962)



UNIVAC

FIELD ENGINEERS

For Univac Missile-Guidance Computers & Tactical Data Systems

Field engineers are now being selected for maintenance assignments on ultra-reliable Univac missile-guidance computers and other military electronic data processing systems.

Openings involve maintenance of the Univac ICBM guidance computer, first of its size to be completely transistorized.

Applicants must have at least 2 years of formal education in Electronics with 3 or more years in maintenance or maintenance-instruction. Experience should be associated with complex electronic equipment such as TV, radar, sonar or digital computing systems.

Before assignment, you receive 2 to 6 months training at full pay in our St. Paul, Minnesota, laboratories. Benefits include company paid life insurance, hospitalization, medical and surgical benefits, relocation expenses and living allowances at field sites.

Openings also for qualified instructors with backgrounds similar to above.

Send complete resume of education and experience to:

R. K. PATTERSON, Dept. Q-9

Remington Rand

Univac



Division of Sperry Rand Corporation
2750 West 7th St., St. Paul 16, Minn.

(All qualified applicants will be considered regardless of race, creed, color or national origin.)



TRY THIS ONE

SPLICING COAX CABLE

When splicing RG-58/U or similar coax, use aluminum foil as a shield connection to minimize stray pickup and

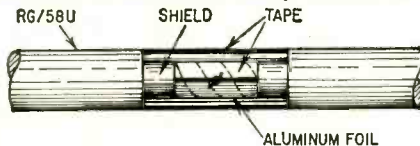

keep impedances constant. Solder and insulate the "hot" lead in the usual way and use a short length of bare wire to connect the shield ends. Over this, wrap several layers of the aluminum foil as shown in the drawing and cover with tape. The resulting joint is neat and electrically similar to the coax.—*William H. O'Brien*

SOLDER MAKES REAMER STOP

To avoid the possibility of reaming a hole too large, wrap wire solder around your reamer to act as a size

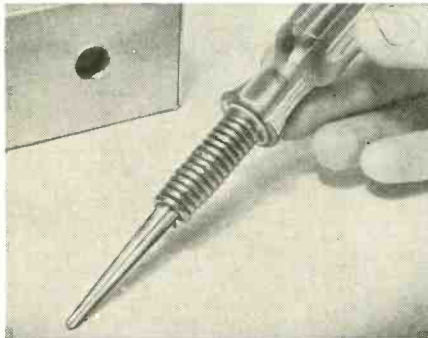

stop. Determine how far to wrap the reamer by guess or by measuring the diameter with a micrometer.—*Scott Mock*

INSULATE THAT FUSE HOLDER

Recently, while building a compact amplifier I was forced to use a clip type open fuse holder. This caused a shock hazard which I minimized in the following manner.

Starting with a piece of 5/16-inch

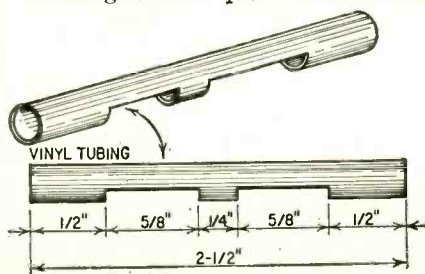

Fig.1

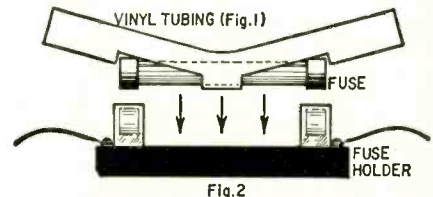

Fig.2

diameter vinyl tubing, cut it to the shape shown in Fig. 1. For easy cutting, squeeze it flat and use a pair of scissors.

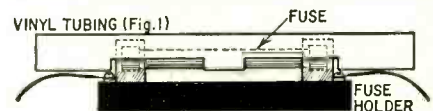

Fig.3

Slip the fuse through the middle band (Fig. 2). Then push the fuse into its holder. Next, fit the slit portions of the tubing over the exposed clips—tug the ends for a snug fit (Fig. 3). Fuse and holder are now fully insulated.—*Alan M. Palmer*

HANDY PARTS HOLDER

Often a set that needs a special part that must be ordered from the manufacturer comes into the shop. This means that the set will be stored until the part arrives. During this waiting period I find that the knobs and hardware have a tendency to disappear, and much time is wasted trying to find substitutes.

I remedied this situation by stocking my shop with about 10 empty coffee cans. As soon as a set is dismantled, the parts are put into one of these cans. If the set must be stored for a few days, the can is stored right along with it. This has entirely eliminated the loss of parts, and prevents the parts of two or more sets getting mixed.

Any can could just as easily be used, but a coffee can is large enough to get your hand into to pull out parts one at a time. This eliminates dumping the entire contents to find a particular part.—*A. J. Krukowski*

CLEARING VARIABLE-CAPACITOR SHORTS

Radios still use variable capacitors and they still get dirty. At some time we all have applied high voltage from a power transformer secondary to the plates of a variable capacitor to remove dirt and other small shorting or conducting particles. Here's a new and better way to do this job, one that averts the risk of burning out a transformer or blowing a fuse.

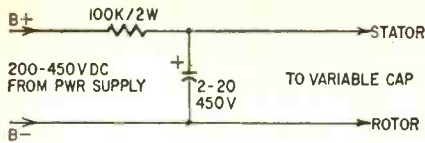

Use the dc B-plus supply to charge an electrolytic capacitor through a 100,000-ohm 2-watt resistor. Use the arrangement shown in the diagram. The full charge on the capacitor is available to burn out the short and, if the short remains, the capacitor simply will not charge again. A voltmeter connected across the capacitor acts as an indicator. If the voltage stays at the B-plus value, the variable is OK, but if it drops to zero, you've got a stubborn short which simply won't burn out. Some other correction, such as shims or mechanical realignment of the plates, may be needed. An occasional fluctuation in the reading simply shows that the electrolytic capacitor is doing its job of burning out shorts and then recharging. Don't forget to disconnect any coils across the variable capacitor while doing this cleanup job.—Rudolf F. Graf

THIRD HAND

Need a third hand? Mount spring type clothes pins as shown and you can hold and rotate small objects to



the position desired. The base of an old 8-inch electric fan is generally heavy enough to stand upright, but if not fill its base with plaster of Paris or sidewalk cement.—I. C. Chapel

50 Years Ago

In Gernsback Publications

HUGO GERNSBACK, Founder

Modern Electrics.....	1908
Wireless Association of America.....	1908
Electrical Experimenter.....	1913
Radio News.....	1919
Science & Invention.....	1920
Practical Electrics.....	1921
Television.....	1927
Radio-Craft.....	1929
Short-Wave Craft.....	1930
Television News.....	1931

Some larger libraries still have copies of Modern Electrics on file for interested readers.

In September, 1911, Modern Electrics

Wireless on Motor Boat, by Richard H. Foster.
 Transmitting Condenser, by H. V. Roome.
 High Powered Condensers, by Frank C. Perkins.
 Ducretet Rotary Spark Gap.
 Long Range Potentiometer.
 A Novel Condenser, by R. S. True.
 Wireless Telegraph and Telephony System, by John B. Brady.
 Improvement on Loose-Coupled Tuning Coils, by P. Mertz.

Service Technicians... LIGHTNING DOES STRIKE TWICE!!

Another Double-Value Reason

to join the  Technicians Book Club

NEW SHORTCUTS TO TV SERVICING

By Leonard C. Lane

2-VOL. \$9.90 set—Only \$6.50

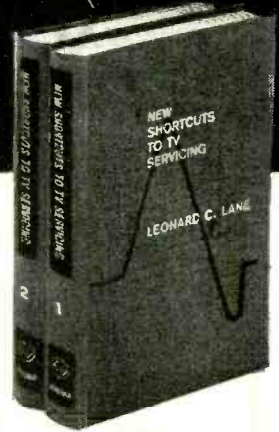

Three months ago Gernsback Library introduced a sensational 2-volume set that has service technicians everywhere buzzing.* Now here's another one just as exciting. This book, too was originally prepared as a training course by a leading home-study school and sold at many times this price.

Different from any servicing book you've ever read. There's no math, no theory. Instead it hammers hard at solving the servicing problems that bug you on those rough days. Rf, if, detector, agc, front end, sync stage, picture tube and many other component problems are carefully analyzed. This book is not just a crutch for tube pullers—but a guide that will help you understand basic troubles. You'll learn how to service sets not yet on the drawing boards! Get this one for your workbench now. The tricks, techniques and shortcuts it offers will help you boost your servicing income for years to come.

*The other one? In case you may have missed it—HOW TO FIX TRANSISTOR RADIOS & PRINTED CIRCUITS. A complete shirt-sleeve course on servicing transistor radios by the same author. Same low price. Same wonderful value—also originally sold for much more as a home study training course. Begin your membership with either one.

IT PAYS TO BUY THE BOOK CLUB WAY

The books retail for \$9.90. But as a club member you can buy them for only \$6.50 plus a few cents postage. Join the club now and take advantage of the book buy of the year.

NO-RISK GUARANTEE: You don't risk a cent. SEND NO MONEY. Look the books over in your own home. Then only when you're convinced they're as good as we say, send payment. If you're not satisfied just send the books back

HOW TO JOIN

Just mail the coupon below. SEND NO MONEY. We'll send you the books for a 10-day No-Risk inspection in your own home.
 • If you like the books keep them and send us your remittance. If you don't, just send them back.
 • A new book is published every few months— you receive it on the same No-Risk inspection plan.
 • Keep only the books you want—pay only for those you keep.
 • You agree to take a minimum of only 4 books—over the whole enrollment period! You may cancel anytime after that. No time limit—no contract to sign.

BUILD A WHOLE LIBRARY OF BOOKS YOU NEED TO GET AHEAD IN SERVICING

The G/L Technicians' Book Club has helped thousands of service technicians everywhere • Do Faster Servicing • Earn More Money • Save money on the books they need to get ahead.

HERE'S HOW IT CAN HELP YOU! This club offers hard-cover editions of today's best servicing books by well-known authors AT DISCOUNTS UP TO 27%! Through mass printing and direct distribution we can offer you these books AT A SPECIAL LOW PRICE plus a few cents postage.

*SEND IN THIS COUPON TODAY

GERNSBACK LIBRARY, INC., Dept. 91c
 154 West 14th St., New York 11, N. Y.

Enroll me in the G/L TECHNICIANS' BOOK CLUB.
 Send me (please check one)

- "How To Fix Transistor Radios and Printed Circuits" (2 Vols.).
 New Shortcuts to TV Servicing

Name.....
 please print

Street.....

City.....Zone.....State.....

SEND NO MONEY!
MAIL THIS COUPON TODAY!

You have nothing to lose
 — everything to gain!

Examine the books at our risk.
 BOOKS PURCHASED FOR PROFESSIONAL
 USE ARE TAX DEDUCTIBLE.



FREE
ELECTRONICS CATALOGS
for 1 full year

from Radio Shack...
fastest growing
electronics house

Don't miss the huge selection, the wonderful values in Radio Shack's better-than-ever catalogs! Just mail the coupon... receive the exciting 1961-62 Buying Guide of 336 pages, 3/4 bigger than last year! Plus all supplements for 12 months. See over 100,000 items: Stereo, Hi-Fi, Ham Radio, Tapes, Kits, Records. New No Money Down credit terms. Satisfaction guaranteed.

RADIO SHACK CORP.
730 Commonwealth Ave., Boston, Mass.

MAIL THIS COUPON TODAY

RADIO SHACK Corp. Dept. 611108
730 Commonwealth Ave., Boston 17, Mass.
Send me Radio Shack's famous electronics catalogs for 1 full year—FREE, POSTPAID.

Name _____
Address _____
City _____ Zone _____ State _____

notice
to owners
of
AR speak-
ers

Until now, AR speakers have been sold under a one-year guarantee covering materials, labor, and freight to and from the factory.

On the basis of our field experience we are now able to extend this guarantee to five years. The extension is retroactive, and applies to any AR speakers bought since 1956.

AR speakers are on demonstration at AR Music Rooms, on the west balcony of Grand Central Terminal in New York City, and at 52 Brattle Street in Cambridge, Massachusetts. No sales are made or initiated at these showrooms.

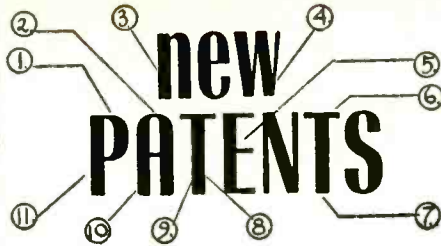

IMPROVED SPACISTOR
Patent No. 2,958,022

Erick M. Pell, Scotia, N. Y. (Assigned to General Electric Co.)

A spacistor is an n-p junction with an intermediate space charge or intrinsic (I) region. As shown in Fig. 1, it is reverse-biased by a battery. Region I, which is nearly free of charges, generates the full battery drop along it, as shown in Fig. 2.

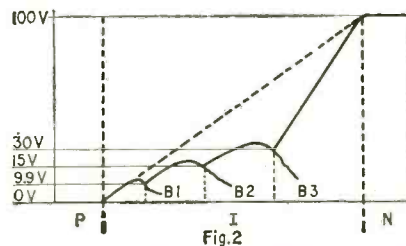
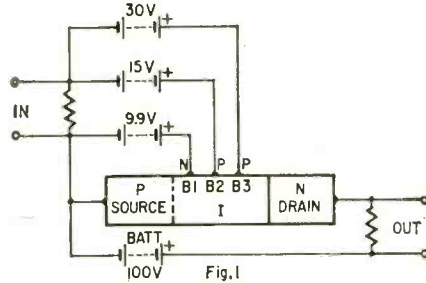

The new spacistor is processed for a very long I region. It has three connections: B1, injector; B2, modulator, and B3, buffer. Each is positively biased with respect to the source electrode, but is negative with respect to the semiconductor at the point of contact. This is shown in Fig. 2, where the dotted line represents voltage drop due to BATT. B1 is connected at a point where the semiconductor is more positive than 9.9 volts, for example.

B1, being n-type and more negative than the material surrounding it, emits electrons into the I region, and these are drawn toward the positive drain electrode. B2 is p-type so it is reverse-biased with respect to the semiconductor. The input signal arrives at B2 and modulates the electron flow. B3 is also reverse-biased. It prevents feedback between output and input. B2 and B3 act like a control and a screen grid, respectively.

The very long I region makes it easier to make connections to it. Also, it lowers the internal capacitance between source and drain.

TREMOLO

Patent No. 2,967,909

Joseph Rice, 103-26 68th Ave., Queens, N. Y.

Two triodes are used, V1-a as an audio amplifier, V1-b as a tremolo phase-shift oscillator.

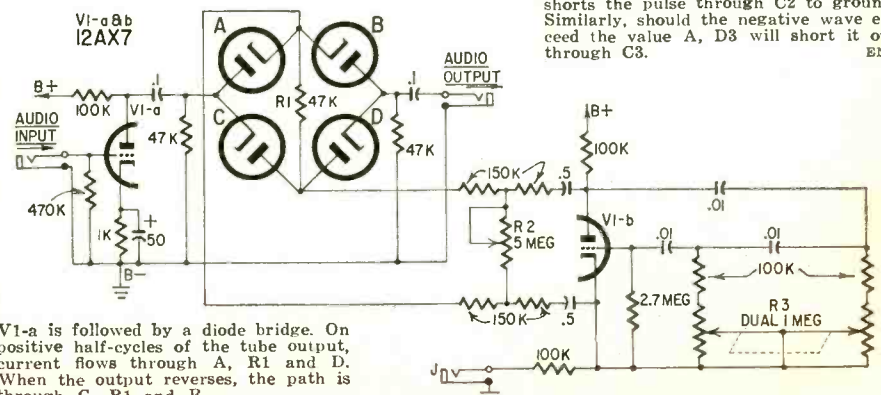

V1-a is followed by a diode bridge. On positive half-cycles of the tube output, current flows through A, R1 and D. When the output reverses, the path is through C, R1 and B.

The rectified audio across R1 is modulated at a very low frequency by the output from V1-b. Note the isolating H-pad after V1-b. R2 adjusts the output level from the oscillator, R3 sets its frequency.

The tremolo effect is turned on and off by a switch or key plugged into J. The double triode may be 12AX7.

NOISE LIMITER

Patent No. 2,961,532

Robert J. Rowley, Cedar Rapids, Iowa. (Assigned to Collins Radio Co., Cedar Rapids, Iowa.)

This limiter is adjustable for any desired percentage of modulation. For example, Fig. 1 shows a 50% AM signal. After detection, it looks like Fig. 2, the negative half (below 0)

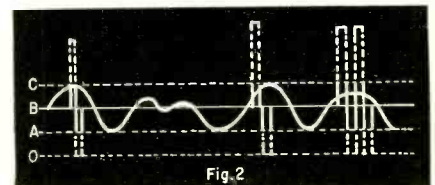
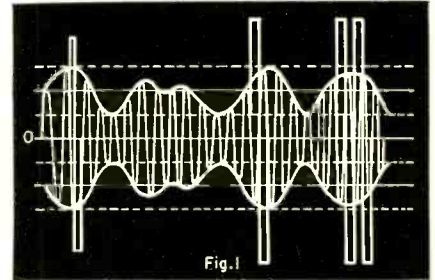

having been wiped out. B is the average carrier level, and A and C are instantaneous audio peaks. This limiter circuit can be set to eliminate any noise pulses having amplitude greater than C or A.

Fig. 3 shows the circuit. The last if stage of a receiver feeds D1 (detector), C1 (rf bypass) and three parallel paths. The center path is tapped by equal resistors R3. Thus the potential at point P2 is proportional to the instantaneous audio wave coming from D1. R1, R2 are chosen to make P1 proportional to the peak C, and P2 proportional to A. Since this makes P1 more positive than P2, and P2 more positive than P3, diodes D2 and D3 do not conduct. Since C2 and C3 are relatively large, the potential at points P1 and P3 cannot follow rapid changes in signal as P2 can.

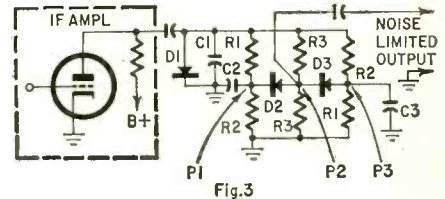

If the instantaneous audio voltage should become greater than C (due to a noise pulse, for example, as shown dotted), P2 becomes momentarily more positive than P1. D2 conducts and shorts the pulse through C2 to ground. Similarly, should the negative wave exceed the value A, D3 will short it out through C3. END

BUSINESS and PEOPLE

Arthur E. Davis (left) was appointed to the new post of executive vice president of Allied Radio Corp., Chicago. He had been vice president, and continues



as treasurer. Alfred W. Preskill (right), former vice president for marketing and administration, assumes the new position of vice president-general manager. Alex Brodsky was newly named as vice president and general manager of the Mail Order & Stores Div. He was previously vice president-general marketing manager. He has been with Allied for over 30 years. Robert Markens now heads the Industrial Div. as general manager. He was formerly controller.



Vernon A. Kamin (left) is now marketing manager, ceramic products, and Bruce Vinkemulder, marketing manager, electromechanical products, in an expansion of the marketing organization at Centralab, Div. of Globe-Union, Milwaukee, Wis. Kamin joined Centralab in 1959 and had previously been with RCA and Motorola. Vinkemulder has been with the company for over 6 years and before that with several leading component manufacturers in various marketing capacities.

Sol S. Sparer, executive vice president of Pacotronics Inc., Glendale, N. Y., was elected to the board of directors.



Louis Kahn was appointed vice president in charge of engineering for Astron Corp., East Newark, N. J. He comes to the company from Aerovox, where he held various management and engineering positions.



Neil M. Blair, president of the RF Products Div. of Amphenol-Borg Electronics Corp., Broadview, Ill., has been named president of the recently acquired FXR Div., Woodside, N. Y. Henry Feldmann, chairman and president of FXR Inc. before it merged with Amphenol-Borg, will continue as chairman of the division.



A. C. "Chuck" Elles was named vice president of Regency Electronics Inc., Indianapolis, Ind. He was promoted from general sales manager.



Earl W. Gray joined Hallicrafters Co., Chicago, as product manager for Citizens-band radio equipment. He comes to Hallicrafters from Florsheim Shoe Co., where he was Midwestern sales representative.



CBS Electronics, Danvers, Mass., will concentrate its future efforts on semiconductors, microelectronics and other electronic products, discontinuing its receiving tube operations at Danvers and Newburyport, Mass., according to an announcement by president Clarence H. Hopper. Raytheon Co. purchased a portion of the CBS entertainment type receiving tube inventory and is offering sales and service of these products to CBS customers.

Jerrold Electronics Corp., Philadelphia, Pa., presented its Rep of the Year Award to the Heimann Co. of Minneapolis. Walter Goodman, manager of the Jerrold Distributor Sales Div. (right), is shown making the presentation to Jack Heimann.



NOW! YOU CAN Master Mathematics



At Home — Only Minutes a Day!

PREPARE yourself NOW for a good future and higher paying job by learning mathematics this amazingly simple way — at home, in your spare time!

Can You Spare 10 Minutes A Day?

That's all it takes with this simplified home-study Course. Thompson's MATHEMATICS FOR SELF STUDY. 5 big volumes, 1533 pages. Hundreds of charts, graphs, diagrams, formulas. Basic "know-how." Time and money-saving short-cuts. Common-sense tips. You master every type of practical mathematical problem quickly and easily.

FREE If You Send Coupon Now

Simplified Accounting—58-page book tells how to keep books: figure balances, profit and loss, collections, depreciation, interest, inventory, credit, etc. Contains 31 sample forms. Lists for \$1, but yours to keep without obligation.

A "Must" for Men Who Want to Get Ahead

Clearly explains all basic principles, equations, probabilities, roots, powers, slide rule, etc. You solve any problem in geometry, surveying, mechanics, navigation, architecture, designing. You compute speed, velocity, rates, integral formulas; analyze sales, production charts; figure statistics, insurance, physics, electricity, radio, TV. MUCH MORE!

Try Complete Course FREE

Send no money. Just mail coupon today for FREE 10-day examination of all five home-study books. If not convinced this great set will let you "write your own ticket" to a higher paying job, return and owe nothing. But mail No-Risk Coupon NOW to: D. VAN NOSTRAND COMPANY, INC., Dept. 189A, 120 Alexander Street, Princeton, New Jersey.

Est. 1848

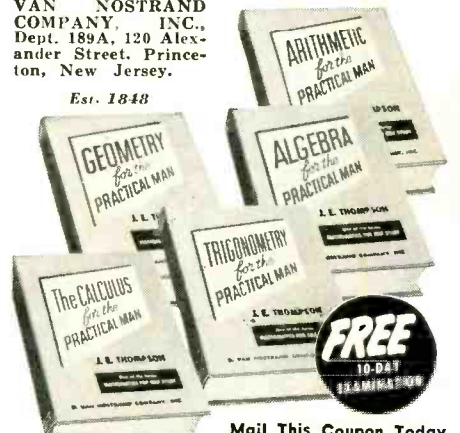

Mail This Coupon Today

D. Van Nostrand Company, Inc., Dept. 189A, 120 Alexander St., Princeton, N.J.

Please send me, for FREE examination, the 5-volume set of Thompson's MATHEMATICS FOR SELF STUDY plus my FREE copy of Simplified Accounting. If not delighted I may return the 5-volume set within 10 days and owe nothing. Otherwise, I will send you \$2.85 (plus small postage) as first payment, and \$3 per month for three months thereafter.

Name (Please Print Plainly)

Address

City Zone State

SAVE! Send full payment of \$11.85 WITH this coupon and WE pay all delivery costs. Return privilege and refund guaranteed (In Canada: 25 Hollinger Road, Toronto 16.) Foreign and A.P.O.—please send \$11.85 with order

Now—24-Hour Tuner Service

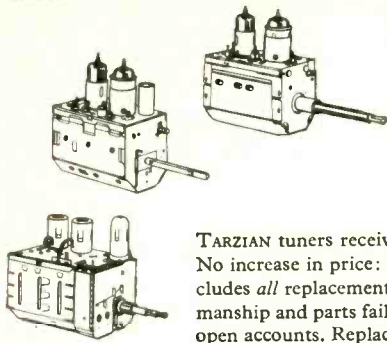

**Tarzian Offers 24-hour
Direct Factory Service
on TUNER REPAIRS
... \$8.50**

TARZIAN tuners received one day will be repaired and shipped out the next. No increase in price: \$8.50 per unit and \$15 for UV combinations. That includes all replacement parts, and a 6-month warranty against defective workmanship and parts failure due to normal usage. Tuners repaired on approved, open accounts. Replacements available at low cost on tuners beyond practical repair.

Tarzian-made tuners easily identified by this stamping. When inquiring about service on other than Tarzian-made tuners, always give tube complement . . . shaft length . . . filament voltage . . . series or shunt heater . . . IF frequency . . . chassis identification. And, allow a little more time for service on these tuners. Use this address for fast, factory repair service:

SERVICE MANAGER • TUNER DIVISION Dept. C



SARKES TARZIAN INC

east hillside drive
bloomington, indiana
edison 2-7251

Mfgs. of Tuners, Semiconductors, Air Trimmers, FM Radios, Audio Tape, and Broadcast Equipment

FREE! CATALOG OF
HI-FI, RADIO, TV
PARTS & ACCESSORIES —
yours for the asking!

Vidaire ELECTRONICS MFG. CORP.
365 BABYLON TPKE. — ROOSEVELT, N. Y.

TAPE RECORDERS

HI-FI COMPONENTS
SLEEP LEARN KITS

Unusual Values
Free 1961
Catalog
DRESSNER,
1523RE Jericho Tpke, New Hyde Park, N.Y.

MERITAPE
Low cost, high
quality recording
tape, in boxes or cans.

Ask By Name For
GENUINE
"NO NOISE" your assurance
of brand name
quality
PRODUCTS

NO-NOISE
Volume Control
and CONTACT RESTORER
• Cleans • Lubricates • Protects
• Not a Carbon Tet Solution
• 6 oz. Spray Can
2 oz. Bottle \$1.00 Net to Servicemen
\$2.25 Net to Servicemen

NO-NOISE
TUNER-TONIC
with PERMA-FILM
• Cleans, lubricates, restores all
tuners, including water type.
• Non-toxic, non-inflammable.
• For TV, radio and FM use.
• Economical—a little does a lot.
6 oz. Aerosol Can \$3.25 Net to Servicemen

FREE
with each can of
ELECTRONIC
CHEMICAL
products—
5" PLASTIC
EXTENDER
• Push Button
• Assembly
• For Pin Point
Applications
• Does Not
Cause
Shorts

ELECTRONIC
Chemical new
formula EC-44
Lubricates, cleans
all electrical
contacts. Econ-
omical . . . a
little does a lot!

6 oz.
spray
can **\$3.50**

ELECTRONIC CHEMICAL CORP.
813 Communipaw Avenue Jersey City 4, N. J.

BUY STANDARD BRAND TUBES
AT LOWEST PRICES

60% OFF LIST!

RCA • GE • SYLVANIA • WESTINGHOUSE

- ALL PREMIUM QUALITY TUBES. ALL BRAND NEW
- ALL TYPES IN STOCK. ALL FRESH STOCKS
- FULL ONE-YEAR GUARANTEE, excepting only burned out or broken tubes.

Type	Net ea.	Type	Net ea.	Type	Net ea.	Type	Net ea.
OZ4	.96	6AH4GT	1.32	6C4	.74	12AT7	1.22
1B3GT	1.16	6AH6	1.86	6CH6A	.90	12AU7A	.98
3B3S	.94	6AL5	.74	6CD6GA2	.32	12AV6	.66
1U4	.94	6AM8A	1.30	6CG7	.98	12AX4GTB	
1U5	.82	6AN8A	1.40	6CG8A	1.26		1.08
1X2A/B	1.22	6AQ5A	.86	6CL6	1.50	12AX7	1.02
		6AU4GTA		6CM7	1.10	12B4A	1.08
2B84	1.02	6AU5GT	1.34	6CQ8	1.32	12BA6	.80
2CV5	1.12	6AU6A	.84	6CY5	1.12	12BE6	.86
3AL5	.74	6AV6	.66	6DE6	.98		
3AU6	.86	6AW8A	1.42	6D6GB	1.64	12HY7A	1.78
3B3S	.94	6AX4GTA		6DT8	.86	12CU6	1.78
3BN6	1.20	6B5	1.08	6J5	1.24	12DQ6B1	.70
3BZ6	.90	6BA9	.80	6J6	1.12	12SA7	.56
3C86	.90	6BC5	.94	6K6GT	.94	12SK7	1.42
3CT6	.88	6BG6GA2	.60	6S4A	.82	12SN7GT	
3V4	.94	6BR7A/B	1.08	6SK7	1.42		1.08
4AQ7A	1.00	6B7A/B	1.34	6SN7GTB	1.22	12SQ7	1.32
5A05	1.32	6BL7GTA		6T8A	1.04	25BQ6GTB	
5DR7A	1.36	6B8A	1.34	6U8A	1.32	25L6GT	.84
5C8S	1.28	6BN4	1.00	6V6GT	.86	35L6GT	.96
5CL8A	1.26	6BN6	1.20	6W4GT	.96	35V4	.56
5U4GB	.84	6BQ6A1	.74	6W6GT	1.12	35Z5GT	.74
5X8	1.30	6BQ7A	1.58	6X3GT	.82	50C5	.86
5Y3GT	.70	6BZ6	.90	6X8A	1.26	50L6GT	.96
6AB4	.86	6BZ7	1.60	12AT6	.66	11Z3	1.00
6AF1A	1.60						
6AG5	1.04						

MINIMUM ORDER \$10.00. Shipped PREPAID
No. C.O.D.s Please

This is but a PARTIAL listing of our more than 500 types in stock at all times. Order ANY type not listed above, take 60% off current list price, and we'll ship promptly, prepaid. Write for our giant current electronic catalog, featuring similar savings in equipment and components. Dept. 163.

ZALYTRON Tube Corporation
220 West 42nd St., New York 36, N.Y.

Sencore Inc., Addison, Ill., is continuing its series of service clinics throughout the nation. Ed Flaxman, vice president-sales, personally conducted the most recent tour through Texas and

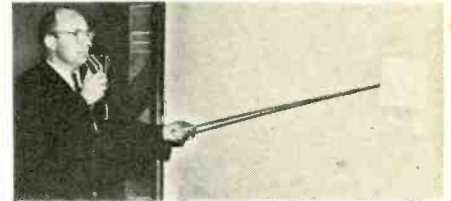

Southern California. He is shown here lecturing to a group in Los Angeles.

Bogen-Presto, Div. of the Siegler Corp., Paramus, N. J., reported such success with its Champagne Line of Sound exhibition at the Electronic Parts Distributors Show in Chicago in May that it has taken the "show on the road." Plans have been made for shows in key cities throughout the United



States. Director of sales, Mort Sumberg (right), is shown pointing out features of the new intercom line to an interested visitor at the New York showing.

Winegard Co. and Channel Master Corp. have agreed on a royalty-bearing patent license based on termination of a pending action in a manner agreeable to both parties.

Auditex Manufacturing Co., Div. of GC-Textron Electronics, Inc., Rockford,



Ill., is packaging its tape recorder and phonograph accessories on blister card displays.

Chemtronics, Inc., Brooklyn, N. Y., is providing distributors with a display rack for its line of electronic chemicals. END

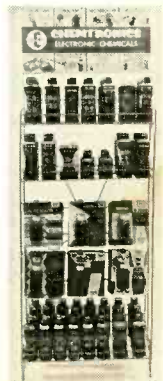

new LITERATURE

Any or all of these catalogs, bulletins, or periodicals are available to you on request direct to the manufacturers, whose addresses are listed at the end of each item. Use your letter-head—do not use postcards. To facilitate identification, mention the issue and page of RADIO-ELECTRONICS on which the item appears. UNLESS OTHERWISE STATED, ALL ITEMS ARE GRATIS. ALL LITERATURE OFFERS ARE VOID AFTER SIX MONTHS.

CITIZENS-BAND novice will find much to instruct him in *Radio Communications for Everyone*. Booklet also suggests proper equipment for industry, farming, emergency and safety work, the professions and beginning amateur and SWL use.—Lafayette Radio, 165-08 Liberty Ave., Jamaica 33, N. Y.

PILOT LIGHT AND TRANSISTORIZED NEON INDICATOR LIGHTS are brought up to date in these presentations of recent developments in the field, *Digest of Pilot Lights, Form L-161C*, and *Transistorized Neon Indicator Lights, Form STI-166A*. Pilot-light digest, 24 pages, 8½ x 11 in, includes life-size illustrations, catalog numbers, lamp data, physical and electrical characteristics, charts, etc. Bulletin on transistorized neon indicator lights, 2 pages, 8½ x 11 in, gives life-size illustrations, specifications, schematic and charts and ordering information.—Dialight Corp., 60 Stewart Ave., Brooklyn 37, N. Y.

SOUND OF MUSIC describes and illustrates award-winning controlled background music system that includes playing equipment, speakers and tape cartridge music library. Built-in loudspeaker available.—Musi-Pak Corp., Dept. M3, 103 E. Hawthorne Ave., Valley Stream, N. Y.

SOUND-SYSTEM ENCLOSURES *Catalog SC-61* replaces manufacturer's *Catalog CS-59*. Large illustrations with one baffle of each size shown so that actual size comparison can be made more easily. Shows corner, thinline wall and space-saver hi-fi baffles.—Argos Products Co., Genoa, Ill.

BI-PHONIC COUPLERS, the self-baffled 440 and 3½-in thin *Modulaire*, described and illustrated in 4-page booklet. Complete specifications and demonstrates decorating possibilities.—Advanced Acoustics Corp., 391 Lakeside Ave., Orange, N. J.

STEREO FM BROADCASTING is explored thoroughly in pocket-size booklet *Factual Answers to Your Questions about Stereo FM Broadcasting*. Text prefaced by brief history of how stereo-

FCC TYPE* ACCEPTED

Sonar Model "E" CITIZENS BAND RADIO

- High level Class "B" push pull modulation
- 8 Crystal controlled channels
- Heavy duty power supply
- Adjustable squelch
- Automatic noise limiter
- R. F. Power indicator
- Switch allows receiver to tune 22 channels
- 1 year guarantee



\$179⁵⁰

with 1 pair of crystals, microphone and power cables

Easy to install. Ideal for home, boat, car or business. Weighs only 9 lbs. . . . 4¾ x 9½ x 11¼.

*FCC Type Accepted means the unit has passed rigid FCC requirements.

World famous for quality in Electronics
SONAR RADIO CORPORATION
3050 West 21st Street • Brooklyn, N.Y.

Sonar Products are 100% American made.

HOW TO MAKE MONEY IN CITIZENS BAND RADIO

AUTHORITATIVE GUIDEBOOK ABOUT THE BOOM IN TWO-WAY MOBILE-RADIO. GIVES FACTS, FIGURES, PAY RATES. WRITE TODAY!

FREE

LAMPKIN LABORATORIES, INC. Dept. 26 BRADENTON, FLA.



YOU'LL BE AMAZED...

at our low, low hi-fi prices. Write for FREE discount catalog A-12, or send for our special quotations on your component needs.

KEY ELECTRONICS COMPANY
120 Liberty St., New York 6, N.Y.

Purchasing A HI-FI SYSTEM?

TIME PAYMENTS AVAILABLE

Up to 2 years to pay!

Send Us Your List Of Components For A Package Quotation

You Can Buy With Confidence AT AIREX

All merchandise is brand new, factory fresh & guaranteed.

Free Hi-Fi Catalog

AIREX RADIO CORPORATION

85-RE Cortlandt St., N.Y. 7, WO 4-1820

Jim Lansing*
Altec Lansing
Electrovoice
Hartley* • Viking
University • Jensen
Acoustic Research
Janszen
Wharfedale
USL Citizen Band
Gonsel
Hallcraft
Texas Crystals
International
Crystals
Concertone
Bell • G.E.
Weathers
Harman-Kardon
Eico • Pilot
ESL • Frazier
Superscope
Dual Changer
Bogen • RCA
Dynakit • Fisher
H. H. Scott
Thorens* Sherwood*
TEC • Roberts
DeWald • National
Sony • Tandberg*
Challenger
Wollensak
Garrard
Miracord
Glaser-Steers
Rek-O-Kut
Polytronics
Norelco • Conrac
Fairchild
Pickering • Sonar
Audio Tape
Magnecord*
Rockford Cabinets

*Fair Traded

PRECISION HI-FI ACCESSORIES



HUM-BUCKING TELEPHONE PICKUP COIL

Hum free transcription, no connection to telephone, rugged cast case.

MODEL HP-70 NET \$6.95

TAPE RECORDING HEAD DEMAGNETIZER

Removes permanent magnetism, protects tape from erasure, minimizes noise and distortion, extended pole piece—easy access.

MODEL HD-40M NET \$4.95



MAGNETIC TAPE ERASER

Bulk erasure of recorded tape, restores tape like new, reduces noise, reel size to 10½" x ½" W, epoxy case, sealed for life.

MODEL HD-11M NET \$18.95



STEREO 3RD CHANNEL OUTPUT TRANSFORMER

Add speaker to fill "hole-in-middle". Matches impedance, polarity and power level. Rating 30 watts. Response 40 to 20,000 C.P.S.

MODEL HM-90 NET \$6.33

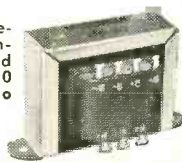

MICROTRAN company, inc.

145 E. Mineola Ave., Valley Stream, N.Y.



WAYS TO BIGGER EARNINGS

Albert C. W. Saunders, noted electronics authority and director of a famous electronic school, shows you the way in clear, easy-to-follow language and diagrams. More than 40 years of experience has gone into these timely how-to-do-it works . . . for your benefit!

1 "WORKING WITH THE OSCILLOSCOPE"

A complete working manual for use at your bench. Exclusive "Block-o-Matic" schematics help you to master "electronics' most useful instrument" quickly, easily. 26 illustrated projects, 200 diagrams demonstrate the 'scope's many uses in electronics, radio, TV, transistors, vacuum tubes, and others. An invaluable book, yet it costs you only \$3 postpaid. CLIP AND MAIL TODAY!

Electronic Technical Publishing Co.
Dept. RE, P.O. Box 306,
Astor Sta., Boston, Mass.

Name _____
Street _____
City & Zone _____ State _____

Satisfaction guaranteed or money refunded.

2 SEVEN LESSON COURSE IN COLOR TELEVISION

Designed to familiarize black-and-white TV technicians with the basic principles of modern Color TV. Seven complete lessons cover standards, definitions, receiver circuitry, servicing, and more. Uses unique "Block-o-Matic" diagrams and lavish illustrations. Streamlined . . . timely and accurate . . . easily understood for application to your actual practice. Complete course, all in one mailing, only \$7.50 postpaid. (With correction service \$10.)

- Please rush me the following:
1 "Working with the Oscilloscope" _____ copies at \$3 each.
2 "Color Television Course" _____ copies at \$7.50 each.
I enclose check or M. O.

Please rush me the following:

phonic FM broadcasting came into being, consists of 27 questions and answers on the subject.—Zenith Radio Corp., 6001 W. Dickens Ave., Chicago 39, Ill.

SPACE FLIGHT is a compilation of references to authoritative works on this subject written on a level between popularized scientific articles and highly technical textbooks. The 12-page booklet outlines courses, dictionaries and guides to further reading.—Bell Telephone Laboratories Inc., 463 West St., New York 14, N. Y.

TRANSISTOR REFERENCE CHART shows expanded transistor line of high-frequency communications, control and switching transistors, high-speed switches and military types. Organized by categories of application with a summary of electronic characteristics. Dimensional outlines and mechanical specifications are shown actual size.—Philo Corp., Lansdale Div., Church Rd., Lansdale, Pa.

TRANSISTORIZED CAR RADIOS acquaints the car-radio service technician with time and money-saving servicing methods based on practical experience with transistor receivers. An introductory survey is followed by discussion of transistor theory, transistor receiver servicing methods and circuits of manufacturer's 1961 all-transistor car radios. Many figures and photos.—Motorola Consumer Products Inc., 9401 W. Grand Ave., Franklin Pk., Ill., 50¢

CITIZENS BAND RADIO, Littlefone, Model CB-3, and its applications in home, office, auto, boating, farms and industry are presented in a 4-page illustrated brochure. Technical specifications.—Hallicrafters Co, 4401 W. Fifth Ave., Chicago 24, Ill.

HARNESSES, ADAPTERS, SOCKETS for servicing all types of TV receivers using any 110° tube illustrated in vivid white-on-black diagrams.—Eby Sales Co. of N. Y., 148-05 Archer Ave., Jamaica 35, N. Y.

MAST-MOUNTED TV/FM BOOSTER, model AB-4, is described and illustrated in a 2-page leaflet. Technical specifications and features are included.—Blonder-Tongue Labs Inc., 9 Alling St., Newark, N. J. END

CORRECTION

There were a few errors in J. H. Thomas' article "CB Transceiver from Car Radio" in the July 1961 issue.

In Fig. 3-b, the parts layout on the printed board, R4 and R5 are transposed, R9 is R8, R10 is R9, R11 is R10 and R12 is R11.

In Fig. 3-a, the printed side of the board, a few additional holes are needed: a hole for R9 in the foil connected to pin 2 of V2, a hole for the other end of R9 in the foil connected to pin 3 of V2, a hole for the ground side of C6 in the foil connected to pin 8 of V2. The grounds for V1 and V2 are interconnected by the shield can of transformer T2.

A complete corrected printed-circuit board is available from Irving Electronics Co., PO Box 9222, San Antonio, Tex.

OUT OF SPACE?

You bet we'd be . . . if we were to tell you all about AUDION'S 'Out of this World Hi Fi Values'.



Write for free Catalog

audion
25-E Oxford Road
Massapequa, New York

NOW! A
POCKET-SIZE
PORTABLE

ONE WATTER

—THE NEW
**OSBORNE
DUO-COM 120***

with rechargeable battery
10 Times the Power of
Ordinary Units!

Up to 18 hours of usable life between charges with range and power never before obtainable. All transistorized: 11 high power transistors plus 3 diodes. Special jacks for external antenna and earphones. Weighs less than 28 ounces. Noise immune squelch control. Only \$149.50. *Easy to obtain license required.

SEE IT AT WESCON—
BOOTH 612



OSBORNE ELECTRONICS CORP. Dept. A-22
13105 S. Crenshaw Blvd., Hawthorne, California

- Send me information on the Osborne 300, 120, 100/100S lines.
- Rush details on your jobber program.

Name _____
Address _____
City _____ Zone _____ State _____

Components • Recorders • Tapes SHIPPED PROMPTLY AT WHOLESALE PRICES

FREE LIST Packaged Hi-Fi
Low Quotes Air Mailed
AUDIO UNLIMITED 190-R Lexington Ave.
New York 16, N. Y.

"TAB" FOR TRANSISTORS & DIODES!!! FULL LENGTH LEADS

Factory Tested & Guaranteed! U.S.A. Mfgd!

PNP HIPOWER 15 Amp Max 25°C
2N441, 2N277 \$1.80 @ 6/59, 25/539,
100/5130, 2N442, 2N278, \$3.75 @
4/512, 25/564, 100/5225, 3 Amp,
2N155, 2N156, 2N255, 2N256, 2N307,
2N554, T03GP €80 @ 20/515, 100/565.

2N123 PNP €45 @ 12 for 55, 100/537
2N292, 2N293 NPN €45 @ 12 for 55, 100/537
2N293 PNP 30c, @ 12 for 59, 100 for 565

GENERAL PURPOSE—PNP—COMPUTER GRADE!
Use as Amplifier—Oscillator—HIFI RF, IF
Logic—Servoamp—Power Supply
Pulse Amplifier or High Current Switch
Vcb. Vce. Veb Approx 40V
GP 3C rated 300mw €65 @ 10 for 55, 100/539
GP10C rated one watt 90c, @ 6—\$5, 100—563

2N176/\$1.80, 2N270/95c, 2N670/\$1.60,
2N671/\$2, Kit PNP or NPN €39 @ 3 for \$1,
Round or Diamond Base Mica Mtg. Kit €30 @,
4/51, Power Heat Sink with Pins 80 Sq.,
\$1.50, 4/55, Kit Glass Diodes Computer Grade
€20 @, 8 for \$1, 100 for \$7, 1000 for \$50.

"TAB", SILICON 750MA* DIODES

GENERAL PURPOSE 400 PIV at 300 MA
SPECIAL 35c each 20 for 56

rms/piv 17/25 10c	rms/piv 35/50 14c	rms/piv 70/100 24c	rms/piv 140/200 29c
rms/piv 210/300 39c	rms/piv 280/400 50c	rms/piv 350/500 64c	rms/piv 420/600 74c
rms/piv 490/700 87c	rms/piv 560/800 93c	rms/piv 630/900 \$1.10	rms/piv 700/1000 \$1.50

Low Priced ★ T200 SILICON DIODES
rated 380piv/266Rms @ 200Ma @ 100°C
36¢ each; 10 for \$3.25; 100 for \$27; 1000 for \$230

Cap. or Batty. Derate 20%

POWER DIODES—STUDS 50Piv/35Rms FACTORY TESTED—GTD!

1.5 Amp €30 @ 100 for \$27, 1000 for \$225
3.0 Amp €50 @ 100 for \$45, 1000 for \$390
6.0 Amp \$1.50 @ 100 for \$100, 250 for \$200
12 Amp \$1.45 @ 100 for \$125, 250 for \$225
35 Amp \$2.30 @ 100 for \$200, 250 for \$400
70 Amp \$3.90 @ 50 for \$175, 100 for \$300
240 Amp \$4.50 @ 50 for \$220, 100 for \$375
*Derate 20% for Capacitive & Battery Load! Amp
Ratings for Studs on Heat Sink!!!

SILICON—5U4C—SPECIAL!!!
OCTAL SILICON DIODE REPLACEMENT 1120Rms/
1600Piv 56 @, 5 for \$25, 100 for \$475, 1000 ?!

"TAB" TERMS: Money Back Guarantee!
Our 17th year. \$2 min. order
F.O.B. N.Y.C. Add shpg charges
or for C.O.D. 25% Dep. Prices
shown subject to change.
111-GH LIBERTY ST., N.Y. 6, N.Y.
Send 25¢ PHONE: RECTOR 2-6245 for Catalog

new BOOKS

RADIO-TELEVISION and BASIC ELECTRONICS (2nd Edition), by R. L. Oldfield. American Technical Society, 848 E. 58 St., Chicago 37, Ill. 5½ x 8¼ in. 400 pp. \$4.95.

Beginners need a clear text and plenty of diagrams. Both will be found here. The book begins with a study of circuits, magnets and tubes. Then it goes on to power supplies, amplifiers and microphones. With this preparation, the author proceeds with a study of FM, AM, hi-fi, TV and transistors. Where simple equations appear, examples are usually provided.

ELEKTRONISCHE MUZIEK-INSTRUMENTEN IN THEORIE EN PRAKTIJK (ELECTRONIC MUSICAL INSTRUMENTS IN THEORY AND PRACTICE), by H. Meijer Jr. and W. Heggie. De Muiderkring, N.V., Bussum, The Netherlands. 5½ x 8½ in. 168 pp. Florins 7.50.

BANDRECORDING-GELUID EN MAGNETISME (TAPE RECORDING-SOUND AND MAGNETISM), by A. van Maaren. De Muiderkring, N.V., Bussum, The Netherlands. 5½ x 8½ in. 112 pp. Florins 5.50.

Electronic Musical Instruments is a comprehensive manual on the construction and theory of do-it-yourself electronic organs. It contains a wealth of information on mechanical detail not usually found in electronic organ books. Written in Dutch, the manual contains many clear illustrations of mechanical constructions which are often a real stumbling block to the home construction of an electronic organ. The volume also contains instructions on troubleshooting and a chapter on how to play the particular organ which provides the central theme of the book.

Tape Recording, a relatively brief introduction to the principles and theory of magnetic recording is quite comprehensive in its theoretical discussions of the recording, reproduction and erasure processes used in tape recording. Written in Dutch.—TJ

ELECTRONIC ORGAN HANDBOOK, by H. Emerson Anderson. Howard W. Sams & Co. Inc., 1720 E. 38 St., Indianapolis, Ind. 5½ x 8½ in. 270 pp. \$4.95.

This book explains the operation of eight manufactured organs. It details check-out and maintenance procedures in language that a radio technician can understand.

HOW TO GET THE MOST OUT OF TAPE RECORDING (Stereo Edition), by Lee Sheridan. Robins Industries Corp., Flushung 54, N. Y. 6 x 9 in. 128 pp. \$1.

This book shows how to install and operate, how to edit and splice. It suggests ways to use the recorder to make money and save time. Interesting stories tell of tape used for business and

ELECTRONICS Engineering-Technicians



Heald's Microwave and Radar Laboratory Equipment.

Bachelor of Science Degree, 30 Months
Save Two Years' Time

- Radio-Television Plus Color Technician (12 Months)
- Electronics Engineering Technology (15 Months)
- Electronics Engineering (B.S. Degree)
- Electrical Engineering (B.S. Degree)
- Mechanical Engineering (B.S. Degree)
- Civil Engineering (B.S. Degree)
- Architecture (B.S. Degree)

Approved for Veterans
DAY AND EVENING CLASSES

Write for Catalog and Registration Application.
New Term Starting Soon.

HEALD'S ENGINEERING COLLEGE

Established 1863
Van Ness at Post, RE
San Francisco, Calif.

Your Name _____
Address _____
City _____
State _____

FREE RAPID TROUBLE SHOOTER GUIDE

FOR-RADIO, TV, HIFI-RECORDERS
NOTHING TO BUY—WRITE TODAY

METREX 519 Hendrix St.
Brooklyn 7, N.Y.

NOW! . . . IT'S QUIETROLE

with the FREE EXTENDER TUBE



Quality QUIETROLE, your first choice "Lubri-Cleaner" in silencing noisy controls and switches on TV, radio and electronic instruments now provides you with a FREE EXTENDER TUBE to easily reach those once "hard-to-get-at" places. You'll like QUIETROLE better than ever now . . . In spray can or bottle.

IN SPRAY CAN or 2, 4, 8 oz. BOTTLES

manufactured by
QUIETROLE
COMPANY

Spartanburg, South Carolina
In Canada: CROSS CANADA ELECTRONICS
12 Laurel Street, Waterloo, Ontario



TV PICTURE TUBES

All Aluminized Glass Types BUY DIRECT AND SAVE

• 12LP4—\$8.95 • 17BP4—\$9.95 • 21AL/ATP4—\$16.75

• 24DP4—\$24.50 • 27EP4—\$39.95

ALL TYPES AVAILABLE

These tubes are made from reprocessed glass. All materials including electron gun are brand new.

All Prices with old Tube F.O.B. Chicago

PICTURE TUBE OUTLET

2922 MILWAUKEE • Chicago 18

FREE Write for complete Picture Tube list.

PROOF OF SUPERIORITY
NO OTHER MICROPHONE
CAN MATCH!



LEADING NEWSWEEKLY
MAGAZINES PICTURE E-V
MORE OFTEN THAN THE NEXT
FOUR BRANDS COMBINED!

Write now for catalog of
microphones preferred by top radio, TV,
newsreel and sound engineers!

Electro-Voice

ELECTRO-VOICE, INC.
Commercial Products
Div., Dept. 911E
Buchanan, Michigan

BECOME A RADIO TECHNICIAN FOR ONLY \$26.95

BUILD 20 RADIO CIRCUITS AT HOME

with the New **PROGRESSIVE RADIO "EDU-KIT"®** only **\$26.95**

ALL Guaranteed to Work!

- A Complete Home Radio Course**
- 12 Receivers
 - 3 Transmitters
 - Signal Tracer
 - Signal Injector
 - Code Oscillator
 - Sq. Wave Generator
 - Amplifier



- No Knowledge of Radio Necessary
- No Additional Parts or Tools Needed
- Excellent Background for TV

FREE Set of Tools, Pliers-Cutters, Tester, Soldering Iron, Alignment Tool, Wrench Set.

WHAT THE "EDU-KIT" OFFERS YOU

The "Edu-Kit" offers you an outstanding PRACTICAL HOME RADIO COURSE at a rock-bottom price. You will learn radio theory, construction and servicing. You will learn how to build radios, using regular schematics; how to solder and wire in a professional manner; how to service and trouble-shoot radios. You will learn how to work with punched metal chassis as well as the new Printed Circuit chassis. You will learn the principles of IF and AF amplifiers and oscillators, detectors, rectifiers, test equipment. You will learn and practice code, using the Progressive Code Oscillator. You will build 20 Receiver, Transmitter, Code Oscillator, Signal Tracer, Square Wave Generator, Amplifier and Signal Injector circuits, and learn how to operate them. You will receive an excellent background for TV. In brief, you will receive a basic education in Electronics and Radio, worth many times the small price you pay, our \$26.95 complete.

PROGRESSIVE TEACHING METHOD

The Progressive Radio "Edu-Kit" is the foremost in educational radio kit in the world, and is universally accepted as the standard in the field of electronics training. The "Edu-Kit" uses the modern educational principle of "Learn by Doing." You begin building a simple radio. Gradually, in a progressive manner, and at your own rate, you construct more advanced multi-tube radio circuits, learn more advanced theory and techniques, and do work like a professional radio technician. These circuits operate on your regular AC or DC house current.

THE KIT FOR EVERYONE

You do not need the slightest background in radio or science. The "Edu-Kit" is used by young and old, schools and clubs, by Armed Forces Personnel and Veterans Administration for training and rehabilitation. One of the most important aspects of the "Edu-Kit" is the Consultation Service which we provide. We welcome students to send us their problems, whether related to any of the material covered in the "Edu-Kit" course or encountered in other experiences in the field of electronics.

THE "EDU-KIT" IS COMPLETE

You will receive all parts and instructions necessary to build 20 different radio and electronic circuits, each guaranteed to operate. Our kits contain tubes, tube sockets, variable electrolytic, mica, ceramic and paper dielectric condensers, resistors, tie strips, coils, hardware, tubing, punched metal chassis, instruction Manuals, hook-up wire, solder, selenium rectifiers, volume controls, switches, etc. In addition, you receive Printed Circuit materials, including Printed Circuit Chassis, special tube sockets, hardware and instructions. You also receive a useful set of tools, pliers, cutters, an alignment tool, professional electric soldering iron, Wrench set, and self-powered, dynamic Radio and Electronics Tester. The "Edu-Kit" also includes Code Instructions and the Progressive Code Oscillator. You will also receive lessons for servicing with the Progressive Signal Tracer and the Progressive Signal Injector, a High Fidelity Guide, FCC Amateur License Training Book, and a Quiz Book. All parts, components, etc., of the "Edu-Kit" are 100% unconditionally guaranteed, brand new, carefully selected, tested and matched. Everything is yours to keep. The complete price of this practical home Radio and Electronics course is only \$26.95.

TROUBLE-SHOOTING LESSONS

You will learn to trouble-shoot and service radios, using the professional Signal Tracer, the unique Signal Injector and the dynamic Radio and Electronics Tester. Our Consultation Service will help you with any technical problems.

J. Stasaitis, 25 Poplar St., Waterbury, Conn., writes: "I have repaired several sets for my friends, and made money. The "Edu-Kit" paid for itself. I was ready to spend \$240 for a course, but I found your ad and sent for your kit."

FREE EXTRAS

- Set of Tools • Radio Book • Radio and Electronics Tester • Electric Soldering Iron • Pliers-Cutters • Alignment Tool • Tester Instruction Book • Hi-Fi Book • TV Book • Quiz Book • Membership in Radio-TV Club: Consultation Service • FCC Amateur License Training • Printed Circuitry • Certificate of Merit • Valuable Discount Card • Wrench Set

UNCONDITIONAL MONEY-BACK GUARANTEE

ORDER FROM AD—RECEIVE FREE BONUS RESISTOR AND CONDENSER KITS WORTH \$7.00

- "Edu-Kit" Postpaid. Enclosed full payment of \$26.95.
- "Edu-Kit" C.O.D. I will pay \$26.95 plus postage.
- Send me FREE additional information describing "Edu-Kit."

Name.....
Address.....

PROGRESSIVE "EDU-KITS" INC.
1186 Broadway, Dept. 180G, Hewlett, N. Y.

pleasure by such personalities as Emory Cook, Marvin Miller and Russ Molloy.

Photos are a big attraction. They show typical equipment and accessories, tape technicians at work, unusual applications for recorders. Listings include suggested tape recordings and tape-corresponding clubs throughout the world.—IQ

MARINE ELECTRONICS HANDBOOK (1st Edition), by Leo G. Sands. Howard W. Sams & Co. Inc., 1720 E. 38 St., Indianapolis, Ind. 5 1/2 x 8 1/2 in. 232 pp. \$3.95.

Written for the boat owner and service technician, this book discusses equipment used for communications, direction finding, depth sounding, steering and radio location. Typical equipment is illustrated with photos and schematics. Methods and instruments for transmitter testing and receiver alignment are explained. Mf, vhf and uhf are included. The book contains maritime channel lists, weather broadcast schedules and radio beacon charts.—IQ

MAGIC OF ELECTRONICS, by Edward J. Bukstein. Frederick Ungar Publishing Co., 131 E. 23 St., New York 10, N. Y. 6 x 9 in. 256 pp. \$1.75.

This is an illustrated, brief account of modern electronic devices and their application. It is written for nontechnical readers to help them appreciate the wonders of modern science. Each page is devoted to a different topic. They include tubes, television, phototube, lie detector, industrial controls, and many others. Each device is illustrated by a photo or a simple diagram.

VACUUM TUBE CHARACTERISTICS, edited by Alexander Schure. John F. Rider Publisher Inc., 116 W. 14 St., New York 11, N. Y. 5 1/2 x 8 1/2 in. 89 pp. \$1.80.

Tubes continue to be important components in electronic circuits. This book discusses them from a theoretical viewpoint and shows how to use them to best advantage. It discusses diodes, triodes, multigrad tubes and special types. Diagrams, formulas and examples are included to explain load lines, transconductance, power output and distortion measurements. Simple algebra is sufficient. **END**



"Laser or no laser! you're not going to use my ruby ring!"

A GRANCO FIRST!

GO WITH EXCLUSIVE GRANCO FM CAR RADIO CONVERTER!

Add the beauty in sound of Granco FM to AM car radio in a marvel of minutes. Superb quality—with Automatic Frequency Control... compact design—only 1 1/4" thick... and ease of installation make this Granco innovation a "must" for every car owner, especially at this low, low price. Available at radio and auto accessory shops everywhere. **ONLY \$49.95**

WRITE FOR FREE LITERATURE
GRANCO America's Leading Specialist in FM
DIVISION · DUMONT EMERSON CORPORATION, Dept. H, 680 FIFTH AVENUE, N.Y. 19

SCHOOL DIRECTORY

LEARN

LEARN
RADAR MICROWAVES
COMPUTERS—TRANSMITTERS
CODE • TV • RADIO

Phila. Wireless Technical Inst.
1533 Pine St., Philadelphia 2, Pa.
A Non-Profit Corp.
Founded in 1908
Write for Free Catalog to Dept. RE-9
Classes now forming

twenty to one dividend . . .

that's the return you can receive from your investment in your college education in engineering or business. Faster advancement, too. Important firms like Tri-State College graduates . . . return regularly to our campus to interview seniors. Become an Electronics Engineer. Quality faster here.

Bachelor of Science Degree in 27 Months

In Electrical (Electronics or Power major), Mechanical, Chemical, Aeronautical, Civil Engineering. IN 24 MONTHS B.S. in Business Administration (General Business, Accounting, Motor Transport, Management majors). For earnest, capable mature students. Small classes. More professional class hours. Beautiful campus. Well-equipped labs, modernized buildings, new dorms. Year-round operation. Enter Jan., Mar., June, Sept. Founded 1881. Write J. G. McCarthy, Director Admissions, for Catalog and "Your Career in Engineering and Commerce" Book.

TRI-STATE COLLEGE 2491 College Ave.
Angola, Indiana

ENGINEERING EDUCATION for the Space Age

NORTHROP INSTITUTE of Technology is a privately endowed, nonprofit college of engineering offering a complete Bachelor of Science Degree Program and TWO-YEAR accredited technical institute curricula. Students from 50 states, many foreign countries. Outstanding successful graduates employed in aeronautics, electronics, and space technology. Write today for catalog—no obligation.

NORTHROP INSTITUTE OF TECHNOLOGY
1181 West Arbor Vitae Street, Inglewood 1, California

SCIENCE ENGINEERING

B.S. Degree—36 mos. • B.E. Degree—27 mos.
Accelerated year-round program: Aero., Chem., Civil, Elec., Mech., Metal., Math., Chem., Physics. Most rapid. Earn board. New classes start Sept., Jan., Mar., June, July. Catalog. 1591 E. Washington Blvd., Fort Wayne 2, Ind.

INDIANA TECHNICAL COLLEGE

Study in the "Valley of the Sun" ELECTRONIC ENGINEERING TECHNOLOGY

College-level resident schooling
Veteran-approved. Catalog on request
Middleton Institute of Electronics
2937 E. McDowell Rd.
PHOENIX
ARIZONA

GET INTO ELECTRONICS

V.T.I. training leads to success as technicians, field engineers, specialists in communications, guided missiles, computers, radar and automation. Basic and advanced courses in theory and laboratory. Assoc. degree in electronics in 28 mos. B.S. in electronic engineering obtainable. ECPD accredited. G.I. approved. Graduates in all branches of electronics with major companies. Start September, February. Dorms, campus. High School Graduate or equivalent.

**VALPARAISO TECHNICAL
INSTITUTE**
Dept. C Valparaiso, Indiana



ENGINEERING COURSES

E.E.
Option Electronics or Power
Mechanical, Civil & Physics
Also in Liberal Arts
presented through
HOME STUDY
Resident Classes Also
Available if Desired
Specify course desired.
**PACIFIC INTERNATIONAL
COLLEGE OF ARTS
& SCIENCES**
Primarily a correspondence
school
5719-M Santa Monica Blvd. Hollywood 38, Calif.

LEARN ELECTRONIC ORGAN SERVICING

This new, high paying profession can now be learned easily in your spare time.

- ★ Complete Training—All Makes and Models
- ★ Scientific Teaching Aids Make Learning Easy
- ★ No Prior Knowledge of Electronics Necessary

GET FULL DETAILS ON THIS
AMAZING COURSE
WRITE FOR FREE BOOKLET

NILES BRYANT SCHOOL
Dept. L, 3731 Stockton Blvd.
Sacramento 20, California

LEARN TRANSISTOR, COMPUTER OR RADAR ELECTRONICS AT HOME!

Prepare now for a profitable career in one of these growing fields. Learn theory and practical application of all makes and types with proven home study courses from the Philco Technological Center.

For FREE information write:

PHILCO
TECHNOLOGICAL CENTER
P.O. Box 4730, Dept. R-2, Philadelphia 34, Pa.

FREE!

ELECTRONICS CAREER KIT

If you're interested in breaking into a good-paying job in Radio-TV-Electronics, I.C.S. will send you absolutely free a famous Career Kit with 3 famous booklets that have helped thousands of others—just like yourself—on the road to real success. Includes:

- 1 "HOW TO SUCCEED" Career Guide—36-page gold mine of career tips and information.
- 2 "JOB CATALOG" of opportunities in your field of interest.
- 3 "SAMPLE LESSON" (math) to demonstrate the famous I.C.S. method.

Send today for your free I.C.S. Career Kit with these 3 famous booklets. There's no obligation. This may be the big break you've been waiting for. Mark and mail the coupon today.

INTERNATIONAL CORRESPONDENCE SCHOOLS

Dept. 37067H Scranton 15, Penna.

Please send free Career Kit with 3 famous booklets

- General Electronics Radio-TV Serv'g Practical Electrician
 Industrial Electronics Sound Equip. Serv'g Profess'l Eng. (Elec.)
 Radio-TV Eng'g Electrical Eng'g Electrical Drafting
 Electronic Servicing Electrical Tech. Other

Name _____ Age _____

Address _____

City _____ State _____

FREE CAREER BOOKLET

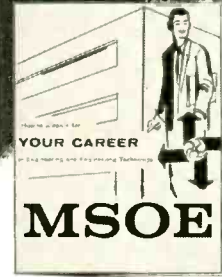

to guide you

to a

successful future

in

ELECTRONICS

RADIO-TV

COMPUTERS

ELECTRICAL

ENGINEERING

This interesting pictorial booklet tells you how you can prepare for a dynamic career as an Electrical Engineer or Engineering Technician in many exciting, growing fields:

**MISSILES • RADAR • RESEARCH
ELECTRICAL POWER • ROCKETRY
AUTOMATION • AVIONICS
SALES • DEVELOPMENT**

Get all the facts about job opportunities, length of study, courses offered, degrees you can earn, scholarships, part-time work — as well as pictures of the Milwaukee School of Engineering's educational and recreational facilities. No obligation — it's yours free.

MILWAUKEE SCHOOL OF ENGINEERING

MAIL COUPON TODAY!

MILWAUKEE SCHOOL OF ENGINEERING
Dept. RE-961, 1025 N. Milwaukee St.
Milwaukee, Wisconsin MS-113

Please send FREE "Your Career" booklet
I'm interested in Electronics Radio-TV
 Computers Electrical Engineering
 Mechanical Engineering
(PLEASE PRINT)

Name _____ Age _____

Address _____

City _____ Zone _____ State _____

I'm eligible for veterans education benefits.

Discharge date _____



**FREE
ELECTRONICS
CATALOGS
for 1 full year**



from Radio Shack...
fastest growing
electronics house

Don't miss the huge selection, the wonderful values in Radio Shack's better-than-ever catalogs! Just mail the coupon... receive the exciting 1961-62 Buying Guide of 336 pages, 2/3 bigger than last year! Plus all supplements for 12 months. See over 100,000 items: Stereo, Hi-Fi, Ham Radio, Tapes, Kits, Records. New No Money Down credit terms. Satisfaction guaranteed.

RADIO SHACK CORP.

730 Commonwealth Ave., Boston, Mass.

MAIL THIS COUPON TODAY

RADIO SHACK Corp. Dept. 61J10A
730 Commonwealth Ave., Boston 17, Mass.

Send me Radio Shack's famous electronics catalogs for 1 full year—FREE, POSTPAID.
Name _____
Address _____
City _____ Zone _____ State _____

Something every
TAPE RECORDER OWNER
should have...

SWITCHCRAFT®
"Mini-Mix"

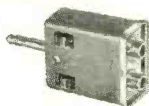

from
\$7.95
MIXES 2
SOUND SOURCES
(1) Voice with record or radio. (2) 2 Mics in different places. (3) Instrument with background music. No technical knowledge necessary.

Built-in volume control for each sound source. Ask for free reference guide No. 236 to select proper "Mini-Mix."

4 CHANNEL MIXERS

Add to the enjoyment and versatility of Recorders. User can blend or fade out signals for professional type recordings.

Monophonic type permits mixing up to 4 sound sources from TV, Radio, Phonograph or Microphones to one input of Recorder. Stereo type provides for Stereo music accompaniment to narration of home movies, etc.

See your Hi-Fi specialist or write for name of dealer nearest you.



SWITCHCRAFT® 5589 N. Elston Ave.
Chicago 30, Ill.

ADVERTISING INDEX

Radio-Electronics does not assume responsibility for any errors appearing in the index below.

Advertiser	September 1961	Page No.
Acoustic Research Inc.		120
Aerovox Corp.		10
Airex Radio Corp.		123
Allied Radio Corp.		28-31
American Technical Writing Schools		77
Atlas Sound Corp.		117
Audio Unlimited Inc.		124
Aulton		124
B&K Manufacturing Co.	75, 103	98
Brooks Radio & TV Corp.		98
Capitol Radio Engineering Institute		90-91
Carston		99
Casle TV Tuner Service Inc.		110
Central Technical Institute		27
Centralab Div. of Globe-Union		8
Chemical Electronic Engineering Inc.		113
Claostat Manufacturing Co. Inc.		19
CLASSIFIED ADS		129
Cleveland Institute of Electronics		9
Coloradaptor		89
Columbia Wire & Supply Co.		112
Commissioned Electronics Co.		128
Covne Electrical School		109
Delmar Engineering Co.		128
Devry Technical Institute		7
Do-set Electronics Inc.		100
Dressler		122
Electro-Voice Inc.		125
Electronic Chemical Corp.		121
Electronic Engineering Co.		110
Electronic Instrument Co. (EICO)		32
Electronic Measurement Co.		82
Electronic Publishing Co.		117
Electronic Technical Publishing Co.		124
Fisher Radio Corp.		84
Gernsback Library Inc.		119
Grantman School of Electronics		13
Hallcrafters		12
Hartman School		25
Heald's Engineering College		125
Heath Co.		64-65
Hekok Electrical Instrument Co.		28
Holt, Rinehart & Winston Inc.		117
Indiana Technical College		114
International Crystal Manufacturing Co.		18
International Rectifier Corp.		128
Jensen Manufacturing Co.	Inside Back Cover	
Johnson (E. F.) Co.		85
Karlson Assoc. Inc.		102
Key Electronics Co.		123
Lafayette Radio	17, 86-87	
Lampkin Labs Inc.		123
Lektron		101
Mark Mobile Inc.		110
Metrex		123
Microiran Co. Inc.		123
Moss Electronic Inc.		104-107
National Radio Institute	15-16, 100	
National Technical Schools		5

North American Phillips Co. Inc.	89
Osborne Electronics Corp.	124
Paco Electronics	69-72
Philco Computer Div.	118
Philco Technological Center	106
Picture Tube Outlet	125
Precision Apparatus Co. Inc.	95
Progressive Edu-Kits Inc.	126
Quam-Nichols Co.	24
Quietrol Co. Inc.	125
RCA Electron Tube Div.	Back Cover
RCA Institutes	78-81
Rad-Tel Tube Co.	130
Radio Shack Corp.	98, 114, 120, 128
Radio-TV Training School	11
Remington Rand Univac	118
Rider (John F.) Publisher Inc.	101
Sams (Howard W.) & Co. Inc.	21, 111
Scott (H. H.) Inc.	20
Seco Electronics Inc.	100
Sencore	97
Sharpe (E. J.) Instruments Ltd. of Canada	115
Sonar Radio Corp.	123
Sonotone Corp.	14
Sprague	99
Switchcraft Inc.	128
Sylvania Electric Products Inc.	Inside Front Cover
TAB	124
Tarzan (Sarties) Inc.	122
Transvision Inc.	113
University Loud Speakers Inc.	93
Utah Electronics Corp.	23
Vanguard Electronics Labs.	100
Van Nostrand (D.) Co. Inc.	3
Vidale Electronics Mfg. Corp.	122
Warren Distributing Co.	103
Weller Electric Corp.	22
Wirecard Co.	73
Xcelite Inc.	76
Zalytron Tube Corp.	122

SCHOOL DIRECTORY PAGE 127

Niles Bryant School
Indiana Technical College
International Correspondence School
Middleton Institute of Electronics
Milwaukee School of Engineering
Northrop Institute of Technology
Pacific International College of Arts & Sciences
Phila. Wireless Technical Institute
Philco Technological Center
Tri-State College
Valparaiso Technical Institute
Printed in USA

EICO new Transistor Stereo/Mono 4-track Tape Deck

Model RP 100W
Completely assembled, wired and tested with 3 heads, and stereo record and stereo playback preamplifiers.

Model RP 100K
Semi-Kit includes transport completely assembled and tested with 3 heads; and control electronics, stereo record, and stereo playback pre-amplifiers in easy-to-assemble kit form.

Write for full specifications

TAPE STORAGE OR CARRYING CASE
reg. 9.95, now 5.95

(Heavy wood construction, waterproof vinyl covering. Holds up to 24 tapes.)
reg. 2.45, now 1.49

(Pressed cardboard, holds 10 tapes or 60 45 rpm records.)

SAXITONE RECORDING TAPE

*Aside guaranteed not to rub off or squeak—or money back. Compare ours with other "Bargain" tape. You'll find it's more than just "price" when you deal with us. We are original pioneers in the tape recorder business and our reputation means everything to us.

600' acetate (plastic), 5".....	.75
600' MYLAR 5" reel.....	.95
900' MYLAR (Polyester), 5".....	.99
1200' MYLAR, 1/2 mil. 5" reel.....	1.18
1200' Acetate (plastic), 7".....	1.19
1200' MYLAR, 1 1/4 mil. (Strong).....	1.68
1800' acetate (plastic), 7".....	1.79
2400' MYLAR 1 mil. thick, 7".....	1.99
2400' MYLAR, untemalized, 7".....	2.69
2400' MYLAR, temalized, 7".....	2.99

Studios. Large Users Even Lower. Plus Postage

TAPE STORAGE CAN

Unique twist-lock insures dust-free moisture-proof, non-breakable. High impact styrene. Ideal shipping container.
reg. 89c now 59c



FERRO-DYNAMICS

"Bookshelf" open end case
reg. 1.25, now 89c

30% off Entire Stock Pre-recorded Music Tape 30% off

NORELCO SPEAKER

Famous AD3800M, twin cone 8" (75-19,000 cycles) discontinued model, former list 16.00, usual net 9.90 going at 4.95 plus postage, (10 for 39.95). Other Norelco speaker sizes at bargain prices — SEND FOR SPEAKER SPECIFICATION SHEET.



SAXITONE TAPE SALES
(DIV. OF COMMISSIONED ELECTRONICS, INC.)
1776 Columbia Rd., NW, Washington, D.C.

Now It's Easy and Fun to
**MAKE SUNLIGHT
WORK FOR YOU**
with Satellite-Type Solar Cells



24-Page handbook gives you detailed instructions, schematic diagrams, where-to-get-parts information.

25c

Use solar cells that convert sunlight into electricity to power your own radio, transistorized receivers, Citizens Band 27 mc transmitter... sun powered audio and tunnel diode oscillators, sun relays... clear descriptive text gives you step by step directions and explanations for each project. Get these interesting projects in the all new IR "EXPERIMENTER'S HANDBOOK"

Mail 25c along with coupon to

IOR

DEPT. RE

INTERNATIONAL RECTIFIER CORP.
222 KANSAS STREET, EL SEGUNDO, CALIFORNIA

Name _____ Age _____
Address _____
City _____ Zone _____ State _____

R-E**Classified****ADS**

Rates—50¢ per word (including name, address and initials. Minimum ad 10 words. Cash must accompany all ads except those placed by accredited agencies. Discount, 10% for 12 consecutive issues. Misleading or objectionable ads not accepted. Copy for November issue must reach us before Sept. 11, 1961.

RADIO-ELECTRONICS, 154 West 14 St., New York 11, N. Y.

BUY — SELL — TRADE cameras, lenses, telescopes, amateur radio equipment. **DENSON ELECTRONICS**, Box 85, Rockville, Conn.

REPAIR ON SURPLUS METERS, test equipment. **BIGELOW ELECTRONICS**, Bluffton, Ohio.

GARAGE DOOR OPERATORS \$59.95. Rugged chain-drive automatic units. Highest quality. Free literature. **DEMSCO INC.**, Sebring 23, Ohio.

TECHNICIAN TO SENIOR ENGINEER via well written resume. True copy, \$1. Revise to suit yourself. **RESUMES**, Box 622, Scranton, Pa.

SPEAKER SALE. Component quotes. Tapes. **BAYLA CO.**, Box 131-RE, Wantagh, N.Y.

HIGHLY EFFECTIVE home-study review for FCC Commercial phone exams. Free literature. **WALLACE COOK**, Box 10634, Jackson 9, Miss.

LOANS by mail. \$100-\$600. Anywhere. Confidential. Write **UNION FINANCE**, Dept. RE, 323 East Camelback, Phoenix, Ariz.

THREE-LINE rubber stamp, \$1. **ELDRIDGE INDUSTRIES**, PO Box 2188, Trenton, N.J.

REPAIR AND TROUBLESHOOTING MANUAL on 16mm sound and projectors. Additional Service Sheets every month. \$6. **WESLEY TROUT**, Engineer, Box 575, Enid, Okla.

WE SELL only tubes and semiconductors. Authorized distributors for top-quality brands—G-E, Amperex, Eimac, Mullard, etc. Buy with confidence for less at **E T S**, 161 Washington St., New York 6, N.Y.

NEW ELECTRONIC-SCIENTIFIC KITS. Mine detectors. SW, experimental, printed circuits. Send 10¢ for catalog. **KIT-TRONICS CORP.**, Dept. B, 6509 Whitman Ave., Van Nuys, Calif.

APPLIANCE, lamp, vacuum parts wholesale. Catalog 25¢. **SECO**, 26 So. 20th St., Birmingham, Ala.

CB's—Output Wattmeter plans. 5 steps to increase range. \$1. **LLOYD'S ELECTRONICS**, Dept. T, Box 92, Upland, Calif.

QUIET OPERATION of your receiver with a Qualitykit noise control. Reduce noise without signal loss by variable attenuation of high frequencies. Improve readability. Available assembled in attractive box for \$4.95, or as kit for panel mounting for \$3.75. With instructions for easy installation. Postpaid from **QUALITY-KIT**, PO Box 5184, North Charleston, S.C.

FRANCHISES MAKE PROFITS! Operate your own exclusive franchised business. Write today for free interesting details. **NATIONAL FRANCHISE REPORTS**, Dept. RE-528, 333 N. Michigan, Chicago 1.

AUTO RADIO COMPONENTS. Write for catalog. **AUTO RADIO ENGINEERING CO.**, 540 W. Larned, Detroit 26, Mich.

DIAGRAMS FOR REPAIRING RADIOS, \$1; television \$2. Give make and model. **DIAGRAM SERVICE**, Box 672 RE, Hartford 1, Conn.

ELECTRONIC RESEARCH SURPLUS, 2½ lb—\$3. **PALAN ASSOCIATES**, 85117 St. SW, Cedar Rapids, Iowa.

WANTED: BC-348's, laboratory equipment, manuals, klystrons. Cash, swap. **ENGINEERING ASSOCIATES**, 434 Patterson Rd., Dayton 19, Ohio.

TRANSISTORIZED products dealers catalog. \$1. **INTERMARKET**, CPO 1717, Tokyo, Japan.

WANTED—MISCELLANEOUS Quicksilver Platinum, Gold, Silver. Ores analyzed. **MERCURY TERMINAL**, Norwood, Mass.

COMPONENTS. Recorders. Tapes. **FREE Wholesale Catalogue.** **CARSTON**, 125-T East 88th St., New York 28, N.Y.

ELECTRONIC SURPLUS CATALOG, 5,000 items. Send 10¢. **BILL SLEP CO.**, Drawer 178 R, Ellenton, Fla.

ALL MAKES OF ELECTRICAL INSTRUMENTS AND TESTING equipment repaired. New and used instruments bought, sold, exchanged. **HAZELTON INSTRUMENT CO.**, 128 Liberty St., New York, N.Y.

RADIO & TV TUBES at Manufacturers' Prices! 100% Guaranteed! Brand-new! No rebrands or pulls! **UNITED RADIO**, Box 1000-R, Newark, N.J.

CASH PAID! Sell your surplus electronic tubes. Want unused, clean radio and TV receiving, transmitting, special purpose, Magnetrons, Klystrons, broadcast types, etc. Want military & commercial lab/test and communications equipment such as G.R., H.P., AN/UPM prefix. Also want commercial receivers and transmitters. For a fair deal write **BARRY**, 512 Broadway, New York 12, N. Y. Walker 5-7000.

DON'T BUY HI-FI COMPONENTS, Kits, Tape, Tape Recorders until you get our low, low return mail quotes. "We Guarantee Not To Be Undersold." Wholesale Catalog Free. Easy Time Payments Plan, 10% down—up to 24 months to pay. **HIFIDELITY CENTER**, 220 RC E 23 St., New York 10, N.Y.

DISCOUNTS UP TO 50% on Hi-Fi amplifiers, tuners, speakers, tape recorders, individual quotations only, no catalogs. **AUDIO WORLD**, 117-20 14th Road, College Point, New York.

LEARN WHILE ASLEEP. Hypnotize with your recorder, phonograph or amazing new Electronic Educator endless tape recorder. Catalog, details free. **SLEEP-LEARNING ASSOCIATION**, Box 24-RD, Olympia, Wash.

PRINTING PRESSES. Type, Supplies, Lists 4¢. **TURNBAUGH SERVICE**, Mechanicsburg, Penna.

SOLAR CELLS. 1½" diam. 20 ma in sunlight. \$1.50 ea. 10—\$10.00. **ELECTRONIC PRODUCTS CO.**, 605 Prairie St., St. Charles, Ill.

PROMPT DELIVERY. We will not be undersold. Amplifiers, Tape Recorders, Tuners, etc. No catalogs. Air Mail Quotes. Compare. **L. M. BROWN SALES CORP.** Dept. R, 239 E. 24th St., New York 10, N. Y.

BUSINESS CARDS, LABELS, RUBBER STAMPS. Send for free descriptive literature. **HEIGHTS INDUSTRIES**, Capitol Heights 27, Md.

PROFESSIONAL ELECTRONIC PROJECTS—Organs, Timers, Computers, etc.—\$1 each. List free. **PARKS**, Box 1665, Lake City, Seattle 55, Wash.

AMPLIFIERS, TUNERS, speakers, radios, cameras, optics. Finest quality, lowest prices. Free catalog. **MYERS IMPORTS**, 623 Gay, Knoxville, Tenn.

NEW CONCEPT OF LEARNING SELF-HYPNOSIS! Now on tape or record! Free Literature. **McKINLEY-SMITH CO.**, Dept. T5, Box 3038, San Bernardino, Calif.

500 PRINTED, GUMMED NAME AND ADDRESS LABELS, \$1.00. No C.O.D.'s. Print clearly. **RE-2, ADDISON MAIL ORDER**, 1840 Addison, Chicago 13.

BEFORE YOU BUY Receiving Tubes or Hi-Fi Components send now for your giant **FREE Zalytron current catalog**—featuring nationally known Zalytron First Quality TV-Radio Tubes, Hi-Fi Stereo Systems, Kits, Parts, etc. All priced to Save You Plenty—Why Pay More? **ZALYTRON TUBE CORP.**, 220 W. 42nd St., N.Y.C.

RENT STEREO TAPES—over 2,000 different—all major labels—free catalog. **STEREO-PARTI**, 811-RE, Centinela Ave., Inglewood 3, Calif.

BUY DIRECT FROM RAD-TEL!!

UP TO 75% OFF ON

RAD-TEL'S FIRST QUALITY

BRAND NEW TUBES

ONE FULL YEAR GUARANTEE

SERVICEMEN: Now speedy one-day service.

BUY DIRECT FROM RAD-TEL! YOU'LL SAVE PLENTY. YOUR ORDER SHIPPED WITHIN 24 HOURS AFTER RECEIVING AND PROCESSING. RAD-TEL SELLS ONLY BRAND NEW TUBES, NOT USED.

THE SIGN OF RAD-TEL'S RELIABILITY



GUARANTEED SET TESTED

RAD-TEL TRANSISTORS

All Transistors Germanium PNP

AF ST* AF Driver. Use as: Driver Low Power Output, Code Osc., DC Amp., Control, Test Instr., Pre-Amp., Timers, Organ, etc. **39c ea.**

RF ST* as Converter in an American set. Use as: Converter Sq. Wave Gen., RF Osc., Amp. Regen. Det., etc. **49c ea.**

IF ST* as 455kc IF in an Amer. set. Use as: IF Amp., Grid Dip Osc., Electronic Computer, RF Osc., Switch, Amp., etc. **49c ea.**

AUTO OUTPUT ST**as Audio Power Output into Speaker. 90% of Auto Radios so Powered. Use as Power Amp., Mobile Power Supply, Voltage Regulator, Osc., DC to DC Converters. **79c ea.**

HI POWER ST**as Hi Power AF Output. Ideal as DC to DC Converter, Multivibrator replaces Vibrator supply. **\$1.39 ea.**

HI CURRENT SILICON RECTIFIERS
15 AMPS
20 ma max Reverse I at PIV

PIV	Price		Lots of	
	Each	10	10	50
50	2.25	2.00	1.75	
100	2.50	2.25	1.90	
200	2.75	2.50	2.25	
300	3.25	2.95	2.70	
400	3.95	3.50	3.00	

500 MA SILICON RECTIFIER Epoxy construction, size of 1-watt resistor
1 reverse at 450 Volts .3 ma
30c lots of 20 ea. **35c** lots of 10 ea. **45c** ea.
Each rectifier "Performance Tested" on an American TV Set

EACH TUBE INDIVIDUALLY & ATTRACTIVELY BOXED

Qty.	Type	Price	Qty.	Type	Price	Qty.	Type	Price
0Z4M		.79	6BA6		.50	12AE6		.43
1AX2		.62	6BC5		.61	12AF3		.73
1B3GT		.79	6BC7		.94	12AF6		.49
1G3		.79	6BC8		.97	12AJ6		.46
1J3		.79	6BD6		.51	12AL5		.45
1K3		.79	6BE6		.55	12AL8		.95
1R5		.62	6BF6		.44	12AQ5		.52
1S5		.51	6BG6	1.66		12AT6		.43
1T4		.58	6BH6		.65	12AT7		.76
1U4		.57	6BH8		.87	12AU6		.50
1U5		.50	6BJ6		.62	12AU7		.61
1X2		.82	6BK7		.85	12AV5		.97
2AF4		.96	6BL7	1.00		12AV6		.41
2CY5		.71	6BN4		.57	12AV7		.75
2EA5		.70	6BN6		.74	12AX4		.67
3AL5		.42	6BQ5		.65	12AX7		.63
3AU6		.51	6BQG6T	1.05		12AZ7		.86
3AV6		.41	6BQ7	1.00		12B4		.63
3BA6		.51	6BR8		.78	12BA6		.50
3BC5		.54	6BU8		.70	12BD6		.50
3BE6		.52	6BY6		.54	12BE6		.53
3BN6		.76	6BZ6		.55	12BF6		.44
3BU8		.78	6BZ7	1.01		12BH7		.77
3BY6		.55	6C4		.43	12BL6		.56
3BZ6		.55	6CB6		.55	12BQ6		1.06
3CB6		.54	6CD6	1.42		12BY7		.77
3CF6		.60	6CF6		.64	12BZ7		.75
3CS6		.52	6CG7		.61	12C5		.56
3DG4		.85	6CG8		.77	12CN5		.56
3DK6		.60	6CM7		.66	12CR6		.54
3DT6		.50	6CN7		.65	12CU5		.58
3S4		.61	6CR6		.51	12CU6	1.06	
3V4		.58	6CS6		.57	12DE8		.75
4BC8		.96	6CU5		.58	12DL8		.85
4BQ7	1.01		6CU6	1.08		12DQ6	1.04	
4BS8	.98		6CY5	.71		12DS7	.79	
4BZ6	.58		6CY7	.71		12DW8	.89	
4BZ7	.96		6DA4	.68		12DZ6	.56	
4CB6	.56		6DB5	.69		12E05	.62	
4CS6	.61		6DE6	.58		12EL6	.50	
4CY5	.71		6DG6	.59		12EG6	.54	
4DE6	.62		6DQ6	1.10		12EZ6	.53	
4DT6	.55		6DT5	.76		12F8	.66	
5AM8	.79		6DT6	.53		12FM6	.45	
5AN8	.86		6DT8	.94		12K5	.65	
5AQ5	.52		6EA8	.79		12SK7GT	.74	
5AT8	.80		6EM7	.91		12SN7	.67	
5BK7A	.82		6EU8	.79		12SQ7M	.78	
5BQ7	.97		6GH8	.79		12U7	.62	
5BR8	.79		6HG6T	.58		12V6GT	.53	
5CG8	.76					12W6	.69	
5CL8	.76		6J5GT	.51		12X4	.38	
5EA8	.80		6J6	.67		17AX4	.67	
5EU8	.80		6K6	.63		17BQ6	1.09	
5I6	.68		6S4	.51		17C5	.58	
5T8	.81		6SA7GT	.76		17CA5	.62	
5U4	.60		6SK7	.74		17D4	.69	
5U8	.81		6SL7	.80		17DQ6	1.06	
5V6	.56		6SN7	.65		17L6	.58	
5X8	.78		6SQ7	.73		17W6	.70	
5Y3	.46		6T4	.99		19AU4	.83	
6AB4	.46		6U8	.83		19BG6	1.39	
6AC7	.96		6V6GT	.54		19T8	.80	
6AF3	.73		6W4	.60		21EX6	1.49	
6AF4	.97		6W6	.71		25BQ6	1.11	
6AG5	.68		6X4	.39		25C5	.53	
6AH6	.99		6X5GT	.53		25CA5	.59	
6AK5	.95		6X8	.80		25C06	1.44	
6AL5	.47		7A7	.61		25C06	1.11	
6AM8	.78		7A8	.68		25D6	1.42	
6AQ5	.53		7B6	.69		25EH5	.55	
6AR5	.55		7Y4	.69		25L6	.57	
6AS5	.60		8AU8	.83		25W4	.68	
6AT6	.43		8AW8	.93		25Z6	.66	
6AT8	.79		8BQ5	.60		35C5	.51	
6AU4	.82		8CG7	.62		35L6	.57	
6AU6	.52		8CX8	.93		35W4	.42	
6AU7	.61		8EB8	.94		35Z5GT	.60	
6AU8	.87		11CY7	.75		50B5	.60	
6AV6	.41		12A4	.60		50C5	.53	
6AW8	.90		12AB5	.55		50DC4	.37	
6AX4	.66		12AC6	.49		50EH5	.55	
6AX7	.64		12AD6	.57		50L6	.61	
						117Z3	.61	

*SET TESTED IN AMER. TRANSISTOR RADIO OF CURRENT MFR.
**SET TESTED IN AMER. AUTO RADIO OF CURRENT MFR. AT 16 VOLT BATTERY SUPPLY.

Rad-Tel eliminates complicated characteristics and numbers with their "SET-TESTED" Transistors. Transistors Tested to Rad-Tel's specifications—available on request. 100% Satisfaction Guaranteed. Substitute or replace with Rad-Tel Transistors on the basis of similar operating characteristics . . . at Low, Low Prices.

● NOT AFFILIATED WITH ANY OTHER MAIL ORDER TUBE COMPANY ●



SEND FOR FREE TROUBLE SHOOTER GUIDE AND NEW TUBE & PARTS CATALOG

RAD-TEL TUBE CO.

DEPT. RE 961 55 CHAMBERS STREET, NEWARK 5, N. J.

TERMS: 25% deposit must accompany all orders, balance COD. Orders under \$5: add \$1 handling charge plus postage. Orders over \$5: plus postage. Approx. 8 tubes per 1 lb. Subject to prior sale. Prices subject to change. No COD's outside continental USA.

So Compact...



X-10

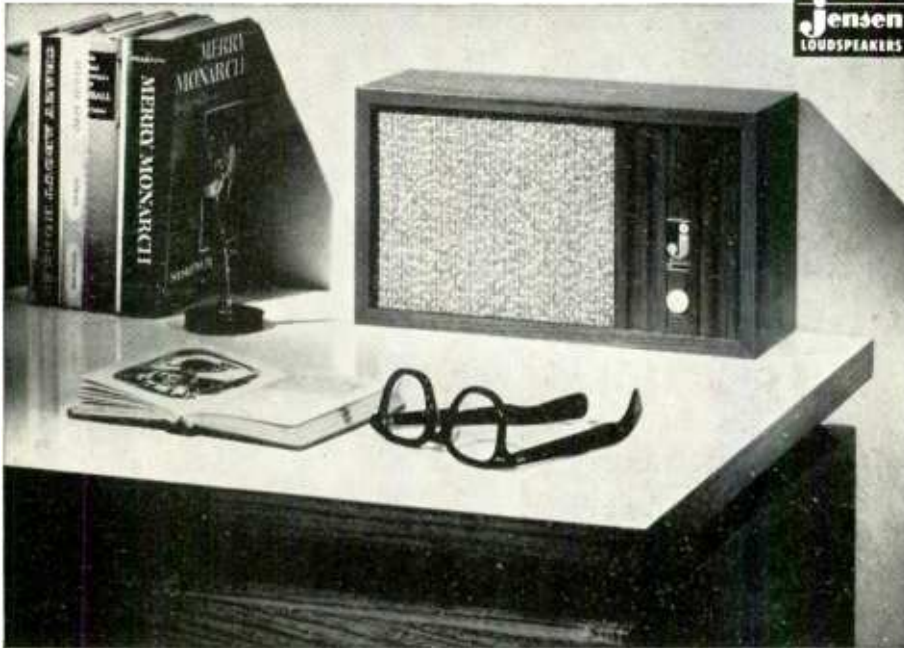

A startling achievement—an ultra-compact (7¼" H, 13" W, 4⅝" D) 2-speaker system capable of sound you'd expect from a much larger unit. Volume control on front. Perfect for FM Multiplex, very low cost stereo, other-room extensions.

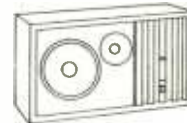

X-10 2-speaker 2-way system for use with amplifier having 4, 8, or 16 ohm output. Power rating 6 watts. Adequate room sound with 1 watt to speaker.
In Oiled Walnut..... **\$29.75**

So Big in Sound...



TF-2

TF-3

Strikingly beautiful compact bookshelf systems—perfect for every stereo or mono hi-fi need. Recent "blindfold" tests by audio experts proved a preference for the TF-3 and TF-2 over "rated" systems costing much more. Make your own careful comparison. You will be delighted with such big sound in small space.

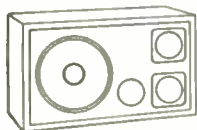
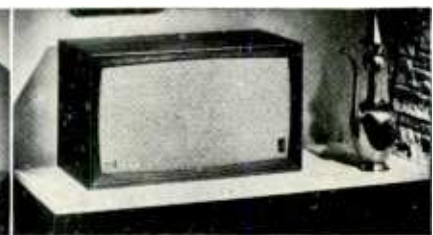
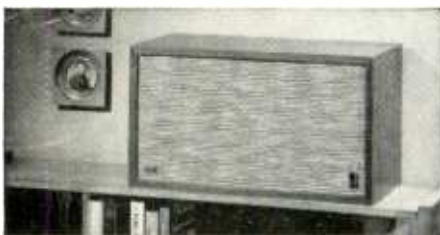

TF-2 3-speaker 2-way system. Full size Flexair® woofer for distortion-free bass response, plus two special direct radiator tweeters giving extended smooth highs. 13½" H, 23¾" W, 11¼" D. In Oiled Walnut.....\$79.50
Unfinished Hardwood..... **\$64.50**

TF-3 4-speaker 3-way system. Covers full frequency range with Flexair® woofer in Bass-Superflex® enclosure, two coloration-free midrange units, and the sensational Sono-Dome® Ultra-Tweeter. 13½" H, 23¾" W, 11¼" D. In Oiled Walnut.....\$99.50
Decorator Styling..... **\$109.50**

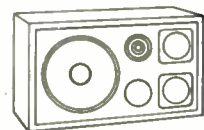

Unfinished Hardwood..... **\$79.50**



jensen MANUFACTURING COMPANY
DIVISION OF THE MUTER CO.

6601 S. Laramie Avenue, Chicago 38, Illinois

In Canada: Renfrew Electric Co., Ltd., Toronto

In Mexico: Universal De Mexico, S.A., Mexico, D.F.

*T.M. Reg.

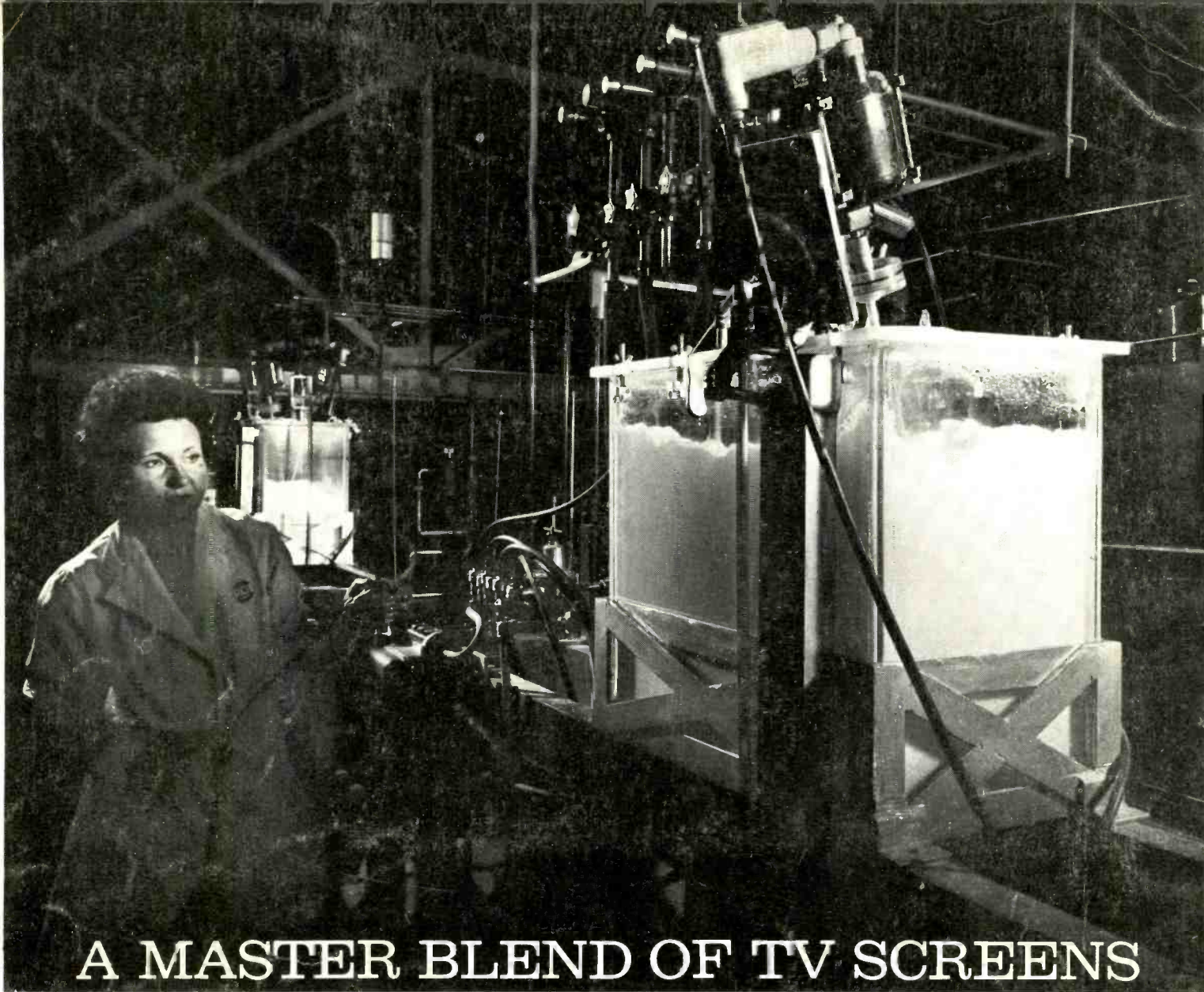

A MASTER BLEND OF TV SCREENS

RCA's Precise Control of Phosphors Assures Finest Picture Quality

Here RCA Silverama Picture Tube screens have their beginning.

Phosphor in a solution of demineralized water (impurity level: less than 1 part per million!) is continuously agitated by electric blenders to maintain uniform suspension. When mixing is complete, solution is sprayed into Silverama's glass envelope which has been scrubbed and rinsed until it is chemically clean. Then with tube on slow-moving, vibration free settling belts (below), phosphor settles evenly over the entire faceplate to provide the smooth, grain-free screen for which Silverama is famous.

This same painstaking care goes into every part of RCA Silverama picture tubes. It is your assurance that every Silverama is the finest replacement picture tube modern science and technology can produce. It contains a precision electron gun—the finest parts and materials, plus a thoroughly clean and inspected reused envelope. Such built-in quality means a better picture in your customers' sets—and therefore, more business, fewer call-backs and valuable word-of-mouth advertising for you. See your Authorized RCA Distributor this week.

129
123
124
101
98

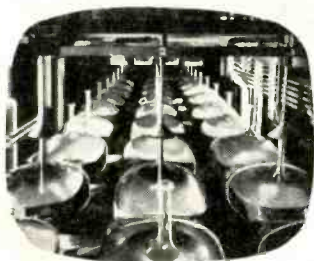

Settling belt moves at less than 10 inches per minute to give ample time for gradual settling and smooth adherence of phosphor to faceplate.

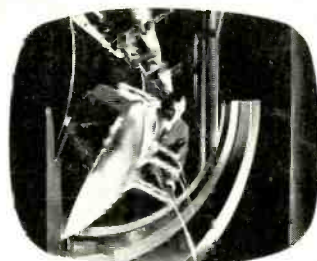

When settling is complete, excess liquid is poured slowly and gently from neck of envelope to avoid disturbing smooth phosphor coating.

RCA ELECTRON TUBE DIVISION, HARRISON, N. J.



The Most Trusted Name in Electronics
RADIO CORPORATION OF AMERICA