

Radio-Electronics

FEBRUARY

TELEVISION • SERVICING • HIGH FIDELITY

HUGO GERNSBACK, Editor

**Versatile Vhf
Transistor Radio
Is Easily Built**

**Do It With
Diodes!**

**Build This
In-Cabinet
Horizontal Sweep
Analyzer**

50c

Multipolarized 4-Way Antenna

A L PRIDDY 6-61
BOX 133 BRANCH ED RJ 1
BELLE W VA

TRIPLET

ACTUAL SIZE

USES UNLIMITED:

- Field Engineers
- Application Engineers
- Electrical, Radio, TV, and Appliance Servicemen
- Electrical Contractors
- Factory Maintenance Men
- Electronic Technicians
- Home Owners, Hobbyists



MODEL 310

complete
VOLT-OHM-
MILLIAMMETER



World's Largest Selling POCKET SIZE V-O-M

FEATURES:

- 1 Hand size and lightweight, but with the features of a full-size V-O-M.
- 2 20,000 ohms per volt DC; 5,000 AC.
- 3 EXCLUSIVE SINGLE SELECTOR SWITCH speeds circuit and range settings. The first miniature V-O-M with this exclusive feature for quick, fool-proof selection of all ranges.

SELF-SHIELDED Bar-Ring instrument; permits checking in strong magnetic fields • Fitting interchangeable test prod tip into top of tester makes it the common probe, thereby freeing one hand • UNBREAKABLE plastic meter window • BANANA-TYPE JACKS—positive connection and long life.

■ Price—only \$34.50; leather case \$3.20.

Available For Immediate Delivery From Your Triplet Distributor's Stock

THE TRIPLET ELECTRICAL INSTRUMENT COMPANY, BLUFFTON, OHIO



MODEL 100

The most comprehensive test set in the Triplet line is Model 100 V-O-M Clamp-On-Ammeter Kit, now available at distributors. The world's most versatile instrument—a complete accurate V-O-M plus a clamp-on-ammeter with which you can take measurements without stripping the wires. Handsome, triple-purpose carton holds and displays all the components: Model 310 miniaturized V-O-M, Model 10 Clamp-On-Ammeter, Model 101 Line Separator, No. 311 Extension leads, and a leather carrying case, which neatly accommodates all the components. Model 101 literally makes it possible to separate the two sides of the line when using Model 10. Extension leads permit use of Model 10 at a distance from the V-O-M. Complete Model 100 is only

\$59.50

MANUFACTURERS OF PANEL AND PORTABLE INSTRUMENTS; ELECTRICAL AND ELECTRONIC TEST EQUIPMENT

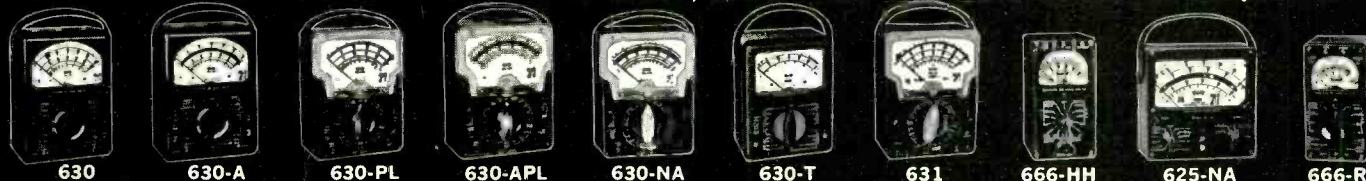

FOR EVERY PURPOSE—THE WORLD'S MOST COMPLETE LINE OF V-O-M'S

" THE CITATION SOUND "

"...FOR THE SAKE OF MUSIC AND OUR DEMANDING LOVE OF IT."

"Over and above the details of design and performance, we felt that the Citation group bore eloquent witness to the one vital aspect of audio that for so many of us has elevated high fidelity from a casual hobby to a lifelong interest: the earnest attempt to reach an ideal—not for the sake of technical showmanship—but for the sake of music and our demanding love of it."

Herbert Reid, Hi Fi Stereo Review

A truly remarkable commentary about a truly remarkable group of products—the Citation Kits by Harman-Kardon.

Mr. Reid's eloquent tribute to Citation is one of many extraordinary reviews of these magnificent instruments. We are proud to present a brief collection of excerpts from Citation reviews written by outstanding audio critics.

"When we first heard the Citations our immediate reaction was that one listened through the amplifier system clear back to the original performance, and that the finer nuances of tone

shading stood out clearly and distinctly for the first time . . . The kit is a joy to construct."

C. G. McProud, Editor, Audio Magazine

"The unit which we checked after having built the kit, is the best of all power amplifiers that we have tested over the past years."

William Stocklin, Editor, Electronics World

"Its listening quality is superb, and not easily described in terms of laboratory measurements. Listening is the ultimate test and a required one for full appreciation of Citation . . . Anyone who will settle for nothing less than the finest will be well advised to look into the Citation II."

Hirsch-Houck Labs, High Fidelity Magazine

"At this writing, the most impressive of amplifier kits is without doubt the new Citation line of Harman-Kardon . . . their design, circuitry, acoustic results and even the manner of their packaging set a new high in amplifier construction and performance, kit or no."

Norman Eisenberg, Saturday Review

PRESENTING THE NEW 1961 CITATION LINE



The CITATION I, Stereophonic Preamplifier Control Center

The many professional features and philosophy of design expressed in Citation I permit the development of a preamplifier that provides absolute control over any program material without imparting any coloration of its own. The Citation I—\$159.95. Factory Wired—\$249.95.

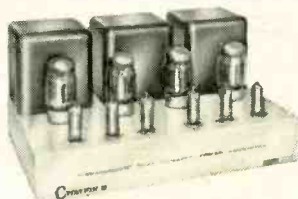

The CITATION II, 120 Watt Stereophonic Power Amplifier

Will reproduce frequencies as low as 5 cycles virtually without phase shift, and frequencies as high as 100,000 cycles without any evidence of instability or ringing. Because of its reliability and specifications the Citation II has been accepted by professionals as a laboratory standard. The Citation II—\$159.95—Factory Wired \$229.95.



The CITATION III, Professional FM Tuner

The world's most sensitive tuner. But more important—it offers sound quality never before achieved in an FM tuner. Now, for the first time Harman-Kardon has made it possible for the kit builder to construct a completely professional tuner without reliance upon external equipment.

The Citation III's front end employs the revolutionary Nuvistor tube which furnishes the lowest noise figure and highest sensitivity permitted by the state of the art. A two-stage audio section patterned after Citation II provides a frequency response three octaves above and below the range of normal hearing. The Citation III is styled in charcoal brown and gold to match all the other Citation instruments. The Citation III—\$149.95—Factory Wired—\$229.95.

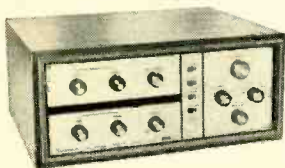

The CITATION IV, Stereophonic Preamplifier Control Center

A compact stereophonic preamplifier designed in the best Citation tradition. It offers performance and features rivaled only by Citation I. The control over program material provided by the new Citation IV enables the user to perfectly recreate every characteristic of the original performance. The Citation IV—\$119.95—Factory Wired—\$189.95.



The CITATION V, 80 Watt Stereophonic Power Amplifier

A compact version of the powerful Citation II. Designed with the same lavish hand, it is conservatively rated at 40 watts RMS per channel with 95 watt peaks at less than 0.5% distortion. The availability of rated power at the extreme ends of the frequency range enables the unit to effortlessly drive the most inefficient speakers. The Citation V—\$119.95. Factory Wired—\$179.95.

For complete information on the new Citation Kits, including reprints of independent laboratory test reports, write to: Dept. RE-2, Citation Kit Division, Harman-Kardon, Inc., Plainview, New York.

All prices slightly higher in the West.

CITATION KITS by
harman kardon

Hugo Gernsback
..... Editor and Publisher
M. Harvey Gernsback
..... Editorial Director
Fred Shunaman
..... Managing Editor
Robert F. Scott, W2PWG
..... Technical Editor
Larry Steckler
..... Associate Editor
I. Queen
..... Editorial Associate
Jack Darr
..... Television Consultant
Fernando Martinez
..... Art Director
Wm. Lyon McLaughlin
..... Tech. Illustration Director
Fred Neinast
..... Art Associate
Elizabeth Stalcup
..... Production Manager
Lee Robinson
..... Director, Advertising Sales
John J. Lamson
..... Eastern Sales Manager
G. Aliquo
..... Circulation Manager
Adam J. Smith
..... Director, Newsstand Sales
Robert Fallath
..... Promotion Manager

Average Paid Circulation
Over 163,000



ON THE COVER

(Story on page 60)

The polarization of the new antenna shown on the cover can be switched electronically and automatically to track missiles or satellites, even when tumbling.

Color original by
Chance-Vought Electronics

Radio-Electronics is indexed in
Applied Science & Technology Index
(Formerly *Industrial Arts Index*)

editorial

33 Upheaval in Electronics—*Hugo Gernsback*

test instruments

- 34 You Can Build a Top-Chassis Horizontal Sweep Analyzer—*Wayne Lemons*
54 New Citizens-Radio Test Set—*Robert F. Scott*
59 Logarithmic Meter—*Nathaniel Rhita*
74 Make Your Meter Easier to Read—*Leo G. Sands*

audio-high fidelity

- 42 Strobe Instrument Tunes Organs—*Richard H. Dorf*
49 Easy-to-Connect Audio Plugs
69 Puzzled About Feedback?—*Norman H. Crowhurst*
96 High-Quality Audio—*A. V. J. Martin*

electronics

- 38 Do It With Diodes—*Donald L. Stoner*
40 Transistor Pack You Can Build to Power Model Railroad—*Paul S. Lederer*
45 Evolution in Relays
81 Effects You Should Know—*J. H. Thomas*

radio

- 50 New and Different Free-Power Radio Construction Project—*William H. Grace, Jr.*
52 L-C Reactance Nomo Saves Calculation—*S. J. Salva and W. R. Morey*
60 Space-Scanning Antenna Is Multi-polarized (Cover Feature)
82 Special-Services Receiver Is Easy to Build—*I. Queen*

industrial electronics

- 46 Klystron—Tube for Outer Space—*Tom Jaski*
93 Test Speaker Speeds Industrial Repairs—*William F. Kernin*

television

- 56 TV Remote Uses One Tube—*Joseph DeMarinis*
61 Television Service Clinic (Watch Those Tube Changes)—*Conducted by Jack Darr*
72 TV Tuner Uses Nuvistor Triode
80 Safe Driving With Closed-Circuit TV—*Manfred von Ardenne*
86 Servicing Sync Separators and Clippers, Part I—*Jack Darr*

the departments

- | | | |
|-------------------------|---------------------------------|-----------------------|
| 118 Business and People | 102 New Patents | 112 Technicians' News |
| 99, 117 Corrections | 103 New Products | 116 Try This One |
| 20 Correspondence | 98 New Tubes and Semiconductors | 114 50 Years Ago |
| 123 New Books | 6 News Briefs | |
| 120 New Literature | 110 Noteworthy Circuits | |

Radio-Electronics February, 1961, Vol. XXII, No. 2. Published monthly at Mt. Morris, Ill., by Gernsback Publications, Inc. Second-class postage paid at Mt. Morris, Ill. Copyright 1961 by Gernsback Publications, Inc. All rights reserved under Universal, International and Pan-American Copyright Conventions.

Subscription Rates: U.S., U.S. possessions and Canada, \$5.00 for one year; \$9.00 for two years; \$12.00 for three years. Pan-American countries \$6.00 for one year; \$11.00 for two years; \$15.00 for three years. All other countries \$6.50 a year; \$12.00 for two years; \$16.50 for three years.

Subscriptions: Address correspondence to Radio-Electronics, Subscriber Service, 154 West 14th St., New York 11, N.Y. When requesting a change of address, please furnish an address label from a recent issue. Allow one month for change of address.

Gernsback Publications, Inc., Executive, Editorial and Advertising Offices, 154 West 14th St., New York 11, N.Y. Telephone ALgonquin 5-7755. Hugo Gernsback, Chairman of the Board; M. Harvey Gernsback, President; G. Aliquo, Secretary.

Advertising Representatives: Los Angeles: Harker-Husted-Coughlin, 400 South Alvarado St. Tel. DUmkirk 7-2328. San Francisco: Harker-Husted-Coughlin, 444 Market St., Tel. GARfield 1-0151. Chicago: 8631 East Prairie Road, Skokie, Ill. Tel. ORchard 5-3740.

Foreign Agents: Great Britain: Atlas Publishing and Distributing Co., Ltd., 18 Bride Lane, London E.C. 4.

Postmaster: If undeliverable, send Form 3579 to: RADIO-ELECTRONICS, 154 West 14th St., New York 11, N.Y. *Trademark registered U. S. Pat. Office.

BREAK THROUGH TO HIGHER PAY

in ELECTRONICS

TV-RADIO

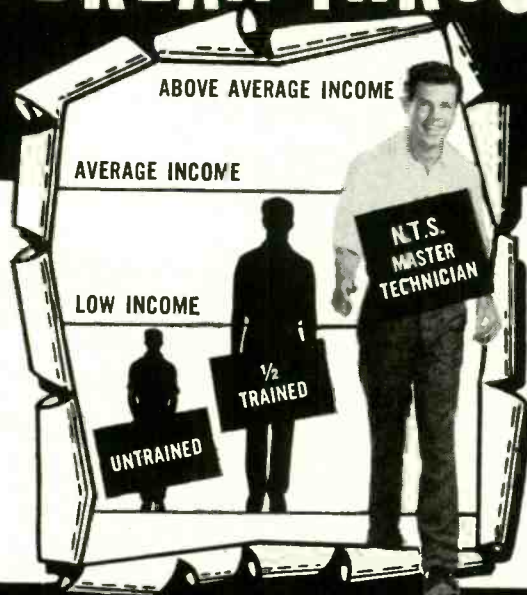

START NOW! Break through the Earning Barrier that stops half-trained men. N.T.S. "All-Phase" training prepares you — at home in spare time — for a high-paying CAREER in Electronics — TV — Radio as a MASTER TECHNICIAN. One Master Course at One Low Tuition trains you for unlimited opportunities in All Phases: Servicing, Communications, Preparation F.C.C. License, Broadcasting, Manufacturing, Automation, Radar and Micro-Waves, Missile and Rocket Projects.

A more rewarding job... a secure future... a richer, fuller life can be yours! As an **N.T.S. MASTER TECHNICIAN** you can go straight to the top in industry... or in your own profitable business.

You work on actual job projects



SUCCEED IN MANY HIGH-PAYING JOBS LIKE THESE...

- TV-Radio Sales, Service and Repair
- Profitable Business of Your Own
- Communications Technician — F.C.C. License
- Hi-Fi, Stereo & Sound Recording Specialist
- TV-Radio Broadcasting Operator
- Technician in Computers & Missiles
- Electronics Field Engineer
- Specialist in Microwaves & Servomechanisms
- Expert Trouble Shooter
- All-Phase Master Technician

19 BIG KITS YOURS TO KEEP



Free book gives you all the facts

NATIONAL TECHNICAL SCHOOLS

WORLD-WIDE TRAINING SINCE 1905
4000 S. FIGUEROA ST., LOS ANGELES 37, CALIF., U. S. A.
Write Dept. RG-21



ACCREDITED MEMBER
... the only nationally recognized accrediting agency for private home study schools.

RESIDENT TRAINING AT LOS ANGELES
If you wish to take your training in our Resident School at Los Angeles, start NOW in our big, modern Shops and Labs. Work with the latest Auto and Diesel engines — all types — fuel injection, automatic transmissions, all power equipment — most complete facilities offered by any school. Expert, friendly instructors. Graduate Employment Service. Help in finding home near school — and part time job while you learn.
WRITE FOR SPECIAL RESIDENT SCHOOL CATALOG AND INFORMATION

N.T.S. Shop-Tested HOME TRAINING is **Better, More Complete, Lower Cost**... and it is your key to the most fascinating, opportunity-filled industry today!

YOU LEARN QUICKLY AND EASILY THE N.T.S. SHOP-TESTED WAY

You get lessons, manuals, job projects, unlimited consultation, graduate advisory service.
You build a Short Wave-Long Wave Superhet Receiver, plus a large-screen TV set from the ground up, with parts we send you at no addi-

tional cost. You also get a Professional Multitester for your practical job projects.

EARN AS YOU LEARN... WE SHOW YOU HOW!

Many students pay for entire tuition — and earn much more — with spare time work they perform while training. You can do the same... we show you how.

SEND FOR INFORMATION NOW... TODAY! IT COSTS YOU NOTHING TO INVESTIGATE.

N.T.S. HOME TRAINING is

- Classroom Developed
- Lab-Studio Planned
- Shop-Tested
- Industry-Approved
- Specifically Designed for Home Study



MAIL COUPON NOW for FREE BOOK and ACTUAL LESSON

NO OBLIGATION!
NO SALESMAN WILL CALL

NATIONAL TECHNICAL SCHOOLS

WORLD-WIDE TRAINING SINCE 1905

Mail Now To
National Technical Schools, Dept. RG-21
4000 S. Figueroa St., Los Angeles 37, Calif.
Please rush FREE Electronics-TV-Radio "Opportunity" Book and Actual Lesson. No Salesman will call.

Name _____ Age _____
Address _____
City _____ Zone _____ State _____
 Check here if interested ONLY in Resident Training at Los Angeles.
VETERANS: Give date of discharge _____

News Briefs

"Compound" Thermogenerator

General Electric has announced a combination thermionic-thermoelectric energy converter that produces twice as much power from a given amount of fuel as would be obtainable from the thermionic converter alone.

The thermionic converter, a device resembling a vacuum tube, produces electricity by heating a filament. Electrons released from this filament or cathode drift across to another (anode) element in the tube, producing an electric current. The effect is analogous to "contact-potential" effect in a receiving diode. A

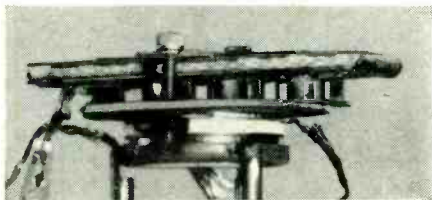

Disc-like thermionic generator is below; thermoelectric unit is above it.

thermoelectric generator is a series of thermocouples.

Since the thermionic generator is most efficient at high cathode temperatures, and the thermoelectric generator works best at lower ones, the waste heat from the one can be used to power the other.

When operated at a cathode temperature of 1150°C, a G-E Z-5386 thermionic converter produces a minimum of 1 watt with about 2.5% efficiency. If the waste heat from a Z-5386, operated at this cathode temperature, is used to power a lead telluride thermoelectric generator, the power output of the cascaded system would be about 2 watts and efficiency about 5-6%.

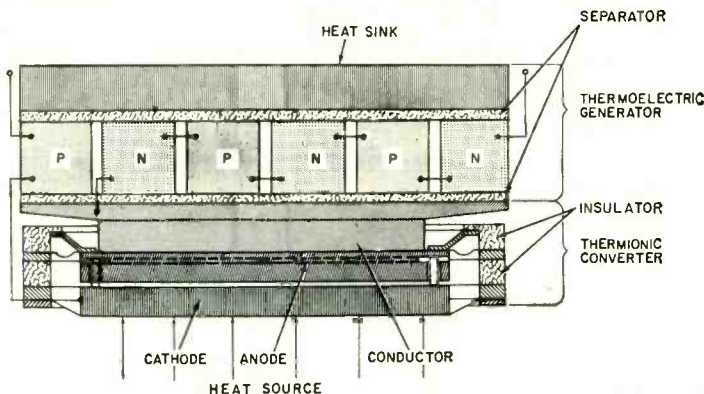

Diagram of compound thermogenerator that appears in the photo above.

Studies by I. T. Sald, of the G-E Power Tube Dept., indicate that efficiencies of 16% and better may be attainable using vapor thermionic converters operating at a cathode temperature of 1325°C, cascaded with lead telluride thermoelectric generators, operating at a hot-junction temperature of 650°C and a heat-sink temperature of about 75°C.

Canadian Station Improves Time-Signal Accuracy

The Dominion Observatory time signals from CHU, Ottawa, Canada, are now cesium-controlled to an accuracy of at least ± 2 parts in 10^9 . CHU broadcasts time signals on 3330, 7335 and 14,670 kc. A pip is transmitted at the beginning of each second, with the 51st to 59th pips inclusive of each minute being omitted, as well as the 1st to 29th pips on the first minute of each hour. The time is announced by voice once each minute in the 10-second gap before the beginning of each minute. A code identification "CHU Canada CHU" is transmitted once during the first half-minute of each hour.

The signals of CHU, because of the voice announcement, are widely used at sports-car rallies and other events where frequent repetition of the correct time is valuable.

Valdemar Poulsen Medal To Videotape Developer

The first native-born American to receive the Valdemar Poulsen medal is Charles P. Ginsburg, of Ampex Corp. The award was due to his "guiding spirit and principal participation in the development of video tape recording."

The Valdemar Poulsen Gold Medal Award was established in Denmark

in 1939 to be awarded each year on the birthday of Valdemar Poulsen to a radio engineer or scientist in recognition of important contributions to the development of the science or art of radio communications or magnetic registration. Winners of the renowned science medal are selected on the basis of recommendations from competent institutions in Denmark and abroad.

The medal has been awarded only six times since its inception in 1939. In that year it was presented to the inventor of magnetic recording, Valdemar Poulsen himself, on his 70th birthday. Later recipients were Sir Robert Watson-Watt and Dr. E. F. W. Alexanderson, 1946; Sir Edward Appleton, 1948; Dr. Balthazar van der Pol, 1952; Dr. Harald Trap Friis, 1954, and Prof. Hidetsugu Yagi, 1958.

Communications Stamp Features Echo I



Post Office recognizes the satellite as a communications instrument in new 4-cent stamp issued December 15 last. Stamp is purple with white lettering.

All TV to Go UHF In 5 to 7 Years?

Our present vhf-uhf TV allocations system must be replaced soon with an all-uhf one, stated FCC Commissioner Robert E. Lee at the winter conference of the Electronic Industries Association. Growing population makes a vhf system unacceptable, and it was an error, he said, to assume that uhf and vhf could compete. Existing uhf stations are being forced out of business by the well-rooted vhf outlets, even though they offer the only solution to the problems of congestion and necessary future expansion.

Commissioner Lee, who has not hesitated in the past to espouse causes in which he was not supported by the other members of the FCC, suggested that once the num-

Now! Work Over
300 PRACTICAL
 PROJECTS with these
 PARTS AT HOME!

to help You learn
ELECTRONICS
 RADIO-TELEVISION-RADAR

NOW . . . at home in your spare time you can get the very kind of training and subsequent Employment Service you need to get started toward real earnings in one of today's brightest opportunity fields—TELEVISION-RADIO-ELECTRONICS. Now that Electronics is entering so many new fields, here is a chance of a lifetime to prepare to cash in on its remarkable growth.

DeVry Tech's amazingly practical home method enables you to set up your own HOME LABORATORY. You spend minimum time to get maximum knowledge from over 300 practical projects, using the same type of basic equipment used in our modern Chicago and Toronto Training Centers!

DeVry Tech Provides EVERYTHING YOU NEED . . .

—to help you master TV-ELECTRONICS. In addition to the home laboratory and easy-to-read lessons, you even use HOME MOVIES—an exclusive DeVry Tech advantage. You watch hidden actions . . . see electrons on the march. Movies help you to learn faster . . . easier . . . better.

LABORATORY TRAINING

Full time day and evening training programs in our modern Chicago and Toronto Laboratories are also available. MAIL COUPON TODAY for facts.



BUILD and KEEP Valuable TEST EQUIPMENT

As part of your training, you build and keep a fine Jewel-Bearing Vacuum Tube VOLTMETER and a 5-inch COLOR OSCILLOSCOPE—both high quality, needed test instruments.

EFFECTIVE EMPLOYMENT SERVICE

Get the same Employment Service that has helped so many DeVry Tech graduates get started in this fast-growing field.



"One of North America's Foremost Electronics Training Centers"

Accredited Member
 of National Home
 Study Council



DeVRY TECHNICAL INSTITUTE
 CHICAGO 41, ILLINOIS

EARN WHILE YOU LEARN

DeVry Tech's practical training helps you toward spare time income servicing Radio and Television sets.

✓ CHECK
 These Exciting
 Job
 Opportunities:

- TV-Radio Broadcast Technician
- Color Television Specialist
- Radar Operator
- Laboratory Technician
- Airline Radio Man
- Computer Specialist
- Quality Control Manager
- Your Own Sales & Service Shop
- . . . PLUS MANY OTHERS

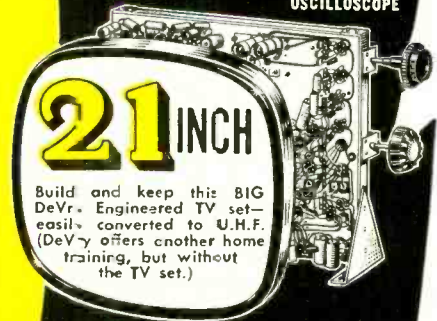

Build and keep this BIG DeVry Engineered TV set—easily converted to U.H.F. (DeVry offers another home training, but without the TV set.)



VACUUM TUBE VOLTMETER

5-INCH COLOR OSCILLOSCOPE

MAIL COUPON TODAY!

DeVRY TECHNICAL INSTITUTE
 4141 Belmont Ave., Chicago 41, Ill., Dept. RE2-R

Please give me your FREE booklet, "Electronics in Space Travel," and tell me how I may prepare to enter one or more branches of Electronics.

Name _____ Age _____
 Street _____ Apt. _____
 City _____ Zone _____ State _____

2045 Canadian residents address: DeVry Tech of Canada, Ltd.
 970 Lawrence Avenue West, Toronto, Ontario

ber of sets capable of receiving uhf passed 12,000,000, manufacturers might find it more profitable to make all-uhf receivers only. He said that the FCC will push for legislation requiring that all future sets be made with provision for receiving uhf. He believes that such legislation has a good chance of enactment. Today's present vhf stations would be removed slowly during the transition period. The old vhf channels could be used for police, industrial and educational TV stations.

According to the newspaper *Home Furnishings Daily*, manufacturers are considering the inclusion of uhf in all receivers very seriously. One manufacturer, H. Leslie Hoffman of Hoffman Electronics Corp., points out that the industry could establish its own uhf requirements, making the enactment of a law unnecessary.

Telephone Engineers Develop Electronic Dream Analyzer

A subvocal speech analyzer for use in the study of dreams is being developed by a group of Illinois engineers in cooperation with doctors from Midwest Medical Research Institute. The engineers are members of a group called Service Activities of Volunteer Engineers (SAVE) which has already devised new equipment useful in therapeutics and medical research.

Studies of dreams would seem to indicate that, when a person dreams that he is saying something, there is some (usually subvocal) activation of the vocal cords. The engineers are attempting a technique which would introduce a high-frequency sound into an artificial larynx—similar to those used in speech aids—pick the sound up as modulated by the movements of the vocal chamber, record it on tape, amplify and play it back.

SMPTE Elects Officers

The 44-year old Society of Motion Picture & Television Engineers elected John W. Servies, National Theatre Supply Co., for a 2-year term as their president. Reid H. Ray was elected executive vice president; Lloyd Thompson, editorial vice president; Harry Teitelbaum, convention vice president, and Herbert E. Farmer, secretary.

Australian Radiotelescope A Mile Long and Wide

A radiotelescope project that will dwarf the famous 600-foot Jodrell Bank antenna is announced from New South Wales, Australia. It will be designed in the shape of a cross, with two arms 1 mile long and 40 feet wide. A reflecting screen will be suspended from the two arms, the shape of the reflector being parabolic. The signals from this reflector will thus be focused on a wire running the length of each arm.

How to Get

An FCC License can be

Your FCC License

Your Guarantee . . .

Completion of the Master Course (both Sections) will prepare you for a First Class Commercial Radio Telephone License with a Radar Endorsement. Should you fail to pass the FCC examination for this license after successfully completing the Master Course, you will receive a full refund of all tuition payments. This guarantee is valid for the entire period of your enrollment agreement.

Free!

FIND OUT HOW:

1. The new electronic devices can be handled by you
2. To solve the problems that will stump your fellow technicians
3. Training is Job Insurance when employment is tough to find . . . and more money for you when times are good

Mail Coupon NOW . . .

RADIO-ELECTRONICS

(Commercial)
an FCC License

your Measure of Success in Electronics

Or Your Money Back!

*mail
coupon
NOW!*

here's proof of good jobs

Irving Laing:

"Your lessons are helping me a lot in my Navy work. You cover topics that were not presented by the Navy at the E.T. School. . . . Your course has helped greatly to get my 2nd class FCC ticket. I am now a radio and T.V. engineer at WTVS and WDTR in Detroit, Michigan."

*Irving L. Laing,
15887 Robson,
Detroit 27, Michigan*

Get all 3 FREE



Accredited by The National Home Study Council

Cleveland Institute of Electronics

Desk RE50B, 1762 E. 17th St., Cleveland 14, Ohio



Please send FREE career information prepared to help me get ahead in Electronics. I have had training or experience in Electronics as indicated below:

- | | |
|---|---|
| <input type="checkbox"/> Military | <input type="checkbox"/> Broadcasting |
| <input type="checkbox"/> Radio-TV Servicing | <input type="checkbox"/> Home Experimenting |
| <input type="checkbox"/> Manufacturing | <input type="checkbox"/> Telephone Company |
| <input type="checkbox"/> Amateur Radio | <input type="checkbox"/> Other..... |

In what kind of work are you now engaged?.....

In what branch of Electronics are you interested?.....

Name..... Age.....

Address.....

City..... Zone..... State.....

Desk RE50B

Receive All These Booklets FREE!

FREE COPIES

of

"HOW TO HAVE BETTER TV RECEPTION"

(Retail Price 50c)
Are available for you
at your distributor
for FREE DISTRIBUTION
to your customers.

Ask your Distributor today
for your Free supply of this
Powerful Sales Aid

TRIO MANUFACTURING CO.
Griggsville, Illinois

YOU GET MORE WITH TRIO ANTENNAS Using the WING DIPOLE



"Most Powerful Dipole in the World"

The dipole is to your antenna what the engine is to the automobile. When you want more power in your automobile you get a bigger engine—When you want better pictures on your TV screen, get a more powerful dipole.

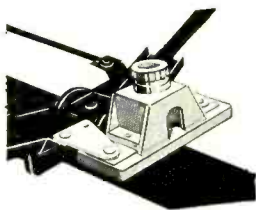

NO STRIP LEAD-IN CONNECTOR

Eliminates wire breakage at the Terminals! The exclusive feature that protects both dealer and consumer from costly, time-consuming repairs.

TRIO MANUFACTURING CO.
Griggsville, Illinois

The telescope was designed by Australian radio astronomer Dr. B. Y. Mills, and the project was announced by Prof. S. T. Butler, head of the school of physics at the University of Sydney.

Senate Committee Charges Neglect of Radio Satellites

The Government appears to have no over-all policy for developing and using communications satellites, reported the Senate Committee on Aeronautical and Space Sciences. The committee, headed by the then Senator Lyndon Johnson, reported that no agency seems to be responsible for drafting such a policy.

Among other things, the report commented pointedly on the allocation of microwave frequencies to private users shortly after the FCC had been warned by Leo A. Hoegh, director of the Office of Civil Defense and Mobilization, to use extreme care in disposing of these frequencies until the needs of space communications could be established.

"A host of intertwined and complex issues which require study and decision in the near future," are raised by the satellites, the Senators stated, warning that the potentialities of satellites for opening new international communications links could be hampered unless critical decisions are made promptly.

Ultrasonic Delay Line Works with Light at Vhf

An acoustical delay line in a bar of optical material, operating at very high radio frequencies, has been announced by Corning Glass Works. Delays up to 160 μ sec at frequencies as high as 30 mc have been reported.

The delay line is a bar of photoelastic material (a material whose optical properties change when stressed by an acoustic wave or other stress). Glass is such a material, and fused silica, an ultra-pure glass, was chosen by Corning Glass

because of its excellent optical and acoustic properties. A ceramic transducer changes the electrical signals into mechanical stresses, which pass down the bar and are absorbed at the far end.

A light source (far left in the drawing) sends light through a system (the three circular plates) that polarizes it in such a way that little light reaches the photocell as long as the bar is not stressed. As the acoustic waves pass down the bar, light does get through in proportion to the strength of the acoustic wave. The photomultiplier tube turns the light signal into an electrical one again.

The time delay can be varied by moving the slit through which the light escapes up or down the bar. Time delays of 160 μ sec were obtained with a 24-inch delay line. The letters L and S refer to orientations of the filters for longitudinal and shear type vibrations of the bar.

Ultrasonic delay lines are used in target-detection radar systems. It may also be possible to use them in computers, and for applications as yet not foreseen.

New Electronic Beacon Talks Boatmen Home

A new type of electronic beacon for users of small boats is now undergoing experimental trials at a New Jersey coast location. Developed by International Telephone & Telegraph Corp. (ITT), it requires no charts or calculations, not even the dot-counting of the simplest previous system, Consolan.

The talking beacon teams up a rotating microwave antenna with a prerecorded tape so that the transmitter announces the direction in which the antenna is pointing every 3°. For example, a boatmen off Cape May would hear "Cape May, 003 . . . Cape May, 006 etc., according to his bearing.

The only piece of equipment the boatman needs is a pretuned, in-

(Continued on page 18)

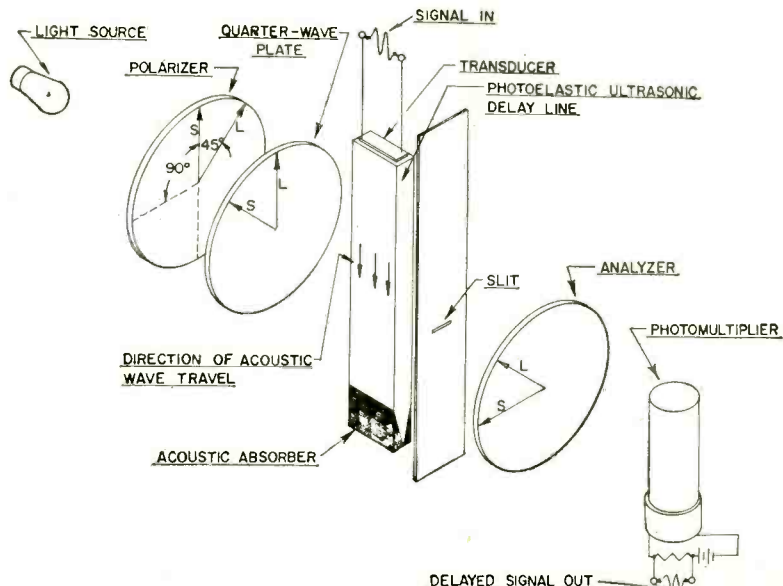

DOUBLES YOUR EFFECTIVE MANPOWER



Fix "Tough Dogs" Fast!

Save Half Your Time!

Step Up Your Profit!

B&K NEW
MODEL 1076

TELEVISION ANALYST

for Black & White and Color



Check all circuits—Pinpoint any TV trouble...in minutes

**By Easy Point-to-Point Signal Injection,
You See the Trouble on the TV Screen and
Correct it—Twice as Fast and Easy!**

There's no longer any need to "lose your shirt" (and customers)—and worry about the lost hours you never recover—on "tough dogs" or even intermittents. *The remarkable B&K Analyst* enables you to inject your own TV signal at any point and watch the resulting test pattern on the picture tube itself. *Makes it quick and easy to isolate, pinpoint, and correct TV trouble in any stage* throughout the video, audio, r.f., i.f., sync, and sweep sections of black & white and color television sets—including intermittents. Makes external scope or wave-form interpretation unnecessary. Most useful instrument in TV servicing! Its basic technique has been proved by thousands of successful servicemen the world over.

The Analyst enables any serviceman to cut servicing time in half, service more TV sets in less time, really satisfy more customers, and make more money.

Model 1076. Net, \$29995

Available on Budget Terms. As low as \$30.00 down.

Combines all the features of both
the Model 1075 and Model A107

- | | |
|--|--------------------------------------|
| COMPLETE R.F. and I.F. | HI-VOLT INDICATOR |
| VIDEO TEST PATTERN | YOKE and HI-VOLTAGE TRANSFORMER TEST |
| COMPOSITE SYNC | |
| FM MODULATED AUDIO | Also Now Provides: |
| COLOR PATTERNS | SWITCH-TYPE TUNER |
| HORIZONTAL and VERTICAL PLATE and GRID DRIVE | NEGATIVE BIAS SUPPLY |
| B+ BOOST INDICATOR | AGC KEYING PULSE |
| | PICTURE TUBE MODULATION |



B & K MANUFACTURING CO.
1801 W. BELLE PLAINE AVE • CHICAGO 13, ILL.
Canada: Atlas Radio Corp., 50 Wingold, Toronto 19, Ont.
Export: Empire Exporters, 277 Broadway, New York 7, U.S.A.

See Your B&K Distributor or Write for Bulletin AP16-E

A HISTORIC TELEPHONE EXPERIMENT BEGINS IN AN ILLINOIS TOWN

New technology brings the dream of an electronic central office to reality . . . foreshadows new kinds of telephone service.

Today, the science of communications reaches dramatically into space, bouncing messages off satellites. But an equally exciting frontier lies closer to home. Bell Telephone Laboratories engineers have created a revolutionary new central office. At Morris, Illinois, an experimental model of it has been linked to the Bell System communications network and is being tried out in actual service with a small group of customers.

This is a special electronic central office which does not depend on mechanical relays or electromagnets. A photographic plate is its permanent memory. Its "scratch pad," or temporary memory, is a barrier grid storage tube. Gas-filled tubes make all connections. Transistor circuits provide the logic.

The new central office is versatile, fast and compact. Because it can store and use enormous amounts of information, it makes possible new kinds of services that will be explored in Morris. For example, some day it may be feasible for you to ring other extensions in your home . . . to dial people you frequently call merely by dialing two digits . . . to have your calls transferred to a friend's house where you are spending the evening . . . to have other numbers called in sequence when a particular phone is busy.

The idea behind the new central office was understood 20 years ago, but first Bell Laboratories engineers had to create new technology and devices to bring it into being. A Bell Laboratories invention, the transistor, is indispensable to its economy and reliability.

This new experiment in switching technology is another example of how Bell Telephone Laboratories works to improve your Bell communications services.

BELL TELEPHONE LABORATORIES

World center of communications research and development



Part of a memory plate of the new electronic central office is shown at right (enlarged 8 times). Spots are coded instructions which guide the system in handling calls and keeping itself in top operating form. Over two million spots are required. Logic and memory are physically separated in the machine, so new functions can be easily added. The experiment is being conducted in co-operation with the Illinois Bell Telephone Company and the Western Electric Company.

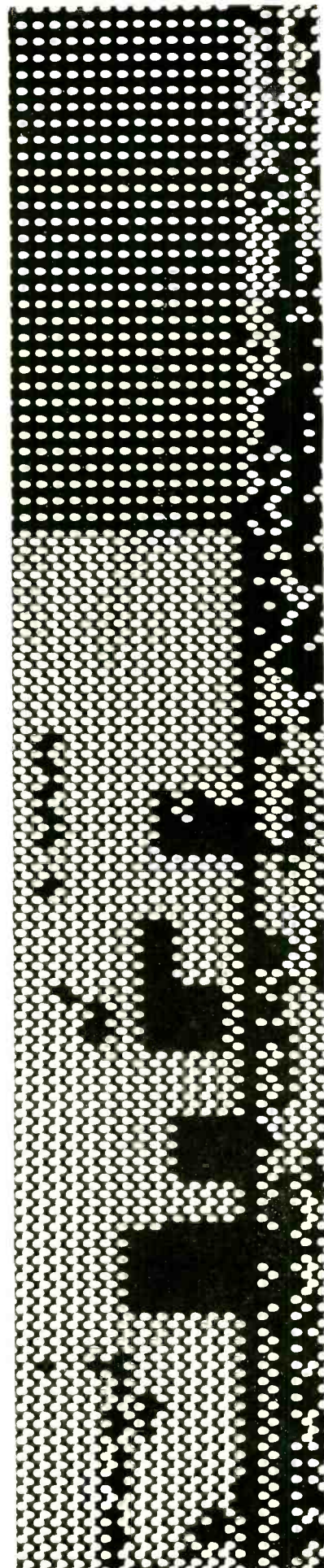

Do you WISH you were EMPLOYED in ELECTRONICS?

Get Your First Class Commercial

F.C.C. LICENSE QUICKLY!

F.C.C. LICENSE—THE KEY TO BETTER JOBS

An F.C.C. *commercial* (not amateur) license is your ticket to higher pay and more interesting employment. This license is Federal Government evidence of your qualifications in electronics. Employers are eager to hire *licensed* technicians.

WHICH LICENSE FOR WHICH JOB?

The **THIRD CLASS** radiotelephone license is of value primarily in that it qualifies you to take the second class examination. The scope of authority covered by a third class license is extremely limited.

The **SECOND CLASS** radiotelephone license qualifies you to install, maintain and operate most all radiotelephone equipment except commercial broadcast station equipment.

The **FIRST CLASS** radio telephone license qualifies you to install, maintain and operate every type of radiotelephone equipment (except amateur) including all radio and television stations in the United States, its territories and possessions. This is the highest class of radiotelephone license available.

GRANTHAM TRAINING PREPARES YOU

The Grantham course covers the required subject matter completely. Even though it is planned primarily to lead directly to a first class FCC license, it does this by **TEACHING** you electronics. Some of the subjects covered in detail are: Basic Electricity for Beginners, Basic Mathematics, Ohm's and Kirchoff's Laws, Alternating Current, Frequency and Wavelength, Inductance, Capacitance, Impedance, Resonance, Vacuum Tubes, Transistors, Basic Principles of Amplification, Classes of Amplifiers, Oscillators, Power Supplies, AM Transmitters and Receivers, FM Transmitters and Receivers, Antennas and Transmission Lines, Measuring Instruments, FCC Rules and Regulations, and extensive theory and mathematical calculations associated with all the above subjects explained simply and in detail.

OUR GUARANTEE

If you should fail the F. C. C. exam after finishing our course, we guarantee to give additional training at **NO ADDITIONAL COST**. Read details in our free booklet.

Learn by Correspondence or in Resident Classes

Grantham training is offered by correspondence or in resident classes. Either way, we train you quickly and thoroughly---teach you a great deal of electronics and prepare you to pass the F. C. C. examination for a first class license. Get details now. Mail coupon below.

This booklet FREE!

This free booklet gives details of our training and explains what an F. C. C. license can do for your future. Send for your copy today.

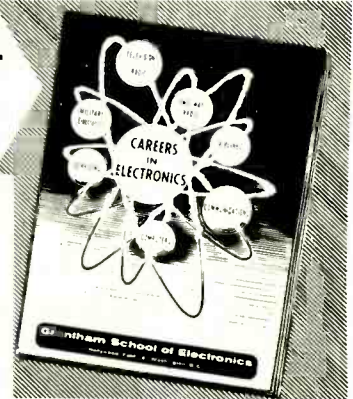

To get ahead in electronics—first, you need the proper training; then, you need “proof” of your knowledge. Your first class commercial F. C. C. license is a “diploma” in communications electronics, awarded by the U. S. Government when you pass certain examinations. This diploma is recognized by employers. Grantham School of Electronics specializes in preparing you to **earn** this diploma.

Grantham training is offered in resident classes or by correspondence. Our **free** booklet gives complete details. If you are interested in preparing for your F. C. C. license, mail the coupon below to the School's **home office** at 1505 N. Western Ave., Hollywood 27, California—the address given in the coupon—and our free booklet will be mailed to you promptly. No charge—no obligation.

Grantham School of Electronics

HOLLYWOOD CALIF.

SEATTLE WASH.

KANSAS CITY MO.

WASHINGTON D. C.

RESIDENT CLASSES HELD IN FOUR CITIES

If you are interested in attending day or evening classes mail the coupon for free information to our home office in Hollywood, Calif.



(Mail in envelope or paste on postal card)

TO: GRANTHAM SCHOOL OF ELECTRONICS
1505 N. Western Ave., Hollywood, Calif.

Gentlemen:

Please send me your free booklet telling how I can get my commercial F.C.C. license quickly. I understand there is no obligation and no salesman will call.

Name _____ Age _____

Address _____

City _____ State _____

I am interested in: Home Study; Seattle classes

Hollywood classes, Kansas City classes, Washington classes

14B

MAIL COUPON NOW—NO SALESMAN WILL CALL



there are drivers

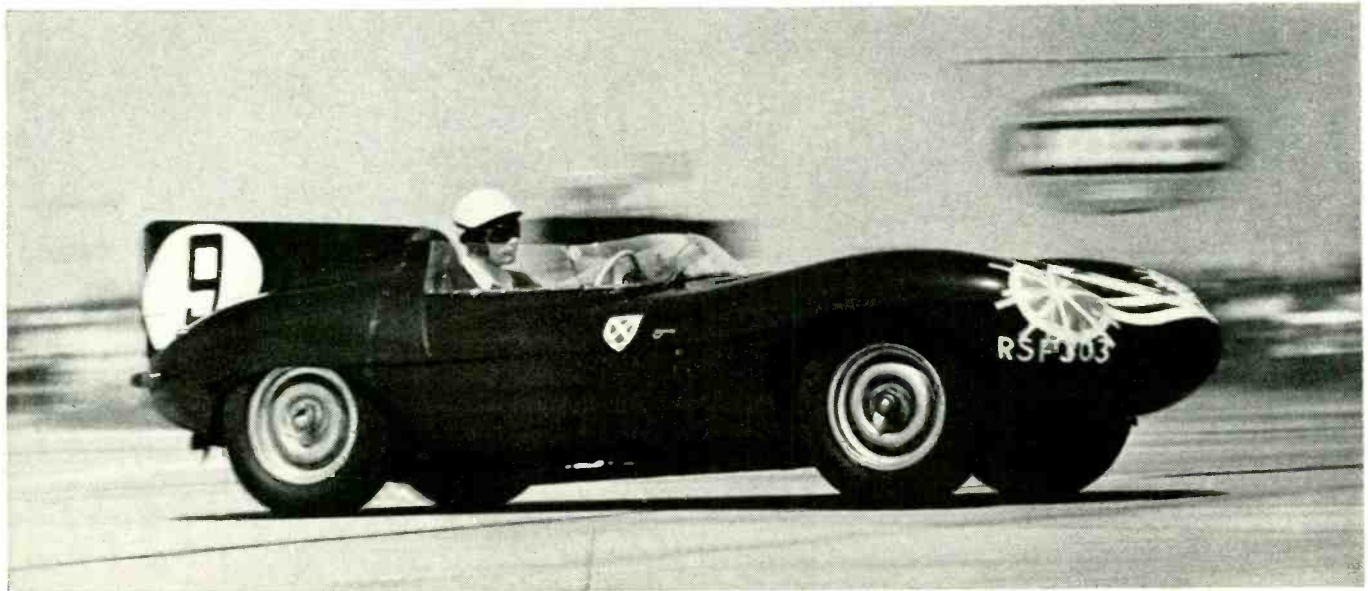

and there are drivers!

Which is by way of saying: *don't use a boy for a man's job!* For performance, efficiency, dependability and penetration, let these man-sized features of University's loudspeaker drivers guide your choice: ▶ One-piece linen base phenolic diaphragm construction yields exceptionally uniform over-all frequency response ▶ Rim-centered palate assembly results in shock- and vibration-proof mechanism ▶ Powerful Gold Dot Alnico 5 magnet assembly ▶ Built-in transformers provide highest degree of versatility of application and flexibility of operation ▶ Individually precision-wound tropicalized voice coils ▶ Important conveniences of field-replaceable diaphragm assemblies, phase-coded terminals, standard threads for interchanging trumpets ▶ Conservatively rated continuous-duty power handling capacity at maximum conversion efficiencies mean lower dollar-per-watt costs for the user ▶ Completely weatherproof construction and acrylic finish assure lifetime protection. ▶ *With drivers like these you're off to a good start.* Now team them up with trumpets from University's all-inclusive line—wide-angle, directional, radial—and you're ahead all the way. For complete details on University public address speakers and accessories, write Desk J-2, University Loudspeakers, Inc., White Plains, N. Y.

CHOOSE FROM THESE SIX DELUXE ID MODELS—FROM 20 TO 60 WATTS

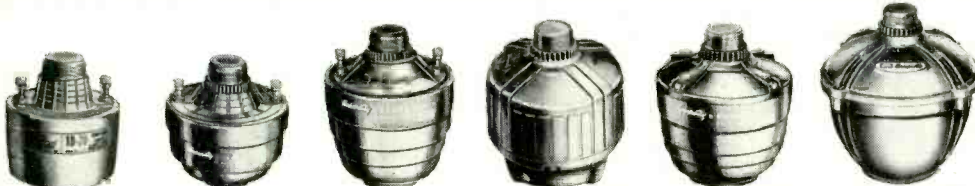

ID-20, 20 watts ID-30, 30 watts ID-40, 40 watts ID-40T, 40 watts ID-60, 60 watts ID-60T, 60 watts

OR FROM THE WORLD FAMOUS STANDARD LINE OF UNIVERSITY DRIVERS



RADIO-ELECTRONICS

FREE!

LAFAYETTE'S 1961 CATALOG

324 GIANT SIZED PAGES

The Complete Catalog Featuring
"The Best Buys In The Business"

- Stereophonic Hi-Fi Equipment
- Public Address Systems
- Tape Recorders
- Radio and TV Tubes and Parts
- Citizen Band Equipment
- Amateur Equipment
- Industrial Supplies

Send for Lafayette's FREE Catalog—the most complete, up-to-the-minute electronic supply catalog crammed full of everything in electronics at our customary down-to-earth money-saving prices.

CONTAINS HUNDREDS OF EXCLUSIVE LAFAYETTE ITEMS NOT AVAILABLE IN ANY OTHER CATALOG OR FROM ANY OTHER SOURCE—SEND FOR YOUR COPY NOW!

A "must" for the economy-minded hi-fi enthusiast, experimenter, hobbyist, engineer, technician, student, serviceman and dealer



Our 40th Year

EASY PAY PLAN—the simplest, and quickest way to get what you want when you want it. As little as \$2 down . . . up to 24 months to pay.



Communications Receiver
KT-200, Kit HE-10, Wired.
64.50 79.95



RK-400 2-Speed
Portable Tape Recorder
49.50

TE-15 Tube Checker
19.95



RW-60 20,000 Ohms Per
Volt Multitester
13.50

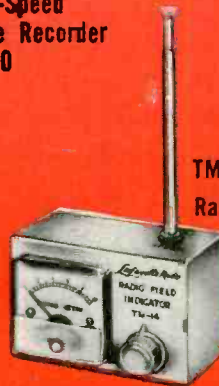

TM-14
Radio Field Indicator
6.95



EE-800WX
Citizen Band Mobile Antenna
6.95

LAFAYETTE RADIO

Mail the coupon today for your
FREE copy of Lafayette Radio's
1961 catalog.



Lafayette Radio Electronics Corp.
Dept. JB-1, P.O. Box 190
Jamaica 31, N. Y.

Send me the FREE Lafayette 324 page
1961 catalog 610

Name _____

Address _____

City _____ Zone _____ State _____

Here's the SPECIALIZED

Let these 2 Ghirardi manuals teach you to
**REPAIR ANY TELEVISION
OR RADIO RECEIVER ever made!**



A. A. GHIRARDI

SAVE \$2.00!

Make your service library complete! Get both these famous Ghirardi books at a saving of \$2.00 under the regular price. See **MONEY - SAVING COMBINATION OFFER** in coupon.

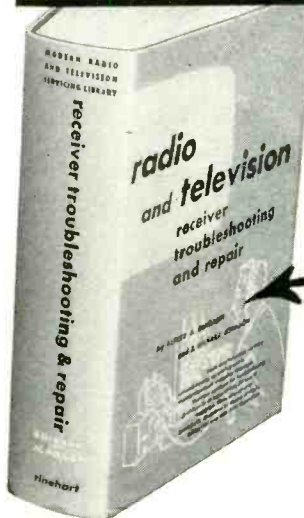

Let these two famous training books teach you to handle all types of AM, FM and TV service jobs by approved *professional* methods—and watch your efficiency and earnings soar! Almost 1500 pages and over 800 clear pictures and diagrams explain EVERY troubleshooting and repair operation as clearly as A-B-C. No needless mathematics. No involved theory. You get straight-from-the-shoulder training of the type that teaches you to do the best work in the shortest time. Each

book is co-authored by A. A. Ghirardi whose radio-electronics training guides have, for more than 25 years, been more widely used for military, school and home study training than any other books of their types. Books are sold separately at prices indicated—or you save \$2.00 by buying them both. Use coupon or order from Dept. RE-21, Technical Div., Holt, Rinehart and Winston, Inc., 383 Madison Ave., New York 17, N.Y.

RADIO & TV CIRCUITRY and OPERATION

Learn about circuits . . . and watch service headaches disappear

You can repair ANY radio, TV or other electronic equipment lots easier, faster and better when you're fully familiar with its circuits and know just why and how each one works . . . and that's exactly the kind of specialized training you get in Ghirardi's 669-page **RADIO & TV CIRCUITRY AND OPERATION** training guide. First it gives a complete understanding of

basic modern circuits and their variations. Finally it shows what troubles to look for and how to eliminate useless service testing and guesswork. Throughout, it gives you the above-average training that takes the "headaches" out of trouble-shooting—the kind that fits you for the best-paid servicing jobs. Contains 417 clear illustrations.

Sold separately for \$9.00—or see **MONEY-SAVING COMBINATION OFFER**.

RADIO & TV TROUBLESHOOTING and REPAIR

Complete training in modern service methods

RADIO & TV TROUBLESHOOTING AND REPAIR is a complete 822-page guide to *professional* service methods . . . the kind that help you handle jobs faster, more profitably. For beginners, this giant book with its 417 clear illustrations is an easily understood course in locating troubles fast and fixing them *right*. For experienced servicemen, it is an ideal way to develop better

methods and shortcuts; or to find fast answers to problems. You learn troubleshooting of all types from "static" tests to dynamic signal tracing methods. Step-by-step charts demonstrate exactly what to look for and how to look. A big television section is a down-to-earth guide to all types of TV service procedures. Read it 10 days at our risk!

Sold separately for \$10.00 or save \$2.00 on **MONEY-SAVING COMBINATION OFFER**.

Cut Radio-TV Test Time IN HALF!

In modern electronic work it's what you know about using instruments that really counts!



This new 316-page **BASIC ELECTRONIC TEST PROCEDURES** manual with its more than 190 illustrations, pattern photos and procedure diagrams teaches you to test any circuit, equipment or component in a fraction of the usual time.

In brief, it is a complete course in professional instrument testing techniques! Covers different ways of doing jobs. For instance, you learn to check for distortion by the "scope, rejection filter, harmonic distortion meter, wave analyzer or oscillator methods. You learn to measure resistance with a current meter, a voltmeter, voltmeter, ohmmeter, or via the bridge method—and so on through all types of testing.

Includes Current checks; measuring Power, Capacitance, Resistance, AF, RF, Phase, Distortion & Modulation; testing Tubes and Semiconductors; testing Amplifiers; checking Sensitivity, RF Gain, Fidelity, AVC Voltage, etc. Even includes industrial electronic test procedures. Everything is *really* complete—and written so you can understand it! Price \$8.00.

Order **BASIC ELECTRONIC TEST PROCEDURES** in coupon.

Now! FIX ANY ELECTRIC MOTOR

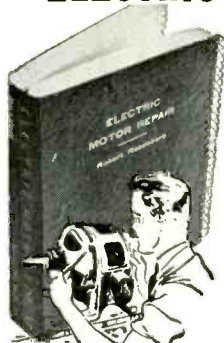

Handle ANY job from minor repairs to complete rewinding

560 pages—Over 900 how-to-do-it pictures

It pays to train for something different! **ELECTRIC MOTOR REPAIR** is a complete guide that helps you cash in on this vast, rapidly growing field. Shows step by step how to handle all repair jobs (including complete rewinding) on practically ANY AC or DC motor or generator in common use—from fractional horsepower to giant industrial motors. Special duo-spiral binding brings text and related how-to-do-it diagrams side by side so that you learn fast, easily and right. Every job is explained so clearly you can hardly fail to understand it. Over 125,000 copies in use in motor repair shops, schools, and for home study. Fully approved by repair specialists, unions and instructors.

It's the ideal book whether you want to train for a good-pay motor repair job or simply want to fix motors as a sideline or hobby!

Order **ELECTRIC MOTOR REPAIR** in coupon. Price only \$9.25.

DON'T THROW OLD RADIOS AWAY!



Here's the data you need to fix old sets in a jiffy!

Just look up the how-to-do-it data on that old radio you want to fix.

Four times out of 5, this giant, 3 1/2-pound, 744-page Ghirardi **RADIO TROUBLESHOOTER'S HANDBOOK** tells what is likely to be causing the trouble . . . shows how to fix it. No useless testing. No wasted time. Using it, even beginners can easily fix old sets which might otherwise be thrown away because service information is lacking. With a few simple repairs, most of these old sets can be made

to operate perfectly for years to come.

THE ONLY GUIDE OF ITS KIND!

Cuts service time in half!

Included are common trouble symptoms and their remedies for over 4,800 models of old home, auto radios and record changers. Arvin, Apex, Avlin, Atwater Kent, Belmont, Bosch, Brunswick, Clarion, Crosley, Emerson, Fada, G-E, Kolster, Majestic, Motorola, Philco, Pilot, RCA, Silvertone, Sparton, Stromberg and dozens more. Includes hundreds of pages of invaluable tube and component data, service short cuts.

Specify **RADIO TROUBLESHOOTER'S HANDBOOK** in coupon. Price only \$10.00. 10-day trial.

USE COUPON FOR **10-day Free Trial!**

TRAINING YOU NEED in its most complete economical and easily understood form

TRAIN AT HOME FOR TV-RADIO-ELECTRONICS . . . at rock-bottom cost!

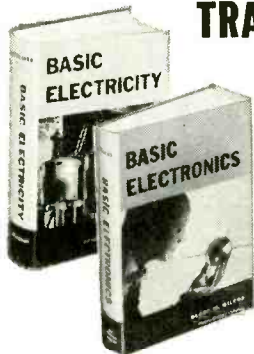

Now! Get your basic training from these two easily understood, low cost books!

Here is complete basic electrical-electronic training specifically written for beginners—priced at a fraction of what you might expect. 785 pages and almost 700 pictures, diagrams and charts in these two big books bring you top notch training that can pave your way to a fascinating electronic career. Every detail is fully and clearly explained. Nothing is omitted—nothing is condensed. In every respect, the material in these books compares more than favorably with "courses" costing many times as much!

BASIC ELECTRICITY—Fundamental electrical principles are the basis of all Electronics—and this 396-page manual gives you a complete working knowledge of them all! Covers everything from electromagnetism to 'phone principles, circuits, wiring, illumination, reactance, impedance, power factor, instruments, controls, measurements, and all types of components and equipment. Includes set-up diagrams, practical examples and problem solutions. Price \$6.25 separately. See Money-Saving Offer!

BASIC ELECTRONICS—This new 389-page guide takes up where Basic Electricity leaves off. Shows how electrical principles are applied in Electronics and gives you a sound grasp of electronic theory, methods, circuits and equipment. Over 375 illustrations explain details clearly. The ideal basic training to help you build a profitable future in TV, radio, communications, hi-fi, industrial electronics and related fields! Price \$6.25 separately.

ONLY \$11.00 FOR THIS COMPLETE HOME TRAINING!

Save \$1.50! See special Money-Saving Offer in Coupon!

Here's everything you need to know about

OSCILLOSCOPES!

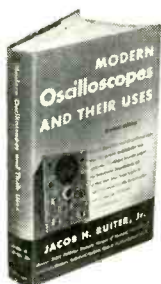

Complete data on using the handiest instrument of all!

Men who know how to use oscilloscopes on all types of jobs don't guess about troubleshooting and tough re-alignment problems! They locate troubles in a jiffy, adjust them quickly and accurately—and this famous 346-page manual teaches you the methods they use.

MODERN OSCILLOSCOPES AND THEIR USES gets right down to earth in telling you all about these versatile instruments and exactly how to use them. Particular attention is paid to AM, FM, and TV realignment procedures. Every detail of testing with 'scopes is explained from connecting the 'scope and setting its controls to adjusting components in the chassis being tested. Illustrated instructions teach you to analyze patterns. Even includes data on quantitative measurements (as used in color TV servicing) and use of 'scopes in lab, industrial electronics and atomic work. 370 illustrations. Price \$8.00.

'Scope experts get the big pay jobs!

Specify **MODERN OSCILLOSCOPES AND THEIR USES** in coupon to order.

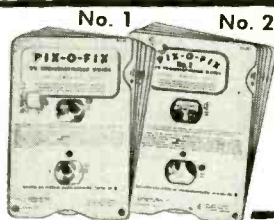

SHORT CUT TO TV REPAIR!

Just turn the dial of the pocket-size **PIX-O-FIX TROUBLE FINDER GUIDE!** When the picture in the PIX-O-FIX window matches the image on the TV screen—presto!—you've got your clue. PIX-O-FIX shows the likely causes of the trouble—indicates

the receiver section involved—then gives clear repair instructions. Two PIX-O-FIX units Nos. 1 and 2 cover 48 different TV troubles. Together, they're a comprehensive guide to quick "picture analysis" servicing of any TV. Price only \$3.00 for the two.

Get your COMMERCIAL OPERATORS LICENSE!

Train for radio's most fascinating, best paid jobs!



This famous book makes it easy to train for your FCC commercial license as an operator aboard ship, in aviation, broadcasting, telecasting, etc. **LICENSE MANUAL FOR RADIO OPERATORS** is a quick, easily understood guide that covers ALL

EIGHT FCC examination elements—not just some of them. Reviews almost 2200 exam questions. Covers everything you'll need to know to pass your examination for 1st or 2nd class radio-phone license holder with flying colors! Price \$6.75.

REPAIR ANY ELECTRICAL APPLIANCE!

Save on repair bills! . . . Earn in your Spare Time!

This 370-page **ELECTRICAL APPLIANCE SERVICE MANUAL** helps you service practically any home electrical appliance. Includes standard and automatic washers, irons, toasters, coffee makers, waffle irons, water heaters, toasters, ranges, cleaners, mixers, razors, clocks, motors, and many more.

Troubleshooting charts quickly help you locate troubles. Easy instructions guide you in making repairs. Tells how to make your own low-cost test tools. Includes appliance refinishing methods. An ideal guide for fixing your own appliances or for building a profitable full or part time appliance repair business! \$6.25.



ORDER NOW

TRY ANY BOOK 10 DAYS FREE!

Dept. RE-21, Technical Division, Holt, Rinehart & Winston, Inc., 383 Madison Ave., New York 17, N. Y.

Send books checked for 10 day FREE examination at prices indicated plus postage. SAVE! Send cash with order and we pay postage. Same 10 day return privilege with money refunded.

Check here for **MONEY-SAVING SERVICE COMBINATION** on Ghirardi's Radio & TV CIRCUITRY & OPERATION and Radio & TV TROUBLESHOOTING & REPAIR. Price \$17.00 for both (plus postage). Regular price \$19.00—you save \$2.00!

Check here for **MONEY-SAVING Basic Training COMBINATION** ON **BASIC ELECTRICITY** and **BASIC ELECTRONICS**. Price \$11.00 plus postage for both big books. Regular price \$12.50—you save \$1.50!

Check here to order

- | | |
|---|--|
| <input type="checkbox"/> Radio & TV CIRCUITRY & OPERATION \$ 9.00 | <input type="checkbox"/> Basic Electronics \$ 6.25 |
| <input type="checkbox"/> Radio & TV Receiver TROUBLESHOOTING and REPAIR 10.00 | <input type="checkbox"/> Modern Oscilloscopes & Their Uses 8.00 |
| <input type="checkbox"/> Basic Electronic Test Procedures 8.00 | <input type="checkbox"/> PIX-O-FIX TV Trouble Finder Guides, Nos. 1 and 2 3.00 |
| <input type="checkbox"/> Electric Motor Repair 9.25 | <input type="checkbox"/> License Manual for Radio Operators 6.75 |
| <input type="checkbox"/> Radio Troubleshooter's Handbook 10.00 | <input type="checkbox"/> Electrical Appliance Service Manual 6.25 |
| <input type="checkbox"/> Basic Electricity 6.25 | <input type="checkbox"/> Handbook of TV Troubles 7.50 |

OUTSIDE U. S. A.
Add 50¢ to price of each book. Cash with order, but money refunded if books are returned in 10 days.

Name _____
Address _____
City, Zone, State _____

New! Master Guide to TIME-SAVING TV SERVICE



Almost regardless of set make or model this remarkable new 302-page **HANDBOOK OF TV TROUBLES** helps you track down TV troubles from the symptoms they produce in the set itself: screen intermittently dark; "blooming"; abnormal contrast; "snow"; poor detail; sync troubles; sound troubles—and all the many other symptoms that indicate something is wrong. Just turn to the "Quick Trouble-Finder Guide" inside the cover. Look up the symptoms exhibited by the set you're working on. The **HANDBOOK** then tells you just



LOOK! LISTEN! what to do and how to do it. Outlines time-saving shortcuts. Eliminates guesswork. More than 150 test patterns, wave form and circuit illustrations explain test results, details and procedures. Printed in large type and bound in sturdy varnished covers for use at the bench. All methods presented have been bench-tested by the author through actual shopwork! Price \$7.50.

Order **HANDBOOK OF TV TROUBLES** in coupon.



As easy
as using
a screwdriver

EVERY ROOM A TV OR FM ENTERTAINMENT CENTER NEW BLONDER-TONGUE TV/FM HOME SYSTEM KIT

It's so easy to enjoy brilliant TV or FM performance on up to four sets. Good reception starts with a remarkable new indoor antenna . Installs easily in attic or other convenient indoor areas. In primary signal areas, eliminates the need for an outdoor antenna, yet provides the reception capabilities of an outdoor antenna. The TV signal is distributed by a quality engineered 4-set coupler  providing exact match, low loss, inter-set isolation. And, you get sparkling TV or FM performance.

HK-1 only \$9.95 list



engineered and manufactured by

BLONDER-TONGUE

9 Alling St., Newark, N. J.

Canadian Div.: Benco Television Assoc., Ltd., Toronto, Ont. Export: Morhan Export Corp., New York 13, N. Y. home TV accessories • UHF converters • master TV systems • industrial TV systems • FM-AM radios



Coast Guard electronic technician chief Donald Actis adjusts the talking beacon transmitter on the New Jersey coast. Strips of talking tape and playback head are seen in the cabinet.

(Continued from page 10)

expensive receiver the size of a tube type portable radio, which can be used with speaker or phones. At the center of a beam, the voice on the two bearings to each side come through faintly. If the boatman hears "006 . . . 009" with equal strength, he can safely assume his bearing is about halfway between the two.

Calendar of Events—March 1961

Cleveland Electronics Conference, Jan. 31-Feb. 2, Cleveland Engineering and Scientific Center, Cleveland, Ohio.
Winter Convention on Military Electronics, Feb. 1-3, Billmore Hotel, Los Angeles.
Second Annual ERA Convention, Feb. 1-4, Ambassador Hotel, Los Angeles.
International Solid State Circuits Conference, Feb. 15-17, University of Pennsylvania and Sheraton Hotel, Philadelphia, Pa.
Fourth International Electronic Components Exhibition, Feb. 17-21, Parc des Expositions, Porte de Versailles, Paris. RADIO-ELECTRONICS will exhibit there.
International Symposium on Semiconductor Devices, Feb. 20-25, UNESCO House, 125, Avenue de Suffren, Paris.
Commercial and Industrial Sound Systems Institute, Feb. 23-24, University of Wisconsin, Madison, Wis.
Pacific Electronics Trade Show (PETS), Feb. 26-Mar. 1, Great Western Exhibit Center, Los Angeles, Calif.
1961 IRE International Convention, Mar. 20-23, Waldorf-Astoria Hotel and New York Coliseum, New York, N. Y.

IRE Elects Officers

Lloyd V. Berkner, president of Associated Universities Inc., is the 1961 president of the Institute of Radio Engineers. The new vice presidents are Franz Ollendorff, research professor at the Technion-Israel Institute of Technology, Haifa, Israel, and J. F. Byrne, manager of the Riverside Research Laboratory, Motorola, Inc., Riverside, Calif. END

ALLIED value-packed 1961

444-PAGE ELECTRONICS CATALOG

including special products available only from Allied

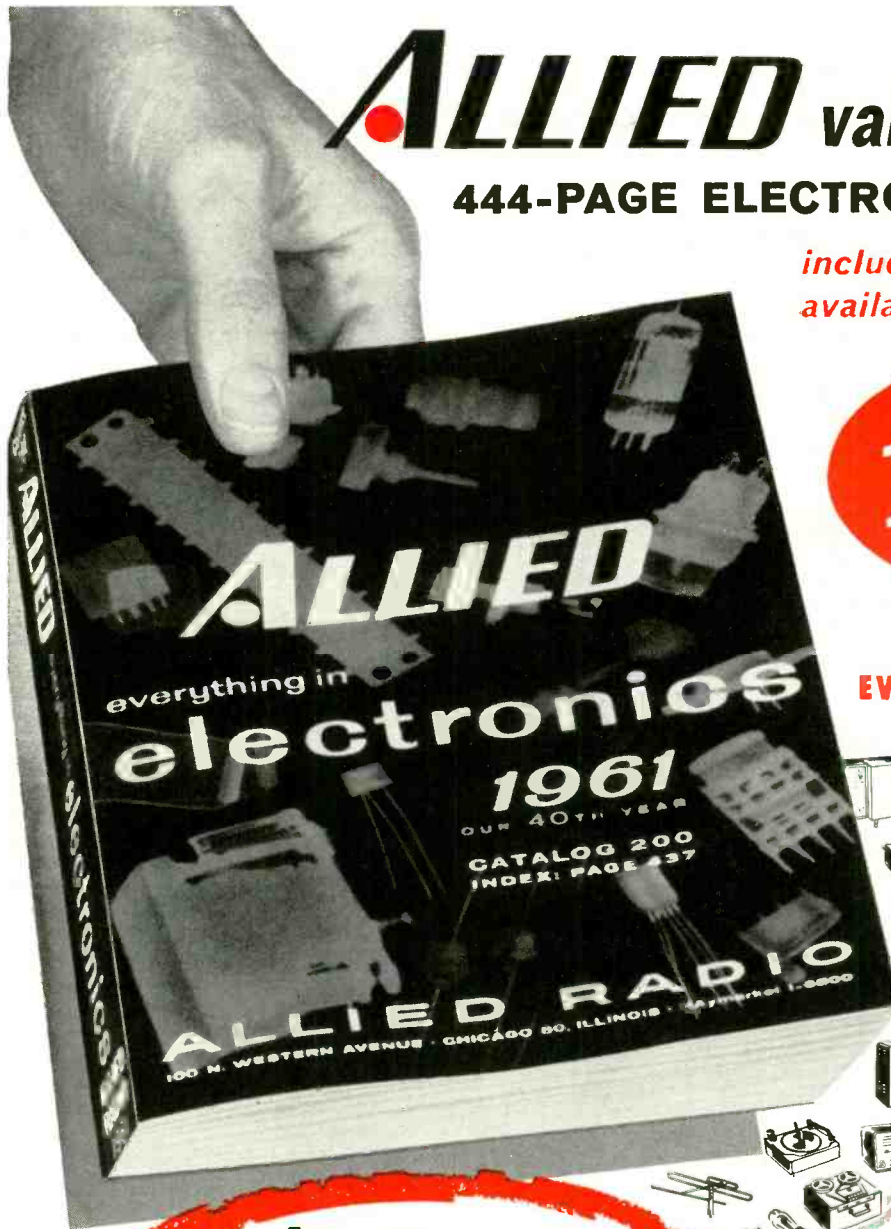

free

SAVE MOST ON EVERYTHING IN ELECTRONICS

- New Stereo Hi-Fi Systems— Everything in Hi-Fi Components
- Money-Saving, Build-Your-Own KNIGHT-KITS® for Every Need
- Best Buys in Recorders & Supplies
- Newest Public Address Systems, Paging and Intercom Equipment
- Amateur Receivers, Transmitters and Station Gear
- Citizen's Band 2-Way Radio
- Test and Laboratory Instruments
- TV Tubes, Antennas, Accessories
- Huge Listings of Parts, Tubes, Transistors, Tools, Books

BUY ON EASIEST TERMS
only \$2 down on orders up to \$50;
only \$5 down on orders up to \$200;
only \$10 down over \$200.
 Up to 24 months to pay.

ALLIED exclusives:

MONEY-SAVING KNIGHT-KITS®—truly the very best in build-your-own electronic equipment—lowest in cost, easiest to assemble, best for performance. Select from a complete line of Stereo hi-fi kits, Hobbyist kits, Test Instrument and Amateur kits. KNIGHT-KITS are an exclusive ALLIED product.

KNIGHT® STEREO HI-FI—Comparable to the best in quality, styling and performance, yet priced far lower. Select super-value KNIGHT components or complete systems and save most. Also see the largest selections of famous-name hi-fi components and money-saving ALLIED-recommended complete high-fidelity music systems.

Exclusive Allied products save you more

You get every buying advantage at ALLIED: Lowest, money-saving prices, fastest shipment, expert personal help, easiest-pay terms, satisfaction guaranteed or your money back.

send coupon today for 444-page catalog

free

ALLIED RADIO

Satisfaction Guaranteed or Your Money Back

World's Largest Electronic Supply House



our 40th year

ALLIED RADIO, Dept. 2-B1
 100 N. Western Ave., Chicago 80, Ill.

Send FREE 1961 Allied Catalog No. 200

Name _____
PLEASE PRINT

Address _____

City _____ Zone _____ State _____

The Family Gathers

to wait for **Centralab**® push-push
(or push-pull) **CONTROLS**



PHOTO: BETTMAN ARCHIVE

H

ail, hail, the gang's all here

They'd be inside if the TV set were working . . . but a push-push control went bloo-ey.

Luckily for them, though, CENTRALAB has replacement units . . . the only push-push units on the market, plus a complete line of 35 push-pulls. Four different types—Adashaft, Universal Shaft, Fastatch or dual concentrics, and Twin types for stereo.

Push-push and push-pull controls are now being used in over 78% of the TV, radio and hi-fi sets coming out of the factories. Find the CENTRALAB replacement you need at your distributors, so the folks can get back inside to see what Wyatt Earp is up to.



Centralab®

THE ELECTRONICS DIVISION OF GLOBE UNION INC.
922B EAST KEEFE AVENUE • MILWAUKEE 7, WISCONSIN
CENTRALAB CANADA LIMITED—AJAX, ONTARIO

B-6101

**ELECTRONIC SWITCHES • VARIABLE RESISTORS • CERAMIC CAPACITORS
PACKAGED ELECTRONIC CIRCUITS • ENGINEERED CERAMICS**

Correspondence



HEAT DISSIPATION

Dear Editor:

I wish to take *strong* exception to a suggestion made by Art Trauffer in the Try This One column in the December, 1960, issue.

It is quite evident that Mr. Trauffer is unfamiliar with the facts of heat dissipation. Observation will show that power transistors and stud type chassis-mounting power diodes have very smooth mounting surfaces. This permits as intimate contact as possible for optimum heat transfer. The transistor crowns are painted dull black for maximum heat radiation and convection to the air.

Since a penny, especially a shiny new one, makes intermittent contact with the transistor, and since this contributes to trapping air pockets, and since the tape holding the penny covers about one-third of the penny's surface, the transistor, if worked at full rated power, will run hot. In addition to the flat surface contact, silicone grease is usually applied to make certain that no air film separates these surfaces.

The term heat sink seems to be misinterpreted by others besides the layman. As in a kitchen sink, there must be a drain to keep the sink, heat or otherwise, from filling up.

Any heat sink must allow the localized heat to move with little impedance and present a large sink to air surface. The closer this sink approaches the transistor surface area, the more useless it becomes, as does the taped penny.

JOE OSOFSKY

Flushing 65, N. Y.

[Is our face red! You're right, and worst of all you might cause a transistor burnout by trying this stunt. Someone will go to Siberia for this. —Editor]

ROTATE STEREO SPEAKERS

Dear Editor:

In speaker arrays for stereo, W. B. Snow (US Patent 2,137,032; Nov. 15, 1938) pointed out that the flanking units should be rotated inward to face the center of the listening area—he called it "toe-in." In his "Basic Principles of Stereophonic Sound," JSMPTE (*Journal of the Society of Moving Picture and Television Engineers*) Vol. 61, No. 11, November 1953, pages 567-89, he again emphasizes the point.

This should follow from simple logic. If speaker axes are parallel, the listening area will be restricted in width and there will be a full-stage-width shift of a virtual sound source with slight
(Continued on page 24)

NOW... 4 GREAT "SALESMEN" SELLING FOR YOU!

Look at this parade of selling power! Sylvania advertising will make an average of over 9 million sales calls each week — thousands in your area — 52 weeks of the year. The top stars of radio, the largest-selling weekly magazine in the country... all selling for you in 1961.

Yes, Sylvania is going all out to help you build profits. All new streamers, in-store display and direct mail are

available from your Sylvania tube distributor. See him today. Stock up on Silver Screen 85 picture tubes and Sylvania quality receiving tubes. Do it now for a fast start to more profits in 1961.

Electronic Tubes Division,
Sylvania Electric Products Inc.,
1740 Broadway, Dept. 248.
New York 19, New York.

**IMPACT
ALL YEAR
LONG**



"ARTHUR GODFREY TIME"
52 weeks of the old redhead, telling his millions of listeners to specify Silver Screen 85 when it's time to replace their old picture tube.



**DON McNEILL'S
"BREAKFAST CLUB"**
Don McNeill, M.C. of the longest-running weekday program in radio, selling his millions of loyal listeners on the advantages of Sylvania Silver Screen 85 picture tubes.



**MONITOR
WITH NICHOLS & MAY**
Star talent like Nichols & May sell the Silver Screen 85 and you — the local independent TV service dealer — on the biggest network weekend show in radio.



**TV
GUIDE**
**FAVORITE OF
7,250,000 TV OWNERS**
TV GUIDE selling you and the Silver Screen 85 picture tube wherever TV sets are in use! Hard-hitting ads telling set owners how to make their old TV's work better than new, with a Silver Screen 85.



SYLVANIA

Subsidiary of **GENERAL TELEPHONE & ELECTRONICS** 

NOW IN KIT FORM!

The RCA Senior VoltOhmyst®

WV-98B(K)

ONLY \$62.50*

With probe, cable, clips and instruction booklet.

Featuring Pre-Assembled Etched-Circuit Board and Pre-Assembled DC/AC-OHMS Probe (WG-299D)

- Easy-to-read meter—6½" wide
- 200-microampere meter movement with less than 1% tracking error
- Precision multiplier resistors accurate to ± 1%
- Meter electronically protected against burnout
- Separate color-coded peak-to-peak and rms-voltage scales
- Die-cast aluminum case with leather carrying handle

MEASURES:

DC voltages, 0 to 1500 volts.
AC voltages, 0 to 1500 volt rms or 0 to 4200 volts peak-to-peak.
Resistances from 0.2 ohm to 1,000 megohms.

RCA WV-98B available factory-wired and calibrated: \$79.50*

Real dollar-savings! Assembly time is cut to the bone!

This extra-heavy etched-circuit board comes with all components completely mounted and soldered. The input probe and cable, likewise, comes to you already assembled and wired.

OTHER OUTSTANDING RCA KIT VALUES...



RCA VOLTOHMYST® KIT WV-77E(K) Only \$29.95*

Famous VoltOhmyst® quality and performance at a low price! Special test features include: separate 1.5-volt rms and 4-volt peak-to-peak scales for accurate low AC measurements. Measures AC and DC voltages to 1500 volts, resistances from 0.2 ohm to 1,000 megohms. Complete with ultra-slim probes, long flexible leads, special holder on handle to store leads.

RCA WV-77E available factory-wired and calibrated: \$43.95*



RCA WV-38A(K) VOLT-OHM-MILLIAMMETER KIT Only \$29.95*

The V-O-M with the extras! • 0.25-volt and 1.0-volt DC ranges • Big easy-to-read 5¼" meter • Non-breakable sealed plastic case—no glass to crack or shatter • Jacks located below switches to keep leads out of the way • Spring clips on handle to hold leads • Attractive, scuff resistant, rugged carrying case, only \$4.95* extra.

RCA WV-38A available factory-wired and calibrated: \$43.95*



RCA SUPER-PORTABLE OSCILLOSCOPE KIT WO-33A(K) Only \$79.95*

Now in kit form. A 'scope you can carry anywhere! Rugged and compact, yet weighs only 14 pounds. Just right for in-the-home and shop troubleshooting and servicing of black-and-white and color TV, radio, hi-fi components, tape recorders, etc. Ample gain and bandwidth for the toughest jobs. Scaled graph screen and internal calibrating voltage source for direct reading of peak-to-peak voltage.

RCA WO-33A available factory-wired and calibrated: \$129.95*

See them all at your Authorized RCA Test Equipment Distributor



The Most Trusted Name in Electronics
RADIO CORPORATION OF AMERICA

*User Price Optional

**AT
LAST!**

RADIO-TV and ELECTRONICS TRAINING ... AT A PRICE YOU CAN AFFORD!



***21 INCH**
Receiver Kit included

Yes, this great course costs far less than any training of its kind given by other major schools! Radio-Television Training School will train you for a good job in Television or Industrial Electronics — AT HOME IN YOUR SPARE TIME.

Think of It—a complete training program including over 120 lessons, Fourteen Big Radio-Television Kits, Complete Color-TV Instruction, Unlimited Consultation Service . . . **ALL at a really big saving to you.** How can we do this? Write to us today . . . and find out!

And what's more — you can (if you wish)

OPEN YOUR OWN RTS-APPROVED AND FINANCED RADIO-TV SERVICE SHOP

We Want Many More Shops This Year

This 38 year old training organization — called RTS, that's Radio-Television Training School — wants to establish a string of Radio-TV Repair Shops in principal cities throughout the U. S. So far, a great many such shops are **NOW IN BUSINESS AND PROSPERING.** We are helping and training ambitious men to become future owners and operators of these shops in all areas.

FOR UNSKILLED INEXPERIENCED MEN ONLY — WE TRAIN YOU OUR WAY!

We must insist that the men we sign up be trained in Radio-TV Repair, Merchandising and Sales by our training methods—because **WE KNOW** the requirements of the industry. Therefore, we will **TRAIN YOU . . .** we will show you how to earn **EXTRA CASH**, during the first month or two of your training period. **YOU KEEP YOUR PRESENT JOB. TRAINING TAKES PLACE IN YOUR OWN HOME, IN YOUR SPARE TIME!**

**COMPLETE
COLOR TV
INSTRUCTION
INCLUDED**

**YOU BUILD THESE
AND OTHER UNITS!**

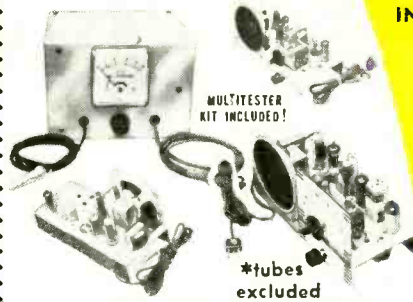

MULTI-TESTER
KIT INCLUDED!

*tubes
excluded

**RADIO-TELEVISION
TRAINING SCHOOL**

815 E ROSECRANS AVENUE
LOS ANGELES 59, CALIFORNIA

Est. 1922

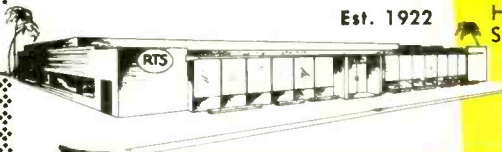

**ACT
NOW!**

**RTS
APPROVED
SERVICE
SHOP**

Get your free book on the
FAMOUS RTS BUSINESS PLAN
find out how you can open
A REPAIR SHOP OF YOUR OWN

We supply and finance your equipment

When you are ready and qualified to operate one of our RTS-Approved TV Repair Shops **WE WILL SUPPLY AND FINANCE EVERY BIT OF EQUIPMENT YOU NEED TO GET STARTED** plus an inventory of parts and supplies. In other words we will stake you . . . **AN OFFER NEVER MADE BEFORE BY ANY TRAINING ORGANIZATION.** Under the RTS Business Plan you receive:

1. An electric sign for the shop front.
2. Complete laboratory of test equipment.
3. Letterheads, calling cards, repair tickets, etc.
4. Basic inventory of tubes, parts, supplies.
5. Complete advertising and promotional material.
6. Plans for shop arrangement.
7. Instructions on how to go into business.
8. Continuous consultation and help.
9. The right to use RTS Seal of Approval, and the RTS Credo.
10. The right to use the Famous Trade Mark.

ACCREDITED MEMBER



RTS' Membership in The Association of Home Study Schools is your assurance of Reliability, Integrity, and Quality of Training.

**ALL
THESE
FREE!**



CUT OUT AND MAIL — TODAY!

RADIO-TELEVISION TRAINING SCHOOL

815 EAST ROSECRANS AVENUE Dept. RE-21
LOS ANGELES 59, CALIFORNIA

SEND ME FREE — all of these big opportunity books — "Good Jobs in TV-Electronics," "A Repair Shop of Your Own" and "Sample Lesson." I am interested in:

- Radio-Television Industrial Electronics (Automation)

Name _____ Age _____

Address _____

City & State _____

302

Mail This Coupon Now—No Salesman Will Call

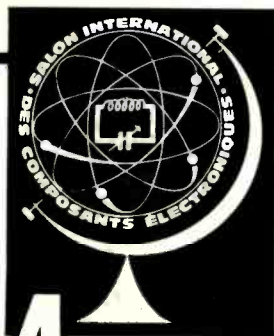

IN PARIS
 PORTE DE VERSAILLES
 from 17th
 to 21st
 February
 1961

4th

INTERNATIONAL EXHIBITION OF ELECTRONIC COMPONENTS

the greatest world meeting
 in the field of electronics.

FÉDÉRATION NATIONALE DES INDUSTRIES ÉLECTRONIQUES
 23, rue de Lübeck, Paris 16^e - PAS. 01-16

INTERNATIONAL SYMPOSIUM ON SEMI CONDUCTOR DEVICES

sponsored by the
 FÉDÉRATION NATIONALE DES
 INDUSTRIES ÉLECTRONIQUES

and organized by the
 Société Française
 des Electroniciens et des
 Radio-Electriciens

UNESCO BUILDING - PARIS
 125, AVENUE DE SUFFREN
 FROM 20TH TO 25 TH FEBRUARY, 1961

(Continued from page 20)

lateral movement of an observer. With speaker axes crossing in the listener area, an observer on the left flank can still hear high-frequency output from the right-flank speaker, normal fusion can take place and a relatively small shift of virtual sound sources take place.

My own practice since 1954 has been with corner flanking speakers which are naturally turned in at 45° so I have been guilty of failing to notice the effect of speakers with their axes parallel. When the significance of the effect is pointed out, an experiment with speakers that can be rotated is revealing.

PAUL W. KLIPSCH

Klipsch & Assoc. Inc.
Hope, Ark.

STRAIN EQUATIONS

Dear Editor:

I thoroughly enjoyed the article "A Look at the Electronic Strain Gauge," by Arthur S. Kramer in the December, 1960, issue. In the article, Mr. Kramer states that determination of average stress intensity in a specimen is accomplished by multiplying the measured strain by E (Young's modulus). According to the theory of elasticity, the relationship between stress and measured strains is given by

$$\sigma_x = \frac{E}{1 - \mu^2} (\epsilon_x + \mu\epsilon_y)$$

where σ_x is the desired stress, μ is Poisson's ratio (ratio of lateral contraction to longitudinal extension) and ϵ_x and ϵ_y are the measured unit strains parallel and perpendicular to the direction of σ_x . The relationship Mr. Kramer refers to, namely

$$\sigma_x = E\epsilon_x$$

is valid only for the simplified case where

$$\epsilon_y = \mu\epsilon_x$$

This last relationship applies, for example, to a long, thin bar stressed in tension. For more complicated stress situations requiring the use of strain gauges for solution, the strain must be measured in two perpendicular directions and a more complicated equation used.

PAUL H. SANDERS, PH.D.
University of Pittsburgh
Pittsburgh, Pa.

TRANSISTOR PREAMP IMPROVEMENTS

Dear Editor:

I have done some further investigation on my transistor stereo preamp (December, 1960) and find some improvements that simplify switching and associated circuitry. They also help reduce the loading effect of one channel on the other when the BLEND control is in the MONO position.

Add a 4,700-ohm resistor to the low side of the AM and FM LEVEL potentiometers. Add a 220,000- and 4,700-ohm resistor in series to ground at the auxiliary input jack.

Connect the ungrounded sides of the 4,700-ohm resistors (above) to the FM, AM and AUX positions on S1-a.

Remove S1-d and S1-b from the circuit; short together all connections that were on S1-d's contacts.



Prepare now
IN SPARE TIME
AT HOME
for great opportunity
field of...

TELEVISION

The future is **YOURS** in
ELECTRONICS

A fabulous field—good pay—fascinating work—a prosperous future! Good jobs or independence in your own business!

Modern Training by Coyne
RIGHT IN YOUR OWN HOME

Coyne brings you the first truly lower cost MODERN QUALITY Television Home Training; training designed to meet Coyne standards. Here is MODERN ELECTRONICS TRAINING with the latest on **Transistors, Printed Circuits, Remote Controls, Test Equipment, UHF, and Color.** No previous experience needed. Personal guidance by Coyne Staff.

The Institution Behind this Training

Famous for over sixty two years. COYNE occupies this entire building which is the new home of COYNE. COYNE'S modern resident training of men in Electronics, Electricity, Television and Radio has produced thousands of successful graduates.



B. W. COOKE, Jr., President

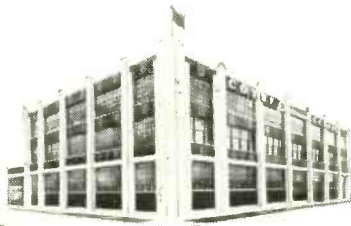

FOUNDED 1899

COYNE ELECTRICAL SCHOOL

CHARTERED AS AN EDUCATIONAL INSTITUTION
 NOT FOR PROFIT

1501 W. Congress Parkway, Chicago 7, Dept. 21-H5

MAIL COUPON NOW FOR DETAILS FREE

FEBRUARY, 1961

LEARN TO
EARN IN SPARE TIME AT HOME

COYNE offers a most practical Home Television Training. Easy to follow step-by-step instructions, fully illustrated with over 2150 photos and diagrams. **Practical Job Guides** to show you how to do actual servicing jobs—**make money early in course.** Keep your present job while in training.

Lower Cost — Easy Terms

We save you money because we don't send you—AND CHARGE FOR—a long list of parts or "put together kits," which you may not want or do not need. With Coyne Television Home Training you pay only for your training, **no costly extras.**

Even though we have added over 130 pages of lesson material recently to cover the latest Electronics subjects we have lowered our tuition while other schools have raised theirs.

SEND COUPON OR WRITE TO ADDRESS BELOW
FOR FREE BOOK

and full details, including Easy Payment Plan. **No obligation, no salesman will call.**

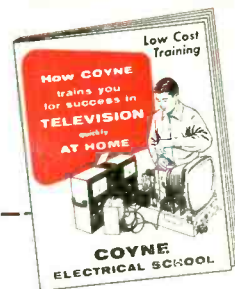

COYNE Television
Home Training Division
 Dept. 21-H5—New Coyne Building
 1501 W. Congress Parkway, Chicago 7, Illinois
 Send Free Book and details on Television Home Training. This does not obligate me in any way.

Name _____

Address _____

City _____ State _____

(Unlike most other schools we do not employ salesmen.)

2 for the money

circuit by
PACO

tubes by
Amperex®

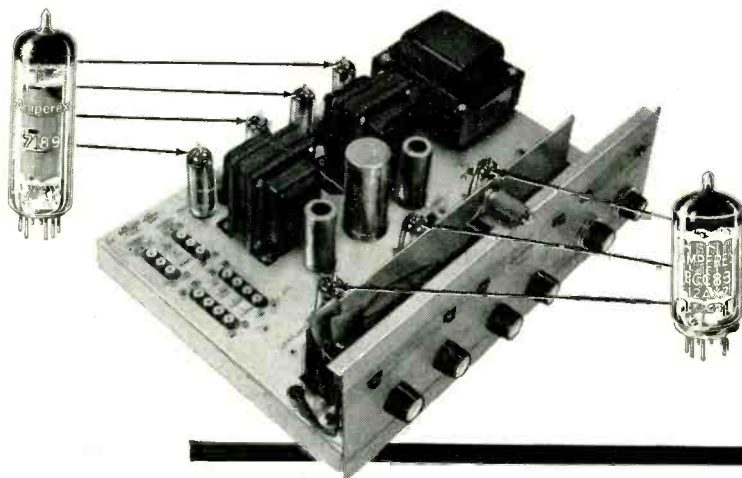

High fidelity manufacturers are vigorous competitors, but in this one respect the quality leaders are unanimous—to fulfill the great expectations of the original drawing-board concept, they use tubes by Amperex!

PACO engineers designed a 40-watt stereo preamp-amplifier kit that would provide remarkable flexibility. Their next step was to assure high gain, inaudible hum, noise and distortion, plus optimum dependability. In the PACO SA-40, the total concept became a reality—with three Amperex 12AX7/ECC83's and four 7189's.

These and many other Amperex 'preferred' tube types have proven their reliability and unique design advantages in the world's finest audio components.

Applications engineering assistance and detailed data are always available to equipment manufacturers. Write: Amperex Electronic Corp., Special Purpose Tube Division, 230 Duffy Ave., Hicksville, Long Island, New York.



about hi-fi tubes
for hi-fi circuitry

AMPEREX TUBES FOR QUALITY HIGH-FIDELITY AUDIO APPLICATIONS

POWER AMPLIFIERS

6CA7/EL34: 60 w. distributed load
7189: 20 w., push-pull
6BQ5/EL84: 17 w., push-pull
6CW5/EL86: 25 w., high current, low voltage
6BM8/ECL82: Triode-pentode, 8 w., push-pull

VOLTAGE AMPLIFIERS

6267/EF86: Pentode for pre-amps
12AT7/ECC81: Twin triodes, low
12AU7/ECC82: hum, noise and
12AX7/ECC83: microphonics
6BL8/ECF80: High gain, triode-pentode, low hum, noise and microphonics

RF AMPLIFIERS

6ES8: Frame grid twin triode
6ER5: Frame grid shielded triode
6EH7/EF183: Frame grid pentode for IF, remote cut-off
6EJ7/EF184: Frame grid pentode for IF, sharp cut-off

RECTIFIERS

6AQ8/ECC85: Dual triode for FM tuners
6DC8/EBF89: Duo-diode pentode
6V4/EZ80: Indirectly heated, 90 mA
6CA4/EZ81: Indirectly heated, 150 mA
5AR4/GZ34: Indirectly heated, 250 mA

INDICATORS

6FG6/EM84: Bar pattern
IM3/DM70: Subminiature "exclamation" pattern

SEMICONDUCTORS

2N1517: RF transistor, 70 mc
2N1516: RF transistor, 70 mc
2N1515: RF transistor, 70 mc

IN542:

Matched pair discriminator diodes

IN87A:

AM detector diode, subminiature

Remove R10, R11 and C6 from the circuit board and add a jumper from the collector of V2 to the base of V3.

Change the BLEND control to a 500,000-ohm inverse-log potentiometer and connect this control between the C1, S1-a junction on each channel.

If wider BALANCE range is desired, the balance controls may be increased to 5,000 ohms. DANIEL E. MEYER

Southwest Research Institute
San Antonio, Tex.

[We wish to stress that these changes are not mandatory to get a properly operating preamp. But they may help improve the unit's operation and sound quality.—Editor]

MAIL FOR THE MAJOR

Dear Editor:

The ideas advanced by Major W. M. Price in regard to the so-called Philadelphia Plan of retail-wholesale parts sales (RADIO-ELECTRONICS, November, 1960) are strictly old-hat and not very apt.

In practice, I doubt that any wholesaler is making any payments to service technicians on such sales, despite the beautiful plan which has been presented. I personally called one distributor's attention to three sales which he had made to an auto mechanic (who brought the parts to me for installation), but I have yet to see a check, even though I have an open account which is in full effect.

Actually, there is a good basis for such a plan. Ethical wallpaper suppliers have been making such payments for years. In fact, they usually ask the name of your paperhanger, in order to make the payments, though he may not be a customer of theirs.

Auto parts, an example used, are almost never sold at a discount to do-it-yourselfers, but carry full list from ethical parts distributors. Note the word ethical—this does not cover Pep Boys, Straus Auto or mail-order houses. Sears lists about 40 pages of auto parts, at prices close to wholesale, so home repairs to autos may be bigger than the major realizes.

Years ago parts sales got off to a bad start, and it will take heroic efforts to correct the present abuses; perhaps they can never be corrected. But I feel that any plan aimed in that direction is better than none at all. The argument that we technicians do not carry adequate stocks is just so much eye-wash. What garage carries spare generators, carburetors, etc. in stock, other than a dealer of a specific line, who may be likened to a brand-line distributor? H. L. MATSINGER

Philadelphia, Pa.

Dear Editor:

In answer to Major Price's letter, I'm going on record as agreeing with him 100%.

One thing we do not have to fear in this business is tube changers. Sooner or later the customer realizes there is more to TV repair than that. The only thing we have to sell is service—the ability to service a set for maximum performance and minimum call-backs.

Look what's ahead in Radio-Electronics

NEXT MONTH . . .

- Servicing Photoflash Equipment
- Tunnel Diode CW Transmitter
- Wideband AC Voltmeter
- Troubleshooting Sync Stages

MARCH issue of Radio-Electronics on sale February 16 at newsstands and parts distributors

Subscription Rates
2 years \$9

3 years \$12

1 year \$5

154 West 14th St., New York 11, N.Y.

Learn RADIO, TELEVISION AND ELECTRONICS by Practicing at Home in Your Spare Time

At No Extra Cost you get specially developed Electronic Training Kits for practical experience. Shop and laboratory practice at home make learning easier, interesting, faster. You do not need a high school diploma or previous experience.

Increasing Demand for Trained Men

This is the Electronics age. Men with Electronic know-how are in demand. They enjoy high pay and growing opportunities for advancement. Satellites, Radar, Automation in Industry, Missiles, Rockets, Planes, Stereo, TV, Radio, Two



Way Communications for transportation are a few of the fantastic developments in the fast growing Electronics industry. If you are not completely satisfied with your work; if you are doubtful about your future, investigate Electronics.

High Pay, Prestige, Bright Future

What branch of Electronics interests you? Thousands of successful NRI graduates prove that NRI's learn-by-practice method is the way to success. You start in your chosen career way ahead of the man who only learns from books. You do not need to give up your job. You do not need to go away to school. You learn at home, get practical knowledge from training kits NRI provides.



Train With the Leader

NRI is the world's oldest and largest home study Electronics school. You benefit from the experience NRI has gained from training men for 45 years. NRI offers you proven courses of home study in Electronics; Principles, Practices and Maintenance—Radio Television Communications—Radio Television Servicing.

Start Soon to Earn More

Soon after enrolling NRI shows you how to apply your knowledge to earn extra money doing Electronics repairs or servicing Radio and Television sets for friends and neighbors. Take the first step toward success now. Find out what NRI offers you. Mail the postage-free card. No obligation. Cost of NRI training is low. Monthly payment plan available. NATIONAL RADIO INSTITUTE, Washington 16, D.C.

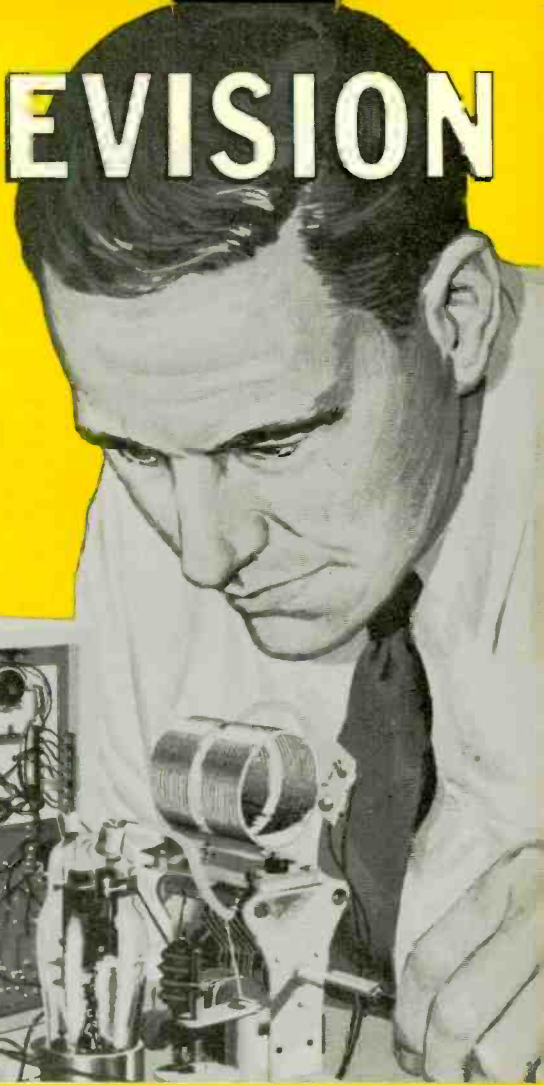
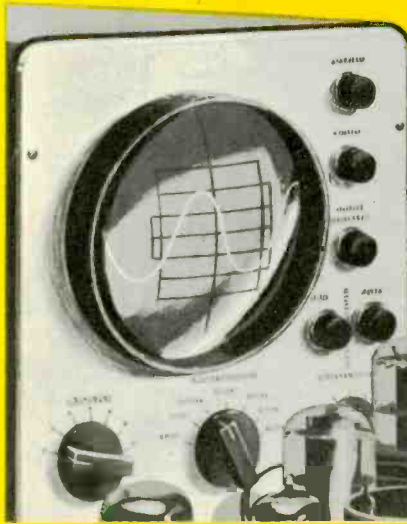

NRI Has Trained Thousands for Success



"I get over twice the salary I made before enrolling. NRI training gave me a thorough understanding." H. ATKINSON, Austin, Tex.



"I started with station CJIC, now in charge of sound effects for CBC. NRI opened doors to greater opportunity for me." F. W. TUDOR, Toronto, Ontario



"Averaged \$150 a month spare time before I graduated. Now have my own full time business and employ 2 men." F. W. COX, Hollywood, Cal.

NEW COURSE IN ELECTRONICS TURN PAGE

Cut Out and Mail—No Stamp Needed

64-PAGE CATALOG FREE

No Salesman will call. (Please PRINT) Z

Name _____ Age _____

Address _____

City _____ Zone _____ State _____

OLDEST & LARGEST HOME STUDY RADIO-TV SCHOOL
National Radio Institute
WASHINGTON 16, D. C.
ACCREDITED MEMBER NATIONAL HOME STUDY COUNCIL

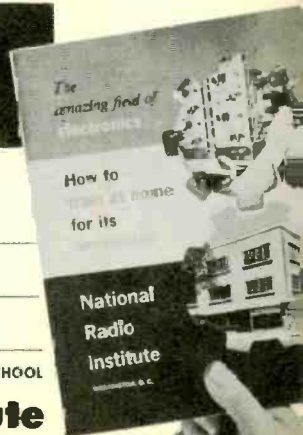



JOB COUNSELORS ADVISE LEARN ELECTRONICS

PRACTICE WITH
17" TV RECEIVER

PRACTICE WITH
LOW POWER TRANSMITTER

PRACTICE WITH ULTRA
HIGH FREQUENCY OSCILLATOR

SPECIAL TRAINING KITS NO EXTRA COST

PRACTICE WITH
D'ARSONVAL TYPE VOLTMETER

PRACTICE WITH
AC-DC RECEIVER

NEW Home Study Course in **ELECTRONICS** Principles-Practices-Maintenance **NOW READY**

This is the Electronic Age. Electronic equipment is already being used to count and control flow of liquids, solids, gases. Electronics is employed to search for oil, make surveys, control traffic, machine complex parts and in atomic installations. Military uses of Electronics are great and expanding rapidly. In business, Automation with Electronics plays an important part, prepares payrolls, calculates engineering formulas.

Learn More to Earn More
Now, to meet the growing demand for trained Electronic Technicians NRI has developed a comprehensive, complete course in Electronics Principles, Practices, Maintenance. This training stresses fundamentals. It is a course specially prepared for beginners and for Technicians. You get both theory and practical experience in an interesting, exciting way.

Ten Special Training Kits Give Practical Experience

You get practical experience with Thyatron Tube circuits, Multivibrators, build a D'Arsonval type Vacuum Tube Voltmeter (Kit 2); work and experiment with pentode tubes, selenium resistors, oscillators, transistors, magnetic amplifiers; and get practical experience in telemetry circuits as used in earth satellites, digital and analog computers (Kit 9).

NRI — Oldest and Largest School

Wishing for success won't bring success. You must act. Get FREE 64-page Catalog from America's oldest and largest home study Electronic-Radio-Television school. It gives facts, opportunities in Industrial and Military Electronics careers, also shows what you learn, tells about NRI's other courses in Radio Television Servicing and Radio Television Communications. Monthly payments plan. Mail Postage Free Card for 64-page Catalog.

NATIONAL RADIO INSTITUTE, Washington 16, D.C.



← SEE OTHER SIDE →

FIRST CLASS
Permit No. 20-R
(Sec. 34.9, P. L. & R.)
Washington, D.C.

BUSINESS REPLY CARD
No Postage Stamp Necessary if Mailed in the United States

POSTAGE WILL BE PAID BY

National Radio Institute
3939 Wisconsin Avenue
Washington 16, D.C.

**POSTAGE FREE CARD
MAIL NOW**

It would be nice to make a profit on every job, but I find myself taking a beating on some jobs in the hope that I'm making a satisfied customer. Chances are I'll never be rich, but like the man says "It's only money."

I. J. OSBORNE

7-11 Home Entertainment Servicing
Pico Rivera, Calif.

Dear Editor:

After reading Major Price's opinion of the Philadelphia Plan in the November 1960 Correspondence Column, I have come to agree with him. The average technician has an inborn fear of something, but he is unable to put his finger on it. After all this is a free country and a person has the right to do as he pleases if it is within the law, and certainly buying supplies from the large dealers he calls wholesalers is. Also, if you approached the average shop for parts, nine times out of ten he doesn't have what you need in stock.

THOMAS FEEMY

Rutherford, N. J.

Dear Editor:

Some courageous distributor defied the major's (Major William M. Price, Correspondence, November 1960) authority and refused to sell him tubes at wholesale prices!

May I suggest he has oversimplified the subject? Perhaps he hasn't tried to make a living from consumer service lately and he may have overlooked developments in the industry during the past 10 years.

Since he doesn't state the source of his information on operation of TV shops and garages, it is difficult to evaluate the validity of his analogy and conclusions.

The sinister reference to "kickback gimmicks" intrigues me. It suggests that we are missing out on a bonanza when we are satisfied with the standard industry discounts. Be specific, major; tell exactly what you mean by the "kickback gimmick."

The men who repair are the lowest paid group in nearly any industry, and TV is on the bottom. Hourly wages according to census and survey figures for the electronics service industry place consumer service at the bottom of the scale.

Since our industry is in the adolescent stage of growth, our attempts to improve our status are disorganized and unsophisticated. Uniform standards must wait on maturity.

During our painful growth, we must expect bitter criticism whenever we oppose the "dual-function jobbers."

The Philadelphia plan isn't an insidious plot to force the major to pay retail prices. I'm sure he has several mail-order catalogs in his desk and may order to his heart's content.

Jobbers need dealers and the Philadelphia plan gives dealers a big prestige boost by preventing the prostitution of fair market value of products with indiscriminate price cutting.

JOHN A. DOYLE

Bath, Me.

END



New kind of KIT from H. H. Scott...

**EASY-TO-BUILD 72 WATT
STEREO AMPLIFIER KIT
LOOKS AND PERFORMS
LIKE FACTORY-
BUILT UNITS!**

\$149⁹⁵*

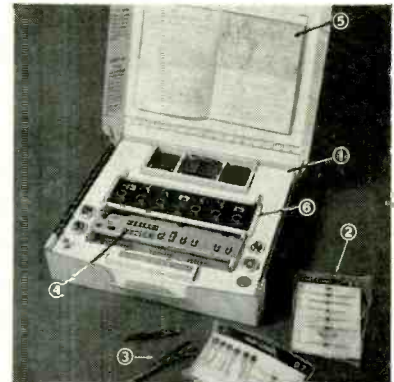

Here's the kit that makes *you* a professional. Beautifully designed, perfectly engineered, and so easy to wire that you can't go wrong. In just a few evenings you can build a professional 72 watt H. H. Scott stereo amplifier . . . one so good it challenges factory-assembled units in both looks and performance.

H. H. Scott engineers have developed exciting new techniques to ease kit-building problems. The Kit-Pak container unfolds to a self-contained worktable. All wires are pre-cut and pre-stripped. Parts are mounted on special cards in the order you use them. All mechanical parts are pre-riveted to the chassis.

Build a new H. H. Scott LK-72 for yourself. You'll have an amplifier that meets rugged IHFM specifications . . . one that delivers sufficient power to drive *any* speaker system . . . one that's professional in every sense of the word.

TECHNICAL SPECIFICATIONS: Full Power Output: 72 watts, 36 watts per channel • IHFM Power Band: extends down to 20cps • Total Harmonic Distortion: (1kc) under 0.4% of full power • Amplifier Hum Level: better than 70db below full power output • Tubes: 4 - 7591 output tubes, 2 - 7199, 4 - 12AX7, 1 - 5AR4 • Weight of Output Transformers: 12 pounds • Amplifier fully stable under all loads including capacitive • Dimensions in accessory case: 15½ w, 5¼ h, 13¼ d. Size and styling matches H. H. Scott tuners.

IMPORTANT FEATURES OF THE NEW H. H. SCOTT LK-72 COMPLETE AMPLIFIER 1. Unique Kit-Pak container opens to a convenient worktable. Folds up at night like a suitcase. 2. Part-Charts — All parts mounted in order of installation. No sifting through loose parts. 3. All wires pre-cut, pre-stripped to cut assembly time. 4. Mechanical parts all pre-mounted. Tube sockets and terminal strips riveted to chassis. 5. Easy-to-follow full color instruction book. 6. Special features include: Center Channel Level control; Scratch Filter; Tape Recorder Monitor; Separate Bass and Treble on each channel; DC operated heaters for lowest hum.

**Slightly higher west of the Rockies.*

H. H. SCOTT

H. H. SCOTT INC., DEPT. 570-02
111 POWDERMILL ROAD • MAYNARD, MASS.

Rush me complete details on your new LK-72 Complete Amplifier Kit, LT-10 FM Tuner Kit, and Custom Stereo Components for 1961.

Name.....
Address.....
City.....State.....

Export: Telesco International Corp.
36 W. 40th St., N. Y. C.



Very Hot News . . . from hallicrafters

Two great new kits... a complete, high-performance AM/CW station,
from the world's most experienced designers of short wave equipment

HALLIKITS, we call them—a completely new concept of kit engineering that brings to your workshop, for the first time, these two outstanding advantages:

First, the unparalleled design experience of Hallicrafters' communications labora-

tories; and *second*, production-line proof of "Constructability" *before you buy*.

Have a wonderful time! Save a bundle of money! End up with a station the most experienced amateur would be proud to call his own.



HT-40 TRANSMITTER, \$79.95

A perfect match for the handsome SX-140, both in quality and appearance. Hallicrafters' transmitter leadership is evident in every precision-engineered feature of this crystal-controlled 75-watt beauty—features as important to old-timers as they are to novices.

- **FEATURES:** You get excellent CW performance as well as AM. Full band switching, 80 through 6 meters. Enjoy easy tune-up and crisp, clean styling that has efficient operation as well as appearance in mind. Unit is fully metered, TVI filtered.
- **SPECIFICATIONS:** Maximum D.C. power input: 75 watts. Power output in excess of 35 watts CW, 30 watts peak AM phone. (Slightly less on 6 meters.) Frequency bands: 80, 40, 20, 15, 10 and 6 meters.
- **TUBES AND FUNCTIONS:** 6DQ5 power output; 6CX8 crystal oscillator and driver; 12AX7 speech amplifier; 6DE7 modulator; silicon high voltage rectifiers.
- **FRONT PANEL:** Function (AC off, tune, standby, AM, CW); Band Selector (80, 40, 20, 15, 10, 6); Drive control; Plate tuning, plate loading, Crystal-V.F.O.; Grid Current; Meter; AC indicator light; RF output.
- **REAR CHASSIS:** Microphone gain; antenna co-ax connector; remote control terminals; AC power cord.



SX-140 RECEIVER, \$94.95

Doesn't it make sense to team up your skill with the experience of a company who has designed and built more high-performance receivers than any other in the world? Especially when the result is the *lowest-priced amateur band receiver available?*

- **FEATURES:** You get complete coverage of all amateur bands 80 through 6 meters, with extremely high sensitivity and sharp selectivity. Unit has RF stage; S-meter; antenna trimmer; and XTAL calibrator. Tuning ratio is 25 to 1.
- **CONTROLS:** Tuning; Antenna Trimmer; Cal. Reset; Function (AC off, standby, AM, CW-SSB); Band Selector; Cal. on/off; RF Gain; Auto. Noise Limiter on/off; Selectivity/BFO; Audio Gain; phone jack; S-meter Adj.
- **TUBES AND FUNCTIONS:** 6AZ8 tuned RF amplifier and crystal calibrator; 6U8 oscillator and mixer; 6BA6 1650 kc. IF amplifier and BFO; 6T8A 2nd detector, A.V.C., ANL and 1st audio; 6AW8A audio power amplifier and S-meter amplifier; (2) silicon high voltage rectifiers.

P.S. Both units are available fully wired, and tested. SX-140, \$109.95. HT-40, \$99.95.

halli-kits from  hallicrafters

Chicago 24, Illinois

... where the new ideas in communications are born!

Export Sales: International Div., Raytheon Co., Waltham, Mass. Canada: Gould Sales Co., Montreal, P.Q.

*dedicated
to
perfection*

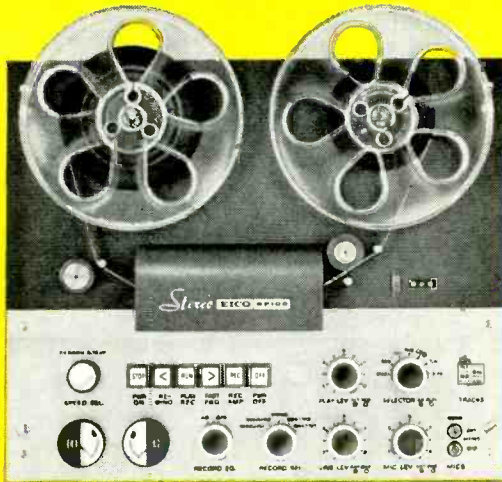

4-TRACK STEREO TAPE DECK

MODEL RP-100W

Completely assembled, wired and tested. **\$395.00**

MODEL RP-100K

Semi-kit includes a completely assembled and tested transport, electronics in kit form. **\$289.95**

Perfected 4-track stereo/mono recording, 4 & 2 track playback. True high fidelity transistor electronics, individual for record & playback, plus separate record & playback heads permitting off-the-tape monitor. 2 recording level meters, mixing, mic & level controls, switched sound-on-sound recording. Electrodynamically braked supply & take-up reel motors; hysteresis synchronous capstan motor. Individual solenoids for pinch-roller & tape lifters. All-electric, interlocked push-button transport control & interlocked safety "record" pushbutton. Precision tape guidance & sweep loading — no pressure pads. No slurring or tape bounce problems. Digital turns counter. Vertical or horizontal mounting. Modular plug-in construction. An original, exclusive EICO product designed & manufactured in U. S. A. (patents pending).

NEW MEDALIST LINE

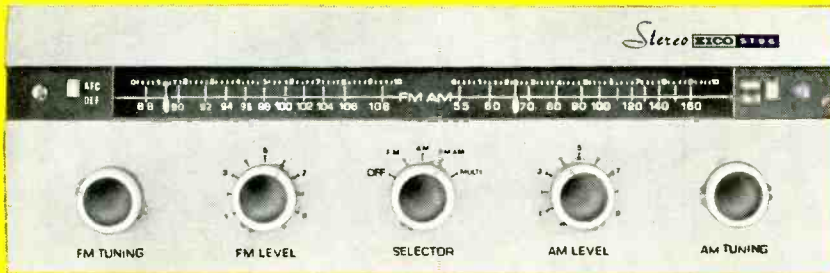

FM-AM STEREO TUNER ST96

Kit \$89.95 Includes Metal Cover and FET Wired \$129.95

FM and AM stereo tuners on one compact chassis. Easy-to-assemble; prewired, prealigned RF and IF stages for AM and FM. Exclusive precision prewired EYE-TRONIC® tuning on both AM and FM.

FM TUNER

Switched AFC (Automatic Frequency Control). Sensitivity: 1.5uv for 20db quieting. Frequency Response: 20-15,000 cps ±1db.

AM TUNER

Switched "wide" and "narrow" bandpass. High Q filter eliminates 10 kc whistle. Sensitivity: 3uv for 1.0V output at 20db S/N ratio. Frequency Response: 20-9,000 cps ("wide"); 20-4,500 cps ("narrow").

OF EICO STEREO



70-WATT INTEGRATED STEREO AMPLIFIER ST70

Kit \$94.95 Includes Metal Cover Wired \$144.95

40-WATT INTEGRATED STEREO AMPLIFIER ST40

Kit \$79.95 Includes Metal Cover Wired \$124.95

BOTH AMPLIFIERS: Complete stereo centers plus two excellent power amplifiers. Accept, control, and amplify signals from any stereo or mono source.

ST70: Cathode-coupled phase inverter circuitry preceded by a direct-coupled voltage amplifier. Harmonic Distortion: less than 1% from 25-20,000 cps within 1db of 70 watts. Frequency Response: ±½db 10-50,000 cps.

ST40: Highly stable Williamson-type power amplifiers. Harmonic Distortion: less than 1% from 40-20,000 cps within 1 db of 40 watts. Frequency Response: ±½db 12-25,000 cps.

Over 2 MILLION EICO instruments in use. Most EICO Dealers offer budget terms.

There's an EICO for your every stereo/mono need. Send for FREE catalog.

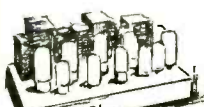

Listen to the EICO Hour, WABC-FM, N. Y. 95.5 MC, Mon.-Fri., 7:15-8 P.M. © 1961 by EICO, 33-00 N. Blvd., L. I. C. 1, N. Y.



EICO, 3300 N. Blvd., L.I.C. 1, N. Y. C-2
 Send free 32-page catalog & dealer's name
 Send new 36-page Guidebook to HI-FI for which I enclose 25¢ for postage & handling.

Name
 Address
 City Zone State

Add 5% in West. Turn Page For More EICO Values.

EXPORT: Roburn Agencies, Inc., 431 Greenwich St., New York 13, N. Y.

UPHEAVAL IN ELECTRONICS

... *Future Electronic Devices Border the Incredible* ...

JUST as electronics of today bears no resemblance to electronics of 50 years ago, the present art cannot be compared to electronics 50 years hence.

And if we consider the ultra-rapid advances during the last 10 years, since the advent of the transistor, we know that we cannot possibly comprehend the potential electronic evolution of the next 50 years. At best, we can glimpse only dimly a few of the future evolvments.

We are now at the beginning of a new upheaval: Microelectronics.* The new art of making practically all electronic components of almost invisible thin films, only a few molecules thick, is already well established. While the components are still not available commercially, many are already orbiting around the earth in our recent satellites and are performing well. It is certain that a large number of electronic microcomponents will be on the market before 1965.

Already the transistor is beginning to be eclipsed in certain directions by the maser and the tunnel diode. Even more promising is the recent newcomer, the yet unnamed cross-film, solid-state cryo-electronic (from the Greek, *cryos*, cold, freezing) device of inventor Ivar Giaever, of General Electric. This new device, a versatile simple component functions at once as a switch, diode, negative-resistance diode, triode, resistor or capacitor!†

Future compact components such as the Giaever device, smaller than a dime, will probably replace the usual radio chassis.

The reader will object to such a prediction because the new device is cryo-operated. It functions only in intense cold, at a temperature of 1.2° Kelvin, near absolute zero, in the vicinity of -459°F.

That means a flask of supercooled helium is needed—a large and cumbersome adjunct, without which a superconductor cannot function. At least not now. Yet in the future we will have purely electronic superconductors without benefit of helium flasks or chemical or mechanical makeshifts.

Curiously, the first pure cryo-electronic device was invented by the French physicist, Jean Charles Athanase Peltier (1785-1845). He made a cross of square antimony and bismuth rods, which, when

connected to a battery, reduced the temperature at the junction to -4.4°C (24.1°F). Today we have reached much lower temperatures with newer metal alloys in the evolution of new nonmechanical air-conditioning and other cooling devices.

It seems quite certain that in the future we will see very efficient semiconductor cryo-electronic units that will be very compact and efficient. There seems to be no good scientific reason why we will not have microcryo-electronic units the thickness of a dime, built up of films of molecular thickness that produce the necessary Kelvin temperature for superconductors.

What will be the advances in loudspeakers? They, too, will shrink in size. Even today we have radios with loudspeakers (for the near deaf) that are so small that they fit within the ear cavity. There seems to be no reason why we will not have small electrostatic speakers the size of a dime, made from a plurality of metal or semiconductor films. Such speakers, despite their minute size, will be able to function well in the open, perhaps better than our large speakers of today. If one realizes how minute a child's whistle is, yet how loud it sounds, one should not conclude that miniature audio devices are not technically feasible.

While the sensitivity of our detecting devices has constantly been increased and while the gain of our amplifiers has been pushed higher and higher, we are still at the very beginning of the art of detection and amplification.

In the not too distant future, we should be able to speak to the antipodes with a two-way pocket radio, battery-operated, the size and thickness of a matchbook, including batteries. It will also be practically noise-free.

There will not be a large demand for antipodal radios—it is simply given here as an illustration of what *can* be done in the future.

Actually, such diminutive radios will probably be carried by citizens for protective purposes, against holdups, robberies and general crimes. Hidden under clothing, the set can be turned on when necessary. Such transceivers will be monitored by police stations or by the policeman on the beat. Help can thus be summoned within seconds. Such devices will certainly be crime preventors, when universally adopted.—H.G.

*See editorial, "Microelectronics," February 1960, RADIO-ELECTRONICS.

† See RADIO-ELECTRONICS, January 1961, page 12.

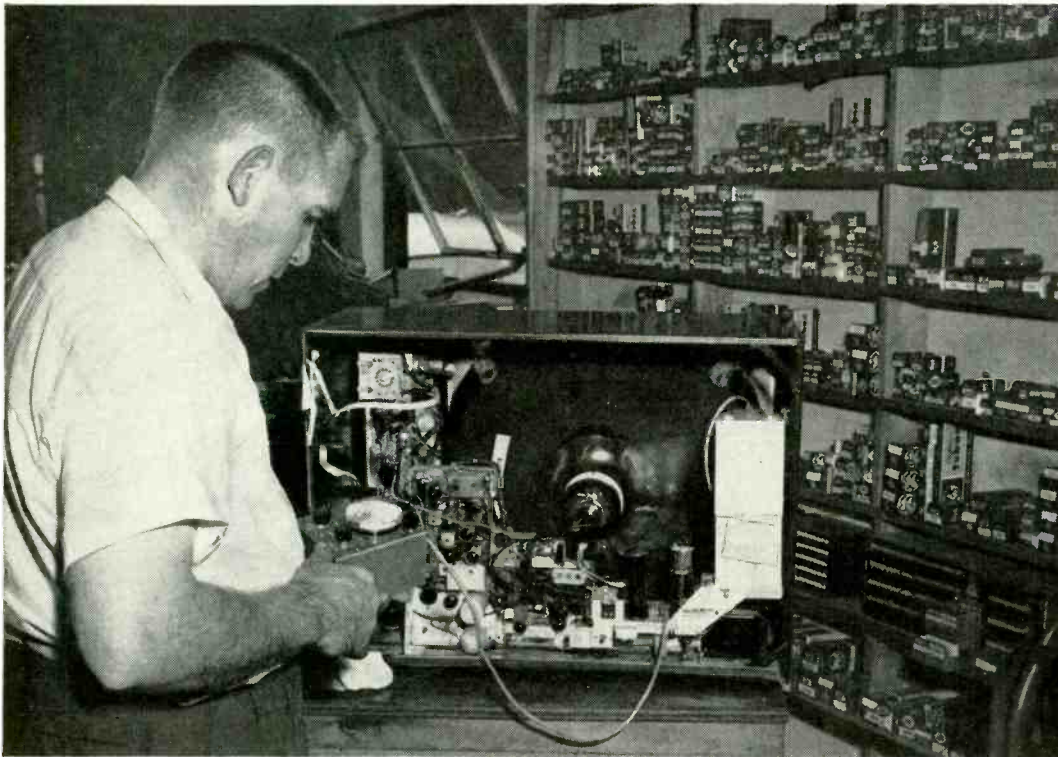

Wayne Lemons using his HSCA to check the horizontal section of a TV receiver.

you can build a TOP CHASSIS horizontal sweep analyzer

Simple to make, easy to use unit speeds horizontal sweep circuit troubleshooting

By **WAYNE LEMONS**

THIS horizontal sweep circuit analyzer (I call it the HSCA) provides a quick and simple method of dividing the horizontal circuit, so you can tell in which direction to troubleshoot.

It also tests circuit performance so that many callbacks may be eliminated. And all this without pulling the chassis.

Parts to build this unit are standard and easily obtained. Calibration is simple. When you get the analyzer built, you'll find it one of the most frequently used pieces of "nonstandard" test equipment. The HSCA will give you an insight into the horizontal circuit that can't be duplicated by any but the most specialized horizontal circuit test instruments.

The HSCA makes four tests at the horizontal output tube:

- ▶ Cathode current.
- ▶ Screen voltage.
- ▶ Oscillator output.
- ▶ Horizontal oscillator frequency.

All four tests are made by simply removing the horizontal output tube (6BQ6, 6CD6, 6AV5, etc.) and plugging it into the HSCA adaptor socket—then plugging the adaptor socket back into the television set. The **HORIZ TYPE** switch is set to the correct position and the TV set is turned on.

The circuit

The horizontal output tube's cathode current is measured by determining the voltage drop across a 5-ohm resistor (R1) placed in series with the cathode (Fig. 1-a). A 20,000-ohm pot (R5) acts as a meter multiplier resistance.

The horizontal output tube screen voltage is measured from either pin 4 or 8 (depending on the tube type) to the cathode. The meter multiplier is a 4.7-megohm resistor (R3) in series with R4, the 1-megohm screen voltage calibrating pot (Fig. 1-b).

The horizontal oscillator output is measured across a 39,000-ohm resistor (R2) placed in series with the cathode

of the horizontal output tube. A 1-megohm pot (R7) is used to calibrate the circuit (Fig. 1-c). When an adapter cable is used, this method of checking oscillator output is more satisfactory than attempting to check from the grid circuit. Any try at reading the ac oscillator output from the grid loads the grid circuit with the capacitance of the adapter cable.

Instruments such as the Doss Pioneer 250 Horizontal Sweep Quantalyst do measure the dc drive from the grid circuit by placing the meter multiplier in the socket adapter. This method effectively isolates the cable capacitance from the grid but makes parasitic oscillations possible unless special techniques are used.

The only disadvantage of measuring the horizontal oscillator output from the cathode of the horizontal output tube is that there must be some current in the horizontal output tube. This is the reason for the sequence of tests in the HSCA. If there is no cathode cur-

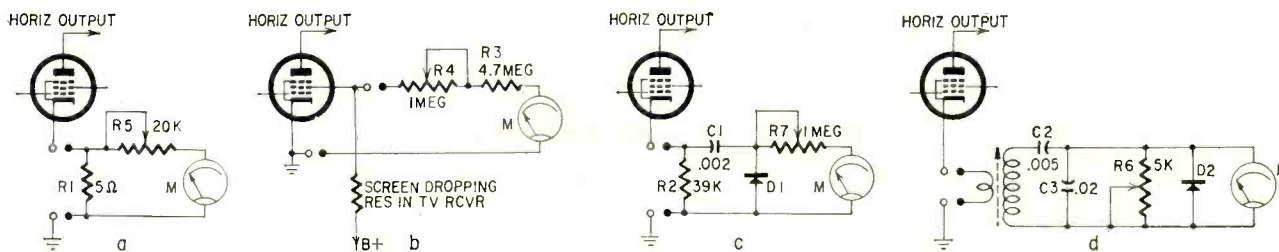

Fig. 1—Simplified circuit of each test the HSCA performs: a—cathode current; b—screen voltage; c—horizontal oscillator output; d—horizontal oscillator frequency.

rent in the first check, then of course there will be no apparent oscillator output, nor frequency for that matter.

Horizontal oscillator frequency is measured by passing the cathode current through a one-turn loop placed around a standard horizontal ringing coil. A capacitance divider, C2 and C3, is placed across the ringing coil to produce a resonant circuit at 15,750 cycles. Diode (D2) and a 5,000-ohm sensitivity control (R6) along with the meter are placed in parallel across the .02-μF capacitor (C3) in the capacitance divider (Fig. 1-d). At resonance, the circulating current is maximum in the circuit. This in turn causes the meter to read maximum or to peak when the horizontal oscillator in the TV set is operating at the correct frequency.

Construction

The HSCA is built into a 5 x 4 x 3-inch case. The size is not important (except as a minimum) and neither is the parts layout. The complete circuit is shown in Fig. 2.

The case is not connected to the common return and actually floats although, if desired, it could be made completely cold by using a .05-μF capacitor and a 100,000-ohm resistor in parallel between the box and common. The case is left floating because some sets do not use the chassis as the common return. In this event a short might occur if the HSCA were brought in contact with the chassis. The common tie point is the negative terminal of the meter.

Perhaps the most difficult thing about the HSCA to build is the adapter socket. Fig. 3 shows it ready to be assembled. Note the staggered length jumper wires on socket SOC. They make it easier to thread them into the pins of plug PL. The five-wire cable should enter PL between pins 1 and 2. Two wires from the cable are soldered to pins 3 and 8 of PL. The three remaining cable wires are soldered to SOC after the jumper wires are threaded into PL just before the two are pushed completely together. Last, SOC and PL are pushed tightly together and the jumpers are soldered into place. Excessive wire protruding through the pins is clipped flush. Make sure none of the cable wires come near jumper wire 5 during final assembly. Pin 5 is hot with rf when single-ended horizontal output tubes are being tested.

The meter used was a surplus unit with 100-μA sensitivity. However, less

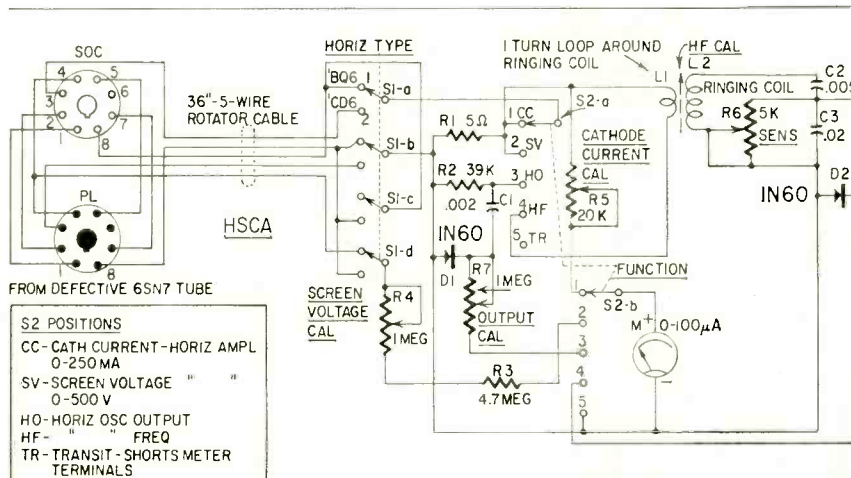

Fig. 2—Circuit of the horizontal sweep circuit analyzer.

sensitive meters might be used by calculating the proper value multipliers. The sensitivity of the frequency-measuring circuit may be increased by making L1 a three- or four-turn winding and lowering the capacitance of C3 to .01 μF.

None of the resistance values are critical except perhaps R3, which should measure near its 4.7-megohm value. Otherwise it may prevent your calibrating the screen voltage circuit properly.

Capacitor C2's size may have to be juggled a little if you cannot get the circuit to resonate at 15,750 with a particular ringing coil. If you use the Thordarson HS-5 or an equivalent, you should have no difficulty using just about any .005 capacitor.

Calibration

To calibrate the cathode current position:

Open the jumper between S1-a and S2-a's rotors and insert an accurate milliammeter. (Most shop vom's have milliamper positions and are sufficiently accurate.) Now connect the HSCA to any TV set that is in good working order. Adjust R5, the cathode-current calibrating pot, for the same current reading as indicated by the milliammeter used for calibration. Full-scale meter reading should be 250 or 300 ma, depending upon the meter used. In our unit, the meter has scale divisions of 0-25, so we used 250 ma. Most TV sets using 'BQ6 type tubes will draw from 90 to 105 ma. Sets using 'CD6 types may draw as much as 180 ma.

Horizontal output screen voltage is calibrated with an accurate vom or vtvm. Hook up the HSCA to a normally operating set and measure the screen

- R1—5 ohms, 1 watt
- R2—39,000 ohms, 1 watt
- R3—4.7 megohms, 1 watt
- R4—pot, 1 megohm, linear taper
- R5—pot, 20,000 ohms, linear taper
- R6—pot, 5,000 ohms, linear taper
- R7—pot, 1 megohm, linear taper
- C1—.002 μF, 600 volts, paper
- C2—.005 μF, 500 volts, ceramic, 10%
- C3—.02 μF, 100 volts, ceramic
- D1, 2—1N60
- L1—1-turn loop of hookup wire around L2
- L2—TV ringing coil, 10-50 mh (Thordarson HS-5 or equivalent)
- M—meter, 0-100 μA (preferably with 0-250 or 0-500 or decimal equivalent scales)
- PL—male octal plug (can be made from discarded 6SN7)
- S1—4-pole 2-position, rotary
- S2—2-pole 5-position, rotary
- SOC—female octal socket
- Case, 3 x 4 x 5 inches (or larger)
- Miscellaneous hardware

voltage between the switch rotor terminals of S1-a and S1-d. Then adjust the screen-voltage calibrating pot R4 for the correct reading on the HSCA. This time use, if possible, 500 volts as full scale. The multiplier resistances shown were selected for this full-scale reading.

To calibrate the horizontal oscillator output, use a 110° set if possible. Install a new oscillator tube and then rotate horizontal-oscillator calibrating

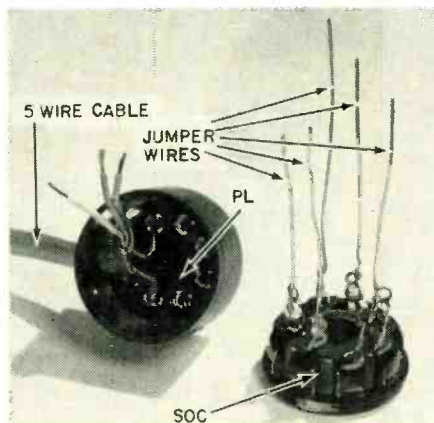

Fig. 3—The socket adapter shown ready for final assembly. See text for details.

pot R7 until the HSCA meter reads about 75% to 80% of full scale. Then check several other sets with the same and different deflection angles. Sets with smaller deflection angles will read correspondingly less on the meter as a general rule. Using the HSCA on several sets will give you the feel of the instrument so you can determine whether there is enough horizontal output to produce high voltage. NOTE: the raster disappears in this position because the horizontal output cathode has a high resistance (39,000 ohms) in series with it.

Calibrating the horizontal oscillator frequency is simplicity itself. With the HSCA connected to a normally operating set, lock in the picture horizontally and turn the HSCA's ringing-coil slug until the meter reads maximum. If the meter deflects off scale, use the sensitivity control to bring it back in range. The HSCA is now ready for use in repairing and adjusting horizontal sweep circuits.

Troubleshooting with the HSCA

Remove the horizontal output tube and insert the HSCA adapter in its place. Then plug the output tube into the adapter. Now we can start checking.

Move the function switch to position 1, cathode current (CC). Read the cathode current. It should be about 90 to 105 ma for 'BQ6, 'BG6, 'AU5 and 'AV5 types; 100 to 140 ma for 'DQ6 types, and 110 to 180 ma for 'CD6, 'DN6 and 'EX6's. If cathode current is low, it may be caused by a defective tube, low screen voltage, a cathode resistor changed higher in value, no plate voltage or low B-plus. High cathode current is usually caused by a defective tube, high screen voltage, little or no oscillator output, a leaky coupling capacitor, shorted turns in the flyback or yoke, a shorted width coil or capacitor, a shorted boost capacitor.

A shorted boost capacitor is easily spotted by taking a resistance measurement between the plate and cathode of the damper tube socket. In most sets this resistance will be 200,000 ohms or more and, in any event, not less than 10,000 ohms. Check the schematic if the reading seems suspicious. Measuring this resistance will also spot a yoke that has broken down between horizontal and vertical windings.

Even if cathode current is high or low, it is a good idea to make the other three tests with the HSCA before doing further troubleshooting. The next three tests may pinpoint the trouble precisely.

Step 2 measures the screen voltage with the FUNCTION switch turned to SV. It should always be as low as is consistent with ample sweep width, and should never exceed about 175 (preferably 150) volts for all tube types except the 'BG6, which may operate normally with up to 375 volts on the screen.

High screen voltage is usually caused by a changed-value screen dropping resistor. If screen voltage is high, check this resistor with an accurate ohmmeter. Of course, a defective tube would also cause a high screen voltage read-

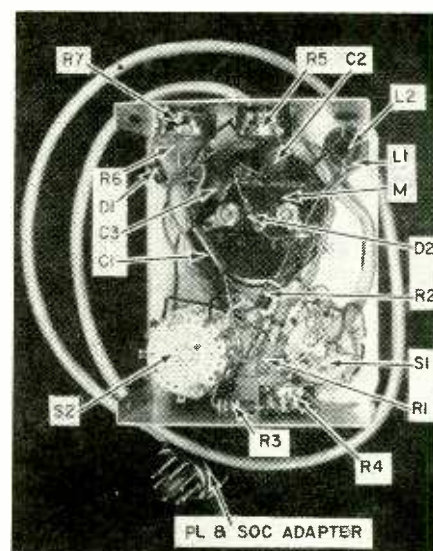
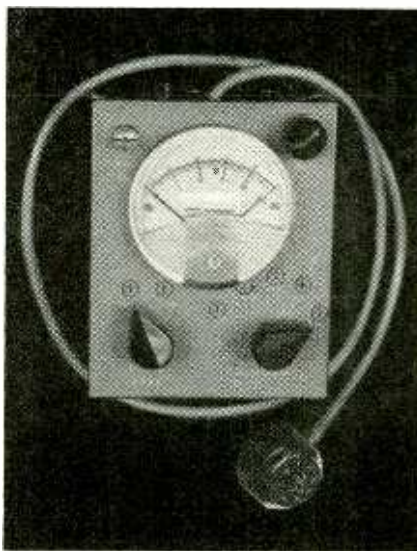

The completed horizontal sweep analyzer. Wiring layout inside the unit. S2 here is surplus 12-position 3-gang unit. Only 2 gangs are used and stop is set for 5 positions.

ing. Low screen voltage is most often caused by a defective tube, a changed-value screen dropping resistor, a shorted or leaky screen bypass capacitor, low B-plus or no plate voltage on the output tube.

Step 3 (S2 set to H0) measures the horizontal oscillator output. This test is especially important in determining whether there is enough drive to the horizontal output tube to develop high voltage. Readings should be 75% of full scale or more for 110° sets; over 60% for 90° sets; over 45% for 70° and over 25% for 50° sets. These are representative readings and depend upon the calibration of the HSCA. The meter will read zero if the oscillator is not working.

Use this position as a very accurate test of horizontal oscillator tubes. Because the cathode of the horizontal output tube is effectively open during this test, you may change horizontal oscillator tubes with the set turned on, without damaging the output tube. Install the new oscillator tube and see if the reading is greater than before. Also—and this is important—recheck step 1 for a change in cathode current. Often a new oscillator tube reduces the cathode current of the output tube from 5 to 20 ma, even though the old tube may seem to be operating properly.

Step 4 measures the horizontal oscillator frequency. This test is vital and is made with S2 turned to HF. Along with the output test, it can point the finger of suspicion either to or away from the horizontal oscillator circuit. Horizontal oscillator drift can also be determined using this test.

To determine whether the oscillator is at the correct frequency—simply rotate the horizontal hold control on the TV set while watching the meter. Maximum deflection will occur on the meter when the set's horizontal oscillator is at the correct frequency (15,750 cycles). If the meter deflects off scale, reduce sensitivity with R6. If there is sufficient horizontal oscillator output (step 3) and if the horizontal oscillator is at (or near) frequency, you can be

sure that any trouble in the horizontal sweep circuit is *not* in the horizontal oscillator but in the output, damper or high-voltage circuits. If, on the other hand, the horizontal oscillator cannot be brought on frequency, as noted by little or no deflection on the meter even at full sensitivity, or if there is insufficient output as registered by a low reading in step 3, the horizontal oscillator faults must be corrected before further tests are made on the sweep circuits.

Horizontal oscillator drift over long periods of time is almost undetectable with conventional test instruments. The HSCA may be used to monitor the oscillator frequency while you are busy elsewhere. Here's how it is done.

Set the HSCA function switch to step 4, horizontal frequency. Turn the set on and, with the channel selector set on an unused channel, turn the horizontal hold until the meter peaks. Now, using the sensitivity control, adjust the meter pointer for an arbitrary number on the meter, say 20. Let the set run for an hour or two or whatever. If the horizontal oscillator frequency changes, the meter reading will drop. Turning the set's horizontal hold control to repeat the meter will show you the circuit has drifted and about how much. If you must turn the horizontal hold control to lower its resistance, the oscillator has drifted low in frequency and vice versa.

Finding intermittents

A bonus feature of the HSCA is that the circuit in the TV set may be disturbed rather violently by opening the cathode repeatedly. Border-line components will nearly always break down under these conditions. So if you have an intermittently failing set or one that blows fuses occasionally, you can probably find the culprit fast with the HSCA. Function switch position 5 opens the cathode completely. Position 5 is the TRANSIT position for when you carry the HSCA on service calls. It shorts the meter, thereby damping the movement. END

HSCA TROUBLESHOOTING CHART

INDICATION	POSSIBLE TROUBLE	HOW TO FIND THE TROUBLE
------------	------------------	-------------------------

TEST 1 — CATHODE CURRENT

Excessive	Defective tube. Shorted boost capacitor. Leaky coupling capacitor. High screen voltage. Little or no oscillator drive. Shorted flyback or yoke. Shorted width coil. Shorted width capacitor.	Replace horizontal amplifier. Check for short between plate and cathode of damper tube. Open cathode (transit position) and measure for positive voltage on grid of horizontal amplifier. (Gassy tube will also show a positive voltage on grid with cathode open.) Measure, test 2. Measure, test 3. Disconnect yoke—if cathode current changes little, flyback is probably defective. Tests 2, 3 and 4 must be normal, however. Disconnect and check for high voltage. Disconnect and check with ohmmeter.
Low	Defective tube. Low screen voltage. Open yoke. Open yoke coupling.	Replace. Measure, test 2. Measure with ohmmeter. Shunt with good capacitor.
None	Defective tube. No B-plus.	Replace. Check fuse, etc.

TEST 2 — SCREEN VOLTAGE

Excessive	Defective tube. Screen resistor changed value.	Replace. Measure with ohmmeter.
Low	Defective tube. Screen resistor changed value. Leaky coupling capacitor. Little or no drive. Little or no plate voltage on horizontal amplifier. B-plus low.	Replace. Measure with ohmmeter. Check as noted in test 1. Check—test 3. Measure voltage with regular voltmeter only if no rf present. Check.
None	Open screen resistor. Shorted screen bypass capacitor. No B-plus.	Measure with ohmmeter. Measure with ohmmeter. Check in normal manner.

TEST 3 — OUTPUT

Little or none	Defective oscillator tube. Defective parts in oscillator circuit. Oscillator off-frequency. Open coupling capacitor. Shorted drive trimmer.	Replace. Make regular diagnosis. Measure—test 4. Shunt with good capacitor. Measure with ohmmeter.
(NOTE: No oscillator output will be registered by the HSCA if the horizontal output tube has no cathode current—test 1.)		

TEST 4 — FREQUENCY

Meter cannot be made to pass through a peak reading at any setting of the TV set's hold control.	Oscillator not at correct frequency.	Replace oscillator tube. Check all electrolytics in the oscillator circuit. Check for changed-value resistors or capacitors. If oscillator is multivibrator type, ground the sync input grid. If it returns to normal frequency, trouble is in phase comparator or sync circuit. Short out ringing coil with 1,000-ohm resistor. If oscillator returns to normal, check for defective ringing coil or capacitor, or misadjustment. For Synchronizers, short out phase adjusting coil and recheck frequency. Check also for leaky sync coupling capacitors, etc.
--	--------------------------------------	---

do it with DIODES

Diodes used to be rectifiers—now they are switches, amplifiers, voltage regulators and even capacitors

By **DONALD L. STONER**

WHAT is a diode? Once, this was an easy question to answer. But that was back when you could say that a diode is a device that lets a current flow in only one direction. Today, a diode might be a switch, an amplifier, a capacitor, a voltage regulator, a conductor of currents in more than one direction, or many things not even remotely associated with rectification! The once humble diode may be used to convert light into electricity, ring an alarm when frost threatens or catch burglars who are after the family valuables.

Let's take a look at the operation of a semiconductor junction diode. Such units consist of a sandwich of p- and n-type germanium or silicon. Impurities are added to the p-type material to make its atomic structure short in electrons. However, due to a sharing of electrons, the structure is still quite balanced. The opposite is true for the n-type material—the atomic structure has a surplus of electrons. When the two materials are joined, you might expect the surplus of electrons in one wafer to cross immediately to the other side and make up the deficit. This does not happen. Each material is electrically neutral or balanced and, if an electron from the n-material crossed to the p-material, each of the two pieces would take on a charge. The n-material, having lost an electron, would be positive and, of course, the p-material would be negative. Actually, a field or barrier is set up between the two pieces and

only the pressure of voltage will force the reluctant electrons across.

The barrier

We might consider the barrier as a little gap between two areas. We might even consider the gap an insulator (which it really is under certain conditions) and the two materials the plates of a capacitor. By applying a reverse bias (negative anode, positive cathode) to the two plates, the width of the gap or barrier can be altered. Thus we have a capacitor whose value can be changed by varying a dc bias applied to it. Naturally enough, if we reverse the polarity of the bias (positive anode, negative cathode), the barrier will break down and the diode will conduct. When alternating voltage is applied, the barrier is alternately broken down and then built up. Current flows only during the half-cycle the barrier is down.

The barrier capacitance is a very real and usable one. Several manufacturers have developed diodes especially for this purpose and have given them names to suggest their purpose. However, *all* germanium or silicon diodes exhibit this property and ordinary general-purpose diodes may be used by experimenters. (The diodes made especially for this application have excellent capacitance stability under varying temperature.)

The variable-capacitance diode lends itself to a variety of applications: automatic frequency control, sweep generators, remote tuning control, frequency modulation and others too

numerous to mention in the space available. Fig. 1 shows an experimental circuit for demonstrating the variable-capacitance effect. Naturally, to avoid rectification, the rf voltage must not exceed the dc bias. Audio applied across the bias will frequency-modulate the signal.

Diode switch

When a diode is forward-biased (positive anode, negative cathode), it actually becomes a conductor, just like a piece of wire. As such, it may be used to connect one component to another, like a switch. Audio or rf may be turned off and on so long as the signal through the diode does not exceed the bias voltage. When this happens, rectification will take place. When the diode is reverse-biased, the barrier is re-erected and no rf or audio can flow. The diode may therefore be used as a switch or, more correctly, as a relay.

Fig. 2 gives the general idea of a diode switching circuit. Of course, it is a simple matter to gang up sections to get any number of poles or functions.

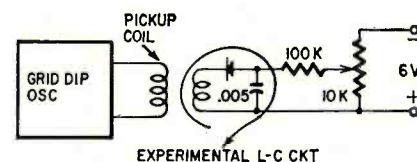

Fig. 1—A reversed-biased germanium diode acts as a variable capacitor. The 10,000-ohm pot varies the reverse bias and, thereby, the capacitance.

I have done this to replace an antenna relay. It has also been used in the place of a signal switching relay in radiotelephone equipment. The advantages of such a device will immediately be obvious. Hard-to-get-at circuits may be conveniently switched, antennas may be changed over up on the tower itself (using only one feed line), and even a receiver bandswitch (and its ganging problems) can be taken over by the diode switch.

The circuitry is simple, there are no moving parts to wear out, and dust

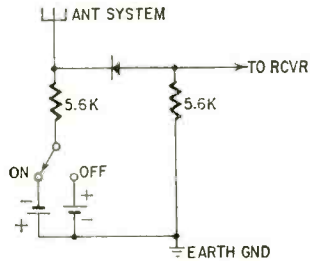

Fig. 2—When the switch is connected to negative end of battery, diode is forward-biased and signals flow from antenna to receiver. In other position, diode switch opens circuit.

cannot cause intermittent operation. The diode must be carefully chosen for each application, however. Silicon power diodes (currently available at low cost) may be used to switch a transmitting antenna. Germanium 1N34's can conveniently switch audio or rf in a high-impedance circuit. In fact, there is nothing that the right semiconductor diode can't switch.

Limit control

Oscillators must run class-A to be very stable. The amplitude of the oscillation must be limited one way or another so that the peaks don't extend into the nonlinear region of the tube's characteristics. A reverse-bias diode, acting as a clipper, might well be used to limit oscillator amplitude. It is already used in audio work where it is called speech clipping.

The principle may be applied to a variety of circuits. Transistor receivers, for example, use the reverse-biased diode to assist age action on strong signals. In this case, the reverse bias is overcome by the age voltage at a predetermined level and the diode becomes a short circuit across an if transformer, thereby causing a reduction in receiver gain. When age drops again, normal operation resumes.

Zener diode

Silicon diodes, when subject to a reverse bias, break down when the bias exceeds a certain figure, and conduct. This is the Zener voltage. The voltage at which this effect occurs is very constant and thus the device makes a good voltage regulator. In this application the barrier has been overcome by sheer force. Zener diodes may be used exactly in the same way as voltage-regulator tubes (Fig. 3). The Zener diode normally conducts and, as the supply voltage rises, the Zener current increases.

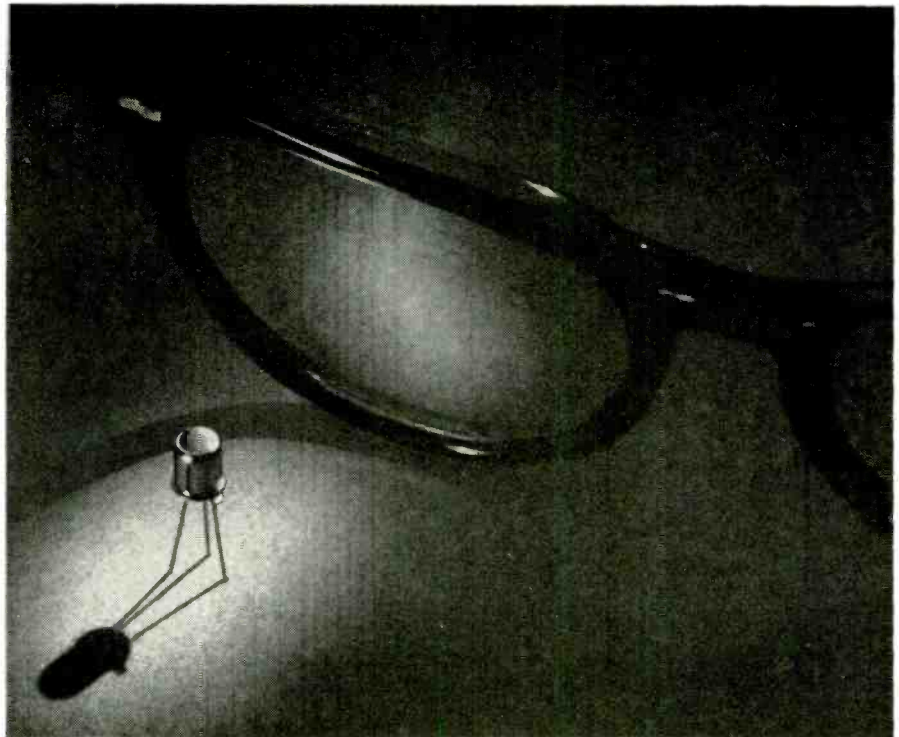

General Electric

Tunnel diodes can be used as amplifiers, oscillators or switches.

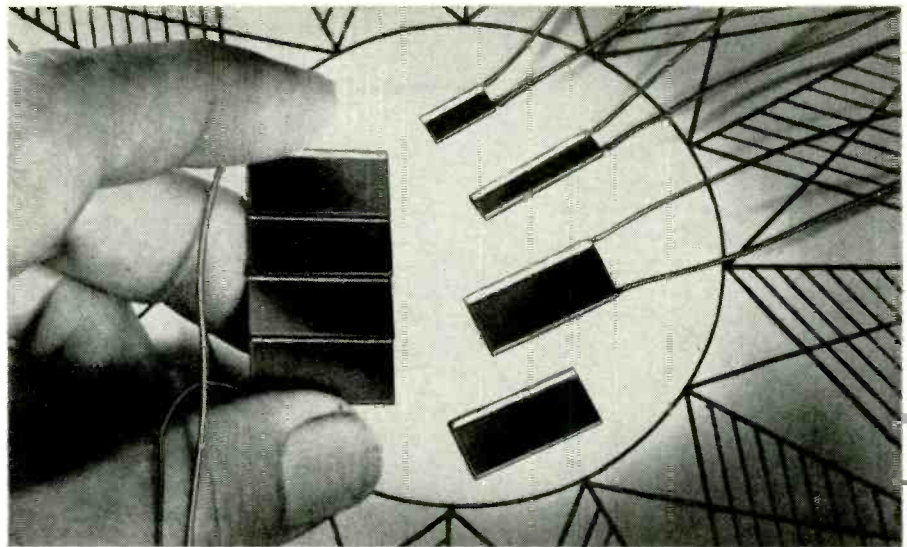

International Rectifier

Silicon solar cells are actually diodes that convert light into electricity.

When the supply voltage decreases, the Zener current likewise decreases. This tends to level off voltage changes for improved regulation in much the same manner as a voltage regulator tube.

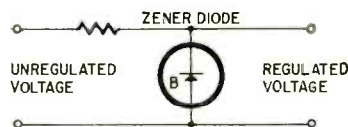

Fig. 3—Zener diode can regulate power supply. It acts like a voltage-regulator tube.

Zener diodes cover a range from a fraction of a volt to several hundred volts. The currents they handle vary from a fraction of a milliamperere to

many amperes. Accuracy may well be perfect or, if such perfection is not required, 20%, 10%, 5% or whatever is needed. The 1N430-A, for example, will hold the voltage constant within .007 volt over a temperature range of -55°C to 165°C ! This type of diode may be used to regulate an accurate source of voltage for instrument calibration, as a solid-state secondary cell and so on. Naturally one wouldn't use such a diode for simple regulation applications. For this purpose there are less expensive units with wider tolerances.

Zener diodes have a variety of uses. They may control the bias in a tube or transistor class-A, -B or -C stage merely by being inserted in the cathode

TRANSISTOR PACK POWERS MODEL RAILROAD

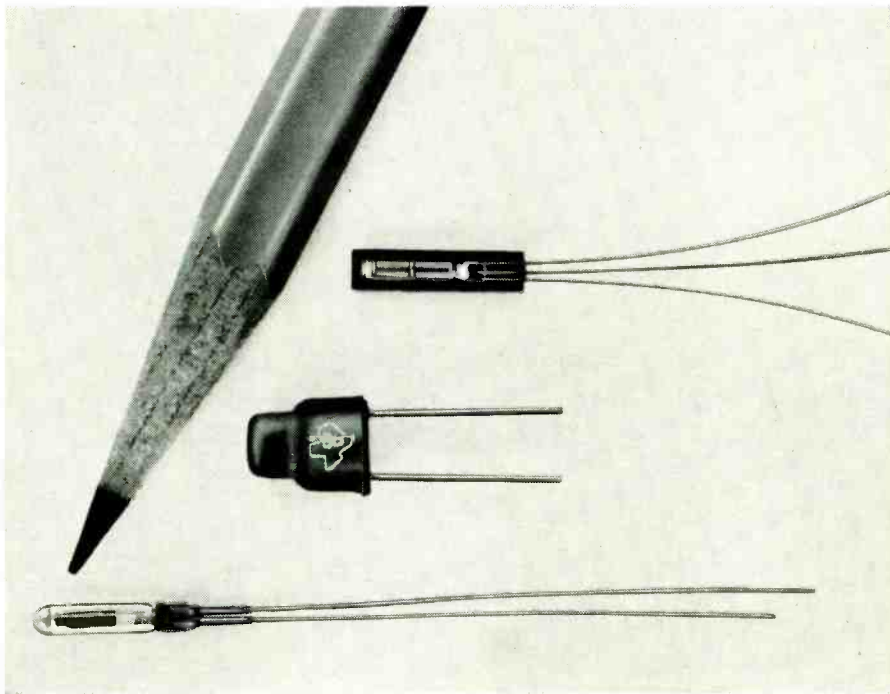

Texas Instruments

Photodiodes generate tiny current when diode junction is illuminated.

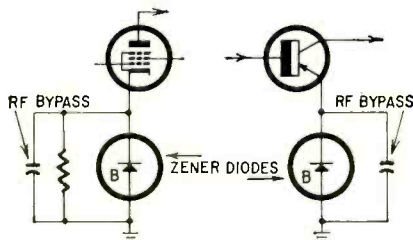

Fig. 4—A Zener diode in the cathode of a tube amplifier (emitter of a transistor amplifier) holds bias constant.

or emitter lead. Such a system is shown in Fig. 4. The arrangement has been used to bias a 7094 single-sideband linear amplifier. The Zener unit may be connected in parallel with a meter to protect it against overloads. It may take the place of coupling capacitors in audio amplifiers or even electrolytics. In a power supply, the Zener diode will represent around 3,000 μf of capacitance even in an inexpensive unit. So numerous are Zener-diode applications that several books have been written about them. Service technicians may expect to

see more and more of them as time goes by.

The photodiode

If, while forward-biased, a junction diode is exposed to light, the current flowing through it will change. The diode has the properties of (and may actually replace) a photocell. The Philips (Amperex) OAP12, for example, has a built-in lens, is less than $\frac{1}{8}$ inch in diameter, generates very low noise and has a host of uses from sound scanning of motion-picture film through computer punch-card scanning to the detection of fire or smoke.

Only the surface has been skimmed when it comes to new applications for modern-day diodes. Tunnel diodes, for example, have not been mentioned, for a full discussion of these devices would more than fill a magazine of this size. The solar cell, too, is really a diode and its applications are numerous. The field of diode application is an exciting one, and one that will pay you to keep abreast of in the months to come. There's something new to be seen almost every day. END

An inexpensive power transistor takes the place of an expensive tapered rheostat

By PAUL S. LEDERER

IN the past few years, model railroad-ing has become increasingly popular. In particular, HO gauge trains have gained a large number of adherents. HO rolling stock is powered by 12 volts dc, fed to the engines through the rails. Most HO train sets are sold with all rolling stock and tracks but without a power pack. It must be bought separately.

The basic power pack consists of a stepdown transformer which feeds a rectifier (either a bridge or center-tapped full-wave type). The resulting pulsating dc passes through a rheostat (for speed control) and through a dpdt switch (to reverse the polarity of the voltage) to the rails.

The rheostat used for speed control is rather special. Its tapered winding consists of a number of sections, each wound of different size wire, with the size (cross-section area) of the wire increasing in the direction in which the slider advances for decreasing rheostat resistance. This permits increased but safe dissipation as the resistance is decreased. A conventional rheostat of the same dissipation rating would have to be wound with wire corresponding to the largest used in the tapered pot. This in turn would result in a smaller overall resistance change and consequently a smaller degree of control over the train speed. Needless to say, tapered rheostats are expensive, about \$6.

The power pack described here does not use a tapered rheostat. Instead it uses a power transistor whose internal resistance is controlled by varying its base bias current. This transistor, a 2N256, is connected in a grounded-

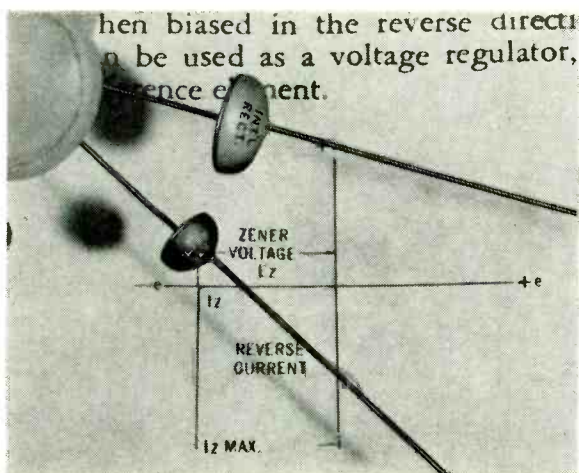

Zener diodes come in a variety of sizes. Both of these units can dissipate 1 watt.

collector configuration.

The transformer, a Stancor type RT-201, has two main stepdown windings; each one delivers 16 volts ac rms. In this power pack they are connected in series with the junction forming the common return for the supply. The other ends of these windings are connected to a center-tapped full-wave selenium rectifier. The particular unit used (IRC J14C1) is designed to handle 1.5 amps at 14 volts dc. (Another rectifier which may be used, the Sarkes-Tarzian D-10, handles 2 amps, which is the maximum capacity of this transformer.)

A 1,000-ohm wire wound potentiometer (R2) is connected across the dc supply and its arm goes to base of the transistor. Varying the position of the sliding contact varies the transistor's base bias current and thereby varies the transistor's internal (collector-to-emitter) resistance. Thus the potentiometer-transistor combination works like the tapered power rheostat in controlling the source resistance of the power supply and therefore the power delivered to the train.

Since the transistor acts as a variable resistor, it must be able to dissipate varying amounts of power safely. The 2N256 has a maximum rated power dissipation of 1.5 watts in free air, and of 6.25 watts with a large heat sink. For 6.25-watt operation, mount the transistor on the aluminum chassis of the power pack. Remove all burrs surrounding the mounting hole to assure good thermal and electrical contact between the case of the transistor (which is directly connected to the collector) and the chassis.

Tests with a typical HO train indicated power requirements of about 4 volts at 400 ma at slow speeds and about 8 volts at 450 ma for fast speeds. In these cases, for a 14-volt dc supply, the transistor must dissipate about 4 watts and 2.7 watts, respectively, well within the dissipation rating of the transistor.

The power pack can easily be expanded to operate two or three trains simultaneously and independently by adding one or two additional potentiometer power transistor combinations and polarity-reversing switches.

Ripple is useful

One other feature deserves attention. Because of high starting friction in the motors used in HO trains, such trains generally start off with quite a jerk when powered by well filtered dc. This poses problems when the train is to be moved only a small distance for switching, coupling and similar operations. For such uses, dc with a lot of ripple on it is better because the resulting pulsating torque overcomes the starting friction more gently. To achieve this, a small amount of ac from an auxiliary winding on the transformer is injected into the transistor's base circuit. This modulates the output at a 60-cycle rate and thereby provides the pulsating power. An spst switch (S2) permits choice of direct or pulsating power.

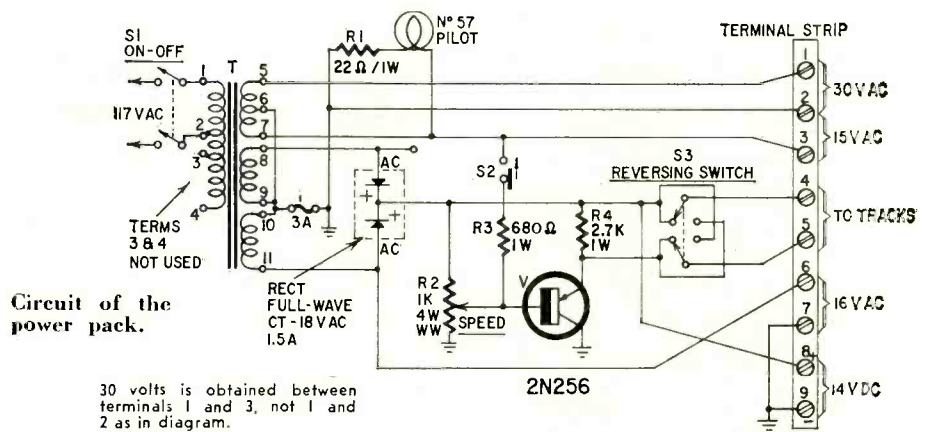

Circuit of the power pack.

30 volts is obtained between terminals 1 and 3, not 1 and 2 as in diagram.

About 16 volts ac (used to operate remote control switches, etc.) is available ahead of the selenium rectifier. A pilot light is connected to the auxiliary 15-volt ac winding. The 3-amp fuse is placed in the common return of all windings so that an overload on any output (ac or dc) will blow it. When that occurs the pilot light goes out too.

- R1—22 ohms, 1 watt
- R2—pot, 1,000 ohms, 4 watts, wirewound
- R3—680 ohms, 1 watt
- R4—2,700 ohms, 1 watt
- F—3 amp fuse or circuit breaker, 3AG size
- RECT—full-wave ct, 19 volts ac (minimum), 1.5 amps dc (minimum) (IRC J14C1 or Sarkes-Tarzian D-10 or equivalent)
- S1—dpst toggle
- S2—spst slide
- S3—dpdt toggle
- T—rectifier transformer, Stancor RT-201
- V—2N256
- Chassis to suit
- Terminal strip, 9 posts or more
- Miscellaneous hardware

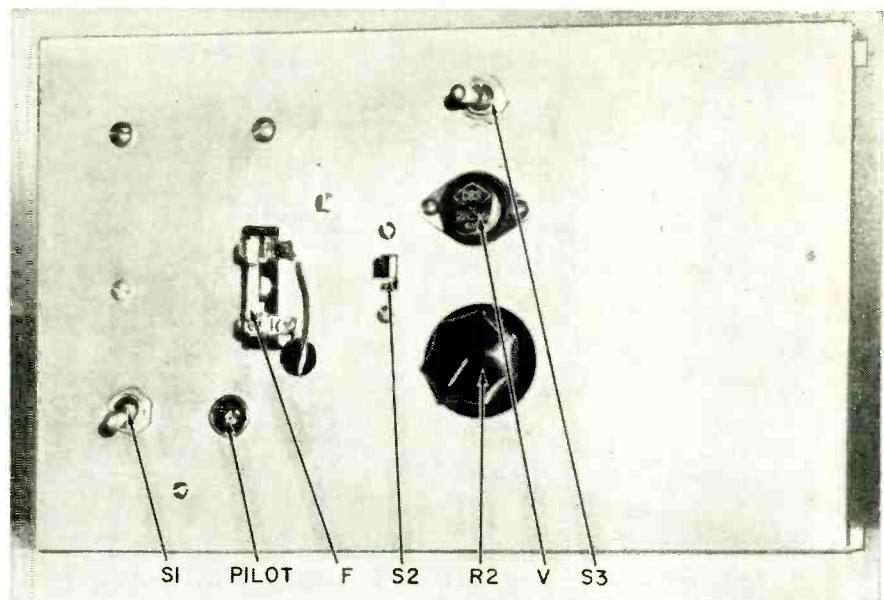

Front panel. Speed control still has to be calibrated.

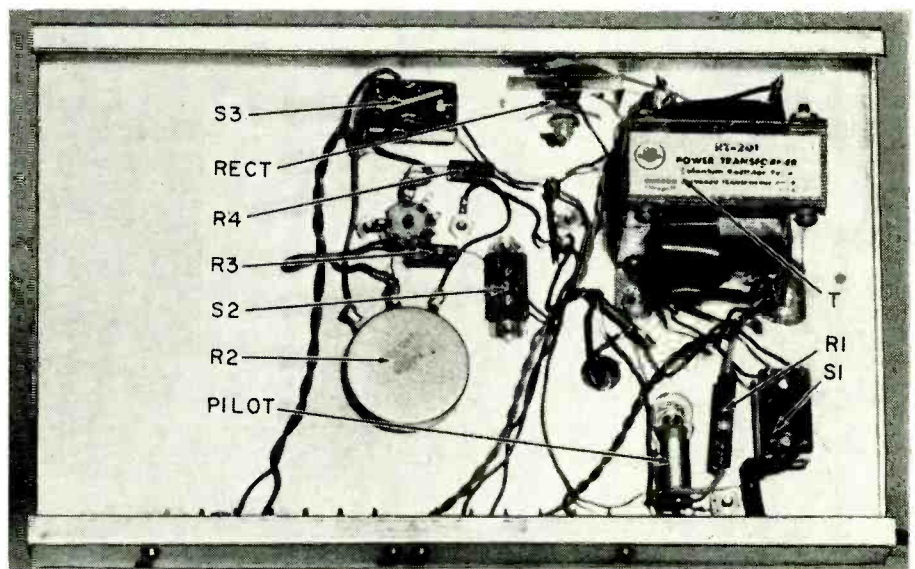

A look under the chassis.

STROBO INSTRUMENT TUNES ORGANS

New low-priced instrument allows technicians to tune an electronic organ as well as repair it

By RICHARD H. DORF *

With electronic musical instruments (especially organs) becoming so popular, there is an increasing market for the service technician to shoot at. Though servicing musical instruments may be a little new and different at first, the theory and practice is the same as with any other piece of electronic equipment.

However, one phase of organ servicing becomes a constant source of frustration to technicians—the final tuning. In this respect, the organ belongs in the musical and not the electronic field; normal test instruments are almost no help at all.

The only instruments that are worth while are stroboscopic types like Conn's Stroboconn and Strobotuner. Few service technicians own them because even the cheaper of the two costs almost \$200.

The writer has developed a new tuning device which is about as accurate as these expensive instruments but costs only a fraction of the above-mentioned figure. It measures only 5¼ inches wide, 6¾ inches high and 2¼ inches deep. It weighs just 2½ pounds and can be easily stuffed into a service kit (or even a good-sized overcoat pocket).

Tuning problems

While the mathematically minded person can easily understand how mu-

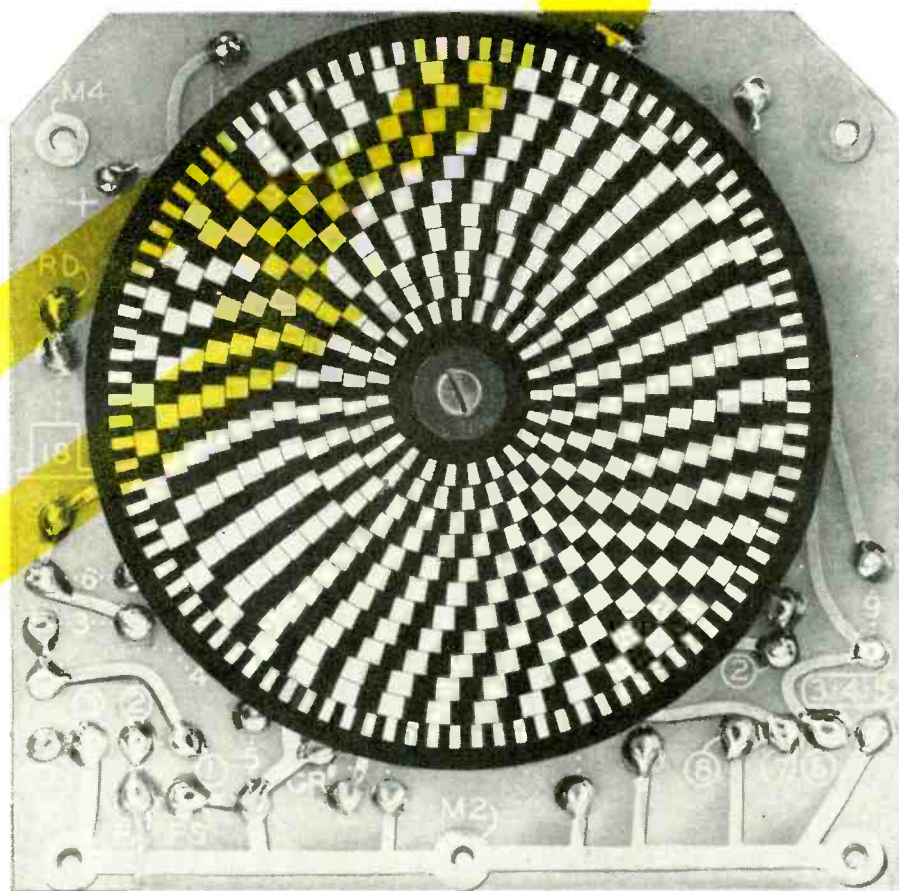

Stroboscope disc is mounted on printed-circuit chassis and rotated at 60 rpm.

sical pitches are arrived at, he is always annoyed at the irrationality of the numbers obtained.

A musical octave, the interval between, say, middle C and the C note next above it (or between any two notes having identical names) is represented by a frequency ratio of 2. Middle A, for example, is 440 cycles; the next higher A is 880 cycles and the next lower 220 cycles. This frequency ratio of 2 is the basic one in music because the human ear and brain sense a feeling of "identity" between any two notes (or pitches) having this frequency ratio. This is not felt to the same degree for any two pitches with a smaller frequency ratio. The musical scale, as used in the Western world, is therefore composed of a number of different pitches (the number, arrived at arbitrarily hundreds of years ago, is 12) with intervals such that the 13th note is twice the frequency of the first. It is therefore used as the first note of the next higher (or lower) scale.

The human ear hears pitch intervals or changes in the same logarithmic fashion as it hears audio power changes. That is, the apparent difference between two pitches depends on a multiplying (or dividing) rather than adding (or subtracting) factor. For instance, the pitch interval between mid-

dle A (at 440 cycles) and the next A (at 880 cycles) seems the same to the ear as the interval or difference between middle A (440 cycles) and the next lower A (220 cycles). The arithmetic differences in the two cases are different—440 cycles in the first and only 220 in the second. But the fact that a constant multiplying or dividing factor—12—has been used in both cases makes the differences seem the same.

Given the problem, therefore, of dividing a frequency ratio of 2—the octave—into 12 equal parts, and with the proviso that the difference between each pitch arrived at and the one just above it or below it must seem to be identical, we must find a multiplying factor. When the frequency of any note is multiplied by this number, the result must be the next note. We take the 12th root of 2 (approximately 1.05946309) as our multiplying factor. The number is irrational and can be carried out to an infinite number of places, depending on how late at night you feel like staying up to keep on figuring.

If we arbitrarily decide, then, that middle A on the keyboard will have a frequency of 440 cycles and we use this factor to determine the frequencies of the other notes, we end up with the scale shown in Fig. 1. This drawing shows the frequency of every note on

*President, Schober Organ Corp.

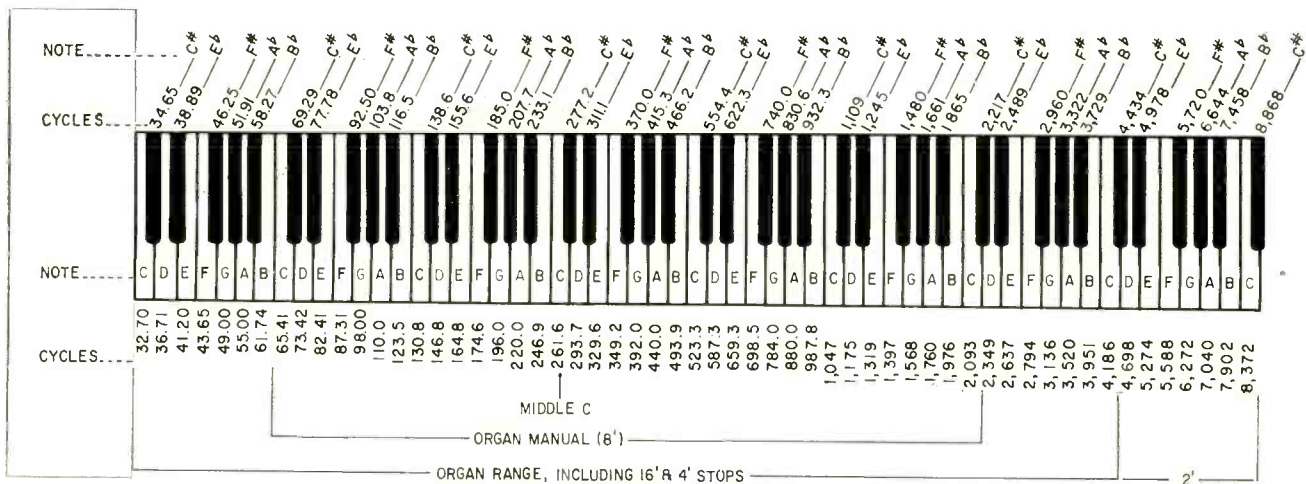

Fig. 1—Standard 88-note piano keyboard.

a piano keyboard. It also indicates the keys on a standard 61-note organ manual. For scientific purposes, the frequency notations should be carried out further, but for our purposes it is accurate enough.

A look at some of the consecutive frequencies gives one the shudders. The only integral relationships in these numbers are the octaves. As a practical matter, this means that if we assume that, say, one of the G's is tuned properly, we can tune the remaining G's by beating them with the first (and with each other)—in effect, comparing harmonics directly. But if you then wanted to go on to the G's or any other notes (none of which are tuned in advance), you wouldn't have a leg to stand on! Nothing is a direct multiple of anything else.

Well, you may say, I have an audio signal generator. Why not use that? The simple answer is that for an instrument to sound anything but sourer than an underripe grapefruit, the notes must be tuned with a bare minimum accuracy of a quarter of 1% (0.25%). A tenth of 1% (0.1%) is a more realistic accuracy, which is even tougher. If your signal generator calibrations are accurate to 5%, you must have a rich uncle! In fact, the only "standard" instrument that can be used in this situation is a digital-readout counter—and if you can afford one of those, you're not in the service business.

Stroboscopes

Excluding a counter, there is almost no device which is self-controlled (not dependent on an external standard) that will maintain its accuracy long enough for tuning a musical instrument. The one exception is a tuning fork made of a very special alloy whose dimensions change extremely little with temperature and time.

But, fortunately, there is one kind of instrument which not only can be very accurate (because its accuracy is controlled by your power company, which in turn checks its own accuracy continually with a primary standard in Washington) but is also a very accurate and easily read indicator. This is the stroboscope, commonly used to judge

phonograph turntable speed. You normally view the stroboscope disc with a light (generally neon) which goes on and off at a fixed rate controlled by the 60-cycle power line. In the space of time between one flash and the next, the disc rotates just enough so that each of the little radial lines printed on it moves to the position previously occupied by the adjacent line. The lines on the disc therefore appear to stand still.

To use this principle for tuning a musical instrument, we use the same apparatus but we turn it around a little. The disc is made to rotate at a constant, known speed controlled by the 60 cycles of the power line and a syn-

chronous motor. The light is energized by an audio signal whose frequency we wish to measure. When we have adjusted the audio frequency correctly, the light flashes at exactly the right rate to make the disc's lines seem to stand still. If frequency of the audio is fast or slow, the disc lines will appear to move in one direction or the other.

It would seem, then, that all we need is a disc with a synchronous motor and an amplifier to supply the organ tones to neon lamps. But there is one little hitch. This will work fine for one frequency (or its multiples). For example, suppose we have a disc rotating once per second and we print on 440 equally



The Schober AT-1 Autotuner with microphone and pickup cable.

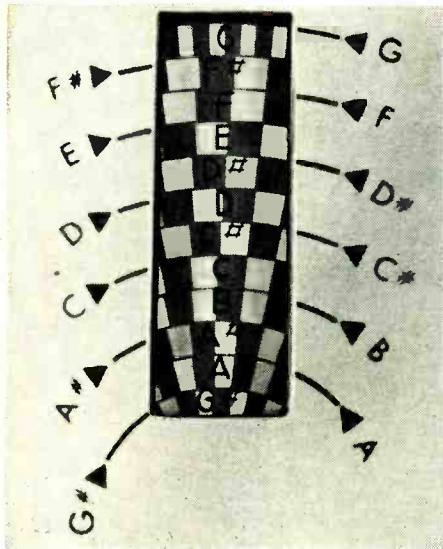

Fig. 2—Close-up of the window through which the disc is viewed.

spaced radial lines. In 1/440 second, then, the disc will move just enough to have each line take the same position that an adjacent one had 1/440 second earlier. If we tune the note A and supply a signal from it to the neon lamps, the disc will seem to stand still and we will have a perfect instrument for tuning A's.

But now what happens if we also want to tune A# (which we do, because otherwise the organ owner will throw us out)? We can hardly make 466.2 radial lines (or holes) on the disc—ever try to drill half a hole? So we have only one choice. We must change the speed of the disc for every note; and every one of these 12 speeds must be as accurately controlled as the first.

The Conn instruments do this in two ways. The Stroboconn contains 12 discs which are rotated at different speeds by a system of gears. The synchronous motor is driven by a tuning-fork oscillator made of a very stable metal. The accuracy is about as good as if the power line were being used. The Stroboconn has only a single disc. Its motor is driven by a self-controlled L-C oscillator. A switch selects any one of 12 speeds. Since the L-C oscillator does not have the required accuracy, its frequency must be checked against the

power-line frequency during use. A switch is provided for the purpose.

The Autotuner

The most economical (and simplest) way to make a tuning stroboscope would be to use a single disc, rotating at a single speed controlled directly by the power line. This has been done in the Schober Autotuner (the invention is covered in the writer's Patent No. 2,919,620).

The principle is simple. The stroboscope disc is used, not to measure the musical frequencies directly, but to measure the differences between adjacent notes. In so doing, a small amount of error is accepted, but it is far less than the tremendous error one would get by measuring actual frequencies on a single-speed disc and it is well within the minimum error required for music.

The head photo shows the stroboscope disc mounted on the front of the printed-circuit chassis. The notes corresponding to the 12 bands are printed on the metal panel and on the plexiglas window. See Fig. 2. The outermost band contains 98 radial marks equally spaced with an accuracy of 5 minutes of arc. This band is the only one used in the "conventional" manner. When the disc is illuminated by neon lamps (energized by the organ output), the second G below middle C is tuned until the marks on the outer band appear to stand still. The note is then tuned to exactly 98 cycles with zero error. In a frequency-divider organ (Schober, Baldwin, Lowery, etc.) this automatically tunes all the G's in the organ. In such organs as the Conn or Allen, the remaining G's must then be tuned by zero-beating with the original one tuned.

Rear view of the Autotuner's printed-circuit chassis and metal panel. The motor rotates the disc between the chassis and panel.

Now we sound the G and G# (Ab, Fig. 1) just above middle C. Both these tones are fed into the amplifier (Fig. 3) either through the microphone supplied or by direct connection to a convenient point in the organ. The first three stages of the Autotuner are simple amplifiers which are so overloaded that they clip and distort the signal. This assures high-amplitude additive and subtractive beat frequencies between the two tones. Capacitors C1 and 2 attenuate both the original tones and the additive beat frequency. The plate load of the fourth stage is the neon lamps, which flash at the frequency of the subtractive beat.

Consulting Fig. 1, we find the desired frequencies are 392 and 415.3 cycles; thus the beat frequency is 23.3 cycles. There are 23 marks on the first (inner most) band of the disc. If we tune the G# until the marks appear to stand still, we will have tuned for a 23-cycle beat and G# will actually be at 415 cycles. The 0.3-cycle error amounts to about .072%.

Next, sound the G# and the adjacent A. Tuning the A until the second pattern appears to stand still. This gives an A frequency of 440 cycles exactly correct. The remaining notes are tuned in the same manner, until the F# has been tuned. This completes the octave and finishes the job for frequency-divider organs. For separate oscillator organs, the remaining octaves are tuned by zero-beating—either by ear or using the Autotuner to indicate the beats through light blinks. If the oscilloscope is handy, it is the fastest and most accurate reference for zero-beating.

Since the disc rotates at 1 revolution per second and the number of marks in each band must be integral, it can measure the beats only to the nearest cycle. This means a maximum possible error of 0.5 cycle which, at the frequencies of

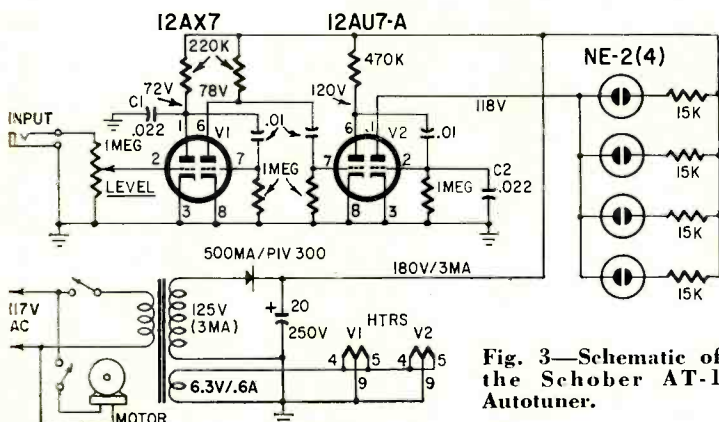

Fig. 3—Schematic of the Schober AT-1 Autotuner.



the notes used, is a maximum of well under 0.1%.

The do-it-completely-yourself enthusiast who scorns to follow the instructions in a kit can probably construct himself an acceptable job by patterning his disc after ours. But the Autotuner is available in kit form and will also be available completely assembled, housed in a sturdy Daka-Ware case. The small Synchron motor and all the circuitry except for the input jack, potentiometer and power transformer is on a printed circuit. A "top-hat" silicon rectifier is used in the power supply. Just one electrolytic filter capacitor is needed, as a small amount of hum does not affect the Autotuner's operation. The silicon rectifier avoids the heat a vacuum-type rectifier would create and helps miniaturization. An ac-dc power supply would have been cheaper but not so safe, hence the transformer is used.

A crystal microphone is furnished as well as a special test cable with clips at one end and a phone plug at the other. This gives the user his choice of a direct connection to the organ's output or mike pickup. The instrument is easy to use and no warmup time beyond that needed for tube heating is necessary.

To answer an obvious question, the Autotuner can be used for piano tuning—for setting the "temperament octave". But, piano tuning is not recommended for amateurs. It is a long and touchy job and you will find that you can break a string as easy as falling off a piano bench. END

OSCILLATOR DRIVES RELAY

Recycling and repeating circuits for flashers, life-test equipment, industrial machinery and the like are often controlled by multivibrators or similar low-frequency oscillators. Sensitive relays control the load circuit. If the load consumes an appreciable amount of

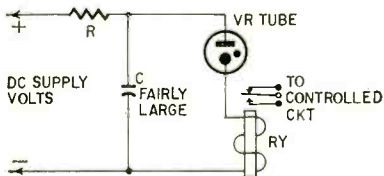

power, auxiliary power relays must be used.

Here is a simple relaxation oscillator that will handle almost any power relay. The VR tube may be an 0A2, 0B2 or any convenient type. Select the values of R and C for the desired repetition rate (frequency) and relay current. The dc and the dc supply voltage should satisfy the requirements of the VR tube and relay. For example, with an 0A2, the supply should deliver a minimum of 185 volts and at least 30 ma. The relay should operate at 30 ma or lower and its contacts should be selected to handle the load current and voltage. —Herbert E. Pasch

EVOLUTION IN RELAYS

AN entirely new departure in relays has been developed and introduced in the form of a unit using printed-circuit contacts, no spring, and a permanent magnet embodied in the relay. It was developed by Executone, Inc., an intercommunicator company using large numbers of relays in its own equipment.

The armature of the new relay is a flat piece of magnetic material, $\frac{5}{8} \times \frac{3}{4}$ inch, backed by a ceramic slab holding the contacts. The pole pieces are two U-shaped units so made that one side of one U is a little higher than the others. The armature rests on this U, and is held there by nothing more than magnetic force. It is positioned by the walls of the case.

A small flat ceramic magnet is held between the two U-shaped pieces. It is magnetized *transversely*, so that one of the U's is magnetized N and the other S. The armature rests between the N and S poles, as indicated at *a* in the figure.

Now suppose that the relay is actuated—that current flows in the coil in such a direction as to set up N and S poles as indicated at *b* in the figure. The outside U-shaped piece that was formerly S is now neutralized, and the other outside one has its strength as an N-pole doubled. The center is now predominantly S. As a result, the armature flips over to the other position. Note that the actuating field can be slightly weaker than, equal to or a great deal stronger than the permanent field and still do the same job.

The contacts are normally printed

on the circuit board to which the relay is clamped. Since the contacts on the armature are of the shorting type—two fingers strapped together—there are two gaps for each contact, dividing the voltage per gap. Pressure is excellent for the paradox of old type relays—when the relay is closed, the spring tension trying to pull it open is maximum—is eliminated. In this relay, the magnetic pull tending to hold the armature in position is at a maximum in both the fully open and the fully closed position. Getting rid of the springs not only makes the action more positive—it reduces the cost of manufacturing the relay.

Units have been constructed to work at voltages from 6 to 24, with a power consumption of about $\frac{1}{2}$ watt. The printed-circuit type of contact adds flexibility to design—the equipment manufacturer can adapt the relay to his own circuit needs. Reliability is another important feature—it was indeed the quest for reliability that led to the research program that developed the new relay. Experiments indicated that it is good for at least a million openings and closings with a load current of 0.5 ampere, and for much more than that with the very small currents often found in electronic equipment. END

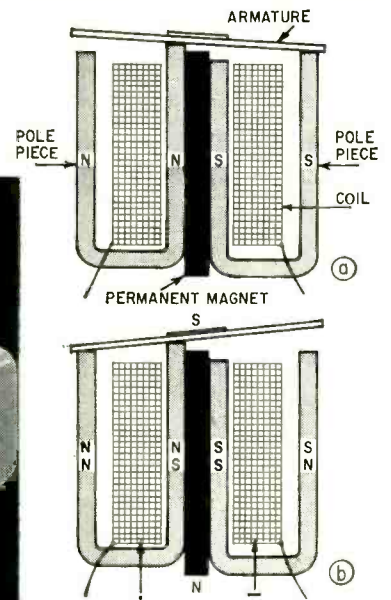
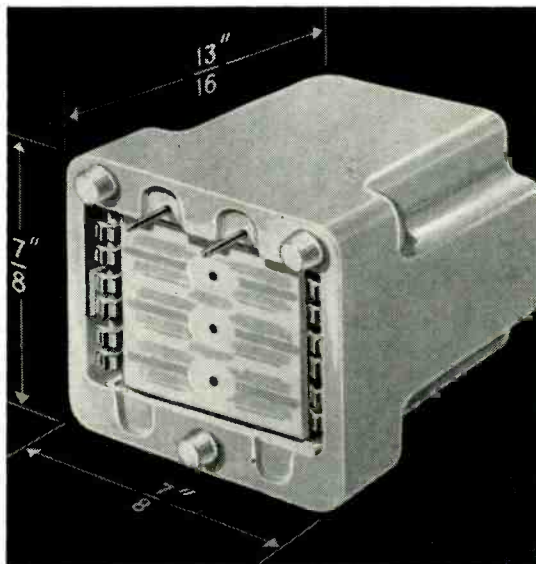

Details of operation.

New Printact relay.

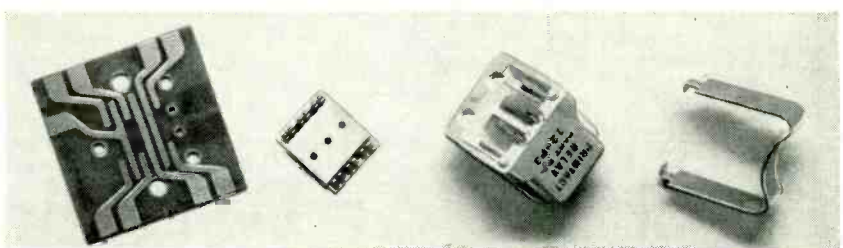

Exploded view of relay.

KLYSTRON- tube for outer space

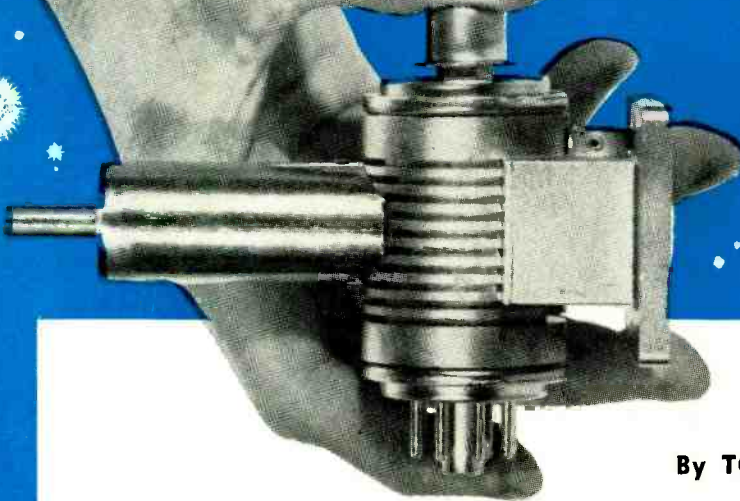

By TOM JASKI

Not only for outer space, but for its usefulness wherever microwaves must be generated, the importance of this tube grows with the industry's use of higher and higher frequencies

WHEN we get to talking to those intelligent beings "out there" on other planets or even in other solar systems, very likely klystrons will be the transmitter tubes that will make our communications possible. Large-power klystrons have been used as amplifiers in the equipment that bounced radar signals off the moon, Venus and satellites in orbit. Klystrons have been used to "interrogate" satellites, and to trigger into action the electronic and mechanical equipment in them.

Less romantic, but even more practical, are other applications for klystrons. Large-power klystrons are used widely in Europe for uhf television transmitters. Here uhf television has not become common enough to need many power klystrons. Klystrons are also the heart of the new "scatter" communications systems in which the line-of-sight rule about microwave transmission is violated simply by using very high-power transmitters, large antennas and ultra-sensitive receivers.

Another major use of klystrons is in experiments with food sterilization. These use high-speed electrons issuing from linear electron accelerators, and these in turn are powered by large klystron tubes.

In linear accelerators, the klystrons provide a mighty push to the electrons

passing through successive drift tubes, eventually speeding them up to almost the speed of light.

What then are these klystrons, what do they look like and how do they operate?

Klystrons were invented just before the start of World War II by the Varian brothers, then graduate students at Stanford University. I remember their little shack behind the Ryan laboratory in the hills behind the university, and the excited talk of a resident in the area who had seen the barbed-wire fence around this little shack develop a mysterious red-hot glowing section of wire. True or not, the klystron has played an enormously important role in the development of radar and microwave communications, and is now on the verge of taking over industrial jobs from other tubes.

Resonant cavities

To start the explanation of klystrons, let us first look into another item, resonant cavities. Understanding cavities is essential to understanding klystrons. All rf oscillating circuits contain resonant elements (Fig. 1-a). As frequency increases, we must decrease the inductance and capacitance of the resonant circuits. We decrease the inductance by decreasing the turns until we

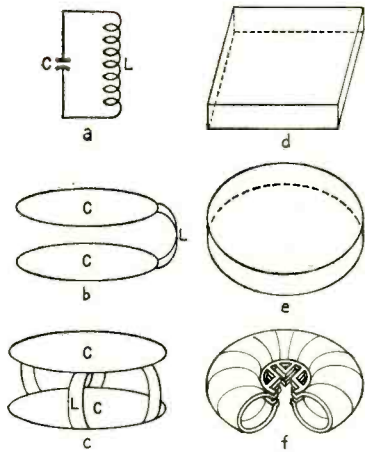

Fig. 1—Evolution of a klystron cavity: a—lumped tuned circuit; b—same, highest possible frequency; c—turns paralleled to decrease inductance; d, e—rectangular and cylindrical resonant cavities; f—klystron cavity. The last three are all derived from c.

have nothing left but a straight wire or even a flat strip of metal. The capacitance is reduced by lowering the number of plates in our capacitor and finally by further separating the plates (Fig. 1-b). Eventually we get to paralleling two inductors (Fig. 1-c) since paralleling two inductors halves their inductance, and the entire process winds up as in Fig. 1-d or 1-e. The final product is a box or cavity, the top and bottom representing the capacitor plates and the sides the paralleled inductors.

Cavities follow certain hard and fast rules, which can be determined easily from common-sense observation. For example, regarding the top and bottom plates of the cavity as plates of a capacitor, we see that they are virtually short-circuited at the edges. This means that at the edges of the plates we cannot have a charge, and therefore no field. From this follows our first rule about cavities: the electric field parallel to a wall must be zero at that wall. Now to maintain any charge which has a field in the center of the plate and none at the edges, the voltage distribution must look something like a sine-wave half-cycle from wall to wall. In fact, this is the simplest way we can maintain a field in a cavity, the simplest "mode" in which we can operate it. It follows that the width of the cavity should be just about a half-wavelength of the microwave energy, or any multiple of that. And the same goes for the length, if the cavity is rectangular.

The magnetic field always associated with an electric field, and always at right angles to it, will then be parallel to the top and bottom of the cavity. Thus it would cut the end plates. But since it is a changing magnetic field, it will induce a current in any conductor within the field, and the end plates have currents induced in them which set up counter-magnetic fields equal to and thus cancelling the first fields.

Here we have the second rule about cavities: the magnetic field must be zero at any wall which it cuts at right

angles. Thus the magnetic field is confined to the box as well. But with the magnetic field we do not have the same dimensional problem, for we can swap density for space. Therefore, the top-to-bottom dimension of the cavity is not as critical, but does determine the capacity of the cavity to maintain a certain field amplitude. For just as a capacitor dielectric would break down if it were too thin for the voltage on the plates, so a cavity can break down, dielectrically speaking, when the voltage gets too high between top and bottom plates. Because we design the cavity carefully as far as dimensions are concerned, we can then set up standing waves in it, and the cavity can easily be excited with small charges on the top and bottom plates.

If we make the cavity an integral part of a vacuum tube, and make part of the top and bottom into a grid area (punch holes in it or slot it), this does not drastically change the properties of the cavity. It can still be excited easily by charge differences between top and bottom plate. The klystron in-

of electrons. But, since this is a steady flow of electrons, the best that we could expect would be a steady potential difference on the grids.

If we manage to excite the cavity between the grids in some way creating an alternating potential between these grids, we will affect the electrons between them. An electron traveling toward a grid that is positive will be attracted and speed up and one traveling toward a negative grid will slow down. If the bottom grid of the lower cavity is momentarily negative, and the top grid positive, the electrons approaching the bottom grid from the cathode will be retarded, while those between the grids approaching the top grid of the first cavity will be accelerated.

In the next half-cycle of applied rf, the lower grid will be positive and the top one negative. Thus electrons which then approach the lower grid will be accelerated, and the electrons which are then between the two grids will be retarded. In this way, the grids and cavity with applied rf will form bunches of electrons, some of which move faster than when they left the cathode and some of which move a bit slower.

When the rf applied to the cavity goes through zero, the electrons then passing through the grids will not be affected, and will just travel on at the same velocity. The lower cavity and grid assembly, forming the bunches, is appropriately called the buncher. (The Varians named this a *rhumbatron*.) In the space between the cavities, the drift space, the electrons that are moving at the original "from-the-cathode" velocity will join some of those which were slowed down. They in turn will be joined by some of those that speeded up. Thus the bunches of electrons in the drift space become denser, and the space between bunches has fewer and fewer electrons.

Were we to let the bunches drift too long, the repulsion between electrons would again scatter them. But we don't give them time to do that. The denser bunches, now with more electrons, pass through the second set of grids. Through these grids then pass alternately dense bunches of electrons and spaces with none or just a few. This is, in effect, a pulsed dc. Pulsed dc can look very much like ac if we shift the base line (different zero level).

The bunches then constitute a periodically changing current capable of inducing an rf voltage in the second cavity. Note that the acceleration and deceleration of electrons between the buncher grids lasted nearly a half-cycle. The bunches which reach the "catcher" grid are also about a half-cycle long. They will induce in the catcher cavity an rf of the same frequency as was applied to the buncher.

Getting power from a klystron

To induce a field in the second cavity, the electrons must give up energy. It is easy to see how this happens after the field has built up. Electrons approaching a negative grid are retarded and

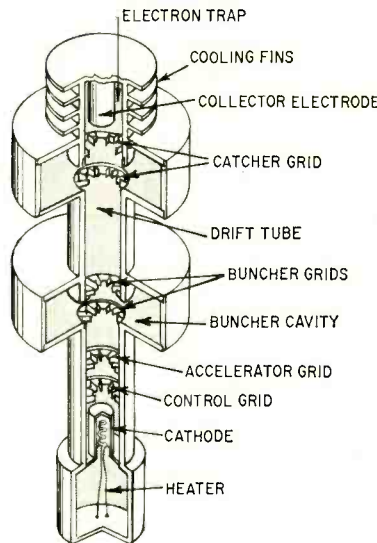

Fig. 2—Typical klystron, cutaway view.

corporates one or more of these cavities with grids in top and bottom. Fig. 2 is a cutaway representation of a typical two-cavity klystron.

The bunching action

At the bottom of the tube we have an electron gun that produces a narrow beam of electrons. This beam leaves the gun under the influence of the accelerating grid, which you can see just below the first cavity. Then the electrons travel on through the two cavities, and the space between them—called the drift space—to the collector, which can collect the electrons because of a positive charge on it. As the electrons travel through the first cavity grids, they constitute a current through these grids, from one grid to the next—after all, a current is nothing more than a flow

impart energy to the grid. Electrons leaving a positive grid are also retarded, giving off energy. Thus if we time the bunches (by regulating the initial velocity of the electrons) to be between the catcher grids only when the first catcher grid is positive and the second catcher grid is negative, while we make sure that we have virtually no electrons between the grids when this situation is reversed, then we draw the maximum energy from our bunches of electrons. This is the way a klystron is operated. The collector and accelerator voltages must be precisely adjusted to get this kind of timing.

If we feed back a portion of the catcher energy to the buncher, the tube will oscillate. If our timing is correct, the phase of the rf will of course be exactly right for the feedback situation, for the bunching occurs when the second buncher grid is negative, and we get the most energy when the second catcher grid is also negative. Amplification is obtained, because the bunches going through the catcher contain many more electrons, thanks to the time spent in the drift space, than the bunches coming out of the buncher.

The energy is coupled into the buncher and out of the catcher cavities with a small loop, which will contain some of the magnetic lines of force of the fields and will thus have a current induced in them.

We can of course use the energy in one of the catcher cavities to excite additional cavities and grids, and this we do many times to increase the energy produced by large klystrons. Fig. 3 shows such a large multicavity klystron made by Eimac, capable of producing 10,000 watts output in the 720-985-mc range.

The reflex principle

But there are also klystrons with but one cavity. The principle is illustrated in Fig. 4. These we call reflex klystrons because the collector at the end of the tube is given a negative voltage, thus repelling the electrons. This electrode is usually called a *repeller*. What happens here is that the electrons, after being bunched in the grids, travel on into the drift space above the cavity for a time, then are repelled back toward the grids. If we repel them with exactly the right velocity to make them arrive at the grids at the correct phase to obtain energy from the electron bunches, the original field is augmented, and we have oscillation. So the reflex klystron is used primarily as an oscillator.

Reflex klystrons come in many shapes. Fig. 5 shows three of World War II vintage, the 417A made by Westinghouse for the S-band (10 cm), the 707B with an external cavity, also for the same frequency range, and the 2K25 used most often as the local oscillator in 3-cm (10,000-mc) radar receivers.

All three are tunable to a certain extent (Fig. 6). The 417A is tuned by changing the cavity dimensions with

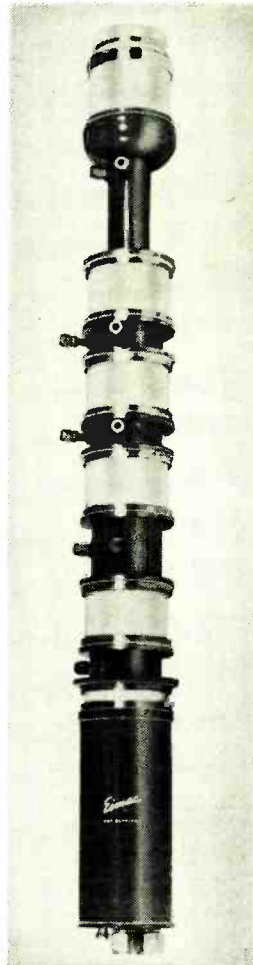

Fig. 3—A 10-kw multicavity klystron.

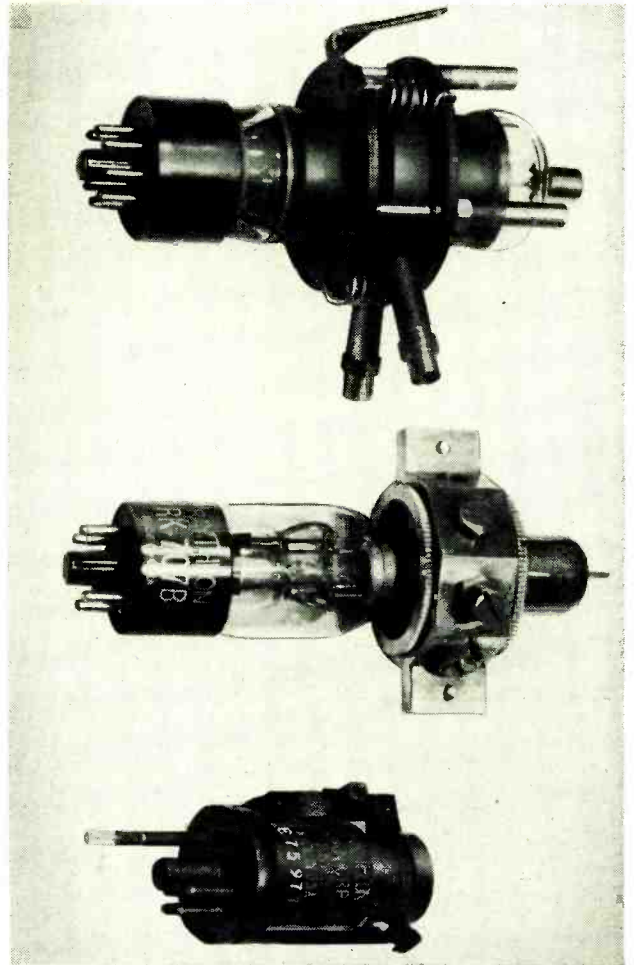

Fig. 5—Three old-time klystrons, the 417A, 707B and 2K25. The 2K25 is still used to generate 3-centimeter waves.

a tuning lever and screws, the 707B by modifying the electric fields in the cavity with slugs projecting into it, and the 25K5 by changing the cavity dimensions with the tuning "bow". The tuning bow is flexed by the screw. This alters the position of the more or less flexible top portion of the metal enclosure, and the top cavity grid with it.

A more modern version of the reflex klystron, using ceramic insulation, is shown in the head photo. Such ceramic klystrons are now produced and regularly oscillate at 25 kmc, while some laboratory models have been used to generate frequencies as high as 100 kmc. The latter are not in production, but are strictly experimental tubes.

Modulation methods

Klystrons can be modulated in various ways. One is to vary somewhat the reflector voltage or, in the power klystron,

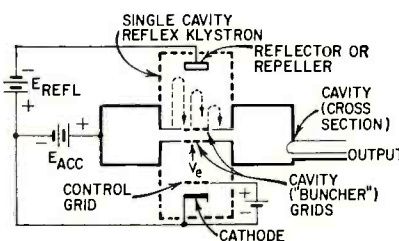

Fig. 4—Cross-section, reflex klystron.

the collector voltage. This has the effect of changing the velocity of the electrons, and thus the frequency of oscillation in the klystron is affected. This kind of modulation is limited within very narrow ranges. Klystrons specially built with a modulating anode near the electron gun can be amplitude-modulated by the simple mechanism of making the electron beam vary in density. Since the amplification of the tube depends on increasing the density of the electron bunches in the drift space, the effect of the bunching will be more pronounced when a lot of electrons are available than when only a few are traveling through the cavity grids. These anode-modulated klystrons are so constructed that the total voltage between the cathode and the tube structure (including the cavities) remains the same. Thus the velocity of the electrons is constant, but the voltage between the modulating anode and the cathode can vary and the quantity of electrons with it.

Very often, particularly in television transmitters, it is actually unnecessary to modulate the klystron. Here it acts as a power amplifier, and the modulation can be introduced at an earlier stage. Thus the klystron amplifies the already modulated signal.

The klystron can be pulse-modulated by the anode in the types which have

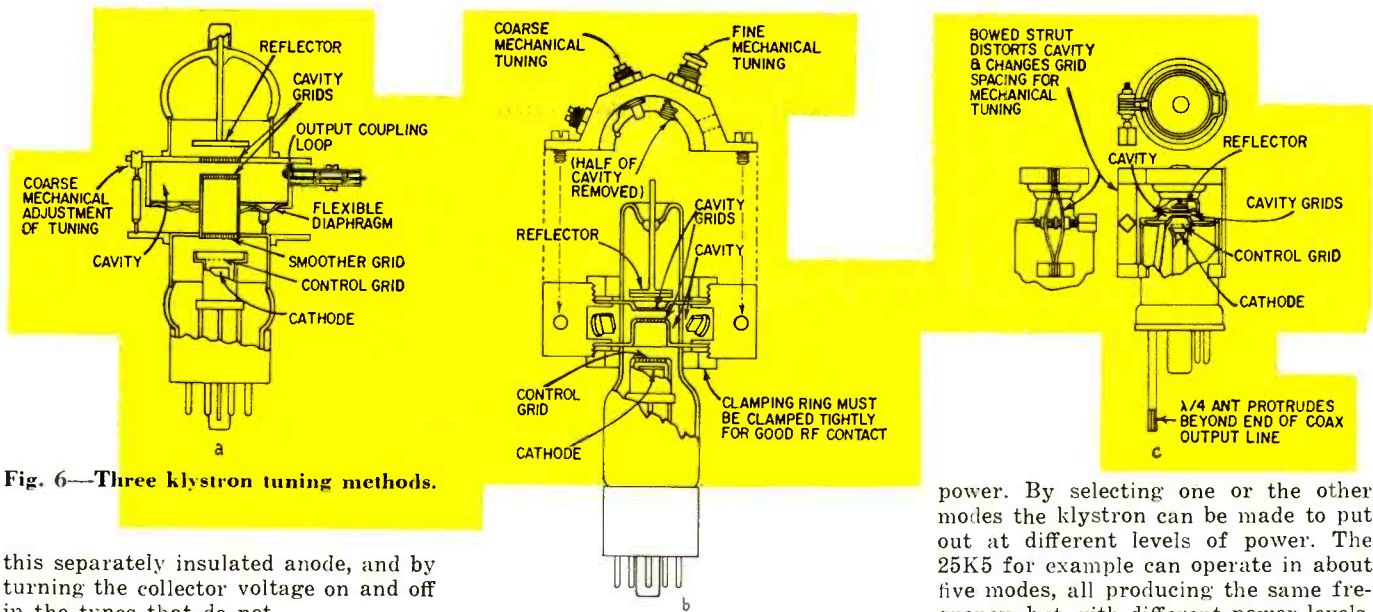

Fig. 6—Three klystron tuning methods.

this separately insulated anode, and by turning the collector voltage on and off in the types that do not.

Except when we want to modulate the klystron, the voltages supplied to the elements must be very stable. Usually they are supplied from well regulated power supplies. The reasons are fairly obvious. If the dc voltages on the cavities and collector or reflector varies, the velocity of the electrons also varies. And, since the speed with which the electrons travel through the buncher determines the frequency of the generated rf, this too would vary.

In the reflex klystron the situation is even more critical. The path the electrons travel must be exactly the right length to allow the electrons on their return voyage to reinforce the original

bunching action. If the path should be altered, by a varying voltage, the electrons would arrive at the wrong time and might partly cancel the bunching. The oscillation would then soon die out.

As a matter of fact, this device is used to allow the reflex klystron to operate in different "modes". The path of the electrons, for oscillation, must always be a multiple of a quarter-wavelength. But whether the tube has a path of $3\frac{1}{4}$ or $4\frac{1}{4}$ wavelengths for the electrons, the action is the same. However, with the longer path, caused by a lower (less negative) reflector voltage, the density of the beam is somewhat affected, and the klystron produces less

power. By selecting one or the other modes the klystron can be made to put out at different levels of power. The 25K5 for example can operate in about five modes, all producing the same frequency, but with different power levels.

As uhf television becomes more popular, the klystron will be used increasingly for high-power amplification in the transmitters. Further increases in uhf scatter communication and in microwave applications as we progress in the space age is also to be expected. The klystron, which has proven its mettle in bouncing signals off our neighboring planets, will most certainly be the power amplifier for space telephony, once man takes the big jump and starts traveling between planets in the solar system and to distant stars. It is a special vacuum tube to be reckoned with for the next few centuries of man's technological development. END

EASY-TO-CONNECT AUDIO PLUGS

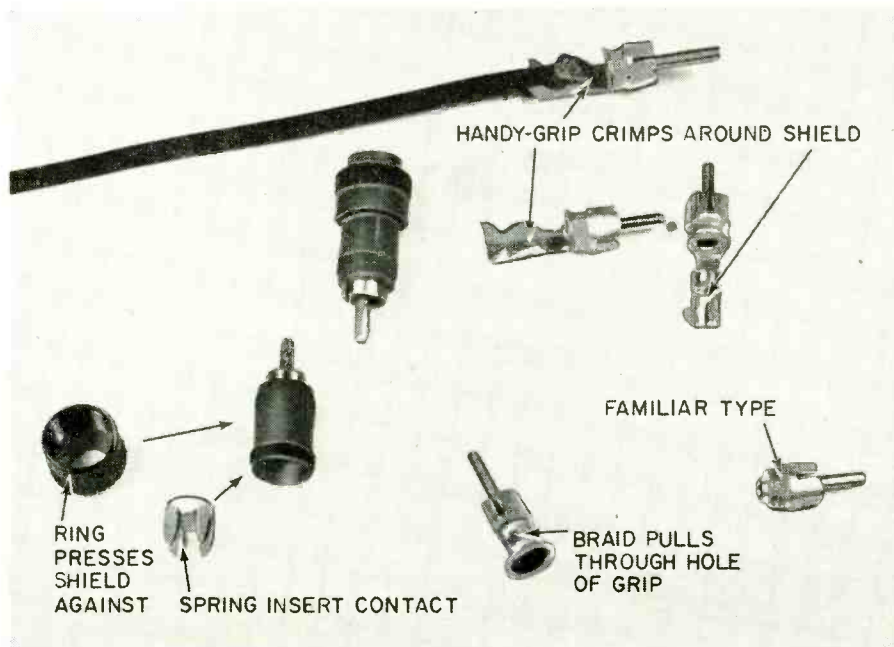

Three audio connectors that simplify job of attaching a phono plug to shielded cable.

SEVERAL audio connectors which make the usually messy and difficult job of putting a phono plug at the end of a shielded audio cable faster and easier are now available. The photograph shows three types, along with a standard one for comparison.

At the upper right are three views of H. H. Smith Co. Handy Grip (No. 1246) which requires soldering of only the center conductor. The shield is secured by crimping the rear-projecting lip around it with pliers. This projection then serves as a convenient handle for plugging in or removing the connector.

The upper-left plug with a black plastic body screws together (shown disassembled at lower left). The center conductor is soldered into the center pin while the shield is secured by pressure of the rear plastic ring as it is tightened against the rear spring insert. This type of plug is available in seven colors including black and white as H. H. Smith No. 1213.

Bottom center in the photograph is the Grip-A-Lip, which requires soldering of the shield after it's pulled through a hole in the rear projecting lip and wrapped around it. Grip-A-Lip is made by DeRo Electronics, 134 Nassau Rd., Roosevelt, N. Y. These plugs are all available through parts jobbers.

NEW AND DIFFERENT FREE-POWER RADIO

Construction and action of this simple radio are described clearly. An excellent project for the beginner

By WILLIAM H. GRACE, JR.

SOMETHING new, something old something different are all found in the circuit of this little radio set. If you have never built a successful free-power receiver, this experience may be both interesting and rewarding. The parts required are few and inexpensive. Anybody who can use a small soldering iron should have no difficulty assembling this simple unit. It will work almost indefinitely if properly assembled. There are no tubes to burn out or batteries to replace—ever.

The radio's schematic (Fig. 1) shows how the components must be connected for satisfactory results. The set is tuned by the antenna series capacitor C1, and the tapped ferrite-cored inductance coil shown in detail in Fig. 2. Note that the lower end of the coil is connected to both ground and the base capacitor. The first tap goes direct to the emitter socket prong and the second tap to the



Comparison shows that, while small, this is not a cigarette-box radio.

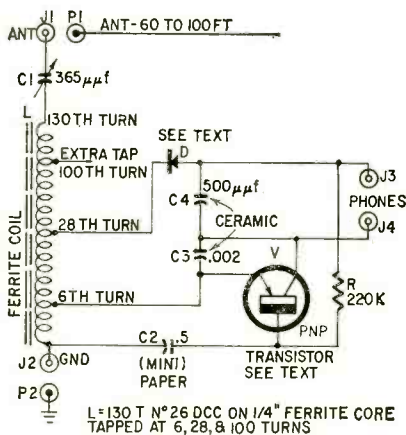

Fig. 1—Free-power receiver uses one diode and one transistor.

cathode or plus side of the diode. The third tap may not be required but may be very useful if your antenna is a long one or if the strongest locals are at the high-frequency end of the band in your location.

The sensitivity of a series-tuned circuit is greatest if the ratio of C to L is large, and the selectivity is best when the reverse holds true. Hence, the third tap may come in very handy for circuit adjustment. If used, it is connected to the tuning capacitor in place of the lead from the coil end.

The anode or minus side of the diode is connected to the nearest phone-tip jack and the other jack to the prong of the transistor socket that connects to the collector. This insures proper current direction. The transistor circuit includes a base-bias resistor which improves the overall performance both as to output volume and signal quality. (The transistor is employed as a base-biased detector in this circuit—the “dif-

ferent” feature mentioned above.)

Some of the transistor types tested did work without the bias but most of them required it for best operation. Approximately 220,000 ohms was found to be about on the nose but other resistance values should be tried with transistors at hand for best results. This resistor provides a negative bias to base.

Winding the coil

The only component which has to be tailor-made is the inductance, though readymade coils may be altered to fit. To the experienced, this coil is a simple one to wind. It should be nothing more to the neophyte than a little effort if the simple suggestions are followed.

A Lafayette superhet loop antenna (catalog item MS-272) provided the ferrite core after unwinding the original wire. It was 3 1/2 inches long by 1/4 inch in diameter. The same core material in 1/4-inch diameter and 7 1/2-inch

lengths can be purchased from the same concern (catalog item MS-331). Each makes two cores of the size needed though only one is required for this receiver. Fig. 2 explains coil detail and the positions of the three taps.

The new antenna coil, which consists of a total of 130 turns, is wound with No. 26 dcc copper wire. Taps are taken at the 6th, 28th and 100th turns by removing the insulation with a knife blade or a piece of sandpaper and then twisting the bare wire upon itself for a twisted-wire tap. All taps should be at least 1/2 inch long to permit easy soldering later.

The only problem in winding any coil is to prevent it from unwinding when beginning or ending it, or whenever taps are to be made. The solution is simple. Secure a small bottle of Ad-a-Grip adhesive (obtainable at hardware stores). It comes in a squeeze type container and allows very small amounts to be used at a time.

After allowing a 6-inch lead, wind on exactly 6 turns and hold with the fingers while a drop or two of the glue is applied to both core and coil. Hold for

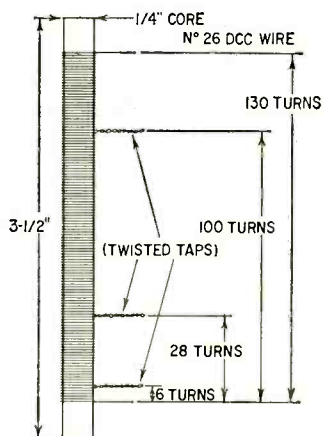

Fig. 2—Winding details of the coil.

a few minutes after spreading the glue with the fingertip. The tap is now made and the winding continued for 22 turns more, at which point the second tap is made in the same manner. Apply a small amount of adhesive before each tap is taken to prevent unwinding.

The third tap is made after 72 turns are wound and the winding is continued for 30 additional turns, a total of 130. Leave a 6-inch finishing lead and apply a drop or two of the Ad-a-Grip to complete the winding. The adhesive left no stains on the winding and has no deleterious effect upon the coil.

This particular coil and series tuning capacitor will come close to covering the entire broadcast band if used with an antenna of about 75 to 100 feet flat-top plus an average length lead-in. Should it fail to include stations at the extreme low-frequency end of the band, a few more turns will be needed. Another way to reach the 550-kc end of the band is to shunt the entire coil with a small capacitance of roughly 25 to 50 μf .

The case is one of the popular polystyrene variety and measures 3 3/4 x 2 1/2

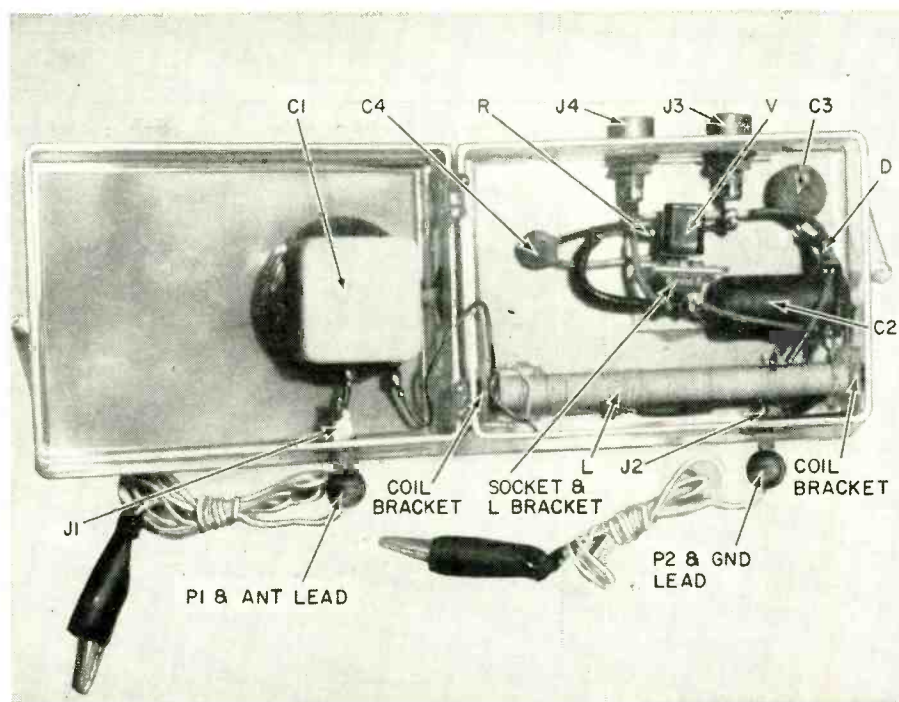

Interior view indicates that construction should be easy.

x 1 1/4 inches with the hinge at the 2 1/2-inch end. These boxes are inexpensive. (It matters little if the dimensions vary from those given.) Purchase two cases when parts are bought because one of them will be used to supply the L-brackets to mount the coil and the transistor socket in the receiver case later. Take care not to crack the case when the holes are drilled; this plastic is very easily cracked. Make a small depression with the point of a sharp knife at the hole sites in both the case and the brackets before drilling. Always be sure to back the plastic with a wooden block and employ as little drill pressure as possible at all times. Only seven holes are required in the case to mount the jacks and the tuning capacitor—four in the upper case half and three in the lower, as seen in the photo.

The plastic L-brackets are sections sawed with a scroll or fret saw from the side walls and bottom of the second case. (See detailed drawings, Fig. 3.) Two brackets are used for coil supports. A 1/4-inch hole is drilled to permit the core to enter the upper arm of the brackets, which will later be cemented to the lower half of the case.

A third and wider bracket is required for the transistor socket. Two small holes are drilled parallel to each other and very close together so that a rectangular shape may be formed to accommodate the socket. Put the socket lock washer in place and the transistor bracket is completed. Do not cement the brackets in position until all the holes have been drilled in the case and the components have all been mounted. Use judgment in tightening the small jack nuts to avoid cracking the case; small fiber or cardboard washers may be set under the nuts to help prevent this. The best cement for attaching the brackets is obtainable in any store that sells ship or plane models—Testor's

polystyrene model cement at 10 cents a tube.

Assembling the set

When the small antenna, ground and the two phone-tip jacks are in place and the Argonne Poly-vari-con capacitor has been mounted, the coil and coil brackets are cemented in the lower half of the case. Use the polystyrene cement sparingly to avoid running, and hold parts with finger and thumb for a few minutes until set.

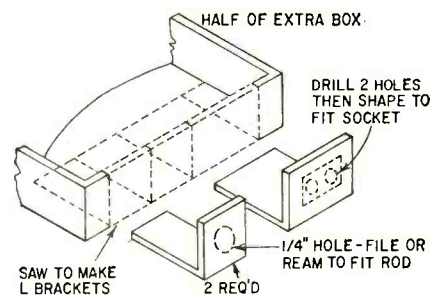

Fig. 3—How the brackets are made.

The transistor socket bracket may now be cemented in the same manner after it has been positioned to allow the needed clearance for the Poly-vari-con that was mounted in the top half of the case. If this bracket is not placed correctly, the case will not close properly. Solder the main leads to the transistor socket to the little prongs before cementing the bracket. Any other small component may often be more easily soldered before it is placed within the case.

When soldering parts within the case, avoid burning the plastic with the iron. Use only rosin-core solder—acid-core solder will cause trouble. A couple of small soldering lugs are used under the aerial and ground-jack locking nuts to facilitate soldering.

L-C REACTANCE NOMO SAVES CALCULATION

Nomogram's expanded-condensed scales give direct readings over a wide range—no need for mental multipliers or divisors

By S. J. SALVA
and W. R. MOREY

CALCULATING reactance values can be a very tedious chore. The figures are large, and the decimal point has a habit of getting away from you. Labor can be lightened, however, by the accompanying nomogram. It will determine reactance values at any frequency from 1 cycle to 1,000 megacycles.

The nomogram is based on the formulas $X_C = \frac{1}{2\pi fC}$ and $X_L = 2\pi fL$, where X_C is capacitive reactance in ohms; X_L , inductive reactance in ohms; f , frequency in cycles per second; C , capacitance in farads, and L , inductance in henries. Resonant-frequency values for any com-

bination of L and C can easily be determined by this nomogram since $X_C = X_L$ in resonant circuits.

The concept of a reactance chart is not new, but typical examples are either limited in frequency range or are broken down and spread over many pages. In this nomogram, all values have been plotted so that the reactance of any inductance or capacitance may be determined simply by placing a straightedge across the proper scales to connect the known quantities. It is actually equivalent to a three-line nomogram three times its length.

Suppose, for example, you wish to determine the reactance of a 2-henry inductance at a frequency of 80 cycles per second. Place a straightedge across the known values on L_1 and F_1 (see example 1). The answer is read as

1,000 ohms on scale X_1 . By referring to scale C_1 , it can be seen that 2 μf of capacitance at 80 cycles per second would have the same reactance. It can also be seen that a circuit employing L and C at these values would be in resonance at 80 cycles per second.

Scales L_1 , X_1 , C_1 and F_1 are used for frequencies up to 1,000 cycles per second. At higher frequencies, scales L_2 , X_2 , C_2 and F_2 are used, with values being read to the left of L_2 , C_2 and F_2 at frequencies up to 1,000 kc, and on the right for frequencies up to 1,000 megacycles. Therefore, if a reactance value is sought for a capacitance of 5 μf at 10 mc, place a straightedge between the values 5 μf , to the right on C_2 , and 10 mc, read on the right side of F_2 (see example 2). The answer is read as 3,100 ohms on X_2 . END

New and Different Free-Power Radio (Continued)

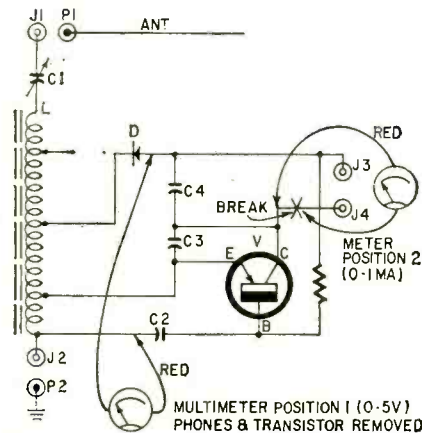

Fig. 4—Setup for measuring power.

Note that the 130th-turn end of the inductance and the tuning capacitor are both located at the hinge end of the case to keep connecting leads short. The L-brackets eliminate the need of a separate panel for supporting the parts. If a subpanel is desired, it may be used, but means a bit more work.

Various makes and types of semiconductor were tested in the experimental phase of this set. Most of them did a good job but the Raytheon diodes CK705 and CK705-A were both exceptionally suited. As to the transistor, Raytheon 2N114, CK768, CK721 and CK722, and G-E 2N107 all performed well. The n-p-n types of junction transistors may also be used if the diode polarity is reversed to provide positive dc to the collector. A Sylvania 2N35 and a G-E 2N170 were both used successfully.

Remember to use a pair of pliers as a heat sink on the leads of both diodes and transistors when soldering. Excessive heat through the leads will ruin them!

Operating

After all soldered connections have been completed, check the wiring against the diagram for errors. Clip the transistor leads to $\frac{1}{2}$ inch long and insert in the socket, attach the aerial and ground and insert phones into the jacks—signals should be heard at once! Two or three stations will be much louder than the others. These stations are furnishing sufficient power to supply the collector's needs. A transistor must have some dc voltage to provide gain or amplification.

If your location is not more than 25 miles or so from a powerful station, and you have an effective aerial and ground, you may expect to hear signals several feet away from the phones on a table top. A signal of such level will work a sensitive PM speaker at modest room level. Secure a speaker with a large, heavy magnet and be certain to use a high-quality, large output transformer. An old-style magnetic speaker, if still in good condition, will do even better, though they are hard to find today.

If for some reason your receiver does not work properly, these troubleshooting suggestions may help: Should no signal be heard after covering the dial carefully, check for errors in wiring or poor solder work at the points of connection. With the transistor removed, signals should still be heard through the diode-phone section of the

circuit. No signal here can mean a bad diode—it's rare. If volume is poor from the best station heard, try another transistor. To determine if the transistor is giving any gain, short out the emitter and collector. A drop in volume shows that all is well.

Measuring power

A multimeter is valuable for checking voltage and current. Remove phones and transistor and place the positive or red meter lead to the ground end of coil; connect the black lead to the minus side of the diode (Fig. 4). Tune the set to a loud station. Set the meter on the 10-volt vdc scale and compare readings with those given below. Take readings of the current in microamperes from same place. Typical readings on loud stations are:

Station	μamp	Volts
WABC	245	.6
WRCA	500	1.9
WCBS	574	2.9

With the meter connected in series with the phones at the collector jack, with transistor in the circuit and the set tuned to the same stations, these readings were observed:

Station	μamp	Volts
WABC	40	.5
WRCA	75	1.75
WCBS	105	2.4

END

REFERENCES

- W. H. Grace, Jr., "Transistor Radio Uses No Power Supply," RADIO-ELECTRONICS, April 1955.
- H. E. Hollman, "Free Power Receivers," RADIO-ELECTRONICS, April 1957.
- W. H. Grace, Jr., "Experimental Carrier Powered Receiver," RADIO-ELECTRONICS, April 1959.

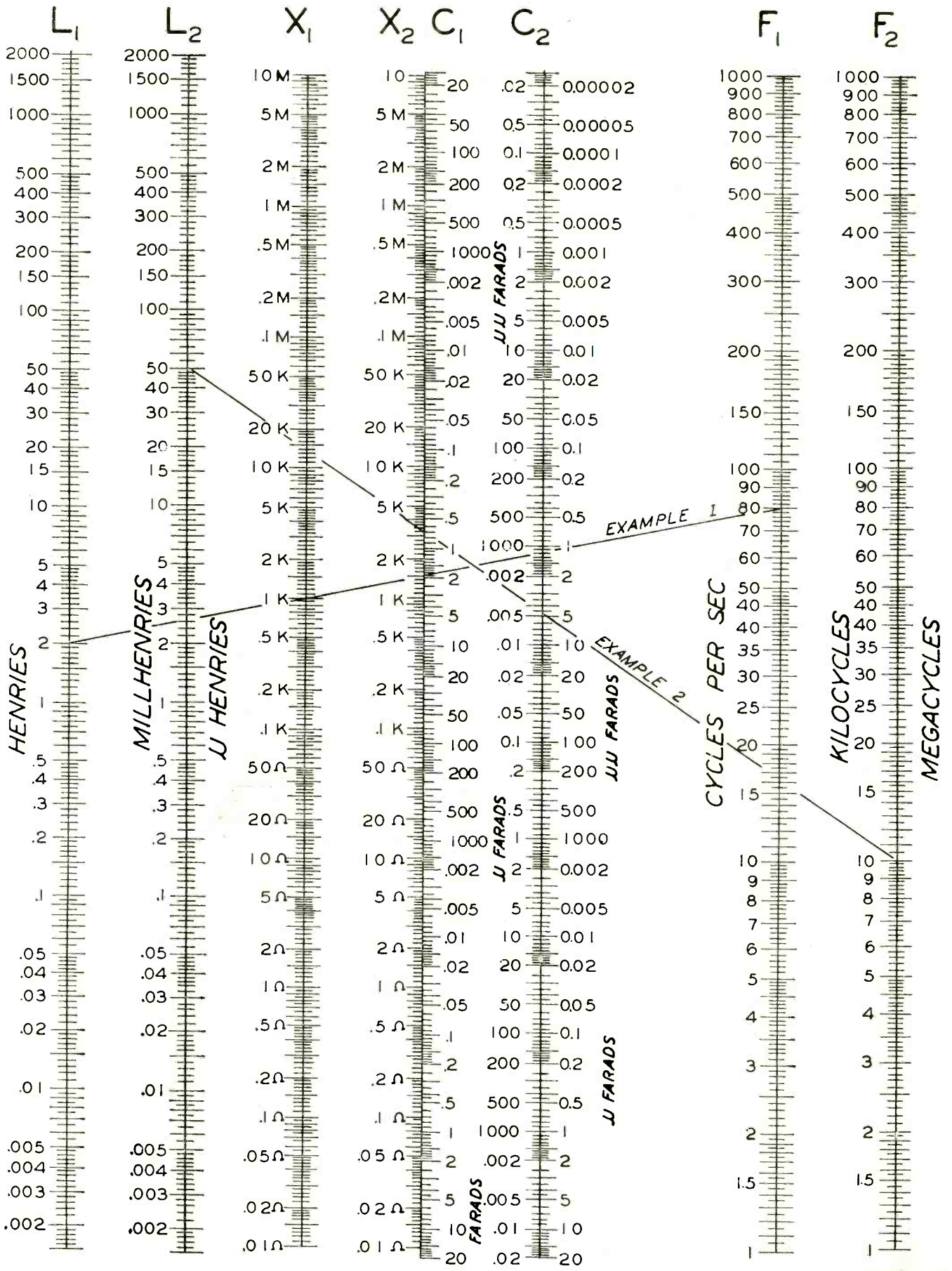



Seco model 500 Crystalalignmeter has bakelite case and easy-to-read front panel.

NEW CITIZENS RADIO TEST SET

Make 7 checks on Citizens-band equipment using a single test instrument

By **ROBERT F. SCOTT**
TECHNICAL EDITOR

THE rapid growth of class-D Citizens-band radiotelephony has led to the development of specialized test instruments such as monitors, rf signal generators, field-strength meters, crystal checkers and tuning meters. All these and other useful functions are combined in Seco's new model 500 two-way radio test set—called the Crystalalignmeter.

The model 500 performs the following functions:

- ▶ Tests activity of fundamental type crystals.
- ▶ Tests the activity of third-overtone type crystals with output in the 26–28-mc range.
- ▶ Serves as a low-power rf signal generator supplying modulated or unmodulated rf signals from third-overtone crystals and modulated signals from fundamental crystals.
- ▶ Operates as an rf indicator for tuning antennas and transmitters for maximum output.
- ▶ Operates as a 0–50-ma plate-current meter.
- ▶ Serves as a visual and audible modulation monitor.
- ▶ Operates as a beat-frequency demodulator and indicator.

The test set's circuit

The circuit of the model 500 is shown in Fig. 1. It consists of two transistor oscillators and a germanium diode used as a mixer-modulator and a meter rectifier. The 2N1225 is a high-frequency transistor operating as a fundamental or overtone-type crystal oscillator, depending on the type of crystal being checked. The 2N44 af oscillator modulates the rf output of the 2N1225 when it is used as a crystal-controlled signal source.

The switch must be in the OFF position when the test set is not being used

or is being used as a plate milliammeter, rf power indicator, monitor or beat-frequency demodulator. The meter is a basic 0–1-ma movement that is used to read plate current, relative rf power output and modulation peaks.

(The manufacturer's diagram of the model 500 shows only the physical arrangement of the terminals of the slide switch and its external connections. We have drawn this switch as a three-circuit four-position type so you can get a better idea of the circuitry.)

The three sets of markings on each switch position seem to be a part of a plot to confuse the operator rather than to help him get the most out of the instrument. For example, there are two MOD RF positions. One—also marked A—delivers modulated rf from fundamental type crystals. The other (C) operates with overtone type crystals. There would be less chance of being used incorrectly if position A was marked MOD FUNDAMENTAL.

Third-overtone CB transmitting and

amateur crystals with output in the 26- to 28-mc range are tested for activity with the switch in the UNMOD RF position. Meter readings increase with Q or crystal activity. A good crystal drives the meter to at least half-scale. A reading in the "?" area indicates a marginal crystal which should be replaced.

In making this test, the 2N1225 oscillator is converted to a third-overtone type circuit similar to those in most Citizens-band transceivers. The oscillator tank is broad-banded for operation in the 26–28-mc range. The circuit is loaded so the rf output indicated on the meter is a measure of crystal Q.

Fundamental type crystals for CB receiver and transmitter circuits and amateur and other services below 20 mc are tested with the switch in the MOD RF (A) position which converts the oscillator into an untuned type similar to a Pierce circuit. Crystal quality is indicated on the meter as described above. Lower meter readings are

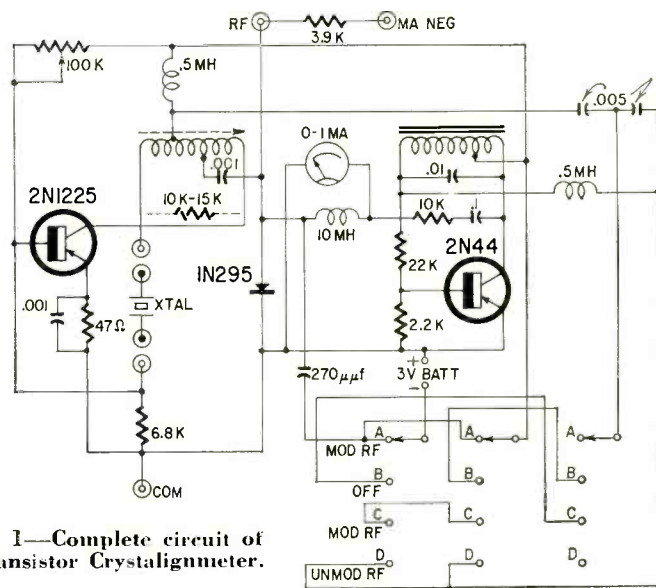

Fig. 1—Complete circuit of 2-transistor Crystalalignmeter.

acceptable from crystals used in receivers, frequency standards and calibrators because they don't have to develop as much power as in transmitting circuits.

The 500 as an rf signal source

The test set can be used as a crystal-controlled signal generator for peaking the receiver's rf and antenna circuits and for checking or setting the squelch threshold. Use the crystal from the transceiver's transmitter or select one for the desired channel. Throw the function switch to UNMOD RF or either of the two MOD RF positions, depending on the type of crystal and whether modulation is needed. Couple the rf output to the set being serviced by placing the test set close to the receiver's antenna input section.

(The rf output of an overtone crystal will be slightly off in the 500's circuit but its frequency is close enough for checking receiver operation. For greater accuracy as a signal generator, use a fundamental type crystal whose fundamental or harmonic falls on the desired channel. For even closer tolerances when using the test set as a calibrator, Seco can supply crystals ground and calibrated especially for the 500's circuit.)

Rf power indicator and monitor

The instrument is handy for checking relative power output when adjusting or comparing antennas and when adjusting transmitter output loading. It is also useful for checking modulation quality.

Rf from the transmitter is picked up on a broad-band tuned circuit, rectified by the 1N295 diode and fed to the meter and phones. The rectifier output is filtered and fed to the meter to indicate relative signal strength or rf power output. Check modulation quality with a pair of headphones plugged into the MA NEG and COM jacks.

Make rf power and modulation measurements with the test set's function switch at OFF and with no crystal in the circuit. Rf power can be picked up by placing the back of the test set close to the base of the antenna or by connecting it to the antenna through the 15-foot shielded accessory cable supplied. The meter can then be carried to the transceiver (on the front seat of the car or in the cabin of a boat) when making adjustments. The plugs on the cable go into the RF and COM jacks on the meter. The small clip (attached to the shield braid) goes to a ground point close to the base of the antenna. The large clip goes to the antenna near the base—with a piece of cardboard or other insulating material under it to provide capacitive coupling when needed to prevent the meter from going off scale. Adjust transmitter loading for maximum loading while keeping the power input within the 5-watt limit for class-D Citizens radio service.

Hum, feedback, distortion and insufficient modulation must be avoided in efficient communications equipment. Monitoring the transmitter's output provides the quickest check on audio

quality. Place the back of the test set close to the antenna base and adjust the spacing for a reasonable deflection on the meter. Modulate the transmitter and listen to the signal on phones plugged into the COM and MA NEG jacks. The meter will kick on modulation peaks.

Tuning the transmitter

The final rf amplifier plate circuit is tuned to resonance as indicated by minimum plate current, and then loaded to the desired power input (5 watts maximum in class-D Citizens radio service). Many CB transceivers have a 100-ohm "sampling" resistor in series with the final amplifier's B-plus supply (Fig. 2). The voltage drop across this resistor is an indication of plate current. The meter in the Seco 500 is calibrated to read up to 50 ma when test leads are plugged into the COM and MA NEG jacks and clipped across the sampling resistor. **WATCH OUT!** The test set's metal panel is at B-plus potential when measuring plate current. Be careful to avoid a shock.

Zero-beating two transmitters

The test set is valuable when tuning all transceivers in a net to precisely the same frequency. Stations on the

same channel may be operating within prescribed tolerances without being on precisely the same frequency. This can make receiving difficult when mobile stations are operating near the limits of their service area or are located in dead spots. With all transmitters at zero-beat on the channel, the receivers can be peaked for maximum sensitivity and selectivity.

Fig. 3 shows the setup for zero-beating two transmitters. The standard and off-frequency transmitters are each, in turn, coupled to the meter's RF jack and the coupling adjusted for a meter reading around one-tenth full scale. With both transmitters on, listen to the beat on phones and adjust the off-frequency rig for zero beat.

(Zero-beating and other frequency adjustments may be made only by holders of first- or second-class radio operator's licenses, using precision frequency-measuring equipment.)

A number of new transistorized test instruments have been announced recently and we plan to discuss them as information is made available by manufacturers. Among the instruments to be covered in future stories are a new precision, counter type frequency meter, a TV field-strength meter and a TV flyback and yoke checker. **END**

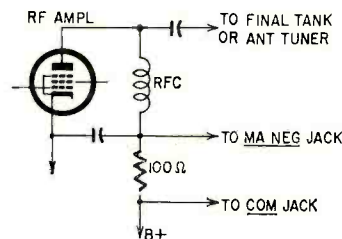
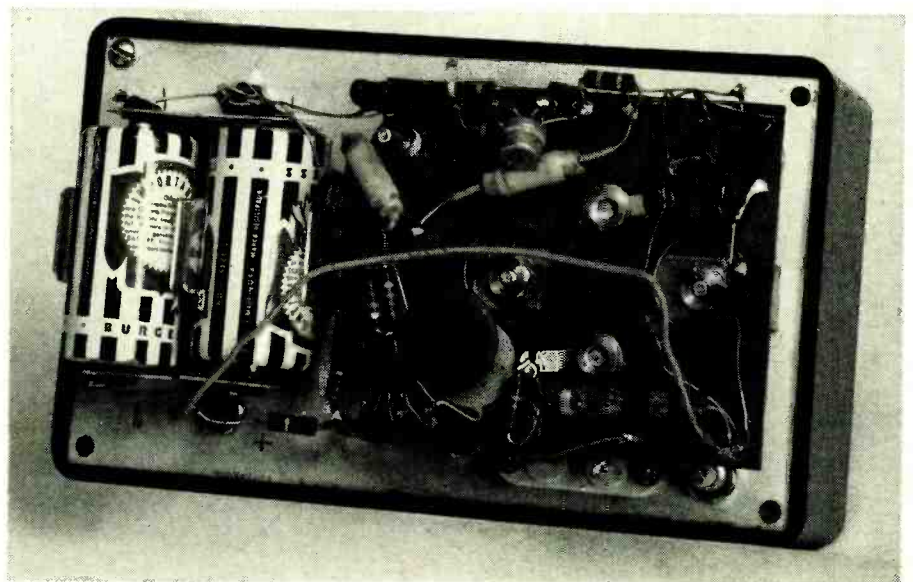
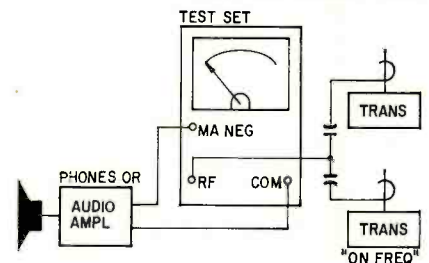

Fig. 2—Hookup for tuning a transmitter.

Fig. 3—Zero-beating two transmitters with the model 500.



Underchassis view of the radio test set.

TV REMOTE USES



1 T U B E

Simple remote-control circuit provides channel-changing and on-off control

By JOSEPH DeMARINIS*

ABOUT a year ago Sylvania introduced a *one-tube* wireless remote control. The service technician familiar with the common two- to seven-tube designs will see the advantages of inherent reliability and operating economy, but may wonder how such a comparatively uncomplicated system can work. We'll try to explain that and also touch on some of the more interesting concepts involved in its design.

The customer holds a transmitter slightly larger than a pack of king-size cigarettes. When he momentarily depresses the button on this unit, the TV tuner advances to the next higher pre-selected channel. A stop between channels 2 and 13 turns the TV set off. The useful range of the system is about 25 feet.

In the TV set, the remote-control receiver normally remains on all the time. It may be turned off by a switch on the front (or top) control panel. A pilot light tells the customer when the remote control is on standby.

To understand how the information is transmitted across a room, first consider two tuned coils very close to one another, lined up end to end (as in a

radio if transformer). An alternating current passing through one coil induces a voltage in the other.

As the distance between the coils is increased, a smaller portion of the magnetic field cuts the secondary winding and the voltage output is reduced. In practice, this voltage falls a little faster than the reciprocal of the distance squared. In other words, this type of system can deliver a strong signal at moderate distances, but output falls off rapidly as the distance increases. (This greatly simplifies the problem of a similar set in the next apartment.)

The system operates at about 8 kc, mainly because interference pickup from the TV set is low at this frequency. Major sources of internal interference are audio, video and harmonics from the vertical retrace pulse. As long as the receiving antenna is kept away from the yoke and flyback, horizontal circuits present little problem. Audio and vertical interference is controlled by proper placement of its respective output transformer and the loudspeaker(s). Video pickup is reduced by careful attention to ground loops.

An optimum *fixed* antenna location was determined for each cabinet model. There is no need to make the antenna orientation adjustable and, therefore,

no danger of maladjustment or shifting during shipping.

Transmitter circuit

The remote-control transmitter is a transistorized Hartley oscillator. The tank coil is wound on a 4-inch ferrite rod and serves as the transmitting antenna (Fig. 1).

The oscillator frequency is determined principally by L1 and C1. These components vary within their production tolerances to give a random spread of transmitter frequencies from about 7.2 to 8.2 kc. (Each receiver can be tuned to match any transmitter.) Thus, it becomes unlikely that close neighbors would own sets operating at the same frequency.

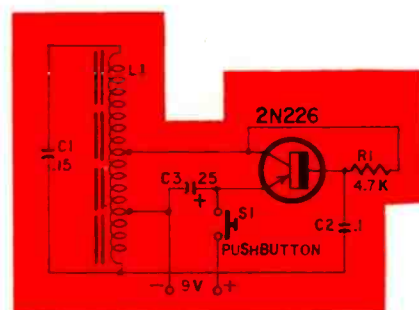

Fig. 1—Transmitter circuit uses a single transistor.

*Senior engineer, Sylvania Electric Products Inc.

The oscillator draws about $\frac{1}{4}$ watt from a mercury battery, and produces more effective radiated power than many competitive systems. This is a major factor in making the one-tube receiver possible. Early estimates gave an average battery life of about 1 year. Recent experience has shown that figure to be *very* conservative.

The receiver

Fig. 2 shows the remote-control receiver circuit. The heart of the one-tube design is a circuit trick, familiar to old timers, but rare in this age of plenty—reflexing! More about this later.

The receiver input coil (L2) is wound on a 7-inch ferrite rod and serves as the receiving antenna. It is resonated with C4 and C5. Providing sufficient antenna tuning adjustment without sacrificing performance proved to be a most difficult design problem. The size of the capacitors ruled out a trimmer, and a simple adjustment of the inductance of a ferrite antenna is not easy. A tuning range of about 1,000 cycles is required.

The antenna is mounted in a phenolic tube with an adjustable ferrite slug attached to the end. The inductance changes slightly when the spacing between this slug and the ferrite rod is varied.

This gives about half the required tuning range. To pick up the rest, C4 is added or removed as required. The tuning range of the slug slightly exceeds the change produced by adding or removing C4.

The tube, a 6A W8, is a pentode-triode chosen because, of all the common receiving tubes, it can give the most gain from one envelope.

Receiver operation

Let's consider the receiver in the standby condition. An incoming signal is picked up by the antenna and the voltage applied to the pentode (V1) grid. The pentode is in a conventional tuned amplifier with the resonant circuit L3-C7 as the plate load. The signal is R-C-coupled to the triode (V2) and amplified again. L4 is an audio-frequency choke and acts as V2's ac plate load. From this plate, the signal is

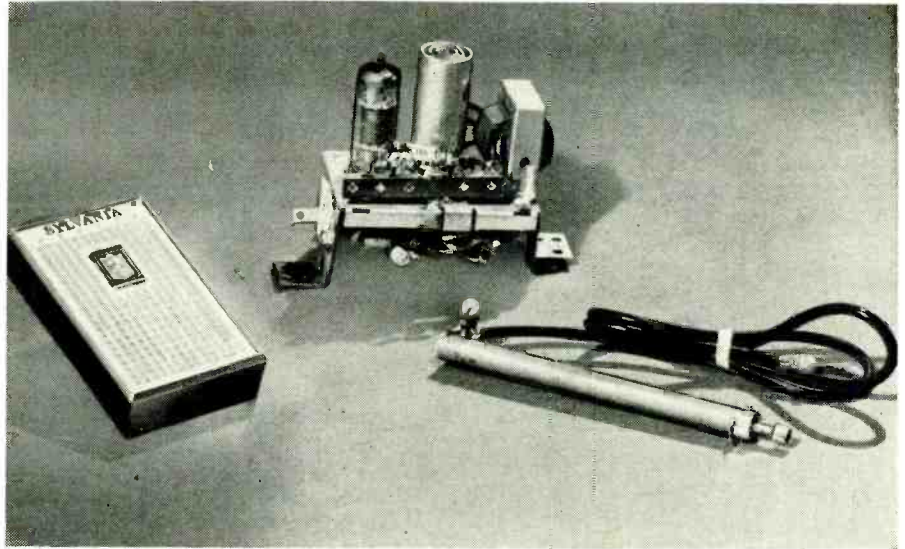

Basic components of Sylvania remote control system. Left to right: transmitter, one-tube receiver, ferrite antenna.

capacitance-coupled to a voltage-doubler detector which gives a positive dc output. C10 and R7 constitute the detector load. This time constant is large enough to peak-detect the 8-kc carrier, but will not sustain the peak voltage of any modulation or pulses (interference) present. The detector output is fed back to the triode grid through R4, a 47,000-ohm resistor.

A glance at Fig. 2 shows that the V2 plate current must flow through the relay coil. A second look at the impedances involved shows that the relay coil is V2's dc plate load.

The positive grid voltage causes an increase of triode plate current that closes the relay. C11 is large enough to bypass the relay coil and keep it from chattering at low frequencies.

We have seen how ac and dc are simultaneously applied to the triode grid. Each component of the output appears across its own plate load; L4 for the ac and the relay for dc. Thus, by reflexing, one tube does the work of two.

Study Fig. 3. It is a plot of amplification factor vs grid bias, and plate current vs grid bias for V2. Note that over a wide range of grid voltage, the am-

plification factor remains almost constant, while the plate current changes substantially. It is this characteristic of triodes that makes reflexing possible without sacrificing (or changing) gain to any extent.

The relay pulls in with 5 ma through the coil and releases at 2 ma. Fig. 3 shows that the above current range is near the flat portion of the μ/E_c curve. R5, called the THRESHOLD (or REMOTE RANGE) control, is used to bias the triode to a standby plate current of 2 ma or less.

Interference from the TV set produces a small output from the detector. The THRESHOLD control must also provide sufficient bias to overcome the interference. If too much bias is ap-

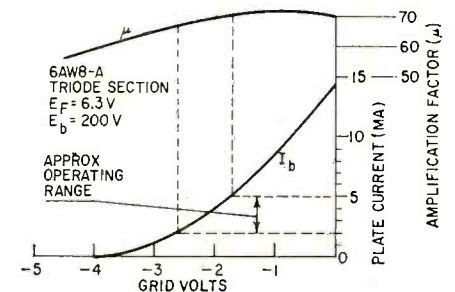

Fig. 3—Characteristics of the 6AW8-A triode section.

plied, the tube's operating point will slide down the μ/E_c curve, seriously reducing gain and therefore the operating range.

R11 bleeds a constant current through the THRESHOLD control to stabilize the bias and reduce dc cathode degeneration.

L3 is a universal-wound coil with an adjustable core and easily tunes the required range.

L4 must be wound on a closed iron core to minimize its external magnetic field. If strong enough, this field would be picked up by the antenna and throw the system into oscillation.

The detector-doubler diode is similar to the type commonly used in horizontal

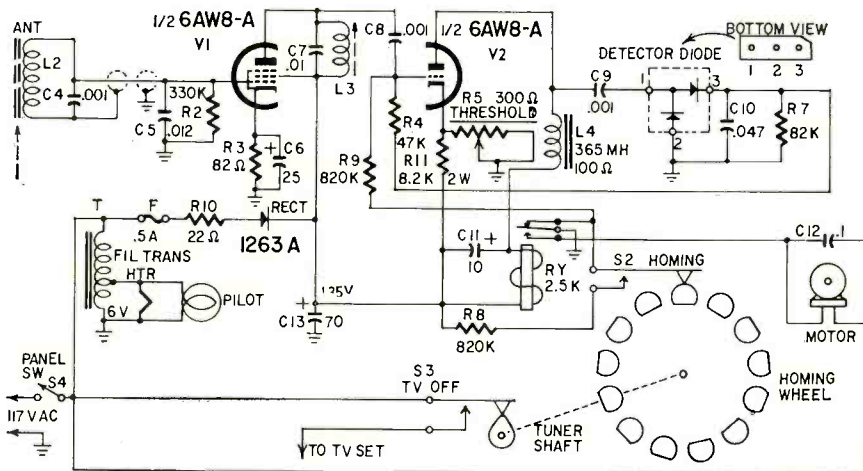

Fig. 2—Remote control receiver circuit 1.

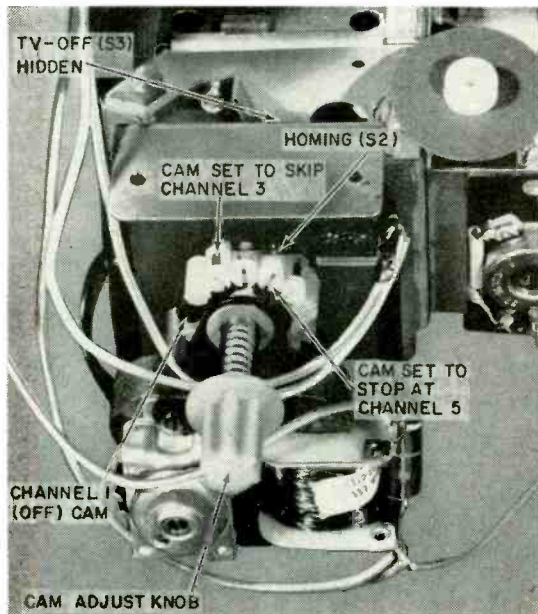

Fig. 4—Original homing wheel assembly.

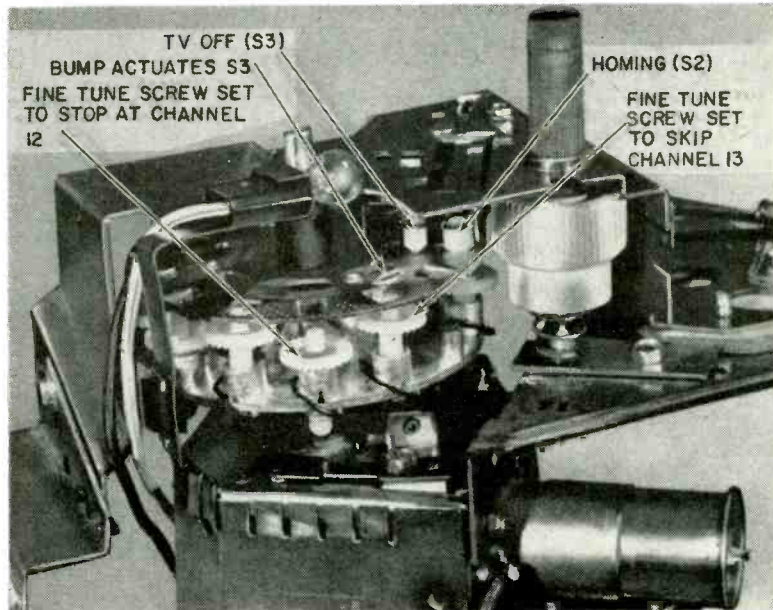

Fig. 5—Revised homing wheel and fine tuning assembly.

afc circuits, but the internal connections are end to end rather than back to back.

Channel-switching mechanism

C12 (Fig. 2) and C16 (Fig. 6) suppress arcing at the relay contacts.

The drive mechanism consists of a motor and gear train coupled to the rear extension of the tuner shaft. A homing wheel is also rigidly coupled to the rear tuner shaft. This wheel has 13 semi-cylindrical nylon cams mounted along its edge (Fig. 4). The nylon rider of leaf switch S2 rests on that perimeter, touching each cam surface as the homing wheel rotates. Twelve of the cams may be turned so that either their round or flat sides face the switch. When a cam, with its round side up, passes under the switch, the leaf is deflected and the contacts open. When the flat side of a cam passes under the switch, the leaf is not deflected and the contacts remain closed. This arrangement not only "tells" the motor exactly when to stop (round side up) but gives us a means to bypass unwanted channels (flat side up). The tuner always stops at the channel 1 or OFF position (that cam cannot be rotated). There, the TV set is turned off by another leaf switch (S3) operated by another simple cam also mounted on the tuner shaft.

Last time we spoke of the signal, it had just closed the relay. That starts the motor. When the tuner shaft has rotated a couple of degrees, the rider of S2 falls into the valley between two homing wheel cams, closing S2's contacts. The incoming signal may now be discontinued, since sufficient B-plus is fed to V2's grid (through R8, S2 and R9) to keep the relay closed and the motor running.

As the tuner comes into the next preselected channel (round side of cam up), the homing switch opens the path from B-plus to V2's grid. The triode returns to its standby condition and the relay opens, instantly grounding the

junction of R8 and R9. This makes the hold-in circuit (R8 and R9) inactive. Should the homing switch close again, the motor will not start. Without this lockout feature, manual tuning would be impossible and homing wheel adjustment very critical.

Alternate channel changer

The initial production run was built as we've just described. Then an improved homing wheel, which works in conjunction with the preset fine tuning, was incorporated.

Take a look at Fig. 5. The disc assembly, with the gear-tooth screws, is firmly attached to the front tuner shaft. Each channel position (except channel 1) has a corresponding gear-tooth screw with a rectangular hole in the top disc above it. Channel 1 has a hole in the top disc but no gear-tooth screw.

Two leaf switches, the on-off switch and homing switch, ride on the top disc. While the tuner shaft is turning between channels, the leaf of the homing switch is deflected upward, keeping the contacts closed. When on channel, the nylon rider of the homing switch falls into a hole in the top disc (as shown in Fig. 5) and the contacts open.

Each channel is fine-tuned by turning its "own" gear-tooth screw, thereby adjusting the position of the fine-tuning plunger on the tuner. (This concept is familiar to service technicians.) To skip a channel, simply turn its fine tune screw all the way up so it blocks the hole in the top disc. The on-off switch opens when a bump or hole (depending on the chassis) in the disc passes under it at the channel 1 position. The tuner is driven, as before, from the rear shaft extension.

Compared to the original setup, this design keeps the homing switch open over a much smaller angular rotation of the tuner shaft, inherently increasing the possible stopping accuracy. However, the time constants (R7-C10 and the relay and C11) of the original re-

ceiver could not react to the fast homing switch, so the tuner never stopped! If these time constants were cut back, the system became prone to impulse interference (arcs, power-line bumps, etc.) and relay chatter. We needed a receiver that would start up slowly (for interference immunity) and stop instantly. The circuit shown in Fig. 6, fulfills this requirement.

The front end of both receivers is the same. Consider the standby condition. An incoming signal develops dc across R7 and C10, the diode load. This positive dc charges C15 through R13, and the voltage across C15 is applied to the triode grid. (See Fig. 7-a. Note that at this time the bottom end of R7 and C15 is grounded.) The time constant of R13-C15 is large, and a sustained signal is required to build up enough voltage to close the relay. Thus, the receiver is insensitive to most impulse interference.

Once the motor has started and the homing switch closed, the circuit takes on the configuration shown in Fig. 7-b. The positive hold-in voltage, derived from B-plus and developed across R14, is fed to V2's grid through R7, R13 and R4. Now V2's grid and cathode form a diode, holding V2's grid at about the cathode potential (normally about 2.5 volts). Since the hold-in voltage across R14 is about 7 volts, C15 charges to about 3.2 volts with the polarity shown in Fig. 7-b.

At the instant the homing switch opens, the "hold-in" voltage disappears and the circuit looks like Fig. 7-c. R14 is such a low impedance that the bottom of C15 is essentially grounded. At that instant, -6 volts appears between V2's grid and cathode, cutting off the tube. The relay opens quickly, shorting R14 for a lockout action, discussed previously. In a few tenths of a second, C15 discharges through R13 and R7, returning the system to the standby condition.

Since V2 is absolutely cut off by the stop signal, the relay cannot chatter

logarithmic METER

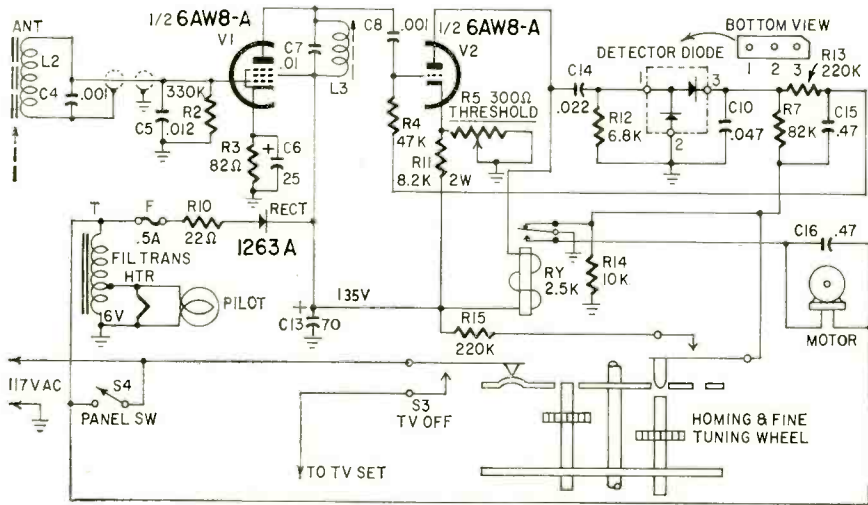

Fig. 6—Remote receiver circuit 2.

then. The long time constant of R13-C15 prevents it from chattering at other times. This enables us to unby-pass the relay and use it as part of V2's ac plate load. The 8-kc impedance of the relay coil is much too high for stable operation, so R12, ac-coupled through C14, is really the ac plate load (Fig. 6).

The original system will bypass pre-selected stop channels if the transmitter button is held down. The revised receiver will normally stop momentarily at each preselected channel while the triode circuit goes through the cycle just described. Most people prefer the latter action.

Operating problems

Both receivers are prone to overloading at distances less than about 5 feet. The large signal is rectified by the triode grid, producing a negative voltage which opposes the positive voltage coming up from the detector. The net result is no dc, or dc of the wrong polarity. Careful orientation of the transmitter will help when testing at close range.

Detailed adjustment and alignment instructions for the service technician are packed *inside* each remote-control TV cabinet. Alignment will be necessary if the transmitter is replaced or repaired. Threshold adjustment may be required if the 6AW8 is replaced, if the line voltage becomes excessively high or low, or as indicated below.

Like all other remote-control systems,

this one may be triggered by external phenomena. In rare cases, some electrical devices may generate a great deal of noise and feed it into the power line. If the same power line runs very close to the TV set (rises in the wall behind the set), it may radiate enough noise to trigger the remote. Moving the set a few feet or else placing it against another wall will usually remedy this problem.

If the dimensions of the room are less than the remote-control range, most cases of interference can be cured by slight clockwise rotation of the threshold control.

As we said earlier, the transmitter has a rather short range and operates on one frequency in a range of 1,000 cycles. This makes it unlikely that one remote will operate a set in neighbors' apartment. However, this may happen and when it does the customer will be unhappy, to say the least. The most effective cure is to trade off one of the remotes and readjust the receiver to match the frequency of the new unit.

The technical reader should now realize that all the considerations making the one-tube design possible are sound. There are no compromising or unreliable tricks. The tube and all components are operated very conservatively and should deliver long, trouble-free service. If repair does become necessary, a thorough understanding of the system should make your service call fast and profitable.

END

AMONG useful items sold by radio stores handling surplus items is an antenna relay designated ARC-5 or BC-442-A. This is a small metal box that contains a thermocouple, mechanical relay and "antenna current indicator" meter. The meter is calibrated uniformly from 0 to 10. With the thermocouple it measures rf from a transmitter into an antenna.

The meter, a dc instrument, is unusual in that it is logarithmic. Each division indicates a current $\sqrt{2}$ times greater than the previous division, except near zero and near full scale. As a power meter, therefore, each division is equivalent to *twice* the power of the previous division.

Here is the measured calibration of a meter (G-E type DW-52) from an antenna relay box:

Meter Calibration	Actual (ma)
0	0
1	0.25
2	0.32
3	0.48
4	0.72
5	1.0
6	1.4
7	2.0
8	2.8
9	4.0
10	6.4

This meter is useful in many ways. It can be used to assemble a wide-range milliammeter or voltmeter. In an ordinary dc meter, there would be a 10-to-1 ratio between full scale and the first division. Here the ratio is approximately 25 to 1. Field-strength meters and other instruments are sometimes designed to have logarithmic response to provide a wide range of values. The range could be increased further by using a logarithmic meter like this one, rather than an ordinary dc meter. In a bridge circuit, this meter can read weak currents without overloading on strong inputs (off balance).—*Nathaniel Rhita*

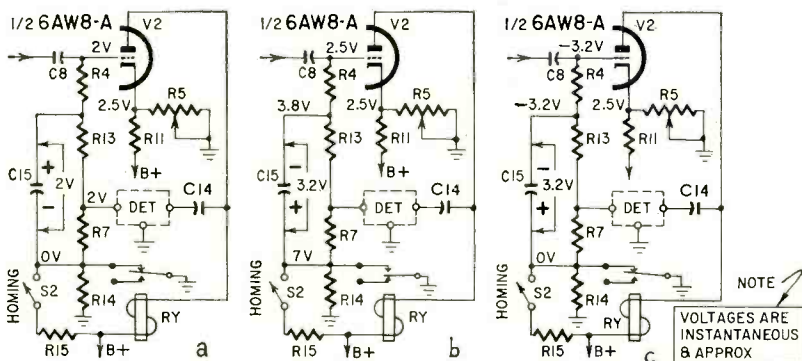
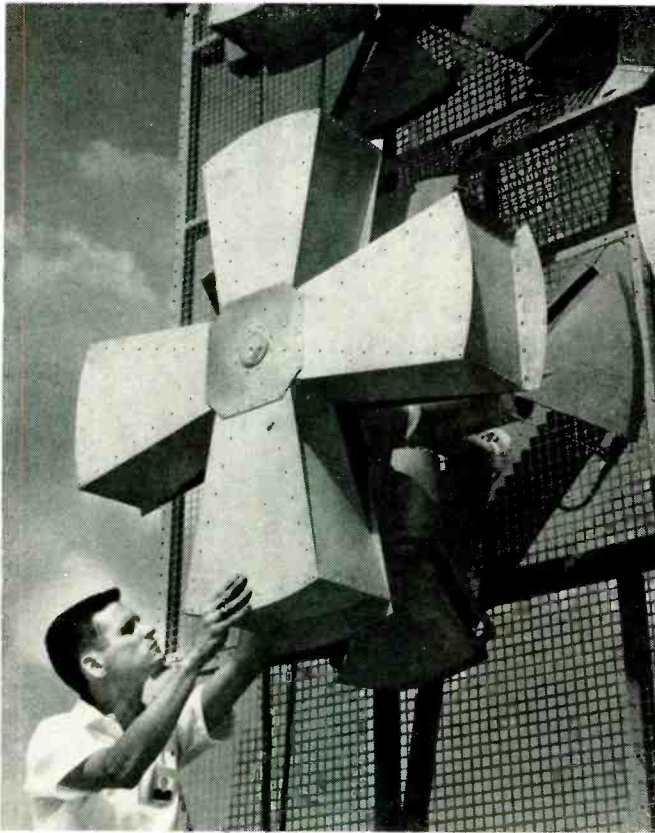

Fig. 7—Triode circuit action in remote receiver 2.



"It's called implosion!"



A closeup view of one unit of the Vought multipolarized antenna

Fig. 1—Details of construction can be seen clearly in this photograph of an actual prototype.

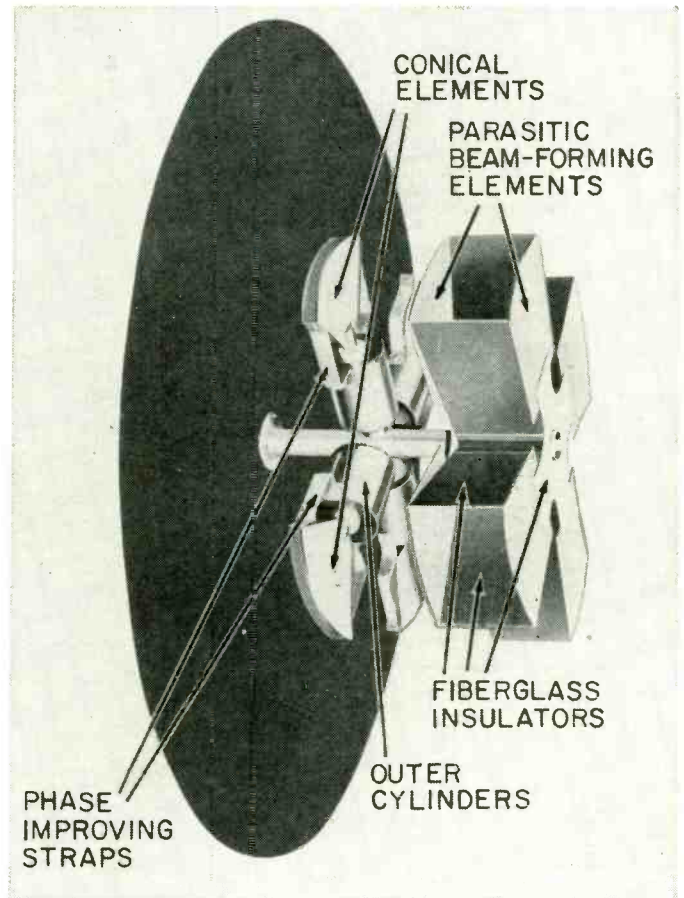

SPACE-SCANNING ANTENNA IS MULTI-POLARIZED

Polarization switches electronically without delay or element changing, simplifies satellite or missile tracking or telemetry

THE unique equipment on our cover this month is a new multipolarized antenna for use in space-vehicle and missile tracking and telemetry. By simple switching it may be polarized vertically, horizontally or circularly with either clockwise or counterclockwise polarization. This makes it equal to four separate antennas of the older type. The polarity best suited for operation with a particular missile or space vehicle is selected by remote switching, or automatically if necessary to change from one to the other instantly.

The highly flexible new unit, developed by the Electronics Div. of Chance Vought, will be used aboard the USNS *Range Tracker*, the Pacific Missile Range's first tracking vessel.

The designer of antenna systems for missiles or satellites usually selects linear polarization, as giving the best all-around coverage pattern. But, with the complex shapes of today's missiles

and satellites, it is extremely difficult to generate pure linear polarization. At some angles, and when rolling or tumbling, the airborne systems produce both the desired and other polarizations, yielding at the ground station a mixture of vertical and horizontal polarization and elliptical polarizations of both right and left sense. Thus, the ground station needs an antenna capable of receiving all polarizations.

This antenna is adapted to these various polarizations by remote switching or by connecting various cabling arrangements at the rear of the ground screen. The difficult element changing of conventional arrays is eliminated.

The multipolarized array is mounted on a ground plane the same size as conventional arrays of equal gain, but offers a 3-to-1 reduction in end-fire length over helical arrays. The reduced end-fire length places the center of gravity closer to the pedestal's center

of rotation and makes the antenna less subject to vibration during the maximum slew rates that are found in tracking.

The best design for a multipolarized antenna seemed to Vought engineers to be one with two separate inputs, one for horizontal, the other for vertical polarization. The antenna could be polarized circularly by inserting a 90° phase shift between the inputs.

How it is built

The antenna designed on this basis consists of two full-wave elements—one horizontal and one vertical—fed from balanced transmission lines. The center-fed full-wavelength elements had a high input impedance. To reduce this impedance, each of the driven elements was enclosed in a tube for approximately half its length each side of center. This tube forms a coaxial transmission line.

FCC 189

WITH so many tubes having identical basing, it is often a temptation to substitute different types in TV tuners. The 6BQ7, 6BZ7, 6BK7, ECC-189, are all identical as far as base connections are concerned and will all work in most tuners. However, the performance of the tuner is often affected by unwise tube substitution. The tube should never be changed unless the performance of the tuner is carefully checked afterward, preferably by a sweep alignment.

It is often possible to replace rf amplifier tubes with other types and improve performance, especially in TV sets used on very weak signals in fringe areas. For example, the 6BQ7 will give about 4,000 μ hos of mutual conductance on the average g_m tester. The Phillips equivalent ECC189 often tests as high as 6,000 μ hos!

Therefore, if the signal is extremely weak, substituting the hotter tube for the original will sometimes give a good improvement in overall performance. However, the set must be checked on all channels, to be sure that it is working properly.

The most common troubles encountered here are oscillation and general instability, due to the extra gain of the hot tube. This will often show up as oscillation on only one channel, usually channel 6. There is not much to be done about this, short of redesigning the tuner, so the only alternative is to go back to the original tube type.

Under certain circumstances, replacing the rf amplifier tube with one having lower gain will cure difficulties! If the signal level is very high, and the trouble is excessive age voltage, general instability, overloading, etc., it might be worth while to try a lower-gain tube in the rf amplifier stage.



Video if amplifier tubes share this characteristic. There are many tubes with identical basing and filament ratings, and the temptation to substitute is very strong at times. However, this can lead to even more trouble than substitution in the tuner. The if stages are almost always age-controlled. The major difference between the various if tube types lies not only in the overall transconductance, but in the shape of the response curve—sharp cutoff, remote cutoff and semi-remote cutoff. Replacing a tube of one type with one having a different curve can lead to many obscure troubles! Incidentally, if such troubles are found, the first step should be to examine the if amplifier tubes closely to see if someone has made such a change! Fig. 1 shows the difference between the curves of several popular types—notice the wide range of voltages required to cut off the various tubes. This could lead

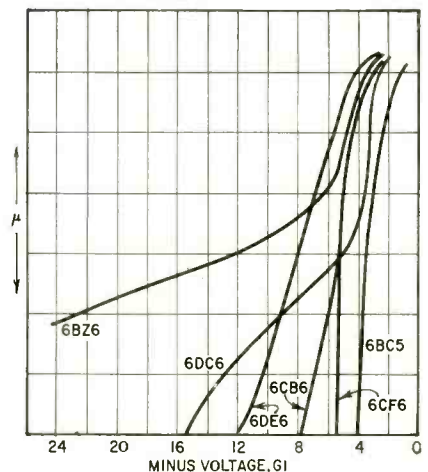

Fig. 1—Cutoff characteristics of popular video if amplifier pentodes. Note wide range of grid 1 voltages required to bring tube to cutoff, also variation of slopes.

Space-Scanning Antenna Is Multi-polarized (Continued)

The center conductor—the original driven element—extends out of the tubular section and is flared out into a conical shape, providing a more broadband radiator.

The outer tube of the coaxial line was connected to a larger cylinder—the one seen in the photographs—at its outer end, to maintain proper radiation patterns. A pair of straps from the edge of the outer cylinder to the end of each center element adds inductance, improves phase relationships.

The parasitic elements

The end-fire structure, which gives the antenna its characteristic Maltese cross appearance, actually consists of two broadband parasitic elements ahead of each driven section. The sides and ends of the Maltese crosses are made of fiber glass, as is the squarish plate in the center of each cross. Thus each of the eight parasitic elements in each cross is insulated from the others. The elements are so spaced as to act as

directors, empirical methods being used to design the structure. They are so shaped as to keep the band wide. (See Fig. 1 at head of story.)

Four of these antennas mounted on a 12-foot-square ground plane constitute a typical array. The antennas are mounted one wavelength apart at 215 mc. An improvement in side-lobe level was obtained by adding a structure on the ground plane between the individual antennas, making each antenna free from reflections from the others.

The resulting Vought Electronics uhf multipolarized antenna has an essentially flat characteristic from 215 to 260 mc, a directional pattern 20° between half-power points, at least 18-db gain and not more than a 1.5-to-1 voltage standing-wave ratio (VSWR) over any part of the band.

Operational techniques

When all four antennas are fed in phase, the array produces a sum pattern ideally suited for receiving telemetry data. The most common tracking sys-

tem is one in which the four antennas are fed into a comparator which produces an output consisting of such a sum channel and an azimuth and elevation difference channel. The azimuth difference channel places the two azimuthal halves of the antenna 180° out of phase, and so produces a deep, sharp null in the direction of the object being tracked. The elevation difference channel produces a similar null in the elevation plane.

Another possibility in addition to polarization diversity is space diversity. Two multipolarized arrays could be spaced approximately 50 wavelengths apart. The horizontal elements of each quad would go to a pair of separate receivers, while the vertical outputs would go to another pair. The output of these receivers would then go to a diversity combiner and thence to either the system's input or a recorder. This system would afford optimum signal strength regardless of the source polarization, and with an effective gain increase in the order of 12 db. END

to troubles not only in the stage affected directly, but in subsequent stages, due to overloading, clipping, distortion and many other troubles.

Agc circuits will also be affected by changes in video if amplifier tubes. For a given signal voltage input, the agc voltage will be quite a bit different, as may be seen from the chart. This will affect, not only the if, but also the tuner.

Therefore, if tube substitutions must be made, be sure that you are substituting the tube with the closest set of characteristics. Even so, performance will probably be adversely affected.

Vertical troubles

We have a pair of Zenith 19R21 chassis that are giving us headaches. The trouble is weak vertical hold in both. This has developed gradually over the last 2 years. One of them, in the shop, will work perfectly for a week at a time, but the vertical hold can be lost by any disturbance (change of line voltage, etc.). We've changed tubes,

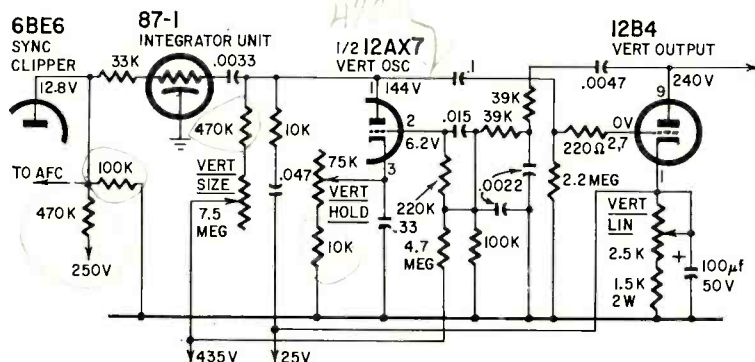

Fig. 2—Vertical circuit of Zenith 19R21 chassis. Integrator is circled.

checked voltages, and everything seems to agree with the schematics. Waveform-wise, I get a vertical sync pulse of about a fourth the height of the kickback pulse, at the output of the integrator. I have shunted the small integrators in the circuit, without results.—W. W. S., Conde, S.D.

Your vertical hold trouble is probably due to an off-value component rather than a completely defective one since the trouble is intermittent. These are always hard to track down.

Zenith uses a small ceramic integrator resembling a disc type capacitor (Fig. 2). These are special and obtainable only from Zenith distributors. I have never found a substitute in a general replacement line, although there may be one somewhere. Check these by replacement, rather than shunting, due to their characteristics.

If this doesn't help, check the plate load resistors of the 6BE6 sync separator (470,000 and 100,000 ohms), the 470,000-ohm resistor in the 12AX7 plate and the 10,000-ohm resistor in the cathode circuit. You might also check the hold control itself for a change in value. While this is rare, I found one the other day that had changed! Leakage in any of the grid coupling capacitors could also give trouble. This would change

the shape of the oscillator waveform, rounding off the top corners, and make it difficult for the sync pulse to hold the oscillator in line.

(Note: some versions of this set used another integrator between the oscillator and output stages in place of the shaping networks. Check this also.)

Unknown set

I have a set with a burned-out flyback and no chassis identification. The old flyback has the letters ET106CM on the mounting bracket and 111C2 on the core. I've written to several people and they tell me that they need more information. Can you recommend a replacement?—L. K., Cape Cod, Mass.

Whoever you wrote to first was right! That isn't much information! However, we're lucky: something about that part number struck me as familiar and about a half-hour's digging through transformer manufacturer's catalogs produced a match! Your mysterious TV set is a Mattison model 630 DXM or MDXL. You'll find a complete sche-

uncontrollable sound; one is trouble in the printed circuitry, the other is a bad contact somewhere in the plug-cable system connecting the volume control and others to the chassis (Fig. 3).

From the symptoms your trouble is probably caused by a bad ground. From the time constant of the trouble, I'd say that the most likely prospect was a thermal intermittent, somewhere in the ground circuit. After the chassis gets thoroughly warmed up, you have a good ground and the volume control action goes back to normal. Good check: run a temporary jumper from the ground lug on the volume control back to the chassis with the set cold and see if this stops the trouble. A scope will help too. Check around the volume-control circuit and see if you don't find a high-level signal someplace where there shouldn't be any!

Red blooming

We have just replaced the 21CYP22 picture tube in an RCA 21CD8845 color set. When we made the convergence adjustments, we found blooming of the red dots, no matter how low the red screen control is set. Overall convergence is good, but there is a red halo around all of the white dots. With the red gun blocked out the green and blue guns track nicely and maintain the proper size over the full range of the brightness control. Is there any other reason for blooming other than excessive screen voltage? Are we correct in surmising that there could be some trouble in the red gun of the new picture tube?—H. E. DeL., Moultrie, Ga.

For your sake, I hope the picture tube is all right! However, just to be sure (and because it is the easiest thing to do!), I'd check the picture tube carefully, comparing the readings of red, green and blue guns. Any defect in the new tube should show up here.

If this doesn't help, check all components in the red circuit very carefully. The screen controls on these sets have a tendency to change value, now and then, due to the current flowing through them. Check the other screen controls (disconnect them) by measuring their resistance. There has been some confusion on these due to production changes, but this was mostly in the older sets like the CTC4A, etc. Also, check the red background control and its associated circuitry for the same thing. It might be a good idea to replace all fixed resistors in the red circuit; there are only three, I think. This would eliminate trouble due to gradual drifting of resistors.

It might also be helpful to run the red purity adjustment once more, to be sure that it is correct.

Tuner replacement

We have an old Dumont, model RA-117A, which uses an Inductuner, and would like to replace this with a Standard Coil GG-2220 or other suitable 12-position tuner. Can you draw me a schematic showing how to make the necessary connections?—H. S. S., New York.

The worst problem here would be the

matic, etc., in Sams Photofact folder 243-7.

A Triad D-15 is a suitable replacement and the folder will give you the conversion data. Incidentally, watch out for the polarity of the agc pulse voltage, which is taken from the width coil on this series.

Too much sound

I'm having trouble with an Admiral 18Y4LS TV. The set comes on with a high level of sound, even when volume control is rotated to minimum setting. This stays on for about 10 minutes, then drops down to normal level which is controllable normally. I've changed tubes and coupling capacitors, and checked filters by substitution to no avail.—L. K. S., Newark, Ohio

There are two possibilities for the

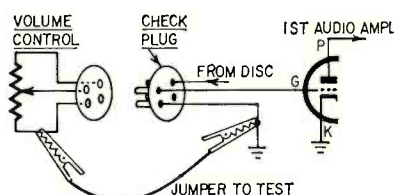

Fig. 3—Improper ground can easily be checked with a length of wire used as a jumper.

physical mounting of the tuner. The GG-2220 Standard Coil tuner is not too large, but I would check the dimensions carefully before going ahead as there won't be much room between the bulge of the picture-tube bell and the tubes. It might be possible to "flange up" some kind of brackets that would allow the new tuner to be canted to one side to give the clearance needed.

This Dumont is a split-sound chassis, but the sound takeoff is from the plate of the second video if so you can use the tuner's output if transformer as is. Be sure to get the 21-mc tuner. The 25.75-mc coil is on the tuner chassis in the original circuit and is included in the new tuner. The present 120- μ f capacitor should provide enough coupling, so leave it in the circuit.

Connect the new tuner as shown in

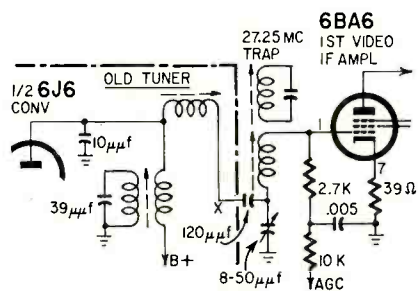

Fig. 4—Partial schematic of first video if stage and tuner output. To replace tuner, break at X.

Fig. 4. Use the shortest possible piece of 52-ohm coax to make the connection from tuner to chassis. Adjust the variable capacitor for the best curve shape after all adjustments have been made. It would be a good idea to run a complete sweep alignment on the tuner and video if's.

Conversions on Sentinel

We have a Sentinel 411 TV chassis to convert to a 17-inch tube instead of the 12LP4, and to install a Standard Coil cascade tuner.—A. J. O., Chicago, Ill.

This is quite a job! You have to change both flyback and vertical output transformers and make several other changes in the circuitry because of the wide difference in tube requirements! Also, this chassis doesn't have room for even the smallest Standard Coil tuner. I'm sorry to say I can't recommend this conversion.

Horizontal shadows

We have a 1930 Techmaster TV which has always had a cloudiness at the left side of the screen. We've replaced the yoke, flyback and sync discriminator transformer, and added a 47-ohm resistor to the 6CD6 plate circuit and a choke to the screen circuit. The choke helped a little, the resistor quite a lot. Turning the horizontal hold to the left moves the picture to the left, and makes the cloudy foldover worse.—J. P. G., Ashland, Quincy, Mass.

They surely can't say you didn't try! Actually you were on the right track in adding suppressors to the horizontal

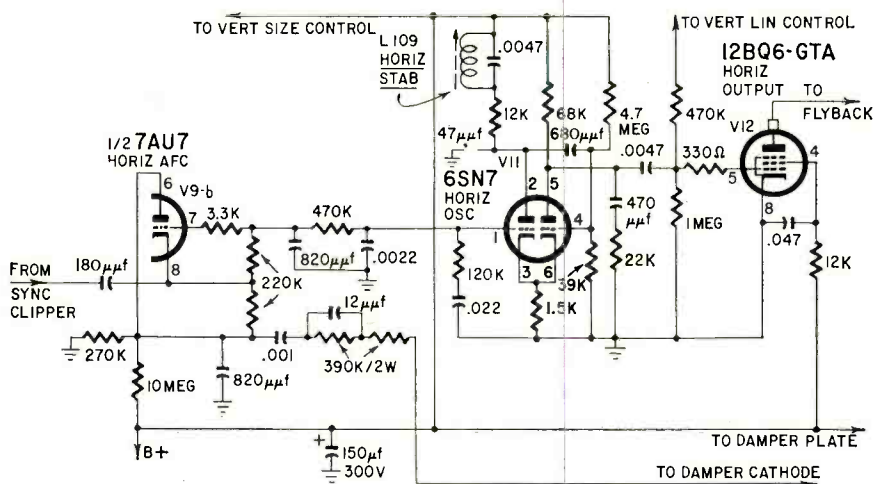

Fig. 5—Horizontal oscillator of G-E 21C30.

output plate and screen circuits. Part of this trouble is caused by radiation of horizontal signals—sometimes into the lead-in cable between antenna terminals and tuner. The basic cause of the trouble is video information caught in the horizontal retrace period. As you forgot to give the model number, I'm going to have to give some general remedies.

The basic cure lies in increasing the horizontal retrace time. Since you have replaced the flyback and yoke, check these for an exact match. However, since the trouble has always been there, this is possible but unlikely. Try changing the capacitance across the 6AL5 plates or whatever type of horizontal phase detector is used, increasing the size of the resistors across the cathodes and changing slightly the size of the capacitors in the R-C network between the phase detector and the horizontal oscillator. Whatever you do, if it increases the time constant of the horizontal blanking, it should show up as a reduction in the shadows.

You might also check voltages around the picture tube very closely. If grid and cathode voltages are not exactly right, the tube may not be sufficiently blanked during horizontal retrace times by the video signal. If the set uses a dc restorer, check it carefully.

Intermittent oscillator

Could you tell me what the trouble is in a Canadian G-E 21C30? When it is turned on, I have sound and no picture. I have to tap the 6SN7-GT horizontal oscillator before the picture comes on. I've changed this tube a number of times, but it seems to keep going bad.—A. R. T., Montreal, Quebec, Canada.

From the symptoms you describe, it would seem that there is an intermittent connection somewhere around the horizontal oscillator socket. However, if it works all right after it starts, this may not be the case. I would clean and tighten all the socket contacts and resolder all suspicious-looking joints, just in case.

The other possibility here would be a marginal condition in the oscillator circuit. This could be due to plate

supply resistors, as shown in Fig. 5. If one of these has increased in value, it could leave your horizontal oscillator right on the verge of oscillation. When you tap the tube, the microphonic noise going through the circuit could be enough to start it oscillating.

Check the ringing coil (L109) for high-resistance joints and check the coupling capacitors for leakage.

No nothing

I have a Hotpoint 14S203 portable TV on the bench and nothing works! No raster, no sound, no tubes lit up. I substituted a new line fuse and fusible resistor without success. All tubes check good in continuity tester. While

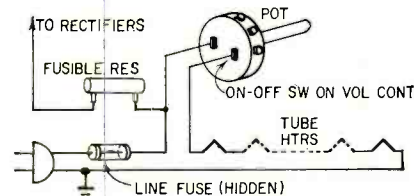

Fig. 6—Series-string circuit has line fuse hidden behind chassis.

I was working on this one, another customer came in with a G-E 14T007 with exactly the same trouble! If you can give me some idea on one of them, I can fix the other one too.—M. H., New York

You get troubles like grapes, in bunches! You have obviously got an open circuit somewhere in the line. Although you say you replaced the line fuse, I am wondering if you got the right one. The line fuse in this chassis (and in that G-E, too) is concealed inside the chassis and can be very hard to find! It is soldered in, at the lower left side of the vertical chassis, looking at it from the back, and the chassis must be pulled to get to it.

Recommendation: check the concealed fuse. If it is OK, start with one ohmmeter prod clipped to the interlock and follow the line circuit up through the on-off switch on the volume control and back to the rectifiers and tube-string (Fig. 6). We've had quite a bit of trouble with the small wire running from (Continued on page 68)

THERE'S A NEW HEATH KIT FOR EVERYONE IN THE FAMILY!

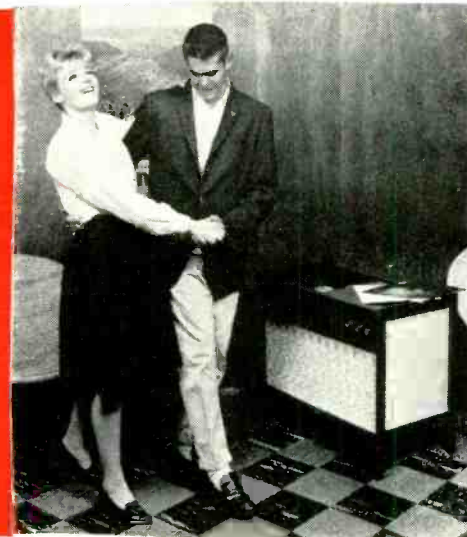
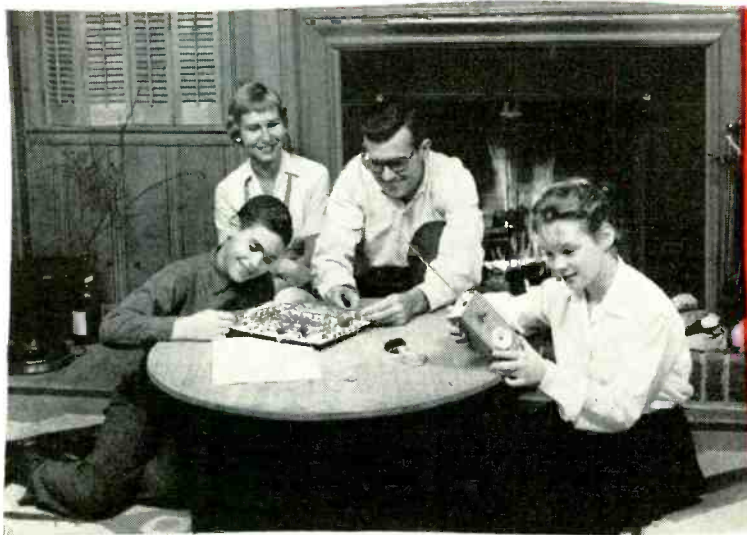

fits both space and dollar budgets!

COMPLETE STEREO-PHONO CONSOLE WIRED OR KIT

Less than 3' long and end-table height, yet its six speakers assure rich, room-filling stereo! Smooth "lows" are delivered by two 12" woofers, "mid-range" and "high" are sparkingly reproduced by two 8" speakers and two 5" cone-type tweeters mounted at wide dispersal angles in the cabinet. The "anti-skate" 4-speed automatic stereo/mono record changer has diamond and sapphire styli. Concentric volume and separate dual bass and treble tone controls are within easy reach. Superbly styled with solid genuine walnut frame, walnut veneer front panel, and matching "wood-grained" sliding top, the cabinet measures just 31 $\frac{3}{4}$ " L x 17 $\frac{7}{8}$ " W x 26 $\frac{3}{4}$ " H. Whether you buy the ready-to-play or kit form, the cabinet is factory assembled and finished; to build the kit, just wire the amplifier and install the changer and speakers. 70 lbs.

Model GD-31 (kit) . . . \$13 dn., \$11 mo. **\$129.95**
 Model GDW-31 (wired) . . . \$15 dn., \$13 mo. **\$149.95**



INTRODUCING

... a superb new line of Stereo Hi-Fi Consoles ...

FACTORY ASSEMBLED, ready to play!

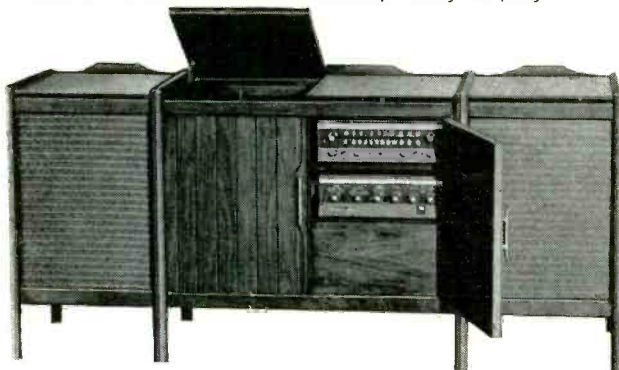

COMPLETE 28-WATT AND 50-WATT STEREO CONSOLES

Now you can buy Heath stereo components factory-wired and tested with beautiful preassembled, prefinished cabinets . . . ready to plug in and enjoy. The consoles are available in both 28 and 50 watt models, with money-saving optional kit plans. The 28-watt model (HFS-26) contains the Heathkit AJ-10 stereo AM/FM tuner, SA-2 stereo amplifier, AD-50A stereo record changer and two US-3 12" coaxial hi-fi speakers. The 50-watt model (HFS-28) contains the Heathkit AJ-30 Deluxe stereo AM/FM tuner; AA-100 Deluxe stereo amplifier; AD-60B Deluxe stereo record changer and two Jensen H-223F coaxial 2-way 12" hi-fi speakers. Specify walnut or mahogany.

Model HFS-26 (wired) . . . 215 lbs. . . \$47.50 dn. **\$475.00**
 Model HFS-27 (kit) . . . \$37.00 dn. **\$370.00**
 Model HFS-28 (wired) . . . 264 lbs. . . \$75.00 dn. **\$675.00**
 Model HFS-29 (kit) . . . \$55.00 dn. **\$550.00**

Cabinets available separately, write for information.



HEATH COMPANY / Benton Harbor, Michigan

**NOW ONLY
HEATH
BRINGS YOU
ALL 3!**



1.
HEATHKIT
for
do-it-yourself
hobbyists.

2.
HEATHKIT
factory-built,
ready to use.

3.
HEATHKIT
learn-by-doing
Science Series
for youngsters.



**PORTABLE 4-TRACK STEREO
TAPE RECORDER KIT**

Delight to the vast treasures available to you in popular 4-track pre-recorded stereo tapes . . . make your own 4-track stereo home recordings . . . (you can even use it as a hi-fi center to amplify and control hi-fi tuners, record players, etc.) Has "record," "play," "fast-forward" and "rewind" functions, 2 speeds (3 $\frac{3}{4}$ " and 7 $\frac{1}{2}$ " per second). Controls include: individual tone balance controls for each channel; level controls; monitoring switch for each channel to let you hear programs as they are being recorded; and a pause button for tape editing. Two "eyetube" indicators provide control of recording levels. Speaker wings may be detached. Cabinet and tape mechanism are completely preassembled. A storage compartment is provided for tape and accessories. 49 lbs.

Model AD-40 . . . \$18 dn., \$16 mo. **\$179.95**

**STEREO/MONO
PORTABLE PHONO KIT**

From jazz to classics, the younger set will have stereo wherever they go! Plays either stereo or mono records on its top quality 4-speed automatic changer with diamond and sapphire styli. Has detachable stereo speaker wing and complete tone and stereo balance controls. Record changer and cabinet are factory-assembled, the kit is a "snap" to build. 15 $\frac{1}{2}$ " x 18" x 8 $\frac{5}{8}$ ". 28 lbs.

Model GD-10 . . . \$7 dn. **\$69.95**

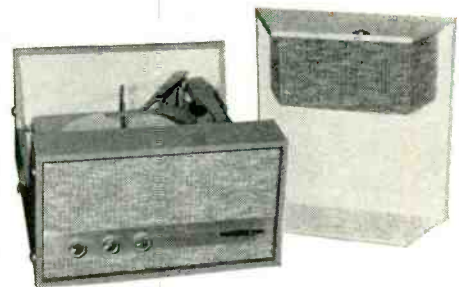

ACOUSTIC SUSPENSION SPEAKER SYSTEM KIT

Using the revolutionary "acoustic suspension principle" licensed to Heath by Acoustic Research, Incorporated, the AS-10 meets and surpasses performance of speaker systems three to four times its size. The 10" bass speaker and two 3 $\frac{1}{2}$ " hi-frequency speakers cover 30 to 15,000 cps with fantastic brilliance and fidelity! Use in upright or horizontal position. Cabinets pre-assembled and prefinished. 32 lbs.

Model AS-10U (unfinished) . . . \$6 dn., \$6 mo. **\$59.95**

Model AS-10M (mahogany) . . . \$6.50 dn., \$6 mo. **\$64.95**

Model AS-10W (walnut) . . . \$6.50 dn., \$6 mo. **\$64.95**



DELUXE AM/FM STEREO TUNER

Exciting new styling and advance-design features rocket this new Heathkit to the top of the stereo hi-fi value list! Featured are: complete AM, FM and simultaneous stereo AM/FM reception; plus a multiplex adapter output; individual flywheel tuning; individual tuning meters on each band; FM automatic frequency control (AFC); and AM bandwidth switch. 24 lbs.

Model AJJ-30 (kit) . . . \$9.75 dn., \$9 mo. **\$97.50**

Model AJW-30 (wired) . . . \$15.30 dn., \$13 mo. **\$152.95**



DELUXE 50-WATT STEREO AMPLIFIER

Look-alike companion to the tuner above, here's two 25-watt channels hi-fi-rated and loaded with extras! Mixed-channel center speaker output; "function selector" for any mode of operation; stereo reverse, balance and separation controls; ganged volume and separate concentric bass and treble tone controls. 5 $\frac{1}{2}$ " H, 15 $\frac{3}{4}$ " W, 13 $\frac{1}{2}$ " D. 31 lbs.

Model AA-100 (kit) . . . \$8.50 dn., \$8.00 mo. **\$84.95**

Model AAW-100 (wired) . . . \$14.50 dn., \$13.00 mo. **\$144.95**

8 new, exciting Heathkit® products on following pages



HEATHKIT®... pioneer in do-it-yourself

NOW... BUY YOUR HEATHKIT FOR as low as \$2.50 DOWN! Yes, under the new, easy Heath Time Payment Plan, orders of \$25.00 or more can be purchased for just 10% down... and up to 18 FULL MONTHS ON BALANCE for orders of \$300 to \$600.

So, don't wait... enjoy that Heathkit you've wanted so long NOW... for just a small amount down, and pay the balance in easy monthly installments!



ANNOUNCING THE ALL-NEW HEATHKIT "WARRIOR" GROUNDED-GRID KILOWATT LINEAR ONLY \$229.95

Here's news to rock the entire Amateur Radio world! The new desk-top Heathkit "Warrior" matches any unit on the market feature for feature with no quality short cuts and slashes the price in half! *Completely Self-Contained*—amplifier and HV, filament, and bias supplies are built in. *Versatile*—drives with 50 to 75 watts, no matching or swamping network required. *Efficient*—stable g-g circuit puts part of drive in output for up to 70% efficiency. *Inexpensive Tubes*—four paralleled 811A's and two 866A's. *Dynamic Regulation*—big oil-filled capacitor and 5-50 henry swinging choke for high peak power output with low distortion. *Design*—special low-capacity filament transformer requires less driving power and eliminates broad-band filament RF choke. *Monitoring*—gives constant output to scope regardless of frequency. *Easily Assembled*—average time 8 hours. *Bands*—80 through 10. *Max. Power Input*—SSB-1000 watts PEP; CW-1000 watts; AM-400 watts (500 using controlled carrier mod.); RTTY-650 watts. Write for Complete Information.

Model HA-10... 100 lbs.... \$23.00 dn., \$20.00 mo..... **\$229.95**



NEW FOR THE SIX & TWO METER VHF NOMADS...

The new "Shawnee" 6-meter and "Pawnee" 2-meter Heathkit transceiver kits bring a new definition to superior performance. And each offers complete AM and CW facilities with the greatest array of features anywhere! *Single Knob Tuning*—tracked VFO and exciter stages. *10 Watt Output*—6360 dual tetrode. *Built-In Low Pass Filter*. *Three-way Power Supply*—built-in for 117vac, 6vdc or 12vdc with separate DC and AC plugs and cables included. *Dual-Purpose Modulator*—10 watts for high level plate modulation or 15 watts for PA operation. *Double Conversion Receiver*—crystal controlled first oscillator. *Voltage Regulation*—on all oscillators. *Complete Controls*—up front on the panel for transmitter and receiver. *Tuning Meter*—auto-switched for signal strength or relative power output. *Slide Rule Dial*—seven inches of spread for receiver and VFO, edge lighted. *VFO or Crystals*—front panel switch of vfo or four crystals for novice, CAP, MARS or net operation. *Spot Switch*—zero in signals with transmitter off. *Complete Shielding*—power supply, final and receiver front end. *Ceramic Microphone*—push-to-talk with coiled cord. And many more—Write for Information. 34 lbs.

Model HW-10... 6 meter, or HW-20... 2 meter \$20 dn., \$17 mo..... **\$199.95**

DELUXE SERVICE BENCH VTVM KIT

Greater accuracy and convenience for precision testing. Big 6", 200 ua meter has longer scales plus separate 1.5v and 5v AC scales. Wider frequency coverage with greater precision is made possible through use of 1% resistors and husky capacitors. Other deluxe features include high-visibility meter and controls; recessed thumb-wheel "zero" and "ohms adjust" controls. Measures AC and DC volts to 1500 in 7 ranges; resistance from .1 ohm to 1,000 megohms in 7 ranges. Db calibrations for relative voltage measurements selected to give 10 db steps between ranges. Test leads included. 9½" H x 6½" W x 5" D. 7 lbs.

Model IM-10... \$3.30 dn., \$5.00 mo..... **\$32.95**



NEW ISOLATION TRANSFORMER KIT

The IP-10 presents a significant improvement in isolation transformers. Provides output voltage from 90-130v in 0.75v steps at 300 watts continuous duty, 500 watts intermittent duty, with 117v input—ample power for even color TV servicing. Built-in meter continuously monitors output voltage with ± 1 volt accuracy (linear scale is electronically expanded to cover 90-140v). Power line input voltage can also be measured by operating spring-return slide switch on front panel. Fused primary. Measures 6½" W x 9½" H x 5" D. 22 lbs.

Model IP-10... \$5.50 dn., \$5 mo..... **\$54.95**



HEATH COMPANY / Benton Harbor, Michigan

electronics—always the leader!

now a new improved
6 meter model
joins this famous
transceiver series



2, 6 & 10 METER TRANSCEIVER KITS

The new 6 meter HW-29A joins "Tener" and "Twoer" to bring you top transceiver values. Like "Twoer," the new HW-29A multiplies to its output frequency from an 8 mc crystal for greater stability. All models have crystal-controlled, 5 watt input transmitters and tunable super-regen receivers that pull in sigs as low as 1 uv... FB for emergency work and "local" nets. Each includes transmit-receive switch, metering jack, ceramic mike and two power cables. Less crystal. 10 lbs.

- Model HW-19...10 meter...\$4 dn., \$5 mo. **\$39.95**
- Model HW-29A...6 meter...\$4.50 dn., \$5 mo. **\$44.95**
- Model HW-30...2 meter...\$4.50 dn., \$5 mo. **\$44.95**
- Model HWM-29-1...Converts early "Sixer" to "A" model. 1 lb. **\$4.95**

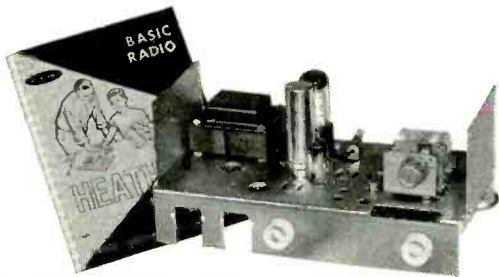

HEATHKIT BASIC RADIO COURSE

Here's a new 2-part series in basic radio for youngsters and adults. "Basic Radio—Part I," available now, teaches radio theory in everyday language, common analogies, and no difficult mathematics. Experiments performed with radio parts supplied result in a regenerative radio receiver. "Part II" of the series, which will be ready March 1, advances your knowledge of radio theory and supplies additional parts to extend your Part I receiver to a 2-band superheterodyne circuit.

- Model EK-2A... "Part I"... 8 lbs. **\$19.95**

FREE CATALOG



Send today for your Free Copy of the latest Heathkit Catalog showing over 200 Heathkit items for hi-fi fans, amateur radio operators, students, technicians, marine enthusiasts, sports car owners and hobbyists. Many Heathkit products are now available in both kit and wired form!

ATTENTION MARINERS!
Keep a "weather-eye" peeled for announcement of a new Heathkit SHIP-TO-SHORE RADIOTELEPHONE... COMING SOON!



be your own
"tune-up" specialist!

NEW ELECTRONIC IGNITION ANALYZER KIT

Checks ignition faults quickly and accurately. One simple hook-up to ignition wiring, and the I0-20 does the rest! No removing plugs, wiring or other engine parts. Checks engine in operation. Switch selection of primary, secondary, parade or superimposed patterns without changing leads to the engine. Detects shorted plugs, defective distributor points, defective wiring, coil and condenser problems, incorrect dwell time, worn distributor parts, etc. Features improved trigger circuit for locked-in patterns without trigger level adjustment; 2-1 vertical and 10-1 horizontal expansion. 8" H x 9½" W x 16" D. 22 lbs.

- Model I0-20...\$8.95 dn., \$9.00 mo. **\$89.95**

MONEY BACK GUARANTEE

Heath Company unconditionally guarantees that each Heathkit product, whether assembled by our factory or assembled by the purchaser in accordance with our easy-to-understand instruction manual, must meet our published specifications for performance or your purchase price will be cheerfully refunded.

ORDER DIRECT BY MAIL OR SEE YOUR HEATHKIT DEALER



ORDERING INSTRUCTIONS
Fill out the order blank below. Include charges for parcel post according to weights shown. Express orders shipped delivery charges collect. All prices F.O.B. Benton Harbor, Mich. A 20% deposit is required on all C.O.D. orders. Prices subject to change without notice.

Please send the following HEATHKITS:

ITEM	MODEL NO.	PRICE

Ship via () Parcel Post () Express () COD () Best Way

() SEND MY FREE COPY OF YOUR COMPLETE CATALOG

Name _____

Address _____

City _____ Zone _____ State _____

Dealer and export prices slightly higher.

BOOST YOUR BRITENER SALES

with these

SIX MAGIC WORDS

from **Perma-Power**

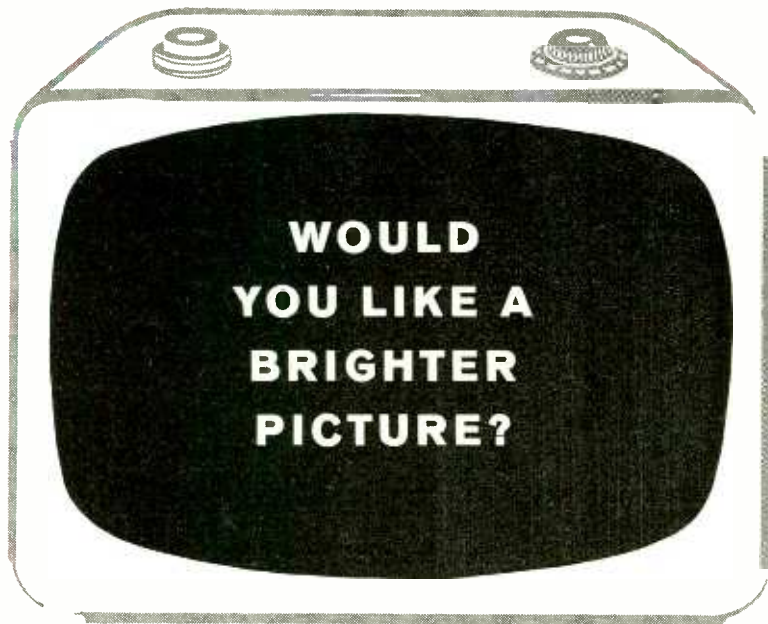

That's a question with only one possible answer—YES. Every customer wants a better, brighter picture... but doesn't realize how easy it is to get one.

When you say you'll brighten the picture—When you quote the low cost—you've sold the customer.

Don't sell Briteners—sell Brighter Pictures!

On every service call, remember to use Perma-Power's 6 Magic Words—Would You Like A Brighter Picture? You'll sell a 12-pack of Briteners almost as fast as you can say Perma-Power!

Perma-Power

COMPANY—3106 N. Elston Ave.—Chicago 18

(Continued from page 63)

the interlock to the fuse, and with the fuses. Many technicians shunt this fuse with wire, then add a more accessible line fuse on the back of the chassis. Just check it out one piece at a time and you'll find the fault.

High-voltage trouble

In an RCA KCS-68E, the raster comes on for about 2 minutes then fades out. If you cool the set off for 5 minutes, the cycle can be repeated. I get a peculiar waveform on the grid of the 6CD6 (Fig. 7). The grid drive becomes flat-topped as the raster fades out.—B. F., Wisconsin.

You've already found the trouble: it lies in that flat-topping of the grid-



Fig. 7—Bad grid-drive waveform kills high-voltage.

drive waveform. The distortion of this signal results in less drive and changes the time constant among other things, all bad!

This would seem to lie in the grid circuit of the 6CD6. A leaky .001 coupling capacitor, the 1-megohm grid resistor changed in value or a gassy 6CD6. By the way, there's another source of trouble in this series: take the horizontal drive trimmer capacitor apart and see if there is any sign of leakage through the mica—discolored spots or burnt places. Moisture getting into this trimmer has caused lots of trouble. Also, check the 47-ohm resistor in the 6CD6 grid!

Weak pix

A Philco 22C4312 had a weak picture, gray and washed-out-looking. There was a bad hum, and the sync was poor. Voltages on screen and plate of the video amplifier were high. I cut the 1-megohm resistor loose from pin 2, the control grid of the 12BY7 video amplifier, and the picture returned to normal. With the resistor replaced, the picture stayed perfect. What was happening in this circuit?—E. S., Ferguson, Mo.

From the symptoms and the voltage readings you gave, I would say that the video amplifier tube had been blocked. It could have been due to the grid resistor being open. This would have caused the grid to accumulate such a highly negative charge that it cut the tube off. As it was not drawing any plate or screen current, there would have been no voltage drop across plate load or screen resistors. Alternatively, the resistor may have been almost shorted out, although this is somewhat unlikely. In any case, restoring the proper bias to the 12BY7 brought the picture back, so the resistor was obviously defective.

END



**Model 300
COMBINATION TESTER**

A complete portable service shop at your side wherever you go

Housed in handsome wood carrying case.

Model 300 **\$99.75** Net

3 ESSENTIAL INSTRUMENTS IN ONE COMPACT UNIT!

① A multiple socket tube tester

② A CRT tester-reactivator

③ A 20,000 ohms per volt VOM and capacity tester

Handy mirror in cover for TV adjustments

AS A TUBE TESTER... will check emission, inter-element leakage and gas content of all tubes.

AS A CRT TESTER-REACTIVATOR... will test, repair and reactivate all black and white and all color picture tubes.

AS A VOM AND CAPACITY TESTER
(20,000 ohms/volt)
DC Voltage: 0 to 7500 volts
AC Voltage: 0 to 1500 volts
Ohms: 0 to 10 megohms
DC Current: 0 to 15 amperes
Capacity: .1 mfd. to 180 mfd.

See your electronics parts distributor!

MERCURY ELECTRONICS CORP. 77 SEARING AVENUE, MINEOLA, NEW YORK

PUZZLED ABOUT FEEDBACK

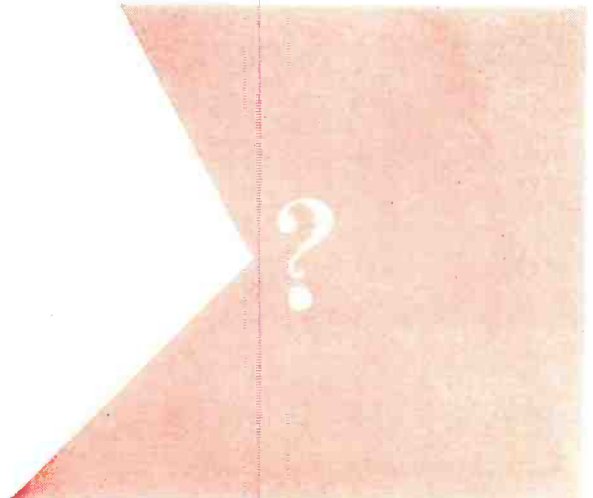

Just what does

"This amplifier has 20 db of feedback" mean?

By **NORMAN H. CROWHURST**

I HAVE written a good deal on the subject of feedback and feel I know what I am talking about. However, quite recently I found myself somewhat puzzled. Not so much by what feedback is or does, but by what the quoted ratings mean. I have seen amplifier specifications stating 20, 30, 40 or even 80 db of feedback. These specifications sometimes indicate that the feedback is the total amount comprised in a number of loops. Some letters from readers (as well as some amplifiers I have recently had for test and evaluation) set me to wondering just how these fantastic numbers are obtained.

One amplifier showed an increase in gain of only 3 to 6 db (depending on frequency) when I opened the overall negative feedback loop. Yet a company engineer had assured me there was more than 20 db of feedback. I looked at the schematic carefully to see if there were any other feedback loops that could possibly account for the rest of the quoted figure.

In opening the feedback loop (Fig. 1), I had merely disconnected the resistor and capacitor (R2 and C) that went from the output transformer back to the cathode of the input stage. This still left a small amount of degenerative feedback due to the unbypassed cathode resistor (R1). As far as I could see from a careful analysis of the circuit, there was no other feedback loop.

A quick calculation indicated that if I bypassed the cathode resistor, I might

increase the gain by 5 db. A quick check with a capacitor proved my calculation correct.

So the maximum possible change in gain produced by feedback in this particular amplifier is 8 to 11 db, depending on frequency. How then could the engineer claim he had more than 20 db of feedback?

Had I not known the engineer personally, I might have dismissed this matter as another exaggerated manufacturer's claim—the sort of thing where a maker claims a fantastic amount of feedback, puts a resistor in there to show there is *some* feedback and the consumer never knows the difference. But I knew this particular engineer would not make a claim unless somehow or other he had found this amount of feedback actually operating.

Then it suddenly dawned on me. The output circuit used pentode tubes (as pentodes). I was testing the amplifier with the conventional dummy resistance load. I took off the load and then checked the effective feedback again. I had more than 20 db. So there was my answer. Under open-circuit conditions, this amplifier really did have the amount of feedback claimed. However, under practical operating conditions, it had much less.

Probably, the average feedback is not as low as the amount I measured because most speaker impedances fluctuate upward from their nominal value rather than downward. On the other hand, there are some speaker impedances where the value quoted as nominal is an *average*. This means that, for example, an 8-ohm loudspeaker may vary from 3 to 20 or 25 ohms (Fig. 2).

When it has a value in the region of 20 to 25 ohms there might be, on this particular amplifier, some 14 or 15 db of feedback. When it is at 8 ohms, it will be the value I measured (8 to 10 db, allowing something for the degeneration in the first-stage cathode). In the frequency range where the speaker gets down to 3 ohms, the feedback almost disappears.

The amplifier nominally has a feed-

back of more than 20 db when measured the "right" way. But in practical operation the feedback will vary from very little up to perhaps 14 db. Let's just see where this feedback occurs.

Maximum feedback will occur at loudspeaker resonance and at high frequencies where its inductive impedance is high. Speaker resonance may be somewhere between 30 or 40 cycles and 150, depending upon the size of the unit and the enclosure in which it is mounted. Here there is maximum feedback to minimize distortion at the speaker's basic resonance and also to provide some damping of this resonance. This sounds as if it may be good. It will prevent low-frequency distortion. Now at the high end, where the voice-coil inductance makes speaker impedance rise, again there will again be a fairly large amount of feedback. This begins to show 2,000 cycles or so, on up.

But in the region of 400 to 1,000 cycles, the loudspeaker impedance is minimum—not much more than the dc resistance of the voice coil, which is probably 2.5 to 3 ohms. This means the amplifier has practically no feedback at all in the important range from 400 to 1,000 cycles.

More than this. Any intermodulation distortion accompanying frequencies in the low range will not be reduced by the feedback because the intermodulation is a distortion of the mid-range frequencies. From the viewpoint of reducing audible distortion, it would be much better if there were comparatively little feedback in the low region near

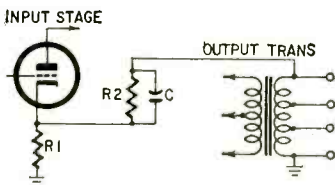

Fig. 1—A typical amplifier uses a resistor-capacitor combination from the output transformer to the cathode of the input stage to supply negative feedback.

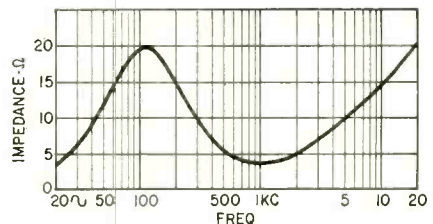

Fig. 2—The impedance of an 8-ohm loudspeaker is not always 8 ohms.

IMPORTANT NEW SAMS BOOKS

Satisfying Customers for Profit

A Practical Guide for Handling Customers!

This *Electronic Industries Association Project* on how to handle customers can mean the difference between success and failure for a service-type business. Describes typical "problem" situations and presents field-tested solutions, showing how a potential trouble can be turned into an asset. Covers problems such as: the customer who thinks he bought a "lemon"; complaints about "too high" service charges; angry customers, etc. Includes 12 unique wallet-size reminder cards to help keep you on the right track. Indispensable if you own, manage or work for a service-type business. 104 pages; 6 x 9". Only **\$1.25**



Rapid Auto Radio Repair

G. Warren Heath provides you with typical schematics and circuit explanations for all types of auto radios (standard 6- or 12-volt conventional, hybrid, all-transistor, foreign, FM, new removable portable types). Gives you hundreds of trouble symptom cures. Includes chapter on troubleshooting tricks from antenna to speaker. Describes auto radio components, including special capacitors, fuses, IF transformers, speakers, transistors, vibrators. If you service auto radios, this book belongs on your bench! 160 pages; 5 1/2 x 8 1/2". Only **\$2.95**

How to Repair Auto Radios Faster!



Building Up Your Ham Shack

How to Assemble & Upgrade Ham Stations!

Howard S. Pyle, W70E, tells what equipment you'll need to get a ham station on the air, how to choose equipment so you can gradually upgrade your station at minimum cost. Describes both factory-built and do-it-yourself gear. Suggests what test and measuring instruments you'll need; how to assemble your ham workshop (including one that fits in a closet). Written for the novice as well as for the veteran "ham." Profusely illustrated. 128 pages; 5 1/2 x 8 1/2". Only **\$2.50**



Servicing Transistor Radios. Vol. 7

Provides complete analysis of 48 domestic and foreign transistor radios produced in 1959-60. Here's all you need to know for quick servicing: Sams Standard Notation Schematics with exclusive Circuit-Trace®; chassis photos; alignment data; servicing tips; complete replacement parts lists. Includes cumulative index to all 7 volumes in the series. 160 pages; 8 1/2 x 11". Only **\$2.95**

Latest in This Valuable Series!



HOWARD W. SAMS & CO., INC.

Order from your Sams Distributor today, or mail to Howard W. Sams & Co., Inc., Dept. S-21 1720 E. 38th St., Indianapolis 6, Ind.

- Send me the following books:
- Satisfying Customers for Profit (PCR-1)
 - Rapid Auto Radio Repair (RAH-1)
 - Building Up Your Ham Shack (NHP-1)
 - Servicing Transistor Radios. Vol. 7 (TSM-7)
- \$.....enclosed. Send Free Book List

Name _____
 Address _____
 City _____ Zone _____ State _____
 (outside U.S.A. priced slightly higher)

the speaker's fundamental resonance and a large amount over the mid range where the distortion becomes evident.

This discussion points up a fact about feedback rating that appears in many guises. *Feedback is not a constant figure.* If it were, there would be no point in using it. Feedback is used to stabilize gain, reduce distortion, control impedance, etc.

If the gain of an amplifier were constant *without* feedback, feedback would not be needed to stabilize it. If the amplifier's gain were constant throughout its frequency ranges, there could be no distortion.

Distortion is, *in effect*, a change of amplification during different parts of the signal cycle. Feedback stabilizes the gain during this period and thereby reduces distortion.

The fact that feedback is necessary indicates that there are some fluctuations that must be reduced or minimized. This means the amount of reduction applied will vary at different points.

Suppose the feedback is used to level off frequency response. Let's assume the amplifier's gain is 6 db more at 1,000 cycles than it is at 20 and 20,000 cycles. If the feedback makes it level over this range, then there must be 6 db more feedback at 1,000 cycles than at the other two frequencies.

When feedback is used to control output impedance, this is done to reduce the fluctuation in output voltage caused by output loading. Consequently, the change in output amplitude at different frequencies due to the impedance characteristic of a loudspeaker will be reduced by this feedback.

Had there been no feedback in the above amplifier, the response would have shown a peak of about 15 db at the speaker's resonant frequency. Feedback can almost eliminate this because, at the resonant frequency, there is almost 15 db more feedback than at other frequencies.

The effect of this feedback can be regarded as either leveling the response, reducing the source resistance of the amplifier or increasing its damping factor. Each of these is a name for the same function. But, whatever name we use, the fact remains that, in this particular example, there is only 3 or 4 db of feedback (not including input-tube cathode degeneration) acting in the region from 400 to 1,000 cycles, and there is probably 10 to 15 db more than this in the region of loudspeaker resonance.

The feedback serves to level off the frequency-response errors that would occur in a pentode output circuit feeding a dynamic loudspeaker. It will similarly reduce the high-frequency rise caused by the inductive impedance of the voice coil. Before feedback, a capacitor from plate to ground was used for the latter purpose.

But, in this particular amplifier, the full range of feedback is being used for impedance compensation—to reduce the response deviation caused by the variation in speaker impedance. As a

result, there is little feedback left to reduce distortion in the mid-frequency range. If you use up, so to speak, the available feedback range for one kind of compensation, the feedback is *not* still available to perform some of its other possible functions. Looked at another way, when feedback is used to reduce output impedance, the amount of feedback used and the ultimate output impedance are co-related.

If the output is open circuit, the output impedance (which is that of the output circuit) is the plate resistance of the output tube transformed down by the output transformer's action. This may be 10 times the nominal impedance or more. Supposing the output impedance looks like 100 ohms at the 8-ohm tap, then 26 db of feedback will reduce this to 5 ohms.

Connect an 8-ohm resistor across the 8-ohm tap. Now we need only 3 db of feedback to reduce this resistance to 5 ohms, and this is about all the feedback we have available.

With the amplifier operating open-circuit, 26 db of feedback is acting. This can work to reduce harmonic distortion or anything else that may occur, but, when you load the amplifier with its nominal 8 ohms (or possibly less), the feedback is reduced. The output impedance remains approximately the same because the starting point is that much lower. The impedance has to be reduced from 8 ohms instead of 100 ohms.

But the feedback available for reducing distortion is also reduced, so now we have only 3 or 4 db of feedback to reduce distortion in place of the 26 db or so that was available when the amplifier was operating open circuit.

To make this discussion relatively easy to follow, we have used one specific example. This is a simple one and more complicated ones could be cited or discussed at even greater length. But this illustrated the cause of this kind of puzzlement.

What this discussion underlines is: A simple statement of the amount of feedback in an amplifier—or in any system for that matter—is not meaningful unless some statement is also made of the conditions under which this feedback is measured. A better statement would indicate the range of operational feedback and the frequency range over which it is measured. To get a true statement of the usefulness of a feedback system, more information is required than a simple number in terms of db. END



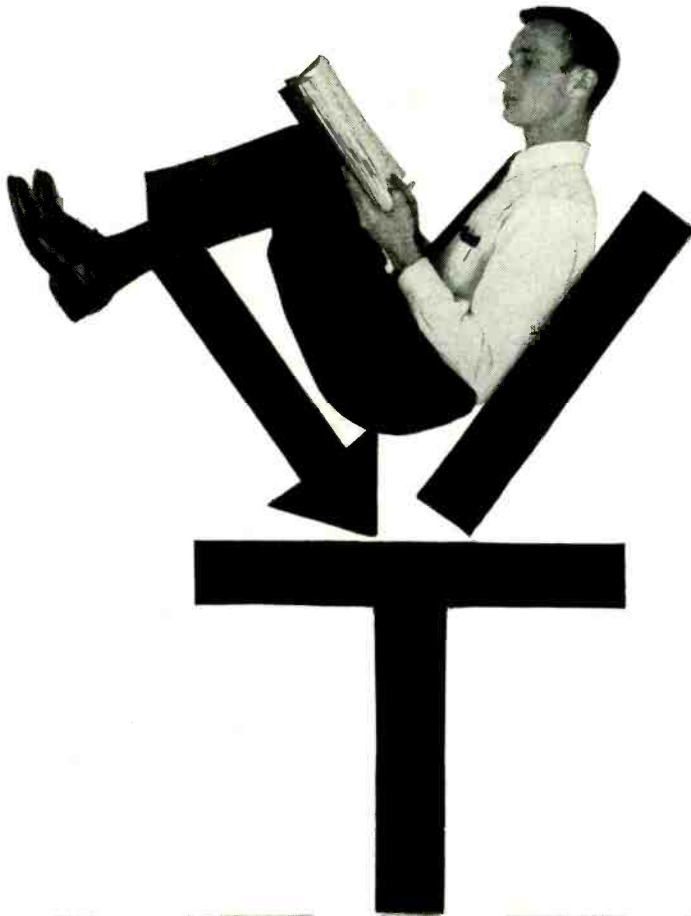

SUBJECTS OFFERED AT NO COST TO YOU:

- ① TRANSISTOR FUNDAMENTALS—complete coverage of transistor theory without the use of mathematics.
- ② GUIDE-MATIC POWER HEADLIGHT CONTROL (Autronic Eye)—lecture and lab.
- ③ TWILIGHT SENTINEL ELECTRIC HEADLIGHT SWITCH—lecture and lab.
- ④ TROUBLE-SHOOTING PROCEDURES for dead or weak low voltage auto radio tuners and trigger circuits.
- ⑤ LECTURE AND LAB. PRACTICE ON "SIGNAL SEEKER" AND "WONDER BAR" auto radio tuners and trigger circuits.
- ⑥ TRANSISTOR CIRCUIT TROUBLE-SHOOTING—lecture and lab. work analyzing defects in transistor circuits.
- ⑦ HYBRID-TYPE AUTOMOBILE RADIOS—low voltage tube and output transistor circuits. Lecture and lab.
- ⑧ DELCO-MATIC ALL-TRANSISTOR GARAGE DOOR OPERATORS—lecture and lab.
- ⑨ AUTO PORTABLE RADIOS—lectures and lab. practice on all-transistor portable radios. Get prepared for the all-transistor auto radio that will appear in the next few years.

THE LATEST ON

TRANSISTORS AND AUTOMOTIVE ELECTRONICS 9 SUBJECTS AVAILABLE TO YOU AT THE FREE DELCO RADIO-GUIDE LAMP ADVANCED TRAINING SCHOOL. One week of instruction. No lab. fees. No tuition charge. Textbooks supplied.

In 1960 over 900 electronics technicians completed our one-week course. You, too, can receive this same valuable training in 1961. Bring yourself up to date on transistors and automotive electronics with personalized instruction at the General Motors Training Center near you. (See schedule below.)

Classes will be conducted by graduate engineers with special training in your field. Diplomas, awarded only to those who successfully complete the courses, will mean a great deal to you—and to your customers.

Register now through your local Delco Electronics Parts Distributor or write directly to Delco Radio Division, General Motors Corporation, Kokomo, Indiana, Attention: Service Manager.

GUIDE LAMP DIVISION GENERAL MOTORS CORP. ANDERSON, INDIANA



DELCO ELECTRONICS TRAINING SCHOOL SCHEDULE						
DATE	REGION 1	REGION 2	REGION 3	REGION 4	REGION 5	REGION 6
1-16	Philadelphia		Detroit			
1-23		Charlotte	Detroit		Dallas	
2-6	Washington			St. Louis		
2-13	Washington	Atlanta			Houston	
2-20			Cincinnati		Houston	Los Angeles
2-27						Los Angeles
3-6	Tarrytown	Memphis		Omaha		
3-13	Tarrytown					
3-20		Jacksonville	Cleveland			San Francisco
4-10	Boston		Cincinnati	Kansas City	El Paso	Portland
4-17	Boston	Atlanta		Kansas City	El Paso	
5-1		New Orleans	Pittsburgh	Minneapolis		Los Angeles
5-8	Union		Pittsburgh		Oklahoma City	
5-15				Milwaukee		
5-22		Memphis	Buffalo			San Francisco
6-5	Philadelphia			Chicago	Denver	
6-12		Charlotte		Chicago		Portland
6-19			Cleveland			
6-26	Union	Atlanta		Minneapolis	Dallas	Salt Lake City



Replace improper equipment with the only
microphone
designed specifically **THE TURNER 350C**
for citizen's band

This reasonably priced, mobile-type ceramic microphone is the perfect replacement for the many improper, tape recorder-type microphones now being used on CB equipment. Has DPST switch wired for relay operation with easily reversible terminals to allow modifications (if necessary); wiring diagram enclosed with each microphone; hanger button and standard dash bracket for mobile rig mounting; and an 11" retracted (five foot extended), plastic-jacketed, coiled cord. Response: 80-7,000 cps. Output: -54 db. List price: \$16.80 complete. See your Turner Distributor, listed below, he has the 350C in stock.

THE TURNER MICROPHONE COMPANY
934 17th St. N.E.
Cedar Rapids, Iowa

ARKANSAS

Little Rock: Southern Radio Supply
Texarkana: Lavender Radio & T.V. Sup.

CALIFORNIA

Downey: Net Electronics
Hemet: Gil Severns
Hollywood: Pacific Radio Exchange
Los Angeles: Radio Product Sales
The Sound Foyer

Oakland: Elmar Electronics

Sacramento: Selectronics
San Francisco: Market Radio Sound Dept.
San Pedro: Marine Radio Service

DISTRICT OF COLUMBIA

Washington: Electronic Wholesalers

FLORIDA

Miami: East Coast Radio & TV
Tampa: Kinkade Radio Supply

GEORGIA

Atlanta: Specialty Distributing

ILLINOIS

Chicago: Nationwide Radio
Irving Joseph, Inc.
La Salle: Klaus Radio & Electric
La Salle Electronics

Peoria: Klaus Radio & Electric

INDIANA

Anderson: Seybert's Radio Sup.
Bloomington: Stansifer Radio Co.
Evansville: Hutch and Son, Inc.
Ohio Valley Sound
Fort Wayne: Pembleton Laboratories
Indianapolis: Brown Distributing Co.
Graham Electronic Sup.
Van Sickle Radio Supply

Kokomo: George's Electronic Sup.
Michigan City: Tri-State Electrical Sup.
Portland: Buck's Hi-Fi
Richmond: Fox Electronics Company
Terre Haute: Midwest Supply Company

IOWA

Cedar Rapids: Iowa Radio Supply

Des Moines: Bob & Jacks, Incorporated
Radio Trade Supply Co.

KANSAS

Topeka: Acme Radio Supply

KENTUCKY

Lexington: Radio Equipment Co.
Louisville: Arcby Electronics
P. I. Burks Company
Peerless Electronic Equipment Co.

LOUISIANA

Baton Rouge: Davis Electronics Sup.
New Iberia: Brooks Electronics

MASSACHUSETTS

Boston: A. W. Mayer Company
O'Donnell Electronic Supply
Radio Shack Corp.

Lawrence: Alco Electronics

MICHIGAN

Ann Arbor: Purchase Radio Supply
Detroit: High Fidelity Workshop
Lansing: Offenhauer Company

MINNESOTA

Minneapolis: Lew Bonn
National Electronics Co.
Harry Starks, Inc.
Schaak Electronics

MISSOURI

St. Louis: Radonics

NEW JERSEY

Berlin: Midstate Radio Supply
Jersey City: Nidisco-Jersey City
Mountainside: Federated Purchaser

NEW YORK

Albany: Greylock Electronics Supply
Buffalo: Radio Equipment Corp.
Farmingdale, L.I.: Gem Electronics
Forest Hills: Beam Electronics
Hicksville: Gem Electronics
Kingston: Greylock Electronics
Long Island City: Spera Electronics
Mt. Vernon: Davis Electronics

New York: Harvey Radio Company
Acme Electronics

Poughkeepsie: Greylock Electronics
Rochester: Rochester Radio Supply

NORTH CAROLINA

Greensboro: Johannesen Electric Company
Raleigh: Southeastern Radio Supply Co.
Winston-Salem: Womack Company

OHIO

Cleveland: Pioneer Electronic Sup.
Columbus: Whitehead Radio Company
Mansfield: Wholesaling, Inc.
Toledo: Lifetime Electronics

OKLAHOMA

Oklahoma City: Johnson Wholesale

OREGON

Portland: United Radio Supply

PENNSYLVANIA

Homestead: M. Leff Radio Parts
Lancaster: George D. Barbey Co.
Lebanon: George D. Barbey Co.
Philadelphia: Radio Electric Service Co.
Pottstown: George D. Barbey Co.
Reading: George D. Barbey Co.
Wilkes-Barre: General Radio & Electronics
York: Radio Electric Service Co.

RHODE ISLAND

Providence: Del Padre Supply Co.
Zetka Distributors

SOUTH CAROLINA

Columbia: Dixie Radio Supply Company

SOUTH DAKOTA

Watertown: Burghardt Radio Supply

TEXAS

Houston: Sound Equipment Inc.

VIRGINIA

Arlington: Rucker Electronic Products
Falls Church: The Television Workshop
Richmond: Banner Electronics, Inc.

WISCONSIN

Chippewa Falls: Bushland Radio Spec.
Eau Claire: Bushland Radio Spec.

THE TURNER MICROPHONE COMPANY

933 17th St. N.E., Cedar Rapids, Iowa

Please send me further information on The Turner 350C citizen's band microphone.

NAME _____

STREET OR RFD _____

CITY _____ ZONE _____

STATE _____

Send this coupon to the nearest Turner distributor listed above or write The Turner Microphone Company for the name of a distributor in your area.

THE TURNER MICROPHONE COMPANY

933 17th St. N.E. . . . Cedar Rapids, Iowa

make your meter EASIER to READ

These range expanders spread out your readings so they cover 10 times as much of the scale

By LEO G. SANDS

HOW can you measure line voltage accurately? It's not as easy as it sounds. A very good ac meter is required. They're not cheap, and are usually found only in laboratories or in the hands of power companies.

My light bulbs started burning out every few weeks. Suspecting that the quality-control procedure of the lamp manufacturer was slipping, I sent the company a complaint. It brought a series of telephone calls from one of the firm's engineers, who immediately suspected high line voltage. This was measured with a vom and a vtvm. They gave different readings! I reported back to the engineer, and he suggested that a much more accurate meter be used.

The lighting engineer pointed out that a 5% increase in line voltage will cut lamp life 50% and, when line voltage is 10% too high, lamps will last only 40% of their rated 750-hour life. Line voltage makes a big difference in TV tube life, as well.

Instead of purchasing an instrument of the required accuracy, the meter range-expander device shown in Fig. 1 was designed. It consists of two 0B2

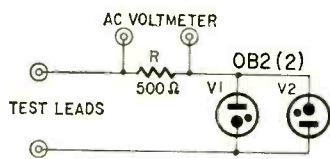

Fig. 1—Basic meter-expander circuit.

voltage-regulator tubes in reverse parallel. (The cathode of V1 is connected to the anode of V2 and vice versa.) Assuming that the highest line voltage to be encountered would never exceed 135, the value of series resistor R was set at 500 ohms. With 135 volts applied, 105 volts is developed across V1-V2 and 30 volts across R. Current through R is 60 ma since $I = E/R$, or $30/500 = .06$ amp. The current through each of the VR tubes is 30 ma.

When the line voltage is only 110 volts, there is still a 105-volt drop across the V-R tubes. But the voltage across R will now be only 5.

By measuring the voltage drop across R with an ac voltmeter set to its 0-30-volt range, the meter will read the line-voltage level minus 105 volts. If the

line voltage is 120 volts, the meter will indicate 15. The meter scale will have been expanded so that it reads 105-130 volts over its full scale.

This kind of device is extremely useful for determining small line-voltage variations accurately. When using an ordinary vtvm or vom set to its 0-300-volt range as an ac voltmeter, a change in voltage from 125 to 120 is indicated by only one scale division, if the scale has 60 divisions. But with the range-expanding device, the 5-volt change covers 10 times as much of the scale, as shown in Fig. 2. It thus becomes possible to note changes of less than 1 volt.

While not as accurate as a very precise laboratory instrument, this setup is a lot better than a conventional vom or vtvm. The V-R tubes maintain voltage constant at 105 volts within 1 volt. A typical meter has a rated accuracy of 2-5% of full scale; some are more accurate. A 2% error on the 300-volt scale is 6 volts. A 2% error on the 30-volt scale is only 0.6 volt, or one-tenth as great.

If the meter accuracy is 2% of full-scale and the V-R tubes hold to within 1 volt, a total of about 1.6 volts error is possible if both errors are in the same direction. But, when using a vom directly, the error when set to the 0-300 range can be from 6 to 9 volts.

To fire the V-R tubes, incidentally, about 30% higher voltage than their rated operating voltage is required. In the expander circuit, the tubes are fired by the ac peak voltages.

The same techniques can be applied to dc measurement. Fig. 3 shows an expanded-scale setup for dc voltages. By setting S1, 105 or 210 volts can be applied as a bucking voltage. When measuring 260 volts, for example, 210 volts are applied at reverse polarity

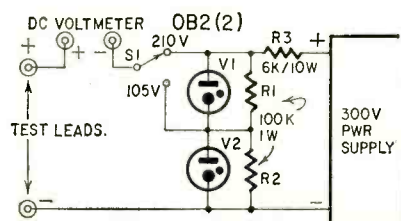

Fig. 3—Expander can be used on dc.

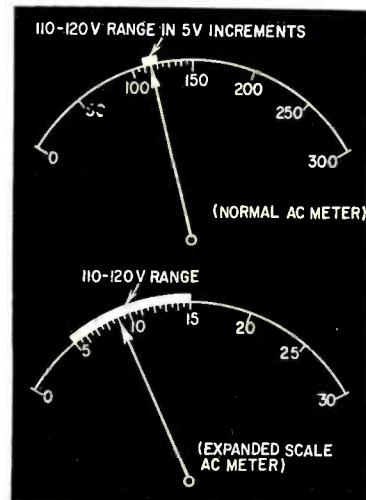

Fig. 2—How reading is spread out.

so that the meter will read 50 volts, the difference between the measured and the bucking voltage. When measuring 150 volts, 105 volts of bucking will give a meter reading of 45 volts. The accuracy becomes greater as the difference between the two voltages becomes smaller.

A technique, long known to Bell Labs engineers, includes a "volt box" (Fig. 4). The volt box is connected in series with a voltmeter that measures the difference between the measured voltage and the bucking voltage. When measur-

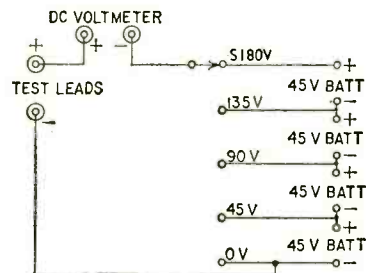

Fig. 4—Volt box extends meter range.

ing 50 volts, for example, S is set to apply 45 volts of bucking. The meter reads 5 volts.

One problem in adjusting voltage regulators in cars is measuring the battery voltage accurately. Fig. 5 shows a circuit using a 0-3 dc milliammeter which indicates 6 to 9 or 12 to 15 volts along its 0-3 scale depending upon the position of S. The batteries are ordinary 1.5-volt dry cells, which measure 1.54 volts per cell when new. When S is set to 6V, zero on the meter scale is 6 volts. When set to 12V, it is 12 volts. In a car equipped with a 6-volt battery,

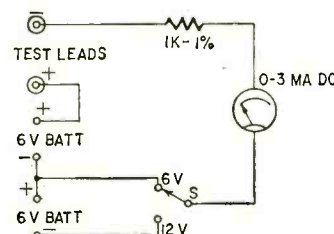

Fig. 5—Useful circuit for 6 and 12 volts.

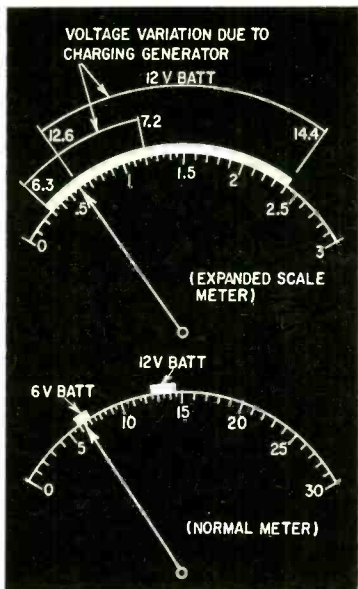

Fig. 6—Readings in 6- and 12-volt ranges.

normal voltage with engine off is 6.3. When the regulator is correctly adjusted and with the engine running, the voltage rises to about 7.2. In a 12-volt battery-equipped car, the voltage range is from 12.6 to 14.4, and up to 15 volts for some railway cabooses and heavy-duty vehicles. Fig. 6 shows the difference in the readability of an ordinary meter and the expanded-scale arrangement.

A word of caution is necessary. Don't

reverse test-lead polarity when using these expanded-scale techniques for dc. In the circuit shown in Fig. 5, for example, reversing the test leads would apply 24 to 27 (instead of 3) volts to the meter circuit when measuring voltage across a 12-volt battery. END

LUCK of the IRISH?

Sitting in a neighbor's home, we were all quietly watching the 21-inch TV screen, observing the technique used by the villain to start one of his nefarious schemes. Just as the hero in this horse opera appeared, horizontal hold departed. The picture started jumping sideways and nothing seemed to help. With much prodding I was convinced to look into the set's rear—with no spare parts on hand I considered this a waste of time, but I looked anyway. We were lucky. This set, a Philco split-chassis model, uses a 12AV7 in its sync section. It uses another 12AV7 in the front end as the rf oscillator. A quick tube switch and—believe it nor not—things were back to normal. Just to insure good results, I replaced the defective tube with a new one the next evening.—Warren Roy

BUILD YOUR OWN THEREMIN!

Now you can enjoy the ethereal, mysterious, fascinating sound of the THEREMIN. You play this most modern of musical instruments without touching it—simply by moving your hands about it. The THEREMIN has no keys, buttons or strings.

For the first time, a transistorized THEREMIN is available in kit form. This easy-to-build musical instrument is featured in the January, 1961, issue of *Electronics World* magazine. For a free reprint of this article and complete information on this exciting new kit, mail this coupon today.



R. A. MOOG CO.

Department C
P.O. Box 253
Ithaca, New York

Please send me complete information on the build-it-yourself THEREMIN.

Name _____
Address _____
City _____ Zone _____ State _____
Please Print

TV-RADIO Servicemen or Beginners...

Send for *Coyne's* 7-Volume Job-Training Set on 7-Day **FREE TRIAL!**



The First Practical TV-RADIO-ELECTRONICS Shop Library!

Answers ALL Servicing Problems QUICKLY... Makes You Worth More On The Job!

Put money-making, time-saving TV-RADIO-ELECTRONICS know-how at your fingertips—examine Coyne's all-new 7-Volume TV-RADIO-ELECTRONICS Reference Set for 7 days at our expense! Shows you the way to easier TV-Radio repair—time saving, practical working knowledge that helps you get the BIG money! How to install, service and align ALL radio and TV sets, even color-TV, UHF, FM and transistorized equipment. New photo-instruction shows you what makes equipment "tick". No complicated math or theory—just practical facts you can put to use immediately right in the shop, or for ready reference at home. Over 3000 pages; 1200 diagrams; 10,000 facts!

SEND NO MONEY! Just mail coupon for 7-Volume TV-Radio Set on 7-Day FREE TRIAL! We'll include the FREE BOOK below. If you keep the set, pay only \$3 in 7 days and \$3 per month until \$27.25 plus postage is paid. Cash price only \$24.95. Or return set at our expense in 7 days and owe nothing. Either way, the FREE BOOK is yours to keep. Offer limited, so act NOW!

"LEARNED MORE FROM THEM THAN FROM 5 YEARS WORK!"

"Learned more from your first two volumes than from 5 years work."
—Guy Bliss, New York

"Swell set for either the serviceman or the beginner. Every serviceman should have one."
—Melvin Masbruch, Iowa.

FREE DIAGRAM BOOK!

We'll send you this big book, "150 Radio-Television Picture Patterns and Diagrams Explained" ABSOLUTELY FREE just for examining Coyne's 7-Volume Shop Library on 7-Day FREE TRIAL! Shows how to cut servicing time by reading picture-patterns, plus schematic diagrams for many TV and radio sets. Yours FREE whether you keep the 7-Volume Set or not! Mail coupon TODAY!



Like Having An Electronics Expert Right At Your Side!

VOL. 1—EVERYTHING ON TV-RADIO PRINCIPLES! 300 pages of practical explanations; hundreds of illustrations.

VOL. 2—EVERYTHING ON TV-RADIO-FM RECEIVERS; 403 pages; fully illustrated.

VOL. 3—EVERYTHING ON TV-RADIO CIRCUITS! 336 pages; hundreds of illustrations, circuit diagrams.

VOL. 4—EVERYTHING ON SERVICING INSTRUMENTS! How they work, how to use them. 308 pages; illustrations.

VOL. 5—EVERYTHING ON TV TROUBLESHOOTING! Covers all types of sets. 437 pages; illustrations, diagrams.

VOL. 6—TV CYCLOPEDIA! Quick and concise answers to TV problems in alphabetical order, including UHF, Color TV and Transistors; 868 pages.

VOL. 7—TRANSISTOR CIRCUIT HANDBOOK! Practical Reference covering Transistor Applications; over 200 Circuit Diagrams; 410 pages.

ALL 7 BOOKS HAVE BRIGHT, MODERN, VINYL CLOTH WASHABLE COVERS

FREE BOOK—FREE TRIAL COUPON!

Educational Book Publishing Division
COYNE ELECTRICAL SCHOOL

1455 W. Congress Parkway, Dept. 21-T1, Chicago 7, Illinois

Yes! Send me COYNE'S 7-Volume Applied Practical TV-RADIO-ELECTRONICS Set for 7-Days FREE TRIAL per your offer. Include "Patterns & Diagrams" book FREE!

Name _____ Age _____

Address _____

City _____ Zone _____ State _____

Check here if you want Set sent C.O.D. Coyne pays postage on C.O.D. and cash orders. 7 Day Money-Back Guarantee.

Coyne ELECTRICAL SCHOOL

1455 W. Congress Parkway
Dept. 21-T1, Chicago 7, Illinois



83 YX 929. Stereo Tape Record-Play Preamp Kit. \$79.95 (less case)

One of the many great Knight-Kit stereo component kits. Professional quality; superb performance with virtually any 3-head tape transport; separate dual-channel recording and playback preamps; permits tape monitoring, sound-on-sound and echo effects. Packed with quality features for every possible stereo and monophonic function...

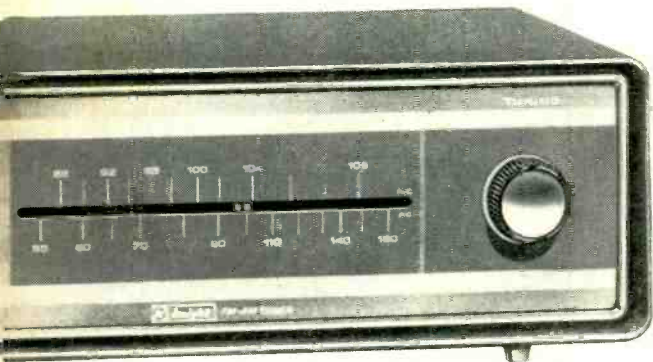

83 YX 928. FM-AM Hi-Fi Tuner Kit. \$49.95

Typical Knight-Kit hi-fi value—incomparable at the price. With AFC, tuned RF stage on FM, multiplex jack. Straight FM tuner kit also available at \$38.95. For deluxe Stereo FM-AM and FM tuner kits, see the Allied catalog...



83 YX 927. 20-Watt Stereo Hi-Fi Amplifier Kit. \$39.95

Biggest bargain in quality Stereo hi-fi. Has special clutch-type dual-concentric level control; simplified control facilities; DC preamp filaments. Similarly styled 32-Watt Stereo Amplifier Kit with full frequency center channel available at a low, low \$59.95...



83 YU 934. Deluxe 70-Watt Stereo Hi-Fi Amplifier Kit. \$119.95

Super-power to drive any of today's speakers, a do-it-yourself stereo masterpiece, featuring: special "blend" control; full-range center channel; tape-source monitor; dual phasing switches; Stereo paralleling switch. For deluxe 40-watt Stereo amplifier at only \$76.95, and 60-watt Stereo amplifier, see the Allied catalog...

Simply

these and 59

knight
A PRODUCT

a pleasure to build...

The most satisfying do-it-yourself experience awaits you when you build a Knight-Kit! You'll marvel at the sheer ease of assembly, absolutely assured by exclusive "show-how" manuals, wall-sized picture diagrams, step-by-step do-and-check instructions, pre-cut wire, "visi-packed" parts and an engineering perfection that eliminates guesswork. You'll get perfect results. You'll enjoy with pride a true custom-built electronic product, professionally engineered and styled—the best you can own. And to top off your pleasure, you'll save substantially at the unbeatable Knight-Kit price...

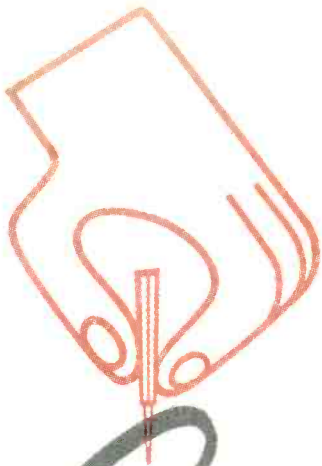

83 YX 712-2. Superhet Citizen's Band Transceiver Kit. \$79.95

Dual-conversion for highest sensitivity and selectivity; crystal-controlled operation on any 2 channels, plus manual tuning. Another Knight-Kit Citizen's Band Transceiver is available at an amazing low \$39.95—see the Allied catalog for full details...

Great!

other money-saving

-kits[®]

OF ALLIED RADIO

and you own the best



83 YX 258. 4-Band "Span Master"® Receiver Kit. \$25.95

Fabulous performer for world-wide reception; thrilling shortwave adventures, plus fine Broadcast; band-switching, 540 KC to 30 MC; with cabinet. For additional receiver kits, radio-intercom, clock-radio, transistor radios, intercom systems, electronic labs and other great hobbyist Knight-Kits, see the Allied catalog...

money back guarantee

Every Knight-Kit is unconditionally guaranteed to meet our published specifications for performance or your purchase price is refunded in full.

only \$2 down

It's easy to buy any Knight-Kit: only \$2 down on orders up to \$50; \$5 down up to \$200; \$10 down over \$200—up to 24 months to pay.

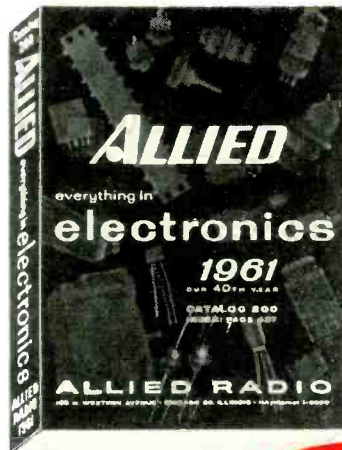

Featured

IN THIS VALUE-PACKED 1961 **444-PAGE ALLIED CATALOG**

Send coupon today for the 1961 Allied electronics catalog (the world's biggest), featuring the complete Knight-Kit line. See the best in electronic kits—save on *everything* in Electronics. Send for your FREE copy now!

sold exclusively by

also available in Canada

ALLIED RADIO

pioneer in electronic kit development

our 40th year



83 Y 125. Electronic VTVM Kit. \$25.75

High sensitivity general-purpose VTVM; 11 meg input resistance; balanced-bridge circuit; 4½" meter. One of many fine instrument kits including 5" scopes, AC VTVM, tube checkers, signal tracer, audio generator, sweep generator, and others, described in detail in the Allied catalog...



free

send coupon today!

**ALLIED RADIO, Dept. 8-B1
100 N. Western Ave., Chicago 80, Ill.**

Send Free 1961 Allied Catalog No. 200

Name _____
PLEASE PRINT

Address _____

City _____ Zone _____ State _____



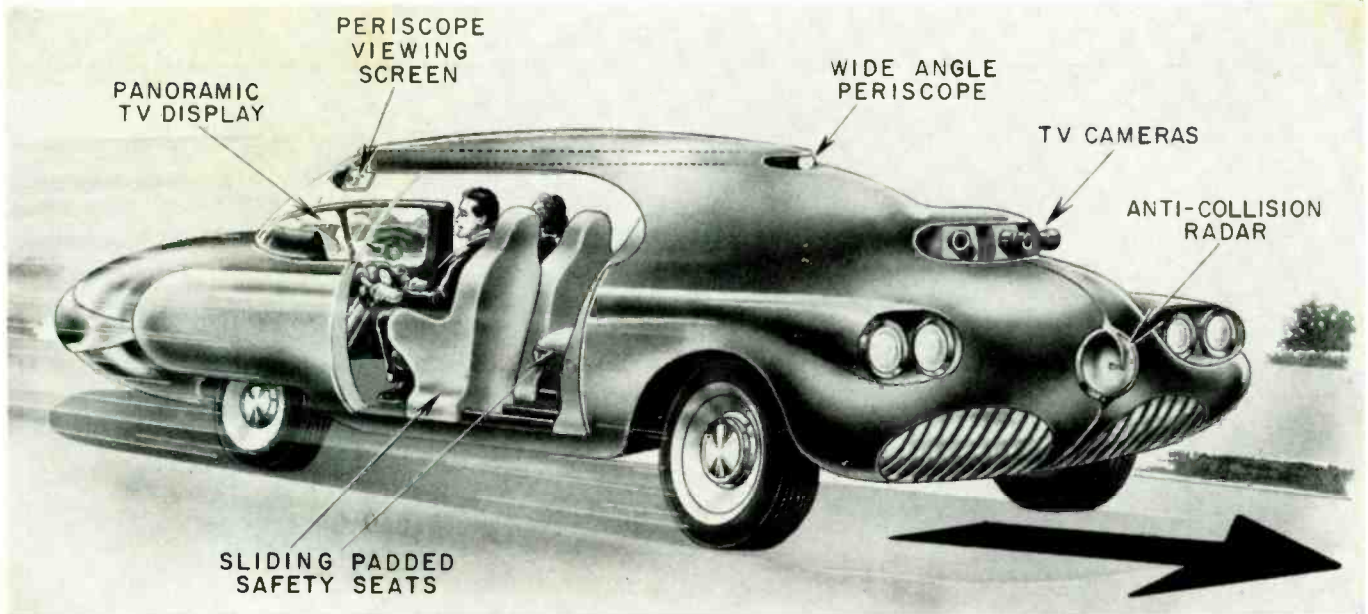

SAFE DRIVING with closed-circuit TV

By MANFRED von ARDENNE*

A FEW months ago the world press carried a truly sensational report: in a mid-air jet explosion the pilot was thrown clear without his parachute. Exceptional luck had him wind up in a haystack with nothing more than a broken leg to complain about.

By this unusual occurrence Nature has shown a way of solving one of the pressing problems of our time, the design of high-speed transportation with greater safety for the traveler:

There exist substances and conditions that permit the complete deceleration of a human body from speeds of several hundred miles per hour within a yard or so, without critical injuries.

High-speed transportation should literally carry its own "haystack" or braking material along for the protection of the traveler in an accident.

Experiments in connection with space flight have shown that deceleration in the order of 35 G can be tolerated without damage. It should be noted that in those experiments the subjects were retained only by belts and the seats were so oriented as to give no protection. If the seat is positioned backward with respect to the direction of travel, one can expect that the body will be suitably braced from head to foot. Under such conditions decelerations of up to 50 G can be tolerated for short periods without more than minor injuries.

Recent progress in the television field makes it possible to consider the radical solution (patent applied for) shown in the drawing and described in the following paragraphs:

It is quite understandable that the solution has been suggested, not by someone in the automotive field, but by an electronics engineer closely asso-

ciated with the television industry. At the present state of the art, only moderate additional development work is needed to create a panoramic (wide-angle) TV installation which permits the driver to be seated with his back to the direction of travel. The picture of exceptional clarity (1,000 lines) would show a panoramic view of the road and surrounding area, as would normally be seen from the front of the car.

Three television cameras, each with a horizontal angle of 70°, could create a picture representing a view of 210°. This picture could be presented on three picture tubes in such a manner as to cover a horizontal angle of only 100° of the driver's view. The driver would thus be able to scan the whole road ahead of him without having to turn his head to see on both sides of his car. A further advantage of this system would be a considerable improvement of visibility in fog. It would only be necessary to install filters in front of the camera lenses to improve response to the longer wavelengths of infrared.

The idea of using closed-circuit television does not appear so farfetched if one remembers that Cadillac has already used a similar approach (a few years ago) to provide a wide-angle view to the rear in one of their experimental cars.

To pick out colored traffic signs one might consider the use of color TV as already used for viewing surgical operations remotely, in medical universities. The present design includes a wide-angle periscope for observing colored traffic signs as well as for emergency use in case of failure of the TV system. This feature can be seen in the drawing, which also shows the arrangement of the driver's seat and the video display.

The TV system permits the placement of the driver as well as the passengers in contoured seats arranged opposite

to the direction of travel, so that the driver's view is to the rear. Proper shaping of the contoured seats [usually referred to in this country as "bucket seats"—*translator*] will assure that the first impact in case of accident (which is nearly always frontal) will push the passengers into the seats and provide proper bracing for the whole body, including the driver. Front and rear seats are rigidly connected to each other and as a result of the impact they will move in unison toward the retarding mass of the padding, or braking material, designed to decelerate the body at a safe rate. The required constant deceleration can be accomplished by selecting braking material of the proper density, as stated above.

Admittedly the inclusion of such a decelerating-mass cushion inside the vehicle will occupy some of the interior space. To minimize this disadvantage the same part of the interior can also store other safety items, such as padding panels which, upon impact, would automatically shoot in front of the windows and other potentially dangerous areas, such as any hard objects in the interior.

A complete covering of potential danger spots assures that later impacts during an accident, which are not always frontal ones, would also not be likely to injure passengers. With reference to the padding, one may think of the excellent protection given by crash helmets; they are so effective that many law-enforcing agencies suggest their use.

The rather radical solution discussed above should not be considered an impossibility at the present state of the art. It was presented with a view to pointing out possible future development of the automobile. It was however also discussed for the purpose of introducing compromise solutions for which technology has the means now and for which today's traffic is more than ready. END

*Director, Manfred von Ardenne Research Institute, Dresden-Weisser Hirsch, Germany.

EFFECTS YOU SHOULD KNOW

By J. H. THOMAS

SOME effects in electronics and allied sciences are named after their discoverers. One of the better known of these for example is the *Edison effect*, Thomas Alva Edison's most important contribution to electronic science. In 1883 he noted that a glass bulb with a heated filament would pass electric current in one direction but not the other. It remained for Fleming, who knew of the Edison experiments, to use the principle for a vacuum tube in 1904.

One of the latest in the category is the *Esaki effect*, as the action of the tunnel diode tends to be labeled. In the course of the history of electronics there are many such effects, named for their discoverer. How many do you know?

1. *Hall effect* is prominent in the literature right now. What is it?

2. Do you recognize the *Thomson effect*?

3. The *Peltier effect*, discovered by 1834, is lately becoming of importance in semiconductor type baby-bottle warmers. Do you know where it appears and what it is used for?

4. The famous Volta also had an effect labeled after him, and it is naturally called the *Volta effect*. What is it?

5. What about the *Joule effect*?

6. More familiar perhaps in circuit work is the *Miller effect*, used in most oscilloscopes. Are you hep?

7. You're pretty hot on science if you've heard of the *Stark effect*.

8. The *Barkhausen effect* has nothing to do with oscillations in a vacuum tube, but instead deals with . . . what?

9. The *Seebeck effect* is one which has never been explained satisfactorily. Do you know what it is?

10. Just to take the sting out of this quiz, here's an easy one. What is the *Doppler effect*? END

(Answers on page 122)

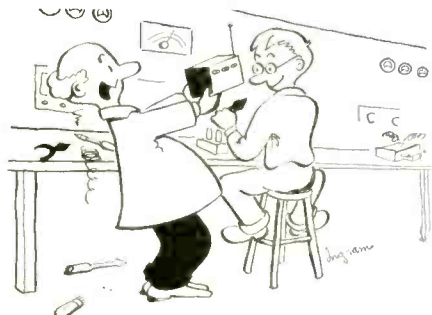

"There it is! The latest in TV remote control! It lets the sponsor turn the sound back on!"

FEBRUARY, 1961

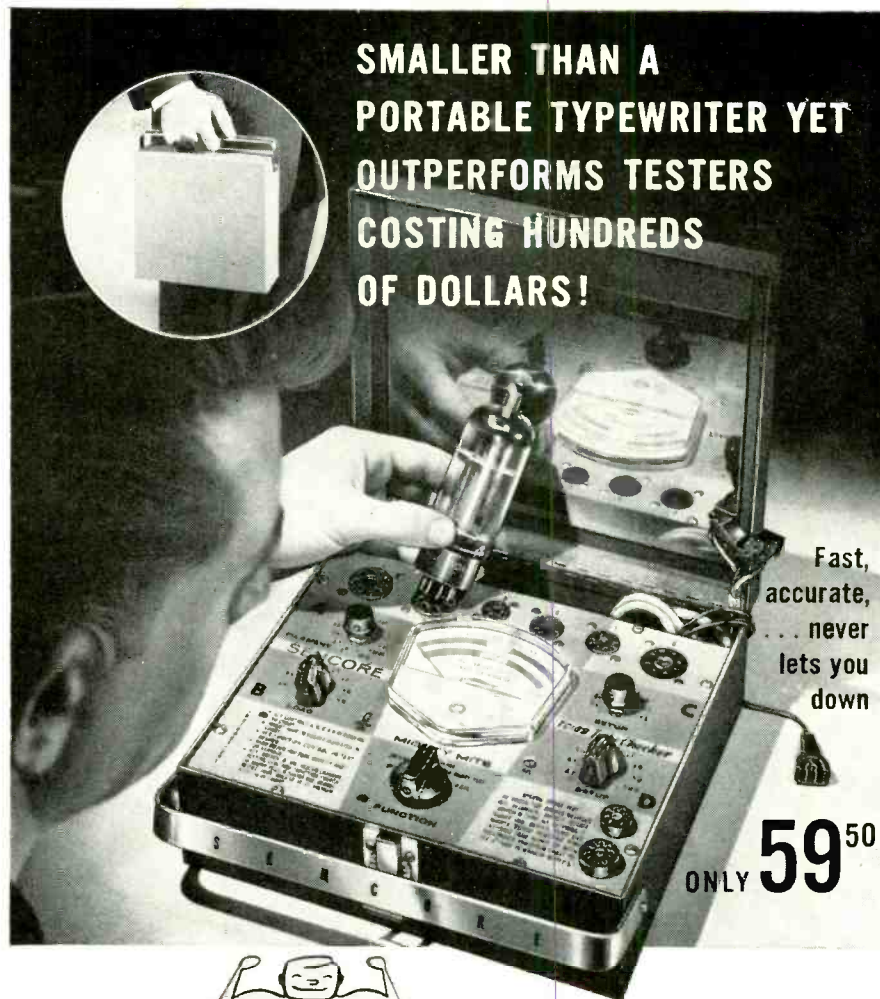

The MIGHTY MITE by SENCORE

The TC109 Tube Checker is a real money maker for the serviceman and a trusty companion for engineers, maintenance men and experimenters. Even students and hobbyists can afford the Mighty Mite for their own use or to service an occasional Radio or TV set. This small complete tester is a tremendous performer that spots bad tubes missed by costly mutual conductance testers.

New unique "stethoscope" approach tests for grid emission and leakage as high as 100 megohms, yet checks cathode current at operating levels. Special short test checks for shorts between all elements. The MIGHTY MITE will test every radio and TV tube that you encounter (over 1300!) plus picture tubes, foreign, five star and auto radio tubes (without damage). As easy to set up as a "speedy tester" from easy to follow tube booklet. New tube charts free of charge. Simple operating instructions are screened on the front panel.

Check these plus Sencore features • Meter glows in dark for easy reading behind TV set • Stainless steel mirror in cover for TV adjustment • Rugged, all steel carrying case and easy grip handle • Smallest complete tester made • Inner chassis can be easily transferred to tube caddy, bench or counter. • Only 9" x 8" x 2½". • Wt. 8 lbs.

See your
Distributor . . .
if he cannot help
you, Pat will



PAT RUDE,
Customer Service

SENCORE, ADDISON 3, ILLINOIS

Dear Pat: Will you please . . .

Send me _____ Mighty Mite

Check or M.O. enclosed (PP Prepaid.) Send C.O.D.

Distributor's Name (if any) _____

Your Name _____

Street _____

City _____ Zone _____ State _____

ALL UNITS FULLY GUARANTEED OR MONEY BACK WITHIN 10 DAYS

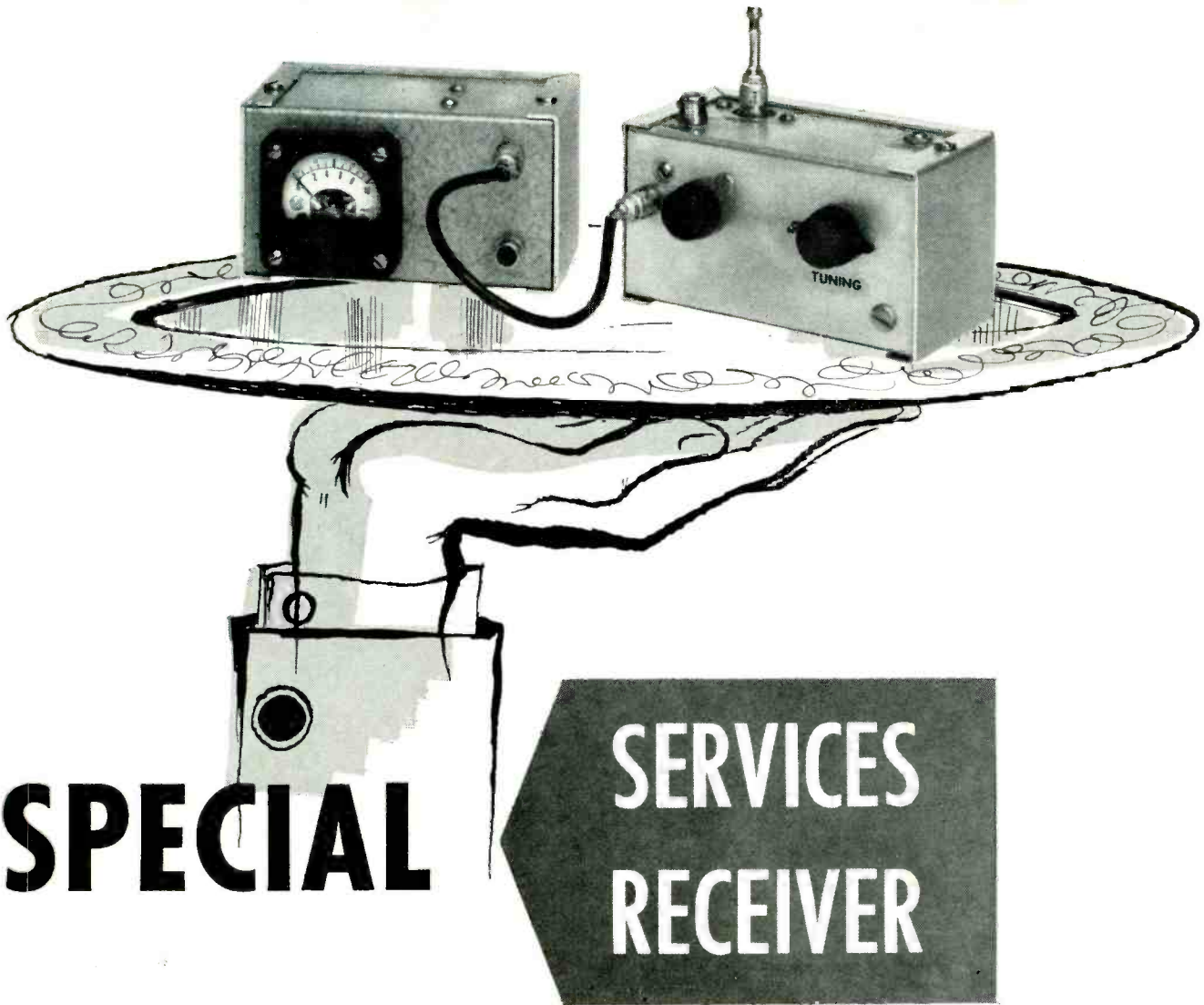

SPECIAL

SERVICES RECEIVER

Listening, radio control and signal-strength measurements are the three duties of this 3-transistor unit

By I. QUEEN

EDITORIAL ASSOCIATE

THE 27-mc Citizens band and the 28- to 30-mc ham band have a lot to offer the hobbyist and the casual listener. You can hear personal and business messages and ham conversations. The Citizens band also provides a frequency for transmission of control signals.

The little receiver described here is designed for special service in these bands. It is suitable for listening, signal-strength measurement and relay control. It tunes from about 25.5 to 30.5 mc, which includes short-wave programs by foreign broadcasters throughout the world on frequencies around 26 mc.

For listening, you need only the first two stages and can omit T2, V3, R5 and R6 (see schematic). Earpiece volume is more than satisfactory even on weak signals. The usual superregenerative hiss should start with R1 about halfway on. If it doesn't, try a different value for R2. It might be wise to use a potentiometer for R2 as its optimum value may change with age or temperature. Tune coil L to center the desired frequency band.

The 2N1143 transistor (V1) is a

high-frequency type that operates very well with only 1.2 volts at 70 μ a! Thus the power supply may be a tiny cell and can be left on for long periods of monitoring. With an audio stage, total battery power drain is still negligible—only 0.4 ma.

I use a little rechargeable cell because of its small size and convenience. It is placed in a bottle cap which is fitted with a phono plug. To operate the set, the cell is plugged into a phono jack on the receiver. I keep an extra unit on hand and use it while recharging the other.

Low power means low radiation. Although the second harmonic of 28 mc falls within TV channel 2, you can use the receiver near a TV without

interference. Actually, with the superregenerator whip a few feet from an indoor TV antenna, interference is negligible!

V3 adds the remote-control feature. It is biased nearly to cutoff. When a carrier arrives, it reduces the bias and increases collector flow. Choose a value for R5 that gives the lowest reading with no signal and maximum reading with signal. It may be made up of two or more resistors in series or parallel to get the required value. A strong carrier should cause more than 1 ma to flow through the relay coil and activate it.

The relay has a mechanical adjustment for sensitivity. Mine is set to operate at 0.8 ma and to release at

Three-transistor unit for listening, signal-strength measurements, and remote control. Covers frequencies between 25.5 and 30.5 mc. Uses rechargeable battery.

When tested by a member of the staff of RADIO-ELECTRONICS at a point some 15 miles from New York City, a number of stations were received. However, none of them were close enough to trigger the relay. But from the meter readings it was apparent that somewhat stronger stations would do the job.

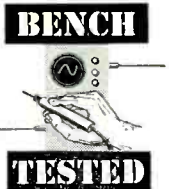

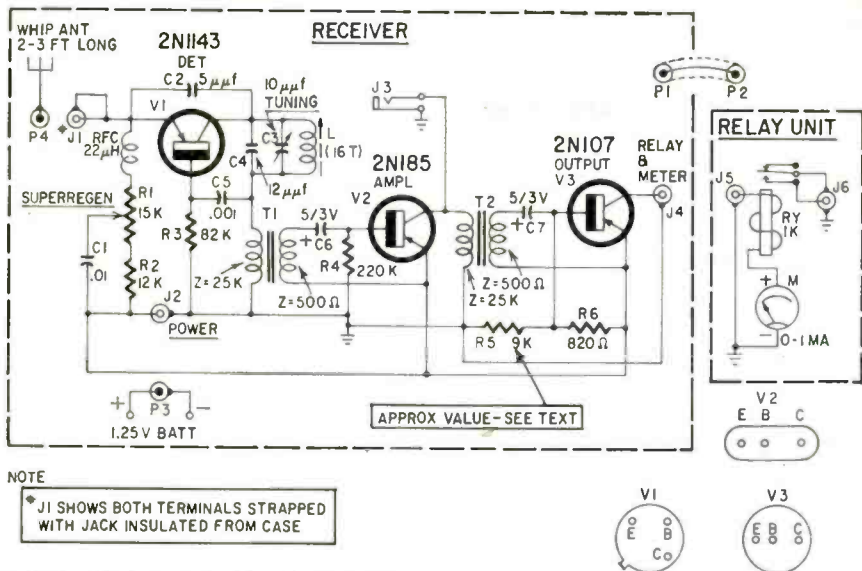

- R1—pot, 15,000 ohms
- R2—12,000 ohms
- R3—82,000 ohms
- R4—220,000 ohms
- R5—9,000 ohms (see text)
- R6—820 ohms
- All resistors 1/2-watt 10%
- C1—.01 μ f, disc ceramic
- C2—5 μ f, ceramic
- C3—10 μ f, air variable
- C4—12 μ f, ceramic
- C5—.001 μ f, ceramic
- C6, 7—5 μ f, 3 volts, miniature electrolytic
- All capacitors 3 volts or higher
- BATT—1.25 volts, rechargeable (Eveready N32T or equivalent)
- J1—phono jack insulated from case
- J2, 4, 5, 6—phono jacks
- J3—phono jack
- L—16 turns No. 28 enameled wire on slug-tuned 1/4-inch form
- RFC—radio-frequency choke, 22 μ h
- M—0-1 ma
- P1, 2, 3, 4—phono plug
- RY—spdt, 1,000-ohm coil (Sigma 5F-1000S/SIL or equivalent)
- T1, 2—interstage transformers: primary, 25,000 ohms; secondary, 500 ohms (UTC SO-3 or equivalent)
- V1—2N1143
- V2—2N185
- V3—2N107
- Transistor sockets (3)
- Earpiece
- Cases, 4 x 2 1/4 x 2 1/4 inches (2)
- Whip antenna, 2 to 3 feet long soldered to P4
- Length of coax (12 inches)
- Miscellaneous Hardware

Circuit of the special-services receiver.

about 0.4 ma. It can easily be energized by a 5-watt carrier at a distance of about 1,500 ft., using an antenna only 2 feet long.

For carrier measurement, a meter (0 to 1 ma) is placed in series with the relay. Adjust R1 for minimum reading (without signal) or slightly beyond minimum (in the lower-resistance direction). My meter reads 0.2 ma at zero signal and above 1 ma on strong signals. If you touch the whip antenna, superregeneration will cease and the meter will deflect to full scale, just as though a strong signal were being received.

All receiver components are housed in a 4 x 2 1/4 x 2 1/4-inch metal box. Relay and meter are in another box of equal size. They are joined electrically by a short shielded lead with phono plugs at both ends. The receiver box also needs a phono jack (J2) for its rechargeable cell and a jack (J1) for the whip antenna (a phono plug is soldered to the antenna). J3 is a miniature earpiece jack.

The superregenerator is a very sensitive receiver which picks up hams and Citizens-banders over many miles. When conditions are right, even thousands of miles can be covered. When it comes to carrier measurement, don't confuse this device with the simpler variety often described. The latter can make measurements up to about 20 feet from the transmitting antenna. This one goes full scale on 5-watt carriers at 1,500 feet or more. All except the weakest of stations will give some sort of deflection. You can monitor signal strength of mobile stations, help your friends adjust their rigs the other side of town, etc.

It is perfectly feasible to leave this receiver on for long periods until a strong carrier throws the relay and calls attention to itself. The power needed to operate the set can be called negligible.

END

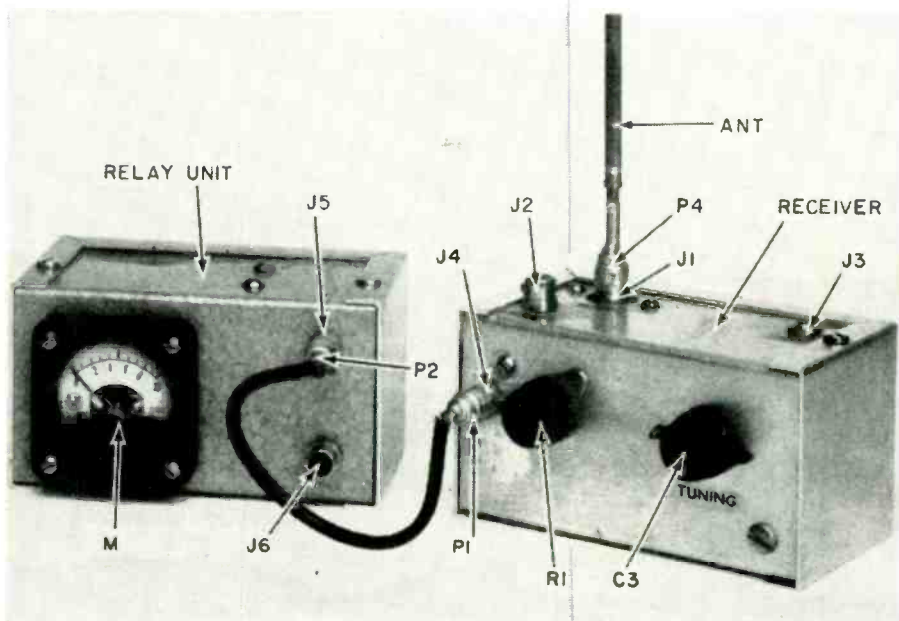

Receiver and relay-meter combination are separate units connected by short length of coax cable.

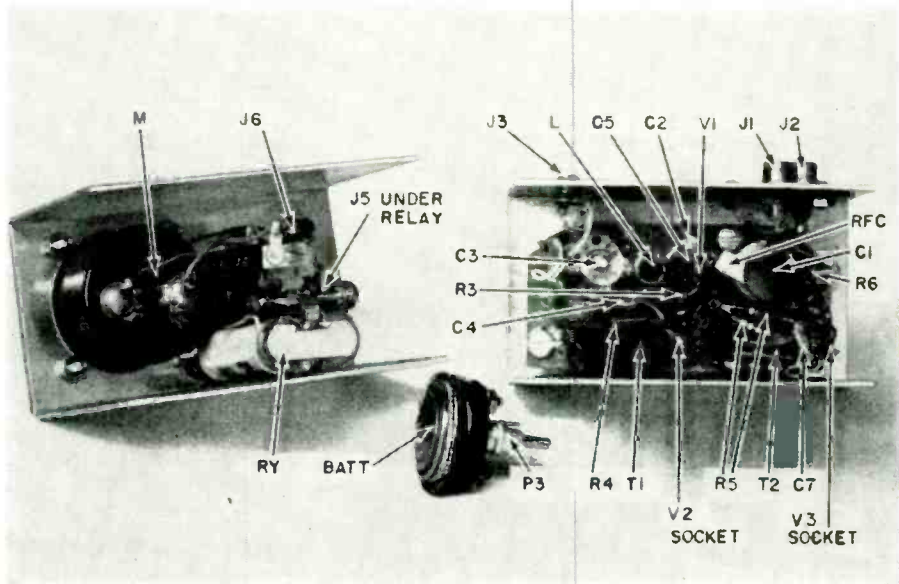

Follow this layout for a minimum of construction difficulties.

World's first Electronic TV Antenna . . .

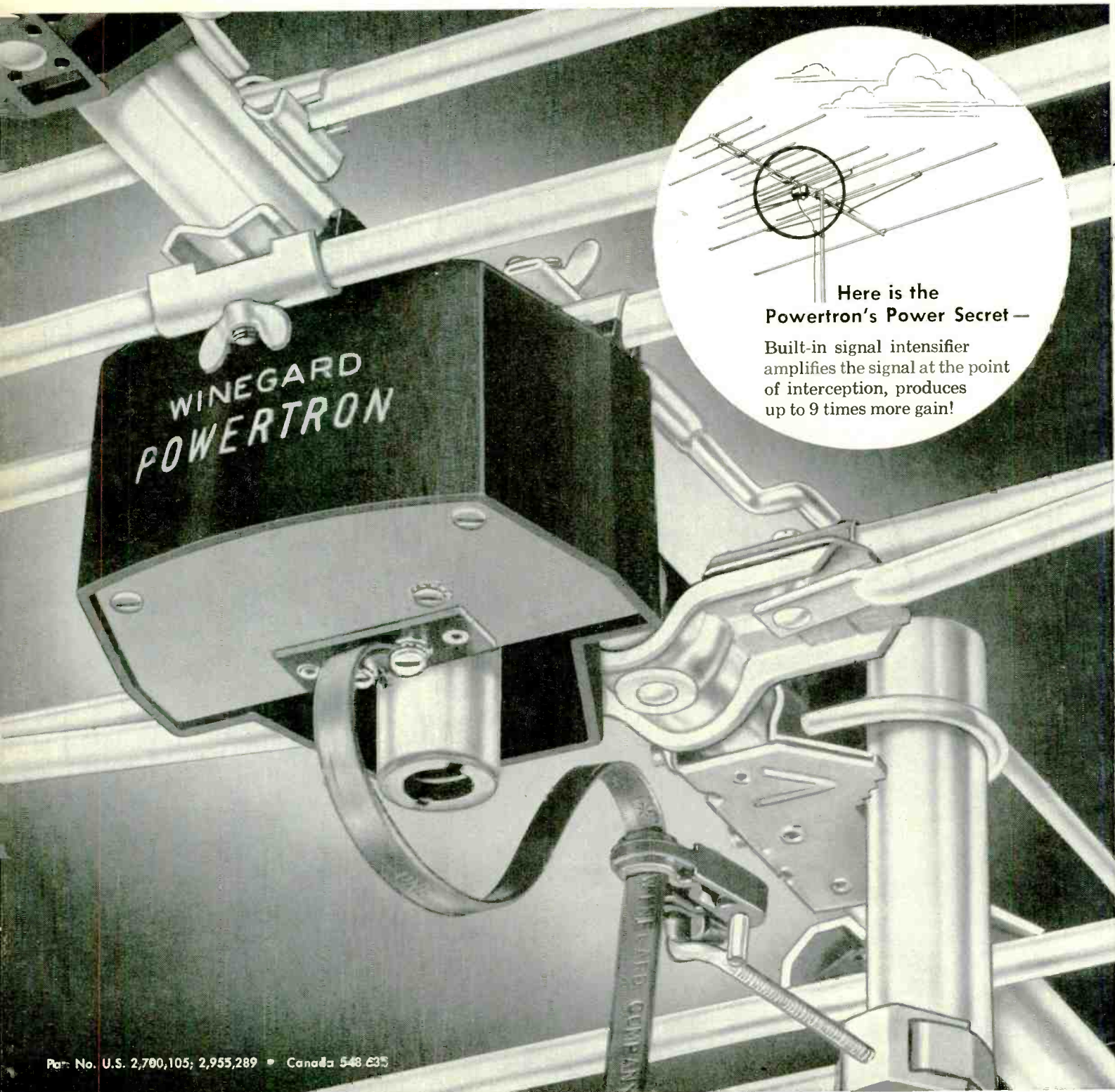

Here is the
Powertron's Power Secret —

Built-in signal intensifier
amplifies the signal at the point
of interception, produces
up to 9 times more gain!

Pat. No. U.S. 2,700,105; 2,955,289 • Canada 548 635

NOW AN ANTENNA WITH 5-9 TIMES MORE GAIN

THAN ANY TV ANTENNA EVER MADE!

Here's the antenna that will obsolete tens of thousands of old-style antennas, will give new life to old TV sets, will build new profits for TV Service Technicians.

WINEGARD POWERTRON

POWERTRON AMPLIFIES TV SIGNALS AT THE POINT OF INTERCEPTION

Now Winegard engineers have designed a new high gain, all-channel yagi antenna incorporating a low noise, high gain RF amplifier in one integral unit! Because the input circuit of this amplifier *exactly matches* the characteristics of the new "Tapered T" driven elements to which it is *directly coupled*, every last particle of signal is amplified. The results are amazing.

We call this new electronic antenna the POWERTRON. The Powertron amplifier uses the frame grid 6DJ8 dual triode (12,500 MHOS) transconductance, in a radical new RF circuit, that allows this one tube to amplify all signals in the VHF TV band, 54 to 216 MC, with a gain of 5 times (14 DB). This gain is added to the gain of the antenna which is a high gain yagi design, quite superior to other all channel antennas.



The Powertron power supply lowers 117 VAC to a safe 24 volts which is fed up the lead-in to the Powertron antenna. Completely fused, the power supply is made shock-proof by an AC isolation transformer.

Imagine what this super-powerful electronic antenna can do! Weak signals become strong and clear—dim pictures bright and contrasty. Old-style tuners pull in snow-free pictures better than 1961 models on ordinary antennas.

You can do many things with this new antenna that are impossible with any other. You can drive up to 6 TV sets in deep fringe, 10 TV sets in normal areas without an additional amplifier. You can put TV outlets in every room of the house and all sets will have better pictures than any single set with a regular antenna.

Because of its extreme sensitivity, Powertron can be installed lower than other antennas. For instance, where 40-ft. masts are normally used, a Powertron can usually be installed at 25 ft., yet give better results!

Where desirable, the Powertron can be remoted up to 1/4 of a mile and still deliver a perfect signal.

In large distribution systems (motels, apartments, etc.), Powertron makes the perfect antenna to use in conjunction with Winegard's 4-tube A-400 or 7-tube A-700 distribution amplifiers.

For critical color, Powertron's extremely linear frequency response makes it the ideal antenna for your "color" installations.



To sum it up, Powertron makes weak TV pictures good, and good TV pictures even better. It *works equally well* for color or black and white reception. It is the world's first all channel (VHF) *electronic* TV antenna, and is a tremendous step forward in the search for improved TV reception.

3 Gold Anodized Powertron Models —

Powertron Model P-44, 14 elements \$74.95 list.

Powertron with Power Pack Model P-44X, 21 elements, \$91.90 list.

Super Powertron Model SP-44X, 30 elements, \$104.95 list.

NEW TELETRONS, TOO! NON-ELECTRONIC, BUT 26% TO 484% MORE POWER INCREASE THAN COLOR'CEPTOR

Similar to the Powertron, but without the RF amplifier, Teletron embodies the same new WINEGARD "TAPERED T" DRIVEN ELEMENTS for proven performance superior to any other non-electronic TV antenna. Teletron is gold anodized, has the same fine quality construction and mechanical features as the Powertron.

3 Gold Anodized Teletron Models —

Teletron Model T4, 14 elements, \$34.95 list.

Teletron Model T-4X, 21 elements, \$51.90 list.

Super Teletron Model ST-4X, 30 elements, \$64.95 list.

COMPARISON OF POWERTRON AND TELETRON MODELS TO WINEGARD COLOR'CEPTOR

Chart shows Gain and Power Increase over Color'Ceptor (CL-4) Antenna

Model		DB Gain Over CL-4	Power Increase Over CL-4	Voltage Gain Over CL-4
P-44	Powertron	14 DB	25.1 Times (2500%)	5.01 Times
P-44X	Powertron with Pack	15.8 DB	38.4 Times (3800%)	6.20 Times
SP-44X	Super Powertron	19.1 DB	81 Times (8100%)	9.0 Times
T-4	Teletron	1.0 DB	1.26 Times (26%)	1.12 Times
T-4X	Teletron with Pack	2.8 DB	1.9 Times (90%)	1.38 Times
ST-4X	Super Teletron	6.1 DB	4.84 Times (484%)	2.2 Times

GET IN ON THE POWERTRON — TELETRON PROFIT BANDWAGON!

Be first in your area to offer the superb Powertron performance to your customers. Take advantage of many new sales aids now available through your Winegard distributor . . . and watch for sales-making consumer ads in **LIFE**

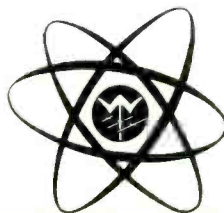

Winegard

Winegard Co., 3013-2 Scotten, Burlington, Iowa

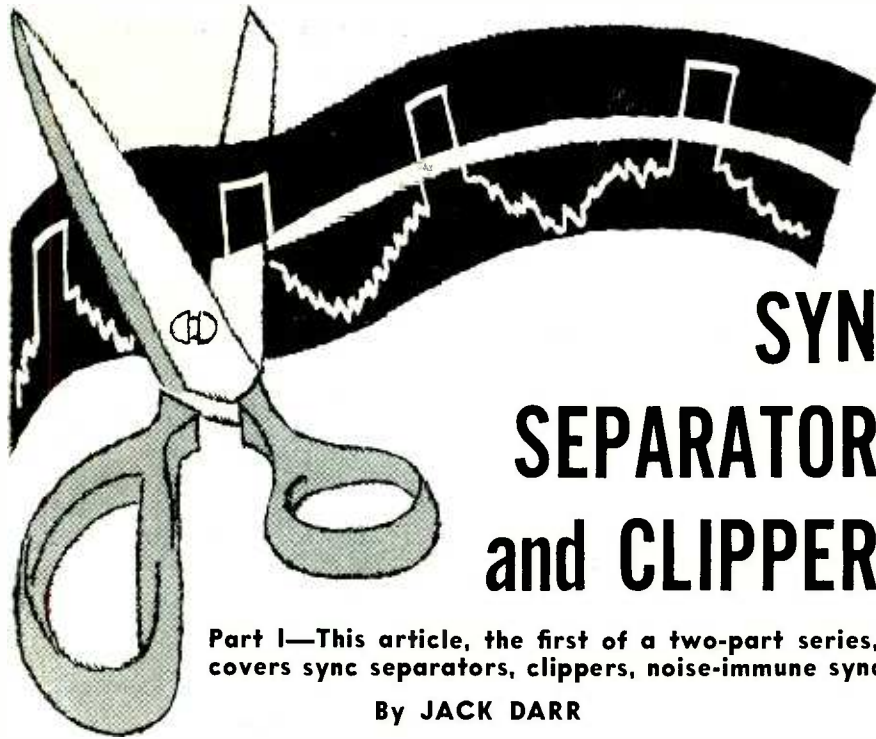

SYNC SEPARATORS and CLIPPERS

Part I—This article, the first of a two-part series, covers sync separators, clippers, noise-immune sync

By JACK DARR

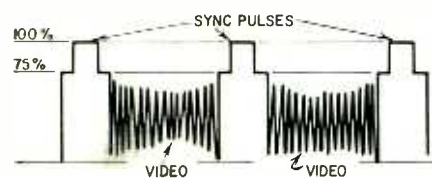

Fig. 1—Video signals are never allowed to rise above 75% of rf signal level.

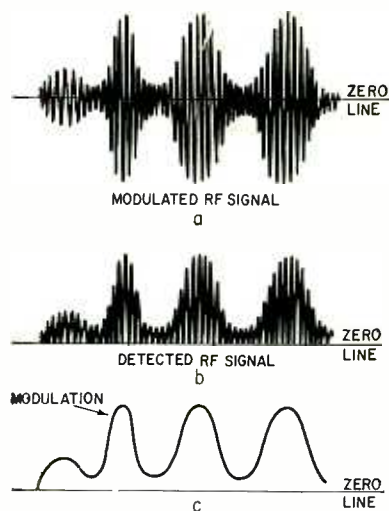

Fig. 2-a—Amplitude-modulated rf signal; b—signal after passing through a detector; and c—after the rf is filtered out.

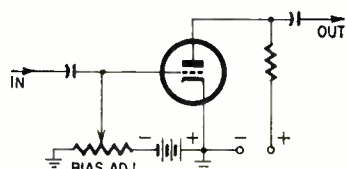

Fig. 3—Varying the grid bias changes the amount of signal getting through.

MANY technicians have a sort of built-in dread of sync clippers, separators and similar stages. Actually, these stages are fundamentally simple.

Let's take them one at a time. What's the basic purpose of a sync-separator stage? Easy; it separates sync! Before you start throwing things at me, let's analyze this a little. All TV sets have two sweep oscillators, which must be synchronized with the signal at 60 and 15,750 cycles. In the received TV signal, there are 60- and 15,750-cycle pulses which we use for this. These sync pulses are transmitted at the peak voltage of the signal. In a perfect signal, the video is never allowed to rise above 75% of this value, so we have the top 25% for our sync (Fig. 1).

To recover these pulses so they can

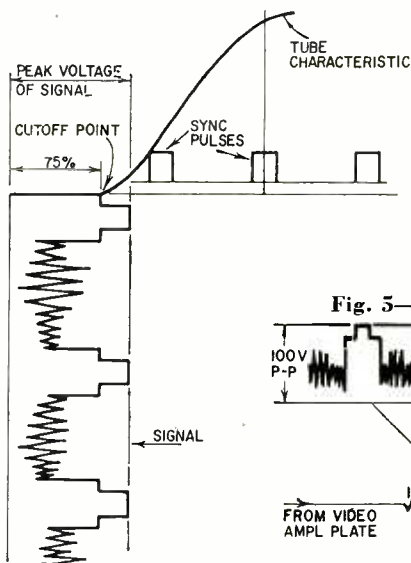

Fig. 4—Only upper 25% of signal (sync pulses) gets through, tube cuts off and will not pass lower part.

be used to lock our oscillators, we detect them as we would an AM signal (Fig. 2-a). Pass them through a diode which allows only half of the signal to flow—that above the zero line in Fig. 2. We pass the resulting signal (Fig. 2-b) through a circuit which filters out the rf pulsations (Fig. 2-c).

To recover the sync from the top of the complete video signal, we pass it through a circuit which "splits off" the top 25% of the signal which contains the sync information we want.

We can do this with a vacuum tube in an amplifying circuit. By adjusting the grid bias, we can control the percentage of the signal which appears in the plate circuit (Fig. 3). By biasing it so that it is normally below cutoff, we can allow only the top 25% of the signal to be passed on into the plate circuits as seen in Fig. 4. We can do this by applying a fixed dc bias to the grid or we can use grid-leak bias (possibly the oldest circuit in electronics!). The incoming signal charges the coupling capacitor and the grid-leak resistor causes a negative voltage to build up on the grid due to the flow of grid current. The grid acts like a diode plate. By varying the values of the resistor and coupling capacitor, we can make the grid seek whatever bias level we need. Note here that tubes used in this type of circuit must always have a very sharp-cutoff characteristic so that the desired sync pulses are clipped cleanly off the top of the signal.

In actual operation the desired bias level can be readily found in any TV set. How? By measuring the peak-to-peak voltage of the video signal applied to the grid. The effective grid bias must always be 75% of the peak-to-peak value because we want to block the lower 75% (the video) and allow only the top 25% to pass through.

Fig. 5 shows the horizontal sync separator and amplifier stages of an RCA KCS-68. Twin triodes (6SN7's) are set up so that the first triode acts as separator and the last pair as an amplifier (the other half of V1 is the vertical sync separator). Bear in mind that both vertical and horizontal circuits are identical even though one works with 60 cycle sync, the other with 15,750-cycle sync. The functions are exactly the same. Only the time constants of the resistors and capacitors are different—to get the most output at that frequency and to prevent interaction between horizontal and vertical sync.

Fig. 5—Horizontal sync separator of RCA KCS-68F.

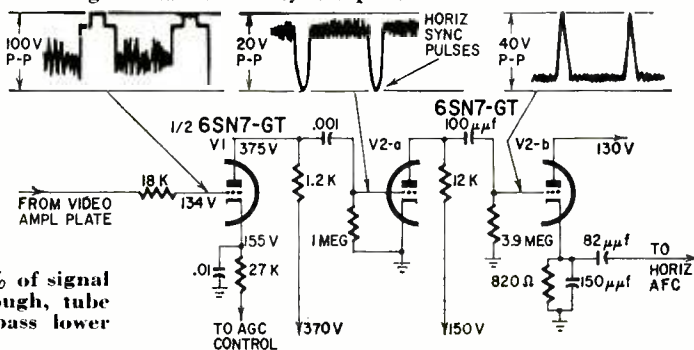

The voltages shown on the sync separator V1 are the actual operating voltages. Note the relationship between the grid-cathode voltage and the peak-to-peak voltage of the signal. Measuring from the cathode to the grid, we read -21 volts (bias). The signal is shown at an amplitude of 100 volts peak-to-peak. Although this is nowhere 75%, it is within the manufacturer's tolerance limits. Notice the waveform shown on the grid at V2-a: the heavy line between pulses is what's left of the video signal. For perfect operation, this video signal should be completely clipped off. In practical circuits, it is often merely compressed very tightly! Actually, if we can get this down to a level like that shown, it won't affect sync-circuit operation at all.

Now we have a signal consisting entirely of horizontal sync pulses, at an amplitude of 40 volts peak to peak, on the grid of the last sync-amplifier stage. The sync is taken from a low-impedance point—across the 820-ohm cathode resistor. Notice the 82- μ f capacitor used to couple the horizontal sync to the horizontal afc. This value is deliberately small and is common to all horizontal sync circuits. Its purpose is to present a very high impedance to the vertical sync pulses (in case any of those are floating around) and to pass the higher-frequency horizontal pulses with little loss. In vertical sync circuits, the opposite is found—small capacitors are used as *bypasses* (connected from plate to ground) so the high-frequency pulses find an easy route to ground while the low-frequency vertical pulses pass merrily on.

A duplicate of this circuit is used to separate, clip and amplify the vertical sync pulses. These are then fed through a vertical integrating network to the vertical oscillator.

You'll find this circuit in many of the older TV sets and in some of the newer ones—it is highly efficient when correctly designed. Older sets used 6SN7's; later ones 12AT7, 12AX7, etc.

Combination circuits

Noise-rejection circuits have been incorporated into many sets, usually in the form of separate tubes biased to clip off noise impulses. More recent sets use a circuit which combines the functions of sync separator, sync clipper, amplifier and noise rejector, all in one. The original tube used in this circuit was the 6BE6, a pentagrid converter type familiar to all radio technicians.

Basically, this tube is called a dual-control heptode. Its internal structure is designed so that either grid 1 or 3 can control the electron stream. The remaining grids are the suppressor (G5) and the "combined screen grid" (G2/G4). In radio work, the cathode, G1 and G2 are used as an equivalent triode with G2 the oscillator "plate." Because of its physical location (nearest the cathode), G1 will have a greater effect on the electron stream than G3—it takes a much smaller voltage on G1 to cut the electron stream off completely than it would take on G3. Aside from
(Continued on page 90)

with **ASSEMBLY MANUALS**

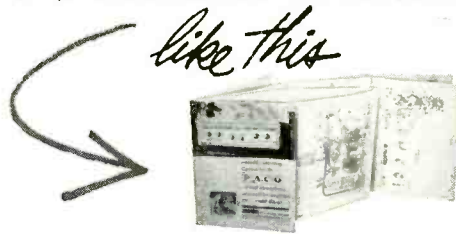

and **ENGINEERING**

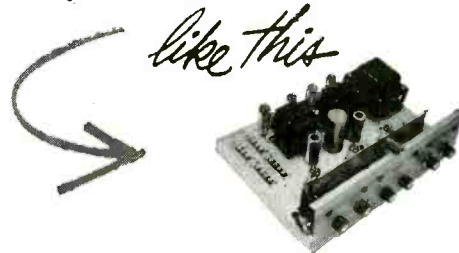

and **STYLING**

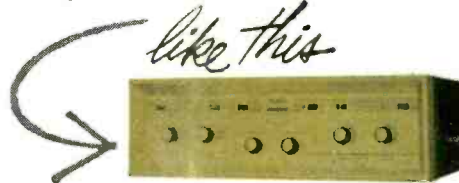

and **SAVINGS**

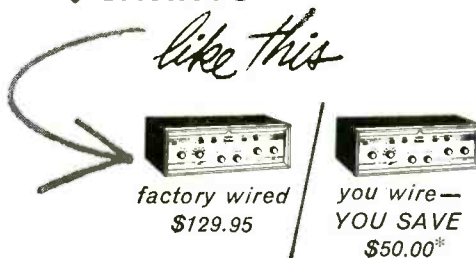

is it any wonder...

THAT **PACO**
HIGH FIDELITY KITS
OUTSELL
FACTORY-WIRED
COMPONENTS

20 to 1!



***MODEL SA-40**
40-watt stereo preamp-amplifier in kit form. Harmonic distortion, less than 0.5% 14 controls. Hum and noise inaudible.
MODEL SA-40—Kit \$ 79.95
MODEL SA-40W—Wired . . . \$129.95

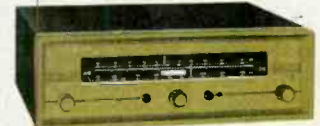

MODEL ST-45
AM-FM SIMULCAST stereo tuner in kit form. Sensitivity—2 μ V for 30 db quieting. MPX facilities.
MODEL ST-45—Kit \$84.95
MODEL ST-45PA—Semi-Kit, with AM and FM tuner sections wired, prealigned and calibrated. . \$99.95
MODEL ST-45W—Wired, aligned, calibrated, ready to operate. \$134.95



MODEL ST-35
FM TUNER KIT. Sensitivity, 2 μ V for 30 db quieting. Easily adapted for MPX and stereo.
MODEL ST-35—Kit \$59.95
MODEL ST-35PA—Semi-Kit, tuner section wired, prealigned. . \$69.95
MODEL ST-35W—Wired, aligned, calibrated, ready to operate. . \$89.95



MODEL L-2
2-WAY, SPEAKER-SYSTEM SEMI-KIT. 10" Jensen woofer and horn-type tweeter. Response, 45 cps to 15 Kc. 23 1/2" W x 13" D x 12" H.
MODEL L-2U—unfinished birch . . . \$59.95
MODEL L-2F—walnut, furniture-finished. \$69.95



MODEL L-1
ULTRA-COMPACT SPEAKER SYSTEM SEMI-KIT. Excellent sound in minimum space. Response, 50 to 14,000 cps. 15 1/2" W x 9 1/4" D x 8 1/2" H.
MODEL L-1U—sanded (unfinished) walnut \$24.95

At leading hi-fi dealers and electronic distributors . . . where you can also see the complete line of PACO test, marine and ham equipment kits.

For complete catalog, write:

PACO
ELECTRONICS CO., INC.

Kit Division of
PRECISION Apparatus Company, Inc.
70-31 84th Street, Glendale 27, L. I., N. Y.
(Subsidiaries of PACOTRONICS, Inc.)

EXAMINE ANY OF THESE TESTERS BEFORE YOU BUY!!

Yes, we offer to ship at our risk one or more of the testers described on these pages.

SUPERIOR'S NEW MODEL 770-A

VOLT-OHM MILLIAMMETER



FEATURES:

- Compact—measures 3 1/8" x 5 7/8" x 2 1/4"
- Uses "Full View" 2 1/2" accurate 850 Microampere D'Arsonval type meter
- Housed in round-cornered, molded case.

SPECIFICATIONS:

- 6 A.C. VOLTAGE RANGES: 0-15/30/150/300/1500/3000 Volts.
- 6 D.C. VOLTAGE RANGES: 0-7.5/15/75/150/750/1500 Volts.
- 2 RESISTANCE RANGES: 0-10,000 Ohms, 0-1 Megohm.
- 3 D.C. CURRENT RANGES: 0-15/150 Ma., 0-1.5 Amps.
- 3 DECIBEL RANGES: -6 db to +18 db, +14 db to +38 db, +34 db to +58 db.

The Model 770-A comes complete with test leads and operating instructions. Price is \$15.85. Terms: \$3.85 after 10 day trial then \$4.00 monthly for 3 months.

SUPERIOR'S NEW MODEL 79

SUPER-METER



WITH NEW 6" FULL VIEW METER

SPECIFICATIONS:

- D.C. VOLTS: 0 to 7.5/15/75/150/750/1,500.
- A.C. VOLTS: 0 to 15/30/150/300/1,500/3,000.
- D.C. CURRENT: 0 to 1.5/15/150 Ma. 0 to 1.5/15 Amperes.
- RESISTANCE: 0 to 1,000/100,000 Ohms. 0 to 10 Megohms.
- CAPACITY: .001 to 1 Mfd. 1 to 50 Mfd.
- REACTANCE: 50 to 2,500 Ohms, 2,500 Ohms to 2.5 Megohms.
- INDUCTANCE: .15 to 7 Henries. 7 to 7,000 Henries.
- DECIBELS: -6 to +18, +14 to +38, +34 to +58.

The following components are all tested for QUALITY at appropriate test potentials. Two separate BAD-GOOD scales on the meter are used for direct readings.

- All Electrolytic Condensers from 1 MFD to 1000 MFD.
- All Selenium Rectifiers. All Germanium Diodes.
- All Silicon Rectifiers. All Silicon Diodes.

Model 79 comes complete with operating instructions, test leads and carrying case. Price is \$38.50. Terms: \$8.50 after 10 day trial then \$6.00 monthly for 5 months.

SUPERIOR'S NEW MODEL 77

VACUUM TUBE VOLTMETER

WITH NEW 6" FULL VIEW METER



Compare it to any peak-to-peak V.T.V.M. made by any other manufacturer at any price!

SPECIFICATIONS:

- DC VOLTS—0 to 3/15/75/150/300/750/1500 volts at 11 megohms input resistance.
- AC VOLTS (RMS)—0 to 3/15/75/150/300/750/1500 volts.
- AC VOLTS (Peak to Peak)—0 to 8/40/200/400/800/2000 volts.
- ELECTRONIC OHMMETER—0 to 1000 ohms/10,000 ohms/100,000 ohms/1 megohm/10 megohms/100 megohms/1,000 megohms.
- DECIBELS—10 db to +18 db, +10 db to +38 db, +30 db to +58 db. All based on 0 db = .006 watts (6 mw) into a 500 ohm line (1.73v).
- ZERO CENTER METER—For discriminator alignment with full scale range of 0 to 1.5/7.5/37.5/75/150/375/750 volts at 11 megohms input resistance.

Model 77 comes complete with operating instructions, probe and test leads and carrying case. Price is \$42.50. Terms: \$12.50 after 10 day trial then \$6.00 monthly for 5 months.

SUPERIOR'S NEW MODEL 80

20,000 OHMS PER VOLT ALLMETER

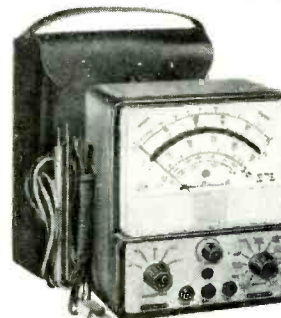

6 INCH FULL-VIEW METER provides large easy-to-read calibrations. No squinting or guessing when you use Model 80.

MIRRORED SCALE permits fine accurate measurements where fractional readings are important.

SPECIFICATIONS:

- 7 D.C. VOLTAGE RANGES: (At a sensitivity of 20,000 Ohms per Volt) 0 to 15/75/150/300/750/1500/7500 Volts.
- 6 A.C. VOLTAGE RANGES: (At a sensitivity of 5,000 Ohms per Volt) 0 to 15/75/150/300/750/1500 Volts.
- 3 RESISTANCE RANGES: 0 to 2,000/200,000 Ohms. 0-20 Megohms.
- 2 CAPACITY RANGES: .00025 Mfd. to 3 Mfd., .05 Mfd. to 30 Mfd.
- 5 D.C. CURRENT RANGES: 0-75 Microamperes, 0 to 7.5/75/750 Milli-amperes, 0 to 15 Amperes.
- 3 DECIBEL RANGES: -6 db to +18 db, +14 db to +38 db, +34 db to +58 db.

NOTE: The line cord is used only for capacity measurements. Resistance ranges operate on self-contained batteries.

Model 80 Allmeter comes complete with operating instructions, test leads and portable carrying case. Price is \$42.50. Terms: \$12.50 after 10 day trial then \$6.00 monthly for 5 months.

SUPERIOR'S NEW MODEL 70 UTILITY TESTER

FOR REPAIRING ALL ELECTRICAL APPLIANCES MOTORS ★ AUTOMOBILES



UTILITY TESTER INCLUDED FREE
64 page condensed course in electricity. Profusely illustrated. Written in simple, easy-to-understand style.

As an electrical trouble shooter the Model 70:

- Will test Toasters, Irons, Broilers, Heating Pads, Clocks, Fans, Vacuum Cleaners, Refrigerators, Lamps, Fluorescents, Switches, Thermostats, etc.
- Measures A.C. and D.C. Voltages, A.C. and D.C. Current, Resistances, Leakage, etc.
- Incorporates a sensitive direct-reading resistance range which will measure all resistances commonly used in electrical appliances, motors, etc.
- Leakage detecting circuit will indicate continuity from zero ohms to 5 megohms (5,000,000 ohms).

As an Automotive Tester the Model 70 will test:

- Both 6 Volt and 12 Volt Storage Batteries • Generators • Starters • Distributors • Ignition Coils • Regulators • Relays • Circuit Breakers • Cigarette Lighters • Stop Lights • Condensers • Directional Signal Systems • All Lamps and Bulbs • Fuses • Heating Systems • Horns • Also will locate poor grounds, breaks in wiring, poor connections, etc.

Model 70 comes complete with 64 page book and test leads. Price is \$15.85. Terms: \$3.85 after 10 day trial then \$4.00 monthly for 3 months.

DID YOU EVER?

- ▶ Order merchandise by mail, including deposit or payment in full, then wait and write...wait and write?
- ▶ Purchase anything on time and sign a lengthy complex contract written in small difficult-to-read type?
- ▶ Purchase an item by mail or in a retail store then experience frustrating delay and red tape when you applied for a refund?

Obviously prompt shipment and attention to orders is an essential requirement in our business... We ship at our risk!

NO

CONTRACT TO SIGN
CO-MAKERS
EMPLOYER
NOTIFICATION

The simple order authorization included in this offer is **all** you sign. We ask only that you promise to pay for or return the goods we ship in good faith.

EXAMINE ANY ITEM YOU SELECT
IN THE PRIVACY OF YOUR OWN HOME

Then if completely satisfied pay on the interest-free terms plainly specified. When we say interest-free we mean not one penny added for "interest" for "finance" for "credit-checking" or for "carrying charges." The net price of each tester is plainly marked in our ads—that is all you pay except for parcel post or other transportation charges we may prepay.

SUPERIOR'S NEW MODEL 82A
MULTI-SOCKET TYPE

TUBE TESTER

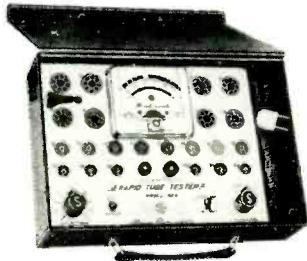

- SPECIFICATIONS:**
- Tests over 1000 tube types.
 - Tests OZ4 and other gas-filled tubes.
 - Employs new 4" meter with sealed air-damping chamber resulting in accurate vibrationless readings.
 - Use of 22 sockets permits testing all popular tube types and prevents possible obsolescence.
 - Dual Scale meter permits testing of low current tubes.
 - 7 and 9 pin straighteners mounted on panel.
 - All sections of multi-element tubes tested simultaneously.
 - Ultra-sensitive leakage test circuit will indicate leakage up to 5 megohms.

Model 82A comes housed in handsome, portable, saddle-stitched Texon case. Price is \$36.50. Terms: \$6.50 after 10 day trial then \$6.00 monthly for 5 months.

SUPERIOR'S NEW MODEL TW-11

STANDARD PROFESSIONAL TUBE TESTER



- Uses the new self-cleaning Lever Action Switches for individual element testing. Because all elements are numbered according to pin-number in the RMA base numbering system, the user can instantly identify which element is under test.
- Free-moving built-in roll chart provides complete data for all tubes. All tube listings printed in large-easy-to-read type.
- **NOISE TEST:** Noise-jack on front panel for plugging in either phones or external amplifier will detect microphonic tubes or noise due to faulty elements and loose internal connections.
- **SEPARATE SCALE FOR LOW-CURRENT TUBES:** Previously, on emission type tube testers, it has been standard practice to use one scale for all tubes. As a result, the calibration for low-current types has been restricted to a small portion of the scale. The extra scale used here greatly simplifies testing of low-current types.

The Model TW-11 comes housed in a handsome, portable, saddle-stitched Texon case. Price is \$47.50. Terms: \$11.50 after 10 day trial then \$6.00 monthly for 6 months.

SUPERIOR'S NEW MODEL 83A

C.R.T. TESTER

Tests and Rejuvenates
ALL PICTURE TUBES



ALL BLACK AND WHITE TUBES
From 50 degree to 110 degree types—from 8" to 30" types.

ALL COLOR TUBES
Test ALL picture tubes—in the carton—out of the carton—in the set!

Model 83A provides separate filament operating voltages for the older 6.3 types and the newer 8.4 types.

Model 83A properly tests the red, green and blue sections of color tubes individually—for each section of a color tube contains its own filament, plate, grid and cathode.

Model 83A will detect tubes which are apparently good but require rejuvenation. Such tubes will provide a picture seemingly good but lacking in proper definition, contrast and focus.

Rejuvenation of picture tubes is not simply a matter of applying a high voltage to the filament. Such voltages improperly applied can strip the cathode of the oxide coating essential for proper emission. The Model 83A applies a selective low voltage uniformly to assure increased life with no danger of cathode damage.

Model 83-A comes housed in handsome portable Saddle-stitched Texon case—complete with socket for all black and white tubes and all color tubes. Price is \$38.50. Terms: \$8.50 after 10 day trial then \$6.00 monthly for 5 months.

SUPERIOR'S NEW MODEL 85

TRANS-CONDUCTANCE TYPE TUBE TESTER

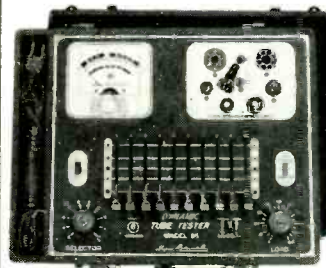

- Employs latest improved **TRANS-CONDUCTANCE** circuit. Test tubes under "dynamic" (simulated) operating conditions. An in-phase signal is impressed on the input section of a tube and the resultant plate current change is measured as a function of tube quality. This provides the most suitable method of simulating the manner in which tubes actually operate in radio, TV receivers, amplifiers and other circuits.
- **AMPLIFICATION FACTOR:** plate resistance and cathode emission are all correlated in one meter reading.
- **SYMBOL REFERENCES:** Model 85 employs time-saving symbols (°, +, ●, ▲, ■) in place of difficult-to-remember letters previously used. Repeated time-studies proved to us that use of these scientifically selected symbols speeded up the element switching step. As the tube manufacturers increase the release of new tube types, this time-saving feature becomes necessary and advantageous.

• **"FREE-POINT" LEVER TYPE ELEMENT SWITCH ASSEMBLY** marked according to RETMA basing, permits application of test voltages to any of the elements of a tube.

• **FREE FIVE (5) YEAR CHART DATA SERVICE.** Revised up-to-date subsequent charts will be mailed to all Model 85 purchasers at no charge for a period of five years after date of purchase.

Model 85 comes complete, housed in a handsome portable cabinet with slip-on cover. Price is \$52.50. Terms: \$12.50 after 10 day trial then \$8.00 monthly for 5 months.

SUPERIOR'S NEW MODEL TV-50A

GENOMETER

7 Signal Generators in One!



- ✓ R.F. Signal Generator for A.M.
- ✓ R.F. Signal Generator for F.M.
- ✓ Audio Frequency Generator
- ✓ Bar Generator
- ✓ Cross Hatch Generator
- ✓ Color Dot Pattern Generator
- ✓ Marker Generator

A versatile all-inclusive GENERATOR which provides ALL the outputs for servicing.

A.M. Radio • F.M. Radio • Amplifiers • Black and White TV • Color TV

The Model TV-50A comes absolutely complete with shielded leads and operating instructions. Price is \$47.50. Terms: \$11.50 after 10 day trial then \$6.00 monthly for 6 months.

SUPERIOR'S NEW MODEL 88

TESTS ALL TRANSISTORS AND TRANSISTOR RADIOS



AS A TRANSISTOR RADIO TESTER

An R.F. Signal source, modulated by an audio tone is injected into the transistor receiver from the antenna through the R.F. stage, past the mixer into the I.F. Amplifier and detector stages and on to the audio amplifier. This injected signal is then followed and traced through the receiver by means of a built-in High Gain Transistorized Signal Tracer until the cause of trouble is located and pinpointed.

AS A TRANSISTOR TESTER

The Model 88 will test all transistors including NPN and PNP, silicon, germanium and the new gallium arsenide types, without referring to characteristic data sheets. The time-saving advantage of this technique is self-evident. A further benefit of this service is that it will enable you to test new transistors as they are released!

Model 88 comes housed in a handsome portable case. Complete with a set of Clip-on Cables for Transistor Testing; an R.F. Diode Probe for R.F. & I.F. Tracing; an Audio Probe for Amplifier Tracing and a Signal Injector Cable. Complete—nothing else to buy! Price is \$38.50. Terms: \$8.50 after 10 day trial then \$6.00 monthly for 5 months.

Try any of the instruments on this or the facing page for 10 days before you buy. If completely satisfied then send down payment and pay balance as indicated on coupon. No interest or finance charges added! If not completely satisfied return unit to us, no explanation necessary.

MOSS ELECTRONIC, INC., Dept. D-856, 3849 Tenth Ave., New York 34, N. Y.

Please send me the units checked on approval. If completely satisfied I will pay on the terms specified with no interest or finance charges added. Otherwise, I will return after a 10 day trial positively cancelling all further obligations.

- | | |
|---|--|
| <input type="checkbox"/> Model 770-A Total Price \$15.85
\$3.85 within 10 days. Balance \$1.00 monthly for 3 months. | <input type="checkbox"/> Model TW-11 Total Price \$47.50
\$11.50 within 10 days. Balance \$6.00 monthly for 6 months. |
| <input type="checkbox"/> Model 79 Total Price \$38.50
\$8.50 within 10 days. Balance \$6.00 monthly for 5 months. | <input type="checkbox"/> Model 83-A Total Price \$38.50
\$8.50 within 10 days. Balance \$6.00 monthly for 5 months. |
| <input type="checkbox"/> Model 77 Total Price \$42.50
\$12.50 within 10 days. Balance \$6.00 monthly for 5 months. | <input type="checkbox"/> Model 70 Total Price \$15.85
\$3.85 within 10 days. Balance \$4.00 monthly for 3 months. |
| <input type="checkbox"/> Model 80 Total Price \$42.50
\$12.50 within 10 days. Balance \$6.00 monthly for 5 months. | <input type="checkbox"/> Model 82-A Total Price \$36.50
\$6.50 within 10 days. Balance \$6.00 monthly for 5 months. |

- | | |
|---|---|
| <input type="checkbox"/> Model 85 Total Price \$52.50
\$12.50 within 10 days. Balance \$8.00 monthly for 5 months. | <input type="checkbox"/> Model TV-50A Total Price \$47.50
\$11.50 within 10 days. Balance \$6.00 monthly for 6 months. |
| <input type="checkbox"/> Model 88 Total Price \$38.50
\$8.50 within 10 days. Balance \$6.00 monthly for 5 months. | |

Name _____
Address _____
City _____ Zone _____ State _____
All prices net. F.O.B. N.Y.C.
Export Division: **Rocke International Corp.**
83 East 40th St., New York 16, N.Y.

ACRO SOUNDINGS

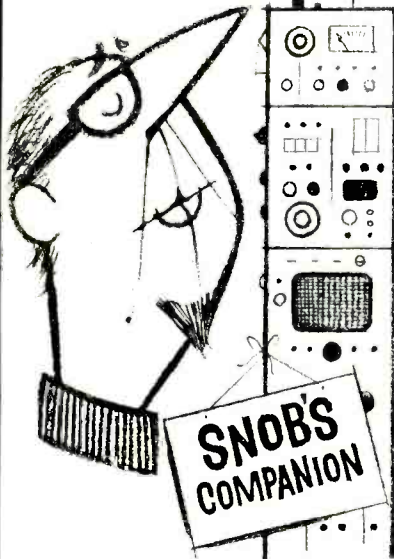

WHAT'S NEXT FROM ACRO?

At last Fall's New York Audio Show, we just happened to eavesdrop on a couple of amplifier manufacturers drinking their lunch and discussing plans for future preamplifier designs. One, who was feeling the effects of his third martini, was bemoaning the lack of new directions in amplifier design and was complaining that, since his preamplifier was already the best in the world, the only way he could go from there was downward in quality and price or off the beaten track into the uncharted wilds of transistorization. The other, who was less inebriated and less pessimistic but no less convinced that his preamp was the world's best, said he was going to put a gaudier-looking front panel on it, change the control knobs, give it a classy-sounding name like "The Snob's Companion," and jack up the price by \$100.

We're glad these individuals weren't reflecting the views of the hi-fi industry in general, because if we thought they were, we'd be looking for another field of endeavour before the whole hi-fi business died of stagnation, reverberation or no reverberation. All of which is another way of saying that we at Acro Products are not convinced that preamplifiers can't be improved. As a matter of fact, we are currently engaged in proving that they can be, and already have a laboratory prototype of what we envision as tomorrow's stereo preamplifier.

It won't have more knobs than ever before, and neither will it have a 14-karat gold front panel or a gadget enabling the creative listener to add distortion to suit his taste. The design will be straightforward and noncritical, control functions will be simplified without sacrificing versatility, and all component parts will be chosen for their durability. As for its performance, this is something we won't commit ourselves to as yet. All we're willing to say at this point is that the best available preamplifiers are not quite as perfect as we had suspected they were.

ACRO PRODUCTS CO.

410 Shurs Lane, Phila. 28, Pa.

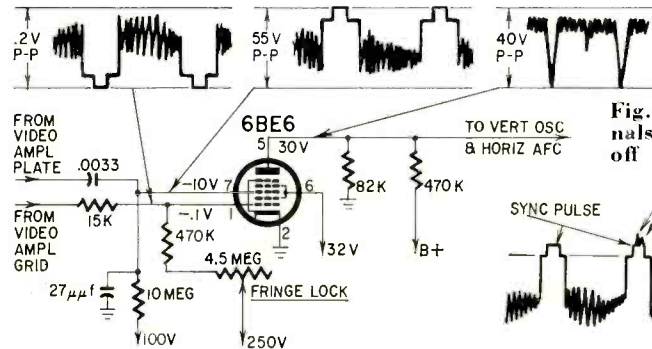

Fig. 6—Negative-going signals on grid 1 of 6BE6 cut off tube on noise pulses.

(Continued from page 87)

this, the tube works exactly like any other pentode amplifier.

In Fig. 6, signals from the video amplifier are applied to both control grids. The signal on G1 comes from the grid circuit of the video amplifier, that on G3 from its plate circuit. The signals are thus always 180° out of phase because of the phase reversal caused by the signal passing through the video amplifier.

Signal amplitudes are shown on the diagram. Note that the signal on G1 is much lower than on G3. In this circuit, G3 acts as the main control grid, so to speak, and G1 gets a rest, functioning only now and then. You might think of G1 as a sort of "spare tire." Most of the time you don't need it, but when you do need it, you need it bad! For the present, let's forget G1 entirely.

We want sync-clipping action first, so we use a tube with a sharp cutoff characteristic for the cleanest sync separation. (Later circuits used a tube especially built for this service, the 6CS6 and others which have very sharp cutoff characteristics.) By selecting proper grid resistors and capacitors, we can get the correct bias by the grid-leak effect mentioned before. The video signal charges the grid capacitor to the proper value and the tube remains cut off until the sync tips rise above this voltage. The tube then conducts, passing only the sync pulses. The video signals here are positive-going (the most positive portion of the waveform).

If a high-value grid-leak resistor is used on G3, the grid draws current when the signal arrives. This current flows through the grid resistor, causing the grid to become more negative. This sets the cutoff point and we have what we wanted, sync separation. In some circuits, you'll find G3 returned through the grid resistor to a source of positive voltage. This improves the sync-clipping action and causes the tube to clip off a small part of the tops of the sync pulses, too. This removes small irregularities and noises which might have arrived with the signal.

Noise rejection

So far, we've been talking about the sync-separating action of this tube and neglecting G1 entirely. Let's wake it up and put it to work. This grid has a small, reversed-polarity video signal on it. If the incoming signal is strong and clean, G1 has nothing to do. Its normal bias is so adjusted that the incoming

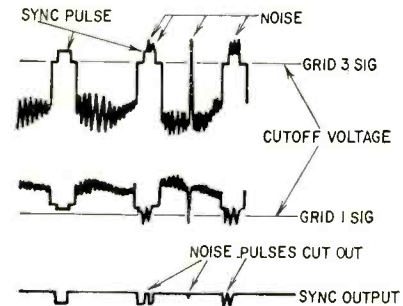

Fig. 7—Signals on grids 1 and 3 of 6BE6, and resulting output signal.

sync tips are just above cutoff and it has no effect on the signals passing through the tube. If the signals are weak and noisy, the grid-leak action on G3 will cause its operating point to shift, allowing strong noise pulses and weak sync pulses to pass through. This makes oscillator action erratic.

Normally, G1's bias is set so that incoming signals just do not cut off the tube. Now, if a strong noise pulse comes through, it causes G1 to cut the tube off, stopping the electron stream entirely for a small fraction of a second (Fig. 7). The grid circuit has a very fast time constant so that it can cut the tube off then "let go" very rapidly. This has the effect of simply chopping the offending noise pulse cleanly out of the circuit. It is not allowed to pass through at all, but instead leaves a small "hole" in the signal, sync or both. Because of the very short duration of most noise pulses—and because of the inherent flywheel action of both oscillators—this hole punching has no visible effect on the picture. The oscillators are stable enough to miss a sync pulse or two.

One thing to check when working around this type of circuit is the adjustment of the noise-gate control. It may be found masquerading under any one of several names on the back of the set. You can always identify it by the fact that it is connected so as to vary G1's bias. Remember, normal action of this grid is *nothing at all!* It should just sit there and have no effect on the signal—unless a strong noise pulse comes through. Misadjustment of the control can have very bad effects. If it is set up too high, G1 will quietly proceed to keep the tube cut off all the time! This has the highly undesirable effect of removing *all* sync! Correct adjustment procedure is: Turn the control up until you can see the sync beginning to get weak—the picture will become very shaky and unstable. Now, turn the control in the opposite direction until the picture becomes stable, then turn it slightly past that point.

The second part of this series will cover BU8's (6BU8, 3BU8, etc.) and sync circuits. TO BE CONTINUED

RCA training at home can be the smartest investment you ever made

Look what you get in the Course in Radio and Electronic Fundamentals

40 Fascinating THEORY LESSONS

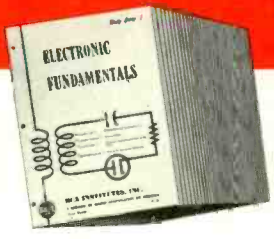

Containing all the basic principles of radio and electronics in easy-to-understand form.

40 EXPERIMENT LESSONS

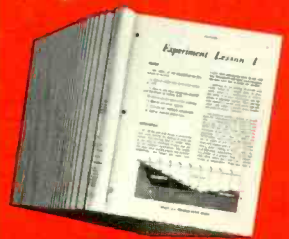

Each containing absorbing, practical experiments bound together in 20 books.

40 SERVICE PRACTICES



Full of practical, time-saving and money-saving servicing tips, bound into 20 books.

PLUS ALL THIS AT NO EXTRA COST...

15 KITS

to build a Multimeter, AM Receiver and Signal Generator. Kits contain new parts for experiments, integrated so as to demonstrate what you learn in the lessons and to help you develop technical skills. Each kit is fun to put together!



MULTIMETER

A sensitive precision measuring instrument you *build* and use on the job. Big 4½" meter with 50 microamp meter movement. 20,000 ohms-per-volt sensitivity d-c, 6,667 a-c.



SIGNAL GENERATOR

A "must" for aligning and trouble-shooting receivers. Build it for your own use. 170 KC to 50 MC fundamental frequencies for all radio and TV work.



AM RECEIVER

Have the satisfaction of building your own radio receiver with this high-quality 6-tube superheterodyne set. Big 5" speaker, fine tone!

Practical work with the very first lesson! Pay-only-as-you-learn! No long-term contracts to sign! No monthly installment payments. Pay only for one study group at a time if and when you order it!

Stake out your future in electronics now!
SEND FOR OUR FREE HOME STUDY CATALOG TODAY!

Just fill out this card and drop it in the mail—no postage needed. →

RCA INSTITUTES, INC.
A Service of Radio Corporation of America
350 West Fourth Street
New York 14, N. Y.



RCA INSTITUTES INC. Home Study School, Dept. ZRE-21

A Service of Radio Corporation of America
350 West Fourth Street, New York 14, N. Y.

Without obligation, rush me the FREE 64-page illustrated book describing your electronic training program (check one). No salesman will call.

Home Study Los Angeles Resident School New York Resident School

Name (Please Print)

Address

City Zone State.....

Veterans: Enter discharge date.....

CANADIANS—Take advantage of these same RCA courses at no additional cost. No postage, no customs, no delay. Enclose this card in envelope and mail to: RCA Victor Company, Ltd., 5581 Royalmount Ave., Montreal 9, Quebec.



The Most Trusted Name in Electronics

HOME STUDY SCHOOL



RCA TRAINING CAN BE THE SMARTEST INVESTMENT YOU EVER MAKE

With RCA Institutes Home Study training you set your own pace in keeping with your own ability, finances and time. You get prime quality equipment as a regular part of the course . . . and you never have to take apart one piece to build another. Perhaps most important, RCA's liberal Pay-As-You-Learn Plan is the most economical home study method *because you pay only for lessons as you order them* . . . one study group at a time! If you drop out at *any* time, for *any* reason, you do not owe RCA one penny! No other obligations! No installment payments required! Licensed by New York State Education Department.

Choose **YOUR FUTURE** from this list of courses:

- Radio and Electronic Fundamentals (see reverse side)
- Television Servicing
- Color Television
- Electronics for Automation
- Transistors

RESIDENT SCHOOLS

START YOUR CAREER IN ELECTRONICS NOW AT RCA INSTITUTES in Los Angeles-New York City

CHOOSE FROM THIS LIST...

	Course	Qualifications	Length of Course
A	Advanced Electronic Technology (T-3)	High School grad, with Algebra, Physics or Science	Day 2¼ yrs. Eve. 6¾ yrs.
B	TV and General Electronics (V-7)	2 yrs. High School, with Algebra, Physics or Science	Day 1½ yrs. Eve. 4½ yrs.
C	Radio & TV Servicing (V-3)	2 yrs. High School, with Algebra, Physics or Science	Day 9 mos. Eve. 2¼ yrs.
D	Transistors	V-3 or equivalent	Eve. 3 mos.
E	Electronic Drafting (V-9)	2 yrs. High School, with Algebra, Physics or Science	Eve. Basic: 1 yr. Advanced: 2 yrs.
F	Color TV	V-3 or equivalent	Day 3 mos. Eve. 3 mos.
G	Audio-Hi Fidelity	V-3 or equivalent	Eve. 3 mos.
H	Video Tape	V-3 or equivalent	Eve. 3 mos.
I	Technical Writing (V-10)	V-3 or equivalent	Eve. 3-18 mos.
J	Computer Programming	High School grad	Day 6 weeks Eve. 24 weeks Sat. 30 weeks
K	Radio Code (V-4)	8th Grade	Eve. as desired
L	Preparatory Math & Physics (P-0)	1 yr. High School	Day 3 mos.
M	Preparatory Mathematics (P-0A)	1 yr. High School	Eve. 3 mos.

FIRST CLASS
PERMIT NO.
10662
NEW YORK, N. Y.

BUSINESS REPLY MAIL

No Postage Stamp Necessary if mailed in U. S.

Postage will be paid by —

RCA INSTITUTES, INC., Dept. ZRE-21
350 West Fourth Street
New York 14, N. Y.

RCA Institutes is one of the largest technical institutes in the United States devoted exclusively to electronics. Co-educational Day and Evening classes. Free Placement Service. Applications now being accepted.

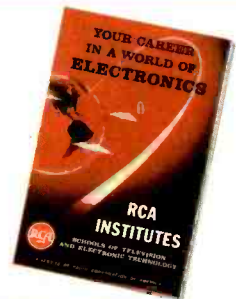

SEND FOR THIS FREE ILLUSTRATED BOOK TODAY. Fill in the other side of the postage-free card and check Resident School.

RCA INSTITUTES, INC. A Service of Radio Corporation of America
350 W. 4th St., N.Y. 14, N.Y. • 610 S. Main St., Los Angeles 14, Calif.



The Most Trusted Name in Electronics

TEST SPEAKER SPEEDS INDUSTRIAL REPAIRS

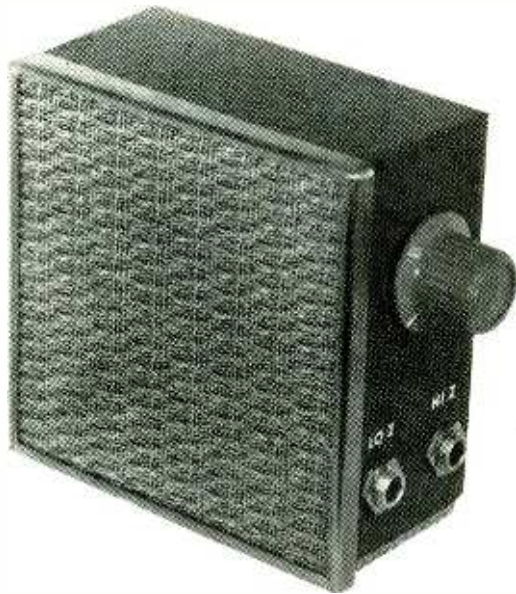

Minimum parts and maximum utility makes this simple unit worth its weight in tunnel diodes

By WILLIAM F. KERNIN

SPEAKER substitution boxes are nothing new—they are probably as old as radio servicing itself. However, here is an up-to-date version of this handy device. It was designed mainly for servicing commercial and industrial intercom and sound systems where compact test gear is essential. As such, it is a versatile instrument that is just as much at home on the service bench aiding in the repair of radio, TV and hi-fi sets as it is in the field.

Fig. 1 shows the circuit. An efficient 2 3/4-inch speaker plus an universal line-to-voice-coil transformer form the heart of the unit. Potentiometer R provides full control of volume. A standard 50-ohm pot—readily available—was used. However, an 8- or 16-ohm T-pad control may be used, if desired.

Note the two input jacks—J1 for HI Z, J2 for LO Z. J1 feeds the transformer's primary. There is a choice of taps to provide the desired input impedance—500, 1,000, 1,500 or 2,000 ohms. The transformer's 8-ohm secondary feeds VOLUME control R through the normally

- R—pot, 50 ohms
- J1—phone jack, 2-conductor, open circuit
- J2—phone jack, 2-conductor, closed circuit
- T—universal line-to-voice-coil transformer (Stancor A-7947 or equivalent)
- Speaker, 2 3/4 inches, 3.2 or 8 ohms
- Cabinet 4 x 4 x 2 inches, black crackle (Bud CU-883 or equivalent)
- Grille cloth
- L-bracket
- Miscellaneous hardware

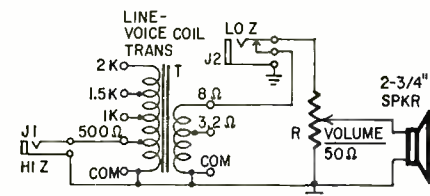

Fig. 1—Circuit of the simple test speaker box.

closed jack J2. This jack is the low-impedance input and connects direct to the VOLUME control. When J2 is in use, the transformer secondary is disconnected from the volume control.

A 4 x 4 x 2-inch black crackle-finish utility box houses the unit. Cement a sheet of speaker grille cloth to the front panel and use a metal L-frame to cover the rough edges (see photo). For lettering, use decals, protected with a couple of coats of clear Krylon spray.

The HI Z input is used to check 275- or 500-ohm speaker distribution lines. Armed with the test speaker, it is a relatively easy matter to localize the trouble in such feed lines by checking for a signal at each junction box or speaker station.

For example, suppose—using the HI Z input—you trace the program or signal to the input of a certain speaker station (Fig. 2). Then, use the LO Z input to check for the signal at the output of the matching transformer at this station. If it isn't there, the fault is in the transformer. If it is there, skip to the speaker terminals. No signal here points to faulty wiring between transformer and speaker. If the signal appears at the speaker terminals, you have a bad speaker on your hands.

This is a simple case. Some speaker stations use switch, volume control and a step attenuator between matching transformer and speaker. Nevertheless,

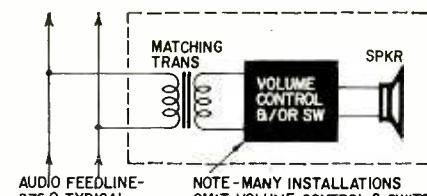
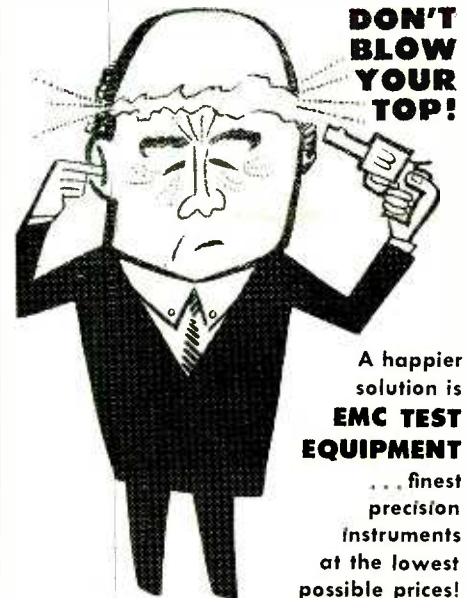

Fig. 2—Typical speaker station than can be checked with the test unit.



A happier solution is **EMC TEST EQUIPMENT** . . . finest precision instruments at the lowest possible prices!

Model 102 Volometer
Features a 3 1/2" 2% accurate—800 microampers D'Arsonval-type plastic front meter with 3 AC current ranges; and the same zero adjustment for both resistance ranges. Specifications . . . AC Voltage—5 Ranges: 0 to 12-120-600-1200-3000 volts. DC Voltage—5 Ranges: 0 to 6-60-300-600-3000 volts. AC Current—3 Ranges: 0 to 30-150-600 ma. DC Current—4 Ranges: 0 to 6-30-130 ma. 0 to 1.2 amps. Two Resistance Ranges: 0 to 1000 ohms, 0 to 1 megohms. Model 102, Wt. 1 lb. 5 oz. Size: 3 3/4" x 6 1/4" x 2". \$14.95; Kit, \$12.50

Model 204 Tune-Battery-Ohm Capacity Tester
Emission tube tester Completely flexible switching arrangement. Checks batteries, under rated load on "reject-good" scale Checks condenser leakage to 1 meg. Checks resistance up to 4 megs. Checks capacity from .01 to 1 mfd. Model 204P, illustrated, \$55.90. Model CRA, Cathode ray tube adaptor, \$4.50.

Model 700 RF-AF Crystal Marker TV Bar-Generator
Complete coverage from 18 cycles to 103 megacycles on fundamentals. Bar generator for TV adjustment with a variable number of bars available for horizontal or vertical alignment. Square wave generator to 20 kilocycles. Wien Bridge AF oscillator with sine wave output from 18 cycles to 300 kilocycles. Crystal marker and amplitude control. Individually tuned coils. Constant RF output impedance. Stepped RF attenuator. Variable percentage of modulation. Model 700 . . . \$55.90

Model 205 Tube Tester
Uses standard emission test. Tests all tubes including Noval and sub-miniatures. Completely flexible switching arrangement. Checks for shorts, leakages and opens. Model 205P, Hand-rubbed oak carrying case, \$47.50 (illustrated), Kit, \$36.20. Model CRA, Cathode ray tube adaptor, \$4.50.

Model 104 Volometer
Features a 4 1/2" .50 microampere meter, with 3 AC current ranges and 3 resistance ranges to 20 megohms. Specifications . . . DC Voltage: 5 ranges (20,000 ohms per volt). 0 to 6-60-300-600-3000 volts. AC Voltage: 5 ranges (1,000 ohms per volt). 0 to 6-60-300-600-3000 volts. DC Current—3 Ranges: 0 to 6-60-600 ma. AC Current—3 Ranges: 0 to 30-300 ma. 0 to 3 amps. 3 Resistance Ranges: 0 to 20K. 0 to 200K. 0 to 20 megs. 5 DB Ranges: —4 to —67 DB. Model 104, with carrying strap. Wt. 2 lbs. 5 oz. Size: 5 1/4" x 6 3/4" x 2 1/4". \$26.95; Kit, \$19.95. Model MVT, 30,000 volt probe for Model 104, \$7.95.

Yes, tell me more, send me **FREE**—a detailed catalog of the complete EMC line. **RE-261**

NAME _____

STREET _____

CITY _____ STATE _____

EMC Electronic Measurements Corp.
625 B'way, New York 12, N. Y.
Ex. Dept., Pan-Mar Corp., 1270 B'way, N. Y. 1, N. Y.

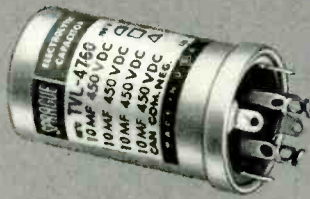

TVL TWIST-LOK® CAPACITORS

These 'lytics take on the toughest TV and radio duty, give maximum trouble-free service, *without HUMMM!* They are dependable at extremely high and low temperatures. Cathodes are etched to meet the needs of high ripple currents, high surge voltages.



TVA ATOM® CAPACITORS

Atom tubulars are service favorites because they fit anywhere, work anywhere. They're the *only* small size 85 C (185 F) capacitors in ratings up to 450 WVDC. They have low leakage current, long shelf life, and withstand high ripple currents, high surge voltages.



TE LITTL-LYTIC® CAPACITORS

The very best ultra-miniature replacements for transistor circuits, offering unusual reliability through all-welded construction. No pressure joints to cause "open" or intermittent circuits. Long shelf life—extremely important in sets used only part of the year.

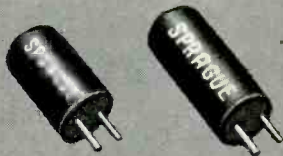

VL VERTI-LYTIC* CAPACITORS

These single-ended molded tubulars are the ideal replacement for units of this type found on printed wiring boards. Keyed terminals assure fast manual mounting and correct polarity. Resin end fill protects against drying of electrolyte or entrance of external moisture.

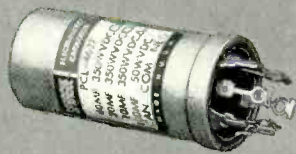

PCL PRINT-LOK® CAPACITORS

The printed circuit version of the Twist-Lok. Universal base replaces any of the printed circuit 'lytics in use today. No makeshift mounting adapters to damage capacitor or add extra height... no possibility of high resistance contacts.

EVERY 'LYTIC YOU NEED...

- every value
- every rating
- every style

Shown here are the more popular of Sprague's big family of Electrolytic Capacitors, the broadest in the industry. Other types include Metal-encased Screwbase; Plastic-encased High-MF; Metal-encased Octal-base; Ultra-low leakage Photoflash. All are listed and described in Sprague's NEW Catalog C-613A. Get your copy from any Sprague distributor, or write Sprague Products Company, 81 Marshall Street, North Adams, Massachusetts.

*TRADEMARK

SPRAGUE®
THE MARK OF RELIABILITY

WORLD'S LARGEST CAPACITOR MANUFACTURER

THE A.E.S. *Gigolo*

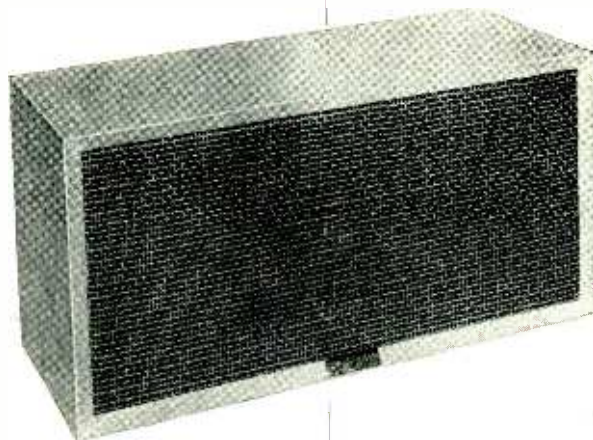

A MIRACLE IN SOUND

After two years of research and development a speaker system we can unconditionally guarantee to be the finest bookshelf unit you have ever heard, REGARDLESS OF PRICE, or your money back.

Over 2500 test systems are now in use in private homes in the Ohio and Michigan area. The acceptance has been unbelievable. Never before a sound so realistic to so many people in so many different homes! These are the facts that enable A.E.S. to make this bold offer.

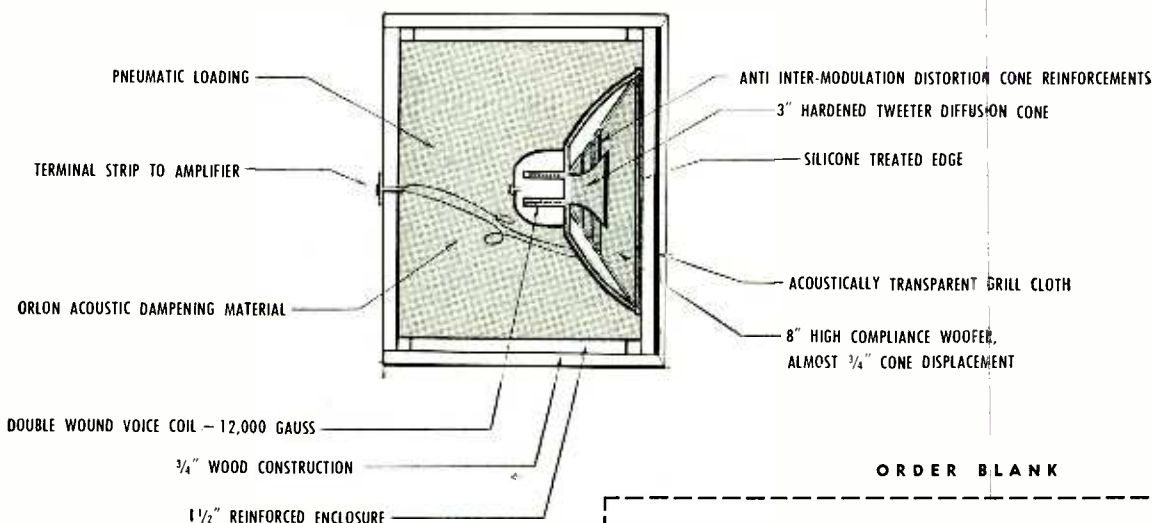

SIZE: 24" wide, 12" high, 9 1/2" deep.

Response: 19-21,000 CPS

This unit will operate at maximum efficiency with amplifiers from 8 to 75 watts.

In limited quantity, and for a limited time only, \$15.00 complete, plus shipping.

ORDER BLANK

A.E.S., Inc.
3338 Payne Avenue, Cleveland, Ohio
Gentlemen please ship GIGOLOs.

I understand these units are guaranteed and if I am not satisfied I may return for a full refund of sales price, \$15.00 each.

Name _____

Address _____

City and State _____

Enclosed find check _____ money order _____

CUSTOMER SERVICE ENGINEERS



OUTSTANDING CAREER OPPORTUNITIES

Continued expansion of the PHILCO COMPUTER DIVISION has created a number of positions for persons with a minimum of 2 years of data processing equipment maintenance and/or installation experience.

Successful candidates will undergo advanced computer training in the PHILCO 2000 System at our Willow Grove, Pa. plant.

ASSIGNMENTS AVAILABLE IN MAJOR CITIES THROUGHOUT U.S.A.

Contact

Mr. John Felos

Professional Employment Manager

**COMPUTER DIVISION
WILLOW GROVE, PA.**

PHILCO
Famous for Quality the World Over

NEW TUBES and SEMI-CONDUCTORS

INDUSTRIAL types predominate this month, but a new entertainment type power transistor that will sell for less than \$2 balances the scales.

Entertainment types

The leading items this month are a PADT unit that could be used in FM tuners, a new power transistor and five new receiving-tube replacements.

2N1517

A p-n-p post alloy-diffusion transistor (PADT) designed for use as an if, rf or video amplifier and for oscillator-converter applications in the medium

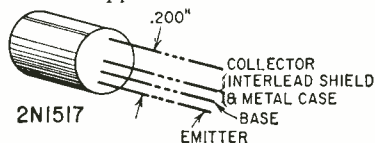

and very high frequency ranges. Available power gain at 100 mc is 10 db minimum.

Maximum ratings of the Amperex 2N1517 are:

V_{CE}	20
I_C (ma)	10
I_E (ma)	10
I_E (reverse) (ma)	1
P_C (mw at 25°C)	83

Low-cost power transistor

A new power transistor from RCA foreshadows the production of all-transistor high-fidelity sound equipment on an economically practical basis. The new transistor, now being sampled to the home entertainment industry, is expected to sell for less than \$2 when it



becomes commercially available early this year.

The device is described as a developmental drift-field power type which incorporates special processing techniques and can deliver high audio power for monaural and stereo sound equipment

when operated either from a car battery or standard house current.

Technically, the transistor is a p-n-p germanium unit and can be used in both class-A and class-B audio amplifiers. It has an alloyed emitter, diffused collector and graded base.

Late Releases

No specs available at this time but Raytheon has announced the addition of five new entertainment type tubes to its replacement-tube line.

Two audio tubes are on the list: a 7-pin 7543 designed as a low-hum non-microphonic replacement for the 6AU6, and the 9-pin 14GT8, a duplex diode—hi-mu triode for use as an FM detector and af voltage amplifier.

The one video tube on the list, the 9-pin 6GN8, is a miniature triode-pentode with the triode section designed for use as a voltage amplifier or sync separator and the pentode section for video amplifier service.

The last two tubes are the octal-based 10EG7, a twin triode with dissimilar sections (one designed as an oscillator, the other as an amplifier for a TV receiver's vertical deflection section), and the 7-pin 2ER5, a miniature, remote-cutoff frame-grid tetrode for vhf television tuners.

Industrial types

Some tiny transistors with the same specs as their big-brother equivalents get us off to a running start. Then come two tiny units that could be lost in a thimble—almost.

Subminiature transistors

A group of subminiature germanium transistors, 21 times smaller than presently available units with the same



characteristics, has been introduced by Raytheon. Electrical equivalents of the 2N404, 2N428, 2N416, 2N417, 2N388 and 2N440, the new subminiatures are 2N799, 2N805, 2N811, 2N813, 2N815 and 2N821, respectively. In the photo, a standard and its equivalent subminiature unit are held side by side.

TI 450, TI 451

Two silicon n-p-n double diffused mesa transistors. These subminiature

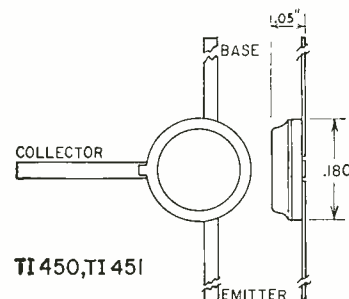

units, intended for switching circuits, are only 0.18 inch in diameter and .05 inch high. Yet, despite their tiny size, they can dissipate as much as 450 mw at 25°C.

Absolute maximum ratings of these two Texas Instruments transistors are:

V_{CB}	25
V_{EB}	5
V_{CE}	20

Electrical characteristics are:

I_{CBO} (reverse collector current) (μa)	0.5
($V_{CB}=15, I_E=0$)	
C_{ob} (common-base output capacitance) ($\mu\mu f$)	5
h_{FE} (dc forward-current transfer ratio)	
($V_{CE}=1, I_C=10$ ma) (TI 450)	60
(TI 451)	120

2N501

A p-n-p germanium micro-alloy diffused-base transistor (MADT) designed for high-speed switching. It makes pos-

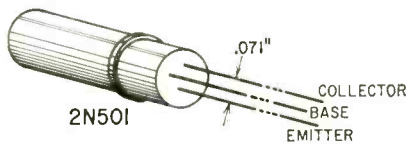

sible simple saturated switching circuits. In binary counters, the CBS 2N501 achieves input counting rates up to 70 mc. It is also useful for low-voltage, tuned high-frequency and wide-band video amplifiers.

Maximum ratings at 25°C are:

V_{CB}	15
V_{CE}	12
V_{EB}	2
I_C (ma)	50
P_{total} (mw)	25

Maximum switching characteristics are:

t_r (rise time) (μmsec)	18
t_s (storage time) (μmsec)	12
t_f (fall time) (μmsec)	10

Particle detectors

Solid-state particle detectors for detecting X-rays, gamma rays and other

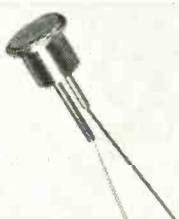

types of radiation have been developed by Semi-Elements Inc. Tests of prototype units show that the sensitivity of these X-ray detectors can be compared directly with the sensitivity of crystal photomultiplier X-ray detector combinations currently in use. END

CORRECTION

In the editorial in the January issue, it was stated that the program "Sea Hunt" was a CBS Network program.

The program was a recorded Ziv-United Artists production shown on WCBS-TV in New York City and independently on a number of other stations throughout the US. The Columbia Broadcasting System network is not involved with it in any way. The error is regretted.

FREE

GIANT 1961 204 PAGE CATALOG

SAVE UP TO 50% ON B-A SELECTED KITS

TOP VALUES IN POWER AND HAND TOOLS

HI-FI AND STEREO SYSTEMS & COMPONENTS

30 PAGES OF BARGAINS NOT IN ANY OTHER CATALOG

100'S OF NEW ITEMS LISTED HERE FOR 1st TIME

BURSTEIN-APPLEBEE 112-14 MCGEE ST., KANSAS CITY 6, MO.

BURSTEIN-APPLEBEE CO. Dept. RE
1012-14 McGee St., Kansas City 6, Mo.

Send Free 1961 B-A Catalog No. 611

NAME _____

ADDRESS _____

CITY _____ STATE _____

RUSH COUPON TODAY!

New Magnifying Lamp for Precision Work!

Swing-O-Lite INSPECTOR

the best lamp you can use for miniature assembly work, bench work, blueprints and schematics, etc.

DEALER & DISTRIBUTOR INQUIRIES INVITED
REPS WANTED—CHOICE TERRITORIES OPEN

Write for FREE CATALOG of complete line. Dept. RE-261

NAME _____

STREET _____

CITY _____ STATE _____

Swing-O-Lite INC.

13 MOONACHIE ROAD, HACKENSACK, N. J.

\$36⁰⁰

LIST LESS BULB

MODEL M1
(45" arm reach)

- 5" diameter precision polished magnifying glass
- 22 watt shadow-free fluorescent light
- Complete arm mobility for exact spot location
- Exclusive convenience electric outlet in base (optional extra)
- Choice of colors and mounts

OTHER MODELS AVAILABLE

BECOME A RADIO TECHNICIAN
for only \$26.95

BUILD 20 RADIO

CIRCUITS AT HOME

with the New Progressive
RADIO "EDU-KIT"®

Reg. U.S.
Pat. Off.

All Guaranteed to Work!

PRACTICAL only
HOME RADIO COURSE **\$26.95**

NOW INCLUDES

- ★ 12 RECEIVERS
- ★ 3 TRANSMITTERS
- ★ SQ. WAVE GENERATOR
- ★ AMPLIFIER
- ★ SIGNAL TRACER
- ★ SIGNAL INJECTOR
- ★ CODE OSCILLATOR



TRAINING ELECTRONICS
TECHNICIANS SINCE 1946

- ★ No Knowledge of Radio Necessary
- ★ No Additional Parts or Tools needed
- ★ Excellent Background for TV
- ★ School Inquiries Invited
- ★ Attractively Gift Packed

FREE EXTRAS

- SET OF TOOLS • RADIO & ELECTRONICS TESTER • ELECTRIC SOLDERING IRON • TESTER INSTRUCTION MANUAL • MEMBERSHIP IN RADIO-TV CLUB; CONSULTATION SERVICE • HI-FI GUIDE • QUIZZES • TV BOOK • FCC AMATEUR LICENSE TRAINING • RADIO BOOK • PRINTED CIRCUITRY • PLIERS-CUTTERS • ALIGNMENT TOOL • WRENCH SET • CERTIFICATE OF MERIT • VALUABLE DISCOUNT CARD

WHAT THE "EDU-KIT" OFFERS YOU

The "Edu-Kit" offers you an outstanding PRACTICAL HOME RADIO COURSE at a rock-bottom price. Our kits are designed to train Radio & Electronics Technicians, making use of the most modern methods of home training. You will learn radio theory, construction, servicing, basic Hi-Fi and TV repairs, code, FCC amateur license requirements.

You will learn how to identify radio symbols, how to read and interpret schematics, how to mount and lay out radio parts, how to wire and solder, how to operate electronic equipment, how to build radios. Today it is no longer necessary to spend hundreds of dollars for a radio course. You will receive a basic education in radio, worth many times the small price you pay, only \$26.95 complete.

THE KIT FOR EVERYONE

The Progressive Radio "Edu-Kit" was specifically prepared for any person who has a desire to learn Radio. The "Edu-Kit" has been used successfully by young and old in all parts of the world, by many Radio Schools and Clubs in this country and abroad. It is used for training and rehabilitation of Armed Forces Personnel and Veterans throughout the world.

The Progressive Radio "Edu-Kit" requires no instructor. All instructions are included. Every step is carefully explained. You cannot make a mistake.

PROGRESSIVE TEACHING METHOD

The Progressive Radio "Edu-Kit" is the foremost educational radio kit in the world, and is universally accepted as the standard in the field of electronics training. The "Edu-Kit" uses the modern educational principle of "Learn by Doing." Therefore, you will construct radio circuits, perform jobs and conduct experiments to illustrate the principles you learn.

You begin by examining the various radio parts included in the "Edu-Kit." You then learn the function, theory and wiring of these parts. Then you build a simple radio. With this first set, you will enjoy listening to regular broadcast stations, learn theory, practice testing and troubleshooting. Then you build a more advanced radio, learn more advanced theory and techniques. Gradually, in a progressive manner, and at your own rate, you will find yourself constructing more advanced multi-tube radio circuits, and doing work like a professional Radio Technician.

Included in the "Edu-Kit" course are twenty Receiver, Transmitter, Code Oscillator, Signal Tracer, Signal Injector, Square Wave Generator and Amplifier circuits. These are not unprofessional "breadboard" experiments, but genuine radio circuits, constructed by means of professional wiring and soldering on metal chassis, plus the new method of radio construction known as "Printed Circuitry." These circuits operate on your regular AC or DC house current.

In order to provide a thorough, well-integrated and easily-learned radio course, the "Edu-Kit" includes practical work as well as theory; troubleshooting in addition to construction; training for all, whether your purpose in learning radio be for hobby, business or job; progressively-arranged material, ranging from simple circuits to well-advanced topics in Hi-Fi and TV. Your studies will be further aided by Quiz materials and our well-known FREE Consultation Service.

THE "EDU-KIT" IS COMPLETE

You will receive all parts and instructions necessary to build 20 different radio and electronics circuits, each guaranteed to operate. Our Kits contain tubes, tube sockets, variable, electrolytic, mica, ceramic and paper dielectric condensers, resistors, tie strips, coils, hardware, tubing, punched metal chassis, Instruction Manuals, hookup wire, solder, selenium rectifiers, volume controls, switches, knobs, etc.

In addition, you receive Printed Circuit materials, including Printed Circuit chassis, special tube sockets, hardware and instructions. You also receive a useful set of tools, a professional electric soldering iron, and a self-powered Dynamic Radio & Electronics Tester. The "Edu-Kit" also includes Code instructions and the Progressive Code Oscillator, in addition to the F.C.C.-type Questions and Answers for Radio Amateur License training. You will also receive lessons for servicing with the Progressive Signal Tracer and the Progressive Signal Injector, and a High Fidelity Guide and Quiz Book. Everything is yours to keep.

J. Statatiz, of 25 Poplar Pl., Waterbury, Conn., writes: "I have repaired several sets for my friends and made money. The 'Edu-Kit' paid for itself. I was ready to spend \$240 for a course, but I found your ad and sent for your Kit."

UNCONDITIONAL MONEY-BACK GUARANTEE

The Progressive Radio "Edu-Kit" has been sold to many thousands of individuals, schools and organizations, public and private, throughout the world. It is recognized internationally as the ideal radio course.

By popular demand the Progressive Radio "Edu-Kit" is now available in Spanish as well as English.

It is understood and agreed that should the Progressive Radio "Edu-Kit" be returned to Progressive "Edu-Kits" Inc. for any reason whatever, the purchase price will be refunded in full, without quibble or question, and without delay.

The high recognition which Progressive "Edu-Kits" Inc. has earned through its many years of service to the public is due to its unconditional insistence upon the maintenance of perfect engineering, the highest instructional standards, and 100% adherence to its Unconditional Money-Back Guarantee. As a result, we do not have a single dissatisfied customer throughout the entire world.

ORDER FROM AD—RECEIVE FREE BONUS RESISTOR AND CONDENSER KITS WORTH \$7.00

- Send "Edu-Kit" Postpaid. I enclose full payment of \$26.95.
- Send "Edu-Kit" C.O.D. I will pay \$26.95 plus postage.
- Send me FREE additional information describing "Edu-Kit."

Name.....
Address.....

Progressive "EDU-KITS" Inc. 1186 Broadway, Dept. 1736
Hewlett, N. Y.

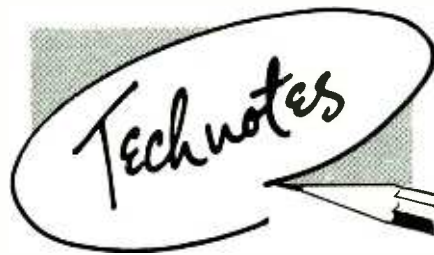

P706 TRANSOLAR RADIO

Motorboating on solar operation will generally occur only at high volume settings when the light level reaching the solar cells is low. Should the motorboating occur at normal

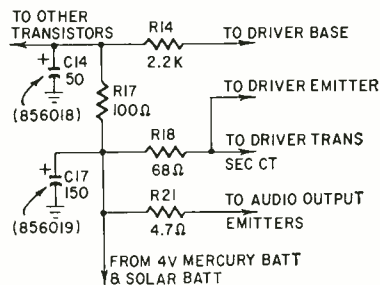

volume and light levels, C17 (150 μ f, 6 volts) may be open. (See partial schematic.)

Bridging a capacitor across C17 while the set is in operation on the solar cells will determine if the capacitor is defective. There will be no change of operation on battery if C17 is open.—*Hoffman Tech Talk*

G-E M5 CHASSIS

Residual audio buzz in the 17-inch models may be caused by the leads from the vertical hold control running too close to the volume-control terminals. This vertical pickup on the volume-control terminals appears as a buzz in the speaker which may be changed in pitch by adjusting the vertical hold control.

The simple cure is to dress the gray and yellow vertical hold-control leads away from the volume-control terminals to eliminate the buzz condition.—*G-E Service Talk*

MOTOROLA TS-542

When this receiver came into the shop, it showed critical horizontal and vertical hold and would intermittently lose

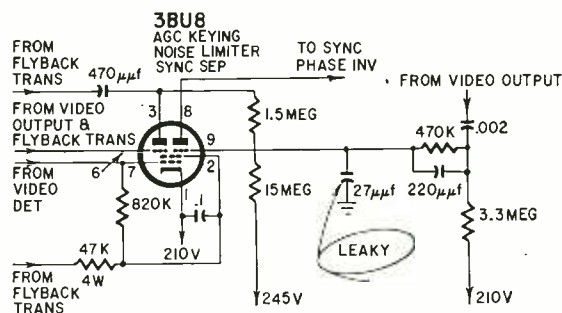

sync. The trouble was traced to a 27- μ f capacitor connected to pin 9 of the 3BU8 sync separator. The capacitor was leaky. When it was replaced with a new 27- μ f unit, the trouble cleared up.—*M. L. Leonard*

ANTENNA NOTE

We never, but never, install an antenna, carrying a booster transformer, that towers 50 feet above the roof of a three-story house without checking the transformer first. If you don't test it, you may have to take down the antenna, shinny up the mast or borrow a satellite to make repairs that a few minutes spent in pretesting would have permitted you to make on the ground. We use only the best types of heavy-duty transmission lines for lead-ins and anchor them securely to minimize wind damage.

Same thing with tubes. What with the hard driving they get as sets get smaller, especially in the portable models,

we never assume a tube is OK because it's in a factory-packed carton. It goes straight to the mutual-conductance tube checker before it's socketed in the set.

Reason is the tube may be congenitally defective. If you stick it in the set on the assumption that it's OK, you go ahead shooting trouble on that premise, so you're fouled up from the moment you stuck that tube in. Similarly we test resistors and capacitors because their value is critical for the compact sets and, unless it's a gold-band piece, a 100,000-ohm resistor may be 25,000 ohms off in either direction.—*Harry J. Miller*

PRECISE 300 SCOPE

After the scope was on for an hour or so, the intensity control would not cut the beam off. The trouble was a leaky 0.1- μ f 12-kv capacitor in the control-grid circuit. Replacing

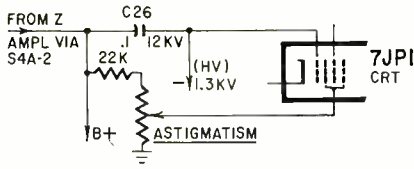

the unit with a 0.1- μ f 16-kv capacitor solved the problem. The higher-voltage replacement also makes future replacement unlikely. This also applies to other scopes.—*Elmer Woods*

IDENTIFYING DUAL DIODES

The new line of G-E TV receivers employs three dual-diode combinations. One is the horizontal phase detector (WT16X7). Two are used in the sonic remote-receiver circuitry, the first as a signal detector (WT16X8) and the other as a bias rectifier (WT16X9). Physically these diodes appear to be much the same but electrically they differ greatly. The phase detector has common anodes, and the bias rectifier is series-connected. While each diode is plainly marked, a simple ohmmeter check can eliminate any confusion with these components.

The diagram below shows the measurements taken with a Simpson 260 meter. A vtvm may be used and the polar-

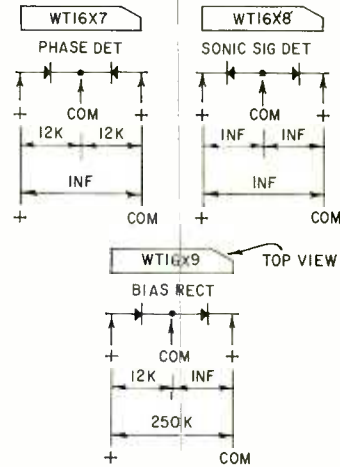

ities of conduction shown will remain the same. However, the values may differ somewhat depending on the particular meter you use.—*G-E Service Talk*

HEATHKIT EA-1 AMPLIFIER

There is a circuit quirk in the Heathkit EA-1 3-watt amplifier. The EF86 audio amplifier tube obtains its screen voltage from the cathode of the EL84 power amplifier through a 270,000-ohm dropping resistor. The screen is bypassed by a 25- μ f 25-volt electrolytic capacitor. The EL84 cathode runs at 46 volts, while the voltage on the EF86 screen is reduced to 24 volts by the dropping resistor. However, if the EF86 tube ever burns out, there will be no more screen current, and thus no drop across the dropping resistor. The voltage at the screen will then rise to 46 volts, severely overvolting the electrolytic and possibly damaging it. Thus, when capacitor replacement is necessary, install a 50-volt unit.—*Charles Erwin Cohn* END

Just Out



New SUPREME 1961 TV Manual

AMAZING BARGAIN

The new 1961 TV manual is the bargain of the year. Covers all important sets of every make in one giant volume. Your price for this mammoth manual is only \$3. This super-value defies all competition. Other annual volumes at only \$3 each. Factory service material simplifies repairs. Includes all data required for quicker TV servicing. Practically tells you how to find each fault and make needed repair. More pages, more diagrams, more service data per dollar of cost.

TELEVISION SERVICING COURSE

Let this new course help you in TV servicing. Amazing bargain, complete, only \$3, full price for all lessons. Giant in size, mammoth in scope, topics just like a \$200.00 correspondence course. Lessons on picture faults, circuits, adjustments, short-cuts, UHF, alignment facts, hints, antenna problems, trouble-shooting, test equipment, picture analysis. Special, only **\$3**

SIMPLIFIED RADIO SERVICING (Introduction to TV)

Explains how to use comparison method to find most radio faults in minutes. Many practical tests without any equipment. Also several sections on use of instruments, Introduction to TV, Schematics, charts, service hints, job sheets cover all sets. New edition. Only **\$1.50**

RADIO VOLUMES



RADIO DIAGRAMS

SUPREME is your best source for all needed RADIO diagrams, and service data. Covers everything from the most recent 1960 radios to pre-war old-timers; home radios, stereo, combinations, transistor portables, FM, and auto sets. Sensational values. Only \$2 for many volumes. Every manual has extra large schematics, all needed alignment facts, printed boards, voltage values, trimmers, dial stringing, and helpful hints. Volumes are large in size, 8 1/2 x 11 inches, about 190 pages. See coupon at right for a complete list of these popular radio service manuals. →

COVERS ALL POPULAR SETS

Here is your service data for faster, easier TV repairs. Lowest priced. Best by comparison. *Supreme TV* manuals have all needed service material on every popular TV set. Helpful, practical, factory-prepared data that will really make TV servicing easy for you. Benefit and save with these amazing values in service manuals. Only \$3 per large, yearly volume.



The repair of any television set is really simple with *Supreme TV* service manuals. Every set is covered in a practical manner that will simplify troubleshooting and repair. This is the help you need to find toughest faults in a jiffy. Most \$3 TV volumes cover a whole year of service material. New *Television Servicing Course* will aid you in learning TV. Be wise, buy *Supreme Manuals* only once each year instead of spending dollars every week.

SIMPLIFIES TV REPAIRS

These giant TV manuals have complete circuits, needed alignment facts, printed boards, servicing hints, production changes, voltage charts, waveforms, and double-page schematics. Here are your authentic service instructions to help you do expert work quicker, and priced at only \$3 per large annual manual. Repair any TV model ever made by having in your shop all 15 volumes as listed in coupon. Your special price for all, only \$40. Or try the new 1961 TV manual to see what an amazing bargain you get for \$3. Send no-risk trial coupon today.

NO-RISK TRIAL ORDER COUPON

SUPREME PUBLICATIONS, 1760 Balsam Rd., Highland Park, Ill.

<input type="checkbox"/> 1960 <input type="checkbox"/> 1959 <input type="checkbox"/> 1958 <input type="checkbox"/> 1957 <input type="checkbox"/> 1956 <input type="checkbox"/> 1955 <input type="checkbox"/> 1954 <input type="checkbox"/> 1953 <input type="checkbox"/> 1952 <input type="checkbox"/> 1951 <input type="checkbox"/> 1950 <input type="checkbox"/> 1949 <input type="checkbox"/> 1948 <input type="checkbox"/> 1947 <input type="checkbox"/> 1946 <input type="checkbox"/> 1942 <input type="checkbox"/> 1941 <input type="checkbox"/> 1940 <input type="checkbox"/> 1926-1938 Manual, \$2.50 <input type="checkbox"/> Simplified Servicing, \$1.50	Popular RADIO Diagram Manuals at only \$2.50 each..... These annual RADIO volumes specially priced at only \$2.50 each..... THIS GROUP ONLY \$2 EACH 1926-1938 Manual, \$2.50 Simplified Servicing, \$1.50	Rush today TV manuals checked <input checked="" type="checkbox"/> below and Radio manuals at left. Satisfaction guaranteed. <input type="checkbox"/> New 1961 TV Manual, \$3. <input type="checkbox"/> 1960 TV, \$3. <input type="checkbox"/> Additional 1959 TV, \$3. <input type="checkbox"/> Early 1959 TV, \$3. <input type="checkbox"/> 1958 TV Manual, \$3. <input type="checkbox"/> Additional 1957 TV, \$3. <input type="checkbox"/> Early 1957 TV, \$3. <input type="checkbox"/> 1956 TV Manual, \$3. <input type="checkbox"/> Additional 1955 TV, \$3. <input type="checkbox"/> Early 1955 TV, \$3. <input type="checkbox"/> 1954 TV, \$3. <input type="checkbox"/> 1953 TV, \$3. <input type="checkbox"/> 1952 TV, \$3. <input type="checkbox"/> 1951 TV, \$3. <input type="checkbox"/> 1957-58 RCA TV Manual, \$1.50 <input type="checkbox"/> New Television Servicing Course, complete... \$3. <input type="checkbox"/> I am enclosing \$..... Send postpaid. <input type="checkbox"/> Send C.O.D. I am enclosing \$..... deposit.
Name:		Address:

Supreme Publications
Sold by All Leading Parts Jobbers

ATR

PRODUCTS FOR MODERN LIVING



ATR PLUG-IN TYPE PORTABLE INVERTERS*

A.C. HOUSEHOLD ELECTRICITY Anywhere... in your own car!
Operates Standard A.C. ● Record Players ● Dictating Machines ● Small Radios ● Electric Shavers ● Heating Pads, etc. In your own car or boat!

MODELS
6-RMF (6 volts) 60 to 80 watts. Shipping weight 12 lbs. DEALER NET PRICE \$33.00
12T-RME (12 volts) 90 to 125 watts. Shipping weight 12 lbs. DEALER NET PRICE \$33.00
*Additional Models Available



ATR "A" Battery ELIMINATOR

For Demonstrating and Testing Auto Radios—TRANSISTOR or VIBRATOR OPERATED!
Designed for testing D.C. Electrical Apparatus on Regular A.C. Lines—Equipped with Full-Wave Dry Disc-Type Rectifier, assuring noiseless, interference-free operation and extreme long life and reliability.

MAY ALSO BE USED AS A BATTERY CHARGER
MODEL 610C-ELIF... 6 volts at 10 amps. or 12 volts at 6 amps. Shipping weight 22 lbs. DEALER NET PRICE \$49.95
MODEL 620C-ELIT... 6 volts at 20 amps. or 12 volts at 10 amps. Shipping weight 33 lbs. DEALER NET PRICE \$66.95

AUTO-RADIO VIBRATORS



By every test ATR Auto-Radio Vibrators are best! and feature Ceramic Stack Spacers—Instant Starting, Large Oversized Tungsten Contacts, Perforated Reed, plus Highest Precision Construction and Workmanship and Quiet Operation!
There is an ATR VIBRATOR for every make of car!
Ask your distributor for ATR's Low Priced type 1400, 6 volt 4-prong Vibrator; and 1843, 12 volt 3-prong; or 1840, 12 volt 4-prong Vibrator. THE WORLD'S FINEST!

There is a trim plate kit for YOUR CAR!

ATR CUSTOMIZED KARADIO



Vibrator-Operated with Tone Control
ATR KARADIO... is ideal for small import cars or compact American cars! Unit is completely self-contained—extremely compact. Powerful 8-tube performance provides remarkable freedom from engine, static, and road noises. The ATR Customized Karadio comes complete with speaker and ready to install. Can be mounted in-dash or under-dash wherever space permits! No polarity problem. Neutral Gray-Tan, baked enamel finish. Overall size, 7" deep, 4" high, and 6 1/2" wide. Shipping weight, radio set, 7 lbs. Model K-1279—12 for 12V Dealer Net Price... \$33.57
Model K-1279—6 for 6V Dealer Net Price... \$33.57

Excellent Tone, Volume, and Sensitivity!
Compact, yet powerful. Fits all trucks, station wagons, most cars and boats. Just drill a 1/8 inch hole in roof and suspend the one-piece unit (aerial, chassis and speaker) in minutes. Watertight mounting assembly holds antenna upright. Yoke-type bracket lets you tilt radio to any angle.
Extra-sensitive radio has 6 tubes (2 double-purpose), over-size Alnico 5 PM speaker for full, rich tone. Big, easy-to-read illuminated dial. Fingertip tuning control. Volume and tone controls. 33-in. stainless steel antenna. Neutral gray-tan enameled metal cabinet, 7 x 6 1/2 x 4 in. high over-all. Shipping weight 10 1/2 lbs.
Model TR-1279—12A for 12V Dealer Net Price \$41.96
Model TR-1279—6A for 6V Dealer Net Price \$41.96

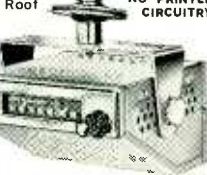

ATR TRUCK KARADIO

See your electronic parts distributor write factory for free literature...
ATR AMERICAN TELEVISION & RADIO CO.
Quality Products Since 1931
SAINT PAUL 1, MINNESOTA—U. S. A.

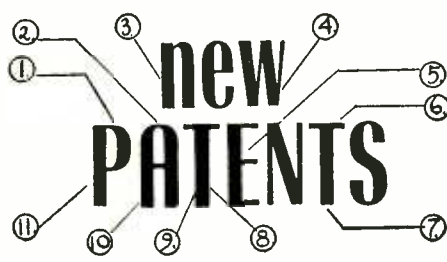

THRESHOLD INDICATOR

Patent No. 2,954,527

Richard W. Bradmiller, Winter Park, Fla. (assigned to Arco Corp., Cincinnati, Ohio)

This circuit indicates when signal amplitude goes above a first threshold value, and also when it drops below a second and lower threshold.

The input signal is rectified and applied as a positive bias to the base of the transistor (Fig. 1). When it is large enough, the circuit begins

minute. Each shot rolls down a feed tube past two stations, each like the one shown. If a defect escapes the first inspection, it is caught by the second. Each station is energized at the proper instant, and each must be thoroughly shielded.

The mechanism counts, rejects and conveys the units as required.

ULTRASONIC SOLDERING

Patent No. 2,951,975

Benson Carlin, Fair Lawn, N. J. (assigned to Alear Instruments, Inc., Little Ferry, N. J.)

It is well known that soldering as well as cutting and mixing can be performed with the aid of a transducer vibrating at an ultrasonic rate. This inventor finds greater efficiency when the transducer is shock-excited periodically and allowed to vibrate at its own resonant (ultrasonic) frequency.

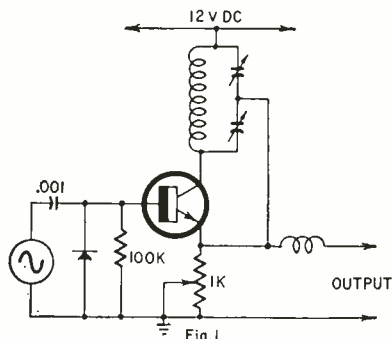

Fig. 1



Fig. 1 illustrates crudely the type of vibration that results. Each shock pulse starts a new train of decaying waves.

to oscillate. Output will be proportional to signal. Oscillations continue until the signal falls below its off threshold, which is lower than its starting point since the oscillator tends to remain operating once it starts (see Fig. 2).

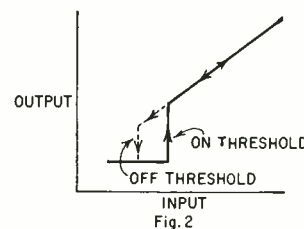

Fig. 2

The gating point is set by the emitter resistor. The output may be rectified and measure to determine whether the circuit is oscillating.

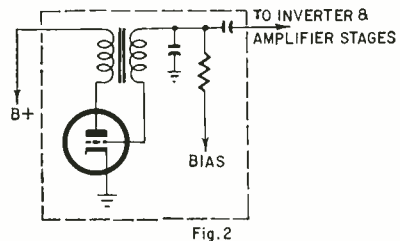

Fig. 2

The driving source may be a pulse generator (Fig. 2) followed by a phase inverter feeding a push-pull output stage. This provides sufficient power for the transducer which must resonate at an ultrasonic frequency.

WIDE-BAND AMPLIFIERS

Patent No. 2,935,696

Cyrus Frank Ault, Clifton, N. J. (Assigned to Allen B. Dumont Labs., Inc., Clifton, N. J.)

This circuit combines two amplifiers to obtain extremely wide bandwidth. A1 is a dc difference amplifier with flat response from dc to as high a frequency as practical. A2 is an ac amplifier which overlaps A1 and remains effective to as high a frequency limit as design permits.

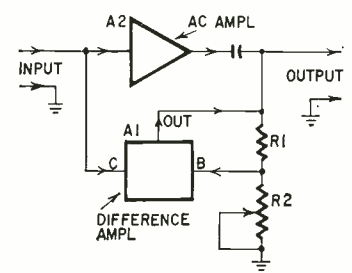

B and C are two inputs to A1 whose output is proportional to their difference. The ratio $\frac{R2}{R1 + R2}$ equals the gain of A2.

At low frequencies B is nearly zero because A2 has little gain, so A1 delivers maximum output. At high frequencies (where A2 is effective) B = C so there can be no output from A1. In the overlap interval, A2's gain rises uniformly, causing B to increase. As a result, the gain of A1 will drop uniformly to give a smooth transition.

END

MAGNETIC INSPECTION

Patent No. 2,938,163

Eugene Roffman and Alfred J. Wyszocanski, Philadelphia, Pa. (Assigned to USA as represented by Secretary of Army)

This device inspects cylindrical objects of magnetic material. It detects cracks, splits, seams, etc. The drawing shows a test unit passing between a set of coils. When the material is flawless, the flux divides equally from the energizing coils into detector coils. A magnetic defect destroys the balance and the detectors deliver electrical output.

The patent describes automatic equipment that inspects 80 or more pieces of 20-mm shot per

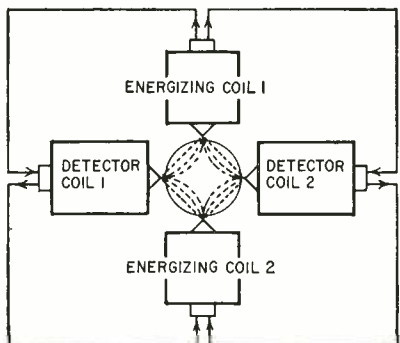

SOLDERING IRON. Model A-1000, 30-watt pencil type. Removable handle screws to cover

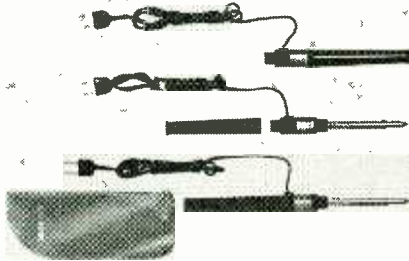

tip and barrel for carrying while hot or for shirt-pocket storage.—L. I. Electrolabs, Inc., 1186 Broadway, Hewlett, N. Y.

PUSH-PULL SWITCH/CONTROLS, C47S. Each



control can be used with a variety of shafts.—Clarostat Manufacturing Company, Inc.—Dover, N. H.

NEW TOOL. Tri-Tap. For tapping new threads or renewing old in metal or plastic. Sizes 6-32,



8-32 and 10-32.—CBS Electronics, Division of Columbia Broadcasting System Inc., Danvers, Mass.

STACK-SWITCH EXPERIMENTAL KITS. No. K-101, assortment of 74 springs of 9 thicknesses, stack assembly pins, rollers, contacts, insulators,

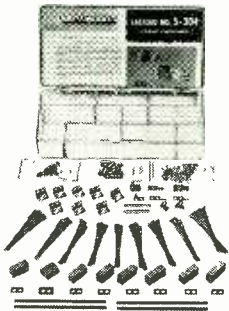

etc. No. K-102: contact springs and parts with 1/4-inch mounting centers. No. K-103: 3/8-inch springs and parts.—Switchcraft Inc., 5555 N. Elston Ave., Chicago 3, Ill.

SERVICE CASE. 40-tool capacity. Top grain

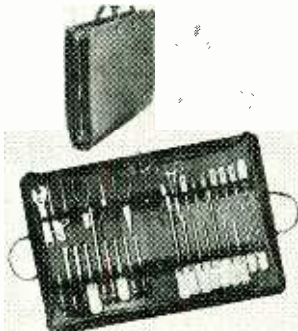

leather case in black or brown with felt type lining.—Xeclite Inc., Orchard Park, N. Y.

TUBE TESTER, model 685 Automatic Dyna-Quik. Multiple-socket testing for existing tube types, punch-card for new. More than 125 commonly used tube types and settings listed on socket panels. Leatherette-covered luggage type

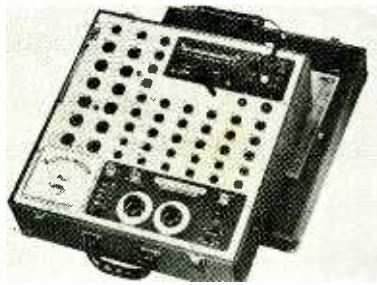

carrying case, 17 x 17 x 7 1/2.—B&K Manufacturing Co., 1801 W. Belle Plaine, Chicago 13, Ill.

TUBE TESTER, model 103. For all radio and TV tubes including latest. Operates by setting 3 controls, inserting tube into socket and press-



ing button. Built-in CRT socket for picture tubes. Tube chart in special compartment. Gray hamertone steel case.—Mercury Electronics Corp., 77 Searing Ave., Mincola, N. Y.

TRANSISTOR TESTER, Transi-Master, model TR110. Tests in-circuit without setup charts.

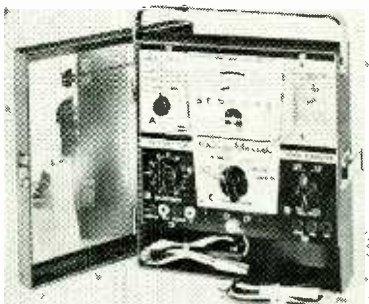

Signal tracer, 12-volt 50-ma meter, af-rf-if signal generator, transi-probe.—Service Instruments Corp., 171 Official Rd., Addison, Ill.

TUBE TESTER, model 151. Makes emission, leakage, filament-continuity and short tests on

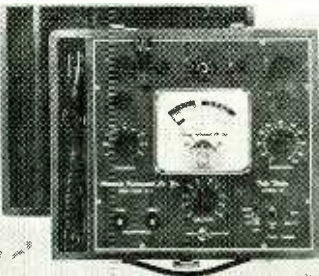

over 1,000 tube types, including modern. Single rotary switch for speedy setup.—Accurate Instrument Co., Inc., New York 59, N. Y.

SLIDING PISTON TRIMMER. Capacitance values from 0.6 µf to 90 µf. Glass or quartz

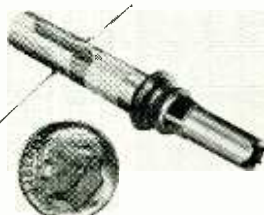

dielectric. Standard, differential, split-stator, open or sealed construction.—JFD Electronics Corp., 6101 16th Ave., Brooklyn 4, N. Y.

new PRODUCTS

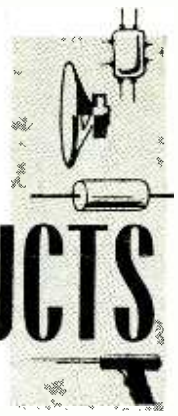

REPLACEMENT FLYBACK TRANSFORMERS. HO-315 replaces Olympic flyback TR-3599-5;

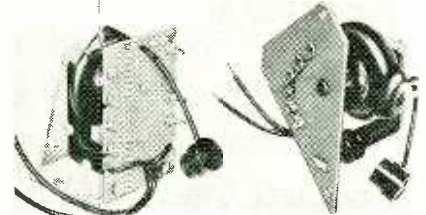

HO-316, TR-5598/B.—Chicago Standard Transformer Corp., 3501 W. Addison St., Chicago 18.

ISOLATION TRANSFORMER, model IP-10. Variable output voltage from 90 to 130 in 0.75-volt steps with 2 heavy-duty 8-position switches. 300-watt power rating continuous duty



or 500-watt in intermittent duty. Built-in meter with ±1-volt accuracy for monitoring output voltage. 6 1/2 x 9 1/2 x 5 inches. 22 lbs.—Heath Co., Benton Harbor, Mich.

MINIATURE TUBULAR ELECTROLYTICS. Type BMT, plastic cases. 3/16- to 5/8-inch diameter. 1- to 2,000-µf capacitance. Voltage ratings, 3 to



50, -30° to +65°C operating range.—Illinois Condenser Co., 1616 N. Throop St., Chicago 22.

TRANSISTOR THERMIN KIT. All parts and instructions. Operates through audio amplifier. Powered by single small battery. Pitch range



(Continued on page 108)

For the Man Who Wants an Advanced Home-Study Program in Electronic Engineering Technology or Nuclear Engineering Technology...

CREI opens the door to
HIGHER STATUS,
BETTER INCOME,
and a **SECURE**
FUTURE in the
forefront of
TECHNOLOGICAL
ADVANCEMENT

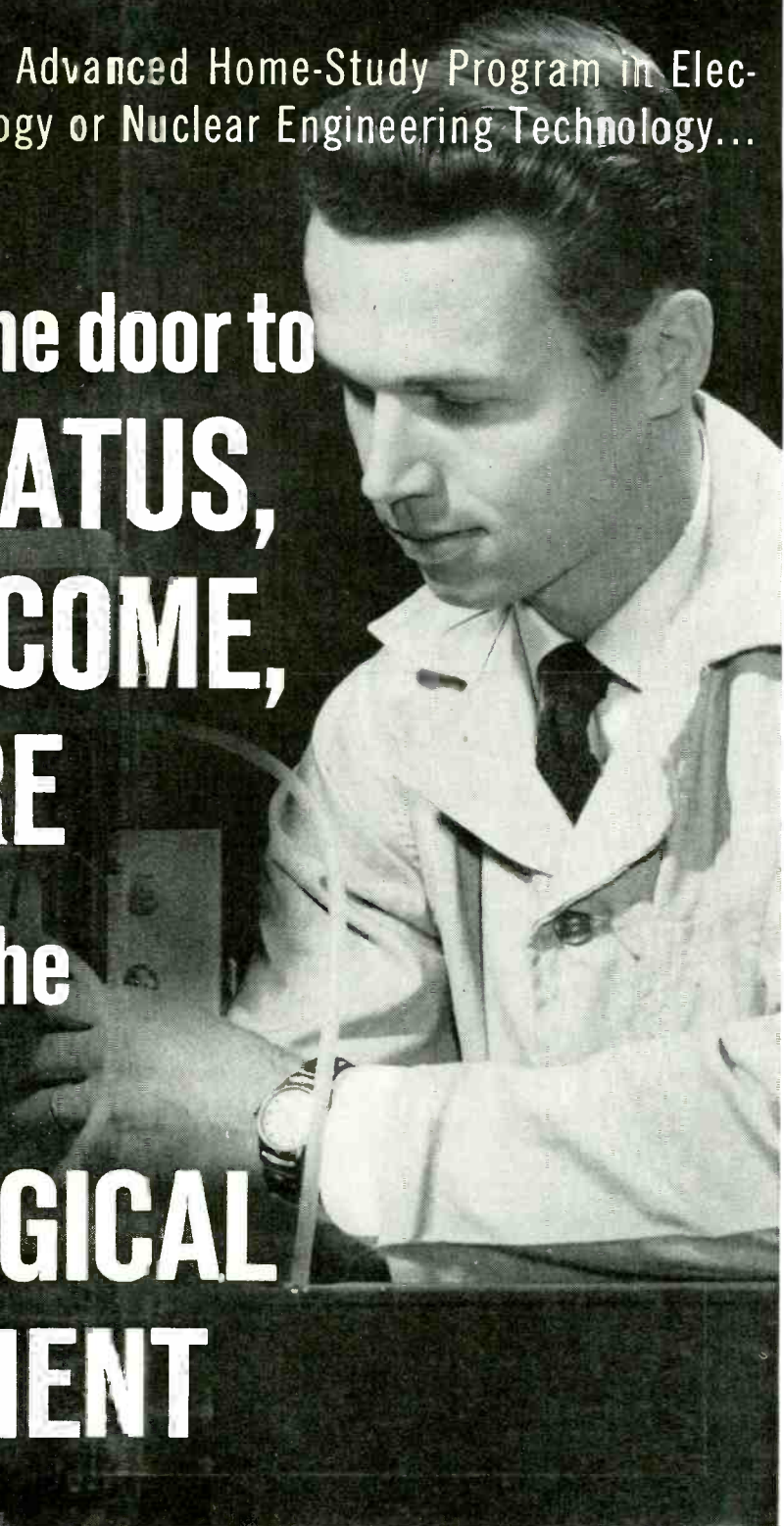

The world of science is the world of the future. There is no career more stimulating, challenging, or rewarding than that of working with topflight scientists and engineers to develop deep space probes and orbital satellite systems . . . package nuclear power reactors to provide economical, long-lasting power anywhere in the world . . . electronics and radioisotopes for use in medicine, agriculture and industry . . . missile systems for the Armed Forces . . . computers and data processing systems which

will become accepted necessities by finance, industry and government . . . to develop a thousand and one concepts that will make our world a better and safer place for all. You can have a career—or speed up your present career—in one or more of these areas if you are eligible to enroll in a CREI home-study program . . . a program recognized everywhere as excellent insurance for a secure future, high professional stature, and better income.

CREI's Extension Division now offers you college-level programs combining the technological content of advanced residence courses with convenience and economy of home study.

The quality of a CREI education may be gauged by the fact that the demand for CREI graduates and students at the CREI Placement Bureau has far exceeded the supply for several years. Many leading companies and Government agencies send representatives to CREI every year to hire graduates and students for their technical staff. The CREI educational programs were developed in conjunction with leading industrial concerns and government agencies directly interested in the nation's scientific and technological future.

There are now more than 20,000 CREI students in all the 50 states and most countries of the free world. You, too, can follow your CREI program while you remain in your present job. You study at home, when and as you choose . . . and you avoid the time and expense of commuting to a residence school. Within two to four years, depending upon the courses you select and the time you have to apply, you can complete a CREI program in engineering technology. The courses are written in easy-to-understand format, and your personal progress is carefully guided by CREI's competent faculty.

CREI programs bring you the latest technical advances and breakthroughs.

Recent advances and new techniques have placed great importance on how modern and up-to-date the individual's education is. Recognizing this, CREI maintains a large staff of engineers, educators and scientists who occupy prominent positions in government and industry. These men continuously revise the CREI courses and incorporate all new technical information. CREI courses are the most modern you will find . . . anywhere.

The CREI program is designed to meet your present and future employment needs and to increase your professional status and earning power.

CREI students frequently gain promotions and increases in pay long *before* they complete the program. As a graduate you will find that you gain stature and respect among your professional colleagues and supervisors, and

NEW 56-Page Catalog Gives Important Facts About Electronics, Nucleonics . . . and CREI. Send Post-Paid Card Attached For Your Free Copy.

Just published to include new courses being offered by CREI, this informative catalogue discusses the electronic and nuclear industries and answers searching questions about future manpower requirements and career opportunities. The catalogue describes all the courses, the alternative programs . . . it introduces the faculty who will be carefully guiding your progress . . . and it points

that you enjoy a personal satisfaction that comes from working and communicating intelligently with your associates. CREI graduates are important members of the engineering team. Your employer will recognize the assets of your up-to-date education . . . to your personal advantage.

Officials of private industry and government approve CREI for their own personnel.

The National Broadcasting Company . . . Radio Corporation of America . . . Pan American Airways . . . The Martin Company . . . Canadair Limited . . . Canadian Marconi . . . the Voice of America . . . the British Air Force, Navy and Army . . . and some 50 other electronic and nuclear organizations actually *pay all or a substantial part of the tuition* for employees taking a CREI home-study program. Right now, there are 5,240 U. S. Navy personnel enrolled in the CREI extension program.

Official accreditation and recognition.

Founded in 1927, CREI is one of the oldest technical institutes in America. CREI co-founded the National Council of Technical Schools, and was one of the first three institutes whose curricula was accredited by the Engineer's Council for Professional Development. The U. S. Office of Education lists CREI as an "institution of higher learning."

CREI conducts a residence school

in Washington, D. C., for those who wish to attend classes. The regular program of 27 months leads to an AAS degree. No previous technical experience or training is necessary for the residence school.

Qualifications for enrollment.

You qualify for CREI enrollment if you have a high school diploma or equivalent, and if you have had basic technical training or practical experience. Send for free catalogue for details. Tuition is reasonable, and veterans can take advantage of the G. I. Bill.

out how the courses are especially laid out for home study. *The catalogue is yours without cost or obligation, and it is of vital importance to every man desiring to further himself in the expanding world of science and technology. Mail this card today for your copy of "Your future in Electronics and Nuclear Engineering Technology."*

ECPD ACCREDITED TECHNICAL INSTITUTE CURRICULA • FOUNDED 1927

The Capitol Radio Engineering Institute



Home Office:
3224 16TH STREET, N.W.,
WASHINGTON 10, D.C., U.S.A.,
Dept. 1402-H

England:
CREI LONDON, GRANVILLE HOUSE,
132-135 SLOANE STREET, LONDON,
S.W. 1, ENGLAND

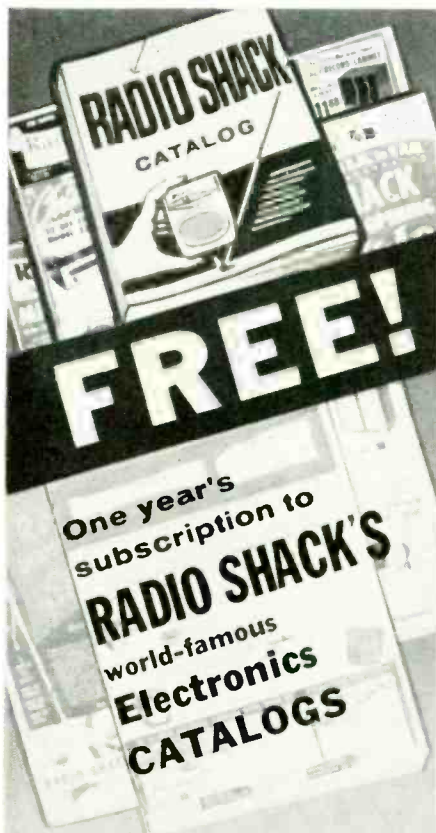

RADIO SHACK CATALOG

FREE!

One year's subscription to **RADIO SHACK'S** world-famous **Electronics CATALOGS**

See the most complete line of quality electronic equipment anywhere

Stereo • Hi-Fi • Tester Kits • Ham Radio • LP Records • Pre-recorded Tapes • Parts • Tools • Accessories

Order anything on Easiest Budget Terms—take up to two years to pay

Receive fastest one-day service on every order; no troublesome delays.

You must be satisfied or Radio Shack refunds your money in full

Compare this typical Radio Shack value

New Portable Tube Checker Kit

\$14.80

\$2.00 down

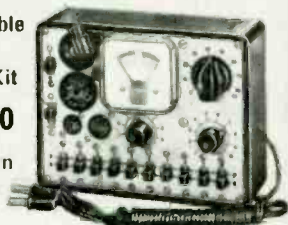

Weighs only 2¼ lbs., yet performs like larger, costlier units! Tests radio, hi-fi, TV tubes for emission, shorts, leaks, opens, intermittents. Tube chart, operating manual included. No. 94L002.

RADIO SHACK CORPORATION
730 Commonwealth Ave., Boston 17, Mass.

MAIL COUPON
Get FREE Catalogs

Radio Shack Corp. Dept. 61810
730 Commonwealth Ave., Boston 17, Mass.
Send latest Electronics Catalog plus every new issue for one year, FREE.

Name _____
Address _____
Postoffice or City _____ Zone _____ State _____

(Continued from page 103)

nearly 4 octaves.—R. A. Moog Co., Box 263, Ithaca, N. Y.

FM TUNER, FM-200. 6 if stages. Sensitivity of 0.5 microvolt for 20-db signal-to-noise ratio for 72-ohm antenna. Capture ratio 1.5 db.



Special circuit automatically locks out a/c when tuning knob is touched and restores a/c when hand is removed.—Fisher Radio Corp., 21-21 44th Drive, Long Island City 1, N. Y.

REPLACEMENT SPEAKER, model 410A2. 1.4-ounce Alnico V Magnet. 6 watts power handling.

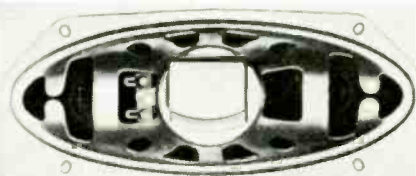

4 to 10 inches. Used in many auto radios.—Quam-Nichols Co., 236 E. Marquette Rd., Chicago.

CARTRIDGE FOR 78-RPM. 3-mil stylus. Flat frequency response from 20 to 20,000 cycles.

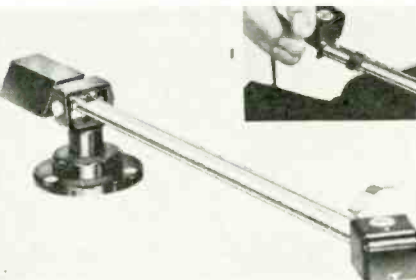

Interchangeable with stereo LP cartridge on London-Scott arm.—H. H. Scott Inc., Dept. P, 111 Powdermill Rd., Maynard, Mass.

AUTOMATIC TURNTABLE, Laboratory Series Type A. Balanced tone arm; full-size, full-weight



turntable; precision motor and automatic record changing mechanism.—Garrard Div., British Industries Corp., Port Washington, N. Y.

PERSONALIZED MIKE, Model 545 Unidyne III. 8½ ounces, 6 inches long. For entertainers who want personal mike of uniform audio quality. Swivel adapter for tilting through 90° from vertical to horizontal. Quick disengage permits use as hand-held unit. Cardioid pickup pattern.



50-15,000-cycle range. Plug and cable adapters. match most common mike and cable connectors. Wood carrying case.—Shure Bros. Inc., 222 Hartrey Ave., Evanston, Ill.

PORTABLE TRANSCRIPTION PLAYER. 20-watt amplifier and speaker. Continuous speed control, 29 through 86 rpm with instant speed selection



at 16, 33-½, 45 and 78 rpm. 4-pole shielded motor. Inputs for 2 microphones and radio tuner.—Bogen-Presto, Div. of Sieglar Corp., Box 500, Paramus, N. J.

STEREO TAPE RECORDER, Continental 300. 4-track. Tape drive mechanism. Recording/play-

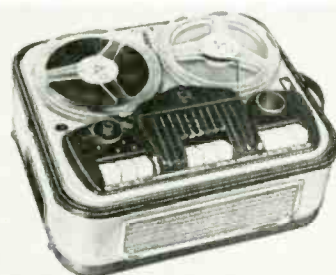

back preamplifier. Power amplifier. Wide-range speaker. Dynamic microphone.—North American Philips Co. Inc., High-Fidelity Products Div., 230 Duffy Ave., Hicksville, N. Y.

STEREO AMPLIFIER, Realistic 40/A. 40 watts. Two 20-watt stereo channels with 80 watts peak



monaural. 9 tubes plus rectifier for 14-tube operation. 8 inputs selectable from front panel. Tape-recorder output. Outlet jack for 3rd-channel speaker.—Radio Shack Corp., 730 Commonwealth Ave., Boston 17, Mass.

STEREO AMPLIFIER, model S-5000 II. 80 watts. 1 set basic controls. Ten 2-channel controls. Stereo normal/reverse and phase-inversion



switches. Dual amplifier monophonic operation with either input source.—Sherwood Electronic Laboratories, Inc., 4300 N. California Ave., Chicago 18, Ill.

STEREO AMPLIFIER KIT, 88YU934. 70 watts. 35 per channel. IHFM music power rating 96 watts. Center-channel output. Output recording jacks independent of volume- and tone-control settings. Tape monitor switch. Separate switch-



able 3¼- and 7½-inch equalization. Cordovan gray with beige and sand-gold front panel of heavy, extruded aluminum. Supplied with parts, tubes, solder, wire, instructions.—Allied Radio Corp., 100 N. Western Ave., Chicago 80, Ill.

SHORT-WAVE RADIO STATION KIT, *Halli-kit*, model *SX-140K* receiver; *HT-40K* transmitter. 6 bands: 80, 40, 20, 15, 10 and 6 meters. For



CW, AM and SSB signals. Receiver front end factory-wired. Instructions and diagrams.—Hallcrafters Co., 4401 W. 5th Ave., Chicago 24.

EDUCATIONAL KIT, *EK-2A*, *Basic Radio, Part I*. For building simple crystal receiver, adding

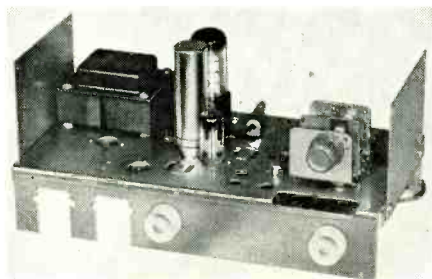

tuned circuit, tubes, transformer and power supply to make regenerative receiver.—Heath Co., Benton Harbor, Mich.

TRANSMITTER, *HE-25*. Single-knob band switching on 80 through 6 meters. Runs 120



watts CW input, 80 through 10, 85 watts CW on 6 and 70 watts phone on all bands.—Lafayette Radio Electronics Corp., 165-08 Liberty Ave., Jamaica 33, N. Y.

2-WAY RADIO, *G-150*, *Business Communicator*. Operates on frequencies within 150-174-mc range assigned by FCC. Basic unit usable for

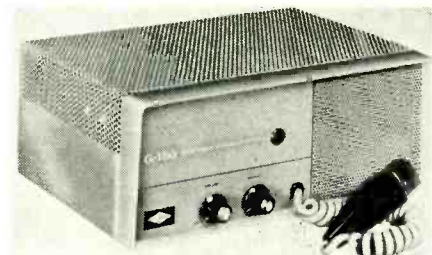

base station and mobile installations. Transmitter, receiver, power supply and loudspeaker. 5 x 12½ x 8½ inches.—Conset Div., Young Spring & Wire Corp., 801 S. Main St., Burbank, Calif.

REPLACEMENT CONTROLS for Motorola auto radios, M/U-2, M/U-6, M/U-7, M/U-8 and

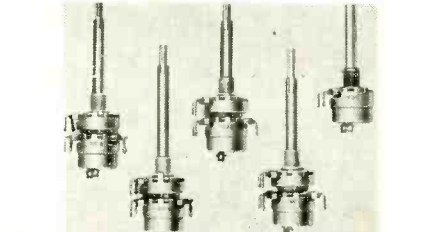

M/U-9.—Centralab, Div. of Globe-Union, 900 E. Keefe Ave., Milwaukee 1, Wis. END

spend one hour a day with this famous course and prepare yourself for a rewarding future

BASIC ELECTRONICS

by Van Valkenburgh, Nooger & Neville, Inc.

The civilian version of the extremely successful illustrated training course used by the U. S. Navy

The Navy course turned out naval trained technicians in record time. More than 100,000 naval trainees learned basic electronics this easy "picture-book" way. The modern course we offer also presents BASIC ELECTRONICS in a "picture-book" manner that everyone can grasp, regardless of previous education. Only a knowledge of the basics of electricity is necessary. So successful has the Rider published course proven in industry, that the nation's leading firms use it to teach their personnel. And, now you can master the basics of electronics at home with this same "learn-by-pictures" training course! (This course is available only from John F. Rider Publisher, Inc. or its dealers).

HERE'S HOW THIS EASY, ILLUSTRATED COURSE WORKS: Every page covers one complete idea. There's at least one carefully selected illustration on that same page to explain it. Then, at the end of every section, you'll find review pages that highlight the important topics you have just covered. You build a thorough step-by-step knowledge at your own pace—as fast as you yourself want to. The illustrations—more than 800 of them and the text are the perfect combination to make the subject of electronics completely understandable.

BASIC ELECTRONICS COURSE NOW AVAILABLE IN TWO WAYS

BASIC ELECTRONICS 5-VOLUME COURSE AVAILABLE AS HERETOFORE. The 5-volume civilian version of the U. S. Navy course covers vacuum tube diodes and power supplies, amplifiers, oscillators, transmitters, and receivers. This is the same as has been available heretofore.

BASIC ELECTRONICS EXPANDED COURSE. The INTEGRATED EXPANDED COURSE consists of 6 volumes, including the 5-volume course, plus a 6th volume which expands into the areas of semiconductors, transistors, and frequency modulation. Transistors and semiconductors are the most modern devices in electronic technology. Everyone interested in the broad subject of electronics now must have a familiarity with transistors and semiconductors. If you are interested in learning the basics of electronics, this 6-volume course is the best that you can buy. If you are among the great many tens of thousands who have completed the 5-volume course, the 6th volume on semiconductors transistors, and FM is a book which you should own. It can be bought separately.

BASIC ELECTRONICS: #170, set of Vols. I to V in soft covers, \$11.25; #170-H, all 5 vols. in single cloth binding, \$12.75.
BASIC ELECTRONICS EXPANDED course, #170-X, sets of Vols. I to VI in soft covers, \$13.85; #170-XH, 6 volumes in single cloth binding, \$14.85.
BASIC ELECTRONICS Vol. 6 only, #170-6 soft cover, \$2.90; #170-6H cloth, \$3.95.

ALSO AVAILABLE — A 5-VOLUME COURSE ON BASIC ELECTRICITY

For those who wish to master the basics of electricity before they progress in electronics, there is BASIC ELECTRICITY. This is the civilian version of the course on electricity used by the U. S. Navy to turn out trained technicians. (This course is available only from John F. Rider Publisher, Inc. or its dealers.)

More than 900 carefully selected illustrations supported by crystal-clear text make electricity completely understandable. #169, 5 vols. soft covers, \$11.25 per set; #169-H all 5 vols. in single cloth binding, \$12.75.

These and many other Rider titles are available at bookstores, electronic parts distributors, dept. stores or direct. Send for new catalog.

Buy these books today—No matter where you buy these books, we guarantee satisfaction, or your money back within 30 days of purchase. RE-2



JOHN F. RIDER PUBLISHER, INC., 116 West 14th Street, New York 11, N. Y.
 Canada: Chas. W. Pointon, Ltd., 66 Racine Rd., Rexdale, Ont.
 Export: Acme Code Company, Inc., 630 9th Ave., N. Y. C.
 India: Asia Publishing House, Bombay and other cities

CUT OUT AND MAIL TODAY



8 FREE BIG ISSUES **OLSON CATALOGS**

TYPICAL VALUE

DIAL TELEPHONE

\$7.93

No. PH-31

Standard phone company model.



We will send you a new issue every 6 weeks for a full year—NO CHARGE! Compare our World Famous Values.

MAIL TO: **OLSON ELECTRONICS**
 (Formerly Olson Radio)

715 S. Forge St., Akron 8, Ohio

SEND FREE CATALOGS

Send Dial Telephone @ \$7.93, plus postage

NAME _____ ADDRESS _____
 CITY _____ ZONE _____ STATE _____

ATLAS "Job Rated" P. A. SPEAKERS



There is an Atlas Speaker Ideally Suited for Every Job

All Atlas P. A. speakers are highly efficient, especially in the voice frequency range, providing the extra "punch" needed to override high level background noise. Most are 100% weatherproof; aluminum and diecast parts are treated with corrosion inhibitors, then finished in "stone hard" baked enamel. The CJ Cobra-Jector horns are constructed of nonresonant, indestructible fiberglass, and HU and TP speaker horns of aluminum, finished in gun-metal grey. The HU and TP speakers are particularly designed for efficient talkback operations. The peaked characteristics within the voice frequencies increase the sensitivity of these speakers as pickup devices.

All HU and CJ speakers are equipped with versatile "Versalock" . . . This rugged, reliable mounting bracket, completely adjustable both horizontally and vertically, provides positive locking in any position.

The DU-12 and DC-5, Atlas' renowned DeCor projectors, are styled to harmonize with any decor, modern or traditional.

Send for free catalog to Dept. RE-2

Model	HU-12N	HU-15N	HU-24N	CJ-14N	CJ-30N	CJ-44	TP-15N	TP-24N	DU-12	DC-5
POWER*	7.5 w	25 w	25 w	7.5 w	25 w	60 w	25 w	25 w	7.5 w	6 w
IMPEDANCE**	8 ohm	8 ohm	8 ohm	8 ohm	8 ohm	16 ohms	8 ohm	8 ohm	8 ohm	8 ohm
FREQUENCY C.P.S.	350-10,000	250-10,000	200-10,000	400-10,000	250-10,000	150-9000	250-10,000	200-10,000	400-120,000	120-7000
LENGTH OVERALL	7 1/4 in.	8 3/4 in.	12 in.	8 in.	1 1/4 in.	23" x 13"	16 1/2 in.	23 in.	14 in.	14 in.
BELL DIAMETER	7 1/2 in.	9 3/4 in.	11 1/4 in.	9 1/2" x 5 1/2"	14" x 6"	19 in.	9 3/4 in.	11 1/4 in.	7 in.	7 in.
NET PRICE	\$16.20	\$20.10	\$22.35	\$18.00	\$24.60	\$43.50	\$31.20	\$34.50	\$19.80	\$13.20

*Input range limited to frequencies above horn cutoff **All models available in 45 ohms at slightly higher prices

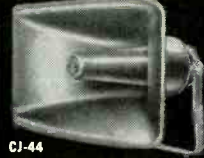

ATLAS SOUND CORP.
1449 39th Street
Brooklyn 18, N. Y.
In Canada:
Atlas Radio Corp., Ltd.,
Toronto, Ontario

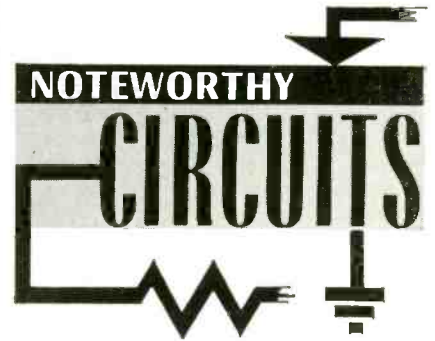

RE: ONE-TURN MOTOR CONTROL

On pages 157 and 158 of the October, 1956, issue, Mr. Schulman described an ingenious control for a one-turn motorized display table. When a switch was momentarily pressed, the table—operated by a 1-rpm motor—started, made

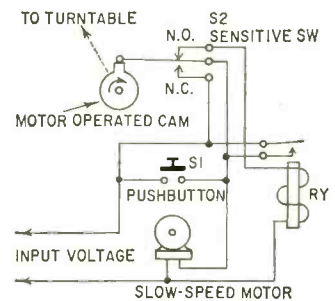

one complete revolution and then stopped. The original circuit required a relay with dpdt contacts. The diagram shows how I simplified the circuit to use a relay with spst normally open contacts.

The circuit is shown as it is with the motor at rest. When S1 is momentarily pressed, it closes the circuit to the motor and simultaneously applies voltage to the relay coil through S2's normally open contacts. The relay contacts close, shunting S1 so the motor continues to run. When the arm of S2 falls off the cam lobe, it opens the circuit to the relay coil and completes the motor circuit through S2's normally closed contacts. The motor continues to run until S2's arm rides up on the cam lobe and opens the circuit.—David C. Crocker, W1TMO

IMPROVING FM TUNER

When I first constructed the Sweet FM tuner (RADIO-ELECTRONICS, October, 1958), sensitivity and selectivity were poor and I began experimenting in an effort to improve these characteristics. Dx and quieting sensitivity can be enhanced by substituting a 6AK5 for the 6BH6 rf amplifier and adding a 6AU6 limiter (see diagram). The 6AK5 approximately doubles the

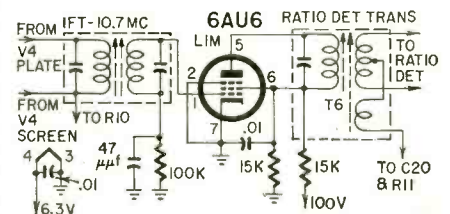

Purchasing A HI-FI SYSTEM?

TIME PAYMENTS AVAILABLE

Up to 2 years to pay!

Send Us Your List Of Components For A Package Quotation

WE WON'T BE UNDERSOLD!

All merchandise is brand new, factory fresh & guaranteed.

Free Hi-Fi Catalog

AIREX RADIO CORPORATION

85-RE Cortlandt St., N.Y. 7, CO 7-2137

Jim Lansing*
Altec Lansing
Electrovoice
Superscope
Hartley * Viking
University * Jensen
Acoustic Research
Janszen
Wharfedale
USL Citizen Band
Gonset * Hallicrafter
Texas Crystals
Concertone
Bell * G.E.
Weathers
Harman-Kardon
Eico * Pilot
Acrosound
Superscope
Dual Changer
Bogen * Leak
Dynakit * Fisher
H. H. Scott
Thorens* Sherwood*
TEC * Roberts
Amplex * DeWald
Sony * Tandberg*
Challenger
Wollensak
Garrard
Miracord
Glaser-Steers
Rek-O-Kut
Components
Norelco
Fairchild
Pickering * Gray
Audio Tape
Magnecord*
Artizans Cabinets
Rockford Cabinets
*Fair Traded

all new edition

up-to-date component prices

PLUS

the quick easy way to figure service charges

EQUALS

Dave Rice's

OFFICIAL PRICING DIGEST

VOL. 4, NO. 1



Flat rate and hourly service charges, based on and showing regional and national averages, plus up-to-date list or resale prices on over 63,000 components. Arranged alphabetically by manufacturers and products, numerically by part number. Compact, convenient size fits in tube caddy, toolbox or pocket. \$2.50 per copy from your distributor.

ELECTRONIC PUBLISHING COMPANY, INC.
180 N. WACKER DRIVE, CHICAGO 6, ILL.

bias at the limiter grid. The slight increase in heater and B-plus drain was the only cost of this improvement.

The limiter was mounted directly behind T6, and the added 10.7-mc if transformer (J. W. Miller 1463) was placed directly behind V4. The table shows the detector output with and without limiter when receiving three fringe-area stations on an attic antenna.

Station	Detector output volts	
	No limiter	With limiter
KFMB	0	-3.0
KPLI	-0.63	-4.5
KGB	-1.8	-4.5

The combination of limiting and ratio detector gives very good results over a wide range of signal levels.

Incidentally, the joke was on me. All my original troubles were eventually traced to a poor ground return in the rf amplifier stage.—Robert W. McDonald

SINGLE-PULSE CIRCUIT

In an industrial application we needed an electronic counter that would be actuated by the first of a series of pulses and not affected by any succeeding ones. A very simple circuit was developed around a 2D21 thyratron biased so it is cutoff with normal plate voltage applied. The tube (see diagram) is made to conduct by applying a positive-going pulse to the grid circuit. If the amplitude of this pulse exceeds the bias the tube conducts. The grid loses control over plate current, and any further pulses applied to the grid are greatly attenuated in the output (cath-

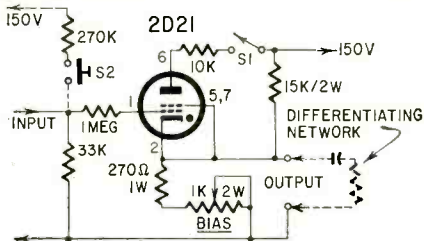

ode) circuit. In this case, the output due to the second pulse is only about 0.2% of its original amplitude.

Output is taken from across the cathode resistor, either directly or through a coupling capacitor. With direct coupling, a positive-going step function of voltage is generated when the tube conducts. The step function ranges from 4 to 19 volts, depending on the setting of the BIAS control. When the output is taken off through a capacitor, we develop a pulse whose shape depends on the coupling capacitance and the load. The BIAS control is set so the tube is cut off with S1 closed. Opening S1 restores the circuit to its non-conducting state after it has been triggered.

A normally open pushbutton or other momentary switch and a 270,000-ohm resistor can be connected as shown in dashed lines between B-plus and the input for manual operation. Closing the switch produces one step function or pulse in the output, depending on the output circuit.—Paul S. Lederer END

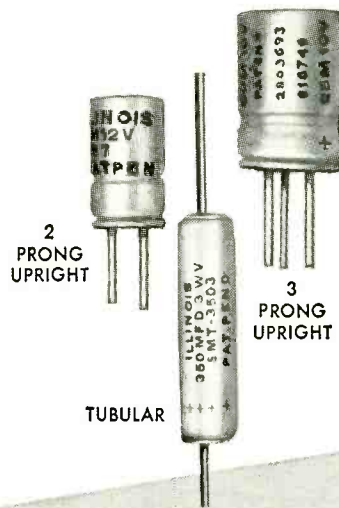

TUBULAR

2 PRONG UPRIGHT

3 PRONG UPRIGHT

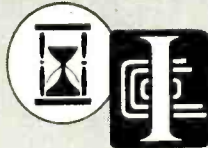

ILLINOIS
CONDENSER COMPANY
1616 North Throop
Chicago 22, Illinois
Phone EV 4-1300

NOW!
In stock at your distributor

SMT
SUB-MINIATURES

For all transistorized electronics

Unsurpassed where size is essential in countless replacement applications. Available in full range of capacities and voltages . . . SMT, SMTU (up-right), upright common positive, upright common negative and non-polarized.

Order from your distributor now. Our new SMT catalog is available upon request.

BRAND NEW
UNITED'S FIRST QUALITY
TUBES DISCOUNTS up to **80% OFF**
GUARANTEED ONE FULL YEAR! NOT USED! NO PULLS! WHY PAY MORE?

Qty.	Tube	Price	Qty.	Tube	Price	Qty.	Tube	Price	Qty.	Tube	Price	Qty.	Tube	Price	Qty.	Tube	Price
024	.75	3CY5	.70	6AG7	.75	6BU8	.69	6BU8	.77	12CU6	1.00	17L6	.57				
1A5	.80	3DK6	.59	6AH4	.82	6BX7	1.02	6BY5	.53	12DA6	.48	18A5	.90				
1A7	.94	3DT6	.49	6AH6	.98	6BY6	.56	6W4	.60	12BR7	.70	18FW6	.49				
1AX2	.70	3Q4	.68	6AM5	3/1.00	6BZ5	.54	6W5	.68	12BV7	.80	18FX6	.52				
1B3	.73	3R5	.89	6A5	.46	6BZ7	.96	6X4	.38	12BY7	.73	18FY6	.40				
1C5	1.02	354	.60	6AL7	1.35	6BZ8	1.05	6X5	.51	12BZ7	.74	19A4	.80				
1C3	.73	3V4	.57	6AM8	.77	6C4	.42	6X8	.75	12C5	.55	19BG6	1.30				
1C4	.60	4AU6	.54	6AN8	.84	6C6	.53	7AD7	.80	12CU5	.55	19T8	.78				
1H5	.75	4BA6	.54	6AQ5	.49	6CD6G	1.20	7AF7	.70	12CN5	.55	21EX6	1.40				
1J3	.72	4BC5	.55	6AQ6	.60	6CD6GA	1.40	7AU7	.60	12CR6	.53	25AX4	.71				
1K3	.72	4BC8	.95	6AR5	.54	6CF5	.63	7EY6	.75	12CT8	.90	25BQ6	.68				
1L4	.60	4BN6	.75	6A55	.59	6CG7	.59	8AU8	.82	12CX6	.58	25CB6	1.00				
1L4A	.99	4B07	.95	6A56	2.25	6CG8	.76	8AW8	.92	12DB5	.63	25CUE	.52				
1L4B	.99	4BS8	.97	6A58	.85	6C7	.65	8BQ5	.59	12DE7	.74	25CD6	1.20				
1L4C	.99	4BU8	.70	6AT6	.42	6CN7	.64	8C7	.67	12DL3	.84	25C6	.50				
1L4D	.99	4BZ6	.57	6AU7	.81	6CQ8	.83	8CM7	.61	12DQ6	1.00	25D6	.50				
1L4E	.99	4BZ7	.95	6AU8	1.05	6CQ8	.57	9C18	.75	12E6	.53	25D6G	1.40				
1L4F	.99	4CB6	.57	6AV6	.49	6CS6	.56	8CX8	.90	12ET5	.72	25E6	.56				
1L4G	.99	4C56	.60	6AV7	.60	6CS7	.70	8E88	.93	12F6	.55	25L6	.57				
1L4H	.99	4CY5	.70	6AV8	.85	6CV5	.57	12AB5	.54	12EK6	.57	25L6G	.57				
1L4J	.99	4DE6	.51	6AV5	.57	6CX8	.90	10C8	.85	12EL6	.49	25Z6	.65				
1N5	.90	4DT6	.54	6AV6	.39	6CV5	.70	11CY7	.74	12EL6	.57	32E5	.52				
15A	1.10	5AN8	.78	6AW8	.88	6CQ5	.57	12AC6	.56	12F5	.75	32E5G	.52				
174	.57	5AV8	1.00	6AX4	.84	6D6E	.57	12AD6	.56	12F8	.65	35L6	.55				
154	.75	5AQ5	.53	6AX5	.75	6DK6	.59	12AE6	.48	12FA6	.49	35L6CT	.56				
155	.90	5AT8	.79	6BA8	.91	6DN7	1.40	12AF6	.48	12FM6	.44	35C5	.50				
1U4	.56	5B8	.96	6BA8	.48	6DT6	.85	12AG6	.45	12FX8	.85	35L6G	.55				
1U5	.49	5BK7	.81	6BC5	.54	6E8	.85	12AF6	.48	12GX8	.85	35W4	.49				
1V2	.99	5B07	.96	6BC7	.93	6E8	.90	12AL5	.44	12CG6	1.05	40B2	1.50				
1X2	.75	5BR8	.78	6BC8	.96	6EA8	.78	12AL8	.94	12H5	.64	50B5	.59				
2AF4	.95	5CG8	.75	6BD6	.50	6EB8	.90	12AL8	.94	12IA7	.72	50B5G	.59				
2B1	1.00	5E8	.79	6BE6	.54	6EB8	.78	12AT6	.45	12J7	.85	50EH5	.54				
2BN4	.63	5EU8	.79	6BF5	.88	6E8	.55	12AT7	.72	12SC7	.75	50L6	.60				
2CY5	.70	5I6	.67	6BF6	.43	6F6	.85	12AU6	.49	12SF5	.75	50L6G	.60				
3A1	.84	5T8	.80	6BG6G	1.40	6G6	.55	12AV6	.40	12S7	.75	50L6G	.60				
3A4	.55	5U4	.59	6BG6GA	1.60	6J5C	.35	12AV6	.40	12S7	.75	50L6G	.60				
3AF4	1.02	5U8	.80	6BH6	.64	6J5GT	.50	12AV7	.74	12S7	.88	50L6G	.60				
3B1	.41	5V4	.82	6BH8	.86	6J6	.68	12AW6	.55	12S7	.88	50L6G	.60				
3AU6	.50	5V6	.55	6BJ6	.61	6J7	.85	12AX4	.66	12S7	.85	50L6G	.60				
3AV6	.40	5W4	.95	6BK5	.85	6K6	.58	12AX7	.62	12U7	.61	50L6G	.60				
3BE6	1.50	5X4	.75	6BK7	.84	6L6	1.10	12AY7	1.44	12U6	.61	50L6G	.60				
3BE6	.50	5X8	.77	6BL7	.99	6S4	.47	12AZ7	.62	12W6	.68	50L6G	.60				
3BC5	.53	5V3	.45	6BN4	.56	6S47	.75	12B4	.62	12X4	.37	50L6G	.60				
3BE6	.51	5Y4	.75	6BQ5	.59	6SC7	.75	12BA6	.48	14H7	.80	50L6G	.60				
3BN4	.63	5A7	1.10	6BQ5	.59	6SF5	.75	12BA7	.95	14N7	.80	50L6G	.60				
3BN6	.75	6A5	1.15	6BQ6	.56	6SB7	.75	12BD6	.49	14XA4	.66	50L6G	.60				
3BU8	.70	6B4	.82	6BQ6	.56	6S7	.75	12BE6	.52	17B06	1.00	50L6G	.60				
3BU8	.70	6B4	.82	6BQ6	.56	6S7	.75	12BF6	.43	CTB	1.00	50L6G	.60				
3BZ6	.54	6AF3	.72	6BQ5	.59	6S7	.75	12BH7	.72	17CUE	.57	50L6G	.60				
3CB6	.53	6AF4	.96	6BQ5	.59	6S7	.75	12BI6	.55	17CUE	.57	50L6G	.60				
3CF6	.59	6AF4A	.96	6BQ5	.59	6S7	.75	12BQ6	.50	17DQ6	1.00	50L6G	.60				
3C56	.51	6AC5	.64	6BQ5	.59	6S7	.75	12BQ6	.50	17H3	.50	50L6G	.60				

ALL-PURPOSE ALUMINUM DIODES—25c EA. WIRE LEADS. 500 mil. silicon rectifiers 59c ea. 10 for \$3.90.

SEND FOR COMPLETE PARTS CATALOG WITHOUT COST USE THIS AD AS ORDER BLANK

UNITED RADIO CO.
ESTABLISHED 1920
BOX 1000 B
NEWARK, N. J.

TERMS: remit full price plus postage with order. No COD. Mail to Dept. RE. Excess postage will be refunded. Subject to Prior Sale \$5 MINIMUM ORDER

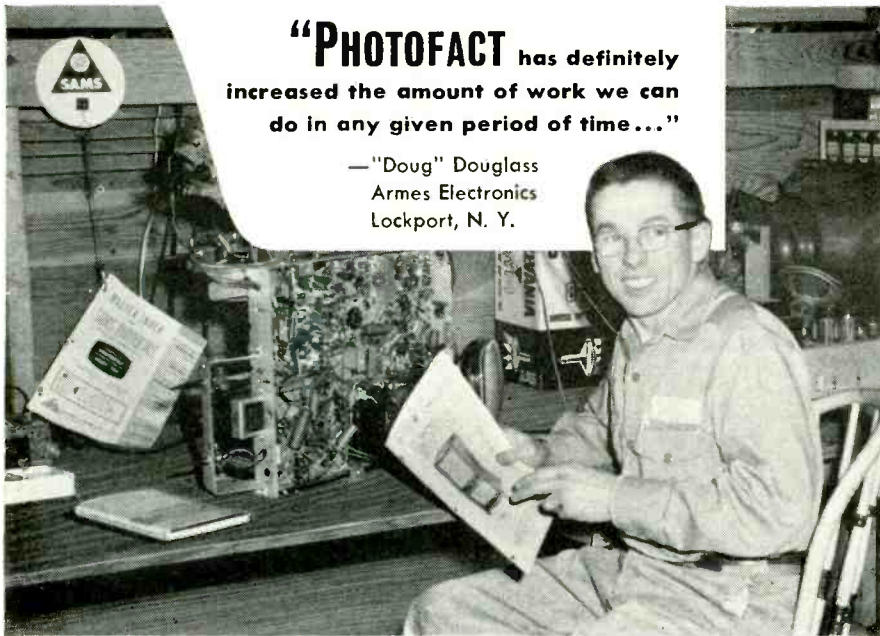

"PHOTOFACT has definitely increased the amount of work we can do in any given period of time..."

—"Doug" Douglass
Armes Electronics
Lockport, N. Y.

Service Technicians! YOU EARN MORE... YOU RATE with the public when you own the PHOTOFACT® service data library!

You enjoy maximum earnings as the owner of a complete PHOTOFACT Service Data Library! It's inevitable, because no matter how expert you are, you can always *save more time on any job, get more jobs done daily—EARN MORE, DAY IN AND DAY OUT...*

What's more—as the owner of a complete PHOTOFACT Library, you know your customers' sets *best*. You can actually show each customer you have the PHOTOFACT Folder covering his very own set. Result: You command public respect and acceptance which paves the way to more business and earnings for you.

HOW TO STAY AHEAD...

Yes, the truly successful Service Technicians are those who own the complete PHOTOFACT Library, who can meet and solve any repair problem—faster and more profitably. And these men *keep ahead* because they're on a Standing Order Subscription with their Distributors to receive all new PHOTOFACTS as they are released monthly. (They're eligible for the benefits of membership in PEET, too—see below!)

ONLY \$10 DOWN puts the complete PHOTOFACT Library in your shop—and you have up to 30 months to pay. See your Sams Distributor today, or write to Howard W. Sams

TECHNICIANS'

NEWS

FLAT-RATE TV SERVICE

A group of California TV service associations has set up a list of flat-rate charges for various service jobs. The scale is based on a study of rates conducted by five TV service organizations: San Francisco Television Service Association; Television Service Dealers Association of San Mateo County; Alameda County Television & Radio Association; Television & Electronics Association of Marin, and the Diablo Valley Radio & Television Association.

Cards handed out by members of these groups list a local-zone service fee which covers removal of the chassis to the shop for service, reinstallation and adjustment of set in home at a \$10.70 fee. The cards also explain that repairs when the set is taken to the shop are priced at the \$10.70 figure plus any specific pricing fees that apply to the particular job. There are 38 of these fixed rates and a group of special-service prices.

The list of fees starts off with \$8.40 for work on the ac input circuit, continue with a \$3 charge for cleaning and lubricating controls, \$15.80 for repairing a turret tuner and end up with complete video and sound alignment for \$15.80. Charges for replacing in-warranty parts are also suggested.

COLOR TV SERVICE SCHOOL

Newton, N. C.—A course on servicing color TV receivers is being sponsored by the Catawba County Radio & Television Association, a member of the N. C. Federation of Electronics Associations. The course is intended to upgrade the TV technician by teaching him practical color TV repairs. Classes are held in shops of association members and are open to all technicians working in the member shops.

WANT JOBBER CODE

Detroit, Mich.—A group of 150 service dealers met as guests of the Television Service Association at the Pick-Fort Shelby Hotel to discuss jobber codes and hear a plan to help combat chain or drugstore tube testers. The TSA suggested code reads:

- Sell only to full-time service dealers with a sales tax license, and a service dealer's license where applicable.
- Maintain delivery schedules only to full-time service dealers.
- Classify students, hams and experimenters, and set up reduced discount schedules accordingly.
- Stock products of manufacturers who evince a willingness to maintain a "to the trade" attitude.

NOW IS THE TIME TO JOIN

"PEET"

THE POWERFUL NEW PROGRAM FOR QUALIFIED TECHNICIANS

If you now own a PHOTOFACT Library or plan to own one, you can apply for membership in "PEET." It's the first industry program really designed to build powerful public acceptance for the Service Technician who qualifies. Builds enviable prestige and business for its members. Benefits cost you absolutely nothing if you qualify. Ask your Sams Distributor for the "PEET" details, or mail coupon today.

HOWARD W. SAMS & CO., INC.
1726 E. 38th St., Indianapolis 6, Ind.

- Send me full details on the new "PEET" Program.
- Send full information on the Easy-Buy Plan and Free File Cabinet deal.
- I'm interested in a Standing Order Subscription.
 - I'm a Service Technician full-time; part-time

My distributor is _____

Shop Name _____

Attn: _____

Address _____

City _____ Zone _____ State _____

• Cooperate with those who have been designated trade association representatives by a bona-fide association in the establishment of the jobber ethic program.

• Enter name and address of purchaser on all sales slips.

COURSE FOR TECHNICIANS

Chicago, Ill.—Nearly 100 TV service technicians went back to school for 2 days to learn the latest servicing techniques and practices, necessary for servicing transistor TV's. The course



is given by field engineers of Motorola and specifically cover service techniques for its 19-inch transistor portable TV.

Initial classes held in eight cities across the US were for service managers of Motorola's distributor network. These people then conduct similar training programs for the dealers and service technicians in their respective areas.

FRTS OK'S LICENSING

Harrisburg, Pa.—The Federation of Radio & Television Service Associations of Pennsylvania unanimously approved the technicians' licensing bill soon to be brought before the State Legislature.

The proposed law will call for a board under the State Department of Public Instructions to administer licensing. One or two technicians and several impartial members would make up the board. All practicing technicians would receive a license to start. Later, all technicians will have to apply for a license and an examination to test their qualifications.

A WRONG MADE RIGHT . . .

A sentence in Admiral's customer instruction sheet accompanying each portable radio which stated, "Power is supplied by four 1.5-volt ordinary batteries obtainable at any drug or hardware store," has been called, by NATESA headquarters, to the attention of Willis Wood, national service director. He promptly wrote back to advise that reference to drug and hardware stores will be dropped and "your dealer" substituted. Thanks to Admiral for that quick action. —NATESA Scope

ESFETA LICENSING FORUM

Albany, N. Y.—Following a recent meeting of the Empire State Federation of Electronic Technicians Associations at the Hotel Wellington, a second and final open forum on licensing was held. The discussion concerned mostly the

distributors throughout New York State who are opposing the proposed licensing bill soon to go before the State Legislature. Two distributors claimed that they were listed by NEDA as against the bill without their consent and were not actually holding this position.

For a copy of the ESFETA-sponsored license bill, write to Mr. Daniel Hurley, License Committee Chairman, 410 Florida Rd., Mattydale 11, N. Y. Enclose a self-addressed envelope.

CSEA TECHNICAL MEETING

Pasadena, Calif.—The California State Electronics Association and the Radio Television Technicians Association met at Vasa Hall. Members were invited to bring along any test instruments which did not perform properly. Stan Gilkinson, technical committee chairman, helped members with test-equipment problems.

A B&K calibrator was on hand for use as standard to check vom's and vtm's. A variable square-wave generator and a wide-band scope were also set up, enabling technicians to check the frequency response of their scopes against a properly operating unit.

TEAM MEETS

St. Louis, Mo.—Details of TEAM's (The Electronic Association of Missouri) certification and bonding program were explained to some 100 service dealers at a recent association meeting at the Coronado Hotel.

Speakers included John L. O'Brien and Charles Thurber of the Better Business Bureau of St. Louis; Anthony Salamone of St. Louis University; Vernon Rudolph, electronics instructor; N. A. Mayer, J. P. McMillian and H. Golden of TEAM, and W. C. Pecht, editor of *TEAM News*.

Under the program, qualified and tested members will be issued a shield and identification cards to serve as guides to the public in its selection of TV repair firms. The program will be policed by TEAM with the cooperation of the Better Business Bureau.

EXPLAIN TO YOUR CUSTOMER . . .

Analogies are useful for explaining difficult subjects. Most of us learned about electrical circuits in terms of water pipes and tanks.

TV sets are things that people *do not* understand, so explaining to a customer why he has to pay for another repair soon after getting a new picture tube is often difficult. But using an analogy can make the task easier.

For example, you can use this approach: "Suppose you take your car to a garage and get a couple of new tires installed. Then a few days later the rear end goes. You will probably curse your luck, but won't blame the mechanic who fitted the tires, nor will you expect to have a new rear end installed free. Now your TV set is like that car. It consists of . . ."

Another time the car analogy can be used is when your customer is deciding to buy a super-deluxe TV set for \$350,

just
out!

NEWEST EDITION of
a HOWARD W. SAMS
BEST SELLER

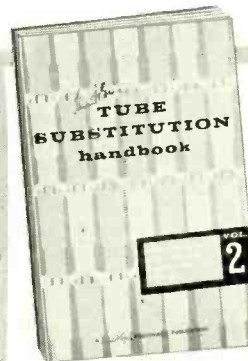

revised!
enlarged!
more
valuable
than
ever!

HOWARD W. SAMS

Tube Substitution Handbook (Vol. 2)

ONLY \$150 • 17% MORE SUBSTITUTIONS THAN IN PREVIOUS VOLUME—over 4,450 substitutes • Covers Receiving and Industrial types, as well as Picture tubes

Don't have the right tube with you? Want to know what's a suitable substitute? Just turn to this handy tube-caddy size book for the answer. Contains over 4,450 recommended substitutes—650 more than in Vol. 1. Receiving tube directory includes 1,644 types with over 2,500 substitutions—a 25% increase. Four other sections list 186 Industrial and 494 European substitutes for American receiving tubes; 453 American receiving tube substitutes for European types; 426 Picture tube types, with 825 direct substitutions. Includes helpful facts on tube substitution and cross-referencing between sections. A "must" book for every tube caddy. 96 pages; 5½ x 8½". Only... \$150



new 1960-1961
TV Circuit Handbook

see what's new
in TV circuits
for 1960-61

Sam Marshall gives you a clear preview of the new circuits you'll find in the '61 sets, what troubles you're likely to meet, what components may be at fault. Thirteen fact-packed chapters cover circuits used by all major manufacturers, from remote tuner controls to picture tubes, including latest color TV developments. Typical circuits most frequently used are described in detail, with block diagrams, schematics and practical descriptions. Troubleshooting check charts pinpoint the most probable causes of trouble. Here's the best "briefing" you can get on the new, unfamiliar TV circuits. 128 pages; 8½ x 11". Only... \$395

HOWARD W. SAMS & CO., INC.

Order from your Sams Distributor today or mail to Howard W. Sams & Co., Inc., Dept. B-21 1720 E. 38th St., Indianapolis 6, Ind.

Send me the following books:

- Tube Substitution Handbook, Vol. 2 (TUB-2)
 1960-1961 TV Circuit Handbook (CHM-1)

\$.....enclosed. Send Free Book List

Name.....

Address.....

City..... Zone..... State.....

(outside U.S.A. priced slightly higher)

For that  **NEW IDEA**
visit the
IRE SHOW

March 20-23, 1961 New York
Coliseum and Waldorf-Astoria Hotel
Members \$1.00, Non-members \$3.00 Age limit—over 18

NEW The Original
"Strobolamp"
by SWITCHCRAFT

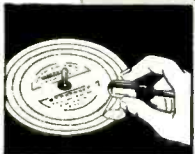
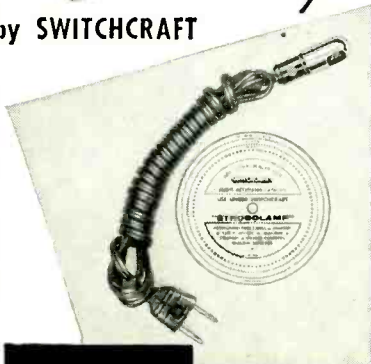

GET THE
MOST FROM
YOUR RECORDS

Incorrect turntable speeds cause Wow and Distortion. Check the speed of your turntable the easy and simple way.

"Strobolamp quickly tells you if 16%, 33%, 45 or 78 rpm speeds are correct. A HI-FI NECESSITY.

Consists of stroboscopic disc and molded neon lamp with 6 ft. AC cord. Only \$1.95 list.

Send for Hi-Fi Catalog A-403. Contact your local Hi-Fi specialist or write factory for dealer nearest you.

SWITCHCRAFT

5579 N. Elston Ave., Chicago 30, Ill.

**GUARD
YOUR
FAMILY**

**FIGHT CANCER WITH A
CHECKUP AND A CHECK
AMERICAN CANCER SOCIETY**

ADD TO YOUR INCOME
**Learn at Home to Fix
APPLIANCES**

**FREE
SAMPLE
LESSON**

Tester Furnished—No Extra Charge. National Radio Institute trains you at home. Every service customer is worth more when you can fix his electrical appliances. Mail coupon for Lesson and Catalog.

National Radio Inst., Dept. FB1, Washington 16, D.C.
Please send me Electrical Appliance Sample Lesson and Catalog FREE (No salesman will call).

Name.....Age.....

Address.....

City.....Zone.....State.....

ACCREDITED MEMBER NATIONAL HOME STUDY COUNCIL

spots a portable for \$125 and asks, "Why is that TV set so much cheaper than this one? Isn't it any good?"

Your answer could be, "It's like comparing a Ford with a Cadillac. There is no doubt that the Ford is an excellent, solidly built car. It's the same with the cheaper TV. To produce a reliable set at that price, the manufacturer has cut out all features that are not absolutely essential. What is left is a good, solid, no-frills set. But, after all, it is the little extras that make the difference. Now take this set, besides automatic picture control and remote control, it has . . ."

An argument based on this approach will usually reassure the customer and neatly place the choice back on his own shoulders.—*Service Engineer, England*

NCFEA MEMBERSHIP MEETING

Durham, N. C.—Annual membership meeting of the North Carolina Federation of Electronic Associations, Inc. elected 1960-61:

President, Charles McBroom of Durham; vice president, Howard Stutts of Newton; treasurer, Joe Woods of Greensboro; secretary, Garland Hoke of Durham. Jim Hornaday of High Point was continued as editor of the association publication, *The Printed Circuit*.

Later, J. B. Archer of the Department of Labor addressed the meeting on the need for training employees for coming needs. He pointed out that statistics indicate a probable shortage of trained people in the next few years.

Next, Charles Bates, associate state supervisor of trade and industrial education, spoke on his department's desire to help NCFA with its training program and also read a release issued by the Department of Public Instruction with respect to the NCFEA licensing program. **END**

50 Years Ago

In Gernsback Publications

HUGO GERNSBACK, Founder

Modern Electrics	1908
Wireless Association of America	1908
Electrical Experimenter	1913
Radio News	1919
Science & Invention	1920
Television	1927
Radio-Craft	1929
Short-Wave Craft	1930
Television News	1931

Some larger libraries still have copies of Modern Electrics on file for interested readers.

In February, 1911, Modern Electrics

Tele-Microphonograph.

New Electrolytic Detector.

New Marconi Circuit.

A Non-Heating Spark Gap, by D. E. McKisson.

80-Foot Wireless Mast, by R. C. Bodie.

A Hot Wire Meter, by P. W. Wormser.

Rotary Tuner, by E. J. Sortore.

Simple Detector Stand, by J. N. Davis.

Compact Tuning Device, by J. E. Crookford.

Electrolytic Detector, by A. P. Gompf.

DX-16 Super Deluxe TV KIT

70° or 90° — operating all 17", 21", 24" and 27" PICTURE TUBES

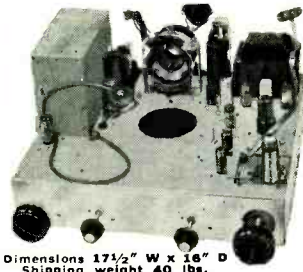

- ★ Produces a 16-Tube Chassis with 30-Tube performance.
- ★ Latest Inter-carrier Circuitry and Multi-section Tubes.
- ★ Standard Neutrode Tuner for Selectivity & Fine Definition.
- ★ All Video and I.F. Coils factory pre-aligned and tuned.
- ★ Large 250ma Power Transformer for dependable service.
- ★ 12" Speaker or Twin-cone 6" x 9" Speaker.

Includes **LIFE-SIZE** step-by-step Building Instructions
Most Up-To-Date and Practical Course in Television

COMPLETE KIT
with SET OF WESTINGHOUSE TUBES \$93.49

4-6CB6, 6U8, 6TS, 6C4, 12BH7, 6SN7, 6BD6, 6W4, 6K6, 1X2B, 5U4, 61N4, 6G8's, incl. in the Tuner (less CRT)

Dimensions 17 1/2" W x 16" D
Shipping weight 40 lbs.

Also sold on **EASY-PAYMENT-PLAN** Buy **LIFE-SIZE** Instructions—\$2.49—and buy Parts as you build.

"ONE DOLLAR" Buys

As much as \$15 worth — Everything Brand New and sold to you with a money back guarantee.
DEDUCT 10% ON ANY ORDER OF \$10 OR OVER
(ON DOLLAR BUYS)

Plus a **FREE SURPRISE PACKAGE**

- 10 — DIODE CRYSTALS 1N34A \$1
 - 100 — ASST. 1/2 WATT RESISTORS some 5% . . . \$1
 - 70 — ASSORTED 1 WATT RESISTORS \$1
 - 35 — ASSORTED 2 WATT RESISTORS \$1
 - 50 — ASST. TUBULAR CONDENSERS \$1
 - 50 — ASSORTED FUSES popular sizes \$1
 - 75 — 220K 1/2 WATT RESISTORS 10% \$1
 - 75 — 470K 1/2 WATT RESISTORS 10% \$1
 - 10 — WIREWOUND RESISTORS 1000Ω-10W \$1
 - 10 — ASST. WIREWOUND RES. 5, 10, 20 watt . . \$1
 - 5 — DIODE CRYSTALS 2-1N21 2-1N22 1-1N64 51
 - 4 — DIODE CRYSTALS 1-1N60 2-1N64 1-1N69 51
 - 4 — DIODE CRYSTALS 1N64 \$1
 - 4 — DIODE CRYSTALS 1N69 \$1
 - 100 — ASST. CERAMIC CONDENSERS \$1
 - 10 — 750K VOLUME CONTROLS less switch . . \$1
 - 100 — MICA CONDENSERS 10Kmmf-500v \$1
 - 10 — HV TUBULAR CONDENSERS .005-6000v . \$1
 - 35 — ASST. DISC CERAMICS best numbers . . . \$1
 - 50 — ASST. MICA CONDENSERS some in 5% . \$1
 - 6 — ASST. SLIDE SWITCHES spst, dpdt, etc. . \$1
 - 4 — BAKELITE KNIFE SWITCHES \$1
 - 3 — ASST. TOGGLE SWITCHES spst, dpdt, etc. \$1
 - 15 — ASST. ROTARY SWITCHES \$15 worth . . . \$1
 - 100 — FINEST NYLON DIAL CORD best size . . \$1
 - 200 — SELF TAPPING SCREWS #8 x 1/2" . . . \$1
 - 35 — ASST. RADIO KNOBS screw and push-on . \$1
 - 100 — ASSORTED KNOB SET-SCREWS \$1
 - 25 — ASSORTED CLOCK RADIO KNOBS \$1
 - 600 — ASST. H'DWARE screws, nuts, rivets, etc. \$1
 - 35 — ASST. SOCKETS octal, novol and miniature . \$1
 - 25 — ASST. PRINTED CIRCUIT SOCKETS . . . \$1
 - 10 — ASST. VOLUME CONTROLS less switch . . \$1
 - 5 — ASST. VOLUME CONTROLS with switch . . \$1
 - 20 — ASST. PILOT LIGHTS popular types . . . \$1
 - 10 — PILOT LIGHT SKTS. bayonet type, wired . \$1
 - 50 — ASST. TERMINAL STRIPS 1, 2, 3, 4 lug . \$1
 - 10 — ASST. RADIO ELECTRO. CONDENSERS . \$1
 - 5 — ASST. TV ELECTROLYTIC CONDENSERS . \$1
 - 25 — ASST. MICA TRIMMER CONDENSERS . \$1
 - 15 — TUBULAR CONDENSERS .47-400v \$1
 - 15 — TUBULAR CONDENSERS .25-600v \$1
 - 6 — TV ION TRAPS standard for all CRT's . . \$1
 - 15 — TUBULAR CONDENSERS .047-600v . . . \$1
 - 2 — ELECTROLYTIC COND. 40/40-150v . . . \$1
 - 3 — ELECTROLYTIC COND. 50/30-150v . . . \$1
 - 25 — ASST. PEAKING COILS popular types . . \$1
 - 1 — ELECTRIC PHONO MOTOR 78rpm 110v . . \$1
 - 300 — ASST. 1/2 W RESISTORS short leads . . \$1
 - 4 — TV CENTERING RINGS \$1
 - 35 — DISC. CERAMIC CONDENSERS 5000mmf . \$1
 - 25 — ASST. RADIO DIAL POINTERS \$1
 - 8 — ASST. LUCITE CASES handy for parts . . \$1
 - 100 — MICA CONDENSERS 820 mmf-500v . . . \$1
 - 3 — ASST. SIZES RADIO CHASSIS PANS . . . \$1
 - 3 — VARIABLE CONDENSERS super 420/162mmf . \$1
 - 4 — OVAL LOOP ANTENNAS ass't hi-gain types \$1
 - 3 — LOOPSTICK ANT. new ferrite adjustable . \$1
 - 3 — 1/2 MEG VOLUME CONTROLS with switch . \$1
 - 5 — ASST. 4 WATT WIREWOUND CONTROLS \$1
 - 5 — 1/2 MEG VOLUME CONTROLS less switch . \$1
 - 5 — 1 or 2 MEG VOLUME CONTROLS 1/switch . \$1
 - 100 — VOLUME CONTROL HEX NUTS \$1
 - 10 — SURE GRIP ALLIGATOR CLIPS \$1
 - 1 — GOLD GRILLE CLOTH 14"x14" or 12"x18" . \$1
 - 5 — SETS SPEAKER PLUGS wired \$1
 - 10 — SETS PHONO PLUGS and PIN JACKS . . \$1
 - 2 — \$2.50 SAPPHIRE NEEDLES 4000 playings \$1
 - 35 — MICA COND. 20-50 mmf & 15-68 mmf . . \$1
 - 35 — MICA COND. 20-100 mmf & 15-270 mmf . . \$1
 - 35 — MICA COND. 20-470 mmf & 15-680 mmf . . \$1
 - 35 — MICA COND. 20-820 mmf & 15-1000 mmf . . \$1
 - 35 — MICA COND. 20-2200 mmf & 15-2400 mmf . \$1
 - 35 — MICA COND. 20-6800 mmf & 15-10000 mmf . \$1
 - 35 — CERAMIC COND. 20-5 mmf & 15-10 mmf . . \$1
 - 35 — CERAMIC COND. 20-25 mmf & 15-47 mmf . . \$1
 - 35 — CERAMIC COND. 20-56 mmf & 15-82 mmf . . \$1
 - 35 — CERAMIC COND. 20-100 mmf & 15-150 mmf . \$1
 - 35 — CERAMIC COND. 20-270 mmf & 15-170 mmf . \$1
 - 35 — CERAMIC COND. 20-1000 mmf & 15-1500 mmf \$1
 - 35 — CERAMIC COND. 20-2000 mmf & 15-5000 mmf \$1
 - 4 — KENRAD TUBES 6SH7 \$1
 - 2 — TOP NAME 12SK7 Tubes \$1
 - 2 — TOP NAME 6507 Tubes \$1
 - 2 — TOP BRAND TUBES 35W4 \$1
 - TOP NAME TUBES OZ4, 1B3, 1X2B, 5U4, 6AC7, 6AX4, 6CB6, 6J6, 6K6, 6U8, 6V6, 6SN7, 6X8, 12AU7, 12AX7, 50L6 Each \$1
 - 3 — TV ALIGNMENT TOOLS assortment #1 . . . \$1
 - 3 — TV ALIGNMENT TOOLS assortment #2 . . . \$1
 - 3 — TV ALIGNMENT TOOLS assortment #3 . . . \$1
 - 3 — TV ALIGNMENT TOOLS assortment #4 . . . \$1
 - 3 — TV ALIGNMENT TOOLS assortment #5 . . . \$1
- EACH ALIGNMENT TOOL is different and valued at over \$1
HANDY WAY TO ORDER—Simply tear out advertisement and pencil mark items wanted (X in square is sufficient); enclose with money order or check. You will receive a new copy of this ad for re-orders.
- ON SMALL ORDERS—Include stamps for postage, excess will be refunded. Larger orders shipped express collect.

BUILD YOUR OWN CABINET FOR TV CHASSIS

Comparable to the type that Top Mfrs. use on high priced TV sets.

CABINET KIT with 90% of the job done, includes—

FRONT SECTION in Solid Mahogany, Walnut or Blond Korina, **TOP, SIDES, BACK, MASK, SAFETY GLASS, ETC.**

And **EASY-TO-FOLLOW ASSEMBLY INSTRUCTIONS**

Front, Top and Sides supplied in a beautiful Piano Finish • Knob panel undrilled • For matching Mask specify type or number of CRT used. Same price—Mahogany, Walnut or Blond. (Shipping weight 36 lbs.)

21" CABINET KIT 26"H, 25"W, 22"D \$26.97

23" TV Cabinet Kit . . \$28.47 24" or 27" TV Cabinet Kit . . \$38.47 24" or 27" Front Panel Assembly . . \$24.97

TECH-MASTER for 1961 ★ "GOLD MEDAL" #2430-B

LATEST #630 CIRCUITRY WORLD'S MOST POWERFUL TV CHASSIS
COMPLETE ready to play — including Tubes, 12" Speaker, Knobs, Etc. (less CRT)
90° TV Chassis \$175.85 • 110° TV Chassis \$182.60 Brochure on request

TUBULAR CONDENSERS—85°C TOP QUALITY—Equally as good for Radio or TV work
.0047-400v, .01-400v, .02-400v, .047-400v, .001-600v, .0047-600v, .01-600v, .02-600v, .03-600v 5c ea.
.1-400v, .25-400v, .47-400v, .047-600v, .1-600v, .25-600v, .001-1000v, .0047-1000v, .01-1000v, 8c ea.
.039-1000v, .047-1000v, .1-1000v, .007-1600v, .03-1600v, .05-1600v, .005-3000v, .001-6000v, 14c ea.

ELECTROLYTIC CONDENSERS—85°C 1-50v, 1-150v, 2-450v, 25-50v, 8-150v 19c ea.
20/20-150v, 50/30-150v, 40-150v, 10-450v, 20-450v, 30-450v, 40-450v, 60-450v, 80-450v 34c ea.

CARBON RESISTORS—Regular factory stock in Stackpole, Speer, etc.
1/2 WATT 10% 10, 39, 47, 100, 120, 150, 270, 330, 390, 470, 560, 680, 820, 1k, 1800Ω 2c ea.
1/2 WATT 10% 2700, 3300, 3900, 4700, 5600, 6800, 8200, 10k, 15k, 18k, 22k, 27k, 33kΩ 2c ea.
1/2 WATT 10% 39k, 47k, 50k, 56k, 68k, 82k, 100k, 120k, 150k, 180k, 220k, 270k, 330kΩ 2c ea.
1/2 WATT 10% 390k, 470k, 560k, 680k, 820kΩ 1, 1.2, 1.5, 2.2, 6.8, 10, 15 MEGΩ 2c ea.
1 WATT 10% 3.3, 10, 39, 100, 120, 150, 330, 470, 560, 680, 820, 1k, 1800, 2700, 4700Ω 3c ea.
1 WATT 10% 6800, 10k, 15k, 18k, 22k, 27k, 33k, 39k, 47k, 68k, 82k, 100k, 150k, 470k, 680kΩ 3c ea.
2 WATT 10% 18, 22, 82, 100, 180, 2200, 3900, 4700, 6800, 8200, 18k, 22k, 100k, 470kΩ 4c ea.

WIREWOUND RESISTORS 5-5w, 16-10w, 20-10w, 47-5w, 100-5w, 140-5w, 220-5w 9c ea.
280-10w, 390-5w, 470-5w, 500-10w, 680-10w, 820-5w, 1K-5w, 1K-10w, 1500-5w, 2K-10w 9c ea.
2500-5w, 3K-10w, 4700-5w, 5K-10w, 6K-10w, 7K-10w, 8200-5w, 10K-5w, 15K-5w, 20K-10w 9c ea.

CERAMIC CONDENSERS 1, 2, 3, 5, 6, 10, 22, 25, 47, 50, 51, 56, 82, 100, 120, 150 mmf 3c ea.

CERAMIC CONDENSERS 220, 250, 270, 330, 470, 1k, 1200, 1500, 2k, 5k, 6800, 10k mmf 3c ea.

MICA CONDENSERS 5, 25, 50, 60, 68, 75, 100, 120, 150, 220, 270, 330, 470, 510 mmf 3c ea.

MICA CONDENSERS 560, 680, 820, 1k, 1500, 2k, 2500, 3300, 4700, 6k, 6800, 8k, 10k mmf 3c ea.

- S15 — "JACKPOT" TELEVISION PARTS \$1
- 10 — ELECTROLYTIC CONDENSERS 100-25/50v . \$1
- 1 — 5" PM SPEAKER alnico #5 magnet \$1
- 1 — 4" PM SPEAKER alnico #5 magnet \$1
- 1 — 3" PM SPEAKER alnico #5 magnet \$1
- 1 — 3 1/2" TWEETER SPEAKER for HI-FI \$1
- 4 — AUDIO OUTPUT TRANS. 50L6 type \$1
- 3 — AUDIO OUTPUT TRANS. 6K6 or 6V6 type . . \$1
- 3 — I.F. COIL TRANSFORMERS 436 kc \$1
- 3 — I.F. COIL TRANSFORMERS 10.7 mc. FM . . . \$1
- 3 — I.F. COIL TRANSFORMERS 262 kc (auto) . . \$1
- 40 — ASST. PRECISION RESISTORS best sizes . . \$1
- 5 — SELENIUM RECTIFIERS 65ma list \$1.50 ea . \$1
- 4 — SELENIUM RECTIFIERS 75ma \$1
- 2 — SELENIUM RECTIFIERS 300ma \$1
- 2 — SELENIUM RECTIFIERS 1-500ma 1-65ma . . \$1
- 10 — TV CARTWHEEL CONDENSERS 10kv \$1
- 3 — TV CARTWHEEL CONDENSERS 20kv \$1
- 2 — TV CARTWHEEL CONDENSERS 30kv \$1
- 1 — TV RATIO DETECTOR COIL 4.5mc \$1
- 1 — TV RATIO DETECTOR COIL 10.7mc \$1
- 1 — TV SOUND I.F. COIL 4.5mc \$1
- 3 — HV RECTIFIER SOCKETS 1B3 m'nted \$1
- 3 — HV RECTIFIER SOCKETS 1X2 m'nted \$1

10-TUBES #1U4..\$1

- 2 — SILICON RECTIFIERS 500ma \$1
- 1 — SILICON RECTIFIER 750ma \$1
- 1 — LB. SPOOL ROSIN CORE SOLDER \$1
- 4 — 50' SPOOLS HOOK-UP WIRE 4 colors . . . \$1
- 10 — 6' ELECTRIC LINE CORDS with plugs . . \$1
- 5 — TV CHEATER CORDS with both plugs . . \$1
- 5 — TV CRT. SOCKETS with 18" leads \$1
- 5 — HI-VOLT. ANODE LEADS with 18" leads . . \$1
- 50 — STRIPS ASST. SPAGHETTI best sizes . . \$1
- 100 — ASST. RUBBER GROMMETS best sizes . \$1
- 100' — TWIN LEAD-IN WIRE 300Ω heavy duty \$1
- 50' — FLAT 4-CONDUCT. WIRE many purposes \$1
- 25' — INSULATED SHIELDED WIRE \$1
- 32' — TEST PROD WIRE deluxe (red or black) . \$1
- 1 — 57 INDOOR TV ANTENNA hi-gain 3 section \$1
- 20 — ASST. TV KNOBS, ESCUTCHEONS, Etc. \$1
- 1 — RCA 70° FLYBACK TRANS. #75240 . . . \$1
- 1 — TV VERT. OUTPUT TRANS. 10 to 1 ratio . \$1
- 15 — ASST. TV COILS sync. peaking, width, etc. \$1
- 15 — ASST. STANDARD TUNER VHF STRIPS . \$1
- 6 — ASST. STANDARD TUNER UHF STRIPS . \$1

BROOKS RADIO & TV CORP., 84 Vesey St., Dept. A, New York 7, N.Y. TELEPHONE CORland 7-2359

Take the backache out of AUTO RADIO SERVICING

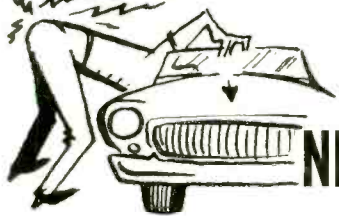

with this
NEW GERNSBACK TECHNICIANS' CLUB BOOK

The toughest part of servicing auto radios is getting them in and out of the car. This book shows you how. But that's not all it does. It points out key differences between servicing home and auto sets, tells you how to set up shop, install rear seat speakers, troubleshoot and repair all types of sets, tuners, power supplies, other components, suppress interference. Includes a chapter on FM, auto phonographs and TV. Get this book now and build your business, increase your income. Read how you can get it and others that will help you get ahead in servicing at spectacular discounts.



Practical Auto Radio Service & Installation

Transistor, Hybrid, FM & AM—
By Jack Greenfield.

Deluxe
hard cover
edition
\$4.60

**YOU CAN GET
THIS \$4.60 BOOK
FOR ONLY \$3.25**

This brand-new book in a beautifully designed hard-cover edition is sold nationally for \$4.60. But through the G/L TECHNICIANS' BOOK CLUB you can get it for only \$3.25 and others like it at similar low prices.

THE G/L TECHNICIANS' BOOK CLUB has helped thousands of service technicians everywhere

- Do Faster Servicing
- Earn More Money
- Save money on the books they need to get ahead.

Here's how it can help you!

This club offers hard-cover editions of today's best servicing books by well known authors AT A DISCOUNT OF 27%! Through mass printing and direct distribution we can offer you these \$4.60 books AT A SPECIAL LOW PRICE plus a few cents postage.

If you prefer—select any one of these books

- Fundamentals of Semiconductors —By M. G. Scroggie.
- How to Get the Most Out of Your VOM —By Tom Jaski.
- Printed Circuits—By Morris Moses.
- The VTVM—By Rhys Samuel. (Reprinted by request)
- Servicing Transistor Radios —By Leonard D'Airo.
- Oscilloscope Techniques—By Alfred Haas.

HOW THE CLUB WORKS

- List the book you want on the coupon below. **SEND NO MONEY.** Please select only one book! It will be sent to you on a No-Risk 10-day inspection plan.
- If you like the book keep it and send us your remittance. If you don't just send it back.
- A new book is published every three months—you receive it on the same No-Risk inspection plan.
- Keep only the books you want—pay only for those you keep.
- You agree to take a minimum of only 4 books—over the whole enrollment period! You may cancel anytime after that. No time limit—no contract to sign.

- TV and Radio Tube Troubles —By Sol Heller.
- Rapid TV Repair—By G. Warren Heath.
- Servicing Color TV —By Robert G. Middleton.
- TV—It's a Cinch—By E. Aisberg.
- Servicing Record Changers —By Harry Mileaf.
- The Oscilloscope—By George Zwick.

SEND IN THIS COUPON TODAY

GERNSBACK LIBRARY, INC., Dept. 21C
154 West 14th St., New York 11, N. Y.

Enroll me in the G/L TECHNICIANS' BOOK CLUB. Begin my membership with the following title. (Please list one only)

Name..... please print
Street.....
City..... Zone..... State.....

**SEND NO MONEY!
MAIL THIS COUPON TODAY!**

**You have nothing to lose
—everything to gain!
Examine the books at our risk.**

BOOKS PURCHASED FOR PROFESSIONAL
USE ARE TAX DEDUCTIBLE.



SIMPLIFY MOUNTING PROBLEMS

Mounting radio parts such as transformers is a cinch if you have a tube of Duro plastic aluminum or steel at hand. You can literally solder or weld

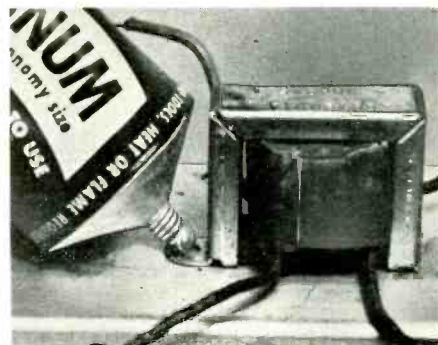

the part to the metal chassis without ever plugging in a soldering iron. And once dry, the liquid metal forms a strong bond between part and chassis. —Albert Mason

BATTERY PROTECTION

We use fingernail polish to coat the positive poles of extra flashlight cells carried in the tool kits of service personnel. The polish insulates the cells so they don't lose their charge when stored among tools. When we are ready to use a battery, the polish is peeled off. —Harry J. Miller

TV ANTENNA ALIGNMENT

To do a rapid one-man job of aligning a TV antenna, loosen the clamps on the mast, and tie a long length of clothesline to each end of the crossarm. Drop

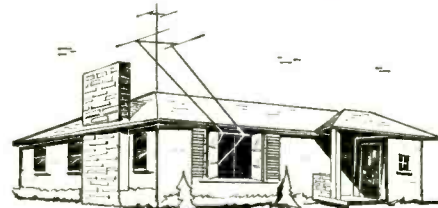

the line down over the roof, bring into a window near the set, then through the window and into the room. Line up the antenna by working the two clotheslines, then retighten the mast clamps. —J. M. Harris

NEW LINE CORD

When a set is received for servicing, we often find a new line cord has been spliced to the old one close to the chassis. Obviously, the old line cord

wore out and the owner spliced a new one on, not considering himself capable of connecting the new cord directly into the set's wiring. However, this is a useful extra service the technician can perform. It takes only a couple of minutes to disconnect the old line cord from the set, cut the splice and wire the new cord in instead.—Charles Erwin Cohn

PENCIL-IRON TINNING

When a file is used on the screw-on tip of a pencil iron preparatory to tinning, there's a good chance of loos-



ening the heating-element barrel that the tip screws onto. Rather than chance this possibility of ruining the heating element, unscrew the tip and screw it onto a bolt or screw clamped in a vise.

—Joe C. Allen

UNIVERSAL VISE

For work on devices that are hard to hold in just the right position—such as small electronic chassis—you can use a panoramic tripod head. A small

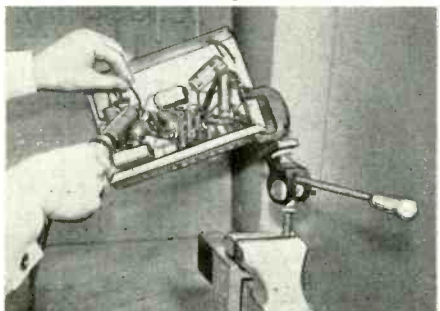

angle bracket is welded to a C-clamp, and a hole tapped for 1/4-20 thread to fit the tripod screw. A same-size machine screw is used to fasten the pan head to a piece of scrap material to clamp in the vise jaws.—Hugh Lineback

END

CORRECTIONS

Capacitors C9, C10, C11 and C12 were mistakenly identified as mica types in the parts list for the stereo preamp in the December issue. Actually, the units used were metallized paper in epoxy resin cases of about the same size and color as conventional mica units. Miniature high-grade paper or metallized paper units can be used for these components and for C13, C17 and C18.

We thank Mr. A. J. Aitken, of Sunnyvale, Calif., for bringing this to our attention.

Mr. Parker reports that the rf choke in his "Transistone" on page 35 of the December issue is a Thordarson WC-30 45-215-mh width/linearity coil instead of the horizontal oscillator coil named in the parts list.

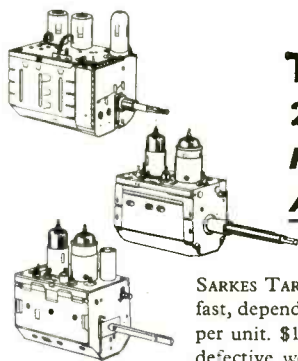

TUNERS REPAIRED \$8.50

24-Hour Service 6-Month Warranty

Repair Charge includes ALL Replacement Parts

SARKES TARZIAN, INC., pioneer in the Tuner Manufacturing business, offers fast, dependable, factory repair service on all makes and models. Cost—\$8.50 per unit. \$15 for UV combinations. Now offering 6-month warranty against defective workmanship and parts failure due to normal usage. Tuners repaired on approved, open accounts. Replacements available at low cost on tuners beyond practical repair.

Tarzian-made tuners easily identified by this stamping. When inquiring about service or replacements for other than Tarzian-made tuners, always give tube complement . . . shaft length . . . filament voltage . . . series or shunt heater . . . IF frequency, chassis identification. And, allow a little more time for service on these tuners. Use this address for fast, factory repair service:

SERVICE MANAGER • TUNER DIVISION DEPT. C



SARKES TARZIAN INC

east hillside drive
Bloomington, Indiana
edison 2-7251

Mfrs. of Tuners, Semiconductors, Air Trimmers, FM Radios, Audio Tape, and Broadcast Equipment

Please mention **RADIO-ELECTRONICS** when answering advertisements

PACKAGE HI FI or SINGLE COMPONENTS
You'll find our prices low and service fast.

Write for our quotation
CENTER INDUSTRIAL ELECTRONICS, Inc.
74-R Cortlandt Street, New York 7, N.Y.

TAPE RECORDERS



HI-FI COMPONENTS SLEEP LEARN KITS

MERITAPE Low cost, high quality recording tape, in boxes or cans.
UNUSUAL VALUES FREE 1961 CATALOG
DRESSNER, 69-32RE 174 St., Flushing 65, N.Y.

NOW—Tune your crystal controlled **CITIZENS BAND** transceiver on ALL channels. No need to buy additional receiver crystals—a **CROWN CITIZENS BAND TUNER** is all you need—simple to install—just plug this tuner into your receiver crystal socket and receive ANY citizens band channel.

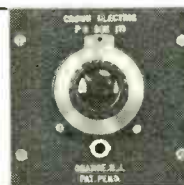

2x4x4 with 2" VERNIER DIAL

Complete Instructions Furnished
Specify Name and Model of Your Set When Ordering

Order Yours Today—Only **\$12.95** Net
No C.O.D.—Send Check or Money Order

CROWN ELECTRIC PRODUCTS CO.
P.O. BOX 171 ORANGE, N. J.
DEALER INQUIRIES INVITED

ELECTRONICS

Engineering-Technicians

Bachelor of Science Degree, 30 Months
Save Two Years' Time

- Radio-Television Plus Color Technician (12 Months)
- Electronics Technician (12 Months)
- Industrial Electronics Technician (12 Months)
- Electronics Engineering (B.S. Degree)
- Electrical Engineering (B.S. Degree)
- Mechanical Engineering (B.S. Degree)
- Civil Engineering (B.S. Degree)
- Architecture (B.S. Degree)

Heald College ranks FIRST West of the Mississippi in "Who's Who in America"

Approved for Veterans
DAY AND EVENING CLASSES

Write for Catalog and Registration Application.
New Term Starting Soon.



Missile headed for outer space. Courtesy of Space Technology Laboratories, Inc.

U.S. Air Force Photo

HEALD'S ENGINEERING COLLEGE

Established 1863

Van Ness at Post, RE
San Francisco, Calif.

Your Name

Address

City

State

"TAB" Tubes Tested, Inspected, Boxed
Six Months Guarantee! No Rejects!
NEW & Used Gov't & Mfgs. Surplus!

Orders \$10 or more, Receiving types only ppd, 48 states
 OA2 .80 6B16 .69 12A76 .80 18S1 1.00
 OB2 .65 6BK7 .99 12A77 .84 11726 1.10
 OC3 .69 6B17 1.25 12AUG .69 4-65A 16.00
 OD3 .59 6B16 .48 12B27 .59 2D21 2/81
 OZ4 .59 6BQ6 1.19 12AX7 .63 3D23 3.85
 1A7 .89 6BZ7 1.25 12BA6 .65 717A 5/81
 1B3 .78 6C4 .43 12BA7 .99 4-125 29.00
 1B5 .78 6C5 .65 12B9 .59 4-125 29.00
 154 .78 6CB6 .80 12BE6 .59 4E27 7.00
 174 .78 6CDB 1.49 12BF6 .59 4PR60 29.50

Send \$25 for Catalog!
 3/81 6H6 3/81 12BH7 .99 4X150G \$15
 1U5 .73 6J5 .52 12BY7 .98 4X250 35.00
 1X2A 1.99 6J6 .48 12B27 .59 4X500 38.00
 3Q4 .68 6K6 .59 12CU6 1.35 5BP1 8.00
 3Q5 .88 6KF 1.65 12SA7 .94 5BP4 7.50
 354 .68 6L6 1.19 12SG7 .89 35T 4.00
 3V4 .39 6SA .59 12SH7 .89 100T 7.00
 5R4 .98 6SB .99 12SJ7 .75 316A 5/81
 5U4 .75 6SA7 .69 12SK7 .94 388A 3/81
 5V4 .89 6SB7 1.19 12SO7 .84 416B 4.00

Wanted Surplus Electronics from schools & U
 5Y3 .59 6SC7 .89 198G6 2.15 450T 42.00
 6AR4 .59 6SQ7 .79 18T8 1.18 6AT7 1.00
 6AC7 .70 6SH7 .69 25BQ6 1.38 809 3.00
 6AG7 .89 6SJ7 .69 25L6 .69 811 4.40
 6AH6 .89 6SK7 .72 25W4 .77 812 3.00
 6AK5 .89 6SL7 .89 25Z5 .69 813 9.98
 6AL5 2/81 6SN7 2/81 25Z6 .75 814 3.45
 6AG5 .69 6SQ7 .74 1E34 3.49 815 2.75
 6AS7 3.00 6S7 .79 1E36 2.29 815 1.00
 6AT6 .49 6TB .98 35L6 .69 829B 8.00

Wanted 504 TL tubes! Top \$ & Paid
 6AU4 1.10 6UB .98 35W4 .49 832A 7.00
 6AU5 1.10 6VGT .79 35W4 .49 832A 3.50
 6AU6 .69 6W4 .79 35Z5 .63 1625 2/81
 6AX4 .79 6W6 .89 50A5 .69 6146 4.00
 6BA6 .59 6X4 2/81 50Z5 .69 6139 9.98
 6BA7 1.00 6X5 .49 50C5 .69 5881 2.70
 6BD6 .69 6Y6 .97 50L6 .69 6550 3.90
 6BE6 .59 6Y7 .89 6T66 3.29 6Y7 1.00
 6BG6 1.50 12AL5 .59 75 .89 5894 12.00
 6BH6 .72 12AQ5 .75 80 .59 7193 10/81

TUBES WANTED! WE BUY! SELL & TRADE!

NEW SILICON 750MA* DIODES TOP HATS
GENERAL PURPOSE 400 PIV at 300 MA
SPECIAL 2 FOR \$1 25 FOR \$8

rms/piv 17/25 12c	rms/piv 50 19c	rms/piv 170/100 29c	rms/piv 140/200 34c
rms/piv 210/300 43c	rms/piv 280/400 55c	rms/piv 350/500 70c	rms/piv 420/600 \$1.00
rms/piv 490/700 \$1.25	rms/piv 560/800 \$1.50	rms/piv 630/900 \$2.00	rms/piv 700/1000 \$2.00

* CAPACITOR INPUT DERATE 20%!
(\$5 or more this item we pay P.P./U.S.A.)

"TAB" KITS! "TAB" THE BEST KITS! "TAB"

- All Kits Contain Most Popular Values & Sizes
- Kit 2 Eng. Parallel Rules
 - Kit 3 Precision Resistors
 - Kit 10 Switches
 - Kit 75 Resistors 1/2 1/4W
 - Kit 150 Carbon Resistors
 - Kit 25 Panel Lamps
 - Kit 12 Electrolytic Cond's
 - Kit 56 Tube sockets
 - Kit 65 Tubular Cond's
 - Kit 500 Lugs & Eyelets
 - Kit 10 Bathub Oil Cond's
 - Kit 5 lbs. Surprise Pkgs.
 - Kit 10 Xmitter Mica Cond'sr.
 - Kit 3 Phone Patch Xfmr's
 - Kit 3 Searchlights
 - Kit Circular Slide Rule
 - Kit 12 Algrt Clip Ass't'd.
 - Kit 5 S.M. Tubes
 - Kit 40 Standoff Insulators
 - Kit 35 Power Resistors
 - Kit 75 Mica Condensers
 - Kit 5 Crystal Diodes
 - Kit 100 Fuses, Assorted
 - Kit 100 Ceramic Cond'sr.
 - Kit 10 Germanium Diodes
 - Kit 5 FT243 Xtal Holders
 - Kit 8 Silicon Diodes
 - Kit 5 Microswitches
 - Kit 4 Ass'd Rectifiers
 - Kit 2 PNP Transistors
 - Kit 4x50 Ft. Hookup Wire
 - Kit 2 Veeder Counters
 - Kit 2-Computer Toroids
 - Kit High Gain XTL Mike

BUY 10 KITS—GET ONE FREE! EACH KIT 99c

NEW BATTERY CHARGER BC6-12V

For 6 or 12 Volt Batteries.
Trickle & Full Charge up to 4 amps
 (Charges 6 & 12 volt batteries.)
 Built BC6-12VB.....\$10.00
 BC6-12VK Preassembled Kit.....\$ 7.50

TRANSISTORS & ACCESSORIES

- 2N441 \$3. 2N442 \$4.50. 2N277 \$4. 2N278 \$5.
 - 2N150 \$1.39. 2N170 \$1.80. 2N177 \$1. 2N178 \$1.75.
 - 2N217 \$1.50. 2N255 \$1.20. 2N270 \$9.95.
 - 2N274 \$1.25. 2N408 \$8.00. 2N410 \$1.20. 2N578 \$1.80.
 - 2N579 \$2.20. 2N581 \$1.25. 2N582 \$2.10. 2N174 \$8.50. 2N413 \$6.50.
- DIAMOND BASE MICA MOUNTING KIT.....\$.30**
DELCO ROUND BASE MICA MOUNTING KIT.....\$.30
DELCO POWER HEAT SINK WITH FINS.....\$1.00
 (\$10 or more this item we pay P.P./U.S.A.)

"VACDAC" SILICON TUBE RECTIFIER

WITH BUILT IN RF SURGE & SERIES BALANCING PROTECTION

TYPE	VRMS/PIV	AMPS	PRICE
ST866	5000/10400	0.3	\$20.00
ST816	5000/7000	0.3	\$16.00
ST5R4	1900/2800	0.5	\$15.00
ST5U4	1120/1600	0.6	\$ 8.00

★ NEW "TEKSEL" SELENIUM RECTIFIERS

FULL WAVE BRIDGE RECTIFIERS. ONE YEAR GTD!
 AMP. 18VAC 36VAC 72VAC 144VAC
 CONT. 14VDC 28VDC 56VDC 118VDC

1AMP	\$ 1.30	\$ 2.00	\$ 4.30	\$ 9.45
2AMP	2.15	3.00	4.75	12.30
3AMP	2.90	4.00	10.90	16.75
6AMP	4.15	8.00	18.75	36.15
10AMP	6.10	12.15	21.45	48.75

Write for Complete Rectifier Catalog

NEW POWER CONVERTER KIT & BUILT

12VDC to 500VDC up to 200MA 10 Watts. Tap at 250VDC Type C1250K \$35. C1250K in KIT Form \$32. Hi efficiency, low ripple, low idle current—Silicon rectifiers! Tough! Light! Mag-metal tape wound transformer, fused & short circuit proof, small in size! Quiet! Light weight! C1250E built, ready to go. Conservatively Rated. Delco Transistors Heavy Finned Heat-sink. 12VDC to 250VDC up to 100MA Type C1225B \$30. C1225K \$28. Kits are preassembled.

"TAB" TERMS: Money Back Guarantee! Our 15th year. \$2 min. order F.O.B. N.Y.C. Add shpg charges or for C.O.D. 25% surp. Prices shown subject to change.
 111-GB LIBERTY ST., N. Y. 6, N. Y.
 Send 25c for Catalog
 PHONE: RECTOR 2-6245

BUSINESS and PEOPLE

General Electric Distributor Sales Operation, Owensboro, Ky., entered the replacement capacitor market with a complete line of electrolytic and paper-Mylar types. To help introduce the line to distributors and dealers, the company included a package of fried grasshoppers to dramatize its "hop" into the replacement field with an introductory selection of 10 of the most widely used capacitors.

Sylvania Electric Products, Electronic Tube Div., Emporium, Pa., recently produced its 2,000,000,000th receiving tube. This achievement comes less than eight years after the manufacture of its

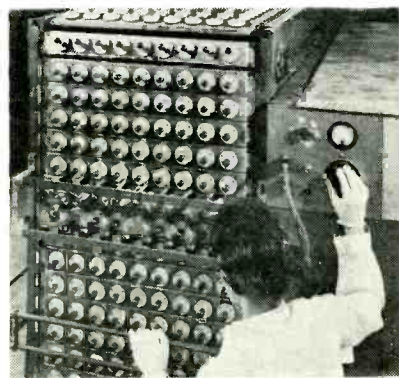

1,000,000,000th tube. A technician at the plant is shown checking voltages of tubes on an automatic aging conveyor prior to final testing.

Shure Bros., Evanston, Ill., has begun construction on a 38,000-square-foot manufacturing addition to its plant. Norman E. Schmidt, Evanston director of building; Tom Friedman, architect;



Bert W. Johnson, Evanston city manager, and S. N. Shure, president of the company, are shown (left to right) at the groundbreaking ceremony.

Pyramid Electric Co., Darlington, S. C., has been sponsoring a series of 3-day sales and engineering seminars at its

plant for representatives from all sections of the country. A. H. Bennett, Pyramid engineer, is shown conducting a lecture for one of the groups. Pyramid also introduced two new Sportsmen's



Delight capacitor kits consisting of assortments of Mylar-paper molded capacitors and 3 trout flies in reusable plastic boxes.

Amperex Electronic Corp., Hicksville, N. Y., is offering service technicians a Goodrich ice bucket free with a special assortment of its most widely used radio and TV replacement tube types.

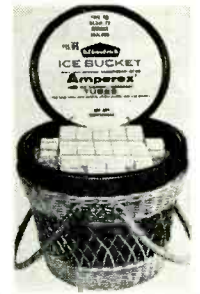

Thomas Roy Jones (left) was elected chairman of the board, Daystrom, Inc., Murray Hill, N. J. John B. Montgomery succeeds him as president. Mr. Jones will continue as chief executive officer.



Mr. Montgomery, a former Air Force general, comes to Daystrom from General Electric's Flight Propulsion Div., where he was vice president and general manager.

Hugh J. Daly joined Globe Electronics, a division of Tectron Electronics, Inc., Council Bluffs, Iowa, as vice president in charge of sales and marketing. He had been vice president in charge of sales with the Magnecord Div. of Midwestern Instruments.



Joseph Gibbs, Paul Pusecker and Jack Wellington have been named Midwestern, Eastern and Western sales managers, respectively, for Blonder-Tongue Labs, Newark, N. J. Gibbs has been with the company for the past seven years. Pusecker is being promoted from sales engineer, and Wellington joins the company from Shell Electronics.

Glen E. Davidson (left) was appointed vice president and director of marketing for the Heath Co., Benton Harbor, Mich. He joined the company from the Fruzola Candy Co., where he had headed an extensive marketing divi-



sion reorganization. Prior to that he was director of marketing for the W. A. Sheaffer Co. Alan Robertson was promoted to product-line manager. He had been senior project engineer in the amateur-radio section. Joe Shafer, project engineer, succeeds him.

John H. Hauser was advanced to the new position of general manager, distributor sales, for CBS Electronics, Danvers, Mass. He was previously distributor sales manager.



Thomas P. Clements was promoted to sales manager of the Distributor Div., Hickok Electrical Instrument Co., Cleveland, Ohio. He joined the company



in 1958 as test equipment sales manager.

Walter A. Clements, vice president, distributor division of Littelfuse, Inc., Des Plaines, Ill., was honored on his tenth anniversary with Littelfuse at an

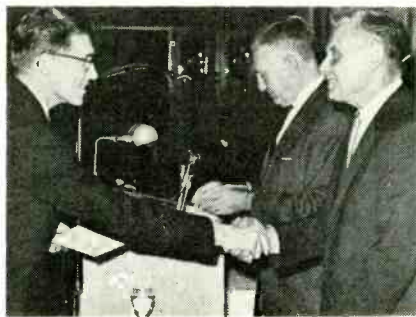

annual dinner at which service awards were presented to employees. He is shown (left), receiving the presentation from E. V. Sundt, chairman of the board of directors, as T. M. Blake, president, looks on.

John M. O'Malley (left) was promoted to superintendent of manufacturing of Clarostat Manufacturing Co.,



Dover, N. H. He has held executive positions with a number of New England firms. Douglas Haynes, production control manager of the company, was promoted to production manager. END

NOW! YOU CAN Master Mathematics



At Home — Only Minutes a Day!

PREPARE yourself NOW for a good future and higher paying job by learning mathematics this amazingly simple way—at home, in your spare time!

Can You Spare 10 Minutes A Day?

That's all it takes with this simplified home-study Course. Thompson's MATH-EMATICS FOR SELF STUDY. 5 big volumes. 1533 pages. Hundreds of charts, graphs, diagrams, formulas. Basic "know-how." Time and money-saving short-cuts. Common-sense tips. You master every type of practical mathematical problem quickly and easily.

A "Must" for Men Who Want to Get Ahead

Clearly explains all basic principles, equations, probabilities, roots, powers, slide rule, etc. You solve any problem in geometry, surveying, mechanics, navigation, architecture, designing. You compute speed, velocity, rates, physics, electricity, radio, TV. MUCH MORE!

FREE If You Send Coupon Now

Simplified Accounting—58-page book tells how to keep books; figure balances, profit and loss, collections, depreciation, interest, inventory, credit, etc. Contains 31 sample forms. Lists for \$1, but yours to keep without obligation.

integral formulas; analyze sales, production charts; figure statistics, insurance, physics, electricity, radio, TV. MUCH MORE!

Try Complete Course FREE

Send no money. Just mail coupon today for FREE 10-day examination of all five home-study books. If not convinced this great set will let you "write your own ticket" to a higher paying job, return and owe nothing. But mail No-Risk Coupon NOW to: D. VAN NOSTRAND COMPANY, INC., Dept. 182, 120 Alexander Street, Princeton, New Jersey. Est. 1848

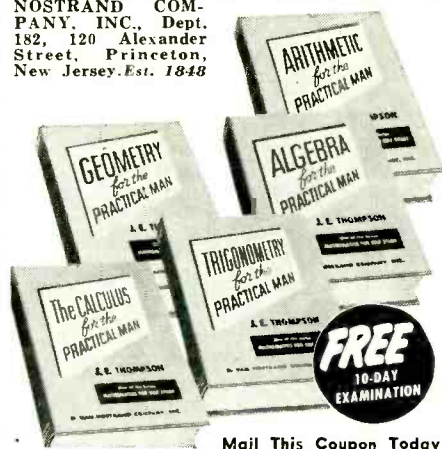

Mail This Coupon Today

D. Van Nostrand Company, Inc., Dept. 182, 120 Alexander St., Princeton, N. J.

Please send me, for FREE examination, the 5-volume set of Thompson's MATHEMATICS FOR SELF STUDY (plus my FREE copy of Simplified Accounting). If not delighted I may return the 5-volume set within 10 days and owe nothing. Otherwise, I will send you \$2.85 (plus small postage) as first payment, and \$3 per month for three months thereafter.

Name..... (Please Print Plainly)
Address.....
City..... Zone..... State.....

SAVE! Send full payment of \$11.85 WITH this coupon and we pay all delivery costs. Return privilege and refund guaranteed. (In Canada: 25 Hollinger Road, Toronto 16.) Foreign and A. P. O.—please send \$11.85 with order

PLEASE SAY YES TO THE NEW MARCH OF DIMES



THE NATIONAL FOUNDATION

TV PICTURE TUBES AT LOWEST PRICES

ALL ALUMINIZED GLASS TYPES			
Type	Price With Old	Type	Price With Old
10BP4	7.95	17BP4	11.50
12LP4	8.95	17CP4	11.50
14AJP4	14.00	17CK/CA/BZ/	21.00
14ATP4	14.00	17DP4	17.00
14B/E/CP4	10.00	17HP4	12.50
14HP4	11.00	17LP4	11.50
14QP4	11.00	20C/DP4	13.50
14RP4	11.00	20H/MP4	14.50
14WZP4	11.00	21A/OS/	21.00
14XP4	11.60	21A/AVP4	16.75
16DP4	12.00	21AWP4	15.75
16K/MP4	9.95	21BTP4	16.75
16LP4	12.50	21CBP4	16.75
16TP4	9.95	21CP4	16.75
16WP4	12.00	21DP4	16.75
17AT/AVP4	12.50	21EP4	16.75
17BP4	9.95	21FP4	16.75
17CP4	12.50	21GP4	16.75
17DP4	14.00	21HP4	16.75
17EP4	14.00	21IP4	16.75
17FP4	14.00	21JP4	16.75
17GP4	14.00	21KP4	16.75
17HP4	14.00	21LP4	16.75
17IP4	14.00	21MP4	16.75
17JP4	14.00	21NP4	16.75
17KP4	14.00	21OP4	16.75
17LP4	14.00	21PP4	16.75
17MP4	14.00	21QP4	16.75
17NP4	14.00	21RP4	16.75
17OP4	14.00	21SP4	16.75
17PP4	14.00	21TP4	16.75
17QP4	14.00	21UP4	16.75
17RP4	14.00	21VP4	16.75
17SP4	14.00	21WP4	16.75
17TP4	14.00	21XP4	16.75
17UP4	14.00	21YP4	16.75
17VP4	14.00	21ZP4	16.75
17WP4	14.00	21AP4	16.75
17XP4	14.00	21BP4	16.75
17YP4	14.00	21CP4	16.75
17ZP4	14.00	21DP4	16.75
18AP4	16.00	21EP4	16.75
18BP4	16.00	21FP4	16.75
18CP4	16.00	21GP4	16.75
18DP4	16.00	21HP4	16.75
18EP4	16.00	21IP4	16.75
18FP4	16.00	21JP4	16.75
18GP4	16.00	21KP4	16.75
18HP4	16.00	21LP4	16.75
18IP4	16.00	21MP4	16.75
18JP4	16.00	21NP4	16.75
18KP4	16.00	21OP4	16.75
18LP4	16.00	21PP4	16.75
18MP4	16.00	21QP4	16.75
18NP4	16.00	21RP4	16.75
18OP4	16.00	21SP4	16.75
18PP4	16.00	21TP4	16.75
18QP4	16.00	21UP4	16.75
18RP4	16.00	21VP4	16.75
18SP4	16.00	21WP4	16.75
18TP4	16.00	21XP4	16.75
18UP4	16.00	21YP4	16.75
18VP4	16.00	21ZP4	16.75
18WP4	16.00	21AP4	16.00
18XP4	16.00	21BP4	16.00
18YP4	16.00	21CP4	16.00
18ZP4	16.00	21DP4	16.00
19AP4	16.00	21EP4	16.00
19BP4	16.00	21FP4	16.00
19CP4	16.00	21GP4	16.00
19DP4	16.00	21HP4	16.00
19EP4	16.00	21IP4	16.00
19FP4	16.00	21JP4	16.00
19GP4	16.00	21KP4	16.00
19HP4	16.00	21LP4	16.00
19IP4	16.00	21MP4	16.00
19JP4	16.00	21NP4	16.00
19KP4	16.00	21OP4	16.00
19LP4	16.00	21PP4	16.00
19MP4	16.00	21QP4	16.00
19NP4	16.00	21RP4	16.00
19OP4	16.00	21SP4	16.00
19PP4	16.00	21TP4	16.00
19QP4	16.00	21UP4	16.00
19RP4	16.00	21VP4	16.00
19SP4	16.00	21WP4	16.00
19TP4	16.00	21XP4	16.00
19UP4	16.00	21YP4	16.00
19VP4	16.00	21ZP4	16.00
19WP4	16.00	21AP4	16.00
19XP4	16.00	21BP4	16.00
19YP4	16.00	21CP4	16.00
19ZP4	16.00	21DP4	16.00
20AP4	16.00	21EP4	16.00
20BP4	16.00	21FP4	16.00
20CP4	16.00	21GP4	16.00
20DP4	16.00	21HP4	16.00
20EP4	16.00	21IP4	16.00
20FP4	16.00	21JP4	16.00
20GP4	16.00	21KP4	16.00
20HP4	16.00	21LP4	16.00
20IP4	16.00	21MP4	16.00
20JP4	16.00	21NP4	16.00
20KP4	16.00	21OP4	16.00
20LP4	16.00	21PP4	16.00
20MP4	16.00	21QP4	16.00
20NP4	16.00	21RP4	16.00
20OP4	16.00	21SP4	16.00
20PP4	16.00	21TP4	16.00
20QP4	16.00	21UP4	16.00
20RP4	16.00	21VP4	16.00
20SP4	16.00	21WP4	16.00
20TP4	16.00	21XP4	16.00
20UP4	16.00	21YP4	16.00
20VP4	16.00	21ZP4	16.00
20WP4	16.00	21AP4	16.00
20XP4	16.00	21BP4	16.00
20YP4	16.00	21CP4	16.00
20ZP4	16.00	21DP4	16.00
21AP4	16.00	21EP4	16.00
21BP4	16.00	21FP4	16.00
21CP4	16.00	21GP4	16.00
21DP4	16.00	21HP4	16.00
21EP4	16.00	21IP4	16.00
21FP4	16.00	21JP4	16.00
21GP4	16.00	21KP4	16.00
21HP4	16.00	21LP4	16.00
21IP4	16.00	21MP4	16.00
21JP4	16.00	21NP4	16.00
21KP4	16.00	21OP4	16.00
21LP4	16.00	21PP4	16.00
21MP4	16.00	21QP4	16.00
21NP4	16.00	21RP4	16.00
21OP4	16.00	21SP4	16.00
21PP4	16.00	21TP4	16.00
21QP4	16.00	21UP4	16.00
21RP4	16.00	21VP4	16.00
21SP4	16.00	21WP4	16.00
21TP4	16.00	21XP4	16.00
21UP4	16.00	21YP4	16.00
21VP4	16.00	21ZP4	16.00
21WP4	16.00	21AP4	16.00
21XP4	16.00	21BP4	16.00
21YP4	16.00	21CP4	16.00
21ZP4	16.00	21DP4	16.00
22AP4	16.00	21EP4	16.00
22BP4	16.00	21FP4	16.00
22CP4	16.00	21GP4	16.00
22DP4	16.00	21HP4	16.00
22EP4	16.00	21IP4	16.00
22FP4	16.00	21JP4	16.00
22GP4	16.00	21KP4	16.00
22HP4	16.00	21LP4	16.00
22IP4	16.00	21MP4	16.00
22JP4	16.00	21NP4	16.00
22KP4	16.00	21OP4	16.00
22LP4	16.00	21PP4	16.00
22MP4	16.00	21QP4	16.00
22NP4	16.00	21RP4	16.00
22OP4	16.00	21SP4	16.00
22PP4	16.00	21TP4	16.00
22QP4	16.00	21UP4	16.00
22RP4	16.00	21VP4	16.00
22SP4	16.00	21WP4	16.00
22TP4	16.00	21XP4	16.00
22UP4	16.00	21YP4	16.00
22VP4	16.00	21ZP4	16.00
22WP4	16.00	21AP4	16.00
22XP4	16.00	21BP4	16.00
22YP4	16.00	21CP4	16.00
22ZP4	16.00	21DP4	16.00

TEST TUBES 8XP4 16.07 8YP4 16.07 1 year warranty

Prices include the return of an acceptable similar tube under vacuum. These tubes are manufactured from reprocessed used glass bulbs. All parts and materials including the electron gun are brand new.

ALL PRICES FOR CHICAGO, ILLINOIS. Deposit required, when old tube is not returned, refundable at time of return. 25% deposit required on COD shipments. Old tubes must be returned prepaid. Tubes shipped Italy Express. Shipped only to Continental U. S. and Canada.

WRITE FOR COMPLETE LIST
—PICTURE TUBE OUTLET—
2922 MILWAUKEE AVE., CHICAGO 18, ILLINOIS
Dickens 2-2048

SAVE on everything in stereo hi-fi and electronics



send for the 1961 ALLIED CATALOG

free

444-PAGES • VALUE PACKED. Write today for the leading Electronics Catalog. World's largest selection, including products and values available only from ALLIED. SAVE ON:

- Everything in Hi-Fi Music Systems & Components • Biggest Selection of Hi-Fi Cabinetry • Exclusive Knight® Super-value Stereo • Knight-Kits®—Best in Build-Your-Own Hi-Fi • Tape Recorders and Phone Equipment • Everything in Electronic Parts, Tubes, Transistors, Test Equipment, Amalour Gear, P.A. Systems, TV Accessories, Tools, Books.

only \$2 down on orders up to \$50 Save most at ALLIED. Write for FREE 1961 Allied Catalog today!

ALLIED RADIO, Dept. 103-B1
100 N. Western Ave., Chicago 80, Ill. **free catalog**

Send FREE 1961 ALLIED Catalog.

Name.....
Address.....
City..... Zone..... State.....

For that  **NEW IDEA**
visit the
IRE SHOW

March 20-23, 1961 New York
Coliseum and Waldorf-Astoria Hotel
Members \$1.00, Non-members \$3.00 Age limit—over 18



Any or all of these catalogs, bulletins, or periodicals are available to you on request direct to the manufacturers, whose addresses are listed at the end of each item. Use your letterhead—do not use postcards. To facilitate identification, mention the issue and page of RADIO-ELECTRONICS on which the item appears. UNLESS OTHERWISE STATED, ALL ITEMS ARE GRATIS. ALL LITERATURE OFFERS ARE VOID AFTER SIX MONTHS.

CONDENSED TUBE CATALOG for use as quick reference guide to initial equipment as well as replacements. Descriptions and basic specs on manufacturer's full line. 25 pages.—Amperex Electronic Corp., Advertising Dept., 230 Duffy Ave., Hicksville, N. Y. Use letterhead.

CUSTOM STEREO GUIDE presents room arrangements and decorating tips. Contains sections on how to select stereo components and what they are, kit-building and technical information. In addition, experts instruct on reading technical specifications and rating one component against another.—H. H. Scott, Inc., Dept. P., 111 Powdermill Rd., Maynard, Mass.

STEREO RECORD AND TAPE CATALOG No. 104 in three sections: records, 2- and 4-track tapes. Sections subdivided into music categories: Classical alphabetical by composer and popular; jazz and other types by artist, group, orchestra or title.—Allied Radio Corp., 100 N. Western Ave., Chicago 80, Ill.

VTVM CATALOG SHEET gives general description, technical features, ranges and specifications of manufacturer's model 850.—Triplet Electrical Instrument Co., Bluffton, Ohio.

STEREO HI-FI treated in three booklets, one on all-in-one stereo receivers, FM/AM tuners and amplifiers; another stereo preamplifiers and amplifiers, FM tuners and loudspeakers in kit and pre-wired form, and a third with tips on room settings and their decoration.—Harman-Kardon, Ames Court, Plainview, N. Y.

TEST EQUIPMENT Catalog No. AP16 features manufacturer's specialized line of professional products. Descriptions, specifications and prices accompanied by ample photos and drawings.—B&K Manufacturing Co., 1801 W. Belle Plaine, Chicago 13, Ill.

ELECTRONICS SUPPLIES Catalog No. 121 rounds up descriptions, specs and prices for assorted TV parts and tubes, microwave equipment, radio parts, tubes and amateur gear, aero-marine radar and test equipment tools. 51 indexed

MAIL COUPON TODAY!

Find out how you can get this book *free!*

the V.T.V.M. by Rhys Samuel published at \$2.50—contains a wealth of information on how the V.T.V.M. works . . . how to use it. Send for particulars on how to get this valuable book.

Mail to Dept. P-1
General Techniques, Inc.
Manufacturers of Quality Electronic Kits
1270 Broadway, New York City 1, N. Y.

Name _____

Address _____

City _____ Zone _____ State _____

GERNSBACK LIBRARY

Low-cost, paper-covered books on all phases of TV, radio, audio-high fidelity and practical electronics

ON SALE AT ALL
BETTER PARTS DISTRIBUTORS

HI-FI RECORDING TAPE

Splices Free (except 2400')
15 day money-back guarantee

1200' 7" Acetate	3.-	12+	24+
1800' 7" acetate	\$1.29	\$1.17	\$1.09
1800' 7" mylar	1.79	1.59	1.45
2400' 7" mylar	2.09	1.99	1.85
2400' 7" tensilized mylar	3.29	2.99	2.75
2400' 7" tensilized mylar	4.25	3.95	3.75

Can Be Assorted. Add 15c Postage Per Reel.
10c For 24+ Lot Orders.

HI-FI COMPONENTS TAPE RECORDERS available from wide variety of stock and shipped within 24 hours. Write for free wholesale catalogue. "WE WILL NOT BE UNDERSOLD." Write us and see why.

CARSTON

125-RD East 88 St.
New York, 28, N. Y.

**FREE Catalog of The WORLD'S
FINEST GOV'T
SURPLUS ELECTRONIC BARGAINS**

MAGNAVOX AUDIO AMPLIFIER

• Mfg'd for the Navy for intercommunication and amplification of radio signals. Uses 2/12A6 tubes in push-pull; also high quality input transformer for carbon microphone, and Receiver input-output transformer has variable control for headset or speaker. Also mounting for 12 Volt Dynamotor, and instruction book. Voltage required for operation 12 VDC and 250 VDC 60 MA. Can be used for mobile or home use. Size: 7 1/2" x 7" x 10". Wt.: 1.5 lbs. Navy #CMX-50128. Complete with 3/12A6 Tubes (1 spare), less Dynamotor. **\$2.95**



Address Dept. RE • All Prices F.O.B., Lima, Ohio
• 25% Deposit Required on C.O.D. Orders

Price—W/12 V. Dynamotor **\$6.95**

FAIR RADIO SALES
2133 ELIDA RD. • P.O. Box 1105 • LIMA, OHIO



SEND NOW FOR BIG FREE CATALOG!

pages. Illustrated.—Arrow Electronics, P.O. Box 3007F21, N. Hollywood, Calif.

CONTROLS FOR STEREO groups data sheets on various potentiometers, switches and pads used in stereo equipment. Many drawings. Aimed at design engineer. — Clarostat Manufacturing Co., Inc., Dover, N. H.

CRYSTALS Catalog C-3 lists items by usage in amateur and Citizens bands, marine frequencies, aircraft channels, commercial frequencies, converters, TV markers and frequency standards. Illustrated. Prices.—Quaker Electronics, Plymouth, Pa.

LOUDSPEAKERS Catalog 165-F to guide in planning stereo and mono hi-fi systems and conversion to stereo. Complete descriptions, specifications and illustrations of manufacturer's systems and their cabinetry, kits and component lines.—Jensen Manufacturing Co., 6601 S. Laramie Ave., Chicago 38, Ill.

PHONOGRAPH REFERENCE CHART and Service Guide lists 1,321 player models of which 1,006 use manufacturer's stereo and mono ceramic cartridges as original equipment and shows how they can be used as replacements in balance of 315. Complete list of replacement needles extra feature.—Sonotone Corp., Elmsford, N.Y.

PRICE-FINDER INDEX for manufacturer's radio and portable phonograph replacement parts features automatic indexing and includes current information on all catalog items.—General Electric Radio & Television Div., Electronics Park, Syracuse, N.Y. \$2.95.

INVENTORY GUIDE for more than 800 tube types provides monthly inventory record and shows what percentage of total inventory each tube should represent for a balanced stock.—Westinghouse Electronic Tube Div., Elmira, N.Y. 35c.

AUDIO PARTS AND EQUIPMENT for industrial and professional applications are cataloged in *Electronic Components for the Space Age*. Completely indexed by product and manufacturer. Industrial tube cross reference. Guide to military standards. Prices.—Harvey Radio Co., Inc., 103 W. 43rd St., New York 36, N.Y.

GENERAL ELECTRONICS products for use of service technicians, hobbyists and researchers in 64-page catalog, FR-61-G. Includes TV and radio chemicals, alignment tools, service aids and hardware.—GC Electronics Co., Div. of Tectron Inc., 400 S. Wyman, Rockford, Ill.

1961 CATALOG of latest electronic and stereo high-fidelity equipment includes among its offerings manufacturer's kit and pre-assembled items, stereo hi-fi components of all major manufacturers, tools, books, optics, cameras and material for the hobbyist, student and experimenter. Over 320 pages.—Lafayette Radio Electronics Corp., 165-08 Liberty Ave., Jamaica 33, N. Y.

BATTERIES for transistor radio and electronic instrument service are listed in new catalog. Both round types in various sizes and ratings from 1½ to 22½ volts and flat types in 9- and 22½-volt models offered. Condensed replace-

Professional Technicians Use CASTLE'S Complete

TV TUNER OVERHAUL

ALL MAKES ONE PRICE

\$9.95

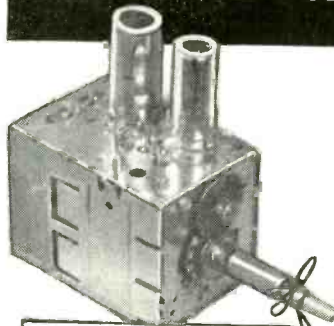

SAME DAY SERVICE!
on Popular Types
48 Hours most Others

VHF TUNERS • UHF TUNERS • UV Combinations*

Castle overhaul charge includes all labor and minor parts and written 90 day warranty. Tubes and major parts are extra at net prices. Tuner to be overhauled should be shipped complete; include tubes, shield cover and any damaged parts. Write down model number and state complaint. Pack well and insure.

Castle pioneered TV Tuner Service almost a decade ago. Overhauling TV Tuners is our only business and all specifications are met exactly

*UV combination tuner must be of one piece construction. Separate UHF and VHF tuners with cord or gear drives must be dismantled and the defective unit only sent in.

Castle TV TUNER SERVICE, INC.

5710 North Western Avenue
In Canada: 136 Main Street

• Chicago 45, Illinois
• Toronto 13, Ontario

FREE! CATALOG OF HI-FI, RADIO, TV PARTS & ACCESSORIES — yours for the asking!

Vidaire ELECTRONICS MFG. CORP.
365 BABYLON TPKE. — ROOSEVELT, N. Y.

OUT OF SPACE?
You bet we'd be... if we were to tell you all about AUDION's 'Out of this World Hi Fi Values'!

Write for free Catalog

audion
25-E Oxford Road
Massapequa, New York

YOU'LL BE AMAZED...
at our low, low hi-fi prices. Write for FREE discount catalog A-12, or send for our special quotations on your component needs.

KEY ELECTRONICS COMPANY
120 Liberty St., New York 6, N. Y.

PUZZLED?
KIT didn't work?
Probably cold solder joints!

World's Finest
ERSIN Multicore
FIVE-CORE SOLDER

Sold only by Radio Parts Distributors.
MULTICORE SALES DIVISION BRITISH INDUSTRIES CORP., Port Washington, N. Y.

ENGINEERING DEGREE IN SCIENCE MATH 27 or 36 MOS.

B.S. degree—36 mos. • B.E. degree—27 mos.
Accelerated year-round program prepares for early employment in fields of Science and Engineering. Regular 4-year program for B.S. Degree completed in 36 months, special engineering degree program in 27. Classes start March, June, July, September, January. Quality education. Graduates employed from coast to coast. Government approved for veteran training. Students from 50 states, 40 countries, 20 buildings; dorms, gym, Campus. Save time and money. Earn board. Write for catalog, 1721 E. Washington Boulevard, Fort Wayne 2, Indiana

INDIANA TECHNICAL COLLEGE

"New 1961 Catalog"

★ A complete catalog of specialized industrial Electronic TUBES and COMPONENTS... featuring Barry Electronics's savings to Industry, Servicemen and Experimenters.
• We have thousands of tube types in stock. First Quality at Sensible Prices. Buy with confidence.
• Prove these values to yourself! Complete and mail the coupon below for your copy of the "Greensheet."
• We'll also purchase your equipment and unused tubes. Send details: BARRY ELECTRONICS CORP., 512 Broadway, New York 12, N.Y. Dept. RE-2.
• Please send me a copy of the new 1961 "Greensheet" and add my name to your mailing list.

(RE-2)
Name..... Title
Company.....
Address.....
City..... State

R-E

Classified

ADS

Rates—50¢ per word (including name, address and initials. Minimum ad 10 words. Cash must accompany all ads except those placed by accredited agencies. Discount, 10% for 12 consecutive issues. Misleading or objectionable ads not accepted. Copy for April issue must reach us before February 10, 1961.

RADIO-ELECTRONICS, 154 West 14 St., New York 11, N. Y.

AUTOMATIC DOOR OPERATORS new famous make. Only \$59.95. Buy direct. Save! Free literature. **DEMSCO, INC.**, Sebring 16, Ohio.

BOOKS—ALL 10c, 2000 titles, all subjects, catalog free. **COSMAO**, Clayton, Ga.

DIAGRAMS FOR REPAIRING RADIOS, television \$2. Give make and Model. **DIAGRAM SERVICE**, Box 672 RE, Hartford 1, Conn.

TELEVISION REMOTE CONTROL—\$7.00. Free Literature—234 Monroe St., Passaic, N. J.

LEARN WHILE ASLEEP, Hypnotize with your recorder, phonograph or amazing new Electronic Educator endless tape recorder. Catalog, details free. **SLEEP-LEARNING ASSOCIATION**, Box 24-RD, Olympia, Wash.

ALL MAKES OF ELECTRICAL INSTRUMENTS AND TESTING equipment repaired. New and used instruments bought, sold, exchanged. **HAZELTON INSTRUMENT CO.**, 128 Liberty Street, New York, N.Y.

USED CORRESPONDENCE COURSES, Books Bought, Sold, Rented, Catalog Free, **VERNON**, Summerville, Ga.

COMPONENTS, Recorders, Tapes. FREE Wholesale Catalogue. **CARSTON**, 215-T East 88th St., New York 28, N.Y.

AMPEX, Concertone, Crown, Magnecord, Presto, Norelco, Bogen, Tandberg, Sherwood, Rek-O-Kut, Scott, Shure, Dynakit, others . . . Trades. **BOYNTON STUDIO**, Dept. RE, 10 Pennsylvania Ave., Tuckahoe, N.Y.

HI-FI PROBLEMS SOLVED on-the-spot by "The Hi-Fi Doctor". Audio, Acoustic, Radio Engineer. Professional visits, day, evening. New York area. **WILLIAM BOHN**, Plaza 7-8569.

CASH PAID! Sell your surplus electronic tubes. Want unused, clean radio and TV receiving, transmitting, special purpose, Magnetrons, Klystrons, broadcast types, etc. Want military & commercial lab/test and communications equipment such as G.R., H.P., AN/UPM prefix. Also want commercial receivers and transmitters. For a fair deal write **BARRY**, 512 Broadway, New York 12, N. Y. **WALKER 5-7000.**

DON'T BUY HI-FI COMPONENTS, Kits, Tape, Tape Recorders until you get our low, low return mail quotes. "We Guarantee Not To Be Undersold." Wholesale Catalog Free. **HI-FIDELITY CENTER**, 1797RC First Avenue, New York 28, N.Y.

DISCOUNTS UP TO 50% on Hi-Fi amplifiers, tuners, speakers, tape recorders, individual quotations only, no catalogs. **CLASSIFIED HI-FI EXCHANGE**, 2375 East 65th Street, Brooklyn 34, N.Y.

NEW CONCEPT OF LEARNING SELF-HYPNOSIS! Now on tape or record! Free Literature. **McKINLEY-SMITH CO.**, Dept. T5, Box 3038, San Bernardino, Calif.

PROMPT DELIVERY, we will not be undersold. Amplifiers, Tape Recorders, Tuners, etc. No. Catalogs, Air Mail Quotes. Compare. **L. M. BROWN SALES CORP.** Dept. R-239, East 24th St., New York 10, N.Y.

SILICON RECTIFIERS! 2 for \$1.00 postpaid. 500PIV at 250MA. Limited Supply. **B-B PRODUCTS**, Box 2231-D, Pasadena, Calif.

1,000 BUSINESS CARDS, "Raised Letters," \$3.95 Postpaid. Free samples. **JOHN H. TAYLOR, R.D. 2**, Box 215, West Middlesex, Penna.

LAMP—APPLIANCE PARTS WHOLESALE. All items for repairing and merchandising. Catalogue 25¢. **SECO**, 26 South 20th St., Birmingham 3, Ala.

ment guide for more than 700 domestic and foreign radio models.—**Bright Star Industries**, 600 Getty Ave., Clifton, N. J.

ANTENNAS, 103 in number, complete with technical data and prices, are fully described in catalog **PL 77**. "Balun"-fed dipoles, mono-, duo-, tri- and 4-band systems, plus rotator indicators, "balun" towers and accessories included.—**Telrex Labs**, Asbury Park 1, N. J. **END**

ANSWERS TO EFFECTS QUIZ

(page 81)

1. The *Hall effect* is the phenomenon that a conductor in a magnetic field will have a potential from side to side in the direction of the field. In fact, the effects show up with virtually no magnetic field in some semiconductors, and in a gas column, as in a neon tube. (But of course there is always *some* magnetic field from the earth.)

2. The *Thomson effect* is the fact that a temperature gradient in a metal is accompanied by a small voltage gradient, the direction of which depends on the metal. The result is that, in a conductor with a current in it, the heat due to resistive effects is slightly greater or less than can be accounted for. In copper, this is more noticeable when the current flows from hot to cold parts. In iron it is the opposite. The small difference we cannot account for is the Thomson effect.

3. The *Peltier effect* is often mistakenly associated with thermocouple effect, because it does take place in a thermocouple. But in fact it is a nuisance there. The Peltier effect is that, when we pass a current through two dissimilar metals at a junction, the junction will either heat or cool, depending on the direction of the current. It is now finding some practical use in the heating and cooling of small objects by semiconductor elements.

4. The *Volta effect* is the voltage created when dissimilar metals are brought into contact. For example, copper and zinc brought into contact will charge the copper negatively and the zinc positively. It is explained as being similar to the creation of "depletion regions" in semiconductor junctions.

5. The *Joule effect* is also known as Joule's law, which is that the heat generated in a resistance equals I^2R . Here it is of particular interest because both the Peltier and Thomson effect are independent of the Joule effect.

6. The *Miller effect* is applied in linearization of the sweep of sawtooth generators. The effect is that the grid-plate capacitance of a triode modifies the effective capacitance in the circuit and varies in effectiveness with frequency, thus contributing to linearity.

7. The *Stark effect* shows up when we mix electric fields and light. Stark discovered that strong electric fields will dissect the spectral lines of various elements into a number of finer lines which relate to the polarization of the material. If you did not get this one, it means only that you are not a professor of physics. If you are, shame on you!

8. The *Barkhausen effect* is the orientation effect of the magnetizing force of a current on the small crystalline elements in a ferromagnetic body. The Barkhausen effect accounts for the steep rise in the magnetization curve up to the "knee." It is created by the *sudden* reorientation of a number of elements which are easily rotated. Barkhausen is generally better known for his discovery of self-oscillation in vacuum tubes when a grid is at a higher potential than the plate.

9. The *Seebeck effect* is the one you are looking for when you use a thermocouple. It is the effect that causes the loop formed by connecting two junctions of dissimilar metals to carry a current if the junctions are at different temperatures. When you use a thermocouple, the couple itself is one junction while the other junction is formed by the connection to the meter. Actually there are two "cold" junctions here, but the effects do not cancel because they are made to different metals (of the thermocouple wires).

10. The *Doppler effect* is the apparent shift in frequency when sound or radio carriers are approaching or receding from the observer. Most well known is the apparent change in tone of a locomotive whistle when it approaches and leaves at great speed.

Solace yourself—If you did not know all the answers, then you learned something new! **END**

SUPER MAGNET SUPER SAVING!

Buy this Little Giant magnet, most powerful made, a sensational bargain! The low price of \$1.95 is less than 50% of what you'd pay for this magnet. Experimenters, hobbyists will find hundreds of uses for this powerful 4 oz. Alnico permanent magnet. **LIFTS 5 lbs. EASILY.** Limited quantity. Order several today. Measures 1 3/4 x 1 1/2". **Item No. 86 \$1.50**



Special Bargain (Shp. Chgs. 10c)

250 POWER TELESCOPE LENS KIT

Make Your own high powered 6 ft. telescope! Kit contains 2" diam., 75" focal length, ground and polished objective lens and necessary eye pieces. Magnifies 50x to 250x. Full instructions.

ITEM NO. 123
\$2.95
(Shp. Chgs. 10c)



AMAZING BLACK LIGHT

250-watt ultra-violet light source. Makes fluorescent articles glow in the dark. Fits any lamp socket. For experimenting, entertaining, unusual lighting effects.



Shp. wt. 2 lbs.
ITEM NO. 87
\$2.95
(P. P. & Hdg. Chgs. 35c)

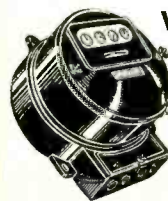

WATT HOUR METER

Leading makes—reconditioned. Ideal for trailer parks. 100-110 volts, 60 cycles. 2-wire A.C. 5 amp. Heavy metal case 8 1/2" x 6 1/4" x 5". Easy to install. Shp. wt. 14 lbs.

ITEM NO. 33
NOW ONLY \$4.50
(P.P. & Hdg. Chgs. \$1.25)

HUDSON SPECIALTIES CO., 160 W. 14th St. Dept. RE 261, New York 7, N.Y.

I am enclosing full remittance for items circled below. (Be sure to include shipping charges.)

87 33 86 123

Name Please Print Clearly

Address

City Zone State

new BOOKS

SERVICING TRANSISTOR TV RECEIVERS, by Milton S. Kiver and Charles R. Gray. Howard W. Sams & Co., Inc., 1720 E. 38 St., Indianapolis, Ind. 5 1/2 x 8 3/4 in. 269 pp. \$4.50.

Transistor TV is an actual fact. This book explains the new circuits and shows how to align and service them. It begins with the fundamentals of transistors for those who have had little experience with them previously. The tuner, if amplifier, sync separator, deflection system and other TV circuits are discussed from a practical viewpoint for practical men.

The final chapter covers test equipment, transistor handling and other topics. Actual circuits and recommended alignment procedures are given. —IQ

STEREO HANDBOOK, by G. A. Briggs. Wharfedale Wireless Works, Ltd., Bradford, Yorkshire, England. 5 1/2 x 8 1/2 in. 146 pp. \$2.50.

According to this author and engineer, "with stereo it is difficult to separate fact from fiction." Here he evaluates the pros and cons, giving not only his own views of the subject but those of other sound experts. He describes the problems and techniques in a way to help the layman select and enjoy his equipment.

Among the topics clearly discussed are stylus and record wear, speakers and their placement, amplifiers, acoustics and broadcast stereo. He compares stereo and mono, disc and tape, and includes diagrams and photos of typical hi-fi installations. —IQ

SOUND MERCHANDISING TECHNIQUES, by Wolton N. Hershfield. Sound Publishing Co. Inc., 299 Madison Ave., New York 17, N. Y. 8 1/2 x 11 in. 61 pp. \$3.

How to sell audio equipment and installations effectively is the basis of this book. It covers its subject carefully, including subjects such as development of a sound merchandising program, selection of the sales engineer, conservation of sales time, application of your product and a breakdown of the public-address system into its component parts.

A second section, called application series, shows nine types of audio systems that are used commercially and details what types of audio equipment are needed in these applications.

HOW TO USE METERS, By John F. Rider and Sol D. Prensky (2nd Edition). John F. Rider Publisher Inc., 116 W. 14 St., New York 11, N. Y. 5 1/2 x 8 1/2 in. 216 pp. \$3.50.

Starting with a description of the principles and construction of various types of meters, the book goes on to describe the many ways meters can be used. Some of the topics include: power

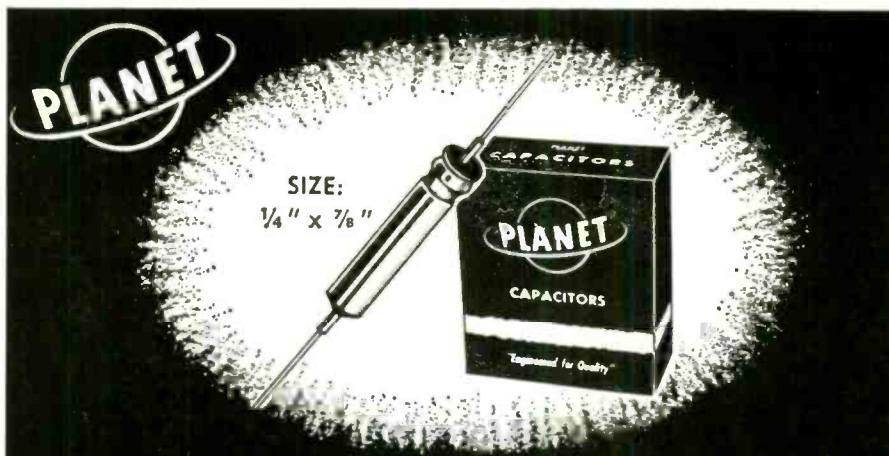

TRANSISTOR LYTICAPS TYPE "TL"

TYPE "TL" . . . Sub-miniature aluminum foil capacitors . . . hermetically sealed in aluminum tubes . . . clear plastic outer insulating sleeves . . . all mechanical internal connections . . . no "cold weld" nor "pressure" connections . . . engineered for quality for replacement in all transistorized circuits.

Write today for complete information.

PLANET SALES CORPORATION
225 Belleville Avenue Bloomfield, New Jersey

Ask By Name For

GENUINE

your assurance
of brand name
quality

"NO NOISE"
PRODUCTS



**NO-NOISE
VOLUME CONTROL
and CONTACT
RESTORER**

- Cleans • Lubricates
- Protects • Carbon Tact Solution

2 oz. Bottle \$1.00
6 oz. Spray Can \$2.25
Net to Servicemen

**NO-NOISE
TUNER-TONIC
with PERMA-FILM**

- Cleans, lubricates, restores all tuners, including wafer type.
- Non-toxic, non-inflammatory.
- For TV, radio and FM use.
- Economical—a little does a lot.

6 oz. Aerosol Can \$3.25
Net to Servicemen



FREE

at your jobbers
**5" PLASTIC
EXTENDER**

- Push Button Assembly
- For Pin-Point Applications
- Does Not Cause Shorts

ELECTRONIC CHEMICAL CORP.

813 Communipaw Avenue Jersey City 4, N. J.

voices from outer space!
SPECIAL OFFER, 25¢

Dramatic Events Recorded First Time From Short Wave Radio!

President's voice from outer space . . . police capture of a gunman . . . radio contact with record altitude flight Many other fascinating, historic events—ships, planes, foreign stations—all transcribed on a limited-edition recording, "The Amazing World of Short Wave Listening," narrated by world-famous newscaster Alex Dreier. If you're alert, adventuresome, send for this remarkable recording today!

As heard on Hallicrafters precision receivers, \$59.95 to \$395.00.



Hallicrafters Department 23, Chicago 11, Ill.
Enclosed is 25¢. Please rush "The Amazing World of Short Wave Listening."

NAME _____
ADDRESS _____
CITY _____ STATE _____

measurement and wattmeters, meters adapted for rf measurements, general electrical tests and measurements, specialized measurements and advanced meter features.—LS

SELECTED SEMICONDUCTOR CIRCUITS HANDBOOK. Edited by Seymour Schwartz. John Wiley & Sons Inc., 440 Park Ave. S., New York 16, N. Y. 6 x 9 in. \$12.

This is a very unusual and useful transistor book. It describes more than 150 practical, tested circuits of all kinds, from simple to complex. Among them are low- and high-frequency amplifiers, oscillators, logic circuits, switches, flip-flops, converters and power supplies. All have been selected for proven performance and wide interest, and all values are specified.

Each chapter is preceded by design information on the circuits. It explains the theory and basic design. Formulas, graphs and references are given.—IQ

TRANSISTOR MANUAL, fifth edition. Semiconductor Products Dept., General Electric Co., Charles Bldg., Liverpool, New York, 5 1/2 x 8 1/2 in. 156 pp. \$1.00.

This latest edition includes material on tunnel diodes and their applications. Like the earlier manuals, it is a complete handbook on transistors, Unijunctions and controlled rectifiers. Design equations, circuits and test information make it useful to designers, engineers and experimenters.—IQ

TELEVISION ANALYZING SIMPLIFIED (2nd Edition), by Milton S. Kiver. B & K Manufacturing Co., 1801 W. Bell Plaine Ave., Chicago 13, Ill. 5 1/2 x 8 1/2 in. 128 pp. \$1.

The book opens with brief descriptions of TV servicing by tube testing, voltage and resistance measurements and signal tracing with a scope. The author then introduces the B & K Television Analyst and describes its use as a point-to-point TV signal injector. The last 14 chapters are devoted to detailed coverage of the Television Analyst as it is used to troubleshoot various sections and circuits in the TV receiver.—RFS

GETTING THE MOST OUT OF VACUUM TUBES, by Robert B. Tomer. Howard W. Sams & Co., Inc., 1720 E. 38 St., Indianapolis, Ind. 5 1/4 x 8 1/2 in. 160 pp. \$3.50.

Engineers say that a tube should give good service for at least 5,000 hours, perhaps as many as 10,000. Yet most defects in electronic equipment are caused by tubes failing before their time. This book, by an authority, points out the causes for early failure and how to avoid them. It shows how poor circuit design can affect tube performance, and it gives basic facts of tube testing.

If you are a user of tubes, a circuit designer or a maintenance technician, this book will help you get better service from your electronic equipment.

BASIC MATHEMATICS FOR ELECTRONICS, by Nelson M. Cooke (2nd edition). McGraw-Hill Book Co., 330 W. 42 St., New York, N. Y. 6 x 9 in. 679 pp. \$10.75

This well known and well read text has been brought up to date. It is written to show radio technicians how math can help them in their work. It (Continued on page 128)

ENGINEERING COURSES



E.E.
Option Electronics or Power
Mechanical, Civil & Physics
Also in Liberal Arts
presented through

HOME STUDY

Resident Classes Also
Available If Desired
**PACIFIC INTERNATIONAL
COLLEGE OF ARTS
& SCIENCES**
Primarily a correspondence
school

5719-M Santa Monica Blvd. Hollywood 38, Calif.

Learn Transistor Electronics At Home!

■ Prepare now for a profitable career in this growing field. Learn theory, construction and applications of all types of transistors with this proven home-study course from the Philco Technological Center.

FOR FREE INFORMATION
PLEASE WRITE TO:

PHILCO
TECHNOLOGICAL CENTER

"C" and Ontario Sts., Philadelphia 34, Pa.

FREE!

ELECTRONICS
CAREER KIT

If you're interested in breaking into a good-paying job in Radio-TV-Electronics, I.C.S. will send you absolutely free a famous Career Kit with 3 famous booklets that have helped thousands of others—just like yourself—on the road to real success. Includes:

- 1 "HOW TO SUCCEED" Career Guide — 36-page gold mine of career tips and information.
- 2 "JOB CATALOG" of opportunities in your field of interest.
- 3 "SAMPLE LESSON" (math) to demonstrate the famous I.C.S. method.

Send today for your free I.C.S. Career Kit with these 3 famous booklets. There's no obligation. This may be the big break you've been waiting for. Mark and mail the coupon today.

INTERNATIONAL CORRESPONDENCE SCHOOLS

Dept. 37087A Scranton 15, Penna.

Please send free Career Kit with 3 famous booklets

General Electronics Radio-TV Serv'g Practical Electrician
 Industrial Electronics Sound Equip. Serv'g Profess'l Eng. (Elec.)
 Radio-TV Eng'g Electrical Eng'g Electrical Drafting
 Electronic Servicing Electrical Tech. Other

Name _____ Age _____

Address _____

City _____ State _____

SCHO DIREC

Study in the "Valley of the Sun" ELECTRONIC ENGINEERING TECHNOLOGY



College-level resident schooling
Veteran-approved. Catalog on request
Middleton Institute of Electronics
2937 E. McDowell Rd.
PHOENIX
ARIZONA

SCIENCE ENGINEERING

B.S. Degree—36 mos. • B.E. Degree—27 mos.
Accelerated year-round program: college of engineering
offering a complete Bachelor of Science Degree Program
Elec., Mech., Metal., Math., Chem., Physics. Modest rate.
Earn board. New classes start Mar., June, July, Sept., Jan.
Catalog: 1521 E. Washington Blvd., Fort Wayne 2, Ind.

INDIANA TECHNICAL COLLEGE

ENGINEERING EDUCATION for the Space Age

NORTHROP INSTITUTE of Technology
is a privately endowed, nonprofit college of engineering
offering a complete Bachelor of Science Degree Program
and TWO-YEAR accredited technical institute curricula.
Students from 30 states, many foreign countries. Outstand-
ingly successful graduates employed in aeronautics, elec-
tronics, and space technology. Write today for catalog—
no obligation.

NORTHROP INSTITUTE OF TECHNOLOGY
1181 West Arbor Vitae Street, Inglewood 1, California

double your income with degree

A college education is a good investment! More rapid advancement, too. Important firms like Tri-State College graduates return regularly to interview seniors on campus. Become an Electronics Engineer. Qualify faster here.

Bachelor of Science Degree in 27 Months

In Electrical (Electronics or Power major), Mechanical, Chemical, Aeronautical, Civil Engineering. IN 30 MONTHS B.S. in Business Administration (General Business, Accounting, Motor Transport, Management majors). For earnest, capable, mature students. Small classes. More professional class hours. Beautiful campus. Well-equipped labs, modernized buildings, new dorms. Year-round operation. Enter Mar., June, Sept., Jan. Founded 1884. Write J. G. McCarthy, Director Admissions, for Catalog and "Your Career in Engineering and Commerce" Book.

TRI-STATE COLLEGE 2421 College Avenue
Angola, Indiana

LEARN
RADAR MICROWAVES
COMPUTERS—TRANSMITTERS
CODE • TV • RADIO
Phila. Wireless Technical Inst.
1533 Pine St., Philadelphia 2, Pa.
A Non-Profit Corp.
Founded in 1907
Write for free Catalog to Dept. RE-2
Classes now forming

FREE ELECTRONICS TEST

Prove to yourself that you are qualified to learn 2-way FM radio servicing. All you need to know is basic electronics to begin studying for a rewarding career in this rapidly growing field. Two-way radio technicians are desperately needed to fill many full and part time job opportunities in service shops throughout the country. The 38 lesson Motorola Training Institute home study course trains you to be a qualified 2-way FM radio technician in as little as 6 to 8 months. Step ahead to greater earnings, a better future by learning 2-way FM radio servicing. Send for FREE Motorola Training Institute electronics test today. No obligation and no salesman will call.

MOTOROLA TRAINING INSTITUTE Dept. A-163
4501 W. Augusta Blvd., Chicago 51, Ill.
Send FREE electronics test and details on MTI home study course.
NAME _____
ADDRESS _____
CITY _____ STATE _____

RADIO-ELECTRONICS

OL TORY

AT LAST! A home study course covering all phases of electric and electronic organ servicing. **A NEW COURSE** An extensive course covering every make of organ—repair, regulating, and troubleshooting.

Electronic ORGAN SERVICING

Your Opportunity To Get Into A New, Rapidly Expanding Field At The Start. Don't Miss It!!

WRITE NOW FOR FREE BOOKLET

NILES BRYANT SCHOOL
Dept. E., 3731 Stockton Blvd.
Sacramento 20, California

NHSC Approved * The Pioneer School
Established 1898

GET INTO ELECTRONICS

V.T.I. training leads to success as technicians, field engineers, specialists in communications, guided missiles, computers, radar and automation. Basic and advanced courses in theory and laboratory. Assoc. degree in electronics in 28 mos. B.S. in electronic engineering obtainable. ECD ac-credited. G.I. approved. Graduates in all branches of electronics with major companies. Start February, September. Dorms, campus. High School Graduate or equivalent. Catalog.

VALPARAISO TECHNICAL INSTITUTE

Dept. C Valparaiso, Indiana



LEARN THE SHORT-CUTS

Professional TELEVISION All-Practice TRAINING

Jump your earnings fixing black-and-white and color sets. Get into the top-pay bracket. NRI's concentrated spare time, low-cost training can do it for you. You'll fix sets faster, easier. Special course for Radio-TV servicemen—not for beginners. Write National Radio Institute, Dept. 1BFT, Washington 16, D.C. Just say, "Send me Professional TV Servicing Catalog."

ELECTRONICS

PREPARE FOR A GOOD JOB!
BROADCAST ENGINEER
RADIO SERVICING AUTOMATION

TELEVISION SERVICING
BLACK & WHITE—COLOR

APPROVED FOR VETERANS AND SURVIVORS
OF VETERANS
BUILDING AIR CONDITIONED
SEND FOR FREE LITERATURE

BALTIMORE TECHNICAL INSTITUTE
1425 EUTAW PLACE, BALTIMORE 17, MD.



Prepare for your career in
**ELECTRONICS
ELECTRICAL ENGINEERING
RADIO-TV
COMPUTERS**

Through study at the Milwaukee School of Engineering, you can gain a sound technical education — and open the door to a rewarding career in the space age as an engineer or engineering technician.

At MSOE, new classes begin quarterly. Previous educational, military, and practical experience evaluated for advanced credit. Veteran approved. Write for more information today.

Associate in Applied Science
degrees — 2 years

Electronics Communications
Technology
Electrical Power Technology
Computer Technology
Air Conditioning Technology
Industrial Technology
Metallurgical Technology

Bachelor of Science degrees—4 years

Electrical Engineering
— Communications option
— Electrical Power option
Mechanical Engineering

Pre-technology program, scholarships, financial aid, and placement service available.



NEW!
FREE
"Your Career"
booklet.
•
MAIL
coupon today!

MILWAUKEE SCHOOL OF ENGINEERING
Dept. RE-261, 1025 N. Milwaukee St., Milwaukee 1, Wis.
(Please Print)

Name Age
Address
City State
Course interest

MILWAUKEE SCHOOL OF ENGINEERING
1025 NORTH MILWAUKEE STREET • MILWAUKEE 1, WISCONSIN

**SAY YOU
SAW IT
ADVERTISED IN ...**



LAFAYETTE 9-TRANSISTOR CITIZENS BAND "WALKIE TALKIE"

Complete Portable Two-Way Communications For Everyone

NO LICENSES, TESTS OR AGE LIMITS



HE-29

ONLY
49⁹⁵
2.00 DOWN
2 for **96⁵⁰**



- Pocket Size — 6³/₈" x 3¹/₄" x 1⁵/₈"
- Fully Transistorized — 9 Transistors plus 1 Diode
- Transmits & Receives From 1.5 to 7 Miles (Depending Upon Conditions)
- Crystal Controlled with Superheterodyne Receiver
- Push-To-Talk Operation
- Uses 8 Inexpensive Penlight Batteries
- Up to 70 Hours Battery Life
- 46 Inch Telescoping Antenna
- Earphone For Personal Listening
- Weatherproof Leather Carrying Case with Shoulder Strap.

As simple and easy to use as your telephone and twice as handy—weighs only 18 ounces and slips easily into your pocket. Just two controls ensure fast, efficient operation—on/off volume and push-to-talk. Low input power of 100MW permits operation without FCC license or permit. Perfect for hunting, fishing, boating, virtually all sports. Use at work—construction, warehouse, office, farm or for in-plant communications. Supplied with 8 penlight batteries, earphone, leather carrying case with shoulder strap and matched crystals for channel 10.

LAFAYETTE HE-15A CITIZEN'S BAND TRANSCEIVER

Not Superregenerative but **SUPERHET!**
Completely Wired



HE-15A

57⁵⁰

5.00 Down

MADE IN U.S.A.

The Greatest Value In The Citizens Band Field—economical, efficient 2-way radio communications from your home, office, auto, truck, or boat. 4 dual function tubes, 2 single function tubes plus 2 rectifiers provide 12 tube performance. Has 5 crystal-controlled transmitting positions while the superheterodyne receiver is tuneable over the full 23 channels. Controls include a three position function switch (transmit, receive, and transmit with spring return), planetary vernier tuning plus an extremely effective full wave variable noise limiter. Supplied with high output crystal microphone and transmitting crystals for channel 9.

HE-15A	Wired & Tested (less antenna)	Net 57.50
HE-19	Whip Antenna	Net 3.95
HE-16	Power Supply for 12 Volts	Net 10.95
HE-18	Power Supply for 6 Volts	Net 10.95

LAFAYETTE HE-20 DELUXE CITIZEN'S BAND TRANSCEIVER

99⁵⁰

5.00 Down

MADE IN U.S.A.
COMPLETELY WIRED! NOT A KIT

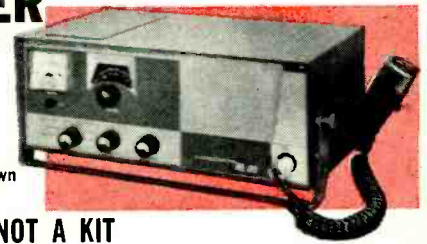

Sensitivity and selectivity that equals and surpasses that of the finest units available. Two will provide an effective communication system up to a distance of 20 miles, depending upon terrain and antenna height. Tuneable Superheterodyne Receiver section covers all 23 assigned channels with a sensitivity of 1 microvolt and provides for 4 crystal controlled receiving channels. 5 watt crystal-controlled transmitter operates on any 4 of 23 channels. Features include an adjustable squelch control, a highly effective series gate noise limiter, foolproof dependable relay switching plus a built-in "S" meter with switch to measure signal strength and to check on wattage input to final. Complete with rugged push-to-talk ceramic microphone, built-in 12V DC/115V AC power supply for mobile and fixed use plus matched crystals for channel 9.

LAFAYETTE RADIO

PLEASE INCLUDE SHIPPING CHARGES WITH ORDER

165-08 LIBERTY AVENUE, JAMAICA 33, N. Y. • OTHER LOCATIONS

NEW YORK, N. Y.
100 6th Avenue

NEWARK, N. J.
24 Central Avenue

BRONX, N. Y.
542 E. Fordham Rd.

PARAMUS, N. J.
182 Route 17

BOSTON, MASS.
110 Federal Street

PLAINFIELD, N. J.
139 W. 2nd Street

Build A Path to A New World of Entertainment

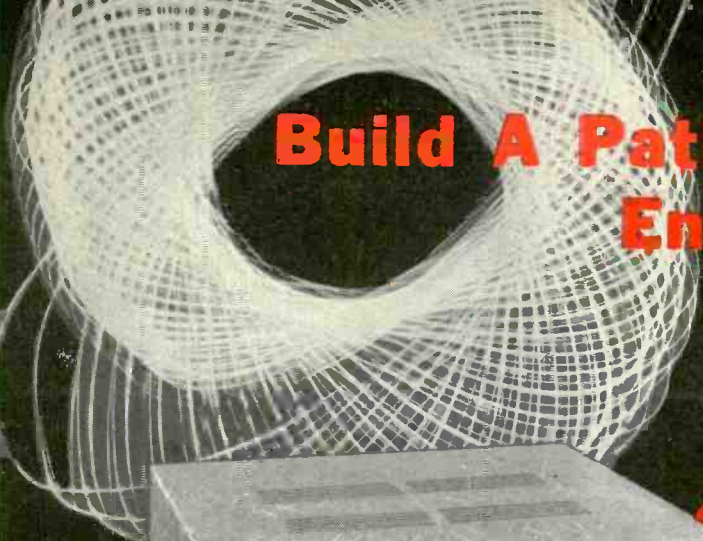

KT-250A
50-WATT STEREO AMPLIFIER ... 74.50



KT-500A
FM-AM STEREO TUNER ... 74.50



KT-600A
STEREO PREAMPLIFIER ... 79.50



KT-600 FM TUNER ... 54.50



KT-236A
36-WATT STEREO AMPLIFIER ... 59.50



KT-550 100-WATT
BASIC STEREO AMPLIFIER ... 134.50

MONEY-BACK GUARANTEE

Lafayette Kits are exclusive products of Lafayette Electronics. Each Lafayette Kit must meet or exceed its published specifications, or your money is refunded in full.

ENGINEERING:

Created with the non-technical builder in mind. There's much more fun in assembling your own kit... and it's so easy.

DESIGN:

Each kit has the fine professional looking touch. Styled to blend with every decor.

VALUE:

You can't get better units at these money saving prices.

QUALITY:

Top performance due to high quality parts and engineering.

All Lafayette Kits are Available on the Easy Pay Plan.



CUT OUT AND PASTE ON POST CARD

Lafayette Radio Dept. JB-1
P.O. Box 190 Jamaica 31, N.Y.

Send me the **FREE 324-Page 1967 Catalog No. 610**

Name _____
Address _____
City _____ Zone _____ State _____

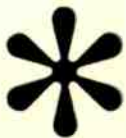

terial will soon reveal the almost total absence of coloration introduced by the AR-3. The sounds produced by this speaker are probably more true to the original program than those of any other commercially manufactured speaker system we have heard. On the other hand, the absence of

*From the Hirsch-Houck Laboratories' report on the AR-3 loudspeaker in the October, 1960 *High Fidelity*. A reprint of the complete report will be sent on request.

AR-3's (and other models of AR speakers) are on demonstration at AR Music Rooms, at Grand Central Terminal in New York City, and at 52 Brattle Street in Cambridge, Massachusetts. Prices are from \$89 to \$225.

ACOUSTIC RESEARCH, INC., 24 Thorndike St., Cambridge 41, Mass.

For that



NEW IDEA

visit the

IRE SHOW

March 20-23, 1961

New York

Coliseum and Waldorf-Astoria Hotel

Members \$1.00, Non-members \$3.00

Age limit—over 18

(Continued from page 124)

reviews arithmetic and discusses algebra, trig, logs and vectors. Mathematical methods are applied to ac networks and tube circuits. Use of the slide rule to lighten calculations is described. Numerical examples are worked out.

Among the many math tables are logarithms, squares, trig functions and wire values. A two-color format emphasizes portions of circuits, headings, rules and equations, to make the book extra readable. Recommended for self-study, review and reference.—IQ

DAVE RICE'S OFFICIAL PRICING DIGEST, Vol. IV, No. 1. Electronic Publishing Co. Inc., 180 N. Wacker Dr., Chicago 6, Ill. 300 pp. 3 3/4 x 8 3/4 in. \$2.50.

This handy book contains a complete list of resale prices for more than 63,000 electronic components. It also includes a table of flat-rate and hourly service charges based on and showing regional and national averages. This book is definitely useful to the service technician as a reference when listing charges for replacement parts.—LS

ELECTRICAL NOISE, by D. A. Bell. Van Nostrand Co. Inc., 257 Fourth Ave., New York 10, N.Y. 6 x 9 in. 342 pp. \$9.75

This is an up-to-date reference book on noise in physical devices. It discusses noise in tubes, metal films and semiconductors. The first chapters review the physical basis for measuring noise and mathematical techniques. A complete volume on the subject, it's excellent for research workers in TV, radio-astronomy, telecommunications and measurement.—IQ

UNDERSTANDING RADIO, by Herbert M. Watson, Herbert E. Welch and George S. Eby. McGraw-Hill Book Co. Inc., 330 W. 42 St., New York, N. Y. 6 1/4 x 9 1/4 in. 706 pp. \$6.20.

A basic guide to radio for the beginner. Also useful as a text. With numerous illustrations and easy-to-read text, this book takes the beginner with little or no electronic knowledge through electricity, magnetism, Ohm's law, vacuum-tube principles, resonance and tuning, receiving circuits, short-wave sets, radio transmitters, to a closing chapter called Looking Ahead in Radio.—LS END

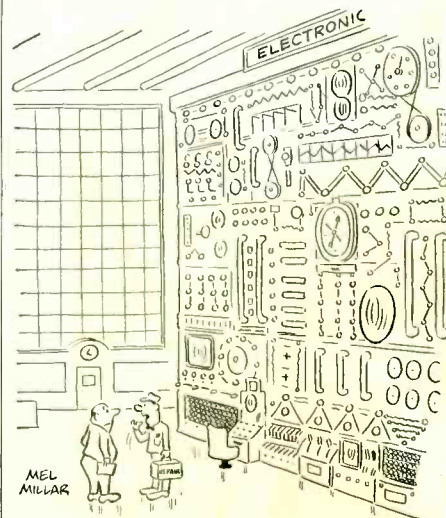

"Looks like I'll have to take it into the shop!"

RAD-TEL

GUARANTEED



RAD-TEL'S FIRST QUALITY

WHY PAY MORE? - BUY
DIRECT FROM RAD-TEL
FOR SAVINGS AND
PERFORMANCE
IN RADIO AND
TV TUBES



Up to 75% OFF on BRAND NEW TUBES

GUARANTEED ONE FULL YEAR!

You Can Rely On Rad-Tel's Speedy One Day Service!

NOT USED — NOT PULLED OUT OF OLD SETS • EACH TUBE INDIVIDUALLY AND ATTRACTIVELY BOXED!

Qty.	Type	Price	Qty.	Type	Price	Qty.	Type	Price	Qty.	Type	Price	Qty.	Type	Price	Qty.	Type	Price
—	0Z4M	.79	—	4BQ7	.96	—	6AR5	.55	—	6CG7	.60	—	6SA7GT	.76	—	8EB8	.94
—	1AX2	.62	—	4BS8	.98	—	6AS5	.60	—	6CG8	.77	—	6SK7	.74	—	10DA7	.71
—	1B3GT	.79	—	4BU8	.71	—	6AT6	.43	—	6CM7	.66	—	6SL7	.80	—	11CY7	.75
—	1DN5	.55	—	4BZ6	.58	—	6AT8	.79	—	6CN7	.65	—	6SN7	.65	—	12A4	.60
—	1G3	.73	—	4BZ7	.96	—	6AU4	.82	—	6CR6	.51	—	6SQ7	.73	—	12AB5	.55
—	1J3	.73	—	4CS6	.61	—	6AU6	.50	—	6CS6	.57	—	6T4	.99	—	12AC6	.49
—	1K3	.73	—	4DE6	.62	—	6AU7	.61	—	6CU5	.58	—	6U8	.78	—	12AD6	.57
—	1L6	1.05	—	4DK6	.60	—	6AU8	.87	—	6CU6	1.08	—	6V6GT	.54	—	12AE6	.43
—	1L5	.59	—	4DT6	.55	—	6AV6	.40	—	6CY5	.70	—	6W4	.75	—	12AF3	.73
—	1R5	.62	—	5AM8	.79	—	6AW8	.89	—	6CY7	.71	—	6W6	.69	—	12AF6	.49
—	1S5	.51	—	5AN8	.86	—	6AX4	.65	—	6DA4	.68	—	6X4	.39	—	12AJ6	.46
—	1T4	.58	—	5AQ5	.52	—	6AX7	.64	—	6DB5	.69	—	6X5GT	.53	—	12AL5	.45
—	1U4	.57	—	5AT8	.80	—	6BA6	.49	—	6DE6	.58	—	6X8	.77	—	12AL8	.95
—	1U5	.50	—	5BK7A	.82	—	6BC5	.54	—	6GG6	.59	—	7AU7	.61	—	12AQ5	.52
—	1X2B	.82	—	5BQ7	.97	—	6BC7	.94	—	6OQ6	1.10	—	7A8	.68	—	12AT6	.43
—	2AF4	.96	—	5BR8	.79	—	6BC8	.97	—	6OT5	.76	—	7B6	.69	—	12AT7	.76
—	3AL5	.42	—	5CC8	.76	—	6BD6	.51	—	6OT6	.53	—	7Y4	.69	—	12AU6	.50
—	3AU6	.51	—	5CL8	.76	—	6BE6	.55	—	6EU8	.79	—	8A8	.83	—	12AU7	.60
—	3AV6	.41	—	5EA8	.80	—	6BF6	.44	—	6EA8	.79	—	8AW8	.93	—	12AV5	.97
—	3BA6	.51	—	5E8	.80	—	6BG6	1.66	—	6HG6T	.58	—	8BQ5	.60	—	12AV6	.41
—	3BC5	.54	—	5J6	.68	—	6BH6	.65	—	6J5GT	.51	—	8CM7	.62	—	12AV7	.75
—	3BE6	.52	—	5T8	.81	—	6BH8	.87	—	6J6	.67	—	8C7	.68	—	12AX4	.67
—	3B6	.52	—	5U4	.60	—	6BJ6	.62	—	6K6	.79	—	8CN7	.97	—	12AX7	.63
—	3BN6	.76	—	5U8	.81	—	6BK7	.85	—	6S4	.48	—	8CX8	.93	—	12AZ7	.86
—	3BU8	.78	—	5V6	.56	—	6BL7	1.00	—								
—	3BY6	.55	—	5X8	.78	—	6BN4	.57									
—	3BZ6	.55	—	5Y3	.46	—	6BN6	.74									
—	3CB6	.54	—	6AB4	.46	—	6BQ5	.65									
—	3CF6	.60	—	6AC7	.96	—	6BQ6T	1.05									
—	3CS6	.52	—	6AF3	.73	—	6BQ7	.95									
—	3CY5	.71	—	6AF4	.97	—	6BR8	.78									
—	3DK6	.60	—	6AG5	.65	—	6BU8	.70									
—	3DT6	.50	—	6AH6	.99	—	6BV6	.54									
—	3Q5	.80	—	6AK5	.95	—	6BZ6	.54									
—	3S4	.61	—	6AL5	.47	—	6BZ7	.97									
—	3V4	.58	—	6AM8	.78	—	6C4	.43									
—	4BC5	.56	—	6AN4	.95	—	6CB6	.54									
—	4BC8	.96	—	6AN8	.85	—	6CD6	1.42									
—	4BN6	.75	—	6AQ5	.50	—	6CF6	.64									

TRANSISTORS — AT FABULOUS DISCOUNTS

	PRICE	TYPE	RATING	ELECTRICAL CHARACTERISTICS		HFE
<input type="checkbox"/>	RF 49¢	GE PNP ALLOY JUNCTION GENERAL PURPOSE RF/AF	200 MW	1CB0 max.	1EB0 max.	VCE = -1.5 Ib = 5 ma 20 min
<input type="checkbox"/>	AF 39¢			20 μa VCB = -3V	20 μa VEB = -3V	
<input type="checkbox"/>	80¢ ea.	Power AF Med. Freq. To-3	MIN. POWER OUTPUT 2.25 W	20 ma VCB = -16V	20 ma VEB = -16V	VCE = -1.5 Ib = 1 ma 40 min
<input type="checkbox"/>	140¢ ea.	Hi Power 15 AMP To 36		40 ma VCB = -100	40 ma VEB = -100	VCE = -1.5 Ib = 1 ma 30 min
Series 830 OHMS						

SEND FOR FREE TROUBLE SHOOTER GUIDE AND NEW TUBE & PARTS CATALOG.

NOT AFFILIATED WITH ANY OTHER MAIL ORDER TUBE COMPANY

RAD-TEL TUBE CO.

55 Chambers Street

Newark 5, N. J.

TERMS: 25% deposit must accompany all orders—balance C.O.D. \$1 HANDLING CHARGE FOR ORDERS UNDER \$5. Subject to prior sale. Please add postage. No C.O.D.'s outside continental U.S.A. Dept. RE-261.

These men are getting practical training in...

ELECTRICITY ELECTRONICS



ON REAL

Motors • Generators
Switchboards • Controls
Modern Appliances
Automatic Electronic
Control Units

TELEVISION RADIO ELECTRONICS



ON REAL

TV Receivers
Black & White and Color
AM-FM and Auto Radios
Transistors • Printed
Circuits • Test Equipment

Train in NEW Shop-Labs of **COYNE**

in Chicago—Electrical and Electronic Center of the World. Prepare for a better job and a successful future in a TOP OPPORTUNITY FIELD. Train on real full size equipment at COYNE where thousands of successful men have trained for 60 years—largest, oldest, best equipped school of its kind. Professional and experienced instructors show you how, then do practical jobs yourself on more than a quarter of a million dollars worth of equipment. No previous experience or advanced education needed. Employment Service to Graduates.

Start Now—Pay Later—Liberal Finance and Payment Plans. Pay most of tuition after graduation. Part-time employment help for students. Choose from nine yearly Starting Dates.

Mail Coupon or Write to Address Below for Free Book—"Guide to Careers." Whether you prefer ELECTRICITY, TELEVISION-RADIO or COMBINED ELECTRONICS, which includes both fields, this book describes all training offered.

Information comes by mail. No obligation and NO SALESMAN WILL CALL.

B. W. Cooke, Jr., Pres. Founded 1899
COYNE ELECTRICAL SCHOOL
Chartered as an Educational Institution Not For Profit
1501 W. Congress Pkwy., Chicago 7, Ill., Dept. 21-5C

MAIL COUPON OR WRITE TO ADDRESS BELOW

COYNE ELECTRICAL SCHOOL
New Coyne Building Dept. 21-5C
1501 W. Congress Pkwy., Chicago 7, Ill.

Send BIG FREE book and details of all the training you offer. I am especially interested in,

Electricity Television Both Fields

Name.....

Address.....

City..... State.....

Unlike most other schools, we do not employ salesmen.

ADVERTISING INDEX

Radio-Electronics does not assume responsibility for any errors appearing in the index below.

Acoustic Research, Inc.....	128	Moss Electronic Inc.....	88-89
Aero Products Company.....	90	National Radio Institute ..	27-28, 96, 114
A. E. S., Inc.....	97	National Technical School ..	5
Airex Radio Corp.....	110	Ohmatsu Electric Co. Ltd.....	96
Allied Radio Corp.....	19, 76-79, 119	Olson Radio Corp.....	109
American TV & Radio Co.....	102	PACO Electronics Co., Inc.....	87
Amperex Electronics Corp.....	26	Perma-Power Company	68
Atlas Sound Corp.....	110	Philco Computer Div.....	98
Audio Unlimited.....	96	Picture Tube Outlet	119
Audion	121	Planet Sales Corp.....	123
B & K Mfg., Co.....	11	Progressive "Edu-Kits" Inc.....	100
Barry Electronics Corp.....	121	RCA Tube Div.....	Back Cover
Bell Telephone Labs.....	12	RCA Institutes	91-92
Blonder-Tongue Labs.....	18	RCA Test Equipment Div.....	22
British Industries (Multicore Sales Div.).....	121	Rad-Tel Tube Co.....	129
Brooks Radio & TV Corp.....	115	Radio Shack Corp.....	108
Burstein-Applebee Co.....	99	Radio TV Training School	23
Capitol Radio Engineering Institute	104-107	Rider, (John F.).....	109
Carston Studios	120	Rinehart & Co.....	16-17
Castle TV Tuner Service Inc.....	121	Rohn Mfg., Co.....	94
Center Industrial Electronics Inc.....	117	Sams (Howard W.) & Co., Inc.....	70, 112-113
Centralab Div. of Globe Union	20	Scott, (H. H.) Inc.....	29
CLASSIFIED ADS P. 122		SENCORE (Service Instruments Corp.).....	81
Cleveland Institute of Electronics	8-9	Sprague Products Co.....	95
Coyne Electrical School	25, 75, 130	Standard Kollsman Industries, Inc.....	3rd Cover
Crown Electric Products Co.....	117	Supreme Publications	101
Delco Radio Div. of General Motors Corp.....	71	Swing-O-Lite Co.....	99
DeVry Technical Institute	7	Switchcraft, Inc.....	114
Dressner	117	Sylvania Electric Products Inc.....	21
Electronic Chemical Corp.....	123	TAB	118
EICO		Tarzian, Sarkes Inc.....	117
(Electronic Instrument Co.)	31-32	Trio Mfg., Co.....	10
Electronic Measurement Corp.....	93	Triplett Electrical Instrument Co.....	2nd Cover
Electronic Publishing Co., Inc.....	110	The Turner Microphone Company	73
Fair Radio Sales	120	United Radio Company.....	111
Federation Nationale de Industries Electroniques	24	University Loudspeakers, Inc.....	14
General Techniques, Inc.....	120	D. Van Nostrand Co., Inc.....	119
Gernsback Library, Inc.....	116	Vidaire Electronics Mfg., Corp.....	121
Grantham School of Electronics	13	Winegard Company	84-85
Hallcrafters	30, 123		
Harman-Kardon	3		
Heald Engineering College	117		
Heath Company	64-67		
Holt, Rinehart & Winston Inc.....	16-17		
Hudson Specialities Co.....	122		
Illinois Condenser Co.....	111		
Indiana Technical College	121		
Institute of Radio Engineers	114, 120, 95, 128		
Key Electronics Co.....	121		
Lafayette Radio Electronics Corp.....	15, 126-127		
Lektron Inc.....	96		
Mercury Electronics	68, 94, 130		
Moog, (R. A.) Co.....	75		

Printed in USA



Model 600 IN-CIRCUIT-RECTIFIER TESTER

CHECKS ALL RECTIFIERS
(selenium, germanium, silicon, copper oxide, etc.)

**BOTH IN-CIRCUIT AND
OUT-OF-CIRCUIT FOR:**

- ✓ Quality ✓ Shorts
- ✓ Opens ✓ Fading
- ✓ Life Expectancy

See your electronics parts distributor!

CHECKS ALL POWER RECTIFIERS WITHOUT DISCONNECTING RECTIFIER FROM CIRCUIT



An exciting new development by Mercury enables you to check the quality of all types of power rectifiers in use today without disconnecting rectifier from circuit. Now, by simply clipping test leads across rectifier right in the circuit and depressing test switch you get an instant reading indicating whether rectifier is good or bad.

- Internally fused... case fully insulated from the power line
- Cannot damage or over heat the rectifier under test
- Cannot blow line fuses, even when checking a shorted rectifier
- Long lasting etched aluminum panel
- Handsome hammer-tone steel case.

\$2750
Net

Model 600

MERCURY ELECTRONICS CORP. 77 SEARING AVENUE, MINEOLA, NEW YORK



PUZZLED

...no need to be

look to this sign of assurance!

The Distributor displaying this sign will solve your tuner problems at a profit to you.

He has available the New Standard Tuner Replacement Guide, including replacement parts listings. This is the only Guide of its kind in the world. Covers all Standard tuners produced through 1959. Includes replacements for many tuners not produced by Standard.

He handles our 48-hour Factory Guaranteed Repair Service and Trade-In Allowance on unrepairable Standard tuners.

See This Authorized Distributor Today



standard kollsman

INDUSTRIES INC. *Formerly Standard Coil Products Co., Inc.*
2085 N. HAWTHORNE AVENUE, MELROSE PARK, ILLINOIS

How do your customers rate you?

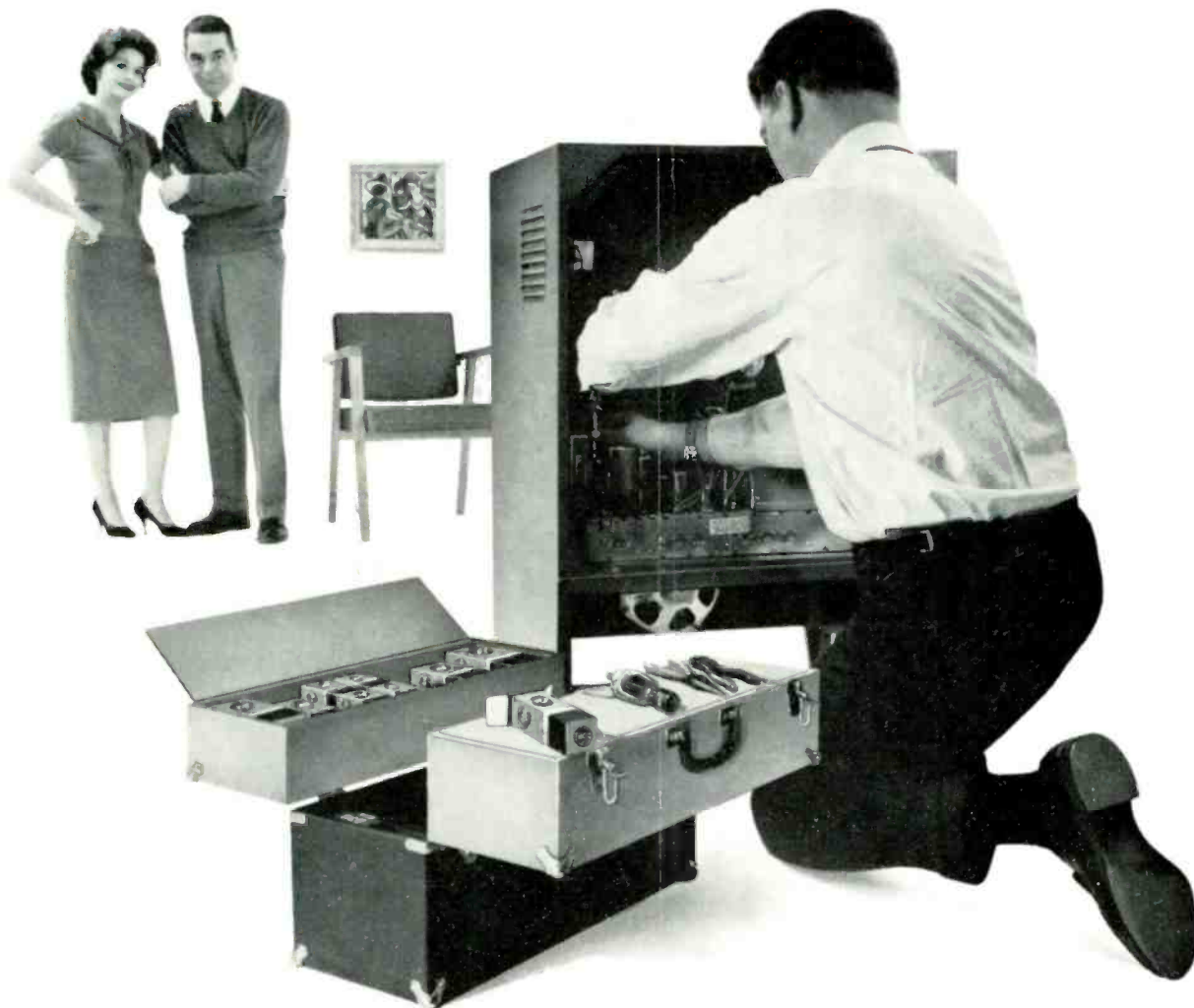

Your reputation is based largely on what happens *after* you leave the scene of each service call. For this reason the name on the tubes you install makes a world of difference. RCA tubes are designed and manufactured to assure customer confidence in you as well as in RCA.

RCA tube quality is your best insurance against call-backs due to premature tube failure.

RCA tube performance puts your workmanship in the best light and protects it through rigid quality control.

RCA's trademark symbolizes a name and reputation customers have respected for decades.

Your customers know that those red-white-and-black RCA tube cartons in your tube caddy represent the most trusted name in electronics. Remember, customer confidence is the cornerstone of your business.

To protect your service reputation before, during and after every service call, make sure your next tube order specifies... **RCA TUBES.**

RCA ELECTRON TUBE DIVISION, HARRISON, N. J.



SIGN OF A SERVICE JOB WELL DONE



The Most Trusted Name in Electronics
RADIO CORPORATION OF AMERICA