

JUNE 1960

Radio-Electronics

How to Read Industrial Diagrams

HUGO GERNSBACK, Editor

Updating the R-E
Twin-Coupled Amplifier

Two-Transistor Radio
Uses Only Six Parts!

More Power from
Smaller Tubes

See page 37

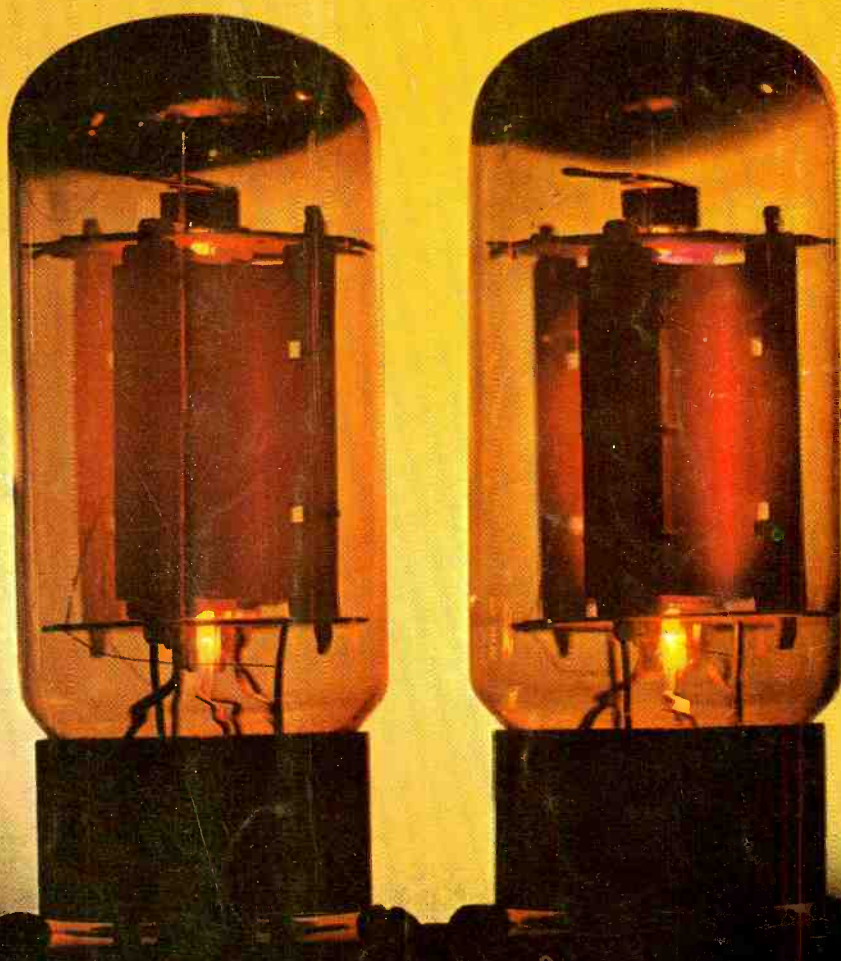

50c

Electronic Laboratories
Help Teach

DAVID BAKER 10-61
R D 2
DOVER 4 PA

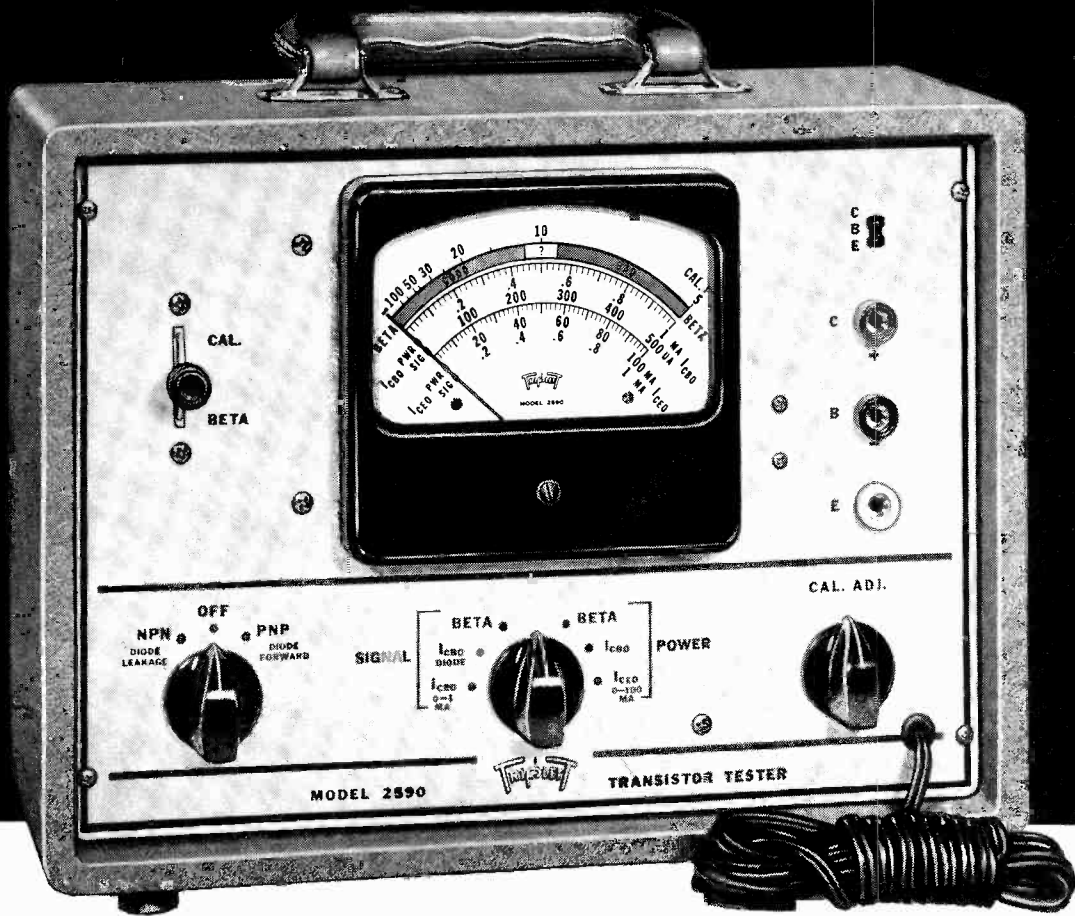

Now you can test transistors under simulated operating conditions . . .
With the NEW Triplet Model 2590 Transistor Tester
Simple to Operate—Versatile—Always Up-to-Date

Simple to Operate—The new Triplet Model 2590 Transistor Tester quickly, easily and accurately tests all power and signal transistors under simulated operating conditions. Only 3 switches and 1 control knob.

Versatile—Has provisions for testing I_{CEO} (at 9.5V), I_{CBO} (at 9.5V) and Beta Amplification (at 3V) on both NPN and PNP transistors. Also checks leakage and forward current of diodes.

Always Up-to-Date—No roll chart, specifications, or special data necessary. All you need know is the transistor type (NPN or PNP and Signal or Power type).

Transistor Socket and External Leads—Allows use with any type basing arrangement.

Accuracy—The Model 2590 is accurate to within $\pm 2\%$ of full scale reading on 0-100 D. C. Ua.

Selector Switch—Provides selection of NPN, OFF or PNP positions.

Function Switch—Provides selection of I_{CBO} Leakage, I_{CEO} Leakage and Beta Gain position for both power and signal transistors.

Beta Switch—Is in the calibrate position normally and is in the Beta test position when pulled down.

Calibrate Adjustment Control—Adjusts for full scale calibration after transistor has been inserted.

Power—115 volts, 50-60 cycle, A.C.

Scales—There are 5 scales on the meter: 0-1 ma. for signal transistor I_{CEO} ; 0-100 ma. for power transistor I_{CEO} ; 0-500 ua. for signal transistor I_{CBO} , also diode leakage and forward current; 0-1 ma. for power I_{CBO} ; 5-100 Beta range also shown as the "GOOD ? BAD" scale.

Case—Handsome gray leatherette case, $11\frac{1}{8}'' \times 8\frac{5}{8}'' \times 5\frac{1}{8}''$; has recessed panel.

MODEL 2590 TRANSISTOR TESTER—
 U.S.A. Dealer Net Price \$49.50

MODEL 690-A PORTABLE TRANSISTOR TESTER

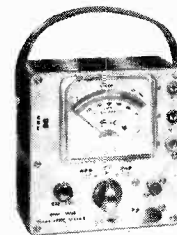

Triplet Model 690-A Transistor Tester is a rugged, small, easily portable unit. Battery operated.

It provides **Leakage** and **Gain** tests for all low and medium power PNP and NPN type transistors. Also checks diodes for forward and leakage current.

A single switch is provided for simplicity in selecting transistor type settings. The OFF position prevents drain on the batteries in case of accidentally shorting the leads. Another operating feature is the use of separate "Calibrate" and "Gain" buttons to eliminate errors.

A transistor socket and a set of external leads are provided for use with any basing arrangement.

MODEL 690-A PORTABLE TRANSISTOR TESTER—U.S.A. Dealer Net Price \$29.50

All Triplet instruments are available nationally through authorized Triplet distributors. A list of the Triplet distributors in your area is available upon request. Write to:



TRIPLITT ELECTRICAL INSTRUMENT COMPANY, BLUFFTON, OHIO
 Manufacturers of Panel and Portable Instruments, Electrical and Electronic Test Equipment

Learn Radio-Television Electronics

by Practicing at Home in Your Spare Time

WITHOUT EXTRA CHARGE YOU GET special NRI kits developed to give you actual practice with Radio-TV receiver or broadcasting circuits and equipment. All equipment is yours to keep.

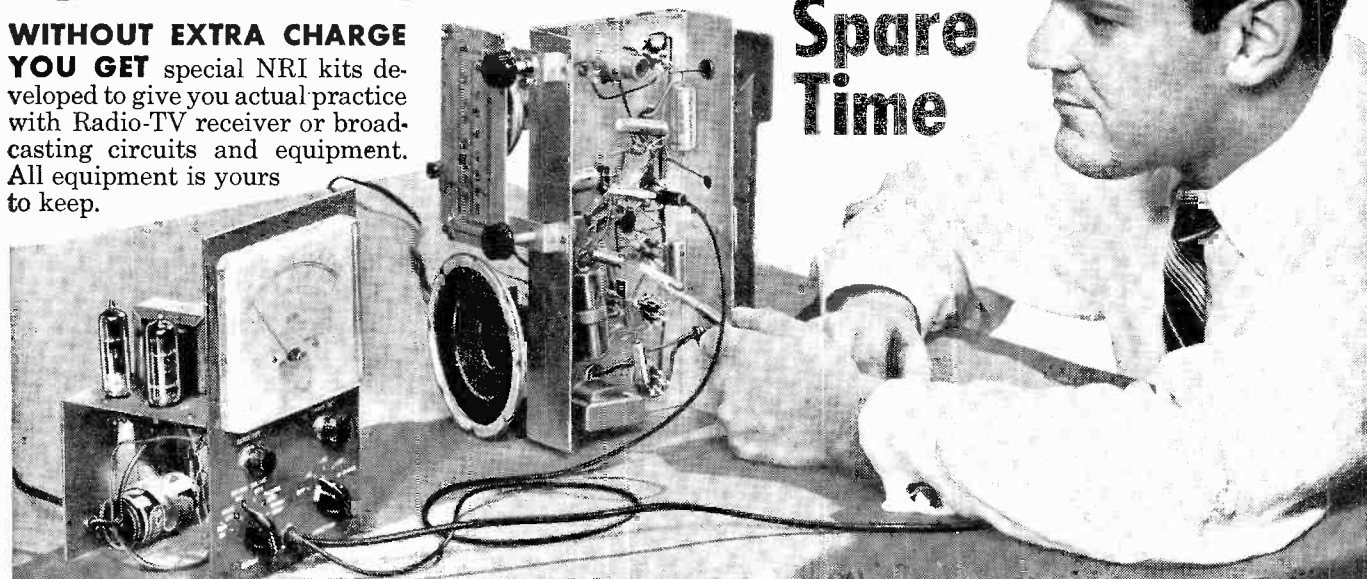

RADIO-TV BROADCASTING (see above) offers important positions as Operators and Technicians. **RADIO-TV SERVICING** Technicians (see below) needed in every community. Their services are respected, their skill appreciated.



Fast Growing Field Offers You Good Pay, Success, Bright Future



J. E. SMITH
Founder

Bigger than ever and still growing fast. That's why Radio-TV has special appeal to ambitious men not satisfied with their job and earnings. More than 4,000 Radio and TV stations. More than 150 million home and auto Radios, 40 million TV sets. Color TV promises added opportunities. For the

trained man, there are good jobs, bright futures in Radio-TV Servicing or Broadcasting.

Training PLUS opportunity is the *ideal combination* for success. So plan *now* to get into Radio-TV. The technical man is looked up to. He does important work, gets good pay for it. Radio-Television offers that kind of work. NRI can supply training quickly, without expense of going away to school. Keep your job while training. You learn at home in your spare time. NRI is the **OLDEST** and **LARGEST** home study Radio-TV school. Its methods have proved successful for more than 40 years.

Added Income Soon - \$10, \$15 a Week in Spare Time

Soon after enrolling, many NRI students start to earn \$10, \$15 a week in spare time fixing sets. Some pay for their training and enjoy extra luxuries this way. Some make enough to start their own Radio-TV shops. NRI training is *practical*—gets quick results. Easy to understand, well illustrated lessons teach you basic principles. And you **LEARN-BY-DOING** by practicing with kits of equipment which "bring to life" things you study.

Find Out What NRI Offers

NRI has trained thousands for successful careers in Radio-TV. Study fast or slow—as you like. Diploma when you graduate. Mail coupon now. Paste it on a postcard or mail in envelope. **ACTUAL LESSON FREE.** Also 64 page catalog that shows opportunities, shows equipment you get. Cost of NRI courses low. Easy terms. **NATIONAL RADIO INSTITUTE, Dept. OFF Washington D. C.**

N.R.I. TRAINED THESE MEN FOR SUCCESS



"I was repairing Radios by 10th lesson. Now have good TV job." **M. R. LINDEMUTH,** Fort Wayne, Ind.



"Doing spare time repairs on Radio and TV. Soon servicing full time." **CLYDE HIGGINS,** Waltham, Mass.

"I had a successful Radio repair shop. Now I'm Engineer for WHPE." **V.W. WORKMAN,** High Point, N.C.



"There are a number of NRI graduates here. I can thank NRI for this job." **JACK WAGNER,** Lexington, N. C.



VETERANS Approved Under G. I. Bills

SEND FOR BOTH FREE

National Radio Institute

Dept. OFF Washington 16, D. C.

Mail me Sample Lesson and 64-Page Catalog FREE. (No salesman will call. Please write plainly.)

Name _____ Age _____

Address _____

City _____ Zone _____ State _____

ACCREDITED MEMBER, NATIONAL HOME STUDY COUNCIL





Radio-Electronics

Formerly RADIO-CRAFT ■ Incorporating SHORT WAVE CRAFT ■ TELEVISION NEWS ■ RADIO & TELEVISION*

EDITORIAL

- 29 Recording the Invisible—Hugo Gernsback

AUDIO-HIGH FIDELITY

- 30 Updating the R-E Twin-Coupled Amplifier—Norman H. Crowhurst
- 33 Electronic Labs Help Teach Languages—Yvon O. Johnson
- 35 Stroboscope Flasher—A. H. Taylor
- 36 Novel "Talkie" Outfit for Slide Projectors—Daniel M. Costigan
- 37 Better Power Pentodes (Cover Feature)

ELECTRONICS

- 38 Ionized Band Encircles the Earth—David Warshaw
- 40 Low-Voltage Silicon Rectifier Adapter—Ronald L. Ives
- 42 Principles of Modern Radar, Part I—Jordan McQuay
- 46 International Electronics Meet at Paris—Jacques Garcin
- 47 Another Forgotten Inventor, Dan C. Wilkerson—Eric Leslie
- 48 Divide and Multiply with a Wheatstone Bridge—Forrest H. Frantz, Sr.

RADIO

- 50 Squelch Without Tubes—R. L. Shaum
- 51 Citizens Hamming up Status of Citizens Band
- 52 All-Transistor FM-AM Portable
- 58 Matchbox Radio—A. V. J. Martin
- 60 Rf Stage Boosts Sensitivity—Bela Foldi

WHAT'S NEW

- 62 Pictorial Reports of New Developments

INDUSTRIAL ELECTRONICS

- 64 Understanding Industrial Diagrams—Tom Jaski
- 69 New Departure in Soldering Irons
- 70 Industry Warns, Counts, Indicates, Controls Photoelectrically—Allan Lytel

TELEVISION

- 76 Intercom Booster Aids TV Director—Donald K. Haahr
- 80 About Those Color TV Controls—Robert G. Middleton
- 86 Tiros in the Sky—Larry Steckler
- 88 TV Service Clinic—Conducted by Jack Darr
- 91 We Learned from the Dogs—R. M. Centerville

TEST INSTRUMENTS

- 94 Dress Up That Meter—C. L. Henry
- 96 Field-Check Color CRT's—James Egan
- 98 An Electronic Transformer—H. F. Woods
- 99 Experimenter's Dual Electroscope—Esten Moen
- 100 Transfer Standard Calibrates Voltmeter—Paul S. Lederer
- 106, 110 Business and People Corrections
- 116 New Tubes and Semiconductors
- 18 Correspondence
- 107 Noteworthy Circuits
- 128 New Books
- 102 Technicians' News
- 126 New Literature
- 119 Technotes
- 105 New Patents
- 121 Try This One
- 111 New Products
- 93 50 Years Ago

ON THE COVER

(Story on page 37)

The red-hot plates of the two power pentodes show that there is a difference in vacuum tubes. Both are overloaded, but the new construction used in one of them spreads heat evenly through the plate for an added margin of safety.

Color original by General Electric

- Hugo Gernsback Editor and Publisher
- M. Harvey Gernsback Editorial Director
- Fred Shunaman Managing Editor
- Robert F. Scott W2PWG, Technical Editor
- Larry Steckler Associate Editor
- I. Queen Editorial Associate
- Elizabeth Stalcup Production Manager
- Wm. Lyon McLaughlin Tech. Illustration Director
- Richard A. Giurlando Art Director
- Fred Neimast Staff Artist
- Lee Robinson Director, Advertising Sales
- John J. Lamson Eastern Sales Manager
- G. Aliquo Circulation Manager
- Adam J. Smith Director, Newsstand Sales
- Robert Fallath Promotion Manager



Average Paid Circulation Over 174,000



RADIO-ELECTRONICS is indexed in *Applied Science & Technology Index* (Formerly *Industrial Arts Index*)

RADIO-ELECTRONICS, June, 1960, Vol. XXXI, No. 6. Published monthly at Mt. Morris, Ill., by Gernsback Publications, Inc. Second-class postage paid at Mt. Morris, Ill. Copyright 1960 by Gernsback Publications, Inc. All rights reserved under Universal, International and Pan-American Copyright Conventions.
SUBSCRIPTION RATES: U.S., U.S. possessions and Canada, \$4.00 for one year; \$7.00 for two years; \$10.00 for three years. Pan-American countries \$5.00 for one year; \$9.00 for two years; \$13.00 for three years. All other countries \$5.50 a year; \$10.00 for two years; \$14.50 for three years.
SUBSCRIPTIONS: Address correspondence to Radio-Electronics, Subscription Dept., 154 West 14th St., New York 11, N.Y. When requesting a change of address, please furnish an address label from a recent issue. Allow one month for change of address.
GERNSBACK PUBLICATIONS, INC. Executive, Editorial and Advertising Offices, 154 West 14th St., New York 11, N.Y. Telephone ALgonquin 5-7753. Hugo Gernsback, Chairman of the Board; M. Harvey Gernsback, President; G. Aliquo, Secretary.
ADVERTISING REPRESENTATIVES and FOREIGN AGENTS listed on page 131.
POSTMASTER: If undeliverable, send Form 3579 to: RADIO-ELECTRONICS, 154 West 14th St., New York 11, N.Y.

*Trademark registered U. S. Pat. Office.

RADIO-ELECTRONICS

NOW!
at a price
you can afford!

MAKE MORE MONEY in TELEVISION RADIO-ELECTRONICS

**BETTER...MORE COMPLETE...LOWER COST...
WITH NATIONAL SCHOOLS SHOP-METHOD
HOME TRAINING!**

BETTER... Training that is proved and tested in Resident School shops and laboratories, by a School that is the **OLDEST** and **LARGEST** of its kind in the world.

MORE COMPLETE... You learn **ALL PHASES** of *Television-Radio-Electronics*.

LOWER COST... Other schools make several courses out of the material in our **ONE MASTER COURSE**... and you pay more for less training than you get in *our course* at **ONE LOW TUITION!**

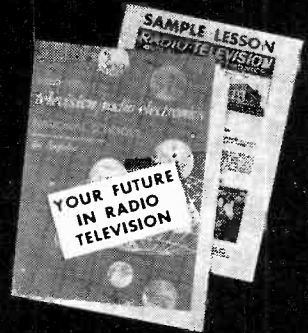
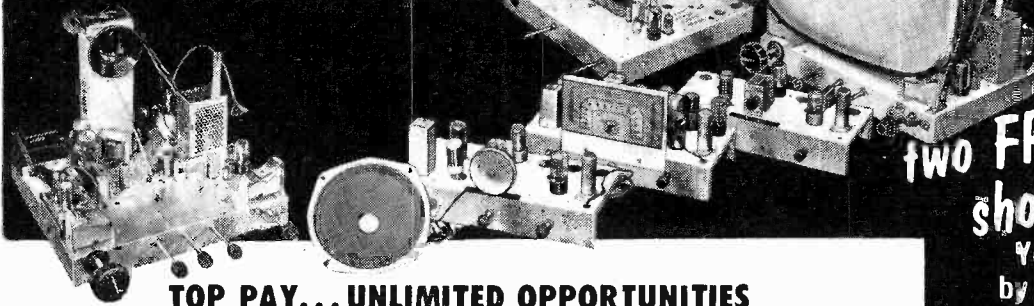

These **TWO FREE** books will show you how!

You get all information by mail... You make your own decision... at home! **NO SALESMAN WILL CALL**

TOP PAY... UNLIMITED OPPORTUNITIES LIFETIME SECURITY CAN BE YOURS!

You are needed in the Television, Radio, and Electronics industry! Trained technicians are in growing demand at excellent pay—in **ALL PHASES**, including Servicing, Manufacturing, Broadcasting and Communications, Automation, Radar, Government Missile Projects.

NATIONAL SCHOOLS SHOP-METHOD HOME TRAINING, with newly added lessons and equipment, trains you in your spare time at home, for these unlimited opportunities, including many technical jobs leading to supervisory positions.

YOU LEARN BY BUILDING EQUIPMENT WITH KITS AND PARTS WE SEND YOU. Your National Schools course includes thorough *Practical* training—**YOU LEARN BY DOING!** We send you complete standard equipment of professional quality for building various experimental and test units. You advance step by step, perform more than 100 experiments, and you build a complete TV set from the ground up, that is yours to keep! A big, new TV picture tube is included at no extra charge.

EARN AS YOU LEARN. We'll show you how to earn extra money right from the start. Many of our students pay for their course—and more—while studying. So can you!

RESIDENT TRAINING AT LOS ANGELES

If you wish to take your training in our Resident School at Los Angeles, the world's TV capital, start **NOW** in our big, modern Shops, Labs and Radio-TV Studios. Here you work with latest Electronic equipment - - professionally installed - - finest, most complete facilities offered by any school. Expert, friendly instructors. Personal attention. Graduate Employment Service. Help in finding home near school - - and part time job while you learn. Check box in coupon for full information.

LESSONS AND INSTRUCTION MATERIAL ARE **UP-TO-DATE, PRACTICAL, INTERESTING.** Every National Schools Shop-Method lesson is made easy to understand by numerous illustrations and diagrams. All instruction material has been developed and tested in our own Resident School Shops, Laboratories and Studios.

SEND FOR INFORMATION TODAY... it can mean the difference between **SUCCESS** and failure for you! Send for your **FREE BOOK** "Your Future in Television-Radio-Electronics" and **FREE Sample Lesson.** Do it **TODAY**, while you are thinking about your future. It doesn't cost you anything to investigate!

GET THE BENEFITS OF OUR OVER 50 YEARS EXPERIENCE

Approved for
GI Training



NATIONAL SCHOOLS

Los Angeles 37, Calif.

YOU GET...

- 19 Big Kits—**YOURS TO KEEP!**
- Friendly Instruction and Guidance
- Job Placement Service
- Unlimited Consultation
- Diploma—Recognized by Industry
- **EVERYTHING YOU NEED FOR SUCCESS!**

SHOP-METHOD HOME TRAINING COVERS ALL PHASES OF INDUSTRY

1. Television, including Color TV
2. Radio AM & FM
3. Electronics for Guided Missiles
4. Sound Recording and Hi-Fidelity
5. FCC License
6. Automation and Computers
7. Radar & Micro-Waves
8. Broadcasting and Communications

NATIONAL TECHNICAL SCHOOLS
WORLD-WIDE TRAINING SINCE 1905

MAIL NOW TO

NATIONAL TECHNICAL SCHOOLS, Dept. RG-60
4000 S. FIGUEROA ST. LOS ANGELES 37, CALIF.
Rush free TV-Radio "Opportunity" Book and sample lesson. No salesman will call.

NAME _____ AGE _____

ADDRESS _____

CITY _____ ZONE _____ STATE _____

Check if interested **ONLY** in Resident School training at Los Angeles.

VETERANS: Give date of Discharge _____

News Briefs

Double-Emitter Transistor

A transistor that can perform a double function (oscillator and mixer when used in a receiver) has been announced by RCA. The double-emitter transistor also makes it possible to obtain improved age in transistor receivers.

The multi-junction drift-field transistor has an n-type base, a p-type collector and two p-type emitters that are so processed that they can function independently of each other.

According to Mr. L. Plus and Mr. R. A. Santilli, RCA engineers, only a limited amount of age can be applied to a conventional converter stage. The new transistor makes it possible to apply age directly to the mixer section without affecting the oscillator section. Another advantage of the unit is freedom from oscillator blocking under transient strong-signal conditions.

Blast Detectors

The first phase of a nation-wide nuclear blast detecting system will soon go into operation, according to Walter P. Marshall, president of Western Union Telegraph Co. The system will consist of detectors scattered around the country (so as to be located near all of the suspected target areas), display panels

to show blast locations and a complicated interconnecting network.

The detectors (see photo) are to be mounted on telegraph poles. There will be three for each target area, arranged in a ring around it. The detectors consist of a group of silicon photocells mounted inside of a lens. The cell output goes to a discriminating circuit that passes only those pulses that are caused by a blast.

The flash from a bomb and therefore the output from the cells are in the shape of a double pulse (see graph). The first is very bright and of short duration; the second, which follows immediately afterwards, has a longer rise time and is of longer duration. The detectors will not respond to sunlight or lightning. They will be "polled" continually to make sure that the system is in proper working order. Built into each detector is a special lighting system that can duplicate the "shape" of a nuclear flash to test the units.

The purpose of the system is to eliminate the confusion that can result in the event of an attack and to indicate exactly what targets have been hit. The detectors send an alarm signal before the blast wave arrives, so even if the units are destroyed, the signal will have been sent.

Locating Radio Stars

A new twin-antenna radio telescope has fixed locations of nine stars outside the Milky Way (the earth's galaxy). The radio observatory was put into operation about 2 months ago at the California Institute of Technology. It has a pair of 90-foot dishes mounted on a railroad track 1,600 feet long. According to the Navy, the "twin dishes produce a resolving power greater than any radio telescope in operation or under construction."

The stars are located through a combination of radio and optical sightings. The general direction of a star is determined by radio telescope. Precise observations are then made through optical telescopes.

New Frequency Standard

The world's most accurate yardstick of radio frequency is now operating on 20 kc, according to an announcement by the National Bureau of Standards. In the past, station WWV (and WWVH, Hawaii) sent out signals that were used as frequency (and time) standards. Because of changes caused by ionosphere level and density changes, the WWV signals could be used with an accuracy of only 1 part in 10^7 (10,000,000). The signal from the 20-kc station can be used with an accuracy of one part in 10^{10} (1,000 times greater accuracy) because the signal does not reflect off the ionosphere (to any great degree), it follows the curvature of the earth instead.

WWVL, located in Sunset Canyon, Colo. (about 20 miles west of Boulder), uses a copper-coated steel cable 3,400 feet long as an antenna. It stretches across the canyon and has a central feed line running 900 feet down to the canyon floor.

This station does not replace WWV, it is only a supplement for users requiring very high accuracy. The National Bureau of Standards estimates that a receiver to pick up this 20-kw station will cost about \$3,000 in small production quantities.

Magnetic Cloud

Pioneer V, the space vehicle that is expected to orbit the sun, appears to have detected a magnetic cloud before the cloud reached the earth.

(Continued on page 10)

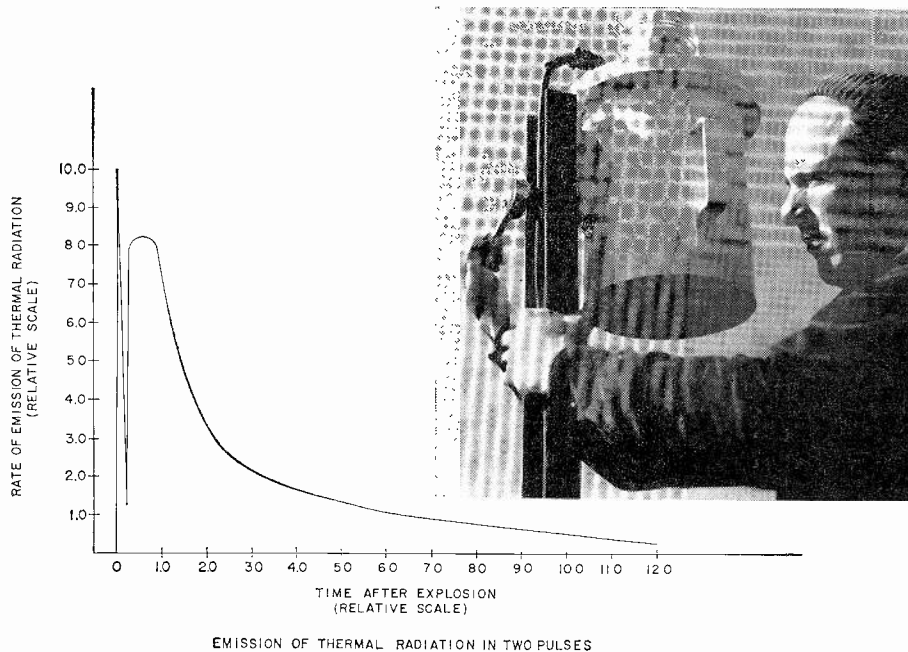

Men 17-55

READ THESE AMAZING FACTS ABOUT A MAN WHO COULD BE YOU!

Are **You** One of
the men who could
prepare for a job that
PAYS REAL MONEY in

**TELEVISION
RADIO**

Electronics

ONLY DeVRY OFFERS ALL THESE FEATURES!

Only DeVry Tech provides Training Movies to make the basic principles of Electronics crystal clear! DeVry's explanations and illustrations are a pleasure to follow. Over 300 practical experiments with actual Electronic parts are included to give you on-the-job type know-how. You even build your own test equipment.

EMPLOYMENT SERVICE

The Industry knows the quality of DeVry training. That's why our Employment Service usually has more demands for graduates than we can fill. We can also help you get started in your own shop.

ARE YOU PASSING UP THE PAYCHECK—THE SOLID FUTURE —THE REAL BREAK—YOU'VE ALWAYS DREAMED OF?

You meet them almost every day . . . the men who want to advance out of humdrum, low-pay, or no-future jobs. Some are men who had to quit school too soon; men just out of school with no idea of what to do; or men looking for help in planning a better future. Yet, many of them could—can, if they're 17-55—train at home, in their spare time, for an exciting career with real money and an inspiring future in the field of Electronics. And the tragedy of it is: they don't know it! They think they need an advanced education, or some special experience, or a lot of money, to start—but what they need most is the will to win. Maybe you're a man like that. Well, here's great news! It's not too late! Electronics offers men like you, when trained, dozens of different job opportunities—from guided missile control to running your own radio-television service shop. Get the full story of the jobs you may prepare for . . . NOW . . . BEFORE the years and responsibilities close in on you.

Send coupon today
no obligation.

EMPLOYMENT
SERVICE

NOTHING
ELSE
LIKE IT

NO
PREVIOUS
TECHNICAL
EXPERIENCE
NEEDED

NO
ADVANCED
EDUCATION
NEEDED

LEARN
AT HOME
OR . . .

.. IN OUR
CHICAGO
OR TORONTO
LABORATORIES

2 MODERN TRAINING CENTERS

Large modern training centers in Chicago and Toronto offer DeVry students day and evening classes. The staffs, facilities and experience of these centers stand back of the home training programs. Whether you train at home or in residence, you're a DeVry Tech man. Look into it now!

Be A Standout in Electronics . . . Be A DeVry Tech Man!

Accredited Member of National Home Study Council
"One of North America's Foremost Electronics Training Centers"



DeVRY TECHNICAL INSTITUTE

CHICAGO 41, ILLINOIS

POCKET GUIDE
Real
Earnings



Electronics in
SPACE TRAVEL

DON'T DELAY!

MAIL COUPON TODAY

DeVRY TECHNICAL INSTITUTE

4141 Belmont Ave., Chicago 41, Ill., Dept. RE6Q

Please give me your FREE booklets, "Pocket Guide to Real Earnings" and "Electronics in Space Travel," and tell me how to prepare to enter one or more branches of Electronics.

NAME _____ AGE _____

PLEASE PRINT

STREET _____ APT. _____

CITY _____ ZONE _____ STATE _____

Check here if subject to military training.

DeVry Tech's Canadian Training Center is located at
626 Roselawn Avenue, Toronto 12, Ontario.

2060

HAROLD S. BLACK, LAMME MEDALIST

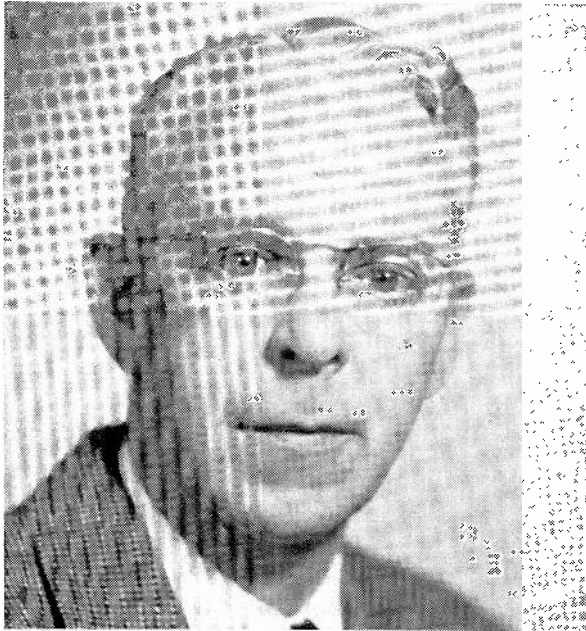

A MAN WINS A MEDAL...AND STRENGTHENS A PHILOSOPHY

The search for the "hitherto unattainable" sometimes ends in strange places.

For years Bell Laboratories engineer Harold S. Black pondered a problem: how to rid amplifiers of the distortion which unhappily accumulated as signal-transmission paths were made longer and amplifiers were added. There had been many approaches but all had failed to provide a practical answer.

Then one day in 1927 the answer came—not in a research laboratory, but as he traveled to work on the Lackawanna Ferry. On a newspaper, Mr. Black jotted down those first exciting calculations.

Years later, his *negative feedback principle* had revolutionized the art of signal amplification. It is a principal reason why telephone and TV networks can now blanket the country, the transoceanic cable is a reality, and military radar and missile-control systems are models of precision.

For this pioneer achievement, and for numerous other contributions to communications since then (some

60 U. S. patents are already credited to him), Mr. Black received the 1957 Lamme Medal from the American Institute of Electrical Engineers. He demonstrated that the seemingly "unattainable" often *can* be achieved, and thus strengthened a philosophy that is shared by all true researchers.

He is one of many Bell Telephone Laboratories scientists and engineers who have felt the challenge of telephony and have risen to it, ranging deeply into science and technology. Numerous medals and awards have thus been won. Two of these have been Nobel Prizes, a distinction without equal in any other industrial concern.

Much remains to be done. To create the communication systems of the future, we must probe deeper still for new knowledge of Nature's laws. We must continue to develop new techniques in switching, transmission and instrumentation for every kind of information-bearing signal. As never before, communications offer an inspiring challenge to creative men.

BELL TELEPHONE LABORATORIES

WORLD CENTER OF COMMUNICATIONS RESEARCH AND DEVELOPMENT





WOW!

get **ASTRON'S Service Caddy FREE**

FREE to all alert
servicemen with purchase
of **ASTRON** capacitors



Holds everything you need — capacitors, resistors, tubes, tools — for home service calls — a complete parts set-up to carry along wherever you go.

Neat — compact — easy to carry — easy to find what you need.

Build up your reputation for efficient service with the Service Caddy — and for guaranteed service . . .

Astron Capacitors with the 2 year Red Seal Performance Guarantee.

Here's the complete Astron Service Caddy package: Service Caddy — with space for tube replacements; tray for other small parts; carrying handle. Supplied completely stocked with Astron Capacitors.

See your authorized Astron distributor.

THE SERVICE CADDY MAY
BE SEEN AT BOOTH 775,
MAY PARTS SHOW



ASTRON

C O R P O R A T I O N
255 GRANT AVENUE • EAST NEWARK, NEW JERSEY

Get Astron's complete new Servicemen's replacement catalog, from your local distributor.

Auto Radio Control Replacement is Child's Play

with new **Centralab** CRL®

Exact Replacement Controls

22 brand new units expand the line!



Now more than ever, one source fills all your needs for auto radio replacement controls. Twenty-two new units expand the CENTRALAB line of exact replacements—give you full coverage of every popular radio in use today, including radios used in foreign cars.

But there's more to it than quality! It's more *convenient* to buy from your electronic parts distributor. Auto radio repair business is easier and more profitable when you don't have to make special trips to the auto parts distributor. Your CENTRALAB distributor will have it!

What about on-off switches for push-button radios? CENTRALAB has the most complete line (SP Series) for Plymouth, Dodge, DeSoto, Chrysler, Ford, Mercury, Lincoln, and Hudson.

A complete control replacement guide for TV and auto radios has been prepared by Howard W. Sams & Co., Inc. Order one from your distributor, and see the wide coverage of exact replacement auto radio controls you get from CENTRALAB.

8-6005

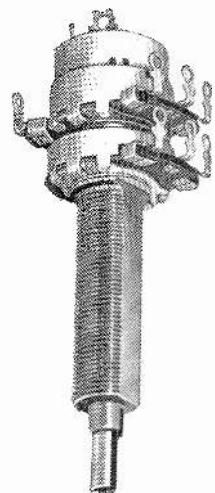

Centralab

THE ELECTRONICS DIVISION OF GLOBE-UNION INC.
922 F. E. KEEFE AVE. • MILWAUKEE 1, WIS.
IN CANADA: P. O. Box 400 • Ajax, Ontario

CONTROLS • ROTARY SWITCHES • CERAMIC CAPACITORS
PACKAGED ELECTRONIC CIRCUITS • ENGINEERED CERAMICS

The instruments on the vehicle observed a sixfold increase in magnetic intensity. About 4 to 8 hours later, the magnetic cloud (or storm) reached the earth and disrupted communications. One unusual point was the failure of the Pioneer's Geiger counters to register any increase in background radiation.

Tube Increases Radar Range

Tests with a "parametric amplifier tube" and a synchronous pumping technique have shown a significant improvement in radar sensitivity, according to Zenith Radio Corp. The improvement is equivalent to a 50% increase in range.

The device is described as a promising newcomer to the vacuum-tube family that provides broad-band signal amplification with very low noise and unconditional stability. Using the synchronous pumping technique, the amplifier is energized by rf power of exactly twice the frequency of the signal transmitted by the radar.

Most Sensitive Listener

The US Army has announced that it is testing a microwave amplifier described as "the most sensitive listening device in the history of science." It is a 25-pound maser (microwave amplification by stim-



ulated radiation) which uses as its heart a 1/2-inch-square synthetic ruby.

The maser is expected to be used to extend the listening range of many devices and provide the sensitivity necessary to detect radio "beeps" from millions of miles out in space, and possibly be the heart of receivers used for vehicle-to-vehicle communication in space.

In operation, the ruby is cooled to a temperature of -452°F by immersing it in liquid helium. At this temperature, the atoms in the crystal move so slowly that noise is almost completely eliminated. Conventional vacuum-tube or transistor

"An F.C.C. License opened up great opportunities in electronics for me..."



JACK STEGELMAN
2530 E. 16 Street
Tulsa 4, Oklahoma

"I liked science in high school, and later I attended a TV school home study course in color TV. For several years I also had a part time TV repair service, and worked for Boeing Aircraft Company as an electronics certification technician. But I soon realized how little I knew about what actually was involved in electronics. What I knew was enough for my job with Boeing, but my future was limited if I didn't learn more math and theory. One day I answered a Cleveland Institute ad, and that's the smartest thing I ever did.

NOW . . . thanks to Institute training . . .

- I have a new better-paying job
- I'm having more fun on the job than ever
- I see a really bright future ahead!

Thanks to Cleveland Institute, I've got a thorough background in basic electronics — and a 2nd class phone license — both 'musts' for my great new job with American Airlines' Jet Overhaul Center. You sure can say 'there goes another satisfied and happy student.' I'll surely recommend the Institute any time I can."

Jack Stegelman

YOU CAN Learn Electronics Easily . . . the Institute Way!

Every day Cleveland Institute receives letters from students and graduates praising the Institute way of training by mail. Here are just a few of the enthusiastic comments: (names and addresses furnished on request):

"... sincere appreciation for your terrific instruction . . . been enrolled only a short period and have gained much knowledge."

"Cleveland Institute should be highly praised for its outstanding presentation of study material..."

"Had no trouble with any part of the course because of the clear method of presenting each subject."

• Accredited by National Study Council.

SEE FOR YOURSELF!
Try Our FREE 5 Day Course
Material Inspection



Send in coupon today, get 3 valuable booklets (How To Get A Commercial F.C.C. License; Opportunities In Electronics For You; A Successful Plan For Electronics Training). Then request inspection of the Course Material for 5 full days — with no obligation!

No Obligation MAIL COUPON TODAY!
Cleveland Institute of Electronics
Dept. RE42B
4900 Euclid Bldg., Cleveland 3, Ohio

Cleveland Institute of Electronics
Dept. RE42B
4900 Euclid Bldg., Cleveland 3, Ohio



Please send Free Booklets prepared to help me get ahead in Electronics. I have had training or experience in Electronics as indicated below:

- | | |
|---|---|
| <input type="checkbox"/> Military | <input type="checkbox"/> Broadcasting |
| <input type="checkbox"/> Radio-TV Servicing | <input type="checkbox"/> Home Experimenting |
| <input type="checkbox"/> Manufacturing | <input type="checkbox"/> Telephone Company |
| <input type="checkbox"/> Amateur Radio | <input type="checkbox"/> Other |

In what kind of work are you now engaged? _____

In what branch of Electronics are you interested? _____

Name _____ Age _____

Address _____

City _____ Zone _____ State _____

RE42B

1500
servicemen
told us*



Perma-Power

VU-BRITES

BRIGHTEN
THE BUSINESS
PICTURE, TOO!

1500 servicemen recently gave us their good *business* reasons for choosing Perma-Power Vu-Brites. You and your colleagues told us that your customers invariably had confidence in the neat-looking product and the attractive package . . . and were pleasantly surprised by the low price (\$9.95 the dozen, net). Result: no sales resistance—a happy satisfied customer who is sure to call back next time—virtually guaranteeing you a highly profitable picture tube sale.

Of course, you have a lot of other good reasons for choosing Perma-Power Vu-Brites. One outstanding reason is that you've never found a defective one. That's because Perma-Power Vu-Brites are engineered for quality, and 100% tested. They instantly restore brilliance and clarity to fading TV pictures. You can use them on either electro-static or electro-magnetic picture tubes, Model C-402 in Series sets, Model C-401 in Parallel sets.

Perma-Power also makes a full line of special purpose brighteners, tube restorers, and accessories, all described in our latest catalog, available free from your distributor, or by writing direct to us. Don't say "brightener," say "Perma-Power" . . . the standard of all comparison.

*on their entry blanks in Perma-Power's Las Vegas contest.

Perma-Power COMPANY

3100 N. ELSTON AVENUE • CHICAGO 18, ILL.

LOOK
WHAT'S
AHEAD

in **Radio-Electronics**
future issues

- Make Your Own Citizens Band Transceiver
- Build the New Bigger Twin-Coupled Amplifier
- The How and Why of Air Ionizers
- Easily Built Narrow-Band Wobulator

The July issue of **RADIO-ELECTRONICS** goes on sale June 28 at all better parts distributors and newsstands. Reserve your copy now.

SUBSCRIPTION RATES

1 year \$4 2 years \$7 3 years \$10
Save up to \$8.00 over the newsstand price

Radio-Electronics 154 West 14th St. New York 11, N.Y.

NEWS BRIEFS (Continued)

amplifiers create so much noise (the hissing heard when a very sensitive receiver is turned up full) that they often override weak signals.

The new maser takes up only 1/3 cubic foot. Earlier models used a magnet weighing up to 500 pounds and costing more than \$4,000. The new maser magnet weighs 12 ounces and costs \$10.

The photograph shows the magnet, ruby and copper transition section (waveguide) used in the maser developed by Hughes Aircraft Co. The maser is an X-band amplifier (8.2 to 12.4 kmc). The synthetic ruby is an aluminum-oxide crystal with a trace of chromium as an impurity and is marketed for about 5 cents per carat.

Calendar of Events

Annual Radar Symposium, June 1-3, University of Michigan, Ann Arbor, Mich.

Radio Frequency Interference Symposium, June 13-14, Washington, D.C.

Spring Conference on Broadcast & TV Receivers, June 20-21, Graemere Hotel, Chicago, Ill.

Electronic Standards & Measurements Conference, June 22-24, NBS Boulder Labs., Boulder, Colo.

Workshop on Solid State Electronics, June 23-24, Purdue University, West Lafayette, Ind.

Congress of the International Federation of Automatic Control, June 25-July 9, Moscow State University, Moscow, USSR.

National Convention on Military Electronics, June 27-29, Sheraton Park Hotel, Washington, D. C.

New England Electronic Conference, June 27-29, Balsams, Dixville Notch, N. H.

1960 Music Industry Trade Show July 10-14, Palmer House, Chicago, Ill.

Conference on Medical Electronics July 21-27, Olympia, London, England.

Ham Licenses Up

According to FCC figures, the number of amateur radio operator licenses in the US now exceeds 200,000. The number of ham stations is approaching 204,500. (The difference in figures is caused by club stations and individuals who have more than one station.) This represents an increase of more than 285% since the resumption of amateur radio operation after World War II.

Navigation Satellite in Orbit

The second successful satellite launching in less than a month put the Transit I-B in orbit. This satellite is the first step toward a world-wide radio-navigation system which will make it possible for ships and aircraft to determine exactly where they are within 1/4 mile. Present navigation systems (Loran and RDF) are comparatively short range (Loran—1,000 miles, RDF—even less) and limited to traveled routes.

The satellite system will call for a total of four Transit's in orbit.

2 Great *knight-kit* Citizens Band Transceiver Kits

PRODUCT OF ALLIED RADIO

YOUR CHOICE OF THE FINEST VALUES IN 2-WAY RADIO EQUIPMENT



For Auto-to-Auto
or Auto to
Home or Office



For Farming
Operations



Local Trucking,
Delivery,
Construction Work

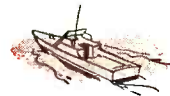

Boat-to-Boat,
Ship-to-Shore

YOU BE THE JUDGE OF
knight-kit VALUE!
FREE Examination Privilege

We invite you to take advantage of our exclusive free examination offer. Order a Knight-Kit Transceiver. Examine it on arrival. Inspect the quality of the components, the circuitry, the easy-assembly manual. We're so confident you'll want the kit, we can make this offer: If you're not **COMPLETELY SATISFIED**, just return the kit for full refund!

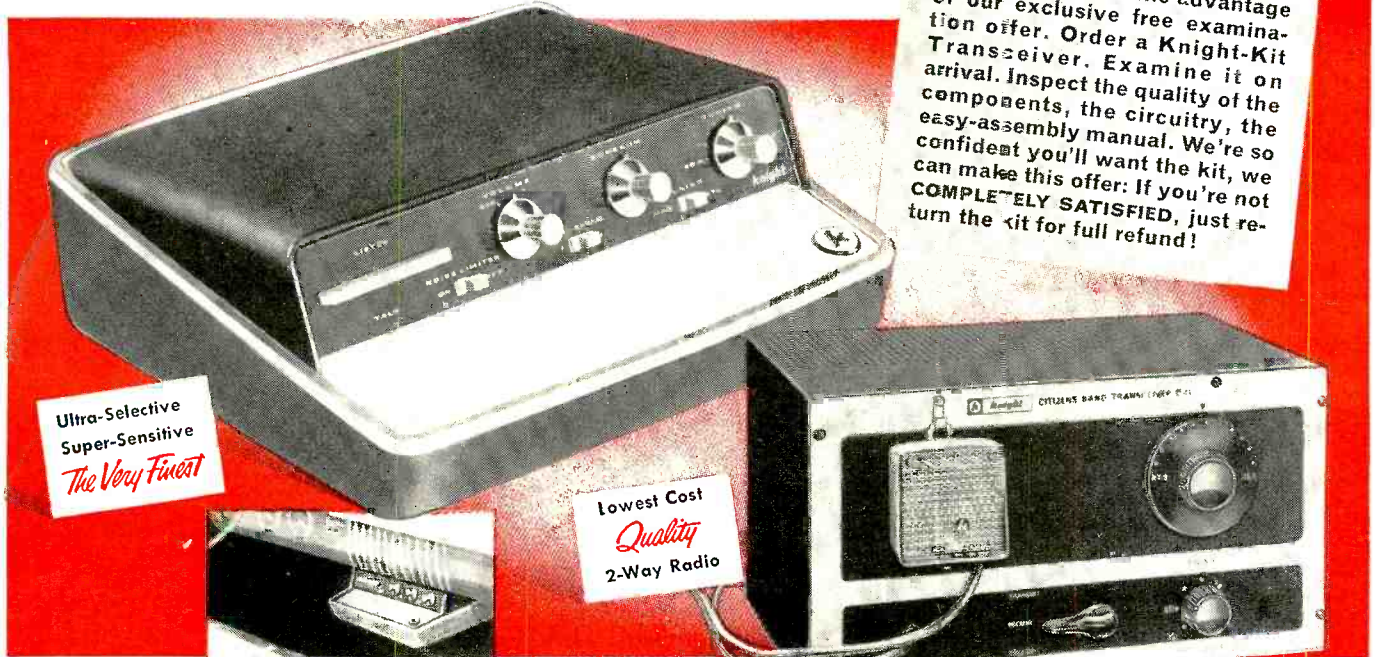

Ultra-Selective
Super-Sensitive
The Very Finest

Lowest Cost
Quality
2-Way Radio

Citizens Band Superhet Transceiver Kit

Y-712L BEAUTIFUL STYLING... UNEXCELLED PERFORMANCE

\$79⁹⁵

\$5
Down

Have dependable, economical 2-way radio communication with this top-rated, do-it-yourself transceiver. Has two crystal-controlled transmitting positions; operates at maximum FCC legal power input of 5 watts fully modulated. Superhet receiver is continuously tunable over the full 22 channel band; also has two optional crystal-controlled fixed frequency positions. Works just like press-to-talk intercom—speaker also serves as mike.

Ultra-selective, highly sensitive dual-conversion superhet receiver features built-in adjustable squelch and noise limiter. Sensitivity (manual) is better than 1 μ v for 10 db S/N; crystal, $\frac{1}{2}$ μ v. Includes built-in AC power supply. Easy to assemble; has dependable printed circuitry and pre-aligned IF transformers. With distinctively styled high-impact case, 5 x 12 x 12". Complete with all parts, wire-type doublet antenna, and one transmitting crystal (available for any channel from 1 to 22—specify preference). FCC application form is included (license is available to any citizen over 18—no exams to take). See below for DC mobile supply, vertical antenna, etc. Wt., 20 lbs.

Model Y-712L. \$5 Down. ONLY **\$79⁹⁵**

- Y-729L. 3 Ft. Vertical Antenna. 2 lbs. NET **6.50**
- Y-714L. Mobile Mounting Bracket. 4 lbs. NET **5.35**
- Y-723L. 6-12 V. Mobile Power Supply. 6 lbs. NET **10.95**
- Y-769L. Optional Receiving Crystal (specify frequency) ... **1.99**
- Y-719L. Optional Hand-Held Mike. 1 lb. NET **9.50**

Top Buy Citizens Band Transceiver Kit

Y-713L Now have your own private 2-way radio system at an amazingly low cost!

\$39⁹⁵

\$2
Down

Consists of easy-to-assemble superregenerative receiver and 5-watt transmitter. Readily fits car, boat or desk. Single, one-switch operation permits talk or listen. Receiver tunes all 22 channels continuously. Built-in AC power supply. Handsomely styled case, 7x10x8". With mike, doublet antenna, and transmitting crystal (specify channel —1 to 22—if you have a preference). See below for antenna, mobile power supply, etc. Shpg. wt., 10 lbs.

Model Y-713L. \$2 Down. ONLY **\$39⁹⁵**

- Y-729L. 3 Ft. Vertical Antenna. 2 lbs. NET **6.50**
- Y-723L. 6-12 V. Mobile Power Supply. 6 lbs. NET **10.95**
- Y-724L. Mobile Mounting Bracket. 4 lbs. NET. **5.35**

ORDER NOW

ALLIED RADIO CORP., Dept. 68-F
100 N. Western Ave., Chicago 80, Ill.

Please ship: Y-712L Transceiver. Y-713L Transceiver.
 Y-729L Y-723L Y-714L Y-724L
 Y-769L Y-719L \$_____ enclosed

Send latest catalog describing Knight-Kits.

Name _____

Address _____

City _____ Zone _____ State _____

Manufactured and sold exclusively by **ALLIED RADIO**

DESIGNED FOR STEREO

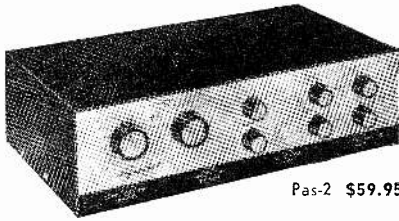

Pas-2 \$59.95

- New stereo control preamp with complete flexibility, fastest construction, and simplest operation.
- All long life components, 1% parts used in critical circuits
- 2 pre-assembled heavy duty printed circuit boards make construction simple and bug-free
- Truly unmeasurable distortion—below 0.05%. Lowest possible noise

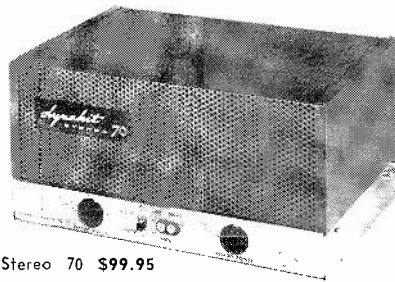

Stereo 70 \$99.95

- Two outstanding 35 watt channels (160 watts peak) to power any speaker. Less than .5% distortion at rated power
- Unequaled transient response — excellent square wave performance
- Absolute stability with every loud-speaker without restriction of band-width
- Smooth and crystal clear sound with superb delineation of heavy passages

WITH DYNAKIT YOU KNOW YOU HAVE THE BEST!

The finest high fidelity you can buy at any price

STEREO IN EASY STEPS

START WITH A SUPERB MONOPHONIC SYSTEM

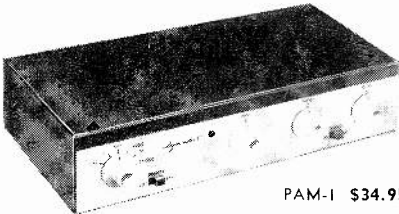

PAM-1 \$34.95

- History-making "no-distortion" preamplifier which has never been equalled
- All feedback design and close tolerance parts result in lowest noise, lowest distortion and finest sound
- 6 hour assembly

EXPAND TO MATCHLESS STEREO

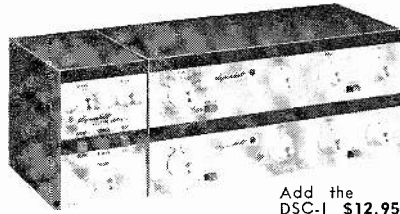

Add the DSC-1 \$12.95

- Every stereo function at your fingertips — including Dyna Blend control
- Unsurpassed flexibility
- Unitized panel or cabinet mount available as an accessory

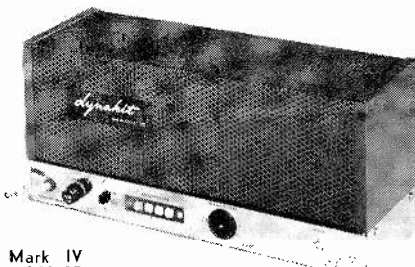

Mark IV \$59.95

- Either the renowned 60 watt Mark III or its new little brother, the 40 watt Mark IV
- 3 hours to build
- A quality of performance unexcelled at any price



Two Mark III's \$79.95 each

- Just add a second Mark III or Mark IV and you have the most recommended, most desired stereo amplifier ensemble
- Dynakits provide the finest in high fidelity

See and hear Dynakits at your local dealer

A post card will bring complete specifications

DYNACO, INC., 3916 POWELTON AVENUE, PHILA. 4, PA.
CABLE ADDRESS: DYNACO, PHILA.

NEWS BRIEFS (Continued)

They will transmit extremely stable radio signals. Six US tracking stations will use these signals to plot the satellites' future orbits accurately. Once predicted, orbital information will be transmitted to the satellite and stored. It will be transmitted back to earth at the appropriate time as a code signal added to the satellite's radio transmission. This will indicate the satellite's position.

Ship navigation techniques will follow this pattern:

As a satellite approaches a listening ship, the frequency of its transmission will seem to change (Doppler effect)—rising as it approaches and falling as it recedes. The ship's navigator will record the Doppler shift and the orbital position transmitted by the satellite. Using this data he will be able to determine where he is. Small computers will simplify this task. The four-satellite network makes it possible for any ship, anywhere in the world, to get a position fix every 90 minutes.

The antenna used by the satellite is rather unusual. It has no elements that project from the satellite. Instead, it is a silver spiral painted on the satellite's skin.

Signal Corps

The United States Army Signal Corps celebrates its 100th anniversary on June 21 of this year. Major Albert J. Meyers (who up until that time had been an army surgeon) was authorized as Signal Officer of the Army on that date in 1860.

Major Meyers developed a method of signalling with wigwag flags during the day and torch at night. The crossed wigwag flags and the torch appear today on the insignia worn by men of the Signal Corps.

A Signal Corps satellite designed to send back photos of the cloud cover of the earth (RADIO-ELECTRONICS, November, 1958, page 32) was placed into orbit on February 17, 1959. Although it was not successful because of spin problems, future satellites were planned. One of these was TIROS I, under the National Space Aeronautics Administration (see page 86).

Color TV on Upswing

RCA plans to double its production of color TV receivers this year. According to P. J. Casella, consumer products executive vice president, the increased production is based on a 40% upswing in color TV sales during the first three months of the year. Already, he said, the tube division is turning out twice as many color picture tubes as at this time last year, and plans a further increase in production this summer. RCA color sales for 1959 are estimated at 100,000 sets. END

Learn Electronics

PREPARE FOR YOUR F. C. C. LICENSE—YOUR TICKET TO A BETTER JOB AND HIGHER PAY!

F. C. C. LICENSE—THE KEY TO BETTER JOBS

An F.C.C. *commercial* (not amateur) license is your ticket to higher pay and more interesting employment. This license is Federal Government evidence of your qualifications in electronics. Employers are eager to hire *licensed* technicians.

WHICH LICENSE FOR WHICH JOB?

The **THIRD CLASS** radiotelephone license is of value primarily in that it qualifies you to take the second class examination. The scope of authority covered by a third class license is extremely limited.

The **SECOND CLASS** radiotelephone license qualifies you to install, maintain and operate most all radiotelephone equipment except commercial broadcast station equipment.

The **FIRST CLASS** radiotelephone license qualifies you to install, maintain and operate every type of radiotelephone equipment (except amateur) including all radio and television stations in the United States, its territories and possessions. This is the highest class of radiotelephone license available.

GRANTHAM TRAINING PREPARES YOU

The Grantham Communications Electronics Course prepares you for a **FIRST CLASS** F.C.C. license, and it does this by **TEACHING** you electronics. Each point is covered simply and in detail, with emphasis on making the subject easy to understand. The organization of the subject matter is such that you progress, step-by-step, to your specific objective—a first class F.C.C. license.

CORRESPONDENCE OR RESIDENCE CLASSES

Grantham training is available by correspondence or in resident classes. Either way (residence or correspondence), we train you quickly and well—no previous training required. Even a beginner may qualify for his first class license in a relatively short time.

RESIDENT CLASSES HELD IN FOUR CITIES

To better serve those students who wish to attend resident classes, Grantham School of Electronics offers **DAY** and **EVENING** classes in four different cities—Hollywood, Seattle, Kansas City, and Washington, D. C. The same rapid course in F. C. C. license preparation is conducted in all four locations. If you are interested in attending a **DAY** or **EVENING** class, indicate the city of your choice in the coupon below, and mail the coupon to Hollywood for *free information*. There is no obligation of any kind.

GRANTHAM SCHOOL OF ELECTRONICS

1505 N. Western Avenue • Hollywood 27, California

In resident classes or by home study, Grantham training is the easy way to learn more quickly—to prepare more thoroughly—for F. C. C. examinations. And your first class F. C. C. license is the quick, easy way to prove to your employer that you are worth more money.

MAIL COUPON NOW—NO SALESMAN WILL CALL →

This booklet
FREE!

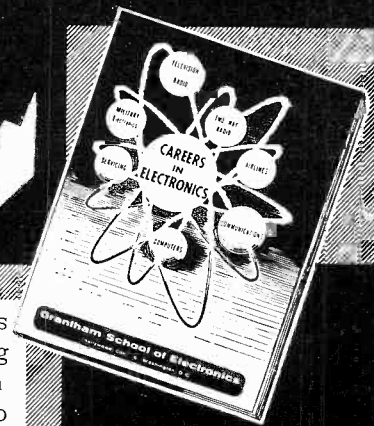

This free booklet gives details of our training and explains what an F. C. C. license can do for your future.

Upgrade Your Income with a First Class F. C. C. LICENSE

HERE'S PROOF...

that Grantham students prepare for F.C.C. examinations in a minimum of time. Here is a list of a few of our recent graduates, the class of license they got, and how long it took them:

	License	Weeks
Mario Bidese, 342 Alexander Avenue, Greensburg, Pa.	1st	12
Richard M. Wilhoit, 2104 Santa Paula, Las Vegas, Nev.	1st	12
Larry R. Perrine, 7 Normandy Place, Champaign, Ill.	1st	15
Emerson F. Lawson, 111 Excelsior Ave., Union, S.C.	1st	12
Marion Woolsey, 3246 Warwick, Kansas City, Mo.	1st	12
Harold W. Johnson, 5070 Hermosa Ave., Los Angeles, Calif.	1st	15
Arthur W. Hardy, 66 Dresser Ave., Great Barrington, Mass.	1st	12
Ralph Frederick Beisner, 2126 Grand, Joplin, Mo.	1st	12
N. B. Mills, II, 110 So. Race St., Statesville, N.C.	1st	12
Dean A. Darling, 403 S. Chase Ave., Columbus 4, Ohio.	1st	12
Paul D. Bernard, 408 First Ave., N. E., Watertown, S.D.	1st	18
Gerald L. Chopp, 518 Aubudon Road, Kohler, Wisc.	1st	12

(Mail in envelope or paste on postal card)



To: GRANTHAM SCHOOL OF ELECTRONICS
1505 N. WESTERN AVE., HOLLYWOOD 27, CALIF.

Gentlemen:

Please send me your free booklet telling how I can get my commercial F.C.C. license quickly. I understand there is no obligation and no salesman will call.

Name _____ Age _____

Address _____

City _____ State _____

I am interested in: Home Study, Kansas City classes, 04-G
 Hollywood classes, Seattle classes, Washington classes

make your first move to ROHN



You Have the Greatest Sales Potential by Far With America's MOST COMPLETE LINE OF

TOWERS—MASTS ROOF TOWERS Installation Accessories

ROHN TV TOWERS

ROHN makes the finest towers available for television reception! Illustrated is the No. 25 with amazing "zig-zag" cross bracing design. The entire tower is rated 33% stronger than other similar sized towers. Yes, sell and install the No. 25 up to 50 feet self-supporting or, properly guyed, up to 360 feet!

Or if you prefer, sell the popular ROHN No. 6 tower with the famous "Magic Triangle" cross-bracing. Both are fully HOT DIPPED GALVANIZED AFTER FABRICATION! Sections in easy-to-handle 10 ft. lengths.

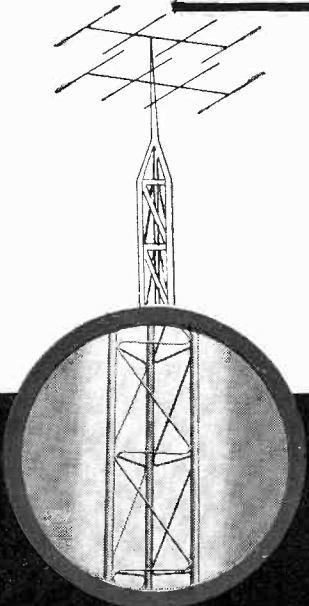

From every standpoint, ROHN Towers offer you MORE . . . more quality, more variety, more advanced design, more sales features, more service, more total sales and more PROFITS! Move forward with these ROHN items!

ROHN COMMUNICATION TOWERS

Here you have FIVE complete lines of heavy-duty, FULLY ENGINEERED communication towers to fulfill any communications requirement. Shown is the ROHN "SS" tower which is self-supporting up to 130 feet. Other models — (30-40-50-60) are available in heights up to 630 feet when guyed! Handle these towers for the demand in your area. There's a complete NEW catalog on this line. Get a copy so you'll have it on hand.

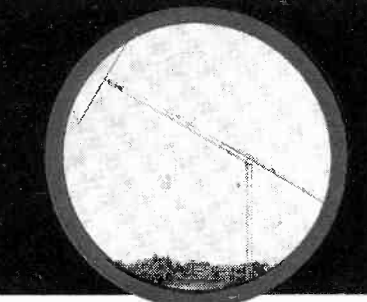

AMATEUR "FOLD-OVER" TOWERS

Specially designed "fold-over" towers are the best ever designed for amateur radio and experimentation. They are the most desired because they "fold-over" completely so you work on the ground for ease and safety. Three sizes, including heavy-duty type to handle any needs. All hot dipped galvanized.

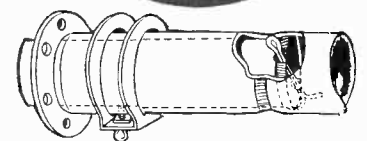
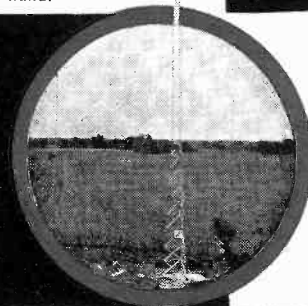

TELESCOPING MASTS

Unexcelled in design, structural strength, and sales appeal. All popular sizes, heights, and weights available. Also, mast tubing in exact specifications that's demanded today.

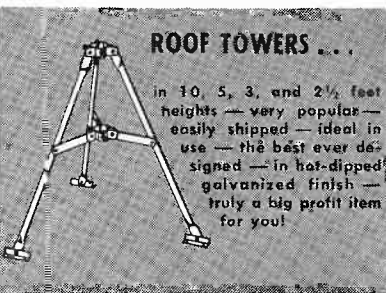

ROOF TOWERS . . .

in 10, 5, 3, and 2 1/2 foot heights — very popular — easily shipped — ideal in use — the best ever designed — in hot-dipped galvanized finish — truly a big profit item for you!

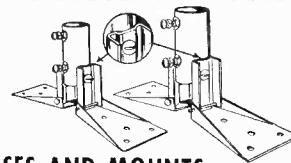

BASES AND MOUNTS

Wide variety of bases and mounts. Special features include "locking" device — also cast aluminum roof mounts — and a host of other installation items . . . get full details.



TV SERVICE TABLE

For holding TV sets while servicing, or storing, or for mobile use of set in such places as motels, hospitals, etc. Ideal for dozens of uses — thousands sold. Large casters — a real work-saver.

ROHN

Manufacturing
Company

116 Limestone, Bellevue
Peoria, Illinois

Get complete catalog from your ROHN representative or jobber or MAIL THIS COUPON!

Gentlemen: Please send me literature on ROHN Towers and Accessories.

Firm _____

Name _____ Title _____

Address _____

City _____ State _____

ANOTHER WAY RCA
SERVES EDUCATION
THROUGH
ELECTRONICS



6 REASONS WHY RCA TRAINING IN ELECTRONICS can be the smartest investment you'll make in your *entire lifetime!*

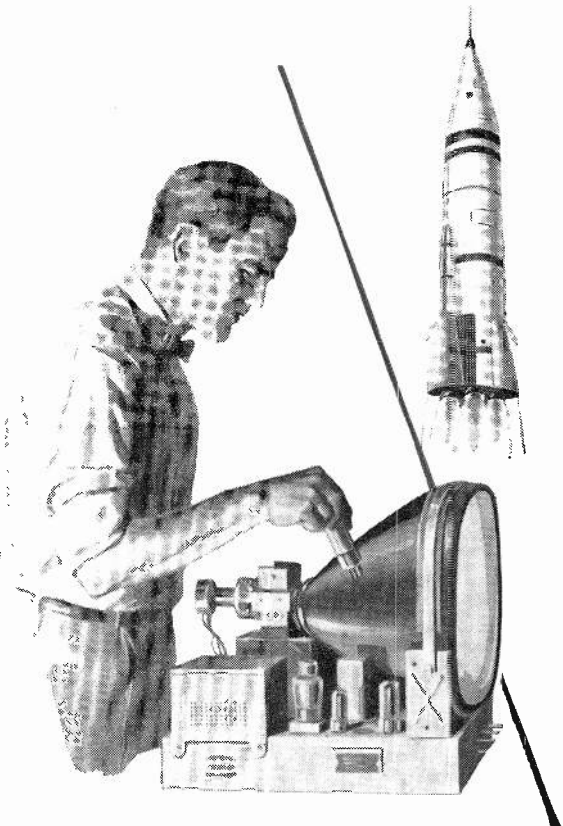

1. You get the finest training-at-home under the supervision of the RCA INSTITUTES, experts in technical training for over 50 years. The very name "RCA" means dependability, integrity, and scientific advance.

2. You get comprehensive training in your choice of four complete, up-to-date Courses . . . from basic electronics theory to Color TV and Automation.

3. You get Theory, Experiment, and Service Practice starting with the very first lesson . . . a complete training package throughout the course. No special technical background is required.

4. You get prime quality equipment as a regular part of your Course . . . equipment that you keep and use on the job. You never have to take apart one piece to build another.

5. You get each study group on a pay-as-you-go basis. Should you wish to interrupt your training at any time, you will not owe RCA Institutes a penny more, unless and until you decide to resume the Course.

6. You get top recognition — worldwide. Graduates of RCA Institutes now work for leaders in the electronics field; many have their own businesses. This record is true tribute to the high quality of RCA Institutes training.

Send for this
64-page Home
Study Catalog
FREE!

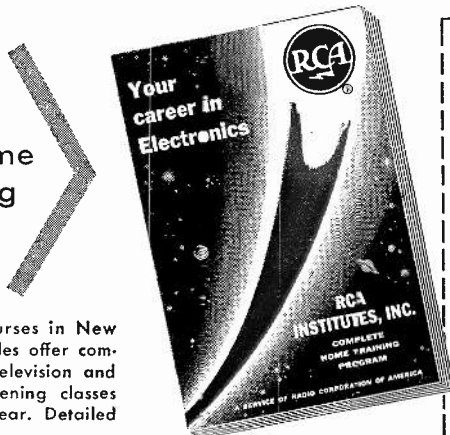

RESIDENT SCHOOL Courses in New York City and Los Angeles offer comprehensive training in Television and Electronics. Day and Evening classes start four times each year. Detailed information on request.

RCA INSTITUTES, Inc. Home Study School

A Service of Radio Corporation of America Dept. RE-60
350 West Fourth Street, New York 14, N. Y.

Please rush me your FREE illustrated 64-page book "Your Career in Electronics," describing your home training programs. No obligation. No salesman will call.

Name Age

please print

Address

City Zone State

Korean Vets! Enter discharge date.....

CANADIANS — Take advantage of these same RCA courses at no additional cost. No postage, no customs, no delay. Send coupon to: RCA Victor Company, Ltd., 5575 Royalmount Ave., Montreal 9, Quebec

To save time, paste coupon on postcard.

A TUBE TESTER FOR EVERY PURPOSE

Here's how easy it is to test all tube types with a **MERCURY TUBE TESTER** — completely, accurately — **IN JUST SECONDS**

**JUST SET FILAMENT AND LOAD CONTROLS...INSERT TUBE...
PRESS QUALITY BUTTON AND READ EMISSION ON METER**

IMPORTANT! Mercury Tube Testers positively cannot become obsolete as they are engineered to accommodate all new tube types as introduced. New tube listings are furnished periodically to all registered owners.

Model 101 Portable Tube Tester THE SPEED AND ACCURACY OF A MULTIPLE SOCKET TUBE TESTER AT A FABULOUSLY LOW PRICE

Checks emission of over 700 tube types... Checks inter-element shorts, leakage and gas content... Checks all sections of multi-purpose tubes... Housed in sturdy gray hammertone steel case... Handy tube chart contained in special back compartment... Size, 9 x 8½ x 2¾"

Model 101
Dealer Net... **\$39.95**

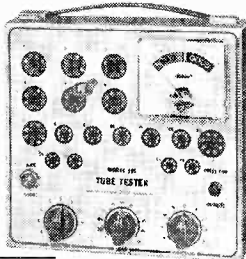

Model 102-P Portable Tube Tester A DELUXE TESTER AT A SENSIBLE PRICE

Checks emission of over 700 tube types... Checks inter-element shorts, leakage and gas content... Checks all sections of multi-purpose tubes... Checks diodes, filament and external continuity, power rectifiers, pilot lamps, auto and TV fuses... Housed in handsome oak carrying case with compartment for all test leads... Size, 11¼ x 12 x 4½"

Model 102-P **\$59.50**
Dealer Net...

Model 102-C Caddy Tube Tester A TUBE TESTER AND TUBE CADDY 'ALL IN ONE'

Includes the specifications of the Model 102-P above... Tester fits securely on guiders but can easily be removed... Tube caddy will hold over 125 tubes... Convenient drawer stores tools and test leads. Size, 9¾ x 16 x 13½"

Model 102-C **\$74.50**
Dealer Net...

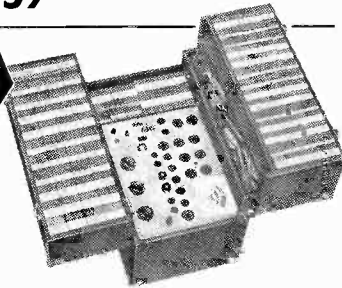

Model AD-1 CRT Adapter available... makes Mercury Tube Testers highly accurate picture tube testers of all black and white picture tubes (including the new **\$3.95** short neck 110 degree RCA type) for emission, shorts and gas content. Dealer Net...

Model 201 Self-Service Tube Tester A VALUABLE MONEY-MAKING ASSISTANT IN YOUR SHOP

Checks quality (emission, shorts and gas) of over 800 tube types... Checks each section of multi-purpose tubes... Tests all 6 and 12 volt standard auto radio vibrators... Handy push button fuse can be reset manually—never needs replacement... Tube compartment with own lock holds over 400 tubes... Tube storage drawers with tube carton dividers and drawer sheets provide for automatic inventory control... Etched aluminum panel always retains its handsome appearance... Takes only 19" x 19" of floor space. Stands 6'1" high... Illuminated colorful plastic display tops the cabinet... Colorful window streamers supplied with each tester to attract customers.

Model 201-F (Floor Model) **\$158.50**
Dealer Net...

Model 201-C (Counter Model) **\$109.50**
Dealer Net...

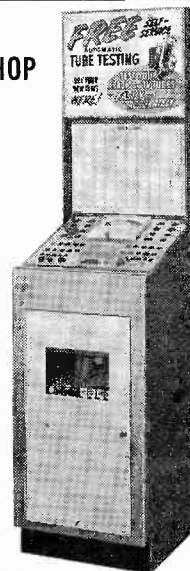

SEE YOUR LOCAL ELECTRONICS PARTS DISTRIBUTOR



ELECTRONICS CORP.
manufacturers of quality electronic products

77 Searing Ave., Mineola, N. Y.

Correspondence



NAME WANTED

Dear Editor:

I would like to locate some under-privileged youngster who is interested in electronics. I have many good books pertaining to radio and TV theory and repair, and would be very happy if I could help someone who, otherwise, couldn't obtain this type of material. The books would cost him nothing, except perhaps postage.

NAME WITHHELD

Cicero, Ill.

[Please send any information or name(s) you may have to: Correspondence Editor, RADIO-ELECTRONICS, 154 W. 14th St., New York 11, N. Y. —Editor]

SUPERCEPTION, MOEBIUS RADIO

Dear Editor:

Concerning the editorial "Superception" (April, 1960, page 31), Mr. Gernsback does not suggest the most exciting possibility that Superception opens up, besides the obvious one of enabling the blind to see and the deaf to hear. By this system, it seems to be perfectly possible to blend a transmission by allowing the inductive fields to overlap the various perception brain centers. Thus one could not only hear music, but "see" it as well. A painting could be "heard" in addition to just seeing it. This could create a whole new art form or series of art forms.

May I be so bold as to suggest that the honored Dr. Fips is on the verge of something magnificent? If he can design his paper-thin radio in such a way that it can be warped, he could twist it into a Moebius strip and thus create the world's first *unilateral* radio!!

STEPHEN A. KALLIS

Albany, N. Y.

DEFENDS "EGGY"

Dear Editor:

One cannot disagree with Robert G. Middleton's intentions in trying to simplify his explanation of characteristic impedance in his article "What's with Characteristic Impedance?" (March, 1960, page 74). One can, however, disagree with some of the things he points out.

His approach, while readable, lacks depth. There is considerable merit in explaining concepts in nontechnical and nonmathematical terms. Yet when this
(Continued on page 22)

IMPORTANT: For the man who wants to make big money in Radio-Television!

ONLY SPRAYBERRY TRAINING IN RADIO and TELEVISION

**OFFERS YOU ALL OF THESE VITAL NEW ADVANTAGES
TO HELP YOU EARN MORE MONEY FROM THE START!**

NEW BUSINESS BUILDERS

...through these practical proven plans and ideas we help you make plenty of extra money in spare time while training.

NEW TRAINING EQUIPMENT

...the famous Sprayberry Training kits have been newly engineered by our staff to offer you the latest in Radio-TV Service Techniques!

NEW TRANSISTOR COURSE

...literally millions of new transistor radios are being used. We show you how to make money fixing them!

NEW HIGH FIDELITY

...there's big money to be made installing and servicing Hi-Fi units. Your Sprayberry training now offers you this valuable and profitable preparation!

TRAIN AT HOME—SPARE TIME

WITH THESE **25 BIG COMPLETE KITS of PARTS & EQUIPMENT**

You learn Radio-TV Servicing the best way... the practical way... testing and assembling these modern kits of equipment.

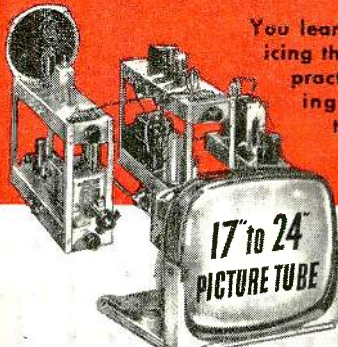

← The new Sprayberry Training Television Receiver, built and tested in 5 sections.

Now offered... this fine modern oscilloscope.

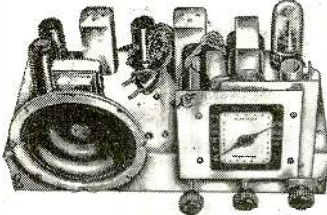

← You build this powerful two-band super-heterodyne radio receiver.

You build the new Sprayberry tester — a complete 18-range Volt-Ohm-Milliammeter test meter.

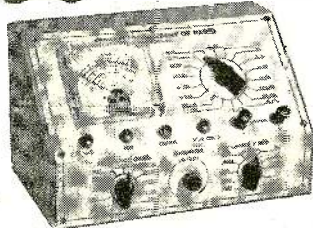

FREE These two big new books are yours free! Find out what Radio-Television offers you!... and let us show you how easily you can learn, even without previous experience of any kind. Rush **COUPON** today!

The field of Radio-Television Servicing is such a fast moving industry that the best jobs and biggest incomes always go first to the man with the most modern, complete and up-to-date training. Thanks to constant revision and improvement... Sprayberry Training helps you earn more from the start... and keeps you earning more in the months and years ahead!

Make no mistake! All radio-television training is not alike. The basic purpose behind Sprayberry Training is to prepare you as rapidly and as surely as possible... to make top money servicing Radio and Television sets and equipment. This is where the big money has been for years... and will continue to be in the years ahead.

It's important for you to know that for over 30 years... Sprayberry Training has been preparing ambitious men for success in this interesting and profitable kind of work. Our school has helped hundreds to qualify for the best jobs... or to get started in profitable businesses of their own. Today our student rolls are the largest in our school's history... because the need and demand for Radio-Television Service Technicians has never been more urgent.

Just \$6.00 Starts You

To encourage more men to enter Radio-Television at once... to help fill the great need for trained men... we're making it easier than ever before to start training. Just \$6.00 enrolls you. This liberal offer is naturally limited. Get the facts now

and consider enrollment while these favorable terms are available to you.

KEEP YOUR JOB... while learning

Under the Sprayberry Plan you train entirely at home in spare time. You combine the most modern lesson training with fascinating and invaluable practical work with 25 big kits of parts and equipment that we supply. You get the equivalent of years of shop practice... and you can train as fast or as slowly as you wish. We help you make excellent spare time money while learning... and everything you receive—lessons, books, manuals, equipment—all yours to keep!

This is the Radio-Television industry's most modern and up-to-the-minute training. Sprayberry is the *one* school that gives you personalized attention and takes a real interest in your progress. Remember... just \$6 starts you! Mail the coupon today. Let the facts speak for themselves. Let us send you our new catalog and sample lesson... and *prove* the kind of opportunity that Sprayberry training can open up for you.

SPRAYBERRY ACADEMY OF RADIO-TELEVISION
Dept. 20-M, 1512 West Jarvis Ave., Chicago 26, Ill.

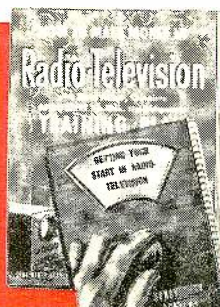

MAIL COUPON—No Salesman Will Call

SPRAYBERRY ACADEMY OF RADIO-TELEVISION
DEPT. 20-M, 1512 W. JARVIS AVE., CHICAGO 26, ILL.

Please rush all information on your ALL-NEW Radio-Television Training Plan. I understand this does not obligate me and that no salesman will call upon me. Include New Catalog and Sample Lesson FREE.

NAME..... AGE.....

ADDRESS.....

CITY.....ZONE.....STATE.....

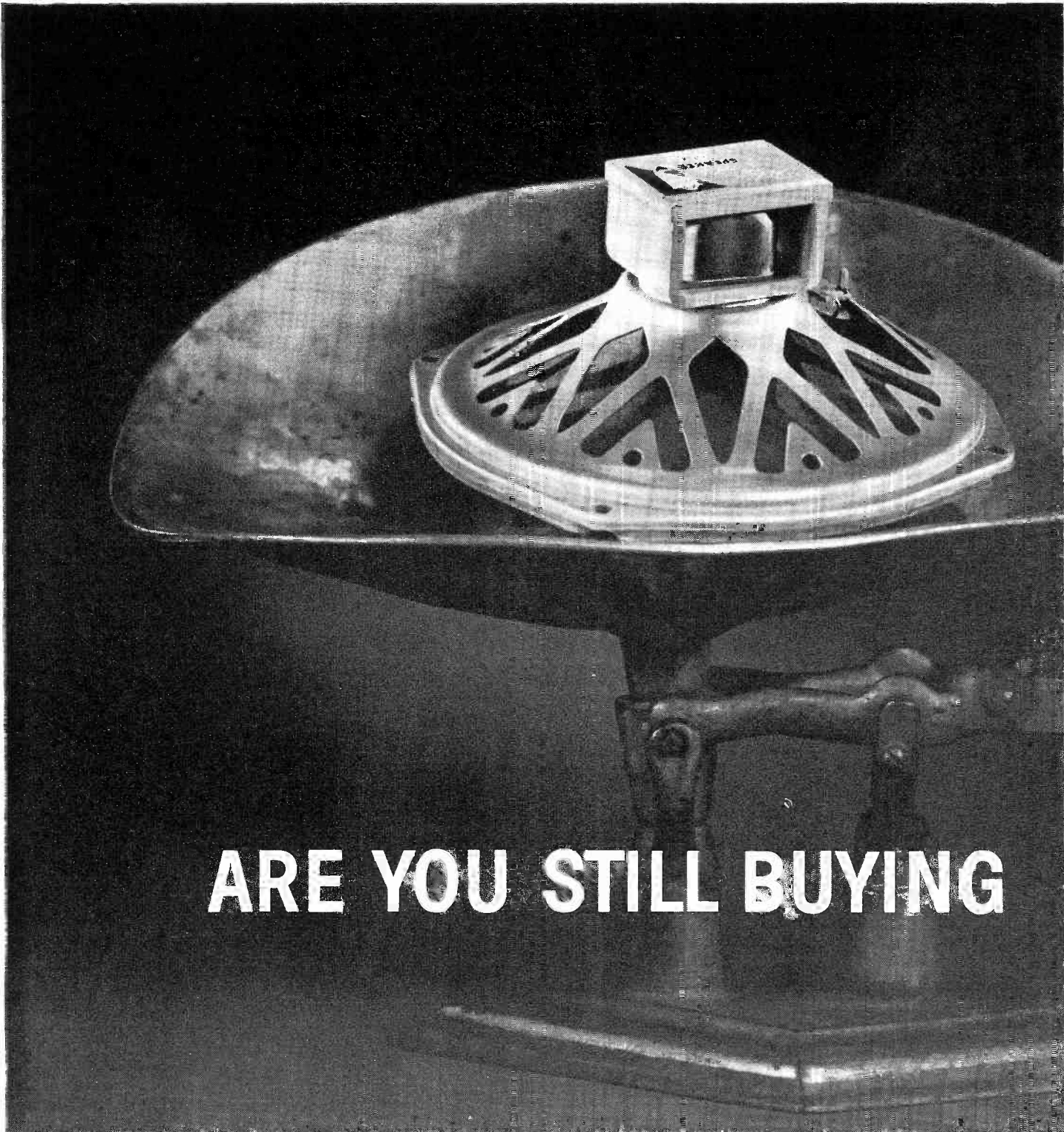

ARE YOU STILL BUYING

Lots of people, people who buy them as well as sell them, still judge a speaker by the weight of its magnet. "The heavier the magnet, the better the speaker," so the old rule of thumb goes. And when speakers were all pretty much alike, that was probably as good a way as any to grade them.

But speakers, like everything else in electronics, have changed enormously over the past few years. Magnet manufacturers know so much more today about making magnets. The magnets used by Delco have more highly oriented grain structures. They're premium grade, more efficient.

And Delco has improved every other speaker part—from basket to gasket, voice coil to cone. All these parts are now made with new, stronger materials. They work better together. They stand up longer. And Delco Radio's precision engineering

makes possible better magnetic circuits. The result is a greater range of rich, deep, distortion-free sound—sound that you once could get only from more expensive speakers with far heavier magnets.

Delco Radio sells speakers by the *sound* instead of by the pound. May we suggest you contact your Distributor soon.

Here's why Delco speakers give more sound per pound: Quality controlled premium magnets • Efficient pot design provides extremely short magnetic path with minimum magnetic air gap to minimize stray flux • High quality steel in magnetic circuit • Exact ratio of cross section area of magnetic air gap to length of air gap gives optimum energy from magnet • Precision manufacture and assembly of parts make possible greater efficiency from magnetic circuit.

SPEAKERS BY THE POUND?

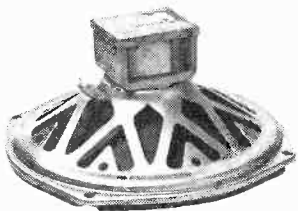

A

Delco gives you a complete line of Hi-Fi speakers. Illustration A is the 8" Model No. 8007. It offers the most highs, the most lows, the most watts in a medium-priced speaker. Designed for replacement use and high fidelity audio systems.

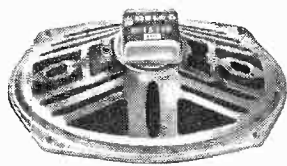

B

Delco's most popular auto radio speakers: (B)—Model No. 6112, 6" x 9", and (C)—Model No. 6109, Delco's exclusive 4" x 10". All Delco auto radio speakers are life tested to perform under severest climatic conditions. All, including our full line of rear seat speakers, are equipped with quality controlled, premium Alnico magnets.



C

DELCO RADIO

Division of General Motors
Kokomo, Indiana

Delco speakers, transistors, transformers and other parts for radios, television and Hi-Fi are available everywhere through Delco Electronic Distributors associated with



yes

STANCOR[®]

has a complete line of
RF-IF COILS

The Stancor name is a synonym for quality and dependability. Just as you rely on Stancor for the best in exact replacement flybacks and yokes, so you can expect the highest standard of performance from Stancor coils. Your parts distributor has them in stock.

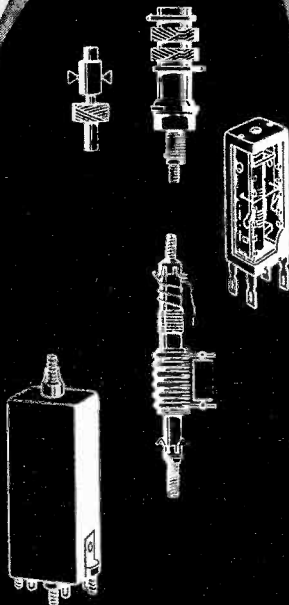

CHICAGO STANDARD TRANSFORMER CORPORATION
3501 ADDISON STREET • CHICAGO 18, ILLINOIS

want back issues?

Back numbers of most issues of RADIO-ELECTRONICS are available upon request

This year's issues	50¢
Last year's issues	40¢
Previous year	45¢, etc.
Maximum	\$1.00

RADIO-ELECTRONICS • 154 West 14th Street, New York 11, N. Y.

CORRESPONDENCE (Continued from p. 18)

is done, we assume that, although the treatment is not exhaustive, it will not unduly distort fact. Mr. Middleton has faulted.

The article started out beautifully. The development of the concept of characteristic impedance was just right. We arrived at the conclusion that the line had a characteristic resistance of 300 ohms. But then, for some reason or other, it became necessary to sneer at "Eggy." "Eggy" says to solve the quadratic equation, which Mr. Middleton does not like to do, *but immediately proceeds to do anyway*. We get two solutions, one positive, one negative. The positive solution is *the only one* which satisfies the definition of characteristic impedance, the only one which could be obtained by experimental test.

Mr. Middleton fails to point out the *real* significance of the -200 ohms. This is the characteristic impedance of the line if we look in from the opposite direction. The -200 ohms has no real significance to us whatsoever.

But in banging away at "Eggy," he goes on to state that negative resistance is as *real* as positive resistance. This is either nonsense or wishful thinking. Sure, we can make something that acts as though it were a negative resistance, but this is not a real resistance like a "composition resistor, lamp filament" etc. (If it is, tell me where I can buy one!). No doubt, this concept of negative resistance has significance, *but not to the discussion at hand*.

My intention in writing this letter is not to point out *all* the inaccuracies or to argue with Mr. Middleton's article. I feel, as he must, that there are many things in the field which should be made more understandable. Most of us who read your magazine are interested, primarily, in the practical aspects of electronics. We relish articles which make the difficult more understandable. But taking a few swipes at "Eggy" just for the sake of taking a few swipes is not what we want. "Eggy" has a real and vital part in the industry today. We may dislike his talking in terms we cannot understand, but that is how he and we are.

JAMES G. MACK, JR.

Lowell, Mass.

[You have hit upon our reason for printing this type of story. It is extremely readable, and experience has shown that—for reasons brought out in this letter and in the original article—many of our readers shy away from anything that hints of being mathematical in nature.—Editor]

CANADIAN CITIZENS BAND?

Dear Editor:

I would like to know if there are any other Canadians like myself who are interested in a Canadian Citizens band? If so, please contact the person nearest you of those listed below. Let them know of your interest and tell them the name and issue of the magazine you

(Continued on page 26)

the people who brought you the



THE LIFETIME GUARANTEE

Utah will renew or replace free this loudspeaker due to any performance failure at any time during the lifetime of the owner. No charge will be made for handling, inspection, labor, materials or servicing for any repair or replacement. Customer pays postage only.



**MORE POWER
PER POUND
SPEAKER** now offer
**MORE SOUND
PER LIFE**

in the revolutionary

Utah

LIFETIME SPEAKER

guaranteed

for the life of the owner

24 hours a day, we lay our reputation (and our profits) on the block! We *guarantee* perfection of performance for a lifetime. To do this, we *have* to make the speakers of our lifetime . . . and we do!

Order a Utah Lifetime for your next replacement and see! (All popular sizes and shapes).

Utah
LIFETIME
SPEAKERS 

Utah Radio & Electronic Corp., Huntington, Ind.

knight-kits® ...

YOU be the judge of

knight-kit®
A PRODUCT OF ALLIED RADIO

quality and value

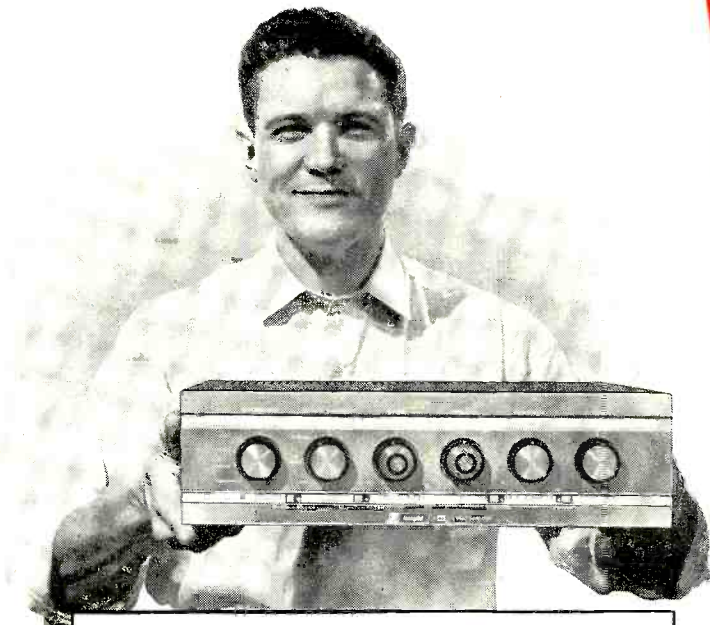

FREE examination privilege

More and more people are finding out how easy it is to build exciting Knight-Kits, how satisfying they are to own, and how much they save.

If you haven't yet enjoyed the experience and fun of building and owning a Knight-Kit, we invite you to take advantage of our free examination offer. Order any Knight-Kit. Examine it on arrival. Inspect the quality of the components, the circuitry, the easy-assembly manual. We're so confident you'll want the kit, we can make this offer: If you're not COMPLETELY SATISFIED, just return the kit for full refund.

Order a Knight-Kit now. Know the thrill of the most satisfying build-your-own experience in electronics.

—ALLIED RADIO

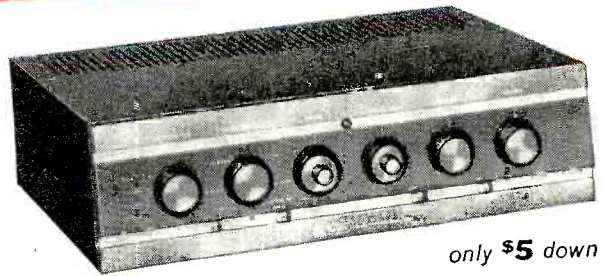

only \$5 down

Y-774 Deluxe 40-Watt Stereo Amplifier, featuring center channel output. Finest amplifier available anywhere in this price range.....\$79.50

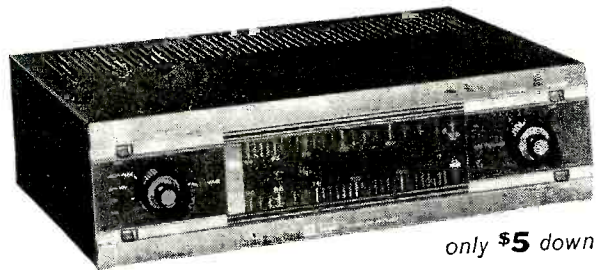

only \$5 down

Y-731 Deluxe FM-AM Stereo Hi-Fi Tuner, with "Magic Eye" tuning for each section; includes Dynamic Sideband Regulation and multiplex add-in feature.....\$87.50

see dozens of other
GREAT HI-FI KITS

- Stereo Deluxe Preamp
- 60-Watt Stereo Amplifier
- Stereo Control
- 25-Watt Amplifier
- 18-Watt Amplifier
- 12-Watt Amplifier
- FM-AM Tuner
- FM Tuner
- Speaker Systems, and others

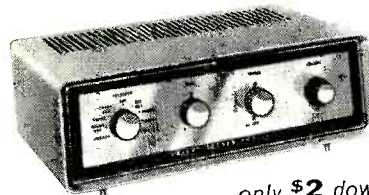

only \$2 down

Y-773 Super-Value 20-Watt Stereo Hi-Fi Amplifier, with special clutch-type dual-concentric level control.

\$44.50

Y-787 FM-AM Hi-Fi Tuner; with AFC and tuned RF stage on FM; includes multiplex jack.

\$49.95



only \$2 down

sold exclusively by

A L L I E D

easiest to build...satisfying to own...money-saving

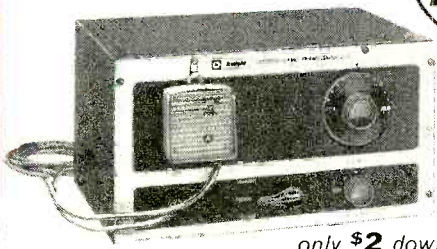

only \$2 down

Y-713 Top value, best-selling Citizens Band Transceiver. Tunable 22-channel super-regenerative receiver, 5-watt transmitter.....\$39.95

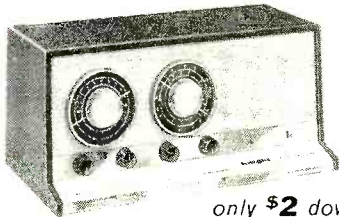

only \$2 down

Y-258 4-Band "Span Master" Receiver; exciting world-wide reception; with cabinet.....\$25.95

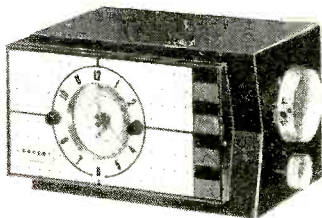

only \$2 down

Y-737 "Ranger" Clock-Radio with Telechron clock, sleep switch and appliance outlet.....\$24.95

plus many other
HOBBYIST KITS

- "Space-Spanner" Receiver
- "Ranger" Radios
- "Ocean Hopper" Radio
- Radio-Intercom
- 5-Transistor Portable
- 2-Transistor Pocket Set
- 2-Way Intercom
- Electronic Lab Kits
- Photoelectric System
- and many others

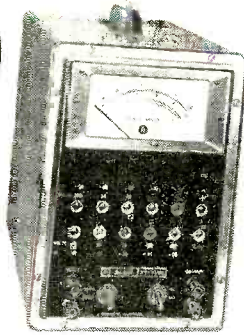

Y-608 Lab quality AC VTVM with amazing Automatic Range Selection; reads as low as 100 μ v.
\$99.50

only \$5 down

Y-125 General-purpose VTVM (11 meg input resistance)
\$25.75

only \$2 down

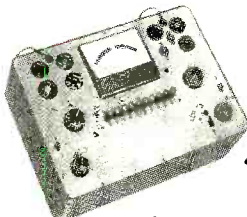

only \$2 down

Y-143 Model "600" Tube Checker (checks over 700 types).....\$32.95

full selection of
INSTRUMENT KITS

- 5" Oscilloscopes
- Tube Checkers
- RF Signal Generator
- Signal Tracer
- Audio Generator
- Sweep Generator
- Battery Eliminator
- Capacity Checker
- Transistor Checker
- R/C Tester, plus many others

ONLY \$2 DOWN
on orders up to \$50;
\$5 down on orders up to \$200...

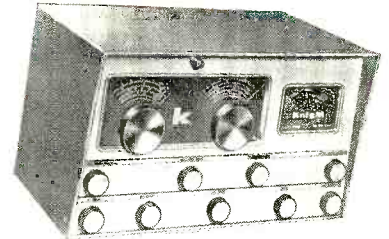

only \$5 down

R-100 Amateur Communications Receiver (Hi-gain, with built-in Q-Multiplier).....\$104.50

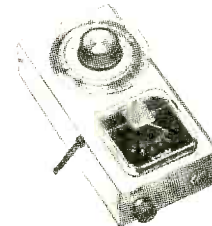

G-30 Amateur Grid Dip Meter (continuous coverage, 1.5-300 mc).....\$22.95

only \$2 down

other fine
AMATEUR KITS

- 50-Watt Transmitter
- Self-Powered VFO
- 100 kc Crystal Calibrator
- RF "Z" Bridge
- Code Practice Oscillator

there's a money-saving **knight-kit** for every need...see them all in the **ALLIED CATALOG**

FREE

Write for catalog featuring the complete KNIGHT-KIT line. Order the kit of your choice—judge quality and value for yourself under our FREE examination privilege!

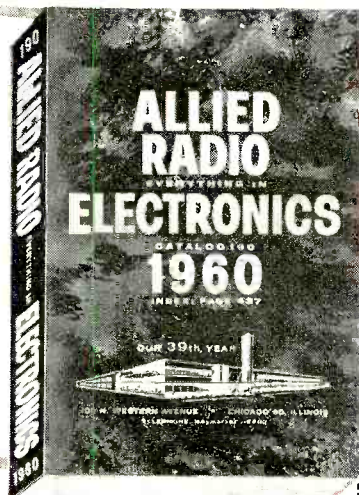

ALLIED RADIO CORP., Dept. 8-F
100 N. Western Ave., Chicago 80, Ill.

Send FREE Catalog featuring Knight-Kits

Name _____

Address _____

City _____ Zone _____ State _____

RADIO

Pioneer in quality electronic kit development...

Just published— Latest issue of Tung-Sol Tips

Write for your free copy today!

**TUNG-SOL TIPS**

**INDUSTRIAL
ELECTRONICS**

applicationinstallationmaintenance

VOLUME 1 NO. 9

Mobile Communication Equipment

Issue #9 in Tung-Sol's widely acclaimed technical series for the industrial serviceman is brimmed full of double-barreled information of the most vital significance . . . especially if you're looking to extend your servicing career into mobile communications, one of the fastest growing avenues in the industrial electronics field. More than just providing essential descriptions of key circuitry, this issue discusses many aspects of F.C.C. regulations concerning servicing of mobile equipment. And like every issue of *Tips*, this one is jam-packed with the most up-to-date information, diagrams and illustrations that deliver valuable know-how to you in depth.

You'll discover:

- ▶ What the F.C.C. requires in transmitter servicing.
- ▶ How a phase-modulated transmitter operates.
- ▶ What the various phase modulation circuits are.
- ▶ What the typical circuitry for multiplying the frequency of FM signals from FM transmitters consist of.
- ▶ What the F.C.C. says about transmitter servicing procedures to prevent spurious transmissions which might cause interference problems.
- ▶ What a *squelch circuit* does for the high gain receivers and how it works.
- ▶ What some of the techniques are to eliminate ignition interference in motor vehicles.

But there is even more . . .

You'll also get a rundown of the equipment you *must* have to service mobile equipment adequately. What's more the entire issue is carefully tailored to supply you with only information that you need in your job. There's nothing extraneous. So don't miss out on this issue. Get your request in immediately. We've been swamped by requests for every issue in this series so far. We expect this issue to be snapped up too. So don't delay . . . write today.

 **TUNG-SOL®**

TUNG-SOL ELECTRIC INC., Newark 4, N. J.

SALES OFFICES: Atlanta, Ga.; Columbus, Ohio; Culver City, Calif.; Dallas, Texas; Denver, Colo.; Detroit, Mich.; Irvington, N. J.; Melrose Park, Ill.; Newark, N. J.; Philadelphia, Pa.; Seattle, Wash. Canada: Toronto, Ontario

CORRESPONDENCE (Continued from p. 22)

saw this in. The sooner the letters start coming, the sooner we can get the ball rolling.

Eastern area—Larry D. Whiting, L. W. Electronics, Strathroy, Ontario, Canada.

Western area—Henry J. Ruhl, Bud's Radio & TV Service, Box 25, McCord, Saskatchewan, Canada.

HENRY J. RUHL
McCord, Sask., Canada

OFFERS SUGGESTIONS

Dear Editor:

Your Try This One column is the first one I turn to in each new issue of RADIO-ELECTRONICS. Almost always I find some useful idea.

The March issue showed how to make a soldering-iron cleaner. Instead of *making* one, you can purchase a suede shoe brush at almost any variety or shoe store.

Also shown was a parts bin for resistors, etc. made out of discarded plastic cheese boxes. A really complete storage file for resistors can be made using 100 manila coin envelopes (2½ x 4¼ inches). Tuck in the end flap, and mark the resistor value in the upper right (or left) corner. The store (or bank) that sold you the envelopes should be able to give you the standard 500-envelope box to keep the envelopes in. For small capacitors, use a larger-size envelope.

I would like to see a note of warning printed about using soldering guns too close to meters. If the needle flicks when you press the trigger, you are too close and may have already affected the meter accuracy. I have seen meter movements completely demagnetized with guns.

Again, many thanks for your Try This One column.

JOSEPH H. SUTTON

Kansas City, Mo.

[Mr. Sutton's ideas seem excellent to us, with the possible exception of resistor storage. Many technicians dislike pulling parts out of envelopes and use either jars, plastic boxes or multi-drawer cabinets.—Editor]

SHORTAGE? WHOSE FAULT?

Dear Editor:

I read the item in the February, 1960 (page 131) issue, about shortage of TV technicians. This lack cannot be blamed on the "greener pastures" but rather on the shops themselves. Good students come out of accredited schools and the shops refuse even to consider them. All you hear from them is the old theme song: "Sorry, no experience." These men are *forced* to go to work for manufacturers or in factories, even though they would prefer to work for a shop.

If the shops want to get technicians to fill their needs, they had better look to their own housekeeping and not try to place the blame on others.

GLENN C. READ
Los Angeles, Calif. END



IF YOU LOVE TO CREATE... BUILD **EICO** KITS

In **STEREO** and

Mono Hi-Fi...
the experts say
your Best Buy
is EICO



Stereo Amplifier-Preamplifier HF81†



Stereo Preamplifier HF85††

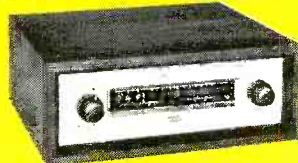

FM Tuner HFT90††
AM Tuner HFT94††
FM/AM Tuner HFTS2††

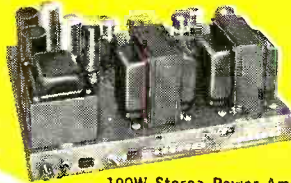

100W Stereo Power Amplifier HF89
70W Stereo Power Amplifier HF87
28W Stereo Power Amplifier HF86



Stereo Integrated Amplifier AF4††



3-Way Speaker System HFS3
2-Way Bookshelf Speaker Systems
HFS5 and HFS1



NEW!
Stereo Automatic Changer/
Player 1007



Over 2 MILLION EICO instruments in use throughout the world. Add 5% in the West.

- Exclusive advanced systematized engineering
 - Latest and finest quality parts
 - Exclusive "Beginner-Tested" easy step-by-step instructions
 - Exclusive TRIPLE quality control
 - Exclusive LIFETIME guarantee at nominal cost
- IN STOCK** — Compare, then take home any EICO equipment — right "off the shelf" — from 1500 neighborhood EICO dealers throughout the U.S. and Canada.

HF81 Stereo Amplifier-Preamplifier selects, amplifies, controls any stereo source & feeds it thru self-contained dual 14W amplifiers to a pair of speakers. Provides 28W monophonically. Ganged level controls, separate balance control, independent bass and treble controls for each channel. Identical Williamson-type, push-pull EL84 power amplifiers. "Excellent" — SATURDAY REVIEW. "Outstanding... extremely versatile." — ELECTRONICS WORLD. Kit \$69.95. Wired \$109.95. Incl. cover.

HF85 Stereo Preamplifier: Complete master stereo preamplifier-control unit, self-powered. Distortion borders on unmeasurable. Level, bass, & treble controls independent for each channel or ganged for both channels. Inputs for phono, tape head, mike, AM, FM, & FM-multiplex. One each auxiliary A & B input in each channel. "Extreme flexibility... a bargain." — HI-FI REVIEW. Kit \$39.95. Wired \$64.95. Incl. cover.

New HF89 100-Watt Stereo Power Amplifier: Dual 50W highest quality power amplifiers. 200W peak power output. Uses superlative ultra-linear connected output transformers for undistorted response across the entire audio range at full power, assuring utmost clarity on full orchestra & organ. 60 db channel separation. IM distortion 0.5% at 100W; harmonic distortion less than 1% from 20-20,000 cps within 1 db of 100W. Kit \$99.50. Wired \$139.50.

HF87 70-Watt Stereo Power Amplifier. Dual 35W power amplifiers identical circuit-wise to the superb HF89, differing only in rating of the output transformers. IM distortion 1% at 70W; harmonic distortion less than 1% from 20-20,000 cps within 1 db of 70W. Kit \$74.95. Wired \$114.95.

HF86 28-Watt Stereo Power Amp. Flawless reproduction at modest price. Kit \$43.95. Wired \$74.95.

FM Tuner HFT90: Prewired, prealigned, temperature-compensated "front end" is drift-free. Prewired exclusive precision eye-tronic traveling tuning indicator. Sensitivity: 1.5 uv for 20 db quieting; 2.5 uv for 30 db quieting, full limiting from 25 uv. IF bandwidth 260 kc at 6 db points. Both cathode follower & FM-multiplex stereo outputs, prevent obsolescence. Very low distortion. "One of the best buys in high fidelity kits." — AUD. CRAFT. Kit \$39.95*. Wired \$65.95*. Cover \$3.95. *Less cover, F.E.T. incl.

AM Tuner HFT94: Matches HFT 90. Selects "hi-fi" wide (20-9000 cps @ -3 db) or weak-station narrow (20-5000 cps @ -3 db) bandpass. Tuned RF stage for high selectivity & sensitivity. Precision eye-tronic tuning. "One of the best available." — HI-FI SYSTEMS. Kit \$39.95. Wired \$65.95. Incl. cover & F.E.T.

New FM/AM Tuner HFT92 combines renowned EICO HFT90 FM Tuner with excellent AM tuning facilities. Kit \$59.95. Wired \$94.95. Incl. cover & F.E.T.

New AF-4 Economy Stereo Integrated Amplifier provides clean 4W per channel or 8W total output. Kit \$38.95. Wired \$64.95. Incl. cover & F.E.T.

HF12 Mono Integrated Amplifier (not illus.): Complete "front end" facilities & true hi-fi performance. 12W continuous, 25W peak. Kit \$34.95. Wired \$57.95. Incl. cover.

New HFS3 3-Way Speaker System Semi-Kit complete with factory-built 3/4" veneered plywood (4 sides) cabinet. Bellows-suspension, full-inch excursion 12" woofer (22 cps res.) 8" mid-range speaker with high internal damping cone for smooth response. 3 1/2" cone tweeter, 2 1/4 cu. ft. ducted-port enclosure. System Q of 1/2 for smoothest frequency & best transient response. 32-14,000 cps clean, useful response. 16 ohms impedance. HWD: 26 1/2", 13 7/8", 14 3/8". Unfinished birch. Kit \$72.50. Wired \$84.50. Walnut, mahogany or teak. Kit \$87.50. Wired \$99.50.

New HFS5 2-Way Speaker System Semi-Kit complete with factory-built 3/4" veneered plywood (4 sides) cabinet. Bellows-suspension, 3/8" excursion, 8" woofer (45 cps res.), & 3 1/2" cone tweeter, 1 1/4" cu. ft. ducted-port enclosure. System Q of 1/2 for smoothest freq. & best transient resp. 45-14,000 cps clean, useful resp. 16 ohms,

HWD: 24", 12 1/2", 10 1/2". Unfinished birch. Kit \$47.50. Wired \$56.50. Walnut, mahogany or teak. Kit \$59.50. Wired \$69.50

HFS1 Bookshelf Speaker System complete with factory-built cabinet. Jensen 8" woofer, matching Jensen compression-driver exponential horn tweeter. Smooth clean bass; crisp extended highs. 70-12,000 cps range, 8 ohms. HWD: 23" x 11" x 9". Kit \$39.95. Wired \$47.95

HFS2 Omni-Directional Speaker System (not illus.) HWD: 36", 15 1/4", 11 1/2". "Fine for stereo" — MODERN HI-FI. Completely factory built. Mahogany or walnut \$139.95. Blond \$144.95.

New Stereo Automatic Changer/Player: Jam-proof 4-speed, all record sizes, automatic changer and auto/manual player. New extremely smooth, low distortion moisture-proof stereo crystal cartridge designed integrally with tonearm to eliminate mid-range resonances. Constant 4 1/2 grams stylus force is optimum to prevent groove flutter distortion. No hum, turntable attractions, acoustic feedback, center-hole enlargement. Only 10 3/4" x 13". Model 1007D: 0.7 mil diamond, 3 mil sapphire dual styli, \$59.75. 1007S: 0.7 mil, 3 mil sapphire, \$49.75. Incl. F.E.T.

†Shown in optional Furniture Wood Cabinet WE71: Unfinished Birch, \$9.95; Walnut or Mahogany, \$13.95.

††Shown in optional Furniture Wood Cabinet WE70: Unfinished Birch, \$8.95; Walnut or Mahogany, \$12.50.

EICO, 33-00 N. Blvd., L.I.C. 1, N. Y.

Show me how to SAVE 50% on easy-to-build top-quality Hi-Fi. Send FREE catalog, Stereo Hi-Fi Guide plus name of neighborhood EICO dealer.

Name.....

Address.....

City..... Zone..... State.....

Listen to the EICO Hour, WABC-FM, N.Y., 95.5 MC, Mon. to Fri. 7:15-8 P.M., Sat. 11:12 P.M. Ask dealer about EICO's Stereo Records Bonus.

© 1960 by EICO, 33-00 N. Blvd., L. I. C. 1, N. Y.

The specs prove it...your best buy is



B
TV-FM SWEEP GENERATOR
AND MARKER #368
KIT \$69.95 WIRED \$119.95

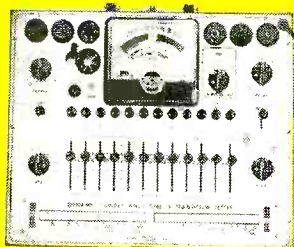
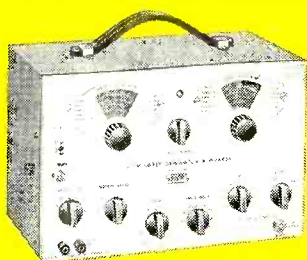

A
DYNAMIC CONDUCTANCE
TUBE & TRANSISTOR
TESTER #666
KIT \$69.95 WIRED \$109.95
Complete with steel cover & handle

C
RF SIGNAL GENERATOR #324
KIT \$26.95 WIRED \$39.95

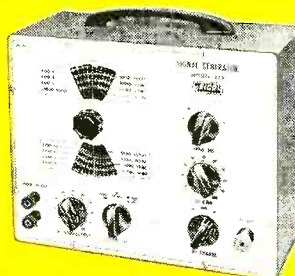

D
PEAK-TO-PEAK
VTVM #232 &
UNIPROBE
KIT \$29.95
WIRED \$49.95

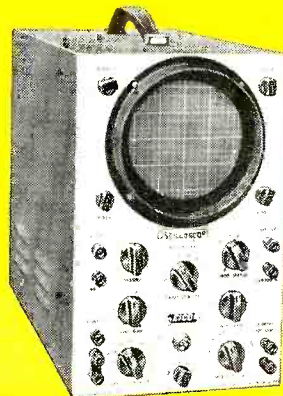
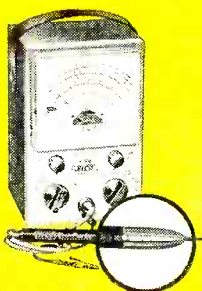

E
COLOR & MONOCHROME
DC TO 5 MC LAB & TV
5" OSCILLOSCOPE #460
KIT \$79.95 WIRED \$139.50
5" PUSH-PULL
Oscilloscope #425:
Kit \$44.95 Wired \$79.95

A Tests all receiving tubes (picture tubes with adapter), n-p-n and p-n-p transistors. Composite indication of Gm, Gp & peak emission. Simultaneous selection of any one of 4 combinations of 3 plate voltages, 3 screen voltages, 3 ranges of continuously variable grid voltage (with 5% accurate pot.). Sensitive 200 ua meter. 10 six-position lever switches: freepoint connection of each tube pin. 10 pushbuttons: rapid insert of any tube element in leakage test circuit. Direct reading of inter-element leakage in ohms. New gear-driven rollchart. CRA Adapter \$4.50.

B Entirely electronic sweep circuit with accurately-biased inductor for excellent linearity. Extremely flat RF output. Exceptional tuning accuracy. Hum and leakage eliminated. 5 fund. sweep ranges: 3-216 mc. Variable marker range: 2-75 mc

in 3 fund. bands, 60-225 mc on harmonic band. 4.5 xtal marker osc., xtal supplied. Ext. marker provision. Attenuators: Marker Size, RF Fine, RF Coarse (4-step decade). Narrow range phasing control for accurate alignment.

C 150 kc to 435 mc with ONE generator in 6 fund. bands and 1 harmonic band! $\pm 1.5\%$ freq. accuracy. Colpitts RF osc. directly plate-modulated by K-follower for improved mod. Variable depth of int. mod. 0-50% by 400 cps Colpitts osc. Variable gain ext. mod. amplifier: only 3.0 v needed for 30% mod. Turret-mounted, slug-tuned coils for max. accuracy. Fine and Coarse (3-step) RF attenuators. RF output 100,000 uv, AF output to 10 v.

D Uni-Probe — exclusive with EICO — only 1 probe performs all functions: half-turn of probe tip selects DC or AC-Ohms. Calibration without re-

moving from cabinet. Measure directly p-p voltage of complex & sine waves: 0-4, 14, 42, 140, 420, 1400, 4200. DC/RMS sine volts: 0-1.5, 5, 15, 50, 150, 500, 1500 (up to 30,000 v. with HVP probe, & 250 mc with PRF probe). Ohms: 0.2 ohms to 1000 megohms. $4\frac{1}{2}$ " meter, can't-burn-out circuit. 7 non-skip ranges on every function. Zero center.

E Features DC amplifiers! Flat from DC to 4.5 mc, usable to 10 mc. Vert. Sens.: 25 mv/in.; input Z 3 megohms; direct-coupled & push-pull throughout. 4-step freq.-compensated attenuator up to 1000:1. Sweep: perfectly linear 10 cps — 100 kc (ext. cap. for range to 1 cps). Pre-set TV V & H positions. Auto sync. lim. & ampl. Direct or cap. coupling; bal. or unbal. inputs; edge-lit engraved lucite screen with dimmer control; plus many more outstanding features.

FREE CATALOG shows you HOW TO SAVE 50% on 65 models of top quality professional test equipment. MAIL COUPON NOW!



New Transistor
Portable Radio RA-6
Kit \$29.95
Wired \$49.95
Incl. F.E.T.; less 9V batt.
Prealigned RF, IF
xfrms; push-pull
audio; 6" spkr.

*PAT. PEND.



NEW Power & Bias
Supply for
Transistorized
Eqpt. #1020 *
Kit \$19.95
Wired \$27.95



NEW Tube &
CRT Fil.
Tester #612
Kit \$3.95
Wired \$5.95
Fast-checks
radio/TV tubes,
pilot lamps, etc.



Series/Parallel
R-C Combination
Box #1140
Kit \$13.95
Wired \$19.95



Tube Tester #625
Kit \$34.95
Wired \$49.95
• tests 600 mil
series string type
tubes
• illuminated
roll-chart
Pix Tube Test
Adapter.....\$4.50



6V & 12V Battery
Eliminator
& Charger #1050
Kit \$29.95
Wired \$38.95
Extra-filtered for
transistor equipmt.
#1060 Kit \$38.95
Wired \$47.95



20,000 Ohms/Volt
V-O-M #565
Kit \$24.95
Wired \$29.95
1000 Ohms/Volt
V-O-M #536
Kit \$12.90
Wired \$14.90



33-00 Northern Blvd. L. I. C. 1, N. Y.

Add 5% in the West. © 1959

TURN PAGE FOR MORE EICO VALUES



R-C Bridge & R-C-L
Comparator #950B
Kit \$19.95
Wired \$29.95
Reads 0.5 ohms-
500 megohms,
10 mfd-5000 mfd,
power factor



VTVM Probes

	Kit	Wired
Peak-to-Peak	\$4.95	\$6.95
RF	\$3.75	\$4.95
High Voltage Probe-1		\$6.95
High Voltage Probe-2		\$4.95
Scope Probes		
Demodulator	\$3.75	\$5.75
Direct	\$2.75	\$3.95
Low Capacity	\$3.75	\$5.75

EICO
33-00 Northern Blvd.
L. I. C. 1, N. Y.

C-6

Show me HOW TO SAVE 50% on Test Instruments
 Hi-Fi Ham Gear. Send free Stereo Hi-Fi Guide.
 Send free short course for novice license. Send me
FREE Catalog, name of neighborhood dealer.

Name.....
Address.....
City.....Zone.....State.....

RECORDING THE INVISIBLE

... *Electronics Will Eliminate Future Air Disasters* ...

NO ONE has actually ever seen radio or television waves in open space, yet our radio and TV sets intercept them readily and make them audible to our ears and visible to our eyes, thanks to modern electronics.

But we are still quite blind to various natural phenomena which frequently become disastrous to human lives and for which electronics so far has offered no solution. Many of these are of a meteorological nature. Because we cannot see air in motion, we are often totally unprepared for the onslaught of sudden violent wind gusts, "twisters", and other atmospheric disturbances. True, a rapidly falling barometer may herald such an event, but there are other peculiar and little understood air perturbations that no known instrument can record or detect today. And frequently they are mass killers of humans.

One of these took 63 lives last March when a Lockheed Electra disintegrated in mid-air, without warning, near Tell City, Ind. Meteorologists are now reasonably certain that the cause of the disaster can be directly traced to Clear-Air Turbulence—called CAT by pilots and meteorologists.

According to Dr. Harry Wexler, head and chief of research for the US Weather Bureau, clear-air turbulence—it can be quite violent—is usually caused by what is known as *wind shear*, the effect of two air layers flowing at different speeds and often in opposite directions.

High-speed airplanes nowadays fly at from 15,000 to 40,000 feet altitude, precisely the region of the so-called *jet stream* which in mid-latitudes moves at about 250 miles per hour from west to east. Because it gives planes additional speed to cut their flying time, pilots seek out the jet stream wherever possible.

But no radar or other instrument in existence today can warn the pilot that he is approaching a CAT region. This region is close to the jet stream—usually below it. It may start at any altitude from 15,000 feet up to 40,000, and is of course quite invisible in a clear and totally cloudless sky. The action of CAT on the unsuspecting airplane personnel is brief, violent and at times disastrous. It is much like flying a plane into a 10-foot-thick, rapidly falling wall of water. An airplane, flying at 500 to 600 miles an hour, can then disintegrate in mid-air.

In the case of the Electra which met disaster near Tell City, the pilot, a few minutes before he passed the check point, radioed that all was well, no trouble. Then silence. The disaster came so fast that there was no time for another radio report. It is probable that, when the plane hit CAT, either one or both of the wings were ripped off suddenly, breaking up the airliner.

It has been known for some years that there is nor-

mally considerable turbulence below and above the jet stream proper. It may become quite rough on planes, depending at what angle and where they enter the jet stream. Not all planes, of course, are demolished or even damaged. But, in all too many cases, passengers not strapped in their seats have been thrown about the aisles violently and injured.

Unfortunately, there probably will be more disasters to our big jet-prop or jet planes before we shall have invented and engineered a practical CAT detector. It seems to us that, for obvious reasons, only electronics can satisfactorily supply the solution.

Let us state categorically that there exists no physical phenomenon that cannot eventually be detected by man.

The CAT effect is no exception. We know that *ordinary* radar is not the answer. Radar can detect clouds, rain, hail or snow, but not moving air masses. Yet it would seem that rapidly moving air layers should not only become electrified, but probably heated. Such rapidly moving atmospheric masses should radiate their energy at a certain frequency, just as do hydrogen clouds millions of miles distant which can be detected by radio-astronomy today. The heat effect of the air masses as they rub against each other—probably quite small—can assuredly be detected in time, via infrared amplifiers.

By using one or the other means, i.e., radio-astronomy and infrared detection—or both combined—it should be possible to evolve a compact instrumentality that can readily be installed in a modern airliner.

By continuously scanning the space ahead, the pilot will have sufficient warning many miles away as to exactly where the maximum turbulence is located. He can then take the necessary precautions to avoid the dangerous CAT centers and change his approach and entry into the jet stream.

We have spoken here of only two eventual approaches of the problem: radio-frequency and infrared techniques. There certainly must be others, not so obvious. There may be a static-electric-amplifier solution, or even a barometrical-amplifier means, among others.

One approach would seem to be obligatory, and that is all the experimental and exploratory work must be performed in a laboratory airplane. It cannot be done from *terra firma*, because of the great speed of the moving air masses as well as their altitude. The scientists in their meteorological plane must fly *with* the CAT within a few miles of its lair to obtain the important data they seek.

This should be an urgent project of the Weather Bureau. It should be instituted at the earliest possible moment before additional air disasters pile up on us.

—H.G.

updating the R-E twin-coupled amplifier

Variations of original twin-coupled amplifier eliminate instability, motorboating and give more gain and add tone controls

By **NORMAN H. CROWHURST**

SINCE the twin-coupled circuit was first published in November, 1957, in *RADIO-ELECTRONICS*, scores of people have built it and added various adjustments or improvements to suit their own particular needs. A few had to make changes to overcome difficulties. Everyone reports that it works well in comparison with everything against which it is compared. Quite a few asked for a larger version—particularly to drive currently popular inefficient loudspeakers with a larger reserve. So here are some of the questions that have come up, with the answers:

A very few asked for constructional details, such as those you might receive with a kit. But many more have written to comment how easy it was to follow the schematic (reproduced in Fig. 1), with the aid of the photos (also reproduced with this article, for the benefit of readers who missed the original story). Several commented that this was the first piece of equipment they had ever built, and they found it quite easy. I mention this as encouragement to any who feel they need more constructional details.

As I mentioned in the original article, the important thing is to keep the output tube wiring (from the transformers and the 0.5- μ f capacitors between cathodes and screens) compact, following the layout illustrated. This is because this wiring carries a high audio voltage which must not be allowed to get near the earlier stages, or instability will result.

Apart from this, layout is simple. Just put the components on the chassis and mark where you want holes drilled and bigger holes made with a knockout punch, and the rest is easy. Alternatively, if you don't want to buy Greenlee punches just for this job, drill holes inside a scribed circle (using compasses), break out the middle part with wire cutters and file to a smooth round hole. It's harder work, but can make quite a presentable job.

Trouble with motorboating

Quite a few ran into this trouble

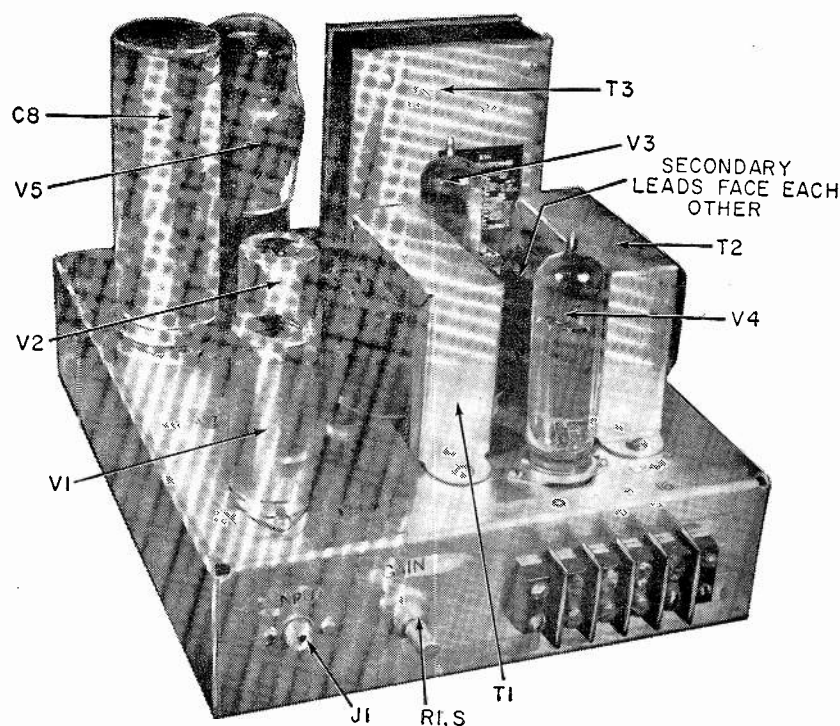

Top view of 15-watt amplifier shows large-parts layout.

when they coupled on a preamplifier, but usually only when the bass boost was turned well up. Sometimes just connecting the preamplifier to the main amplifier started it, regardless of any setting of controls. These differences depended on the type of preamplifier circuit used.

The motorboating is due to insufficient decoupling in the B-plus supply to the preamplifier. As a result, there is enough feedback from the power output stage to the preamplifier stages to cause low-frequency oscillation. Fig. 1 shows the original circuit. The take off point for the preamplifier's B-plus (marked 240 v) has proved quite successful in many instances. But where instability has occurred, it has always been cured by adding a separate feed point for the preamplifier, as shown in Fig. 2. Using a separate feed permits

better filtering, without causing loss of voltage to the first stage of the twin coupled amplifier.

Use a resistance that will drop between 50 and 100 volts. (Use Ohm's law to calculate the drop from the preamplifier tube currents.) Use enough electrolytic capacitance to get adequate decoupling (stop instability) or eliminate hum from the preamplifier stages.

Loss of bass

Two or three have found the twin-coupled produces a bass loss, in comparison with some other amplifiers, although otherwise its performance is completely satisfactory.

This is invariably due to poor matching. In two instances the reader was using the twin-coupled with a ceramic or crystal pickup, without any preamplifier. This will work, but the input

resistance of the amplifier as originally built is too low—causing this bass loss—as well as some loss of sensitivity.

The remedy is simple. Just change the input control from 100,000 ohms to 1 megohm or higher.

Another case where the preamplifier had the tone controls in its output circuit showed the same trouble. Here the bass boost works effectively only if the input to the main amplifier is at least 1 megohm and preferably higher. Making the same change remedied matters here too.

More gain needed

This complaint also came from those who used ceramic pickups without a preamplifier. It is not too difficult to remedy. The gain can be increased by reducing the feedback. Besides increasing the value of the feedback resistors, the balance of the voltage fed to the second half of the 12AX7 needs readjusting. The table gives approximate alternative values. If you wish, you can use a potentiometer to make fine adjustment, as shown in Fig. 3, the same as for the original circuit.

A few found insufficient gain because the preamplifier they are using gives less than a volt output. Surprisingly, there are preamplifiers that give less than a volt output even when given more than a volt input. This is because the gain does not equal the losses introduced by the tone control circuits.

Tone controls

Several people asked how treble and

bass controls can be added to the twin-coupled amplifier. It is feasible to do this only by adding another stage. Also, where full output is required for less than a volt input, an extra stage is the better way of remedying matters because it avoids sacrificing feedback. Fig. 4 shows circuits using one half of a 12AU7. Other tubes with similar specifications can also be used.

When an extra stage is added for use with another preamplifier that has insufficient output, extra care is needed in decoupling the B-plus feed for the preamplifier. Fig. 2 shows the combined feed arrangement. Values will have to be determined by experiment. First see how much you can drop the B-plus voltage in resistor R without restricting the preamplifier output or making it distort. The value of R will depend on the voltage drop you can stand and the total current drain of the preamplifier. Having found a suitable value of R by experiment, make the value of C large enough to prevent instability at all settings of the preamplifier tone controls, or to eliminate hum induced in these stages.

Voice-coil feedback

That voice-coil feedback experiment of mine, described in RADIO-ELECTRONICS in October, 1956, inspired some to want to combine it with the twin-coupled circuit. As described in that article, the feedback must be worked out individually according to speaker and amplifier characteristics. But Fig. 5 is a good starting point, using the

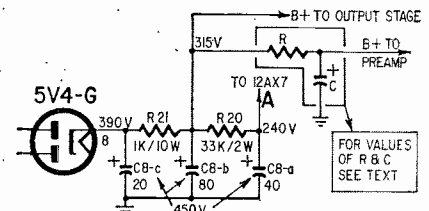

Fig. 2—Power takeoff point A for additional stage. Additional decoupling provides power takeoff for preamp.

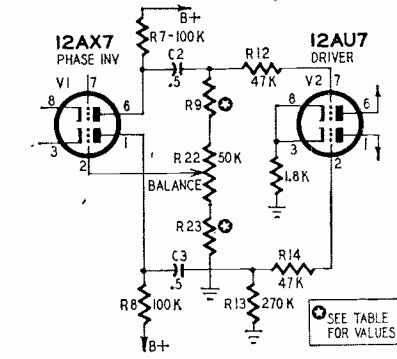
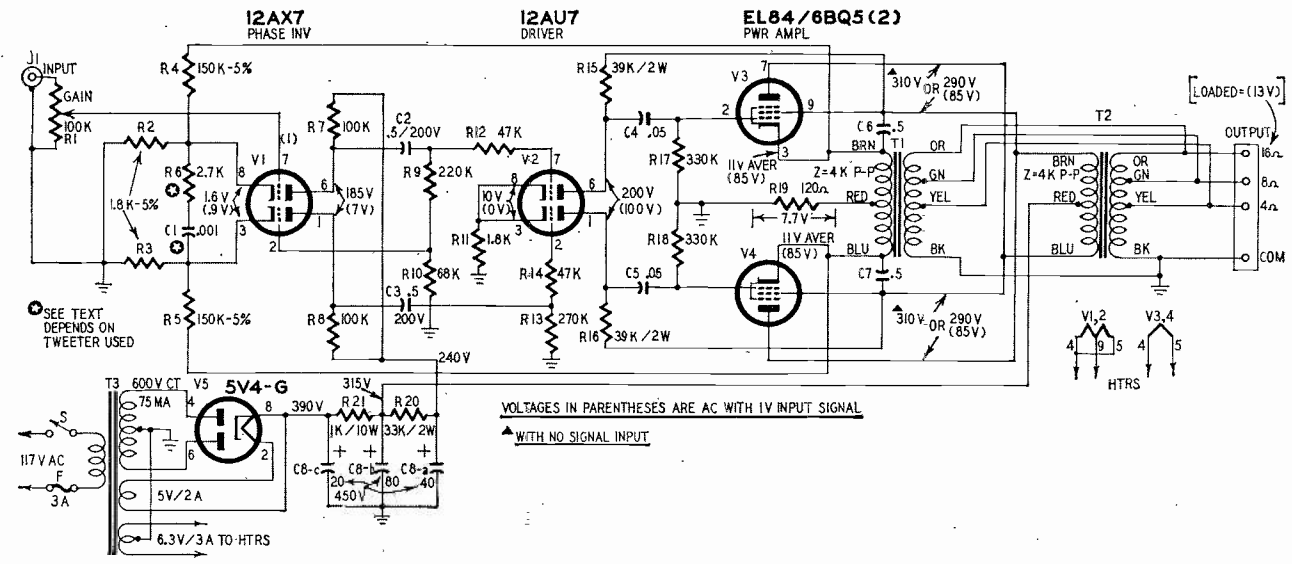

Fig. 3—Balance control for phase inverter.

Revision of Values to Get More Gain

Approx. feedback (db)	R4, R5 (Kil-ohms)	R9 (Kil-ohms)	R10 (Kil-ohms)	R23 (Kil-ohms)
14 (original)	150	220	68	47
12	220	220	51	33
8	470	270	33	10



- R1—pot, 100,000 ohms, audio taper, with spst switch
- R2, 3—1,800 ohms, 5%
- R4, 5—150,000 ohms, 5%
- R6—2,700 ohms, 5%
- R7, 8—100,000 ohms
- R9—220,000 ohms
- R10—68,000 ohms
- R11—1,800 ohms
- R12, 14—47,000 ohms
- R13, 26—270,000 ohms
- R15, 16—39,000 ohms, 2 watts
- R17, 18—330,000 ohms
- R19—120 ohms, 2 watts
- R20—33,000 ohms, 2 watts
- R21—1,000 ohms, 10 watts, wirewound
- R22—pot, 50,000 ohms, linear taper
- R23—47,000 ohms

- R24, 25—100,000 ohms
- All resistors 1/2 watt, 10% unless noted
- C1—001 μf
- C2, 3—0.5 μf, 200 volts, paper tubular
- C4, 5—.05 μf, 600 volts
- C6, 7—0.5 μf, 600 volts, paper tubular
- C8—40—80—20 μf, 450 volts, electrolytic, can type
- F—Fuse, 3 amp
- J1, 2—phono jacks
- S—spst switch on R1
- T1, 2—output transformers, 7 1/2 watts, 4,000 ohms, plate to plate ct: 8-, 16-, 32-ohm secondary (Stancor A-8094, Thordarson Meissner 22521, Merit A-2997, Triad S-34X)
- T3—power transformer: primary, 117 volts; secondary, 600 volts, ct, 75 ma; 5 volts, 2 amp; 6.3 volts, 3 amp. (Triad R9A, Chicago PV70A or equivalent)

- V1—12AX7
- V2—12AU7
- V3, 4—EL84
- V5—5V4-G
- Chassis, 9 x 7 x 2 inches
- Sockets, 9-pin shielded (2)
- Sockets, 9-pin unshielded (2)
- Socket, octal
- Fuse extractor post
- Barrier strip, Cinch-Jones 4-141 or equivalent
- Grommets, 3/8 inch (4)
- Grommet, 1/4 inch
- Tie strip, Cinch-Jones 52A
- Tie strip, Cinch-Jones 53C (one mounting lug removed)
- Miscellaneous hardware

Fig. 1—Circuit of the basic twin-coupled amplifier.

AUDIO—HIGH FIDELITY

original twin-coupled as a basis. Change R2, R3 to 2,700 ohms, 5%. The 0.1- μ f capacitor in Fig. 5 bypasses voice-coil feedback above 1,000 cycles. The .003- μ f capacitors limit electrical feedback to frequencies above this point. R6 and C1 level off the high-frequency response of the amplifier. Their values may be varied for smoothest response when using voice-coil feedback. They are not necessary when using an electrostatic tweeter.

It may be hard to get very much feedback this way, because there is not too much gain available. On the other hand, remember that feedback obtained this way is far more effective in reducing *overall* distortion than amplifier feedback alone.

I would not recommend tackling this project unless you have an audio oscillator so you can check frequency response and make the necessary circuit adjustments to get balanced performance.

A preamplifier

This is something I still hope to get made up in due course, for publication in this magazine. Many readers have requested it. The problem is that scarcely any two readers want the *same* preamplifier. Some want the bare essentials: equalization but no tone controls, loudness compensation or filtering of any kind (rumble, scratch, etc.); others want "the works". Yet others would like this feature but not that, in various combinations. Finally stereo has thrown in a whole lot of other ideas, including how to arrange for balance and combined control facilities.

What I hope to do when time permits is develop a basic design with a number of circuit elements that can be combined in custom fashion to suit everyone's individual need. If you want the bare essential and think tone controls are superfluous to high fidelity, then build it that way. If you want any particular feature, add it as required, in the appropriate circuit position. But this approach needs careful planning and circuit workout to make sure everyone really gets what he wants.

More power

A large percentage of readers have been asking for more power. Some have even built two amplifiers and paralleled them. I am told this works quite well. But I am not in favor of it, for if either amplifier deteriorates, it will load down the other. This will give you even less power than one amplifier by itself. To me this doubles the opportunity for failure.

Several amplifier manufacturers use parallel operation (with the same theoretical disadvantage) and say they get no adverse complaints. This seems to mean equipment is so much more reliable these days that even doubling the chance of failure does not make the total liability big enough to matter!

Probably the main objection to parallel operation is that it doubles the

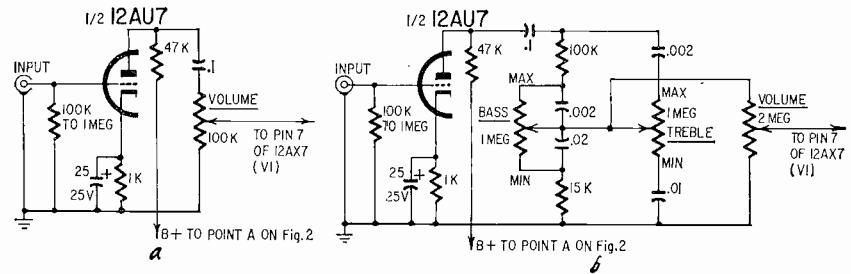
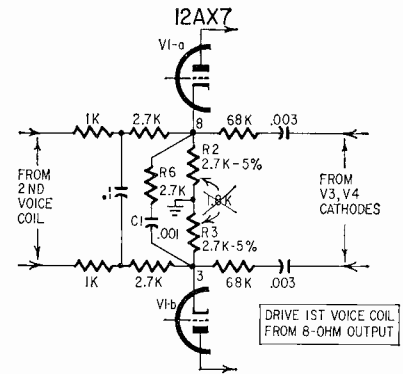
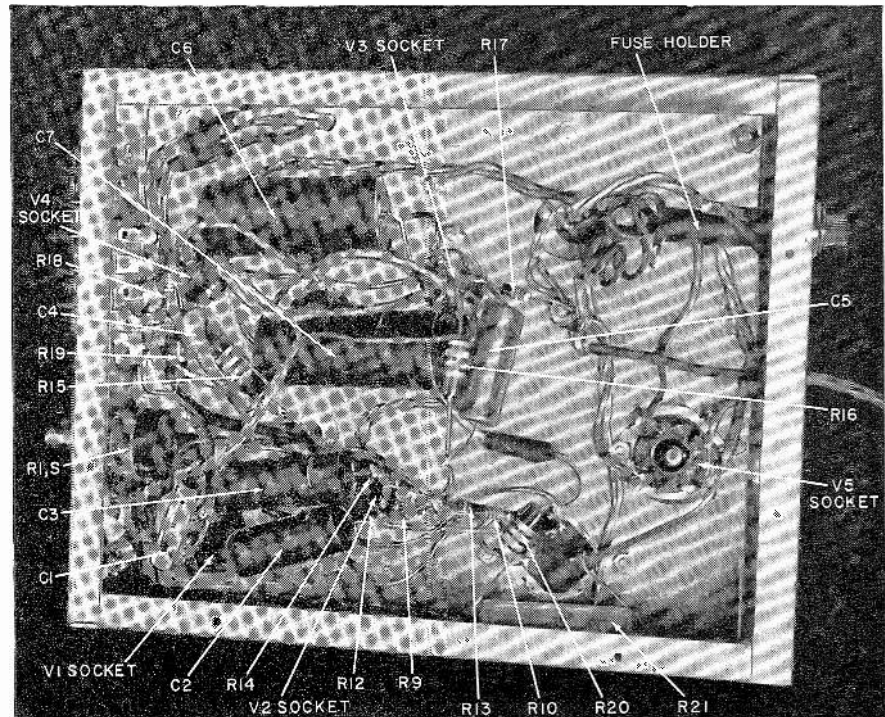

Fig. 4—Extra stage gives (a) extra gain, (b) tone controls.

Fig. 5—Second voice coil provides feedback.



Underchassis view of twin-coupled high-fidelity amplifier.



work and cost. Some have gotten more power from the circuit merely by changing tubes and making some corresponding changes in the power supply and circuit values. To a certain extent this works. How much more power you can get depends to some extent on whether you are prepared to sacrifice some maximum power at the extreme low end—20 to 30 cycles.

Some manufacturers are using the circuit and have larger transformers made specifically for them. But this will not help readers, because such transformers are available only on quantity order. However, transformer manufacturers have now made a larger-version

twin-coupled output transformer available as a catalog item, so that problem is now solved.

In a later issue we will show how to go about setting up a larger version, tailored to your own requirements or choice of tubes. You may use either the original transformer or the new larger version. Another thing we propose to include is how to use a transformer *input* circuit. This has been asked for two or three times. It seems the one-time prejudice against audio transformers is fading. There are stock transformers that will serve for this use without the manufacturers having to invent a new catalog number! END

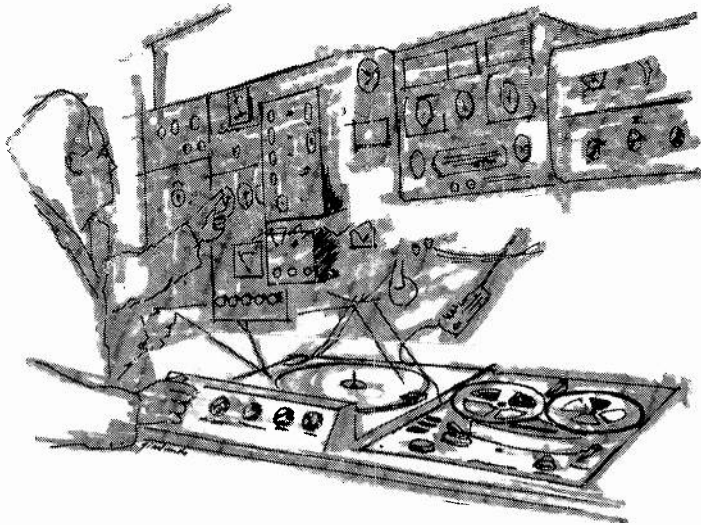

electronic labs help teach languages

Students can learn a foreign language or do brushup work with the aid of these laboratories

By YVON O. JOHNSON, W6WKG*

DOES your local high school or college have a modern foreign-language laboratory? That is, does it have a room with the necessary electronic equipment so a student can sit in an individual booth, listen to recorded foreign speech from disc or tape, respond vocally to it, then compare his response with the original "master"?

Interest in language laboratories has increased because the people of the United States are becoming aware that the ability to understand and speak languages of other peoples is of vital importance to us and to world peace. This realization is evidenced in the National Defense Education Act of 1958 (Public Law 85-864). Title III of this law authorizes Federal grants to state educational agencies on a dollar-for-dollar matching basis for purchasing laboratory equipment—including audio-visual materials—suitable for use in teaching modern foreign-languages in public elementary or secondary schools and for minor remodeling of space used for such equipment.

Role of the electronics technician

This field should be of special interest to the electronics technician. Modern foreign-language laboratories use the latest devices and techniques in magnetic recording. They provide employment opportunities ranging from design and assembly to installation and maintenance.

Schools usually purchase the equipment—magnetic tape and disc recorders and players, turntables, amplifiers, control panels, microphones, headphones, etc.—and installation on bids. Dealers are often companies specializing in audio-visual equipment. These companies employ electronic technicians who are familiar with these items.

Early language labs were often

"home-brew" affairs assembled by an electronics-minded instructor. With the increased complexity of equipment plus the opportunity of qualifying for matching Federal funds, professional installations are becoming more and more the rule.

Likewise, servicing the labs is swinging from the "do-it-yourself" type by the lab director to servicing by the installation contractor, dealer or service agency.

An electronics technician may well find it profitable as well as interesting to learn the basic needs of language labs. New equipment is reaching the market constantly, but you can easily learn the basic principles underlying all language labs and their equipment.

Purpose of the laboratory

While the labs you may visit will vary in certain respects, they all have the same basic purpose: to provide regular practice in hearing, imitating, understanding and responding to correct foreign speech, as well as providing a chance for the student to compare his efforts with the instructor.

You might run into differences of

opinion among educators as to the role of the lab in an overall language program. Some believe that the lab should be only supplementary. They view it as a library or workshop where a student can go to drill or brush up.

Educators holding the opposite viewpoint state that most of the instruction should take place in the lab. They say: "The lab should bear the main burden of teaching the student; the classroom should be supplementary."

Needless to say, many educators hold views between these extremes. I mention these opposite viewpoints because the theory as to the use of the lab can affect the type and amount of equipment you will find in it.

Types of labs

The simplest system—and not truly a language lab according to our definition—consists of a playback device. A magnetic tape or phonograph record is played to students listening on headphones. The students may sit around a table or in booths. A booth enables a student to repeat in privacy the words he hears.

Should there be booths, you might

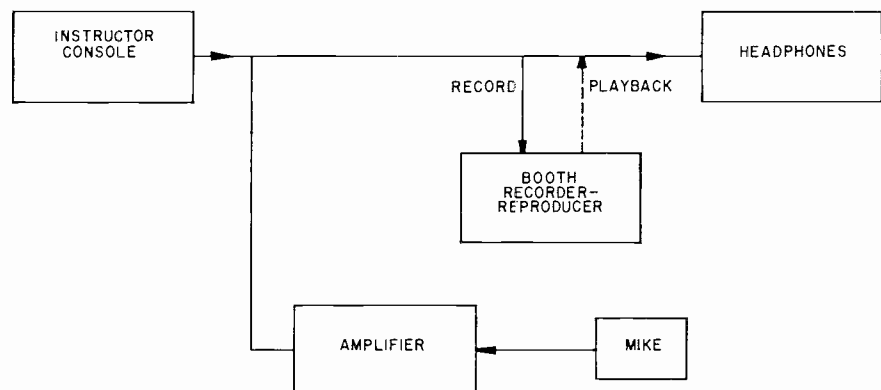
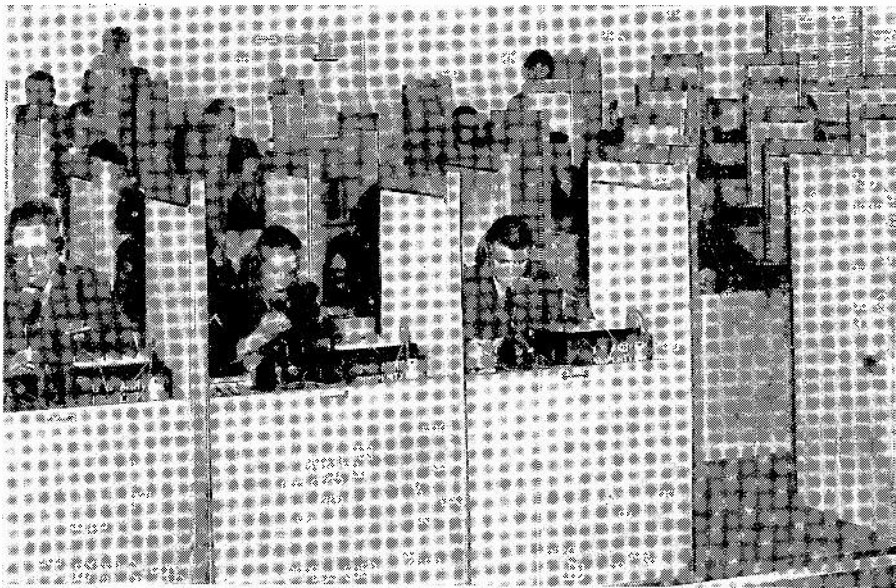

Fig. 1—Simplified block diagram of system allowing student to monitor while recording himself and master. Playback enables student to judge his efforts.

* Audio-visual building coordinator, Herbert Hoover J. H. S., San Francisco, Calif.

AUDIO—HIGH FIDELITY



Student booths at US Army Language School, Monterey, Calif. Booths usually have fronts which can be folded or lowered.

US Army

find an individual microphone and amplifier for each student to allow him to hear his response in the headphones.

Next comes the system which permits the student to record his response along with the original master. By playing back this recording, the student can judge how he is doing.

Fig. 1 illustrates how this can be done by having a magnetic disc or tape recorder in the booth to record the master signal coming from the instructor's console along with the response of the student. (The student also monitors himself while recording.)

Only a single-channel tape recorder is needed in this system. Califone Corp.'s Simplex-LP 902 student recorder has its tape reels and heads fully enclosed so it is not necessary for the student to handle the tape. As the tape approaches either end, a light flashes the words, "End of tape," several times. Should the student disregard the light, the reels will stop without the tape coming off the reels, and the light will remain on. The instructor can change the reels when he desires.

A dual-channel tape recorder can be used as shown in Fig. 2. Not only can the student record master material from the instructor's console along with his own response, but he can place a master tape on the machine in his booth and use it, instead of the instructor's console, as the program source.

This is possible because master material is already present on one channel of the tape and the student response can be recorded on the other channel at the time he uses the tape. In operation, the master channel of the tape machine is on *playback* while the student channel is on *record*.

In some units, the *student channel* will record the master speech coming from the master channel as well as the response from the student. After re-

ording, the student can play back his channel to hear the master material followed by the response.

Other units do not record the output of the master channel on the student channel. Such a unit provides for simultaneous playback of both channels so the student can hear the master material followed by the response.

Either way, the student can erase only his channel, *not the master channel*. Thus he can repeat the entire performance by playing back the master track and making a new recording on the student track. When he is finished with the tape, it can go back into the tape library with the master channel still intact.

If the channel selected for master use is the same one an ordinary dual-track tape recorder records on monaurally, master tapes can be made on any ordinary tape recorder.

The relationship to two-track stereo tape equipment is apparent. The major difference is that in a two-track stereo tape recorder (one that *records* as well as reproduces stereo tapes) both tracks are performing the same function at the same time. This is not necessarily so in language-lab applications. As pointed out, one track might be recording while the other track is playing back.

An example of magnetic tape equipment is the Viking of Minneapolis CS75 student console which can record the incoming material from the instructor console on both the master and the student channels of the tape simultaneously. The student's response is also recorded at the same time on the student channel. Thus, a new master tape duplicating the original material is made. The student can reuse this master tape again and again.

The student channel is erased each time he makes a new recording on it; the master channel is not erased. Both

channels can be erased by the instructor setting a switch at his console whenever he desires the student to duplicate a new master.

While we have been mentioning only tape recorders in connection with the system shown in Fig. 2, we must not forget that magnetic-disc equipment is also used.

Magnetic Recording Industries model 45 Magneticon Examiner has two turntables—one for the master disc, one for the student disc—and associated amplifying and mixing equipment that makes it possible for the student to monitor himself and to record his response along with an incoming master from the instructor console. He can also record his response to the master disc played on the unit. The 9-inch discs are pregrooved for tracking, almost indestructible and instantly reusable.

The student can quickly "start-stop" between turntables. This means that the master disc does not need to contain pauses for student-response time, and the student disc can be solid with responses.

Minor variations

You will find minor variations from the basic systems. Functions are generally the same; how they are handled varies.

For example, all systems must have some means of controlling the volume level of the various signals to the headphones and to the recorder. The trend is to have the student control only the volume to his own headphones. The

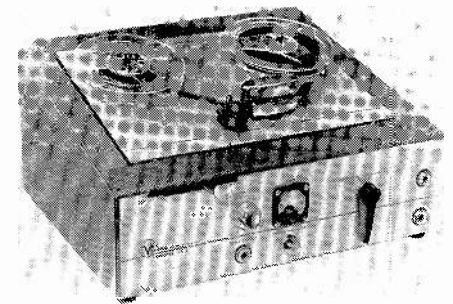

Viking of Minneapolis

Viking CS75 for use in booths has dual-channel tape recorder, inter-channel coupling amplifier and intercommunication facilities.

recording levels are preset and the student cannot change them.

If the student's tape recorder can record on the master channel, the switch for this function must not be where the student can move it, or an irreplaceable master could be destroyed.

Magnetic Recording Industries models 65 and 68 tape units have a concealed selector switch for recording on the master channel; the Viking CS75 has the switch for this function at the instructor console.

Instructor consoles may be in the open in the same room with the booths or in a small room similar to a studio control room.

STROBOSCOPE FLASHER

A GAS (neon) tube on sinusoidal ac usually flashes at double frequency and lights during an appreciable part of each half-cycle. For sharp images of moving objects, the flashes should be much shorter than the time between flashes. This flasher, consisting of a grid-leak-biased class-C amplifier and a switching tube with an inductive load, gives short, sharp flashes at the fundamental frequency. It should not be operated without the gas lamp or the high transient voltage may damage the choke or the tube. For very short flashes, C2's value should vary inversely with frequency. The value shown is satisfactory at 440 cycles.

A typical use is for setting turntable speed by WWV where there is no controlled-frequency ac line. As too many lines would be necessary at turntable speed, cement a small paper strobe disc

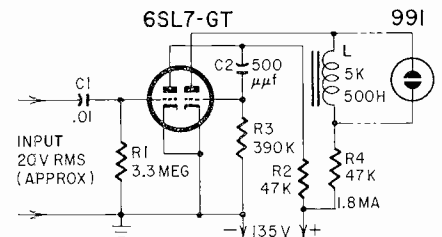

to the governor (see photo). Illuminate it with a small neon lamp, and view it through a peephole in the cabinet. For the General Industries type 20004 turntable and WWV 440 cycles, 16 dark sectors are right within 0.4%. For other turntables, use whatever

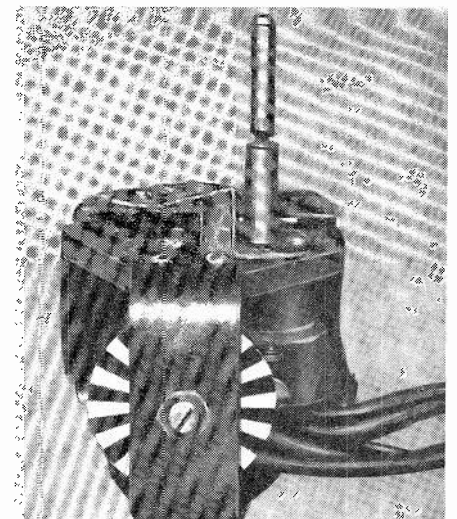

flash frequency (f) and number of sectors (N) that give most nearly

$$60f$$

the right speed: rpm =

$$\frac{N \times \text{gear ratio}}{60f}$$

The system is ideal when the phono or other rotary equipment is in a remote area not served by power lines. Also, the circuit can be used wherever you want a sharp flash from an audio signal.—A. H. Taylor



DuKane Corp.

Instructor console can handle up to 50 students between one and four tape players in pull-out drawers.

The console generally has a distribution amplifier to send programs to the booths. Student amplifiers might be at the console if not in the booths. The student amplifier might be a separate unit or might be part of the recording/playback equipment if it is in the booth.

The console will usually have several possible program sources: one or more tape decks; magnetic disc players; conventional record turntables; microphones and external audio sources such as from a 16-mm sound track.

Also, the console control panel may have elaborate switching: the teacher can monitor any booth; the teacher can record any student on a tape recorder at the instructor console; the teacher can intercommunicate with any student.

You might find a system that uses lights to indicate when one party wishes to communicate with the other and in which the other party must throw a switch to complete the circuit.

Safety in the installation

Anyone installing or repairing language-laboratory equipment must observe safety regulations called for by law and by common sense.

I saw one high school installation that was well done from a safety viewpoint.

In this installation all electronic equipment is properly grounded by three-wire cable and devices. *Even the desk lamp in the booth is grounded so there is no chance of shock should the "hot" side of the ac line accidentally contact the metal lamp fixture.*

Make sure the installation is properly fused and ventilated. Have a master switch for the entire installation for use in case of emergency and to make it possible for the instructor to know that all booths are shut off without having to check them individually.

Other business opportunities

As a technician you might watch this field not only for the advances in electronic equipment that will occur, but also for the business opportunities offered.

Use by schools and colleges of this equipment will build up the desire of students to own or rent their own equipment even though not required by the course.

You can also use these same basic principles in interconnecting or mixing equipment and in making custom installations for individuals wanting their own facilities for language study at home.

END

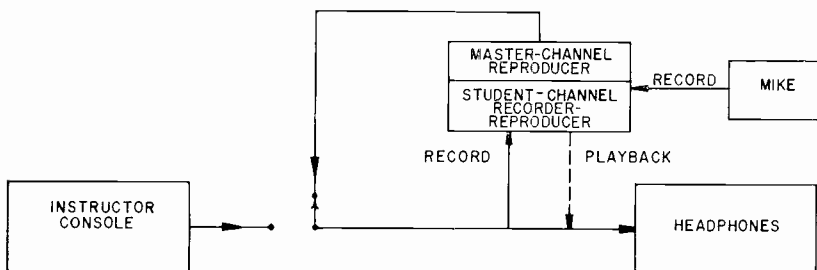

Fig. 2—Simplified block diagram of system allowing student to record his response to material from either console or master track on his tape.

novel "Talkie" outfit for Slide Projectors

Use a tape recorder to add a recorded commentary to your collection of 35-mm slides, complete with background music and change-slide indicators

By DANIEL M. COSTIGAN

IT ISN'T uncommon to find electronics enthusiasts dabbling in photography. And with 35 mm dominating the field, many of them, including myself, have frequently gone through the routine of dragging out the slide projector and screen when company comes and talking ourselves hoarse through 50 or 100 slides or more, only to find our audiences struggling to stay awake by the time the show ends.

I decided that the way to remedy this situation would be to put my tape recorder to work and let it do the talking for me. As the first step I designed a simple mixing circuit that would combine the outputs of a microphone and a phonograph, so I could record a sequence of descriptive narratives against an appropriate musical background. The narration, of course, corresponds to a certain group of slides, prearranged in a particular sequence, while the musical background simply adds a professional touch.

The basic circuit shown in Fig. 1 is, in a sense, a simple voltage divider, but one in which the higher voltage appears closer to ground potential than the lower one. The object is to equalize the two voltages by putting a heavy shunt (R2) across the higher one. The high voltage in this instance is the phonograph output (assuming a typical crystal or ceramic pickup unit is used) and the low voltage is the microphone output. Since both are fed to the recorder's microphone input, the phonograph output must be attenuated.

When R1's wiper is at the microphone end, not only is the microphone output fed directly to the tape recorder, but some of the phonograph's output seeps through R1 and is superimposed on that of the microphone. When the wiper is moved to the phonograph end, the microphone is effectively out of the circuit and the phonograph output is fed directly to the tape recorder.

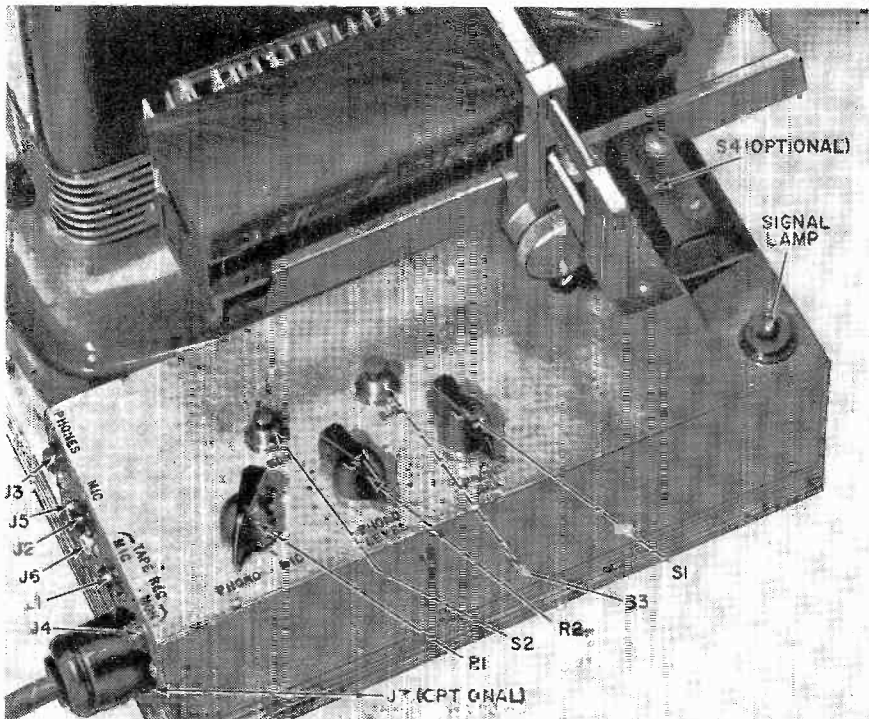

The control unit and slide projector are mounted on the baseboard and are ready to go into operation.

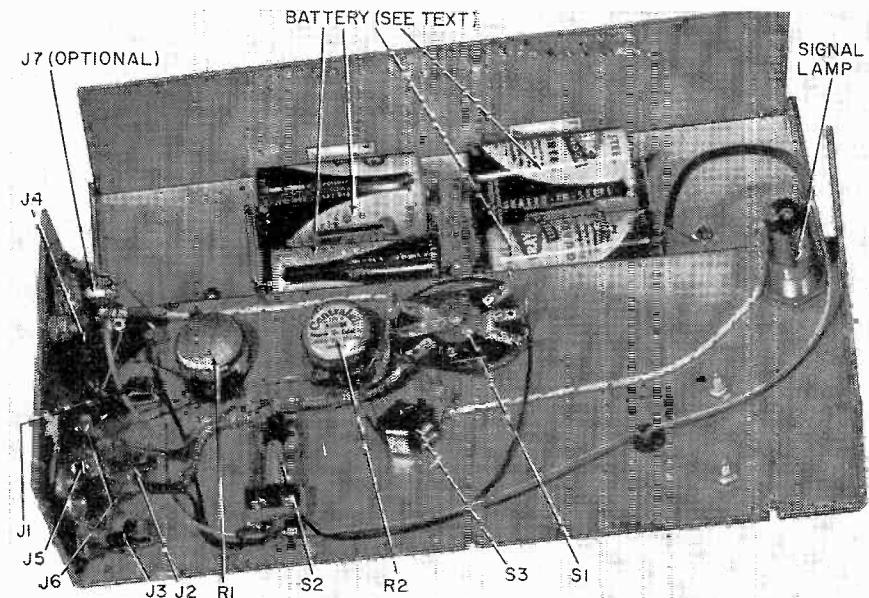

As you can see, size was a matter of matching the projector rather than squeezing in components.

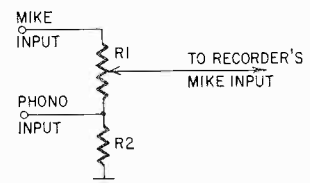

Fig. 1—Basic mixing circuit used in the Talkie control.

COVER FEATURE

Better Power Pentodes

OUR cover photo shows how a new kind of plate construction increases the maximum output from power pentodes. Two interchangeable audio pentodes are shown, both operating under a severe overload of 80 watts plate dissipation.

In the older type 6L6-GB, whose conventional plate is rated at 22 watts dissipation, the overload causes a hot spot which shows up as a bright red

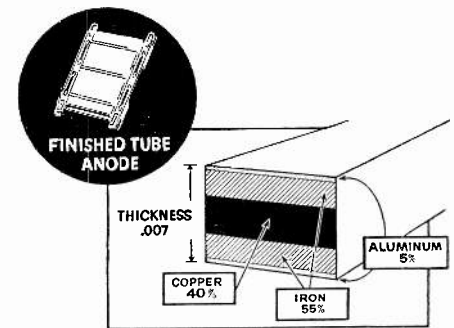

area on the tube's anode (plate). This hot spot limits the available power output.

The newer tube, a G-E 7581, has ratings similar to the 6L6 except for its plate dissipation, which is 8 watts higher—30 watts. This tube, under the same overload, shows only a dull red glow over the entire surface of its plate because of its unusual construction.

This special kind of plate is made by General Electric and will be used in all their power pentodes. It is a five-layer sandwich of copper, iron and aluminum. G-E starts off with a copper core, adds a layer of iron to each side and coats the whole works with aluminum (see diagram). The copper provides excellent heat dissipation, the iron contributes its strength and the aluminum radiates the heat from the surfaces. As the cover photo shows, it works and works well.

A similar method of construction, with a three-ply material, is used for anodes in power rectifiers made by G-E. The metals serve the same purpose with the added feature of having a polished copper surface facing the cathode and reflecting heat to it. This also provides a considerable degree of increased efficiency as compared with older single-metal type rectifier anodes.

The result is a pleasing professional sounding effect with the background music always present. It is simply lowered in volume whenever narration is injected. (In the actual unit a pot was also used for R2 so variations in the level of different records could be compensated for.)

Control unit

The mixing circuit is integrated into a general control unit designed to fit under the projector base. It is built into a 10 x 4 x 2½-inch aluminum chassis with a 10 x 10-inch piece of ¾-inch plywood for the baseboard. Four holes corresponding to the rubber feet on the bottom of the projector are drilled in the baseboard. The projector sits in these holes and its weight holds it in place.

Fig. 2 is the control unit circuit. The signal lamp is a standard pilot light operated by (SIG) switch S3 and is used during the recording process to give the narrator his cue to start talking (assuming a second person does the narrating).

A variety of background music is made available by using two phono-graphs. While one is in operation, the other stands by with an alternate record. The MON switch (S2), shown in its normal position, switches the headphones from the tape recorder output to the idle phonograph so the operator can set the pickup arm at the desired spot on the alternate record before switching over.

The output of the average crystal or ceramic cartridge should be enough to operate headphones directly. Through phono selector switch S1, only the phonograph that is idle is contacted when the MON switch is pressed.

The snap-action switch S4 and socket J7 are optional. They are included only to facilitate a possible future adaptation of the unit to a completely automatic system including a tape-marking and signaling device. For the same reason, the dc supply is substantial enough to satisfy any additional current require-

Fig. 3—Circuit for signaling device to let you know when to change slides.

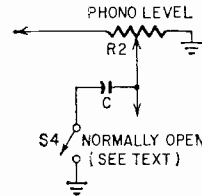

ments that may arise. Otherwise, its only function is to operate the signal lamp, so a single dry cell will suffice in place of the bulky cluster of cells shown in the photo. S4 need not be connected to the battery. You may want to connect it across two terminals of J7 and use it to control an external circuit.

When the unit is ready for service, the least complicated method is to use the background music swelling up to full volume between narrations as a signal to change the slide. However, there may be instances where a single narration will apply to more than one slide. Then, you should inject an audible signal which can be distinguished from the background music.

The signal should not appreciably distract from the music, and would have to be introduced in the phono input since the microphone is ineffective while the background music is at full volume.

Fig. 3 suggests a way of doing this with S4. Whenever a slide is changed, S4 closes momentarily, shunting the phono input with capacitor C, making the music more bassy for an instant. When the slides are being shown, this momentary change of tone tells you when to change the slide. The capacitor's value is best determined by experiment.

If you decide to include this feature in the unit, the projector's elevating mechanism (if it has one) cannot be used during the recording process because the projector must remain fixed relative to snap-action switch S4. The design of the mounting bracket for this optional switch is determined by the projector used.

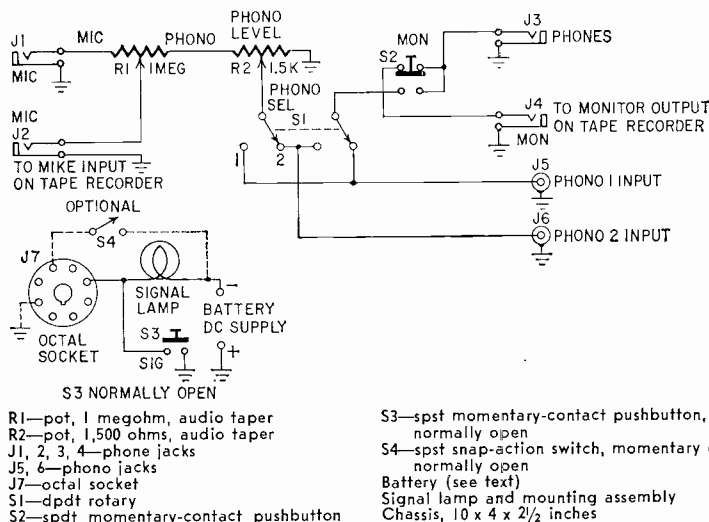

- R1—pot, 1 megohm, audio taper
- R2—pot, 1,500 ohms, audio taper
- J1, 2, 3, 4—phone jacks
- J5, 6—phono jacks
- J7—octal socket
- S1—dpdt rotary
- S2—spdt momentary-contact pushbutton
- S3—spst momentary-contact pushbutton, normally open
- S4—spst snap-action switch, momentary contact, normally open
- Battery (see text)
- Signal lamp and mounting assembly
- Chassis, 10 x 4 x 2½ inches

Fig. 2—A combination of switches and the basic mixing circuit form the complete control unit.

IONIZED BAND encircles the earth

Electronic studies point toward the discovery of a 100-mile-wide ionized band that circles the earth

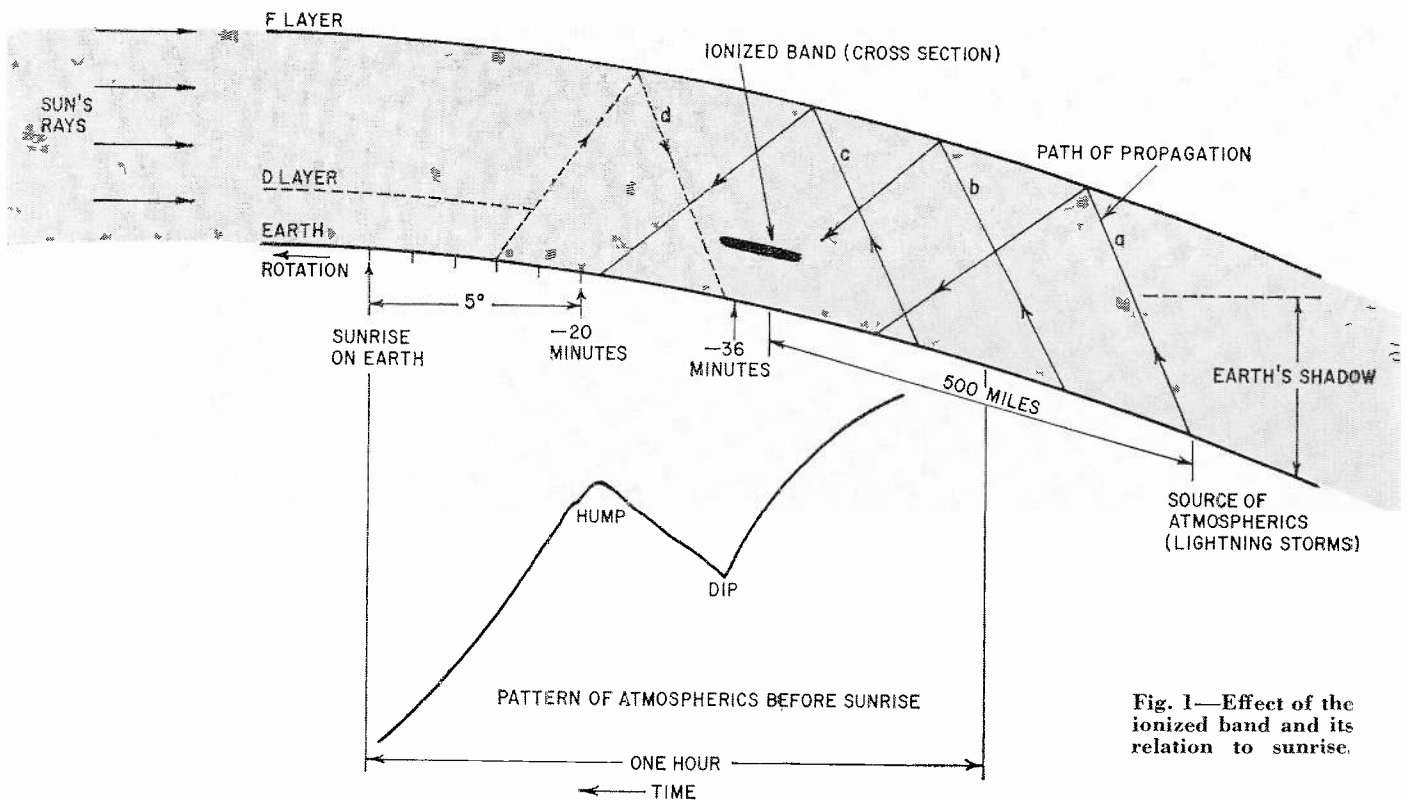

Fig. 1—Effect of the ionized band and its relation to sunrise.

By DAVID WARSHAW

RECORDINGS of atmospheric at 27 kc indicate the presence of an ionized band about 100 miles wide encircling the earth at an altitude of 50 miles.

Members of the AAVSO¹ Solar Division, using transistorized receivers² at various locations in the United States, are recording Sudden Enhancements of Atmospherics (SEA's) at 27 kc for the National Bureau of Standards Indirect Flare-Detection Patrol. SEA's caused by solar flares, are received and recorded only during daylight hours, although the equipment operates continuously day and night. As a result, a very strange pattern in the recording traces of the observers was discovered. The pattern showed a small dip and hump, or a fall and rise in level, about a half-hour before sunrise.

What does it mean?

The reason for the strange dip pattern on the recordings 36 minutes before sunrise could be an ionized band, about 100 miles wide, 50 miles above the earth. About 36 minutes before the earth's sunrise, reception of the atmospheric pulses is weakened for about 8 minutes, during the period when the ionized band is located directly between the receiving station and the high E- and F-layers. The ionized band temporarily blocks the atmospheric pulses normally reflected via these layers to the receiving station (Fig. 1, path b).

The reason for the hump pattern—which follows the dip,

¹American Association of Variable Star Observers, Solar Div., 6130 157th St., Flushing 67, N. Y.

²Solar-Flare Indicator—Transistorized, RADIO-ELECTRONICS, August, 1956, and Improved Solar-Flare Indicator, RADIO-ELECTRONICS, January, 1959.

appearing on the recordings about 20 minutes before sunrise—could be the existence of a space, or weakly ionized separation, in the D-layer region. The hump indicates an improvement in the reception of the atmospheric pulses and a consequent rise in the level of the recorded trace (Fig. 1, path c).

When the earth has rotated the receiving station to a location 20 minutes before sunrise, the atmospheric pulses become stronger for about 8 minutes. They are then reflected from the high E- and F-layers, down through this separation to the receiving station. The separation between the ionized band and the beginning of the D-layer is about 100 miles. (At New York's latitude, 1° or 4 minutes of the earth's rotation is equal to about 50 miles. The duration of the dip and the hump on the record is about 8 minutes for each, or 100 miles.)

Not only does the before-sunrise pattern of the dip and hump indicate the presence of a narrow ionized band encircling the earth, but there is also an after-sunset pattern of a hump and dip to offer additional proof of its existence. A recorded trace from an observing station on the West Coast of the United States clearly shows both the sunrise and sunset patterns for Feb. 28 and March 1, 1959 (Fig. 2). The West Coast member of the AAVSO observing group in China Lake, Calif., is Justin Ruhge, a physicist at a missile base, who operates his own home-made receiver in his spare time. His equipment runs unattended for several days.

When atmospheric pulses are received, they are stored for about 60 seconds, averaged into a direct-current output, then graphically recorded. The normal recorded trace is

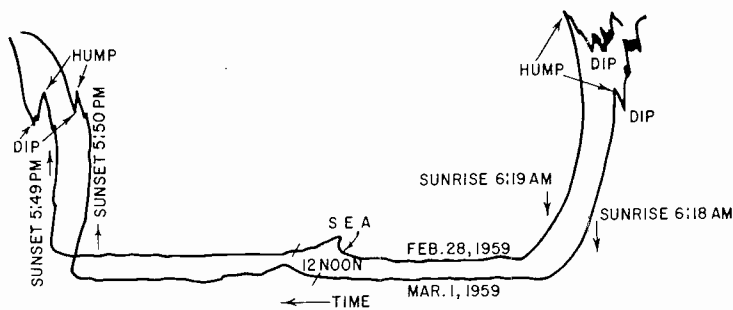

Fig. 2—Recorded trace shows hump and dip that indicate the presence of the ionized band.

rather high during the night and low during the day. The D-layer, created only by the sun's rays, does not exist at night, so atmospheric pulses received during the night from the thunderstorm centers are reflected from the higher E- and F-layers. When the reflecting ceiling is higher, it reflects from greater distances and the receiving station is able to receive a greater number of atmospheric pulses from more thunderstorm sources on this very low frequency of 27 kc.

How the D-layer works

As the earth rotates the receiving station into daylight, the D-layer, formed by the sun's rays, gradually begins to take form about 50 miles overhead, below the higher E- and F-layers. As atmospheric pulses at 27 kc cannot pass through the D-layer, it becomes the reflecting ceiling. Because the D-layer is lower, the number of reflections increases and each reflection absorbs some of the energy of the atmospheric pulses. As a result, the receiving station receives fewer and weaker atmospheric pulses and the recorded trace gradually falls to a lower level. The trace usually remains low during daylight hours, except when a solar flare causes an SEA.

On the daylight side of the earth, the sun's rays create the D-layer region, an umbrella of ionization, 50 miles above the sunlit half of the earth's surface. The amount of sunlight intensity concentrated on a surface increases with the sine of the angle formed by the sun's rays and the surface (Fig. 3).

For this reason the earth's surface is weakly illuminated at sunrise, but not by the sun's direct rays. 50 miles directly above the earth at sunrise, the concave or under surface of the D-layer region is also weakly concentrated for the same reason. At this same 50-mile altitude the sun's rays form an angle of about 10° to a neighboring layer or region which curves into the earth's shadow, and the concentration on this layer is more intense.

The neighboring layer, about 100 miles wide, is the ionized band, which is separated from the actual D-layer. It is illuminated and ionized by the sun's rays penetrating the earth's atmosphere below the 50-mile altitude. Until recently it was not thought probable that the ionizing rays could penetrate this lower altitude enough to induce formation of the ionized band. The existence of radiation that penetrates below the D-region is taken for granted nowadays.

For each day of August, 1958, when there were thunderstorms in the mountains of New England, the recording traces received in New York failed to show the pre-sunrise dip and hump patterns. When reception is from the northeast, instead of the usual southwest, the reflecting ceilings are the E- and F-layers. The propagation path from this source to the receiving station passes through the separation or space between the D-layer and the ionized band (Fig. 1, path d). Because neither the D-layer nor the ionized band blocks the path of propagation, the recording trace shows no dip or hump pattern.

Position of the band

On Dec. 21, at geographic latitude 77.5° north, the ionized band is located directly overhead for about 2 hours before

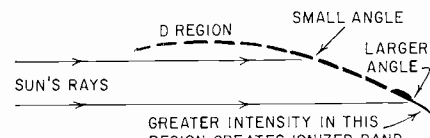

Fig. 3—How amount of sunlight increases with sine of angle formed by sun's rays and surface.

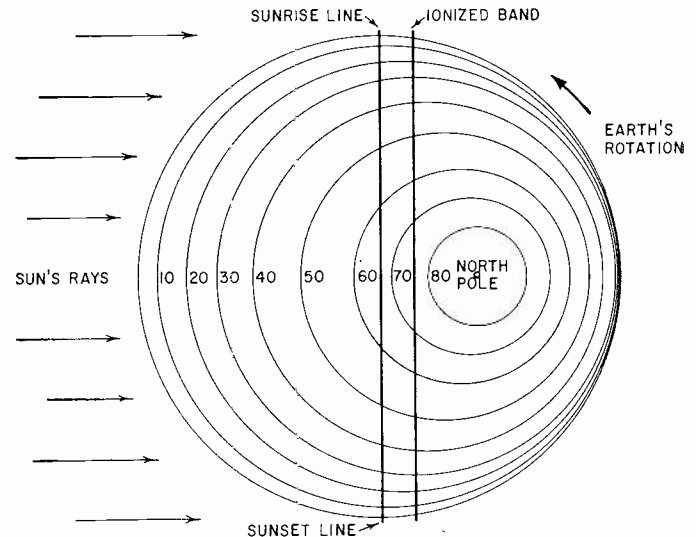

Fig. 4—Ionized band in Northern Hemisphere—Dec. 21.

and after noon, as shown in Fig. 4. However, it is not difficult to plot the ionized band for the other seasons. For example, during the summer it is directly overhead for about 4 hours around midnight at geographic latitude 56.5° north. During the March and September equinoxes, at all latitudes except 80° north, the ionized band is directly overhead a half-hour before local sunrise and a half-hour after local sunset, for only a few minutes. At 80° north latitude, the ionized band is directly overhead from about 10 pm to 2 am. When plotting the position of the ionized band for any day of the year, remember that the ionized band encircles the earth in a plane perpendicular to the sun's rays and situated about 10° farther than the tangent point made by the sun's rays to the earth's surface (sunrise). Some of the communications problems of airlines using the arctic areas should be eased with the knowledge of the exact location of the ionized band.

Recent rocket observations of the upper atmosphere have indicated that shortwave radio fadeouts (5 to 30 mc) are caused by an extra ionized layer which is formed by an increased intensity of X-rays emitted by the sun during solar flares. This extra layer of ionization may extend downward to about 12 miles below the normal D-layer while the higher layers appear to remain undisturbed during the fadeout.³ The extra or additional layer, present during solar flares, temporarily makes a better reflecting ceiling for atmospheric pulses on 27 kc, thus causing an SEA at the same time as the solar flare.

AAVSO Solar Division members receive and record SEA's and send the recordings to their chairman, H. L. Bondy in Flushing, N. Y. He analyzes the tabulations for the Central Radio Propagation Laboratory, Radio Warning Services Section of the National Bureau of Standards, in Boulder, Colo. SEA record tabulations are correlated and published monthly by the National Bureau of Standards CRPL in series F, part B, Solar-Geophysical Data, listed under Ionospheric Effects of Solar Flares. The Indirect Flare Detection Patrol gathers the information appearing under SEA's, SCNA (Sudden Cosmic Noise Absorption) at about 18 mc and bursts of solar radio noise, which are also at 18 mc.

END

³Science, Jan. 17, 1958.

Low Voltage SILICON RECTIFIER ADAPTER

By RONALD L. IVES

*Make plug-in replacements
for vacuum-tube rectifiers*

ABOUT 3 years ago the cartridge type silicon rectifier appeared on the market and was immediately adopted in industrial and military work. It has not been as widely used in communication and amusement radio equipment, perhaps because designs were all made for vacuum-tube and selenium rectifiers.

Advantages of silicon rectifiers over all other types are many: no standby current, low voltage drop, easy replacement, very long life and small size.

When a silicon rectifier replaces a vacuum tube, there is an immediate reduction of 10 to 15 or more watts in the drain on the power transformer, and a proportional reduction in the heat radiated by the equipment. Output voltage goes up about 10% because of the low internal drop in the rectifier (1.5 volts per unit, at full load). Replacements are reduced, because of the long life of the silicon unit. In one batch tested, only 3% failed during 10,000 hours of service. No statement of average life is yet possible, as most of those under test seem to be immortal.

Characteristics

The typical silicon-rectifier cartridge, such as the Sarkes Tarzian M-500, is about 1 inch long and 13/32 inch in diameter. It has a central ceramic barrel and metal ends, the cathode end being notched for identification and to prevent backward insertion in the clips supplied for it.

Electrical characteristics of this type of rectifier, which carries the JETEC number 1N1084, are:

Max peak inverse volts.....	400
Max rms volts.....	280
Max dc load at 100°C.....	0.5 amp
Voltage drop at full load.....	1.5

It is recommended that rms input volts be halved for a capacitive load in half-wave circuits. If the load is pure resistance, as in Fig. 1-a, with an applied rms voltage of 280, the piv (peak inverse voltage) will be $280\sqrt{2}$, or 396 volts, which is just below the allowable maximum. If the load is capacitive, the charge on the capacitor adds to the inverse voltage from the transformer winding and the total is, or may be, with 280 rms volts applied, 792 volts, which far exceeds the maximum piv allowable. With 140 volts applied, the piv with a capacitive load is 396, and the rectifier rating is not exceeded.

Neglecting this limitation on the piv rating of silicon rectifiers has resulted in a number of serious equipment failures.

Heat radiation from a silicon rectifier of this type, at full

load, is 0.75 watt. Unless it is operated in a confined space which is also thermally insulated, it will run cool by any ordinary standard. In typical communication equipment use, these rectifiers run from 15 to 25°C above ambient.

With capacitive loads, a 5-ohm surge-reduction resistor is recommended by the manufacturer. Any number of these rectifiers can be used in series without requiring any special circuitry.

A full-wave rectifier circuit, using silicon rectifiers and meeting all physical requirements of the rectifiers, is shown in Fig. 2. As the circuit fills the needs of most communications receivers and uses components already in the sets, except for the rectifiers, it is not difficult to change from the rectifiers in use to silicon units. If a vacuum-tube is replaced by silicon rectifiers, one 5-volt winding, rated at 2 or more amps, is available for other use in most instances.

Obviously, if the transformer voltage is higher than 280, more than two silicon rectifiers must be used in series, and the value of the surge damping resistor must be increased. For tube replacements at high voltages, special silicon rectifiers are made, with a socket mounting, for direct replacement of tubes. For medium voltages, these plug-in adapters are costly, as they are rated for much higher applied and peak inverse voltages than usually encountered in receivers and low-powered transmitters.

Make an adapter

Where per-plate voltages of the equipment under consideration do not exceed 280 rms and a full-wave octal-based rectifier tube is used, a low-cost universal silicon rectifier adapter can be made. It plugs into the tube socket.

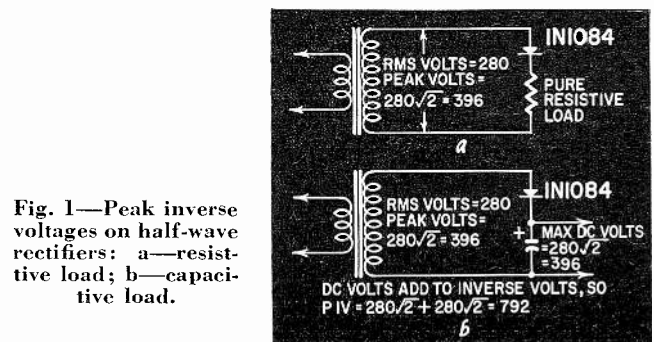

Fig. 1—Peak inverse voltages on half-wave rectifiers: a—resistive load; b—capacitive load.

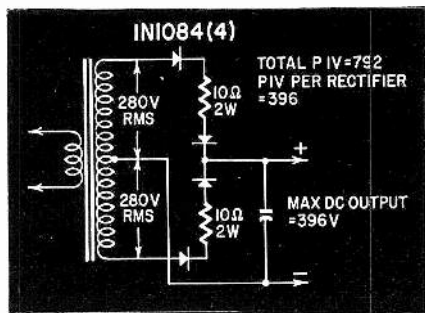

Fig. 2—Full-wave center-tap rectifier circuit using silicon rectifiers. Two rectifier units per leg are used here as a safety factor.

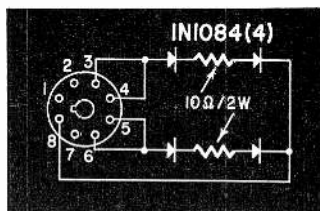

Fig. 3—Octal base connections for universal adapter.

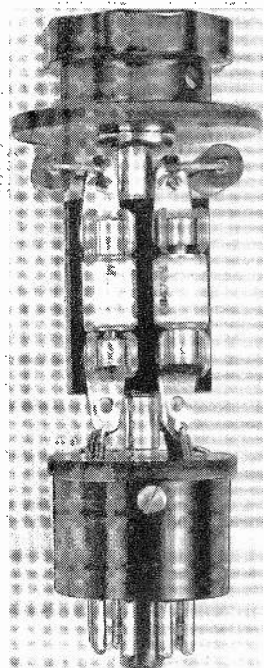

Fig. 4—Front view of completed adapter.

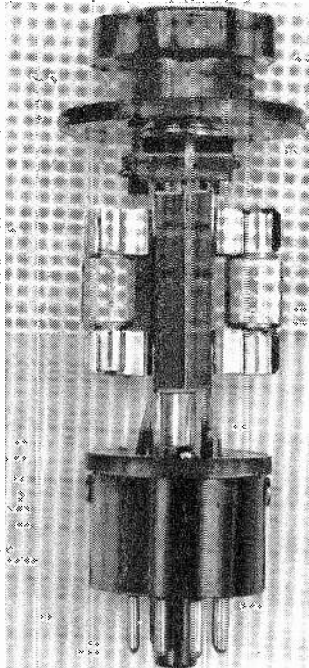

Fig. 5—Side view of assembled adapter.

The circuit is shown in Fig. 2. Base connections which make the adapter work in the octal socket of any 5- or 6.3-volt full-wave rectifier tube are shown in Fig. 3.

Adapter construction is simple, and requires few parts. Principal ones needed are four 1N1084 silicon rectifiers (Sarkes Tarzian M-500's or equivalent), and two dual mounts for them (Littelfuse 099063 or equivalent).

Straighten the crossed lugs at one end of each mount, and file a shallow groove lengthwise up the center back of each. Bolt the two mounts back to back, using 4-40 x 1/4-inch binding-head screws and nuts. Run a No. 28 twist drill lengthwise through the center of this sandwich, using the previously filed grooves as a guide. Run a 4 1/2-inch 6-32 threaded rod through this hole, allowing about equal projection at each end. Put a lock washer on each end of the threaded rod, and run a 1/2-inch long, 1/4-inch diameter, 6-32 inside threaded spacer (H. H. Smith No. 2122 or equivalent) onto each end. Tighten them firmly against the fiber of the mounts.

On the top end put a flat washer over the screw, and another spacer. Tighten it firmly against the washer. Run a spacer onto the other end of the threaded rod and tighten it.

Join the top lugs on opposite rectifier mounts with 10-ohm 2-watt resistors. The clip arrangement on the mounts automatically gives the required series-aiding rectifier connection.

Force a 10-32 cup washer over the top spacer, and drive it down until it presses firmly against the flat washer already in position. Over the same end of the assembly, slip a disc of bakelite, about 1 1/2 inches in diameter, 1/8 inch thick and with a 1/4-inch center hole. Over this slip a knob of any convenient dimensions, press it firmly against the bakelite disc, and tighten its setscrew firmly. This top assembly provides a convenient handle for the adapter, and the bakelite disc prevents accidental contact with hot portions of the rectifier mounts. A skirted knob can be used here, if desired, with its index line oriented to show the direction of the base key.

Prepare a bakelite disc about 1 3/8 inches in diameter, 1/8 inch thick, and with a 1/4-inch center hole. Clean up an old octal tube base, being sure that the pins are clear of solder and old wire. Old base cement can be removed by scraping or be softened by methyl-ethyl-ketone (a rubber-cement solvent) and then wiped out. Prepare a round piece of bakelite about 1/2 inch thick, and roughly 1 1/2 inches in diameter so that it will just fit into the top of the tube base. An old knob is excellent for this purpose as it already has a center ferrule to take the adapter's center shaft.

Mount the bakelite disc on the plug just prepared, using screws tapped into the plug and taking care that the centers coincide. Drill four holes through both bakelite pieces for the rectifier leads and mount the top assembly on the disc and plug assembly. Use either a bolt through the center, or the ferrule and setscrew if a knob was used to make the plug.

Pass a 6-inch length of medium-gauge hookup wire (such as No. 24) through each of the four holes in the adapter base assembly, and solder each to one lug of the rectifier mount. Put a 1 1/4-inch length of sleeving over each wire.

In the tube base, bridge pins 3 and 4, and 5 and 6, with solid wire. Pass both cathode leads from the rectifiers through pin 8 of the base. Then put one anode lead through either pin 3 or 4, and the other through either pin 5 or 6. Pull leads tight, and slip base of rectifier assemblage into tube base. Solder leads, clip off surplus wire, and fasten base assembly into the tube base with two small screws.

The adapter is now finished and ready to use. Remove the tube it will replace, and plug the adapter into the socket.

A number of simple changes can be made in the construction of an adapter of this type without impairing its operation. The adapter shown has almost the same physical dimensions as a 5U4-G. By mounting two sets of back-to-back clips in tandem and using eight rectifier cartridges, voltages up to 560 each side of center tap can be handled. Many other variations in both circuitry and format are possible, and all will work well if the piv ratings of the silicon rectifiers are not exceeded. END

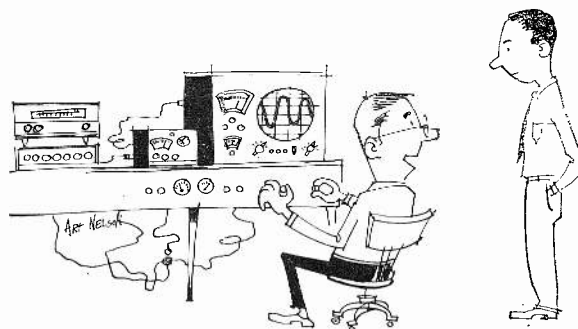

"I never did get around to buying a speaker. I enjoy music better on the oscilloscope anyway!"

PRINCIPLES OF MODERN RADAR

Part I—The first section of this two-part series describes the operation of pulse-modulated and frequency-modulated radar, and shows some of the ways of displaying data

By **JORDAN McQUAY**

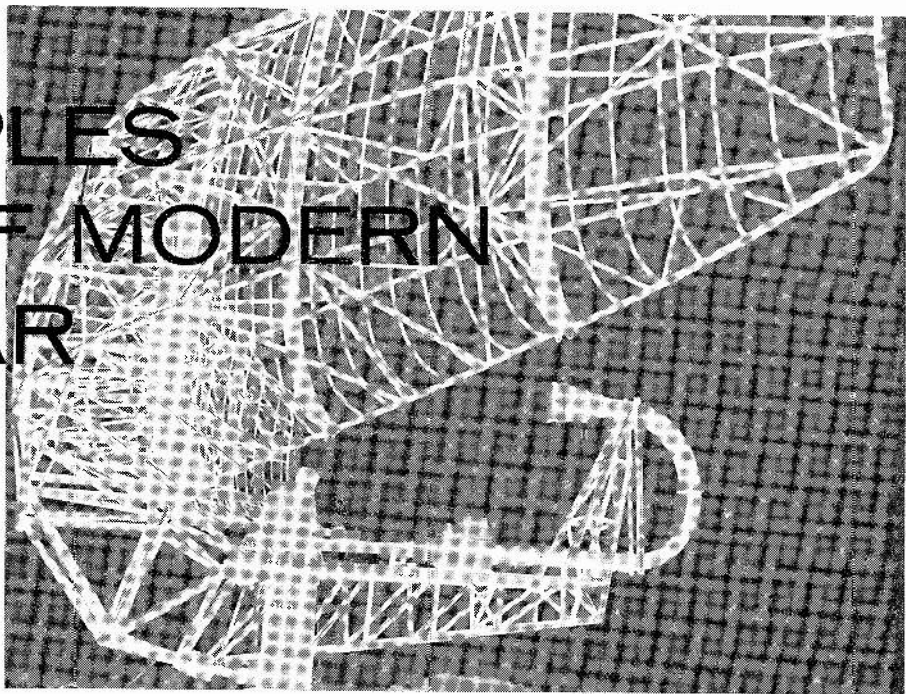

MODERN radar has advanced far beyond the ponderous equipment of short range and limited accuracy that emerged as one of the major technical achievements of World War II.

Through continuous improvement, the range of modern radar has been increased to global and even outer-space distances. Accuracy has been infinitely improved. And the usefulness has been expanded—with many new military as well as commercial applications.

Originally developed as a military weapon, radar was a closely guarded secret until the closing days of World War II. With dissemination of technical data to the radio-electronics industry, came extensive development and continuous improvement. Today, radar has achieved advanced technical status. Because of its inherent nature and operating characteristics, it is primarily a military adjunct to national defense. But it also has many peaceful uses.

For navigation at sea, small radars (Fig. 1) are installed on pleasure boats and small commercial vessels. Larger setups are used on ocean-going liners and transports (Fig. 2).

For air navigation and flight safety, radar is used aboard aircraft as altimeters and to map areas over which the plane is flying. Ground-based radar is used to control flights of aircraft (Fig. 3).

For storm detection, radar can locate and portray heavily charged clouds associated with hurricanes, thunderheads and other weather disturbances (Fig. 4).

Military radar is used for short- and long-range surveillance, artillery fire control, mortar locating, aerial navigation, electronic mapping and many other purposes.

Whatever the application, the basic principles of all types of radar equip-

ment are deeply rooted in radio and electronics.

Accuracy has been improved through increased use of microwaves—often in the *millimeter* part of the spectrum—through development of electron tubes and circuitry capable of handling such wavelengths. Advanced types of cathode-ray tubes now permit pictures of extreme definition and accuracy. Many of the important new developments in high-speed automatic data-processing equipment have been applied directly to modern radar.

Radar in general

A radar is a composite radio-electronic apparatus that detects and locates objects and targets—such as aircraft, ships, buildings, mountains, terrain, and even people—at various distances and with incredible accuracy, even when darkness, fog or clouds make the targets invisible.

A radar consists essentially of a microwave transmitter, an antenna system, a microwave receiver, a timer or synchronizer and an indicator—all working with microsecond precision.

Rf energy is broadcast in any desired direction. When it strikes an object or target, a minute portion of the rf energy is reflected and returns to the radar within a few thousandths of a second.

Knowing the speed of rf energy (186,000 miles per second) and measuring time differences between the transmitted energy and any reflected echoes, these data are translated electronically into direct distance or *range*—from the radar to each object or target. For example, an echo is picked up 100 μ sec after the rf energy pulse is transmitted. In that length of time, the rf energy has traveled 18.6 miles. This means that the object is half that distance or 9.3 miles away. (The distance is halved

because the signal has to travel both ways—to the object and back.)

The angular direction or *azimuth* of a target is determined by the physical position of the movable antenna system.

Through accurate measurements of range, altitude, and azimuth, the exact location of any target can be determined by electronic geometry—whether the target is in space, or on the ground or sea.

Data obtained directly or through electronic processing are displayed continuously on an indicator. This is usually a cathode-ray tube, called a *scope*. Any of several different kinds of scopes (Fig. 5), may be used, depending upon the type of data to be displayed—range, altitude, azimuth or other.

The A-scope is widely used—but provides only range data. The scan is a single horizontal line across the scope screen, which is calibrated in feet, yards or miles. The beginning of the trace first shows the main pulse radiated by the radar transmitter. Then, various objects and targets appear along the trace at distances corresponding to their range from the radar. Since the antenna beam is highly directive, the maximum-strength signal appears as the brightest glow along the trace of an A-scope when the antenna is pointing directly at the target—providing a physical indication of its azimuth.

The B-scope plots range against azimuth and is used primarily for radar on aircraft. There is a vertical sweep, and the position of the sweep is aligned with the azimuth position of the antenna—which usually scans a region up to 90° on either side of the aircraft, dead ahead. Reflected signals from targets appear on the B-scope as small glowing spots.

The C-scope plots elevation against azimuth and is also used aboard aircraft. The display is similar to a graph,



Sperry Rand

Fig. 1—Indicator of radar used for small-boat navigation.

with the vertical center of the scope representing a direction dead ahead.

The J-scope presents the same type of range information on a circular trace that the A-scope presents on a horizontal trace. Advantage of the J-scope over the A-scope is that the J-scope has a longer trace for a given range. This allows more accurate determination of distance between the radar and a target. Reflected signals appear as outward deflections of the circular trace of the J-scope.

The PPI-scope—Plan Position Indicator—is an electronic polar map. At the center of the scope screen is the main pulse, representing the location of the radar. A circular scale around the screen is calibrated in degrees of azimuth with respect to the location of the radar. The distance from the center of the screen to the illuminated spot of a target is the range to that target. The scan of a PPI-scope is a trace extending from the center of the tube to the outer edge of the screen. This trace is rotated around the circumference of the A-scope synchronously with the physical rotation of the antenna system. Objects or targets within range of the radar appear on the screen as bright spots. Utilizing a long-persistence screen, the PPI-scope thus provides a polar map of the area within range of the radar.

For all kinds of scopes, target data are displayed almost instantly. If a target moves or changes its position, the scope display will also change.

The effective range of any radar depends upon its ability to distinguish between reflected energy from objects and targets, and other interfering "noise" signals and disturbances which may be present. Although the radar transmitter may radiate as much as several kilowatts of power, only a part reaches the target and a still smaller amount is reflected to the radar receiver. Reflected signals may be as weak as $1 \mu\text{v}$ upon reaching the antenna system.

To economize on transmitted power and to provide extremely accurate target reporting, rf energy is concentrated in a very narrow beam by the antenna system. This is done with various kinds of parabolic reflectors

associated with the active elements of the antenna. For low-power short-range radar, a small-size antenna is sufficient. For long ranges, the antenna is sometimes very large (see head photo).

The entire antenna system is constructed to move or rotate so that the narrow beam of rf energy can probe a large arc across the region or area being searched or surveyed.

Depending on its design, a radar can detect and locate targets at ranges of a few thousand feet or yards—or thousands of miles.

The primary qualification of any radar is its ability to measure accurately all reflected signals in terms of range or distance. There are three basic methods of measurement corresponding to the three basic kinds of modern equipment: (1) pulse-modulated or PM radar, (2) frequency-modulated

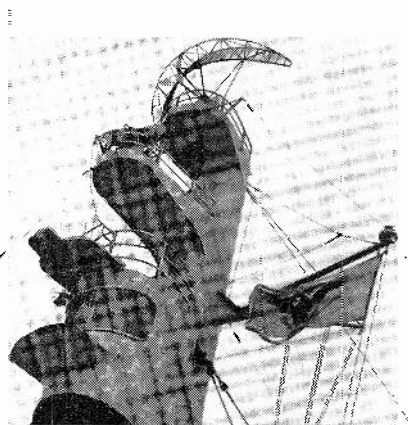

Raytheon

Fig. 2—Radar antenna system on masthead of S. S. United States.

or FM radar and (3) pulse-Doppler or PD radar.

Pulse-modulated radars

PM radar is widely used for detecting and locating air and sea targets. Range is measured in terms of the time required for a pulse of rf energy to travel to a target and return to the radar.

For short ranges, radars are physically small and compact (Fig. 1).

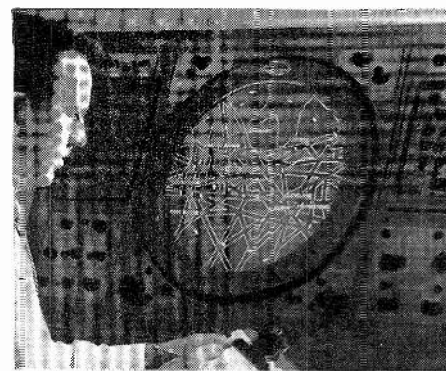

Raytheon

Fig. 3—Radar for aircraft control allows traffic controllers to pinpoint plane locations.

Larger PM radars locate targets as far as the horizon (Fig. 6). Even larger ones are used to track missiles and satellites at distances of thousands of miles (Fig. 7).

All PM radars are basically similar (Fig. 8). A microwave transmitter—usually a magnetron—broadcasts extremely short-duration pulses of amplitude-modulated rf energy at regular intervals. The number of such pulses per second is called the prf (pulse recurrence frequency) and is controlled by the timer of the radar. The prf is usually a fixed value of several thousand pulses per second. The duration of each rf pulse is extremely short—only a few microseconds. After radiating each pulse, the transmitter is switched off to allow the reception of echoes from targets within range of the PM radar. After this interval, the transmitter is turned on again and broadcasts a brief rf pulse. The process is repeated over and over again, according to the prf of the radar.

Pulse constants—the prf and the pulse width—determine the maximum and minimum range limits as well as the range accuracy and resolution of a PM radar.

Enough time must be allowed between the transmitted pulses for echoes to return from targets within range of the radar. Otherwise the reception of echoes from more distant targets will be

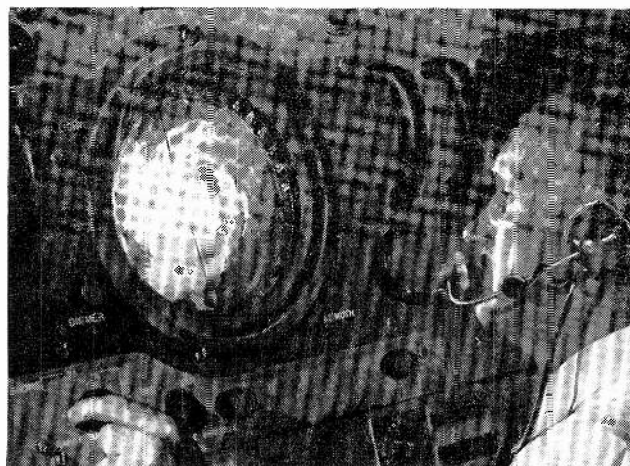

Raytheon

Fig. 4—Viewing an actual hurricane on the indicator of a storm-detector radar.

ELECTRONICS

obscured by succeeding pulses of rf transmission. This necessary time interval fixes the highest possible value of prf.

When the antenna system is turned or rotated at a constant speed (usually about 10 or 20 rpm), the beam of pulsed rf energy strikes a target for a relatively short time. During this time, enough rf pulses must be transmitted to assure receiving sufficient echoes to produce an indication on the radar scope. Thus, the rotational speed of the scope plus the persistence of the scope screen determines the lowest possible value of prf.

The minimum range at which targets can be detected is determined primarily by the duration of each transmitted pulse. If a target is so close to the radar that its echo is returned before the transmitter is switched off, reception of such echoes will be impossible.

A *duplexer*, or TR switch, permits use of a single antenna for both transmission of rf pulses and reception of echoes. When the transmitter is operating, the duplexer blocks off the microwave receiver. When the transmitter is not functioning, all incoming echo signals are fed from the antenna directly to the receiver.

A radar receiver is a superheterodyne tuned to the same frequency as the transmitter (several thousand megacycles). It is highly sensitive to the weak echo signals, which are often less than a microvolt. These signals are mixed with the signal from a local oscillator (usually a klystron) to provide an if signal of 30 or 60 mc for broadband if amplification. After detection, the pure video signals are amplified and then applied to an indicator or scope. Most radar receivers also include automatic circuits for local oscillator frequency control and for gain control of incoming echo signals.

Transmitter and receiver are synchronized by a *timer*, which may be physically associated with the transmitter, receiver or indicator. The timer consists essentially of a controlled master oscillator, which establishes the prf and provides trigger voltages for other elements of a PM radar.

At the indicator, echo signals are measured in terms of the time interval between the transmission of an rf pulse and the reception of its reflected echo. This gives a direct, visual indication of range to an object or target. There is usually some "ground clutter" at ranges close to the radar, and there is usually an intense signal marking the main pulse of the transmitter; but this "interference" is fixed and at very close range.

The azimuth or direction of a target is determined by the angular position of the antenna system.

When the elevation or altitude of a target is required, such data are computed electronically from known information about the range and azimuth.

Improved types of radars have antenna systems that do not move physi-

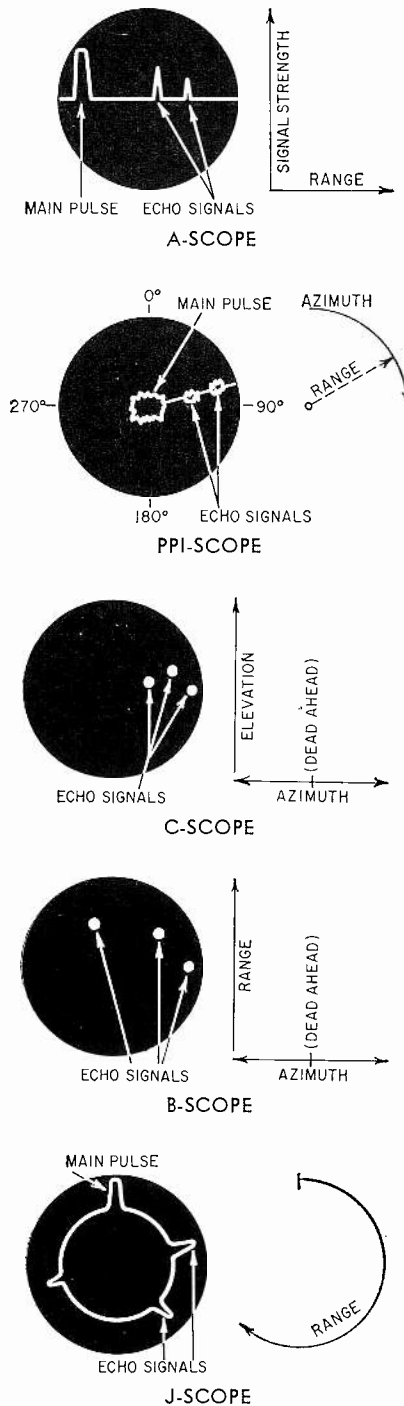
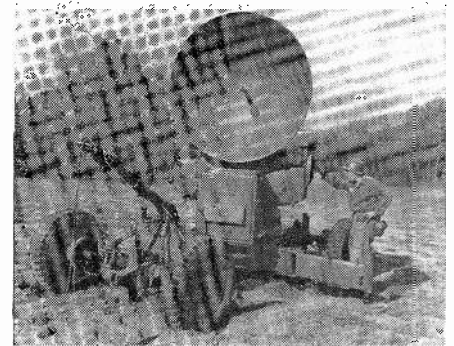

Fig. 5—Some typical radar scope presentations.

cally. The pulsed rf beam scans vertically and horizontally by electronic means, and the antenna is stationary. This is sometimes called *frequency scanning*.

Very-long-range PM radar recently developed utilizes ionospheric scatter to detect and locate targets at ranges of several thousand miles. Rf pulses—at about 30 mc—are beamed directly at the ionosphere, and bounce back and forth between the earth and reflecting layers until they strike a target in space, such as a missile or aircraft. Echoes return via the same scatter



US Army

Fig. 6—Radar used for anti-aircraft fire control.

path, eventually reaching the receiver of the PM radar (Fig. 9).

Frequency-modulated radars

Instead of transmitting pulses of rf energy, an FM radar transmits a continuous wave varied rapidly and below a reference frequency.

Reflected waves (from objects or targets) arrive at the radar receiver some time after transmission, and thus have a slightly different frequency from that of the rf energy being broadcast at the moment of reception.

A comparison between the transmitted wave and the reflected wave at any instant provides a *difference frequency*. Knowing the speed of rf energy and knowing the rate at which the transmitted frequency is varied, electronic measurement of the difference frequency is a means of accurately measuring the range to a reflecting object or target.

Azimuth or direction of a target is determined conventionally, according to the physical position of the antenna system with respect to the target.

When either the FM radar or a target is moving with respect to the other, the frequency of the reflected wave will also be subject to the Doppler effect. This effect causes a further change in the frequency of the reflected wave, and provides a means of determining the speed or movement of the radar with respect to the target, or of the target with respect to the FM radar.

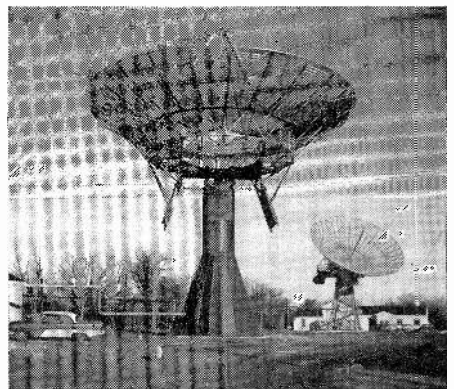

US Army

Fig. 7—Long-range radar antennas for tracking missiles and satellites in outer space.

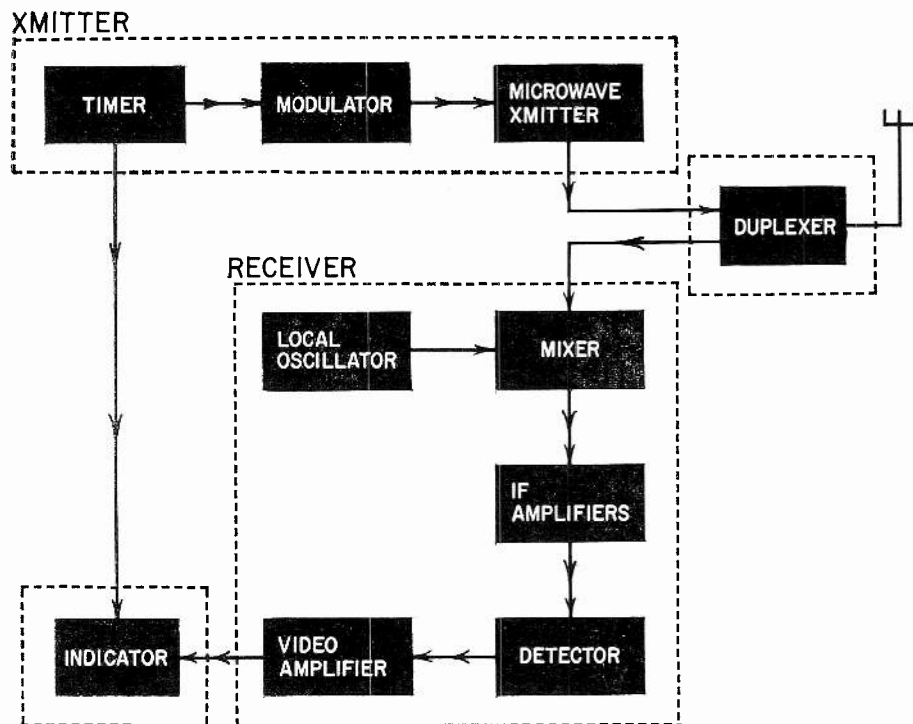

Fig. 8—Block diagram of a pulse-modulated radar.

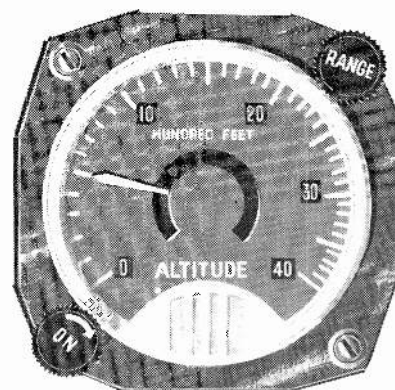

Fig. 10—Indicator of airborne FM radar used as altimeter.

is used as an altimeter, meters are used to simplify reading by pilots (Fig. 10). As an altimeter, the range or distance to ground—the plane's actual altitude—is measured.

Unlike PM radar, there is no realistic minimum range for FM radar. In practice, an airborne altimeter can determine distances as short as a few feet. Additionally, FM radar provides greater range precision and is more compact than the PM types.

The FM radar uses most of the units already described for the PM type, and the block diagram of Fig. 8—with slight modifications—could be used to picture an FM radar. The local oscillator in the FM type is connected to the detector as well as the mixer, and the amplifier need not be a video type, since no sharp pulses are handled. As will be explained below, two antennas are used, and the microwave transmitter has a direct connection to the mixer instead of the connection between timer and indicator of the PM radar.

A microwave transmitter—usually a magnetron—operates continuously at a reference frequency of 500 to 1,000 mc or higher. A timer controls variations in this frequency. Unlike a PM radar, FM radar is not required to handle a high peak power output during transmission of rf energy.

Since an FM radar transmits and receives signals simultaneously, separate antennas are used for transmission and reception. When an FM radar is used as an altimeter, an antenna is located on each wing of the aircraft.

Low-reactance (large-diameter) half-wave dipoles are widely used for antennas at about 500 mc. Four- and five-element Yagi arrays have also been used. At operating frequencies above 1,000 mc, parabolic-cylinder reflectors are used with half-wave dipoles. Also used are slot type antennas which, for airborne installations, are mounted flush with the outer surface of an aircraft.

Reflected waves from the receiving antenna are fed to the mixer, which also accepts an attenuated signal directly from the microwave transmitter. The mixer is a balanced detector, com-

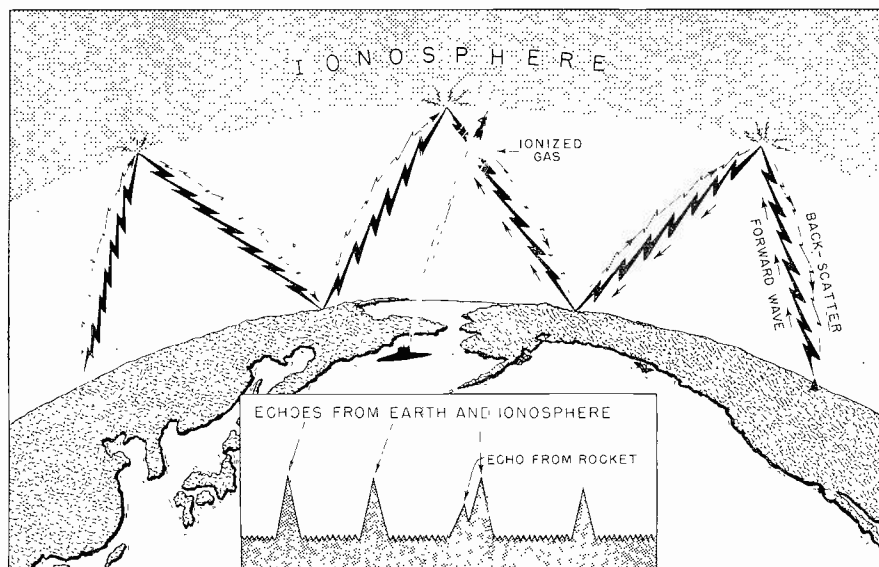

Fig. 9—Using ionospheric scatter to detect targets at long range.

posed of triodes (for 500-mc operation) or crystal diodes and waveguide circuits (for 1,000 mc and higher).

By combining these two input frequencies, the mixer produces a difference frequency, which is a varying low-frequency, or if signal. This signal passes through several if linear amplifiers. After detection, the signal is amplified and analyzed. Changes in the frequency of this signal represent measurements of range to an object or target. Some form of spectrum analyzer is used to differentiate between signals received simultaneously from several targets.

Indicators for FM radar may be any kind of scope (Fig. 5). When the radar

The basic block diagram shows in Fig. 8 omits much of the ingenious and complicated circuitry included in an effort to distinguish between target signals and "noise" interference. These techniques are associated with such high-sounding terminology as "information theory" and "correlation of data." Despite these advances and improvements, there is still great difficulty in telling one target signal from another and, particularly, in distinguishing moving targets. This has led to the development of a new and advanced kind of equipment known as the pulse-Doppler or PD radar, which will be discussed in the next part of this article.

TO BE CONTINUED

INTERNATIONAL ELECTRONICS MEET AT PARIS

By JACK GARCIN

Transistorization, miniaturization, new instruments and TV techniques are highlights of all-nation Show

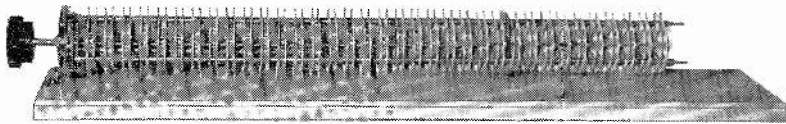

A 35-wafer switch made by Chambaut and operating with low shaft torque

THE third International Tubes and Components Exhibition (Salon International de la Pièce Détachée et de Tubes Electroniques) was held in Paris from the 19th to the 23rd of February, 1960. It was a very successful and extremely interesting display of the world's best products in the fields of electronic parts, tubes, measuring and test equipment and audio amplifiers. Four hundred stands occupied an area of 14,000 square meters and, during the 5 days of the show, attracted numerous visitors from 32 countries.

The international character of the show was due not only to the 61 stands occupied by non-French companies, coming from 12 countries (among which the United States was represented by some 20-odd stands), but also to the participation of 15 of the principal foreign magazines specializing in electronics, including of course RADIO-ELECTRONICS.

For the first time, the spectator was able to compare on a grand scale the products marketed under the world's principal brand names. The first conclusion to be drawn is that *there is no great difference between the products of different countries.* Technique and industrial practice have come to be shared by all the producers of the world. And if some differences still exist, they are tending to disappear.

The French electronic material was found to exhibit the same tendencies as that of other countries—tendencies that can be characterized in two words: *miniaturization* and *transistorization*.

Transistors are continuing their victorious offensive and tend to replace tubes more and more in different domains. One televiser was *entirely equipped with transistors*, except, of course, the picture tube. This particular model was a prototype, the price of which would be too high to permit immediate mass production. But experienced observers expected to see completely transistorized televisers on the market shortly.

The *Tecnetron*, the field-effect tran-

sistor described in RADIO-ELECTRONICS when it first appeared (see "Tecnetron—Competitor to the Transistor?", by E. Aisberg, May 1958, page 60) was on view and will shortly be produced in large quantities by the French Thomson-Houston Co.

A revolution in the field of television is under way in France—the *introduction of 110° tubes*. Such tubes—now almost universal in US sets—have been made in French factories for more than a year. But up to the present they were all destined for export to European countries in which the 625-line standard is in use.

The high definition of French television—where the image is explored with 819 lines—presented difficulties to the introduction of 110° tubes. To deflect the beam 20,475 times per second (25 frames at 819 lines) over a 21-inch screen requires a notably greater

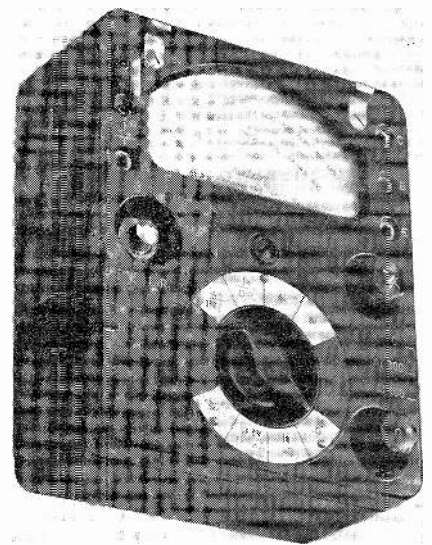

This Transistormetre by Metrix permits rapid measurement of different types.

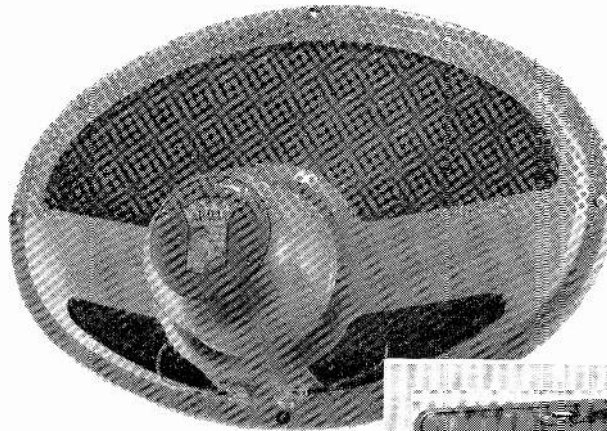

Philips GM 6020 micro-voltmeter. It indicates the polarity of the measured voltage automatically by lighting one of the two neon lamps marked + and -, at left.

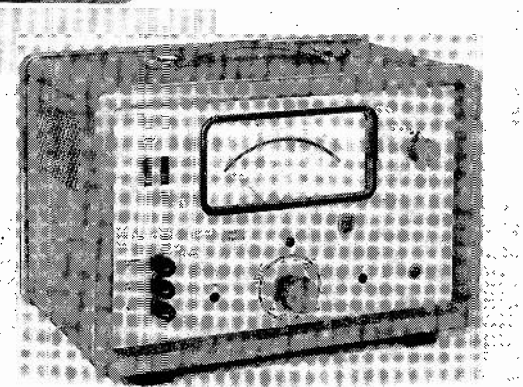

To make it easier to put the speaker beneath the picture tube in a TV receiver, Audax has come up with this unit with an off-center magnet.

ANOTHER FORGOTTEN INVENTOR?

By ERIC LESLIE

amount of power than is needed for lower-definition systems.

It was therefore necessary to create tubes powerful enough to amplify sweep-circuit currents sufficiently. The deflection yokes themselves had to be made deeper, to avoid deformations and defects that could otherwise appear at the edges of the picture.

Now all these difficulties have been resolved and the 110° tube has made a triumphal entry into 819-line television set design and production.

The French television market is still far from saturation, as seen from an American viewpoint. This country of

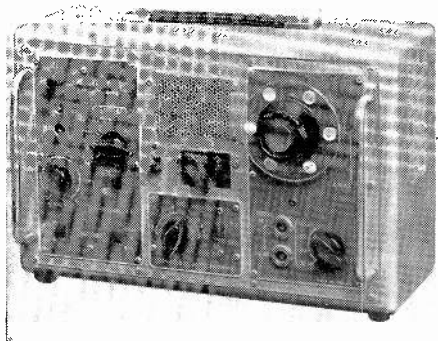

A typical piece of European test equipment, this signal generator by Centrad permits a choice between 6 high-frequency channels and between the two principal European standards of definition: the 819 lines of France and part of Belgium and the 625 lines standard in most of the rest of Europe.

45,000,000 inhabitants counts only 1,500,000 televisers at the present moment, though practically the whole territory is within the service area of the French television system. To improve this situation, an additional chain of TV stations is planned, to transmit a second program. Like the first, it will belong to "Radiodiffusion Television Francais," a Government organization.

Next year the fourth International Exhibition will be held, also at Paris, from Feb. 17 to 21. At almost the same time (Feb. 20-26, 1961) the International Congress of Technique devoted to semiconductor devices takes place. Once more Paris will be, next year, the rendezvous of all the electronicians of the world. **END**

WEATHER RADIO

Weather prediction via freak radio reception is reported from Belle Glade, Fla. Gene McCabe of Pioneer Grower's Cooperative can tell what's coming by checking on long-distance pickup of the two-way radio used to talk with his men in the field where they choose vegetable crops for quick freezing.

Ordinarily, their transceivers work only up to 20 miles. But every now and then they pick up Ontario, Canada, or an oil company in Texas. They've learned from experience that 2 to 3 days later they'll invariably have a cold spell!

ONE of the unexpected discoveries of the International Geophysical Year (IGY) was that the radiosonde was invented and forgotten or buried in Government files nearly 10 years before it was re-invented and became a part of the geophysicist's standard equipment. The radiosonde, which carries temperature- and pressure-measuring instruments into the upper atmosphere and radios their readings back to a ground station, is one of the fundamental instruments of atmosphere exploration. At one time, the instrument was expected to become the symbol of the IGY. A Westport, Conn., engineer, Lawrence B. Whit, therefore compiled a radiosonde history for reference. To his great surprise, he found that a radiosonde-like device was described in 1924 by Dan C. Wilkerson, an engineer living in Washington, D. C.

Mr. Wilkerson, late in 1923, offered Dr. Tallman of the Weather Bureau a radio "tell-tale" that would transmit barometric measurements from an unmanned balloon. "Weather balloons" were already known and in use but, like modern nose cones, had to be recovered before their records could be used. Wilkerson proposed to end that with a device that would send barometric information back continuously, and whose signals would also indicate the position of the balloon.

This equipment was a little heavy by modern radiosonde standards—60 pounds, Mr. Wilkerson admits—and the Weather Bureau was short of funds to develop the idea. Therefore, in 1924, Wilkerson turned his attention to the Armed Forces. He pointed out, in a letter that shows wide knowledge of the field at that time, that methods of guiding missiles and unmanned planes being experimented with at the time were practically useless beyond line-of-sight. His "tell-tale" transmitter in the missile or atmospheric vehicle would radio its exact position at all times, so that its course could be corrected as long as it was within radio range.

Even while trying to sell the military on the guided-missile aspects of his "tell-tale" Wilkerson did not lose sight of its possibly more important meteorological features and, in a memorandum sent to the US Army Air Service on Sept. 3, 1924, he suggested that this radio-controlled system could be used for "sending out an exploration dirigible into the upper air to get the facts on:

Heaviside layer
Presence of deadly nitrogenous gases in upper air strata
Presence of solid particles of nitrogen
Effect of gravity
Penetration of radio signals beyond atmospheric limits."

Further on in the same memo he stated:

"... the sounding of the upper air, which has

been a cause for increased scrutiny due to the development of radio . . . is made possible at altitudes at which man cannot live."

In an article appearing in Hugo Gernsback's *Radio News*, March, 1925, Wilkerson showed how the same system of radio talk-back from the guided object could be used in a moon rocket to correct its course and keep it directed toward the moon, and to find out whether and how far radio communication works outside the atmosphere.

Meanwhile, a couple of small airborne transmitters had been made, one of which was tested on the ground at College Park, Md., and was said to have been tested in a Messenger plane by

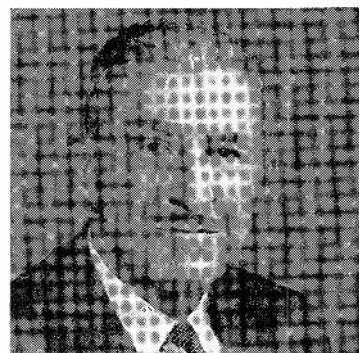

Dan C. Wilkerson, who described the radio "tell-tale" in 1924.

Navy engineers. The other one was shipped to Washington, but before any definite report on it came back, the Navy decided that the matter was important from a security standpoint, and in March, 1925, Wilkerson received a letter from the Bureau of Ordnance, Navy Department, that stated in part:

"This bureau regards the work it has done and is doing on the problem in question as highly confidential, and does not care to disseminate the fact that such work is underway . . . It also assumes that you will not communicate to anyone excepting directly interested departments of our Government plans or proposals based upon your knowledge of the objects which this bureau is seeking in this particular work."

Forced to discontinue to even suggest that a radiosonde might be practical, Wilkerson found it impossible to go further with the instrument. Later on, when Mr. Whit attempted to obtain more records of these early experiments, it was found that the correspondence between Wilkerson and the various Government departments as well as the plans and memoranda regarding the invention, were still classified after more than 30 years. One set of these records was finally cleared during 1958-59, and Wilkerson was free to discuss this early work in public, years after the radiosonde that he had proposed in those documents had become an indispensable instrument in most of the weather bureaus of the world, and in all the missile and satellite projects now known to be using radio space-tracing. **END**

DIVIDE and MULTIPLY with a WHEATSTONE BRIDGE

By FORREST H. FRANTZ, SR.

Properly set up, a Wheatstone bridge becomes a simple calculating machine

ELECTRONIC computers are taking over many of the drudgery jobs in business and engineering. We're all intrigued by the capability, speed and immensity of the giant electronic "brains." Actually they aren't brains, but merely slaves to do drudgery math and record keeping for mankind.

While there's reason for us to be awed by computers, there's no reason to shy away from them and decide they can't be understood. There are simple computer schemes that are easy to understand and duplicate (see "Mr. Math," RADIO-ELECTRONICS, June 1958, page 47). This article describes one you can build in a couple of hours. It uses a simple Wheatstone bridge circuit.

The basic circuit of the Wheatstone bridge is shown in Fig. 1. The resistances in the bridge (A, B, C and D) have a special relationship when meter M reads zero. The relationship is:

$$(1) \quad \frac{A}{B} = \frac{C}{D}$$

If resistances B, C and D are 10, 20 and 30 ohms, respectively, and the resistance of A is unknown, it may be determined by solving the formula for A and substituting the known values. Thus, multiplying both sides of the equation by B:

$$(2) \quad A = \frac{BC}{D} \\ = \frac{10 \times 20}{30} \\ = 6.67$$

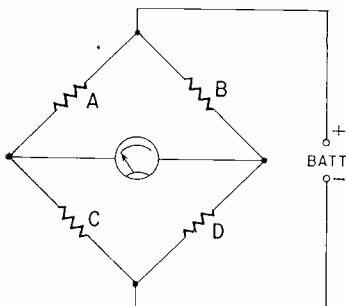

Fig. 1—Basic circuit of a Wheatstone bridge.

In just this way the Wheatstone bridge helps measure unknown resistances, and the dials on the front of the bridge are usually calibrated to give the unknown resistance direct. If we use the Wheatstone bridge principle but use potentiometers with calibrated scales for all four resistances, it's a simple matter to come up with a calculator that can multiply and divide. The circuit of such a device is shown in Fig. 2. The potentiometers are wire-wound and must be linear if you want to use linear scales without special calibration. The type specified in the parts list is inexpensive and will give accurate results. The battery supplies voltage to the bridge when either S1 or S2 is depressed. Meter M is the null detector and may be an external meter on the lowest milliampere range if you have a multimeter and wish to economize. S1 is depressed for coarse null; S2 for fine null. This arrangement makes things easy on the meter by minimizing off-scale deflections.

To multiply

Formula (2) can be used to work most problems. To multiply 32×36 , for example, set 32 on B and 36 on C. Since you want the answer on pot A, you must set D to a multiple of 10 that gets the answer in the range of the A pot. Try setting D at 100. Now, depress S1 and adjust A for coarse meter null. Then depress S2 and adjust A for a fine meter null. Pot A reads 11.5 at null. Multiply by 100 (move the decimal point two places to the right) since pot D divided the problem by 100. The answer is 1,150. If you multiply 32×36 , the true answer is 1,152. The error is less than 0.2%. In general, the error will not be this small, but it will be reasonably small if you do a good construction job and are careful in setting numbers on the potentiometer dials. Results are comparable with those obtained on an ordinary slide rule. There'll be more examples of how this calculator can be used later.

The Wheatstone bridge calculator is

built onto a $8\frac{1}{2} \times 12\frac{1}{2}$ -inch panel of $\frac{1}{8}$ -inch Masonite. A wooden base may be attached to it with wood screws if you prefer a vertical panel.

The dial scales are linear and have 50 equal divisions. Every fifth division line is longer than the others. On scales A and B, each division corresponds to 1 ohm of resistance and every fifth division represents a 5-ohm increment with a full-scale value of 50 ohms. On scales C and D, each division represents 2 ohms, each fifth division a 10-ohm increment, and the full-scale value is 100 ohms. The electrical rotation of the potentiometer is 280° . Therefore, each scale division is 5.6° . Each fifth division is 28° . The dial layout is shown in Fig. 3.

To make the dials, draw four circles 4 inches in diameter on a piece of high-quality paper. Cut these circles out and, with a protractor and ruler, mark off 10 major 28° divisions. Label these 0, 5, 10, 15, 20, etc. to 50° for scales A and B, and 10, 20, 30, etc. to 100° for

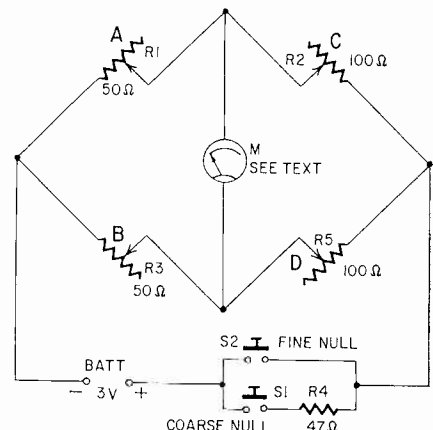

R1, 3-pot, 50 ohms, linear (Clarostat 58C1-50 or equivalent)
R2, 5-pot, 100 ohms, linear (Clarostat 58C1-100 or equivalent)
R4—47 ohms, $\frac{1}{2}$ watt, 10%
BATT—penlight cells (2 in series)
M—0-1-ma meter (Shurite 8300Z or equivalent)
S1, 2-spst pushbutton
Battery holder for two penlight cells
Panel and dials and knobs (see text)
Miscellaneous hardware

Fig. 2—Circuit of the Wheatstone bridge calculator.

Closeup of the calculator's front panel.

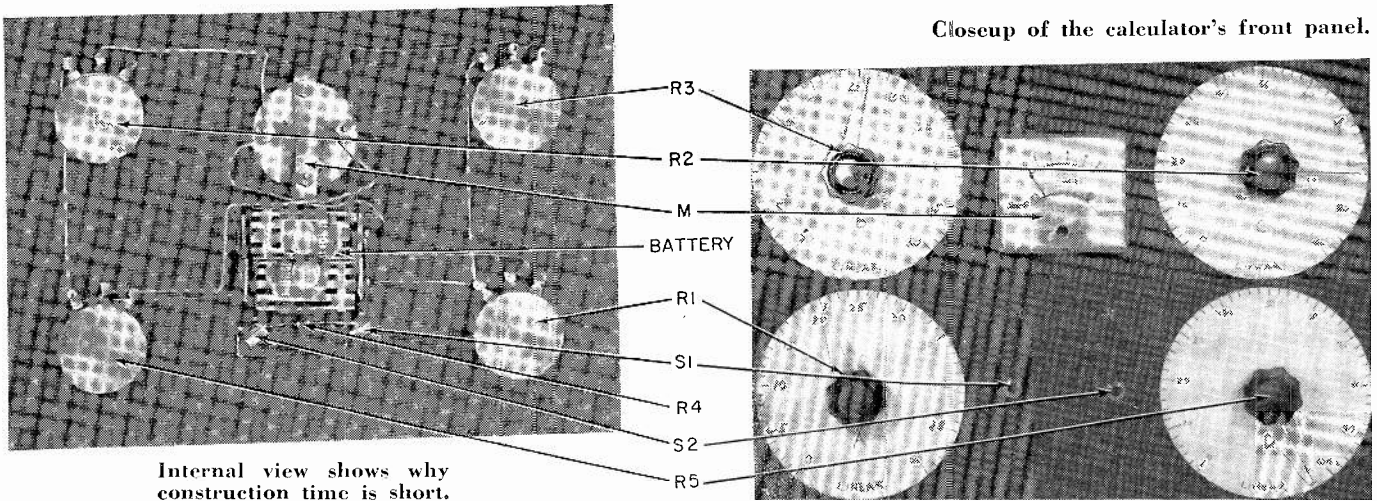

Internal view shows why construction time is short.

C and D. Next, fill in the minor divisions 5.6°, 11.2°, 16.8° and 22.4° from the preceding major division. Finally, draw a 3/8-inch center hole, and cut it out. Ink the scales in if you wish. Fasten the dials to the panel with rubber cement. Be sure the panel is clean, and go easy with the rubber cement. Center the dials over the potentiometer holes.

Cut the pot shafts to 1/2 inch. Place a hex nut on each potentiometer bushing before mounting. Adjust the position of this nut till the bushing extends the thickness of a hex nut beyond the front of the panel, and then fasten the front hex nut. This makes the pointer knob ride close to the scale.

The pointer indicators are made by cutting out plastic pointers, scratching a hairline on them with an ice pick, filling the hairline with India ink, and then attaching the pointers to plain knobs with service cement. Be sure the hairline is aligned with the center of the knob shaft hole. Fig. 4 shows the pointer in detail. Fasten the pointer knobs to the pots so that the pointer travels an equal distance beyond the first and last graduation on the scale. The pointer travels beyond the ends of the scale since the potentiometer arm rides over the end connections on the pot.

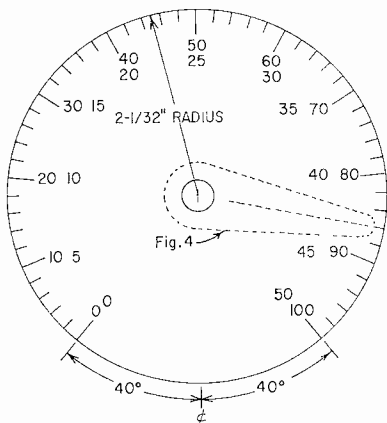

Fig. 3—Dial arrangement for the four pots. Use outer numbers for C and D, inner numbers for A and B.

Mount S1, S2, and the meter, and wire the calculator. Use the photos for guidance. Insert the battery, and you're ready to calculate.

Using the instrument

Here are a few examples of how you can use the calculator. Simple numbers that you can check mentally are used in the first few problems.

- **Problem 1:** There's a 40-volt drop V across a 30-ohm resistor R. Compute (a) the current I through the resistor, (b) the power P dissipated.

Solution:

- (a) $I = V/R$, $I = 40/30$. Set 40 on C, 10 on B. 30 on D. The result obtained by adjusting A for meter null is 1.33. Since B was set on 10, the result is 10 times the actual answer. So divide the answer by 10 (move the decimal point one place to the left) to get 1.33. The answer your calculator will give on the problem might look more like 1.31 or 1.35, but accuracy is still better than 2%.

- (b) $P = VI$

From the preceding problem, V (30) is set on C. Set I (1.33) × 10 or 13.3 on B, and set D to 100. Adjust A for null. The result is 4.0. Since we multiplied by 10 in setting B and the problem was divided by 100 in setting D, the result on A must be multiplied by 10 to obtain the answer, which is 40. This is reasonably close to the longhand answer (39.9).

- **Problem 2:** A car traveled 45 miles per hour for 10 minutes. How far did it go?

Solution:

$$\text{Distance} = \text{Speed} \times \text{Time} = \frac{45 \text{ miles}}{60 \text{ minutes}} \times 10 \text{ minutes}$$

Set 45 on B, 10 on C, and 60 on D. Adjust A for null. The result is 7.5 miles. In this case, the result on A is the answer because the numbers were set directly on the pots without scale multipliers.

- **Problem 3:** Square 35.

Solution:

Set 35 on B, 35 on C, 100 on D. Adjust A for null. The result is 12.2 on A. This must be multiplied by 100 since the problem was divided by the 100 set on D. The answer from the

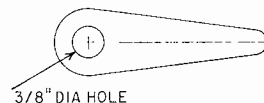

Fig. 4—Diagram of the pointers. Make four from clear plastic; see text for details.

calculator is 1,220, which is reasonably close to the actual result (1,225).

- **Problem 4:** Find the square root of 20.

Solution:

Set 20 on A. Since the square root of 25 is 5, the answer will be near 5. Set B to 50, C to 50, and D to 100. Depress S2 and decrease B and C equally for a null. When B equals C at null, the result on either of them, divided by 10, is the answer. Again the division is required because of the scaling. Although using multipliers and divisors may seem complicated, you'll catch on quickly. The practice actually will help you in your understanding of math.

- **Problem 5:** A 30-, 40- and 90-ohm resistor are connected in parallel. What is the total resistance?

$$R = \frac{1}{1/R_1 + 1/R_2 + 1/R_3}$$

Solution:

Set B to 10, C to 100, D to 30 and adjust A for null. You're calculating 1,000/R, and the result on A is 33.3. Write it down.

Leave B at 10, C at 100 and set D to 40. The result of 1,000/R, when A is adjusted for null is 25. Write it down.

Leave B at 10, C at 100 and set D to 90. Adjust A for null and write down the result. It's 11.1.

Add the results of the preceding steps: 33.3 plus 25 plus 11.1 is 69.4. Leave B set to 10, C set to 100 and set 69.4 on D. Adjust A for null. The result on A is 14.4. This is the answer since the numerator-scale multiplier cancelled out the denominator-scale multiplier. Incidentally, I obtained 14.2 as the final answer on my calculator. If you're careless along the way, you may get much further off.

Here's another pointer on getting accuracy. Adjust for a close null. Alternately press and release S2 in getting the fine null to be sure that there's no movement of the meter needle in going from one switch position to the other. If you use a 0-1-ma meter for a null indicator, you can increase the null sensitivity by boosting battery voltage to 6 (four flashlight batteries in series) or by providing a transistor amplifier for the meter.

Once you get the hang of using the calculator with formula (2) (which I used in most of the illustrative problems), explore formula (1) and the formula AD = CD. With a little bit of thought and practice, you can do a lot with this calculator. And you'll increase your skill with mathematics too. END

SQUELCH WITHOUT TUBES

By R. L. SHAUM, W5HEO*

HERE is a way to add a relay squelch circuit to almost any receiver without adding another vacuum tube to amplify the AVC voltage. No additional tube is needed if the first audio amplifier is used as a dc amplifier in addition to its normal audio function.

Fig. 1 shows a conventional first audio amplifier stage. It normally draws about 1.5-ma plate current. Fig. 2 shows that plate load resistor R2 has been changed from 100,000 to 47,000 ohms. This almost doubles the tube's class-A current so a 2-ma relay may be reliably closed. The relay is placed in series with the plate load resistor, where it becomes a part of the power supply decoupling network consisting of R3 and C2.

Because relays usually close at a particular current and remain closed even when the current is reduced to some fraction of its original value, something must be done to keep the squelch from locking on threshold signals. For the 8,000-ohm relay shown, the closing current is 1.8 ma and the opening current 0.8 ma. A 10,000-ohm resistor placed across its coil will shunt nearly half of its current, so we place the resistor across the coil and through a set of normally open contacts on the relay. When the relay closes (at 1.8 ma), it shunts itself and reduces its coil current to 1 ma, or the threshold of opening. When plate current drops slightly, the relay opens, removes its shunt resistor and automatically becomes sensitive to closure again. This relay, then, operates over the small plate current range of 1.7 to 1.8 ma.

In Fig. 2, if the grid is grounded, as it is when no signal is being applied, the bias developed through R4 and R5 will allow only about 1.5 ma of plate current to flow. If the relay is open, the current is insufficient to close it. On the other hand, if the relay was previously closed, the shunt resistor would reduce relay current to less than 0.8 ma, and it opens anyway.

The 0.1-ma differential plate current represents a plate-voltage variation of about 5 volts. It is not enough to change the operating point of the amplifier appreciably, but this operating point could be disturbed by the

incoming direct-current switching signal. Even if AVC is used, the voltage may be in the order of 50 to 60. D3, which clamps the grid return to the junction of R4 and R5, limits the switching voltage. The bottom of R4 is the normal grid-return point, and it therefore represents the proper class-A amplifier bias setting. Thus the switching signal cannot saturate the tube and cause audio distortion.

The squelch action occurs when the switching signal from the voltage doubler (consisting of C5, C6 and diodes D1 and D2) drops to about 6 volts. When this happens, the relay opens, and a second set of its contacts switches the grid coupling capacitor C1 from the audio source to ground, with resultant silence. When an incoming carrier causes the voltage across C4 to rise to about 12, the relay closes and applies audio to the grid again. This function, of course, could as easily be in the speaker circuit.

There are ways to improve the squelch circuit, but for various reasons they were found to be undesirable. For example, a 12- to 15-volt Zener diode could be substituted for R5 to produce higher dc gain, but Zener diodes are still somewhat expensive. The dc gain at R5 can be maintained by adding a resistor from R5 to B-plus so about 15

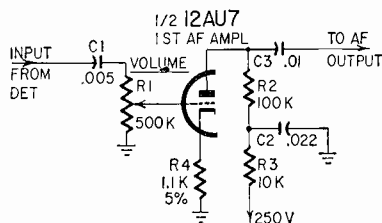
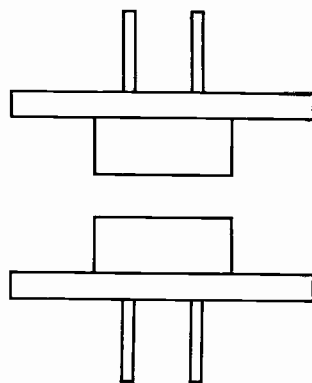

Fig. 1—A conventional first audio amplifier.

volts of bias is developed, but the voltage divider would drain 3 to 5 ma, and this may not be desirable if you have a marginal power supply. Fig. 3 shows this system.

Some precautions must be taken to assure best results from the squelch circuit. The receiver should have delayed AVC. Fig. 4 illustrates a simple way to get it. The bias arrangement of Fig. 2 may not have the desired voltage stability, so it would be preferable to



use that of Fig. 3. If audio is heard when the relay is open, there is a good possibility that C4 is not large enough; but if C4 is made too large it will slow down the response of the relay. Actually, a little audio can be reassuring to the listener. If it is annoying, it would be better to switch the audio at the plate or speaker output. If you have trouble making the relay cut off, check D3 because, if it is leaky in the reverse direction, it will tend to keep the tube biased on.

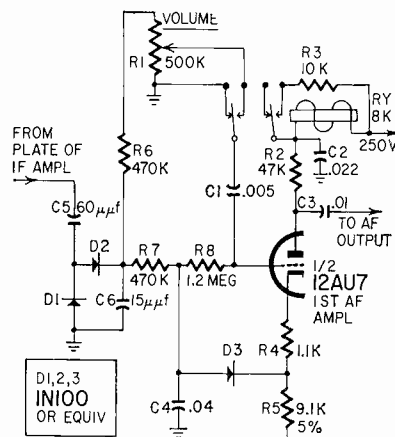

- R1—pot, 500,000 ohms
- R2—47,000 ohms
- R3—10,000 ohms
- R4—1,100 ohms, 5%
- R5—9,100 ohms, 5%
- R6, 7—470,000 ohms
- R8—1.2 megohms
- All resistors 10%, 1/2 watt unless noted
- C1—.005 μf
- C2—.022 μf
- C3—.01 μf
- C4—.04 μf
- C5—60 μf ceramic
- C6—15 μf ceramic
- D1, 2, 3—1N100 or equivalent
- D2, 3—8,000 ohms, dpdt

Fig. 2—Audio amplifier with squelch components.

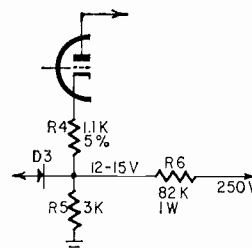
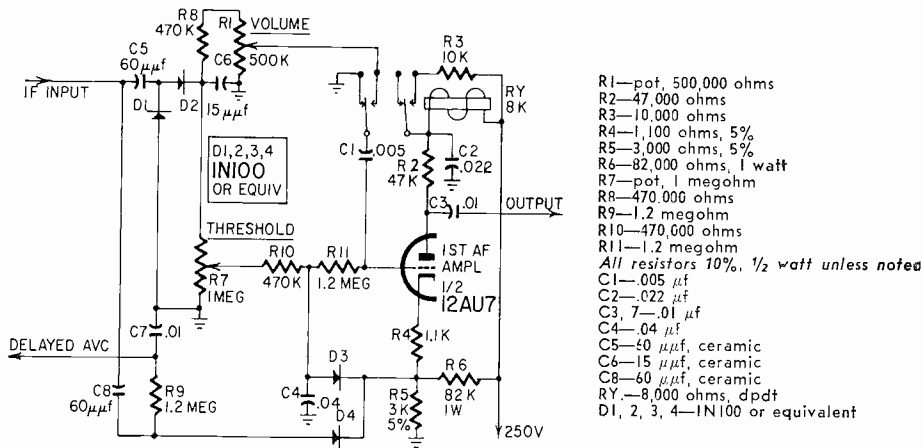

Fig. 3—Using a voltage divider for bias.

* Sandia Corp.



Threshold control is best achieved by the rf gain control, since this way it is not necessary to add a hole to the receiver panel. Otherwise, the circuit of Fig. 4 is suitable. But, if it is necessary to cut a hole, you should try to get the maximum benefit from R7 and use it for an rf gain control. This is especially true in noisy areas when you are using delayed avc, because the

squelch circuit will open long before the avc circuit begins to work. This insures maximum signal-to-noise performance.

The circuits shown were tested on an Hammarlund SP-600-J receiver (Super Pro), but there is no reason to believe they won't work elsewhere. Another application of this circuit might be found in a Conelrad alarm system. **END**

CITIZENS HAMMING UP STATUS OF CITIZENS BAND

A very large proportion of Citizen's band licensees are abusing the privileges granted them, according to recent reports on 11-meter activity. These newcomers to two-way radio are cluttering up the band with straight rag-chewing, according to long-time hams who have taken to the new service for industrial or personal short-hop communications.

Most of the newcomers go through the formality of calling specific friends, though some call CQ openly, but then they discuss equipment, antennas, output stages—everything radio amateurs have always talked about.

There's nothing wrong with this sort of activity—in the ham bands. But the class-D radio service was opened up by the FCC specifically to provide a band for *communicating*, sending messages from one point to another, not for the advancement of radio through technical experimental development, "not as a hobby in itself." The FCC states that it did not "intend to parallel the activities of the presently operating ham bands."

William D. Johnson, engineer in charge of FCC's District 2 Field Engineering and Monitoring Div., says, "People who have the right and the real need to work in this band are being crowded out by 'users' who operate improperly." He said that FCC offices are putting additional men on monitoring work, and that some men have even been working overtime voluntarily at some of the almost 50 FCC primary and secondary monitoring stations and enforcement offices around the country.

Citizens-band self-policing clubs are

springing up, and are being encouraged by the Commission. They are already performing valuable service, sending in evidence on improper and unlicensed operation.

A substantial number of license holders have received citations for rag-chewing, overpower (maximum is 5 watts) and other improper operation. FCC officials state definitely that repeated offenders will have their tickets rescinded.

It has been pointed out that the FCC originally envisioned Citizens radio primarily as a way for individuals and companies to set up intercommunicating systems, though no prohibition against talking to stations in other systems was intended, so long as it was for getting messages through to specific people. For example, a taxicab company may have 25 transmitters, each of which talks only to other members of the system. Another system may be a TV service dealer who has two trucks out on calls, with a total of only three transmitters in his system. The members of these two systems may talk to each other to *carry a message*. But they may not "ham" back and forth, chewing the rag or experimenting to see how far away they can receive each other.

It is to be hoped that self-policing will work out in the Citizens band. If it doesn't, legitimate users of the band may go elsewhere, and the FCC would then likely take the band away from the licensees remaining, since they belong in the amateur frequencies. They would then be forced to study and get regular amateur licenses, or to go off the air entirely. **END**

NEXT MONTH

Transistor Reflex Pocket Radio

Here's a tiny set almost anyone can build. Its circuit is simple and the reception excellent. Build one for yourself and see just how good a modern all-transistor reflex receiver can be.

Modern Industrial Oscillographs

You can put more than 30 simultaneous traces on an *oscillograph*, while 5 will crowd the service technician's oscilloscope screen. Learn where this important industrial instrument is used, how it works and how to work with it.

How Air Ionizers Work

Medical studies show that negatively ionized air tends to promote good health. The air is ionized with a piece of electronic equipment the service technician may be called on to check or repair. It's really simple—find out for yourself.

Servicing Horizontal Output Stages

This is one of the toughest parts of a TV receiver. Proper servicing techniques are a must. If you have trouble repairing horizontal output circuits you may pick up some time- and trouble-saving information.

ALL-TRANSISTOR FM-AM PORTABLE

First US-made receiver uses 11 transistors and 3 diodes to put FM in a carry-it-with-you package

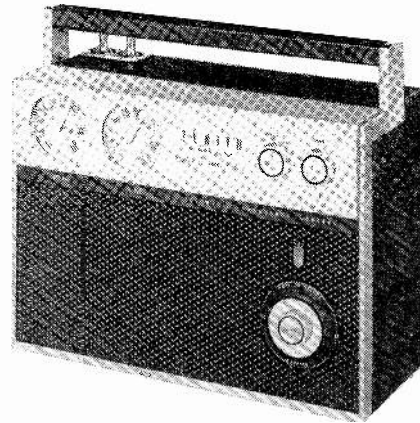

ONE of the first FM-AM all-transistor receivers to reach the United States was the Sony TFM-151. A later model, the TFM-121, was described by Robert F. Scott in the April issue. Now the first American-made unit has been released. It is the Zenith Royal 2000.

This set is an 11-transistor portable, powered by eight D-cells which are good for some 300 hours of listening. Audio output from a 5 x 7-inch speaker is $\frac{1}{2}$ watt undistorted. The whole works is assembled into an 11 $\frac{1}{2}$ x 8 x 4 $\frac{3}{4}$ -inch package that weighs 11 $\frac{3}{4}$ pounds.

The set's vital statistics are:

FM	
Sensitivity (50 mw above noise)	4-9 μ v
(30 db quieting)	8-13 μ v
Second channel interference ratio	
(110- μ v input)	37 db
Image rejection	40 db
If rejection	55 db
AM	
Sensitivity	
(50 mw above noise)	9-12 μ v/meter
(20 db signal/noise ratio)	50-80 μ v/meter
Image rejection	77 db
If rejection	60-95 db

To increase the set's usefulness, Zenith has included a phono jack that permits using the unit as an FM tuner feeding a hi-fi system or a phono amplifier for crystal or ceramic phono cartridges. More on this feature later.

FM operation

The set picks up an FM signal with either its built-in collapsible dipole, its built-in capacitance antenna, or an external antenna (see schematic and inside photo). This signal is fed to the rf amplifier, a common-base arrangement, which is used to avoid the necessity of neutralizing a common-emitter stage. For the same reason, both the mixer and oscillator are also common-base configurations.

Next comes the 10.7-mc if strip. Three if amplifiers are used—all neutralized common-emitter amplifiers. Note the double transformers in the first and second if stages. These are used for both FM and AM. The third if stage is not used for AM.

A ratio detector incorporating two point-contact diodes separates the audio. One of these diodes also provides the agc voltage which is applied to the base of the first if amplifier. Agc is also fed to the rf amplifier and mixer. This is tapped off the first if amplifier's emitter.

Another tap off the ratio detector supplies afc information to the afc stage. The tuning element of this stage is the afc transistor's collector-base capacitance. The transistor is set up as a dc amplifier with its base and emitter bypassed for 10.7 mc. An afc off position lets the user listen to a weak station whose channel is adjacent to a strong one. The extreme lock-in range of the afc is about 800 kc at 500 μ v.

AM operation

Except for the third if amplifier and the afc transistor (not used during AM operation), circuit operation remains about the same. Of course, tuned circuits are switched when we go from AM to FM operation. Also, when we go to AM reception, the rf amplifier is switched from common-base to common-emitter operation. This is needed to get a satisfactory noise figure for AM listening. The ferrite-coil AM antenna is in the set's carrying handle.

The radio detector diodes are not

used as the AM detector. A separate diode, in the third if transformer can, is used. Agc is taken off this diode too, and is fed back to the agc-controlled stage as in the FM agc system.

Audio circuits

The audio stages are, of course, common to both AM and FM. They include one interesting feature—a phono jack and switch arranged so the radio can be used as tuner for a hi-fi system (by disconnecting the audio amplifier and feeding the ratio detector's output to the external audio equipment) or as a phono amplifier (for portable recorder use or as the second-channel amplifier in a stereo system).

The first audio amplifier is a common-emitter stage that powers a common-emitter driver. The tone control is between these two stages and regulates both bass and treble response. About 10 db of negative feedback is taken from the voice-coil winding on the power transformer and applied to the driver's emitter.

END

Inside the portable. The various antennas are pointed out.

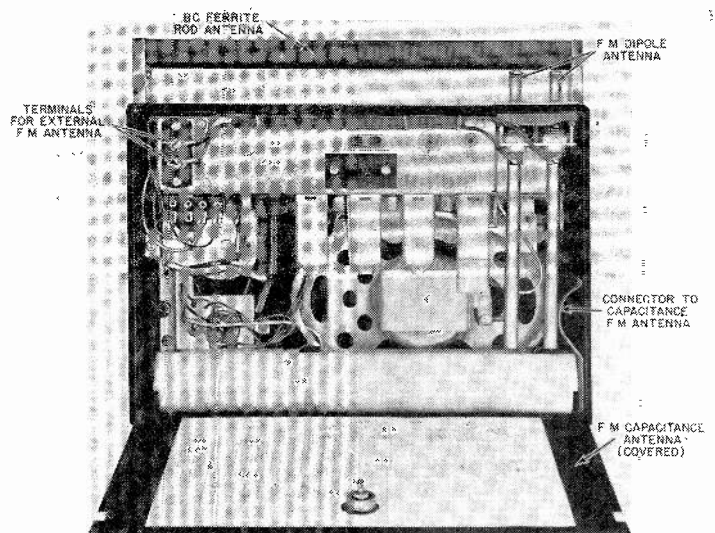

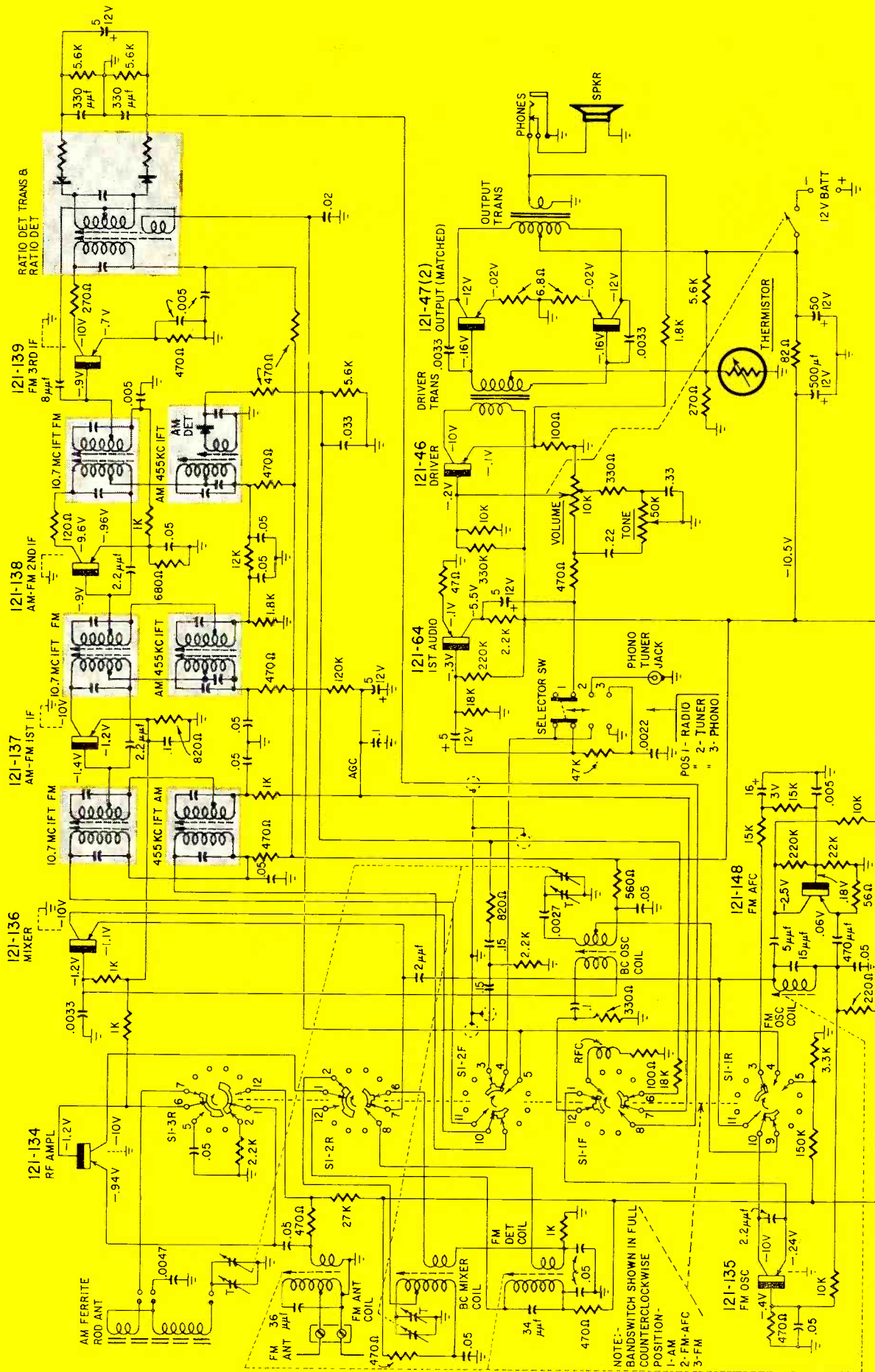

Circuit of the 11-transistor receiver.



Presents 18 New Kits for

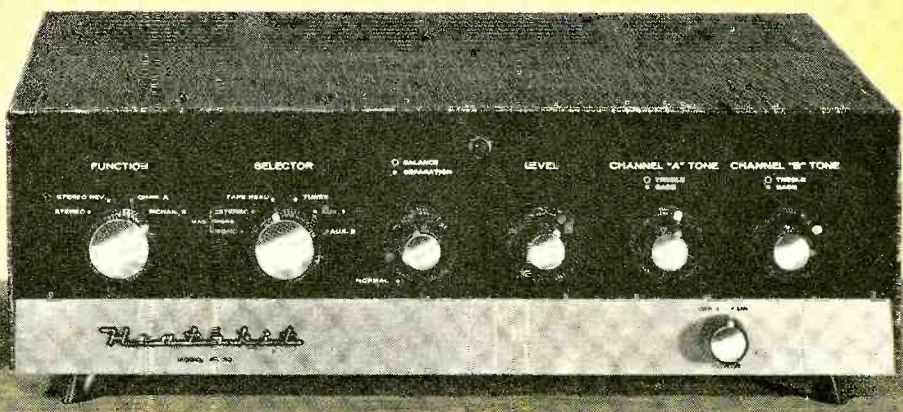
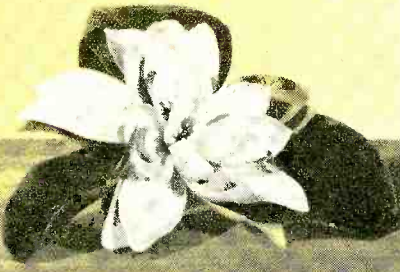
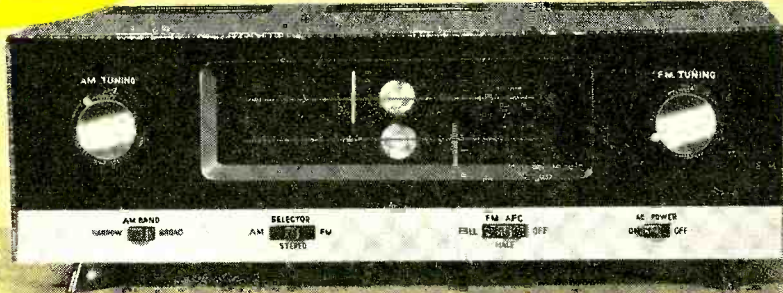

GO STEREO IN STYLE . . . WITH HEATHKIT® QUALITY AND ECONOMY!

ECONOMY STEREO AM/FM TUNER KIT (AJ-10)

Full fidelity AM and FM reception, plus up-to-the-minute design features are yours at minimum cost with this new Heathkit stereo tuner. Features include: 2.5 uv. sensitivity for 20 db of quieting; individual flywheel tuning; separate magic-eye tuning indicators for AM and FM; AM bandwidth switch; 3-position (off-half-full) automatic frequency control (AFC); FM multiplex adapter output; built-in FM rod antenna; terminals for external AM and FM antennas; "AM," "STEREO" and "FM" function selector switch. 14 lbs.

\$59.95
AJ-10
 \$6.00 dn., \$6.00 mo.

HI-FI RATED 25/25 WATT STEREO AMPLIFIER KIT (AA-50)

In one handsome package, you get both stereo power and control, with a host of deluxe features. Hi-fi rated at 25 watts per stereo channel (50 watts monophonic), this new Heathkit design includes channel separation control . . . new mixed center speaker output . . . stereo reverse and balance controls . . . separate tone controls for each channel with ganged volume controls . . . five switch-selected inputs for each channel (stereo "mag. phono," tape head, three hi-level). Extra input for mono "mag. phono." Special outputs for tape recording. 30 lbs.

\$79.95
AA-50
 \$8.00 dn., \$8.00 mo.

YOUR "BEST BUY" IS HEATHKIT® HI-FI!

FREE CATALOG
 Send for your copy today! . . . describes over 150 Heathkit hi-fi, ham radio, test, marine and general products.



STEREO/MONO RECORD PLAYER KIT
 Four speeds (16, 33 1/3, 45 and 78 RPM); Sonotone 8T.A4-SD ceramic stereo cartridge. 10 lbs.
AD-10 \$33.95

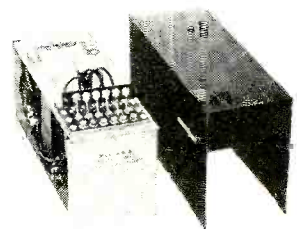

MIXED LOWS STEREO CROSSOVER KIT
 Delivers stereo bass frequencies to single woofer; highs to individual wing speakers. 10 lbs.
AN-10 \$19.95

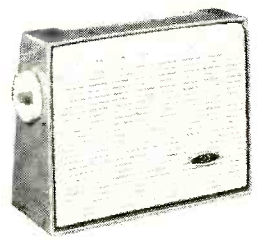

TRANSISTOR PORTABLE KIT
 Tremendous value: 6-transistor circuits. Fun to build!
XR-2P (plastic)
 6 lbs. **\$29.95**

Just 10% DOWN ON ORDERS OF \$55 OR MORE!

Your Summertime Enjoyment

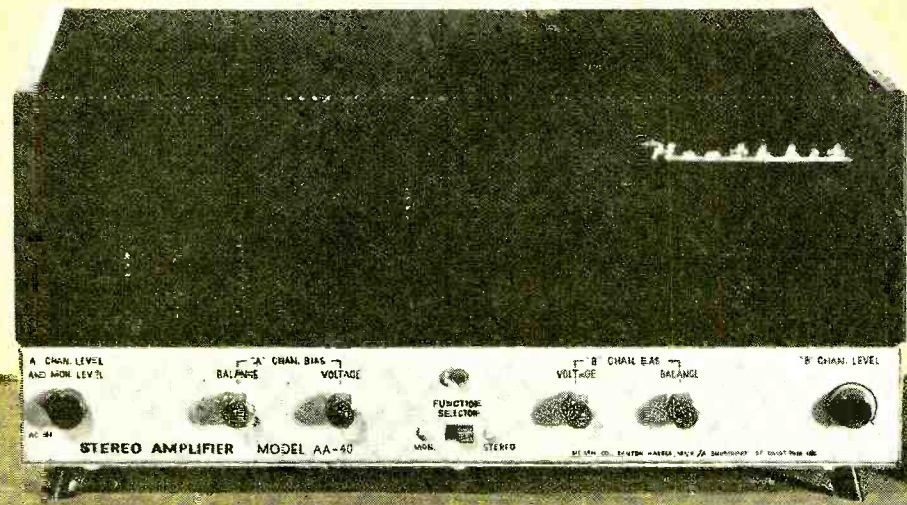
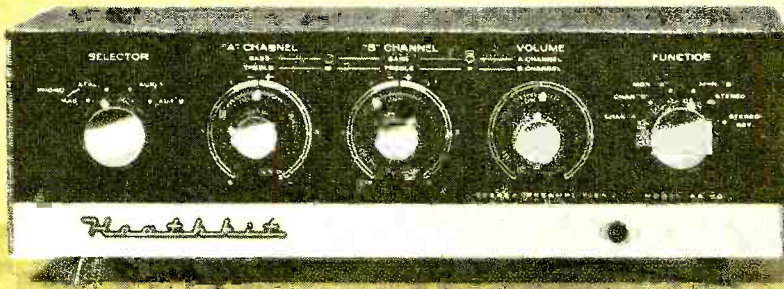

HEATHKIT® . . . FOR FLEXIBILITY and COMPATIBILITY!

ECONOMY STEREO PREAMPLIFIER KIT (AA-20)

A low-cost, versatile stereo preamplifier control center. Four inputs each channel accept magnetic cartridge; crystal or ceramic cartridge; and tuner, tape, TV, etc. Six position function switch gives flexible stereo or monophonic use. Features cathode follower outputs plus hi-level outputs for tape recorder drive, calibrated Baxandall-type tone controls for each channel, clutch-type volume controls, filament balance controls, and accessory AC sockets. Self-powered. Styled in black and gold. Shpg. wt. 8 lbs.

\$34.95
AA-20

PROFESSIONAL RATED 35/35 WATT BASIC AMPLIFIER KIT (AA-40)

Doubles as a superb dual 35 watt stereo amplifier or a full-fledged 70 watt monophonic amplifier. Features: mixed-channel center speaker output; individual level controls; "Stereo-Mono" switch (ties both amplifiers to one level control for monophonic use); dual outputs for 4, 8, 16 and 32 ohm speakers. Paralleling outputs for 70 watt monophonic use matches 2, 4, 8 and 16 ohm speakers. 41 lbs.

\$79.95
AA-40
\$8.00 dn., \$8.00 mo.

Now . . . a complete Mobile PA Sound System in easy-to-build, HEATHKIT® form!

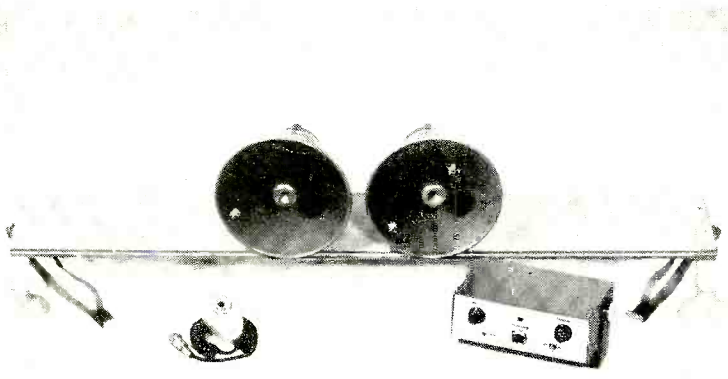

MOBILE PA SOUND SYSTEM

Perfect for political campaigns, advertising, sporting events. The powerful amplifier operates from any 12 v. car battery. Features an all-transistor circuit; inputs for microphone and music source. Two channel mixing circuit "fades" auxiliary input when used with microphone supplied . . . lets you override music with voice without changing control settings. Outputs for 8 and 16 ohm speakers. Mounts easily under auto dash. Mobile PA Amplifier Kit (AA-80). 7 lbs. . . . **\$39.95**

COMMERCIAL SOUND SYSTEM (CSS-1): consists of AA-80 Amplifier; microphone; plywood car-top carrier; one 16 ohm, 15 watt outdoor speaker. 24 lbs. . . . **\$84.95**

COMMERCIAL SOUND SYSTEM (CSS-2): same as above except with 2 speakers. 30 lbs. . . . **\$99.95**

EXTRA HORN SPEAKERS (401-38): As described above. 6 lbs. . . . **\$19.95**

SAVE 50% . . . ON THE WORLD'S BEST QUALITY KITS!



First... With The Finest

a subsidiary of
DAYSTROM, INCORPORATED



Buy The Best in Quality At Half the Cost With Heath

CITIZENS BAND TRANSCEIVER KIT (GW-10 Series)

Superb 2-way Citizens Band communication! Superheterodyne receiver may be switched to crystal control or continuous tuning. Featured are an automatic "series gate" noise limiter, to minimize ignition interference, etc.; and adjustable squelch control to silence receiver during "standby." Press-to-talk microphone features a coil-cord connection to the transceiver. Transmitter is crystal controlled on any one of 23 assigned channel frequencies chosen. Order model GW-10A for 117 v. AC operation, and GW-10D for 6 or 12 v. DC operation; both have self-contained power supply. 11 lbs.

GW-10A (117v. AC) or **GW-10D** (6 or 12v. DC) **\$62.95** ea.
\$6.30 dn., \$6.00 mo.

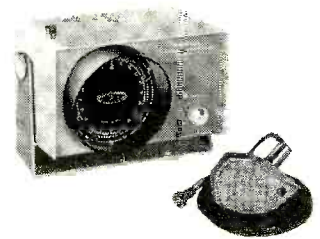

TRANSISTOR DEPTH SOUNDER KIT

Shows depth, type of bottom and submerged objects from 0-100 feet. Powered by 6 flashlight cells. 10 lbs.
DS-1 **\$69.95** (\$7 dn., \$7 mo.)

6 & 10 METER HAM TRANSCEIVER KITS

Combined crystal controlled transmitters and variable tuned receivers. Operate fixed or mobile. 10 lbs.
HW-19 (10 meters) **\$39.95** ea.
HW-29 (6 meters) (less XTAL)

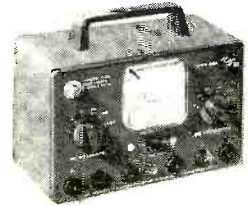

3-BAND "MARINER" TRANSISTOR DIRECTION FINDER KIT (DF-3)

Priced far below pre-assembled units of comparable quality, the DF-3 includes such important features as: 9-transistor circuit; 6 flashlight battery power supply; pre-assembled, pre-aligned tuning section; new modern styling; rugged aluminum splash-proof cabinet. Covers broadcast band, beacon and aeronautical band, and marine-telephone band. Special "sense" antenna eliminates "double null" effect common in many direction finders. Circuit has high gain IF amplifier and audio output amplifier delivering up to 380 mw of audio power to the large 4" x 6" weatherproof speaker. 13 lbs.

\$99.95
DF-3
\$10.00 dn., \$9.00 mo.

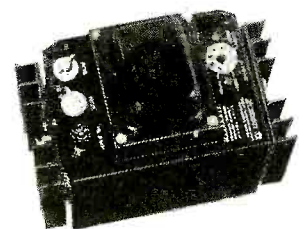

TRANSISTOR MOBILE POWER SUPPLY

All-transistor! Provides plate, screen and bias voltages for mobile amateur equipment. 120 watts ICAS. 10 lbs.
HP-10 **\$44.95**

EDUCATIONAL KIT

First of a series . . . designed to teach, as you build, the basic "yardsticks" of electronics. Consists of kit and text-workbook. Finished volt-ohm-milliammeter has many uses. 4 lbs. **EK-1** **\$19.95**

TIME PAYMENTS!
Use Heath's convenient time payment plan . . . only 10% down on orders of \$55 or more.

in Easy-to-Build Electronic Kits



MUTUAL CONDUCTANCE TUBE TESTER KIT (TT-1)

An impressive list of electronic and mechanical features make this tube tester one of the finest values in the electronics industry. Tests Gm (amplifiers) from 0 to 24,000 micromhos, Emission, Leakage, Grid Current ($\frac{1}{4}$ microampere sensitivity), Voltage Regulators (built-in variable DC power supply), Low Power Thyatron and Eye tubes. Features 300, 450 and 600 ma constant current heater supplies, Life Test, Hybrid Tube test, built-in switch-operated calibration circuit. Large, easy-to-meter. Constant tension, free rolling illuminated chart. Kit includes 7 wiring harnesses. Assembly skill of technician or higher recommended; assembly time, 40 hours average. Black leatherette case with white trim, nylon feet, removable top. A specialized tool of unusual value that will pay for itself many times over! 27 lbs.

TT-1 **\$134⁹⁵**
 (\$13.50 dn., \$12.00 mo.)

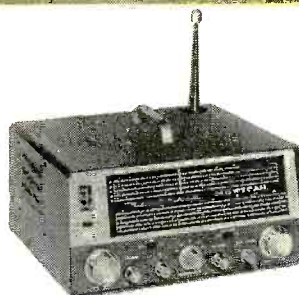

WORLD-WIDE, ALL BAND RADIO RECEPTION

- Ceramic IF "Transfilters"
- Five Bands
- Flashlight battery power

10 TRANSISTOR "MOHICAN" GENERAL COVERAGE RECEIVER KIT

First kit of its kind uses ceramic IF "Transfilters." Covers 550 to 30 mc on 5 bands, with 5 separately calibrated bands to cover amateur frequencies (including 11 meter citizens band). Powered by 8 flashlight batteries.

Built-in 54" whip antenna, tuning meter, headphone jack. (less batteries) 20 lbs.) **GC-1** **\$109⁹⁵**
 \$11.00 dn., \$10.00 mo.



send today for Your FREE HEATHKIT® CATALOG

Over 150 items of hi-fi, marine, amateur, test and general equipment are illustrated and described in the complete Heathkit catalog.

HEATH COMPANY, Benton Harbor 20, Michigan

Please send the following HEATHKITS:

ITEM	MODEL NO.	PRICE

Ship via () Parcel Post () Express () COD () Best Way

() SEND MY FREE COPY OF YOUR COMPLETE CATALOG

Name _____

Address _____

City _____ Zone _____ State _____

B Dealer and export prices slightly higher.

RADIO

If you are looking for a diminutive transistor receiver that is about the ultimate in economy and power consumption, this set is the answer.

As for the simple circuitry, try to beat it. It uses two transistors, a tuned circuit and a cheap battery. No resistors and no coupling capacitors are used. Hardware consists of a plastic box $2\frac{1}{2} \times 1\frac{1}{2} \times \frac{1}{2}$ inches. If you want to be foolishly lavish, add two miniature jacks, and you are in business.

Easy single-control thumb tuning, no tricky feedback arrangement, absolutely noncritical circuit and assembly and good audio quality. Sounds attractive? Okay, here we go.

The circuit is shown in Fig. 1. The input is made up of a slug-adjusted broadcast-band coil tuned by a miniature polyethylene-insulated variable capacitor. A tap on the coil is directly connected to the base of the first transistor, a 2N229 mounted in a common-emitter detector circuit. Its collector is direct-coupled to the base of the second transistor, a 2N107 used as an audio amplifier in a common-emitter circuit. The output signal is taken between the collector and the negative side of the 5.5-volt battery.

The trick lies in the choice of transistors. Besides being about the cheapest types available, one of the three-legged critters is an n-p-n while the other is a p-n-p. This allows the direct cascading used in the circuit, the first transistor being fed by the base current of the second one, and at the same time providing a base circuit return.

A medium-impedance headset is connected to the output. The best impedance is somewhere between 1,000 and 5,000 ohms, and any value in this range will be suitable.

The tuned input circuit is connected to ground and antenna terminals. Any pipe, faucet, central heating system, etc. makes a suitable ground. Though not absolutely necessary, a good ground improves reception.

The antenna determines the set's sensitivity and selectivity. For good sensitivity, it should be long, but this makes for poor selectivity. Local conditions dictate the best compromise. In Pittsburgh, a legitimate antenna some 25 feet long, a 10-foot length of wire dangling out of the window and a box bedspring in a nonmetallic building have been used with good results. The half-dozen local stations were received with sufficient selectivity and loud-speaker volume. If a decent radio antenna is available, chances are it will be too good. It can then be connected to the tap on the coil, or a small capacitor, (10 to 100 μf) can be inserted between antenna and receiver to reduce coupling.

Adjusting the inductance is easy. Choose one of the local stations near the edge or the center of the broadcast band, set the variable capacitor to the approximately corresponding position, and adjust the inductance slug until the station is heard. Then clip off the excess

MATCHBOX RADIO

This "radio with no parts" uses nothing more than two transistors, a variable capacitor, an antenna coil and a battery

By A. V. J. MARTIN

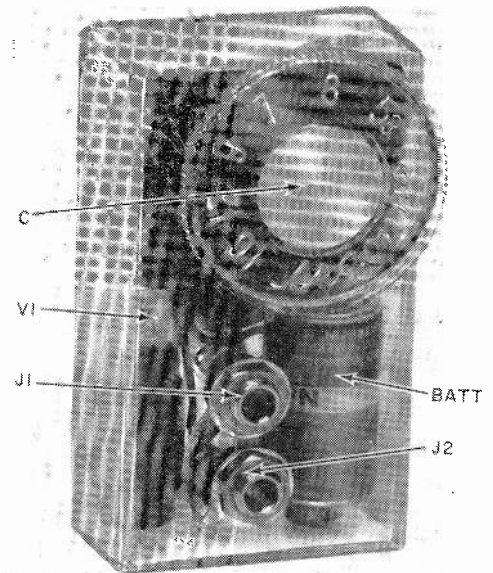

(Right) The completed receiver in its tiny case. The two phone jacks are optional extras.

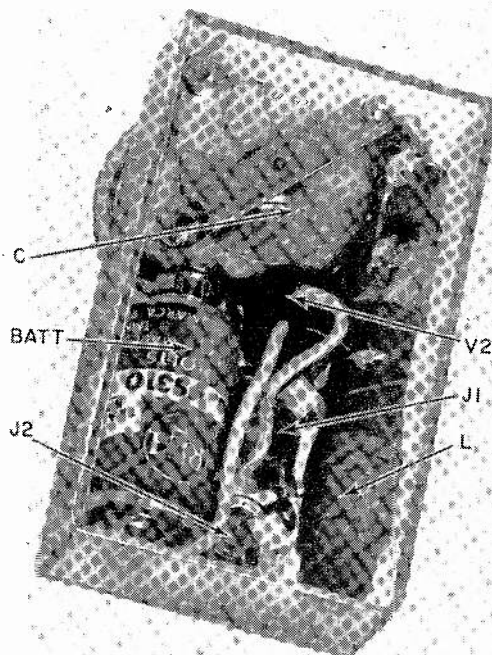

(Left) Back view reveals parts layout.

A member of the staff of RADIO-ELECTRONICS tried out the matchbox receiver on a good antenna about 25 miles from New York City. Six stations were received with excellent headphone volume. Selectivity was notably better than with many small transistor receivers. No attempt was made to use the set with a speaker—from the headphone level it was apparent that the majority of the stations received would not operate a speaker.

BENCH



TESTED

RADIO

length of the adjusting screw so the coil can fit into the box.

Build one for yourself

The photographs give a good idea of the parts layout. The small size of the box might seem to make things difficult, but not if the proper sequence of operations is followed. First, drill the hole for the variable capacitor, so the unit just fits in the corner of the box.

The receiver should be entirely assembled out of the box. Solder the metal cap of the coil to the capacitor lug. Connect the tuned circuit. Then, using cellophane tape, fasten the two transistors against the coil. Now connect the transistors, leaving the output connection (second transistor's collector) free for the time being. Connect the battery clips with two 1-inch lengths of flexible insulated wire. Insert the battery and connect a headset to the output collector. You should hear a click. Touch the tuning capacitor's stator lug with a screwdriver. Noise should be heard in the headset. Connect antenna and ground to the input circuit, and local stations will pour in. Adjust inductance and cut off excess screw length as previously described. Disconnect the battery and insert the receiver in its box. Slip the battery into place. It should slip in and out easily and is held by its connecting wires. In the empty space between battery and coil, I added two miniature jacks, one

for phones, the other for antenna and ground. If you want to follow suit, mark the position of the jacks with a sharp point after fitting them in the empty space. Empty the box, drill the holes, mount the two jacks and put the receiver back in the box.

The output jack is wired so the battery is connected only when a plug is pushed into the jack.

Be careful handling the soldering iron inside the box. The plastic melts

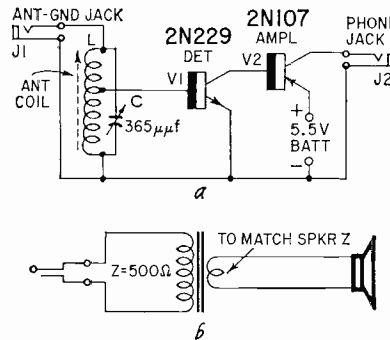

BATT—5.5 volts (RCA VS310 or equivalent)
 C—tuning capacitor with dial, 365 μf
 (Lafayette 445 or equivalent)
 J1, J2—phone jacks
 L—antenna coil (Lafayette MS-299 or equivalent)
 V1—2N229
 V2—2N107
 Plastic case, 2 1/2 x 1 1/2 x 1/2 inches

Fig. 1—*a*—Circuit of the simple receiver; *b*—if you use a speaker, don't forget to add an output transformer.

so easily that it would flow over the table if Brigitte Bardot happened to look at it.

When inserting the battery, respect the orientation indicated so you won't have to worry about accidental contact with the capacitor. Another word of caution is in order: When you connect the battery, respect the polarity indicated. An error will cost you at least one transistor.

For the experimentally minded, a few variations can be tried. To begin with, a lot of spare room is available in the box. Another transistor might be added, but when I tried it, we got so little improvement that the idea was dropped.

Of course, any sensible way of connecting the antenna, ground, and headset or speaker can be used. I tried some subminiature plugs fastened to the box, and ran into trouble when soldering.

A ferrite-core antenna coil could be used and would do away with the antenna system, at least on local stations. I did not try this since no suitable coil was available. Another experiment might be to wind a fine wire coil on the sides of the box and use it as an antenna instead of the internal coil. A good coat of varnish should protect this winding. A similar idea would be to use the back of the box and wind a flat loop antenna, using polystyrene coil dope to hold it in place.

Some sort of whip antenna could be plugged into the antenna jack. END

YOU CAN ALSO DO THE BIG JOBS WITH WIZARDS

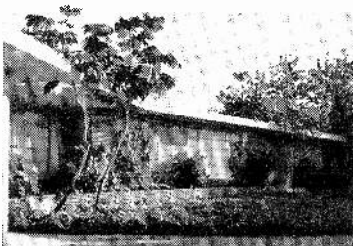

HOME—7 Outlets—One Antenna—No Amplification: Residence of Bob Barker, MC of the popular daytime NBC show Truth Or Consequences.



HOTEL—120 Outlets—One Antenna—One Amplifier: The Montecito—6650 Franklin, Hollywood, California.

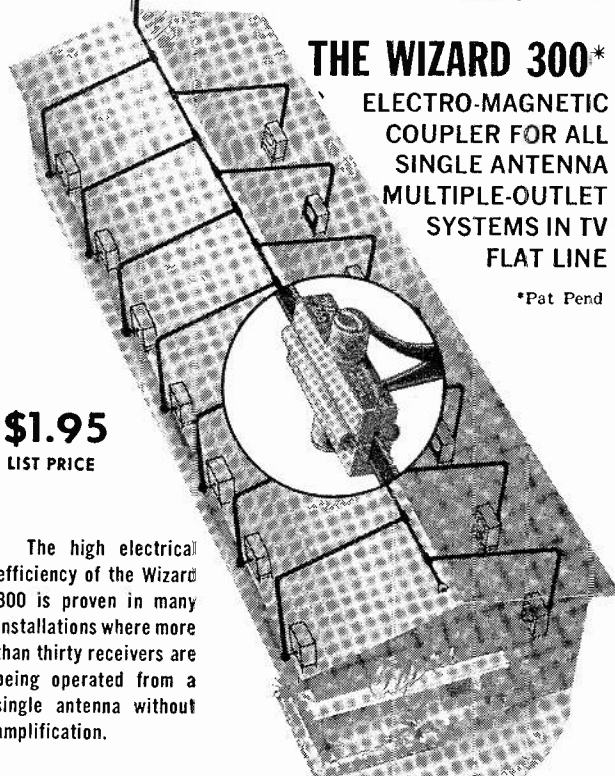

THE WIZARD 300*

ELECTRO-MAGNETIC COUPLER FOR ALL SINGLE ANTENNA MULTIPLE-OUTLET SYSTEMS IN TV FLAT LINE

*Pat Pend

\$1.95
LIST PRICE

The high electrical efficiency of the Wizard 300 is proven in many installations where more than thirty receivers are being operated from a single antenna without amplification.

Information on any of the above jobs and a brochure covering Wizard System installations is available. Write Dept. RE 129

CHARLES ENGINEERING, INC.
6053 Melrose Avenue • Los Angeles, California

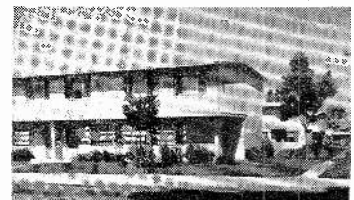

HOUSING PROJECT—2,549 Wizards Installed To Date: L.A. Housing Authority, Los Angeles, California.



APARTMENT—39 Outlets—One Antenna—No Amplification: The Del Rio—10236 Old River School Road, Downey, Calif

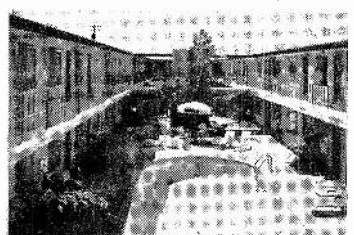

APARTMENT—48 Outlets—Two Antennas (24 Outlets each)—No Amplification: The Paramount Riviera—12447 Paramount Blvd., Downey, California.

RF STAGE BOOSTS SENSITIVITY

Regenerative rf stage has preset re-generation control for simpler tuning

By BELA FOLDI, KN1GLI

REGENERATIVE detectors are popular among novice hams because of their simplicity and low cost. But in such a stage, the tube's grid-cathode circuit acts like a diode rectifier in which current flows that loads the tuned circuit and ruins the high Q. Ruining the tuned circuit's Q kills the selectivity of the whole stage.

Since grid current varies with the

audio modulation, feedback depends on the momentary modulation. When a station is selected, feedback has to be adjusted according to the strength of its signal to prevent oscillation. For this reason, we cannot use all the regeneration without getting uncomfortable oscillation. Besides, two-knob tuning is difficult and not the most modern solution.

In my circuit (Fig. 1) the tuned circuit is electrically separated from the regenerative tube, so they do not influence each other. I do this economically by using a double triode 12AX7 or a triode-pentode 6U8. The first section (V1-a) is a cathode-follower amplifier which has a very low distortion, though its amplification factor is less than one. From cathode resistor R1 the rf goes

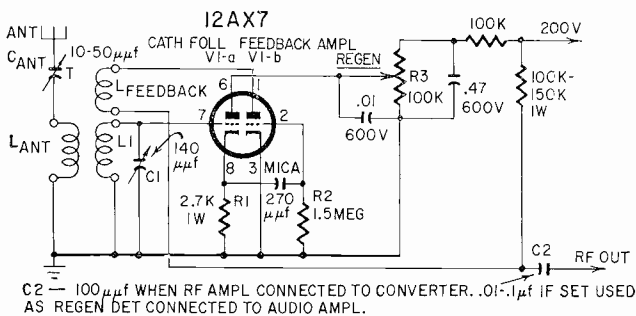

Fig. 1—Basic circuit of the simple rf stage.

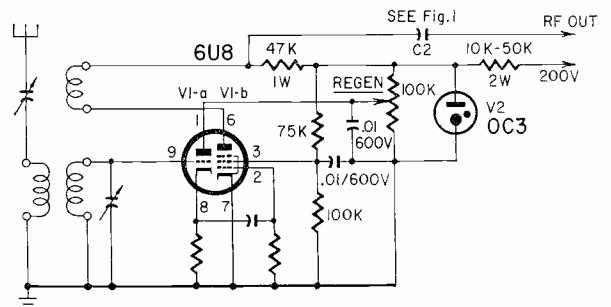
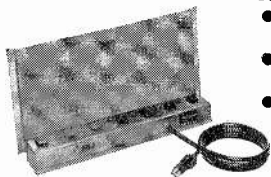

Fig. 2—Stability is increased by adding voltage regulator.

SPECIFY



For Master Antenna Systems



ANTENNA FILTER AND FILTER BASE

- Sharp Selectivity for Antenna Multiplexing
- Single Channel Prealignment Eliminates Field Adjustments
- TUG-PLUG* Quick-Disconnect Fittings and Built-In Connecting Cable Simplify Installation

Years of EXPERIENCE in the television transmission field, plus the MOST ADVANCED RESEARCH AND DEVELOPMENT FACILITIES have made ENTRON the watchword in quality, precision-built master television antenna equipment.

Modular design of the entire Entron system assures ease and rapidity of installation, inspection, and maintenance. Each component also features the Entron TUG-PLUG*, a revolutionary, time-saving, quick-disconnect fitting.

COMPLETE LINE OF OUTLETS IN ALL ATTENUATIONS FROM 10 TO 30 DB.

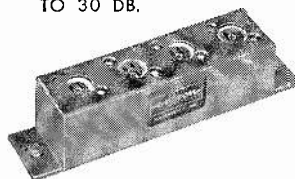

- Easily Installed—No Special Tools Required
- OP Series (Flush Mounting)—OB Series (Surface Mounting)
- DK Series with Two Outlets (Both Flush and Surface Mounting)
- New TUG-PLUG* Quick-Disconnect Fittings
- Response Flat from AM thru VHF TV Band

SA-23 AMPLIFIER

- High Power Output—High Gain
- 10,000 Hour, Type 6922 Tubes
- Long Life Silicon Rectifiers
- Separate Tilt and Gain Controls for Each Band
- New TUG-PLUG* Quick-Disconnect Fittings

Plug-in power splitters available to split signal 2 or 4 ways. Ask for ES-2 or ES-4.

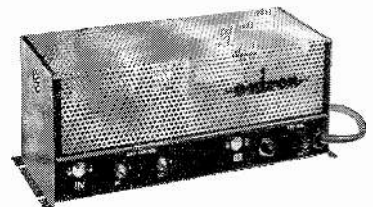

*Trade Mark

For further information, write or phone: **entron INCORPORATED** P. O. Box 287 Dept. A Bladensburg, Md. Phone: APpleton 7-9585

RADIO

to V1-b's grid. Its plate supplies feedback to the tuned circuit. So the feedback coil is electrically separated because V1-b's grid will not load V1-a's grid.

I used a potentiometer (R3) to adjust the feedback for maximum strength just before the whistle. Since I don't have to touch this pot once it is set, the rig appears as a one-hand tuning device. This is especially helpful when tuning in fading shortwave stations. Frequency coverage depends on the value of the tuned circuit (L1-C1).

Coils can be wound to cover whatever frequencies the user prefers. Those who have no experience in coil winding may make up an experimental set on 1¼-inch diameter forms (Amphenol 24-6P or equivalent). These are six-prong plug-ins. Wire can be No. 28 enamel-covered—or larger for the higher-frequency coils. The tickler (L_{feedback}) is closewound with No. 28 or smaller wire, spaced about ¼ inch from the ground end of L1. The antenna coil varies with the antenna. It may be from 2–12 turns, wound between the turns of L1 at the ground end. Winding data for the four experimental coils for 2–28 mc:

Coil 1—L1 5 turns, spaced to 1 inch; tickler 4 turns.

Coil 2—L1 10 turns, spaced to 1 inch; tickler 6 turns.

Coil 3—25 turns triple-spaced; tickler 8 turns.

Coil 4—50 turns double-spaced; tickler 12 turns.

Coils are wound double- and triple-spaced by winding with two or three wires, then stripping off the extra windings. If the circuit does not oscillate, reverse the feedback winding and try more turns. If you run into a dead spot (part of the tuning range over which the set will not regenerate) increase or decrease the antenna trimmer (C_{ant}) or reduce the antenna coil turns. The coils may be squeezed together or pulled apart to adjust inductance and the tickler may be slid closer to or farther away from L1 to change coupling. When the coils are adjusted right, paint them with thin coil cement (that's why it got its name) and let them dry. Then they will be completely stable. If they have all been adjusted with the pot in the same position, we can change from one band to the other with only a minimum adjustment of regeneration.

The device can be used as the first stage of a regenerative receiver or as a high-sensitivity rf stage in superheterodynes. In this case we have to tune L1-C1 in resonance with the superheterodyne's tuned antenna circuit. Note that we can expect more sensitivity and selectivity of this solution than from a regular two-tube rf amplifier.

The unit can also be used as a complete regenerative detector. Just hook a pair of phones to its output. If you couple the detector to an audio amplifier for speaker operation, use a .01–0.1- μf capacitor for C2. END

RCA needs experienced tech writers for Project BMEWS!

**Permanent positions
available at Riverton, N. J.**

BMEWS—The Ballistic Missile Early Warning System—needs exceptional technical writers *now* . . . men who can work closely with top-flight engineers in creating technical handbooks of descriptive theory and operating and maintenance instructions.

At RCA, technical writers have room to grow. Their knowledge and experience is supplemented and expanded through RCA's vast electronic experience and extensive facilities.

If you are a technical writer and experienced in radar, or digital circuitry, RCA is interested in you. This interest begins with top salaries and extends to the most liberal company benefits—including a tuition-loan refund plan to help you on your road to the top!

You'll be working in the new air-conditioned RCA Service Company offices at Riverton, N. J., just a few minutes from Philadelphia and a short hour's drive from seashore points. RCA will provide relocation assistance.

Today, send us a résumé, so that you can begin a rewarding career at RCA. Address your correspondence to:

**Mr. J. P. Thatcher, Empl. Mgr.
RCA Service Co., Dept. BM-14F
1908 Bannard Street
Riverton, New Jersey**



RCA SERVICE COMPANY

A Division of Radio Corporation of America

what's

new

?

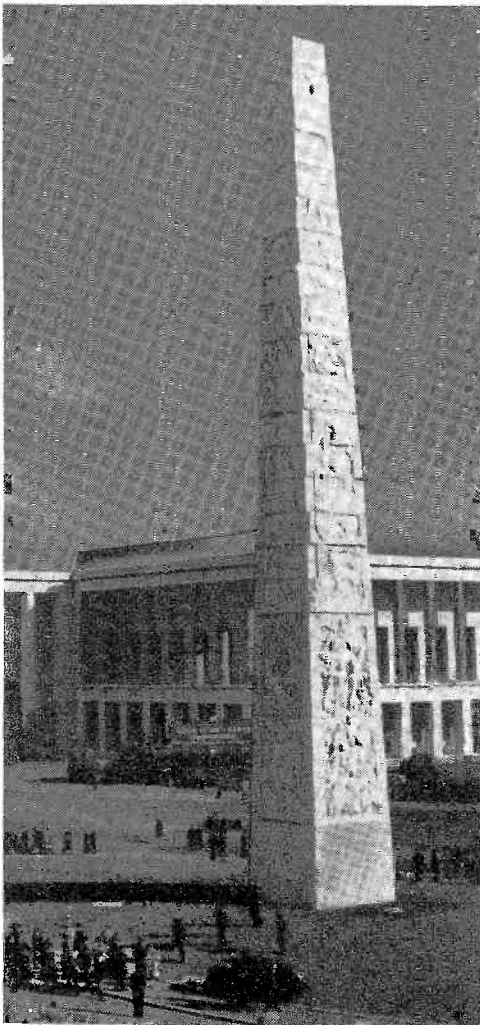

MARCONI ANTENNA is the name of this obelisk on the grounds of Permindex, the new world trade center in Rome. Bas-relief panels depict incidents in Marconi's life. A miniature gold obelisk and a diploma will be awarded yearly to the person contributing most to "the progress and development of the ideas and discoveries of Guglielmo Marconi, in any field of human endeavor."

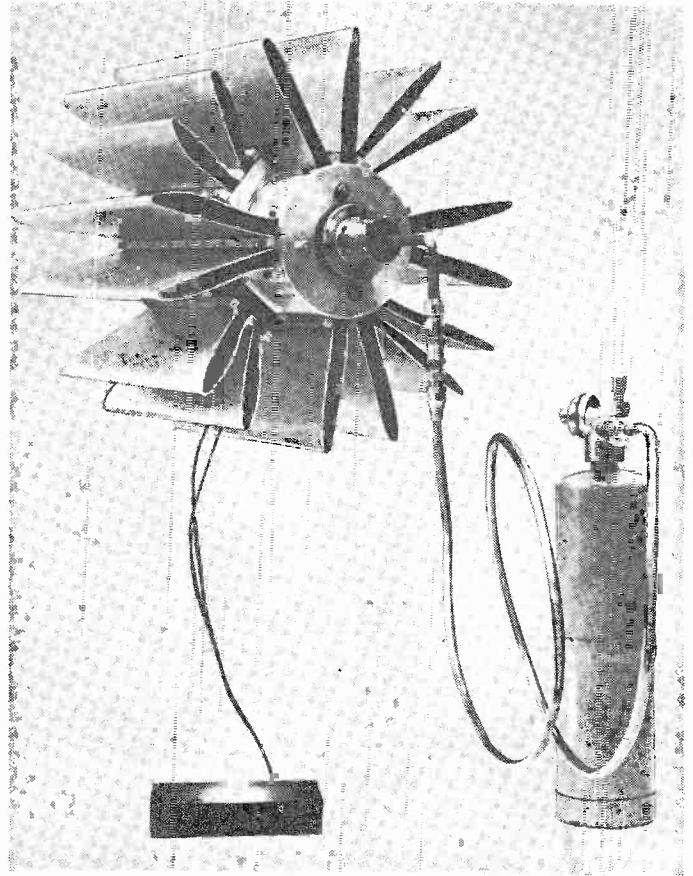

THERMOELECTRIC GENERATOR by General Instruments Corp. runs continuously on \$10 worth of propane a year. The 12- x 12-inch cylinder produces 5 watts of power. Its "super-efficient" constant-temperature burner uses more than 85% of the heat content of the fuel. Semiconductor "thermopiles" convert the heat directly into electricity. The unit is designed for use in remote areas where other sources of power are either unreliable or short-lived.

CARDIAC PACEMAKER, designed to be implanted in the human body, has batteries for 5 years. During this period it will watch for faltering or irregular heartbeat, and supply electric pulses to the heart muscles to start and steady heartbeat. Wilson Greatbatch demonstrated the unit at the last IRE convention.

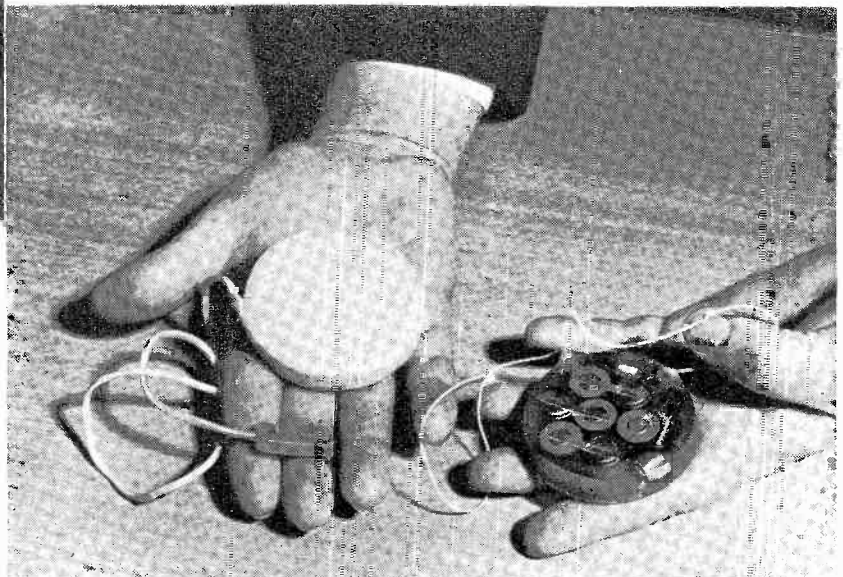

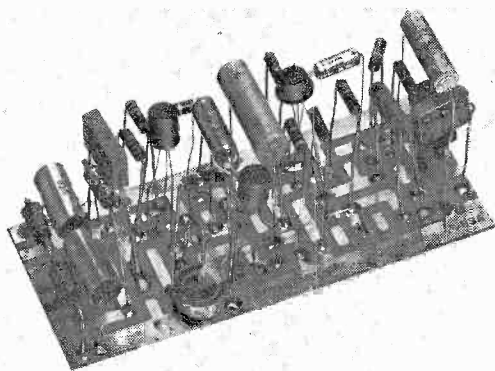

PRINTED - CIRCUIT BREADBOARD for experimental circuit layout comes etched and tinned. *Dynamaze* by Dynameans, Inc. is designed for use with transistor circuits. It may be reused many times or be punched or drilled for permanent parts mounting. Base material is Epoxy-glass.

LOW-NOISE ANTENNA is used with maser to make a receiver so sensitive it cannot be used for point-to-point contacts on the earth. Atmospheric thermal noise would obscure the signal. It will probably be used for space-probe signal pickup or communication via satellite bounce.

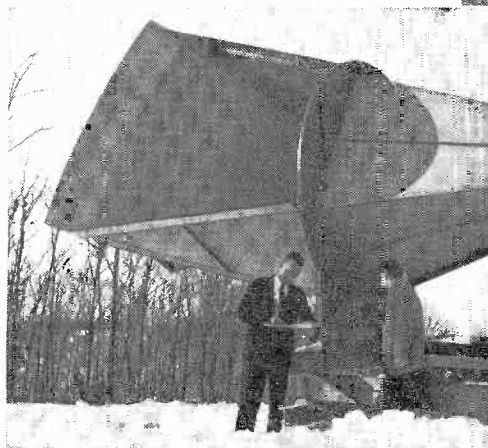

MOST POWERFUL TUBE can produce 5 megawatts peak power at an average level of 300 kw at 450 mc. Made by RCA, the A-2346 weighs 150 pounds. It has been developed for possible use in outer-space communications, industry and intercontinental TV.

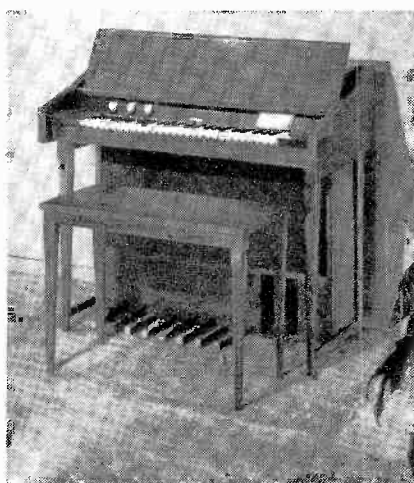

ELECTRONIC ORGANS in low-price range, *Baron* (shown) and *Baroness* (no pedal board), by Electro-Voice have 32-note manuals. Additional 17 keys at end of manual play chords in the normal manner. Or they will each produce chords at the turn of a switch. Both models have six voices, variable tremelo and built-in speaker.

SUN-POWERED-AUTO is actually renovated 1912 electric with Solar King (International Rectifier Corp.) panel of more than 10,000 silicon cells supplying the power. Cells could be mass-produced for \$2,000 to \$3,000.

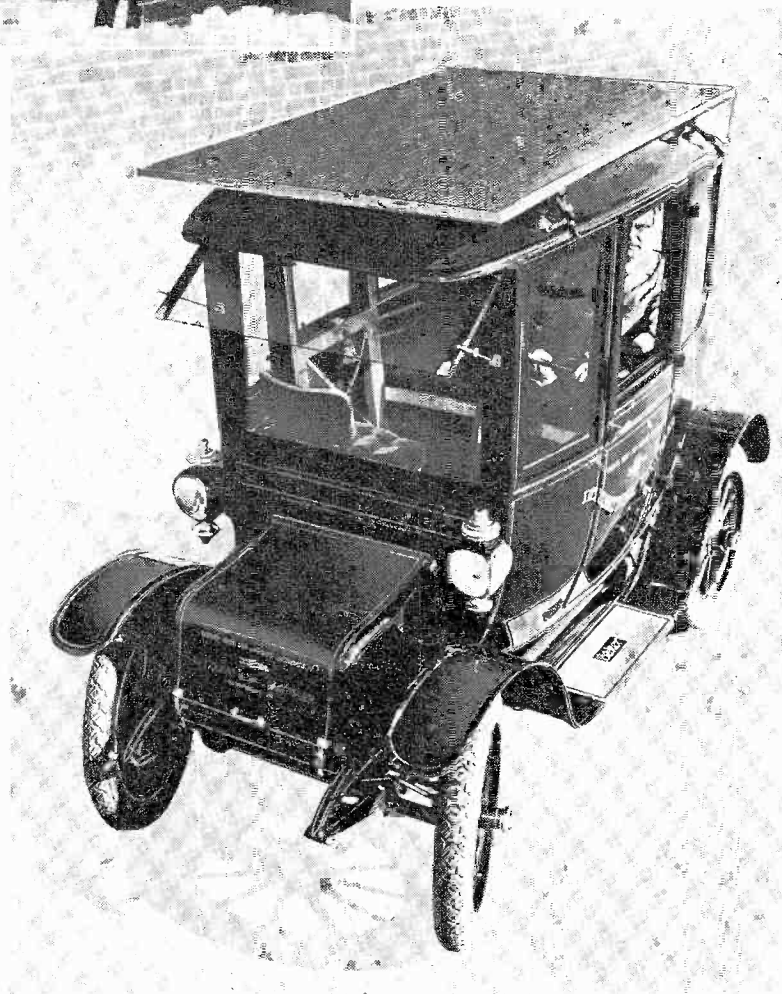

UNDERSTANDING INDUSTRIAL DIAGRAMS

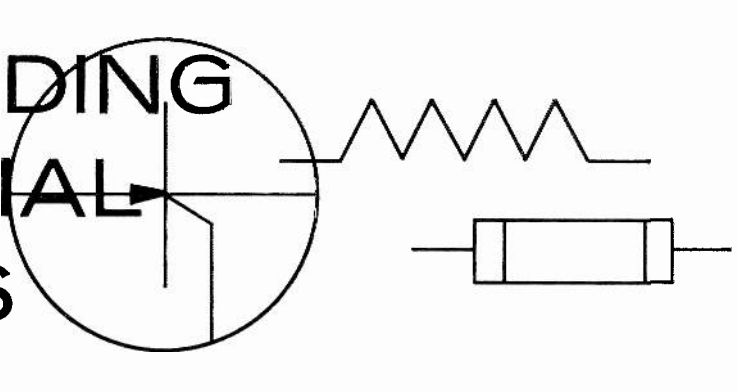

Know the symbols and types of diagrams you may encounter and the problem is half solved

By TOM JASKI

YOU do not read an industrial electronics diagram as you do a communications electronics one. They just aren't the same. Symbols differ, and the same symbols may represent different components. However, once a few basic points are clarified, industrial schematics will be no more difficult to read than the familiar communications schematic.

The table presents a list of symbols with the communications symbol on the left, definition in the center, industrial symbol on the right. In most instances the differences are not great, and many devices are represented by the same symbol in both communications and industrial usage. But there are some differences which may get confusing.

One of these is the industrial symbol for a relay contact. It looks very much like the communications symbol for a capacitor. Also, the industrial symbol for a normally closed relay might be confused with the communications variable-capacitor symbol.

The American Standards Association (ASA) has been trying to standardize

symbols, but it is difficult to get such symbols universally accepted. Many industrial electronics engineers and draftsmen were once communications engineers and carry with them old habits of presentation. Manufacturers have extensive files of diagrams and catalog cuts which were made before standardization became an obvious necessity, and the cost of changing existing drawings may be prohibitive.

There is no real impasse. It is simply a matter of time before a practice becomes universal, and eventually industrial electronics will play such an important role in our lives that there will probably be a tendency to unify the existing symbols. But this may be a long time away. In the meantime you must get along with the mixture and compromises now in use.

Types of diagrams

Drawing practices also vary. Industry has long used "wiring" and "elementary" diagrams, unlike the schematic diagrams used in communications. Fig. 1 shows the difference between the

three types. In the wiring diagram (Fig. 1-a) items such as relay contacts are drawn adjacent to the relay coil. This is also true in the schematic (Fig. 1-b). But in the elementary diagram (Fig. 1-c), we are concerned primarily with showing the sequence of events. So if A must happen before B, we show A first and then B, even if they are part of the same piece of equipment. If we have a transformer, and the items fed by various secondaries are separated in the elementary diagram, we will cheerfully draw all the secondaries where they are needed, and thus scatter the parts of the transformer all over the sheet. This is graphically illustrated by the separation of the relay contacts from their coil. Of course, parts thus separated must be carefully identified.

Elementary diagrams came in vogue with the introduction of complicated relay control diagrams, where the circuit often could not be understood unless there was a clearly indicated sequence of events in the diagram. (*Symbols, pages 66-67; text continued page 68*)

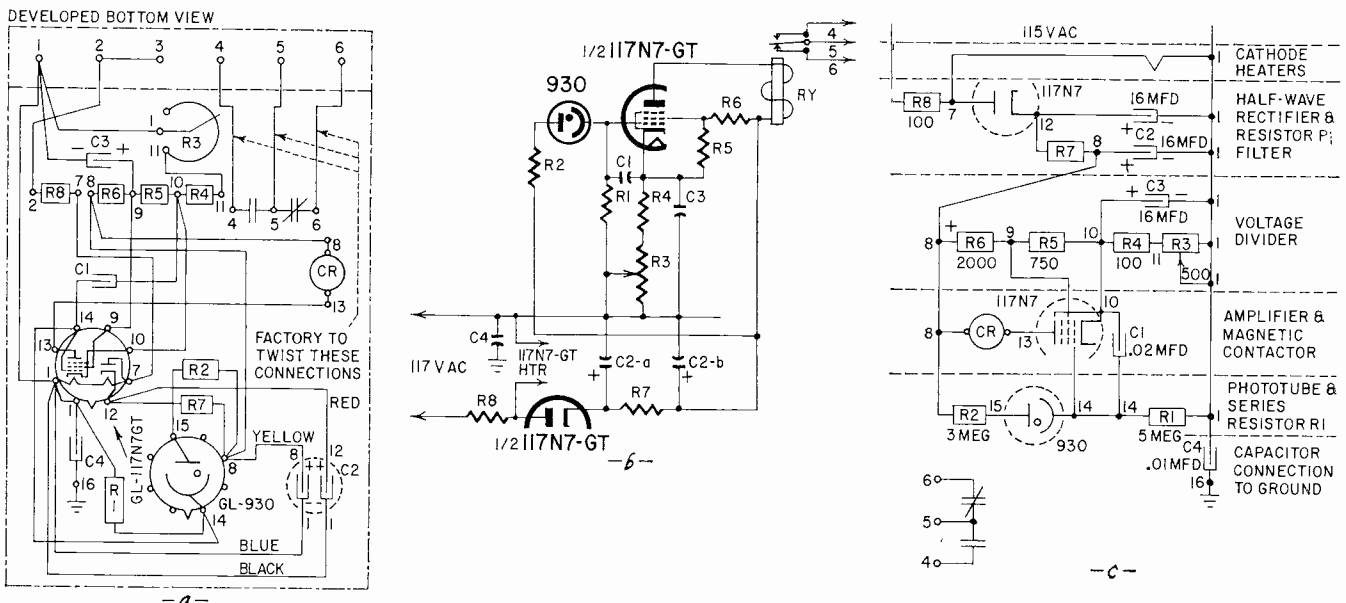
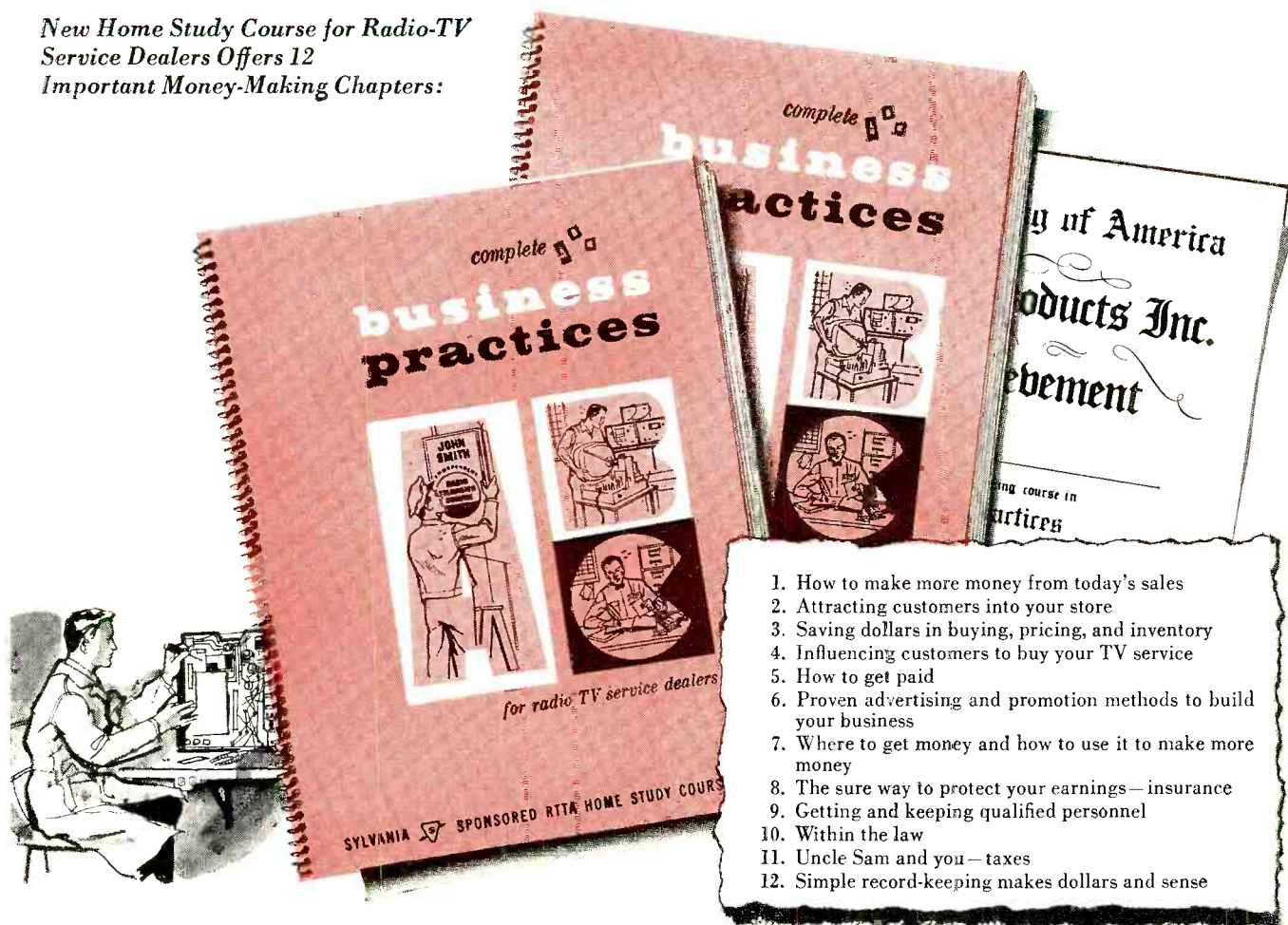

Fig. 1—Circuit of a G-E photoelectric relay: a—wiring diagram (industrial); b—schematic diagram (communications); c—elementary diagram (industrial).

Let SYLVANIA help you improve your business—now!

*New Home Study Course for Radio-TV
Service Dealers Offers 12
Important Money-Making Chapters:*



1. How to make more money from today's sales
2. Attracting customers into your store
3. Saving dollars in buying, pricing, and inventory
4. Influencing customers to buy your TV service
5. How to get paid
6. Proven advertising and promotion methods to build your business
7. Where to get money and how to use it to make more money
8. The sure way to protect your earnings—insurance
9. Getting and keeping qualified personnel
10. Within the law
11. Uncle Sam and you—taxes
12. Simple record-keeping makes dollars and sense

As a service dealer you wear two "hats"—(1) you are a technical expert, qualified to repair and maintain electronic equipment, and (2) you are an independent shopowner, a businessman important to the economy of our country.

You can succeed in your profession only if you are thoroughly trained in both service and sales.

SYLVANIA now offers an outstanding, valuable course in "business practices." It's easy to get. Easy to use. Sure to help you build more profits.

A certificate of achievement is awarded on completion of the course. Display it in your shop . . . it tells all your customers that you are a trained serviceman—a trained businessman.

**YOUR AUTHORIZED SYLVANIA TUBE DISTRIBUTOR HAS COMPLETE DETAILS. CALL HIM NOW.
CHECK YOUR TUBE STOCK FIRST. AND ASK HIM FOR SYLVANIA TUBES!**
Electronic Tubes Division, Sylvania Electric Products Inc., 1740 Broadway, New York, N. Y.

SYLVANIA





Subsidiary of **GENERAL TELEPHONE & ELECTRONICS** 

Understanding Industrial Diagrams (Text begins page 64)

Table of Symbols

Communication	Industrial	Communication	Industrial
 DIODE (KENOTRON)		 RECTIFIER OR DIODE	
 FULL-WAVE RECTIFIER		 THERMISTOR	
 TRIODE (PLIOTRON)		NONE	 THERMOCOUPLE
 THYRATRON		NONE	 THERMAL OVERLOAD
 PENTODE		 AIR-CORE COIL	 OR
 PHOTOCELL		 IRON-CORE COIL	 OR
NONE	 IGNITRON	 SLUG-TUNED COIL	
 P-N-P TRANSISTOR		 TRANSFORMER	
 N-P-N TRANSISTOR		NONE	 SATURABLE CORE
 P-N-P TETRODE TRANSISTOR		NONE	 3-PHASE TRANSFORMER WINDINGS
 UNIUNCTION TRANSISTOR		 RELAY COIL	
 P-N-P FIELD EFFECT TRANSISTOR		 ARM  SLOW-CLOSING RELAY	 SO
 CONTROLLED RECTIFIER		 ARM  SLOW-RELEASE RELAY	 SR
 SOLAR BATTERY		 SLOW-ACTING RELAY	 SA

Table of Symbols

Communication		Industrial	Communication		Industrial
	NO (NORMALLY OPEN) RELAY CONTACT			ANTENNA	
	NC (NORMALLY CLOSED) RELAY CONTACT			BATTERY	
	SPDT RELAY CONTACT			CONNECTOR	
NONE	DELAYED-OPENING RELAY CONTACT			MANUAL SWITCH	
NONE	DELAYED-CLOSING RELAY CONTACT			PUSHBUTTON SWITCHES	
	LIMIT SWITCH			PILOT LAMP	 LETTER FOR COLOR
	CIRCUIT BREAKER			NEON LAMP	
NONE	MAGNETIC OVERLOAD			FUSE	
	RESISTOR			CIRCUIT WIRE	NONE
	TAPPED RESISTOR			GROUND BUS	NONE
	ADJUSTABLE RESISTOR		NONE	CONTROL WIRE	
	CAPACITOR		NONE	POWER WIRE	
	VARIABLE CAPACITOR			CROSSING WIRES, NO CONNECTION	
 CHASSIS 	GROUND	 OR 		CROSSING WIRES CONNECTED	

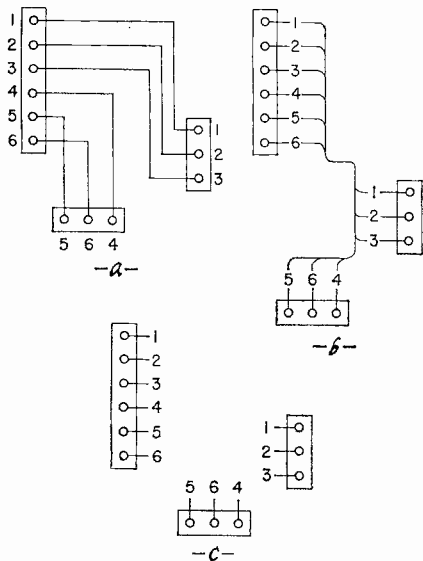

Fig. 2—Three ways of drawing multiple-lead wiring: a—all leads are drawn; b—all leads are combined into one lead and terminals are numbered; c—no leads are shown, terminals are numbered.

They served so well there that the practice was carried over into other kinds of circuits.

But this is not all. Another difference is illustrated in Fig. 2. Almost invariably in communications diagrams all connections are shown, even if it means drawing many parallel lines (Fig. 2-a). In industrial diagrams there may be so many parallel wires that the drawing becomes impractical. Then the draftsman will pull these wires into one line and will designate the origin and destination with a number (Fig. 2-b).

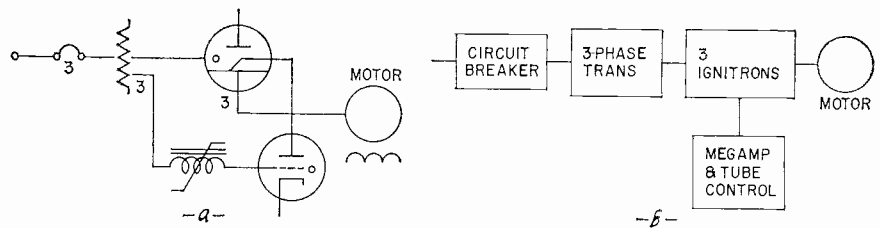

Fig. 3-a—one-line diagram; b—block diagram. Both serve the same purpose.

This does not mean necessarily that these wires are cabled, although they often are.

We can go one step further, leave out the lines altogether and simply designate the origin and destination of the wires (Fig. 2-c). This is universal and long established practice in wiring diagrams used in large power-house switchboards and control systems, and is being carried over into industrial electronics. For one accustomed to having every line drawn, this may need some study.

Long familiar to communications are block diagrams. Their equivalent in industrial diagrams are single- (one-) line diagrams. These are essentially similar to block diagrams, except that instead of blocks with designations written in, the single-line diagram often shows the more graphic single-line symbols as in the power business. Fig. 3 shows the difference. Single-line diagrams are used to give a quick view of the entire system and its major components.

A fifth kind of diagram you may encounter is the construction diagram. It is very much like the wiring diagram and sometimes serves the same pur-

pose. Construction diagrams show the components in their actual physical relationship, with quite a lot more accuracy than a wiring diagram, and show only terminals. Thus rather than show the vacuum tubes and transformers with their internal construction schematically presented, only circles or rectangles are shown with the actual terminals and socket connections. Unless you are familiar with all the components involved, it is almost impossible to determine function from a construction diagram. Such diagrams also indicate how wires are dressed, whether or not they are cabled, and how various parts are fastened. It usually takes several construction drawings to give all the details of a particular system or instrument.

Here you have the most important differences in diagrams you may have to cope with. There are many hybrids, wiring and construction diagrams mixed, schematics and elementary diagrams combined and so on. Nor can you expect to find a pure application of symbols of one kind or another everywhere. But knowing about the possible differences is half the battle in coping with them. END

solder removal made easy

COSTLY repairs are being reduced at ITT Federal Electric, Clifton, N. J., with a vacuum pump connected to a length of Teflon tubing. The device is used to remove solder from connections being disassembled. Once the joint is hot and the solder melted, the vacuum pump pulls the molten solder away through the Teflon tube. An ordinary fuel-line filter keeps the solder from getting into the pump (see diagram).

In one particular application, we had to remove quartz crystals from printed-circuit boards. With normal methods of heating the joint and wiggling leads free, excessive heat would ruin an average of \$30 worth of crystals per board. With the vacuum pump pulling the molten solder away, heat can be removed much sooner and all the crystals can be saved. The job goes much faster too.

The Solder removal method also has many other applications in repair operations. Solder can be drawn away from almost any type of soldered connection to facilitate the removal of components. This makes an easy job of the old problem of removing solder from tube socket pins, terminal lugs, printed-circuit feedthrough holes, and other difficult spots.

The only problem you are likely to

encounter in using the device is that, after long use, some solder may start to build up around the end of the Teflon tube. When this happens, cut off the clogged end and you're back in business.

We use a ¼-hp motor to insure picking up all molten solder, an automotive type fuel-line filter and a 4-foot length of 8-gauge Teflon sleeving.—William J. McGuinness

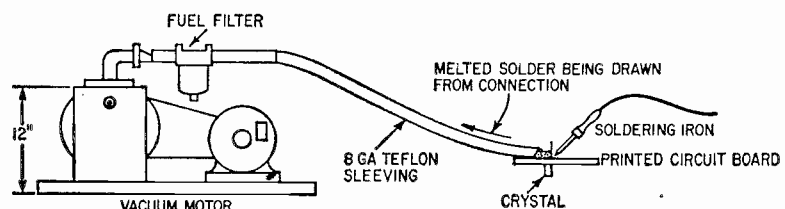

INDUSTRIAL ELECTRONICS

new departure in soldering irons

IN the past many of us have selected a soldering iron largely on the basis of its wattage rating. Actually, there are other things to consider more carefully. The heat capacity (thermal capacity) of the iron and its temperature are very important, too. Unfortunately, temperature can vary widely.

There have been irons with temperature regulation using a bimetallic element as a thermostat. In some of these, the control element is so far back of the working tip of the iron that its action is very slow. In many cases, the temperature variation is close to 100°F. Since the best general range is only about 100°, between 650° and 750°, and since many irons start off after initial heating much below or above this temperature, control in use is out

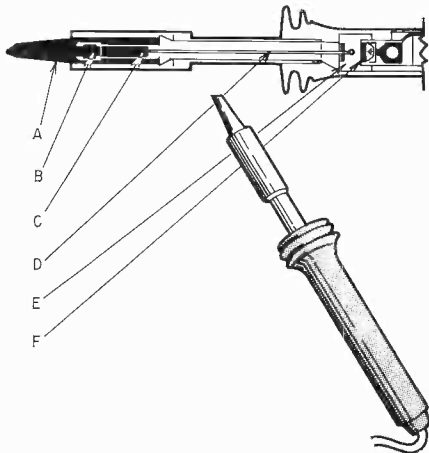

of the question for them. Irons used with temperature-regulating bench stands have an even greater temperature swing than 100°, and go out of control as soon as they're taken out of the stand for use.

One of the latest types of irons regulates its temperature within a total swing of about 40°F. It uses a magnetic control which opens the circuit at a predetermined temperature. When the tip reaches this temperature, a small magnetic iron slug in the tip loses its attraction to a magnet.

Referring to the drawing, it may be seen that copper tip A includes temperature-sensitive element B which loses ability to attract magnet C above the critical temperature, though it attracts the magnet below the critical temperature. Magnet C is fastened to switch F by connecting rod D and yoke assembly E. When cold, element B attracts magnet C, closing switch F, which turns on the current. After the current heats the iron to the critical temperature, element B loses attraction for magnet C, opening the switch and cutting off the current.

The iron is the Magnastat, made by Weller. END

JUNE, 1960

SENSITIVE

H. H. Scott's famous Wide-Band Circuitry makes this the most sensitive tuner available for under \$180! Usable sensitivity 2.5 μ v (IFM standards). H. H. Scott's unique wide-band transformers separate stations so close together you were never able to listen to them before.

DRIFT FREE

You never have to retune the station, whether it's strong or weak. Exclusive H. H. Scott Wide-Band design keeps the station in tune without the need for distortion-producing A.F.C.

FAMOUS H. H. SCOTT QUALITY

The same silver-plated Wide-Band front end... the same copper bonded to aluminum chassis... the same Wide-Band detector found in all H. H. Scott tuners.

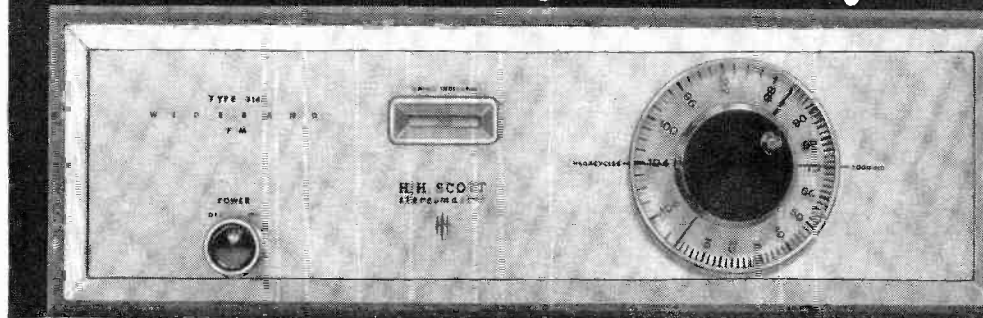

new TUNER

H.H. SCOTT • WIDE BAND • \$114.95*

Here at last is an H. H. Scott Wide-Band FM tuner at a modest price. The new 314 ranks with the very finest FM tuners available. H. H. Scott's exclusive Wide-Band design delivers more distortion-free sensitivity; long range reliability; better station separation, even when measured by stringent IHFM standards. The fine performance of this unit is made possible by the use of special Wide-Band circuit components manufactured exclusively for H. H. Scott. The new 314 measures a compact 15½ wide x 5¼ high x 13¼ deep. Listen to this fine tuner at authorized H. H. Scott dealers everywhere. You'll be amazed at the fine performance it offers at this exceptional price.

*West of Rockies \$116.95



Technical Specifications (IHFM Method)
Signal to Noise Ratio: 60 DB below 100% Mod.; Harmonic Distortion: 0.8%; Drift: 0.02%; Capture Ratio: 6 DB; Audio Hum: 66 DB below 1v; AM Suppression: 55 DB.



H. H. SCOTT

H. H. SCOTT, INC., 111 Powdermill Road, Dept. REE
Maynard, Mass.

- Please rush me complete technical specifications on your new 314 Wide-Band FM tuner.
- Also include your new catalog and award winning booklet "How To Use High Fidelity Components in Your Decorating Plans".

Name.....

Address.....

City..... State.....

Export: Telesco International, 36 W. 40th St., N.Y.C.

Industry controls warns indicates counts PHOTOELECTRICALLY

By ALLAN LYTEL

MANY control systems rely on photoelectric cells for an efficient job. For example, they often handle the otherwise difficult task of counting products on a conveyor belt. Since a photocell or phototube can detect objects that have odd shapes, they simplify the counting process. Then, too, photoelectric counters are much faster than mechanical types and require less maintenance.

Fig. 1 shows a dual-purpose system. It indicates the number of large and small packages and counts the total number. Two photoelectric counters do the job. The one in the low position (on the left) counts all the boxes. The other counter is set so it counts only the high boxes. The low boxes pass under its light beam and not through it. By subtracting the number of large boxes from the total, you get the number of small boxes. Similar arrangements can be used to count three sizes of containers.

Fig. 2 shows a control system often used where packages are filled from a hopper. The feed to the hopper is usually continuous and at a steady rate. However, if the filling line should slow down or stop, the hopper can overflow, wasting material. The photoelectric control shown prevents this. Whenever the level in the hopper blocks the light beam, the feed is cut off.

Another variation of this type of system is shown in Fig. 3. Here, a motor-driven conveyor delivers boxes to a weighing station. However, the weighing station cannot handle the boxes as rapidly as the conveyor delivers them. To solve this problem a photocell is set up so it stops the conveyor whenever a box breaks the light beam. This triggers an electronic timer that restarts the belt after a suitable interval. The belt runs until another box breaks the light beam, and so on.

Photoelectric relay circuits

Sometimes operating speed is not im-

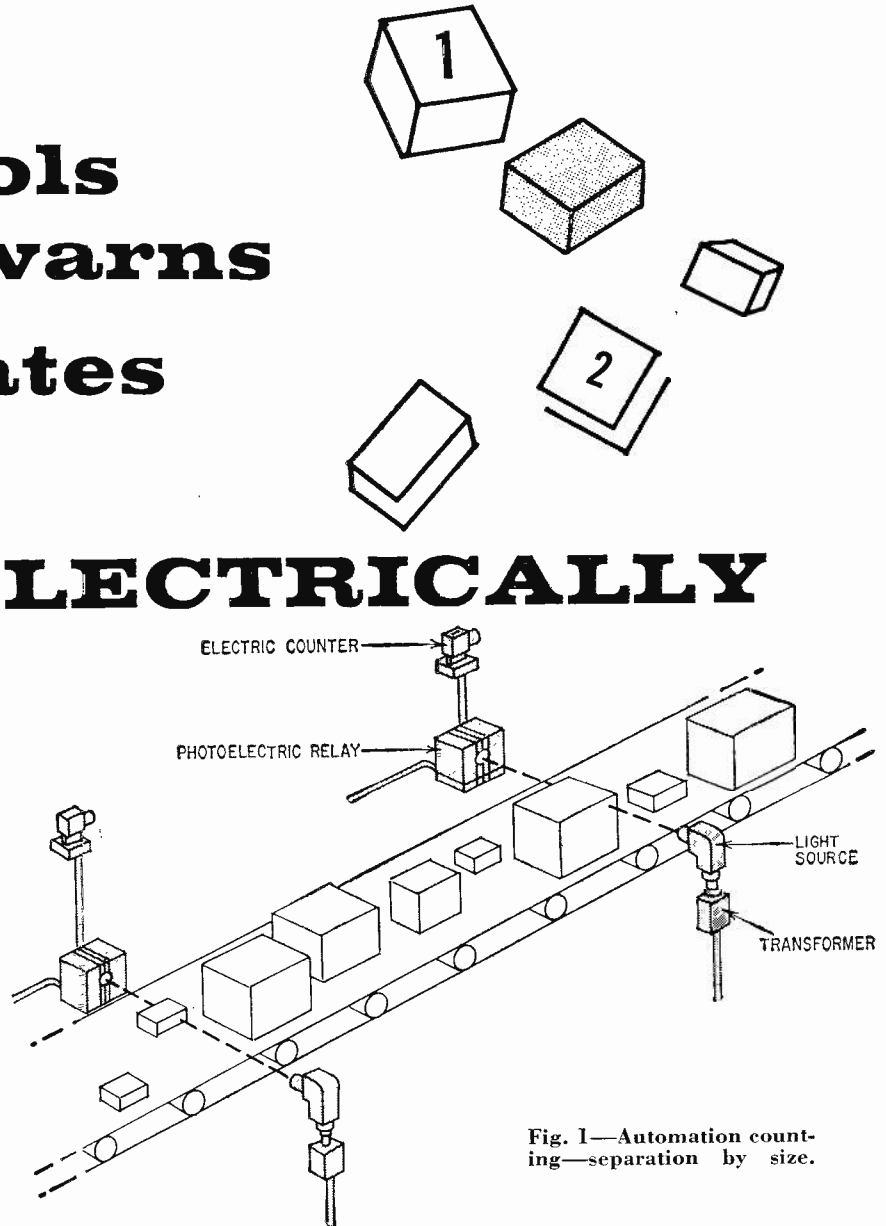

Fig. 1—Automation counting—separation by size.

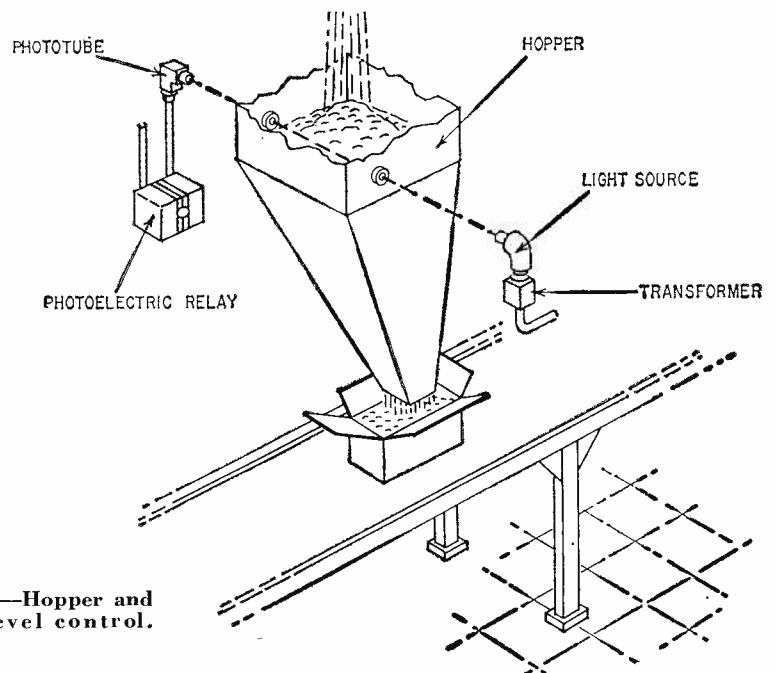

Fig. 2—Hopper and bin level control.

portant and 60-cycle ac can be used for the phototube and amplifier plate supply. With an ac supply they conduct only while their plates are positive. While such an arrangement is inexpensive, it has drawbacks. A tube with self-rectifier action is going from conduction to cutoff 60 times a second. For low-speed operation this is satisfactory, but for high-speed operation dc plate supplies are used.

Fig. 4 shows a circuit designed for speeds up to 1,200 operations a minute. It is not high-speed in a radio sense but, if the device is counting packing cases on a conveyor belt, 1,200 a minute is very fast.

The unit's power supply uses a 6X4 as a half-wave rectifier. Note that the power transformer's two primaries can be tied in parallel for 117-volt or in series for 230-250-volt operation.

Relay RY1 (operating relay) in series with the 5AQ5 plate is energized when light falls on the 1P40 phototube. With 75 volts across the 1P40 and a 10-megohm load a steady small current flows while light falls on the cathode. The drop across the load makes the phototube's cathode positive—it is tied to the control grid of the pentode through a 1-megohm resistor.

A voltage divider (6,000, 3,000, and 1,200 ohms) is also across the 75-volt line. A sensitivity control, the 3,000-ohm potentiometer, adjusts the positive cathode voltages. When the light beam is interrupted, the 1P40 stops conducting and positive grid voltage is removed. Because of the positive cathode voltage, pentode plate current is reduced and plate relay RY1 opens.

There are a number of safety features in this circuit. A failure in either the light source, the rectifier tube or its associated circuit, or the amplifier tube will open the plate relay. If the control is being used as a safety device, the fail-safe feature is important since failure of the control will not go unnoticed. A second relay (RY2) is another safety device. It energizes after the circuit is warmed up. It de-energizes if the phototube goes off or the amplifier tube fails. Relay contacts are wired in series so if either relay opens the controlled device is cut off.

Examples of uses for this relay are in Figs. 5, 6 and 7. In Fig. 5 a photoelectric control is used as a hand guard. If the operator's hands interrupt the light beam, the machine will not operate. In this application, phototube or light-source failure must stop the machine. Photoelectric devices alone are not recommended for safety protection since they can be fooled or tricked.

An automatic system for photographing book pages is illustrated in Fig. 6. When the page reaches the stop, it breaks the light beam and actuates the camera. Note that the beam is focused so it is very narrow where the page hits it, assuring accurate operation.

A carton sorter is shown in Fig. 7. Different register marks are used on the cartons. A register mark is a

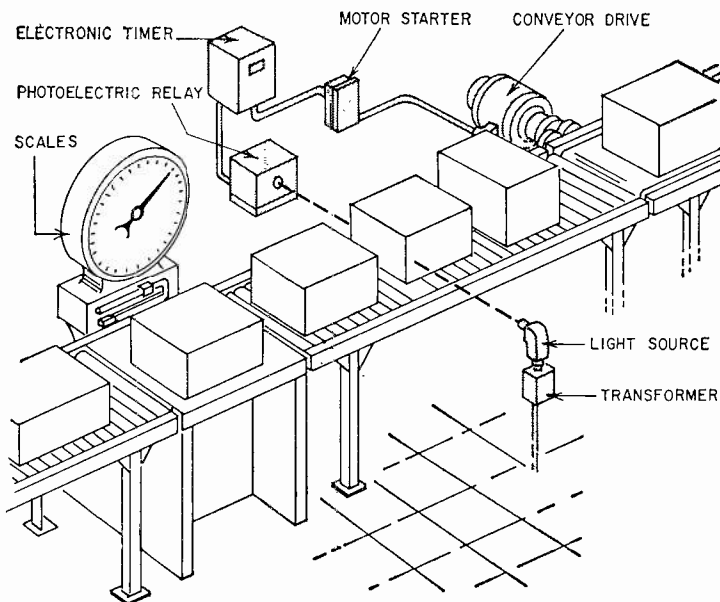

Fig. 3—Conveyor feed control.

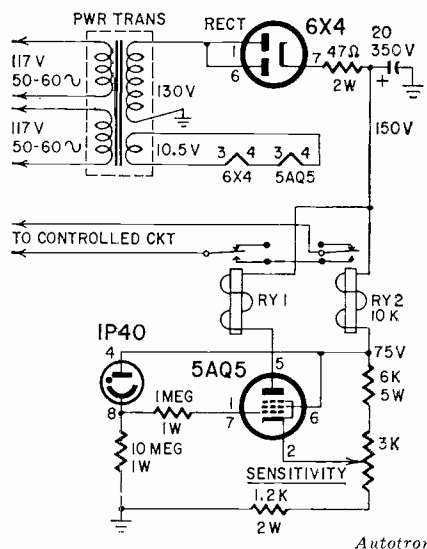

Fig. 4—High-speed photoelectric circuit handles up to 1,200 operations per minute.

printed area used for photoelectric control because of the way the light beam reflects from it. In this example there are cartons with two types of register marks, high and low, as well as no marks. All cartons move along the main conveyor belt from right to left. At the first station, cartons with low register marks actuate the control which pushes these cartons onto the first side conveyor. Cartons with high register marks are pushed off onto the second side conveyor by the second control station. Unmarked cartons continue down the main conveyor.

Modulated-light relays

Photoelectric devices are often used outdoors. An ordinary light source would have to be very bright to operate a photoelectric relay in direct sunlight, but a modulated light beam overcomes this problem.

Fig. 8 is the circuit of the G-E CR7505-BI09G3 modulated-light relay. It works like a radio receiver. A photo-

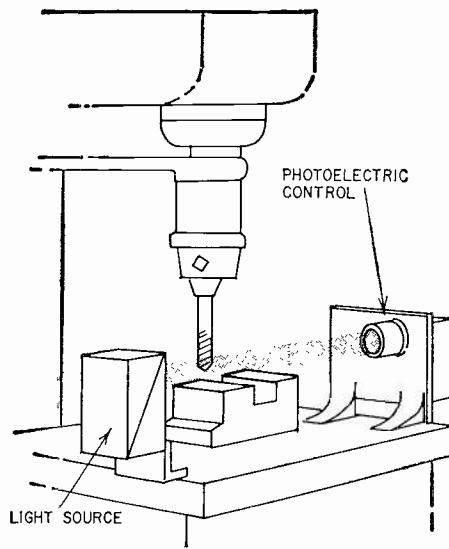

Fig. 5—Photoelectric hand guard for dangerous machinery.

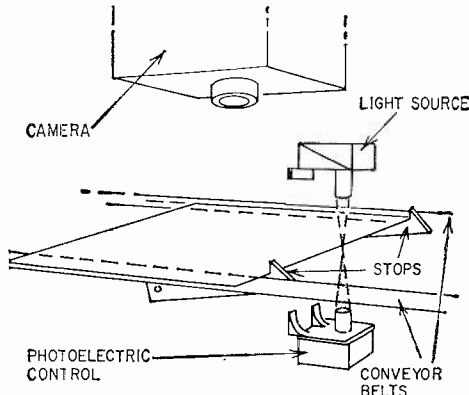

Fig. 6—Automatic photographing of book pages.

tube (V1) is connected to two R-C-coupled amplifiers. The 6SH7 has a tuned plate circuit which responds only to the desired modulated light. A diode detector (V4-a) feeds the output stage (V4-b) which drives relay RY in its plate circuit.

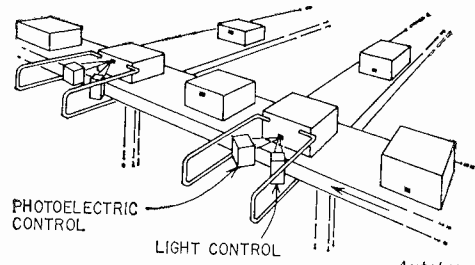
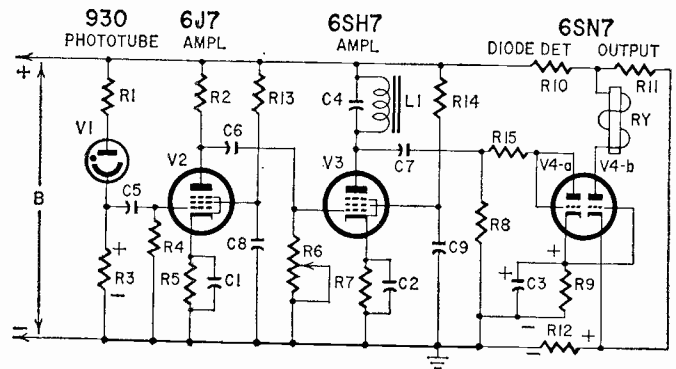

Fig. 7—Sorting cartons by register marks.

Fig. 8—Circuit of a General-Electric modulated-light relay.



Light falling on its cathode causes the phototube to draw current, but steady light, or slowly changing light intensity, will not pass through the ac amplifiers because of the coupling capacitors. But the light source for this relay is chopped by a rotating disk—is interrupted about 900 times per second. This is the system's carrier. The chopped light causes a series of dc pulses through R3, R1 and the photo-

tube. There is a current pulse for each light segment at the 900-cycle rate. These pulses are coupled to the 6J7 control grid. Their polarity across R3 is positive, as indicated, and they appear at the 6J7 as an ac signal. The amplified signal is applied to the 6SH7 but, because of the resonant plate load (C4, L1), only signals of the desired frequency are amplified.

V4-a is connected as a diode detector.

Current flow from cathode to plate creates a voltage drop across R9 so the cathode is above ground. This positive voltage is directly coupled to the grid of the output tube (V4-b). There is a positive voltage on V4-b's cathode from R12, which is part of a voltage divider across the supply voltage. Without any received signal there is no detection, no drop across R9, and V4-b's grid is at ground. This keeps V4-b cut off when no signal is being received, when steady unmodulated light is received or when the beam of modulated light is interrupted at a rate other than 900 cycles.

The proper signal, however, drives V4-b's grid positive enough to overcome the cathode bias and the tube conducts, closing relay RY. If the modulated beam is interrupted (even for 0.1 second), V4-a stops the detecting action since it no longer receives an ac signal. C3 discharges through R9,

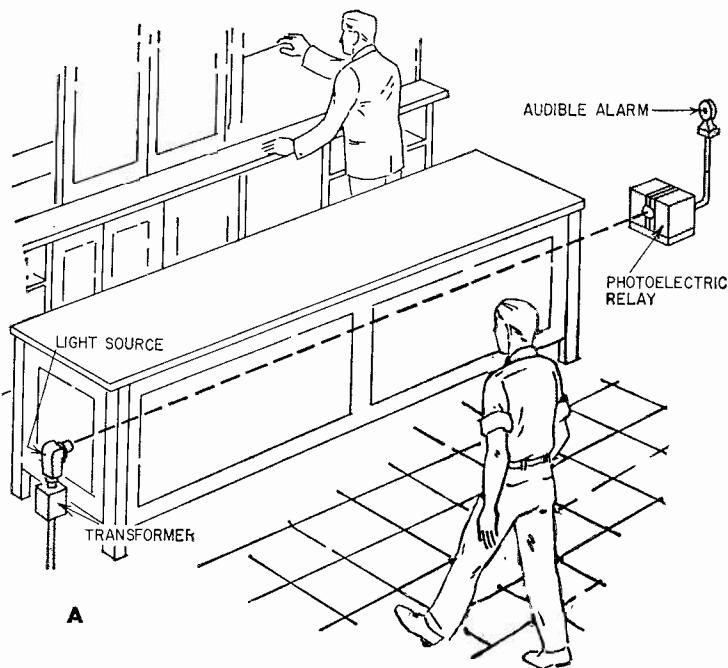
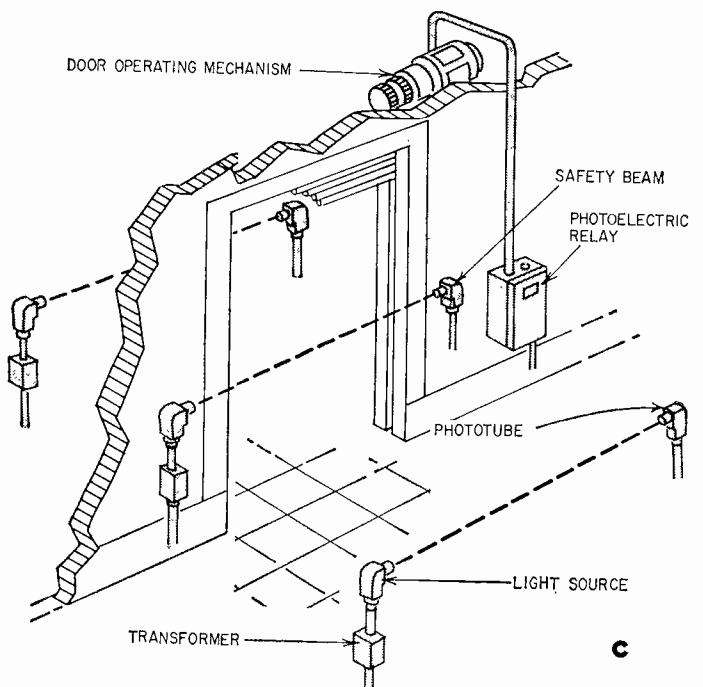
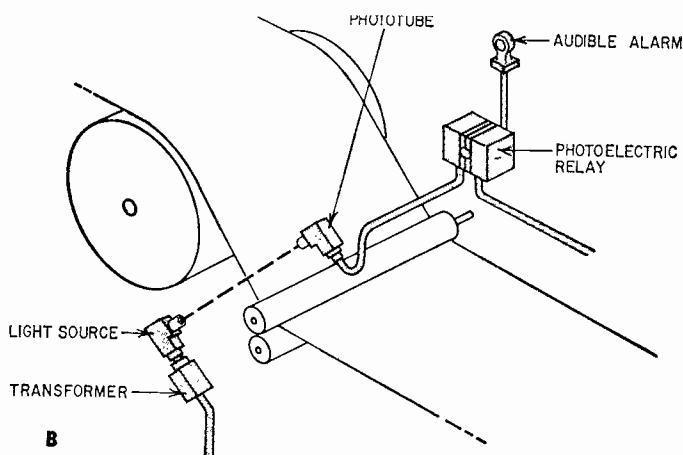

Fig. 9—(Left) Sales-counter installation indicates approaching customers. (Below) Door opener is triggered by vehicles or people approaching from either side. (Lower left) Web break detector stops machine if there is a break in the material feed.



making V4-b's grid negative in a grid-leak action. As soon as V4-b is cut off, relay RY opens and gives an alarm through an external circuit.

A modulated-light relay can operate in daylight over distances up to 1,000 feet. Sunlight must not be focused on the phototube cathode or it will be destroyed. Such equipment can protect outdoor installations against intruders.

Three ways of using such controls are shown in Fig. 9. A sales-counter application is shown in Fig. 9-a. A photoelectric relay and buzzer automatically signals the approach of a customer. Each counter can have its own signal system.

In Fig. 9-b an automatic overhead door opener is shown. As a person or vehicle approaches the door (from either direction) the interrupted beam of light operates a relay that controls the door opening mechanism. A safety beam in the door frame keeps the door from closing until the vehicle clears the doorway.

An automatic break detector is shown in Fig. 9-c. A break in the roll or web trips an alarm and can also stop the machine. There are many other more complex control systems for machines which use long rolls of material but this type is a simple alarm or safety device.

Service and maintenance

To prevent shutdowns, a regularly scheduled program of preventive maintenance is required. At least once every month:

- ▶ Dust the lenses with a clean, soft cloth.
- ▶ Check the lineup between the light source and the phototube holder. (The light-source lamps have an expected life of about 1,000 hours at 5.2 volts and 3,000 hours at 4.8 volts.)

The following routine is suggested for servicing:

1. Inspect the light source for burned-out lamps.
2. To determine if the trouble is in the control panel or the phototube, disconnect the phototube connections and touch a jumper momentarily between the terminals to which the phototube anode and cathode connections were made. If the relay operates, the fault is not in the panel. Replace the phototube and check its connections for continuity and leakage. With the phototube removed, resistance between phototube leads should be about 1,000 megohms; resistance between the leads and ground should be greater than 100 megohms.
3. If the relay fails to operate in step 2:
 - ▶ Check for power on the incoming line by measuring the voltage at the incoming terminals.
 - ▶ Replace the tube.
 - ▶ Check the three transformer secondary voltages and the one dc voltage shown on the diagram.

Smoke detection

Photoelectric control of smoke from

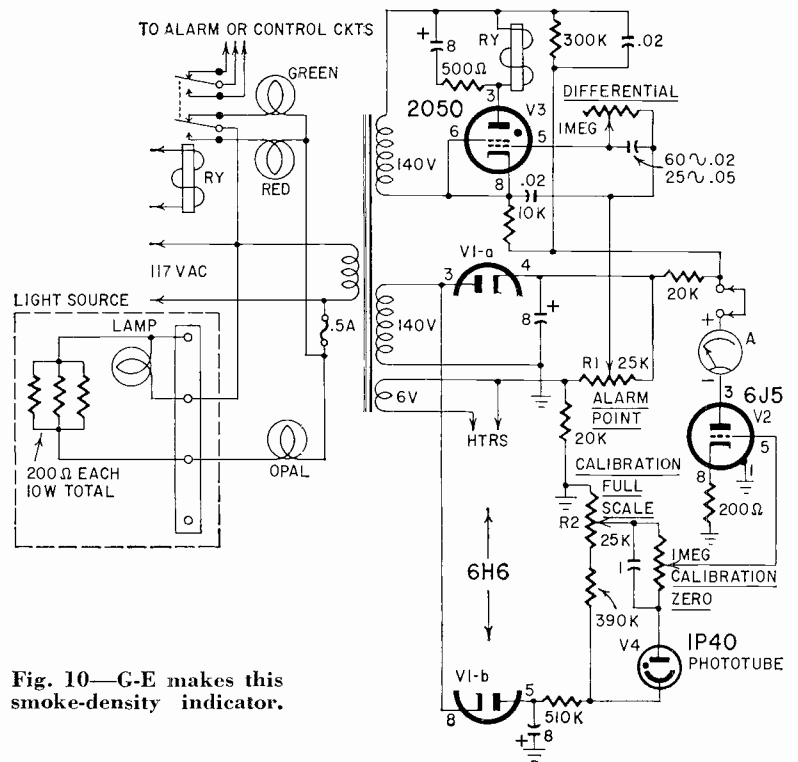

Fig. 10—G-E makes this smoke-density indicator.

industrial furnaces is becoming increasingly important. The General Electric CR7505-R201 is a smoke-density indicating unit. Because black smoke absorbs light, the amplified phototube current can be read directly on a milliammeter calibrated in "smoke density." This is true for black smoke only. Local ordinances must be considered and taken into account when calibrating the equipment. When the preset value is reached, a thyatron is triggered which trips an alarm.

The unit's circuit is shown in Fig. 10. Half-wave rectifiers are used. The negative supply is used for the phototube (V4). The positive supply goes to the 6J5 amplifier. The 2050 thyatron

has an ac plate supply which is one of the power transformer secondaries. Control R1 sets the value to trigger the alarm. Control R2 is a calibration for the indicator meter.

High-speed, high-sensitivity controls

In applications where both high speed and high sensitivity are needed, the CR7505-N210-N211-N212 relays can handle up to 600 counts a minute with a relay or up to 1,000 counts a minute with a dc counter or fast operating load in plate output circuit.

A 6SJ7 voltage amplifier and a 6V6 power amplifier provide great sensitivity (Fig. 11). A 6H6 rectifier supplies the voltage amplifier and the

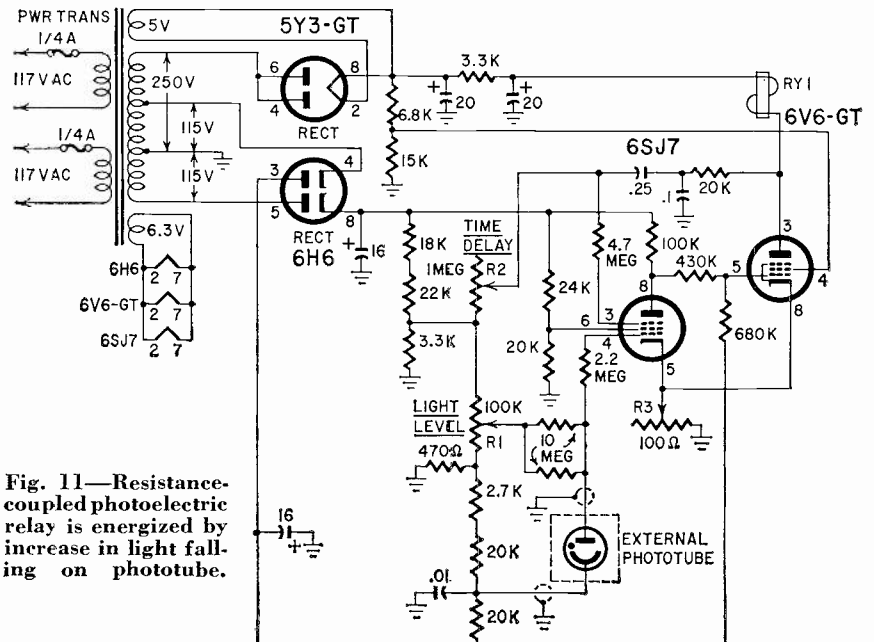

Fig. 11—Resistance-coupled photoelectric relay is energized by increase in light falling on phototube.

INDUSTRIAL ELECTRONICS

phototube. A separate 5Y3-GT, with its plates tied, is the power amplifier plate supply. Three adjustable controls are provided. R1 adjusts the amount of light required to actuate relay RY1. R2 adjusts the length of time the relay remains energized after it is turned on by the power amplifier. R3 adjusts the difference between the relay pickup (energized state) and dropout (de-energized state).

The circuit is direct-coupled from the phototube to the voltage amplifier and from the voltage amplifier to the power tube. It energizes the light relay on a light increase. Because of the direct coupling, the circuit responds to slow changes in light level which appear as low-frequency signals. By using capacitive coupling, the same circuit can be made responsive to only rapid changes in light intensity.

After the light source and phototube holder are properly aligned and focused, the LIGHT LEVEL control must be properly set for successful operation, using the following procedure:

A. For capacitive coupling:

1. Turn the LIGHT LEVEL knob (R1) completely clockwise.

2. Make and break the light beam at the source, using the same percent of cutoff that will normally occur. If the light is reflected, provide the normal signal repetitively.

3. Rotate the LIGHT LEVEL knob slowly counterclockwise until the relay starts operating. Note this position.

4. Continue rotating the LIGHT LEVEL knob counterclockwise until the relay stops operating. Note this position.

5. These positions should be separated by at least two divisions for consistent operation. The proper setting is halfway between these positions.

If the proper adjustments cannot be obtained despite proper alignment and focusing of the light beam, proceed as follows:

a. If the relay does not follow the light-source flashes or if there is insufficient difference between the positions found in steps 3 and 4, apply flashes by covering and uncovering the phototube lens. If the relay works now, ambient light must be reduced or an aperture must be placed inside the phototube holder to reduce the total light reaching the phototube.

b. If response is still off, recheck the aim, focus, distance and cleanliness of optical parts. Check connections and replace the phototube. If no response is obtained, follow the instructions provided by the manufacturer.

B. For resistive coupling:

Resistive coupling should not be used outdoors unless necessary. If it is used, ambient light must be excluded.

Repeat the first four steps above.

5. Make and break the light beam at the phototube lens. The relay will probably start operating again. Continue rotating the LIGHT LEVEL knob counterclockwise until the relay stops operating. Note this position.

Fig. 12 — a — photoelectrically controlled unit cuts extruded metal bars to length; b — warning device keeps lift drivers from taking too tall a load through protected door.

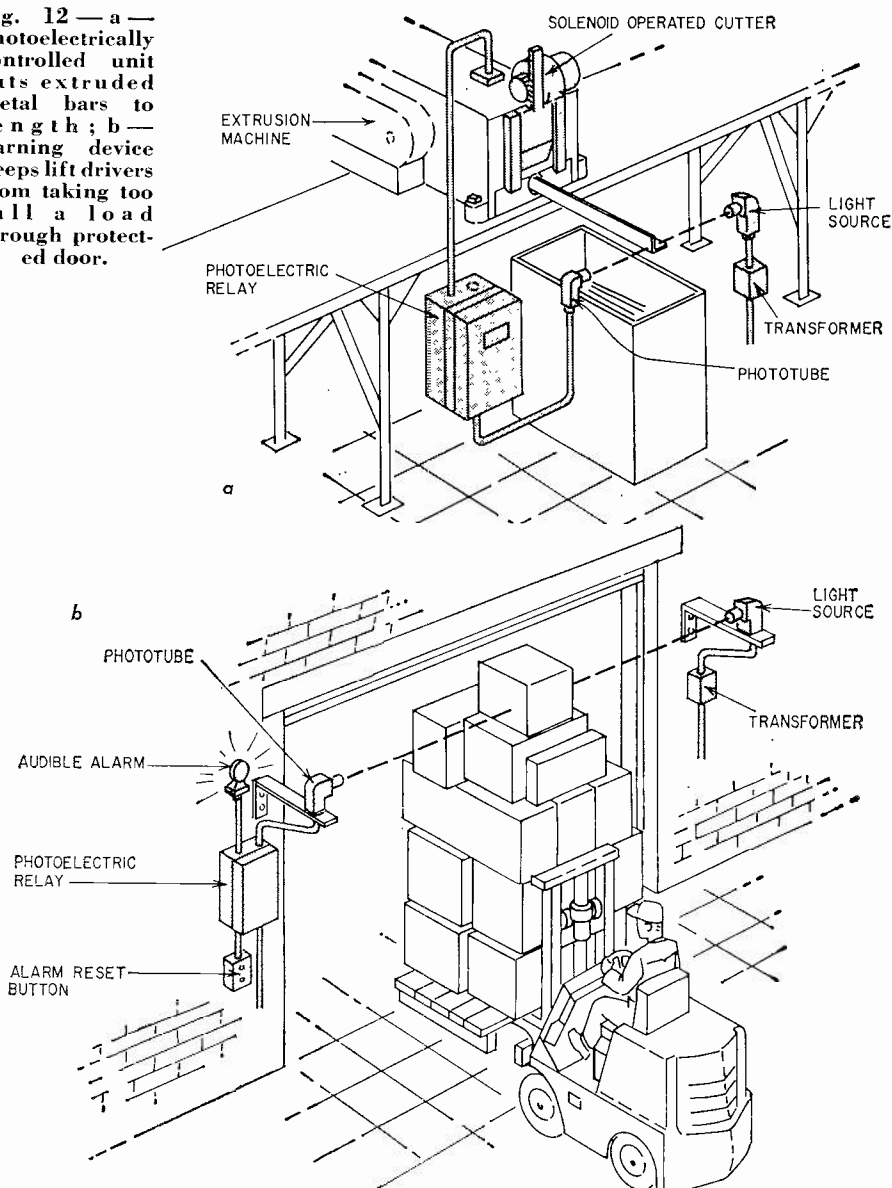

6. If the position in step 5 is more than one numbered division from the position in step 4, there is too much ambient light and it should be decreased.

7. If the position in step 4 is less than three numbered divisions from the position in step 3, there is insufficient change in illumination. If these positions are less than 5 on the dial, increase the sensitivity by disconnecting one of the 10-megohm resistors between R1 (LIGHT LEVEL control) and the phototube.

8. If the position in step 4 is above 7 on the dial, it can be brought into better range by masking off part of the phototube lens.

C. Relay differential adjustment:

This control does not normally require readjustment. But if the magnetic relay chatters (which may occur after the tubes are changed), the control (R3) should be turned clockwise just beyond the point where chattering stops. This increases the voltage differential between pickup and dropout.

Two uses for these relays are shown

in Fig. 12. Fig. 12-a illustrates a control that automatically signals a cutting mechanism when the proper length of material protrudes from the machine. The device triggers the cutoff mechanism. As the extruded material leaves the press and breaks the light beam, the photoelectric relay energizes the cutoff mechanism. Tolerances of 1/16 inch may be held by providing a mask in front of both the phototube and light source with a 1/16-inch wide slit.

Fig. 12-b is a safety overheight signal. When a lift truck approaches with a load which will not clear a doorway or overhead conveyor, the light beam is interrupted and the alarm sounds. The alarm will continue to sound until the reset button is pushed. The equipment may be used indoors and will detect objects 1½ inch in diameter or larger traveling at speeds up to 10 miles an hour.

As we have seen, photoelectric controls perform many industrial duties. Knowing how they work and the differences between the various types is the first step toward keeping them operating properly. END

INTRODUCING THE

**BLONDER
TONGUE**

10th
Anniversary Line

better TV products
for better TV reception
... UHF & VHF

Today — nearly every American family enjoys television's wide range of entertainment and educational programming. Ten years ago this was not so, for there were problems that had to be overcome in order to provide the nation with top quality TV reception — weak signal areas, interference, areas geographically inaccessible to telecasts; areas where many antennas had to operate from a single antenna; UHF areas with peculiar reception problems. Ten years ago, Blonder-Tongue designed and produced its first product, a TV booster, the model HA-1. Immediately it was accepted for the dramatic improvement it brought to fringe area TV reception.

During the 10 year period in which the TV art achieved the advanced state that exists today, Blonder-Tongue was responsible for 22 important patents that expanded the scope and improved the quality of TV reception. Blonder-Tongue TV signal amplifiers, UHF converters, couplers, CCTV cameras and accessories provide better reception to more than 3 million TV receivers in the home, school, motels, hotels, hospitals and industry. To the nation's TV viewers, we dedicate our 10th Anniversary Line.

IT'S TRANSISTORIZED

to provide a new high in reliability—units can be left in operation indefinitely without damage from overheating. Practically eliminates need for service calls.

IT'S TRANSISTORIZED

to reduce operating costs — low power drain makes operating costs negligible. Also has battery plug for 22 volt DC supply.

IT'S TRANSISTORIZED

to achieve performance previously impossible —new circuitry (pat. pend.) provides maximum gain and minimum noise, high output capabilities with low cross modulation. Can be used with low input signals. Insures top performance for color and black-and-white TV, plus coverage of the FM radio band.

IT'S TRANSISTORIZED BLONDER-TONGUE BT-3

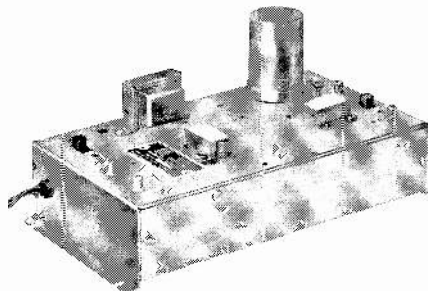

all
transistorized
broadband
tv/fm amplifier

More features to make the BT-3 ideal for master TV systems.....List 99.50

- Separate low band (Channels 2 to 6 and FM) and high band (Channels 7 to 13) inputs permit the use of separate low and high band antennas and insertion of attenuators, if necessary, to equalize signal levels from both bands. Also has provision for single input for combined high and low band signals.
- Convenient Output Monitor Jack permits system checking and adjustment without interrupting service.
- Solderless 75 ohm coax cable fittings—input and output 75 ohm.
- Gain: 18—15 db (channel 2-6); 19 db (7-13); 15—9 db (88-108 mc.).
- Maximum output: 0.7 volts max. for 1% cross modulation (total of both bands); 1.25 volts max. for 3% cross modulation (total of both bands).

Available at parts distributors. For further information write Dept. RE-6.



BLONDER-TONGUE LABORATORIES, INC. 9 Alling Street, Newark 2, New Jersey

In Canada: Teleequipment Mfg. Co., Ltd., London, Ont. Export: Morhan Export Corp., N. Y. 13, N. Y.



INTERCOM BOOSTER AIDS TV DIRECTOR

High noise levels won't muddle instructions to the TV cameraman if a booster amplifier is added to the studio's standard intercom system

By DONALD K. HAAHR

HERE comes a time in almost every station operation when intercommunication between director and cameramen is not loud enough to overcome ambient noise. The two most common program offenders are sportscasts and musicals. Quick camera changes during the climax are important, yet this is the time of greatest program volume. We have used three methods to solve this situation here at WOI-TV, and they seem to help enough to make them worth passing on to others.

The WOI-TV remote equipment is Du Mont, model 124E, and the studio has RCA TK-11-A cameras. In comparing both systems without modifications, the studio equipment has a far superior intercom system. The important difference is the operating voltage on the carbon-mike button. Du Mont supplied 8 volts at each operating location while RCA furnished this voltage to all locations with a common supply adjustable to 24 volts. However, on certain musical productions in the studio, even the RCA system was inadequate.



Headphones

Our first step toward improving this condition was to construct a bracket which mounts the microphone assembly of a Western Electric type 52AW transmitter to a surplus double-cushion headset (see photos).

Our crew likes them because they offer intercom to both ears, block unwanted sound from the normally unused ear, are rugged and more comfortable, especially in cold weather. The parts needed to make this modification are replacement parts for the Western Electric type 52AW headset, consisting of a No. L4AH 10-foot retractable cord, a 55AW transmitter, an N1 transmitter unit, a No. 310 plug, a P-458981 transmitter cap and a bracket we constructed as shown in the photos. Six of these are used on all our remotes as well as on

a large number of our regular studio programs.

Director intercom amplifier

Our second step was to try to operate at a higher talk level by incorporating an amplifier. The talk circuits normally use two-wire interconnection, and the impedance varies from 50 to 100 ohms with the number of headsets. Normally, the talk voltage was about 0.5 peak to peak, while the maximum, about 3 volts, seemed to be limited by cross-talk to the video circuits in the camera cable. However, a 3-volt level was comfortable and adequate, so an amplifier with a gain of about 10 was considered adequate.

In the amplifier we use, the cathode voltage of the first section of a 6201 is used to supply the carbon mike, gain is controlled in the grid circuit of the second stage, and the output is transformer-coupled to the line (Fig. 1). Having used the amplifier for more than a year, we find it fills a definite need. We have installed it at the director's position in the WOI-TV remote truck and connected it through the camera control unit. The normal flow of traffic is from the director, who is usually in the quieter location, which allows him to hear adequately without amplification. However, if the director is also in a noisy location, there is still the problem of his being able to hear at the increased level that the cameramen and floor director enjoy. So we added a key switch that allows the

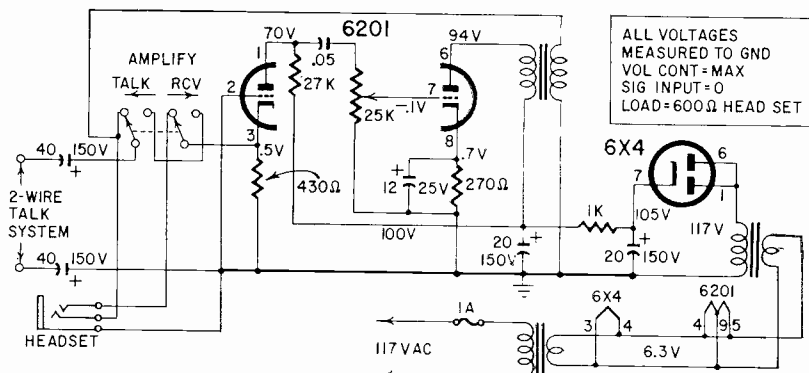
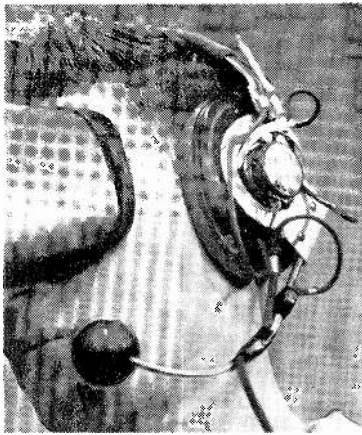

Fig. 1—Circuit of a vacuum-tube type intercom booster.



Simple bracket mounts mike assembly of Western Electric headset to surplus double-cushion headset.

director to have line audio amplified and his headset alone on the output. This still leaves the disadvantage that the director's mike will be amplified into his own earpiece.

Headset transistor booster

These efforts to improve intercommunication in the studio led us to conclude that it would be desirable to have an amplifier at each headset location. Each one should have its own volume control. If possible, the audio in the interconnection circuits should be at its original carbon-mike button output level. It would be desirable to have a self-contained power source and produce adequate signal levels at a low construction and maintenance cost.

We decided on a transistor amplifier with a self-contained power supply, high operating efficiency and low-impedance circuits. To maintain simplicity, we choose a circuit intended as a telephone pickup. Tests showed it worked satisfactorily into our series-wired low-impedance (600-ohm) headsets.

The first WOI-TV revision to the circuit called for adding a second coupling capacitor at the input to provide dc isolation as well as a single common to be used between the receiver (earpiece) transmitter (microphone) of the headset. Then a level control was added. It took the form of a 5,000-ohm pot in V2's collector circuit. It also reduced battery drain at lower volume levels. A 3,900-ohm resistor was tied across the level control to maintain sufficient dc on the collector and prevent distortion. A 75-ohm resistor was placed across the input side of the coupling capacitor to provide a low-resistance dc return for other headsets as well as to stabilize the high-capacitance input to the amplifier, Fig. 2.

The complete amplifier is built into a 2 1/4 x 2 1/4 x 4-inch case. Some difficulty was encountered with the size of some of the components, so a larger case might be advisable. To keep the entire circuit above ground, we used an insulated chassis made from 3/16-inch plexiglass.

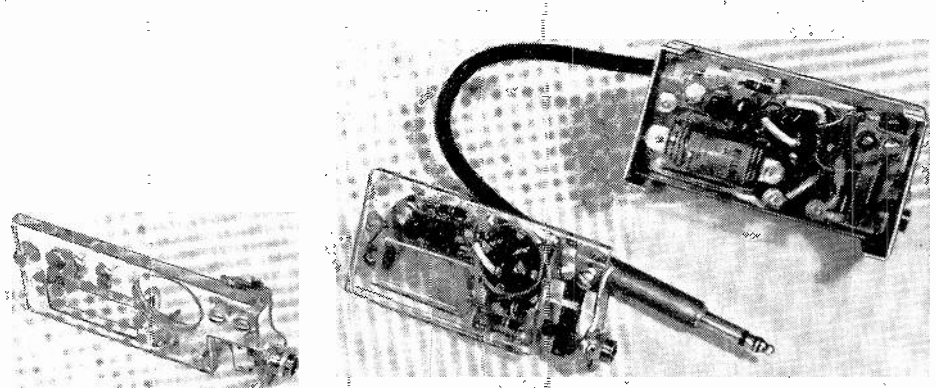

Three stages in the construction of the transistor booster: (front)—chassis drilled and jack J fastened in place; (middle)—all components mounted and wired; (top)—batteries in place and input cable connected.

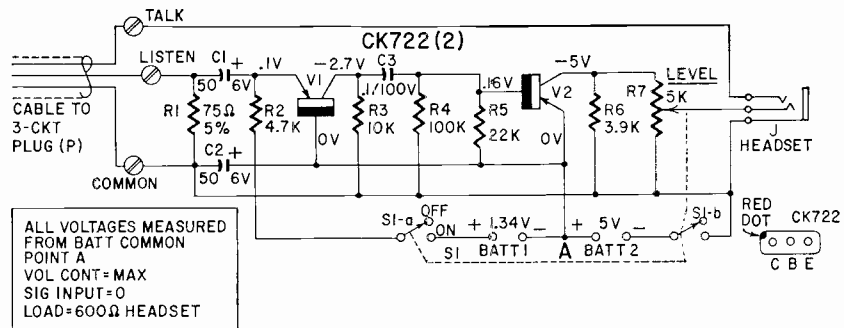

- R1—75 ohms, 5%
- R2—4,700 ohms
- R3—10,000 ohms
- R4—100,000 ohms
- R5—22,000 ohms
- R6—3,900 ohms
- R7—pot, 5,000 ohms with dpst switch
- All resistors 1/2-watt 10% unless noted
- C1, 2—50 µf, 6 volts, miniature electrolytics
- C3—1 µf, 100 volts, paper
- BATT1—1.34 volts, mercury (Mallory RM625R or equivalent)

- BATT2—5 volts, mercury (Mallory TR-114R or equivalent)
- J—telephone jack, 3 circuits
- P—telephone plug, 3 circuits
- SI—dpst on R7
- V1, 2—CK722
- Transistor sockets (2)
- Case, 4 x 2 1/4 x 2 1/4 inches
- Plexiglass chassis, 2 x 4 x 3/16 inches
- Broom clip
- Miscellaneous hardware

Fig. 2—A portable unit, this 2-transistor intercom booster is powered by long-life built-in batteries.

It was drilled and tapped for 4-36 screws to mount all solder lugs and battery clips. A piece of fiberboard was used to insulate the three-circuit jack from the case. The battery case for the nonstandard combination of batteries was made by cementing a split piece of 3/4-inch plexiglass tube to the bottom side of the chassis and cutting a hole large enough to allow the batteries to slip through. Metal clips are mounted at each end of the holder to make electrical connections, and a small spring inserted to maintain tension on these clips. The rest of the assembly is fairly

straightforward. We find that spring-steel broom clips are handy for attaching the amplifier to the camera pan handle.

We have used these amplifiers about 3 hours per week for the last 3 months on remotes, as well as in our microwave communications system, and find them very satisfactory. No batteries have had to be replaced, which speaks well for the operating economy.

I wish to acknowledge my indebtedness to Thomas F. West, Leo E. Runge, Keith Ketcham and Chuck Benn for their valuable assistance. END

Fig. 3—Chassis layout for transistor intercom booster.

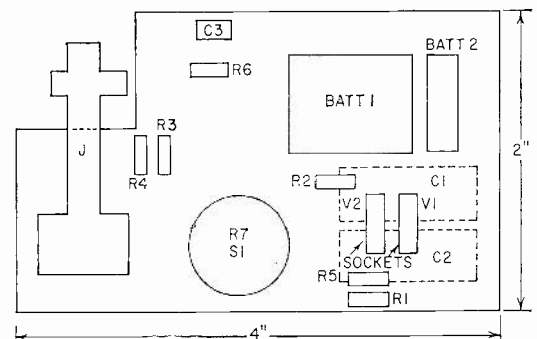

SUPERIOR'S
NEW MODEL 77

VACUUM TUBE VOLTMETER

WITH NEW 6" FULL-VIEW METER

Compare it to any peak-to-peak V.T.V.M. made by any other manufacturer at any price

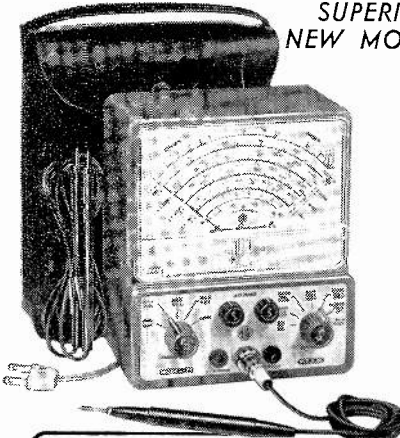

Model 77—VACUUM TUBE VOLTMETER
... Total Price \$42.50—Terms: \$12.50 after 10 day trial, then \$6.00 monthly for 5 months if satisfactory. Otherwise return, no explanation necessary!

- ✓ Model 77 completely wired and calibrated with accessories (including probe, test leads and portable carrying case) sells for only \$42.50.
- ✓ Model 77 employs a sensitive six inch meter. Extra large meter scale enables us to print all calibrations in large easy-to-read type.
- ✓ Model 77 uses new improved SICO printed circuitry.
- ✓ Model 77 employs a 12AU7 as D.C. amplifier and two 9006's as peak-to-peak voltage rectifiers to assure maximum stability.

AS A DC VOLTMETER: The Model 77 is indispensable in Hi-Fi Amplifier servicing and a must for Black and White and color TV Receiver servicing where circuit loading cannot be tolerated.

AS AN AC VOLTMETER: Measures RMS values of sine wave, and peak-to-peak value if complex wave. Pedestal voltages that determine the "black" level in TV receivers are easily read.

AS AN ELECTRONIC OHMMETER: Because of its wide range of measurement, leaky capacitors show up glaringly. Because of its sensitivity and low loading, intermittents are easily found, isolated and repaired.

Model 77 comes complete with operating instructions, probe and test leads. Use it on the bench—use it on calls. A streamlined carrying case, included at no extra charge, accommodates the tester, instruction book, probe and leads. Operates on 110-120 volt 60 cycle. Only.....

- ✓ Model 77 uses a selenium-rectified power supply resulting in less heat and thus reducing possibility of damage or value changes of delicate components.
- ✓ Model 77 meter is virtually burn-out proof. The sensitive 400 microampere meter is isolated from the measuring circuit by a balanced push-pull amplifier.
- ✓ Model 77 uses selected 1% zero temperature coefficient resistors as multipliers. This assures unchanging accurate readings on all ranges.

SPECIFICATIONS

• DC VOLTS—0 to 3/15/75/150/300/750/1,500 volts at 11 megohms input resistance. • AC VOLTS (RMS)—0 to 3/15/75/150/300/750/1,500 volts. • AC VOLTS (Peak to Peak)—0 to 8/40/200/400/800/2,000 volts. • ELECTRONIC OHMMETER—0 to 1,000 ohms/10,000 ohms/100,000 ohms/1 megohm/10 megohms/100 megohms/1,000 megohms • DECIBELS—10 db to +18 db, +10 db to +38 db +30 db to +58 db. All based on 0 db = .006 watts (6 mw) into a 500 ohm line (1.73V). • ZERO CENTER METER—For discriminator alignment with full scale range of 0 to 1.5/7.5/37.5/75/150/375/750 volts at 11 megohms input resistance.

\$42⁵⁰
NET

SUPERIOR'S NEW
MODEL 79

SUPER-METER WITH NEW 6" FULL-VIEW METER

A Combination VOLT-OHM MILLIAMMETER.
Plus CAPACITY, REACTANCE, INDUCTANCE AND DECIBEL MEASUREMENTS. Also Tests SELENIUM AND SILICON RECTIFIERS, SILICON AND GERMANIUM DIODES.

Specifications

D.C. VOLTS: 0 to 7.5/15/75/150/750/1,500.
A.C. VOLTS: 0 to 15/30/150/300/1,500/3,000.
D.C. CURRENT: 0 to 1.5/15/150 Ma, 0 to 1.5/15 Amperes.
RESISTANCE: 0 to 1,000/100,000 Ohms, 0 to 10 Megohms.
CAPACITY: .001 to 1 Mfd, 1 to 50 Mfd.
REACTANCE: 50 to 2,500 Ohms, 2,500 Ohms to 2.5 Meg-ohms.
INDUCTANCE: .15 to 7 Henries, 7 to 7,000 Henries.
DECIBELS: -6 to +18, +14 to +38, +34 to +58.
The following components are all tested for QUALITY at appropriate test potentials. Two separate BAD-GOOD scales on the meter are used for direct readings.
All Electrolytic Condensers from 1 MFD to 1000 MFD.
All Selenium Rectifiers. All Germanium Diodes.
All Silicon Rectifiers. All Silicon Diodes.

Model 79 comes complete with operating instructions and test leads. Use it on the bench—use it on calls. A streamlined carrying case included at no extra charge accommodates the tester, instruction book and test leads.....only

The Model 79 represents 20 years of continuous experience in the design and production of SUPER-METERS, an exclusive SICO development.
In 1938 Superior Instruments Co. designed its first SUPER-METER, Model 1150. In 1940 it followed with Model 1250 and in succeeding years with others including Models 670 and 670-A. All were basically V.O.M.'s with extra services provided to meet changing requirements.

Now, Model 79, the latest SUPER-METER includes not only every circuit improvement perfected in 20 years of specialization, but in addition includes those services which are "musts" for properly servicing the ever increasing number of new components used in all phases of today's electronic production. For example with the Model 79 SUPER-METER you can measure the quality of selenium and silicon rectifiers and all types of diodes—components which have come into common use only within the past five years, and because this latest SUPER-METER necessarily required extra meter scale, SICO used its new full-view 6-inch meter.

\$38⁵⁰
NET

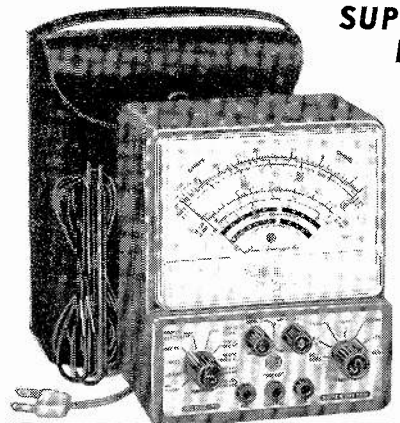

Model 79—SUPER-METER ... Total Price \$38.50—Terms: \$8.50 after 10 day trial, then \$6.00 per month for 5 months if satisfactory. Otherwise return, no explanation necessary!

GENOMETER

7 Signal Generators in One!

- ✓ R.F. Signal Generator for A.M.
- ✓ R.F. Signal Generator for F.M.
- ✓ Audio Frequency Generator
- ✓ Bar Generator
- ✓ Cross Hatch Generator
- ✓ Color Dot Pattern Generator
- ✓ Marker Generator

A versatile all-inclusive GENERATOR which provides ALL the outputs for servicing:

A.M. Radio • F.M. Radio • Amplifiers • Black and White TV • Color TV

R. F. SIGNAL GENERATOR: The Model TV-50A Genometer provides complete coverage for A.M. and F.M. alignment. Generates Radio Frequencies from 100 Kilocycles to 60 Megacycles on fundamentals and from 60 Megacycles to 180 Megacycles on powerful harmonics.

DOT PATTERN GENERATOR (FOR COLOR TV) Although you will be able to use most of your regular standard equipment for servicing Color TV, the one addition which is a "must" is a Dot Pattern Generator. The Dot Pattern projected on any color TV Receiver tube by the Model TV-50A will enable you to adjust for proper color convergence.

VARIABLE AUDIO FREQUENCY GENERATOR: In addition to a fixed 400 cycle sine-wave audio, the Model TV-50A Genometer provides a variable 300 cycle to 20,000 cycle peak wave audio signal.

MARKER GENERATOR: The Model TV-50A includes all the most frequently needed marker points. The following markers are provided: 189 Kc., 262.5 Kc., 456 Kc., 500 Kc., 1000 Kc., 1400 Kc., 1600 Kc., 2000 Kc., 2500 Kc., 3579 Kc., 4.5 Mc., 5 Mc., 10.7 Mc. (3579 Kc. is the color burst frequency).

BAR GENERATOR: The Model TV-50A projects an actual Bar Pattern on any TV Receiver Screen. Pattern will consist of 4 to 16 horizontal bars or 7 to 20 vertical bars.

THE MODEL TV-50A comes absolutely complete with shielded leads and operating instructions.

\$47⁵⁰
NET

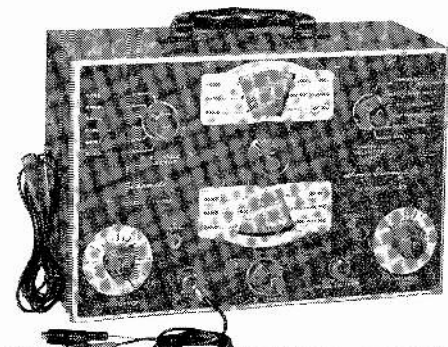

Model TV-50A—Genometer. Total price—\$47.50—Terms: \$11.50 after 10 day trial, then \$6.00 monthly for 6 months if satisfactory. Otherwise return, no explanation necessary!

CROSS HATCH GENERATOR: The Model TV-50A Genometer will project a cross-hatch pattern on any TV picture tube. The pattern will consist of non-shifting, horizontal and vertical lines interlaced to provide a stable cross-hatch effect.

EXAMINE BEFORE YOU BUY!
USE APPROVAL FORM ON NEXT PAGE

SUPERIOR'S NEW MODEL TW-11

STANDARD PROFESSIONAL

TUBE TESTER

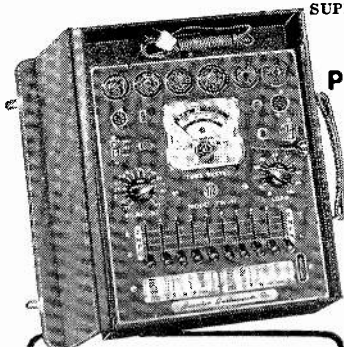

Model TW-11—Tube Tester
 Total Price\$47.50
 Terms: \$11.50 after 10 day trial, then \$6.00 monthly for 6 months if satisfactory. Otherwise return, no explanation necessary.

★ Tests all tubes, including 4, 5, 6, 7, Octal, Lock-in, Hearing Aid, Thyatron, Miniatures, Sub-miniatures, Novals, Subminars, Proximity fuse types, etc.

★ Uses the new self-cleaning Lever Action Switches for individual element testing. Because all elements are numbered according to pin-number in the RMA base numbering system, the user can instantly identify which element is under test. Tubes having tapped filaments and tubes with filaments terminating in more than one pin are truly tested with the Model TW-11 as any of the pins may be placed in the neutral position when necessary.

★ The Model TW-11 does not use any combination type sockets. Instead individual sockets are used for each type of tube. Thus it is impossible to damage a tube by inserting it in the wrong socket.

★ Free-moving built-in roll chart provides complete data for all tubes. All tube listings printed in large easy-to-read type.

NOISE TEST: Phono-jack on front panel for plugging in either phones or external amplifier will detect microphonic tubes or noise due to faulty elements and loose internal connections.

EXTRAORDINARY FEATURE

SEPARATE SCALE FOR LOW-CURRENT TUBES: Previously, on emission-type tube testers, it has been standard practice to use one scale for all tubes. As a result, the calibration for low-current types has been restricted to a small portion of the scale. The extra scale used here greatly simplifies testing of low-current types.

The Model TW-11 operates on 105-130 Volt 60 Cycles A.C. Comes housed in a handsome portable saddle-stitched Texon Case. Only **\$47⁵⁰**

SUPERIOR'S NEW MODEL 82A

Multi-Socket Type

TUBE TESTER

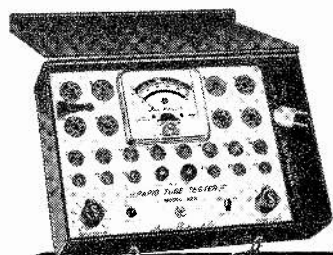

Model 82A—Tube Tester
 Total Price\$36.50
 Terms: \$6.50 after 10 day trial, then \$6.00 monthly for 5 months if satisfactory. Otherwise return, no explanation necessary.

TEST ANY TUBE IN 10 SECONDS FLAT!

- 1 Turn the filament selector switch to position specified.
- 2 Insert tube into a numbered socket as designated on our chart (over 600 types included).
- 3 Press down the quality button—

THAT'S ALL! Read emission quality direct on bad-good meter scale.

SPECIFICATIONS

- Tests over 600 tube types
- Tests OZ4 and other gas-filled tubes
- Employs new 4" meter with sealed air-damping chamber resulting in accurate vibrationless readings
- Use of 22 sockets permits testing all popular tube types and prevents possible obsolescence
- Dual Scale meter permits testing of low current tubes
- 7 and 9 pin straighteners mounted on panel
- All sections of multi-element tubes tested simultaneously
- Ultra-sensitive leakage test circuit will indicate leakage up to 5 megohms

Production of this Model was delayed a full year pending careful study by Superior's engineering staff of this new method of testing tubes. **Don't let the low price mislead you!** We claim Model 82A will outperform similar looking units which sell for much more — and as proof, we offer to ship it on our examine before you buy policy.

To test any tube, you simply insert it into a numbered socket as designated, turn the filament switch and press down the quality switch — **THAT'S ALL!** Read quality on meter. Inter-element leakage if any indicates automatically.

Model 82A comes housed in handsome, portable Saddle-Stitched Texon case. Only **\$36⁵⁰**

SUPERIOR'S NEW MODEL 83

C. R. T. TESTER

TESTS AND REJUVENATES ALL PICTURE TUBES

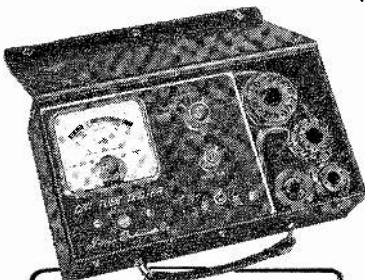

Model 83—C.R.T. Tube Tester
 Total Price\$38.50
 Terms: \$8.50 after 10 day trial, then \$6.00 monthly for 5 months if satisfactory. Otherwise return, no explanation necessary.

ALL BLACK AND WHITE TUBES

From 50 degree to 110 degree types — from 8" to 30" types.

ALL COLOR TUBES

Test ALL picture tubes—in the carton—out of the carton—in the set!

- Model 83 is not simply a rehashed black and white C.R.T. Tester with a color adapter added. Model 83 employs a new improved circuit designed specifically to test the older type black and white tubes, the newer type black and white-tubes and all color picture tubes.
- Model 83 provides separate filament operating voltages for the older 6.3 types and the newer 8.4 types.
- Model 83 employs a 4" air-damped meter with quality and calibrated scales.
- Model 83 properly tests the red, green and blue sections of color tubes individually—for each section of a color tube contains its own filament, plate, grid and cathode.

- Model 83 will detect tubes which are apparently good but require rejuvenation. Such tubes will provide a picture seemingly good but lacking in proper definition, contrast and focus. To test for such malfunction, you simply press the rej. switch of Model 83. If the tube is weakening, the meter reading will indicate the condition.
- Rejuvenation of picture tubes is not simply a matter of applying a high voltage to the filament. Such voltages improperly applied can strip the cathode of the oxide coating essential for proper emission. The Model 83 applies a selective low voltage uniformly to assure increased life with no danger of cathode damage.

Model 83 comes housed in handsome portable Saddle Stitches Texon case—complete with sockets for all black and white tubes and all color tubes. Only **\$38⁵⁰**

SHIPPED ON APPROVAL NO MONEY WITH ORDER — NO C. O. D.

Try any of the instruments on this or the facing page for 10 days before you buy. If completely satisfied then send down payment and pay balance as indicated on coupon. **No Interest or Finance Charges Added!** If not completely satisfied return unit to us, no explanation necessary.

MOSS ELECTRONIC, INC.

Dept. D-764, 3849 Tenth Ave., New York 34, N.Y.

Please send me the units checked on approval. If completely satisfied I will pay on the terms specified with no interest or finance charges added. Otherwise, I will return after a 10 day trial positively cancelling all further obligations.

- Model 77.....Total Price \$42.50 \$12.50 within 10 days. Balance \$6.00 monthly for 5 months.
- Model 79.....Total Price \$38.50 \$8.50 within 10 days. Balance \$6.00 monthly for 5 months.
- Model TV-50A.....Total Price \$47.50 \$11.50 within 10 days. Balance \$6.00 monthly for 6 months.

- Model TW-11.....Total Price \$47.50 \$11.50 within 10 days. Balance \$6.00 monthly for 6 months.
- Model 82A.....Total Price \$36.50 \$6.50 within 10 days. Balance \$6.00 monthly for 5 months.
- Model 83.....Total Price \$38.50 \$8.50 within 10 days. Balance \$6.00 monthly for 5 months.

Export Division: Rocke International Corp., 13 East 40th St., New York 16, N.Y.

Name.....

Address.....

City..... Zone..... State.....

All prices net, F.O.B., N. Y. C.

about those color

tv controls

By ROBERT G. MIDDLETON

SERVICE technicians now tackling practical work in color TV servicing and installation are often baffled by the many names used for the same service controls. The chart lists these names, defines control function, usual location of the controls, results of misadjustment and notes interaction where it exists. This is a tabulation to be tacked over your bench for ready reference. There's a trend toward standard naming of controls. In the meantime, we have to be on our toes!

FUNCTION	NAMES	LOCATION	DESCRIPTION	RESULT OF MISADJUSTMENT	INTERACTION
Center-screen convergence (Fig. 1-a).	Beam-positioning, static convergence, converging or beam-correcting magnets; dc convergence controls.	On convergence yoke (neck of pix tube) or front access panel (Fig. 1-b).	Magnets turn or slide in neck assembly. Pots adjust dc through coils on convergence yoke.	Color fringing in monochrome pix.	Each control shifts other two somewhat.
Sideways motion of blue beam (Fig. 2). Used with above controls.	Blue lateral corrector, blue lateral magnet, blue lateral beam magnet; blue convergence control.	On pix-tube neck (looks like ion trap). May be directly over blue gun or at 2 o'clock to it (Fig. 7). May be pot on front access panel.	Usually PM slug which turns or slides in strap or ring. Rarely, pot which adjusts dc in coil on pix-tube neck.	Color fringing in monochrome pix.	Shifts adjustment of 3 above controls to some extent, most in 2 o'clock position.
Center-screen color purity (Fig. 4).	Purity magnets or device; color purity control or magnet; purity current control.	On pix-tube neck. (Looks like centering magnets on monochrome set.) On older sets pot on chassis.	Flat ring magnets with projecting tabs rotate on tube neck.	Raster tinting in monochrome picture. Localized incorrect hues in color pix.	With convergence and centering controls slightly.
Center-screen color purity.	Deflection yoke.	On pix-tube neck as in monochrome receiver.	Larger than monochrome yoke. Movable in all directions. Moved along pix-tube neck for purity.	(As above.) Also tilts raster if rotated incorrectly. Must be centered on tube neck.	With purity and convergence controls.
Color purity around screen edges.	Rim magnets; field-neutralizing, dc purity, rim coil control; field equalizer, swivel, color equalizer magnet.	Usually around pix-tube rim. Sometimes pot on front access panel.	Individual permanent magnets or coil around pix-tube rim. Sometimes coil and permanent magnets.	Raster tinting at edges of screen in monochrome pix. Incorrect hues in color pix.	With convergence controls to some extent.
Lower convergence-magnet cores to neck of pix tube.	Retraction lever. (Used on older-model sets.)	On back of deflection yoke, between it and convergence yoke.	Flat lever with spring followup. Thrown to lift magnets from tube neck for shipment.	Convergence impossible unless lever thrown to lower magnets.	None

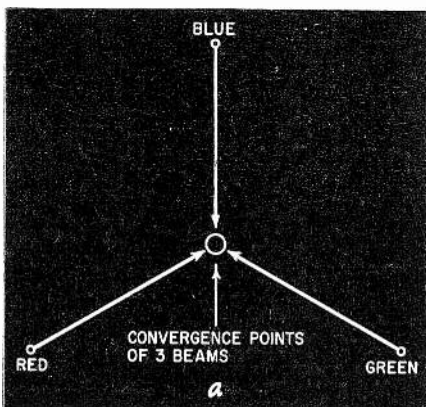

Fig. 1—a—Color dot motions resulting from adjusting the three beam magnets; b—set-up controls on access panel. Note the three static controls at the left which produce the dot motions in a.

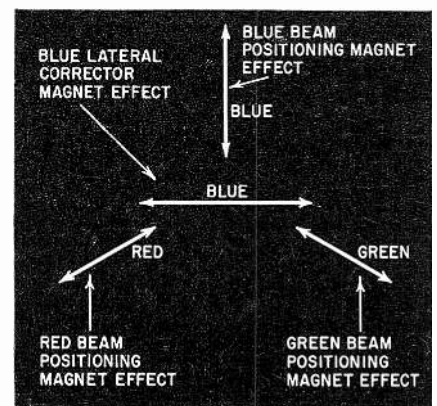
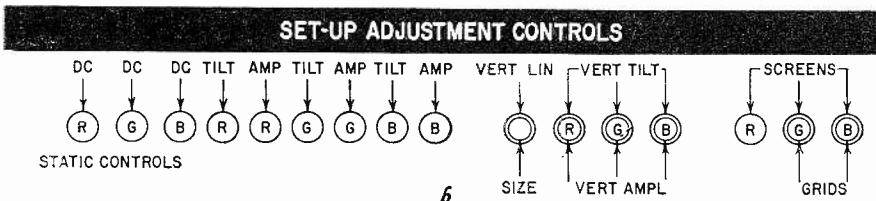

Fig. 2—Another control—the blue lateral—moves the blue beam left or right.

FUNCTION	NAMES	LOCATION	DESCRIPTION	RESULT OF MISADJUSTMENT	INTERACTION
Protect owner from shock if back board removed.	High-voltage interlock. (Not on all receivers.)	On back of high-voltage cage.	Plastic tube containing center pin and flat grounding springs.	Set inoperable with back board off, unless HV cheater inserted (Fig. 5). ²	None
Adjust chroma signal voltage.	Color-intensity chroma gain, color, color-saturation, color-contrast or chroma control.	Front or side of cabinet. (Operating control.)	Knob control. Adjusts vividness of color in picture.	Too low; color pix weak, washed out. Too high; colors objectionably vivid.	Negligible interaction with other controls.
Adjust chroma signal phase.	Color-phasing, color-fidelity, hue or color-shading control.	Front or side of cabinet. (Operating control.)	Knob control. Adjusts color spectrum.	All hues in color pix appear in wrong colors.	Normally negligible. Interaction if color sync unstable.
Converging top and bottom of screen.	Vertical amplitude, parabola or dynamic amplitude control. (3 controls: 1 each red, green, blue.)	Back or front chassis apron, or in separate convergence box (Fig. 1-b).	Pot control. Adjusts convergence current through convergence coils.	Color fringing in monochrome pix.	With other convergence controls.
Converging top and bottom of screen.	Vertical tilt, sawtooth or phase control. (3 controls: 1 each red, green, blue.)	Back or front chassis apron, or in separate convergence box (Fig. 1-b).	Pot control. Adjusts phase of ac through convergence coils.	Color fringing in monochrome pix.	With other convergence controls.
Converging left and right sides of screen.	Horizontal amplitude parabola or dynamic amplitude control. (3 controls: 1 each red, green, blue.)	Back or front chassis apron, or in separate convergence box (Fig. 1-b).	Pot. Adjusts ac through convergence coils.	Color fringing in monochrome pix.	With other convergence controls.
Converging left and right sides of screen.	Horizontal phasing, tilt or dynamic phasing control. (3 controls: 1 each red, green, blue.)	Back or front chassis apron, or in separate convergence box (Fig. 1-b).	Pot or slug. Adjusts phase of ac through convergence coils.	Color fringing in monochrome pix.	With other convergence controls.
Tracking electron guns in color pix tube.	Screen control, G2 control. (3 controls: 1 each red, green, blue.)	Behind operating control panel, on back or front chassis apron, or in convergence control box.	Pot adjusts bias on pix-tube screen grid.	Tinting in monochrome pix.	With background and brightness controls.
Tracking electron guns in color pix tube.	Background difference, G1 or grid control. (3 controls: 1 each red, green, blue.)	Behind operating control panel, on back or front chassis apron, or in convergence control box.	Pot adjusts bias on pix-tube control grid.	Tinting in monochrome pix.	With screen and brightness controls.

¹Pot, when present, adjusts current through rim coil. Perhaps reversing slide switch also.
²Failure to insert cheater can damage HV rectifier or flyback or blow HV fuse.

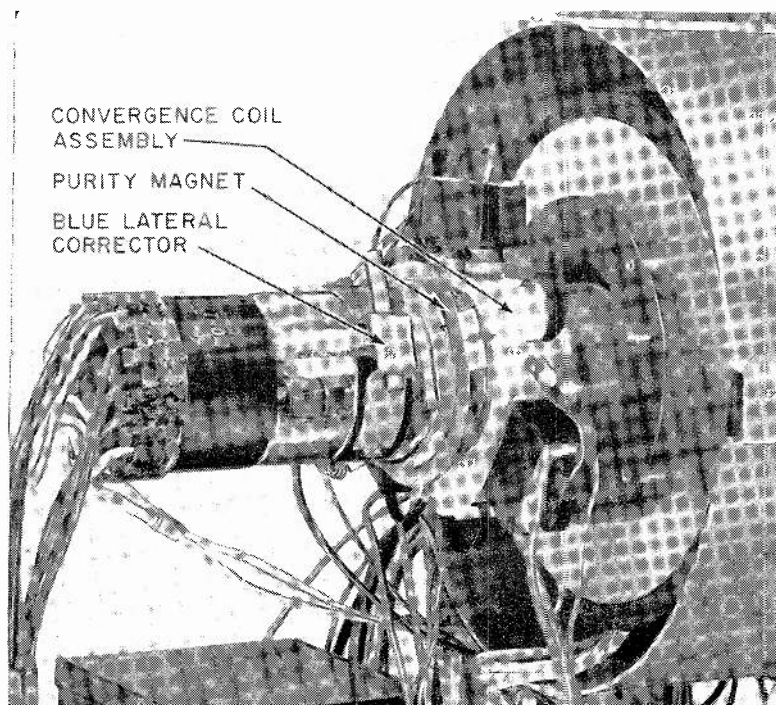

Fig. 3—The blue lateral corrector is mounted in the 2 o'clock position in this Admiral receiver.

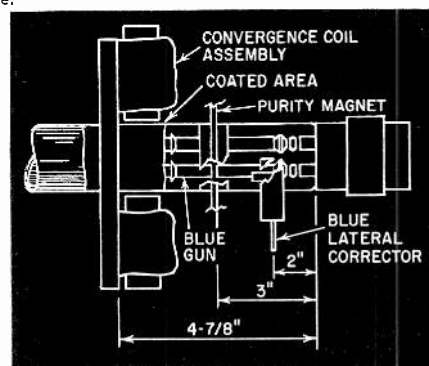

Fig. 4—Typical locations of purity magnet(s), blue lateral corrector and convergence coil assembly on neck of a color picture tube.

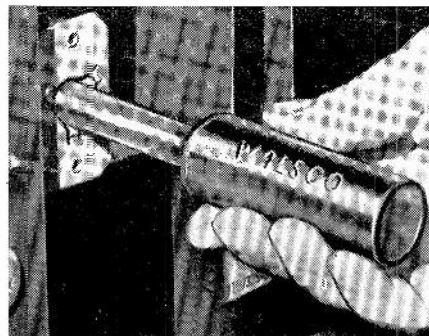
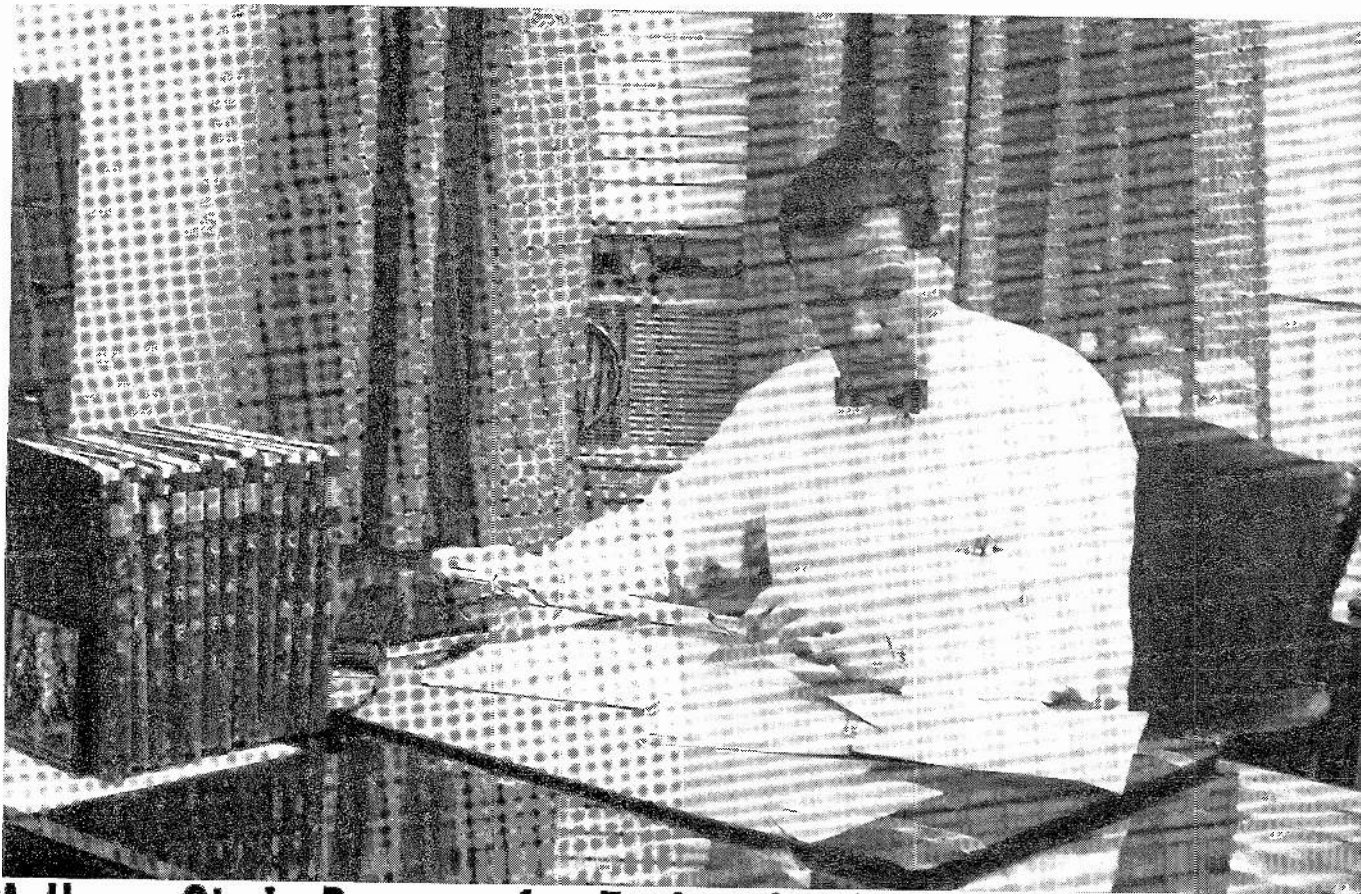

Fig. 5—Technician inserting high-voltage cheater into high-voltage interlock.



A Home Study Program for Engineering Technicians and Professional Engineers Comparable in Technological Content to College-Level Electronics Residence Courses.

CREI's Extension Division offers combinations of courses in advanced electronics engineering technology to meet present or future employment requirements, and step up your earning power.

A CREI program, the product of 33 years experience, is neither short-cut nor magic formula. It is an accredited home study curriculum which may take as little as 18 months, or as much as 3 years, depending upon the course selected and amount of stick-to-itiveness brought to bear. The program is designed specifically for men employed in a technical capacity in the electronics industry, where a shortage of manpower with advanced technical education not only exists, but shows every likelihood of increasing.

Now fifth in volume among American industries, the elec-

tronics industry offers almost unlimited employment and advancement opportunities. Applications of new electronic developments in automation, instrumentation, industrial electronics, aeronautical electronics, guided missiles, servomechanisms, computers, astronautics and telemetering create new jobs every day. Yet, paradoxically, industry growth does not always mean individual growth. Companies actively seeking men with modern, advanced technological knowledge are simultaneously firing mediocre men who lack this knowledge.

CREI students (more than

20,400 are currently enrolled) keep pace with the needs of the ever-advancing electronics industry and are eagerly sought by employers who offer solid opportunities for rapid promotion.

Since 1927 we have directed the technical education of students in advanced electronics engineering technology. We developed the prototype civilian electronics course for the Army Signal Corps in 1941, supplied 300,000 texts to the U. S. Navy in a special course for radio technicians in the South Pacific in 1943, trained hundreds of technicians during World War II for the Signal Corps. We co-founded

the National Council of Technical Schools, which first established scholastic and business standards for the technical school field. We were among the first three technical institutes whose curricula were accredited by the Engineers' Council for Professional Development. In 1946 we instituted the group training programs used by companies representing the cream of the electronics and aviation industries. CREI courses are widely employed today in company-sponsored educational plans by companies throughout the U. S. and Canada.

What does this record of achievement mean to you as a CREI student? It means that industry and the Armed Services alike respect CREI men. It means that your CREI diploma is a door-opener. Significantly, Help Wanted ads often specify "CREI education or equivalent required." Our Placement Bureau, which helps graduates and advanced students find more desirable positions, is always available to CREI men. While no placement guarantees will be made by CREI or any other reputable institution, for many years the demand for CREI graduates and advanced students has far exceeded the supply.

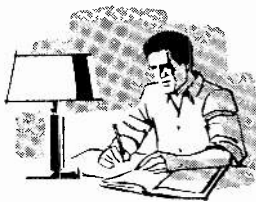

CREI HOME STUDY ADVANTAGES.

This advanced technical education is accomplished on your own time, during hours chosen by you. You waste no time in travel. You have plenty of time to do your best. Your work is under the supervision of a regular staff instructor who guides your progress step by step. Courses are prepared and taught by men experienced both in teaching and in electronics, presented in easy-to-understand form, kept up to date by periodic revision. Experience in more than three decades of home-study teaching, during which time we have corrected and commented on many hundreds of thousands of examinations, en-

ables us to anticipate questions in our lesson material.

CREI STUDENTS are professional electronics engineers and technicians, all over the world and in every phase of electronics, about one-third military, the rest civilian. Their median age is 28. In 1958 they devoted approximately 1,572,400 hours to 104,831

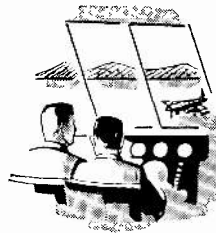

lesson texts, answered and were individually graded upon 1,048,310 searching questions and engineering problems. They studied advanced electronics engineering technology associated with transistors, microwaves, forward scatter, computers, servomechanisms, radar, electronic navigational devices and the entire field of modern electronics. New students enrolled during the year are on the missile ranges of

Vandenburg AF Base and Cape Canaveral. They are at Alamogordo and China Lake, at SAC bases around the world. They are in the research laboratories and manufacturing plants where the latest

electronic equipment is designed and produced. They maintain electronic equipment for United Air Lines, and Trans-Canada Air Lines. They share in electronics at All America Cables and Radio, Inc., and The Martin Co. They work for USIA (Voice of America) and Columbia Broadcasting System, for Gates Radio and Federal Electric, to name but a few. All of the firms mentioned offer their personnel CREI education under company sponsorship. CREI men are found by the hundreds among field engineers of major electronic manufacturers. They're across the world and across the street. They're men

you'll compete with—to gain or hold your place in the electronics profession.

If ambition is part of your make-up—if you

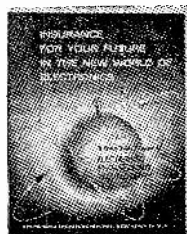

want to convert interest and energy into dollars of income—if you want to convert your spare evening hours into material benefit and the personal satisfaction that comes with advancement and respect of your associates—then CREI's home study education assures you of:

1. A solid foundation of college-level, advanced technical electronic engineering knowledge.

2. A means of keeping abreast of the complex developments in electronics.

3. The ability to communicate intelligently with your engineering associates and superiors.

4. The best preparation for professional advancement in electronics as the industry demands more qualified personnel.

QUALIFICATIONS FOR CREI. College degree is not essential. If you have had basic electronic education, practical experience in electronics and a high school education, you can probably qualify. A good way to find out: Use the postage-paid card. It will bring you the free 54-page book which has launched thousands on their advanced careers: "Insurance for Your Future in the New World of Electronics." Tuition is reasonable and may be paid monthly. It takes just one \$10-a-week raise to repay your investment in CREI education and leave you a substantial bonus the first year. Available to veterans under GI bill.



RESIDENCE SCHOOL in Washington, D. C. for those who can attend classes. Day and evening classes start at regular intervals. Qualified graduates earn AAS degree in approximately 27 months. Electronics experience not required for admission.

CAPITOL RADIO ENGINEERING INSTITUTE

ECPD Accredited Technical Institute
Curricula. Founded 1927

Dept. 1406-G-1
3224 16TH ST., N.W.
WASHINGTON 10, D. C.

EE

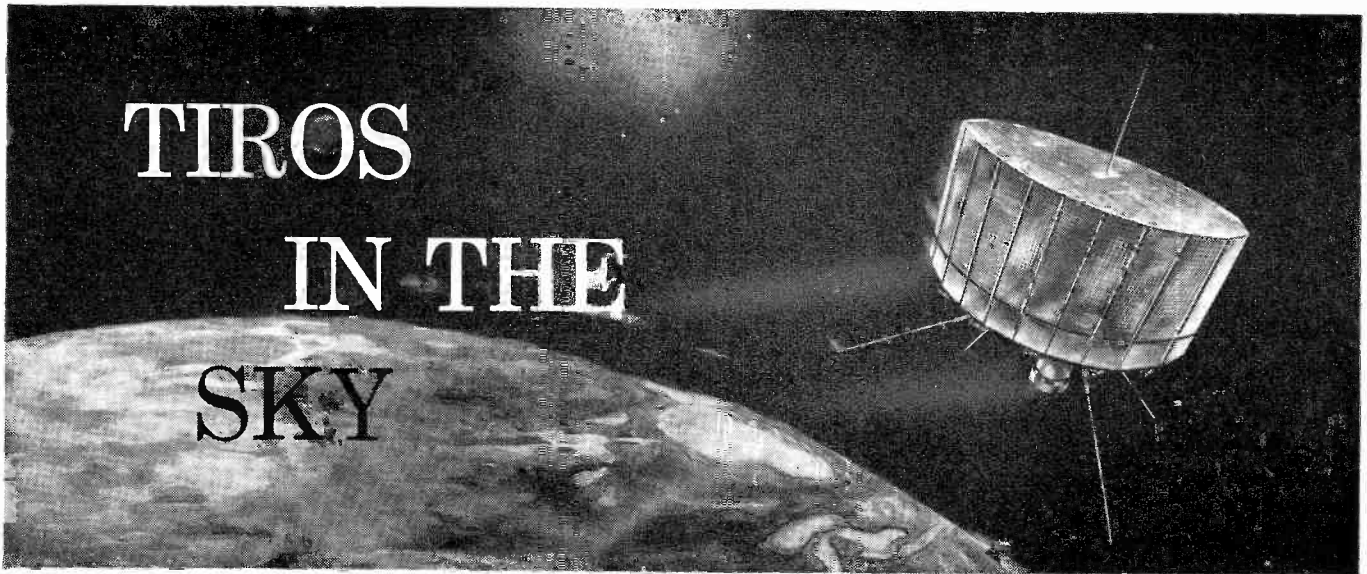

By **LARRY STECKLER**
ASSOCIATE EDITOR

IN the early morning hours of April 1, 1960, a Thor-Able satellite-carrying rocket left Cape Canaveral, Fla., to mark a new high in space technology. The satellite, named *TIROS I*—Television, Infra-Red, Observation Satellite, now orbits the earth once every 90 minutes and travels at about 18,000 mph. It is packed with 250 pounds of TV cameras, tape recorders, TV and radio transmitters and receivers, and other electronic equipment with an outer wrapping of more than 9,000 solar cells.

The satellite itself is shaped like a large drum. It measures 42 inches in diameter, is 19 inches high and weighs 250 pounds. The photos show internal and external views of *TIROS I* and the various components are pointed out.

The main purpose of *TIROS I* is to photograph the cloud cover around the earth and transmit this information to tracking stations. Such photos give meteorologists cloud patterns that indicate the birth or existence of hurricanes, cyclones and other weather activity. It is hoped that these pictures will also give meteorologists a better understanding of the causes of our weather. Mosaics made up of *TIROS I* photographs are expected to aid in making more accurate long-range and immediate weather forecasts.

(It is interesting to note that *TIROS I* was foreshadowed in Hugo Gernsback's *Forecast 1959*, a Christmas booklet issued in December, 1958. The Television Space Observatory, pictured on the cover of that booklet, would, among much other equipment, carry a TV camera, to record "... the birth of every major storm, tornado, hurricane or typhoon. Every snowstorm or other atmospheric disturbance will be observed ... then tracked if deemed necessary." Other equipment described as part of TVSO's complement is also used by *TIROS I*.)

TV camera system

To do its job, *TIROS I* has two TV cameras. Each one is about the size of a water glass and uses a 1/2-inch vidicon tube and a focal-plane shutter. One has a wide-angle lens that photographs an area that measures 800 miles on a side. The other camera has a narrow-angle lens to get more detailed pictures (80 miles on a side).

The cameras are designed to take a series of 32 still pictures and record them on magnetic tape. Then they are stored until played back to a ground station on request. The recorders hold a reel of 400 feet of 1/2-inch Mylar-base tape which moves at 50 ips during recording and playback—3 1/2 minutes to

play back all 32 photos. As the pictures are played back and transmitted to earth, the tape is erased, preparing it for further recording of new pictures on its next orbit.

Besides recording the pictures, the recorder also tapes coded signals that indicate the rotational position of the satellite as a time reference to help identify the pictures when they are received on the ground. *TIROS I* carries small infrared detectors to sense the heat radiation of the earth as the satellite spins. As the scanners sweep across the earth, a pulse is developed. Signals marking the beginning and end of each pulse are sent to a ground station where they are timed and re-

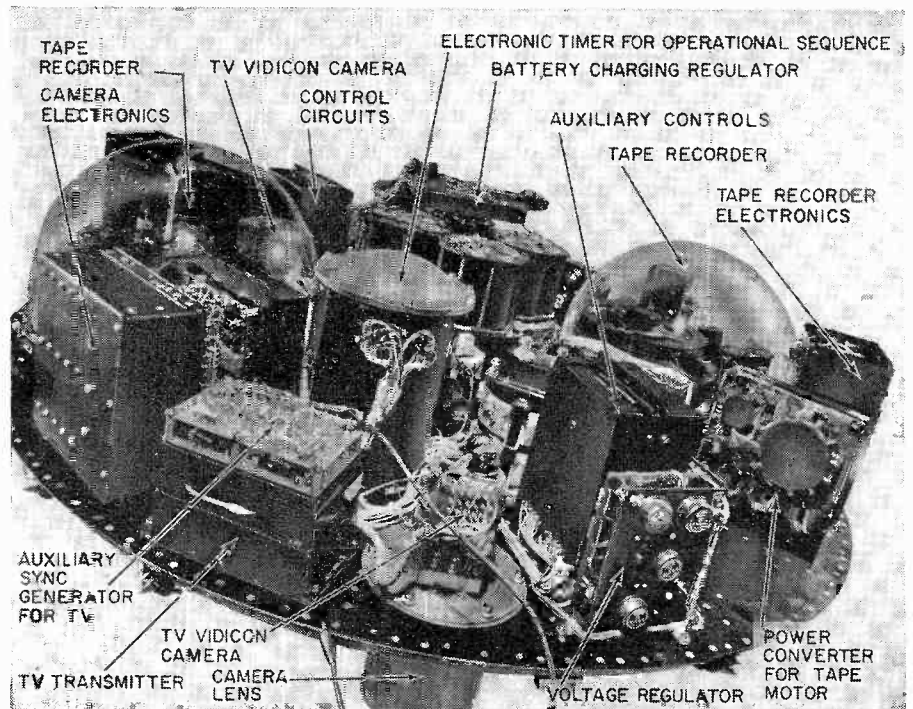

With its outer shell of solar cells removed, the internal electronic systems of *TIROS I* are revealed.

corded on punched tape. This recorded data is then processed to give an accurate account of the spin axis attitude of the satellite in its orbit.

After picture taking is completed and the satellite comes within range of a ground station, a command signal turns on the TV recorders and transmitters and sends the pictures to earth. If the TV cameras are pointing earthward when the satellite is within range of a ground station, pictures can be taken and relayed directly to the ground station, bypassing the tape recorders. This gives somewhat better reproduction. Some of the photos taken by TIROS I are shown on these pages.

Each camera-tape recorder team has its own transmitter, a 2-watt FM unit that operates in the 200-mc band. They transmit only on command while the satellite is within transmitting range of a ground station.

Two electronic timing mechanisms, one per camera, store programming instructions from the ground for picture taking during the next orbit. This can be scheduled as much as three orbits in advance. Coordinated with a master clock at the ground station, the timing devices receive their instructions in the form of pulses. These coded signals establish the time during the next orbit when the TV cameras start working.

So meteorologists can identify the direction of each picture taken, TIROS carries a north indicator system which automatically measures the angle of the sun in relation to the satellite. The resulting signal sent to the ground with each picture is processed by a "sun-angle computer" and is displayed on a TV screen to indicate North in the image.

Telemetry transmitters

Beacon transmitters supply tracking

One of the photographs taken by the wide-angle camera aboard TIROS I.

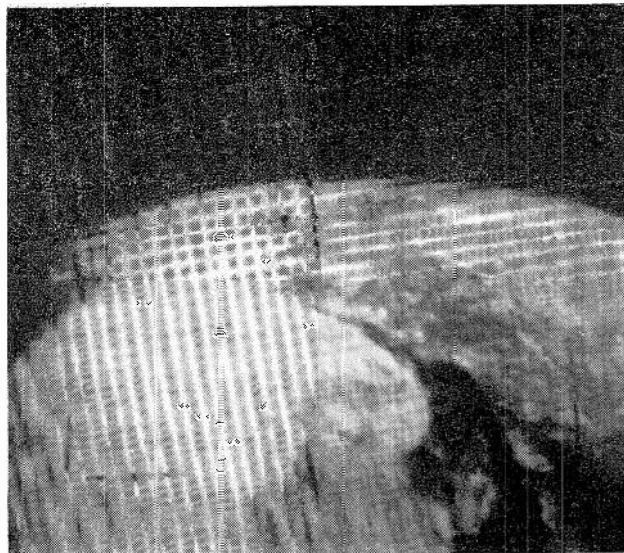

NASA

and telemetering information. The beacon transmitters are always on. However, they can be turned off on command from the ground if necessary. Minitrack stations pick up the beacon signals and track the satellite along its journey through the heavens.

Both transmitters are all-transistor units that are contained in a space only 15 inches in diameter and 1½ inches high. The beacon transmitters are also used to send telemetry data back to earth—a running account of temperature in the satellite, battery charge levels, and other conditions that influence the satellite's operation.

For greater reliability, the same information is transmitted by both beacon transmitters at the same time. One operates on 108.00 mc, the other on 108.3 mc. Both transmitters have a 30-mw output.

More than 9,000 solar cells are mount-

ed on the top and sides of TIROS I to generate the electric power needed by the satellite. They are connected so the power converted from sunlight gives the voltages needed to operate the various power supplies. As a whole, the power supply delivers 28 and 14 volts to accommodate the various power requirements of the satellite system.

A bank of 63 nickel-cadmium storage batteries power the equipment. Voltage regulators stabilize power supplies that deliver operating voltage to the electronic circuitry. Direct battery output, unregulated, operates the tape transport, telemetry switches and other non-critical circuitry.

TIROS I is expected to operate successfully for about 3 months. Useful life is limited to this period for two reasons. First, the satellite is stabilized in its orbit by making it spin. As it travels around the earth, this spinning motion decreases. When it reaches less than 9 revolutions per minute, one of three pairs of small rockets on the satellite's base is fired. This increases the rotation to the desired 12 rpm. However, these rockets are expected to keep the satellite spinning for only 3 months. The second reason is that the reliability of the large number of individual components that make up the operating portion of the satellite is not considered great enough to give the satellite a much longer useful lifetime.

The TIROS system, including the satellite and its associated ground network, was designed and built by scientists and engineers of RCA's Astro-Electronics Product Div. at Princeton, N. J., under the general systems management of the National Aeronautics and Space Administration and technical direction of the United States Army Signal Research and Development Laboratory at Fort Monmouth, N. J.

Two more TIROS satellites are scheduled for launching this year. These will carry infrared sensors, completed too late to be installed in TIROS I. They will be used to map relative temperatures of the earth's surface. END

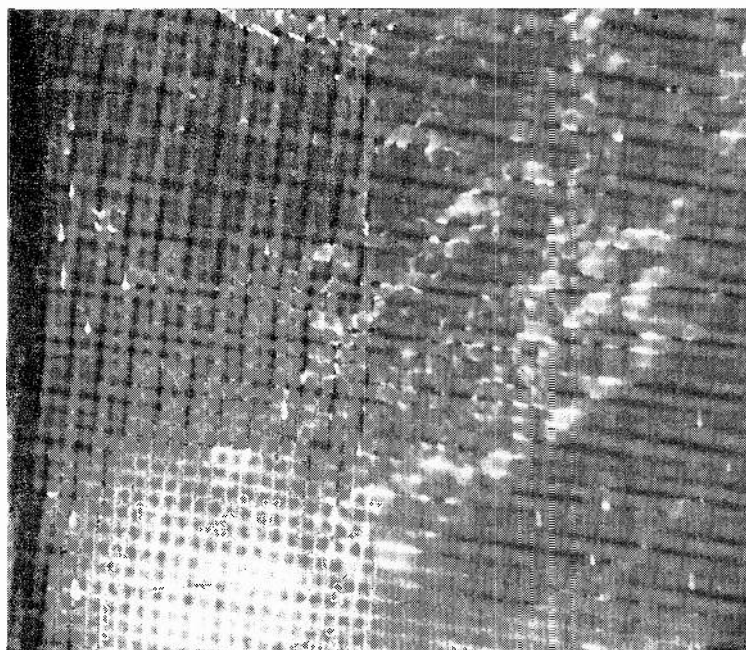

NASA

The narrow-angle camera gives a more detailed view of the Earth's cloud cover.

TV Service Clinic

conducted by
JACK DARR

CALLBACKS are a big problem in TV service work. One way to avoid them is to be very careful in making diagnoses, and very thorough in the final checkout after repairs are completed. Be on the lookout for those marginal defects which show up in one circuit after repairs have been made to another. I found a very good word in the dictionary for this a while ago: serendipity. Roughly, this means "to find one thing while looking for another." (Truthfully, that's the way I found it; I was looking for something else!) In this application, it would mean finding unsuspected troubles in a circuit while checking out an entirely different one.

A typical example of what not to do would be simply to adjust vertical height and linearity controls—instead of pulling the chassis and checking the circuit completely—to cure a case of vertical instability. By these adjustments, instability can sometimes be alleviated, but not eliminated: the real trouble is in leaky capacitors, drifted resistors, weak sync or the like. If the vertical output waveform looks some-

thing like Fig. 1-a, you might have a weak output tube or leaky coupling capacitor. The waveform should look like Fig. 1-b: with a good clean, sharp point, for proper linearity. In the sync input circuit a barely perceptible sync pulse (Fig. 1-c), seen as a mere "wobble" on the waveform, would make the vertical hold extremely unstable. A good strong sync pulse (Fig. 1-d) would snap the picture into place firmly.

Similar troubles show up in horizontal oscillator and sync circuits. For instance, if you found very unstable horizontal hold, adjusting the ringing coil, horizontal hold control, etc., could bring the set into synchronization, but the controls quite obviously don't have enough range to allow continuous, stable operation. Tube changing seems to help somewhat, so there's your choice: change the tube, and leave the set as it is (taking a chance on a callback within a few days) or pull the chassis and find the real trouble.

This kind of trouble can be caused by drifting resistors, leaky capacitors, defective and noisy controls, and even dirty tube-socket contacts. Fig. 2 shows only a few of the sources of trouble. Any component which helps to determine, in any way, the operating frequency of the circuit is a possible suspect. The R-C networks in plate and grid circuits of the horizontal oscillator, circled in Fig. 2, are all prime suspects. Voltage supplies here are also critical. Be sure that the plate-voltage source is up to its rated value, and that plate-load resistors are not suffering from thermal drift.

Age circuits are another good source of this kind of trouble. If the set has an adjustable age control, check its setting on all usable channels, after the set has been returned to the home. This is especially important where rectifiers or rectifier tubes have been changed, tubes replaced in the tuner or video if, or any part replaced which could affect the signal level applied to the age tube. If the control happens to be left "on the edge," a sudden increase in signal levels will cause the set to bend, buzz or black out entirely, meaning a quick callback.

Noise-elimination circuits also suffer from the complaints outlined above. Always be sure that the setting of the "noise" or "sync-stability" control is checked and left in the position that gives maximum picture stability. Improper setting of this control can definitely cause bad sync stability, by clipping sync pulses. This is perfectly normal, so watch out for it.

Before leaving any repair job, go over it with the proverbial fine-tooth comb, and see if you can't find those "marginal defects." This may save you much time, and an equivalent amount of money!

Poor vertical linearity

We have a Zenith Super K TV chassis, which has poor vertical linearity. Not the usual result, but too much height at the top, and the linearity control won't bring it down. We have tried replacing the cathode bypass electrolytic and the coupling capacitors, but it still has trouble. The 12B4 tube tests good.—P. O. S., Denver, Colo.

This is an odd but not uncommon complaint in this series, and others using the 12B4 tubes as vertical output amplifiers. To cure the excessive height, replace the 12B4 tube! Apparently, the old tube will have almost, but not quite, enough output to deliver a perfectly linear scan signal to the yoke. Therefore, we unconsciously advance the vertical height control to fill the screen, and the linearity goes bad. A scope will show the flattening of the top of the waveform (Figs. 1-a and 1-b) and the change when the tube is replaced.

No high voltage

In an Admiral 21B1 TV, there is no high voltage. If I disconnect the yoke,

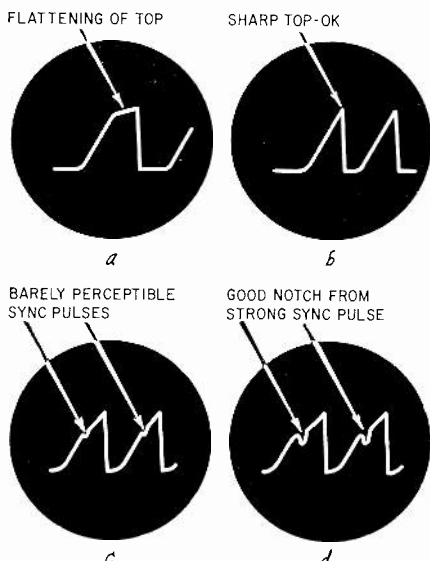

Fig. 1—Vertical waveform: a—flattening of the top of output waveform, possibly caused by a weak tube; b—correct waveform; c—barely perceptible sync pulse, unstable hold; d—strong sync pulse.

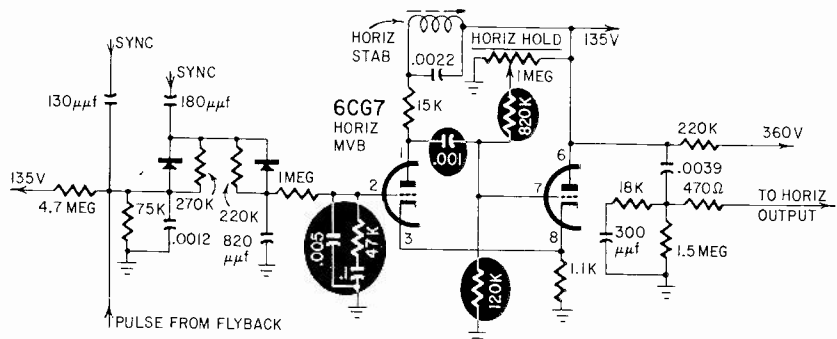

Fig. 2—Horizontal multivibrator and phase-detector circuits. Circled components could cause instability if their value changed.

TELEVISION

the voltage returns. I have changed everything in the B-boost system, also C431 with no results. Disconnecting the vertical output from the boost circuit has no effect.—W. E. P., Los Angeles, Calif.

This looks like yoke trouble. You have already checked most of the common sources of trouble here, including

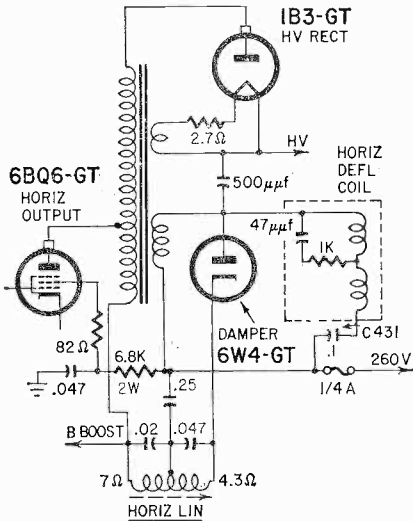

Fig. 3—Horizontal deflection of Admiral 21B1.

the vertical output circuit and the capacitor in series with the yoke lead, C431. Therefore, the trouble must be due to shorted turns in the yoke which are causing the high voltage to be "shorted out" by lowering the Q of the yoke-flyback system (Fig. 3).

Leakage in the yoke-return capacitor, C431, is a very common source of trouble in this circuit, as it lowers the B-plus too much to allow correct operation.

Short tube life

I can't get tubes to last in a Motorola 21T25CH TV set. The 12L6 audio output tube goes most often, but the 12DQ6 and the 19AV4 don't last either. I have put four 4BQ7's in the tuner. I measured the heater voltages and they are: 12DQ6—14 vac; 19AV4—20 vac; 12L6—14 vac. The rest of the tubes are normal, but they warm up slowly when the set is in the shop.—A. M., Kenosha, Wis.

It is obvious that you must have a very high line-voltage condition at the house where the TV set is used. The heater string on this set adds up to almost 120 volts, and even a line voltage as high as 125 would not give you the huge overload you mention. Take line-voltage readings at the home at several times during the day if possible. Better still, ask the power company to put a recording voltmeter on the line for 24 hours; they are usually glad to do so. I fully expect you'll find a line voltage somewhere in the neighborhood of 140 volts! This is not uncommon; we have had several cases like it of late. In some cases,

OXFORD the Leader

OXFORD SPEAKERS

... Preferred for
Original Equipment
... Proven for
Replacement

GET IN THE MAJOR LEAGUES!

Oxford is the major supplier of speakers to original equipment manufacturers throughout the world. Our replacement speakers, too, meet the most exacting design requirements. We have a complete line for any application... from 2½" to 15". Order Oxford... you'll be glad you did!

Our catalog is available upon request.

OXFORD Components,

A Division of Oxford Electric Corp.

556 West Monroe St., Chicago 6, Illinois

Oxford Speakers are available from recognized electronic parts distributors

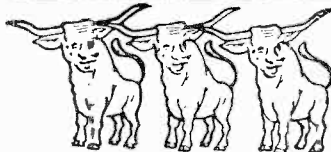

RESIST-O-CHEST

ends
"cigar box
confusion"
COMPACT
ALL-METAL
HINGED-LID



Order from
your IRC
Distributor



FREE!

with any of 10 Handy-Pak
Carbon Resistor Assortments
34 to 77 Values

\$24⁴⁸ to \$110⁸⁸ Dealer Net

INTERNATIONAL RESISTANCE COMPANY
DISTRIBUTOR SALES DIVISION
414 N. 13th STREET • PHILADELPHIA 8, PA.

Olson

FREE

Fill in coupon for a FREE One Year Subscription to OLSON RADIO'S Fantastic Bargain Packed Catalog—Unheard of LOW, LOW, WHOLESALE PRICES on Brand Name Speakers, Changers, Tubes, Tools, H-Fis, Stereo Amps, Tuners and thousands of other Electronic Bargains.

NAME _____
ADDRESS _____
CITY _____ ZONE _____ STATE _____

If you have a friend interested in electronics send his name and address for a FREE subscription also.

OLSON RADIO CORPORATION

708 S. Forge St., Akron 8, Ohio

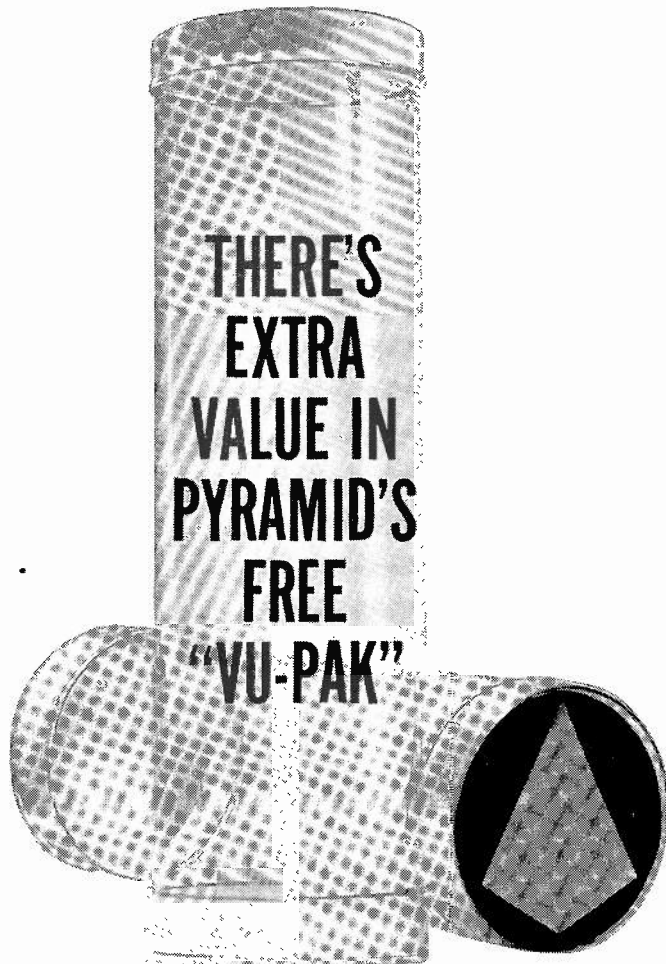

SENSATIONAL NEW CAPACITOR PACKAGE WITH 4+ FEATURES

- 1. New Way To Buy Highest Quality Capacitors**
- 2. New Vu-Paks Store Electronic Parts In Your Shop**
- 3. New-Vu-Paks Give You Free Identification Labels**
- 4. New Vu-Paks Fit Your Capac-o-mat***

Pyramid, long famous for quality capacitors, has developed another first—the FREE “Vu-Pak”. Now, after an electrolytic twist-mount is installed, you don't discard the package. Use it to store the spare parts and tools that clutter your bench. This transparent plastic package comes with an extra blank label for your handy storage identification. You'll know where everything is—when you need it.

Another Great Service for Servicemen from Pyramid

The *Capac-o-mat holds your Vu-Paks. The Capac-o-mat fits right on your shelf or hangs on the wall. Designed by Pyramid to hold 54 Vu-Paks, it's sturdy and “dust-free”.

SPECIAL—Each Vu-Pak contains one coupon. 50 Coupons enable you to get Pyramid's Capac-o-mat at big, big savings.

See your authorized Pyramid Distributor for your Capac-o-mat and quality Pyramid capacitors.

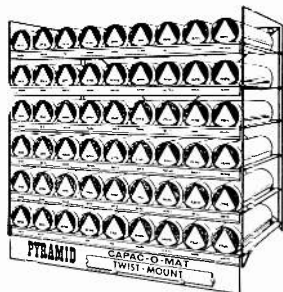

PYRAMID ELECTRIC COMPANY

DISTRIBUTOR DIVISION: UNION CITY, NEW JERSEY
 Factories: Gastonia, North Carolina • Darlington, South Carolina • In Canada: Wm. Cohen, Ltd., 8900 Tanguay St., Montreal • Export: Morhan Exporting Co., 485 Broadway, New York 13, N. Y.

TELEVISION

addition of too much load to one side of a three-wire circuit will cause an unbalance, raising the line voltage on the other side correspondingly. A ballast or tube-saver in series with the TV set will help out, until you can get the line voltage down to normal.

Charring resistors, controls

So far I have replaced the contrast control in an RCA 21T7417U twice. Each time, it is accompanied by burning out the 6AQ5 cathode resistors, and charring the 18,000-ohm resistors in the plate circuit. The picture goes gray and white, no blacks at all, and there is a loss of horizontal sync after it's been running for a while. Before I replace the burned parts again I'd like to know what's causing this.—J. P., West Hollywood, Fla.

To get “basic” about it, this trouble is being caused by excessive plate cur-

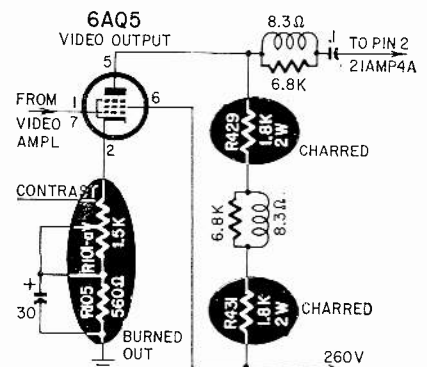

Fig. 4—Video-output stage of RCA 21T7417U. Circled components were damaged by excessive plate current.

rent in the 6AQ5 video amplifier! Since all the parts damaged are in that same circuit (Fig. 4), this must be the source of your trouble.

The most likely suspect, of course, would be the 6AQ5 tube, with an internal short, and very likely an intermittent one (something like a screen-control grid short or even very heavy leakage). Aside from this, leakage through the coupling capacitor, altering the grid bias, would have the same result.

I would suggest replacing all the defective parts, including the video peaking coils, which may have been damaged by heavy current, replacing the tube, then taking a reading of the cathode current by inserting a milliammeter in series with the bottom of the contrast control. At these voltages, your plate current should be less than 45 ma, and the screen current less than 4.5 ma.

Missing voltages

I have on the bench a Stromberg-Carlson TC-19 which is puzzling me. I replaced one of the 5U4's and a resistor which burned out when the 6BG6-G screen bypass shorted. Now, I can't get any voltages on the age tube screen, the 6AU6 or any of the if tubes. This

set has a plug for the controls, which I left in the cabinet. Could this be the cause of the trouble?—L. P., Brooklyn, N. Y.

Yes, that's right. The B-plus circuits are connected through this plug. When it is pulled, the B-plus feed to the age tube, the if plates and screens and several other circuits are opened. The plug must be in place before the set will play at all.

The sound trouble you mentioned could also be due to an incorrect setting of the agc switch. In "fringe" position, on this chassis, it would cause a very quick agc block, unless you had a very small signal input.

Before you return the set, check the two 6,800-ohm resistors in the horizontal output tube screen circuit. When the capacitor shorted out, they got at least a momentary overload and could have burned enough to cause a change in value. They will be found between the two 6BG6-G tubes, toward the flyback transformer.

Voltage-doubler trouble

I have high-voltage trouble in a Sylvania 512-1 TV chassis. It uses a voltage-doubler circuit in the high-voltage supply. When I received the set, the three resistors from the cathode of the first rectifier to the plate of the second were overheated and charred, and had changed value. I replaced them with the right value, but these get hot too. I tried replacing the tubes, and the three high-voltage filter

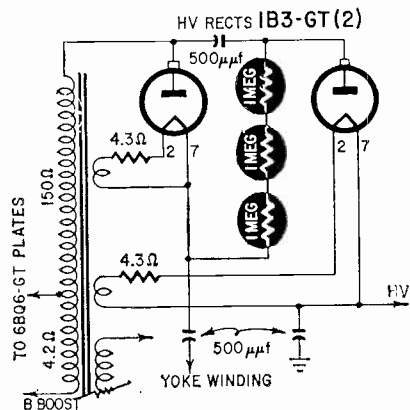

Fig. 5—Voltage-doubler circuit showing 1-megohm resistors that overheat.

capacitors, but the resistors still get too hot. I would appreciate any help you could give me on this trouble.—A. H., Tipton, Ind.

From the description, I am afraid that you have used the wrong type resistor for this replacement (Fig. 5). Special high-voltage types are made just for this kind of work. They have extremely good insulation and are rated to withstand the tremendous pulse voltages which show up across them. Ordinary service type replacement resistors will not stand up in this application. If you'll use the special units, you will find your troubles are over since you have replaced everything else in the circuit! END

we learned from the dogs!

By R. M. CENTERVILLE

THINGS are not what they seem, as they say in the books, and nowhere is the old saw better illustrated than in servicing dog TV receivers. Take the case of one that was brought into the shop with a complaint of no raster. A bypass capacitor had shorted, taking with it a couple of resistors and one of the coils in the horizontal sweep circuit. The faulty components were replaced, after which the raster failed to fill the screen satisfactorily. The B-plus boost voltage was subnormal, and the second-anode voltage a little low. Otherwise, the dc voltages measured OK. All dc resistances measured correct. The raster, though narrow, was bright.

A scope was not available in the shop, so ac voltage checks could not be made by this means, and the vtvm did not provide peak-to-peak indication. Checks of the capacitors in the sweep circuit with a capacitor checker and by substitution did not affect the narrow raster. Although resistance checks of the flyback transformer and yoke were replaced, as a shorted turn or two cannot be detected by a resistance measurement. The narrow raster remained unaffected. At this point, it was realized that a great deal of time was being wasted, and a scope was obtained to check the ac voltages in the defective section of the chassis.

First the grid-driving waveform to the horizontal output tube was checked. Since the plate of the horizontal oscillator received its supply voltage from the booster circuit, a separate power supply was first required to bring the plate voltage of the horizontal oscillator up to normal. The scope then indicated correct peak-to-peak voltage for the drive waveform, showing that the trouble was on the secondary side of the transformer. With the horizontal oscillator operating from the bench power supply, a scope check was next made on the secondary side of the transformer; the peak-to-peak voltage here was subnormal.

This was a real sticker, because the sweep circuit had been almost completely rebuilt with new components. At this point, the technicians went into conference and sat down with the circuit diagram to try to study the problem out.

The "hot" side of the sweep circuit was arranged as shown in Fig. 1. It seemed that all possibilities of voltage attenuation in this circuit had been eliminated. Then the clue appeared!

One of the technicians recalled that coil L was not an exact replacement, but was another inductor which had the same value of dc resistance. He pointed

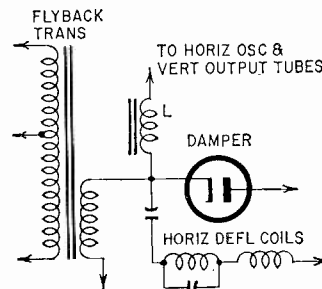

Fig. 1—The dog in the manger here was L, which was draining the horizontal sweep voltage into the horizontal oscillator and vertical output circuits.

out that it would be quite possible for the replacement coil to have lower inductance but the same resistance, if wound with a wire one or two sizes smaller than the original coil. Another technician observed that this coil was situated in the circuit in such manner that subnormal inductance would attenuate the sweep current; in other words, the coil was being used as an ac choke to isolate the dc booster load from the flyback transformer and yoke. He suggested that excessive inductance would not have an attenuating effect on the sweep voltage, if the dc resistance of the coil were not too high.

We experimented, using another non-standard replacement in the form of the primary of a spare flyback transformer. The primary winding was connected into the circuit in place of coil L (Fig. 1). This primary coil had more turns and a larger core than the burnt-out one, and hence an obviously larger value of inductance. Its dc resistance was also higher than specified, although not a great deal more.

As soon as the receiver was turned on, the raster filled the screen, and the receiver operated normally, proving the correctness of the circuit analysis. An important lesson had been learned the hard way: *There is no necessary rela-*

Now Completely SELF-CONTAINED

For Testing & Rejuvenating ...

BLACK AND WHITE and COLOR including 110° TUBES

NEW CRT 440

CATHODE REJUVENATOR TESTER

B&K

TESTS AND REJUVENATES

all black & white and color picture tubes at correct filament voltage from 1 to 12 V.

TESTS AND REJUVENATES

110° tubes with 2.34, 2.68, 6.3 and 8.4 volt filaments.

TESTS AND REJUVENATES

color picture tubes. Checks each color gun separately same as black & white tubes.

Used by Thousands of Professional Servicemen
MAKES NEW PICTURE TUBE SALES EASIER

Gives you more value than ever—all-in-one. Quickly checks and corrects most TV picture tube troubles in a few minutes right in the home without removing tube from set. Gives new useful life to weak or inoperative tubes. Checks leakage. Restores emission and brightness. Repairs inter-element shorts and open circuits. Life test checks gas content and predicts remaining useful life of picture tube. Completely self-contained in leatherette-covered carrying case. Net, \$74⁹⁵

ACCESSORIES for USE ONLY with FORMER B&K Models 400 and 350 CRT

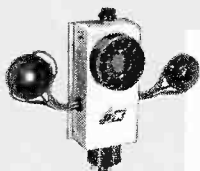

Model C40 Adapter. For use only with all previous B&K Model 400 and 350 CRT's. Tests and rejuvenates TV color picture tubes and 6.3 volt 110° picture tubes. Net, \$9.95

Model CR48 Adapter. For use only with all previous B&K Model 400 and 350 CRT's. Tests and rejuvenates 110° picture tubes with 2.34, 2.68, and 8.4 volt filaments. Net, \$4.95



See your B&K Distributor
or Send now for Bulletin ST24-E



B & K MANUFACTURING CO.

1801 W. BELLE PLAINE AVE • CHICAGO 13, ILL.
Canada: Atlas Radio Corp., 50 Wingold, Toronto 10, Ont.
Export: Empire Exporters, 277 Broadway, New York 7, U.S.A.

ELECTRONIC ENGINEERS — ELECTRONIC TECHNICIANS

Step Up the Voltage of Your Careers

THIS may be the TRANSFORMER you need: The FEDERAL AVIATION AGENCY in Alaska offers you interesting and profitable Federal Civil Service careers. Install and maintain electronic devices for air navigation, flight control, avionics, telecommunications and related equipment and systems. Travel at government expense. Liberal employee benefits. Additional overseas allowances. BSEE degree or 4½ years combined specialized training and experience in basic and advanced electronic theory and practices required. For full information, AIR MAIL:

FEDERAL AVIATION AGENCY
Box 440, Anchorage, Alaska

PHOTOGRAPHS

RADIO-ELECTRONICS can use good photographs of service benches, service shops, high-fidelity audio layouts, and any other interesting and original radio-electronic devices.

We will pay \$7.50 each for good professional photos or equivalent, suitable for reproduction.

Full information on subject photographed will increase their acceptability.

The Editor, **RADIO-ELECTRONICS**
154 West 14th St.
New York 11, N. Y.

TELEVISION

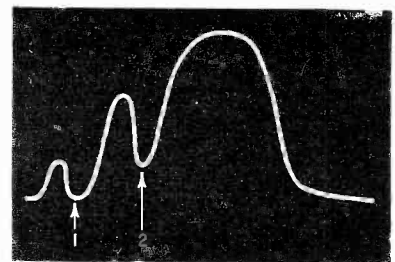

Fig. 2—Dip at 1 was tunable by adjusting sound trap, but dip at 2 did not respond to any tuning adjustments.

relationship between dc resistance and ac impedance.

Case of the missing trap

Another instructive situation was encountered while troubleshooting a receiver for poor picture quality. A routine check was being made of the frequency response, starting with the if amplifier. It appeared that one of the if traps must be improperly adjusted, because a deep dip appeared in the re-

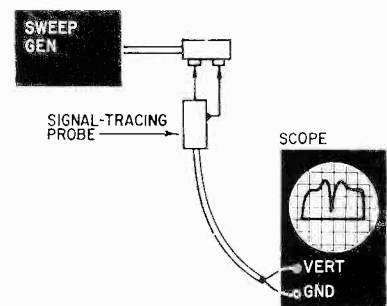

Fig. 3—The sweep generator was the big bad wolf in this mystery. Note the response.

sponse curve, point 2, Fig. 2. But no adjustment of the available tuning slugs would move the dip. This was a disconcerting situation. The circuit diagram was next studied carefully to determine what circuit factor might be responsible for the unexpected dip in the curve. No clue was uncovered.

Since the dip was unchanged by adjusting any of the tuning slugs, or the trap slug, it became evident that some spurious trap action was present. The search was extended to the decoupling and heater bypass capacitors, on the assumption that the supply lines might be operating as tuned stubs. All were found in good condition. The mystery of the missing trap deepened.

It was then suggested that the sweep output cable might be improperly terminated, and hence acting as a resonant stub. This lead was dismissed. Then we thought that the scope input cable was possibly operating as a tuned stub, being coupled back into the 45-mc if amplifier through the residual capacitance of the picture detector. The isolating resistor at the input of the scope cable was increased from 10,000 to 75,000 ohms, with no success, and the technician was about ready to put the receiver into the dog class.

Another technician observed that the regular shop equipment was not being

TELEVISION

used in the test but, instead, a sweep generator which was the technician's own personal property. He observed that it might be well to check out the sweep generator for flatness, to determine whether the false trap indication was being caused by the generator. The regular shop equipment was rolled over to the bench, and connected to the receiver under test. Presto! . . . the mysterious trap dip disappeared from the if response curve. Next, the defective sweep generator was checked out with the arrangement shown in Fig. 3, which verified the conclusion.

Finally, an inquiry was made to find what was wrong with the generator. The instruction book for the instrument showed that the swept output for the 45-mc if band was obtained by beating together two oscillators; one of them swept from 72 to 84 mc in the test, while the other operated at a fixed frequency of 37.5 mc. The difference frequency, 34.5 to 46.5 mc, was being used in the test. The second harmonic of the 37.5-mc fixed oscillator (75 mc) fell into the band of the swept oscillator (72 to 84 mc), causing a serious disturbance and spurious response at 37.5 mc in the swept output.

Although the sweep generator was unstable at this end of the band for 45-mc if amplifier alignment, because of the large spurious output, it was next determined it *could* be made to work by running the dial slightly off-scale on the next lower band. This next lower band operated with a 75-mc fixed oscillator, instead of a 37.5-mc fixed oscillator, so the second harmonic fell outside the operating range, causing no difficulty.

Another important lesson had been learned the hard way: *Don't assume the trouble must always be in the receiver—perhaps it's in the test equipment this time!* END

50 Years Ago

In Gernsback Publications

HUGO GERNSBACK, Founder

Modern Electronics	1908
Wireless Association of America	1908
Electrical Experimenter	1913
Radio News	1919
Science & Invention	1920
Television	1927
Radio-Craft	1929
Short-Wave Craft	1930
Television News	1931

Some larger libraries still have copies of Modern Electronics on file for interested readers.

In June, 1910, Modern Electronics

An Adjustable Impedance Coil, by Austin C. Lescarboursa.
Photo Telephone.
Wireless Secrecy.
Tubular Condenser, by Harold Birkmire.
Tuning and Interference, by James M. Murdock.
New French Detector.
The Depew Wireless Bill.
Double Action Aerial Switch, by E. W. Cole.
The Peroxide of Lead Detector, by Samuel F. Kerr.
Compact Receiving Outfit, by Louis Phillis.
Safety Pin Detector, by C. F. Lindstrom.
Handy Detector Exciter, by Irwin Masters.
Loop Antennae Switch, by Lawrence E. Hammond.

COMPLETELY RELIABLE AUTOMATIC MONEY-MAKER

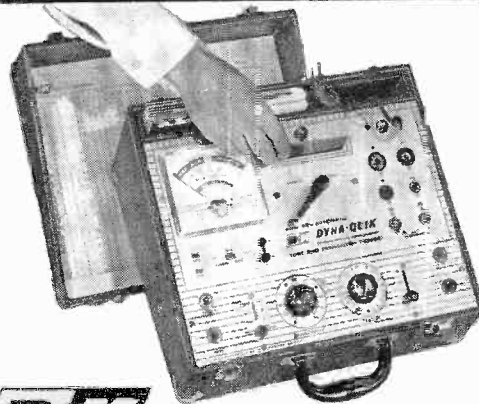

B&K MODEL 675 AUTOMATIC DYNA-QUIK

DYNAMIC MUTUAL CONDUCTANCE TUBE AND TRANSISTOR TESTER

Here is automation that combines both speed and accuracy for profitable professional servicing. Pre-tested and field proved. Keeps paying you dividends day after day. *Measures true dynamic mutual conductance.* Makes complete tube test in seconds under actual operating conditions of the set. Checks average set in a few minutes. Provides instantaneous heater continuity test. Shows true tube condition on "Good-Bad" scale and in micromhos. Patented automatic line compensation. Tests transistors, diodes, and rectifiers, too. **Net, \$169.95**

See Your B&K Distributor or Send for Bulletin ST24 E

B & K MANUFACTURING CO.
1801 W. BELLE PLAINE AVE • CHICAGO 13, ILL.

Canada: Atlas Radio Corp., 50 Wingham, Toronto 10, Ont.
Export: Empire Exporters, 277 Broadway, New York 7, U.S.A.

SIMPLIFIED AUTOMATIC DYNA-CARD SYSTEM

Only 60 indexed phenolic Dyna-Cards test over 600 tube types. Dyna-Card automatically sets socket connections.

MORE ACCURATE TESTS FOR PROFESSIONAL SERVICING

Tests each section of multiple tubes separately for true Gm, Shorts, Gas, Grid Emission and Life.

MINIMIZES OBSOLESCENCE

Easily kept up-to-date with extra cards and punch supplied with every unit.

By checking all tubes in the set, you can **Sell More Tubes Per Call INCREASE YOUR INCOME** Save Call-Backs and Satisfy More Customers.



free

GIANT NEW

Most complete electronics buying guide in America! Over 100,000 items—stereo, hi-fi, tapes, ham radio at low money-saving prices! 15-day no-risk home trial on any item!

8-TRANSISTOR PORTABLE RADIO

with battery **\$29.95**

Outperforms all portables under \$100! It's a radio, a speaker, a P.A. amplifier. 6½ x 3-9/16 x 1¾". Typical Radio Shack value!

RADIO SHACK CORP.



ELECTRONICS CATALOG plus every new issue for full year

See the latest and best electronics equipment in Radio Shack's big 312-page book! Mail coupon! Receive your FREE copy plus a FREE subscription to all new issues for a year!

MAIL COUPON NOW

Radio Shack Corp., 730 Commonwealth Ave.
Boston 17, Mass. Dept. 50F10

Send FREE Electronics Catalog—Also every new issue for 12 months, a full year's subscription free.

Name _____
Address _____
Postoffice _____
or City _____ Zone _____ State _____

Dress up that meter

A good-looking meter scale is not hard to make, if you have a camera

By C. L. HENRY

HOW many times have you completed an extra-special construction project, only to have it marred by a poor meter scale? But it is easy to have professional-looking meter scales for all your equipment. Most instruments are easier to operate (and look better) with proper scales on the meters. Now neither you or I are professional draftsmen, but fortunately we don't have to be. All you will need is a camera with a good lens, a protractor, compass and a lettering guide. If you are an amateur photographer who processes his own black-and-white photos, you will probably have everything else you need. If you do not process your photos, you can get that part of the job done at your local camera store without too much cost.

The first step in making your own meter dial or scale is to measure the angle or arc of the present scale on your meter (Fig. 1). The new scale must match this, of course. Measure from the left side of the scale to the right with a protractor, and note the angle. Make sure the base line of the protractor passes over the center of the meter movement. In Fig. 1 the angle measured was 90°.

Now draw the new meter scale on a large piece of paper, preferably white, matte and the larger the better. A piece of white drawing paper such as is being used in Fig. 2 is probably best. Make this as neat a drawing as possible, using a lettering guide for the letters and numbers. The guide should be available from art-supply and stationery stores. Also make your lettering and drawing heavy. This is necessary since we are going to reduce this drawing photographically.

Fig. 3 shows the next step in making the meter scale. Set up the completed drawing or pin it to the wall. Put a sheet or other piece of white material behind the drawing, so that it extends 2 feet or so beyond the edges of the drawing paper. [Use white paper or a large sheet of art mounting board—sheets wrinkle.—*Editor*]. Set up your

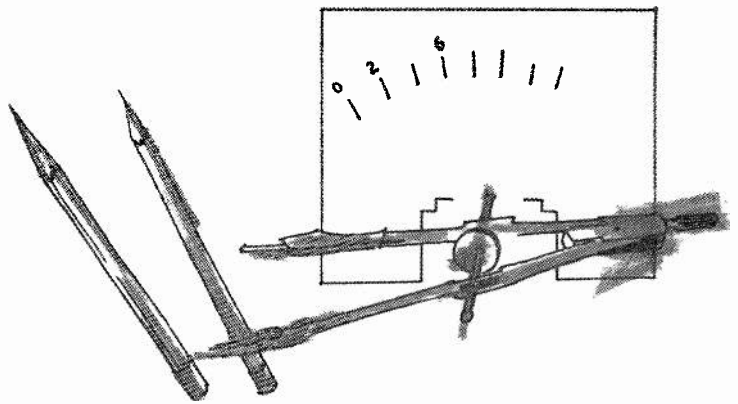

camera in front of the drawing on a tripod, after determining the proper distance required to fill the negative with the drawing (a closeup lens adapter may be required). The *Kodak Data Book on Copying*, which you can find at your photo dealer, will be useful in determining this.

If your camera is a twin-lens or single-lens reflex, focusing is fairly simple. However, if it uses a rangefinder or zone focusing, you must use a ground glass to focus on the drawing. Obtain a piece of thin glass that is lightly frosted on one side. Cut this to fit in the film gate of your camera, as shown in Fig. 4. Then, observing the image on the ground glass, focus the camera on the drawing. After focusing, put the film in the camera, being very careful not to change the distance of the camera from the drawing or the focus adjustment.

You should use Kodak Verichrome Pan (Panatomic-X or a line-copying film should give better results) or a similar medium-speed film in your camera. Kodalith, available in cut-film sizes, is specially suited to this work. After loading the film in the camera, set up two lights as shown in Fig. 3. The lights should be set at 45° to the plane of the drawing. Adjust the lights carefully so that the light is even across the entire drawing. You can do this by sight, but a more accurate method is to check the lighting with a photoelectric exposure meter. You can also determine the proper exposure while adjusting the lights. After you even the lighting, read the exposure meter. Set the aperture on your camera to f16 or f22 to get as much depth of field as possible. Use whatever shutter speed is necessary, and make as many exposures as you wish. A good idea is to make several exposures at twice the proper shutter speed, several at the proper speed and several at one-half the proper shutter speed.

After you have made the exposures, develop the film in a high-contrast developer, such as Kodak D-11 or equivalent. If you must use a medium-contrast developer such as Kodak D-76, develop the film 3 minutes longer than normal, to build up the contrast. After fixing the film, hold it up to a light and look it over. The background should be very dense, and the scale and lettering clear.

You are now ready to make the print as in Fig. 5. Use the highest-contrast paper available. The paper I used for this is Kodabromide F-5, single-weight. (The F indicates glossy paper.) Remove the scale from your meter and place it on the easel of your enlarger. With your best negative in the enlarger, turn it on and adjust the size of the image on the easel until it coincides *exactly* with the scale on the original metal meter scale. Remove the metal meter scale from the easel, put in your paper and make a print.

After the print is processed and thoroughly dried, it can be installed on the meter. Carefully trim the print to fit the meter scale, and glue it in place. Be sure to use a glue that will not harm the print (Fig. 6). As a final touch, a dulling spray may be applied to the meter scale to remove any surface reflection.

Using the method just described, you can have any type of meter scale that you wish. If you don't have the facilities to process your film and prints, you can expose the film and tell the processor exactly how you want it finished, including the exact size of the final print. This should cost little more than the processing of one roll of film. **END**

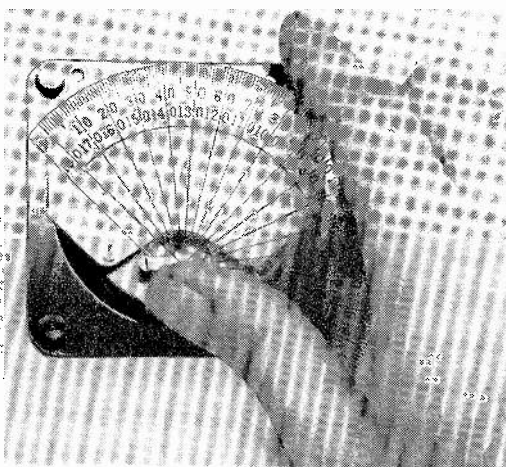

Fig. 1—Measure the arc of the old scale from left to right.

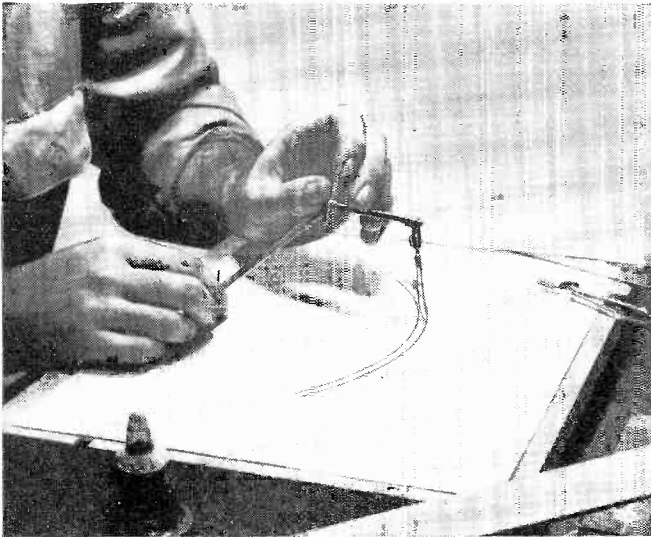

Fig. 2—Draw the meter scale as large as possible.



Fig. 3—Pin or tape the drawing to a suitable background such as a sheet or a white wall. (Second light is out of sight at right.)

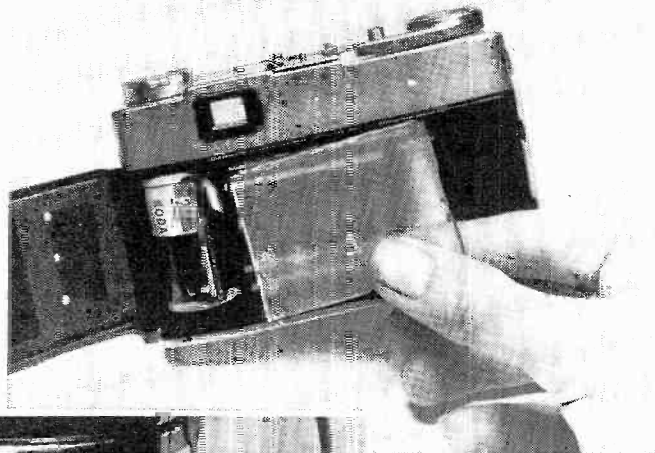

Fig. 4—Be sure the ground glass used for focusing fits flush against the film guides.

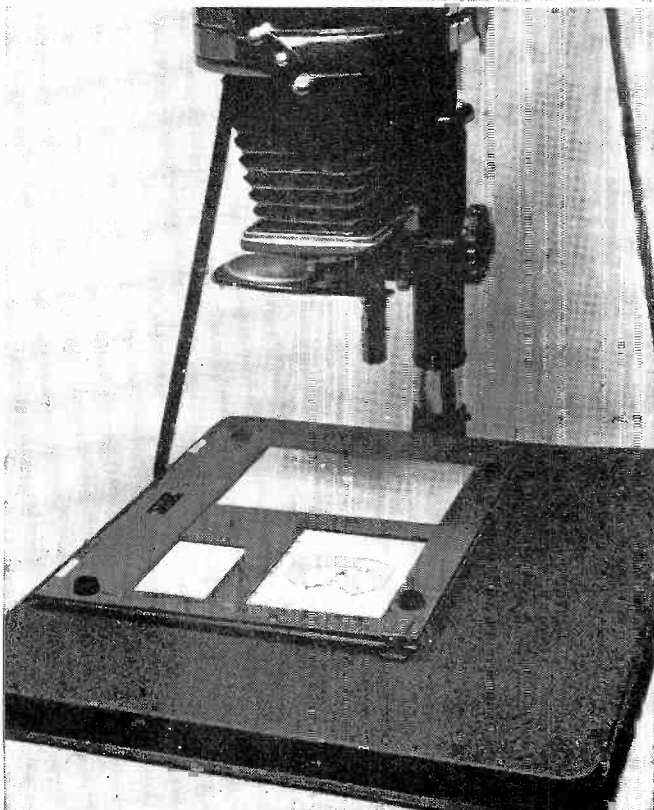

Fig. 5 (lower left)—Adjust the image size to match the old scale.

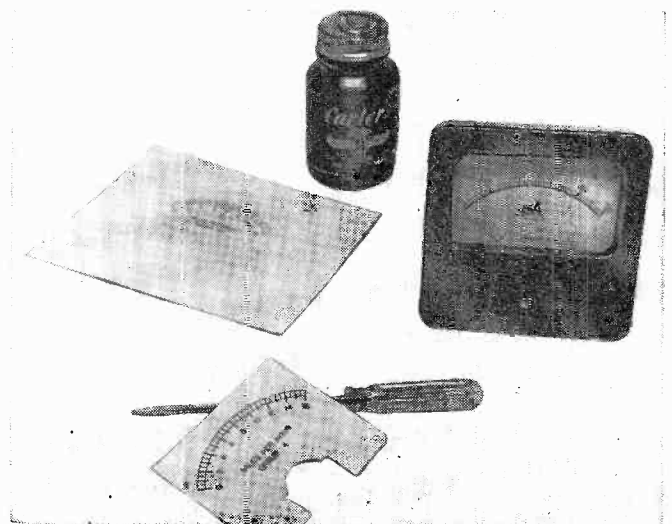

Fig. 6—Trim the print and glue it to the rear of the old meter scale.

FIELD-CHECK COLOR CRT'S

By JAMES EGAN

AN experienced technician will have little trouble in recognizing the symptoms of a low-emission monochrome CRT. All he does is watch the picture as the brightness control is rotated. The problem of evaluating the condition of a color CRT in the field is somewhat more complicated since some of the symptoms displayed by a weak color tube may also be caused by bad components elsewhere in the receiver or by improper setup adjustments.

The color CRT may develop low emission in one or more of its guns, and the symptoms will vary according to the particular combination. Typical symptoms are excessive warmup time required for the screen to reach a neutral shade of gray, changes in screen color when brightness control is rotated, colored lowlights or highlights on black and white programs, and poor reproduction of colors on color programs.

In designing the unit described here, my primary objectives were compactness, light weight and rugged construction as it is primarily a field service instrument. It is so compact that it can be carried in a pocket or slipped into the service kit. To maintain simplicity and low cost, I use an ordinary 20,000-

*Used with a vom,
pocket-sized unit
checks emission of color
picture tubes*

ohms-per-volt multimeter to provide the readings. This is no problem as the meter is already part of the service kit.

Fig. 1-a shows how the output voltages are developed across the individual cathode resistors.

New tubes should give readings close to 2 volts. Any gun reading less than 0.75 volt after 3 minutes' warmup is

weak, but still usable if the receiver can be adjusted for acceptable tracking of the brightness. When only one of the guns is weak, the screen will tend to swing toward the color of that gun as brightness is reduced. A CRT which doesn't read at least 0.5 volt on all guns after a 3-minute warmup should be replaced.

The 3-minute figure is arbitrary and there may be some customers who will be willing to replace the kine before it reaches this level of performance.

Fig. 1-b shows construction details. The socket used fits all color CRT's currently being produced, and virtually all in use. END

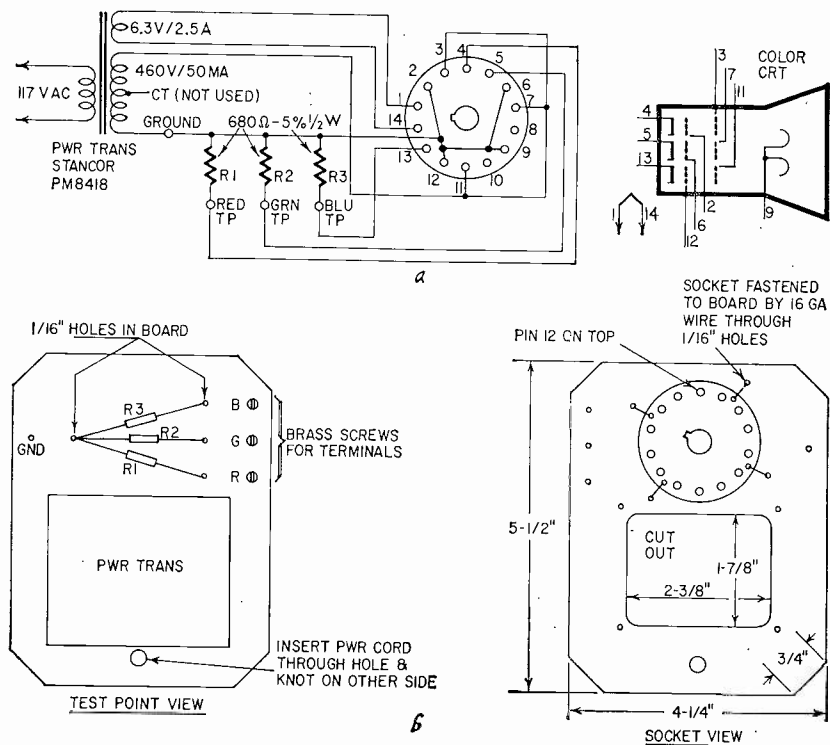
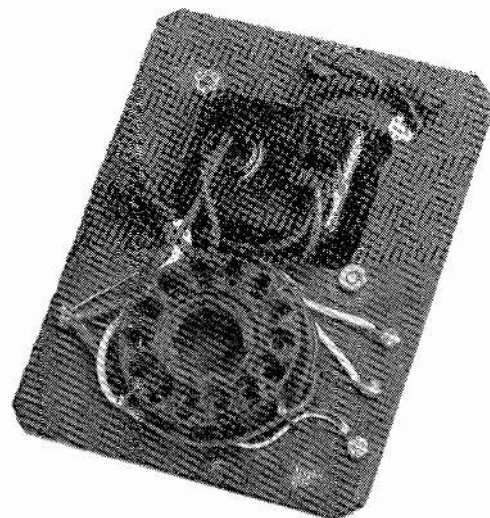
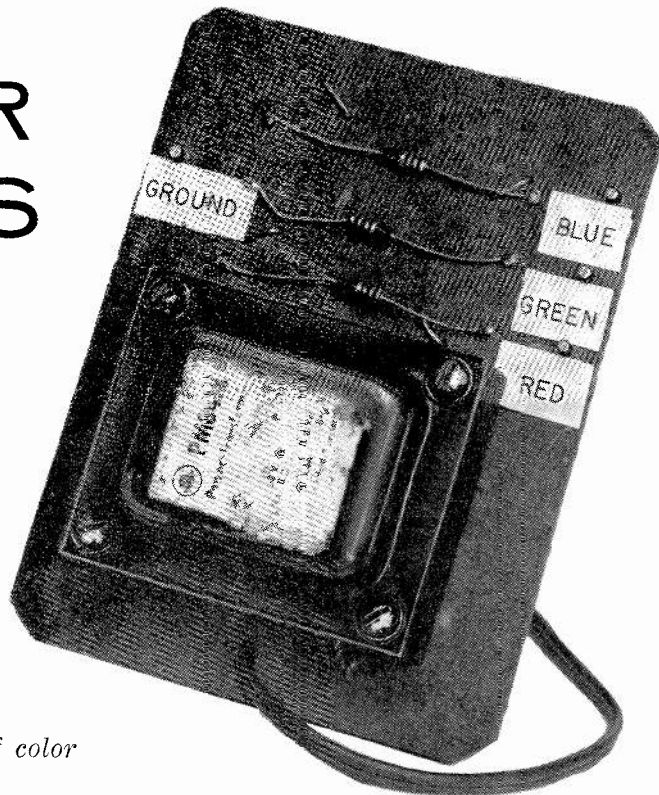

Fig. 1-a—Circuit of the tester; b—assembly instructions.



Fourteen-pin color-tube socket is on bottom of checker chassis.

Remember us? We're still cutting call-backs...



... because my new plates behave like plates ... not filaments. You can forget your low-voltage rectifier problems.

Your CBS 5U4GB

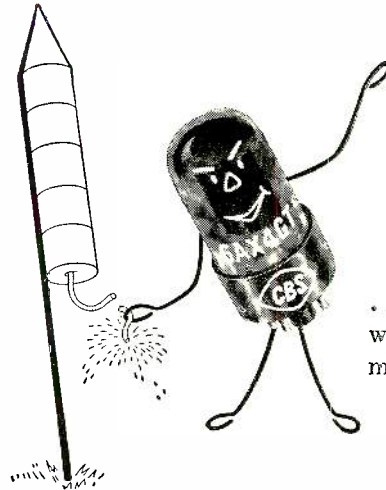

... because you get no fireworks with me. That means no more damper arcing for you.

Your CBS 6AX4GT

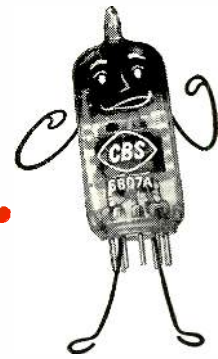

... because I've got new coil heaters. You can wave goodbye to your front-end troubles.

Your CBS 6BQ7A

... because I like high voltage. So stop worrying about arcs and burnouts.

Your CBS 1B3GT

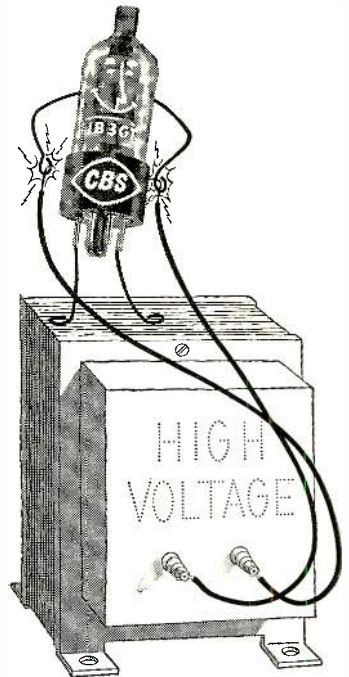

... because I'm loaded with performance, man. You buy no sync problems with me.

Your CBS 6CG7



TOTAL RELIABILITY ... proved in performance

Yes, we are typical CBS receiving tubes especially designed to cut your call-backs. We offer you *total reliability* ... proved in performance by leading TV set manufacturers — and service technicians too. You can profit more from the *total reliability* of CBS tubes. Just make it a habit always to replace with us ... and with other dependable CBS tubes.

**COLUMBIA
NEEDLE
CATALOG**

COLUMBIA NEEDLES NOW AT YOUR ELECTRONIC PARTS DISTRIBUTOR

The Columbia phonograph needle line is now available from your local distributor of CBS Electronics products. You'll find it a complete line ... a quality line ... with a famous name, a proud name known and respected by your customers. Ask *your* distributor for dependable Columbia needles.



CBS ELECTRONICS, Danvers, Mass.
A Division of Columbia Broadcasting System, Inc.

Receiving, industrial and picture tubes • transistors
and diodes • audio components • and phonographs

an electronic transformer

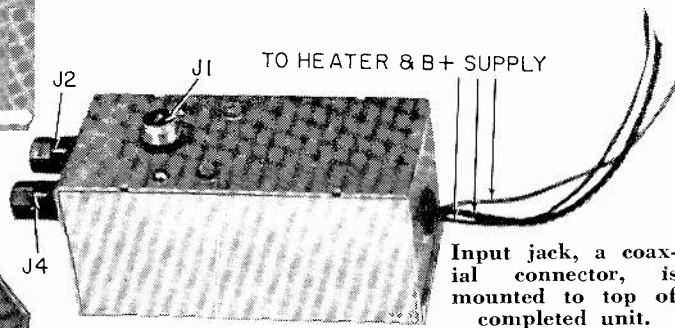
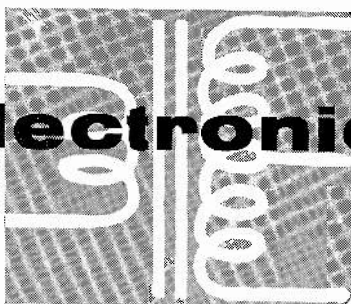

Input jack, a coaxial connector, is mounted to top of completed unit.

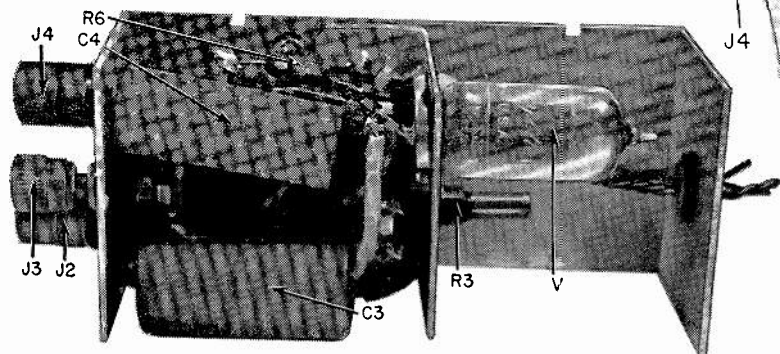

A look inside the case shows the compact parts layout.

Balance your signal generator's sine-wave output and change it to low impedance with this simple unit

By H. F. WOODS

FREQUENTLY a device capable of transforming an unbalanced source of audio voltage to a voltage balanced with respect to ground is needed, for example when an R-L-C bridge is to be driven with a conventional audio signal generator.

If a push-pull amplifier is to be driven by a conventional audio signal generator, detector, phono pickup, or microphone, the same need exists. In addition, an impedance transformation may be desired. It is often desirable to convert a high-impedance output to low impedance, minimizing high-frequency attenuation and reducing electrostatic hum pickup. The electronic transformer does these jobs.

Its circuit is uncomplicated and might be best described as a cathode follower-phase splitter. It consists of two cath-

ode followers—the first driven by the applied signal, the second by the 180° phase-shifted signal from the plate of the first triode. Fig. 1 shows the phase relationships that exist at the various tube elements for a given input waveform.

The circuit diagram is shown in Fig. 2. Note that few parts are used and voltage requirements are moderate. The potentiometer (R3) is a BALANCE CONTROL. It allows the input to the second tube to be adjusted so that the outputs measured from cathode to ground of the triodes are of equal magnitude.

The photos show an underchassis and top views of the completed device. The electronic transformer is housed in a 2½ x 2¼ x 5-inch interlocking box chassis. A piece of aluminum, used as a subchassis, provides a mount for the 12AU7 and the BALANCE CONTROL. Input to the tube is brought in through a coaxial connector on the top of the case. The output leads come out to one of the ends. Power leads are brought out through the other end.

To balance the electronic transformer, connect the power supply leads to an external power supply. Heaters and plates use 6.3 volts ac and 250 volts dc, respectively. Apply a 1,000-cycle signal of about 4 volts to the input terminals. Connect an audio voltmeter, a high-impedance ac voltmeter or an oscilloscope from across J2 and J3 (ground). Record the magnitude of the signal at this point. Then connect the instrument which you are using across J4 and J3 to ground. Adjust the balance control till the signal is equal in magnitude to the value observed across J2

and J3. When this step is completed, recheck the magnitude of the signal across J2 and J3. If the output levels are not quite equal, it may be necessary to readjust the BALANCE CONTROL to secure a fine adjustment.

The electronic transformer has many applications for the service technician and experimenter. Remember, it is *not* a high-power-handling device, and the signal input should never exceed 6 volts. Furthermore, it is not presented as a high-fidelity device. Distortion is reasonably low for bridge measurements and routine audio testing, but the audio enthusiast should not attempt to utilize the circuit described as part of a hi-fi audio system. **END**

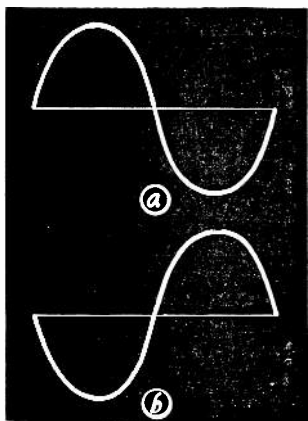
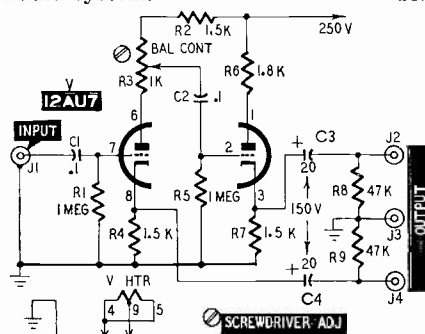

Fig. 1—Phase relationships at 12AU7 socket: a—grid and cathode of first triode section; b—grid and cathode of second triode and plate of first triode section.



- R1, 5—1 megohm
- R2, 4, 7—1,500 ohms
- R3—pot, 1,000 ohms
- R4—1,800 ohms
- R6—1,800 ohms
- R8, 9—47,000 ohms
- All resistors ½ watt, 10%.
- C1, 2—0.1 μf
- C3, 4—20 μf, 150 volts, electrolytics
- J1—coaxial connector
- J2, 3, 4—3-way binding posts
- V—12AU7
- Socket, 9-pin miniature
- Chassis (case), 2¼ x 2½ x 5 inches
- Miscellaneous hardware

Fig. 2—Transformer circuit.

experimenter's dual electroscope

Easy-to-build unit measures electrostatic charges; both negative and positive

By **ESTEN MOEN**

THE electroscope is a tool, but it has become as obsolete as the stone axe of the paleolithic era. Yet surprisingly, the one described here is an educational novelty that gives convincing proof that the face of an ordinary TV receiver does carry an electrostatic charge.

The instrument is shown in the diagram. It is a 6 x 8-inch piece of polystyrene plastic clamped between two right-angle metal brackets. In each upper corner a 2-inch metallic plate is cemented to the plastic. The plate is a piece of foil from a package of cigarettes, placed so the foil sides face each other.

The "gold leaf" or swinging vane is a strip of aluminum foil which is lifted off the cigarette wrapper. They are 2 inches long and 1/2-inch wide. Dip the wrapper in hot water for about 10 minutes to simplify the job and lessen the chance of tearing the foil. This strip is fastened to the foil plate with a small piece of cellulose tape. As you can see, a very rough kilovolt scale is marked on the plastic for each swinging vane.

To charge the electroscope, you will need two pocket combs. Cover about an inch of the end of one comb with foil. The foil-covered comb becomes the "charge splitter," the other carries the "inducing charge."

Flick the inducing comb once through dry hair and, holding it close to the charge splitter, touch the charge splitter to the foil that contacts one of the electroscope vanes. The vane is now negatively charged. Then take the combs away and separate them. Next, take the charge splitter and touch it to the foil on the other side of the dual electroscope. You have just put a positive charge on that vane.

For proof of the polarities, set the instrument about 6 or 8 inches from your TV set screen. Turn the receiver on and, as soon as it warms up, the electroscope leaves will swing in opposite directions. Varying the brightness will cause a small swing in each leaf's position. It makes a good demonstration of some facts to which we often pay little attention. END

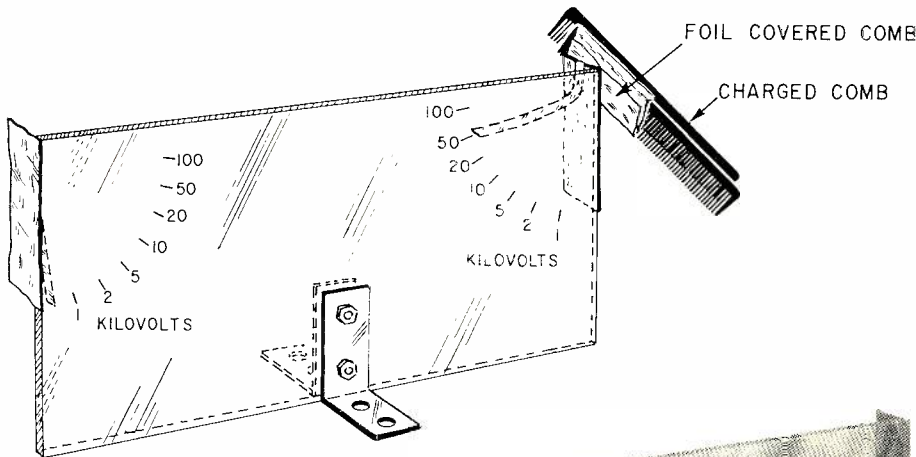

Charging the electroscope.

Instrument constructed by I. Queen of the Radio-Electronics staff.

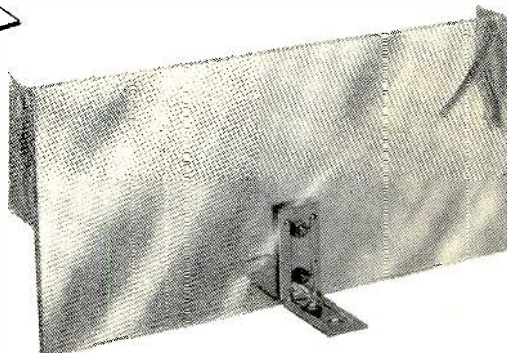

SERVICE MASTER... EVERY TOOL YOU NEED 99% OF THE TIME

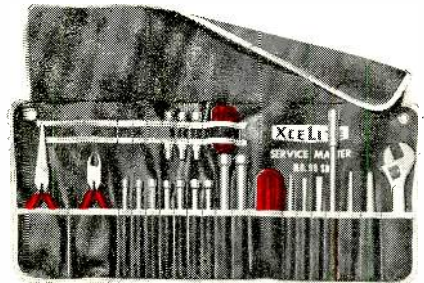

complete 23-piece kit for radio, TV, and electronic service calls

2 HANDLES:

shockproof plastic. Regular 4" length ... 2" Stubby. Interchangeable. Patented spring holds snap-in tools firmly in place.



9 NUTDRIVERS:

High Nickel chrome finish, 3/16" to 1/2"



3 STUBBY NUTDRIVERS:

1/4", 3/16", 3/8"



EXTENSION BLADE:

Adds 7". Fits both handles.



3 SCREWDRIVERS:

Two slotted ... 3/16", 3/32" #1 Phillips



2 REAMERS:

1/8-3/8", 1/4-1/2"



ADJUSTABLE WRENCH:

6" thin pattern, 1" opening



LONG NOSE PLIER:

"Cushion Grip", 2 1/4" nose



DIAGONAL PLIER:

"Cushion Grip", hand-honed cutting edges



ROLL UP KIT:

Durable, plastic-coated canvas. Compact, easy-to-carry.

Ask your distributor to show you kit 99 SM



XCELITE, INC. • ORCHARD PARK, N. Y.
Canada: Charles W. Pointon, Ltd., Toronto, Ont.

TRANSFER STANDARD CALIBRATES VOLTMETER

*With this simple unit you can make
your ac voltmeter accurate to 1%*

By PAUL S. LEDERER

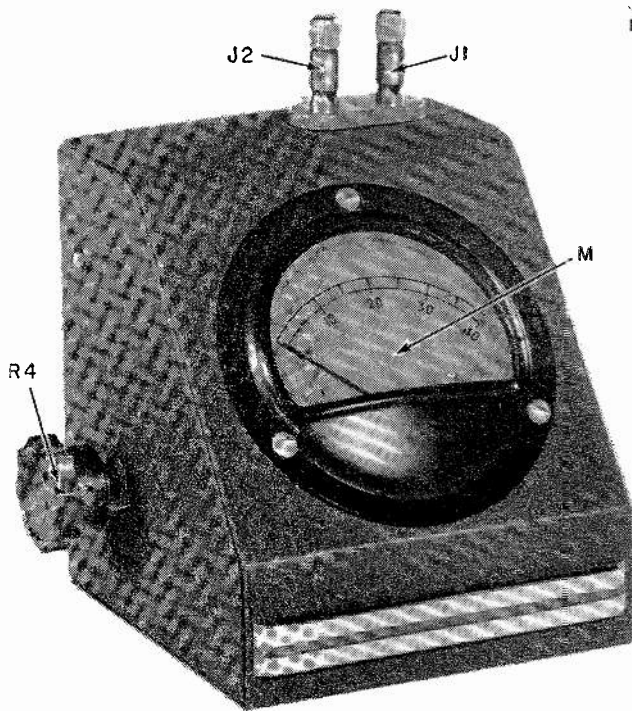

AS electronic devices get more complex more accurate test instruments are needed to service them. This is particularly true of test instruments used for servicing industrial electronic equipment.

How can a technician be sure his meters are accurate? One way is to buy only laboratory type precision equipment that has an accuracy of 0.5% and will retain it for years of use. But these meters are too expensive for the service technician—they cost a few hundred dollars each, and they won't take rough handling.

A more practical method is to use a standard vtvm or multimeter and keep it accurately calibrated. To do this on dc ranges, and keep the meter within 1%, a reliable known source of dc is required. Mercury cells are probably the simplest dc voltage standard available. The RM type made by Mallory, when new, has a voltage of about 1.345. With moderate use (about 1-ma drain for 100 hours) it drops to 1.31 volts and stays there till near the end of its useful life. However, for calibration, drain is very low and a new mercury cell can be used a dc calibration standard for as much as a year and still supply 1.34 volts within 1%.

Ac calibration is a little different. There are no real physical standards of ac voltage. There are only devices

that relate ac to dc by matching the effects of both. The most common effect is heating. For example, ac line voltage, 117 volts rms, produces the same amount of heat in a pure resistance as 117 volts dc in the same resistance.

Standards which relate ac to dc are called transfer standards. Commercial units have accuracies as high as .05% of the voltage over the ac range. But their prices are high enough to keep them out of reach of all but large labs.

However, it is possible to build a transfer standard with 1% accuracy for about \$10. The home-built unit matches the heating effect of ac to that of dc in the filament of a miniature receiving tube, a 1T4.

How it is done

The voltage source delivers current through a variable resistance (R4) into the series combination of a fixed resistance and the filament of a diode-

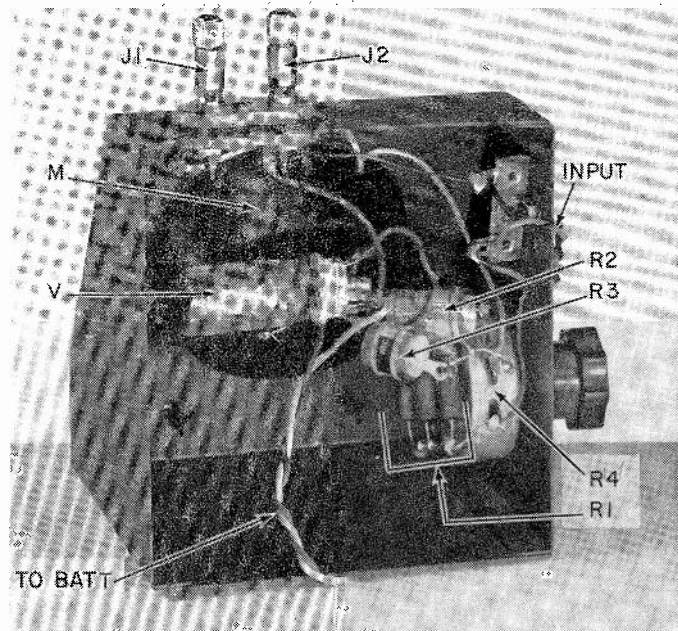

A look inside the calibrator.

Precision transfer standard for calibrating ac voltmeters.

► Compares heating effect of dc and ac voltages to calibrate ac meter.

- 1% accuracy
- inexpensive
- compact

TEST INSTRUMENTS

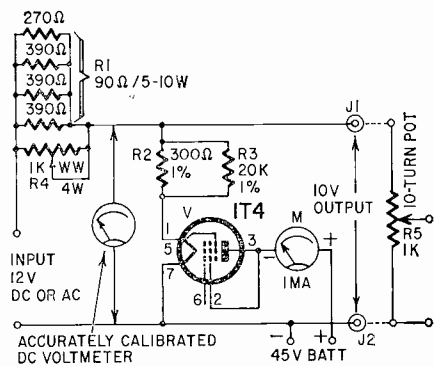

R1—90 ohms, 5-10 watts (made up of three 390-ohm 2-watt units and one 270-ohm 2-watt unit)
 R2—300 ohms, 1%, wirewound
 R3—20,000 ohms, 1%, wirewound
 R4—1,000 ohms, 4 watts, wirewound
 R5 (optional)—precision voltage divider, 1,000 ohms, 10-turn Helipot or similar unit
 PA1T—45 volts
 J1, 2—binding posts
 M—1-ma meter
 V—1T4
 Case—meter case
 Miscellaneous hardware

Circuit of transfer standard.

connected 1T4, causing it to emit electrons. These are collected by the plate and pass through a 1-ma meter. Since the number of electrons emitted is a function of the filament's temperature, and this in turn is a function of the filament current squared, a small change in filament current causes a much larger change in indicated plate current. R4 adjusts the current in the circuit. In this application the 1T4 filament is operated at 0.75 volt and 30 ma, to increase the effect of small current changes.

A 12-volt battery is hooked to the transfer standard and the voltage appearing across the parallel combination of R2, R3 and the 1T4 filament is fed to a dc voltmeter (a precision or carefully calibrated unit must be used as it determines the ac accuracy). Then R4 is adjusted until the pointer of the plate-current meter (M) is on a fixed mark on the scale near full scale—for example, the 0.8 or 0.9 mark. When the

pointer is on the mark, the voltage read by the dc voltmeter is checked and recorded. The most important thing is to be able to reproduce this meter reading later.

Now disconnect the battery, but leave the dc voltmeter connected (or replace it with a load that has the same resistance). Then connect an ac source (about 12 volts rms) to the standard's input and connect the ac voltmeter to be calibrated to the standard's output. Now adjust R4 until the meter pointer is on the same mark on the scale as before. *The rms value of the ac voltage fed to the ac voltmeter is now exactly the previously recorded dc voltage.*

The unit is designed to deliver 10 volts. Its usefulness can be extended by adding a precision voltage divider at the output. This is necessary if a mercury-cell reference is to be used.

If the mercury-cell reference is used, calibration follows this procedure: measure the mercury cell voltage on the 1.5-volt scale of a 20,000-ohms-per-volt dc voltmeter. Then adjust R4 as before. Next adjust R5 until the dc voltmeter indicates the exact voltage of the mercury cell (1.34 volts). *The voltage-divider setting must not be disturbed during the rest of the calibration.* Now, connect the ac source to the transfer standard's input and connect the ac voltmeter to be calibrated to the voltage divider's output. When R4 is adjusted for the same indication on the meter as for dc, the rms value of the ac voltage fed to the ac voltmeter is exactly 1.34.

Tests of the standard's accuracy showed that after a 1-minute warmup before each operation, the setting that produced 9.99 volts on a dc voltmeter produced indicated ac voltages from 9.90 to 9.82 for frequencies between 20 and 20,000 cycles. Since the limit of error in the meters used is about 1.5%, it appears that the accuracy of this transfer standard is about 1% between 20 to 20,000 cycles. END

TIGHTEN METER FACES

One major maintenance problem with older panel meters is the loosening of the glass window under vibration or pressure. Not only is the loose glass annoying, but it increases the danger of meter damage by dust and moisture entering the case.

Many kinds of cement have been used to hold the glass in such meters without much success. The photo shows an exploded view of a typical panel meter and illustrates a simple permanent repair.

As the photo shows, the meter glass is held in the case by a close-fitting metal retaining ring. Once loosened, a light pressure on the glass will press the sleeve back into the meter case and result in a rattling glass.

Light crimping with diagonal pliers in three or four places around the cir-

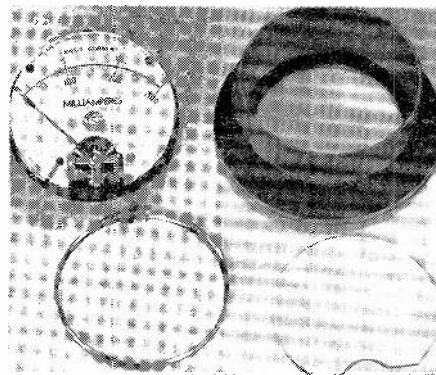

cumference of the ring will make a permanent cure. When reassembled, the projections from the plier crimps dig into the bakelite case and resist any pressure short of breaking the glass. —Roy E. Pafenberg

... and now, the incredible

SHURE
PROFESSIONAL

tone arm

for any cartridge . . . stereo or monophonic

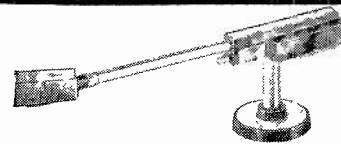

new safety

for records. Surface wear is held to absolute minimum through flawless tracking made possible by an ingenious and unprecedented combination of adjustments. Optimum static and dynamic balance, precise height, correct cartridge "overhang," and incredibly accurate stylus force are quickly achieved and easily maintained without guesswork.



new sound

from records. Modern high-compliance, light tracking cartridges (Shure M3D compliance is 4.0×10^{-6} cm/dyne; 3 gm. tracking) require arm balance of a high order in all planes to deliver ALL the sound, undistorted. The Shure arm pivots on drag-free precision bearings. Precision adjustments assure optimum suspension and permanent balance, regardless of cartridge characteristics.



new simplicity

in installation and operation. Installs completely from top side of motorboard—without solder. Lock-on heads are instantly interchangeable. Direct-reading stylus force gauge with instant disconnect, and "micrometer" counterweight assembly permit visual static balance checks at any time.

new savings

Surprisingly, the Shure Tone Arm costs less than other quality tone arms that do not have its many features.

M232 for 12" records	\$2995 net
M236 for 16" records	\$31.95 net
M232 with Shure M7D	\$53.95 net
M232 with Shure M3D	\$74.95 net

Literature:

SHURE BROTHERS, INC.
222 Hartrey Avenue, Evanston, Illinois

"I certainly wouldn't be without PHOTOFACTS"

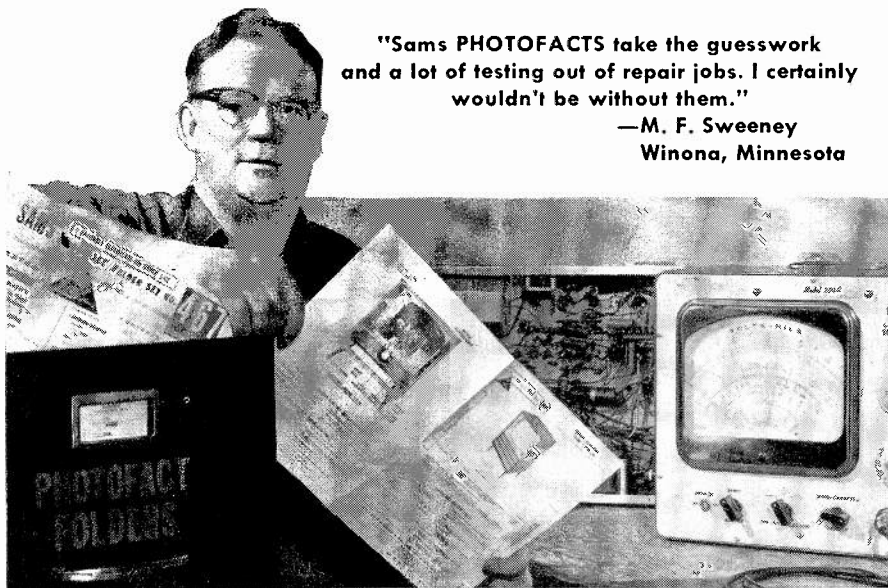

"Sams PHOTOFACTS take the guesswork and a lot of testing out of repair jobs. I certainly wouldn't be without them."

**—M. F. Sweeney
Winona, Minnesota**

Service Technicians! YOU EARN MORE... YOU RATE with the public when you own the PHOTOFACT® service data library!

You enjoy maximum earnings as the owner of a complete PHOTOFACT Service Data Library! It's inevitable, because no matter how expert you are, you can always *save more time on any job, get more jobs done daily—EARN MORE, DAY IN AND DAY OUT...*

What's more—as the owner of a complete PHOTOFACT Library, you know your customers' sets *best*. You can actually show each customer you have the PHOTOFACT Folder covering his very own set. Result: You command public respect and acceptance which paves the way to more business and earnings for you.

HOW TO STAY AHEAD...

Yes, the truly successful Service Technicians are those who own the complete PHOTOFACT Library, who can meet and solve any repair problem—faster and more profitably. And these men *keep ahead* because they're on a Standing Order Subscription with their Distributors to receive all new PHOTOFACTS as they are released monthly. (They're eligible for the benefits of membership in PEET, too—see below!)

ONLY \$10 DOWN puts the complete PHOTOFACT Library in your shop—and you have up to 30 months to pay. See your Sams Distributor today, or write to Howard W. Sams

TECHNICIANS'

NEWS



MORE ON D-I-Y TUBE TESTERS

Put the do-it-yourself tube tester to work for you, says Morton Binder (sales manager, Vis-U-All Products Co.) in the *NATESA Scope*. "The public likes the convenience of self-service tube testers—they enjoy the do-it-yourself feeling. . . . Furthermore, they feel they are not imposing on the service technician's time when they test their own tubes. . . . Self-service tube testing is here to stay."

He goes on to say that the technician can take advantage of this trend by installing his own D-I-Y tester. This has several advantages: The customer knows where he can get service if his problem turns out to be more than just a bad tube. You give the customer the assurance that he is getting name-brand tubes. He can get advice if he needs it—this is good advertising. The customer will go to the store that has been helpful rather than just picking a store at random. And last, *but not least*, you make the profit on the tubes.

HOME-STUDY COURSE

Principles of operating and servicing two-way radio equipment are covered in a course offered by the Motorola Training Institute. It is designed to prepare the electronics technician to meet the demands of the expanding two-way radio field. It is intended for the technician who already has sufficient basic electronic knowledge and experience to pass an FCC technical license exam.

The Institute will supply a free entrance examination to help you evaluate your ability to complete the course. For information on the 38-lesson course, write The Motorola Training Institute, 4501 W. Augusta Blvd., Chicago 51, Ill.

TESA TO SUE?

Should local TESA's hire lawyers and prosecute the customer complaints listed below? TSA (Iowa) *Beacon* is asking its readers "to write and let us know if you think we should prosecute . . . or keep them under the rug or in the closet."

"One shop returned a set to a lady and told her to let the solder dry and set for 24 to 48 hours. Of course, when she turned the set on a day or so later, it would not work. She still has not been able to get the technician to return and fix the set.

"A customer, after waiting several weeks for the return of his set was told that the charge would be \$..... and that the trouble was in the tuner. He decided not to have them fix it,

NOW IS THE TIME TO JOIN

"PEET"

THE POWERFUL NEW PROGRAM FOR QUALIFIED TECHNICIANS

If you now own a PHOTOFACT Library or plan to own one, you can apply for membership in "PEET." It's the first industry program really designed to build powerful public acceptance for the Service Technician who qualifies. Builds enviable prestige and business for its members. Benefits cost you absolutely nothing if you qualify. Ask your Sams Distributor for the "PEET" details, or mail coupon today.

HOWARD W. SAMS & CO., INC.
1726 E. 38th St., Indianapolis 6, Ind.

- Send me full details on the new "PEET" Program.
- Send full information on the Easy-Buy Plan and Free File Cabinet deal.
- I'm interested in a Standing Order Subscription.
 - I'm a Service Technician full-time; part-time

My distributor is _____

Shop Name _____

Attn: _____

Address _____

City _____ Zone _____ State _____

picked it up and took it to another shop. This man found that 'the tuner had been cut all to heck with a pair of side cutters.' The set was examined by members of the local TESA, Independents, and a service engineer recommended by the local BBB. All agreed that the cutting had been deliberate and could not have been done in the course of repairing it."

LICENSE BILL DEFEATED

The Delaware State House of Representatives voted down a TV technician licensing bill 28-3. The bill, sponsored by the Television Service Dealers Association of Delaware, had been introduced into the legislature almost a year and a half ago.

Several House members spoke out against the bill, calling it "class legislation to protect a certain few," and saying that it would stop "the little man from getting into a business of his own."

James Mayhart, an official of TSDA, commented that about 80% of the association's members have one- and two-man shops and that, without such a law, there is no way to tell who is qualified to perform service work and who is not. He also says that TSDA plans to have the bill reintroduced at the next session of the Legislature.

WHERE TO BUY

An often-ignored problem has caused a group of distributors to take a full-page ad in the TSA (Michigan) News. The ad, in the form of a comic strip, deals with the situation that frequently arises when distributors do not sell retail. Its captions read:

"I'm an electronic hobbyist and I'd like to buy some parts." Electronic Distributor: "Sorry fella. You'll have to get them from an authorized service dealer." Service Dealer: "Can't help you buddy. I don't have the components you need. I only carry replacement parts for radio and TV sets." Customer: "By George, I'll order from this catalog I got from out of town. They'll supply me."

The final square urges service dealers to stock parts for hobbyists (or order them if necessary) to keep the business right in the local area.

ETA ELECTS OFFICERS

The Winston-Salem (No. C.) Electronic Technicians Association has elected Dick Tamer, president; Clifton Lynch, secretary, and Griffith Blain, treasurer.

MISBRANDING LAW

An all-around measure recommended by Attorney General Louis J. Lefkowitz and designed to protect the buyer has been passed by the New York State Legislature. Part of this program requires that "all television and radio tubes which are rebuilt, reconditioned, used or otherwise not of first quality must be clearly labeled. . . ." This is

designed to cut out counterfeiting and misbranding of tubes and also make it necessary for a service technician installing such a tube to notify the customer of its condition. Used, rebuilt or reconditioned appliances must also be properly labeled.

WHY AREN'T YOU ON THE LIST?

RADIO-ELECTRONICS is publishing a list of all of the known television service associations in North America. Every now and then some association writes in and asks why they have not been listed. We can list you only if we know about you. We have no way of detecting an association's existence unless it (or a member) decides to write to us. We would like to hear from associations in Arkansas, Connecticut, Florida, Georgia, New Hampshire, Oklahoma, Rhode Island and Texas.

If your association has not been listed, send us the name and address of its secretary and president. If you need help locating the association nearest you, drop us a card. Write to: Associations Editor, RADIO-ELECTRONICS, 154 W. 14 St., New York 11, N. Y.

MINNESOTA
MINNESOTA TELEVISION SERVICE ENGINEERS, INC. (MINTSE)
P. O. Box 4429
Minneapolis 21, Minn.

SOUTHEASTERN MINNESOTA, DISTRICT No. 1
Donald Folsum
16 N. W. 4th St.
Faribault

SOUTH CENTRAL MINNESOTA, DISTRICT No. 2
H. B. Corbett
PO Box 356
Amboy

NORTH MINNEAPOLIS & SURROUNDING COUNTIES, DISTRICT No. 3
John W. Hemak
4401 Quincy St. N. E.
Minneapolis 21

ST. PAUL & RAMSEY COUNTY, DISTRICT No. 4
Robert Rohweder
1319 Blair St.
St. Paul 4

DULUTH TV RADIO SERVICE ASSOCIATION
Robert Johnson
32 E. 4th St.
Duluth

INDEPENDENT RADIO TELEVISION SERVICE ASSOCIATION
Donna Andrikan, president
4302 Upton S.
Minneapolis 10

ADDITION TO ONTARIO LIST
NIAGARA ELECTRONIC TECHNICIANS ASSOCIATION
Donald G. Woodruff
2516 Caswell St.
Niagara Falls, Ont.

SOUTH MINNEAPOLIS, DISTRICT No. 5
Warren Schei
5329 Penn. Ave., S.
Minneapolis 19

CENTRAL MINNESOTA, DISTRICT No. 6
Howard Johnson
519 3rd St.
Sauk Center

SOUTHWESTERN MINNESOTA, DISTRICT No. 7
Erwin Larson
1016 S. 1st St.
Willmar

NORTHEASTERN MINNESOTA, DISTRICT No. 8
John Ringsted
1601 Woodland Ave.
Duluth 3

LOCAL ASSOCIATIONS
RADIO TELEVISION SERVICE ASSOCIATION, MINN.
John Farmer
202 Russell S.
Minneapolis 5

TESA-ST. PAUL
Clarence Thole
833 E. 7th St.
St. Paul 6

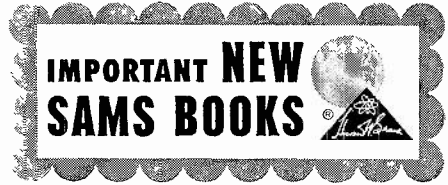

"Using and Understanding Probes"

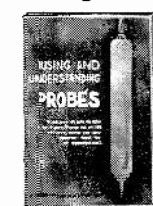

Helps you get more out of your test equipment! Rudolf Graf shows you how best to use all types of probes in radio-TV servicing. Includes valuable section on special-type electronics probes and their use in industry, agriculture, medicine, etc., for observing, testing, exploring and measuring. Provides a complete understanding of the use of all probe types: direct, isolation, high-voltage, low-capacitance, rectifying, demodulator, signal-tracing and signal-injection. 200 illustrations; 266 pages; 5 1/2 x 8 1/2". Only **\$3.95**

"Servicing Unique Electronic Apparatus"



Cash in on growing new opportunities in electronics servicing. Jack Darr gives you the know-how on such equipment as: Watchmaster watch timer and tester; RF diathermy machines; liquid-flow timers; electronics photoflash units; electric scoreboards; RF heaters; gas-fired boiler controls; garage-door openers; movie sound systems; strobe tuning devices; photoelectric cells; ultrasonic cleaners, etc. Complete; profusely illustrated; 128 pages; 5 1/2 x 8 1/2". Only **\$2.50**

Timely for TV Antenna Work



Television Antenna Handbook. A practical guidebook for the antenna installer and serviceman. Thoroughly covers needs of each reception area (primary, secondary, far-fringe). Chapters include: the TV signal, characteristics of basic antennas, commercial antenna types, transmission lines, antenna rotators, installation planning, on-location tests, tools and equipment, towers, masts and guying, roof-top techniques, antenna installation, UHF and color, unusual installations and problems, boosters and multi-set installations, and servicing the antenna system. Most complete and practical book on the subject. 248 pages, 5 1/2 x 8 1/2". 265 illustrations. Only **\$3.95**



TV Signal Distribution and Antenna Techniques. Practical and complete information about installation of antenna systems serving two or more TV receivers. Gives procedure and equipment requirements for installations required by hotels, apartments, stores, institutions, trailer parks, community antenna systems. Covers: selection and orientation of antennas, selection of proper distribution systems, reception and special installation problems, selling systems, making bids and estimates, and other subjects. 176 pages, 5 1/2 x 8 1/2". Only **\$2.95**

HOWARD W. SAMS & CO., INC.

Order from your Sams Distributor today, or mail to Howard W. Sams & Co., Inc., Dept. F20 1720 E. 38th St., Indianapolis 6, Ind.

Send me the following books:

- "Using and Understanding Probes" (PRG-1)
- "Servicing Unique Elect. Appar." (SED-1)
- "Television Antenna Handbook" (TAD-1)
- "TV Signal Distribution" (DSB-1)

\$.....enclosed. Send Free Book List

Name _____

Address _____

City _____ Zone _____ State _____

(outside U.S.A. priced slightly higher)

BRAND NEW UNITED'S FIRST QUALITY TUBES

GUARANTEED ONE FULL YEAR!
NOT USED! NO PULLS!
WHY PAY MORE...

DISCOUNTS up to
75% OFF

Qty.	Type	Price	Qty.	Type	Price	Qty.	Type	Price	Qty.	Type	Price	Qty.	Type	Price	Qty.	Type	Price
024GT	75	5A9B	85	6B06/GT	99	6EW6	57	8CX8	90	12CA5	70						
1A5GT	80	5AQ5	85	6C0U	99	6J5GT	50	8EB8	90	12CN5	65						
1A7GT	85	5AT8	92	6BQ7	78	616A	66	12CY7	74	12CS5	55						
1B3GT	75	5AV8	94	6BR8	77	617GT	89	12AB5	61	12CU5	54						
1C5GT	85	5B5	83	6BS5	92	6K6GT	57	12AC6	54	12CS	54						
1DN5	55	5BK7A	80	6BU8	65	6L7	45	12AC6	54	12CX6	52						
1G3GT	70	5BQ7A	90	6BX7GT	95	6S4A	47	12AE6	45	12DB5	55						
1K3GT	70	5BR8	80	6BY6	53	6SA7GT	75	12AF3	65	12DE8	71						
1L4	60	5EA8	75	6BZ6	53	6SH7GT	75	12AF6	48	12EL6	42						
1LAG	95	5EUB	75	6BZ7	95	6SF6GT	75	12AJ6	42	12DQ6	99						
1L84	99	5T8	80	6BZ8	99	6SH7GT	75	12AL5	50	12D57	73						
1LC6	99	5U4GB	57	6C4	42	6C8E	53	12AT5	95	12EL6	54						
1CD5	99	5U4	82	6C8E	53	6C8E	53	12AT6	42	12EK6	54						
1E3	99	5V4G	87	6C8E	53	6C8E	53	12AT7	70	12E26	54						
1LG5	99	5V6GT	54	6C8E	53	6C8E	53	12AT7	70	12E26	54						
1LH4	99	5W4GT	90	6C8E	53	6C8E	53	12AV6	49	12F5GT	64						
1R5	61	5X6	80	6C8E	53	6C8E	53			12FR8	58						
1S4	75	5Y3GT	44	6C8E	53	6C8E	53			12FR8	58						
1S5	50	6A1	1.10	6C8E	53	6C8E	53			12FR8	58						
1T4	50	6A2GT	75	6C8E	53	6C8E	53			12FR8	58						
1U4	56	6A4	45	6C8E	53	6C8E	53			12FR8	58						
1U5	49	6AF3	65	6C8E	53	6C8E	53			12FR8	58						
1V2	99	6A8	84	6C8E	53	6C8E	53			12FR8	58						
1X2B	74	6AF4A	90	6C8E	53	6C8E	53			12FR8	58						
2AF4A	90	6AG5	63	6C8E	53	6C8E	53			12FR8	58						
2BN4	59	6AH6	93	6C8E	53	6C8E	53			12FR8	58						
2C95	69	6AK5	99	6C8E	53	6C8E	53			12FR8	58						
3A3	83	3 For \$1.00		6C8E	53	6C8E	53			12FR8	58						
3AF4A	90	6AL5	44	6C8E	53	6C8E	53			12FR8	58						
3AL5	41	6AL7GT	1.35	6C8E	53	6C8E	53			12FR8	58						
3AM6	50	6AM8	77	6C8E	53	6C8E	53			12FR8	58						
3AV6	40	6AN8	84	6C8E	53	6C8E	53			12FR8	58						
3A4	55	6AQ5	49	6C8E	53	6C8E	53			12FR8	58						
3BA6	52	6AR5	62	6C8E	53	6C8E	53			12FR8	58						
3BC5	59	6AS5	66	6C8E	53	6C8E	53			12FR8	58						
3BE5	50	6AS8	47	6C8E	53	6C8E	53			12FR8	58						
3BN4	59	6AT6	42	6C8E	53	6C8E	53			12FR8	58						
3BN6	65	6AU4GT	80	6C8E	53	6C8E	53			12FR8	58						
3BU8	65	6AUSGT	49	6C8E	53	6C8E	53			12FR8	58						
33Y6	54	6AU6	49	6C8E	53	6C8E	53			12FR8	58						
3Z25	54	6AU7	70	6C8E	53	6C8E	53			12FR8	58						
3C25	54	6AU8	80	6C8E	53	6C8E	53			12FR8	58						
3CF6	59	6AV6	39	6C8E	53	6C8E	53			12FR8	58						
3CS6	59	6AW8	85	6C8E	53	6C8E	53			12FR8	58						
3DR6	59	6AX4GT	71	6C8E	53	6C8E	53			12FR8	58						
3DT6	49	6AX5GT	71	6C8E	53	6C8E	53			12FR8	58						
3Q4	64	6BA6	48	6C8E	53	6C8E	53			12FR8	58						
3Q5GT	64	6BA7	48	6C8E	53	6C8E	53			12FR8	58						
354	59	6BA8	89	6C8E	53	6C8E	53			12FR8	58						
3V4	57	6BC5	53	6C8E	53	6C8E	53			12FR8	58						
4AUG	65	6BA7	90	6C8E	53	6C8E	53			12FR8	58						
4RA6	54	6BD6	50	6C8E	53	6C8E	53			12FR8	58						
4BC8	95	6BE6	54	6C8E	53	6C8E	53			12FR8	58						
4BN5	59	6BE6	54	6C8E	53	6C8E	53			12FR8	58						
4BQ7A	94	6BF6	42	6C8E	53	6C8E	53			12FR8	58						
4BS8	92	6BG6G	1.55	6C8E	53	6C8E	53			12FR8	58						
4BU8	95	6BG6A	1.55	6C8E	53	6C8E	53			12FR8	58						
4B26	57	6BH6	65	6C8E	53	6C8E	53			12FR8	58						
4C56	58	6BH8	84	6C8E	53	6C8E	53			12FR8	58						
4C75	70	6BK7B	84	6C8E	53	6C8E	53			12FR8	58						
4DE6	60	6BL7GT	90	6C8E	53	6C8E	53			12FR8	58						
4DY5	60	6BN4	56	6C8E	53	6C8E	53			12FR8	58						
5AM8	78	6BQ5	58	6C8E	53	6C8E	53			12FR8	58						

MATCHED PAIR STEREO AMPLIFIERS
3 Tubes per channel (12AV6-35W4-50C5) with output trans, bass and treble controls. Completely wired, ready to connect speakers and stereo pickup. 6 MATCHED TUBES INCLUDED.
BOTH UNITS Y-101 \$9.98

ONE STAGE AC-DC UTILITY AMPLIFIERS
Ideal replacement for portable phonos, paging systems, Scientific rectifier. Completely wired with AC cord, Vol. control and switch. Very compact, 2 1/4 x 4 1/2 x 3 1/2. COMPLETE WITH TUBE
Y-102 \$2.49

CONDENSER SPECIALS
50-30-MFD-150V Fresh Stock, made by Dumont
SPECIAL C-101 39c each 4 for \$1.29
60-40-MFD @ 150V 20-MFD @ 25V
SPECIAL C-102 49c each 3 for \$1.39

TECHNICIANS' NEWS (Continued)

tenance is practiced on commercial equipment and technicians should do it also.

Another point mentioned was sales of accessories and extras by technicians. Mr. Anger said: "You have a great advantage over the counter and floor salesmen; you have entry to the customer's home . . . these little extras and accessories you sell total up to big dollars at the end of the year."

POLICE COOPERATION

The Indianapolis Police Department, taking notice of the increase in TV shop thefts, has agreed to give extra surveillance to ITTA (Indianapolis Television Technicians Association) members' shops during the trouble hours. Police Inspector Schmidt made the following suggestions:

Strive for publicity; more action will come if the citizens are kept aware. Keep shops well illuminated at night. Keep portable TV sets and transistor radios in a location where they are hard to pick up easily. Report any information you may have, such as license numbers and descriptions. Report cases where a customer says he can beat a quoted price on a new set by an unreasonable amount. Mark serial numbers of all sets on some permanent part of the set such as the yoke mounting or chassis.

CENSUS REPORT

The average total revenue per year for service shops (all types, large and small) in Washington State is \$11,920, according to preliminary figures released by the Federal Government. TSA Service News (Washington) goes on to report that firms without payrolls (one-man shops) do an annual gross of \$5,945. These figures, from a 1958 census, reveal that the average weekly wage is \$73.25.

The IPET (Independent Professional Electronic Technician) of California comments that the average TV "servicer", putting about 72 hours a week into his operation, makes about 98c an hour (using figures from eight states, not just Washington). They point out that the one-man shop is usually a husband-and-wife deal, with the "wife or other member of the family rendering vitally needed functions . . . doing so for absolutely nothing." END



"This one is a real dog!"

UNITED RADIO CO.

ESTABLISHED 1920

BOX 1000
NEWARK, N. J.

TERMS: remit full price plus postage with order. No COD. Mail to Dept. RE. Excess postage will be refunded.

Subject to Prior Sale
\$5 MINIMUM ORDER

ALWAYS INSIST ON PROVED BRAND NAMES
Ask By Name For **GENUINE "NO NOISE" PRODUCTS**
BEWARE OF CHEAP SUBSTITUTES

NO-NOISE TUNER-TONIC
With PERMA-FILM

- Economical—a little does a lot.
- Cleans, lubricates, restores all tuners, including wafer type.
- Non-toxic, non-inflammatory.
- Use for TV, radio and FM.

6 Oz. Aerosol Can
\$3.25
NET to Servicemen

NO-NOISE VOLUME CONTROL and CONTACT RESTORER

- Cleans Lubricates
- NOT A CARBON TET SOLUTION

2 Oz. Bottle \$1.00
3 Oz. Spray Can \$2.25
NET to Servicemen

NOW AVAILABLE FREE AT YOUR JOBBERS 5" PLASTIC EXTENDER

With Push Button Assembly
For Pin-Point Applications
Does Not Cause Shorts

ELECTRONIC CHEMICAL CORP. 813 Communipaw Avenue Jersey City 4, N. J.

new PATENTS

DIRECT-READING FREQUENCY METER

Patent No. 2,900,601

John L. Corl, Richmond, and James F. Gordon, Concord, Calif. (Assigned to Beckman Instruments, Inc., S. Pasadena, Calif.)

This device permits reading up to 100 mc, using a counter whose maximum is only 1 mc. The frequency is indicated by flashing neon lamps. The unknown signal is heterodyned against a local oscillator (through attenuators). The counter measures the difference beat.

beating against either 27 or 28 mc. These are the only harmonics that can cause a reading on the counter. The lower harmonic is correct.

As an example, assume an unknown of 27,864,976 cycles. As various multipliers are selected, we find that both 27 mc and 28 mc give

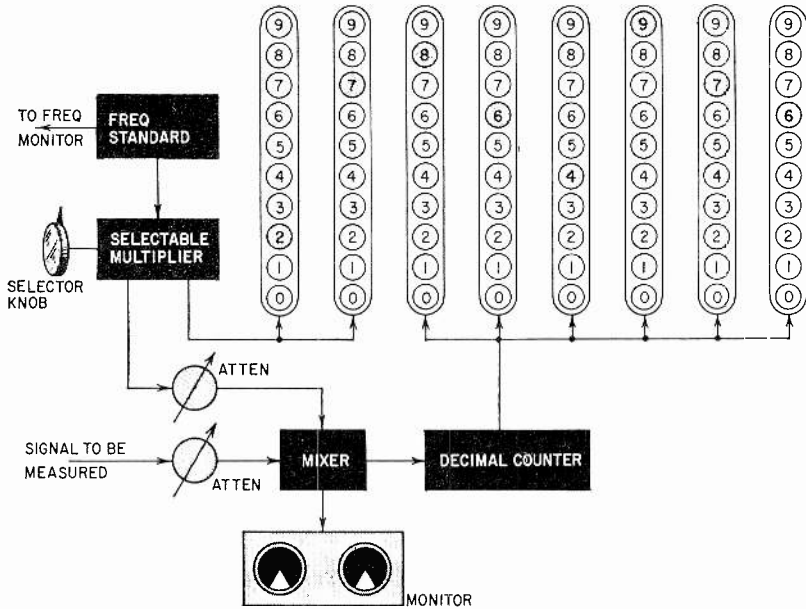

The frequency standard may be a 1-mc oscillator, whose harmonics (integral mc) are selected by a multiplier. Only two harmonics can generate a beat within range of the 6-digit counter. For example, if the unknown is 27,865,462 cycles, such a beat can result by

readings, so we choose 27 mc. The beat is then 864,976 cycles as indicated by the neon. For convenience, the multiplier is connected in such a way that its frequency is indicated by the first two digit columns. In this case, the correct frequency of 27,864,976 will be visible.

RADIO FIX

Patent No. 2,921,306

David Lawrence Jaffe, Great Neck, N. Y. (Assigned to Polarad Electronics Corp.)

The location of a radio transmitter can be found by triangulation. Two fixed receivers de-

termine a base line. Each measures the angle between base line and transmitter. This supplies

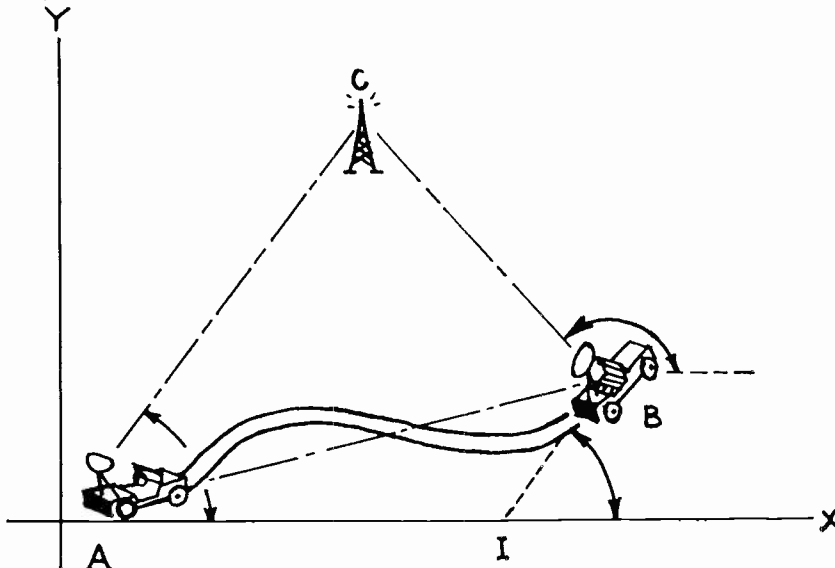

If you are a career-minded engineer or technician . . .
RE-DIRECT your future aims to high standing in **NUCLEAR ENGINEERING** technology

Learn Nuclear Engineering Technology through an advanced home study program offered by CREI Atomics. Enrollment is limited.

ONLY A LIMITED NUMBER OF MEN will be accepted at this time for this program of home study offered by CREI ATOMICS, an expertly-staffed extension division of The Capitol Radio Engineering Institute.

U.S. Atomic Energy Commission states about the severe shortage of trained people in nuclear technology: "... the immediate goal is to retrain, through short courses . . . those already grounded in traditional disciplines." Through CREI Atomics you can now combine your present technical education and engineering experience with knowledge in nuclear engineering and technology. The result: increased career opportunities and corresponding income advantages as the nuclear field develops.

Program of study includes—

Nuclear Physics, Reactor Physics, Thermodynamics, Reactor Technology, Reactor Controls, Instrumentation for Reactor Control, Isotopes, Health Physics—many other subjects



USE THIS COUPON TO REQUEST DETAILED CATALOG

CREI Atomics
 3224 16th Street, N.W.
 Washington 10, D.C.
 Please send me complete information about CREI ATOMICS.

name _____
 street _____
 city _____ state _____
 job title _____

2

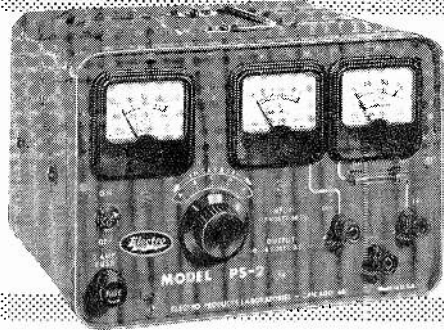

MODEL PS-2

2 OUTPUT RANGES

\$49⁹⁵ net

-IN-1 DC POWER SUPPLY

1... use it for operating **ALL TYPES** of auto radios
(transistor, hybrid and tube)

2... use it for operating **personal portable radios**
(transistor)

...also operates experimental transistor circuits, relays; use it for electroplating, laboratory work.

- Transistor protection with separately fused milliammeter.
- Longer life with EPL patented conduction cooling.

2 OUTPUT RANGES

VOLTS	CURRENT	RIPPLE
0-16	5 amps.	0.5%
0-20	75 ma.	0.15%

Compare With Others At Your Distributor... Send For Literature!

ELECTRO PRODUCTS LABORATORIES 4501-R Ravenswood, Chicago

Canada: Atlas Radio Corporation Ltd., Toronto

0156

BEST FILTERING, REGULATION



IN PARIS
FROM FEBRUARY
17th to 21st
1961

**4^e international
exhibition
of electronic
components**

from february 20th to 26th 1961
International Technical Congress
Subject: semi-conductor devices

FÉDÉRATION NATIONALE DES INDUSTRIES ÉLECTRONIQUES FRANÇAISES (F.N.I.E.)

23, rue de Lübeck - PARIS 16^e - Tél.: PASsy 01-16

ATTENTION...

Service

Technicians'
Associations

Club Members

Student Groups

Special subscrip-
tion rates to RA-
DIO-ELECTRON-
ICS are available
to associations,
clubs, schools, em-
ployee groups,
etc. For informa-
tion write—

G. Aliquo

NEW PATENTS (Continued)

enough information for determining the "fix".

This patent does the work with a single mo-
bile receiver. Moving along any path (see dia-
gram), it contains a computer that determines a
base line and the angles. A directional antenna
aboard the vehicle may be designed to point al-
ways to the transmitting source.

The vehicle may move along a curving road
from A to B. From the line AB and the two
angles, the computer calculates and indicates
the desired point C. The equipment is complex,
requiring speedometers, servos, resolvers, in-
tegrators, etc. More details are contained in the
patent specification.

WIDEBAND TUNER

British Patent No. 803,822

John Donald Burke, Hornechurch, Essex, England.

This tuner can cover a wide spectrum—for
example, from 500 kc to 500 mc or more—with
a single dial.

The diagram shows six coils mounted in series
around a circle. A rotary core can pass through
each coil in turn. Note the grounded pointer
that contacts the various shorting bars. In the
diagram the low end of coil A is shown shorted

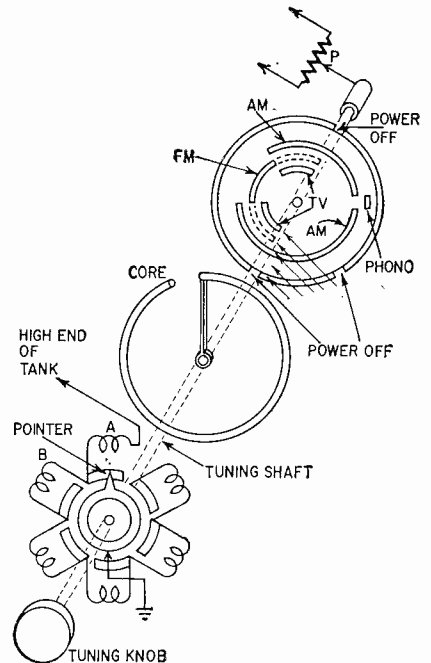

to ground and all other coils are removed from
the circuit when the core is in position to move
through A. The tuner is now set for the highest
frequency band.

As the dial is rotated counterclockwise, the
pointer begins to contact the next bar and coils
A and B are now in the circuit. All others are
out of the circuit. At this time the core is in
position to tune coil B, the next lower band.
In this way, one coil after another is switched
and the core always tunes the one nearest to
ground.

The single dial also controls other functions.
When set for TV channels, the AM sound
channel is automatically switched in. For FM
channels, the if and detector are automatically
switched for FM sound, etc. There are also
positions for phono (GRAM) and to shut off
power (MAINS OFF). Volume control is handled
by pushing or pulling the dial in or out. This
adjusts P as desired. END

CORRECTION

In the circuit of the "Darkroom
Timer," page 127 of the April issue,
the upper end of R3 should connect to
the OFF terminal of S1-b as indicated
in the text. Also, we must stress that
the timing capacitor (C2) should be a
high-quality paper or oil-filled unit.

Our thanks to Ken Greenberg of
Chicago for pointing out the erroneous
connection to S1-b.

NOTEWORTHY CIRCUITS

FOUR TRANSISTOR CLASS-B CIRCUITS

These four circuits are the basic types used with the 2N109 transistor. You will note that they differ only with respect to the driver transformer's secondary impedance, the bias network

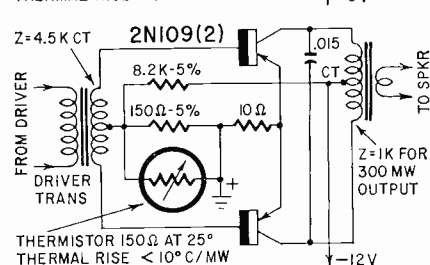
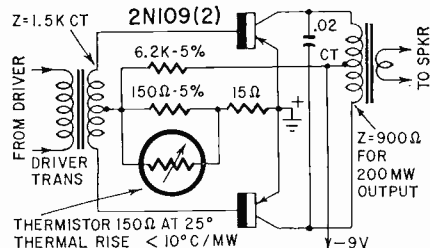
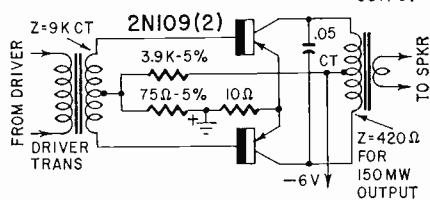
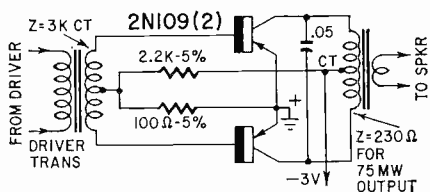

and the use of an emitter resistor to provide degeneration. The driver transformer in all of the circuits is chosen for the best combination of power gain and distortion, not to match the input. The power supply should be properly bypassed to get maximum efficiency. Large values for the bypass capacitors will be needed since the load impedance is small.—RCA Application Note 165

TOUCH-PLATE RELAY

With a touch-plate relay, you can turn things on without pressing a pushbutton. You need only touch your finger lightly to a small metal plate or to the end of a piece of wire. When

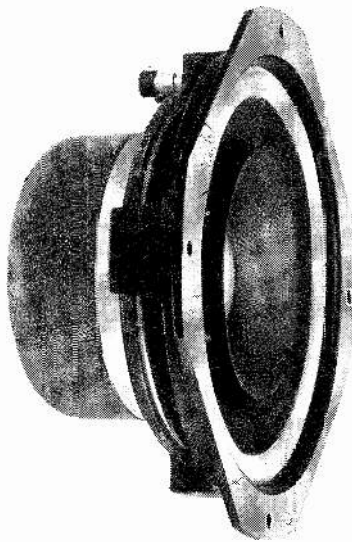
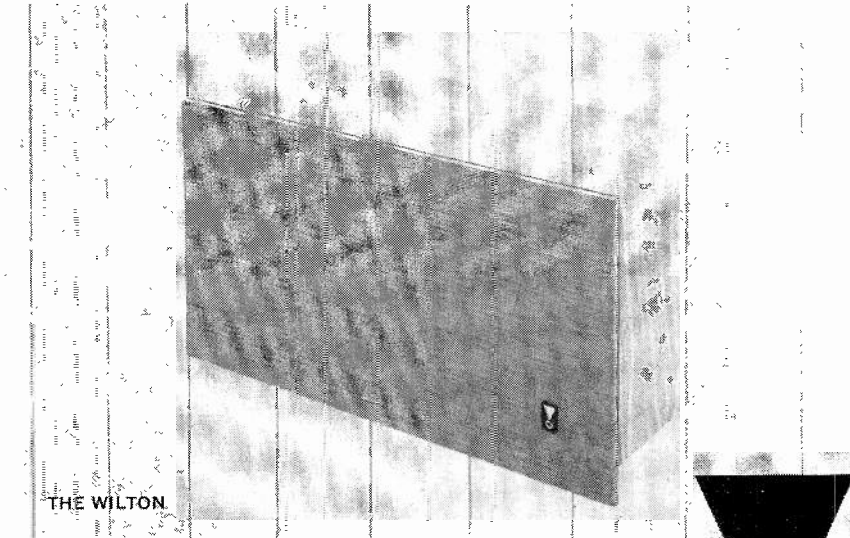

NEW JBL UTILITY ENCLOSURE FOR BUILT-IN SYSTEMS

"What's the best way to build a JBL Linear-Efficiency Speaker into a wall or cabinet?" This is the question most frequently asked of us since the introduction of the precision-made, long-linear-excursion, relatively-high-efficiency JBL loudspeakers. The answer is provided in the new Wilton systems. The Wilton is a minimum-volume acoustical enclosure for use with either the LE8, eight-inch, full-range, Linear-Efficiency Speaker (System D47LE8) or with the S5 two-way, network-divided Linear-Efficiency System (D47S5). It must be ordered with a system factory-installed; it is never available separately. The Wilton is an unfinished birch enclosure measuring 11 3/4" x 23 3/4" x 11 3/4". The surface is sanded at the factory on four sides ready for finishing, and may be used as a free-standing enclosure either vertically or horizontally. You have your choice of either a flush-mounted grille for this use or an overlapping grille for custom, built-in installations. Using the Wilton is an excellent way to convert a piece of furniture into a components cabinet. For a complete description write for your free copy of JBL Bulletin SB1019.

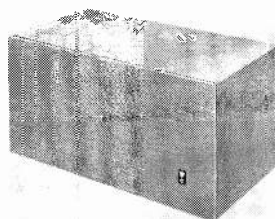

Free-standing Wilton is factory-sanded on four sides so enclosure can be placed either horizontally or vertically. Grille snaps out for convenience of home craftsman who wants to apply his own finish.

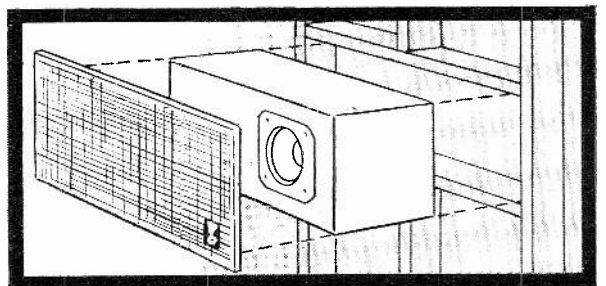

Custom-installation version of Wilton has snap-on grille that overlaps enclosure 1 1/2" on all four sides to cover gap between enclosure and wall framing or cabinet opening.

JAMES B. LANSING SOUND, INC., LOS ANGELES 39, CALIFORNIA

ALL NEW!



EMC advances in Audio and Test Equipment — by far the Best Values obtainable in Wired or Kit form.

EMC Model 801 RC Bridge and In-Circuit Capacity Checker

A new comprehensive resistance and capacity checker. It measures condensers for actual value, leakage, and power factor. In addition it measures condensers while still connected in their original circuits for opens, shorts or intermittents.

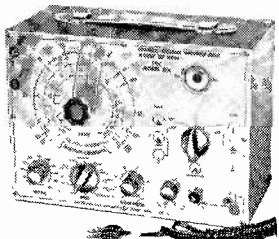

Model 801 Wired\$38.95 — Model 801 Kit\$24.95

EMC Model 802 Signal Tracer and Generator

Generates its own audio, IF and RF signal for tracing. Uses both a magic eye tube and a speaker for signal detection. Checks noisy components.

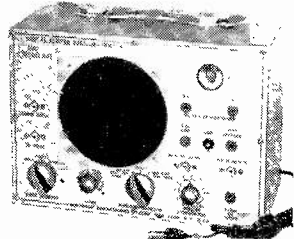

Checks and compares magnetic, ceramic and crystal cartridges. Supplied with two shielded audio probes and RF crystal demodulator probe. Model 802 Wired\$38.95 Model 802 Kit\$24.95

EMC Model 107A Peak to Peak Vacuum Tube Volt-Ohm Capacity Meter

6" meter cannot burn out — entirely electronic. Measures peak to peak AC voltages to 2800 volts in 6 ranges.

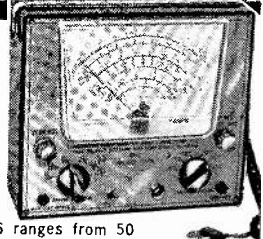

Measures capacity in 6 ranges from 50 mmfd to 5000 mfd. Measures resistance in 6 ranges from .2 ohm to 1000 megs. Measures DC volts to 1000 volts in 6 ranges. Input resistance 16.5 megs. Model 107A Wired\$51.40 — Model 107A Kit\$36.50

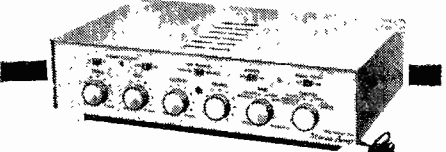

EMC Model 214 Stereo Amplifier

A compact, highly attractive dual 14W amplifier with built in preamplifiers having 56 watts peak power output. Has rumble filter and contour control switch. Extremely low distortion and noise level. It can be used as a 28 watts (56 watts peak) monaural amplifier or as a monaural amplifier so arranged that one pre-amplifier is used to drive the internal amplifier while the other preamplifier is used to drive any existing monaural amplifier.

Model 214 Wired \$106.80 — Model 214 Kit\$68.90

RE 66

Yes, tell me more, send me **FREE** a detailed catalog of the Complete EMC Line.

NAME

STREET

CITY STATE

EMC Electronic Measurements Corp.
625 B'way, New York 12, N. Y.
Pan-Mar Corp. 1270 Broadway New York, N. Y.

NOTEWORTHY CIRCUITS (Continued)

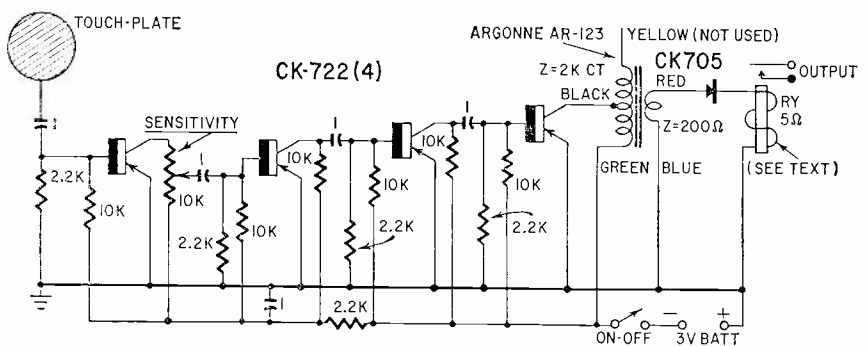

the circuit is transistorized and run at 3 volts, there is no danger of electric shock. Touch-plate relays are being used to operate doorbells, call signals, alarms, counters, safety devices, psychological measuring equipment, gaming devices, lights, door openers, intrusion alarms and many other similar contrivances.

The diagram shows the transistor circuit. This arrangement is entirely reliable. Standby current is only about 8 ma, so two series-connected size-D flashlight cells will give more than a week's service, 24 hours a day. For continuous unattended service, as in doorbell operation, the dc operating voltage may be provided by a simple line-operated power supply consisting of a filament transformer, crystal diode and 20-μf filter capacitor. (Still no shock hazard if a good-grade transformer is used.) The touch plate is a

1-inch-diameter metal disc insulated from ground. It can also be simply the end of the input lead wire.

The circuit is a sensitive af amplifier. Touching the plate injects a signal into the amplifier from stray pickup by your body. The amplifier's output is rectified by the crystal diode and closes the relay. The action is similar to the pinning of a low-range vtm when the input probe is touched. The relay remains closed as long as the finger is in contact with the plate. The relay is a surplus 1-ma 5-ohm unit (Triplet meter type sensitive relay) obtainable from Blan the Radio Man, 64 Dey St., New York, N. Y., for \$7.90. The nearest commercial equivalent is the Barber & Colman type AYLZ 4524S (13 ohms, 1.7 ma). Note: the Triplet unit's contacts are rated at only 50 ma and an additional relay may be needed.

To put the circuit into operation, in-

DOUBLE PROFITS

with these two ILLINOIS "HOT" LINES

Time Tested Quality

You really make extra profits with ILLINOIS UMP Twist Prong Capacitors which are especially designed for TV replacement. Each capacitor is fully guaranteed for one year . . . and is needed and in demand for replacement use NOW!



UMP

Here are popular, fast moving capacitors which mean repeat business for you. They withstand extreme moisture and temperature conditions. Made of highest quality and unconditionally guaranteed for one year, these attractively-priced capacitors are packaged in eye-appealing boxes.

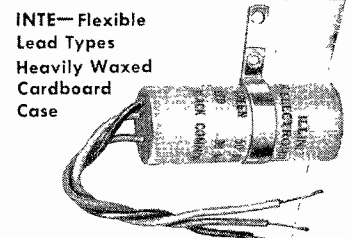

ELECTROMITE

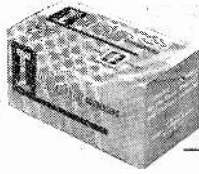

ILLINOIS "UMP" and "ELECTROMITE" Capacitors are available from leading electronic parts distributors.

ILLINOIS

CONDENSER COMPANY
1616 NORTH THROOP STREET
CHICAGO 22, ILL. EV 4-1300

Write for our complete catalog.

Export Department: 15 Moore Street, New York 4, New York

TIME TO CLEAN UP YOUR SYSTEM...

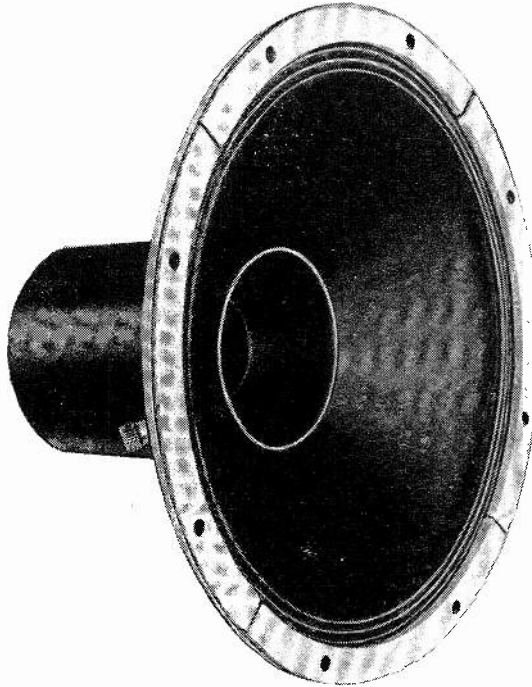

Norelco® T-7 LOUDSPEAKERS

with voice coil magnets of Ticonal-7 steel (30% more efficient* than Alnico V)

*... 30% more efficient response to the full signal range of your amplifier... WHETHER ITS RATED OUTPUT is 10 WATTS or a HUNDRED... at any listening level from a whisper to a shout!

Guild-crafted by Philips of the Netherlands to give you

THE CLEANEST SOUND AROUND

Ask for a demonstration wherever good sound is sold or write to:

**NORTH
AMERICAN
PHILIPS
CO., INC.**

High Fidelity Products Division,
230 Duffy Avenue,
Hicksville, L. I., N. Y.

What articles would you like to see published in
RADIO-ELECTRONICS
Maybe you're the man to write them. Ask for an author's guide.
RADIO-ELECTRONICS 154 West 14th St., New York 11, N. Y.

ELECTRONICS

Engineering-Technicians

Bachelor of Science Degree, 30 Months

Save Two Years' Time

- Radio-Television Plus Color Technician (12 Months)
- Electronics Technician (12 Months)
- Industrial Electronics Technician (12 Months)
- Electronics Engineering (B.S. Degree)
- Electrical Engineering (B.S. Degree)
- Mechanical Engineering (B.S. Degree)
- Civil Engineering (B.S. Degree)
- Architecture (B.S. Degree)

Heald College ranks FIRST West of the Mississippi in "Who's Who in America"

Approved for Veterans
DAY AND EVENING CLASSES

Write for Catalog and Registration Application.
New Term Starting Soon.

Missile headed for outer space. Courtesy of Space Technology Laboratories, Inc.

U.S. Air Force Photo

HEALD'S ENGINEERING COLLEGE

Established 1863

Van Ness at Post, RE
San Francisco, Calif.

Your Name

Address

City

State

NOTEWORTHY CIRCUITS (Continued)

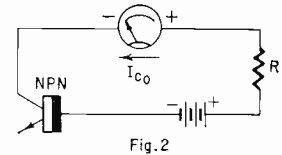

Fig. 2

lower meter readings mean higher alpha.

For leakage measurements, the circuit is arranged as in Fig. 2. The emitter

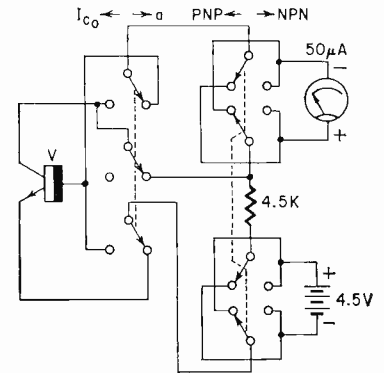

Fig. 3

is left open, and the meter reads collector current directly in microamps.

Fig. 3 shows the complete tester. Note its simplicity.—I. Queen END

CORRECTION

In our March issue (page 137) a short item on a light blinker appeared. The diode listed, a 1N1058, is not now available. As a substitute, use a Sarkes Tarzian M-500. It has been pointed out that the 80-ohm relay in this unit is hard to obtain. The relay is quite uncritical, and can have a coil impedance anywhere between 30 and 150 ohms. For 6-volt use, try the Sigma 11FZ-40-ACS/SIL; for 12 volts, the Sigma 11FZ-150-ACS/SIL.

We thank Mr. James D. Clark, of Lake Mills, Wis., for calling these points to our attention.

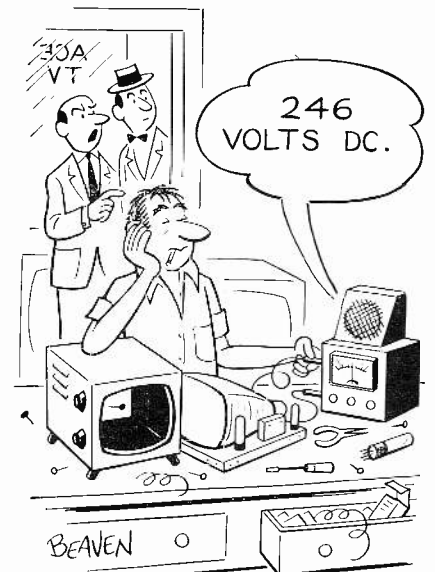

"He's a genius all right, but he's the laziest man in ten states!"

new PRODUCTS

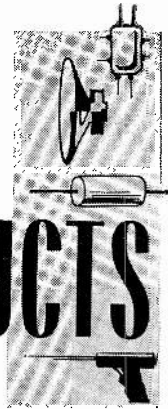

RF-IF COILS for radio, TV and commercial replacement needs, includes miniature and printed-circuit if transformers, rf chokes, peaking coils, adjustable rf coils.—Chicago Standard Transformer Corp., 3501 W. Addison St., Chicago 18, Ill.

CERAMIC FILTERS for use as interstage-coupler and emitter bypass elements in transistor if amplifiers. *TF-01A* and *TO-*

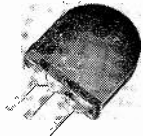

O1A (shown) Transfilters resonate at 455 kc, reduce bandpass of if amplifier.—Clevite Electronic Components, 3405 Perkins Ave., Cleveland 14, Ohio.

ANTENNAS for 27-mc Citizens band improve performance

as compared with standard ground planes. *Multibeam* series vertically polarized with all-aluminum construction. *Omnidirectional MB27-O* has gain of 3 db, *Bidirectional MB27-B* 6 db and *Unidirectional MB27-U* 8 db as compared with ground-plane antennas.—Winegard Co., 3000 Scotten, Burlington, Iowa.

LINE AMPLIFIER for 8 to 88 mc. All-transistor *T-Amp* has automatic gain control, 35 volts on cable powers up to 50 ampli-



fiers. For community cable systems.—Benco Television Associates Ltd., 27 Taber Rd., Rexdale, Ontario, Canada.

TRANSISTOR INVERTER model *2-120W* converts 12 volts dc to 117 volt 60-cycle ac. Power rating 125 watts continuous, 200 watts intermittent. 5½ pounds. No moving parts. Kit or wired and tested.—Arkay International, Inc., 88-06 Van Wyck Expressway, Jamaica 18, N.Y.

TRANSCEIVER KIT for Citizens band. Model *GW-10* available in ac or dc models. Built-in noise limiter. Superhet receiver may be tuned to any of 23 channels or crystal-controlled. Adjustable squelch circuit silences receiver during standby. Microphone has press-to-talk switch. Hardware sup-

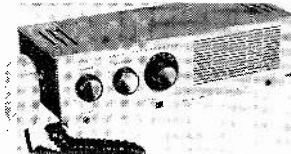

plied for under-dash mounting.—Heath Co., Benton Harbor Mich.

TRANSCEIVER KIT for 11-

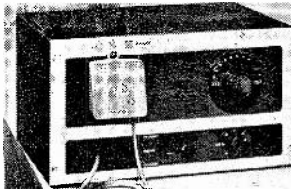

meter Class-D Citizens band. Has 5-watt transmitter and superregenerative receiver. Receiver tunes all 23 channels, transmitter crystal-controlled on any one channel. Model *C-11* powered by 117 volts ac. 6-12-volt dc mobile power supply vertical antenna and mobile mounting bracket, available.—Allied Radio Corp., 100 N. Western Ave., Chicago 80, Ill.

FILAMENT CHECKER model *T-5* kit indicates continuity of tube heaters, fuses, pilot lamps



or any low-resistance circuit. Miniature alligator clips used for special-base tubes. Powered by 2 penlight cells. Pin straighteners on panel for 7- and 9-pin miniature tubes.—PACO Electronics Co., Inc., 70-31 84th St., Glendale 27, N.Y.

TUBE TESTER model *211* checks octal, locktal, miniature

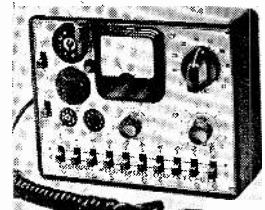

IT'S THE NEW MARK II FROM WESTON:

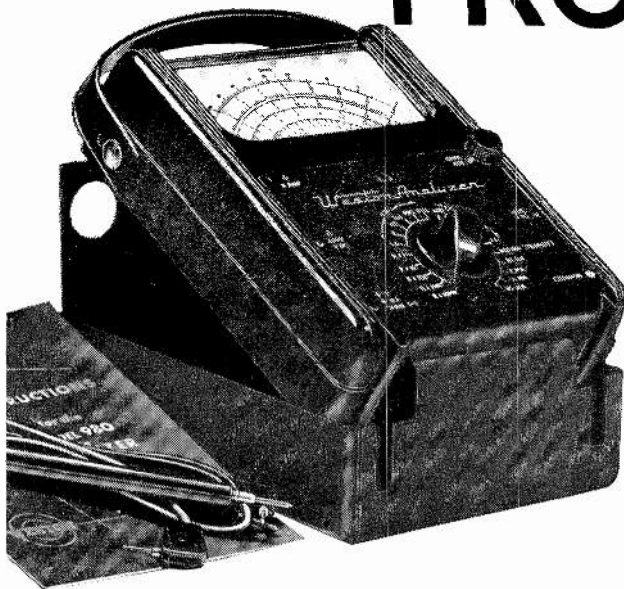

an advanced new design for the
WORLD'S FINEST PORTABLE ANALYZER

Here's an all-new version of the famous WESTON MODEL 980 Volt-Ohm-Milliammeter . . . engineered to offer you

- **INCREASED RANGE.** High-voltage range has been extended to 4000 volts.
- **INCREASED SENSITIVITY.** D-C sensitivity of 20,000 ohms/volt; accuracy within 2% of full scale.
- **IMPROVED SHIELDING.** Cormag® mechanism assures positive magnetic shielding; housing shields against electrostatic interference.
- **GREATER RUGGEDNESS.** Spring-backed jewel movement resists shock, vibration; case is impact-resistant. Ohm-ranges are fuse-protected.
- **SIMPLIFIED CONTROL.** Single dial control for range and function switching.
- **NEW COMPACTNESS.** Size and weight are reduced for maximum convenience and portability.

Order from your local Weston distributor. For information, write to Weston Instruments Division, Daystrom, Inc., Newark 12, N. J. In Canada: Daystrom, Ltd., 840 Caledonia Rd., Toronto 19, Ont. Export: Daystrom's International Sales Division, 100 Empire St., Newark 12, N. J.

DAYSTROM, INCORPORATED
WESTON INSTRUMENTS DIVISION

World leader in measurement and control

NEW PRODUCTS (Continued)

tubes for shorts, leakage, opens and quality, also electron-ray tubes and voltage-regulator types. — **Electronic Measurements Corp.**, 625 Broadway, New York 12, N. Y.

TRANSISTOR TESTER model 2590. Accurately tests power and signal transistors under simulated operating conditions. Set of external leads, besides transistor socket, permits testing transistors with any type base

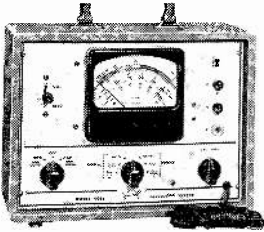

arrangement. — **Triplet Electrical Instrument Co.**, Bluffton, Ohio.

TUBE TESTER model 102-C built into tube caddy that holds over 125 tubes. To test tubes, set 3 controls and press button.

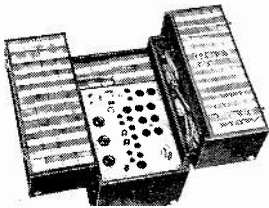

Can also be used out of the caddy. — **Mercury Electronics Corp.**, 77 Searing Ave., Mineola, N. Y.

OSCILLOSCOPE model ES-525 has push-pull amplifiers. Vertical amplifier response 10 to 500,000 cycles within 3 db; horizontal, 10 to 150,000 cycles within 3 db. Vertical sensitivity 20 mv per inch. Illuminated graticule, Z-axis modulation in-

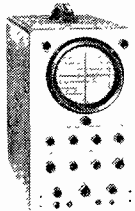

put, frequency - compensated step attenuator. Square-wave response to 50,000 cycles. Audible monitoring facilities via tip jacks. — **Precision Apparatus Co.**, 70-31 84th St., Glendale, N. Y.

POCKET-SIZE VOM model TE-10 has 10,000-ohms-per-volt movement. Uses 1% resistors. 3½-inch meter face. Single switch selects ranges. Measures to 1,200 volts ac or dc, 0 to 120 μ a dc and to 3 megohms. Color-coded test leads. Pigskin case

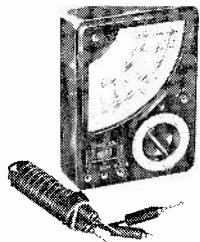

available. — **Lafayette Radio Corp.**, 165-08 Liberty Ave., Jamaica 33, N. Y.

EDUCATIONAL KIT model EK-1. First of series of educational electronic kits. Combina-

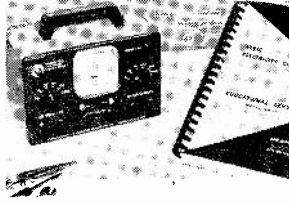

tion kit and text-workbook contains instructions and equipment for learning theory and construction of dc series and parallel circuits, meters and application of Ohm's law to these circuits. Owner ends up with working multimeter. — **Heath Co.**, Benton Harbor, Mich.

PHONE PLUG for silent connections. Musicians use cable with plugs on both ends to connect instrument to amplifier. *Silent Plugs* eliminate "squeal" and hum that often result when plug is removed from instrument. Small pin shorts plug

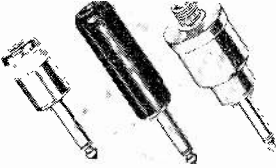

until it is inserted in jack. — **Switchcraft, Inc.**, 5555 N. Elston Ave., Chicago 30, Ill.

VARIABLE AC SUPPLY model T-266. 0 to 150 volts at

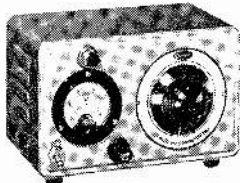

300 watts. Meter indicates output voltage. Input 117 volts ac. Fused, 2 output receptacles. — **Olson Radio Corp.**, 260 S. Forge St., Akron, Ohio.

FLYBACKS AND YOKES for TV replacement. All yokes have anti-pincushion magnets. 110³ yokes have 6 leads in both networked and unnetworked versions. 59 flybacks have been added to manufacturers line. — **Triad Transformer Corp.**, 4055 Redwood Ave., Venice, Calif.

SERVICE CEMENT No. 502-2. For speaker repairs or cone replacements, cementing loose



tube bases and repairing plastic cabinets. 2-ounce bottle with applicator. — **Chemtronics, Inc.**, 870 E. 52nd St., Brooklyn, N. Y.

STEREO TUNER KIT No. 83-YX731 (FM-AM kit) and **No. 83-YX732** (FM only, add-on AM kit is **No. 83-YX733**) have moving-bar tuning indicators. Continuously variable afc, 10-ke

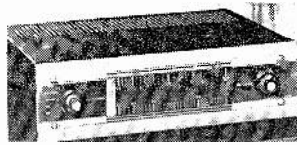

AM whistle filter, narrow- or wide-band AM if stage. Flywheel-weighted tuning knobs. — **Allied Radio Corp.**, 100 N. Western Ave., Chicago 80, Ill.

STEREO RECEIVER Recital (TA-224). Separate FM, AM sections, pair 12-watt amplifiers and dual preamps. FM sensitivity 2.5 μ v for 20-db quieting. FM response 30 to 15,000 cycles

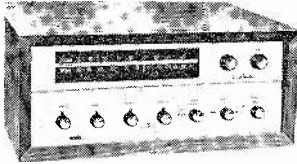

within 0.75 db, including standard de-emphasis. Amplifier response 15 to 30,000 cycles within 0.5 db. Also phono and tape-head inputs. Output impedances 8 and 16 ohms. — **Harmon-Kardon, Inc.**, 520 Main St., Westbury, N. Y.

STEREO AMPLIFIER model HF-89, kit or wired. 50 watts per channel or 100 watts combined. Response 20 to 20,000 cycles at full output. Outputs 4, 8 and 16 ohms. Output stage is pair

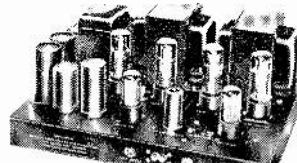

of Ultra-Linear, fixed-biased EL-34's per channel, 18-db feedback. Silicon diode power supply. — **Electronic Instrument Co., Inc.**, EICO, 33-00 Northern Blvd., Long Island City 1, N. Y.

STEREO AMPLIFIER model LA-210 has 5 watts output per channel. Response 40 to 30,000



cycles at normal listening level (1 watt). Dual volume and ganged tone controls. Harmonic distortion 2%. IM distortion 3% at full output. Hum and noise 65 db below full output. 5 tubes, feeds 4-, 8- or 16-ohm speakers. — **Lafayette Radio Corp.**, 165-08 Liberty Ave., Jamaica 33, N. Y.

STEREO TUNER model AJ-10, available in kit form. Function switch selects AM, FM or AM-FM stereo. Output for multiplex adapter. Flywheel tuning, separate electron-ray tuning indicators for AM and FM. FM sensitivity 2 μ volts for 20-db

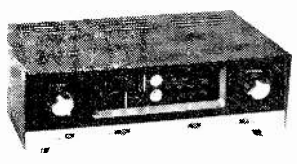

quieting. Built-in AM rod antenna. Switch selects "full afc, half afc and afc off". — **Heath Co.**, Benton Harbor, Mich.

STEREO AMPLIFIER model AA-40 stereo and monophonic reproduction. Response 20 to 20,000 cycles at full rated out-



put. Each channel 35 watts or 70 watts monophonic. Distortion less than 1% over full range at full output. Kit has mixed-channel output for center-channel speaker or to distribute monophonic sound to other sections of house. — **Heath Co.**, Benton Harbor, Mich.

STEREO PREAMP KIT, model S-1001. Flat response from 5 cycles to 60 kc within 1 db. IM

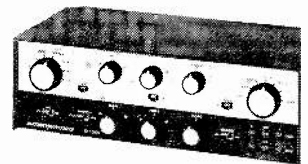

distortion at 1.5-volt output 0.16%. 7 pairs of inputs, third-channel output. Selector, bass, treble, balance, volume, mode, input level controls. Scratch and rumble filters. Phase-reversal switch. Panel lights indicate mode of operation. Magnetic phono input sensitivity, 2 μ v for 1.5-volt output. — **Acro Products Co.**, 369 Shurs Lane, Philadelphia 28, Pa.

STEREO PREAMP KIT model 83YX768 uses printed circuits, 12AX7's in input stage and dc on all heaters keep hum and

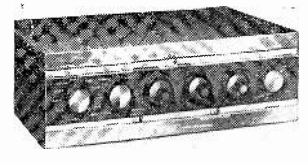

noise to minimum. Separate tape outputs unaffected by tone and volume controls. Cathode-follower outputs, scratch and rumble filters. 5 equalization positions for monophonic records. Channels may be reversed from front panel. — **Allied Radio Corp.**, 100 N. Western Ave., Chicago 80, Ill.

BUILDING - BLOCK RECORDER line allows beginners to add recorder components piece by piece rather than replace existing equipment. Line includes 5 tape decks and 6 preamps. Assembly can be started with low-priced tape

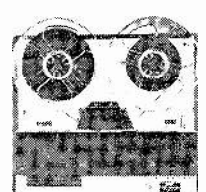

deck, built up with another pre-amplifier to record and playback 2- or 4-track stereo. — **Telectronic Corp.**, 35-18 37th St., Long Island City 1, N. Y.

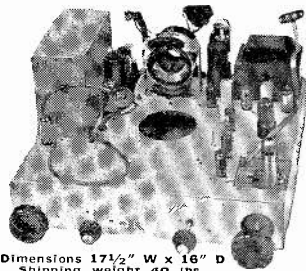

Dimensions 17 1/2" W x 16" D
Shipping weight 40 lbs.

BUILD YOUR OWN DX-16 TV CHASSIS

- ★ 70° or 90°—operating all 17", 21", 24" and 27" CRT's.
- ★ Produces a 16-Tube Chassis with 30-Tube performance.
- ★ Latest Intercarrier Circuitry and Multi-section Tubes.
- ★ Standard Neutrode Tuner for Selectivity & Fine Definition.
- ★ All Video and I.F. Coils factory pre-aligned and tuned.
- ★ Large 250ma Power Transformer for dependable service.
- ★ 12" Speaker or Twin-cone 6" x 9" Speaker.
- ★ LIFE-SIZE step-by-step Building Instructions included.

COMPLETE KIT with Westinghouse Tubes \$93.49
4-6BC6, 6U8, 6T8, 6C4, 12BH7, 6SN7, 6DO6, 6W4, 6K6, 1X2B, 5U4, 6BN4, 6GC8, incl. in the Tuner (less CRT)

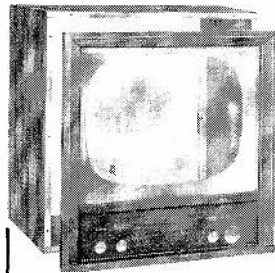

BUILD YOUR OWN CABINET FOR ANY TV CHASSIS

Comparable to the type that Top Mfrs. use on high priced TV sets.

CABINET KIT with 90% of the job done, includes—**FRONT SECTION** in Solid Mahogany, Walnut or Blond Korina. **TOP, SIDES, BACK, MASK, SAFETY GLASS, ETC.** And **EASY-TO-FOLLOW ASSEMBLY INSTRUCTIONS**

Front, Top and Sides supplied in a beautiful Piano Finish • Knob panel undrilled • For matching Mask specify type or number of CRT used. Same price—Mahogany, Walnut or Blond. (Shipping weight 36 lbs.)

21" CABINET KIT \$26.97
26" H, 25" W, 22" D

23" TV Cabinet Kit . . \$28.47 24" or 27" TV Cabinet Kit . . \$38.47 24" or 27" Front Panel Assembly . . \$24.97

"ONE DOLLAR" Buys

As much as \$15 worth — Everything Brand New and sold to you with a money back guarantee.

DEDUCT 10% ON ANY ORDER OF \$10 OR OVER (ON DOLLAR BUYS)
Plus a FREE SURPRISE PACKAGE
10-TUBES #1U4.. \$1

Also serves as a 1T4

Brand New, Mfd. by TUNG-SOL, Regular list price \$2.40 ea.

- | | |
|--|---|
| <input type="checkbox"/> 1-PHONO MOTOR 78rpm—complete \$1 | <input type="checkbox"/> 1-AUTO VIBRATOR 6V, non-synch. \$1 |
| <input type="checkbox"/> 1-3" PM SPEAKER alnico #5 magnet \$1 | <input type="checkbox"/> 100-ASST. 1/2 WATT RESISTORS some 5% \$1 |
| <input type="checkbox"/> 1-4" PM SPEAKER alnico #5 magnet \$1 | <input type="checkbox"/> 70-ASST'ED 1 WATT RESISTORS some 5% \$1 |
| <input type="checkbox"/> 1-5" PM SPEAKER alnico #5 magnet \$1 | <input type="checkbox"/> 35-ASST'ED 2 WATT RESISTORS some 5% \$1 |
| <input type="checkbox"/> 1-3 1/2" TWEETER SPEAKER for Hi-Fi \$1 | <input type="checkbox"/> 25-ASST. PRINTED CIRCUIT SOCKETS \$1 |
| <input type="checkbox"/> 3-AUDIO OUTPUT TRANS. 50L6 type \$1 | <input type="checkbox"/> 50-ASST. TUBULAR CONDENSERS \$1 |
| <input type="checkbox"/> 3-AUDIO OUTPUT TRANS. 6X6 push-pull \$1 | <input type="checkbox"/> 20-TUBULAR CONDENSERS .047-600v \$1 |
| <input type="checkbox"/> 2-AUDIO OUTPUT TRANS. 6K6 push-pull \$1 | <input type="checkbox"/> 15-TUBULAR CONDENSERS .47-400V \$1 |
| <input type="checkbox"/> 15-ASST. TV COILS sync. peaking, width \$1 | <input type="checkbox"/> 20-TUBULAR CONDENSERS .01-1000v \$1 |
| <input type="checkbox"/> 3-I.F. COIL TRANSFORMERS 456 kc \$1 | <input type="checkbox"/> 20-TUBULAR CONDENSERS .005-600v \$1 |
| <input type="checkbox"/> 3-I.F. COIL TRANSFORMERS 10.7 mc FM \$1 | <input type="checkbox"/> 20-TUBULAR CONDENSERS .01-600v \$1 |
| <input type="checkbox"/> 3-I.F. COIL TRANSFORMERS 262kc (auto) \$1 | <input type="checkbox"/> 15-TUBULAR CONDENSERS .25-600v \$1 |
| <input type="checkbox"/> 4-OVAL LOOP ANTENNAS ass't. gain \$1 | <input type="checkbox"/> 10-HV TUB. CONDENSERS .007-1600v \$1 |
| <input type="checkbox"/> 3-LOOPSTIC ANT. new ferrite adjustable \$1 | <input type="checkbox"/> 10-ASST. RADIO ELECTROLYTIC COND \$1 |
| <input type="checkbox"/> 3-VARIABLE COND. super 420/162 mfd \$1 | <input type="checkbox"/> 5-ASST. TV ELECTROLYTIC COND \$1 |
| <input type="checkbox"/> 3-ASST. SIZES RADIO CHASSIS PANS \$1 | <input type="checkbox"/> 2-ELECTROLYTIC COND. 40/40-450v \$1 |
| <input type="checkbox"/> 12-RADIO OSCILLATOR COILS 156 kc \$1 | <input type="checkbox"/> 3-ELECTROLYTIC COND. 80-450v \$1 |
| <input type="checkbox"/> 3-1/2 MEG. VOLUME CONTROLS w/switch \$1 | <input type="checkbox"/> 3-ELECTROLYTIC COND. 50/30-150v \$1 |
| <input type="checkbox"/> 5-50K VOLUME CONTROLS less switch \$1 | <input type="checkbox"/> 50-ASST. MICA CONDENSERS some in 5% \$1 |
| <input type="checkbox"/> 1-ASST. 1/2 WATT WIPER COILS \$1 | <input type="checkbox"/> 50-ASST. CERAMIC COND. some in 5% \$1 |
| <input type="checkbox"/> 10-ASST. VOLUME CONTROLS less switch \$1 | <input type="checkbox"/> 50-ASSORTED FUSES popular sizes \$1 |
| <input type="checkbox"/> 5-ASST. VOLUME CONTROLS w/switch \$1 | <input type="checkbox"/> 10-ALLIGATOR CLIPS \$1 |
| <input type="checkbox"/> 100-VOLUME CONTROL HEX NUTS \$1 | <input type="checkbox"/> 50-100K 1/2 WATT RESISTORS 5% \$1 |
| <input type="checkbox"/> 1-GOLD GRILLE CLOTH 14x14or 2x18 \$1 | <input type="checkbox"/> 50-470K 1/2 WATT RESISTORS 10% \$1 |
| <input type="checkbox"/> 5-SETS SPEAKER PLUGS wired \$1 | <input type="checkbox"/> 50-2.2 MEGΩ 1/2 W. RESISTORS 10% \$1 |
| <input type="checkbox"/> 10-SETS PHONO PLUGS and JACKS \$1 | <input type="checkbox"/> 10-ASST. WIREWIND RES. 5, 10, 20 \$1 |
| <input type="checkbox"/> 2-52.50 SAPPHIRE NEEDLES 5000 plays \$1 | <input type="checkbox"/> 40-ASST. PRECISION RESISTORS best sizes \$1 |
| <input type="checkbox"/> 20-ASST. PILOT LIGHTS popular types \$1 | <input type="checkbox"/> 35-ASST. DISC CERAMIC COND. 5000 mmf \$1 |
| <input type="checkbox"/> 10-PILOT LT. SKTS. bayonet type wired \$1 | <input type="checkbox"/> 25-ASSORTED MICA TRIMMER COND. \$1 |
| <input type="checkbox"/> 50-ASST. TERMINAL STRIPS 1, 2, 3, 4 lug \$1 | <input type="checkbox"/> 10-6" ELECTRIC STRIPS w/plugs \$1 |
| <input type="checkbox"/> 20-ASSORTED TUBE SHIELDS best sizes \$1 | <input type="checkbox"/> 5-TV CHEATER CORDS w/both plugs \$1 |
| <input type="checkbox"/> 35-ASST. RADIO KNOBS. 5/16" push \$1 | <input type="checkbox"/> 4-50' SPOOLS HOOK-UP WIRE 4 colors \$1 |
| <input type="checkbox"/> 100-ASSORTED KNOB SET-SCREWS \$1 | <input type="checkbox"/> 50-FLAT COND. WIRE many purposes \$1 |
| <input type="checkbox"/> 25-ASST'ED RADIO DIAL POINTERS \$1 | <input type="checkbox"/> 35-MICA COND. 20-5mmf & 15-25mmf \$1 |
| <input type="checkbox"/> 25-ASST'ED CLOCK RADIO KNOBS \$1 | <input type="checkbox"/> 35-MICA COND. 20-50 mmf & 15-68mmf \$1 |
| <input type="checkbox"/> 15-ASST. TARIARY SWITCHES \$15 worth \$1 | <input type="checkbox"/> 35-MICA COND. 20-100mmf, 15-270mmf \$1 |
| <input type="checkbox"/> 3-TOGGLE SWITCHES spst, dpdt, etc. \$1 | <input type="checkbox"/> 47-0mmf, 15-680mmf \$1 |
| <input type="checkbox"/> 5-SLIDE SWITCHES spst, dpdt, etc. \$1 | <input type="checkbox"/> 35-MICA COND. 20-820mmf 15-1000mmf \$1 |
| <input type="checkbox"/> 35-ASST. SOCKETS octal, nov. & m'ature \$1 | <input type="checkbox"/> 35-MICA COND. 20-220v, 15-2400mmf \$1 |
| <input type="checkbox"/> 5-TV CRT. SOCKETS with 19" leads \$1 | <input type="checkbox"/> 35-MICA COND. 20-680v, 15-10,000 mmf \$1 |
| <input type="checkbox"/> 15-TV CARTWHEEL CONDENSERS 10 kv \$1 | <input type="checkbox"/> 35-CERAMIC COND. 15-19mmf \$1 |
| <input type="checkbox"/> 7-TV CARTWHEEL CONDENSERS-15 kv \$1 | <input type="checkbox"/> 35-CERAMIC COND. 20-25mmf, 15-47mmf \$1 |
| <input type="checkbox"/> 3-TV CARTWHEEL CONDENSERS 30 kv \$1 | <input type="checkbox"/> 35-CERAMIC COND. 20-56mmf, 15-82mmf \$1 |
| <input type="checkbox"/> 3-HV RECTIFIER SOCKETS 1B3 m'ntd \$1 | <input type="checkbox"/> 35-CERAMIC COND. 15-150 mmf \$1 |
| <input type="checkbox"/> 1-HV RECTIFIER SOCKETS 1X2 m'ntd \$1 | <input type="checkbox"/> 35-CERAMIC COND. 15-150 mmf \$1 |
| <input type="checkbox"/> 20-ASST. TV KNOBS, ESCUTCHEONS, etc. \$1 | <input type="checkbox"/> 35-CERAMIC COND. 20-270, 15-470 mmf \$1 |
| <input type="checkbox"/> 35-ASST. PEAKING COILS popular types \$1 | <input type="checkbox"/> 35-CERAMIC COND. 20-1000, 15-1500mmf \$1 |
| <input type="checkbox"/> 1-RCA SYNCHRO. GUIDE COIL #205R1 \$1 | <input type="checkbox"/> 35-CERAMIC COND. 20-2000, 15-5000mmf \$1 |
| <input type="checkbox"/> 1-RCA SYNCHROLOG COIL #205R1 \$1 | TOP BRAND TUBES-1B3, 1X2B, 6U8, 6SN7, 6K6, 6X8, 6AX4, 12AU7 Each \$1 |
| <input type="checkbox"/> 1-STANDARD ACC COIL 1R4AG \$1 | |
| <input type="checkbox"/> 1-RATIO DETECTOR COIL 4.5 mc \$1 | |
| <input type="checkbox"/> 1-RATIO DETECTOR COIL 10.7 mc \$1 | |

HANDY WAY TO ORDER—Simply tear out advertisement and send items wanted (X on square is sufficient); enclose with money order or check. You will receive a new copy of this ad for re-orders.

ON SMALL ORDERS—Include stamps for postage, excess will be refunded. Larger orders shipped express collect.

TECH-MASTER for 1960 ★ "GOLD MEDAL" #2430-B

WORLD'S MOST POWERFUL TV CHASSIS

COMPLETE ready to operate (less CRT) 90° \$175.85 110° \$182.60 Catalog on request

Philmore Citizens' Band TRANSCEIVER KIT #TC-11 115v ... \$39.95

Complete with Cabinet, 5 Tubes, Microphone, Crystal your choice and illustrated Step-by-step Instructions #TC-612 6 or 2v. 44.49 #TV-15 ANTENNA 4.50

FREE—5 ALIGNMENT TOOLS for Radio & TV with each KIT. We pay shipping charge. Catalog on request

Modernize Your TV Set

STANDARD NEUTRODE TUNER

Latest 21mc type, replaces CASCODE PENTODE, Etc. Improves performance. Complete with Tubes & Instructions. \$15.97

- RC-121 STEREO GARRARD CHANGER 4-speed 29.97
- RC-88 STEREO GARRARD CHANGE 4-speed 44.62
- C-98 STEREO GARRARD CHANGER 4-speed 53.24
- G.E. STEREO DIAMOND CARTRIDGE #GC7 11.97

- 110° TV CONVERSION KIT all Essential Parts \$17.42
- 90° TV CONVERSION KIT all Essential Parts 15.98
- 70° TV CONVERSION KIT all Essential Parts 13.97
- UNIVERSAL 70° FLYBACK TRANSFORMER 4.86
- UNIVERSAL 90° FLYBACK TRANSFORMER 5.24
- UNIVERSAL 110° FLYBACK TRANSFORMER 5.24
- 17" TV MASK gray 13 3/4" x 17 1/4" 1.49
- 21" TV MASK gray 18" x 22 1/2" 2.38
- 23" TV MASK gray 18" x 22 1/2" 3.78
- 21" or 23" TV SAFETY GLASS 18" x 22 1/2" 5.16
- 24" or 27" TV MASK gray 21" x 26" 4.93
- 24" or 27" TV SAFETY GLASS 21" x 26" 5.87

TUBULAR CONDENSERS—85°C TOP QUALITY—Equally as good for Radio or TV work
.0047-400v, .01-400v, .02-400v, .047-400v, .001-600v, .0047-600v, .01-600v, .02-600v, .03-600v 5¢ ea.
.1-400v, .25-400v, .47-400v, .047-600v, .1-600v, .25-600v, .001-1000v, .0047-1000v, .01-1000v, 8¢ ea.
.039-1000v, .047-1000v, .1-1000v, .007-1600v, .03-1600v, .005-3000v, .001-6000v, 14¢ ea.

ELECTROLYTIC CONDENSERS—85°C 1-50v, 1-150v, 2-350v, 25-50v, 8-150v 19¢ ea.
20/20-150v, 50/30-150v, 40-150v, 10-450v, 20-450v, 30-450v, 40-450v, 80-450v34¢ ea.

CARBON RESISTORS—Regular factory stock in Stackpole, Speer, etc.

- 1/2 WATT 10% 10, 39, 47, 100, 120, 150, 270, 330, 390, 470, 560, 680, 820, 1k, 1800Ω . . . 2¢ ea.
- 1/2 WATT 10% 2700, 3300, 3900, 4700, 5600, 6800, 8200, 10k, 15k, 18k, 22k, 27k, 33kΩ . . . 2¢ ea.
- 1/2 WATT 10% 39k, 47k, 50k, 56k, 68k, 82k, 100k, 120k, 150k, 180k, 220k, 270k, 330kΩ . . . 2¢ ea.
- 1/2 WATT 10% 390k, 470k, 560k, 680k, 820k, 1k, 1.2, 1.5, 2.2, 6.8, 10, 15 MEGΩ2¢ ea.
- 1 WATT 10% 3.3, 10, 39, 100, 120, 150, 330, 470, 560, 680, 820, 1k, 1800, 2700, 4700Ω . . 3¢ ea.
- 1 WATT 10% 6800, 10k, 15k, 18k, 22k, 27k, 33k, 39k, 47k, 68k, 82k, 100k, 150k, 470k, 680kΩ 3¢ ea.
- 2 WATT 10% 18, 22, 82, 100, 180, 220, 390, 470, 680, 820, 18k, 22k, 100k, 470kΩ . . . 4¢ ea.

WIREWOUND RESISTORS 5-5w, 16-10w, 20-10w, 47-5w, 100-5w, 140-5w, 220-5w 16¢ ea.
280-10w, 390-5w, 470-5w, 500-10w, 680-10w, 820-5w, 1K-5w, 1K-10w, 1500-5w, 2K-10w . . .16¢ ea.
2500-5w, 3K-10w, 4700-5w, 5K-10w, 6K-10w, 7K-10w, 8200-5w, 10K-5w, 15K-5w, 22.5K-12w . . .16¢ ea.

CERAMIC CONDENSERS 1, 2, 3, 5, 6, 10, 22, 25, 47, 50, 51, 56, 82, 100, 120, 150 mmf . . . 3¢ ea.
CERAMIC CONDENSERS 220, 250, 270, 330, 470, 1k, 1200, 1500, 2k, 5k, 6800, 10k mmf . . . 3¢ ea.
MICA CONDENSERS 5, 25, 50, 60, 68, 75, 100, 120, 150, 220, 270, 330, 470, 510 mmf . . . 3¢ ea.
MICA CONDENSERS 560, 680, 820, 1k, 1500, 2k, 2500, 3300, 4700, 6k, 6800, 8k, 10k mmf . . . 3¢ ea.

- | | | | |
|--|--|--|--|
| <input type="checkbox"/> 200-SELF TAPPING SCREWS #8 x 1 1/2" \$1 | <input type="checkbox"/> 2-SELENIUM RECTIFIERS 100 ma \$1 | <input type="checkbox"/> 25-INSULATED SHIELDED WIRE \$1 | <input type="checkbox"/> \$15-1" JACKPOT TELEVISION PARTS \$1 |
| <input type="checkbox"/> 50-TERM'L STRIPS best type, 10 lugs \$1 | <input type="checkbox"/> 1-SELENIUM RECTIFIER 450 ma \$1 | <input type="checkbox"/> 32-TEST PROD. WIRE deluxe (red & black) \$1 | <input type="checkbox"/> 600-ASST. HOWARE screws, nuts, riv., etc. \$1 |
| <input type="checkbox"/> 1-2 MEGOHM RESISTOR 20w for #630 \$1 | <input type="checkbox"/> 1-LB. SPOOL ROSIN CORE SOLDER 40/60 \$1 | <input type="checkbox"/> 100-FINEST NYLON DIAL CORD best size \$1 | <input type="checkbox"/> 8-ASST. LUCITE CASES handy for parts \$1 |
| <input type="checkbox"/> 1-SILICON RECTIFIER 750 ma 500v \$1 | <input type="checkbox"/> 3-TV ALIGNMENT TOOLS assortment #1 \$1 | <input type="checkbox"/> 1-RCA 70° FLYBACK TRANS. 75240 \$1 | <input type="checkbox"/> 75-MINIATURE ZIP CORD 3 conductor \$1 |
| <input type="checkbox"/> 5-DIODE RECTIFIERS 3-IN22 2-IN22 1-IN64 \$1 | <input type="checkbox"/> 3-TV ALIGNMENT TOOLS assortment #2 \$1 | <input type="checkbox"/> 1-RCA FLYBACK TRANS' MR #311-T1 \$1 | <input type="checkbox"/> 4-KENRAD 6SH7 TUBES \$1 |
| <input type="checkbox"/> 3-DIODE CRYSTALS 1-IN60, 1-IN64, 1-IN69 \$1 | <input type="checkbox"/> 3-TV ALIGNMENT TOOLS assortment #3 \$1 | <input type="checkbox"/> 50-MICA COND'SERS 10000mmf-500v \$1 | <input type="checkbox"/> 3-TOP BRAND 6C4 TUBES \$1 |
| <input type="checkbox"/> 2-SELENIUM RECT. 1-65 ma & 1-250ma \$1 | <input type="checkbox"/> 3-TV ALIGNMENT TOOLS assortment #4 \$1 | <input type="checkbox"/> 100-MICA CONDENS. 1mmf-500v \$1 | <input type="checkbox"/> 3-TOP BRAND 1L5S \$1 |
| <input type="checkbox"/> 2-SELENIUM RECT. 1-75ma & 1-150 ma \$1 | <input type="checkbox"/> 3-TV ALIGNMENT TOOLS assortment #5 \$1 | <input type="checkbox"/> 100-CERAMIC COND. 2mmf-500v \$1 | <input type="checkbox"/> 3-Kenrad 1L53 TUBES \$1 |
| | | <input type="checkbox"/> 50-CERAMIC COND. 250mmf-500v \$1 | <input type="checkbox"/> 2-TOP BRAND 35W4 \$1 |

BROOKS RADIO & TV CORP., 84 Vesey St., Dept. A, New York 7, N. Y. TELEPHONE: CO 7-2359

BECOME A RADIO TECHNICIAN

for only \$26.95

BUILD 20 RADIO

CIRCUITS AT HOME

with the New Progressive

RADIO "EDU-KIT"®

All Guaranteed to Work!

PRACTICAL only
HOME RADIO COURSE \$26.95

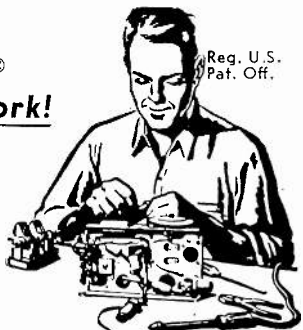

Reg. U.S. Pat. Off.

NOW INCLUDES

- ★ 12 RECEIVERS
- ★ 3 TRANSMITTERS
- ★ SQ. WAVE GENERATOR
- ★ AMPLIFIER
- ★ SIGNAL TRACER
- ★ SIGNAL INJECTOR
- ★ CODE OSCILLATOR

- ★ No Knowledge of Radio Necessary
- ★ No Additional Parts or Tools needed
- ★ Excellent Background for TV
- ★ School Inquiries Invited
- ★ Attractively Gift Packed

FREE EXTRAS

- SET OF TOOLS ● RADIO & ELECTRONICS TESTER ● ELECTRIC SOLDERING IRON ● TESTER INSTRUCTION MANUAL ● MEMBERSHIP IN RADIO-TV CLUB: CONSULTATION SERVICE ● HI-FI GUIDE ● QUIZZES ● TV BOOK ● FCC AMATEUR LICENSE TRAINING ● RADIO BOOK ● PRINTED CIRCUITRY ● PLIERS-CUTTERS ● ALIGNMENT TOOL ● WRENCH SET ● CERTIFICATE OF MERIT ● VALUABLE DISCOUNT CARD

WHAT THE "EDU-KIT" OFFERS YOU

The "Edu-Kit" offers you an outstanding PRACTICAL HOME RADIO COURSE at a rock-bottom price. Our kit is designed to train Radio & Electronics Technicians, making use of the most modern methods of home training. You will learn radio theory, construction, servicing, basic Hi-Fi and TV repairs, code, FCC amateur license requirements.

You will learn how to identify radio symbols, how to read and interpret schematics, how to mount and layout radio parts, how to wire and solder, how to operate electronic equipment, how to build radios. Today it is no longer necessary to spend hundreds of dollars for a radio course. You will receive a basic education in radio, worth many times the small price you pay only \$26.95 complete.

THE KIT FOR EVERYONE

The Progressive Radio "Edu-Kit" was specifically prepared for any person who has a desire to learn Radio. The "Edu-Kit" has been used successfully by young and old in all parts of the world, by many Radio Schools and Clubs in this country and abroad, for instruction and rehabilitation of Armed Forces Personnel and Veterans throughout the world.

The Progressive Radio "Edu-Kit" requires no instructor. All instructions are included. Every step is carefully explained. You cannot make a mistake.

PROGRESSIVE TEACHING METHOD

The Progressive Radio "Edu-Kit" is the foremost educational radio kit in the world, and is universally accepted as the standard in the field of electronics training. The "Edu-Kit" uses the modern educational principle of "Learn by Doing." Therefore you will construct radio circuits, perform jobs and conduct experiments to illustrate the principles which you learn.

You begin by examining the various radio parts included in the "Edu-Kit." You then learn the function, theory and wiring of these parts. Then you build a simple radio. With this first set, you will enjoy listening to regular broadcast stations, learn theory, practice testing and troubleshooting. Then you build a more advanced radio, learn more advanced theory and techniques. Gradually, in a progressive manner, and at your own rate, you will find yourself constructing more advanced multi-tube radio circuits, and doing work like a professional Radio Technician.

Included in the "Edu-Kit" course are twenty Receiver, Transmitter, Code Oscillator, Signal Tracer, Signal Injector, Square Wave Generator and Amplifier circuits. These are not unprofessional "breadboard" experiments, but genuine radio circuits, constructed by means of professional wiring and soldering on metal chassis, plus the new method of radio construction known as "Printed Circuitry." These circuits operate on your regular AC or DC house current.

In order to provide a thorough, well-integrated and easily-learned radio course, the "Edu-Kit" includes practical work as well as theory, troubleshooting in addition to construction; training for all, whether your purpose in learning radio be for hobby, business or job; progressively-arranged material, ranging from simple circuits to well-known Hi-Fi and TV. Your studies will be further aided by Quiz materials and our well-known FREE Consultation Service.

THE "EDU-KIT" IS COMPLETE

You will receive all parts and instructions necessary to build 20 different radio and electronics circuits, each guaranteed to operate. Our Kits contain tubes, tube sockets, variable, electrolytic, mica, ceramic and paper dielectric condensers, resistors, the strips, coils, hardware, tubing, punched metal chassis, Instruction Manuals, hookup wire, solder, selenium rectifiers, volume controls and switches.

In addition, you receive Printed Circuit materials, including Printed Circuit chassis, special tube sockets, hardware and instructions. You also receive a useful set of tools, a professional electric soldering iron, and a self-powered Dynamic Radio & Electronics Tester. The "Edu-Kit" also includes Code Instructions and the Progressive Code Oscillator, in addition to the F.C.C.-type Questions and Answers for Radio Amateur License training. You will also receive lessons for servicing with the Progressive Signal Tracer and the Progressive Signal Injector, and a High Fidelity Guide and Quiz Book. Everything is yours to keep.

J. Statistis, of 25 Poplar Pl., Waterbury, Conn., writes: "I have repaired several sets for my friends, and made money. The 'Edu-Kit' paid for itself. I was ready to spend \$240 for a course, but I found your ad and sent for your Kit."

UNCONDITIONAL MONEY-BACK GUARANTEE

The Progressive Radio "Edu-Kit" has been sold to many thousands of individuals, schools and organizations, public and private throughout the world. It is recognized internationally as the ideal radio course.

By Popular demand, the Progressive Radio "Edu-Kit" is now available in Spanish as well as English.

It is understood and agreed that should the Progressive Radio "Edu-Kit" be returned to Progressive "Edu-Kits" Inc., for any reason whatever, the purchase price will be refunded in full, without quibble or question, and without delay.

The high recognition which Progressive "Edu-Kits" Inc. has earned through its many years of service to the public is due to its unconditioned assistance upon the maintenance of perfect engineering, the highest instructional standards, and 100% adherence to its Unconditional Money-Back Guarantee. As a result, we do not have a single dissatisfied customer throughout the entire world.

ORDER FROM AD—RECEIVE FREE BONUS RESISTOR AND CONDENSER KITS WORTH \$7.00

- Send "Edu-Kit" Postpaid. I enclose full payment of \$26.95.
- Send "Edu-Kit" C.O.D. I will pay \$26.95 plus postage.
- Send me FREE additional information describing "Edu-Kit."

Name.....

Address.....

Progressive "EDU-KITS" Inc.

1186 Broadway, Dept. 165-G
Hewlett, N.Y.

NEW PRODUCTS (Continued)

TAPE RECORDER. 5-inch empty reel, microphone and cord for radio. Operates at 3 3/4 or 7 1/2 ips by making simple capstan adjustment. 17 lb. 11 1/2

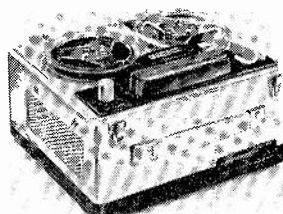

x 10 x 7 inches. Input jacks for microphone and radio; output jack for external speaker.—Radio Shack Corp., 730 Commonwealth, Boston 17, Mass.

TAPE RECORDER model RK-400. Single function control selects reverse, stop, play and record. 3 3/4- and 7 1/2-ips operation. Recording-level indicator



lamp, 5-inch heavy-duty speaker. Microphone, cord for recording from radio, and empty reel supplied.—Lafayette Radio Corp., 165-08 Liberty Ave., Jamaica 33, N.Y.

MAGNETIC RECORDING TAPE. New backing is said to be twice as strong and 16 times as tear-resistant as acetate backing. No. 311 with Tencar backing has uniform high-potency oxide for full-range frequency response plus silicone lubrication for smooth travel past recording heads.—Minnesota Mining & Manufacturing Co., 900 Bush Ave., St. Paul 6, Minn.

INVERTED SPEAKER Magni-Magic has pot and magnet assembly inside cone. Voice-coil rubbing eliminated by automatic coil centering. Slim-design

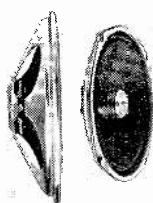

speaker in 8- and 6 x 9-inch —Utah Radio & Electronics Corp., 1124 E. Franklyn St., Huntington, Ind.

BAFFLE KIT model 1 for 12-inch speakers. Bass-reflex enclosure of full-grain white hardwood ply, available in



birch finish. Volume 4 1/2 cubic feet.—Homewood Industries, 26 Court St., Brooklyn, N.Y.

SPEAKER SYSTEMS, Lancaster 100, Lindon 100 (illustrated) and **Lorraine 100.** Designed for along-the-wall, book-

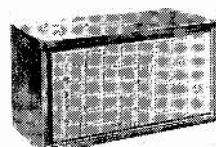

case or shelf, and corner placement, respectively. Large models use LS12 speaker, book-case model uses LS8. Mid-range or high-frequency stepup kits available. Walnut, mahogany or lined-oak finishes.—Electro-Voice, Inc., Buchanan, Mich.

PA AMPLIFIER model AM-149, 2 microphone and 1 phono input with volume control for each. Response 30 to 20,000

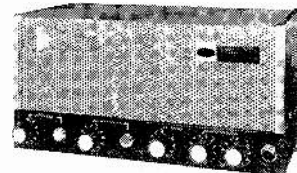

cycles within 3 db. Power rating 33 watts. Outputs 4, 8 and 16 ohms, and 70.7-volt line.—Olson Radio Corp., 260 So. Forge St., Akron, Ohio.

CERAMIC CARTRIDGE and needle combination has 20% higher output. Dyna-Points have plastic bumpers to protect generating element if tone arm is dropped on record. Available



with 2 sapphire tips or diamond LP tip and sapphire tip for 78-rpm records.—Jensen Industries, Inc., 7333 W. Harrison, Forest Park, Ill.

MICROPHONES that give unobstructed view of speaker avail-

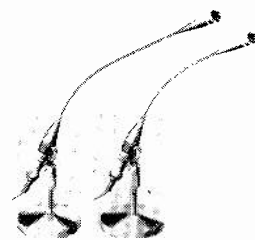

able in two sizes, model 652, 24 inches long, and model 652A, 15 inches. Both dynamic mikes have response of 50 to 12,000 cycles. Plastic baffles add directivity, boost brilliance at 6,000-cycle range. Low-impedance output of -60 db.—Electro-Voice, Inc., Buchanan, Mich.

TRANSISTOR AMPLIFIER model TA-12. Ultra-miniature 4-stage amplifier. Minimum gain 73 db at 1,000 cycles. More than 16 parts built in. Mercury cell

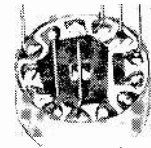

as power source, external volume control. Power output up to 0.5 mw without clipping.—Centralab, Div. Globe-Union, Inc., 900 East Keefe Ave., Milwaukee 1, Wis. END

All specifications on these pages are from manufacturers' data.

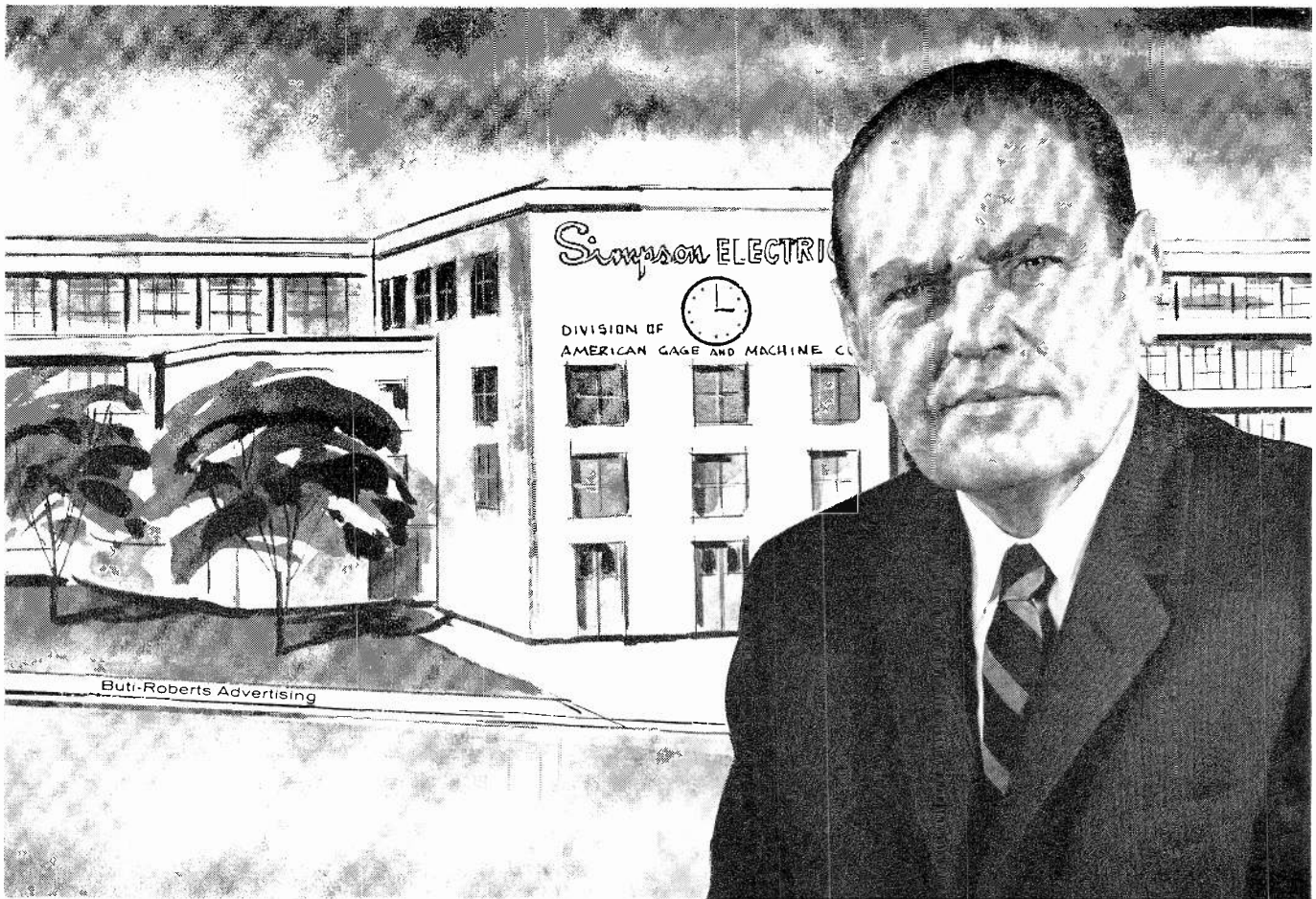

“We get the Simpson sales story across to jobbers by selling through independent electronic representatives”

Says Mel Buehring, Director of Sales, Simpson Electric Co.

“Merchandising, good customer relations, and product information are all a big part of the Simpson Electric Company sales picture. We’ve found that in 99% of the sales areas, the best way to be sure we’re getting through to the jobbers is to work with independent representatives. You can count on their knowing their jobs. These experts talk the jobber’s language and they know the ins and outs of the marketing and distribution problems peculiar to their particular area.

“And because he works his territory in-

tensively, the representative gets a friendly reception that is immeasurable in goodwill and reflected in gross sales.”

Whatever your line, you can benefit from the special talents and experience of the independent electronics Representative. And it’s easy to find Representatives especially suited to your particular sales requirements. One effective way is through the “Lines Available” columns in ERA’s publication, *The Representor*, distributed monthly to all member Representative companies. Write for complete details.



Electronic Representatives Association

600 So. Michigan Ave., Chicago 5, Illinois

Dedicated to improving and extending the role of the representative in electronics marketing.

Transistor Radio Servicing CAN be Highly Profitable

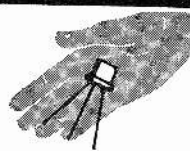

The **ONLY** Complete Transistor Radio Service Lab
Everything you need for less than \$50

Check Transistors, Diodes, Rectifiers . . .



SENCORE TRC4 TRANSISTOR CHECKER

Accurately checks all transistors in hearing aids, radios and power transistors in auto radios. Tests for opens, shorts, leakage, current gain. Measures forward-reverse current ratio on all crystal diodes. Measures forward and reverse currents on selenium rectifiers. With set-up chart for accurate checking of each transistor. Size, 5x4½x2½". With batteries. DEALER NET..... **19⁹⁵**

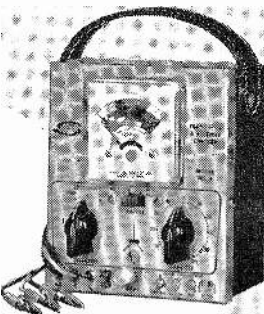

Replace Batteries During Repair . . .



SENCORE PS103 BATTERY ELIMINATOR

All-new "Transi-Pak," twin to TRC4 Checker above. Provides variable DC voltage to 24 volts; 1.5-volt biasing tap (a "must" for servicing Philco and Sylvania radios). Metered current output, to 100 ma. Handles 200-ma peaks. Two 200-mfd electrolytics provide proper filtering and low output impedance. No hum or feedback problems. Ideal for alignment using station signal; adjust IF slugs for max. current, also ideal for charging nickel-cadmium batteries. Size, 5x4½x2½". DEALER NET..... **19⁹⁵**

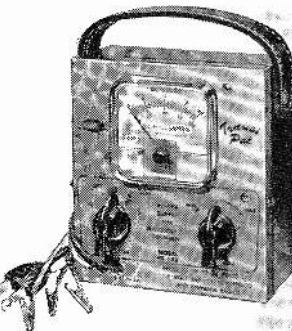

Find Defective Stage in a Minute . . .



SENCORE HG104 HARMONIC GENERATOR

New signal generator designed primarily for fast signal-tracing of transistor radio circuits. No need to unsolder all transistors. Provides RF, IF and audio signals *simultaneously*, drastically cutting service time. Traces from speaker to antenna. Clear 1000 cycle note signal is heard in speaker from all good stages. Signal weakens or stops at defective stage. Equally as effective for testing TV, hi-fi and other audio circuits also. Size, 3½x4½x1¾". With batteries. DEALER NET..... **9⁹⁵**

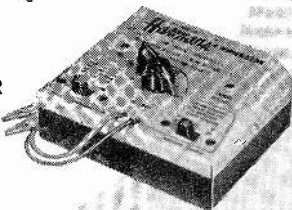

Turn page for other

SENCORE
Time Savers



SENCORE
ADDISON 2, ILLINOIS

The July Issue of

RADIO-ELECTRONICS

on sale June 28,

Order your copy now from your local dealer

TAPE RECORDERS

HI-FI COMPONENTS
SLEEP LEARN KITS



MERITAPE
Low cost, high quality recording tape, in boxes or cans.
UNUSUAL VALUES FREE
1960 CATALOG
DRESSNER, 69-02RE 174 St., Flushing 65, N.Y.

MAIL ORDER HI-FI

You can now purchase all your HI-FI from one reliable source and be assured of perfect delivery. Carston makes delivery from NY stock on most HI-FI, Recorders and tape within 24 hours. SEND US A LIST OF YOUR HI-FI REQUIREMENTS FOR OUR WHOLESALE QUOTATION and our FREE wholesale catalogue.

CARSTON STUDIOS 125-RD E. 88 St. New York 28, N. Y.

NEW TUBES and SEMI-CONDUCTORS

REALLY new is the theme this month as we have specifications on two of the newest semiconductor devices—tunnel diodes and semiconductor thyratrons with a switch-off gate.

Tunnel Diodes

CTD-400, -401, -402, -403, -404

A few of the many applications for tunnel diodes are in memory and logic functions, amplifiers, oscillators and mixers. Because of their many advantages, including low noise and switching speeds in the order of a few milli-

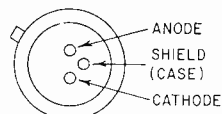

CTD-400, CTD-401
CTD-402, CTD-403
CTD-404

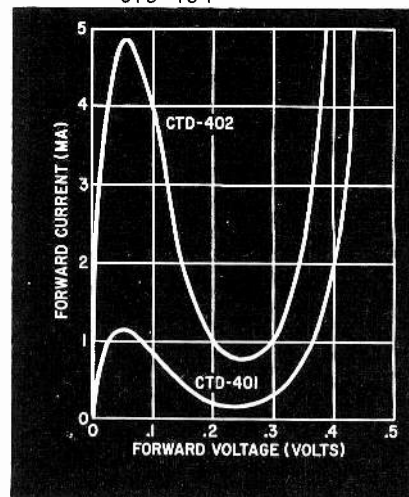

microseconds, they are ideally suited for use in both commercial and military systems.

Tentative specifications for these Clevite tunnel diodes are shown in the diagram and the table.

Type	Peak Current Range (I _p in ma)
CTD-400	1-10
CTD-401	1- 4
CTD-402	3- 6
CTD-403	5- 8
CTD-404	6-10

TSW-30, -60

These devices, named Transwitch, represent a new type of semiconductor.

NEW TUBES & SEMICONDUCTORS (Contd.)

Made from silicon, they are p-n-p-n switching devices which are similar to thyratrons but can be switched off through the gate. This, together with their inherent bi-stable characteristics, makes the devices useful in computer applications and switching operations.

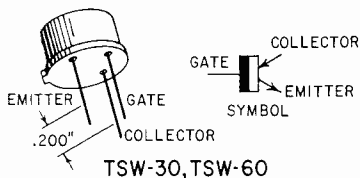

TSW-30, TSW-60

Absolute maximum ratings of the Transistron TSW-30 and TSW-60 are:

	TSW-30	TSW-60
I_f (forward current) (ma)	50	50
V_{BO} (minimum breakover voltage)	30	60
V_R (peak reverse voltage)	30	60

Typical specifications and characteristics at 25°C are:

V_S (saturation voltage)	1.0
I_{CO} (forward off current) (μ a)	0.1
I_R (reverse current) (μ a)	0.1
$V_{G\ on}$ (gate voltage to switch on)	0.7
$I_{G\ on}$ (gate current to switch on)	(ma) 0.1
$V_{G\ off}$ (gate voltage to switch off)	-1.2
$I_{G\ off}$ (gate current to switch off)	(ma) -7.0
I_H (holding current) (ma)	2

2N424

N-p-n silicon transistors designed for high-power switching and amplifier applications, these units are sealed in welded metal cases with a square base. The collector is connected to the case.

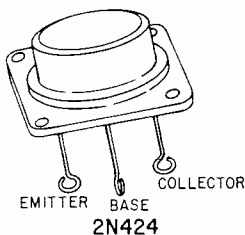

Maximum ratings of these Silicon Transistor Corp. 2N424 are:

V_{CE}	80
V_{EB}	10
P_{total} (at 25°C) (watts)	85
(at 100°C) (watts)	45
Electrical characteristics are:	
h_{FE} (dc current gain)	60
R_{CS} (saturation resistance) (ohms)	10
h_{fe} (high-frequency current gain)	2

CST-1739, -1740, -1741, -1742, -1743

A line of miniature power amplifiers for audio amplifier and switching circuits. The small case size makes the units adaptable to a variety of mounting requirements where space is at a premium.

Absolute maximum ratings of these Clevite units are:

V_C supply (transformer-coupled load, class-A or -B amplifier) (resistance load, class-A amplifier)	20
V_{CE} (resistance load, class-A amplifier)	40
V_{CE} (resistance load, class-A amplifier)	20
V_{EB}	35



A complete range of capacitors and resistors at your command.

SENCORE HANDY 36 SUBSTITUTION UNIT

Serviceman . . . Engineer . . . Experimenter . . . here's a unit that really saves you time. The Handy 36 provides the 36 most often needed capacitors and resistors for fast, on the spot substitution. The 12 position, 3 wafer switch individually selects one of the 36 components. You simply dial the value you want to the exact or closest reading. Substitution is still the only time tested method for determining whether or not a component is faulty while operating in circuit.

Eliminate time wasted in hunting for parts to use in testing. Say goodbye to the soldering mess created by substituting individual components. Put an end to the twisted wires and messy parts you've tossed in parts drawers.

The Handy 36 is simple to use. If a component is suspected of being shorted, open one end and substitute the Handy 36. Or, merely parallel any capacitor or resistor you think is open.

Model H36. DEALER NET 1275

Ask any parts distributor for the "Handy 36", accept no substitute.

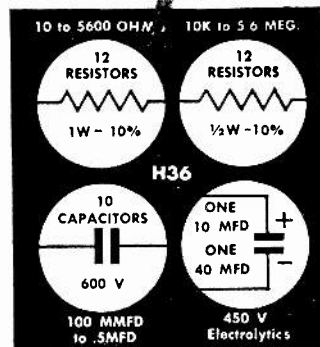

The Handy 36, with new improved circuitry, pays for itself in the first month by saving you those valuable minutes. The parts alone in the H36 would cost you more than the completed unit.



6 oz. SPRAY CAN

Also available in: 2 oz. bottles, 4 oz. brush top cans, 8 oz., quart or gallon cans.

SOLD WITH MONEY BACK GUARANTEE



- CLEANS
- RESTORES
- LUBRICATES

OUR ARMED FORCES USE KLEEN-LUBE BECAUSE IT IS A NON-INFLAMMABLE, NON-TOXIC, ANTI-FRICTION LUBRICANT THAT CLEANS AND LUBRICATES IN ONE SIMPLE APPLICATION

FREE!

CONTAINS MIRICALUBE LEAKPROOF CAPILLARY NEEDLE (FOR PIN POINT SPRAYING) PLUS 10" FLEXIBLE TUBE (FOR HARD TO REACH PLACES)

IDEAL FOR

- TV TUNERS
- VOLUME CONTROLS
- RELAYS
- CONTACT SWITCHES
- ELECTRICAL AND MECHANICAL BUSINESS MACHINES

SEND FOR FREE SAMPLE

Name
 Address
 Firm Name (if any)
 Mail To
 KLEEN-LUBE INC.
 1706 Hudson Blvd., Jersey City, N.J.

"KLEEN-LUBE MEANS CLEAN CONTACTS"

KLEEN-LUBE INC. Jersey City, N.J.

Pinpoint in Seconds...

HORIZONTAL & VERTICAL SWEEP TROUBLES

NEW

SENCORE

Time Saver

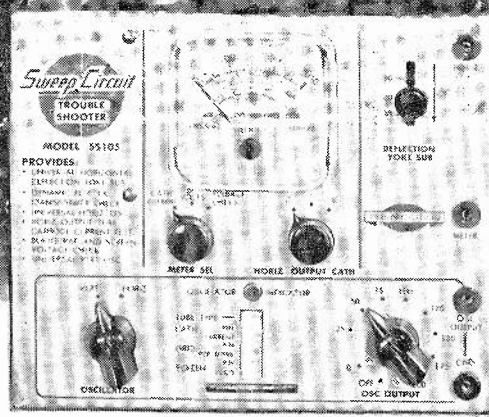
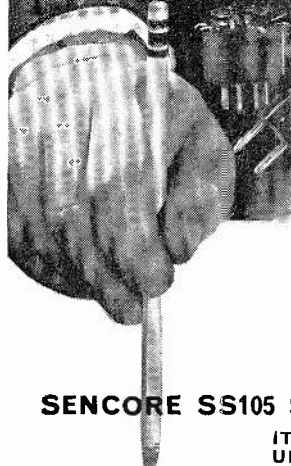

The missing link in TV service...

SENCORE SS105 SWEEP CIRCUIT TROUBLE SHOOTER

IT'S A ... UNIVERSAL HORIZONTAL OSCILLATOR. For direct substitution. No wires to disconnect in most cases. Traces trouble right down to the defective component. Variable output from 0-200 volts, peak-to-peak. Oscillator will sync to TV sync signal giving check on sync circuits.

HORIZONTAL OUTPUT CATHODE CURRENT CHECKER. A proven method that quickly checks the condition of the horizontal output tube and associated components. Adaptor socket prevents breaking wires. Easily replaceable Roll Chart gives all necessary pin, current and voltage data. New Roll Charts are Free.

UNIVERSAL DEFLECTION YOKE. A new, simple way to determine yoke failure accurately—without removing yoke from picture tube. Merely disconnect one yoke lead and substitute. If high voltage (also bright vertical line) is restored, TV yoke is defective.

DYNAMIC FLYBACK TRANSFORMER CHECKER. Merely flip switch to "Flyback Check" and meter will indicate condition of flyback transformer, in degrees of horizontal deflection. Extremely sensitive and accurate; even shows up one shorted turn on flyback.

VOLTMETER. For testing bootstrap, screen and other voltages. Direct-reading voltmeter, 0-1000 volts.

UNIVERSAL VERTICAL OSCILLATOR. Checks oscillator, output transformer and yoke. Merely touch lead to component and check picture on screen.

SS105 is completely self-contained, nothing else is needed. New Improved Circuit... DEALER NET 42⁹⁵

HORIZ. OSC.	VERT. OSC.
HORIZ. O.P. STAGE	VERT. O.P. STAGE
HORIZ. FLYBACK XFORMER	VERT. O.P. XFORMER
HORIZ. DEFLEC. YOKE	VERT. DEFLEC. YOKE

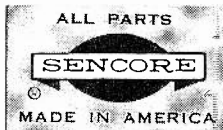

SENCORE

ADDISON 2, ILLINOIS

NEW TUBES & SEMICONDUCTORS (Contd.)

I_c (Class-A or -B amplifier)	3.0
(peak amps)	
I_b	2.0
(amps)	

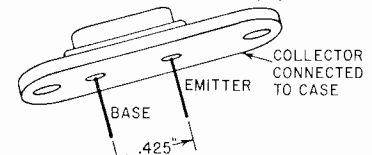

CST-1739, CST-1740, CST-1741, CST-1742, CST-1743

Characteristics of these transistors are:

	-39	-40	-41	-42	-43
G_{FE} (power gain)	28	28	32	34	36
(min db)					
D (distortion) (max %)	5	5	5	5	5
h_{ie} (input impedance)					
(max ohms)	35	20	20	25	30

2N706

An n-p-n diffused silicon mesa transistor for use in logic circuits.

V_{CE}	20
V_{CB}	25
V_{EB}	3

Maximum ratings and electrical characteristics of the Fairchild 2N706 at 25°C are:

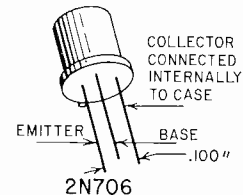

Characteristics of the Fairchild 2N706 at 25°C are:

h_{FE}	15
h_{fe}	2
C_{ob} (collector capacitance)	5
($\mu\mu\text{f}$)	

2N1500

A germanium micro-alloy diffused-base p-n-p transistor, specifically designed for very high speed switching. Operates reliably in switching circuits at speeds of more than 20 mc. The transistor's excellent high-frequency response at very low collector voltages

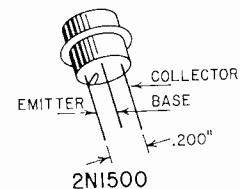

is made possible by placing the collector in the diffused region of the base. The unit can also be used in low-voltage high-frequency amplifiers, both tuned and wideband video types.

Maximum ratings of this Philco transistor are:

V_{CB}	15
V_{CE}	12
V_{EB}	2
I_c (ma)	50
P_{total} (mw)	50

Electrical characteristics at 25°C are:

h_{FE}	6
C_{ob} ($\mu\mu\text{f}$)	1.5
t_r (rise time μsec)	13
t_s (storage time μsec)	7
t_f (fall time μsec)	7

END

ENGINEERING DEGREE IN SCIENCE MATH 27 or 36 MOS.

Accelerated year-round program prepares for early employment in fields of Science and Engineering. Regular 4-year program for B.S. Degree completed in 36 months, special engineering degree program in 27. Classes start quarterly—June, September, January, March. Quality education. Graduates employed from coast to coast. Government approved for veteran training. Students from 50 states, 40 countries, 20 buildings, dorms, gym, Campus. Save time and money. Earn board while studying. Write for catalog and complete information. 1760 E. Washington Blvd., Fort Wayne 2, Indiana

INDIANA TECHNICAL COLLEGE

HI-FI & STEREO COMPONENTS

Send us your list for a **SPECIAL PACKAGE DEAL QUOTE** No sale too small. Trade-ins accepted. **BONAFIDE** offers biggest discounts on all standard brands. Expert advice and full guarantee are assured at

BONAFIDE ELECTRONICS
Dept. RE6, 89½ Cortland St., N.Y. 7, N.Y.
WE WILL NOT BE UNDERSOLD

FREE! CATALOG OF HI-FI, RADIO, TV PARTS & ACCESSORIES — yours for the asking!

Vidaire ELECTRONICS MFG. CORP.
44 CHURCH ST. • BALDWIN, N. Y.

Technotes

RCA 6RF9

Some of these AM-FM units may have an excessive amount of hum which becomes very apparent at or near low volume.

This hum is usually caused by incorrect lead dress. R17, a 27,000-ohm resistor from the low end of the volume control, may be dressed too close to a high-voltage ac lead from the power transformer. Simply run R17 away from the transformer as much as possible. Also avoid any other ac leads. — C. S. Lawrence

G-E 17P1330

Complaint: Vertical foldover. In many models this fault can be

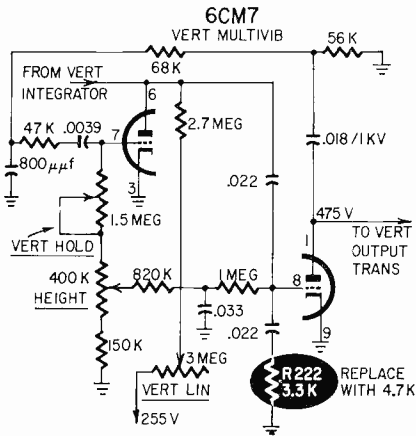

corrected by replacing resistor R222 (3,300 ohms) with a 4,700-ohm unit. — Warren Roy

COMPENSATING CAPACITORS

In vertical circuits of the newer TV sets, some special capacitors are used. They are not encapsulated and look like ordinary paper units. However, they have specific temperature compensating characteristics and close tolerances. If you have to replace one, be sure that you use a replacement with the same characteristics. If you don't, the vertical section operation may be affected. — W. C. Warren

ZENITH 23H22

This 17-inch model came into the shop after a series of complaints of intermittent and noisy sound. A check of the audio circuits gave no indication of the trouble. Then we took notice of the B-plus supply to the audio output tube, and reasoned that trouble here could cause the symptoms the set showed. A check of these components revealed that R26, a 3,500-ohm 10-watt resistor, was intermittent. A simple replace-



A New Dynamic Approach

Check over 1300 tubes for

- Cathode Emission
- Grid Emission
- Leakage
- Shorts
- Gas

SENCORE "MIGHTY MITE" TUBE CHECKER

Answers the needs of the fast moving, profit minded serviceman who hates time consuming call backs. A "mite" to carry but a whale of a performer with more efficiency than testers costing much more.

New unique circuitry tests for grid emission and leakage as high as 100 megohms yet checks cathode current at operating levels. Special short test checks for shorts between all elements. The MIGHTY MITE will test every radio and TV tube that you encounter (over 1300!) plus picture tubes. Set up controls as easy as "A B C D" from easy to follow tube chart. New tube charts provided free of charge.

AND check these added Sencore servicing features: • Meter glows in dark for easy reading behind TV set • Stainless steel mirror in cover for TV adjustments • Rugged, all steel carrying case and easy grip handle • Smallest complete tester made.

Model TC109.....DEALER NET **59⁵⁰**

Ask your distributor for the "MIGHTY MITE" with the mirror in the cover

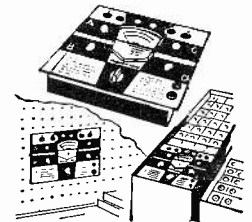

Use it everyday in every way. Especially designed so you can transfer inner chassis to your tube caddy, bench or counter. Only 9" x 8" x 2 1/2".



SENCORE

ADDISON 2, ILLINOIS

SUPER MAGNET SUPER SAVING!

Buy this Little Giant magnet, most powerful made, a sensational bargain! The low price of \$1.95 is less than 50% of what you'd pay for this magnet. Experimenters, hobbyists will find hundreds of uses for this powerful 4 oz. Alnico permanent magnet. LIFTS 5 lbs. EASILY. Limited quantity. Order several today. Measures 1 3/4 x 1 1/4". Item No. 86 **\$1.50** Special Bargain (Shp. Chgs. 10c)



250 POWER TELESCOPE LENS KIT

Make your own high powered 6 ft. telescope! Kit contains 2" diam., 75" focal length, ground and polished objective lens and necessary eye pieces. Magnifies 50x to 250x. Full instructions.

ITEM NO. 123 **\$2.95** (Shp. Chgs. 10c)



AMAZING BLACK LIGHT

250-watt ultra-violet light source. Makes fluorescent articles glow in the dark. Fits any lamp socket. For experimenting, entertaining, unusual lighting effects.



Ship. wt. 2 lbs. **\$2.95** ITEM NO. 87 (P. P. & Hdng. Chgs. 35c)



WATHOUR METER

Leading makes—reconditioned. Ideal for trailer parks, 100-110 volts, 60 cycles. 2-wire A.C. 5 amp. Heavy metal case 8 1/2" x 6 1/4" x 5". Easy to install. Ship. wt. 14 lbs.

ITEM NO. 33 **NOW ONLY \$4.50** (P.P. & Hdng. Chgs. \$1.25)

HUDSON SPECIALTIES CO., 160 W. 14th St Dept. RE-6-60, New York 7, N.Y. 5 am enclosing full remittance for items circled below. (Be sure to include shipping charges.) 87 33 86 123

Name Please Print Clearly
Address
City Zone State



CAN OPENER IS SERVICE TOOL

Although a beer-can opener may be considered standard equipment for thirsty radio-TV service technicians, its usefulness to the nondrinking technician as a service tool should not be underestimated. I often use one as a tube lifter for stubborn tubes (I don't use it with the set turned on for it might short out the base pins), and I use its sharp point for opening solder-clogged terminal eyes. The point is also handy for making holes in wood siding for starting screw-in standoff insulators. If kept in a toolkit along with other tools, a can opener will undoubtedly solve many other service problems.—James C. Conrad

POWER-TRANSISTOR SOCKETS

It's easy to make socket for power transistors. Just take a new 7- or 9-pin tube socket, straighten the little hook

at the bottom of a pin, and push it through the hole. This way you can take out as many pins as you need. Take the pins you have removed and solder them to the end of the wire you want to connect to the transistor's base or emitter, and push it on. For a neat and short-free job you can pull a piece of spaghetti over the joint of pin and wire. If you have only used tube sockets, break one with a hammer or pliers to free the pins.—Bela Foldi

REDUCE LINE-CORD FRAYING

The line cord on your soldering iron will have a longer life if you keep it from fraying. Just wind a coil spring

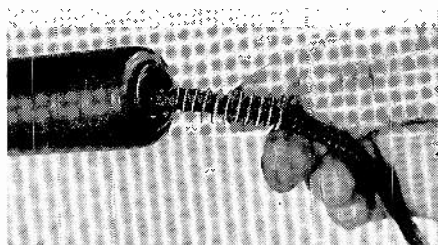

around the line cord for a distance of several inches. Then force the end of the spring inside the soldering iron's handle.—Ken Murray

SEE-THROUGH PROBE GUARDS

If your test probe doesn't have finger guards to keep the tips of your fingers out of hot circuits, make some from

NOW! A down-to-earth guide to MODERN TEST PROCEDURES

Alternate Test Methods • Cautions • Correct Instrument Usage • Readings • Connections and Control Settings • Test Techniques • Time-Saving Methods ... and all the rest!

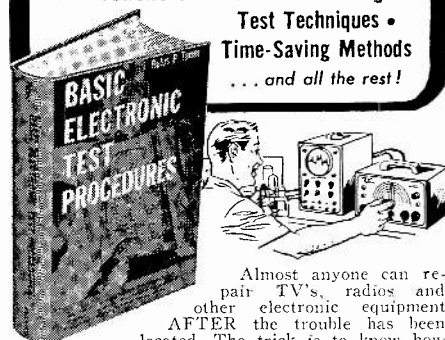

Almost anyone can repair TV's, radios and other electronic equipment AFTER the trouble has been located. The trick is to know how to spot troubles in the first place—and that means knowing how to use instruments fast and accurately. Actually, it's amazing what you can do with only a few instruments—providing you know how to use different kinds for the same job; how to select the right ones; where to use them; how to connect them into circuits; how to set controls; how to read them; and how to follow professional test procedures every step of the way. And that's exactly what this new 316-page book with its more than 190 how-to-do-it pictures and procedure sketches teaches you.

IT'S WHAT YOU KNOW ABOUT USING INSTRUMENTS THAT COUNTS!

BASIC ELECTRONIC TEST PROCEDURES by Eufus Turner helps you learn to troubleshoot any circuit, equipment or component in half the usual time. Covers different methods for doing specific jobs. For instance, you learn to check distortion by the 'scope, rejection filter, harmonic-distortion meter, wave analyzer or audio oscillator methods. You learn to make resistance measurements with a current-meter, a volt-ammeter, a volt-meter, an ohmmeter, or via the bridge method. Subjects include current checks; power, capacitance, resistance, AF, RF, phase, distortion, and modulation measurements; tube and semi-conductor testing; audio amplifier tests; sensitivity, RF gain, fidelity, AVC voltage, operating voltage checks, etc.; visual alignment techniques—even transmitter and industrial electronic test procedures. Price only \$6.50.

CONSIDER OSCILLOSCOPES for instance!

Simplified explanations of modern oscilloscope techniques show how to use your 'scope as a volt-meter, current meter, variable frequency oscillator, etc., or for making RF, phase or AM measurements; for distortion and deflection checking; square wave testing; visual AM and FM alignment; and for many other jobs. Every detail is explained—from making connections to analyzing patterns.

INDUSTRIAL ELECTRONICS, TOO!

STILL ANOTHER BIG FEATURE is the book's usefulness in acquainting you with industrial electronic test techniques—including testing non-electronic phenomena such as strain, pressure, etc.

PRACTICE 10 DAYS . . . FREE!

Dept. RE-60, RINEHART & CO., INC.
232 Madison Ave., New York 16, N. Y.

Send BASIC ELECTRONIC TEST PROCEDURES for 10-day FREE EXAMINATION. If I decide to keep book, I will then send you \$6.50 plus a few cents postage in full payment. If not, I will return book postpaid and owe you nothing. (SAVE! Send \$6.50 with your order and Rinehart pays the postage. Same 10-day guarantee with your money promptly refunded if you're not more than satisfied with book.)

NAME

ADDRESS

CITY, ZONE, STATE.....

OUTSIDE U.S.A.—Cash with order only. Price \$7.00. Money back if book is returned in 10 days.

DON'T buy an expensive CAR RADIO (unnecessarily)

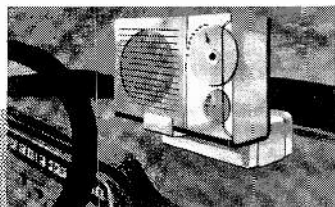

- magnet base**
Instantly removable prevents theft
- adjustable**
Fits any size pocket transistor large or small
- no antennas!**
Built-in set antenna does the job
- no wiring!**
Even motor suppressors are unnecessary

Cardio master

Converts A Transistor Radio Into A Car Radio



For All Makes of Cars and Trucks

Cardio master is a super powerful permanent magnetic device designed to hold a portable transistor radio in the area of a car's windshield in such a manner as to make it operate as an auto radio. No installation, wiring, additional antennas, or motor suppressors are required. Car's owner can instantly remove a radio from the Cardio master for use as an ordinary portable or to avoid the possibility of theft while the car is parked.

Volkswagen, Opel, Vauxhall, MG, Simca, Fiat, Renault, Ford, Chrysler and General Motors . . . to name a few. Ideal for truck drivers since Cardio master requires no installation, and can be removed instantly.

Only \$4.95 with Full Profit Margins



Increased sale of transistor radio and replacement batteries will add to the BIG profits to be derived from the sale of Cardio master. See your parts jobber or write for bulletin.

MFG. BY R-COLUMBIA PRODUCTS CO., INC. HIGHWOOD, ILL.

"TAB" Tubes Tested, Inspected, Boxed—Six Months Guarantee!! No Rejects! NEW & Used Gov't & Mfrs. Surplus!

Orders \$10 or more, Receiving types only ppd, 48 states

0A2	.80	6B16	.60	12A76	.59	1851	1.00
0B2	.65	6B7K	.69	12A77	.84	11726	1.10
0C3	.69	6C17	1.22	12B16	.69	4-65A	16.00
0D3	.35	6B86	.98	12A77	.69	2D21	2/81
0Z4	.59	6B06	1.10	12A77	.79	3023	3.85
1A7	.89	6B7K	1.25	12B16	.65	717A	5/81
1B3	.78	6C4	.43	12B17	.69	4-125	29.00
1R5	.78	6C5	.69	12B06	.59	4-250	35.00
1S4	.78	6C6	.80	12B66	.59	4E27	7.00
1T4	.78	6C6E	1.49	12B76	.59	4E27	20.50

Send 5¢ for Catalog

1U4	3/81	6H6	3/81	12B77	.99	4X150G	\$15
1U5	.73	6J5	.52	12B77	.98	4X250	35.00
1X2A	.68	6J6	.48	12B27	.99	4X500	38.00
3Q4	.68	6K6	.59	12C16	1.45	58P1	4.98
3Q5	.89	6K7	.74	12S47	.94	58P4	4.98
3S4	.68	6L6	1.19	12S67	.89	35T	4.00
3V4	.83	6S4	.59	12S77	.89	100T	7.00
5R4	.98	6S8	.99	12S77	.75	316A	5/81
5U4	.80	6S7	.89	12S77	.99	388A	3/81
5V4	.80	6S87	1.19	12S77	.84	416B	4.00

Wanted Surplus Electronics from schools & U

5Y3	.59	6S7	.89	198G6	2.15	450T	42.00
6B4	.59	6S7	.79	1977	1.11	307	1.00
6A7	.70	6S7	.69	25B06	1.39	809	3.00
6A7	.80	6S7	.69	25L6	.69	811	4.40
6A8	.69	6S7	.74	25K7	.74	812	3.00
6A5	.69	6S7	.89	25Z5	.69	813	9.00
6A5	2/81	6S7	2/81	25Z6	.75	814	3.45
6A5	.67	6S7	.97	501A	3.49	815	2.35
6A7	3.00	6S7	.79	EL37	2.49	826	.59
6A7	.49	6T8	.98	35L6	.69	829B	8.00

Wanted 50¢ TL tubes Top \$ \$ Paid

6AU4	1.10	6U8	.49	35U4	.49	832A	7.00
6AU5	1.19	6V6GT	.70	35Y4	.69	866A	2.75
6AU6	.69	6W4	.75	35Z5	.63	1625	5/81
6AX4	.79	6X4	.89	61A	.69	61A	4.99
6B6	.59	6X4	2/81	50B5	.69	5879	.98
6B7	1.00	6X5	.49	50C5	.69	5881	2.70
6B8	.69	6X6	.69	50E6	.69	5882	3.90
6B8	.59	7N7	.89	KT66	3.29	5654	1.00
6B8	1.50	12AL5	.59	75	.89	5894	12.00
6B8	.72	12AQ5	.75	80	.59	7193	10/81

TUBES WANTED! WE BUY! SELL & TRADE!

"TABSTAT" C1250EE NEW POWER CONVERTER UP TO 500VDC & 200MA TAPPED AT 250 VDC

HI EFFICIENCY, LOW RIPPLE, LOW IDLE CURRENT — SILICON RECTIFIERS TOROIDAL CORE MAG-METAL TAPE WOUND TRANSFORMER FUSED & SHORT CIRCUIT PROOF. SMALL IN SIZE! QUIET! LIGHT WGT! C1250EE BUILT READY TO OPERATE—\$38.

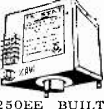

"TAB" KITS! "TAB" THE BEST KITS! "TAB"

- All Kits Contain Most Popular Values & Sizes
- Kit 2 Eng. Parallel Rules
 - Kit 35 Precision Resistors
 - Kit 10 Switches
 - Kit 75 Resistors 1/2 1/2W
 - Kit 150 Carbon Resistors
 - Kit 25 Panel Lamps
 - Kit 12 Electrolytic Cond's
 - Kit 56 Tube Sockets
 - Kit 600 Tubular Cond's
 - Kit 500 Lugs & Eyelets
 - Kit 10 Bathing Oil Cond's
 - Kit 5 lbs. Surprise Solder
 - Kit 10 Xmttr Mica Cond's.
 - Kit 3 Phone/Patch Xfms
 - Kit 3 Searchlights
 - Kit Circular Slide Rule
 - Kit 12 Algrt Clip Asst'd.
 - Kit 5 Sub-Min Tubes
 - Kit 40 Standoff Insulators
 - Kit 35 Power Resistors
 - Kit 75 Mica Condensers
 - Kit 5 Crystal Diodes
 - Kit 100 Fuses, Assorted
 - Kit 100 Ceramic Cond's.
 - Kit 10 Germanium Diodes
 - Kit 15 FT-231 Hal. Tubes
 - Kit 8 Silicon Diodes
 - Kit 5 Microswitches
 - Kit 4 Assorted Rectifiers
 - Kit 2 PNP Transistors
 - Kit 4x50 Ft Hookup Wire
 - Kit 2 Vector Cutters
 - Kit 2—Computer Toroids
 - Kit High Gain XTAL Mike

BUY 10 KITS—GET ONE FREE! EACH KIT 99¢

YOUR BEST BUY! "TAB" FOR BARGAINS

- "IRISH" TAPE 1200' BEST GRADE \$1.59 @ 6 for \$9
- SNOOPERSCOPE TUBE 2" \$5.00 @ 2 for \$9
- 4X150 HITED CHIMNEY \$7.00 @ 2 for \$11
- BC221 NEW ORIG. SIG CORPS RECALIB & RECONDITIONED OVSEAS PKCD NEW CALIBRATION BOOK MINT COND. \$11.00
- NEW BC1335 26.9 to 38.9 Mc's TRANSCEIVER WITH GR12V SUPPLY & SPARES OVSEAS PKCD. \$89
- RIG-UN 200-400Mc's RCVR Less tubes \$25
- AN-ARR2 RCVR GOOD COND. Less tubes \$1.59
- SEND FOR NEW CATALOG 25¢
- XMTTRG MICAS .006 @ 2500VDC \$5.00 5 for \$2
- DC METER 4" ROUND 0-1MA \$5.00 5 for \$2
- CO-AX CNCTRS PL259A \$4.50 @ 5 for \$2
- HVY DTY 115V/60WZ SELNS \$11.00 2 for \$2
- DC METER 800MA/3" \$9.00 SPECIAL \$5.75
- TS44AP/WF-USN SCOPE L/N \$49.00
- 829B SOCKET 95¢ 819 SOCKET \$1.00
- NEW VARIAC or EQUAL 0-135V/7.5A \$5.50
- NEW VARIAC or EQUAL 0-135V/3A \$10.65

TRANSISTORS & ACCESSORIES

- 2N441 \$3.20 2N442 \$4.50 2N277 \$4.24 2N278 \$5.50
- 2N159 \$1.39 2N176 \$1.80 2N177 \$1.28 2N178 \$1.75
- 2N247 \$1.50 2N255 \$1.20 2N270 \$9.50
- 2N274 \$1.25 2N408 \$9.00 2N514 \$1.20 2N578 \$1.80
- 2N579 \$2.20 2N581 \$1.25 2N582 \$2.10 2N174 \$8.50 2N443 \$6.50
- DIAMOND BASE MICA MOUNTING KIT \$.30
- DELCO ROUND BASE MICA MOUNTING KIT \$.75
- DELCO POWER HEAT SINK WITH FINS \$.75

NEW Selenium Radio & TV Rectifiers! GTD.

65ma 45¢ @ 6 for \$2; 100ma 45¢ @ 12 for \$5; 250ma 65¢ @ 10 for \$6; 300ma 88¢ @ 10 for \$8; 500ma \$1. @ 10 for \$8, 25 for \$18

Orders this Item \$10 or More, Postpaid 48 States!

***NEW "TEKSEL" SELENIUM RECTIFIERS**

FULL WAVE BRIDGE RECTIFIERS, ONE YEAR GTD!

AMP.	18VAC	36VAC	72VAC	144VAC
CONT.	14VDC	28VDC	56VDC	118VDC

1AMP	\$1.30	\$ 2.00	\$ 4.90	\$ 9.45
2AMP	2.15	3.00	6.25	12.30
3AMP	2.90	4.00	8.60	16.75
6AMP	4.15	6.00	18.75	36.15
10AMP	6.10	12.15	26.30	51.75

Write for Complete Rectifier Catalog

NEW SILICON 500MA RECTIFIERS

GENERAL PURPOSE 400 PIV at 250 MA
SPECIAL 2 FOR \$1 25 FOR \$10

rms/piv	35/50	rms/piv	70/100	rms/piv	140/200	rms/piv	210/300
	50¢						
rms/piv	280/400	rms/piv	350/500	rms/piv	420/700	rms/piv	490/700
	78¢		\$1.00		\$1.26		\$1.50
rms/piv	560/800	rms/piv	630/900	rms/piv	700/1000	rms/piv	770/1100
	\$1.59		\$1.89		\$2.58		\$3.12

(\$5 or more we pay postage 48 states.)

"TAB" TERMS: Money Back Guarantee! Our 15th year. \$2 min. order F.O.B. N.Y.C. Add shpg charges for C.O.D. 25¢. Prices shown subject to change.

111-GJ LIBERTY ST., N. Y. 6, N. Y.
Send 25¢ PHONE: REGTOR 2-6245 for Catalog

TRY THIS ONE (Continued)

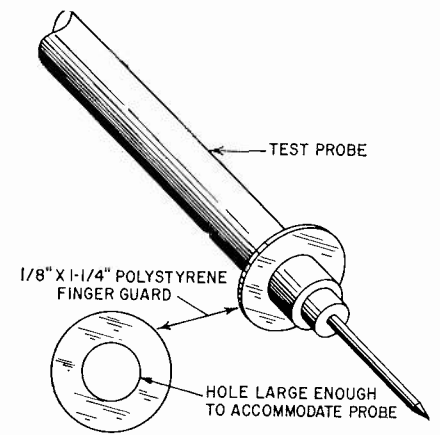

clear polystyrene plastic. Cut two 1 1/4-inch discs from a clear sheet of 1/8-inch plastic and drill a hole in the center of each to accommodate the barrel of your test probes. Slip the guards in place as shown. If they don't fit snugly, apply a daub of service cement to hold them in place. These see-through finger guards won't hamper your vision when testing in cramped circuits and will keep your finger tips safe.—John A. Comstock

WIRE STRIPPER

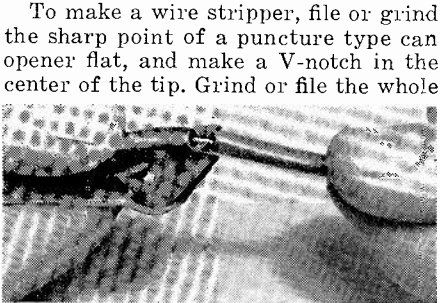

To make a wire stripper, file or grind the sharp point of a puncture type can opener flat, and make a V-notch in the center of the tip. Grind or file the whole

tip, including the bottom of the V to the thickness of a knife-blade edge. To use the stripper, place the wire in the notch, put your thumb over the end of the wire and pull the opener toward the wire's end, while holding the wire with your other hand.—Jerome A. Carlson

ELIMINATE WARMUP TIME

Before the popularity of selenium rectifiers, many portable radios used the 117Z3 rectifier. When the radio is operated on batteries, there is no warm-up period but, since the 117Z3 has an indirectly heated cathode, there is a long warmup period when operated on the power line. A selenium rectifier could be substituted to eliminate this warmup time, but there is rarely enough room to mount one. Substitute a 500-ma silicon diode soldered directly to the rectifier tube socket. Install a 47-ohm, 1-watt surge resistor in series with the silicon diode. Pins 2 and 7 on the 117-Z3 socket are generally unused and may be used as tie points for the diode and surge resistor. Increase the value of the dropping resistors to restore normal B-plus and filament voltages and the set is ready for "instant operation" on batteries or ac-dc power line.—Albert J. Krukowski

SOLDERING CAST IRON

Speed soldering to cast-iron, galvanized-iron or steel components by removing the hair bristles from the tin-handled brush commonly used to spread liquid flux and replacing them with a piece of fine copper wires from a bundle of stranded cord.

Connect the positive side of a 3-volt battery to the brush handle and the negative to the work. Then use the copper brush to spread the flux (cut muriatic acid or paste Nokorode flux) on the work.

This lends a thin plating of copper, and soldering becomes easier and goes faster.—Stan Clark

SPARE IRON TIPS

It's no cinch to keep track of those spare tips for a pencil soldering iron. You often spend several minutes

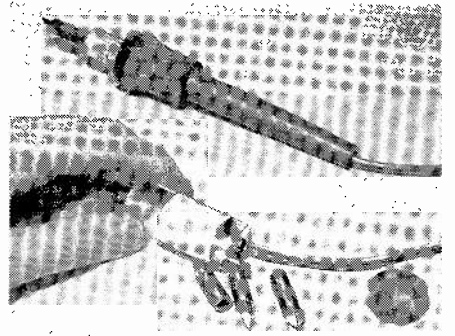

searching through your tool assortment to find the needed tip. A small plastic vial taped to the iron's power cord makes a handy storage place for the spare tips.—J. A. Compton

MIRROR HOLDER

An inspection mirror carried in a toolbox usually breaks in no time at all. Put it safely out of the way by attach-

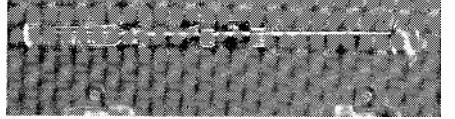

ing a fuse holder to the inside of your toolbox lid as shown. The mirror snaps into the clips of the fuse holder.—Scott Mook



"Professor Iggle, I finished that capacitance bridge you asked me to wire up."

BUSINESS and PEOPLE

Sencore, Addison, Ill., is shipping its rectifier Trouble Shooter RS 106 in a

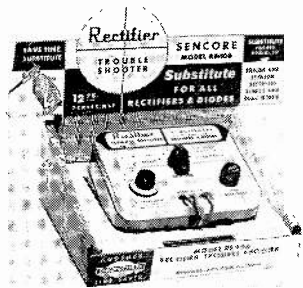

new type shipping-display container which is fast becoming standard packaging for all Sencore units.

Federated Industries, Chicago manufacturer of electronic games, is diversifying to enter the replacement speaker market. Russ D. Gawne, vice president and general manager of the firm, said the new lines will include Crescent replacement speakers, Falcon hi-fi reproducers and speaker systems, speaker enclosures, and wall and ceiling baffles.

Electro-Voice Inc., Buchanan, Mich., inaugurated a new order-handling and shipping system for its needle and cartridge division. C. E. "Pete" Seaman, manager of the division, supervises the filling of an order, received four hours earlier, by Mrs. Irene Riggs of the Shipping Dept.

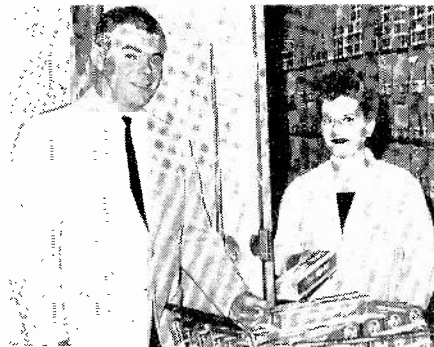

RCA Electron Tube Div., has designed a new rugged plastic package which pro-

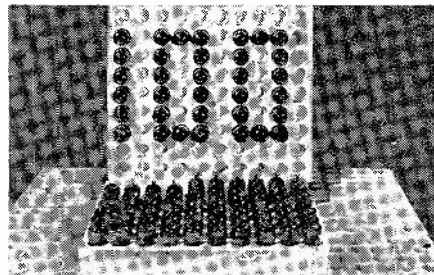

vides maximum protection for miniature receiving tubes during handling.

TUBE PROBLEM:

The Armed Forces needed a new version of the 6J4 reliable tube type which would provide a tube life of almost 1000 hours. Existing tubes of this type had an average life of only 250 hours. In addition, this new tube had to be produced under ultra-high quality control standards.

SONOTONE SOLVES IT:

By making improvements in the cathode alloy and setting up extremely tight controls in precision, manufacture and checking, Sonotone engineers produced a 6J4WA with a *minimum* life of 1000 hours... most running *much longer*.

RESULTS:

The Sonotone 6J4WA is one of three reliable tubes now being manufactured under U. S. Army Signal Corps RIQAP (Reduced Inspection Quality Assurance Program), monitored by the U. S. Army Signal Supply Agency. And the same rigid quality standards apply to Sonotone's entertainment type tubes as well.

Let Sonotone help solve *your* tube problems, too.

Sonotone

Electronic Applications Division, Dept. T2-60

ELMSFORD, NEW YORK

Leading makers of fine ceramic cartridges, speakers, microphones, tape heads, electron tubes.

In Canada, contact Atlas Radio Corp., Ltd., Toronto

Purchasing A HI-FI SYSTEM?

NOW YOU CAN CHARGE IT!

If you are an International credit card holder. Up to 10 months to pay. No down payment necessary.

Send Us Your List Of Components For A Package Quotation

WE WON'T BE UNDERSOLD!

All merchandise is brand new, factory fresh & guaranteed.

AIREX RADIO CORPORATION

64-RE Cortlandt St., N.Y. 7, CO 7-2137

Altec Lansing
Electrovoice
Jensen
Hartley • Stephens
University
Acoustic Research
Janszen
Wharfedale
Karson Cabinets
Viking
Concertone
Bell • G.E.
Weathers
Harman-Kardon
Eico • Pilot
Sherwood
Acrosound
Quad Ampl & Spkrs
Dual Changer
Bogen • Leak
Dynakit • Fisher
H. H. Scott
Uher Recorder
Thorens (Fair Traded)
Pentron • Roberts
Ampex • DeWald
Sony
Challenger
Wollensak
Garrard
Miracord
Glaser-Steers
Rek-O-Kut
Components
Norelco
Fairchild
Pickering • Gray
Audio Tape
Magnecord
Full Line of
Wellcor Cabinets

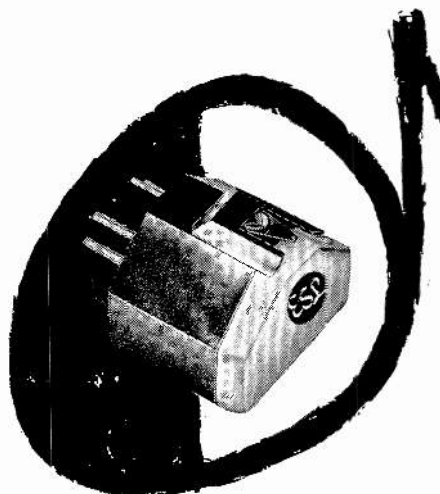

Note Perfect!

Do you hear all the notes on your stereo records—and hear them with true clarity and naturalness? If not, join the change to the superb new ESL-C99 Micro/flex, the note-perfect cartridge that makes all stereo records sound better. Only \$49.50 at your dealer's; write for data.



FOR LISTENING AT ITS BEST

Electro-Sonic Laboratories, Inc.

Dept E • 35-54 36th St • Long Island City 6, NY

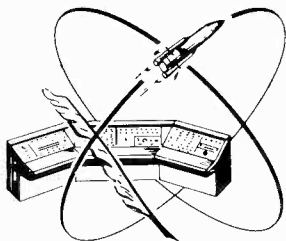

TECH WRITING

a professional career

at

Burroughs

MILITARY FIELD SERVICE DIVISION

You can enter this new and important field which is emerging today as a dynamic and indispensable part of our expanding long range programs.

If you want to realize your full technical potential in terms of advancement and recognition for your talents, here are some specifics you will want to consider:

- Burroughs MFSD Tech Manuals Department consists of a highly skilled Technical Publications team made up of 5 sections: 1) Tech Writing, 2) Editing, 3) Publications Preparation, 4) Technical Art, 5) Reproduction.
- Burroughs Tech Manuals Department's increased business has recently made it necessary to acquire additional operating space within our modern building in an attractive Philadelphia suburb. This Department now totals over 150 employees.

If you are a graduate of an electronics school, with a good background in theory (writing experience is not necessary)...and would like to discuss these growth positions carrying top salaries and benefits, write today to Mr. G. E. Rogers, Dept. 2496, Military Field Service Division, Burroughs Drive, Radnor, Pa.



Burroughs Corporation

"NEW DIMENSIONS/in computation for military systems"

HELP WANTED?—you'll get what you want if you advertise in RADIO-ELECTRONICS Opportunity Adlets. Rates as low as \$5. Write

RADIO-ELECTRONICS

154 West 14th Street

New York 11, N. Y.



LOOK
no further . . . if you're searching for hi-fi savings. Write us your requirements now.
Key Electronics Company
120-A Liberty St., N.Y. 6, N.Y.
Cloveverdale 8-4288

OUT OF SPACE?

You bet we'd be... if we were to tell you all about AUDION's 'Out of this World Hi-Fi Values'!

Write for free Catalog

audiON
25-E Oxford Road
Massapequa, New York



BUSINESS AND PEOPLE (Continued)

Clarostat Manufacturing Co., Dover, N. H., is offering service technicians a steel cabinet free with the purchase of the complete selection of carbon con-



trols, Pick-A-Shafts, switches and push-pull control switches it contains. The complete package is known as the ABC Handy-Bin.

GC Electronics, Div. of Textron Electronics, Rockford, Ill., extended its new TV replacement-knob line from 97 to 242 items.



S. H. "Penny" Bellue was elected vice president in charge of marketing for Osborne Electronic Sales Corp., Los Angeles manufacturer of transformers, instruments and two-way transistor radios. He joined the company from Hughes Aircraft's Products Group.



Leland W. Aurick is now manager, advertising and sales promotion, industrial market, for RCA's Electron Tube Div. He formerly directed industrial advertising in both renewal and original equipment markets.



William H. Weed was promoted to advertising and sales promotion manager for Raytheon's Industrial Components Div., Newton, Mass. He had been field sales administrator for control knobs and mechanical components product lines.



George E. Althouse (left), office manager of Heath Co., Benton Harbor, Mich., was promoted to the new post of Cus-



tomter Service Dept. manager. **Matthew R. "Matt" Cutter**, supervisor of adjustments, succeeds him.

Harvey Schmit (left), and **Earl Clemick** were advanced to sales manager, engineered ceramics, and packaged



electronic circuit sales, respectively, for Centralab, Div. Globe-Union, Milwaukee, Wis. Both were previously assistant industrial sales managers.

Joseph M. Murray joined Blonder Tongue Laboratories, Newark, N. J., as assistant personnel director. He comes from Piels Bros., where he was plant personnel manager.



Howard Burgess (left), and **J. Gordon Edge** were named marketing managers of the Cornell-Dubilier Mica Capacitor Div., Providence, R. I., and Radio Noise Filters and Feed-Thru Capacitors

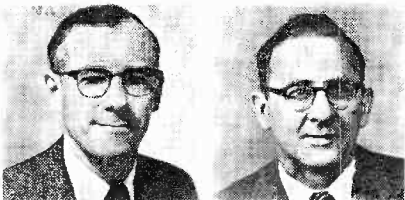

Div., New Bedford, Mass., respectively. Burgess was formerly with Raytheon and Edge, a project engineer in charge of the C-D radio noise suppressor laboratory.

Irving Rossman, Pentron Corp., was elected president of the Association of Electronic Parts & Equipment Manufacturers, Inc. (EP&EM). Other officers: **Warren Stuart**, Belden Manufacturing Co., first vice president; **Bruce Winke-mulder**, Centralab, second vice president; **Kenneth Hathaway**, Ward Leonard Electric Co., treasurer, and **Kenneth C. Prince**, executive secretary. **Wilfred Larson**, Switchcraft, **Robert E. Svoboda**, Amphenol-Borg and outgoing president of EP&EM, and **Richard Crossley**, Electro-Products Laboratories, were named to the board of directors. Rossman was also chosen to represent EP&EM on the board of directors of the Electronic Industry Show Corp.

Obituaries

Floyd H. "Woody" Woodworth, pioneer microphone and cartridge manufacturer and former president of Astatic Corp., Conneaut, Ohio, in Venice, Fla., at the age of 73.

Frank A. Hinners, radio pioneer and president of Hinners-Galenek Radio Corp., Forest Hills, N. Y., at the age of 66. He was a founder of the IRE and the De Forest Pioneers. **END**

WORLD FAMOUS

MOHAWK MIDGETAPE PROFESSIONAL 500

HIGH SPEED

POCKET TAPE RECORDER

NO ON ELECTRICITY REQUIRED

Used by NBC - CBS and numerous radio and TV stations, for recording in the field.

Records anything it hears and plays it right back in unbelievable broadcast quality.

Special built-in "VU Meter".

Weights only 3 lbs.

OPERATES ON ONLY 1 BATTERY

THE PEER OF POCKET TAPE RECORDERS... MIDGETAPE IS AMERICAN MADE.

"Science Fiction" accessories available for confidential recordings.

For literature on model 300... 400... 500 write Dept. RE.

ALL TRANSISTORIZED

Mohawk...
business machines corp.
944 halsey street brooklyn 33, new york
manufacturers

COYNE
TRAINS YOU
IN SPARETIME
AT HOME

COYNE QUALITY TRAINING AT LOWEST COST

TELEVISION

RADIO-COLOR TV

Only from famous COYNE do you get this modern up-to-the minute TV Home Training. Easy to follow instructions—fully illustrated with 2150 photos and diagrams. Not an old Radio Course with Television tacked on. Includes UHF and COLOR TV. Personal guidance by Coyne Staff. *Practical Job Guides* to help you EARN MONEY QUICKLY IN A TV-RADIO SALES AND SERVICE BUSINESS—part time or full time. COSTS MUCH LESS—pay only for training—no costly "put together kits."

SEND TODAY FOR FREE BOOK
SEND COUPON or write to address below for Free Book and full details including EASY PAYMENT PLAN. NO COST OR OBLIGATION—NO SALESMAN WILL CALL.

B. W. COYNE, Jr., Pres. FOUNDED 1899
ELECTRICAL SCHOOL

CHARTERED AS AN EDUCATIONAL INSTITUTION NOT FOR PROFIT
1501 W. Congress Pkwy. Dept. AO-H5 Chicago 7, Ill.

COYNE Television Home Training Div.
New Coyne Building, Dept. AO-H5
1501 W. Congress Pkwy., Chicago 7, Ill.

Send FREE BOOK and details of your Television Home Training offer.

Name _____
Address _____
City _____ State _____

NEW!

ALCO

20,000 ohms per volt

VOLT-OHM-MILLIAMMETER

MODEL TS-60H

- High sensitivity—20,000Ω per volt
- Modern design
- Exceptionally wide scale arc
- Compares with 4 1/2" meters
- Measures 3 1/4" wide x 4 1/2" x 1 1/6"
- Compact, black bakelite cabinet

D.C. Volt Ranges—5, 25, 250, 500 and 2500 @ 20,000Ω per volt
A.C. Volt Ranges—10, 50, 100, 500 and 1900 @ 10,000Ω per volt
D.C. Current—50μa, 2.5ma, 250ma
Resistance—0-60,000 ohms, 0-6 megohms
Capacity—.001 mfd.-1 mfd (w/10 VAC supply) .00001 mfd.-.001 mfd (w/100 VAC supply) **\$16.95**
Decibel—-20db to +22db complete

ORDER DIRECT
OR FROM YOUR NEAREST DISTRIBUTOR

ALCO ELECTRONIC PRODUCTS, INC.
Dept. E-6, 3 Wolcott Ave., Lawrence, Mass.

What are you doing about

SEMICONDUCTORS

No doubt about it—semiconductors are going to mean more and more in your future in electronics. Do you know all you should about them? This latest G/L Technicians' Club book brings you up-to-date on semiconductor developments, helps you get set for the future. It's a complete rundown on the theory and practical applications of transistors, diodes, photocells, solar generators, varistors, thermistors, masers, mavers—in fact, the works. If you want to move ahead in electronics, get this book now. Here's how you can get it—and other books that will help you get ahead in servicing—at a spectacular discount.



By M. G. Scroggie, B.S.E.E.
Deluxe hard-cover edition \$4.60
ABOUT THE AUTHOR

NEW!

Mr. Scroggie, a World War II radar officer in the RAF, is a top-rated British engineering consultant and technical writer on semiconductors. He has written over 700 technical articles.

YOU CAN GET THIS \$4.60 BOOK FOR ONLY \$3.25

This brand-new book in a new beautifully designed hard-cover edition is sold nationally for \$4.60. But through the G/L TECHNICIANS' BOOK CLUB you can get it for only \$3.25 and others like it at similar low prices.

THE G/L TECHNICIANS' BOOK CLUB

has helped thousands of service technicians everywhere

- Do Faster Servicing
- Earn More Money
- Save money on the books they need to get ahead.

Here's how it can help you!

This club offers hard-cover editions of today's best servicing books by well known authors AT A DISCOUNT OF 27%! Through mass printing and direct distribution we can offer you these \$4.60 books AT THE WHOLESALE PRICE plus a few cents postage.

If you prefer—select any one of these books

- How to Get the Most Out of Your VOM —By Tom Jaski.
- Printed Circuits—By Morris Moses.
- Rapid Radio Repair —By G. Warren Heath.
- Servicing Transistor Radios —By Leonard D'Airo.
- Oscilloscope Techniques —By Alfred Haas.

How the Club Works

- Select the book you want on the coupon below. SEND NO MONEY. Please select only one book! It will be sent to you on a No-Risk 10-day inspection plan.
- If you like the book keep it and send us your remittance. If you don't just send it back.
- A new book is published every three months—you receive it on the same No-Risk inspection plan.
- Keep only the books you want—pay only for those you keep.
- You agree to take a minimum of only 4 books—over the whole enrollment period! You may cancel anytime after that. No time limit—no contract to sign.

- TV and Radio Tube Troubles —By Sol Heller.
- Rapid TV Repair—By G. Warren Heath.
- Servicing Color TV —By Robert G. Middleton.
- TV—It's a Cinch—By E. Aisberg.
- Servicing Record Changers —By Harry Mileaf.
- The Oscilloscope—By George Zwick.

SEND IN THIS COUPON TODAY

GERNSBACK LIBRARY, INC., Dept. 60C
154 West 14th St., New York 11, N. Y.

Enroll me in the G/L TECHNICIANS' BOOK CLUB. Begin my membership with the book checked below. Please check one only.

- | | |
|--|---|
| <input type="checkbox"/> FUNDAMENTALS OF SEMICONDUCTORS | <input type="checkbox"/> OSCILLOSCOPE TECHNIQUES |
| <input type="checkbox"/> HOW TO GET THE MOST OUT OF YOUR VOM | <input type="checkbox"/> TV and RADIO TUBE TROUBLES |
| <input type="checkbox"/> PRINTED CIRCUITS | <input type="checkbox"/> RAPID TV REPAIR |
| <input type="checkbox"/> RAPID RADIO REPAIR | <input type="checkbox"/> SERVICING COLOR TV |
| <input type="checkbox"/> SERVICING TRANSISTOR RADIOS | <input type="checkbox"/> TV—IT'S A CINCH |
| | <input type="checkbox"/> SERVICING RECORD CHANGERS |
| | <input type="checkbox"/> THE OSCILLOSCOPE |

Name.....
Street..... please print
City..... Zone..... State.....

**SEND NO MONEY!
MAIL THIS COUPON TODAY!**

You have nothing to lose — everything to gain! Examine the books at our risk.

Stay ahead in servicing—keep up with the new techniques, circuits, devices. New books on timely topics now in preparation.

new LITERATURE

Any or all of these catalogs, bulletins, or periodicals are available to you on request direct to the manufacturers, whose addresses are listed at the end of each item. Use your letter-head—do not use postcards. To facilitate identification, mention the issue and page of RADIO-ELECTRONICS on which the item appears. UNLESS OTHERWISE STATED, ALL ITEMS ARE GRATIS. ALL LITERATURE OFFERS ARE VOID AFTER SIX MONTHS.

1960 CATALOG No. 121059 has 144 pages listing electronic parts, sound-system components and test instruments.—McGee Radio Co., 1901-07 McGee St., Kansas City 8, Mo.

RELAY CATALOG No. 160 has illustrations, specifications and dimensional diagrams on telephone type and small, medium, miniature and subminiature relays. Dust covers of both plastic and metal, heavy-duty and power contacts and time-delay relays are covered.—Magnecraft Electric Co., 3354B W. Grand Ave., Chicago 51, Ill.

BBB BOOKLET is entitled *Facts You Should Know about Home Study Schools*. The Metropolitan Boston (Mass.) Better Business Bureau (Educational Division) has published this as part of their Fact Booklet Series.—Available from National Camera Repair School, Box 174AO, Englewood, Colo.

PARTS CATALOG has 360 pages listing tubes, transistors, ham gear, TV and radio parts and many other items of interest to the experimenter, service technician or ham. There is a special index to new products as well as an index to manufacturers.—Rochester Radio Supply Co., Inc., 600 E. Main St., Rochester, N. Y. or Syracuse Radio Supply Co., Inc., 620 S. Salina St., Syracuse, N. Y.

AMPLIFIERS, preamps, microphones and a stereo cartridge are listed in a 6-page folder. Photographs of the units are shown along with descriptions and specifications.—Dynaco Inc., 3916 Powelton Ave., Philadelphia 4, Pa.

SMALL BUSINESS HANDBOOK, How to Build Profits By Controlling Costs is written from the viewpoint of the small business man. A 48-page booklet, it deals with record keeping, analysis of figures and the use of ratios as a means of comparing performance.—Dun & Bradstreet, Inc., P.O. Box 803, Church St. Station, New York 8, N. Y. \$1

FLYER lists TV replacement parts, test instruments, tubes and other electronic gear. Write and request latest

flyer.—Brooks Radio & Television Corp., 84 Vesey St., New York 7, N. Y.

CERAMIC MAGNETS and their characteristics are listed *Bulletins 18A and 353*. These magnets, made of Indox I, V and VI, are used in traveling-wave tubes, loudspeakers and motors.—Indiana Steel Products, Div. of Indiana General Corp., Valparaiso, Ind.

RECTIFIER HANDBOOK has 7 chapters on such subjects as semiconductor theory, manufacturing methods, rectifier circuits, filter-circuit design and application techniques. The *Silicon Rectifier Handbook* is available to readers of this magazine at half price.—Sarkes Tarzian, Inc., Semiconductor Div., Section 3002B, Bloomington, Ind. 50c to RADIO-ELECTRONICS readers.

INDUSTRIAL RELAYS are described in *Bulletin GEA-7021*, a 12-page booklet covering general-purpose, machine-tool, latched-in and time-delay relays. Dimensions, ratings and ordering instructions are given.—General Electric Co., Schenectady 5, N. Y.

VOLTAGE DIVISION is discussed in the second half of an article entitled "Properties of Rectifier Systems and Means to Improve Voltage Division." Write on your letterhead and request *Rectifier News, RN-360*.—International Rectifier Corp., El Segundo, Calif.

OPERATING PRINCIPLES of the Bi-Phonic Coupler, the coneless loudspeaker that uses a 15 x 22-inch panel as the vibrating element, are discussed in a 4-page folder.—Advanced Acoustics Corp., 67 E. Centre St., Nutley 10, N. J.

TIME CHART, the *Rider Global Time Conversion Simplifier No. 238*, simplifies converting time in one zone to time in another. This 17 x 22-inch chart (it folds for storage in a paper slip case 5 3/4 x 8 3/4 inches) is of interest to all people interested in regional or global time differences, from those who have

to make long-distance phone calls to hams who want to make a contact in a distant time zone.—John F. Rider, Inc., Publisher, 116 W. 14 St., New York 11, N. Y. \$1.

LOUDSPEAKERS are listed on a comparative basis in the *Public Address Speaker Guide*. This 4-page, pocket-size guide lists the advantages of the manufacturer's units.—Electro-Voice, Inc., Buchanan, Mich.

CATALOG SUPPLEMENT lists high-fidelity, ham, industrial and general-purpose merchandise. Also includes a number of sales items, new items and closeouts.—Radio Shack Corp., 730 Commonwealth Ave., Boston 17, Mass.

RECORDING-HEAD GUIDE lists more than 25 brands of tape recorders and the replacement head that can be used for repair or to convert the machine to 2-track or 4-track stereo. This 16-page booklet also shows specifications and illustrations of the recording (and erase) heads. *RMM-2* is available from jobbers and tape recorder dealers.—Robins Industries Corp., 36-27 Prince St., Flushing 54, N. Y. 50c

TRANSISTORS are listed in a 4-page availability catalog which covers 412 germanium transistors suitable for use in computers, industry, missiles and the entertainment field. Type numbers are given as well as a list of applications.—Electronic Transistors Corp., 9226 Hudson Boulevard, North Bergen, N. J.

AIRCRAFT INSTRUMENTS are described in *Manual 05-100-B*. This illustrated manual provides specifications, mounting information and detailed text on ammeters, voltmeters, resistance and thermocouple thermometers, trim-tab, frequency and course indicators; current transformers; resistance bulbs and shunts. Gratis to interested individuals.—Daystrom, Inc., Weston Instruments Div., 614 Frelinghuysen Ave., Newark 12, N. J. END

ORDER YOUR ENCLOSURE KITS FROM HOMEWOOD Bring out the best in your speakers... save dollars in assembly and finishing costs... get the fun of "doing-it-yourself"!

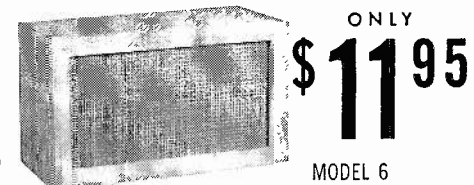

Factory assembled, ready for finishing. Makes your 8" speaker sound like a million! Made of 1/2" hardwood ply, beautifully grained and smoothly sanded. 10" h. x 16" w. x 9" d. 9 lbs. Order two for matched stereo performance.



MODEL 1 4 1/2 cubic feet of baffle space assures you crispest, cleanest bass response from any 12" speaker system. Full-grained white birch ply, with pre-attached bracing cleats for easy assembly. Kit includes everything you need for assembly. 29" h. x 20" w. x 12 1/2" d. (5" legs). 25 lbs. \$18.95

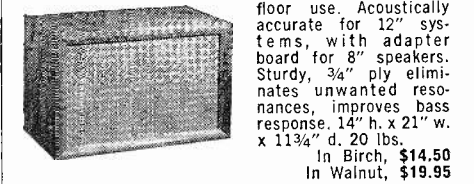

MODEL 2 Clear-grained on four sides for bookshelf or floor use. Acoustically accurate for 12" systems, with adapter board for 8" speakers. Sturdy, 3/4" ply eliminates unwanted resonances, improves bass response. 14" h. x 21" w. x 11 3/4" d. 20 lbs. In Birch, \$14.50 In Walnut, \$19.95

MODEL 13. Finishing kit; includes generous quantities of everything you need to do a professional, long-lasting finishing job, plus brush, sandpaper and easy-to-follow instructions. Specify: Mahogany, Walnut, Blonde, Oak, Fruitwood, Maple, Cherry, Ebony, Natural. \$3.88

Ten-day money-back guarantee. All items shipped freight collect. Please send check or M.O. (No COD's)

HOMEWOOD INDUSTRIES, Inc.
26A Court Street, Brooklyn 1, N. Y.
Please send me:
() Model 6 () Model 1 () Model 2 (Birch) (Walnut)
() Model 13
() HomeWood catalog
I enclose remittance in the amount of \$ _____
Name _____
Address _____
City _____ Zone _____ State _____

OPPORTUNITY ADLETS
Rates—50¢ per word (including name, address and initials). Minimum ad 10 words. Cash must accompany all ads except those placed by accredited agencies. Discount, 10% for 12 consecutive issues. Misleading or objectionable ads not accepted. Copy for August issue must reach us before June 15, 1960.
RADIO-ELECTRONICS,
154 West 14 St., New York 11, N. Y.

CASH PAID! Sell your surplus electronic tubes. Want unused, clean radio and TV receiving, transmitting, special-purpose, Magnetrons, Klystrons, broadcast types, etc. Want military & commercial lab/test and communications equipment such as G.R., I.P., AN/UPM prefix. Also want commercial receivers and transmitters. For a fair deal write BARRY, 512 Broadway, New York 12, N. Y. WALKER 5-7000.

AMPEX, Concertone, Crown, Magnecord, Presto, Norelco, Boreen, Tandberg, Sherwood, Rek-O-Kut, Scott, Shure, Dynakit, others... Trades, ROYSTON STUDIO, Dept. RE, 10 Pennsylvania Ave., Tuckahoe, N.Y.

LEARN CODE. Quality for Amateur or Commercial License. Free Book. CANDLER, Dept. RE-6, Box 9226, Denver 20, Colo.

COMPONENTS, Recorders, Tapes. FREE Wholesale Catalogue. CARSTON, 215-T East 88th St., New York 28, N. Y.

DISCOUNTS UP TO 50% on Hi-Fi amplifiers, tuners, speakers, tape recorders, individual quotations only, no catalogs. CLASSIFIED HI-FI EXCHANGE, 2375 East 65th Street, Brooklyn 34, N. Y.

HIGHLY EFFECTIVE HOME-STUDY REVIEW for FCC Commercial Phone Exams. Free Literature. Write: "Chief Instructor", COOK'S SCHOOL OF ELECTRONICS, Dept. RE, Box 10634, Jackson 9, Miss.

UNUSUAL VALUES Hi-Fi components, tapes, tape recorders. Catalog. Package quotations. BUDGET HI-FI, 83-06D Victor Ave., Elmhurst, N. Y.

AUTOMATIC DOOR OPERATORS. New famous make. Only \$59.95. Buy Direct. Save! Free Literature. DEMSCO, Sebring 9, Ohio.

DIAGRAMS FOR REPAIRING RADIOS \$1. Television \$2. Give make, model. DIAGRAM SERVICE, Box 672 RE, Hartford 1, Conn.

ALL MAKES OF ELECTRICAL INSTRUMENTS AND TESTING equipment repaired. HAZLETON INSTRUMENT CO., 128 Liberty Street, New York, N. Y.

LOW QUOTES on everything HI-FI & Stereo Tapes. Bargain List: HI-FI, Dept. RE, Roslyn 5, Pa.

COMEDY PARTY RECORDS. 45 RPM \$1 each or 6 for \$4.95. HOLLYWOOD JOKERS Dept. B, P.O. Box 1986, Hollywood 28, Calif.

LEARN CIVIL and criminal investigation at home. Earn steady, good pay. INSTITUTE APPLIED SCIENCE, 1920 Sunnyside, Dept. 26A, Chicago 40, Ill.

CAMERA Repairs needed! You can learn manufacturers' service methods at home, in your spare time! Free, big illustrated book tells how! Write today. NATIONAL CAMERA REPAIR SCHOOL, Dept. RE-6, Englewood, Colorado.

PROFESSIONAL ELECTRONIC PROJECTS — Organs, Timers, Computers, etc.—\$1 each. List Free. PARKS, Box 1665, Seattle 55, Wash.

NEW CITIZENS BAND CARDS. etc. PEARCE, 192 Osborne, Danbury, Conn.

SONGPOEMS and LYRICS WANTED! Mail to: TIN PAN ALLEY, INC. 1850 Broadway, New York 19, N. Y.

LEARN WHILE ASLEEP. Hypnotize with your recorder, phonograph or amazing new Electronic Educator endless tape recorder. Catalog, details free. SLEEP-LEARNING ASSOCIATION, Box 24-RD, Olympia, Wash.

RADIO & TV TUBES at Manufacturers' Prices! 100% Guaranteed! Brand New! No re-brands or pulls! UNITED RADIO, Box 1000-R, Newark, N. J.

RADIO & TELEVISION TUBES — Brand new — 1st quality, no rejects, top new brands in original boxes, 60% off list, FREE BONUS with orders. Prompt deliveries. U T C, Box 306, Syosset, New York.



GERNSBACK LIBRARY
Low-cost, paper-covered books on all phases of TV, radio, audio-high fidelity and practical electronics
ON SALE AT ALL
BETTER PARTS DISTRIBUTORS

3 Great New Kits for Stereo

by **PACO**

...with the famous specially-prepared giant-size diagrams and super-simple step-by-step instructions for fool-proof assembly and wiring. Crafted by PACO, Kit Division of **PRECISION Apparatus Company, Inc.**, world-famous manufacturers of laboratory electronic test equipment for over a quarter of a century.

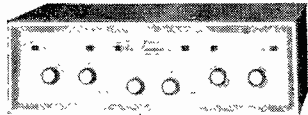

The **PACO SA-40 40 WATT STEREO PREAMP-AMPLIFIER** The Last Preamp-Amplifier You'll Ever Have to Buy

Model SA-40—KIT, complete with gold and satin black cabinet. Net Price: \$79.95
 Model SA-40W—FACTORY-WIRED, complete with gold and satin black cabinet. Net Price: \$129.95

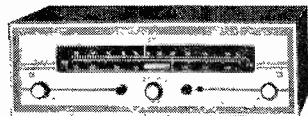

The **PACO ST-45 AM-FM STEREO TUNER** A Truly Unusual Engineering Achievement in Stability and Sensitivity

AVAILABLE THREE WAYS:

Model ST-45—KIT, with factory pre-aligned transformers, complete with gold and satin black cabinet. Net Price: \$84.95

Model ST-45PA—SEMI-KIT, with both FM and AM tuner sections factory-wired and completely pre-aligned and calibrated for hairline sensitivity, complete with gold and satin black cabinet. Net Price: \$99.95

Model ST-45W—FACTORY-WIRED, aligned, calibrated and assembled, complete with gold and black satin cabinet. Net Price: \$134.95

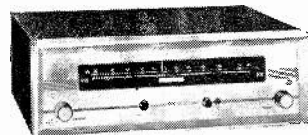

The **PACO ST-35 FM TUNER**

AVAILABLE THREE WAYS:

Model ST-35—KIT, with factory pre-aligned transformers, complete with gold and satin black cabinet. Net Price: \$59.95

Model ST-35PA—SEMI-KIT, with tuner section factory-wired and completely pre-aligned for hairline sensitivity, complete with gold and satin black cabinet. Net Price: \$69.95

Model ST-35W—FACTORY-WIRED, aligned, calibrated and assembled, complete with gold and satin black cabinet. Net Price: \$89.95

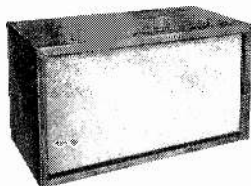

NEW PACO 2-WAY SPEAKER SYSTEM SEMI-KIT featuring Jensen Mid-Range Woofer and Horn-Type Tweeter

Model L2-U—SEMI-KIT, with unfinished, sanded cabinet. Net Price: \$59.95

Model L2-F—SEMI-KIT, with walnut-finished cabinet. Net Price: \$69.95



AVAILABLE AT LEADING ELECTRONIC PARTS DISTRIBUTORS & WHEREVER GOOD SOUND IS SOLD.

You'll want much more data... the performance specifications will amaze you... write for complete, illustrated brochure to:

PACO ELECTRONICS CO., INC.
 70-31 84th Street, Glendale 27, L. I., New York
 Kit Division of **PRECISION Apparatus Company, Inc.**

new BOOKS

MOST OFTEN NEEDED 1960 TELEVISION SERVICING INFORMATION. Compiled by **M. N. Beitman.** Supreme Publications, 1760 Balsam Road, Highland Park, Ill. 8 1/2 x 10 3/4 in. 192 pp. \$3.

A collection of selected schematics and essential servicing information for 1960-line TV receivers produced by 15 leading manufacturers.—LS

PRINCIPLES OF FREQUENCY MODULATION, by **B. S. Camies.** John F. Rider Publisher Inc., 116 W. 14 St., New York 11, N. Y. 5 1/2 x 8 1/2 in. 147 pp. \$3.50.

FM is somewhat more difficult to understand than AM because the theory is more complex. This book explains the subject for students, amateurs and engineers. Modulators, noise, interference and detectors are discussed. The advantages of FM are compared with those of AM. The second half of the book is devoted to applications. These include microwave, radar, facsimile, etc. A knowledge of math up to calculus is desirable to understand the text fully.

GUIDE TO THE LITERATURE OF MATH AND PHYSICS, by **Nathan Grier Parke III.** Second Edition. Dover Publications, Inc., 180 Varick St., New York 14, N. Y. 8 x 5 1/4 in. 436 pp. \$2.49.

There are so many good books on mathematics, physics and engineering that a guide is necessary for intelligent reference and study. This one lists more than 5,500 works under 120 subject headings like astronomy, electronic engineering, solid state, number theory, etc. Foreign books, including Russian works, and their translations appear.

Part 1 covers the principles of reading, self-study and reference. It tells how to consult catalogs, indexes, tables

and encyclopedias. Part 2 explains each subject heading, then suggests a reading or study program, followed by the main listing.

The book ends with a comprehensive author and subject index, plus a catalog of Dover Books on science and engineering.

MARINE RADIO FOR PLEASURE CRAFT, by **Harold McKay.** Gernsback Library Inc., 154 W. 14th St., New York 11, N. Y. 5 1/2 x 8 1/2 in. 160 pp. \$2.95.

Electronics is doing much for boating safety and comfort. This book will help you understand and operate devices like radio transmitters and receivers, radio direction finders, wind indicators, auto pilots and depth sounders. It also tells how to make a radio call, repair equipment and charge batteries.

Receivers and transmitters get special attention. The Citizens and marine bands, shortwave, direction finding, vhf, antennas are some of the topics covered. Listings include frequencies of Coast Guard and weather stations, WWV schedule, Bell System stations, and places to obtain pamphlets pertaining to boating.—IQ

SHORTWAVE PROPAGATION, by **Stanley Leinwall.** John F. Rider Publisher, Inc., 116 W. 14th St., N. Y. 11, N. Y. 5 1/2 x 8 1/2 in. 151 pp. \$3.90.

Hams, professional radio operators and shortwave listeners can make good use of this book. It discusses the ionosphere, sunspots, magnetic storms and their effects on radio communications. It tells how to interpret propagation data from the Bureau of Standards, and how to make your own propagation predictions.

The author devotes one chapter to

TV PICTURE TUBES

At Lowest Prices

10BP4 ... \$ 7.95	17BP4 ... \$ 9.95	21AMP4 ... \$15.75
12LP4 ... 8.50	17CP4 ... 17.00	21ATP4 ... 15.75
14B/CP4 ... 9.95	17GP4 ... 17.60	21AUP4 ... 15.75
16DP4 ... 12.00	17HP4 ... 12.50	21EP4 ... 13.50
16EP4 ... 12.75	17LP4 ... 11.50	21FP4 ... 14.50
16GP4 ... 14.50	17QP4 ... 9.95	21WP4 ... 14.50
16KP4 ... 9.95	17TP4 ... 17.00	21YP4 ... 14.50
16LP4 ... 10.95	19AP4 ... 16.00	21ZP4 ... 13.50
16RP4 ... 9.95	20CP4 ... 13.50	24CP4 ... 23.50
16WP4 ... 12.00	20HP4 ... 14.50	24DP4 ... 24.50
16PT4 ... 9.95	21AP4 ... 22.10	27EP4 ... 39.95
17AVP4 ... 12.50	21ALP4 ... 15.75	27RP4 ... 39.95

1 year warranty

Aluminized tubes \$3.00 for 21"; \$5.00 for 24" and 27" additional. Prices include the return of an acceptable similar tube under vacuum. These tubes are manufactured from reprocessed used glass bulbs. All parts and materials including the electron gun are brand new.

ALL PRICES FOB CHICAGO, ILLINOIS. Deposit required when old tube is not returned, refundable at time of return. 25% deposit required on COD shipments. Old tubes must be returned prepaid. Tubes shipped Rail Express. Shipped only to Continental U.S. and Canada.

WRITE FOR COMPLETE LIST.

PICTURE TUBE OUTLET
 2922 North Milwaukee Ave.
 Chicago 18, Ill. Dickens 2-2048

CARTOONS

RADIO-ELECTRONICS

pays \$3.00

for good cartoon ideas

and \$15 and up

for finished work

RADIO-ELECTRONICS

154 West 14th St.
 New York 11, N. Y.

SCHOOL DIRECTORY

engineering degree in 27 months

Grasp your chance for a better life. Rapid advancement. Better income. **BACHELOR OF SCIENCE DEGREE IN 27 MONTHS** in Elect. (Electronics or Power major), Mech., Civil, Aero., Chem., Engineering. **IN 36 MONTHS** in Business Administration (General Business, Accg., Motor Transport Mgt. majors). Small classes. More professional class hours. Well-equipped labs. Campus. Dorms. Modest costs. Year-round operation. Founded 1884. Enter Sept., Jan., Mar., July. Write J. G. McCarthy, Director of Admissions, for Catalog and "Your Career in Engineering and Commerce" Book.

TRI-STATE COLLEGE 2460 College Ave. Angola, Indiana

SCIENCE ENGINEERING

BACHELOR'S DEGREE IN 27 OR 36 MONTHS
Accelerated year-round program: Aero., Chem., Civil, Elec., Mech., Metal.; Math., Chemistry, Physics. Modest rate. Exam board. New classes start June, Sept., Jan., March. Catalog, 1580 E. Washington Blvd., Fort Wayne 2, Indiana.

INDIANA TECHNICAL COLLEGE

GET INTO ELECTRONICS

V.T.I. training leads to success as technicians, field engineers, specialists in communications, guided missiles, computers, radar and automation. Basic and advanced courses in theory and laboratory. Assoc. degree in electronics in 29 mos. B.S. in electronic engineering obtainable. ECPD accredited, G.I. approved. Graduates in all branches of electronics with major companies. Start September, February. Dorms, campus. High School graduate or equivalent. Catalog.

VALPARAISO TECHNICAL INSTITUTE
Dept. C Valparaiso, Indiana



ELECTRONICS

PREPARE FOR A GOOD JOB!
BROADCAST ENGINEER
RADIO SERVICING AUTOMATION

TELEVISION SERVICING
BLACK & WHITE—COLOR

APPROVED FOR VETERANS AND SURVIVORS
OF VETERANS
BUILDING AIR CONDITIONED
SEND FOR FREE LITERATURE

BALTIMORE TECHNICAL INSTITUTE
1425 EUTAW PLACE, BALTIMORE 17, MD.

ELECTRONICS BOOKS

I.C.S. will send you FREE 3 valuable booklets that tell you where the big-pay jobs are in Radio-TV, Electronics... who are the industry's most-wanted men... how you can "cash-in" in a big way on your future. There's no obligation. Don't delay. Mail the coupon now!

INTERNATIONAL CORRESPONDENCE SCHOOLS

Dept. 40633E, Scranton 15, Penna.
Please send free success book, sample lesson, and catalog checked.
 General Electronics Radio-TV Serv'g Practical Electrician
 Industrial Electronics Sound Equip. Serv'g Profess'l Eng. (Elec.)
 Radio-TV Eng'g Electrical Eng'g Electrical Drafting
 Electronic Servicing Electrical Tech. Other _____
Name _____ Age _____
Address _____
City _____ State _____

Learn Transistor Electronics At Home!

■ Prepare now for a profitable career in this growing field. Learn theory, construction and applications of all types of transistors with this proven home-study course from the Philco Technological Center.

FOR FREE INFORMATION
PLEASE WRITE TO:

PHILCO
TECHNOLOGICAL CENTER
"C" and Ontario Sts., Philadelphia 34, Pa.

ENGINEERING HOME STUDY COURSES

Courses written by world authorities in all branches of engineering and science and proved successful by thousands of our graduates. One hour each day in your spare time will start you off to higher pay, security and prestige. Personalized instruction methods ensure rapid progress. Fill in the coupon and indicate the course of interest. We will send you a complete outline of the course and a booklet describing the Institute and our advanced teaching methods.

- RADIO
- ELECTRONICS
- TELEVISION
- CIRCUIT
- MATHEMATICS
- ELECTRICAL ENG.
- TELEPHONY
- CIVIL ENG.
- SURVEYING
- ARCHITECTURE
- FORESTRY
- MINING
- STRUCTURAL
- MECHANICAL ENG.
- INDUSTRIAL ENG.
- & MANAGEMENT
- REFRIGERATION
- DRAFTING
- PLASTICS
- AERONAUTICAL
- ENG.
- HIGH SCHOOL
- CHEMICAL
- MATHEMATICS
- JOURNALISM
- ACCOUNTING

MAIL THIS COUPON TODAY

CANADIAN INSTITUTE OF SCIENCE & TECHNOLOGY LIMITED
748 Century Bldg., 412, 5th St. N.W., Wash., D.C.
NAME.....
ADDRESS.....
CITY.....STATE.....
COURSE OF INTEREST.....
Canadians: Send to C.I.S.T., 748 Garden Bldg., 263 Adelaide St. West, Toronto, Ontario.

C. I. S. T.

FREE CAREER BOOKLET

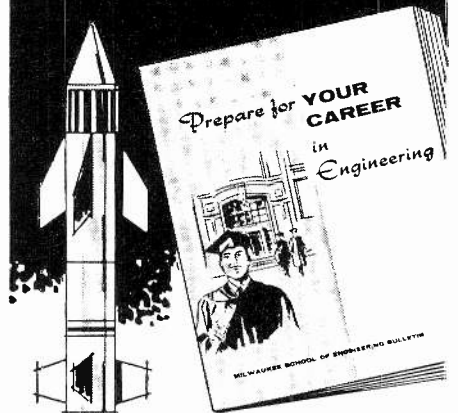

to guide you to a successful future in

**ELECTRONICS
RADIO-TV
COMPUTERS
ELECTRICAL
ENGINEERING**

This interesting pictorial booklet tells you how you can prepare for a dynamic career as an Electrical Engineer or Engineering Technician in many exciting, growing fields:

**MISSILES • RADAR • RESEARCH
ELECTRICAL POWER • ROCKETRY
AUTOMATION • AVIONICS
SALES • DEVELOPMENT**

Get all the facts about job opportunities, length of study, courses offered, degrees you can earn, scholarships, part-time work — as well as pictures of the Milwaukee School of Engineering's educational and recreational facilities. No obligation — it's yours free.

MILWAUKEE SCHOOL OF ENGINEERING

MAIL COUPON TODAY!

MILWAUKEE SCHOOL OF ENGINEERING
Dept. RE-660, 1025 N. Milwaukee St.
Milwaukee, Wisconsin MS-113
Please send FREE "Your Career" booklet
I'm interested in Electronics Radio-TV
 Computers Electrical Engineering
 Mechanical Engineering
(PLEASE PRINT)
Name..... Age ..
Address.....
City..... Zone... State ..
 I'm eligible for veterans education benefits.
Discharge date.....

For 1960 It's...

"COMPACT"

tools by VACO®

for the
Electronics Service Trade

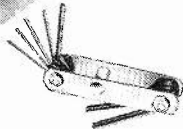

HK-17 Hex Key Set
\$1.00 net



DE-810 Double Nut Driver
\$.79 net



AN-2 Tester
\$.79 net



PK-8 Nut Driver
\$.48 net



ND-141 Combination
Screw & Nut Driver
\$.79 net



SP-19 Probe
\$.96 net



A-86 Pencil Type Driver
\$.60 net

• "Compact" in Size:
they fit the pocket

• "Compact" in Price:
they fit your
pocketbook too

Ask Your Parts Jobber or
Your Jobber Salesman

VACO PRODUCTS COMPANY, 317 E. Ontario St., Chicago 11, Illinois

In Canada: Atlas Radio Corp., Toronto 19, Ontario

July issue of
RADIO-ELECTRONICS
will be on sale June 28th, 1960

PROFESSIONAL
technicians

use
Dave Rice's
OFFICIAL
ORDER BOOKS

for every
TV-RADIO
service
call

This is the businesslike approach to service record keeping. TriPLICATE forms serve as order form, invoice and office record, with spaces for complete information on every job. Separate listings for receiving tubes, pix tube, parts, serial numbers, labor and tax charges, signatures, etc. 75c a book, \$6.50 for dust-proof box of 10. In stock at your distributor. Write for your free folder describing Dave Rice's OFFICIAL ORDER BOOKS, including an actual size sample copy of the handy order form.

For customer's prices on every replacement part, plus flat rate and hourly service charge data, regional and national, Dave Rice's OFFICIAL PRICING DIGEST, listing over 63,000 items. \$2.50.

ELECTRONIC PUBLISHING CO., INC.
180 N. WACKER DRIVE
CHICAGO 6, ILLINOIS



ALL THE CONVENIENCES OF HOME WILL
TRAVEL WITH YOU WHEREVER YOU GO

NOW! FROM ARKAY

ARKAY 12 VOLT TRANSISTOR INVERTER



Model 2-120W

KIT

\$29.95

Factory wired \$35.95

use these and more from car or boat battery

Build it in a few short hours — install it in minutes! Transistorized circuit adapts any 12 Volt battery to 115 Volt AC.

- Portable TV
- Electric Razor
- Communications Receiver
- Amplifier
- Table Radio

ONLY ARKAY

Golden '60 components give a
LIFETIME GUARANTEE!

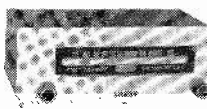

FM TUNER KIT

\$39.95

Factory wired \$64.95

All delicate adjustments have been done at the factory on the completely pre-wired, prealigned front end. All the worry is removed — only the fun is left! Professional quality FM Tuner with AFC for drift-free reception, precision tuning indicator, 3 double-tuned IF stages. FM-7 KIT

arkay

88-06 Van Wyck Expressway Richmond Hill 18, N.Y.

NEW BOOKS (Continued)

predictions for the ham bands from the present to 1966. A large (folding) time chart attached to the rear cover converts time in all parts of the world to local time.

DESIGN OF TRANSISTORIZED CIRCUITS FOR DIGITAL COMPUTERS, by Abraham I. Pressman. John F. Rider, Publisher, Inc., 116 W. 14th St., N.Y. 11, N.Y. 6 x 9 in. 316 pp. \$9.95.

Modern computers rely either on transistors or magnetic elements. This book is for circuit designers who wish to learn about their transistor circuits. The author uses "worst-case" analysis which takes into account the extreme tolerance of all components and voltages.

Beginning chapters explain the fundamentals of basic building blocks and logical chains, and develop the principles of transistors. From this point progress to advanced circuitry is rapid. Actual examples illustrate gating and switching design, flip-flops and miscellaneous transistor circuits. Measured waveforms for the circuits designed are drawn to show agreement between theory and practice.—IQ

STEREO . . . HOW IT WORKS, by Herman Burstein. Gernsback Library Inc., 154 W. 14th St., New York 11, N. Y. 5 1/2 x 8 1/2 in. 224 pp. \$2.90.

How stereo hi-fi reproduction works is the story this book has to tell. It covers all the techniques now in use, from disc phonos, through radio broadcasting, to magnetic tape. All phases of how the various pieces of equipment operate are discussed, from phono cartridges to four-track tape and FM multiplexing. Chapters on stereo microphone techniques and installing stereo systems round out the book, making it useful to anyone interested in stereo.—LS

ELECTRONIC GUIDE, 1959 International Edition. Electronic Guide Publishing Co., 4131 Toluca Lake Ave., Burbank, Calif. 7 x 10 in. 191 pp. \$7.50

This is a reference directory of articles that have appeared in nearly 50 publications (including this one) from English-speaking countries. They are listed under general headings; antennas, audio, computers, radio-TV, sonics-ultrasonics, etc. Each section contains a monthly listing of magazines and their articles. This should be a great help to busy technicians and engineers.—IQ

PHOTOTUBES, edited by Alexander Schure. John F. Rider Publisher, Inc., 116 W. 14th St., N. Y. 11, N. Y. 5 1/2 x 8 1/2 in. 96 pp. \$1.80.

This book is for technicians and experimenters who want more than a mere casual knowledge of the subject. It sets forth the basic laws of photoelectricity and related subjects, the construction of vacuum and gaseous tubes and the design of amplifier circuits. Math is limited to simple equations and their solution. Review questions and numerical examples are included. END

ADVERTISING INDEX

Radio-Electronics does not assume responsibility for any errors appearing in the index below.

Airex Radio Corp.	123	National Radio Inst.	3
Alco Electronic Mfg. Co.	125	National Technical Schools	5
Allied Radio Corp.	13, 24, 25	North American Philips Co., Inc.	110
Arkay International Inc.	130		
Astatic Corp.	3rd Cover	Ohmatsu Electric Co. Ltd.	131
Astron Corp.	9	Olson Radio Corp.	89
Audion	124	Opportunity Adlets	127
		Oxford Components, Inc.	89
B & K Mfg., Co.	92, 93		
Parry Electronics Corp.	131	PACO Electronics	122
Pell Telephone Labs.	8	Perma-Power Company	12
Blonder-Tongue Labs.	75	Picture Tube Outlet	128
Bonafide Radio	118	Progressive "Edu-Kits", Inc.	114
Brooks Radio & TV Corp.	113	Pyramid Electric Co.	99
Burroughs Corp.	124		
		RCA Tube Div.	Back Cover
CBS-Electronics	97	RCA Institutes	17
Capitol Radio Engineering Inst.	82, 85	RCA Service Company	61
Carston Studios	116	Radio Shack Corp.	93
Castle TV Tuner Service	109	R-Columbia Products Co., Inc.	121
Centralab Div. of Globe Union	10	Rinehart & Co., Inc.	121
Charles Engineering Co.	59	Rohn Mfg., Co.	16
Chicago Standard Transformer Corp.	22		
Cleveland Institute of Radio Engineering	11	Salon International de la Picee	
CREI-ATOMIC Div. of Capitol Radio		Detachee Electronique	116
Engineering Inst.	105	Sams (Howard W.) & Co., Inc.	102, 103
Coyne Electrical School	120, 125	Scott Inc. (H. H.)	69
		Secore	116, 117, 118, 119
Daystrom, Inc.	111	Shure Brothers, Inc.	101
Delco Radio Div. of General Motors Corp.	20, 21	Sonotone Corp.	123
DeVry Technical Institute	7		
Dressner	116	Sprayberry Academy of Radio TV	19
Dynaaco Inc.	14	Sylvania Electric Products, Inc.	65
Electro-Products Labs.	106	TAB	122
Electro-Sonic Labs.	123	Sarkes Tarzian, Inc.	120
Electronic Chemical Corp.	104	Teltron Electrical Co.	109
Electronic Instrument Co.	27, 28	Triplet Electrical	
Electronic Measurement Corp.	108	Instrument Co.	Second Cover
Electronic Publishing Co., Inc.	130	Tung-Sol Electric Co.	26
Entron Inc.	60		
Electronics Representatives		United Radio Co.	104
Association (ERA)	115	Utah Radio Products Corp.	23
Federal Aviation Agency	92		
Gernsback Library	126	Vaco Products Company	130
Grantham School of Electronics	15	Vidaire	118
		Weston Electrical Instrument Corp.	111
Heald Engineering College	110		
Heath Company	54, 55, 56, 57	Xcelite, Inc.	99
Homewood Industries	127		
Hudson Specialties Co.	119		
		SCHOOL DIRECTORY PAGE 131	
Illinois Condenser Co.	108	Baltimore Technical Institute	
Indiana Technical College	118	Canadian Institute of Science & Technology	
International Resistance Corp.	89	Indiana Technical College	
		International Correspondence School	
Key Electronics Co.	124	Milwaukee School of Engineering	
Kleen-Lube Inc.	117	Philco Technological Center	
		Tri-State College	
Lafayette Radio	132	Valparaiso Technical Institute	
James B. Lansing Sound, Inc.	107	ADVERTISING REPRESENTATIVES: Los Angeles:	
Lektron Inc.	120	Harker-Husted-Coughlin, 600 South New Hampshire, Tel.	
		DUnkirk 7-2328. San Francisco: Harker-Husted-Cough-	
Mercury Electronics (Sub. of Century)	18	lin, 414 Market St., Tel. CArfield 1-2481. Chicago: 8631	
Mohawk Business Machines	125	East Prairie Road, Skokie, Ill., Tel. ORchard 5-3740.	
Moss Electronic Inc.	78, 79	FOREIGN AGENTS: Great Britain: Atlas Publishing and	
		Distributing Co., Ltd., 18 Bride Lane, London E.C. 4.	
		Printed in the United States of America	

BARRY'S JUNE BUYS

- Johnson No. 237 tube sockets for 813, etc. Un-used. 95¢ ea. (2 for \$1.80).
- Uoinite Sockets for 829B, 826 3E29, AX9903/5894, 4-65A, etc. Sale Price \$1.00.
- Xmtg. Socket Ceramic for 826, 832A, etc. 75¢.
- Johnson Xmtg. Socket for 8008, 5C22, etc. Johnson No. 122-244. \$1.40.
- Octal Ceramic Sockets. 15¢.
- 7 Prong Ceramic Sockets for 1625's, etc. 20¢.
- Sylvania Polymer Type 301, Six AC & DC Ranges. Reads up to 1,000 Volts. (Up to 30,000 V. w/Syl. Type 225 Voltage Probe). Resistance up to 10,000 Megs. in ranges. True peak-to-peak readings up to 2,800 Volts. Brand new. Orig. box. Reg. \$109.50. Sale price \$59.50.
- Choke Special (Thordarson). 5 Hy 200 Ma. Herm. sht. Compact. Size Insulators. 1600 V. insul. approx. 115 ohms DC res 2 1/2" x 2 1/2" x 3 1/2". Wt: 2 1/2 lbs. \$1.00.
- New Westinghouse IN1169 Silicon TV Rectifiers. Replaces TV Selenium Rectifiers and gives you greater B+ Voltage. \$1.20.
- RCA TV Remote Control Unit (controls sound & picture) for 1955 & earlier model RCA sets. \$12.50 Comp. w/instruction manual.
- The U.S.A. and the World—in Beautiful 3-D. For the home or office. New True Raised Relief Maps with mountains & valleys you can actually feel. In its own frame, ready for hanging. Rich colors. 28 1/2" x 18 1/2". Made of sturdy Vinylite. These are the maps selected by the U.S. Weather Bureau for display in airport weather stations. Treat yourself today. Only \$9.95 (eat. avail.).
- C. R. Tubes Type 3BP1 w/matching socket. Un-used. Removed from equipment. Both tube and socket \$1.50.
- New. Professional Closed-Circuit TV Cameras. For Industry, schools, banks, etc. Approx. \$700.00 (eat. avail.) Most reasonable price for units of this calibre.
- Sonotone Rechargeable Battery Cartridge Model FC-2. Cartridge is size of two reg. size flashlight batteries. Will last indefinitely by plugging into any AC socket to recharge \$6.95.
- Silicon Rectifier 350 Ma/130 R.M.S. 50¢ each (10 for \$4.00).
- 130V 500 Ma. Selenium Rectifier. Brand new. Radio Receptor. 50¢ each.
- Jaeger Clock Movements No. HA-563B. Operates on 1.5 VDC. All you need are hands and dial plate. \$1.00 each (10 for \$8.00).

OA385	5UP1	11.00	409A/	
OC345	6AC765	6AS6.	1.00
OD345	6AG790	576	17.00
CIK	6.00	6AJ650	577	12.00
2G21	2.00	6AK480	WL616/	
E-1000A.	90.00	6AK580	ML100@	25.00
1A350	6AK680	KU627 ..	6.00
1B2670	6AR690	825	4.50
1B45	7.00	6AS695	806	6.00
1B85	7.00	6AS7G ..	2.50	807	1.10
1P23	1.50	6AT8	1.00	80885
1P24	1.00	6AX790	811	2.75
2A3	1.50	6BD4A ..	8.00	815	3.95
2BP1	4.00	6C640	82660
2C39	5.00	6D650	829B	7.00
2C39A	H.00	6J4	1.00	833	4.00
2C43	6.50	6J6W50	832A	6.75
2C46	4.75	6L6G	1.25	833A	40.00
2J21	3.00	6L6M	1.35	836	1.50
2J22	4.00	6Q5G	2.00	83790
2J27	4.00	7B7	5.00	866A	2.00
2J42	55.00	10KP7 ..	17.00	872A	3.00
2U50	30.00	12A635	81885
2K25	8.00	12AX7 ..	.90	161690
2K28	24.00	12BY7 ..	1.00	161925
2V3G60	12DP7 ..	15.00	1624	2.00
C31	7.50	12DP7A ..	19.00	162530
3AL540	12SX7 ..	1.30	162610
3B24W	2.75	14A475	1855/	
3B25	2.50	14C775	8896.	300.00
3B28	2.75	14H765	2013/	
3B29	5.00	14J785	6211 ..	.50
3BP1	1.50	FG-32 ..	1.00	2014/	
3C22	45.00	35T6	2.50	6CL6 ..	.50
3C23	5.00	WL41/		5517 ..	.65
3D23	3.50	FG41/		5651 ..	1.00
3KP1	8.50	WL-5830	40.00	5692 ..	3.65
4D32	17.50	HF100 ..	8.00	5702 ..	1.75
4J36	30.00	204A	8.00	5881 ..	2.40
4J37	30.00	250R	5.00	5965 ..	.75
5AV8	1.25	300B	5.50	5998 ..	3.00
5AZ460	307A	1.00	8211 ..	.90
5CP1A	13.00	WE-313C	1.50	8012 ..	.50
5J26	70.00	WE-339A	4.00	8012A ..	2.25
5L.P1	6.00	350A	1.70	8013 ..	2.00
5R1A	25.00	350B	1.20	8014A ..	40.00
5R4GY	1.15	350B	1.20	8020 ..	5.00
5T455	WE-388A	1.00		

- Large Stock of National Electronic & Westinghouse Tubes and Semi-conductors.
 - One of the largest diversified tube stocks in the Country. All tubes guaranteed for cost of index only. Receiving tubes, 90 days from receipt and Special Purpose & Xmtg. tubes, 30 days from receipt. Guarantee does not cover breakage or misuse. All shipments are insured against breakage. Types shown are small fraction of inventory. Write for detailed price lists—free.
- Prices: F.O.B. N.Y.C.
- Write for prices on beautiful White or Red & Black Tube Cans. Also Tube Stackers.
 - Minimum order \$5.00
 - Write for "Green Sheet" Catalog, check full of specials on Components and Equipment.

Walker 5-7000

BARRY ELECTRONICS CORPORATION

512 BROADWAY, NEW YORK 12, NEW YORK

new "LEADER" test instrument

LAG-55 AUDIO GENERATOR SINE SQUARE

A multi-purpose generator for measurements on audio equipment—amplifiers, speakers, networks. Three waveforms: sine, square and complex for all types of measurements including response, distortion, transient and I-M distortion checks. Full range is from 20 to 200,000 cps, output 5 volts with minimum amplitude variation throughout whole range.

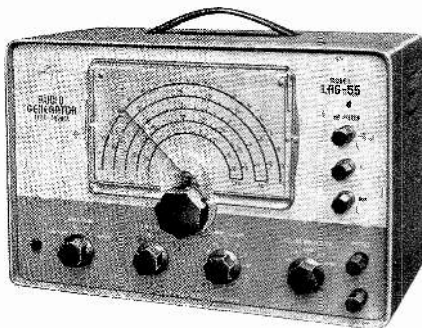

The LEADER test instruments are being used in the more than 36 countries, attesting their excellence in design, performance and usefulness.

OHMATSU ELECTRIC CO. LTD.

2596, 5-CHOME, KAMIMEGURO, MEGURO-KU, TOKYO, JAPAN
Cable Address "OHMATSUELEC" TOKYO

NEW

LAFAYETTE HE-15 CITIZENS BAND 11 METER 2-WAY SUPERHETERODYNE TRANSCEIVER

MADE IN U.S.A.

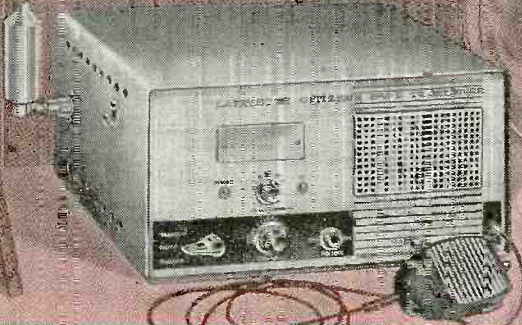

COMPLETELY WIRED
NOT A KIT!

64.50

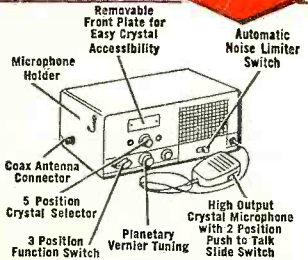

ONLY 5.00 DOWN

Not Superregenerative but **SUPERHET!**



- 5 CRYSTAL CONTROLLED TRANSMITTING POSITIONS
- SUPERHETERODYNE TUNEABLE RECEIVER OVER FULL 22 CHANNEL BAND
- 4 DUAL FUNCTION TUBES, PLUS 2 SINGLE FUNCTION TUBES, PLUS 2 RECTIFIERS FOR 12 TUBE PERFORMANCE
- PLANETARY VERNIER TUNING
- COMPLETE WITH TRANSMITTING CRYSTAL FOR 27.065MC
- MEETS ALL FCC REGULATIONS
- REMOVABLE FRONT PLATE FOR EASY ACCESSIBILITY OF CRYSTALS
- UNEXCELLED RECEPTION ON LAND AND SEA... COMPARES WITH UNITS COSTING 3 TIMES AS MUCH

The Lafayette HE-15 meets all FCC requirements and operates in much the same manner as police and other short wave communications systems. The Transceiver features 5 crystal controlled transmitting channels operating at a maximum legal power input of 5 watts fully modulated. RF stage in both transmitter and receiver. Any one of 5 transmitting frequencies may be instantly selected by the 5 position crystal selector on the front panel. These 5 crystals are readily accessible by means of a removable front plate and this may be easily interchanged with any 5 crystals of the remaining 22 allocated citizens band frequencies.

The Superheterodyne receiver is tuneable over the full 22 channel band with 3 watts audio output. Controls include a 3 position function switch (transmit, receive, and transmit with spring return), planetary vernier tuning plus squelch noise limiter coil of switch. All coils are ferrite tuned. Output impedance matches 52 and 72 ohm antenna with Amphenol type coax connector for operating into dipole, ground plane or rod antenna. Has large 4" PM speaker; input jack for crystal or ceramic microphone; power receptacle in rear for AC line and 6 or 12 volt external power supply. Transceiver is supplied with single transmitting crystal for channel 9. Complete high output with crystal microphone, and brackets for easy mounting of unit in auto, boat, etc. Operated on 115 volts AC. Addition of 6 or 12 volt power supply (separately supplied) adapts transceiver for mobile operation. Size 5 1/2" H x 6 3/8" D. Shpg wt., 11 lbs.

HE-15 Factory Wired and Tested (Less antenna), 5.00 Down.....	Net 64.50
HE-19 Whip Antenna.....	Net 3.95
HE-16 Power Supply For 12 Volts.....	Net 11.95
HE-18 Power Supply For 6 Volts.....	Net 11.95

NEW! LAFAYETTE TELESCOPIC CITIZENS BAND WHIP ANTENNA

- Chrome Plated
- Telescopes From 16 1/2" to 40"
- Mounts Vertically or Right Angle

3.95

An outstanding antenna value. This high quality three section telescoping antenna is designed for attachment directly to your citizens band transceiver. Ideal for point to point service over short distances. Molded base leading coil has a threaded stud with a PL-259 plug—connector for vertical or right angle mounting. Shpg. wt.; 1 lb. HE-19 Net 3.95



NEW! LAFAYETTE RADIO FIELD INDICATOR

A Must For Ham & Citizens Band Operators

- Provides a Continuous Indication of Transmitter Output • Rugged 200 ua Meter Movement • Completely Portable — Requires no Electricity, Batteries or Transmitter Connection.
- With this rugged, new radio field indicator you can check performance of your marine, mobile or fixed transmitter... actually measures the RF field generated by any transmitter between 100KC and 250MC regardless of power. Features a 200 ua meter movement with a variable sensitivity control. Phone jack at rear of indicator accepts earphones thus providing an aural check of transmitter output. Antenna extends from 3 1/4" to 10 3/4". Powerful magnet on bottom plate allows easy mounting on car dashboard or metal surfaces. Use anywhere... requires no electricity or batteries. Dimensions: (less antenna) 3 1/8" W x 2 1/4" H x 2" D. TM-14 Net 7.95

7.95

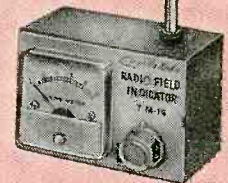

NEW! LAFAYETTE "Tiny"

6 Transistor Radio
SENSATIONAL PERFORMANCE
In a Small Package!

- 6 Transistor Plus a Germanium Diode
- Superheterodyne Circuit • Vest Pocket Size
- Built In Earphone Jack For Private Listening
- Trouble-Free Printed Circuit

Engineered and constructed with the jewel like precision of a fine watch... true superhet circuit, with push-pull audio output powers either the built-in dynamic speaker or the personal-type earphone. Extremely sensitive... built-in ferrite—rod antenna brings in distant stations like locals. Employs standard 9 volt battery for economical service. Housed in smart black and gold rugged plastic case. Measures only 4" x 2 1/2" x 1 1/4" and weighs a mere 1 ounce. Complete with battery, carrying case and earphone. Shpg. wt., 2 lbs.

FS-206 "Tiny" 6-Transistor Radio... Net 19.95



19.95

PLEASE RUSH ITEMS CHECKED!

- HE-15 CITIZENS BAND TRANSCEIVER
- TM-14 RADIO FIELD INDICATOR
- FS-206 "TINY" 6 TRANSISTOR RADIO
- HE-19 WHIP ANTENNA
- FREE 308 PAGE CATALOG 600

Enclosed Find \$.....(Please include postage to cover shipping)

FREE 308 Giant Size Pages!

Name.....

Address.....

City.....Zone.....State.....



Everything in Hi-Fi and Electronics

LAFAYETTE RADIO,
P. O. BOX 222, JAMAICA 33, N.Y. Dept.

JF-6

ANNOUNCING
THE NEW ASTATIC NEEDLE LINE
 MORE COMPLETE THAN ALL COMPETITIVE LINES COMBINED

IT'S A NATURAL
 FOR TOP SALES AND PROFIT!

- Now, for the first, a needle line that gives you EVERYTHING you will ever need — even the hard-to-get EXOTIC styles — no more wasted time and money searching for sources or turning customers down.
- Today's first name in cartridges is tomorrow's first name in needles and cartridges.
- Astatic's quality reputation builds EXTRA sales volume.
- Now buy cartridges and needles from ONE source — single ordering, single delivery, single billing, simplified bookkeeping.

GO BY BRAND...
 GO BUY ASTATIC

ASTATIC

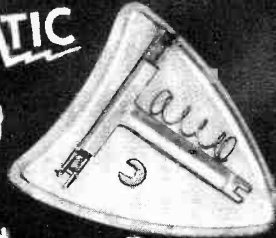

KNOWN
 THE WORLD OVER

ASTATIC

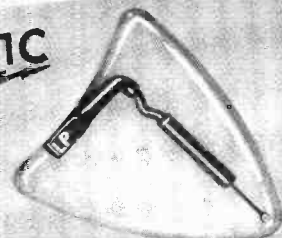

KNOWN
 THE WORLD OVER

THE INDUSTRY'S MOST ATTRACTIVE, EASY-TO-USE CATALOG

Write for your free copy on company letterhead.

THE **Astatic** CORPORATION, CONNEAUT, OHIO

IN CANADA: CANADIAN ASTATIC LIMITED, TORONTO, ONTARIO
 EXPORT SALES: ROBURN AGENCIES, INC., 431 GREENWICH ST., N. Y. 13, N. Y., U.S.A.

FACTS



to help you sell more
RCA Silverama Picture Tubes

... the All-New replacement picture tubes that command premium price and profits.

Here are the facts—proof that RCA Silverama is your customers' best picture tube buy.

1 FREE OF GLASS DEFECTS. Glass cord lines, scratches, chips, or buffed faceplates are common defects found in many brands of tubes made with used glass. Surest way to avoid these defects and also obtain the latest optical advances in faceplate engineering: an All-New RCA Silverama!

2 ALL-NEW. Of the three largest-selling brands of replacement TV picture tubes, only RCA Silverama is guaranteed 100% all-new—new glass, new gun, new phosphor, new everything! You'll get written proof—right on the warranty card.

3 FINEST SCREEN QUALITY. Advanced screen coating and bonding processes combined with RCA's giant vibration-free screen settling machines assure the maximum in picture screen quality and uniformity.

4 RCA "KNOW-HOW" RCA's continuous product research and advanced design engineering have resulted in RCA Silverama picture tubes being steps ahead of all other brands.

5 WORLD'S FINEST. RCA Silverama is manufactured in the world's most modern manufacturing plant using all-new premium-quality materials. Result? RCA Silverama is the world's finest picture tube.

© Silverama



RADIO CORPORATION OF AMERICA

Electron Tube Division

Harrison, N. J.