

BUILD A SENSITIVE WIDE-BAND VTVM

APRIL 1959
IND

Radio-Electronics

WUDO GERSBACH, Editor

Reduce Noise in TV Antennas

Build a Free-Power Transistor Radio

Stop Phono Record Groove Jumping

Reflex Enclosures

**Small-Boat
Radio
Tune-Up Time**

See page 4

35¢
U.S. and
Canada

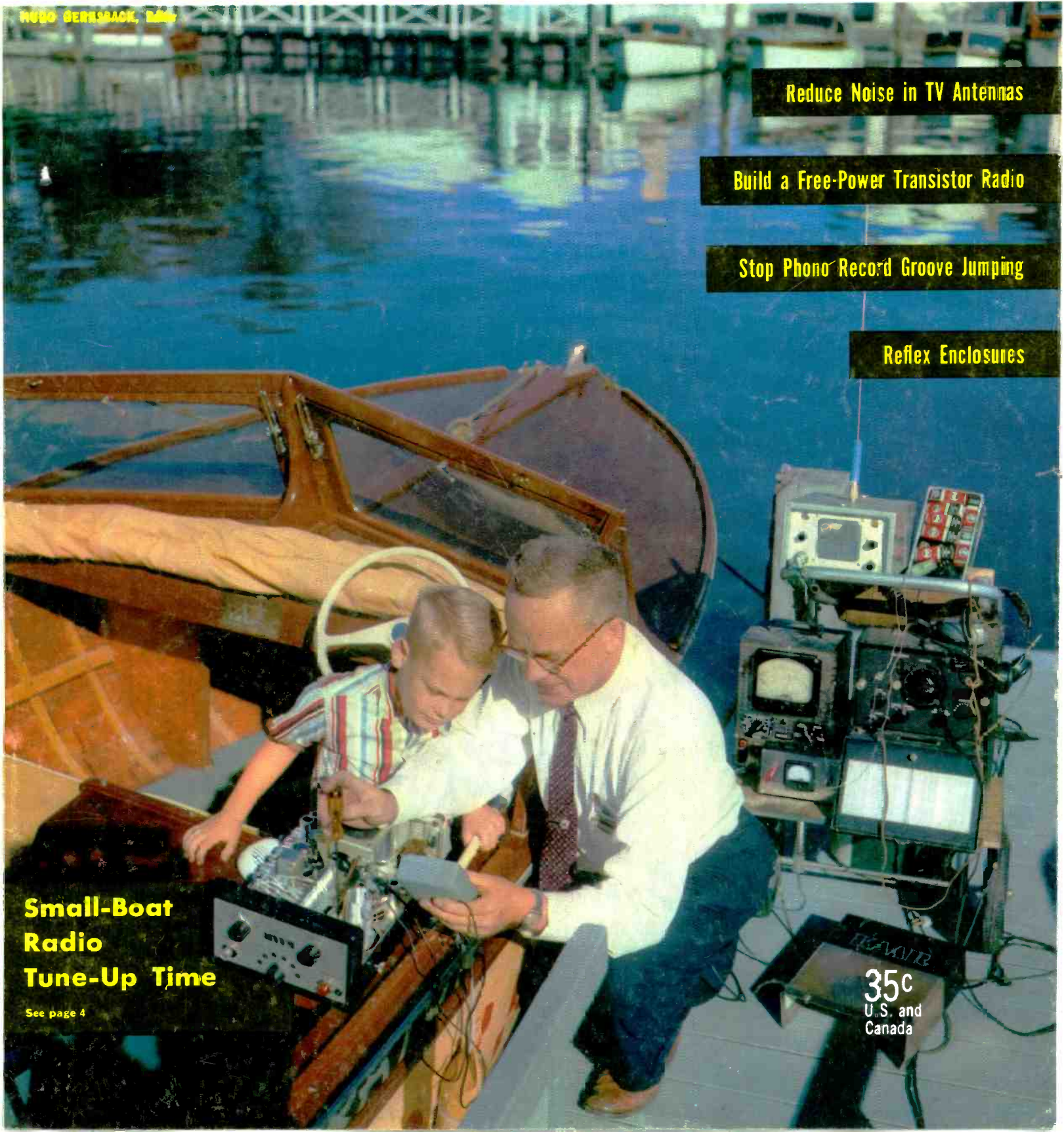

The Old Frontier...

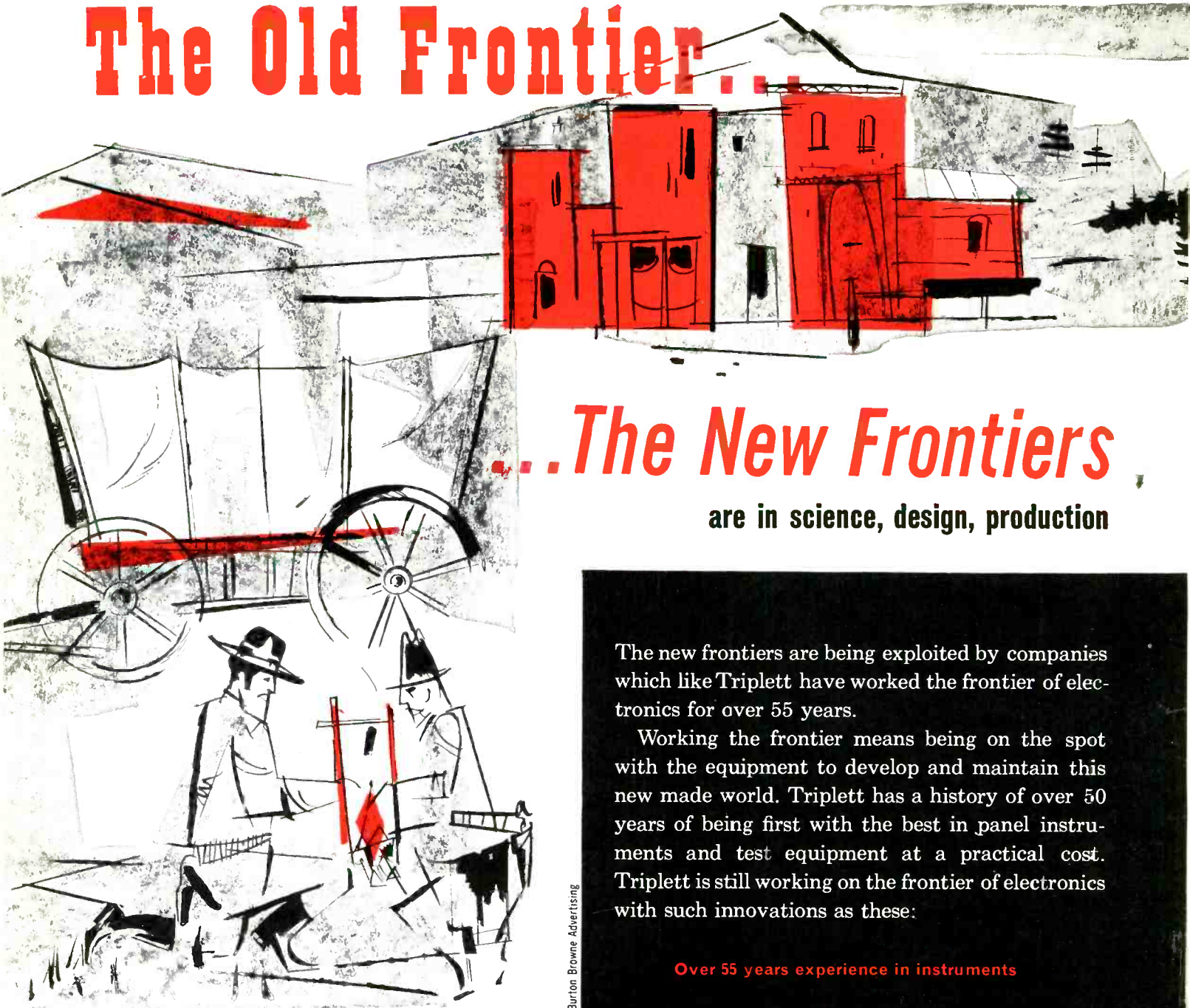

...The New Frontiers

are in science, design, production

The new frontiers are being exploited by companies which like Triplet have worked the frontier of electronics for over 55 years.

Working the frontier means being on the spot with the equipment to develop and maintain this new made world. Triplet has a history of over 50 years of being first with the best in panel instruments and test equipment at a practical cost. Triplet is still working on the frontier of electronics with such innovations as these:

Over 55 years experience in instruments

Barton Browne Advertising



Model 310 a complete miniature V-O-M with single switch selection and the ranges and accuracy of units several times its size. Used with Model 10 clamp-on ammete plugged in it becomes one of the world's most versatile pieces of test equipment—even measuring current flow without stripping wires.



Model 630-PL V-O-M with such advanced features as an unbreakable clear plastic front for wide range, shadowless, instant vision, polarity reversing switch, single king size knob for selecting both range and circuit, continuous resistance readings from 0.1 ohm to 100 megohms.



Model 690-A, a new Transistor Tester with more Triplet "plus" in accuracy and simplicity, for testing leakage and gain of all low and medium power PNP and NPN transistors. Small, rugged, battery-operated, it measures DC Beta from 5 to infinity. Affords exact tests for shorts, checks forward & reverse leakage of diodes. Features single switch selection of transistor types, positive "off" to prevent accidental battery drain, separate "calibrate" and "gain" buttons eliminate errors, transistor socket and external leads for any basing arrangement.



New Unimeters—a great step forward in increasing meter inventory flexibility while cutting inventory cost. These Select-Your-Range unimeters consist of only two basic meter movements, which can be combined with any one of a number of separate dial-component units for a wide variety of meter ranges. Movements quickly and simply slide onto dial-components and lock together—no soldering, no wiring. Exclusive Triplet Bar-Ring construction for self-shielding, greater accuracy and sensitivity.

TRIPLET

Triplet Electrical
Instrument Company
Bluffton, Ohio

Throughout the world Triplet first . . . to last

Learn Radio-Television

Servicing or Communications

by Practicing at Home

in Spare Time

N. R. I. SENDS kits with which you practice building circuits common to Radio and TV sets. You LEARN-BY-DOING to locate Radio-TV troubles. As part of N. R. I. Servicing Course, you build Vacuum Tube Voltmeter and AC-DC receiver. Use VTVM to conduct experiments, earn extra money fixing sets in spare time

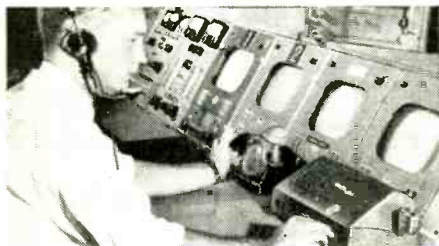
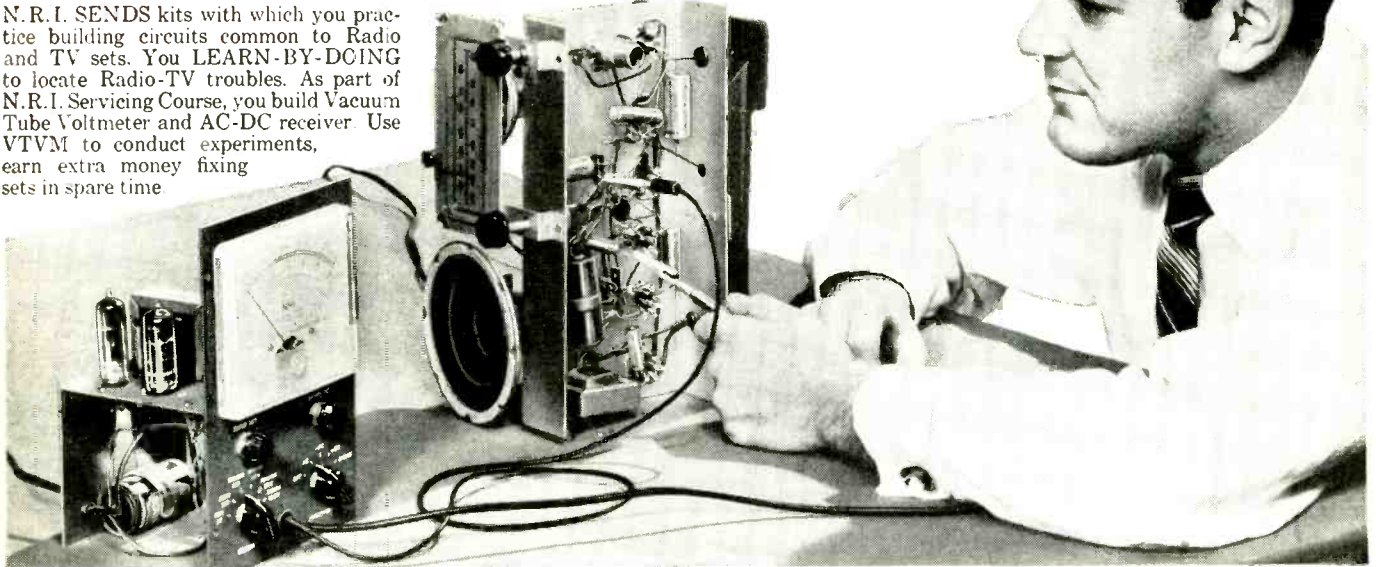

RADIO-TV BROADCASTING (see above, offers important positions as Operators and Technicians. RADIO-TV SERVICING Technicians (see below) needed in every community. Their services are respected, their skill appreciated.



Fast Growing Field Offers You Good Pay, Success, Bright Future

Bigger than ever and still growing fast. That's why Radio-TV has special appeal to ambitious men not satisfied with their job and earnings. More than 4,000 Radio and TV stations. More than 150 million home and auto Radios, 40 million TV sets. Color TV promises added opportunities. For the trained man, there are good jobs, bright futures in Radio-TV Servicing or Broadcasting.

Training PLUS opportunity is the ideal combination for success. So plan now to get into Radio-TV. The technical man is looked up to. He does important work, gets good pay for it. Radio-Television offers that kind of work. NRI can supply training quickly, without expense of going away to school. Keep your job while training. You learn at home in your spare time. NRI is the OLDEST and LARGEST home study Radio-TV school. Its methods have proved successful for more than 40 years.

Added Income Soon - \$10, \$15 a Week in Spare Time

Soon after enrolling, many NRI students start to earn \$10, \$15 a week in spare time fixing sets. Some pay for their training and enjoy extra luxuries this way. Some make enough to start their own Radio-TV shops. NRI training is practical—gets quick results. Easy to understand, well illustrated lessons teach you basic principles. And you LEARN-BY-DOING by practicing with kits of equipment which "bring to life" things you study.

Find Out What NRI Offers

NRI has trained thousands for successful careers in Radio-TV. Study fast or slow—as you like. Diploma when you graduate. Mail coupon now. Paste it on a postcard or mail in envelope. ACTUAL LESSON FREE. Also 64 page catalog that shows opportunities, shows equipment you get. Cost of NRI courses low. Easy terms. NATIONAL RADIO INSTITUTE, Dept. 9DF, Washington 16, D. C.



J. E. SMITH
Founder

N.R.I. TRAINED THESE MEN FOR SUCCESS



"I was repairing Radios by 10th lesson. Now have good TV job." M. R. LINDEMUTH, Fort Wayne, Ind.



"Doing spare time repairs on Radio and TV. Soon servicing full time." CLYDE HIGGINS, Waltham, Mass.

"I had a successful Radio repair shop. Now I'm Engineer for WHPE." V. W. WORKMAN, High Point, N. C.



"There are a number of NRI graduates here. I can thank NRI for this job." JACK WAGNER, Lexington, N. C.



VETERANS Approved Under G. I. Bills

SEND FOR BOTH FREE

National Radio Institute

Dept. 9DF, Washington 16, D. C.

Mail me Sample Lesson and 64-Page Catalog FREE. (No salesman will call. Please write plainly.)

Name _____ Age _____

Address _____

City _____ Zone _____ State _____

ACCREDITED MEMBER, NATIONAL HOME STUDY COUNCIL





APRIL, 1959

Radio-Electronics

Formerly RADIO-CRAFT ■ Incorporating SHORT WAVE CRAFT ■ TELEVISION NEWS ■ RADII & TELEVISION

EDITORIAL

- 31 Electronics vs War—Hugo Gernsback

TEST INSTRUMENTS

- ✓ 32 Sensitive Wind-Band Ac Vtvm—Phillip D. Blais
- 36 Using Scope Probes—R. M. Centerville
- 39 Simple Capacitor Checking Method—George P. Pearce

RADIO

- ✓ 41 ABC's of Mobile Radio, Part III—Leo G. Sands
- ✓ 44 Echo Sounder for Small-Boat Owners—Elbert Robberson
- 48 Radio Telegraphy in 1866—Darrell L. Geiger
- 49 Experimenter's Carrier-Power Receiver—Dr. William H. Grace

WHAT'S NEW

- 51 Pictorial Reports of New Developments

TELEVISION

- 52 Hush the Noise in Antennas and Lead-ins—Engineering Staff, Scala Radio Co.
- 54 TV's Tricky R-C Circuits—Cyrus Glickstein
- 57 TV Service Clinic—Conducted by Robert G. Middleton
- 59 Color-Projection Systems
- 60 Small Claims Court in Session—H. A. Highstone

AUDIO-HIGH FIDELITY

- ✓ 61 The Record Skips—Charles W. Farrington
- 76 Ultra-Steered-Stereo Projector—Mohammed Ulysses Fips
- 82 All About the Reflex Enclosure, Part II—P. G. A. H. Voigt
- 95 New Discs and Tapes, Stereo and Mono—Reviewed by Chester Santon

ELECTRONICS

- ✓ 98 Cold-Cathode—Revolutionary New Heaterless Tube—Eric Leslie
- ✓ 99 Electronics Guides Your Car—Vladimir K. Zvorykin and Leslie E. Flory

- | | |
|----------------------------------|-------------------------|
| 134 Books | 125 Noteworthy Circuits |
| 129 Business and People | 116 On the Market |
| 108, 133 Corrections | 127 Patents |
| 24 Correspondence | 110 Technicians' News |
| 132 Literature | 123 Technotes |
| 106 New Tubes and Semiconductors | 121 Try This One |
| 6 News Briefs | 131 50 Years Ago |

ON THE COVER

(More on page 59)

Marine radio service specialist Maurice Holland tunes up a small-boat radio preparatory to the 1959 sailing season.

Color original by Jacques Saphier

- Hugo GernsbackEditor and Publisher
- M. Harvey GernsbackEditorial Director
- Fred ShunamanManaging Editor
- Robert F. ScottW2PVG, Technical Editor
- Larry StecklerAssociate Editor
- I. QueenEditorial Associate
- Robert G. MiddletonTelevision Consultant
- Elizabeth StalcupProduction Manager
- Cathy CocozzaAdvertising Production
- Wm. Lyon McLaughlinTech. Illustration Director
- Sol EhrlichArt Director
- Fred NeinastStaff Artist
- Lee RobinsonGeneral Manager
- John J. LamsonSales Manager
- G. AliquoCirculation Manager
- Adam J. SmithDirector, Newsstand Sales
- Robert FallathPromotion Manager



Average Paid Circulation Over 199,000



RADIO-ELECTRONICS is indexed in *Applied Science & Technology Index* (Formerly *Industrial Arts Index*)

RADIO-ELECTRONICS, April, 1959, Vol. XXX, No. 4. Published monthly at Mt. Morris, Ill., by Gernsback Publications, Inc. Second-Class mail privileges authorized at Mt. Morris, Ill. Copyright 1959 by Gernsback Publications, Inc. All rights reserved under Universal, International and Pan-American Copyright Conventions.

SUBSCRIPTION RATES: U.S., U.S. possessions and Canada, \$4.00 for one year; \$7.00 for two years; \$10.00 for three years; single copies 35c, Pan-American countries \$5.00 for one year; \$9.00 for two years; \$13.00 for three years. All other countries \$5.50 a year; \$10.00 for two years; \$14.50 for three years.

SUBSCRIPTIONS: Address correspondence to Radio-Electronics, Subscription Dept., 154 West 14th St., New York 11, N.Y. When requesting a change of address, please furnish an address label from a recent issue. Allow one month for change of address.

GERNSBACK PUBLICATIONS, INC., Executive, Editorial and Advertising Offices, 154 West 14th St., New York 11, N.Y. Telephone ALgonquin 5-7755. Hugo Gernsback, Chairman of the Board; M. Harvey Gernsback, President; G. Aliquo, Secretary.

BRANCH ADVERTISING OFFICES and FOREIGN AGENTS listed on page 139.

POSTMASTER: If undeliverable, send Form 3579 to: RADIO-ELECTRONICS, 154 West 14th St., New York 11, N.Y.

*Trademark registered U. S. Pat. Office.

RADIO-ELECTRONICS

NOW!
at a price
you can afford!

MAKE MORE MONEY in TELEVISION RADIO-ELECTRONICS

**BETTER...MORE COMPLETE...LOWER COST...
WITH NATIONAL SCHOOLS SHOP-METHOD
HOME TRAINING!**

BETTER...Training that is proved and tested in Resident School shops and laboratories, by a School that is the **OLDEST** and **LARGEST** of its kind in the world.

MORE COMPLETE...You learn **ALL PHASES** of *Television-Radio-Electronics*.

LOWER COST...Other schools make several courses out of the material in our **ONE MASTER COURSE**... and you pay more for less training than you get in *our course* at **ONE LOW TUITION!**

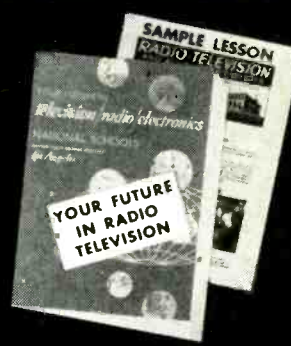

These two **FREE** books will show you how!

You get all information by mail... You make your own decision... at home! **NO SALESMAN WILL CALL**

TOP PAY... UNLIMITED OPPORTUNITIES LIFETIME SECURITY CAN BE YOURS!

You are needed in the Television, Radio, and Electronics industry! Trained technicians are in growing demand at excellent pay—in **ALL PHASES**, including Servicing, Manufacturing, Broadcasting and Communications, Automation, Radar, Government Missile Projects.

NATIONAL SCHOOLS SHOP-METHOD HOME TRAINING, with newly added lessons and equipment, trains you in your spare time at home, for these unlimited opportunities, including many technical jobs leading to supervisory positions.

YOU LEARN BY BUILDING EQUIPMENT WITH KITS AND PARTS WE SEND YOU. Your National Schools course includes thorough *Practical training—YOU LEARN BY DOING!* We send you complete standard equipment of professional quality for building various experimental and test units. You advance step by step, perform more than 100 experiments, and you build a complete TV set from the ground up, that is yours to keep! A big, new TV picture tube is included at no extra charge.

EARN AS YOU LEARN. We'll show you how to earn extra money right from the start. Many of our students pay for their course—and more—while studying. So can you!

LESSONS AND INSTRUCTION MATERIAL ARE **UP-TO-DATE, PRACTICAL, INTERESTING.** Every National Schools Shop-Method lesson is made easy to understand by numerous illustrations and diagrams. All instruction material has been developed and tested in our own Resident School Shops, Laboratories and Studios.

SEND FOR INFORMATION TODAY... it can mean the difference between **SUCCESS** and failure for you! Send for your **FREE BOOK "Your Future in Television-Radio-Electronics"** and **FREE Sample Lesson.** Do it **TODAY**, while you are thinking about your future. It doesn't cost you anything to investigate!

GET THE BENEFITS OF OUR OVER 50 YEARS EXPERIENCE

Approved for
GI Training

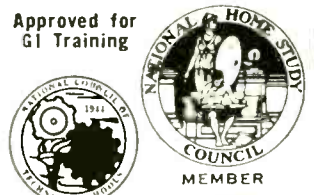

NATIONAL SCHOOLS
Los Angeles 37, Calif.

YOU GET...

- 19 Big Kits—**YOURS TO KEEP!**
- Friendly Instruction and Guidance
- Job Placement Service
- Unlimited Consultation
- Diploma—Recognized by Industry
- **EVERYTHING YOU NEED FOR SUCCESS!**

SHOP-METHOD HOME TRAINING COVERS ALL PHASES OF INDUSTRY

1. Television, including Color TV
2. Radio AM & FM
3. Electronics for Guided Missiles
4. Sound Recording and Hi-Fidelity
5. FCC License
6. Automation and Computers
7. Radar & Micro-Waves
8. Broadcasting and Communications

RESIDENT TRAINING AT LOS ANGELES

If you wish to take your training in our Resident School at Los Angeles, the world's TV capital, start **NOW** in our big, modern Shops, Labs and Radio-TV Studios. Here you work with latest Electronic equipment - - professionally installed - - finest, most complete facilities offered by any school. Expert, friendly instructors. Personal attention. Graduate Employment Service. Help in finding home near school - - and part time job while you learn. Check box in coupon for full information.

NATIONAL TECHNICAL SCHOOLS

WORLD-WIDE TRAINING SINCE 1905

MAIL NOW TO

NATIONAL SCHOOLS, Dept RG-49

4000 S. FIGUEROA ST. LOS ANGELES 37, CALIF.

Rush free TV-Radio "Opportunity" Book and sample lesson. No salesman will call.

NAME _____ AGE _____
ADDRESS _____
CITY _____ ZONE _____ STATE _____

Check if interested **ONLY** in Resident School training at Los Angeles.
VETERANS: Give date of Discharge _____



NEWS BRIEFS

TV PROGRAM LICENSING bill has been introduced in the New York State Legislature by Assemblyman A. Bruce Manley. It is intended to give the State's highest educational authorities censorship power over television of the type that they now have over motion pictures. If passed, many TV programs will have to get a license from the Board of Regents at a cost of \$50 or less for each half hour. Public-service, sporting events and news programs would be exempted from the licensing requirement.

Mr. Manley has stated that TV shows had been offering "a disproportionate amount of crime, sex, horror, terror, brutality and violence," harming the morals of young people and promoting juvenile delinquency.

ULTRA-VIOLET MICROSCOPE brings heretofore invisible things to light. Based on the ultrascopes, an ultra-violet converter tube, the new device makes it possible for scientists to study living cancer cells. Previously, these were transparent under an ordinary microscope and had to be killed and stained before viewing. Announced by RCA, the ultra-violet microscope is a modified optical microscope. A standard microscope body is used, but, the lenses are made of quartz (ordinary glass

absorbs ultra-violet light). The ultrascopes tube fits over the top of the microscope and is connected to its 12,500-volt power supply (see diagram). An ultra-violet light source projects light through the specimen and the microscope's objective lens. This beam then hits the ultrascopes' face plate, which is ultra-violet-sensitive. The image converter tube changes the invisible ultra-violet light into a visible green-tinted picture on the tube's fluorescent viewing screen.

MAPPING THE WASTELANDS becomes possible at a fraction of the time and cost formerly necessary with the help of a new Doppler radar device. Mapping of desert or waste areas has been especially difficult because of their lack of landmarks. The air surveyor was forced to use navigational systems that required expensive manned ground stations. The new system, called *Radan*, is completely self-contained and operates by direct measurement of the direction and distance traveled. It is produced by General Precision Laboratory Inc., Pleasantville, N. Y.

The system has been used by the Aero Service Co., Philadelphia, Pa., to make an aerial survey of 40,000 miles of the central Sahara Desert in southern Libya. The exploration target was oil.

A similar guided survey will cover part of the Spanish Sahara in southwestern Morocco.

Radan uses the same principle as police highway radars. If a radar beam is reflected from a car moving toward the instrument, the length of the reflected waves will be shorter than if the car were stationary, since the car moves a slight distance toward the radar between each wave. The faster the car comes, the greater this *Doppler effect*. In the *Radan* system, four beams are radiated diagonally downward toward the terrain. They are so patterned that they reach the ground at the extremities of an X-shaped figure, with the airplane directly above the center of the X.

To measure forward speed, the front and rear pair of beams are compared; for side drift, the two diagonal pairs are compared. Results are fed into a computer which indicates the difference between the actual and desired course on a dial, permitting the pilot to fly a true course. For mapping a large area, a number of range lines are plotted and the plane made to fly each of them successively, photographing the terrain beneath with its mapping cameras.

LIVE ACTION and miniature background sets (1/6 scale), still photographs or motion pictures are blended into a single TV scene through a device called *VideoScene*. It enables live television to use a variety of scenes in a limited area, eliminating the need for bulky sets. In the CBS Television Network's *VideoScene* technique the master camera has two pickup tubes. One photographs the actor against a special reflective pattern background made by Minnesota Mining and Manufacturing Co. The second tube, sensitive to the highly reflective indigo background, silhouettes the actor and blacks out the background scene in the area he occupies. The background camera photographing the miniature set feeds its picture into a keying amplifier, where the background picture is combined with the picture of the actor as a single scene.

The "live" camera and the background camera are linked through a servo system which synchronizes their movements so the background and actor are always perfectly matched. As the master camera pans, tilts or zooms while photographing the actor, the background camera follows.

In its present form, *VideoScene* is designed for black and white but can be adapted for color television.

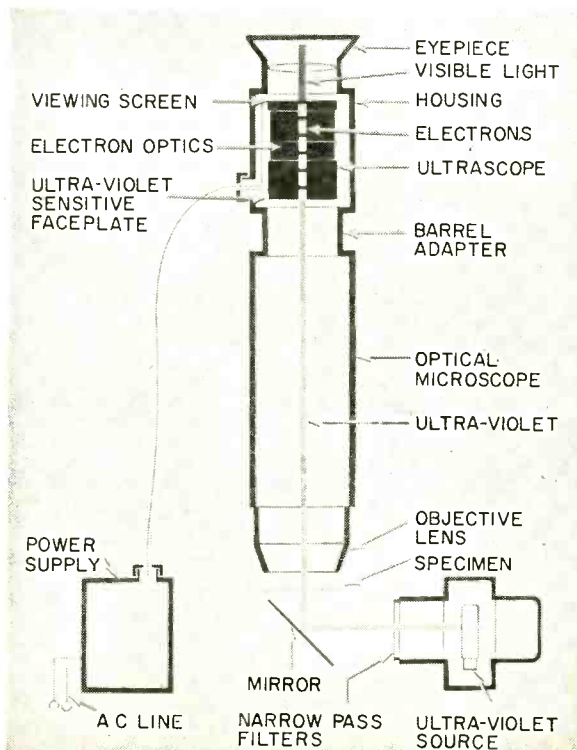

SOMETHING NEW* HAS BEEN ADDED TO THE
DEVRY TECH TRAINING PROGRAM

Prepare in Spare Time At Home for a

JOB THAT PAYS REAL MONEY

in TELEVISION-RADIO-ELECTRONICS

Many DeVry-trained men who now hold good jobs paying real money were once looking for opportunity, yet wondering if they needed advanced schooling, special experience, or higher math. They clipped a DeVry Tech coupon, mailed it in—and were pleasantly SURPRISED! Now they work in one of today's fastest-growing fields—TELEVISION-RADIO-ELECTRONICS. Many have their own profitable service shops. DeVry Tech's "Learn-by-Seeing," "Learn-by-Reading," "Learn-by-Doing" training made the difference! You, too, may train at home the DeVry Tech way with wonderful, helpful movies, clear texts and valuable home laboratory equipment—or in our well-equipped Chicago or Toronto Training Centers.

Now something NEW* has been added to help you learn more by "doing." You can choose to build and keep your own top quality 6-speaker STEREOGRAPHIC SOUND SYSTEM that will provide thrilling enjoyment for years to come. Plans are furnished so that you can also build your own speaker cabinets—or we can tell you where to buy them. DeVry Tech's specially designed Stereo System includes:

- Turntable with Stereo cartridge • Stereo Amplifier
- Stereo Pre-Amplifier • 2 Cross-Over Networks
- Six Speakers: two 12-in., two 8-in., two 3-in.

When you build your own equipment, you learn about the working parts. You can repair, adjust, maintain. You learn by doing—the DeVry Tech way. You put basic principles into "on-the-job" practice.

*** NEW!**

Build Your Own 6-Speaker HIGH FIDELITY STEREOGRAPHIC SOUND SYSTEM

... another wonderful DeVry advantage

Special SHORT COURSE in High Fidelity Sound Reproduction including Stereophonic Systems also available. Ideal for hobbyists, music lovers and those wanting to ADD to their incomes.

MANY OPTIONS!

NOW . . . DeVry Tech men can take their choice of any or all of the quality equipment shown above: The Stereo System . . . the Scope and Meter . . . a 21-inch TV Set (not pictured) . . . or ALL THREE. But no matter which way you do it, you get practical home training at its best . . . the kind you need to get started in the fast-moving Electronics field. Send coupon for details.

"One of North America's
Foremost Electronics
Training Centers"



Accredited Member of
National Home Study Council

DEVRY TECHNICAL INSTITUTE

4141 BELMONT • CHICAGO 41, ILL. • Formerly DeFOREST'S TRAINING, Inc.



VACUUM TUBE
VOLT METER

5-INCH
WIDE BAND
OSCILLOSCOPE

**GET
2
FREE
BOOKLETS!**

Clip the coupon now for two booklets that answer many questions about your chances for success in this field. "Electronics and YOU" and the remarkable "Pocket Guide to Real Earnings" (just off the press) are yours without obligation.

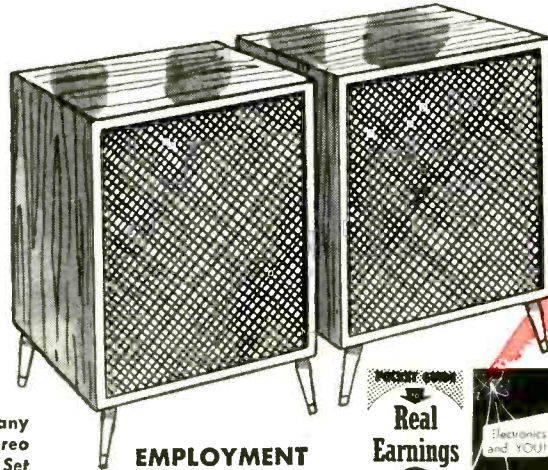

EMPLOYMENT SERVICE

DeVry Tech offers real, down-to-earth employment service to help you toward a good job after graduation — even provides help in starting your own servicing business.



MAIL TODAY FOR FREE FACTS

DeVry Technical Institute
4141 Belmont Ave., Chicago 41, Ill., Dept. RE-4-P
Please give me your two FREE booklets, "Pocket Guide to Real Earnings" and "Electronics and You," and tell me how to prepare to enter one or more branches of Electronics.

NAME _____ AGE _____
PLEASE PRINT
STREET _____ APT. _____
CITY _____ ZONE _____ STATE _____

Check here if subject to military training.
DeVry Tech's Canadian Training Center is located at
2053 626 Roselawn Avenue, Toronto 12, Ontario



The Greater Vibrator

Radiart Vibrators are unaffected by bounce, jounce, heat, cold, moisture. There's a replacement type for every 6- and 12-volt application. Ask your Radiart Distributor for a free Radiart Vibrator Replacement Guide or write The Radiart Corporation, 2900 Columbia Avenue, Indianapolis 5, Indiana.



RADIART
TOBE
Vibrators

NEWS BRIEFS (Continued)

DR. W. R. G. BAKER, director of the EIA Engineering Department, announced the formation of the National Stereophonic Radio Committee. Set up to study methods of broadcasting stereophonic sound by AM, FM and TV stations, the committee is composed of technical experts in the field. Six panels within the committee will review the technical factors involved. Dr. Baker said all known technical proposals for such systems would be studied and urged those who have such proposals to submit them to the committee, through the EIA Engineering Department's asso-

Calendar of Events

Symposium on Millimeter Waves, Mar. 31-Apr. 2, Engineering Society Building, New York, N. Y.

Pittsburgh Hi-Fi Music Show, Apr. 3-5, Penn-Sheraton Hotel.

British Radio and Electronic Component Show, Apr. 6-9, Grosvenor House and Park Lane House, London, England.

Buffalo (N. Y.) Hi-Fi Music Show, Apr. 10-12, Hotel Statler.

Conference on Industrial Instrumentation and Control, Apr. 14-15, Illinois Institute of Technology, Chicago, Ill.

Southwestern IRE Conference & Electronics Show, Apr. 16-18, Dallas (Tex.) Memorial Auditorium and Baker Hotel.

Conference on Analog & Digital Recording & Controlling Instrumentation, Apr. 20-21, Bellevue-Stratford Hotel, Philadelphia, Pa.

British Industrial Photographic & TV Exhibition, Apr. 20-24, London, England.

Annual Technical Conference on TV & Transistors, Apr. 21-22, Cincinnati, Ohio.

National Aeronautical Electronics Conference, May 4-6, Biltmore Hotel, Dayton, Ohio.

Society of Motion Picture and Television Engineers Convention, May 4-8, Fontainebleau Hotel, Miami, Fla.

URSI Spring Meeting, May 5-7, Washington, D. C.

1959 Electronic Components Conference, May 6-8, Ben Franklin Hotel, Philadelphia, Pa.

7th Regional IRE Technical Conference and Trade Show, May 6-8, University of New Mexico, Albuquerque, N. M.

Joint Conference on Automatic Techniques, May 11-13, Pick-Congress Hotel, Chicago, Ill.

1959 Electronic Parts Distributors Show, May 18-20, Conrad Hilton Hotel, Chicago, Ill. For manufacturers, representatives and distributors only. RADIO-ELECTRONICS will exhibit in Room 504 and GERNSBACK LIBRARY in Booth 107.

5th National Symposium on Instrumental Methods of Analysis, May 18-20, Shamrock-Hilton, Houston, Tex.

International Convention on Transistors, May 21-27, Earl's Court, London, England.

National Telemetry Conference, May 25-27, Brown Palace and Cosmopolitan Hotel, Denver, Colo.

ciate director, Virgil M. Graham, 11 W. 42 St., New York 36, N. Y. The committee's formation was suggested last November by Dr. Baker.

OPEN LETTER TO THE FCC suggests five changes in rule making to "insure a complete and equitable utilization of

Do you WISH you were EMPLOYED in ELECTRONICS?

F.C.C. LICENSE—THE KEY TO BETTER JOBS

An F.C.C. *commercial* (not amateur) license is your ticket to higher pay and more interesting employment. This license is Federal Government evidence of your qualifications in electronics. Employers are eager to hire *licensed* technicians.

WHICH LICENSE FOR WHICH JOB?

The **THIRD CLASS** radiotelephone license is of value primarily in that it qualifies you to take the second class examination. The scope of authority covered by a third class license is extremely limited.

The **SECOND CLASS** radiotelephone license qualifies you to install, maintain and operate most all radiotelephone equipment except commercial broadcast station equipment.

The **FIRST CLASS** radio telephone license qualifies you to install, maintain and operate every type of radiotelephone equipment (except amateur) including all radio and television stations in the United States, its territories and possessions. This is the highest class of radiotelephone license available.

GRANTHAM TRAINING PREPARES YOU

The Grantham course covers the required subject matter completely. Even though it is planned primarily to lead directly to a first class FCC license, it does this by **TEACHING** you electronics. Some of the subjects covered in detail are: Basic Electricity for Beginners, Basic Mathematics, Ohm's and Kirchhoff's Laws, Alternating Current, Frequency and Wavelength, Inductance, Capacitance, Impedance, Resonance, Vacuum Tubes, Transistors, Basic Principles of Amplification, Classes of Amplifiers, Oscillators, Power Supplies, AM Transmitters and Receivers, FM Transmitters and Receivers, Antennas and Transmission Lines, Measuring Instruments, FCC Rules and Regulations, and extensive theory and mathematical calculations associated with all the above subjects explained simply and in detail.

OUR GUARANTEE

If you should fail the F. C. C. exam after finishing our course, we guarantee to give additional training at **NO ADDITIONAL COST**. Read details in our free booklet.

Get
Your First Class Commercial

F.C.C. LICENSE QUICKLY!

CORRESPONDENCE OR RESIDENCE CLASSES

Grantham School of Electronics *specializes* in F.C.C. license preparation. Correspondence training is conducted from Washington, Hollywood, and Seattle; also, resident **DAY** and **EVENING** classes are held in all three cities. Either way, by correspondence or in resident classes, we train you quickly and well.

This booklet
FREE!

This free booklet gives details of our training and explains what an F. C. C. license can do for your future.



HERE'S PROOF...

that Grantham students prepare for F.C.C. examinations in a minimum of time. Here is a list of a few of our recent graduates, the class of license they got, and how long it took them:

| | License | Weeks |
|---|---------|-------|
| Roy E. Alexander, Pikeville, Kentucky | 1st | 12 |
| Robert J. Conley, 129 W. 46th St., New York 36, N. Y. | 1st | 14 |
| W. R. Smith, 1335 E. 8th St., Long Beach, Calif. | 1st | 12 |
| Howard E. Martz, 301 S. Penn. St., Fairmount, Ind. | 1st | 24 |
| John W. Dempsey, Box 55, Rising Sun, Md. | 1st | 12 |
| Donald H. Ford, Hyannis RD, Barnstable, Mass. | 1st | 12 |
| Richard J. Falk, 2303 Holman St., Bremerton, Wash. | 1st | 22 |
| Denson D. McNully, 1117 N. Houston St., Amarillo, Texas | 1st | 9 |
| James D. Hough, 400 S. Church St., East Troy, Wisc. | 1st | 12 |
| Odie B. Perry, Jr., Rt. #3, Zebulon, N. C. | 1st | 12 |
| Milton C. Gee, Rt. #1, Washington, N. J. | 1st | 11 |

Grantham School of Electronics

Hollywood Division

1505 N. Western Ave.
Hollywood 27, Calif.
(Phone: HO 7-7227)

Washington Division

821-19th Street, N.W.
Washington 6, D.C.
(Phone: ST 3-3614)

Seattle Division

408 Marion Street
Seattle 4, Wash.
(Phone: MA 2-7227)

MAIL COUPON TO SCHOOL NEAREST YOU

(Mail in envelope or paste on postal card)



To: **GRANTHAM SCHOOL OF ELECTRONICS**

821-19th, NW 1505 N. Western 408 Marion
Washington Hollywood Seattle

Gentlemen:

Please send me your free booklet telling how I can get my commercial F.C.C. license quickly. I understand there is no obligation and no salesman will call.

Name _____ Age _____

Address _____

City _____ State _____

I am interested in: Home Study, Resident Classes 94 D

Are you a recording engineer?

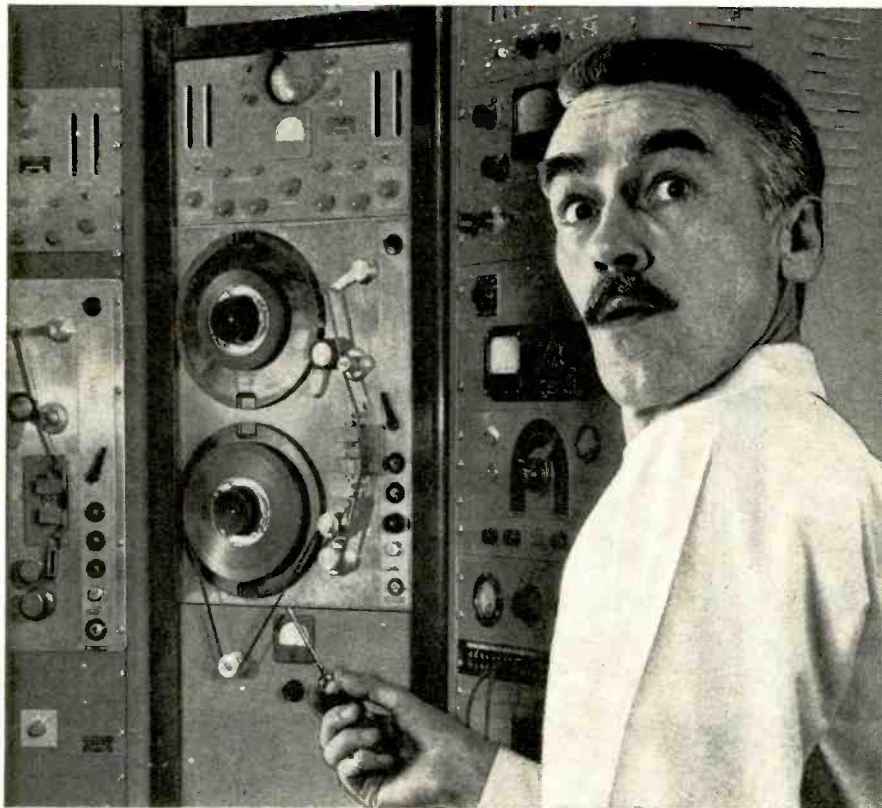

"No, I'm a plumber

...but I know good recording tape"

AUDIOTAPE, the thinking recordist's tape, gives you the full, rich reproduction so satisfying to the happy audiophile — be he doctor, lawyer or Indian chief. Because behind every reel of Audiotape are two decades of research and development in sound recording.

When you buy a reel of Audiotape you're getting the tape that's the professionals' choice. Why? For example, the machines that coat the oxides onto the base material are unique in this field — designed and built by Audio engineers who couldn't find commercial machines that met their rigid specifications. Then there's the C-slot reel — the fastest-threading reel ever developed. For that matter, there's the oxide itself — blended and combined with a special binder that eliminates oxide rub-off.

There are many more reasons why the professionals insist on Audiotape. They know that there is only one quality of Audiotape. And this single top quality standard is maintained throughout each reel, and from reel to reel — for all eight types of Audiotape. That's what makes Audiotape the world's finest magnetic recording tape. For recording engineers, doctors, garbage men, investment brokers, sculptors . . . and plumbers!



Manufactured by AUDIO DEVICES, INC.
444 Madison Ave., New York 22, New York
Offices in Hollywood & Chicago

audiotape
TRADE MARK

NEWS BRIEFS (Continued)

the 88-108-mc band assigned to FM." These changes, detailed in the letter by Charles W. Kline, president of FM Unlimited Inc., are:

1. 105.1-107.9 mc be designated for use by class-A stations only with a maximum power of 3 kw and maximum height of 300 feet, instead of 1 kw at 250 feet.
2. 91.5-104.9 mc be designated for use by class-B stations only.
3. 88.1-91.3 mc be designated for use by class-N (noncommercial) stations — educational, religious, municipal, etc. All 10-watt "campus" stations be assigned to 88.1 mc only.
4. Stations licensed to metropolitan-suburban and community areas be designated as class-A stations and be required to provide maximum service for the areas to which they are assigned.
5. Class-B stations in Zone 1 be permitted the equivalent of 20 kw at 1,000 feet, instead of 20 kw at 500 feet.

Justification for the preceding suggestions is included in the letter along with a list showing what the new channel allocations would look like if the suggested changes are adopted. An interesting point is the following paragraph—one of the reasons behind suggested change 1.

"As FM allocations now stand, class-A channels are situated between or adjacent to metropolitan class-B channels. However, according to present rules, there must be an 800-kc separation between two class-B stations serving the same area. Nevertheless, applications are beginning to be granted for class-A stations serving suburban sections of metropolitan areas—only 400 kc away from existing class-B stations. These suburban class-A stations not only interfere with the primary coverage of the adjoining class B's but are themselves prevented from rendering maximum service to their communities because they are 'hemmed in' by the same class-B stations whose coverage they are interfering with."

TWO ON A CHANNEL is the basic principle behind TASI (Time Assignment Speech Interpolation). Bell Telephone Labs say that using this system they can increase the capacity of a 36-channel submarine telephone cable to handle 72 talkers.

In a normal two-way phone conversation, each person, on the average, speaks only half the time and, even while he is speaking, there are gaps and pauses in his speech. So if the two directions of transmission are separated, each path is idle more than half the time. If two conversations were interlaced to take advantage of these gaps, you could get twice as many conversations per channel.

In practice, more than two channels are needed for the system to work—two talkers would frequently speak at the same time. In a submarine telephone cable, say one with 36 channels,

TAKE A LOOK AT YOUR FUTURE IN RADIO-TV-ELECTRONICS—FREE!

I.C.S. Career Kit tells you where the big-pay jobs are...who are the industry's most wanted men...how you can "cash in" in a big way on your own future.

Here's your chance to find out where you're going—fast! And it won't cost you a thing except the time it takes to clip and mail the coupon at the bottom of this page.

Radio-TV-Electronics is the fastest growing industry of all time. Opportunity for men in this field is almost unlimited. The rewards are great.

But to "cash in" you must be properly trained. You must know more than simply wires and tubes. You must be able to understand and apply the principles of Radio-TV-Electronics.

That's where I. C. S. comes in . . . the world's oldest and largest technical training school. Here are the people who know—who can tell you—what you need to go places in Radio-TV-Electronics.

You get the full story with your free I. C. S. Career Kit.

So take a minute now to get a look at your future in Radio-TV-Electronics. Send for your free I. C. S. Career Kit. You have nothing to lose. You can gain an exciting, well-paid career in a vital industry.

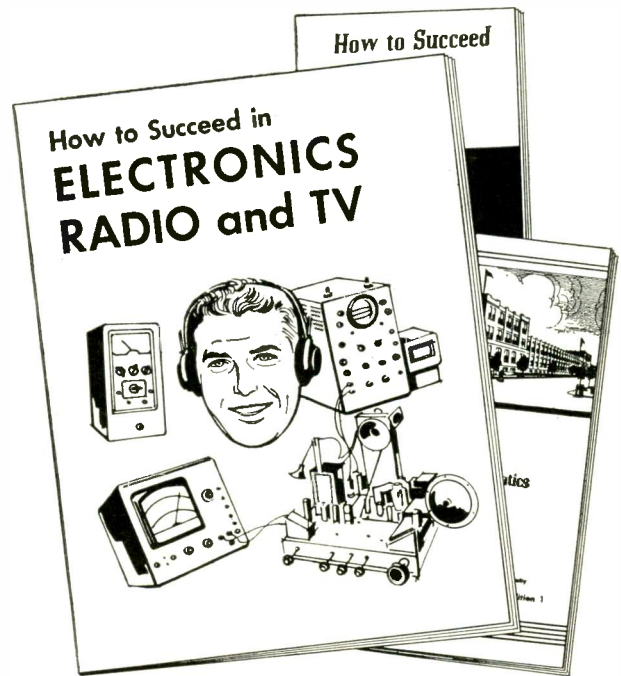

Send the coupon below for your free I. C. S. Career Kit!

- 1 "How to Succeed," 36-page guide to advancement
- 2 Electronics, Radio and TV handbook or the field of your choice
- 3 Sample lesson (Math) to demonstrate I. C. S. Method

For Real Job Security—Get an I. C. S. Diploma! I. C. S., Scranton 15, Penna.

Accredited Member,
National Home Study Council

INTERNATIONAL CORRESPONDENCE SCHOOLS



BOX 91465C, SCRANTON 15, PENNA.

(Partial list of 259 courses)

Without cost or obligation, send me "How to Succeed" and the opportunity booklet about the field BEFORE which I have marked X (plus sample lesson):

RADIO TELEVISION ELECTRONICS

- General Electronics Tech.
- Industrial Electronics
- Practical Radio-TV Eng'r'g
- Practical Telephony
- Radio-TV Servicing

BUSINESS

- Cost Accounting
- Managing a Small Business
- Purchasing Agent

DRAFTING

- Electrical Drafting

HIGH SCHOOL

- High School Diploma
- Good English
- High School Mathematics

ELECTRICAL

- Electrical Engineering
- Elec. Engr. Technician
- Elec. Light and Power
- Practical Electrician
- Professional Engineer (Elec.)

LEADERSHIP

- Industrial Foremanship
- Industrial Supervision
- Personnel-Labor Relations
- Supervision

Name _____ Age _____ Home Address _____
 City _____ Zone _____ State _____ Working Hours _____ A.M. to _____ P.M. _____
 Occupation _____

Canadian residents send coupon to International Correspondence Schools, Canadian, Ltd., Montreal, Canada. . . . Special tuition rates to members of the U. S. Armed Forces.

an averaging effect occurs and at any one instant there is a greater probability of enough free time to accommodate the larger number of conversations.

TASI is essentially a group of high-speed switches and an electronic computer. When there are more talkers than channels, the equipment connects active talkers by disconnecting talkers who are inactive at that moment. In turn, the disconnected talker is assigned another momentarily inactive channel when he starts to speak again. A talker is disconnected only when he is silent.

When a talker starts speaking, his voice triggers a speech detector. The detector is scanned by a control circuit similar to a modern digital computer. The control circuit sends a coded tone burst consisting of four audio tones which precede the voice over the available channel. After the 10-millisecond tone burst, the control circuit connects the talker to the same channel. The coded tones operate switches which connect the talker to the proper line at the receiving end.

THOUSANDS OF MESSAGES handled for personnel at isolated Arctic and South Pacific posts earned Julius M. J. Madey, 18, of Clark, N. J., General Electric's 1958 Edison Radio Amateur Award for public service. One of a family of four licensed radio amateurs, Madey spends an average of 90 hours a week at his station K2KGJ in his home.

Madey transmitted more than 12,000 messages in the past year, maintaining almost continuous contact with the far-flung outposts from mid-afternoon to



8 am. Several times, he has handled official Navy and Coast Guard messages for those services.

Active in local Civil Defense and other community activities, his work has been featured in several magazines and newspapers. He won student science-fair honors several years ago for inventing an ultrasonic drill. He now plans building a system for creating man-made "whistlers," the eerie high-frequency sounds in space which are attracting scientific attention.

MECHANIZED MAIL PROCESSING from start to finish is the unusual feature (Continued on Page 18)

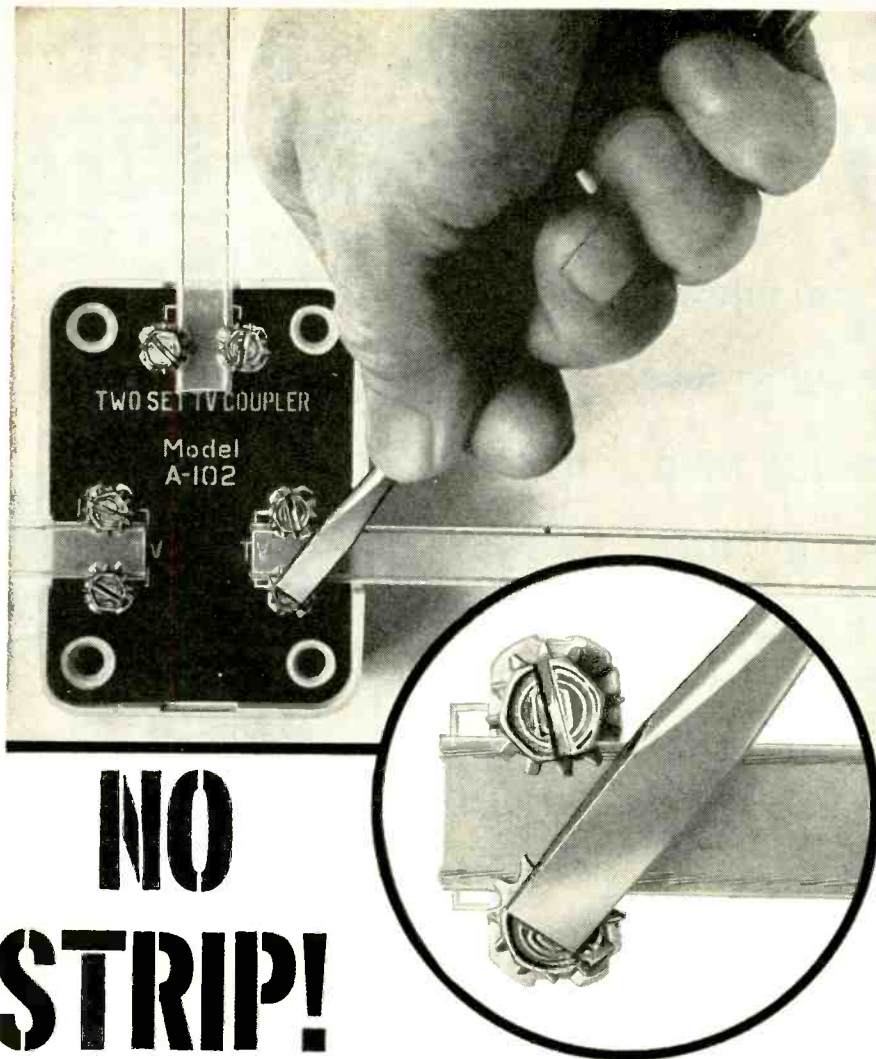

NO STRIP!

4 NEW COUPLERS

In just a matter of seconds, new quality engineered B-T couplers featuring 'No-Strip' terminals provide a low loss, matched installation for superior multi-set performance.

B-T 'NO-STRIP' TERMINALS

Speedy, Secure Positive Installation - No Stripping. Simply slide the 300 ohm ribbon into groove provided on the coupler and tighten slotted hex head terminal screws. 12 sharp teeth bite through the insulation making positive electrical contact...secure, weather-proof. Eliminates loss and impedance mismatch caused by exposed wires.

2-SET COUPLER - MAXIMUM INTER-SET ISOLATION - MINIMUM SIGNAL LOSS

Model A-102 Two-Set Coupler delivers more signal to each TV or FM set, with greater inter-set isolation than other couplers. A new original B-T circuit with phase cancellation feature automatically defeats interfering signals. No ghosts, no smears, ideal for color TV and FM. List 2.95.

NEW B-T COUPLERS - FOUR-SET, HI-LO AND UHF-VHF

A-104 FOUR-SET COUPLER - Low-loss 300 ohm directional coupler only 7.5 db insertion loss and 12 to 20 db inter-set isolation. Flat response 50 to 220 mc. List 3.95.

A-105 HI-LO ANTENNA COUPLER - Combines low-band and high-band VHF antennas or provides separate low and high outputs from a common line or antenna. List 3.50.

A-107 UHF-VHF ANTENNA COUPLER - Combines VHF and UHF antennas, or provides separate VHF and UHF outputs from a common line or antenna. List 3.50.

A-100 OUTDOOR MOUNTING KIT - Bracket and strap assembly for fast, easy mast mounting for Models A-102, A-104, A-105, A-107. List 90¢.

• SMARTLY STYLED • WEATHERPROOF • NON-BREAKABLE CASE



Available at parts distributors. For further information write Dept. RE-4
BLONDER-TONGUE LABORATORIES, INC.

9 Alling Street, Newark 2, N. J.

free!

ALLIED'S 1959

value-packed 452-page ELECTRONIC SUPPLY CATALOG

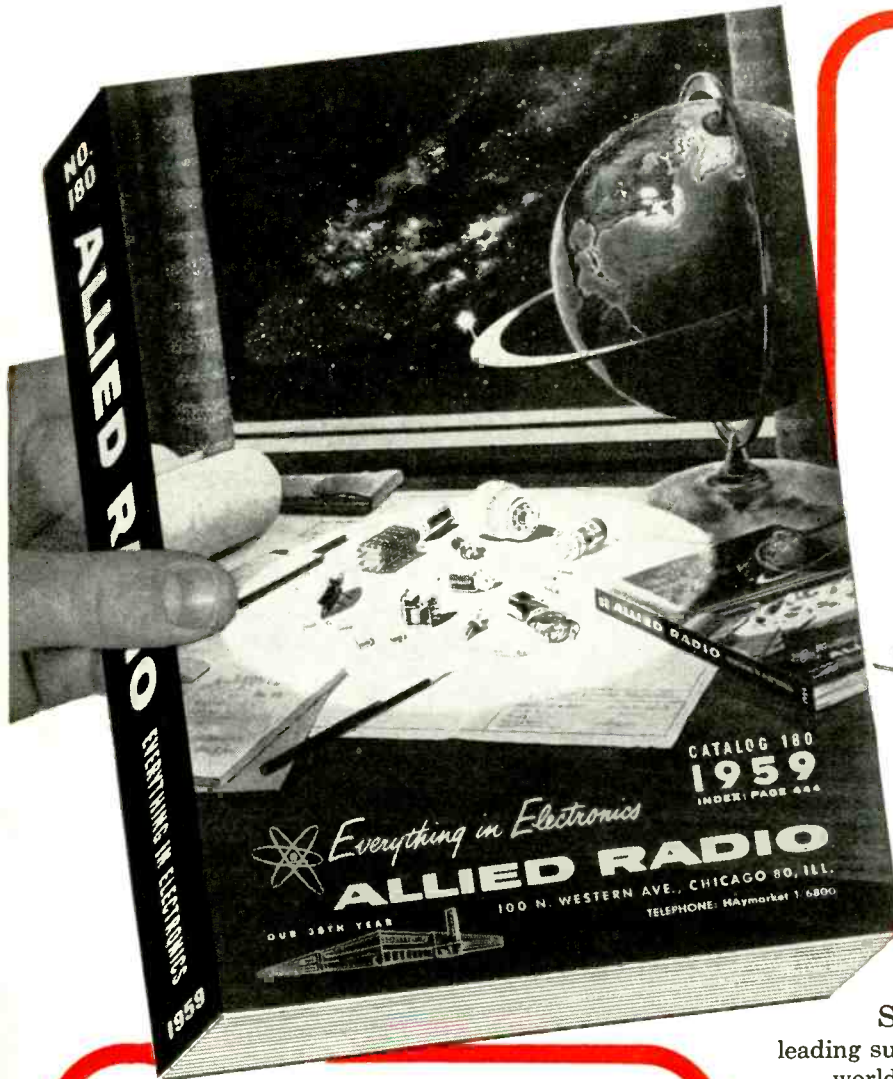

the only COMPLETE guide
to everything in electronics

WORLD'S LARGEST STOCKS

- Latest Stereo Hi-Fi Systems—Everything in Hi-Fi Components
- Money-Saving, Build-Your-Own KNIGHT-KITS—Latest Models
- Values in Recorders and Supplies
- Latest Public Address Systems, Paging and Intercom Equipment
- Amateur Receivers, Transmitters and Station Gear
- Test & Laboratory Instruments
- Specialized Electronic Equipment for Industrial Application
- TV Tubes, Antennas, Accessories
- Huge Listings of Parts, Tubes, Transistors, Tools, Books

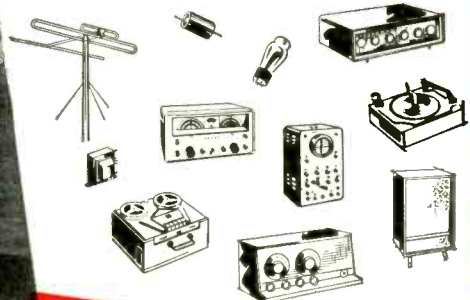

featuring:

MONEY-SAVING knight-kits: Finest electronic equipment in money-saving kit form. Complete selection of latest Hi-Fi amplifier, tuner and speaker kits (new Stereo units); Hobbyist kits; Test Instruments and Amateur kits. KNIGHT-KITS are an exclusive ALLIED product.

HI-FI! STEREO! See the world's largest selection of quality Hi-Fi music systems and famous name components. First with the latest in STEREO! Save on ALLIED-recommended complete systems. Own the best in Hi-Fi for less!

EASY PAY TERMS: Only 10% down; available on orders of \$20 or more. Fast handling—no red tape.

ALLIED RADIO



our 38th year
World's Largest Electronic Supply House

Send for ALLIED's 1959 Catalog—it's the leading supply guide—452 pages packed with the world's largest selection of quality electronic equipment at lowest, money-saving prices. Get every buying advantage at ALLIED: fastest shipment, expert personal help, lowest prices, guaranteed satisfaction...

send for the leading
electronic supply guide



ALLIED RADIO CORP., Dept. 2-D9
100 N. Western Ave., Chicago 80, Ill.

Send FREE 452-Page 1959 ALLIED Catalog

Name _____

Address _____

City _____ Zone _____ State _____

**THE
ARCTIC EYE
THAT NEVER
SLEEPS**

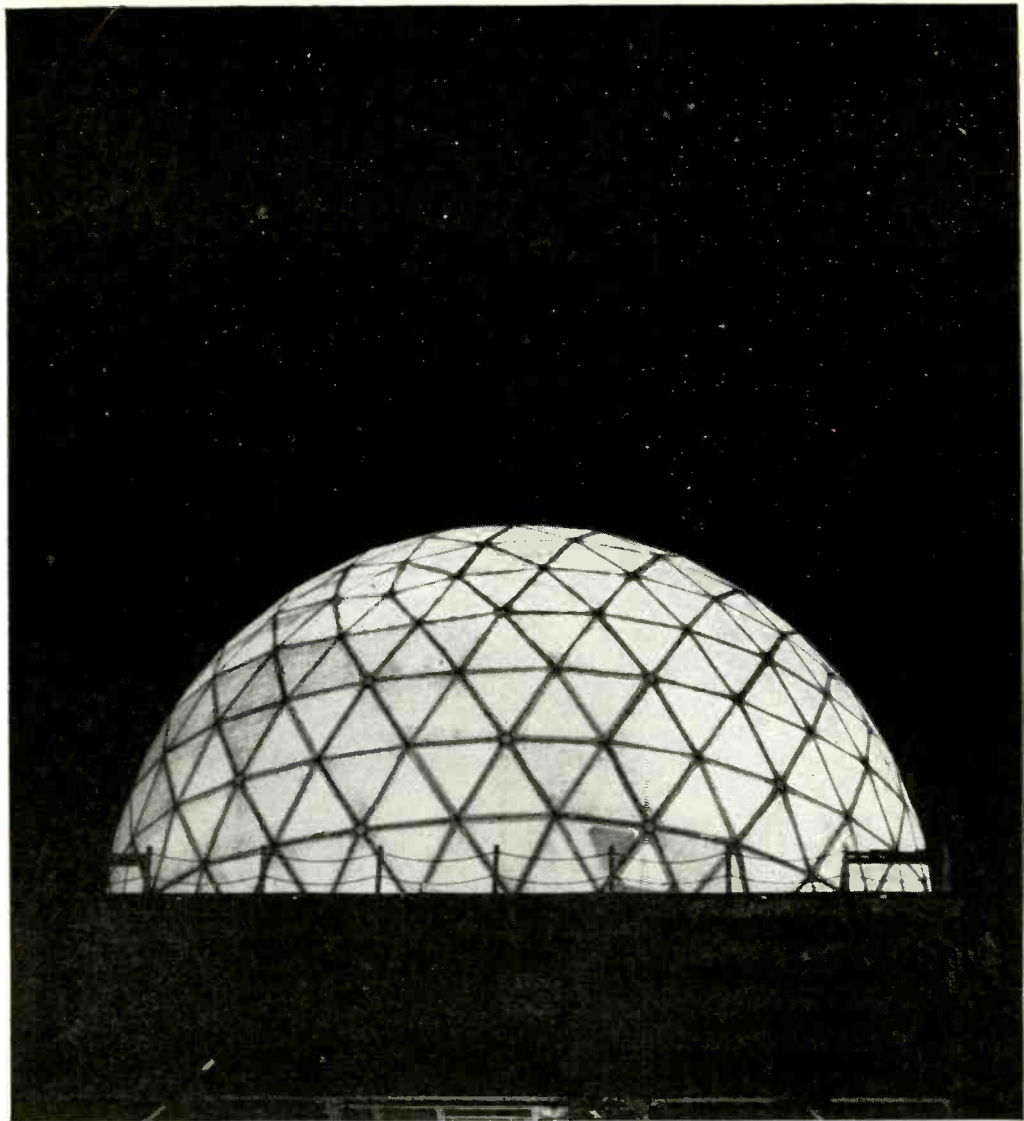

This plastic radome houses a radar antenna constantly scanning the skies to detect the presence of aircraft. A line of these radars provides early warning of any threatening approach to the North American continent.

The Distant Early Warning Line is now on perpetual guard duty. Spanning the Arctic from Baffin Island to Alaska, this great system was conceived at the Lincoln Laboratory of M.I.T. and produced under the leadership of Western Electric.

But first the DEW Line had to be engineered into a workable system. This was done at Bell Telephone Laboratories.

The obstacles were formidable. Conventional means of communication—telephone poles, cables and even line-of-sight microwave radio—weren't feasible. A complicated system had to be made to operate reliably in a climate so cold that outdoor maintenance is impracticable farther than a few hundred feet from heated habitation.

Whenever possible, Bell Laboratories engineers utilized well-proven art. But as it became necessary, they innovated. For example, they designed and directed the development of a new and superior radar which automatically scans the skies, pinpoints a plane and alerts the operator.

To reach around the horizon from one radar station to another, they applied on a massive scale a development which they pioneered—transmission by tropospheric scatter. Result: at a DEW Line Station you can dial directly a station more than a thousand miles away and converse as clearly as with your home telephone.

Bell Laboratories' contribution to the DEW Line demonstrates again how telephone science works for the defense of America.

BELL TELEPHONE LABORATORIES

WORLD CENTER OF COMMUNICATIONS RESEARCH AND DEVELOPMENT



If you have some knowledge of Radio or Television or Electronics now and want to BECOME A PROFESSIONAL SERVICE TECHNICIAN

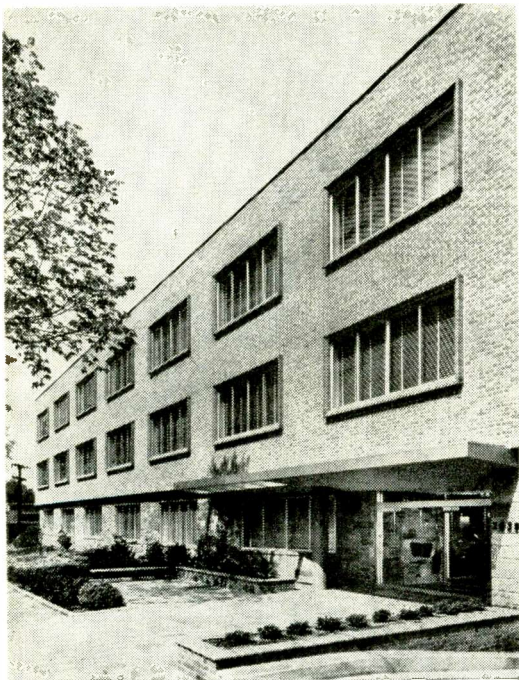

Over 40 years ago, J. E. Smith, founder of the National Radio Institute, pioneered in teaching Radio by the home study method. Today, this magnificent building is completely devoted to NRI's Radio-TV Electronics training. Here up-to-date laboratory and research facilities are constantly testing new developments and improved methods of training men for Radio-TV Electronics careers.

All-Practice Method



NRI's Professional TV Servicing Training is practical, complete. You make tests and experiments to help thoroughly understand TV problems. You get equipment to build a 5" Oscilloscope, a 17" picture tube and all components for building a TV receiver. Comprehensive Color TV manuals also included. You learn how experts diagnose TV defects, get knowledge of professional techniques. Mail the coupon for free catalog now. NATIONAL RADIO INSTITUTE, Washington 16, D. C.

you will want to investigate the special **ALL-PRACTICE TRAINING PLAN** developed for men like you by the **OLDEST AND LARGEST** home study **Radio-Television school**

MAIL THIS TO NRI NOW

National Radio Institute, Dept. 9DFT Washington 16, D.C.

Accredited Member National Home Study Council

Please send me a FREE copy of your catalog "How to Reach the Top in TV Servicing." I understand no salesman will call.

Name.....Age.....

Address.....

City.....Zone.....State.....

(Note: This training is NOT for beginners)

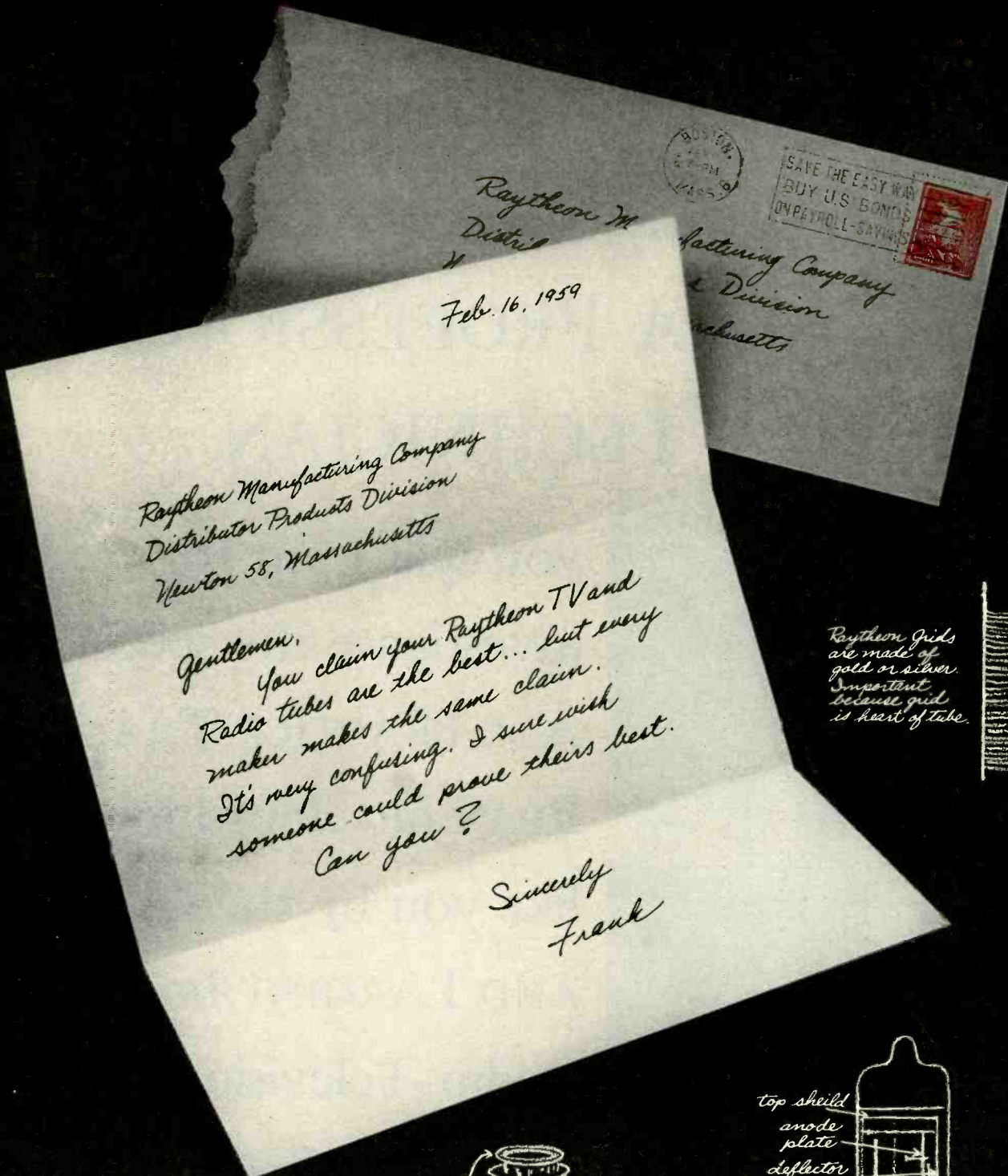

Raytheon grids are made of gold or silver. Important because grid is heart of tube.



Imported getter is circular... holds more powder... creates better vacuum

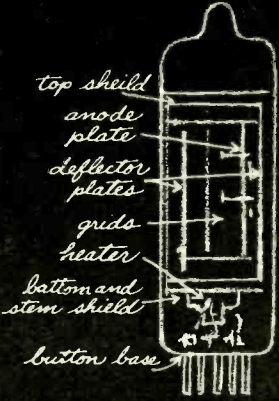

all made by Raytheon



RAYTHEON MANUFACTURING COMPANY

DISTRIBUTOR PRODUCTS DIVISION

55 CHAPEL STREET • NEWTON 58, MASSACHUSETTS • BIGELOW 4-7500

Dear Frank:

How can I prove Raytheon Tubes are superior to all others? A good question and I'm going to try and give you an honest answer!

First, we believe that what we put in Raytheon TV and Radio Tubes . . . and the way we make them . . . are the real reasons why they are best. Pictures of quality control, manufacturing processes, might help convince you, but would they actually prove the end result is a quality product?

You still wouldn't be sure that the Raytheon replacement Tube you put in your customer's set was as good as or better than the original and would outlast it in saving you all those no-charge repeat calls.

To be sure, Frank, we could give you a long list of how we make all our own tube parts—use imported getters, special grids, ceramic insulated multiple fold heaters, and many, many others—but do you really care about these things?

You know, of course, that Raytheon is the world's largest exclusive manufacturer of Electronic Components. Raytheon Tubes and Components which go into 21 of our nation's missiles have to be better than normal. They don't just have to be good!

Honestly, Frank, maybe we can't prove superiority . . . but you can! You and thousands of men like yourself are proving it every day. I would suggest that as long as there is a doubt in your mind, why don't you find out for yourself by using Raytheon Tubes as others have done? I don't know of any other way.

Thanks for your letter . . . let's hear from you again real soon. I know you're going to be convinced.

Sincerely,

RAYTHEON MANUFACTURING COMPANY

Ray Raytheon

P.S. I'll be talking to you again next month.

Excellence in Electronics

a quarter-century of **PRECISION*** know-how

is now yours in



quality electronic equipment in **KIT FORM**

FOR:

electronic hobbyists and amateur radio

hi-fi custom building and service

science education and technical schools

industrial testing and quality control

PACO is the only line of test instrument kits engineered and produced under the auspices of a leading test equipment and meter manufacturer.

and, you pay nothing extra for the convenience of buying PACO kits directly from your own local parts distributor.

COMPARE PACO against any other kits for performance, appearance, ruggedness, ease of operation and simplicity of assembly and wiring.

COMPARE PACO's superbly detailed, step-by-step instruction manuals and giant size wiring diagrams, against any you have ever seen.

SEE HOW PACO sets an entirely new standard in electronic instrument kit design and kit assembly instruction.

► Available and on display at leading electronic parts distributors.

► Write for free descriptive bulletin.

| | |
|---|--|
|  <p>MODEL B-10 Battery Eliminator Kit • less than 0.3% ripple output • no external filters required Kit Net Price:\$41.95 Factory Wired:\$49.50</p> |  <p>MODEL S-55 Wideband 5" Oscilloscope • response DC to 5 Mc • push-pull V and H amplifiers Kit Net Price:\$87.50 Factory Wired:\$139.50</p> |
|  <p>MODEL C-20 Res-Cap-Ratio Bridge Kit • 10 mmfd to 2000 mfd • 1/2 ohm to 200 megs Kit Net Price:\$20.95 Factory Wired:\$31.50</p> |  <p>MODEL T-60 Tube Checker Kit • full free-point lever selector system • built-in roll chart Kit Net Price:\$38.75 Factory Wired:\$54.50</p> |
|  <p>MODEL G-30 RF Signal Generator Kit • 160 Kc to 240 Mc in 8 bands • 120 Mc fundamental output Kit Net Price:\$28.50 Factory Wired:\$39.95</p> |  <p>MODEL T-65 Transistor and Crystal Diode Tester Kit • tests I_{cbo}, gain, leakage, etc. • tests both p-n-p and n-p-n types Kit Net Price:\$39.95 Factory Wired:\$59.50</p> |
|  <p>MODEL M-40 High Sensitivity V-O-M Kit • 20,000 ohms/volt DC • 10,000 ohms/volt AC Kit Net Price:\$31.50 Factory Wired:\$37.50</p> |  <p>MODEL V-70 Vacuum Tube Voltmeter Kit • wide-range • peak-to-peak Kit Net Price:\$31.50 Factory Wired:\$47.50</p> |
|  <p>MODEL S-50 5" Cathode Ray Oscilloscope Kit • push-pull vertical and horizontal amplifiers Kit Net Price:\$49.50 Factory Wired:\$84.50</p> |  <p>MODEL Z-80 RF-AF Signal Tracer Kit • high gain RF and AF amplifier • visual and audible indicator Kit Net Price:\$29.50 Factory Wired:\$42.50</p> |



ELECTRONICS CO., INC.

70-31 84th Street, Glendale 27, L. I., New York
Export: 458 B'way, N. Y. 13, U.S.A., Canada: Atlas Radio Corp., Toronto 19.

*A DIVISION OF **PRECISION APPARATUS COMPANY, INC.**

of the Post Office's first fully mechanized mail processing plant and post office to be built at Providence, R. I. As in many modern mechanized systems electronic equipment plays an important role. Operations of this plant will be supervised from an elevated control center that will have visual and electronic views of all activities. Cancelled letters will be sorted by operators seated at keyboards which control other machines that will sort thousands of letters hourly. The postal station will be built and equipped by Interlex Systems Inc., a subsidiary of ITT. Scheduled completion date is September, 1960.

TALKBACK TV lets the student watching a remote TV receiver ask and answer questions, and hear questions and answers from students in other classrooms. Currently used in Cortland, N. Y., the system was reviewed in a paper by R. C. Norton and J. B. Davidson of the New York Telephone Co., at the recent general meeting of the AIEE in New York.

Regular telephone circuits provide the talkback over a single pair of wires between each classroom and the studio. Two small loudspeakers are placed in each room and one on the teacher's desk. Using, reversible amplifiers, these speakers serve as both mike and receiver.

ONE NEW TV STATION and the return of an old-timer reinforce the nation's networks.

KOKH-TV, Oklahoma City, Okla.....25
WHCT, Hartford, Conn.....18

WHCT came back on the air after an absence of a little over a month.

One station closed down:
KXLJ-TV, Helena, Mont.....12

KIDO-TV, Boise, channel 7, became KTVB in January, and WKTV, Utica, N. Y., switched from channel 13 to channel 2.

Leslie F. Garrett, of Derry, N. H., reminded us of our oversight in omitting WHDH-TV, Boston, Mass., channel 5, from our January master list and also called to our attention that WAST, Albany-Schenectady-Troy, channel 13, was shown incorrectly as WTAS. We thank him for his interest.

The US total is now 549, of which 463 are vhf and 86 uhf. KOKH-TV is educational, therefore the non-commercial total is 37.

ELECTRONICS COURSE via radio, sponsored by the First Army, celebrated its first anniversary with the New Year. Outstanding specialists have given lectures over the First Army MARS SSB Technical Net each Wednesday night. Ham members of MARS follow up the lectures with calls, contributing to a "forum by radio."

Although theoretically limited to a 1,000-mile radius of New York, the net has received letters from as far as the Azores, 2,500 miles distant.

The MARS technical sessions are conducted each Wednesday at 9 pm on 4030-kc upper sideband. **END**

**WE'RE MAKING IT EASIER THAN EVER TO BECOME A WELL PAID
RADIO-TELEVISION SERVICE TECHNICIAN**

**NOW - Just \$6 Starts You Training in
RADIO-TELEVISION
the SPRAYBERRY "Learn-by-Doing" Way . . .**

**25 BIG, COMPLETE KITS
of PARTS & EQUIPMENT**

To help you learn *fast* the practical side of Radio-Television, we send you expertly engineered training kits to test and assemble for interesting, valuable shop-bench practice!

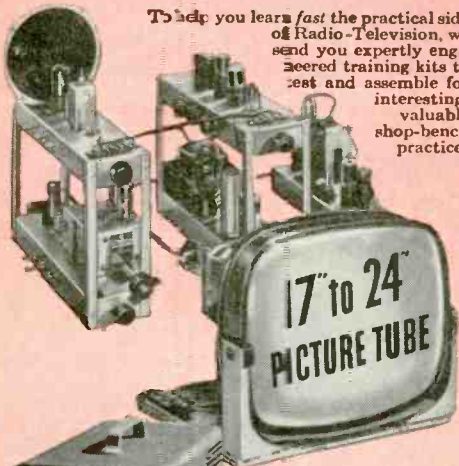

• The new Sprayberry Training Television Receiver, built and tested in 5 sections.

• Now offered . . . this fine modern oscilloscope.

• You build this powerful two-band superheterodyne radio receiver.



**Big New
CATALOG
AND
Sample Lesson
FREE!**

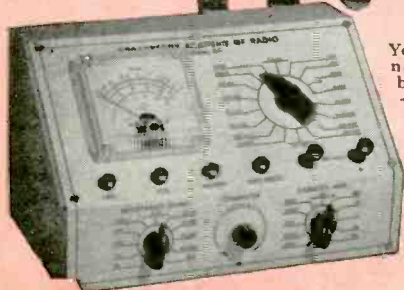

You build the new Sprayberry tester—a complete 18-range Volt-Ohm-Milliammeter test meter.

★ ★ ★ ★ This great industry is begging for trained men . . . to step into good paying jobs or a profitable business of their own! Our new plan opens the doors of Radio-Television wide to every ambitious man who is ready to act at once!

Men by the thousands . . . trained Radio-Television Service Technicians . . . are needed at once! Perhaps you've thought about entering this interesting, top paying field, but lack of ready money held you back. Now—*just \$6 enrolls you* for America's finest, most up to date home study training in Radio-Television! Unbelievable? No, the explanation is simple! We believe Radio-Television *must* have the additional men it needs as quickly as possible. We are willing to do our part by making Sprayberry Training available for less money down and on easier terms than ever before. This is your big opportunity to get the training you need . . . to step into a fine job or your own Radio-Television Service Business.

Complete Facts Free—Act Now; Offer Limited

Only a limited number of students may be accepted on this liberal and unusual basis. We urge you to act at once . . . mail the coupon below and get complete details plus our big new catalog and an actual sample lesson—all free. No obligation . . . no salesman will bother you.

HOME STUDY TRAINING IN SPARE TIME

Under world-famous 27-year old Sprayberry Plan, you learn entirely at home in spare time. You keep on with your present job and income. You train as fast or as slowly as you wish. You get valuable kits of parts and equipment for priceless shop-bench practice. And everything you receive, lessons and equipment alike, is all yours to keep.

LET US PROVE HOW EASILY YOU CAN LEARN!

Radio-Television needs YOU! And Sprayberry is ready to train you on better, easier terms, that any ambitious man can afford. *Just \$6 starts you!* Mail coupon today . . . let the facts speak for themselves. You have everything to gain. Let us prove the kind of opportunity that's in store for you!

SPRAYBERRY Academy of Radio-Television
1512 Jarvis Avenue, Dept. 20-T, Chicago 26, Illinois

Mail This Coupon Now—No Salesman Will Call

Sprayberry Academy of Radio-Television
Dept. 20-T, 1512 W. Jarvis Ave., Chicago 26, Ill.

Please rush all information on your ALL-NEW Radio-Television Training Plan. I understand this does not obligate me and that no salesman will call upon me. Include New Catalog and Sample Lesson FREE.

NAME..... Age.....

ADDRESS.....

CITY..... ZONE..... STATE.....

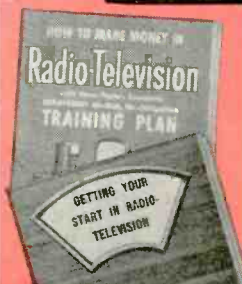

OUT OF THIS WORLD PERFORMANCE...

with RMC Discap[®] Ceramic Capacitors

The same dependability that prompted the selection of RMC Discaps for the power supply of the Explorer IV satellite can now be yours for use in servicing TV and radio sets. These quality ceramic capacitors, favorite of original equipment manufacturers, will help cut time-consuming callbacks, and at the same time, brighten your profit picture.

RMC Discaps are available from your distributor in a handy 5-pack that prevents tangling of leads, and stores as easily as a file card.

© Trademark of Radio Materials Company, a division of P. R. Mallory & Co. Inc.



Another veteran of outer space—Mallory Mercury batteries. They've gone up with every U.S. satellite. In satellites or transistor radios, they can't be beat for long, fade-free life.



FP Capacitors—the original 85°C filter with the hum preventing etched cathode.



Gem Capacitors—tops in moisture proof design for buffer, by-pass or coupling.



Gold Label[®] Vibrators—unequaled performance and life... the quietest vibrator ever.
*Trademark

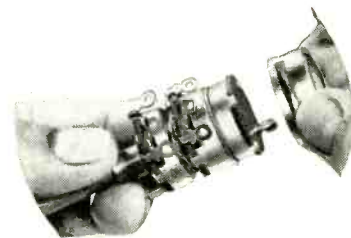

Sta-Loc Controls—design allows your distributor to custom-assemble in just 30 seconds, any of over 38,000 combinations.

P. R. MALLORY & CO. Inc.
MALLORY

P. R. MALLORY & CO. Inc., INDIANAPOLIS 6, INDIANA



LET RCA TRAIN YOU IN ELECTRONICS

RCA Institutes celebrates Fifty Years of Electronic Training by introducing its newest Home Study Course . . .

ELECTRONICS FOR AUTOMATION

. . . Now you have *four* comprehensive courses for your electronic training . . . from basic electronic theory to the more advanced principles of color TV and Automation.

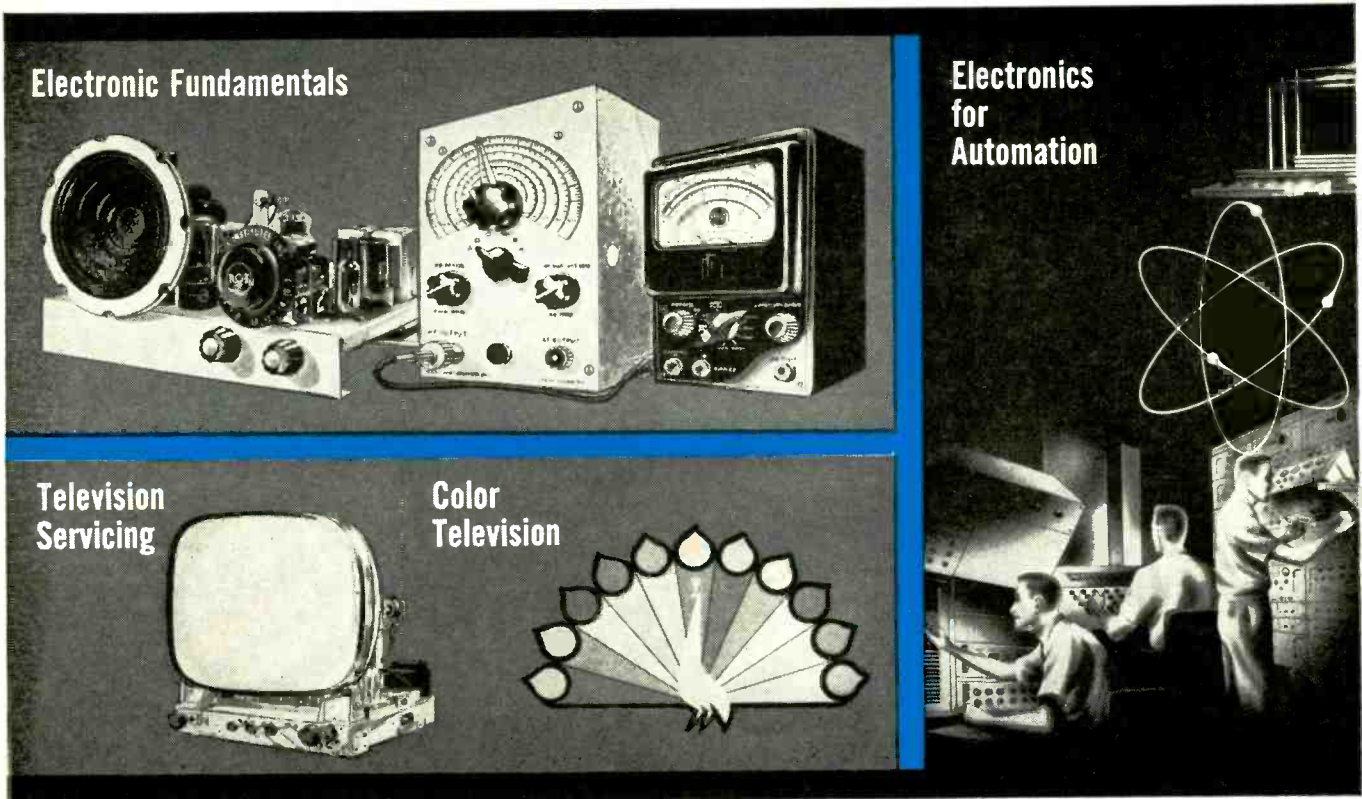

Send for our 64 page Home Study Catalog

FREE!

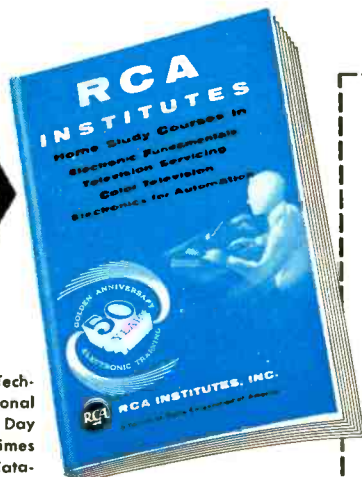

RESIDENT SCHOOL offers Technical Institute and Vocational School Courses in Electronics. Day and Evening classes start 4 times each year. Resident School Catalog sent free on request.

Practical work with the very first lesson. Pay-as-you-learn. You need pay for only one study group at a time.

RCA INSTITUTES, Inc. Home Study School, Dept. RE-49

A Service of Radio Corporation of America
350 West Fourth Street, New York 14, N. Y.

Without obligation, send me the FREE catalog of Home Study Courses. No salesman will call.

Name
Please print

Address

City Zone State

Korean Vets! Enter Discharge Date

CANADIANS — Take advantage of these same RCA courses at no additional cost. No postage, no customs, no delay. Send coupon to: RCA Victor Company, Ltd., 5001 Cote de Liesse Rd., Montreal 9, Quebec
To save time, poste coupon on postcard.

**ONLY
UNIVERSITY
MAKES
28
DIFFERENT PUBLIC
ADDRESS SPEAKERS
5
DIFFERENT PUBLIC
ADDRESS DRIVERS**

ONLY WITH  CAN YOU GET...

THE SPECIFIC SPEAKER YOU NEED—no “all-purpose” compromises, but the right speaker for the right job—paging, explosion-proof, super-power, etc.—with several models in each class.

THE RIGHT POWER YOU NEED—from 5 watts to 600 watts. *Not* more than you need, *not* less than you need.

THE SOUND DISPERSION YOU NEED—deep or shallow penetration, narrow or wide, 360° horizontal... only with University can you put the sound where you want it.

THE FREQUENCY RESPONSE YOU NEED—your choice of high and low cut-offs as required—whether to cut

through extreme noise levels, or for true high fidelity music reproduction.

THE ECONOMY YOU NEED—lowest initial costs for planning and installation, lowest running costs, lowest repair and service costs.

... and only with University can you get the quality you need... every University speaker boasts exclusive design features, the finest of materials, exacting standards in construction and must pass rigid performance tests. All these are your assurance that University will do the job better, longer, and at lowest possible cost.

... THAT'S WHY UNIVERSITY IS THE UNIVERSALLY ACCEPTED NAME IN THE ENTIRE FIELD OF SOUNDCASTING

How you can choose the right speaker for the specific application...



Invest \$1 for the invaluable 64-page UNIVERSITY TECHNOLOG, the authoritative reference book for planning P.A. speaker systems

Only book of its kind... packed with the solid factual data you need to save time and money. Covers in detail: how to select the proper driver for the specific job, directional vs. wide-angle horns, best use of radial trumpets, high fidelity in P.A., coping with reverberation, methods of overload protection, etc. Includes specs, charts, diagrams, and the *exclusive* SOUND SYSTEM DESIGN CHART—effective guide for planning typical installations. Send \$1.00 to Desk J-10, University Loudspeakers, Inc., 80 So. Kensico Ave., White Plains, New York.

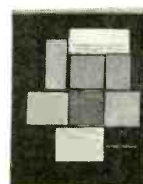

Send for FREE copy of Product Catalog

Contains information and specifications on all University public address speakers... directional, radial, wide-angle, paging and talk-back, submergence-proof, high fidelity weatherproof, super-power, explosion-proof, portable soundcasting, etc. Also, high fidelity cone speakers, enclosures and speaker systems suited for commercial installations.

Use Delco Radio Service Parts!

8-inch "Hi-Fi" speaker, No. 8007 offers the most highs, the most lows, the most watts in a medium-price speaker. Designed for replacement use and high fidelity audio systems.

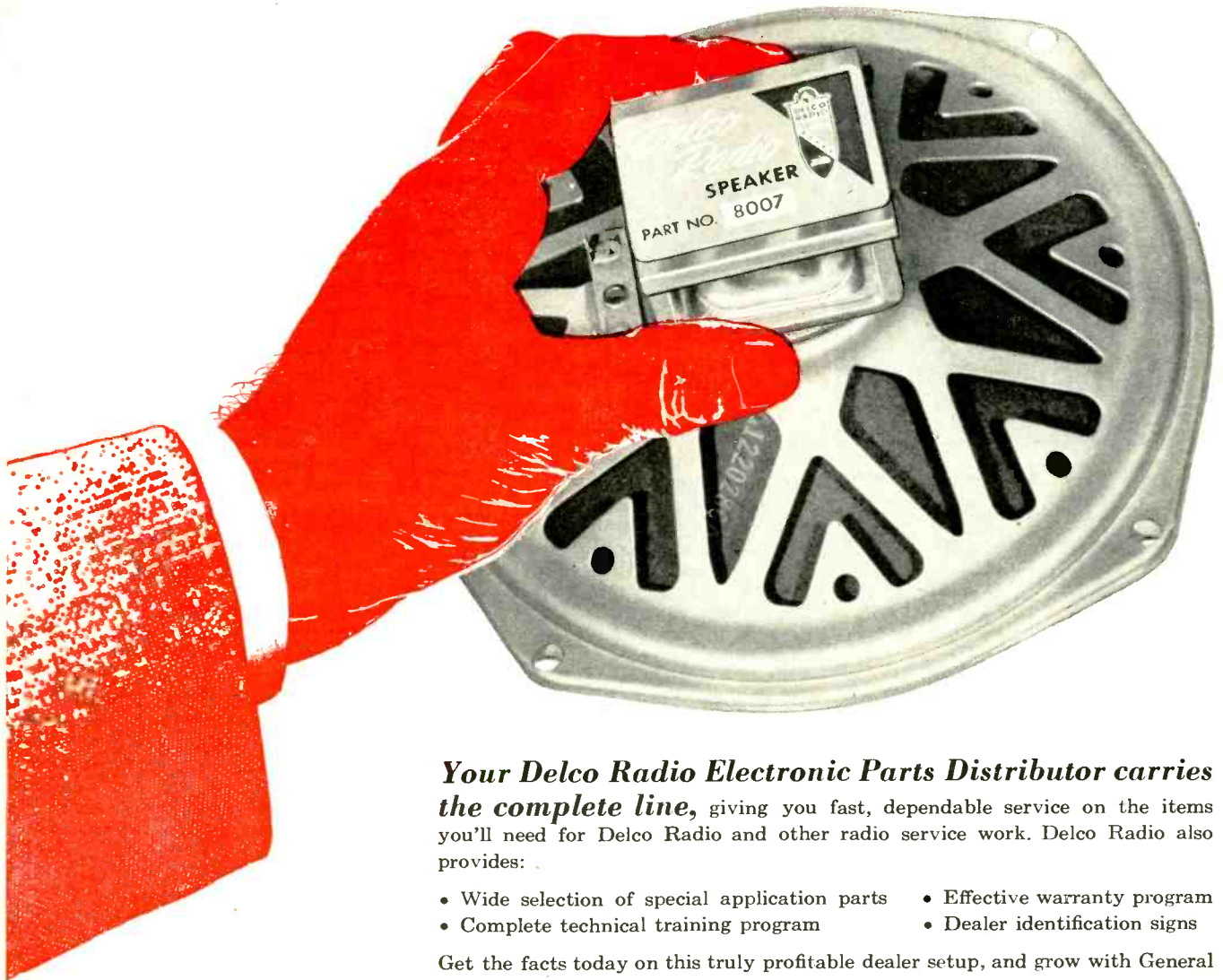

Your Delco Radio Electronic Parts Distributor carries the complete line, giving you fast, dependable service on the items you'll need for Delco Radio and other radio service work. Delco Radio also provides:

- Wide selection of special application parts
- Complete technical training program
- Effective warranty program
- Dealer identification signs







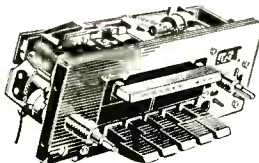

Get the facts today on this truly profitable dealer setup, and grow with General Motors!

Available everywhere through Electronic Distributors associated with . . .



DELCO RADIO

DIVISION OF GENERAL MOTORS, KOKOMO, INDIANA

| | | | |
|---|--|--|--|
|  <p>TRANSISTORS</p> |  <p>TUNER PARTS</p> |  <p>TUBES</p> |  <p>IRON CORES</p> |
| |  <p>TRANSFORMERS</p> |  <p>COILS</p> |  <p>RESISTORS</p> |
| | |  <p>VIBRATORS</p> |  <p>CAPACITORS</p> |
| | | |  <p>CONTROLS</p> |

Tung-Sol audio tubes
now twin-packed
in matched pairs
by the manufacturer

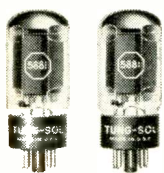
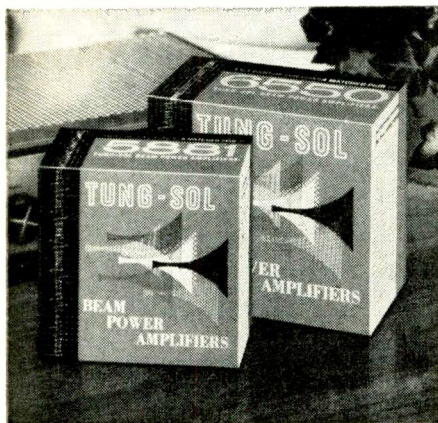

5881 For service in amplifiers of up to 50 watts.

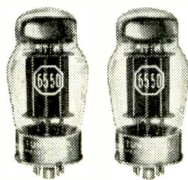

6550 For service in amplifiers and commercial audio equipment of up to 100 watts.

NOW you can come as close to faultless sound reproduction as the design and circuitry of your hi-fi equipment will permit. Tung-Sol 5881 and 6550 beam-power amplifier tubes are factory-matched to very tight performance limits and twin-packed to help you achieve lowest distortion levels at all volume levels.

Use of Tung-Sol 5881 and 6550 tubes has long been associated with amplifiers of the very finest design. These tubes have always been produced to closest possible tolerances with cathode current ranges held to an absolute minimum.

Now, in twin-packed pairs, they assure the hi-fi enthusiast and the commercial sound engineer of replacement tubes that will provide new standards of performance—a feature of special importance with the newest amplifiers and loudspeakers, particularly binaural sound equipment. See your parts supplier.

Tung-Sol Electric Inc., Newark 4, New Jersey.

TUNG-SOL®

Correspondence



INTERFERENCE-PRONE SETS

Dear Editor:

The letter "TVI and the Law" in your September 1958, issue omits a rather important consideration. The writer, Mr. Dagion, fails to mention that interference as it finally shows up on the picture tube or in the loudspeaker is *due* to, not caused by, two different things.

First, there is the fact that some machines actually emit spurious radiation. This sort of thing is controlled by rules of the FCC which require proper shielding to eliminate *illegal* emission. Recent rulings have required manufacturers to hold down local oscillator emission by shielding or filtering in radio and TV sets and other devices which may emit radiation. Most manufacturers are glad to go along with this sort of treatment because they have to keep peace with their customers.

But the most frequent problem is lack of discrimination in the receiving equipment—both TV and radio. In an effort to get a sharper picture, more brilliant sound—and perhaps most important, to cut production costs—manufacturers use broad-band circuits which will not discriminate between the desired signal and the unwanted one beyond a given point. "Funnel" type front ends which seemingly reach out for unwanted interference have been a considerable problem to those owning industrial, commercial or amateur gear when the fault lies with the design techniques of the manufacturer of the receiving equipment.

This has been recognized by most leading TV manufacturers, who supply, through their distributors, filters to eliminate this trouble, usually at no cost to the service technician or customer. Such filters are not installed at the time of manufacture since the percentage of these interference cases is so low that it would become an unnecessary production expense if incorporated in all sets. It has become standard procedure to supply filters only when required.

The primary misunderstanding is blaming the equipment producing the interference rather than the nonselective receiving equipment. In practically every case, owners of electronic equipment are most anxious to clean their own houses and avoid offending the public but are unable to do the whole job because of design deficiencies in receiving equipment.

After dealing with this difficulty a good many times, I am convinced that

the dealer who sells the receiver owes the purchaser an explanation of the problem. Though some may not be aware of this situation, most dealers are and they are doing a distinct disservice to the electronics business and the service profession by not explaining it to the customers who are troubled. There is no excuse for trying to place the blame on an equipment user when it belongs on the set manufacturer.

BOB FORMAN

Forman Co., Monmouth, Ill.

(The problem of TV and radio interference will be treated in detail in a forthcoming issue.—Editor)

ANOTHER SA5-M REPLACEMENT

Dear Editor:

The SA5-M used by Ted Ladd in a light meter (page 123, December, 1958) and Rufus P. Turner in a light-powered frequency standard (page 58, February 1959) has been dropped from our standard products line. However, this cell can be replaced by a newer type unit that operates at a higher efficiency. It is the type S-1020B (unmounted) or the SD-1020B (mounted). Two of these cells connected in parallel replace the SA5-M.

HARRY NASH

Chief Application Engineer
 International Rectifier Corp.

REFLEX CORRECTION

Dear Editor:

Something unfortunate seems to have happened at a vital spot to my article ("All About the Reflex Enclosure," Part I, February, 1959).

The diagram on page 39 with its three sine curves each a quarter cycle later than the previous one is correct. The error is in the explanation on page 40, column one.

The wording refers to port air velocity and states: "It also increases between E and G." *That is wrong.* The two sentences there should read: "It increases between D and F. The air moving through the port (Fig. I-2-c) moves forward between E and G."

As additional explanation I would say that port air velocity increases (in a forward direction) during the whole time of forward acceleration—from D to F and not E to G. Maximum velocity is therefore reached at F, 90° later than maximum acceleration. The air particle displacement at the port passes through its mid-point at F and reaches maximum forward displacement at G. It is thus at its maximum 180° after maximum rearward motion of the cone (E). By then the cone is fully forward

ownership of a **PHOTOFACT** SERVICE DATA LIBRARY SPELLS SUCCESS FOR SERVICE TECHNICIANS

here's actual proof from the men who know

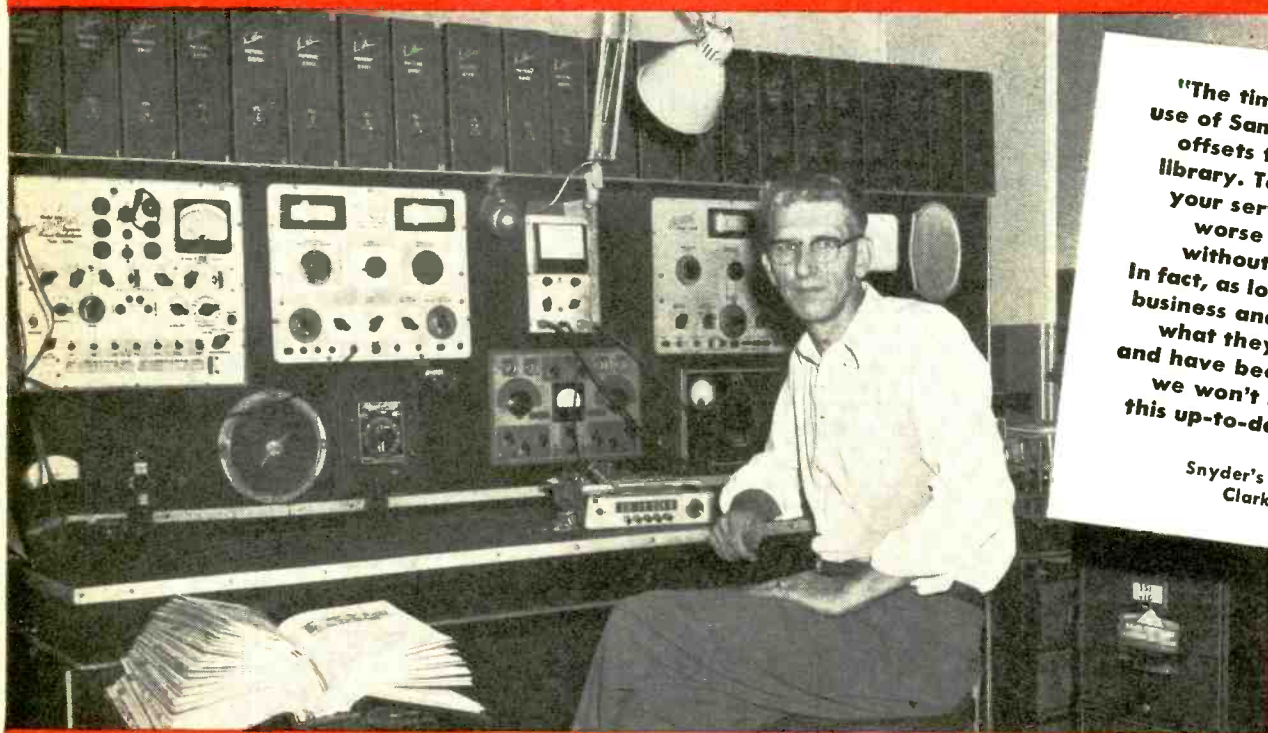

"The time saved by the use of Sams more than offsets the cost of the library. To do without your service would be worse than operating without a V.T.V.M. In fact, as long as we are in business and Sams remain what they are today and have been in the past, we won't be without this up-to-date service."

—Frank Snyder,
Snyder's Sales & Service,
Clarksburg, West Va.

HERE'S MORE PROOF...FROM COAST-TO-COAST

ARIZONA

"I would not take anything for my valuable collection of Sams PHOTOFACT."

—Charles S. Cook,
Winslow, Arizona

IDAHO

"My PHOTOFACT library is an indispensable source of service information on the...TV sets serviced in our shop. Without this information, the time required to complete many repair jobs would be prohibitive."

—Richard Huntley,
Craigmont, Idaho

WISCONSIN

"With the PHOTOFACT file to back us, we have complete confidence that we can handle any service problem brought to the shop."

—Howard R. Olds,
Darlington, Wis.

TEXAS

"I don't see how anyone can run a shop without a set of PHOTOFACT. I would be lost without mine. They are a must on any bench job. You can do a faster job with the information in PHOTOFACT."

—T. A. Hopkins,
Quannah, Texas

OHIO

"PHOTOFACT speeds up my service on repairs and the file cabinets help dress up the shop."

—Ed Rahm, Toledo, Ohio

MASSACHUSETTS

"PHOTOFACT has been one of the mainstays in my service business. The PHOTOFACT library has cut my service time well in half and has more than paid for itself already. In the best words—PHOTOFACT kept my new business in the black."

—Benjamin L. Hall,
Edgarton, Mass.

PENNSYLVANIA

"They are just great. Cuts service time to a minimum."

—Virgil Franceschini,
Barnesboro, Pa.

These are just a few of the hundreds of "Success with PHOTOFACT" letters in our files. Service Technicians everywhere are enjoying the profit-making advantages of a

complete PHOTOFACT Library. If you're not among them, see your Sams Distributor today, or write direct to Howard W. Sams for full details. Use coupon below.

NEW EASY-BUY PLAN! It's the money-saving way to build your complete profit-making PHOTOFACT Library! NO INTEREST—NO CARRYING CHARGE—AS LITTLE AS \$10 DOWN

FREE! Valuable steel file cabinets for PHOTOFACT monthly subscribers and Library purchasers.



Valuable booklet shows you how PHOTOFACT boosts your profit-capacity.

FREE!

Send for it!



HOWARD W. SAMS & CO., INC.

2205 E. 46th St., Indianapolis 6, Ind.

- Send me Free booklet "Your Guide To Maximum Profits"
 I'm a Service Technician: full-time; part-time

My Distributor is: _____

Shop Name _____

Attn. _____

Address _____

City _____ Zone _____ State _____



whether your plans are modest
or unlimited...

you can
build
your ideal
stereo system
with the
finest
loudspeakers...



Compact, proportioned for bookshelf or table top, JBL Bel-Aires—a pair with components in mirror-image arrangement—will give you the clean, exquisitely detailed stereo reproduction that can only be achieved with transducers of the highest precision.



Now JBL enclosures are matched for stereo. If you own a JBL C34, C35, C37, C39, or C40, you can add a matching enclosure with speaker units arranged in a pattern that is a mirror image of your present system.



The JBL Ranger-Paragon is the ultimate stereo speaker system. Developed as a master monitor for use in perfecting stereo recording techniques, the Paragon adds to twin folded horns and professional driver units a radial refraction panel which integrates the two sound sources and disperses true stereo throughout the room.

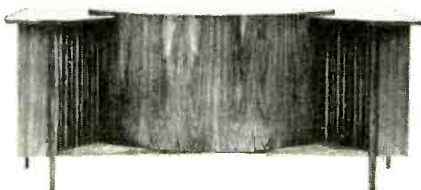

The JBL Ranger-Metregon incorporates the virtues of radial refraction in an enclosure of acceptable size for the average living room. No hole in the middle, no split soloists, but sound reproduction spatially proportional to its original source. The Metregon accepts seven different speaker system combinations; can be upgraded progressively.

Write for free catalog and data sheets.

JAMES B. LANSING SOUND, INC.
3249 casitas avenue, los angeles 39, california

CORRESPONDENCE (Continued)

again and so the port air displacement synchronizes with the motion of the front of the cone. Relative to the inward cone motion which compressed the air cushion in the first place, port motion is reversed in phase.

In connection with Fig. I-3, it should be made clear that the left side illustrates "what one might expect" (and actually happens at very low frequencies), but does NOT happen when reflexing. The right side of that figure illustrates conditions when reflexing.

Toronto, Canada P. G. A. H. VOIGT

KNOCKS PRINTED CIRCUITS

Dear Editor:

I think it is about time we got a report out concerning the printed circuits radio and television manufacturers have been using.

We get about two printed-circuit sets to every wired set. The trouble is usually twice as difficult to trace. Parts replacement is also twice as difficult because of the heat-sensitive copper foil and multiple-terminal components. We usually run into twice as many tough dogs and find twice the number of failures per year on printed circuit sets than on wired sets. The failures result from leakage between foil wiring or component breakdown due to the compactness of portables and lack of sufficient ventilation. Usually twice the time is spent in troubleshooting printed circuits. Therefore, printed circuits are a loss to technicians. I still prefer wired sets. I have asked the opinion of many of the technicians in my area—they agree.

BRIAN CHIN

New York, N. Y.

RUMBLE'S RUMBLE

Dear Editor:

In the Try This One column in the January, 1959, issue (page 136), Mr. C. E. Cohn recommends disconnecting the plate-load resistor of the first audio stage from B plus and connecting it to the plate of the output tube as a method of applying inverse feedback. However, the item failed to point out that you only get inverse feedback if there are an even number of stages in the amplifier. If there are an odd number of stages, positive feedback occurs and the amplifier oscillates. ROBERT RUMBLE
San Luis Obispo, Calif.

SWEET MUSIC

Dear Editor:

I feel like someone who has been given a map with indications for finding buried treasure. For composers, your "Micromusic" (editorial in the March 1959 issue) is the open sesame to a cave of infinite sound and I, for one, am infinitely grateful.

Your article also calls to mind these warning words of Einstein's: "Our actual situation cannot be compared with anything in the past. We must radically change our ways of thinking, our method of action."

My thanks for "Micromusic."
New York, N. Y. EDGARD VARESE

END

SAVE $\frac{1}{2}$ THE TIME

Make Twice The Profit!

in TV
Trouble-Shooting

**THIS EASY
SIGNAL INJECTION
POINT-TO-POINT
DIRECT VIEWING
WAY**

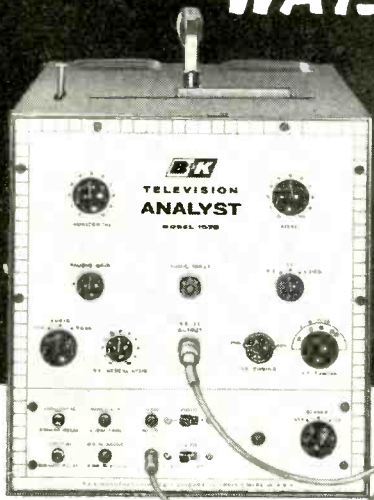

MODEL 1075



TELEVISION ANALYST

New Technique Makes TV Servicing Easier, Faster, More Profitable

Thousands of service technicians already save thousands of hours every day with the amazing B&K TELEVISION ANALYST. Enables you to inject your own TV signal at any point and watch the resulting test pattern on the picture tube itself. Makes it quick and easy to isolate, pin-point, and correct TV trouble in any stage throughout the video, audio, r.f., i.f., sync, and sweep sections of black & white and color television sets—including *intermittents*. Makes external scope or wave-form interpretation unnecessary. Enables any serviceman to cut servicing time in half, service more TV sets in less time, really satisfy more customers, and make more money. Color generator provides both rainbow pattern and color bars..

MODEL 1075 TELEVISION ANALYST. Complete with standard test pattern, white dot, white line, and color-bar slide transparencies, and one clear acetate. Net, **\$25995**

See your B&K Distributor or Write for Bulletin ST21-E

B&K MANUFACTURING CO.
3726 N. Southport Ave. • Chicago 13, Illinois
Canada: Atlas Radio Corp., 50 Wingold, Toronto 10, Ont.
Export: Empire Exporters, 458 Broadway, New York 13, U.S.A.

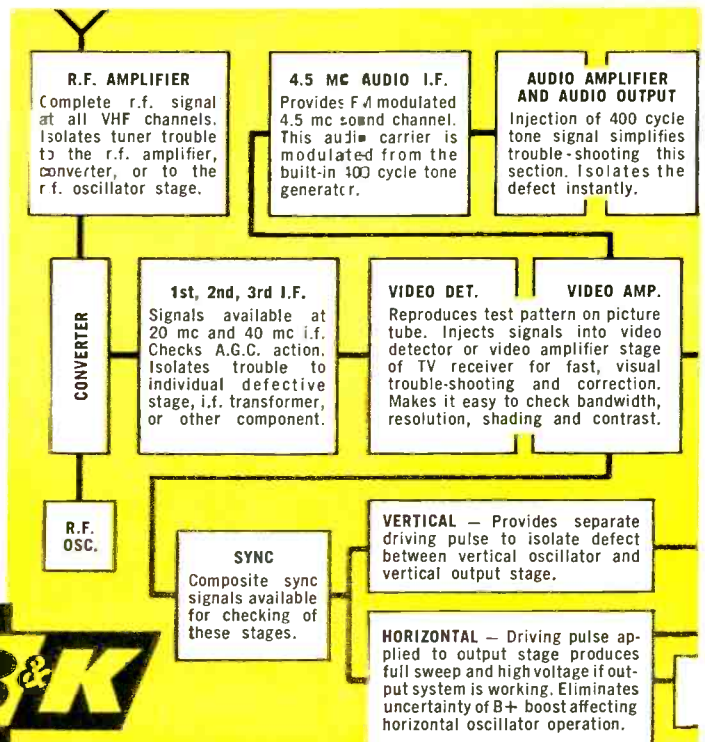

designed by and for the technician

**NEW
1959
EDITION
\$1.85**



This new Handbook was designed especially for the technician. Planned for on-the-job use, it is compact, handy, rugged . . . lies flat when open. Its modern styling permits quick, easy reference. And, of course, it is up-to-the-minute, complete in one volume . . . with data for receiving, special and picture tubes as well as semiconductors. Get your copy today from your CBS-Hytron distributor.

Reliable products through Advanced-Engineering

CHECK THESE FEATURES

- 550 pages
- 1050 receiving tubes
- 390 TV picture tubes
- 270 special-purpose tubes and semiconductors
- Comprehensive data, popular types
- Reference data, seldom-used types
- Appendix especially for technicians

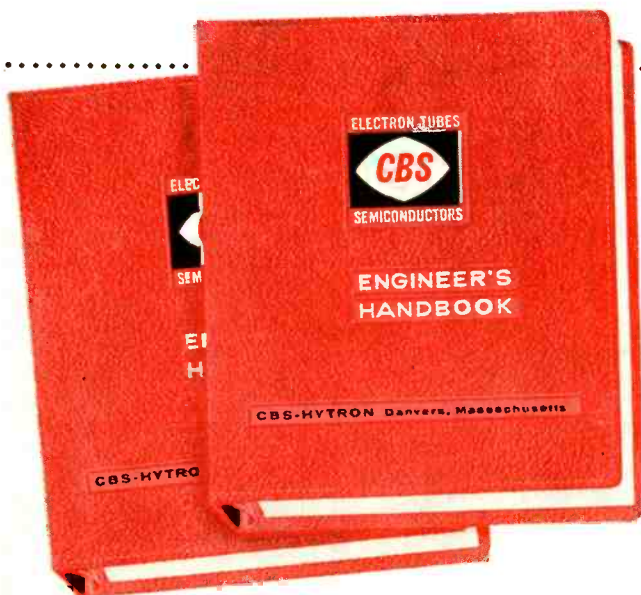

Engineer's Handbook

NOW TWO VOLUMES \$10.00

Additional hard-cover binders:

\$3.00 for 1, \$5.50 for 2.

This modern Handbook has expanded into two volumes. It includes receiving, special and picture tubes and semiconductors. Features are: Complete EIA engineering design data on current tubes • tabulated quick-reference data for seldom-used types • 375 two-color design curves • over 700 pages, two colors • handy 8¼ by 9½ inches • sturdy hard covers • 16-ring metal binders • appendix • supplement service available. Order direct.

CBS-HYTRON, Danvers, Massachusetts
A Division of Columbia Broadcasting System, Inc.

**STEREO
STEREO
AND
MONAURAL**

the
experts
say...
in HI-FI
the best buys are

EICO[®]

World-famous
EICO advantages
guarantee your complete satisfaction:

- Advanced engineering • Finest quality components
- "Beginner-Tested," easy step-by-step instructions
- LIFETIME service & calibration guarantee
- IN STOCK — Compare, then take home any EICO equipment—right "off the shelf"—from 1900 neighborhood EICO dealers.



Stereo Preamplifier HF85



Stereo
Amplifier-Preamp
HF81



Monaural Integrated Amplifiers:
50, 30, 20, and 12-Watt
(use 2 for Stereo)



Monaural Power Amplifiers:
60, 50, 35, 30, 22 and 14-Watt
(use 2 for Stereo)
Stereo Power Amplifier HF86



FM Tuner HFT90
AM Tuner HFT94



Bookshelf
Speaker System
HFS1



Omni-directional
Speaker System HFS2
36" H x 15 1/4" W x 11 1/2" D



Monaural Preamplifiers:
HF65, HF65A
(stack 2 for Stereo)



Over 1 MILLION EICO instruments in use throughout the world.

NEW STEREOPHONIC EQUIPMENT

HF85: Stereo Dual Preamplifier is a complete stereo control system in "low silhouette" design adaptable to any type of installation. Selects, preamplifies, controls any stereo source—tape, discs, broadcasts. Superb variable crossover, feedback tone controls driven by feedback amplifier pairs in each channel. Distortion borders on unmeasurable even at high output levels. Separate level input in each channel for mag. phono, tape head, mike. Separate hi-level inputs for AM & FM tuners & FM Multiplex. One each auxiliary A & B input in each channel. Independent level, bass & treble controls in each channel may be operated together with built-in clutch. Switched-in loudness compensator. Function Selector permits hearing each stereo channel individually, and reversing them; also use of unit for stereo or monophonic play. Full-wave rectifier tube power supply. 5-12AX7/ECC83, 1-6X4. Works with any high-quality stereo power amplifier such as EICO HF86, or any 2 high-quality mono power amplifiers such as EICO HF14, HF22, HF30, HF35, HF50, HF60. "Extreme flexibility . . . a bargain" — HI-FI REVIEW. Kit \$39.95. Wired \$64.95. Includes cover.

HF86: Stereo Dual Power Amplifier for use with HF85 above or any good self-powered stereo preamp. Identical Williamson-type push-pull EL84 power amplifiers, conservatively rated at 14W, may be operated in parallel to deliver 28W for non-stereo use. Either input can be made common for both amplifiers by Service Selector switch. Voltage amplifier & split-load phase inverter circuitry feature EICO-developed 12DW7 audio tube for significantly better performance. Kit \$43.95. Wired \$74.95.

HF81: Stereo Dual Amplifier-Preamplifier selects, amplifies & controls any stereo source — tape, discs, broadcasts—& feeds it thru self-contained dual 14W amplifiers to a pair of speakers. Monophonically: 28 watts for your speakers; complete stereo preamp. Ganged level controls, separate focus (balance) control, independent full-range bass & treble controls for each channel. Identical Williamson-type, push-pull EL84 power amplifiers, excellent output transformers. "Service Selector" switch permits one preamp-control section to drive the internal power amplifiers while other preamp-control section is left free to drive your existing external amplifier. "Excellent" — SATURDAY REVIEW: HI-FI MUSIC AT HOME. "Outstanding quality . . . extremely versatile" — RADIO & TV NEWS LAB-TESTED. Kit \$69.95. Wired \$109.95. Includes cover.

MONO PREAMPLIFIERS (stack 2 for Stereo) HF-65: superb new design. Inputs for tape head, microphone, mag- phono cartridge & hi-level sources. IM distortion 0.04% @ 2V out. Attractive "low silhouette" design. HF65A Kit \$29.95. Wired \$44.95. HF65 (with power supply) Kit \$33.95. Wired \$49.95.

MONO POWER AMPLIFIERS
(use 2 for STEREO)

HF60 (60W), HF50 (50W), HF35 (35W), HF30 (30W), HF22 (22W), HF14 (14W): from Kit \$23.50. Wired \$41.50.

MONO INTEGRATED AMPLIFIERS
(use 2 for STEREO)

HF52 (50W), HF32 (30W), HF20 (20W), HF12 (12W): from Kit \$34.95. Wired \$57.95.

SPEAKER SYSTEMS (use 2 for STEREO)

HF52: Natural bass 30-200 cps via slot-loaded 12-ft. split conical bass horn. Middles & lower highs: front radiation from 8 1/2" edge-damped cone. Distortionless spike-shaped super-tweeter radiates omni-directionally. Flat 45-20,000 cps, useful 30-40,000 cps. 16 ohms. HWD 36", 15 1/4", 11 1/2". "Eminently musical"—Holt, HIGH FIDELITY. "Fine for stereo"—MODERN HI-FI. Completely factory-built: Mahogany or Walnut, \$139.95; Blonde, \$144.95.

HF51: Bookshelf Speaker System, complete with factory-built cabinet. Jensen 8" woofer, matching Jensen compression-driver exponential horn tweeter. Smooth clean bass; crisp extended highs. 70-12,000 cps range. Capacity 25 w. 8 ohms. HWD: 11" x 23" x 9". Wiring time 15 min. Price \$39.95.

FM TUNER HFT90: Surpasses wired tuners up to 3X its cost. For the first time, makes practical even for the novice the building of an FM tuner kit equal to really good factory-wired units. No alignment instruments needed. Pre-wired, pre-aligned temperature-compensated "front end" is drift-free — eliminates need for AFC. Precision "eye-tronic" DM-70 traveling tuning indicator, supplied pre-wired, contracts at exact center of each FM channel. Pre-aligned IF coils. Sensitivity 6X that of other kit tuners: 1.5 uv for 20 db quieting, 2.5 uv for 30 db quieting, full limiting from 25 uv. IF bandwidth 260 kc at 6 db points. Frequency response uniform 20-20,000 cps ± 1 db. Cathode-follower & Multiplex outputs. Flywheel tuning, automatic gain control, stabilized low limiting threshold for excellent performance from weaker signals, broad-band ratio detector for improved capture ratio & easier tuning, full-wave rectifier & heavy filtering, very low distortion. "One of the best buys you can get in high fidelity kits"—AUDIOCRAFT Kit Report. Kit \$39.95*. Wired \$65.95*. Cover \$3.95. *Less Cover, F.E.T. incl.

NEW AM TUNER HFT94: Matches HFT90. Selects "hi-fi" wide (20c — 9kc @ —3 db) or weak-station narrow (20c — 5kc @ —3 db) bandpass. Tuned RF stage for high selectivity & sensitivity; precision "eye-tronic" tuning. Built-in ferrite loop, prealigned RF & IF coils. Sensitivity 3 uv @ 30% mod. for 1.0 V out, 20 db S/N. Very low noise & distortion. High-Q 10 kc whistle filter. Kit \$39.95. Wired \$69.95, incl. Cover & F.E.T.

BEFORE YOU BUY, COMPARE:

You may examine the complete EICO line at any of 1900 neighborhood EICO distributors coast to coast. Compare critically with equipment several times the EICO cost—then you judge. You'll see why the experts recommend EICO, kit or wired, as your best buy.

EICO, 33-00 NORTHERN BLVD., L.I.C. 1, N.Y.
Fill out coupon on other side for FREE CATALOG

Copyright 1958 by Electronic Instr. Co., Inc., 33-00 N. Blvd., L. I. C. 1, N. Y.

Add 5% in the West.

the specs prove it . . .
your **BEST BUY** is

EICO®

for COLOR & Monochrome TV servicing

FREE CATALOG

shows you **HOW TO SAVE 50%**
on 50 models of top quality
professional test equipment.
MAIL COUPON NOW!

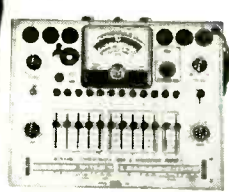

NEW! DYNAMIC CONDUCTANCE TUBE & TRANSISTOR TESTER #666 KIT \$69⁹⁵ WIRED \$109⁹⁵

COMPLETE with steel cover and handle.

SPEED, ease, unexcelled accuracy & thoroughness. Tests all receiving tubes (and picture tubes with adapter). Composite indication of Gm, Gp & peak emission. Simultaneous sel of any 1 of 4 combinations of 3 plate voltages, 3 screen voltages, 3 ranges of continuously variable grid voltage (with 5% accurate pot). New series-string voltages: for 600, 450, 300 ma types. Sensitive 200 ua meter. 5 ranges meter sensitivity (1% shunts & 5% pot). 10 SIX-position lever switches: freepoint connection of each tube pin. 10 pushbuttons: rapid insert of any tube element in leakage test circuit & speedy sel. of individual sections of multi-section tubes in merit tests. Direct-reading of inter-element leakage in ohms. New gear-driven rollchart. Checks n-p-n & p-n-p transistors: separate meter readings of collector leakage current & Beta using internal dc power supply. Deep-etched satin aluminum panel; rugged grey wrinkle steel cabinet. CRA Adapter \$4.50



NEW! Transistorized Power & Bias Supply =1020 Kit \$19.95 Wired \$27.95



NEW! Battery-Powered Filament Continuity Tester =612 Kit \$3.95 Wired \$5.95



Series/Parallel R-C COMBINATION BOX =1140 KIT \$13.95 WIRED \$19.95



TUBE TESTER =625 KIT \$34.95 Wired \$49.95
• tests 600 mil series string type tubes
• illuminated roll-chart

Pix Tube Test Adapter.....\$4.50



6V & 12V BATTERY ELIMINATOR & CHARGER =1050 KIT \$29.95 WIRED \$38.95
Extra-filtered for transistor equip.
=1060 KIT \$38.95 WIRED \$47.95



Miniaturized MULTI-SIGNAL TRACER =145A KIT \$19.95 WIRED \$28.95



20,000 Ohms/Volt V-O-M =565 KIT \$24.95 Wired \$29.95



1000 Ohms/Volt V-O-M =536 KIT \$12.90 Wired \$14.90

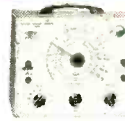

R-C BRIDGE & R-C-L COMPARATOR =950B KIT \$19.95 Wired \$29.95
Reads 0.5 ohms-500 megs, 10 mfd-5000 mfd, power factor



| VTVM PROBES | KIT | Wired |
|----------------------|--------|--------|
| Peak-to-Peak | \$4.95 | \$6.95 |
| RF | \$3.75 | \$4.95 |
| High Voltage Probe-1 | | \$6.95 |
| High Voltage Probe-2 | | \$4.95 |
| SCOPE PROBES | | |
| Demodulator | \$3.75 | \$5.75 |
| Direct | \$2.75 | \$3.95 |
| Low Capacity | \$3.75 | \$5.75 |



NEW! TV-FM SWEEP GENERATOR & MARKER #368 KIT \$69⁹⁵ WIRED \$119⁹⁵

Entirely electronic sweep circuit (no mechanical devices) with accurately-biased inductor for excellent linearity. Extremely flat RF output: new AGC circuit automatically adjusts osc. for max. output on each band with min. ampl. variations. Exceptional tuning accuracy: edge-lit hairlines eliminate parallax. Sweep Osc. Range 3-216 mc in 5 fund. bands. Variable Marker Range 2-75 mc in 3 fund. bands; 60-225 mc on harmonic band. 4.5 mc Xtal Marker Osc., xtal supplied. Ext. Marker provision. Sweep Width 0-3 mc lowest max. deviation to 0-30 mc highest max. dev. 2-way blanking. Narrow range phasing. Attenuators: Marker Size, RF Fine, RF Coarse (4-step decade). Cables: output, 'scope horiz., 'scope vertical. Deep-etched satin aluminum panel; rugged grey wrinkle steel cabinet.



COLOR and Monochrome DC to 5 MC LAB & TV 5" OSCILLOSCOPE #460 KIT \$79⁹⁵ WIRED \$129⁵⁰
• Features DC Amplifiers!

Flat from DC-4.5 mc, usable to 10 mc. VERT. AMPL.: sens. 25 rms mv/in; input Z 3 megs; direct-coupled & push-pull thruout; K-follower coupling bet. stages; 4-step freq-compensated attenuator up to 1000:1. SWEEP: perfectly linear 10 cps-100 kc (ext. cap. for range to 1 cps); pre-set TV V & H positions; auto. sync. ampl. & lim. PLUS: direct or cap. coupling; bal. or unbal. inputs; edge-lit engraved lucite screen; dimmer; filter; bezel fits std photo equip. High intensity trace CRT. 0.06 usec rise time. Push-pull hor. ampl., flat to 400 kc, sens. 0.6 rms mv/in. Built-in volt. calib. Z-axis mod. Sawtooth & 60 cps outputs. Astig. control. Retrace blanking. Phasing control. 5" PUSH-PULL Oscilloscope =425: Kit \$44.95, Wired \$79.95. 7" PUSH-PULL Oscilloscope =470: Kit \$79.95, Wired \$129.50.

NEW! RF SIGNAL GENERATOR #324 KIT \$26⁹⁵ WIRED \$39⁹⁵



150 kc to 435 mc with ONE generator! Better value than generators selling at 2 or 3 times its cost! Ideal for IF-RF alignment, signal tracing & trouble-shooting of TV, FM, AM sets; marker gen.; 400 cps audio testing; lab. work. 6 fund. ranges: 150-400 kc, 400-1200 kc, 1.2-3.5 mc, 3.5-11 mc, 11-37 mc, 37-145 mc; 1 harmonic band 111-435 mc. Freq. accurate to ±1.5%; 6:1 vernier tuning & excellent spread at most important alignment freqs. Etched tuning dial, plexiglass windows, edge-lit hairlines. Colpitts RF osc. directly plate-modulated by K-follower for improved mod. Variable depth of int. mod. 0-50% by 400 cps Colpitts osc. Variable gain ext. amplifier: only 3.0 v needed for 30% mod. Turret-mounted coils slug-tuned for max. accuracy. Fine & Coarse (3-step) RF attenuators. RF output 100,000 uv; AF sine wave output to 10 v. 50-ohm output Z. 5-way jack-top binding posts for AF in/out; coaxial connector & shielded cable for RF out. 12AU7, 12AV7, selenium rectifier; xmfr-operated. Deep-etched satin aluminum panel; rugged grey wrinkle steel cabinet.



NEW! PEAK-to-PEAK VTVM #232 & UNI-PROBE (pat. pend.) KIT \$29⁹⁵ WIRED \$49⁹⁵
Half-turn of probe tip selects DC or AC-Ohms.
Uni-Probe - exclusive with EICO - only 1 probe performs all functions!

Latest circuitry, high sensitivity & precision, wide ranges & versatility. Calibration without removing from cabinet. New balanced bridge circuit. High Z input for negligible loading. 4 1/2" meter, can't burn-out circuit. 7 non-skip ranges on every function. 4 functions: +DC Volts, -DC Volts, AC Volts, Ohms. Uniform 5 to 1 scale ratio for extreme wide-range accuracy. Zero center. One zero-adj. for all functions & ranges. 1% precision ceramic multiplier resistors. Measure directly peak-to-peak voltage of complex & sine waves: 0-4, 14, 42, 140, 420, 1400, 4200. DC/RMS sine volts: 0-1.5, 5, 15, 50, 150, 500, 1500 (up to 30,000 v. with HVP probe & 250 mc with PRF probe). Ohms: 0.2 ohms to 1000 megs. 12AU7, 6AL5, selenium rectifier; xmfr-operated. Deep-etched satin aluminum panel, rugged grey wrinkle steel cabinet.

EICO, 33-00 Northern Blvd., Long Island City 1, N. Y.

C-4

Show me **HOW TO SAVE 50%** on Test Instruments Hi-Fi Nam Gear. Send me **FREE** Catalog and name of neighborhood dealer.

Name.....
Address.....
City..... Zone..... State.....

TURN PAGE FOR MORE EICO VALUES

EICO®

Send for **FREE CATALOG** NOW

Prices 5% higher on West Coast.

33-00 Northern Blvd., Long Island City 1, N. Y.

ELECTRONICS vs WAR

... *Why the Billions of Defense Dollars?* ...

THE following letter by the mother of a young son is one of many similar ones which have reached us periodically throughout the years. It deserves every reader's thoughtful attention, as it correctly mirrors the sentiments of a large cross-section of our population in these most unusual times in our history. The letter is slightly condensed from the original.

In an old (September, 1955) issue of your magazine that my young son brought home recently, I was interested in some statistics given in the editorial "The Giant Electronics Industry." To quote: "By far the largest customer of the industry is the United States Government. Defense purchases of electronic equipment last year are estimated at \$2,300,000,000, . . . and may go up to over \$4,000,000,000 a year by 1964."

In my opinion it bodes no good for the future when great nations and blocs of nations concentrate so much of their economy & know-how in technology & science on purely destructive mechanisms of rapidly increasing power. It is obvious that this stupid (in my opinion) waste of human ingenuity is extremely corrupting in several ways. For example, the world's human energy is channeled destructively instead of constructively, natural entropy is needlessly increased by the addition of human entropy, young people sense unknowingly the terrible possibilities of modern technological warfare—hence the rise in juvenile delinquency—and a disproportionate part of national incomes goes into what the nations call defense. It is true that defense mechanisms are needed but not to such an unbalanced degree. Otherwise, if our grave problems should be settled by arbitration or other civilized methods instead of war, I simply cannot see how economies that lean heavily on war mechanisms will be able to adjust to a constructive economy without very considerable hardship.

Whole populations today are living under the black and real shadow of huge scale slaughter; therefore please tell us about the need for far greater applications of technology & science for *constructive* purposes.

Baldwin Path,
Huntington, N.Y.

MRS. P. CAMMER

The ideas expressed so well by our correspondent are unfortunately not new. They have occurred to every thinking individual since our aborigine days, millenia ago. War, unhappily, has been with us always, and "war" will be with us until the end of the world, *in one form or another*.

The nations recognizing this must build up their defenses, and this admittedly brings considerable waste in its wake. This is true of most large-scale human endeavors.

If the people of a community are threatened by periodically recurring floods, they sooner or later must build a dam or levee to keep the waters from flooding their homes. If they skimp in labor, money—and good engineering—their work may go for naught, as the Johnstown flood demonstrated. Hence, it is better for safety's sake to spend more rather than less. Incidentally, while building many dams, we learn in time how to build them better, and often more economically.

When a nation bolsters its defenses, the human energy expended is not necessarily all channeled destructively. To

the contrary, the nation builds up its economy, enriches its engineering in the country's industrial plant, gives vast employment and, through hundreds of byproducts of every imaginable kind, enhances its standard of living.

Even war machines become peace messengers. Our large four-motor civilian airplanes are, in reality, bombers in a new dress. Our new passenger jet planes were born as war planes. *They were brought to their present perfection solely because of our defense efforts.* Is this not in a way a constructive result?

The greatest difficulty most people have today is their inability to distinguish between human-made war and our constant war against non-human enemies.

We are always at war with famine, cold, heat, floods, tempests, epidemics, insect pests and microbe invasions, be they colds, measles or tuberculosis. We fight a continuing war against cancer and heart disease, and countless other minor wars. Our war with accidents of every kind will never be won as long as the world lasts. Nearly 10 million a year, almost 100,000 deaths in the U.S. alone—the best we can hope for is to reduce this frightful toll.

Add up the cost of all these wars, which is far greater in lost lives and treasure in a single decade than any periodic man-made war you can name. The money we pour into the *defense* against these non-man-made wars is fantastic, yet we know we dare not stop lest we revert to the dark ages when man died before he was 40, mostly due to ravages of unconquered diseases.

As to the billions of dollars we pour into the defense against man-made war during peace, it is in the end a cheap insurance against such a war. *The more formidable our defense, the less the chances of war, be it man-made or nature.* Take one instance, smallpox, which accounted for millions of deaths and disfigurement of hundreds of millions before vaccination was introduced.

Now let us turn to the comparatively few billions of dollars expended yearly in electronics. It was World War I which gave us radio and radio communication as we have it today. War or defense *always* speeds up technological inventions, whether we like it or not, and we all hate war. World War II gave us radar and countless other inventions including the atomic bomb, which, when used as atomic power, in the near future, will be a far more important instrument for peace than anything man ever knew.

The electronic defense billions we expend now and later, we repeat, bring in their wake not only war inventions but countless others as byproducts which we would not have otherwise. These discoveries, inventions, devices and methods help us in the fighting of our other wars, too, as, for instance, in the electronic battle against diseases. Since World War II, electronbiology and electronics in medicine, among others, have become big branches in the art of medicine and disease prevention.

Americans should realize that the terminology *war* should no longer apply solely to man-made war. We have never been at peace since man arrived on this planet and we probably never shall be. As long as humanity endures, there will always be an eternal war for man's survival. —H.G.

TEST INSTRUMENTS

Laboratory accuracy in a home-built unit lets you measure ac voltages between .0001 and 10 volts with an error of less than 2% over a bandwidth of 9 cycles to 8.5 mc

SENSITIVE WIDE-BAND

AC VTVM



By PHILLIP D. BLAIS

AC VOLTAGE measurements are probably the most important method of evaluating circuit performance. Most vtvm's cannot be used because of insufficient sensitivity and bandwidth. Crystal rectifier probes and preamplifiers are commonly used in attempts to increase the range of ordinary vtvm's. Calibration of such accessories is very difficult, and stability is poor. The ac vtvm described is of laboratory quality, and its accuracy is surpassed by only a few very expensive commercial units.

The requirements for a laboratory voltmeter are many. High input impedance, reliability, etc. are all familiar to the technician. Statistics can best represent these qualities:

| | |
|---------------------|---|
| Ranges (full scale) | .005, .01, .05, 0.1, 0.5, 1, 5, 10 |
| Bandwidth | 9 cycles-8.5 mc $\pm 5\%$ 20 cycles-3.5 mc $\pm 4\%$ 25 cycles-2.5 mc $\pm 2\%$ |
| Input impedance | 10 megohms, 25 μ mf |
| Noise level | Equiv. to 20- μ v input |
| Negative feedback | 30 db |
| Line-voltage error | Less than 2% 90-125 volts |

The serious experimenter will immediately see the advantages of this voltmeter and its possibilities in his workshop. Design of preamplifiers, power amplifiers and other test equipment is possible with such an instrument.

Basic circuit design

A block diagram of the ac vtvm is shown in Fig. 1. A cathode follower in

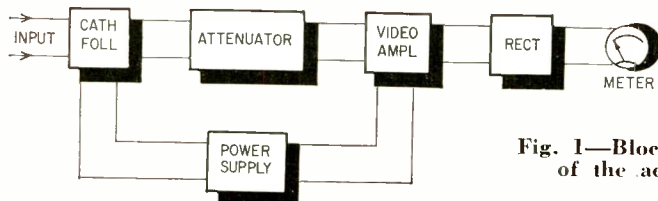

Fig. 1—Block diagram of the ac vtvm.

the input provides a high input and a low output impedance for the attenuator, which is composed of low-value precision resistors. At all frequencies the attenuator is compensated against errors due to stray capacitance, by small trimmer capacitors. No attenuator compensation is needed on the .005-volt range because there is no additional series resistor between V1's cathode and V2's grid. Thus the current due to V2's input capacitance does not affect the attenuation. At high frequencies, it does shunt the attenuator as a whole and produce an error. This error is very small, because of the low output impedance of the cathode follower, and is negligible up to 10 mc.

The 5- and 10-volt ranges are not compensated because the input reactance to V2 is much larger than the 1.5 ohms presented by the attenuator. On these two ranges the attenuator's output impedance is approximately 1.5 and 0.75 ohm while the input reactance to V2 is approximately 800 ohms at 10 mc. Thus, over 99% of the current in V1's cathode passes through R12 and R13, producing an error of less than 1%.

The attenuator is followed by a high-gain video amplifier to boost small voltages. The output of the video amplifier is rectified by a full-wave diode rectifier and applied to a 0-1-ma milliammeter.

Nonlinear elements, such as vacuum tubes, in a circuit always produce distortion and variations in gain with

changes in applied voltage, temperature, etc. Gain variations are intolerable in voltmeters, and some way to control this source of error is needed. The most practical way to stabilize gain is through the use of negative feedback. In this voltmeter 30 db of negative current feedback is applied around four stages, in the video amplifier, and is responsible for many of the desirable characteristics. The meter is included in the feedback circuit for good scale linearity.

The power supply is electronically regulated to reduce further the effects of line-voltage variations. A dc heater supply reduces hum and noise in the first amplifier stages.

Cathode follower and attenuator

A voltmeter's accuracy is often limited by attenuator accuracy. The impedance of an attenuator should be as low as possible to minimize the effects of stray capacitance. Large values of resistance show frequency effects which yield an effective ac resistance considerably lower than the dc value. An ordinary 1/2-watt 1-megohm carbon resistor has an effective resistance of only 570,000 ohms at 10 mc. Precision carbon resistors suffer least from this effect and are used in this voltmeter's attenuator. See Fig. 2.

Resistors R12 and R13 in the attenuator are 0.75 ohm and are not commercially available precision units. Use parallel combinations such as 1 and 3 to obtain 0.75 ohms, or fabricate from resistance wire. If resistance wire is used, keep the inductance at a minimum by keeping the area enclosed by the loop of wire to a minimum. At 5 mc, an inductance of only .02 μ h has a reactance of 0.75 ohm and contributes an error of 41%. A short hairpin-shaped loop is satisfactory.

Capacitors C3 through C10 in com-

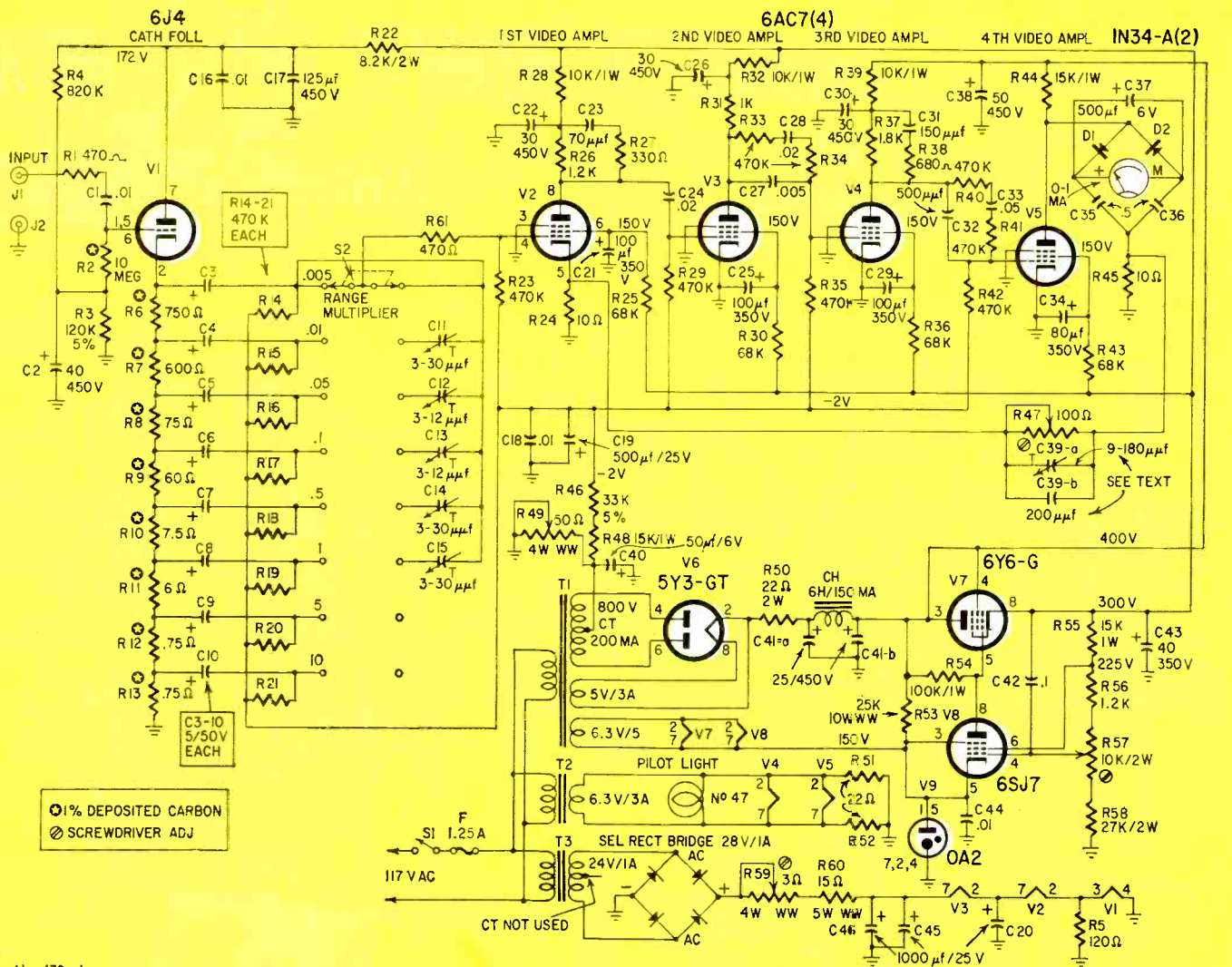

- R1, 61—470 ohms
- R2—10 megohms, 1%
- R3—120,000 ohms, 5%
- R4—820,000 ohms
- R5—120 ohms
- R6—750 ohms, 1%
- R7—600 ohms, 1% (300 and 300 in series)
- R8—75 ohms, 1%
- R9—60 ohms, 1% (50 and 10 in series)
- R10—7.5 ohms, 1% (30 and 10 in parallel)
- R11—6 ohms, 1% (5 and 1 in series)
- R12, 13—0.75 ohm, 1% (3 and 1 in parallel)
- R14, 15, 16, 17, 18, 19, 20, 21, 23, 29, 33, 34, 35, 40, 41, 42—470,000 ohms
- R22—8,200 ohms, 2 watts
- R24, 45—10 ohms
- R25, 30, 36, 43—68,000 ohms
- R26, 56—1,200 ohms
- R27—330 ohms
- R28, 32, 39—10,000 ohms, 1 watt
- R31—1,000 ohms
- R37—1,800 ohms
- R38—680 ohms
- R44, 48, 55—15,000 ohms, 1 watt
- R46—33,000 ohms, 5%
- R47—pot, 100 ohms, carbon
- R49—pot, 50 ohms, 4 watts, wirewound
- R50—22 ohms, 2 watts
- R51, 52—22 ohms
- R53—25,000 ohms, 10 watts, wirewound
- R54—103,000 ohms, 1 watt

- R57—pot, 10,000 ohms, 2 watts
- R58—27,000 ohms, 2 watts
- R59—pot, 3 ohms, 4 watts, wirewound
- R60—15 ohms, 5 watts, wirewound
- All resistors 1/2-watt 10%, unless noted
- C1, 16, 18, 44—0.1 μf disc ceramic
- C2—40 μf, 450 volts, electrolytic
- C3, 4, 5, 6, 7, 8, 9, 10—5 μf, 50 volts, electrolytic
- C11, 14, 15—3-30 μf, miniature disc trimmer
- C12, 13—3-12 μf, miniature disc trimmer
- C17—125 μf, 450 volts, electrolytic
- C19—500 μf, 25 volts, electrolytic
- C20, 45, 46—1,000 μf, 25 volts, electrolytic
- C21, 25, 29—100 μf, 350 volts, electrolytic
- C22, 26, 30—30 μf, 450 volts, electrolytic
- C23—70 μf, mica
- C24, 28—0.2 μf, disc ceramic
- C27—0.005 μf, paper
- C31—150 μf, mica
- C32—500 μf, mica
- C33—0.5 μf, paper
- C34—80 μf, 350 volts, electrolytic
- C35, 36—0.5 μf, miniature paper
- C37—500 μf, 6 volts, electrolytic
- C38—50 μf, 450 volts, electrolytic
- C39-a—9-180 μf, trimmer (see text)
- C39-b—200 μf, mica (see text)
- C40—50 μf, 6 volts, electrolytic
- C41-a, -b—25 μf, 450 volts, electrolytic
- C42—0.1 μf, paper

- C43—40 μf, 350 volts, electrolytic
- All capacitors 600 volts unless noted
- CH—6 henrys, 150 ma
- D1, 2—IN34-A
- F—1.25 A
- J1, 2—terminal-binding-post assembly (National FWH or equivalent)
- M—0-1 ma
- RECT—full-wave bridge, selenium, 28 volts output, 1 amp or higher
- S1—spst toggle
- S2—5-gang 5-pole 8-position steatite rotary
- T1—power transformer: primary, 117 volts; secondary, 800 volts ct, 200 ma; 5 volts, 3 amps; 6.3 volts, 5 amps; (Thordarson 24R07 or equivalent)
- T2—filament transformer: primary 117 volts; secondary, 6.3 volts, 2 amps (Stancor P6466 or equivalent)
- T3—filament transformer: primary, 117 volts; secondary, 24 volts ct, 1 ampere (Triad F-40X or equivalent)
- V1—6J4
- V2, 3, 4, 5—6AC7
- V6—5Y3-GT
- V7—6Y6-G
- V8—6SJ7
- V9—0A2
- Pilot lamp, No. 47
- Chassis
- Miscellaneous hardware

Fig. 2—It takes nine tubes and two crystal diodes to give the ac vtm its accuracy.

bination with resistors R14 through R21 reduce transients in the input circuit when changing ranges, and reduce waiting time. Trimmer capacitors C11 through C15 are adjusted during calibration to compensate for stray capacitance in the attenuator. The attenuator is constructed on a five-gang eight-position steatite switch, and details are shown in the photo. Unused sections are disabled by removing the rotor.

A two-pole eight-position rotary could have been used, but it would not allow for easy attenuator construction. All components are mounted on the switch.

A 6J4 triode is the input cathode follower, because of its unusually high transconductance—12,000 μmhos. The special circuit used to obtain the grid bias on the 6J4 reduces the noise figure² and illustrates the many special precautions used to obtain the low

noise figure. Heater current required by the 6J4 is less than that for a 6AC7, and the 6J4 heater is shunted by R5 to allow series connection of the tubes' heaters. The grid circuit has a small resistor near the tube socket to prevent parasitic oscillations when the input is short-circuited.

Video amplifier

The video amplifier consists of four

TEST INSTRUMENTS

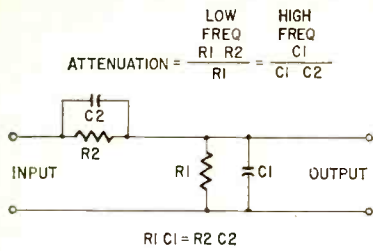

Fig. 3—How to determine component values for a frequency-compensated attenuator.

6AC7 stages. The 6AC7's are used because of their high transconductance and low noise figure. The first two 6AC7's have a dc heater supply. The cathodes of the second, third and fourth video amplifiers are grounded directly to reduce hum and noise. This also removes any complex impedances in the cathode circuits, which tend to produce degeneration at low frequencies.

A collective back-bias arrangement provides the required negative grid voltage.³ Each grid is returned to a common negative voltage source provided by the center tap of the plate power transformer winding. This voltage is proportional to the total current, and in this way a collective self-bias source is maintained. This design is responsible for the complete absence of hum in the video amplifier.

The screen grids of the 6AC7's are supplied through large screen dropping resistors from the voltage-regulated supply to reduce changes in transconductance due to changes in line voltage. Very large screen bypass capacitors keep degeneration and phase shift small at low frequencies. The cost of electrolytic capacitors is small and "bargain" units may be used here. If their quality is questionable, bypass each one with a .01- μ f ceramic unit to eliminate high-frequency inductance effects. These capacitors, not shown in Fig. 2, were used in the finished vtm. They are visible in the bottom view of the video amplifier. They are coded

with the number of the bypassed electrolytic and the suffix "a".

The coupling between stages involves R-C networks called Bode networks¹ to control phase shift and attenuation, for stability with negative feedback. These networks are the result of many trials and calculations, and should not be varied. The balance between frequency response and phase shift is delicate when applying 30 db of negative feedback around four stages with a bandwidth of 10 mc, and the design is vindicated by the final result.

The final 6AC7 stage has a high plate load resistance—15,000 ohms. It is shunted by the relatively low impedance of the meter circuit. The meter-circuit current is thus equal to the ac tube current, which is equal to the transconductance multiplied by the ac grid voltage. The current is rectified by the two germanium rectifiers and applied to the meter circuit as pulsating dc, filtered by C37. The two half-waves of current are then recombined by capacitors C35 and C36, and applied to R45. The negative-feedback voltage is taken from R45. Being familiar with negative feedback, we realize that this tends to keep the voltage across R45 constant. This voltage is merely a measure of the current through the meter circuit, and thus the feedback is actually negative current feedback. The tendency to maintain constant current through the meter circuit by negative current feedback results in a very linear scale regardless of changes in the rectifier's forward characteristics with applied voltage. Feedback is adjusted with R47, and the voltmeter gain is adjusted during calibration by R47. C39 corrects the negative feedback at higher frequencies to improve frequency response.

Capacitor C39 consists of a 9–180- μ f trimmer in parallel with a 200- μ f mica. However, in my unit the trimmer is adjusted for maximum capacitance and the total value of the combination is 380 μ f. Due to differ-

ences in construction and tubes, a different value may be required. The outside limits to the value you may need in the meter you build are 40 μ f and .0015 μ f. For best results try a 170–780- μ f trimmer as a start. The chances are the value you need will be within its range.

The first 6AC7 stage has a small grid-isolating resistor R61 to prevent parasitic oscillations at high frequencies.

The power supply is straightforward in design and construction and will not be discussed in detail. A separate chassis is used for the power supply to isolate unwanted signals and to facilitate adjustment and repair. I used a power transformer from an old Atwater-Kent and two 6.3-volt heater transformers. However, you can use the arrangement shown in the schematic for greater convenience.

Construction hints

Construction is not critical or tricky and the layout may be modified for special requirements. The layout shown in the photos is recommended for general use. Input capacitance can be reduced slightly by placing V1 closer to the input terminals, and is recommended. A separate, totally enclosed chassis for the attenuator and cathode follower is a necessity to reduce hum pickup in the high input impedance. Placement of circuit components is not critical, although normal precautions should be taken.

The attenuator resistors are the only precision components required; all other components are normal 10% tolerance. Some attenuator resistor values are not stock items, but may be made up as combinations of stock values. Use a heat sink when soldering precision resistors to prevent a permanent change in resistance due to heating. Broad limits are possible on all electrolytic capacitors and nearest available values may be used.

The custom appearance of the indi-

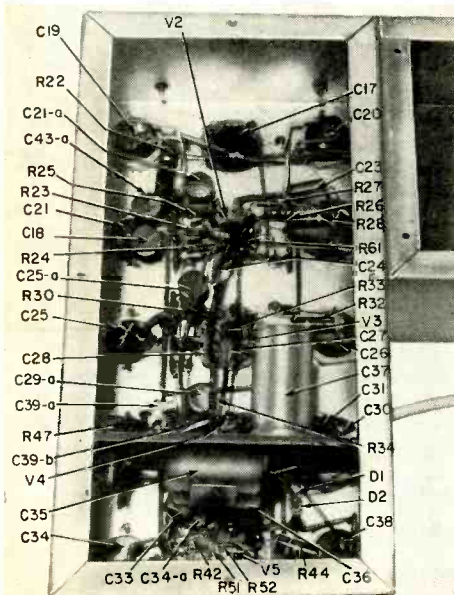

A look under the video amplifier chassis.

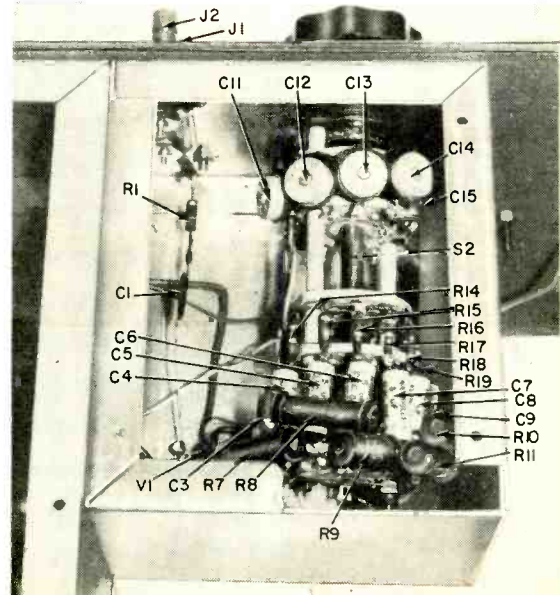

The attenuator is in a chassis of its own.

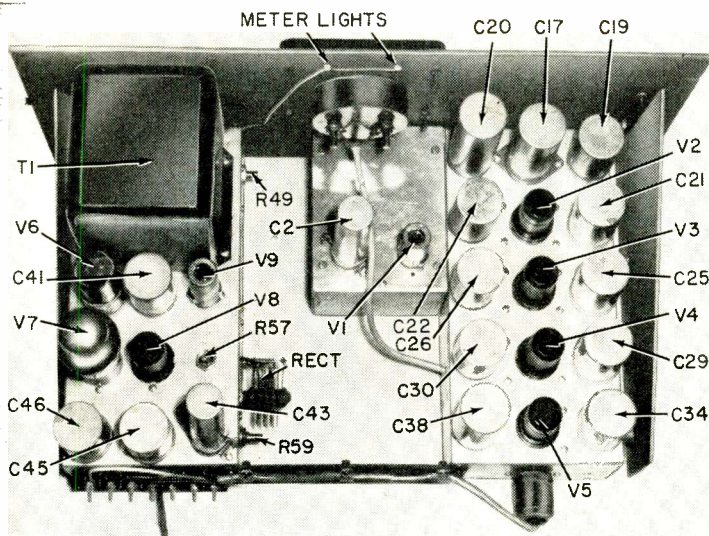

The finished chassis has a professional look.

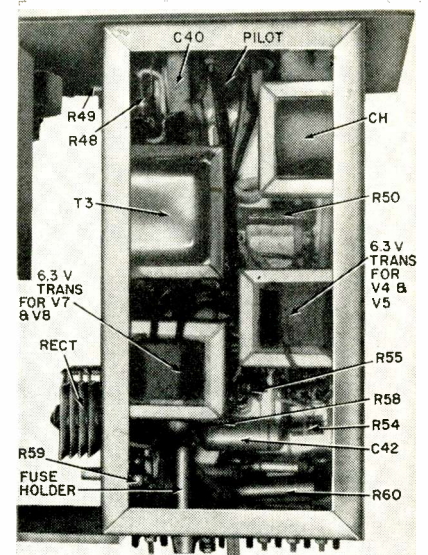

Under the power-supply chassis.

cating meter is obtained by using a standard 4½-inch Triplett 0-1 millimeter. The unwanted lettering is removed from the meter scale by gently rubbing with a small cloth dampened with acetone.

Two sets of scale numerals should be applied to match the attenuator ranges. Appearance may be further enhanced by drilling two small holes through the back of the meter and inserting two small pilot lights. These holes must be drilled with a hand drill, being extremely careful not to damage the delicate meter movement. Orient the meter so drill chips fall away from the suspended coil and pivots.

Use decals to label the front of the instrument and give a professional appearance. The clear birch wood cabinet is assembled with screws and glue. Give the sanded surface several coats of clear lacquer, until it is glossy. The finished instrument is very attractive, and professional in appearance and performance.

Adjustments and calibration

Now that the instrument is completed, it must be adjusted to make measurements. After a 30-minute warm-up, adjust:

1. The voltage-regulated supply. Set R57 for 300 volts at the cathode of the 6Y6-G.
2. Heater voltage. Trim R59 to get 18.9 volts dc at C45 and C46.
3. Grid bias in video amplifier. Rotate R49 until -2 volts is obtained across C40.

This completes the adjustments, and all voltage measurements are with respect to chassis ground. It may be necessary to repeat these twice.

Calibration is more difficult, and ingenuity is required if laboratory standards are not available. Get a 60-cycle source that is within the voltmeter's range and the most accurate meter available. With the appropriate meter scale and range setting adjust R47 until the voltmeter reads the same as

the calibrating voltmeter used as the "standard."

The attenuator trimmer capacitors require a frequency source above 3 mc with a variable output. The required steps are:

1. Set the voltmeter range switch to .005 volt. Adjust the output of a signal generator, set between 3 and 10 mc and connected to the voltmeter, so the voltmeter reads full scale.
2. Without changing the signal generator's output, set the voltmeter range to .01, and adjust trimmer capacitor C11 until the output meter reads half scale (.005).
3. Adjust the signal generator's output until the voltmeter reads full scale. Now set the voltmeter range switch to .05, and adjust C12 until voltmeter reads .01 volt.
4. Adjust the output of the signal generator until the voltmeter again reads full scale. Set the meter to 0.1, and adjust C13 until voltmeter reads half scale.
5. Increase signal generator output for full-scale reading. Change voltmeter range switch to 0.5, and adjust C14 to read 0.1 on voltmeter.
6. Finally, increase signal generator again to give full-scale deflection, and change the voltmeter range switch to 1 volt. Adjust C15 for half-scale reading.

This completes the attenuator adjustments, and the attenuator should be independent of frequency.

High-frequency calibration is the final adjustment necessary before use. Set the signal generator at 7 mc and the output at 1 volt. The output may be measured at this level and frequency by using a simple diode rectifier probe and an ordinary dc vtvm. The 1-volt output is applied to the input of the voltmeter, and C39 adjusted to give a full-scale reading on the 1-volt range. The voltmeter is then placed in the cabinet, and is ready for use.

Occasionally, due to a 6AC7 with an unusually high transconductance, the

video amplifier's gain requires more than 30 db of negative feedback for correct calibration, and any attempts to reduce the gain, by adjusting R47 for correct calibration, may result in violent circuit oscillation. Poorly placed components can also cause oscillation. The stability margin for this voltmeter is only 6 db and is ideal for flat response. Changing circuitry is not advised as a solution, and the best method to correct this trouble is to increase the bias on the 6AC7 tubes by adjusting R49 until oscillation ceases. In this manner, the total gain may be adjusted for 30 db of feedback.

Input attenuators and probes

The reader may wonder why the top range of this ac vtvm is only 10 volts. Why not higher? The reason is simple. It is better to add attenuation by an external attenuator or by a probe, and achieve an even higher input impedance. A 100× attenuator could have been placed in the grid circuit of the input cathode follower to get ranges 100 times those on the present range switch, but the input capacitance would still be approximately 20 μf. However, with an external probe attenuator, the input capacitance can be made as small as 2 or 3 μf.

Probes and external attenuators are more versatile, and are necessary at high frequencies to prevent standing waves in the leads. Attenuators and probes may be designed and constructed as in Fig. 3.

For frequency-independent attenuation, $R1C1 = R2C2$. The designer must include the input capacitance and resistance of the voltmeter as being in parallel with R1 and C1. Also, in the case of probes, the capacitance of the cable must be added to C1. END

References

- 1 International Resistance Co., *Bulletin B-1*.
- 2 Lansford-Smith, *Radiotron Designers Handbook*, pages 789-90.
- 3 Lansford-Smith, *Radiotron Designers Handbook*, page 597.
- 4 Bode, H. W., "Network Analysis and Feedback Amplifier Design," D. Van Nostrand.

using SCOPE PROBES

Like a diode tube, a single probe won't handle all jobs. Knowing where and when to use what probe speeds servicing

By **ROBERT G. MIDDLETON**
RADIO-ELECTRONICS TELEVISION CONSULTANT

WITHOUT question, the oscilloscope is among the most essential instruments used in TV troubleshooting. Most technicians have little difficulty in operating their scopes with direct test leads, but *scope probes* often lead to questions.

Field experience proves that some technicians are confused when it comes to which probe to use in a specific application. This article will clarify that question. In general, scope probes extend the applications of a service scope into high-frequency, high-impedance and high-voltage circuits. Without suitable probes, scope applications are seriously limited.

The better grades of probes are adjustable, so their characteristics can be matched to various scopes. Thus, better low-capacitance probes have service adjustments for both



A typical scope demodulator probe.

probe resistance and capacitance, and the capacitance-divider probe for probe capacitance. Accordingly, these probes can be adjusted for accurate operation with *any* modern scope.

A demodulator probe does not require a service adjustment, since no attenuation factor is involved and the probe responds upon the basis of the peak-to-peak voltage of the applied signal. The total output from a demodulator probe is applied directly to the scope input terminals.

HIGH-VOLTAGE CAPACITANCE-DIVIDER PROBES

(Also termed High-Voltage 100-to-1 Divider Probe)

A probe that extends the permissible input voltage rating of a scope to 10,000 peak volts is the high-voltage capacitance-divider type. Without such a probe, a service scope typically withstands only 600 peak volts before waveform distortion starts. Excessively high input voltages will damage a scope's input circuit unless a suitable probe is used.

A high-voltage probe of this type is usually designed for 100-to-1 attenuation. Thus, if a 10,000-volt waveform is applied to the probe, the scope receives 1/100 of this voltage, or 100 volts, which is well within the capability of the vertical amplifier for undistorted reproduction. The probe can be used to

advantage at the plate of the horizontal output tube to check the peak-to-peak voltage of the flyback waveform and to compare its shape with the service data specifications for the receiver.

When measuring peak-to-peak voltages, the operator adds two zeros to the scope calibrating factor when the probe is used and no recalibration is required. It is clear that use of decimal attenuation factors in such probes greatly speeds up practical applications. Of course, the probe must be used with an up-to-date scope which has a step attenuator calibrated in intervals of 10 ($\times 1$, $\times 10$, $\times 100$, etc.).

A 100-to-1 capacitance divider probe can be used also to check the waveform

and peak-to-peak voltage at the cathode of a damper tube, across the horizontal-deflection coils and similar high-voltage points.

There is one limitation in the use of a capacitance-divider probe which must be recognized—the probe is not suitable for checking 60-cycle sweep circuits. At 60 cycles, the resistive component of the scope input circuit becomes appreciable with respect to the reactance of the probe and, since the capacitance-divider probe is uncompensated, its use must be restricted to horizontal-frequency circuits. However, this is not a matter for practical concern, since a 10-to-1 probe will handle the operating voltages of vertical-frequency circuits.

Circuit

This is a high-voltage ac probe, designed to operate at input voltages up to 10,000 peak volts. The IX2-A tube serves as a small high-voltage capacitor. The trimmer is used to calibrate the probe for 100-to-1 attenuation.

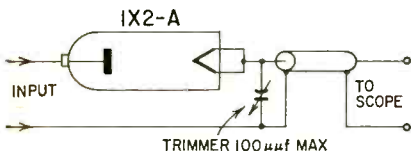

Applications

Probe can be used to check waveforms and peak-to-peak voltages at the plate of the horizontal output tube, cathode of damper tube and across horizontal deflection coils. Should be used in horizontal-frequency circuits only. Distorts 60-cycle (vertical) waveforms.

LOW-CAPACITANCE PROBES

(Also termed High-Impedance or 10-to-1 Attenuating Probe)

A low-capacitance probe effectively *increases the input impedance* of the scope input circuit. This lets you test high-impedance circuits without undue loading and the resulting waveform distortion incurred when direct test leads are used in this type circuit. For example, many synchronizing circuits,

such as the popular Synchroguide phase detector, have high internal impedances and using a low-capacitance probe lets you adjust such circuits more accurately than otherwise possible.

Low-capacitance probes are usually adjusted to provide an impedance step-up of 10 times. Concurrent with this

provision for high input impedance is a loss of signal, also of 10 times. In other words, signal strength is traded for stepped-up input impedance. However, the bargain is a good one, as the available signal is usually much greater than required for full-screen deflection, while a higher input impedance is

often required for an undistorted waveform display.

The attenuation factor of 10 is chosen so the scope's basic calibration factor is retained, whether or not the low-capacitance probe is used. If the low-capacitance probe is connected to the scope's input, the operator merely adds one zero to his calibration factor and

peak-to-peak waveform voltages can be measured without recalibrating the scope's vertical amplifier.

A low-capacitance probe is also valuable for checking signal levels through a video amplifier, as it keeps you from loading the peaking coils excessively. Tests can be made at either the plate or the grid of a video amplifier tube.

Circuits

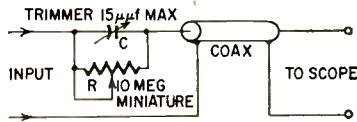

When C is set at 1/9 the input capacitance of the cable and scope, and R is set at 9 times the scope's input resistance, the probe has 10-to-1 characteristics—the input resistance becomes 10 times higher and the input capacitance 10 times lower than when a direct cable is used to the scope's input terminals.

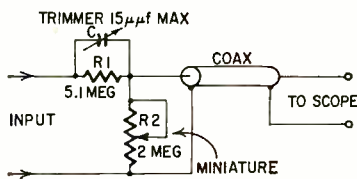

Value of R1 principally determines the probe's input resistance. A 5-megohm metallized-film resistor is suitable for probe construction. Potentiometer R2 is adjusted to provide 10:1 signal attenuation at low frequencies and C to provide 10:1 attenuation at high frequencies. The scope input capacitance is reduced to 1/10 by use of the probe, but input resistance is multiplied by a factor less than 10.

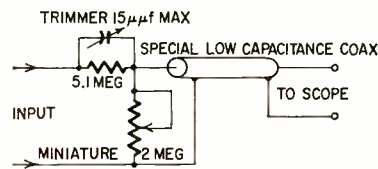

Because the input capacitance of a scope may be about 20 μf, while the input capacitance of the cable may be about 100 μf, it is clearly advantageous for the scope user to employ low-capacitance coaxial cable with the probe.

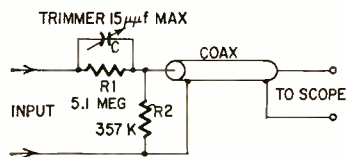

A low-capacitance probe is sometimes simplified by using fixed values for both R1 and R2. This arrangement makes it possible to obtain high-frequency compensation, but low-frequency compensation is correct only with the scope for which the probe was designed.

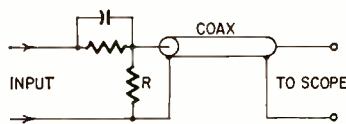

Maximum simplification of the low-capacitance probe is shown here. Fixed values of resistance and capacitance are used, and proper compensation at low and high frequencies can be obtained only for one particular scope.

NOTE: Low-capacitance probes can be used properly only if the scope has a step attenuator which has the same input resistance and capacitance on each step. Most modern service scopes have satisfactorily constant input impedance on the X1, X10, X100 and X1,000 steps.

When testing at the picture tube, the most accurate waveform reproduction is obtained by unplugging the picture-tube socket and inserting the probe tip into the video-signal socket terminal (grid or cathode). The input capacitance of the probe substitutes for the input-capacitance of the CRT, and nearly normal load conditions are realized.

Applications

Because the probe has 10 times higher input impedance than a direct cable, it is sometimes called a "high-impedance" probe. The 10-to-1 factor is not always provided, but is preferred to facilitate peak-to-peak voltage measurements with a calibrated scope. The 10-to-1 probe imposes a 90% loss on the signal applied to the scope.

This arrangement is similar to the foregoing, except that a fixed resistor is used in series, and the potentiometer is placed in shunt. Better compensation (better square-wave response is obtained with this arrangement) at the expense of slightly greater complexity.

Low-capacitance coaxial cable may be difficult to obtain, but may be constructed by stripping the central conductor out of a length of RG-59/U cable and threading a No. 36 copper wire through instead. This arrangement drops the cable input capacitance to about 1/8 its nominal value. Attenuation factor is still 10:1, but the input capacitance is very much less.

To illustrate the low-frequency consideration, good low-frequency compensation is obtained when R2 equals 357,000 ohms, provided the scope's input resistance is 1 megohm. However, this is not always the case—a scope may have as little as 500,000 ohms input resistance or as much as 3 megohms.

Compensation error which results when this type of probe is used with various scopes can be made less serious by using a small value of resistance for R, and a high cable capacitance. This is a "brute-force" arrangement in which compensation is approximated at a sacrifice of input impedance advantage.

VARIOUS DEMODULATOR PROBES

(Also called Detector, Crystal, High-Frequency, RF or Travelling Detector Probe)

The photo shows a typical demodulator probe. This type of probe lets you use a scope in higher-frequency circuits than otherwise possible. Popular uses for the demodulator probe are signal tracing in if amplifiers, display of single-stage if response, display of video amplifier response curves and display of bandpass amplifier response in color television receivers.

There is a practical limitation in the application of a demodulator probe. Remember that waveforms of more than 50 volts peak to peak tend to produce

pattern distortion, while outputs in excess of 100 volts peak to peak can impair the sensitivity of the crystal diode or burn it out completely.

A demodulator probe used with a scope must have several special features. Unlike a probe designed for a vtm, a scope demodulator probe must rectify the rf component of the waveform and it must pass the modulation envelope of the signal to the scope's vertical amplifier. Accordingly, a scope demodulator probe must have optimum filter characteristics to meet the service

applications for which it is intended.

The probe shown on page 36 has a voltage-doubler configuration in the crystal-diode network to provide maximum sensitivity. With such a probe, you can trace if signals back to the tuner output, provided a reasonable signal input is applied to the receiver's antenna input terminals. When a strong TV station signal is not available, the output of a sweep generator is useful for signal tracing.

The demodulating capability of such probes is somewhat limited, due to the

TEST INSTRUMENTS

appreciable input capacitance of service scopes, and this point should be clearly recognized so the receiver is not unjustly blamed for limitations of probe response. The demodulating capability of the probe permits good reproduction of a vertical sync pulse, but only partial reproduction of a horizontal sync pulse. Hence, signal-tracing procedures should always be followed with the scope deflection rate set to 60 cycles (or 30 cycles), and the observations based upon the observed display of vertical sync pulses.

To display a bandpass amplifier response curve, the fundamental requirement is that the probe be capable of displaying a 60-cycle square-wave en-

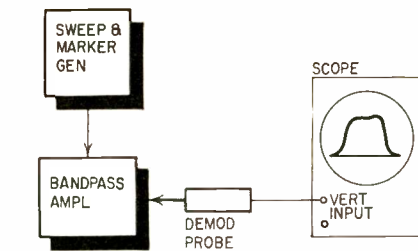

Fig. 1—Test setup for checking bandpass amplifier response in a color TV receiver.

velope without distortion. The probe is capable of this response, and hence the test setup shown in Fig. 1 provides an accurate check of bandpass amplifier

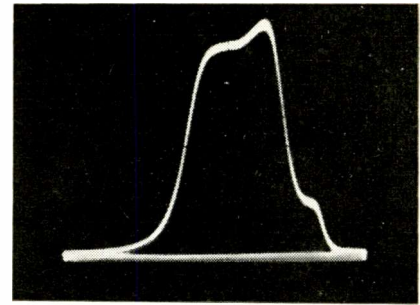
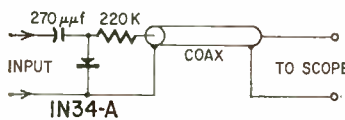
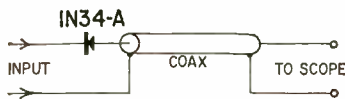

Fig. 2—Typical bandpass amplifier response curve obtained with the test setup in Fig. 1.

response in a color TV receiver, with the result shown in Fig. 2.

Circuits

Simplest form of demodulator probe, made up of a germanium diode in series with the shielded input cable. The input cable serves as a charging capacitor. A series-detector arrangement, providing half-wave rectification.



A general-purpose demodulator probe. The detector is arranged in shunt, with a 270-μf charging capacitor. The shielded input cable is isolated from the high-frequency circuit in the probe by a 220,000-ohm resistor. Half-wave rectification is provided.

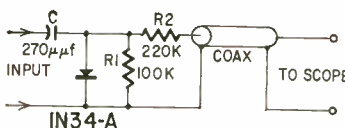

This arrangement for a demodulator probe is the same as the preceding version, except that the diode is shunted by a 100,000-ohm resistor. When a diode with a high front-to-back ratio is used, the shunt improves the probe's demodulating capability.

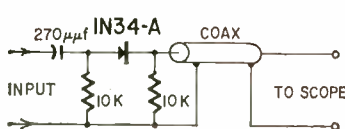

Demodulator-probe arrangement using a series detector, with a 10,000-ohm shunt on both sides of the diode and no cable isolation. Sensitivity is moderate, and demodulating capability is considerably greater than for the foregoing types of demodulator probes. Demodulates horizontal sync pulse satisfactorily.

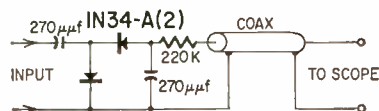

This arrangement is used in a voltage-doubler demodulator probe, sometimes called a peak-to-peak high-frequency probe. The probe network provides full-wave rectification and correspondingly greater sensitivity, compared with a half-wave probe.

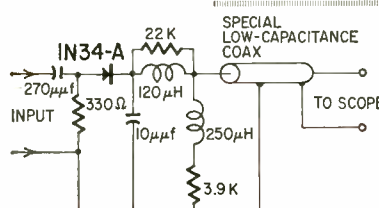

Wide-band demodulator probe, with high-frequency compensation for reproducing envelope frequencies up to 4 mc. The input cable to the scope is of special low-capacitance construction having an outer diameter of 1/2 inch and a No. 40 central conductor.

NOTE: The input resistance of all service demodulator probes is relatively low and the input capacitance is appreciable. For this reason, the probe tends to load signal circuits in which it may be applied, and the user must be aware of this limitation to avoid the possibility of drawing false conclusions in some test situations.

Applications

Arrangement is simple and economical, but has limited demodulating capability—horizontal sync pulse is greatly attenuated and distorted, although vertical sync pulse is demodulated without severe distortion. Input cable is not isolated from the probe network and operates as a resonant stub at various high frequencies, which makes the probe appear insensitive at certain radio frequencies.

This type is not resonant at radio frequencies and provides uniform sensitivity. Sensitivity is less than that of doubler types, but its cutoff frequency is considerably higher than that of a doubler probe. The series charging capacitor permits using it in signal circuits where some 60-cycle hum voltage may be present. Vertical sync pulses are demodulated reasonably well, but horizontal sync pulses are greatly attenuated and distorted.

Demodulating capability cannot be extended indefinitely by lowering the value of R1, because a limitation is imposed by the time constant of R2 and cable capacitance. It is not practical to reduce the value of R2 appreciably because cable capacitance then imposes an excessive capacitive shunt across the diode and reduces the detector efficiency.

Chief disadvantage of this probe arrangement is lack of rf isolation between the cable and the probe network. Therefore, the probe's sensitivity will appear quite good at some radio frequencies, but poor at others. The series input capacitor provides good rejection of 60-cycle hum voltages.

Demodulating capability is not greater than that of conventional half-wave types and horizontal sync pulses are greatly attenuated and distorted. Vertical sync pulses are reasonably well demodulated. The frequency cutoff is only about half as high (about 100 mc) as that of typical half-wave probes.

To obtain the 4-mc bandwidth of output signal from the probe, the scope's input capacitance must be maintained very low (not over 10 μf). This necessitates bypassing the step attenuator and applying the cable output directly to the grid of the cathode-follower input stage. The probe's sensitivity is much less than that of the narrow-band probes shown above.

SIMPLE CAPACITOR CHECKING METHOD

*Simple circuit plus multimeter
make accurate test instrument*

By **GEORGE P. PEARCE**

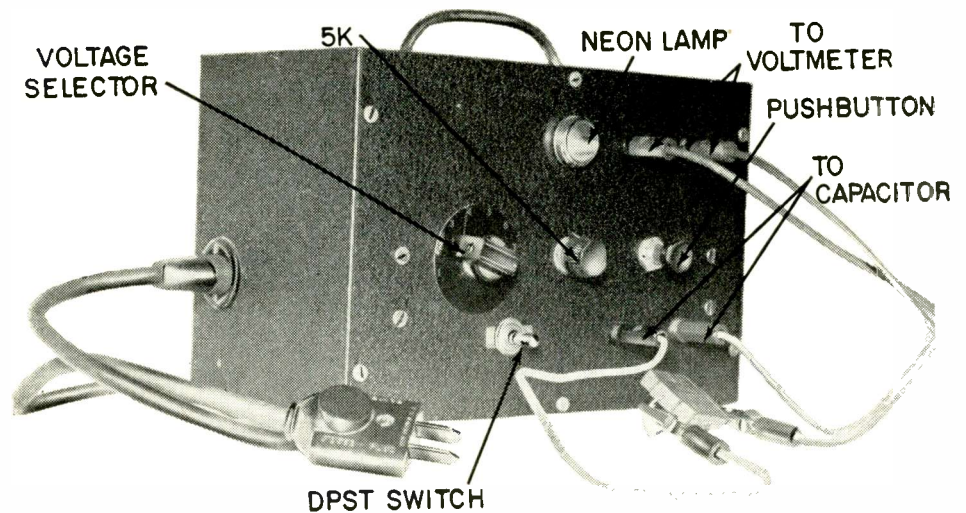

Front-panel view showing all controls.

FOR several years I have been testing capacitors by measuring the current flow through them when connected in a 120-volt 60-cycle line and calculating the capacitance by the standard formula. I never liked the idea although it gave very good results. The trouble was that while testing I was pestered with the disturbing thought of what would happen to the delicate and expensive 50- μ a meter in my multitester if the capacitor under test should puncture or short—a flip, a puff of smoke and no meter. I finally decided to build a capacitor checker for testing a wide range of capacitances, one that could not possibly damage my expensive meter even if a capacitor should short while I read the meter.

The circuit is shown in the schematic diagram. The potentiometer permits obtaining the exact voltage required for any test on capacitors from .00025–10 μ f. My junkbox supplied all the items needed to assemble the checker, except the steel cabinet which I bought. The transformer has a 270-volt secondary with taps at 120, 30, 8 and 1.5 volts. I happened to have a burnt-out power transformer so I pulled it apart, cleaned the steel laminations, wound the coil for the above voltages and re-assembled it. The amount of secondary current required is very small so fine

wire can be used. I had some No. 33 enameled copper wire on hand and used this for the secondary winding.

(A tube tester transformer has all the voltages but 270. Readers wishing to wind their own transformers would be well advised to pick up one in good condition—from the junkbox, preferably—with a secondary of roughly the required voltage. The filament windings and half the secondary can then be removed and the other taps obtained by winding some of the secondary wire back on again. The center tap will then become the common lead, with 270 volts on one side and the tapped winding from 1.5 to 120 volts on the other. The number of turns needed per volt can be learned by counting the turns on a filament winding and dividing the figure by the voltage of the winding.—*Editor*)

To obtain the testing range I used five voltage scales on my multitester:

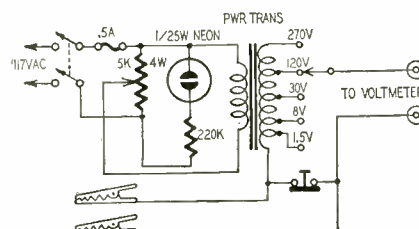

250, 100, 25, 5 and 1. I wound the transformer for a higher voltage in each range so that even during the lowest house voltage I would be able to get what was necessary. This is where the potentiometer is so valuable. All that has to be done is to set the selector switch to the nearest higher voltage. Then, with the potentiometer, reduce and adjust the voltage to the meter to the exact amount needed for a given range.

Operating the checker

Suppose the transformer is set to deliver exactly 250 volts to the multitester. If, say, a .001- μ f capacitor is placed in series in one of the leads to the meter, the reading will no longer be 250 volts but something less. It is best to read this deflection on the uniform scale which has the most divisions. On my meter there is a scale divided into 50 spaces that I always

1—power transformer with tapped secondary (see text); 1—5-position selector switch; 1—pushbutton switch, normally closed; 1.5-amp fuse and holder; 1—5,000-ohm 1-watt potentiometer; 1—220,000-ohm resistor; 1—1/25-watt neon lamp and holder; 2— alligator clips; 1—cabinet.

Schematic of the capacitor checker.

TEST INSTRUMENTS

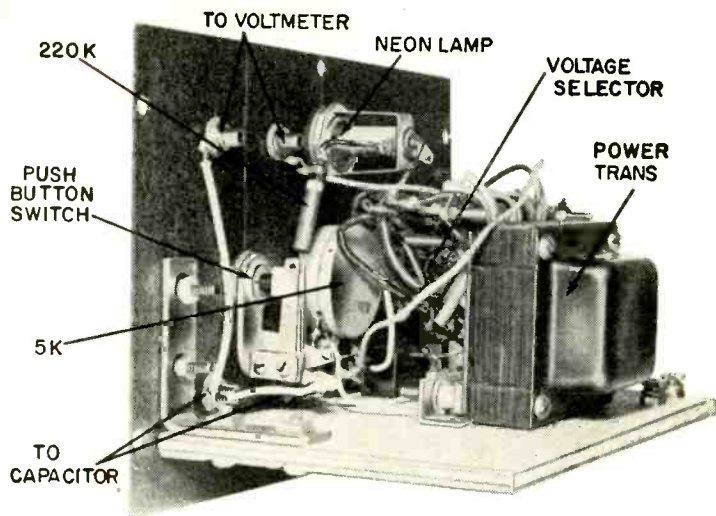

Layout of capacitor checker parts.

use when checking capacitors. On this scale, with 250 volts potential, I get a deflection of 4 divisions when testing a .001- μf capacitor, about 0.7 division for a .00025- μf capacitor and 46 divisions for a .03- μf unit.

By providing a table based on these and other readings the value of any capacitor from about .00025 to .05 μf can be determined immediately in the 250-volt range. If the capacitor to be tested is larger than .03 μf , say .07 μf , then it cannot be tested at 250 volts because the needle deflection would be too small to give an accurate reading.

This difficulty can be easily overcome simply by taking the next lower voltage from the transformer (in my case, the 120-volt tap) and then carefully adjusting the potentiometer to give full-scale deflection. Readings on this scale can be taken on capacitors ranging from about .001 to 0.1 μf , on the 25-volt scale from .005 to 0.2 μf , on the 5-volt scale from .03 to 1.2 μf and on the 1-volt scale from 0.5 to 10 μf . It does not matter what the scale ranges are on your multimeter or even a simple high-resistance ac voltmeter, you can make your calibration to suit.

When the capacitor to be tested is placed between the alligator clips (see diagram), it is shorted and the meter reads the transformer voltage. Pushing the test button removes the short and places the capacitor in series with the circuit so you can take the capacitor reading. Release the button and check to see that the voltage has not changed while testing. You now have a simple method of getting an exact voltage across the terminals of the capacitor under test and reading the meter deflection. You know that any other capacitor that gives the same deflection under the same voltage will have to have the same capacitive reactance (and capacitance). Thus you can equate the scale divisions with microfarads. This is your test scale.

It is possible to calculate the exact reading for every capacitor within the

range of the multimeter, but it is a lot of trouble. It is easier to just pick up a couple of dozen good fixed capacitors from .00025 to about 10 μf and, one by one, get the readings at the various voltages. Then make a table similar to that shown. When testing a capacitor, should the needle just barely dip, you will have to turn to a lower voltage. If the needle swings too near zero, you will have to use a higher voltage. The alligator clips are very

| TYPICAL CAPACITOR RATINGS (50-division scale—numbers indicate divisions from full scale) | | | | | |
|---|----------------------|------|------|------|------|
| Capacitor (μf) | Meter Scale—Volts Ac | | | | |
| | 250 | 100 | 25 | 5 | 1 |
| .00025 | 0.7 | | | | |
| .001 | 4.0 | 1.5 | | | |
| .002 | 10.0 | 4.0 | | | |
| .005 | 20.0 | 8.5 | 1.5 | | |
| .01 | 34.0 | 18.5 | 4.0 | | |
| .015 | 41.0 | 28.0 | 7.0 | | |
| .03 | 46.0 | 39.0 | 14.0 | 2.0 | |
| .05 | 48.0 | 45.5 | 23.0 | 4.0 | |
| 0.10 | | 48.0 | 33.0 | 8.0 | |
| 0.20 | | | 44.0 | 16.5 | |
| 0.50 | | | | 36.0 | 8.5 |
| 1.0 | | | | 44.0 | 10.5 |
| 1.2 | | | | 45.0 | 11.0 |
| 2.0 | | | | | 22.0 |
| 4.0 | | | | | 36.0 |
| 6.0 | | | | | 42.0 |
| 8.0 | | | | | 46.0 |
| 10.0 | | | | | 47.6 |

handy for they bite onto almost any kind of capacitor connection. If a capacitor should suddenly short, no harm will come to the meter—it will simply swing to full deflection and stay there.

Because the test voltage at times is as high as 250 it is advisable to open the line switch when clipping to a capacitor. When checking a pile of capacitors, one is apt to become confused and either snap the switch twice or not at all so to be absolutely safe I included the little 1/25-watt neon lamp in the primary circuit so it would glow whenever the primary circuit was energized. END

NEXT MONTH

Golden Ears or Bats' Ears?

Is the widely touted frequency response of modern high-fidelity audio equipment necessary—or useful? This and some other fetishes of hi-fi are discussed—and demolished—by George Fletcher Cooper.

Water Is the Trigger

A 1-transistor alarm that senses rain and actuates a relay to shut windows and doors, or warns sleepers of rain. It can also be adjusted to act as a humidity alarm or relay.

Tube Changers and "tube changers"

Depending on whether the service technician knows what he is doing or not, tube changing can be the quickest and best service technique or it can be worthless. The Old-Timer distinguishes between tube changers and Tube Changers.

ABC's of MOBILE RADIO

Part III—Circuitry and special features of mobile radio equipment

By LEO G. SANDS

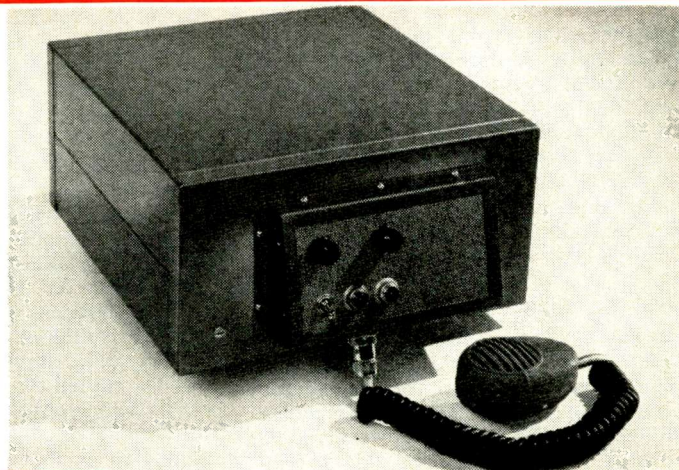

New 450–470-mc mobile radio developed by Bennett Laboratories is an AM unit.

ALL makes of mobile equipment are essentially similar: the transmitters must conform to the same FCC technical standards and the receivers must have competitive characteristics. They do differ in circuitry, special features and styling.

Mobile equipment

A mobile unit is a radio station on board a vehicle or one carried by a person. A typical mobile unit consists of a transmitter and receiver with their power supply, an antenna system, hand microphone or handset, speaker, control head and interunit cabling. The transmitter, receiver and power supply are usually housed in a single sheet-metal case, forming a package often called a "communications unit," which is mounted in the trunk or under the dash of a passenger automobile (or in a box or other protective enclosure when installed on a truck).

Some manufacturers have weather-proof cases for radio units that will be exposed to the elements. Sometimes the radio is installed without an external protective enclosure when used indoors. The control head, speaker and microphone are installed near the driver. Mobile communications units installed under the dash of a vehicle are generally provided with a built-in speaker, and the controls are mounted on the front panel.

The transmitter, receiver and power supply may be on individual chassis strips fastened together or combined on a single chassis. Sometimes, there is more than one receiver strip and, in some sets, space for selective-calling decoders or auxiliary audio amplifiers is provided. In some early sets, the transmitter and receiver were packaged as separate units.

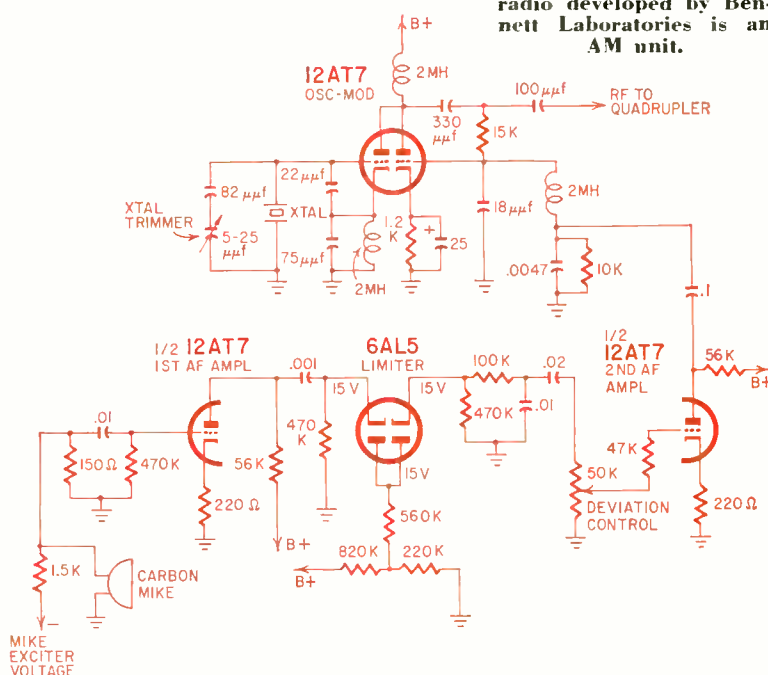

Fig. 1—Unique phase modulator used in the Bendix Dyna-Com 1V14A for the 25–54-mc band.

Mobile units are also available for the 1.6–8.0-mc portion of the radio spectrum. Operation at these relatively low frequencies is restricted to certain industries and governmental agencies which have special need for longer-range communication than is normally available in the vhf and uhf bands.

These medium-frequency mobile units are AM whereas most vhf and uhf equipment are FM. AM vhf sets, compatible with aviation radio systems, are used on land vehicles in airport utility applications and are operated

in the 118–134-mc aeronautical band. Some low-power-industrial (LPI) units for the 25–54- and 152–162-mc bands are also AM. Also using AM is a new 450–470-mc mobile unit recently developed by Bennett Laboratories.

Ordinarily, the mobile transmitter and receiver are operated sequentially. The receiver is left on so a signal can be intercepted. A squelch circuit silences the speaker except when a strong enough signal to override background noise triggers the squelch circuit and activates the receiver's audio amplifier.

RADIO

The receiver is disabled and the transmitter turned *on* with the press-to-talk button on the handset or palm microphone. This also switches the antenna from the receiver to the transmitter. When the press-to-talk button is released, the transmitter is turned *off* and the receiver turned on.

Rated power output of mobile transmitters ranges from 0.1 to more than 100 watts. Most mobile units operate interchangeably from either a 6- or 12-volt battery, although there is a trend toward eliminating the requirement for 6-volt operation since modern cars have 12-volt batteries. Mobile units for on trains are generally designed for direct operation from 64 volts dc though some operate from 117 volts ac furnished by a de-to-ac rotary or vibrator type converter.

25-54-mc equipment

Because of its long-range capabilities, the 25-54-mc band is popular and used by nearly all who are eligible for licensing in this band. Ignition noise and skip interference, however, are more of a problem than at higher frequencies.

Most mobile radio manufacturers build units for this band. Bendix Radio, for one, makes both wide-band and narrow-band mobile sets in 30- and 60-watt models. They can be operated from either 6- or 12-volt batteries without modification and are available with vibrator or transistor power supplies.

The Bendix Dyna-Com 1V14A is a narrow-band model for operation on any frequency in the 25-54-mc range. Output power is 30 watts. Frequency stability of $\pm 0.003\%$ is obtained without a crystal oven while $\pm 0.0006\%$ stability is realized when a temperature-controlled crystal oven is used. Crystal frequency is multiplied 16 times by a quadrupler and two doubler stages. A single 6146 is used as the final rf amplifier. In the 60-watt model, a pair of 6146's is used.

Bendix uses the unique phase modulator shown in Fig. 1. A 12AT7 dual-triode serves as the crystal oscillator-modulator. The audio modulating signal is fed to the grid of one of the triodes, causing both phase and amplitude modulation. The following class-C stages erase the amplitude modulation, yielding an FM signal at the transmitter's output.

The signal from the microphone is amplified by one section of a dual-triode whose output is fed to the second audio amplifier stage through a dual-diode limiter. The limiter, which uses biased diodes, prevents overdriving the second audio stage, effectively eliminating overmodulation. A 50,000-ohm potentiometer at the input of the second audio stage may be adjusted to set maximum frequency deviation to any point between 0 and ± 15 kc.

The receiver employs a unique double-conversion superheterodyne circuit. However, three, not two intermediate frequencies are used. The out-

put of the mixer is at 5.8 mc. The main if amplifier and first and second limiters are tuned to 262.5 kc. The second limiter, however, also acts as a frequency doubler. Its plate circuit, tuned to 525 kc, feeds a third limiter which in turn feeds the discriminator, also tuned to 525 kc. The frequency-doubling action also doubles frequency deviation at the discriminator's input.

To provide ± 7.5 -kc if bandpass and more than 100-db attenuation of signals ± 17 kc off frequency center, two 5.8-mc filter networks are used between the first and second mixers, and four 262.5-kc bandpass filters in the main if amplifier of narrow-band models. Nine triodes and only one pentode are employed as amplifiers in the if section. However, pentodes are used in the three limiter stages. Most of the triode if amplifiers are used in a grounded-grid arrangement and are followed by a cathode follower. Thus, the if transformers are connected between two cathodes rather than between plate and grid as they would be in a conventional pentode if strip.

The Bendix Dyna-Com low-band sets have three separate chassis. One contains the transmitter, another the receiver. The power supply, receiver audio output stage and transmitter speech amplifier-limiter are on the third. All three are in a single metal enclosure.

152-162-mc units

Much of the available so-called 152-162-mc band equipment is also operable in the 144-148-mc Amateur band as well as the 162-174-mc Government band.

This is true of General Electric's Progress Line. This equipment may be packaged in various combinations in different size cases, as is true with 25-54-mc G-E units, to meet individual requirements.

G-E model 4ET21 transmitters are rated at 50 watts output when operated between 144-162 mc, and 40 watts from 162-174 mc. The crystal frequency is multiplied 24 times and frequency deviation can be adjusted from 0 to ± 15 kc for wide- or narrow-band operation. Deviation is automatically regulated to prevent overmodulation. Two-channel operation may be obtained by adding a second crystal oscillator. Four frequency-multiplier stages are used, compared to three in G-E equivalent low-band (25-54-mc) equipment. Otherwise the circuitry is similar.

In G-E model 4ER25 receivers, as in low-band G-E units, multiple-tuned circuits are used ahead of the rf amplifier and between various stages. Separate crystals are used for the first and second converters (mixers). The first if amplifier section is tuned to 8.7 mc and the second section to 290 kc. Similar circuitry is used in G-E low-band receivers. The if filters may be replaced when converting from wide-band to narrow-band operation.

Two limiter stages precede a Foster-Seely type discriminator which drives

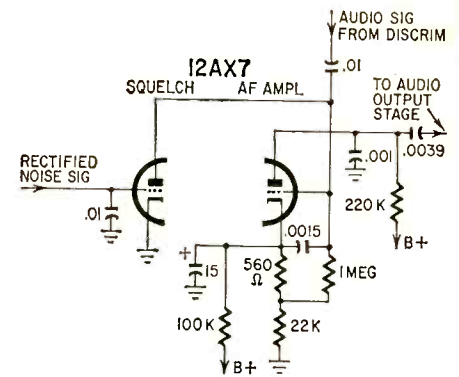

Fig. 2—Simplified diagram of the squelch circuit found in G-E model 4ER25 receivers.

both the audio amplifier and the squelch circuit. In the squelch circuit, shown in simplified form in Fig. 2, the higher-frequency components of the noise voltage at the discriminator's output when no signal is being received are amplified and fed to a noise rectifier. The dc output of the noise rectifier, which is a voltage doubler, is fed to the squelch tube. The grid of the squelch tube is driven to cathode potential, causing plate current to flow and developing a large drop across the plate resistor. This biases the first audio amplifier to cutoff, disabling it and electronically muting the speaker.

When a strong enough signal is received, the high-frequency noise components are eliminated from the discriminator output by the limiter stages. The squelch tube no longer disables the audio amplifier, because of the absence of noise, the received audio signal is amplified and heard through the loudspeaker. Squelch threshold is set by an external variable control.

The choice of 6- and 12-volt power supplies which use vibrators or a combination of a vibrator and a dynamotor depends upon transmitter requirements. There are also transistor power supplies. Smaller than their electromechanical equivalents, they have no moving parts.

For the 450-470-mc band

Several makers are turning out uhf mobile units for the 450-470-mc band. Transmitter power is less significant at ultrahigh and microwave frequencies and range is limited more by obstructions in the signal path than by lack of power. To get a significant extension in range by raising transmitter power would require a drastic increase, beyond the capabilities of existing mobile equipment.

When operating on the same frequency, the man with the higher-powered rig has the advantage that his signal can sometimes *capture* receivers within range, blanking out a signal from a lower-powered transmitter. This *capture effect* occurs in FM systems. The stronger signal saturates the limiter of a receiver, making it insensitive to a weaker signal on the same frequency. The stronger signal

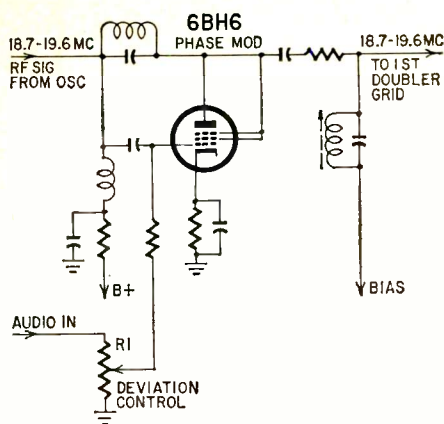

Fig. 3—This phase modulator is in the Kaar Expeditor, 450-470-mc transmitter. It is shown in simplified form.

does not necessarily come from the most powerful transmitter but could come from a lower-powered transmitter a short distance away.

While many uhf mobile transmitters on the market can be loaded to as much as 50 watts input to the final, Kaar Engineering Corp. deliberately designed its TR500 and TR501 Expeditor mobile units for lower power. The transmitters of these 450-470-mc mobile units are loaded to 12 watts input to the final on frequencies where more than 10 watts is permitted and to 10 watts for use in the Citizens band.

Actual field tests revealed that under conditions when a 50-watt-input unit provided 12-mile range, a 10-watt set reached out to 10 miles.

Since a 10-watt set would provide adequate range in urban applications, Kaar designed a compact uhf mobile unit which consumes very little battery power. When transmitting, only 8.5 amperes is required (with 12.6 volts dc input) compared to 20 or more amperes for higher-powered sets.

The transmitter, receiver and transistor power supply are housed in a single case. The model TR500 is intended for mounting under the dash or for use as a base station. It has a built-in speaker, and the operating controls are on the front panel. The TR501, intended for trunk installation, has an external control head, external speaker and remoting cables.

The transmitter section employs nine tubes. A new type, the 6939, is used in the tripler and power amplifier stages. It costs considerably less than tubes used in these stages in earlier equipment. Tests also indicate that it has a greater life expectancy.

While many vhf transmitters employ conventional coils and capacitors in the rf tank circuits, resonant lines or cavities are used in uhf transmitters, lines tunable by trimmer capacitors are used in the plate circuit of the tripler and both the grid and plate circuits of the power amplifier of this equipment.

Frequency stability is $\pm 0.0025\%$ in standard models and, when a temperature-controlled crystal oven is used,

stability is increased to $\pm 0.001\%$. The crystal frequency is multiplied 24 times.

Fig. 3 is a simplified schematic of the phase modulator. The audio signal from the speech amplifier is fed through a speech clipper to the grid of the 6BH6 phase modulator. This causes the rf signal being fed to the first doubler to lead and lag in step with the modulation. This changes the phase of the rf signal reaching the first doubler, giving the effect of frequency modulation. Potentiometer R1 can be set to produce frequency deviation from 0 to a maximum of ± 15 kc.

Overmodulation is prevented by a speech clipper inserted between the speech amplifier and the phase modulator. Fig. 4 shows the speech amplifier and clipper sections of the transmitter. The components have been selected to favor amplification of speech between

ciated oscillator feed local-oscillator signal to the third mixer.

An adjustable L-C filter assembly between the third mixer and the 1,500-kc if amplifier, normally supplied with the equipment, provides adequate selectivity for operating on a 100-kc channel-spacing basis (100 db down at ± 100 kc). Another filter may be installed at any time to provide adequate selectivity for 50-kc channel spacing (100 db down at ± 50 kc).

The squelch circuit is of the signal-to-noise ratio type, activating the first audio amplifier when background noise is quieted by the presence of a signal. An afc circuit automatically adjusts the first and second mixer local-oscillator frequencies to the incoming signal. The afc correction ratio is 5 to 1 over a frequency range of ± 20 kc; a switch is provided for disabling afc if desired.

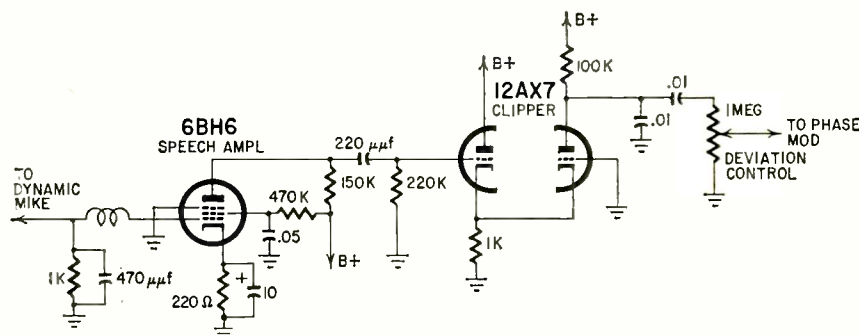

Fig. 4—Speech amplifier and phase modulator circuitry of the Kaar TR500.

300 and 3,000 cycles. The clipper is a two-stage cathode-coupled amplifier which saturates when overdriven, limiting the amplitude of the audio signals reaching the modulator.

The receiver has 18 tubes. It employs triple conversion using 50 mc, 10 mc, and 1,500 kc as intermediate frequencies. Two rf stages, employing coaxial lines, precede the first mixer, which delivers a 50-mc signal to an if amplifier which feeds the second mixer. One if stage at 10 mc feeds the third mixer whose 1,500 kc output is amplified by two more if stages. Two limiter stages precede the phase detector which feeds audio to a two-stage audio amplifier.

A single crystal provides local-oscillator signal for both the first and second mixers. The crystal signal is fed through two tripler stages to the first mixer and directly to the second mixer. A separate crystal and asso-

The afc control voltage is obtained from the cathode of one of the diodes of the unique phase detector (discriminator) shown in Fig. 5. This detector is sensitive to changes in phase of the incoming if signal yielding the audio component which is fed to the audio amplifier.

The Kaar Expeditor is furnished with either a transistor power supply for 12-volt dc operation only or a universal vibrator type supply for 12-volt dc or 117-volt ac operation. The latter unit permits using the same set as either a mobile unit or as a base station.

So far we have examined several types of mobile equipment. Units for 25-54-, 152-162- and 450-470-mc bands have been described. Next month we continue with details on portable equipment, railroad radio, and AM operation in the 118-134-mc band. A few words on antennas and a forecast of things to come end the series. TO BE CONTINUED

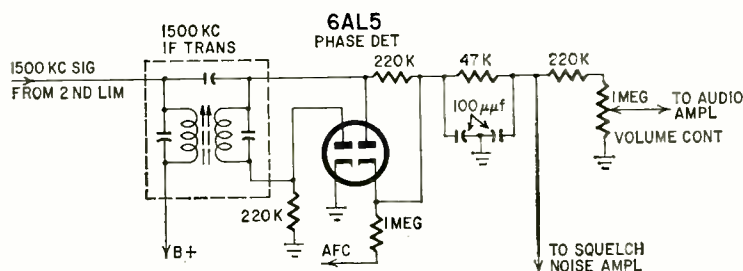
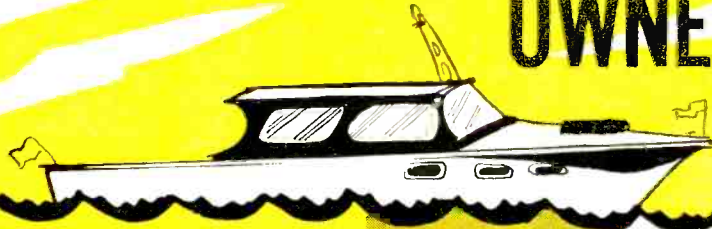

Fig. 5—Phase detector in the receiver section of the Kaar TR500.

You can determine the distance to the ocean floor with an echo sounder. But can you tell someone how it works and can you fix one that comes into your shop?

ECHO SOUNDERS for SMALL BOAT OWNERS



By **ELBERT ROBERSON**

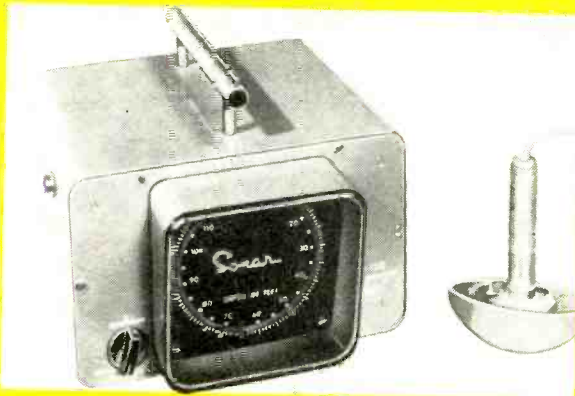

Sonar portable echo sounder with single-hole transducer.



Bendix recorder. Right: double type transducer. Left: power cable, "stuffing tube" seals transducer cable passing through hull.



Ross Sportsman echo sounder consists of indicator, power unit and transducer.

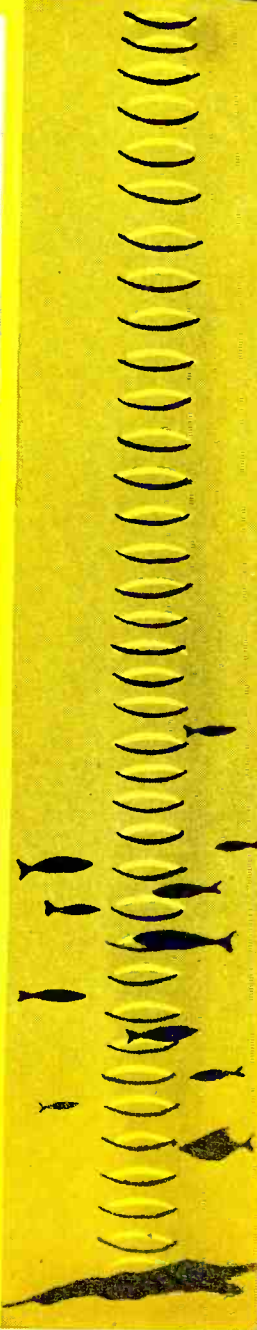

WHEN a person gets out in a boat, the land may fade in the distance and seem very remote. Actually, it is never very far away—straight down. Knowing just how far away this closest land lies has always been one of the navigator's prime concerns. And nowadays, the term "navigator" means about 30 million Americans. Use your electronic skill to help these boatmen keep track of the bottom, and you'll be aiding public convenience and safety, and very likely helping yourself financially.

The first commercial echo sounders were several-hundred-pound brutes scattered in pieces throughout a ship, from the bridge deck to the keel. To carry one, a vessel had to be a thousand-tonner, with an owner having money to match. Today, a good sounder can be bought with lunch money and carried away under an arm. No toys, either, are these. They will spot the bottom as effectively as the big babies, and even find fish.

The science of echo sounding began with percussion devices, set in the hull of a ship, that periodically sent out a walloping burst of sound. An operator equipped with a microphone, headset and stop watch measured the interval between the main bang and the echo from the bottom. Sound has an average velocity in salt water of 4,800 fps (feet per second). If the bottom lay 2,400 feet below, the sound would return in 1 second.

In shallow water, it would take a fast man with a stop watch to measure this interval, so various clockwork mechanisms were devised. One had a depth-graduated dial which started revolving when the sound was sent out. The returning echo stopped the dial, and the distance to the bottom could be read off. Primitive though it may seem, this basic scheme is so effective that some variation of it is employed in most echo sounders used today.

The timer indicator

The heart of most modern echo

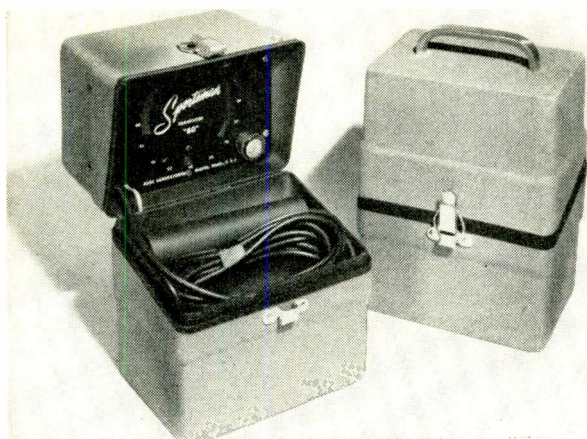

Ross Labs transistor sounder uses permanently installed or portable transducer.

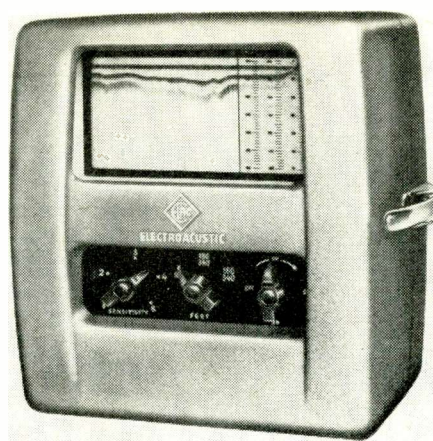

ELAC (Electroacoustic) echo sounder showing recorded trace of bottom.

sounders is a constant-speed ac motor, which drives a rotating arm carrying a neon bulb at its end. The circle described by the neon lamp on this arm constitutes the time base, and foot or fathom (6-foot) calibrations are superimposed on a transparent cover.

The rotating arm also is fitted with a contactor or magnetic keying arrangement which initiates the sound pulse at time zero. A returning echo causes the neon bulb to flash, and the distance to the bottom is read off the scale. By running the arm at different speeds, the maximum range of the indicator is made to be any desired value from under a hundred feet to many thousands.

Motor speed and accuracy depend upon a carefully regulated power supply, which converts dc power from the boat's batteries to ac. Two kinds of power supply are used: the vibrator type, which chops battery current into square waves that are stepped up to the motor voltage by a transformer, and the more recent transistor oscillator or chopper, which does the same thing electronically.

Instead of indicating depths with a flashing light, some instruments are built to record the contour of the bottom on a specially prepared sheet of graph paper. In place of the revolving arm an electrical stylus on a motor-driven belt writes vertically on the slowly moving sheet of paper. At the return of each echo, the stylus burns a mark, which is interpreted in terms of depth from calibrations printed on the paper. The result is a profile map of the bottom over which the boat has sailed. By comparing this with a standard navigational chart, underwater landmarks may be spotted, or schools of fish.

One instrument, manufactured by Bludworth Marine, has an all-electronic timing and indicating system. A multi-vibrator flip-flop and integrating circuit allows current flow to build up through a conventional meter 12 times a second. The sound signal is sent out in synchronization. If no echo is re-

turned within the 1/12 second, the meter will reach full scale. However, when an echo is received, the integrating circuit is cut off, allowing only a proportionate amount of the full-scale current to flow. Therefore, the angle of needle deflection indicates the depth, up to 200 feet.

The most elaborate instruments, used on large fishing vessels or ocean-going ships, use electronic timing circuits, with depths indicated as a trace on a cathode-ray tube.

Transducers

The next distinguishing feature of an echo sounder is the transducer system which sends the pulse of sound downward into the water and receives the echo. Some instruments have two transducers—one for each function—while others have one that serves both for sending and receiving.

Magnetostriction transducers use a stack of nickel laminations, excited by current through a coil. An oscillatory discharge of current through the coil causes the nickel to expand and contract, or "ring," and the resulting sound is transmitted from the transducer face to the water. Oscillating frequencies are in or near the ultrasonic range, from 14 to about 50 kc.

Piezoelectric transducers use Rochelle salt crystals or ceramic wafers. An oscillatory pulse of voltage applied to the crystal electrodes causes physical oscillation, which is transmitted through the transducer face to the water. Frequencies used with piezoelectric transducers extend all the way up to 500 kc. Low frequencies have the longest range, while high frequencies detect smaller objects and have better resolution.

For insulation and cooling, and to seal out moisture, transducer housings are filled with a special oil which also acts as an efficient conductor of sound. Most housings are designed to be fitted onto the surface of the keel or the boat's hull, while others are intended to be recessed to present a smooth outer surface to the flow of water. Sometimes transducers are installed

inside the hull, in a specially constructed water-filled well. This form of installation eliminates holes in the hull and is a convenient method to use for installations made while the boat is in the water.

Driver-oscillator

To excite the transducer a powerful pulse of current or voltage which oscillates at the transducer's resonant frequency must be generated. The simplest drivers use a gaseous discharge tube or thyratron, fired by the keying circuit in the timer-indicator, to discharge a capacitor into a magnetostrictive transducer. Circuit time constants are chosen to create an oscillatory current discharge at the desired frequency.

Another system uses a coil in parallel with a piezoelectric transducer in the cathode circuit of a thyratron. When the keyer drives the thyratron into conduction, a capacitor discharge is impressed upon this cathode "ringing circuit," creating the oscillatory pulse.

Still another method is to use a conventional oscillator circuit, such as the Colpitts or Hartley. Its output is impressed upon the transducer when the tube is keyed by the timer.

Video amplifier

The type of circuit used to amplify returning echoes depends upon the frequency of oscillation. At frequencies just above the audible range, a conventional R-C-coupled amplifier, using up to five tubes, with coupling components chosen to accentuate the "highs," will turn the trick. Higher-frequency amplifiers very closely resemble radio receiver if amplifiers, and have three or four transformer- or impedance-coupled stages.

Put it all together

You can see how the different parts of an echo sounder work together by tracing through the schematic of the Ross echo sounder (Fig. 1). The vibrator and vacuum-tube rectifier

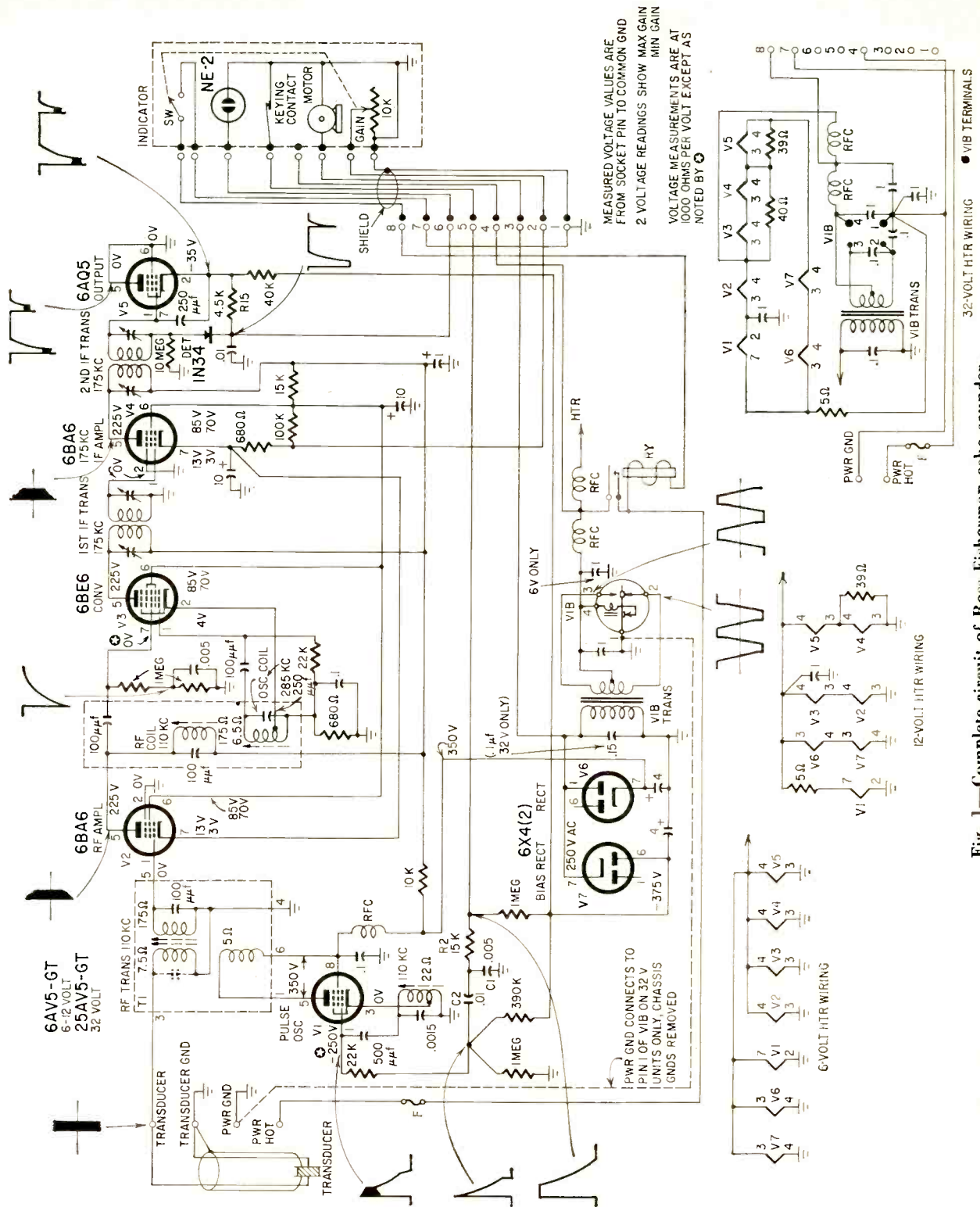

Fig. 1—Complete circuit of Ross Fisherman echo sounder.

power supply and the heater lineup follow conventional mobile equipment design. Power consumption is approximately 40 watts, with inputs of 6, 12 or 32 volts dc.

The synchronous ac timing motor (box labeled INDICATOR) is run from the secondary of the vibrator transformer, the speed being kept within $\pm 5\%$ by the vibrator. Connected to the motor shaft are the keying contractor and the neon-bulb echo indicator.

Once every revolution of the motor

arm, the keying contractor closes momentarily. This grounds the network through which a highly negative blocking bias from rectifier V7 is applied to the grid of oscillator V1. When the contact opens, the blocking bias is not reapplied for a total time of 1 millisecond, because of the grid network's time constant (R2, C1, C2). During the time that the bias is removed, V1 oscillates at 110 kc, its power output appearing at the plate.

This burst is applied through trans-

former T1 to the ceramic transducer unit, which oscillates in resonance, sending the pulse down through the water. Another secondary also sends a small amount of energy to the receiver.

While most receivers consist of a resistance, transformer- or impedance-coupled amplifier, this unit is a superheterodyne, closely resembling a low-frequency radio receiver. With a local-oscillator frequency of 285 kc, the signal is converted to 175 kc in V3, and amplified. The if amplifier ends up

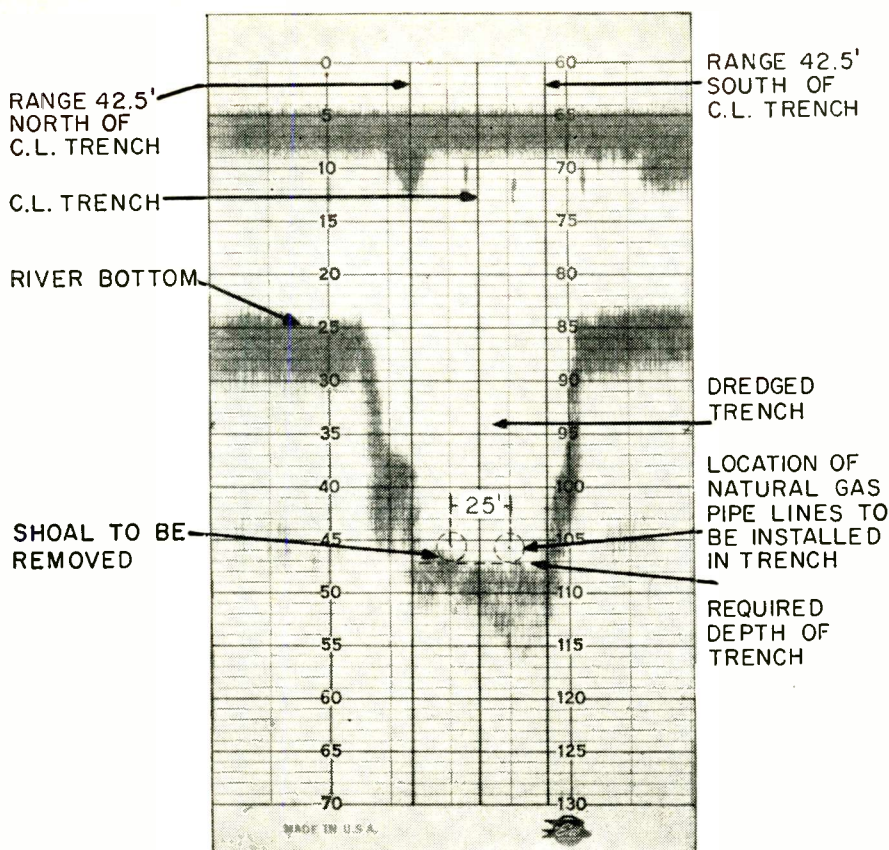

Chart of a pipe-laying operation as traced by a recording echo sounder.

with a diode detector that applies a negative voltage to V5's grid.

The output tube plate is grounded and its cathode connected to the -375-volt line through a 40,000-ohm resistor. The tube is used as a variable resistance. To see how it acts to trigger the neon indicating lamp, see Fig. 2, a simplified diagram of the circuit.

V5 forms part of a voltage divider that applies current to the neon lamp. When V5 conducts, as during normal operation (no pulse), it acts as a low resistance and does not let enough current flow through R15 to fire the neon lamp. When the 1-millisecond transmitted pulse from V1 reaches V5's grid, the tube is cut off and becomes a very high resistance. Now current flows through the tube is at a minimum and enough current flows through R15 to flash the lamp. This is at the zero depth point. When the pulse ends, V5 conducts once again.

The entire circuit has quick recovery so that, immediately after the pulse is transmitted, the system is ready for the reception of echoes. Echoes striking the transducer are coupled into the receiver by T1, and amplified.

After the neon lamp flashes at the zero depth point, it continues around the indicating scale. When the echo is picked up and fed through the receiver, V5 is cut off once again and the neon lamp flashes—this time indicating the distance to the bottom.

Any echo which falls outside the envelope of the transmitted pulse shows

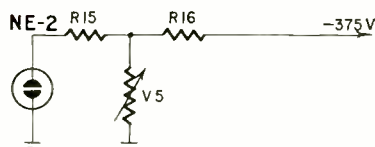

Fig. 2—Partial simplified schematic shows neon triggering circuit.

as a flash of light, so depths from about 1 foot down are registered.

Installation

Indicators should be located where they can be easily viewed by the man at the helm. Instruments using flashing

lights should be placed in an area where direct sunlight will not fall on the dial, if possible. An external power supply can be mounted in a locker below or in the engine compartment. Keep equipment as far from the compass as conditions permit, and make sure at the time of installation that putting the equipment in place does not swing the compass off.

Transducers are most easily installed when the boat is hauled out or laid up for off-season storage. For this reason, it is a good idea to sell the owner on the idea of an installation in the winter, so the underwater parts can be installed during layup. Some agencies sell the transducer in the winter, the remainder being purchased later. This has the further advantage to the customer of spreading out payments, and it also provides winter work for technicians.

Transducer installation ranges from mounting a clip on the hull, for portable or "flashlight" types, to boring one or more holes in the bottom, and fitting and sealing on fairing blocks for streamlining.

Techniques have even been worked out for installing the transducer on the bottom of the boat while it is in the water. This involves boring a hole in the bottom and sending a "leader" float through the hole and up to the surface of the water outside. Then the transducer cable is attached to the leader, and the unit is pulled down outside the hull. Next, the mounting bolt is pulled up into the hole, and the fastening nuts are installed. A little water comes into the boat in the process, but hardly enough to get your feet wet, and certainly not enough to be dangerous.

The transducer should be mounted so the sending face points exactly straight down. A position amidships is generally best, since the forward part of many fast boats is often out of the water, or at least picking up quantities of air which boil along the bottom for a considerable distance and would block off transmission and reception of signals. In the stern, engine and propeller

Oscilloscope indicator made by Edo.

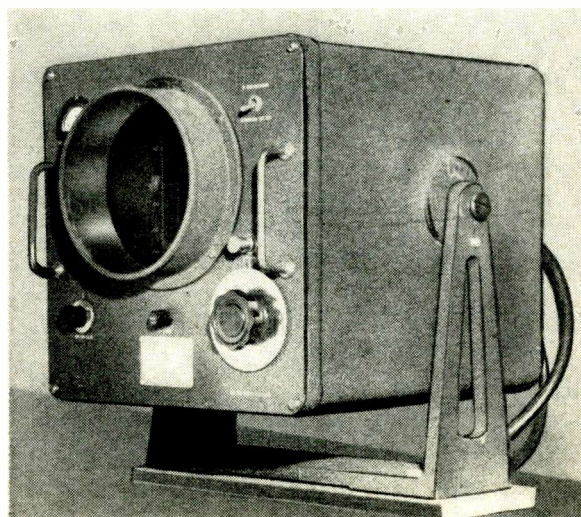

RADIO

vibration and noise create interference that might obliterate the sounding signals. Another consideration is to make sure that the transducer is not located where it might be damaged by the cradle when the boat is being hauled. The face of the transducer should not be painted.

Wiring should conform to manufacturer's instructions. Also, it is a good idea to get acquainted with the recommendations of the National Fire Protection Association. Standards for small craft are set forth in their publication No. 302, available for 50 cents from their office at 60 Battery March St., Boston 10, Mass. Be particularly careful that battery connections are not reversed from the specifications.

Service

As in other mobile electronic equipment, vibrators and tubes should be checked in case of trouble—and remember the neon bulb. Also, the motor should be inspected and lubricated periodically and slip rings, brushes and contactors must be kept scrupulously clean. Intermittent or jumpy indications are usually caused by a dirty contactor or slip rings. An oscilloscope is very handy for servicing by signal tracing, but in its absence trouble can be corrected by the well known procedure of cleaning and tightening connections, checking voltages and resistances, and exercising a little common sense.

One of the peculiarities of marine electronic equipment is that it suffers more from lying idle than from being used. Gear which is operated daily keeps dry. The controls and other vulnerable points are kept clear of corrosion. Capacitors stay formed and the owner becomes familiar with proper operation. Always stress the point that the equipment is aboard to be used, and actually benefits thereby. If the owner operates the equipment every time he is aboard his boat, service will probably amount to nothing more than a routine yearly check up. END

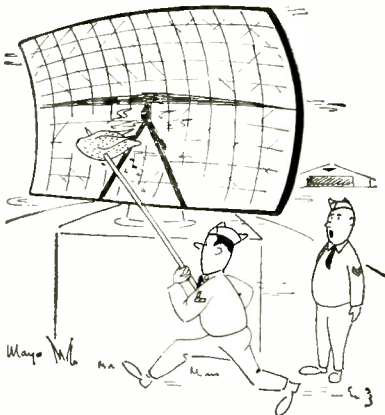

"Ok! Ok! Don't burn it to a crisp this time!"

RADIO TELEGRAPHY in 1866

Like Columbus, Marconi wasn't first

By **DARRELL L. GEIGER**

YEARs before Marconi was even born, a now forgotten Washington, D. C., dentist, Mahlon Loomis, was communicating by wireless telegraphy for distances of at least 14 miles. Thus, wireless communication, far from being new, is nearly as old as most other practical uses of electricity. The electric lamp was not invented until 1878, long after Loomis' successful experiments.

Dr. Loomis called his system "aerial telegraphy," and his first public demonstration was made in 1866 between two peaks of the Blue Ridge mountains of Virginia. A kite was sent up from each site, each with a small piece of fine copper-wire gauze attached to its underside. Metallic kite strings, 600 feet long, the ground ends submerged in water, conducted the signals to earth. Galvanometers were used to indicate signal reception.

In his later patent application he states that he dispenses with all "artificial" batteries, using the "natural" or



Dr. Mahlon Loomis.

Wall Street crash and later by the Chicago Fire.¹ Dr. Loomis died shortly after, without realizing his ambitions.

Loomis was led to his experiments by noting that in wire telegraphy, the earth (charged, it was then supposed, with negative electricity) could be made to serve as one conductor. Why then

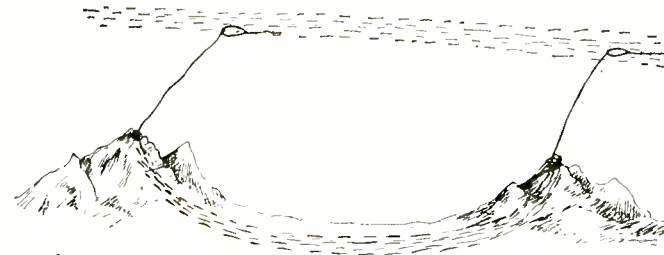

Sketch of Loomis' transmitting and receiving setup. (Reproduction from Loomis' sketch, 1865. Original drawing now in archives of Library of Congress, Washington, D. C.)

"free" electricity of the atmosphere for power "Upon these mountain tops I erect suitable towers and apparatus to attract the electricity—or in other words to disturb the electrical equilibrium—and thus obtain a current of electricity, or shocks, or pulsations which traverse or disturb the positive electrical body above and between the two given points. . . ."

Loomis states that reception was perfect during the cloudy part of the day, "as exact and distinct as any that ever traveled over metallic conductors." The distance was 14 to 18 miles. In 1896, thirty years later, Marconi had succeeded in signaling barely more than 1 mile. Loomis was granted patent No. 129,971, entitled "Improvement in Telegraphing," on his invention in 1872, two years before Marconi was born!

After receiving his patent Loomis, as had Morse before him, appealed to Congress for funds. But Congress did not have the imagination to cope with an idea this revolutionary. Funds were refused and two companies formed to back him were wiped out, first by a

could not the upper atmosphere, also abundant with electricity, be used as the other conductor, thus doing away with all wires?

By making contact with the atmospheric stratum of electricity through towers built on high mountains, Loomis visualized world-wide communication. The atmospheric electricity, which he considered as positively charged, would with the negative electricity of the ground furnish all needed power.

Should Loomis rather than Marconi be acclaimed the inventor of radio? Probably not. For one thing he did not know that his method of communication was by radio waves. Loomis' patent specifications show that he himself considered his method to be similar to that used with wire telegraphy. But as primitive as his ideas seem to us now, they were advanced for their time. Had Loomis lived, who knows how he would have influenced the early development of radio? END

¹ Mary Texanna Loomis, *Radio Theory and Operating*, Loomis Publishing Co., Washington, D. C., 1925.

EXPERIMENTER'S CARRIER- POWER RECEIVER

*Want something for nothing?
Try a free-power one-transistor
radio receiver that
doesn't need a battery*

By DR. WILLIAM H. GRACE

If you live within 10 miles or so of a broadcasting transmitter, this circuit is a way to get something for nothing. The field created by the nearby transmitter can supply the power you need to operate a 1-transistor receiver. Circuits of this type have appeared before (see "Transistor Radio Uses No Power Supply," *RADIO-ELECTRONICS*, April, 1955, and "Free Power Receiver," *RADIO-ELECTRONICS*, April, 1957). But the one described here has a few unusual features.

Some models consist of two receivers including separate antennas. In this unit (see Fig. 1) only one antenna is needed and the detector, amplifier and power supply are connected by only one lead to the rf or tuned section. No ground return is used as it is not needed. At first glance the circuit may appear unworkable, but it does work, and very efficiently at that.

Check for power

Before building any free-power receiver you should determine if your location, plus a suitable antenna system, will deliver enough power to operate the amplifier. There are at least two ways to do this. Dr. H. E. Hollmann, in his April, 1957, article "Free Power Receivers," suggests a formula for the purpose. It is a simple, workable method by which the transmitter's power, the effective length of the receiving antenna and the distance of the receiver from the transmitter are correlated mathematically to give the power available in microwatts.

There is one important factor Dr. Hollmann did not include in his formula that affects the strength of a

receiver's signal, and that is the height of the receiving antenna. In practice, antenna height contributes as much as its effective length to signal strength, so place the receiving antenna as high as you can possibly get it.

The second way to determine the amount of available power is empir-

ical—erect the longest and highest single-wire antenna possible in your location and connect it to the simple crystal set shown in Fig. 2. The tuner and the two diodes are connected with clip leads as these components will be used in the receiver. Place a microammeter across the diodes and, if you get a reading of 500 μ a or better, you should have enough power for a batteryless transistor radio. If you get a reading between 1 and 2 ma, you have enough dc to operate an efficient speaker. Of course, a good ground such as a water-pipe will contribute to the power received. Sometimes multiple ground connections to separate grounds produce even greater current.

In making your tests, be certain you have tuned in your strongest station because this is the frequency you will use later. In short, if you live within reasonable distance of a strong transmitting station, have an antenna at least 100 or 150 feet long and 35 to 45 feet high, you should have no power shortage. I have seen antenna systems only 75 feet in length at an average height of 35 feet that were capable of delivering better than 1 ma when located in a favorable spot and I have obtained nearly 3 ma, 17 miles north of a New York City station, at night during the winter season.

The receiver circuit

While the few components required are familiar to all radio men and need no description, the unconventional circuit does require some discussion. Its operation is similar to that of the double-diode arrangement in the power-checking circuit of Fig. 2 with detector

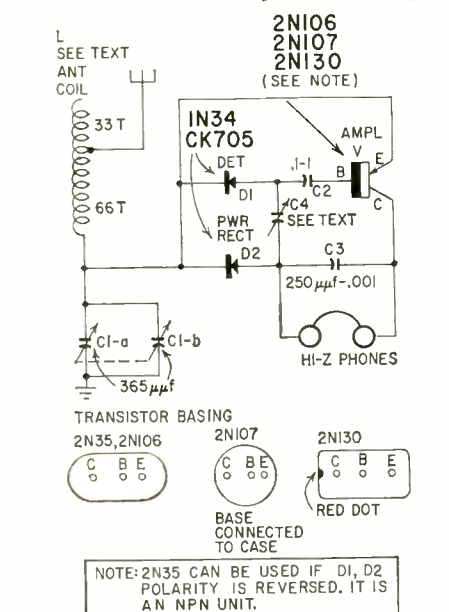

C1—2-gang variable capacitor, 365 μ F each section
C2—0.1 to 1 μ F
C3—250 μ F to .001 μ F
C4—(see text)
D1, 2—IN34, CK705
L—antenna coil, 99 turns No. 22 or 24 dcc on 2-inch diameter form, tapped at 33 turns
V—2N35, 2N106, 2N107, 2N130
High-impedance headphones
Miscellaneous hardware

Fig. 1—Circuit of the batteryless receiver.

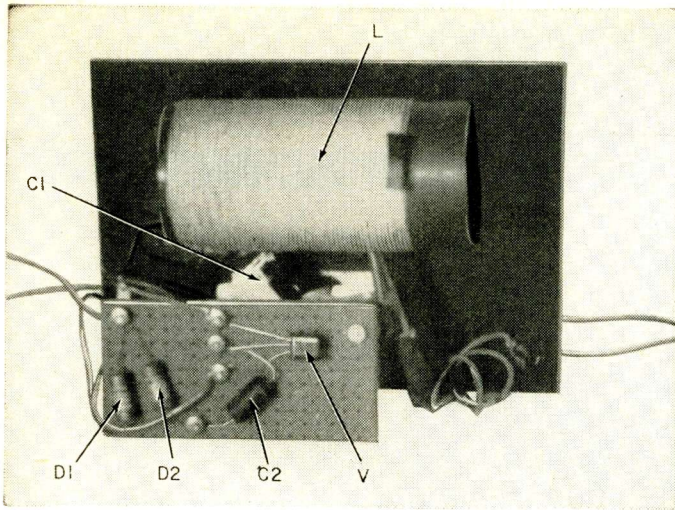

One possible parts layout for the carrier-power receiver.

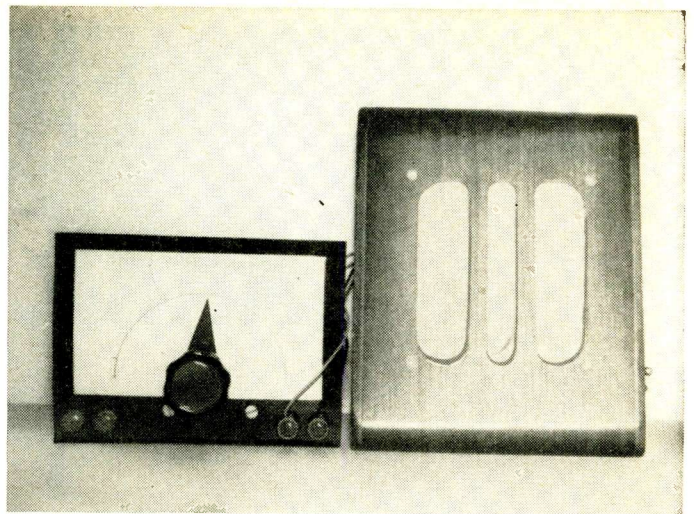

The author got enough output from his set to drive a speaker.

diode D1 working in conjunction with the emitter to the base element of the transistor. Diode D2 is set up so the rectified carrier dc is supplied to the collector in the proper direction. While the circuit appears freakish upon casual inspection, its operation is entirely conventional.

It may interest readers to know that in the power-checking circuit, one of the diodes may be replaced with an rf choke with equal efficiency. This latter type of one-wire feed was used quite often in the circuitry of wavemeters in the days of spark and is employed today in the Miller hi-fi crystal tuner.

Of the several types of diodes tested, the 1N34 and CK705 were found suitable, with perhaps a shade in favor of CK705's. Various types of junction transistors were tried and some performed better than others. Among those which seemed to produce the loudest and clearest signals were the Raytheon 2N106, 2N130, G-E 2N107 and Sylvania 2N35. The last is a n-p-n type and, if used, the polarity of both diodes must be reversed. The circuit works just as well with either type of transistor if proper current direction is insured. The value of the base capacitor is not critical and values from 0.1 to 1 μf were suitable. A base-bias resistor did not add to the circuit's efficiency. Try several diodes and transistors, using the ones that perform best in your final circuit. Many inexpensive types are suitable.

Almost any type of coil may be used in the antenna circuit. A single-layer coil of 99 turns of No. 22 or 24 dcc wire, tapped at the 33d turn allowed for adjusting the total inductance used, so I could adjust for the most favorable ratio of L to C in the series-tuned circuit. For best power response C1 should be the largest value that will let the circuit be resonant at a given frequency in respect to the value of L—more current is passed when the ratio of C to L is large. Naturally, a series-tuned tank is not the most selective type of tuning element, but selectivity

is not too important with this receiver. Because both the signal frequency and the power or carrier frequency are the same. A station has to be on frequency for the power circuit to function, hence the amplifier works only when there is sufficient power to activate it. Furthermore, it is unlikely that any builder lives at a location where more than two or three local transmitting stations furnish enough power for signal overlapping. So selectivity is sacrificed for simplicity.

Some operating notes

Receiver operation is exactly the same as that of a simple crystal set—the one dial is moved to the point of greatest volume. With certain transistors, a heterodynelike whistle may be heard just to the higher-frequency side of the station resonant point on the dial. The whistle is caused by feedback, but does not interfere with reception if the dial is turned a slight bit toward the lower-frequency side. By adjusting

C4, a small tuning capacitor or medium-sized trimmer, the whistle can be eliminated. The point of clearest reception is easily noted, and once adjusted need not be changed.

Another interesting point noted was that it does not seem to make much, if any, difference how long a conductor is used to connect the tuning circuit to the rest of the set. One experiment was made with the tuner proper left in one room while the rest of the unit was placed 40 feet away in another part of the house. There was no reduction in volume.

If the receiver is operating correctly, its output is in the order of four to eight times that of a plain crystal set. Exact measurements cannot be given because the volume always depends on the actual power delivered by the antenna. In some places the volume level is surprisingly strong—enough to drive a sensitive PM or an old magnetic type speaker, should one be at hand. Signals from a pair of headphones should be audible 10 or 15 feet away. The whistle effect will be absent and the quality ragged if power is borderline. A longer antenna will usually end this problem.

The percentage of modulation of the transmitter can also affect reception on a receiver of this type if the modulation is less than 100%, the quality of the receiver's output will be far better than otherwise. There must always be more carrier power to the collector than voice signal.

The experimental receiver described above uses the same station to furnish both the signal and power but somewhat more advanced circuitry leads to a batteryless receiver which uses the carrier frequency of a very strong transmitting station to amplify the signals from a low-level or weaker station on another frequency. The receiver described here serves as an interesting introduction to the construction of more complicated receivers using the free-power principle. And we all like to get something for nothing.

END

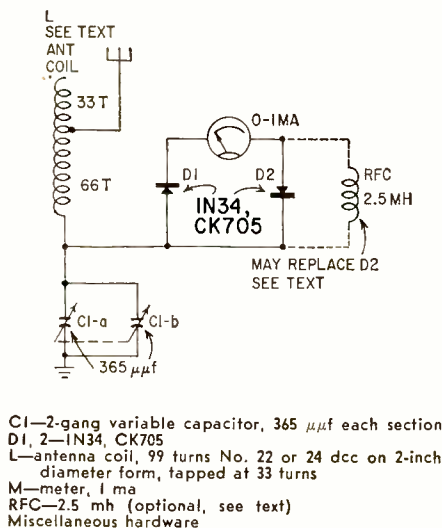
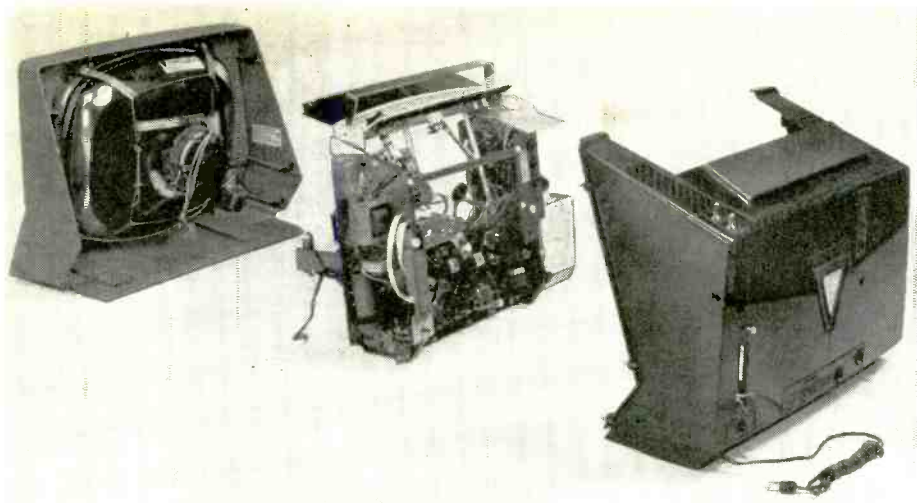

Fig. 2—To check available power use this setup.



EASE OF SERVICING is emphasized in this new 17-inch TV which doubles as a portable and table model. Housed completely in plastic, the chassis is exposed by removing eight screws (three on each side, two on the top) and sliding the cabinet off. The chassis may be completely removed by unscrewing two more screws, providing access to the filter capacitors. Made by Sylvania, this model is called the Dualette.

what's

new

?



MAGNETIC DISC RECORDER combines disc and tape techniques; records and plays back 70 seconds of material on each side of a 7-inch disc at 33 $\frac{1}{3}$ rpm. Recording grooves are premolded into the blank disc which is said to have a life expectancy equal to or greater than tape. Recorded material on the discs may be easily erased. The magnetic head (inset) consists of two C-shaped pole pieces which protrude through the narrow slot (arrow). The recorder in the photo was designed by RCA for broadcasting use; plug-in pickups convert it for playing of standard records or transcriptions. Another version is designed for computer use. No unit for use in the home has as yet been developed.

UNIQUE ANTENNA DESIGN using 33 end-fire arrays in parallel is a scale model of a 40-foot telemetry antenna which will soon be built for operation at about 200 mc by GB Electronics Corp., subsidiary of General Bronze Corp., Garden City, N. Y. The antenna has a gain of 30 db, and is the equivalent of a 60-ft. paraboloid. Other versions of this design, called SVE (for "swept volume efficiency"), replace parabolas in radar and scatter installations. Made of lightweight aluminum, they are far lighter and easier to ship, install and maintain than conventional parabolic units.

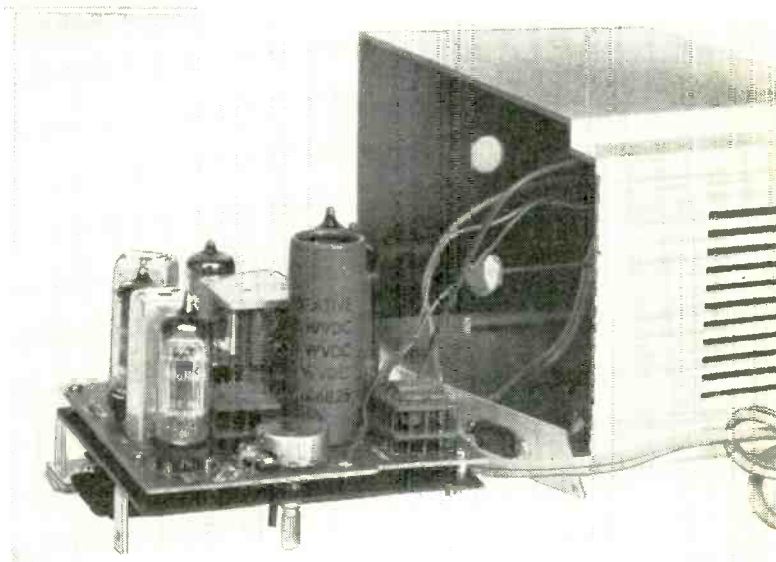

MODULES FOR THE KIT BUILDER have now appeared. This Knight chassis (model 83 Y 737 clock radio) uses two of them in its circuitry. The module terminals are pushed into predrilled holes in the printed-circuit board and soldered by the constructor on the under side. All the small fixed resistors and capacitors in the set are in the modules. The schematic supplied to the do-it-yourselfer is standard, with indications showing the module terminals.

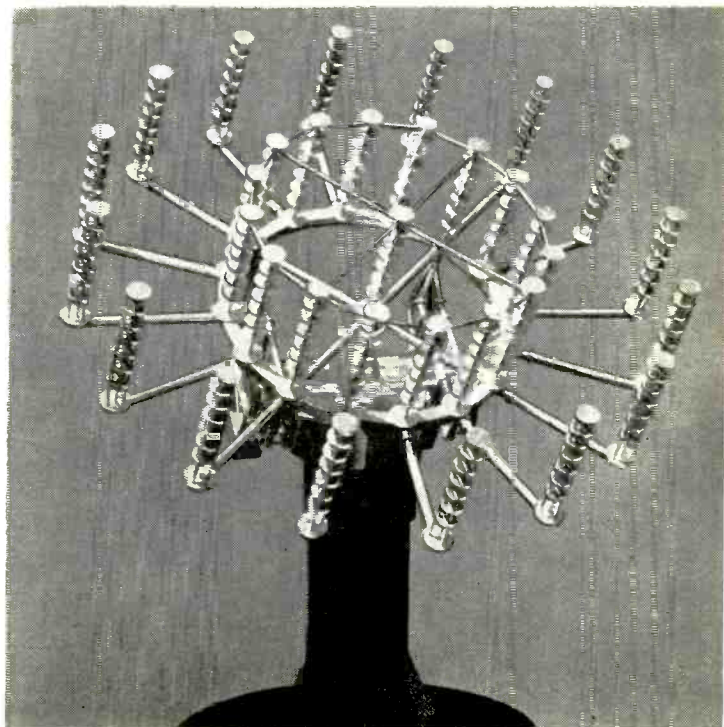

HUSH

the noise in antennas and lead-ins

Noise can be generated right in the antenna or lead-in—or in the connections. In fringe areas this added noise may make the difference between a usable picture and a snow-storm

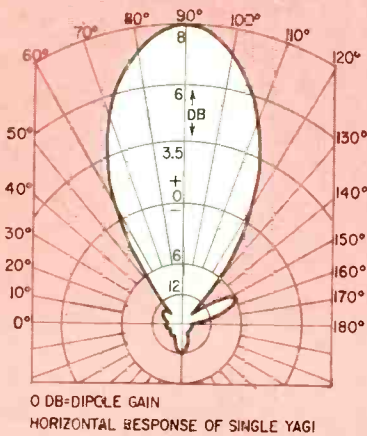

Fig. 1—Polar diagram for a single 10-element Yagi.

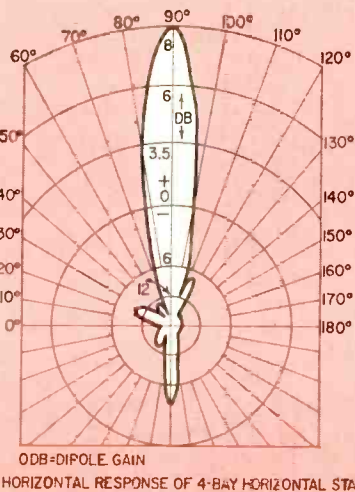
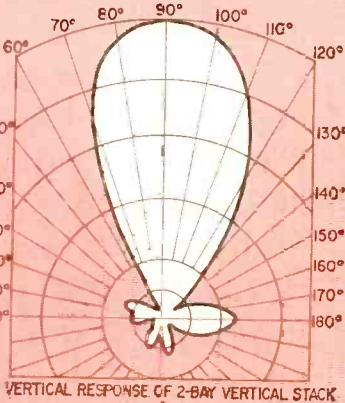
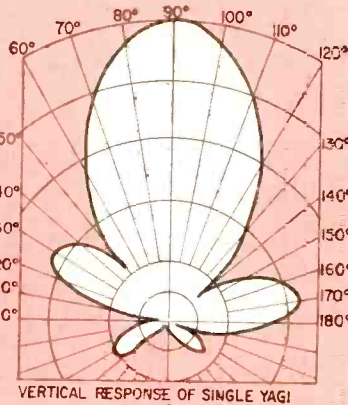

Fig. 2—Horizontal polar diagram for a 4-bay horizontally stacked array.

Fig. 3—These illustrations show how noise from above or below can be rejected by vertical stacking: a—vertical pattern of single 10-element Yagi; b—vertical pattern of two 10-element Yagis.



By The Engineering Staff,
Scala Radio Co.

WE measure signal strength in microvolts. If the number of microvolts is above a certain minimum value, we sometimes consider an antenna installation to be satisfactory.

Such a simple measurement can be misleading. What we really need to know is *how much the signal is above the noise level*. For example, 500 μ v on a field-strength meter is usually considered good. But such a 500- μ v signal can be completely unsatisfactory in a very noisy area. On the other hand, a signal of only 150 μ v can be very good if noise is low.

How antennas generate noise

Noise can be, and often is, generated right in the antenna and lead-in system. Metallic antennas corrode when exposed to the weather. Oxidation on metal surfaces adds resistance to the system and decreases antenna efficiency.

Oxidation is chiefly responsible for the noise that develops as the antenna ages. Here is what can happen: The lead-in terminals usually consist of zinc- or cadmium-plated steel bolts. They pass through holes punched or drilled through the aluminum antenna feed element.

Lead-ins and connecting lugs are usually made of copper. These metals fall at opposite ends of the galvanic

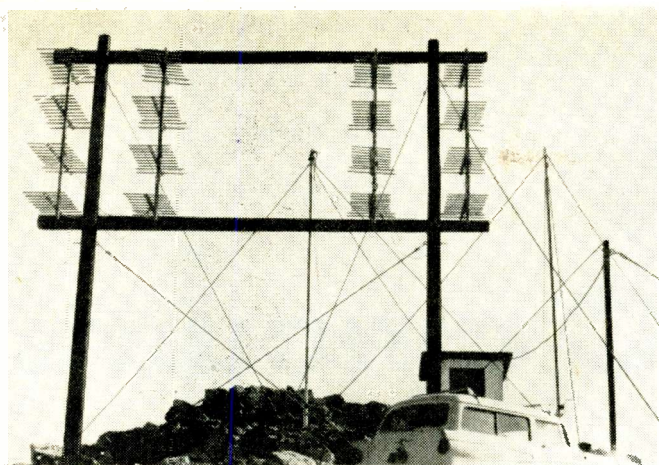

Installation at Eagle Mountain, Calif. The left bay is cut to channel 7, right bay to channel 9.

Courtesy Jerrold Electronics Corp.

table. Moisture causes them to form a battery, oxidizing and corroding the metal.

Vibration varies the pressures on the oxidized surfaces. This makes them a changing resistance in series with the transmission line. It changes the terminal impedance and causes the signal at the receiver to vary.

Corrosion progresses more rapidly as time passes. Eventually, a point is reached where there is no effective connection between transmission line and antenna.

The same situation occurs at points where antenna elements are spliced. Hence, we can reduce the inroads of corrosion by protecting connections from the weather. They should be covered with a good high-frequency insulating tape. You can also protect a joint with silicone jelly—Dow Corning No. 5, or some equivalent product.

Corrosion problems are reduced by replacing the cadmium- or zinc-plated screws with stainless-steel or Monel screws of the same size. Noise voltages generated by other joints, such as the connection of the matching section to the driven elements, can also be protected by tapes and plastics. The same precaution applies to joints at center folds, which are provided for easy assembly and shipping.

Polar diagram helps fight noise

We can reduce noise further by proper use of the antenna's radiation pattern (see "Dipoles and Yagis," November, 1958).

For example, Fig. 1 is the polar diagram for a single 10-element Yagi (for a forward gain of 8 db over a dipole). Note that the sensitivity lessens considerably at the sides and rear.

In addition to a gain of 8 db, we have pickup rejection exceeding 12 db from the sides and rear of the array. The smaller lobe at the right would not be present in free space. However, it should be considered in most installations, because of the disturbance of the antenna field by the supporting tower.

This means that much less noise is picked up from the sides and rear. If noise comes from the sides, it can be

reduced even further by horizontal stacking. Fig. 2 shows this. Note the increased rejection of pickup from the sides. We can increase this rejection still further, if we wish, by additional horizontal stacking.

If there is a noise source below (or above) the antenna array, we can help solve this problem by vertical stacking, as shown in Fig. 3. Two prominent but minor vertical lobes to the left and right of the single Yagi (Fig. 3-a) (caused by side radiation of the driven element) can be reduced considerably by using *two* vertically stacked antennas (Fig. 3-b). We can stack more than two arrays, to reduce these lobes still further.

Stacking in both horizontal and vertical planes reduces noise from both planes. For example, in the Barstow, Calif., community system, the antennas are located on a tower on a hillside. The city of Barstow is immediately below. A main highway is on the right. After experimenting with various methods of stacking, four Yagis were used for each channel, stacked both horizontally and vertically.

A community system in Guyman, Okla., on the other hand, had little trouble from the sides. Most of the noise was coming from *below* the antenna site. Hence, eight Yagis were stacked vertically for the troublesome channel.

The photo shows the Eagle Mountain installation, located approximately

175 miles from Los Angeles TV transmitters. After careful probing to locate a constant signal level and maximum rejection of man-made noise from the town 2,000 feet below, it was decided to use eight 10-element Yagis for each channel. They were stacked two horizontally and four vertically.

Co-channel interference

Co-channel interference is caused by two TV stations operating on the same channel. This is often a problem in community systems. In fringe areas, signals are received over long distances, because the antenna site is usually on a very high mountain or tower.

We recognize co-channel interference as a venetian-blind or windshield-wiper pattern in the picture. The windshield-wiper pattern results from interfering sync and blanking pulses. Sometimes, sound is distorted by co-channel interference.

The usual method of locating the source of interference is to study a map of the area. However, because of reflections, conclusions drawn from a map may be incorrect. Direction of the interference can be determined by rotating the antenna carefully, until maximum unwanted signal is noted. Then, measure the angle between the wanted and unwanted signals. This angle, plus the signal strength of the interference, gives the installation man the data needed to determine the required directivity of the array.

A single-channel Yagi has 30° to 60° beam width to the half-power point. Horizontal stacking of the two Yagis reduces this figure to half, approximately. If four Yagis are used, the figure is further reduced.

Thus, the greater the number of antennas stacked in a horizontal plane, the greater is the directivity obtained.

Remember, vertical stacking affects only the vertical lobe. Horizontal stacking effects only the horizontal lobe. Hence, if you need directivity in both planes, stack antennas both vertically and horizontally.

Following our discussion of noise rejection, the next article will cover locating the best antenna sites, shattered wavefronts, impedance matching, antenna spacing and phasing for maximum gain. END



TV'S

TRICKY

R-C CIRCUITS

By CYRUS GLICKSTEIN*

EVERY so often, in servicing some section of a TV receiver, I've come across a complex R-C circuit which made me scratch my head. Complex (series-parallel) R-C circuits don't act like series R-C circuits. They don't even act like each other. *Each basic type of complex R-C circuit acts in a different way.*

The circuit in Fig. 1 is part of the phase-detector system of horizontal afc (automatic frequency control) found in many TV sets. Afc keeps the horizontal oscillator at the correct frequency by changing out-of-phase sync pulses to a dc correction voltage when the oscillator starts to slip out of sync. Afc circuits must prevent noise pulses from developing any control voltage in the system, since that would cause a loss of sync. The systems must also prevent hunting.

Afc hunting

Too much correction voltage developed at the instant the oscillator goes off frequency causes hunting (moving rapidly above and below correct frequency). To prevent hunting, over-correction of the horizontal oscillator must be avoided by building up the correction voltage gradually.

The general operation of horizontal afc circuits has been described many times. However, almost no information has previously appeared on exactly how anti-hunt action takes place. A large correction voltage is developed instantaneously when circuit conditions change, but the afc circuit is designed to allow only a small part of this to be applied to the horizontal oscillator at the first instant. As the horizontal oscillator starts to come back to frequency, less correction voltage is developed. A point is finally reached where just enough correction voltage is generated to keep the oscillator at the correct frequency under the new circuit conditions. This full correction voltage is applied to the horizontal oscillator's grid.

Hunting is prevented by the small time lag between the instantaneous generation of the input correction volt-

age (across R3 or R4 in series with R2 in Fig. 1) and the comparatively slow increase of dc correction voltage applied to the grid (across C2). If the full correction voltage were applied immediately to the grid, the horizontal oscillator would shift frequency in the opposite direction, generating a correction voltage of opposite polarity to cause another frequency shift in the original direction, and so on. The oscillator would hunt above and below the correct frequency.

Therefore, the portion of the phase-detector circuit in Fig. 1 consisting of R1, C1, C2, R2 and R3-R4, has three functions:

1. It integrates out-of-phase sync pulses so that only the average correction voltage is applied to the horizontal oscillator to bring it back to the correct frequency.

2. It reduces the effect of noise pulses and minimizes development of a control voltage by these pulses.

3. It prevents hunting.

The R-C circuit has a long time constant and the correction voltage is taken off C2. It can therefore be considered an integrating circuit. The dc correction voltage is applied to one grid of the horizontal oscillator. Positive correction voltages decrease the oscillator's frequency and negative pulses increase the frequency.

A specific example will clarify this action. Assume the plate voltage of the horizontal oscillator drops. When this occurs, the oscillator shifts to a lower frequency. The horizontal sawtooth, fed to the phase-detector diodes (V2), is

Those odd-looking R-C networks in the TV set's horizontal circuits aren't so hard to understand

now out of phase with the incoming sync pulses. Negative pulses are developed across R2 as a result. These pulses are applied to the parallel combination R1, C1 in series with C2 (see Fig. 1). During the initial charge period, series capacitors C1 and C2 act as a voltage divider.

The capacitors charge through R3 or R4. This time, they charge through R3. The time it takes for them to charge depends on the circuit's time constant. At the first instant, the capacitors short out R2. As more sync pulses come in they start to charge. The pulse voltage divides across them in inverse ratio to their capacitance. That is, since C2 is 10 times as large as C1, C2 has approximately 1/10 as much voltage or 1/11 of the applied voltage. The capacitors charge through R3 but discharge slightly through R2 and R1 between pulses.

As C2 charges, the oscillator starts to return toward its original frequency due to the negative correction voltage on its grid. The sync pulses applied to R1, R2, C1 and C2 become smaller since the frequency is a little less off. As smaller sync pulses are applied to C1 and C2, the capacitors try to charge to a smaller voltage. They still continue to charge, since an integrating circuit is unable to charge instantly to the applied voltage because of its long time constant.

As C2 continues to charge, the oscillator's frequency continues to change toward the original frequency. The out-of-phase sync pulses become smaller. C2 continues to charge more slowly as

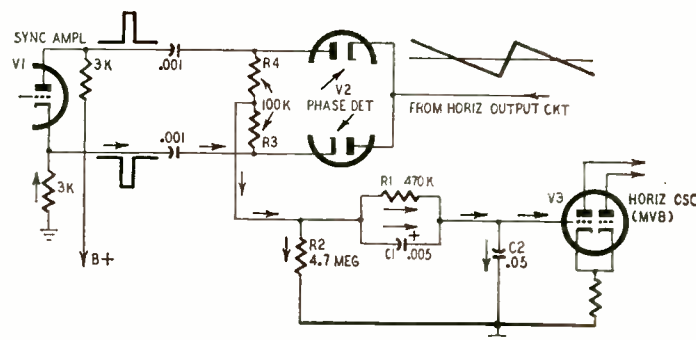

Fig. 1—Phase-detector R-C circuit. Arrows show charge path for C2 when negative incoming pulses are developed.

*Author of *Repairing Television Receivers* (John F. Rider Publisher, Inc.).

it is now closer to the maximum applied voltage. Also as C2 continues to charge, C1 reaches a maximum value and then discharges, allowing C2 to charge fully. (This action is typical in this type of complex R-C circuit and will be discussed in greater detail later.)

Phase and frequency

A point is reached where equilibrium is established with C2 charged to the maximum amplitude of the sync pulses and there is just enough correction voltage at the oscillator's grid to give the correct oscillator frequency. The phase of the picture is slightly different but the frequency is correct.

The difference in phase causes a slight sideways displacement of the picture. This displacement is unavoidable and necessary to keep generating a correction voltage as long as the oscillator's plate voltage remains low (Fig. 2). The same kind of corrective action occurs for any change in operating conditions of the horizontal oscillator circuit.

Action of this circuit becomes clear by comparing it with several basic circuits. If two capacitors are connected in series across a battery, both charge instantly (Fig. 3). If a resistor is placed in series with the capacitors (Fig. 4), the action is a combination of a series R-C circuit and the instantaneous action described above. When the switch is closed, the capacitors start to charge. The voltage across each capacitor rises while the voltage across the resistor falls. Through the charge period, the voltage across C1 plus the voltage across C2 plus the voltage across R1 adds up to the battery voltage. When they are fully charged, the smaller capacitor has the larger voltage across it. Voltages across the capacitors equal the source voltage and there is no voltage across the resistor.

In Fig. 5-a, a parallel R-C network is in series with a capacitor. When the switch is closed, the battery voltage divides across the two capacitors. In this first instant R1 has no effect on the action, but immediately thereafter C1 starts to discharge through R1 at a rate

determined by the network's time constant. At the same time C2 continues to charge through R1 until it charges to the source voltage while C1 discharges to zero (Fig. 5-b). Curves showing the voltage change across each capacitor appear in Figs. 5-c and 5-d.

The basic R-C circuit corresponding to the one in the phase-detector circuit is shown in Fig. 6. It acts like a combination of the two preceding circuits, but not exactly like either.

When the switch is first closed, C1 and C2 short out R1 and R2, placing the whole battery voltage across R3. As the capacitors charge, the voltage across R2 rises. The voltage across R2 equals the voltage across C1 plus the voltage across C2. In the same way the voltage across R1 rises. Throughout the first part of the charge period, voltages across the capacitors are in inverse proportion to their capacitance. Also, during this period, voltage across R3 decreases across R2 increases.

At the instant the increasing current through R1 equals the decreasing current through C2, C1 stops charging and starts to discharge through R1. This occurs because the total current keeps dropping as C2 continues to charge (C1 is fully charged). Therefore, the voltage across R1 must drop as the current drops. C1 cannot keep its full charge and starts to discharge through R1. C2 charges while C1 discharges. The voltage across R2 keeps increasing, the voltage across R3 keeps decreasing. The voltage across R1 decreases as C1 discharges. As the voltage across R3 started at battery potential and went down while the voltage across R2 started at zero and went up, a point is reached where the voltages across the resistors are proportional to their resistance. At this instant C2 (charged to the voltage across R2) stops charging. C1 is discharged and there is no voltage across R1. A steady current flows through R2 and R3, and they act as a voltage divider.

In the circuit of Fig. 1, positive or negative pulses of decreasing amplitude are the source of voltage, rather than a battery. However, circuit action is essentially the same.

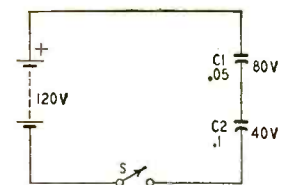

Fig. 3—Two capacitors in series with a battery act as a voltage divider.

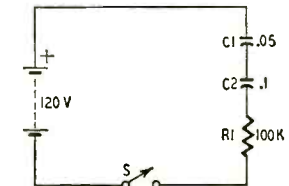

Fig. 4—Series resistor slows down the charge action of the capacitors.

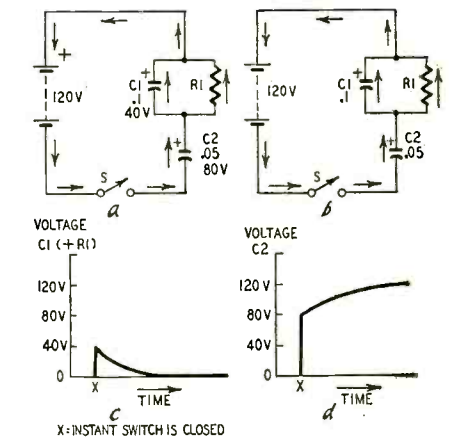

Fig. 5—Action of a parallel R-C network in series with a second capacitor.

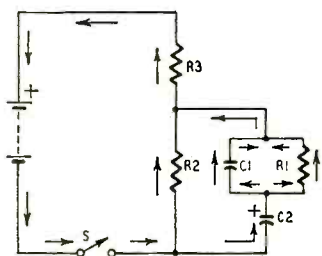

Fig. 6—Basic circuit corresponds to portion of Fig. 1 phase detector. Arrows show current paths during initial charging period.

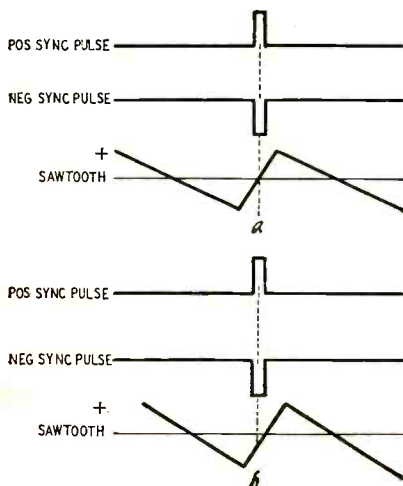

Fig. 2-a—Sawtooth voltage in phase with sync pulses; b—out of phase sawtooth voltage results in negative correction voltage.

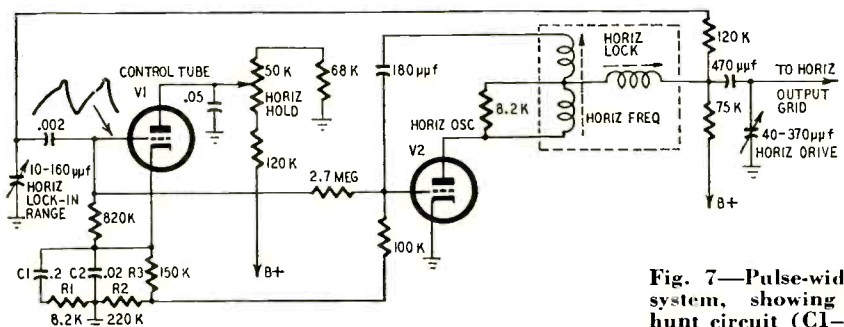

Fig. 7—Pulse-width afc system, showing anti-hunt circuit (C1-R1).

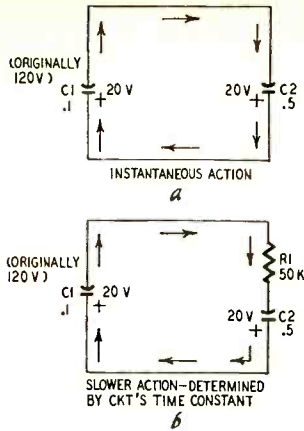

Fig. 8—Circuit action when a charged capacitor is placed across an uncharged one.

The integrating action of this circuit tends to make it less sensitive to noise pulses. Fast, random pulses have little effect in building up a charge on C2. R1 has a double function in the anti-hunt portion of the circuit (R1-C1). First it lets C1 discharge toward the end of the correction period, allowing C2 to build up to the full amplitude of the source pulses. Second, it provides a dc path from the horizontal oscillator's grid to ground through R2.

In this circuit, if C2's capacitance decreases or C1's increases, correction voltages may build up too fast and cause hunting.

Pulse-width circuit

Another common afc circuit is the pulse-width circuit (see Fig. 7). R1-C1 in V1's cathode circuit acts as the anti-hunt network. In this system, a composite signal appears at V1's grid at the end of every line. This signal consists of a trapezoidal (modified sawtooth) signal with a sync pulse riding on top. If the oscillator's frequency changes, the sync pulse is displaced on the composite signal, making the top either narrower or wider. This makes the control tube, normally cut off between pulses, conduct for a longer or shorter interval when the signal comes in. This, in turn, develops a smaller or larger average cathode voltage. Part of the positive cathode voltage is tapped off by R2 and applied to V2's grid. This tapped positive voltage bucks the negative voltage at the oscillator's grid. This bucking voltage determines the point at which the oscillator fires, thereby controlling oscillator frequency.

C1-R1 in V1's cathode circuit prevents hunting by not allowing full correction voltage to be applied to the oscillator's grid at the instant there is a change of frequency. As in the phase-detector system C1-R1 act so that the correction voltage at the grid builds up gradually. The circuit permits an equilibrium point to be reached after several cycles, when a slightly displaced sync pulse provides the required amount of corrective voltage for the oscillator's grid. The correct horizontal frequency

is re-established even though the change in operating conditions continues. As before, there is a slight phase displacement of the picture to maintain the correction voltage.

The exact action to the C1-R1 anti-hunt network can be understood by noting the action in the simplified circuits of Fig. 8.

When a charged capacitor is placed across an uncharged one (Fig. 8-a), it discharges into the uncharged one and the voltages across the two become equal. If both capacitors have the same capacitance, the charged one loses half its charge before the voltages become equal. If one capacitor is larger, C2 in Fig. 8-a, it requires more electrons to charge to same voltage as C1. So C1 will discharge more than half its electrons before the voltages across the two capacitors become equal.

Since $Q = CE$, $E = Q/C$. If two capacitors of unequal C are to have the same E, the smaller capacitor must have a smaller Q (quantity of electrons). C1 originally had 120 volts. C1 is 0.1 μf and C2, 0.5 μf. To find the new voltage across both capacitors remember that C2, the uncharged capacitor, is five times as large as C1. Therefore it must have five times as much charge for the capacitors to have the same voltage across them. When C2 is placed across C1, C1 discharges to 1/6 of its original charge or 20 volts. Five parts of the original charge go to C2, one part remains in C1. There are now 20 volts across both capacitors.

Add a resistor to Fig. 8-a as shown in Fig. 8-b. The charged capacitor is again allowed to discharge into uncharged C2. The only effect of the resistor is to slow down the action.

Anti-hunt system

Fig. 9 shows the exact action of the pulse-width anti-hunt circuit. When the switch is closed (Fig. 9-a), C2 instantly charges to the battery voltage. C1 charges more slowly through R1 and can charge to battery voltage only if the switch is kept closed for a period of about 5 RC. (A capacitor charges to 63% of the battery voltage in 1 RC and to 100% in about 5 RC, in a series R-C circuit.) If the switch is kept closed for only a fraction of this time, C2 charges to the full battery voltage but C1 charges to only a small fraction of this voltage. When the switch is opened, C2 discharges into C1 through R1 (Fig. 9-b). C2 also discharges through R2. However, R2 is a high-resistance path compared to C1-R1. Most of the charge in C2 is discharged into C1. Also, since C1 is large compared to C2, C2 loses most of its electrons and its voltage in discharging into C1. C2 gains a small voltage. At the instant the voltages across the capacitors becomes equal, they both discharge through R2 (Fig. 9-c).

The effect of placing C1-R1 across C2, while opening and closing the switch, is to make C2 lose part of its

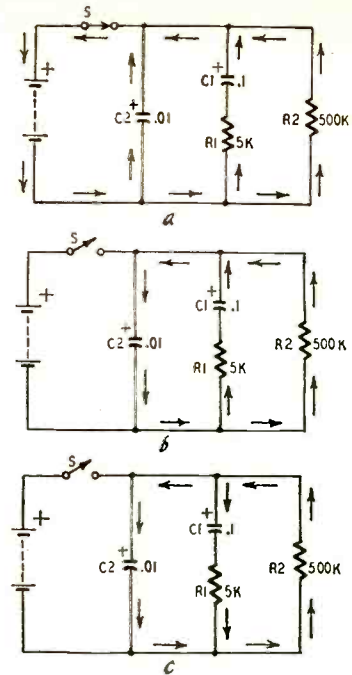

Fig. 9—Equivalent circuit illustrates action of a series anti-hunt network (C1-R1).

voltage each time the switch is opened. Without C1-R1, C2 would immediately charge to the battery voltage and keep this voltage at practically the same value during the intervals when the switch is open. With C1-R1 in the circuit C2 discharges into C1 at the instant the switch is opened, but, as the switch is repeatedly closed and opened, the average voltage across the capacitors builds up the battery voltage.

Hunting in the afc circuit of Fig. 7 may be caused by anti-hunt capacitor C1 opening or decreasing in value. The anti-hunt circuit would naturally be checked first for defects. However, other possibilities are: cathode capacitor C2 increasing, R2 increasing or R3 decreasing in value.

The basic principles used in analyzing the anti-hunt circuits can be applied to many other complex R-C circuits in TV receivers. END

Transistor Lecture Series

Beginning April 1 and continuing for the next five Wednesday evenings, the Boston Section of the Institute of Radio Engineers will sponsor a series of practical, workshop type transistor conferences. Each will be given by an expert in the field of transistors. The whole venture is supported by six leading transistor manufacturers.

The six-session series will be held at Boston's John Hancock Hall, beginning at 7:30 pm. Cost of the whole course is \$7 to IRE members and students, \$10 to others. For further information, write to the Boston Section, IRE, 73 Tremont St., Boston 8, Mass.

PROBLEMS of ringing in the raster or in the picture often are perplexing at the service bench. Hence, we are giving this subject a once-over-lightly this month.

First, we have to distinguish clearly between raster ringing and picture ringing. Raster ringing (Fig. 1) is apparent even when there is no picture. It shows up as a series of vertical gray bars at the left side of the screen.

There are two sources of these bars in a raster:

1. The ringing voltage can be picked up by the video input lead to the cathode-ray tube.
2. The ringing voltage can be generated by transient oscillations in the yoke circuit.

It is easy to distinguish between these types of ringing. If you shunt a 0.1- μ f capacitor from the video signal lead to chassis, the first type disappears, but the second type does not.

If you find that the bars disappear when the shunt capacitor is connected in circuit, the remedy is to dress the video signal lead out of any field that

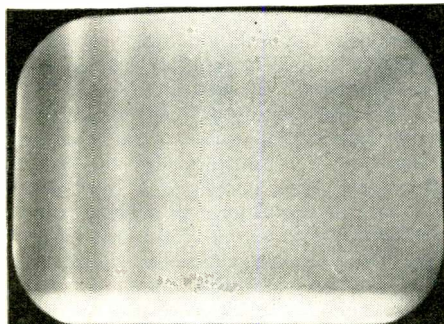

Fig. 1—Vertical bars caused by transient ringing in horizontal yoke circuit. (Foldover was a separate trouble.)

might cause such bars. Ringing fields are strongest near the high-voltage cage.

On the other hand, if you find that the bars remain with the shunt capacitor connected, the yoke circuit needs attention. As shown in Fig. 2, a fixed capacitor or sometimes a resistor and capacitor are needed across the "high" side of the horizontal yoke winding.

Values required vary considerably, but 56 μ f is typical for C. Sometimes the value is rather critical. R is relatively low, and the best value can be found only by experiment.

Note that Fig. 1 also shows a vertical foldover. The receiver had a weak vertical output tube, which was replaced to correct this raster trouble.

If you inspect the ringing bars carefully, you can distinguish between the two types of displays just described. When the ringing voltage is picked up by the video signal lead, the raster lines remain straight but they change in intensity to give the appearance of a bar.

On the other hand, when the bars are caused by transient ringing in the yoke circuit, the raster lines become curved or kinked, as shown in Fig. 3.

Ringing in the picture only is caused by sharp peaks in the response curve—

either in the if or video amplifier. The proper procedure is to use a good sweep and marker generator, with a scope, to align the circuits for flat-topped response.

Distorted sound

I have an Admiral 20Z4FFB with distorted sound. It has a background hiss which follows the sound, especially on loud peaks. Sometimes a crackling noise comes through. Any suggestions?—A. A., Chicago, Ill.

The trailing hiss in the audio is characteristic of regeneration. The best approach will be to sweep the 4.5-mc intercarrier circuits from the sound takeoff point to the FM detector circuit. Regeneration will show up as a sharply peaked response curve. By checking the circuit components systematically,

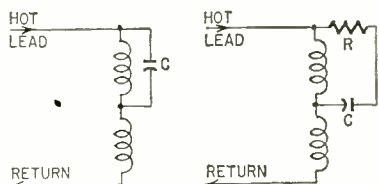

Fig. 2—Transient ringing can be corrected or minimized by shunting the horizontal yoke winding with a capacitor or capacitor and resistor in series.

you will be able to see from the scope pattern which fault has been corrected.

Conversion problem

Can you provide a diagram and list of parts to change from a 16- to a 21-inch picture tube in a Video Products K33130 receiver?—J. I., Fort Lee., N. J.

We have found in the past that this type of conversion is difficult, but it is a job which can be done if cost is not the primary factor. I would suggest that you consider reworking the chassis in accordance with the circuit and parts list for the RCA 21-T-6115, as published in standard service data.

Fuse-blowing 6DQ6

I would like some information about fuse blowing and shorts in the 6DQ6 in an RCA 21D8588. (I replaced it with

a 6BQ6.) Also, how can focus be adjusted for a sharp and clear picture?—A. V. P., Troy, N. Y.

It would be advisable to check the voltages at the 6DQ6 socket. Drive or screen voltages may be too high. This receiver uses an electrostatically focused picture tube. The focus electrode requires different voltages for picture tubes with varying manufacturing tolerances. Try adjusting this voltage from zero to full B-plus, to find the best focus.

Drifting vertical hold

The vertical hold drifts in a Motorola TS45 as the set warms up. A heat lamp test shows that the chassis is heat-sensitive. However, I cannot pinpoint this to a definite component. I will appreciate any help.—J. I. L., Niagara Falls, N. Y.

You have made a good start with the heat lamp. The next step is to heat individual components in the general trouble area to see which one is heat-sensitive. Use a soldering gun, and hold it close to each suspected component in turn. You will soon be able to run down the faulty part.

Problem in a color set

I hope you can help solve a problem which has stumped local techs, including the factory service people. A CTC5 color set has off-tolerance vertical linearity. The horizontal linearity also is not too good. Scanning lines are bunched at the top, then spread for about 3 inches, after which the raster appears normal. To avoid a long list of tests and replacements, many parts were replaced in the sweep circuits, the PW board changed, and the chassis tested in another cabinet to check the yoke and picture tube. This is not a breakdown, as it was delivered this

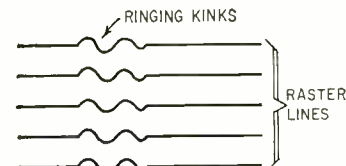

Fig. 3—A ringing yoke circuit shows up as kinks in the scanning lines.

TELEVISION

way. Hope you can help.—R. D. P., Marrero, La.

I have seen this type of difficulty in another make of color set, as delivered from the plant. This might be a lead which would apply. The trouble was caused by filtering and decoupling capacitances which were on the low side. As a result, peak current drains were affecting the operation of the vertical section noticeably. With capacitances on the high side in the power-supply circuits, better regulation is obtained, as shown by scope tests.

Too much width

Could you give me a lead on how to reduce the width on a Philco 22C4014, code 131?—F. L. T., Fortville, Ind.

The simplest method is to slide a sleeve of aluminum foil under the yoke. This has very little effect on height, but reduces the width of the picture.

No color sync

We have in our shop a CBS Columbia color receiver, model 205C1, which gives good black-and-white reception. On color reception, however, the colors are in red, green and blue horizontal bars across the screen. Can you give

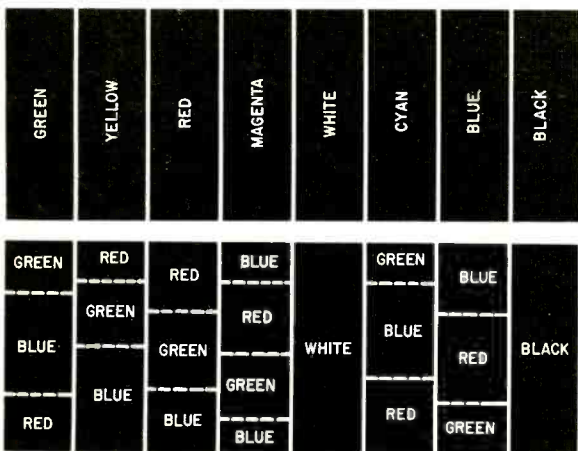

Fig. 4—Loss of color sync causes color picture to split up into horizontal strips of red, green and blue. Color bar generator pattern makes fault obvious.

any clues as to where the trouble could be?—H. S., Leesburg, Ind.

This is loss of color sync. It would be advisable to try new tubes in the color sync section first. Then try adjusting the color afc balance control for zero volts to ground, with burst present. (See Figs. 4 and 5). If this does not snap the color into sync, the possibility of color sync circuit trouble must be investigated.

Bright, blurred vertical bar

A G-E 21C115 is giving us some difficulty. The raster has a wide vertical bar which is both bright and blurred. The picture can be seen at the left- and right-hand sides, but appears at low brightness. The vertical hold control has been replaced. A suspected electrolytic checked out OK on an ohmmeter test. We would appreciate any assistance.—F. L. A., Los Angeles, Calif.

You are probably on the right track in checking out the electrolytics. I have

seen similar cases in which loss of capacitance in decoupling electrolytics caused just this trouble. This is a good job for a scope. The vertical bar is most likely caused by spurious ac voltages entering at one of the picture-tube electrodes. The scope will show whether the dc supplies to the picture-tube electrodes are clean or not. Then, it is a simple matter to follow back through the faulty supply circuit, to find a faulty decoupling capacitor. There is a lesser possibility that the sawtooth current waveform through the horizontal yoke windings is distorted, but your report does not seem to indicate scanning distortion.

Horizontal nonlinearity

We have an Olympic 21KB24 in the shop with considerable nonlinearity. The sweep is compressed on the left and expanded on the right. Since there is no linearity coil in the circuit, we would like to get data on adding one to overcome this difficulty.—J. B., New York, N. Y.

Since the original circuit does not provide for a linearity coil, it is quite possible to get satisfactory linearity if the circuit components are within tol-

erance. Instead of changing the original design, it would be advisable to locate the faulty component. First check the sweep-circuit capacitors for correct values. If this does not turn up the fault, check the horizontal oscillator plate voltage. This should be close to 240 volts. Low plate voltage will cause a nonlinear sweep.

Faulty test instruments?

We recently added a popular sweep and marker generator and a scope to our shop equipment. Failing to get true displays of curves, we returned the generator to the factory for a checkup, but we are having difficulty and are taking alignment jobs to another shop. Do you consider the popular type of alignment equipment adequate?—W. S., Saco, Me.

Our experience has been that inadequate sweep and marker generators disappeared from the market a number of years ago. The equipment you mention should perform satisfactorily. Difficulties in making sweep-alignment tests are to be expected, until the operator has gained considerable experience. Control settings are more numerous than in simpler instruments, and one incorrect setting can throw the pattern completely off. After the operator learns the ropes, such incorrect operation is immediately recognized. Since you have access to a shop which is doing sweep-alignment work, it might be possible to check your instruments against theirs on a chassis, and observe the control settings used by their operator.

Power-line interference

I would like to eliminate interference that seems to be coming from the power lines. Three or four of my customers in different parts of town are having the same trouble. It seems to be a 120-cycle interference, producing two dark bars about 2 inches wide horizontally across the screen. There is a loud buzz. Sometimes the picture rolls and tears. The local channel is unaffected.—J. K., Toledo, Ohio

This report is indicative of diathermy interference. It is quite possibly being radiated from power lines about town. The interference is not noticeable on your local channel because the high signal strength gives a high a/c voltage and suppresses the effect of the interference voltage. The only possibility of eliminating the interference at the receiver is to use a directional antenna. A better plan is to run down the source of the interference and eliminate it. If you can establish that the interference is being radiated from power lines, I am sure that your local utility company will offer you all possible assistance in locating the source and eliminating the cause.

Split picture

An Admiral 20A1 has an intermittent split picture. The horizontal lock control does not correct the split picture, but will cause a high-pitched

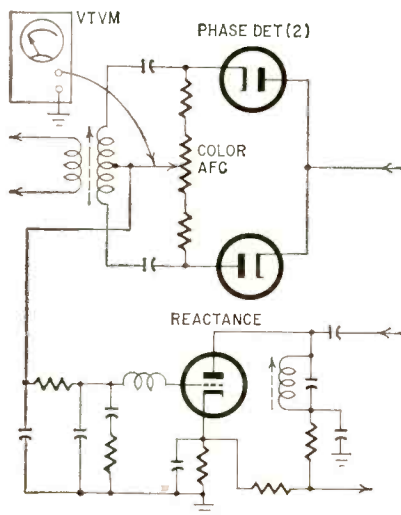

Fig. 5—To adjust color afc balance control, tune in a color signal. Connect a vtvm where indicated. Adjust control for zero volts.

squeal with a bright vertical line at right screen. The trouble occurs on commercials or from outside interference. If the receiver is turned off, it will start up again OK.—J. O., Copiague, N. Y.

This is a squegging condition which is almost certainly caused by poor decoupling between circuits which include the horizontal output system. This is a sneaky type of trouble, because usual dc voltage checks do not turn it up. It can be easily found with a scope, which will show abnormally high ac voltages on dc supply buses. Check bypass and decoupling capacitors.

16-21-inch conversion

I would like some advice on converting a Hyde Park 16CD from a 16DP4 picture tube to a 21EP4.—B. P., New York, N. Y.

Some of these receivers used a 60° yoke on the 16DP4 glass tube. If this receiver has a 60° yoke, the 21EP4 can be used with minor electrical changes. Width may be insufficient. If so, it can be increased by any of the usual methods, such as shunting a 20-30- μ f 6,000-volt capacitor from the 6BG6-G plate to chassis. If the receiver does not have a 60° yoke, it will need to be supplied.

Horizontal jitter

I am writing for your opinion on horizontal jitter in a Regal 101. The

jitter does not affect the entire picture at one time, but occurs at all points at irregular intervals. Only sections of the picture jitter, and the raster is unaffected. All tubes and the horizontal oscillator coil have been replaced. Capacitors and resistors in the Synchronlock section check out OK. I will appreciate any help you may offer.—J. C. K., Manchester, N. H.

There is not a great deal to go on here, but this report could describe the effect of a small arc somewhere in the flyback or high-voltage circuits. This should be investigated. Frequent intermittent breakdown in an electrolytic capacitor could also be responsible. The report does not indicate that this possibility has been eliminated.

Convert to intercarrier sound

I have the problem of converting a DuMont RA112 to intercarrier sound. Can you help me?—J. S., Bronx, N. Y.

Disconnect the existing sound-takeoff lead. Remove the second sound trap, located at the picture detector input. Take intercarrier (4.5-mc) sound from the plate of the second video amplifier. This can be done by using a 1- μ f capacitor at this point. The sound if system must be converted to 4.5 mc. I would suggest using a circuit similar to the Trav-Ler 517-82. The sound if is driven from the 1- μ f coupling capacitor. END

RADIO IN YOUR BOAT

Now is the time to install new marine radiotelephones or reinstall the old ones on cabin type boats. On open outboards, the new type "outboard radiotelephone," which is designed for easy installation and removal, should be given its "start of the season" tune-up, since every radiotelephone should be tuned to match a specific boat's antenna and ground system. The Kaar TR249 shown on the cover fits onto a permanently installed mounting plate from which it can be quickly slipped off and made more accessible for tune-up before being placed into service for the 1959 boating season. Tune-up includes frequency check, trimming and tube testing. Be sure also to read the interesting article about echo sounders in this issue. The color transparency was taken by Jacques Saphier of Paramus, N. J. at Freeport on Long Island and shows Maurice Holland, veteran marine radio service specialist doing the tune-up with Lee Sands watching.

COLOR-PROJECTION SYSTEMS

TWO color TV projectors, both developed in Europe, have been demonstrated in the US by two pharmaceutical firms, which will use them for closed-circuit medical demonstrations and seminars. Both color systems set new records for brightness and screen size.

The Swiss-developed Eidophor system, long in preparation (RADIO-ELECTRONICS, October, 1946; October, 1952) was unveiled by Ciba Pharmaceutical

Products Inc. Unlike conventional TV projection systems, it does not depend on a cathode-ray tube as the light source and therefore has vastly increased brightness: it can project a bright color picture on a 12 x 16-foot theatre screen.

Eidophor (a Greek word meaning "image bearer") works in this way: An electron beam bombards, and modifies, the surface of a film of oil on a concave mirror. Light from a xenon arc lamp passing through the resulting "wrinkles" in the oil film is projected through a special grating onto the screen. The field-sequential color system is used. The Eidophor projector (left) is 5½ feet high, weighs 800 pounds.

The other new color TV unit is the 1,500-pound Norelco projector built by Philips of Eindhoven, Netherlands, and introduced in this country by Smith, Kline & French Laboratories, Philadelphia.

It uses the more conventional Schmidt optical system, with three separate projector "barrels"—one for each color. It projects a color TV picture of good brightness on a 9 x 12-foot screen. The standard NTSC (broadcast) color system is used. END

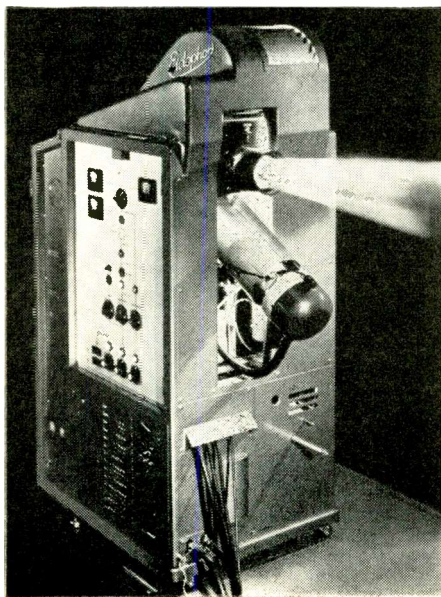

Smith, Kline & French use three projector 'barrels' for their color projection system.

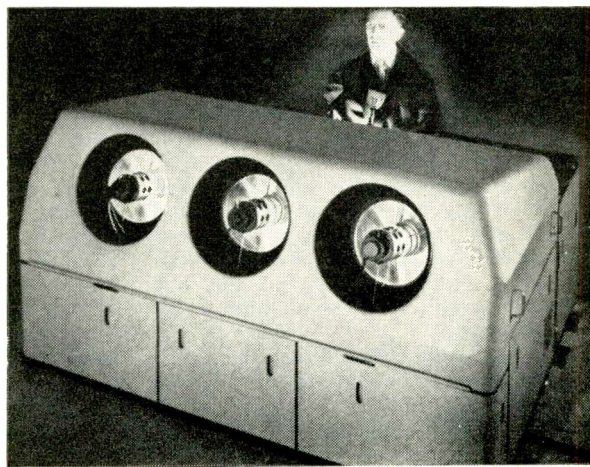

Eidophor system does not use a cathode-ray tube as the light source.

Small Claims Court in Session...

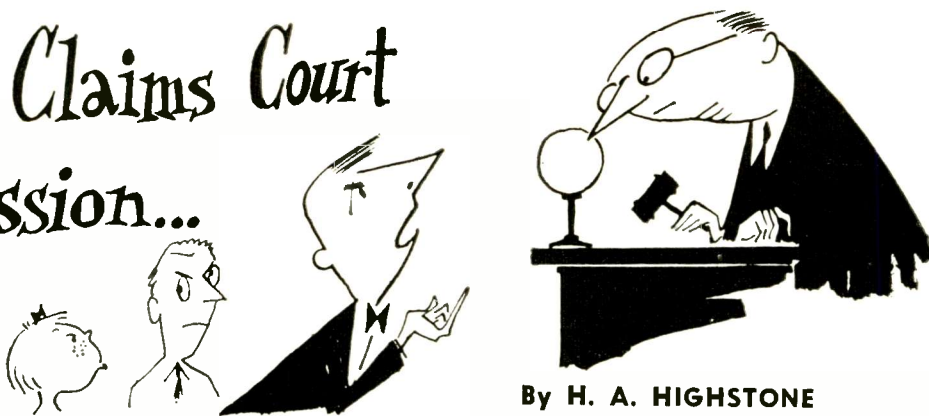

By H. A. HIGHSTONE

Case 441: Flyback TV Service vs. Slowblow, Praying Judgment in the Sum of \$6

Q—Please tell the court in your own words, Mr. Slowblow, your reasons for refusing to pay the plaintiff \$6 allegedly due for one home-service call.

A.—Well, this man was out to my house about two weeks before and was supposed to have fixed my TV, but he didn't. In fact it played worse than it did before, and I told him so. Right away I said this call should be free.

Q.—How did he respond?

A.—Well, he fumbled around in a book and finally came up claiming his records showed it had been five months since he had been there, and why hadn't I phoned him before if I was dissatisfied?

Q.—Why hadn't you?

A.—I meant to, but just never got around to it.

Q.—Go on.

A.—That seemed to make him mad. Right away he began picking on my kids, asking would I please stop them from jumping on his tube caddy, he called it. Next he snatched some tools away from Junior, who was only looking at them. If he hadn't been so rough, he wouldn't have startled little Clevis and made him break the guy's mirror, like he did.

Q.—You said the plaintiff grew progressively belligerent?

A.—Yes. When I told him I knew there was nothing wrong with my TV except a small tube, he stopped doing anything for about a minute; just sat there glaring into the back of the cabinet, muttering. Sounded like he was kind of swearing under his breath. He didn't even answer when I explained how I'd adjusted all the knobs and controls on the back so he wouldn't have to waste any time fooling with them.

Q.—It was at this juncture that the plaintiff took exception to your dog?

A.—Well, he seemed to be dead scared of Queenie, although I told him she never bites. She just growls and snarls and lunges like that whenever strangers are around. She acts like she was ready to eat you up, but actually there ain't a mean hair in all her 95 pounds.

Q.—You have charged that the plaintiff appeared to be making alibis. How was that?

A.—He was trying to alibi, all right. You see, the trouble with my TV was

a short in the condenser or else a short in a small tube. Also it wasn't throwing a very good picture; kind of smeary, which was the main trouble. This short would make the screen go squiggly about every three or four hours, and sometimes it would go four or five days without shorting. That was when this man tried to tell me that intermittents, he said they were, generally had to be taken into the shop for repairs. Right then I said nobody was going to take my TV to no shop. You know how it is; let one of these racketeers get hold of your set and he loads it up with defective parts that break down again right away and bingo, he's got you on the hook again.

Q.—By this time you say the plaintiff became so surly that your children began crying. Tell the Court what happened.

A.—Not all the kids; just little Aspic. All she wanted was to have him wait and leave the set on channel 4 until the Bugs Bunny cartoon was over, but this man kept switching around from channel to channel. Finally he batted little Aspic's hand away from the selector knob so hard she started crying. She's a very sensitive child, you know; her teacher says she's definitely "unusual."

All this got Queenie worked up of course. I kept telling this man she didn't mean a thing by snarling and showing her teeth but he grabbed a big soldering iron out of his kit and acted like he was all set to knock her brains out. The only way I got him to drop the iron was by dragging Queenie out and locking her in the kitchen.

Q.—Everything went from bad to worse quite rapidly thereafter?

A.—It sure did. I have a very good book, "How To Fix Your Own TV," which tells everything. It starts in with aerials, all about the difference between Comicals and Yogis and Elephant Ears, and ends up explaining exactly how to adjust your own iron trap. Very thorough. I could see this man was getting nowhere fixing my TV—I don't think he knows his business—so I tried to help him by showing him page 17, where it says when a set goes squiggly, the thing to do is stick a screwdriver in the horizontal something-or-other.

These TV guys are all alike. The minute they find out you know some-

thing about your set, they get mean. Like that other TV gyp downtown where I took my tubes to be tested. Sold me four new ones and the set didn't work a bit better, actually worked worse. Then got very mean and said absolutely no dice when I tried to insist on getting my money back.

Q.—Please confine your remarks to the current case, Mr. Slowblow. Will you proceed?

A.—The way it wound up was by this Flyback TV guy insisting he had to take the set into his shop if he was going to correct this intermittent, and also to find out why the picture was so smeary. When I said uh-uh, nobody was taking my TV into no shop just because the condenser was shorted, he had the nerve to try to collect \$6 for a service call. Now he sues me for it!

Q.—You said earlier you subsequently called a second TV repairman who succeeded in correcting the trouble in your home?

A.—Yes. And that goes to show how little this Flyback guy knows about his business. This second man was mean too; didn't like Queenie and got huffy when Aspic broke the lid on his tube tester, but he fixed my set all right, after I all of a sudden remembered and told him how I had tried swapping tubes around in different sockets, hoping that could cure the trouble. It was something about a 6CB6 and a 6AU6 changed around which made the picture smeary and here this Flyback guy . . . Hey, what's he doing, jumping over that rail at me? Ow! Help! Murder! Get him offa me! Police! Judge! . . .

END



It's seldom the record that causes the skipping—groove jumping is nearly always the fault of the player. Here's a simple, process-of-elimination treatment for record playing's worst nuisance

the record SKIPS

By CHARLES W. FARRINGTON

SELDOM considered as a subject for service, the skipping and sticking of records is already a hot problem from the industry down to the customer, and it's getting hotter.

Those responsible for and those affected by the problem bat the ball of blame back and forth without producing any remedy. Included are record buyers and dealers, player dealers, distributors and manufacturers.

The ability of the service technician, combined with his unbiased understanding of the situation, can provide the only tangible relief presently available to the frustrated victim of it all—the customer. The remedy can be effectively applied only with clear comprehension of the facts which pose the problem.

Ignored and unrecognized, a common law of standards actually exists for records and playback equipment: *Virtually all 33- and 45-rpm records can be traced without trouble by the majority of players.*

The fact that one allergic record player is unable to trace a particular pressing can never condemn that pressing as "defective" so long as a majority of representative players can trace it. One exception is the vastly superior record, of wide dynamic range, courageously marketed by a few manufacturers; these can be traced only by components of high compliance.

The standard level of record manufacture is necessarily held to a compatibility with the class of parts used in \$19.95 super hi fi. To be marketable, any record run must meet these unnatural but exacting playback requirements. As a result, records have a strict uniformity, limiting to be sure, but nevertheless adhering to high tolerances which are sadly missing in playback apparatus. Therefore, players which are unable to trace all ordinary records are subjects for service.

An awareness of such facts permits a straightforward approach to the cure of skipping. One other help is an understanding of the human attitudes involved.

For instance, the record dealer usually placates the customer with an affable exchange. This avoids argument

and explanation, but omits the genuine help of locating the real cause of trouble. Player dealers receive fewer complaints, and usually parry those they do with condemnation of records. A little investigation and enlightened servicing could be profitable!

Until some miracle happens to pull into sync the makers of players and the makers of records, here is easy first aid. Service technicians and set owners with superior do-it-yourself ability can be sure of results by following a simple formula.

Although many factors contribute to improper groove tracing, checking all of them is seldom required except to insure optimum preservation and performance of records; skipping usually is cured early in the process.

Testing the equipment

The control in these tests is the current production standard already described—*Any record which can be played by a majority of equipment is normal.*

Test the record first, on equipment in which:

1. The needle is perfect; either new or checked by microscope.
2. Cartridge compliance is considerably superior to that in the one that skipped.
3. The arm is friction-free, nonresonant and nonautomatic (even to trip switch).
4. Stylus pressure is well within the range recommended by the cartridge manufacturer.

Examine under magnification the dull marks left on the record at skip points if tracing is still imperfect (except for the slight clicks to be expected at points where the previous stylus skipped). If jagged or lateral, usually caused by mishandling, accidental needle drop or jarring the turntable, an identical record can be tried on the original player. If there's no skip, check and remedy either handling and care of records or susceptibility of the turntable to any kind of jarring.

Examine the needle with a microscope of at least 100 × power (Fig. 1). Any worn needle should be quickly re-

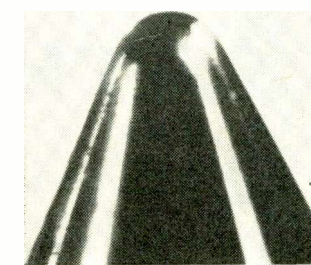

Fig. 1—Microphotograph of a worn needle tip (top) compared with a good one. Worn needles should be replaced immediately.

placed, but the idea that worn needles are a primary cause of skipping is subject to question. Some cases of skipping which are stopped by replacing the needle may have had other contributing factors. To check on this probability, the tests can be continued with the worn needle. If some other remedy proves effective, its benefit plus needle renewal will provide a double gain toward record preservation.

Reject compromise needles. Quick surgery is the remedy for a hot appendix, and for any compromise needle—cut it out! Replace with a microgroove point. If 78's are used, change the cartridge or give the customer two needles.

After each of the remaining tests, try the record again. If it can be traced without skips, further procedure is optional.

Level the turntable with a circular spirit level.

Measure stylus pressure, accurately, (Continued on page 74)

Here are a few reasons why...

EASY TO BUILD

Heathkits are engineered for easy kit construction. You need no electronic or kit building experience whatsoever to successfully complete your own kit. Use of printed circuit boards and pre-wired, pre-aligned assemblies cut construction time. Manuals are carefully prepared, employing step-by-step instructions written in simple, non-technical language. Large pictorial diagrams and photographs show you exactly where each part goes.

LASTING QUALITY

Only top quality components go into Heathkits, assuring you of a finished product that is unsurpassed in performance, dependability and endurance. Rigid quality control standards are maintained at the Heath factory to see that each component lives up to its advertised specifications. Heathkits are conservatively rated. No performance claims are made that are not thoroughly proven and tested under the most stringent laboratory conditions.

ADVANCED ENGINEERING

Progress in electronics engineering never stands still at Heath. The latest developments in circuit design and components are exploited by Heath engineers, offering you superior performance at lower costs. New advances in all fields of electronics are carefully watched by Heath engineers to keep abreast of the rapidly growing industry. The modern, up-to-date styling of Heathkits make them a handsome addition to your home or workshop.

WORLD-WIDE REPUTATION

A pioneer in do-it-yourself electronics, Heath Company, over more than a decade, has established public confidence in its products both in the United States and abroad. Today, as the world's largest manufacturer of electronic kits, Heath stands as the leader in its field.

GREATER SAVINGS

Do-it-yourself Heathkits save you up to 1/2 the cost of equivalent ready-made equipment. Direct factory-to-you selling, eliminating middle-man profit, plus the tremendous Heath purchasing power mean even further savings to you. And the convenient Heath Time Payment Plan allows you to use and enjoy your Heathkit NOW, while you pay for it in easy installments.

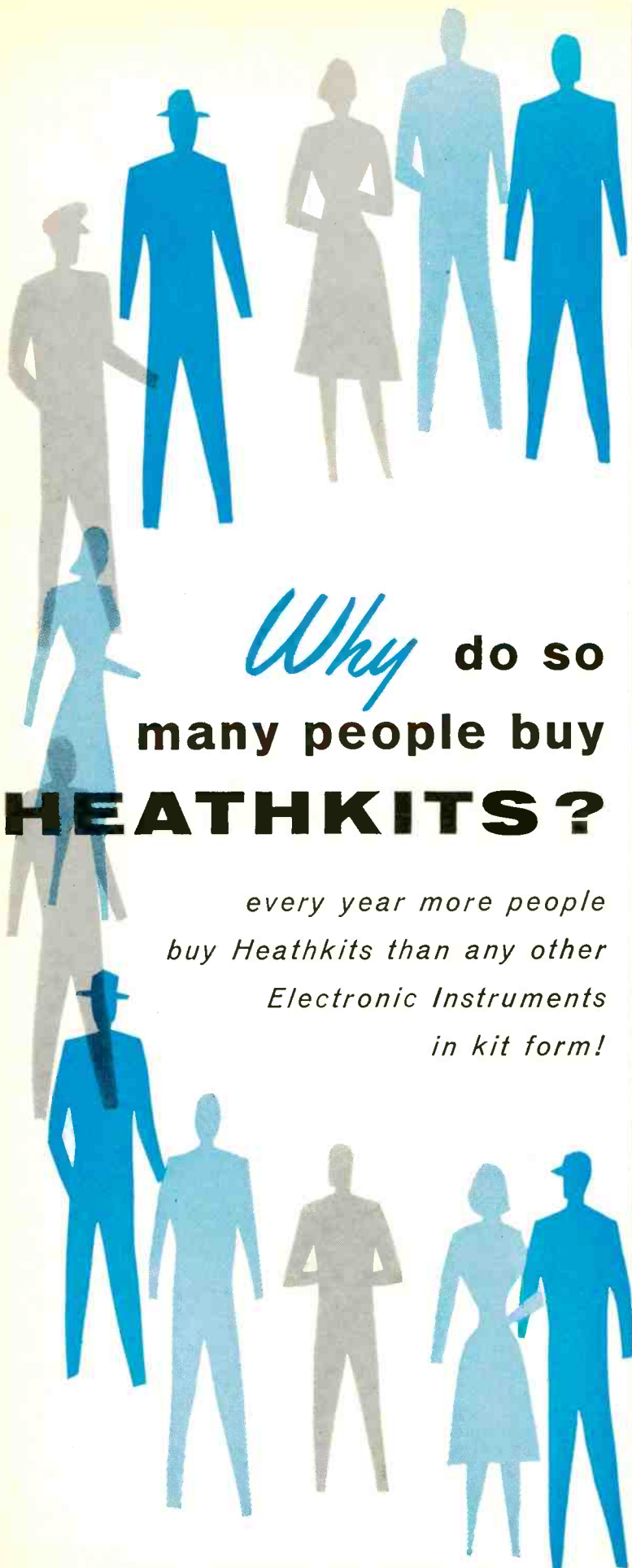

Why do so many people buy **HEATHKITS?**

every year more people buy Heathkits than any other Electronic Instruments in kit form!



HEATH COMPANY
Benton Harbor 20, Michigan

 a subsidiary of Daystrom, Inc.

TRANSISTOR PORTABLE RADIO KIT

Fun for the whole family, this easy-to-build 6-transistor portable radio is ready to go wherever you go. The modern molded plastic case with pull-out carrying handle and fully enclosed back add beauty and convenience to this splendid kit. Six name-brand (Texas Instrument) transistors are used for good sensitivity and selectivity. The 4" x 6" PM speaker with heavy magnet provides "big set" tone quality. Use of this large speaker and roomy chassis make it unnecessary to crowd components adding greatly to the ease of construction. Transformers are prealigned making the radio ready for use as soon as kit is assembled. A built-in rod-type antenna assures good reception in all locations. Six standard flashlight batteries are used for power, providing extremely long battery life (between 500 and 1,000 hours) and they can be purchased anywhere. Stylish cabinet is two-tone blue molded plastic with gold inlay and measures 9" L. x 7" H. x 3 3/4" D. Shpg. Wt. 6 lbs.

MODEL XR-1L: Identical to XR-1P except in handsome leather case instead of plastic case. Leather carrying strap included. Shpg. Wt. 7 lbs.

LEATHER CASE: Can be purchased separately if desired. Fits all XR-1P and earlier XR-1 chassis. No. 93-1. Shpg. Wt. 3 lbs. **\$6.95.**

HEATHKIT
MODEL XR-1P
\$29⁹⁵



MODEL XR-1L **\$34⁹⁵**

NAVIGATE BY PORTABLE RADIO



HEATHKIT
MODEL DF-2
\$69⁹⁵



2-BAND TRANSISTOR PORTABLE RADIO DIRECTION FINDER KIT

Enjoy the safety, convenience and entertainment of this self-contained, self-powered, six-transistor superheterodyne radio direction finder. It receives aeronautical and marine beacons as well as standard band broadcasts with startlingly clear tone reproduction over a long range. Covering the beacon band from 200 to 400 kc and broadcast band from 540 to 1620 kc, the DF-2 is designed to take directional "fixes" on both aircraft and marine beacons as well as standard broadcast stations, while providing the entertainment of a high quality transistor portable radio. You are able to receive aircraft weather reports every thirty minutes and constant Coast Guard beacons on the 200 to 400 kc band. A dial light is provided for night operation. Power is supplied by six standard flashlight batteries which will last you up to one year under normal operation. Shpg. Wt. 9 lbs.

POWER CONVERTER KIT

Now you can operate your TV set, radio, razor, and other AC electrical equipment directly from your 12-volt boat or car battery. With the Heathkit Power Converter you can enjoy the convenience of home electricity whether boat cruising or on automobile trips. Two power transistors are employed for years of trouble-free, dependable service. No moving parts to wear out, no tubes to replace. Shpg. Wt. 8 lbs.



MODEL PC-1
\$24⁹⁵

ELECTRONIC IGNITION ANALYZER KIT

Ideal for use on automobiles, boats, aircraft engines, etc., the IA-1 checks ignition systems with the engine in operation (400 to 5,000 RPM). Shows the condition of coil, condenser, points, plugs and ignition wiring. Shows complete engine cycle or just one cylinder at a time. Two test leads are supplied, each 10' long, which will enable you to reach either the breaker points or the spark plug wires. Shpg. Wt. 20 lbs.



MODEL IA-1
\$59⁹⁵

ELECTRONIC TACHOMETER KIT

Useful on inboard and outboard boats, as well as in automobiles, the TI-1 operates directly from the spark impulse of the engine. Use on any spark ignited 2 or 4 cycle engine of any number of cylinders. Completely transistorized, it works with 6, 8, 12, 24 or 32 volt DC systems. Indicates revolutions-per-minute from 0 to 6,000. Calibration control provided for adjusting to engine type. Easy-to-build and easy-to-install. Shpg. Wt. 4 lbs.

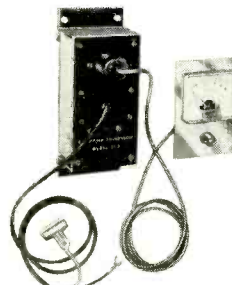

MODEL TI-1
\$25⁹⁵

PROFESSIONAL OSCILLOSCOPE KIT

Everything you could possibly want in an oscilloscope is found in the new Heathkit model OP-1. Featured are DC coupled amplifiers and also DC coupled CR tube un-blanking. The triggered sweep circuit will operate on either internal or external signals and may be either AC or DC coupled. The polarity of the triggering signal may also be selected, and any point on the waveform may be selected for the start of the sweep by using the "triggering level" control. An automatic position is also provided, in which the sweep recurs at 50 cycle rate, but can be driven over a wide range of frequencies with no additional adjustment. Prewired terminal boards are used for rapid, easy assembly of all critical circuits. Power supply is transformer operated utilizing silicon diode rectifiers and is fused for protection. Handsome cabinet features silver anodized front panel with red and black lettering and matching knobs. Shpg. Wt. 34 lbs.

HEATHKIT
MODEL OP-1

\$179⁹⁵



VARIABLE VOLTAGE REGULATED POWER SUPPLY KIT

Invaluable in experimental and design work, the PS-4 eliminates the need for building up a separate power supply for each new circuit tried. It provides a convenient source of variable regulated B+, variable bias voltage and filament voltage for labs and work shops. The PS-4 supplies regulated B+ output continuously variable from 0 to 400 volts DC at up to 100 ma, bias voltage variable from 0 to -100 volts DC at 1 ma, and filament voltage of 6.3 volts AC at 4 amps. Separate panel meters continuously monitor voltage and current output. Rugged, top-rated components used throughout for long, reliable service. Shpg. Wt. 16 lbs.



HEATHKIT
MODEL PS-4

\$54⁹⁵

Your best
dollar value...



HEATH COMPANY • Benton Harbor 20,
Michigan

Subsidiary of Daystrom, Inc.

TEST OSCILLATOR KIT

Provides the test frequencies most often used by servicemen in repairing and aligning modern broadcast receivers. Five fixed-tuned frequencies (262 kc, 455 kc, 465 kc, 600 kc and 1400 kc) are quickly selected for troubleshooting or alignment of the IF frequency and high and low end of the broadcast band for proper tracking. Shpg. Wt. 4 lbs.



HEATHKIT
MODEL TO-1

\$16⁹⁵



HEATHKIT
MODEL O-12

\$65⁹⁵

"EXTRA DUTY" 5" OSCILLOSCOPE KIT

Laboratory quality at utility scope price makes this instrument an unusual value. The Heath patented sweep circuit functions from 10 CPS to better than 500 kc in five steps, giving you five times the usual sweep obtained in other scopes. Vertical frequency response extends from 3 CPS to 5 mc +1.5 db -5 db without extra switching. An automatic sync circuit with self-limiting cathode follower provides excellent linearity and lock-in characteristics. Extremely short retrace time and efficient blanking action are characteristic of this scope. Frequency response of the horizontal amplifier is within ± 1 db from 1 CPS to 200 kc. Horizontal sensitivity is 0.3 volts RMS-per-inch. Construction is simplified through the use of two etched metal circuit boards and pre-cut, cabled wiring harness. Complete step-by-step instructions and large pictorial diagrams are supplied for easy assembly. An ideal scope for all service applications as well as in standard or color TV servicing. Shpg. Wt. 22 lbs.



MODEL SG-8 **\$19⁵⁰**

RF SIGNAL GENERATOR KIT

A "must" for any beginning serviceman, this indispensable instrument is used for aligning tuned circuits quickly and tracing signals in faulty RF, IF and audio circuits. Covers 160 kc to 110 mc on fundamentals in five bands and from 110 mc to 220 mc on calibrated harmonics. Coils are pre-wound and calibrated. Complete with output cable and instructions. Shpg. Wt. 8 lbs.



MODEL AG-9A **\$34⁵⁰**

AUDIO SIGNAL GENERATOR KIT

This unique generator uses three rotary switches to select two significant figures and a multiplier to determine audio frequency, allowing return to the exact frequency previously measured when making multiple frequency measurements. Covers 10 CPS to 120 kc with less than .1 of 1% distortion between 20 and 20,000 CPS. Shpg. Wt. 10 lbs.



MODEL TS-4A **\$49⁵⁰**

TV ALIGNMENT GENERATOR KIT

TV service technicians will appreciate the outstanding features found in this sweep generator. Provides essential facilities for aligning FM, monochrome TV or color TV sets. The all-electronic sweep circuit employs a trouble-free controllable inductor which varies frequency by magnetic means. An unusual buy at this low price. Shpg. Wt. 16 lbs.



MODEL CD-1 **\$59⁹⁵**

COLOR BAR AND DOT GENERATOR

The CD-1 combines the two basic color servicing instruments, a color bar and white dot generator in one versatile and portable unit, which has crystal controlled accuracy and stability for steady lock-in patterns. (Requires no external sync leads.) Easy-to-build and easy-to-use. No other generator on the market offers so many features at such a great price saving. Shpg. Wt. 13 lbs.

ETCHED CIRCUIT VTVM KIT

Time proven for dependability, accuracy and overall quality, the V7-A is one of the wisest investments you can make for your electronic workshop or lab. Its multitude of uses will make it one of the most often used instruments in your possession. Use it to measure all operating voltages and potentials such as B+ and AC-DC, or straight AC power supplies, filament voltage, bias voltage, AVC voltage, line voltage, etc. Ideal for measurements in all types of AM, FM and TV circuits. Checks discriminator or detector operation, AVC or AGC performance, while the ohmmeter may be used to measure circuit continuity, circuit resistance, to test out individual components with resistance measurement, or to trace circuit wiring through cables or chassis openings. Front panel controls consist of rotary function switch and a rotary range selector switch, zero-adjust and ohms-adjust controls. Precision 1% resistors are used in the voltage divider circuit for high accuracy and an etched circuit board is employed for most of the circuitry. The circuit board not only simplifies assembly but permits levels of circuit stability not possible with ordinary conventional wiring methods. Shpg. Wt. 7 lbs.



HEATHKIT
MODEL V7-A
\$25⁹⁵

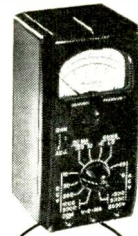

HEATHKIT
MODEL M-1
\$17⁹⁵

HANDITESTER KIT

Ideal for use in portable applications when making tests away from the work bench or as an "extra" meter in the service shop. The combination function range switch simplifies operation. Measures AC or DC voltage from 0 to 10, 30, 300, 1,000 and 5,000 volts. Direct current ranges are 0 to 10 ma and 0 to 100 ma. Ohmmeter ranges are 0 to 3,000 and 0 to 300,000. Top quality, precision components used throughout. Small and compact, take it with you wherever you go. Very popular with home experimenters and electricians. Test leads and 1½ volt size C battery are included with the kit. Shpg. Wt. 3 lbs.



HEATHKIT
MODEL MM-1
\$29⁹⁵

20,000 OHMS/VOLT VOM KIT

Portable and accurate, this kit features a 50 ua 4½" meter and 1% precision multiplier resistors for high accuracy. No external power required. Provides a total of 25 meter ranges on a two-color scale. Sensitivity is 20,000 ohms-per-volt DC and 5,000 ohms-per-volt AC. Measuring ranges are 0-1.5, 5, 50, 150, 500, 1,500 and 5,000 volts AC and DC. Measures direct current in ranges of 0-150 ua, 15 ma, 150 ma, 500 ma and 15 a. Resistance multipliers are X 1, X 100 and X 10,000. Covers -10 db to +65 db. Housed in an attractive bakelite case with plastic carrying handle. Batteries and test leads included. Shpg. Wt. 6 lbs.

TUBE CHECKER KIT

Brand new in every respect, the TC-3 features outstanding performance and ease of operation. Sockets are provided for 4-pin, 5-pin, 6-pin, 7-pin, large, 7-pin miniature, 7-pin sub-miniature, octal, loctal, and 9-pin miniature tubes. Protection against obsolescence is provided by a blank socket to facilitate modification for checking newly added tube types. A 10-lever switch makes it possible to connect any element to any other element regardless of the pin numbers involved. A neon bulb indicator shows filament circuit continuity and leakage or shorts between elements. A specially designed spring loaded roll chart mechanism permits the roll chart to run freely throughout its entire length without binding. Thumb wheel drive knobs are provided on both sides of the panel to accommodate the left handed operator. Compact and small in size, the TC-3 is ideally suited for portable applications. Both the roll chart and the meter are illuminated to facilitate use in darkened areas. Shpg. Wt. 12 lbs.



HEATHKIT
MODEL TC-3
\$39⁹⁵

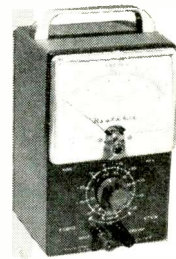

MODEL AV-3
\$29⁹⁵

AUDIO VTVM KIT

This vacuum tube volt meter emphasizes stability, broad frequency response and sensitivity for accurate measurement of critical AC voltages. Features a large 4½" 200 ua meter with increased damping in the meter circuit for stability in low frequency tests. Measures AC from a low value of 1 millivolt to a maximum of 300 volts AC (RMS). Voltage ranges are: 0-.01, .03, .1, .3, 1, 3, 10, 30, 100 and 300 volts. Db ranges cover -52 to +52 db. 1% precision multiplier resistors used for maximum accuracy. Frequency response is essentially flat from 10 CPS to 200 kc. Shpg. Wt. 6 lbs.



MODEL CT-1 **\$7⁹⁵**

IN-CIRCUIT CAPACI-TESTER KIT

This handy kit checks capacitors for "open" or "short" right in the circuit. Detects open capacitors from about 50 mmf, not shunted by an excessive low resistance value. Checks shorted capacitors up to 20 mfd (not shunted by less than 10 ohms). Checks all bypass, blocking and coupling capacitors of the paper, mica or ceramic types. (Does not detect leakage nor check electrolytic condensers.) Electron beam "eye" tube is used for quick indication. A 5-position function switch is featured which controls the power to the instrument and selects the test being made. Easy to build and easy to use. Test leads included. Shpg. Wt. 5 lbs.



MODEL BE-5 **\$39⁹⁵**

LOW RIPPLE BATTERY ELIMINATOR KIT

Completely up to date the BE-5 will power all the newest transistor circuits requiring 0 to 12 volts DC, and the new hybrid automobile radios using both transistors and vacuum tubes. An extra low-ripple filter circuit is employed holding AC ripple down to less than .3%. Doubles as a battery charger or marine converter. Shpg. Wt. 21 lbs.



MODEL T-4
\$19⁹⁵

VISUAL-AURAL SIGNAL TRACER KIT

New in every respect the T-4 features a built-in speaker and electron beam "eye" tube for signal indication, and a unique noise locator circuit. Ideal for use in AM, FM and TV circuit investigation. Transformer operated for safety and high efficiency. Complete with test leads and informative construction manual. Shpg. Wt. 5 lbs.

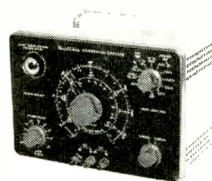

MODEL C-3 **\$19⁵⁰**

CONDENSER CHECKER KIT

Check unknown condenser and resistor values quickly and accurately as well as their operating characteristics with this fine instrument. All values are read directly on a calibrated scale. An electron beam "eye" tube indicates balance and leakage. A valuable addition to any service shop or lab. Shpg. Wt. 7 lbs.



HEATHKIT
MODEL TX-1
\$234⁹⁵

- Built-in cooling fan
- Rotating Slide Rule Dial
- Compact, Stable, VFO
- Provision for SSB Adapter

\$50.00 required on C.O.D. orders. Shipped motor freight unless otherwise specified.

"APACHE" HAM TRANSMITTER KIT

This beautifully styled transmitter has just about everything you could ask for in transmitting facilities. The "Apache" is a high quality transmitter operating with a 150 watt phone input and 180 watt CW input. In addition to CW and phone operation, built-in switch selected circuitry provides for single-sideband transmission through the use of a plug-in external adapter. A completely redesigned, compact and stable VFO provides low drift frequency control necessary for SSB transmission. A slide rule type illuminated rotating VFO dial with full gear drive vernier tuning provides ample bandspread and precise frequency settings. The bandswitch allows quick selection of the amateur bands on 80, 40, 20, 15 and 10 meters (11 m with crystal control). This unit also has adjustable low-level speech clipping and a low distortion modulator stage employing two of the new 6CA7/EL34 tubes in push-pull class AB operation. Time sequence keying is provided for "chirpless" break-in CW operation. The final amplifier is completely shielded for greater TVI protection and transmitter stability. A formed one-piece cabinet with convenient access hatch provides accessibility to tubes and crystal socket. Die-cast aluminum knobs and front panel escutcheons add to the attractive styling of the transmitter. Pi network output coupling matches antenna impedances between 50 and 72 ohms. A "spotting" push button is provided to allow tuning of the transmitter before switching on the final amplifier. This feature also enables the operator to "zero-beat" an incoming frequency without placing the transmitter on the air. Equip your ham shack now for top transmitting enjoyment with this outstanding unit. Shpg. Wt. 110 lbs.

New Styling...
New Features



HEATH COMPANY
Benton Harbor 20, Michigan

a subsidiary of Daystrom, Inc.



HEATHKIT
MODEL SB-10
\$89⁹⁵

SINGLE SIDEBAND ADAPTER KIT

Designed as a compatible plug-in adapter for the model TX-1 it can also be used with transmitters similar to the DX-100 or DX-100-B by making a few simple circuit modifications and still retain the normal AM and CW functions. Easy to operate and tune, the adapter employs the phasing method for generating a single sideband signal, allowing operation entirely on fundamental frequencies. The critical audio phase shift network is supplied, completely pre-assembled and wired in a sealed plug-in unit. Features include single-knob bandswitching for operation on 80, 40, 20, 15 and 10 meters, an easy-to-read panel meter, built-in electronic voice control with anti-trip circuit. Enjoy the advantages of SSB operation by adding this fine kit to your ham shack now. Shpg. Wt. 14 lbs.

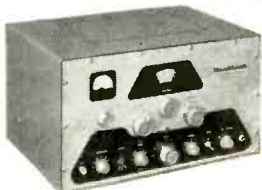

MODEL
DX-100-B
\$189⁵⁰

\$50.00 deposit required on C.O.D. orders. Shipped motor freight unless otherwise specified.

DX-100-B PHONE & CW TRANSMITTER KIT

The same fine performance of the time proven DX-100 is retained in the DX-100-B with improvements in the crystal and loading circuits. The one-piece formed cabinet has convenient access hatch for changing crystals, etc. and the chassis is punched to accept sideband adapter modifications. Features a built-in VFO, modulator and power supply, complete shielding to minimize TVI, and a pi network output coupling to match impedances from 50 to 72 ohms. RF output is in excess of 100 watts on phone and 120 watts on CW. Covers 160 through 10 meters. Single-knob bandswitching and illuminated VFO dial and meter face. RF output stage uses a pair of 6146 tubes in parallel, modulated by a pair of 1625's. Designed for easy assembly. Measures 11 1/2" H. x 19 1/2" W. x 16" D. Shpg. Wt. 107 lbs.



MODEL DX-40 **\$64⁹⁵**

DX-40 PHONE & CW TRANSMITTER KIT

Operates on 80, 40, 20, 15, 11 and 10 meters, using a single 6146 tube in the final for 75 watt plate power input CW, or 60 watts phone. Single-knob bandswitching, pi network output, complete shielding, provision for three crystals and VFO. D'Arsonval movement panel meter. Shpg. Wt. 25 lbs.



MODEL DX-20 **\$35⁹⁵**

DX-20 CW TRANSMITTER KIT

This fine unit covers 80, 40, 20, 15, 11 and 10 meters with single-knob bandswitching. Features a 6DQ6A tube in the final for 50 watt plate power input, pi network output, complete shielding to minimize TVI. Easy to build with complete instructions supplied. Shpg. Wt. 19 lbs.

"MOHAWK" HAM RECEIVER KIT

Designed for ham band operation and for maximum stability and accuracy, the Heathkit "Mohawk" receiver will let you enjoy ham activities to the utmost. This 15-tube receiver features double conversion with IF's at 1682 kc and 50 kc and covers all the amateur frequencies from 160 through 10 meters on seven bands. An extra band is calibrated to cover 6 and 2 meters using a converter. The "Mohawk" is specially designed for single-sideband reception with crystal controlled oscillators for upper and lower sideband selection. A completely pre-assembled, wired and aligned front end coil/bandswitch assembly assures ease of construction and top performance. Many more important features are provided in this outstanding receiver for dependable and effective amateur communications. Ruggedly constructed with well rated components throughout. Shpg. Wt. 66 lbs. Matching accessory speaker kit; optional extra. Model AK-5. \$9.95. Shpg. Wt. 8 lbs.

- **Prewired and Aligned Coil/Bandswitch Assembly**
- **Crystal Controlled Oscillators for Drift-Free Reception**

HEATHKIT
MODEL RX-1
\$274⁹⁵



HEATHKIT
MODEL AR-3
\$299⁵

(LESS CABINET)

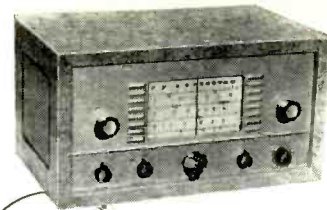

ALL-BAND RECEIVER KIT

A fine receiver for the beginning ham or short wave listener. Frequency coverage is from 550 kc to 30 mc in four bands. Features include bandswitch, handsread tuning, phone-standby-CW switch, antenna trimmer, noise limiter, RF and AF gain controls and head-phone jack. Easy to build. Shpg. Wt. 12 lbs.

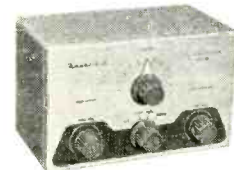

MODEL
QF-1
\$9⁹⁵

"Q" MULTIPLIER KIT

Use with any receiver with IF frequency between 450 and 460 kc to add additional selectivity for separating two signals or to reject one signal and eliminate heterodyne. A great help on crowded phone and CW bands. Not for use with AC-DC type receivers. Simple to connect with cable and plugs supplied. Shpg. Wt. 3 lbs.

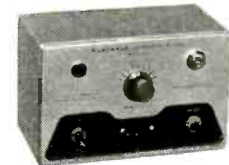

MODEL
CA-1
\$13⁹⁵

"AUTOMATIC" CONELRAD ALARM KIT

This easy-to-build device gives instant warning and cuts AC power to your transmitter when a monitored station goes "off-the-air". Use with any radio receiver having an AVC circuit. A sensitivity control adjusts to various AVC levels. Incorporates a heavy duty six-ampere relay and manual "reset" button to reactivate the transmitter. Complete instructions provided for connection to receiver. Shpg. Wt. 4 lbs.

"SENECA" VHF TRANSMITTER KIT

Brand new in every respect, the model VHF-1 "Seneca" is the latest addition to our line of ham transmitters. This self-contained 6 and 2 meter transmitter features built-in VFO, modulator, and dual power supply. A pair of 6146 tubes are employed in the push-pull final amplifier stage and features up to 120 watts input on phone and 140 watts input on CW in the 6 meter band. Slightly less in the 2 meter band to prolong amplifier tube life. Panel controls allow VFO or crystal control, phone or CW operation on both amateur bands. Four switch-selected crystal positions. Complete RF shielding to minimize TVI. Spotting push-button provided. The VFO slide rule type dial features edge-lighting and vernier tuning. An ideal transmitter for the ham who wants to extend operation into the VHF region. Shpg. Wt. 56 lbs.



HEATHKIT
MODEL VHF-1
\$159⁹⁵



MODEL AM-2 **\$15⁹⁵**
REFLECTED POWER METER KIT

Check the match of your antenna transmission system by measuring the forward and reflected power or standing wave ratio from 1:1 to 6:1. Handles a peak power of well over 1 kilowatt and may be left in antenna feed line. No external power required. 160 through 6 meters. For 50 or 75 ohm lines. Shpg. Wt. 3 lbs.



MODEL B-1 **\$8⁹⁵**

BALUN COIL KIT

Unbalanced coax lines can be matched to balance lines of either 75 or 300 ohms by using this balun coil kit. Use without adjustment from 80 through 10 meters at power up to 200 watts. May be located any distance from transmitter or antenna. Protective cover included. Shpg. Wt. 4 lbs.



MODEL VX-1 **\$23⁹⁵**

ELECTRONIC VOICE CONTROL KIT

This unique device lets you switch from receiver to transmitter merely by talking into your microphone. Provision is made for receiver and speaker connections and also for a 117 volt antenna relay. Adjustable to all conditions by sensitivity and variable time delay controls provided. Shpg. Wt. 5 lbs.



MODEL VF-1 **\$19⁵⁰**

VARIABLE FREQUENCY OSCILLATOR KIT

Far below the cost of crystals to obtain the same frequency coverage this VFO covers 160, 80, 40, 20, 15, 11 and 10 meters with three basic oscillator frequencies. Better than 10 volts RF output on fundamentals. Requires only 250 volts DC at 15 to 20 ma, and 6.3 V AC at 0.45 a. Illuminated dial reads direct. Shpg. Wt. 7 lbs.

Beautifully Styled With Plenty of
Room For The Most Complete
Stereo System



MODEL SE-1 (center unit) **\$149⁹⁵** Shpg. Wt. 162 lbs.

MODEL SC-1 (speaker enclosure) **\$39⁹⁵** each Shpg. Wt. 42 lbs.

STEREO EQUIPMENT CABINET KIT

This superbly styled cabinet ensemble is designed to hold your complete home stereo hi-fi system, consisting of a "stereo equipment center" flanked by two individual "stereo wing speaker enclosures". The unit has room for all the components required for stereo sound. Although designed to hold Heathkit stereo components, it is not frozen to this arrangement. The kit is supplied with mounting panels precut to accommodate Heathkits, but interchangeable blank panels are also furnished so you can mount any equipment you may already have. The precut panels accommodate the Heathkit AM-FM tuner (PT-1), stereo preamplifier (SP-1 & 2), and record changer (RP-3). Record changer chassis pulls out easily for convenient loading and unloading. Adequate space is provided for record storage and a pair of matching Heathkit power amplifiers (from 12 to 70 watts). The stereo wing speaker enclosures are open backed, cloth grilled cabinets designed to hold the Heathkit SS-2 or similar speaker systems. The cabinets are available in beautifully grained 3/4" solid core Phillipine mahogany or select birch plywood suitable for the finish of your choice. The matched grain sliding tape deck access door on top pops-up flush when closed. Entire top features a shaped edge. Hardware and trim of brushed-brass and gold finish. Rich toned grille cloth is flecked in gold and black. No woodworking experience required. All parts pre-cut and predrilled for easy assembly. Maximum overall dimensions (all 3 pieces): 82 3/4" W. x 36 1/2" H. x 20" D. Center Cabinet: 47 1/2" W. x 36 1/2" H. x 20" D.



HEATHKIT
MODEL CE-1
\$43⁹⁵
each

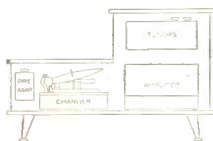

CHAIRSIDE ENCLOSURE KIT

Combine all of your hi-fi equipment into one compact control center and, at the same time add a beautiful piece of furniture to your home. The CE-1 is designed to house AM and FM tuners (BC-1A and FM-3A) and the WA-P2 preamplifier along with the majority of record changers which will fit in the space provided. Changer compartment measures 17 3/4" L. x 16" W. x 9 5/8" D. Adequate space is provided in the rear of the unit to house any of the Heathkit amplifiers designed to operate with the WA-P2. Good ventilation is achieved through properly placed slots in the bottom and back of the enclosure. Overall dimensions are 18" W. x 24" H. x 35 1/2" D. All parts are pre-cut and predrilled for easy assembly. The Contemporary cabinet is available in either mahogany or birch, and the Traditional cabinet is available in mahogany suitable for the finish of your choice. Beautiful hardware supplied. Shpg. Wt. 46 lbs.

Plan your own
Hi-Fi System...



HEATH COMPANY • Benton Harbor 20,
Michigan
a subsidiary of Daystrom, Inc.

HEATHKIT
MODEL RP-3
\$64⁹⁵



**HIGH FIDELITY
RECORD CHANGER KIT**

Every outstanding feature you could ask for in a record changer is provided in the Heathkit RP-3, the most advanced changer on the market today. The unique turntable pause during the change cycle saves wear and tear on your records by eliminating the grinding action caused by records dropping on a moving turntable or disk. Record groove and stylus wear are practically eliminated through proper weight distribution and low pivot point friction of the tone arm. Clean mechanical simplicity and precision parts give you turntable performance with the automatic convenience of a record changer. Flutter and wow, a major problem with automatic changers, is held to less than 0.18% RMS. An automatic speed selector position allows intermixing 33 1/3 and 45 RPM records regardless of their sequence. Four speeds provided: 16, 33 1/3, 45 and 78 RPM. Changer is supplied complete with GE VR II cartridge with diamond LP and sapphire 78 stylus, changer base, stylus pressure gauge and 45 RPM spindle. Shpg. Wt. 19 lbs.

"BASIC RANGE" HI-FI SPEAKER SYSTEM KIT

The popularity of this modestly priced speaker system attests to its high fidelity performance. The SS-2 provides an ideal basic speaker for your home hi-fi system. Flexibility of design allows it to be used as a table top model or as an attractive console with optional legs. May also be used as a supplementary speaker in more advanced systems or as replacement speaker for TV sets, etc. The specially designed tweeter horn rotates 90 degrees allowing you to use the speaker in an upright position if desired, as in the Heathkit stereo wing speaker enclosures. Total frequency range is from 50 to 12,000 cycles-per-second. An 8" mid-range woofer covers from 50 to 1,600 CPS while a compression-type tweeter with flared horn covers 1,600 to 12,000 CPS. Both speakers are by Jensen. A variable balance control allows level adjustment of the high frequency speaker. Power rating is 25 watts. Constructed of 1/2" veneer-surfaced plywood suitable for light or dark finish. All wood parts are pre-cut and pre-drilled for simple, quick assembly. An added feature of the SS-2 is that, although an outstanding performer in its own right, it may be combined with the SS-1B "range extending" speaker system later to extend the frequency range at the high and low ends of the audio range. Build in just one evening for many years of listening enjoyment. Shpg. Wt. 26 lbs.

ATTRACTIVE BRASS TIP ACCESSORY LEGS convert SS-2 into handsome console. 14" legs screw into brackets provided. All hardware included. Shpg. Wt. 3 lbs. No. 91-26. **\$4.95.**

Assemble it in

Just One Evening



HEATHKIT
MODEL SS-2

\$39⁹⁵

OPTIONAL LEGS
NO. 91-26 **\$4.95**

DIAMOND STYLUS HI-FI PICKUP CARTRIDGE

MODEL MF-1 **\$26⁹⁵**

Replace your present pickup with the MF-1 and enjoy the fullest fidelity your library of LP's has to offer. Designed to Heath specifications to offer you one of the finest cartridges available today. Nominally flat response from 20 to 20,000 CPS. Shpg. Wt. 1 lb.

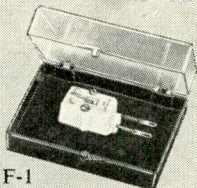

"RANGE EXTENDING" HI-FI SPEAKER SYSTEM KIT

Designed exclusively for use with the SS-2, the SS-1B employs a 15" woofer and a super tweeter horn to extend the range of the SS-2 to an overall response of ± 5 db from 35 to 16,000 CPS. When used together the two units form an integrated four-speaker system and are designed to combine into a single piece of attractive furniture. Impedance of the SS-1B is 16 ohms and power rating 35 watts. A control is provided to limit the output of the super tweeter. Constructed of beautiful 3/4" veneer-surfaced plywood suitable for light or dark finish of your choice. All parts are pre-cut and pre-drilled for simple assembly. No woodworking experience required. All hardware included. Shpg. Wt. 80 lbs.

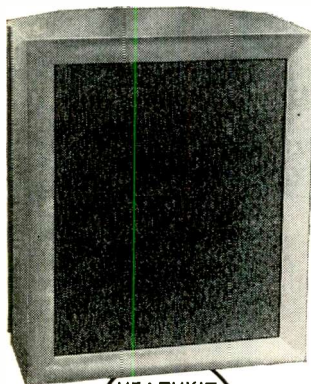

HEATHKIT
MODEL SS-1B

\$99⁹⁵

**Extended
Frequency Range
for Your SS-2**

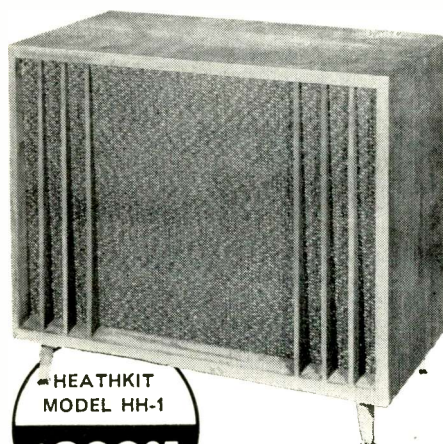

HEATHKIT
MODEL HH-1

\$299⁹⁵

"LEGATO" HI-FI SPEAKER SYSTEM KIT

It is difficult to describe in words the performance of this magnificent speaker system. You may never find absolute perfection in reproduced sound, but the Legato comes as close to achieving it as anything yet devised. Perfect balance, precise phasing, and adequate driver design combine to produce the superb quality of reproduction inherent in this instrument. The crisp, clear high frequencies and rich full bass engulf you in a sea of life-like tone. Two 15" Altec Lansing low frequency drivers cover frequencies from 25 to 500 CPS while a specially designed exponential horn with high frequency driver covers 500 to 20,000 CPS. The unique crossover network is built-in making electronic crossovers unnecessary. The Legato emphasizes simplicity of line and form to blend with modern or traditional furnishings. Constructed of 3/4" veneer-surfaced plywood in either African mahogany or white birch suitable for light or dark finishes of your choice. All parts are pre-cut and pre-drilled for easy assembly. Shpg. Wt. 195 lbs.

Easy to buy...

Easy to build

Easy to use...



**HEATH
COMPANY**

Benton Harbor 20,
Michigan

High Fidelity AM
and FM reception
in a Single Set

HEATHKIT
MODEL PT-1

\$89⁹⁵



Professional Stereo-Monaural AM-FM Tuner Kit

Enjoy stereophonic broadcasts as well as outstanding individual AM and FM radio reception with this deluxe 16-tube AM-FM-stereophonic tuner combination. Features include three etched circuit boards for high stability and ease of construction, prewired and prealigned FM front end, built-in AM rod antenna, tuning meter, FM-AFC (automatic frequency control) with on-off switch, and flywheel tuning. A multiplex jack is also provided. AM and FM circuits are tuned individually making it ideal for stereo applications since both AM and FM can be used at the same time. A switch selected tuning meter functions on either AM or FM. Cathode follower outputs with individual level controls are provided for both AM and FM. Other features include variable AM bandwidth, 10 kc whistle filter, tuned-cascade FM front end, FM AGC and amplified AVC for AM. Anywhere from 1 to 4 limiters or IF's assure smooth, non-flutter reception on weak or strong stations alike. The silicon diode power supply is conservatively rated and is fuse-protected assuring long service life. Flywheel tuning combined with new edge-lighted slide-rule dial provide effortless tuning. Use of three printed circuit boards greatly simplifies construction. Vinyl-clad steel cover is black with inlaid gold design. Shpg. Wt. 20 lbs.



MODEL FM-3A
\$26⁹⁵

HIGH FIDELITY FM TUNER KIT

The Heathkit FM-3A Tuner will provide you with years of inexpensive hi-fi enjoyment. Features broad-banded circuits for full fidelity and better than 10 uv sensitivity for 20 db of quieting. Covers the complete FM band from 88 to 108 mc. Stabilized, temperature-compensated oscillator assures negligible drift after initial warmup. Employs a high gain cascode IF amplifier and has AGC. Power supply is built-in. IF and ratio transformers are prealigned as is the front end tuning unit. Two outputs provided, one fixed, one variable, with extra stage of amplification. Shpg. Wt. 8 lbs.

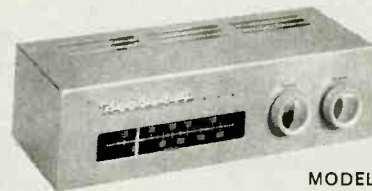

MODEL BC-1A
\$26⁹⁵

HIGH FIDELITY AM TUNER KIT

The BC-1A incorporates many features not usually expected in an AM circuit particularly in this low price range. It features a special detector using crystal diodes and broad band-width IF circuits for low signal distortion. Audio response is ± 1 db from 20 CPS to 9 kc with 5 db of pre-emphasis at 10 kc to compensate for station rolloff. Covers the complete broadcast band from 550 to 1600 kc. Prealigned RF and IF coils eliminate the need for special alignment equipment. Incorporates AVC, two outputs, two antenna inputs and built-in power supply. Shpg. Wt. 9 lbs.



MODEL W-6 **\$109⁹⁵**

"HEAVY DUTY" 70 WATT HI FI AMPLIFIER KIT

Designed for "rugged duty" called for by advanced hi-fi systems and P.A. networks. Silicon diode rectifiers assure long life and heavy duty transformer provides excellent power supply regulation. Variable damping control provides optimum performance with any speaker system. Quick change plug selects 4, 8 and 16 ohm or 70 volt output and the correct feedback resistance. Shpg. Wt. 52 lbs.



MODEL W-5 **\$59⁷⁵**

25 WATT HI FI AMPLIFIER KIT

Enjoy the distortion-free high fidelity sound from one of the most outstanding hi-fi amplifiers available today. Features include a specially designed Peerless output transformer and KT66 tubes. Frequency response is ± 1 db from 5 to 160,000 CPS at 1 watt and within 2 db 20 to 20,000 CPS at full 25 watts output. Hum and noise are 99 db below 25 watts. Shpg. Wt. 31 lbs.

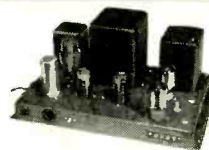

MODEL W-4AM **\$39⁷⁵**

SINGLE CHASSIS 20 WATT HI FI AMPLIFIER KIT

A true Williamson-type high fidelity circuit, the W-4AM features 5881 push-pull output tubes and a special Chicago-Standard output transformer to guarantee you full fidelity at minimum cost. Harmonic distortion is 1.5% and IM distortion is below 2.7% at full 20 watt output. Hum and noise are 95 db below full output. Taps for 4, 8 or 16 ohm speakers. Shpg. Wt. 28 lbs.

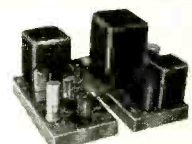

MODEL W-3AM **\$49⁷⁵**

DUAL CHASSIS 20 WATT HI FI AMPLIFIER KIT

Another famous Williamson-type high fidelity circuit, the W-3AM features the famous Acrosound TO-300 "ultralinear" output transformer and 5881 tubes. The power supply and main amplifier are on separate chassis for installation flexibility. Harmonic distortion is less than 1% and IM distortion is less than 1.2% at 20 watts. Shpg. Wt. 29 lbs.



HEATHKIT
MODEL SP-2
(STEREO)
\$56⁹⁵

**Monaural-Stereo Preamplifier Kit
(2-Channel Mixer)**

This unique kit allows you to purchase it in the monaural model if desired and then add the second or stereo channel later. The SP-2 features 12 separate inputs, six on each channel, with input level controls. Six dual concentric controls consist of: two 8-position selector switches, two bass, two treble, two volume level and two loudness controls, a scratch filter switch and a 4-position function switch. A separate on-off switch is provided. The function switch provides settings for stereo, 2-channel mix, channel A or B for monaural use. Inputs consist of tape, mike, mag phono and three high-level inputs. NARTB equalization and RIAA, LP, 78 record compensation are provided. A remote balance control is included. Printed circuit boards for easy assembly. Built-in power supply. Shpg. Wt. 15 lbs.



MODEL SP-1 (MONAURAL)
\$37⁹⁵ Shpg. Wt. 13 lbs.

MODEL C-SP-1 (CONVERTS SP-1 TO SP-2)
\$21⁹⁵ Shpg. Wt. 5 lbs.

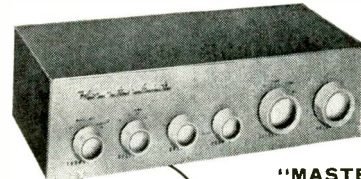

HEATHKIT
MODEL WA-P2
\$19⁷⁵

**"MASTER CONTROL"
PREAMPLIFIER KIT**

Control your hi-fi system with this compact unit. Features 5 switch-selected inputs to accommodate a record changer, tape recorder, AM tuner, FM tuner, TV receiver, microphone, etc., each with level control. Provision also for a tape recorder output. Equalization for records through separate turnover and rolloff switches for LP, RIAA, AES and early 78's. Shpg. Wt. 7 lbs.

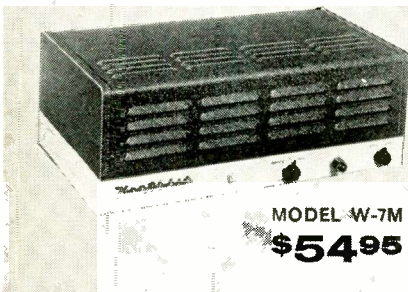

MODEL W-7M
\$54⁹⁵

**"EXTRA PERFORMANCE" 55 WATT
HI FI AMPLIFIER KIT**

Enjoy this high fidelity power amplifier at less than a dollar per watt. Full audio output and maximum damping is conservatively rated at 55 watts from 20 CPS to 20 kc with less than 2% total harmonic distortion throughout the entire range. Features famous "bas-bal" circuit, EL-34 output tubes and special 70 volt output. Shpg. Wt. 28 lbs.



MODEL UA-1
\$21⁹⁵

**"UNIVERSAL" 12 WATT HI FI
AMPLIFIER KIT**

The versatility and economy of this fine kit make it a truly "universal" hi-fi amplifier. An ideal basic amplifier for any hi-fi system or a perfect addition to gear your present hi-fi system to stereo sound. Uses 6BQ5/EL84 push-pull output tubes for less than 2% harmonic distortion throughout the entire audio range. Shpg. Wt. 13 lbs.

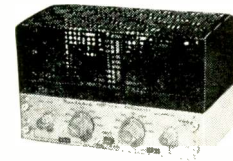

MODEL
XO-1
\$18⁹⁵

**ELECTRONIC
CROSSOVER KIT**

This unique instrument separates high and low frequencies and feeds them through 2 amplifiers into separate speakers. Located ahead of the main amplifier, it virtually eliminates IM distortion and matching problems. Note: Not for use with Heathkit Legato speaker system. Shpg. Wt. 6 lbs.

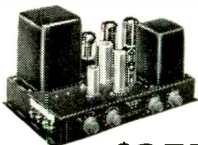

MODEL A-9C **\$35⁵⁰**

**GENERAL-PURPOSE
20 WATT AMPLIFIER KIT**

Designed for home installation as well as for PA requirements, the A9-C combines a preamplifier, main amplifier and power supply all on one chassis. Four switch-selected inputs are provided as well as separate bass and treble tone controls offering 15 db boost and cut. Detachable front plate allows for custom installation. Shpg. Wt. 23 lbs.



MODEL SW-1 **\$24⁹⁵**

SPEEDWINDER KIT

A real timesaver, the SW-1 leaves your tape recorder free for operation while rewinding tape at the rate of 1200 feet in 40 seconds. Prevents unnecessary wear to the tape and recorder. Handles up to 10 1/2" tape reels. Handles 800' reels of 8 and 16 millimeter film as well. Automatic shutoff prevents whipping at end of rewind. Shpg. Wt. 12 lbs.

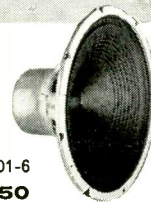

NO. 401-6
\$7⁵⁰

12" UTILITY SPEAKER KIT

Replace inferior speakers in radio or TV sets to obtain better tone quality or set up an auxiliary speaker for testing purposes with this convenient, high quality speaker. The speaker will handle up to 12 watts with a frequency response of ±5 db from 50 to 9,000 CPS. Speaker impedance is 8 ohms and has a 6.8 oz. magnet. An outstanding dollar value. Shpg. Wt. 7 lbs.

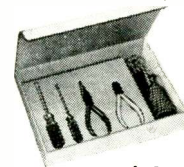

MODEL TK-1 **\$9⁹⁵**

COMPLETE TOOL SET

These basic tools are all you need to build any Heathkit. The pliers, diagonal side cutters, 2 screwdrivers, and soldering iron are all of top quality case hardened steel for hard duty and long life. Pliers and side cutters are equipped with insulated rubber handles for safety. A good example of just how easy Heathkit building really is. Shpg. Wt. 3 lbs.

HIGH FIDELITY TAPE RECORDER KIT

The model TR-1A tape deck and preamplifier combination provides all the facilities you need for top quality monaural recording/playback with fast forward and rewind functions. $7\frac{1}{2}$ and $3\frac{3}{4}$ IPS tape speeds are selected by changing belt drive. Flutter and wow are held to less than 0.35%. Frequency response at $7\frac{1}{2}$ IPS ± 2.0 db 50-10,000 CPS, at $3\frac{3}{4}$ IPS ± 2.0 db 50-6,500 CPS. Both units may be mounted together or separately affording high flexibility in every application. Features include NARTB playback equalization—separate recording and playback gain controls—cathode follower output and provision for mike or line input. Signal-to-noise ratio is better than 45 db below normal recording level with less than 1% total harmonic distortion. A filament balance control allows adjustment for minimum hum level. Complete instructions provided for easy assembly. Overall dimensions of tape deck and preamp is $15\frac{1}{2}$ " W. x $13\frac{1}{2}$ " H. x 8" D. Shpg. Wt. 24 lbs.



Includes tape deck assembly, preamplifier and roll of tape.



HEATHKIT
TE-1
\$39.95

Tape preamplifier sold separately if desired. Shpg. Wt. 10 lbs.



Many more Heathkits to choose from

hi-fi: Amplifiers—Preamplifiers—Speaker Systems—AM/FM Tuners—Equipment Cabinets—Record Player—Tape Recorder—Electronic Crossover—Stereo Equipment.

test: Oscilloscopes—Voltmeters—RF Signal Generators—AF Generators—Analyzers—Battery Eliminators—Tube Checkers—Condenser Checkers—Computer—Color Bar & Dot Generator—Sweep Generator—Impedance Bridge—Power Supplies—Probe Kits—R/C Decade & Substitution Kits.

ham radio: Transmitters—Receivers—Antenna Accessories—Voice Control—Conelrad Alarm—Variable Frequency Oscillator—SSB Adapter—"Q" Multiplier.

marine: Direction Finders—Marine Converter—Rudder Position Indicator—Fuel Vapor Detector—Charge Indicator—Power Meter.

general: Tool Set—6-Transistor Portable Radio—Radiation Counter—Electronic Timer—Crystal Receiver—Superheterodyne Receiver.

Send for Catalog describing over 100 easy-to-build electronic instruments in kit form. Complete specifications and detailed information on Hi-Fi—Test—Ham and Marine kits.

Save with Heathkits... the quality name in kit form electronics.



**"BOOKSHELF" 12 WATT
AMPLIFIER KIT**

Here are a few of the reasons why this attractive amplifier is such a tremendous dollar value. You get rich, full range, high fidelity sound reproduction with low distortion and noise . . . plus "modern styling". The many features include full range frequency response 20 to 20,000 CPS ± 1 db with less than 2% distortion over this range at full 12 watt output—its own built-in preamplifier with provision for three separate inputs: mag phono, crystal phono, and tuner—RIAA equalization—separate bass and treble tone controls—special hum control—and it's easy-to-build. Complete instructions and pictorial diagrams show where ever part goes. Cabinet shell has smooth leather texture in black with inlaid gold design. Cabinet measures 12 $\frac{1}{2}$ " W. x 8 $\frac{3}{16}$ " D. x 4 $\frac{3}{8}$ " H. Output transformer has taps at 4, 8 and 16 ohms to match the speaker of your choice. An ideal unit to convert your present hi-fi system to stereo sound. Shpg. Wt. 15 lbs.

An Amplifier, Preamplifier
all in one!



HEATHKIT
EA-2
\$28⁹⁵

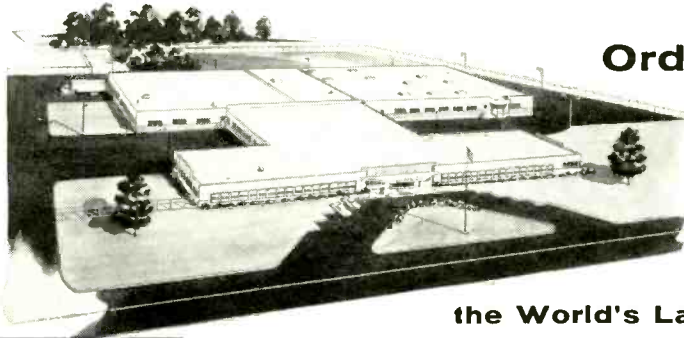

Order direct by mail...

Save $\frac{1}{2}$ or more over equivalent ready-made products by buying direct and assembling them yourself. Heathkit Style, Performance and Quality are unsurpassed!

**the World's Largest Manufacturer
of Electronic Instruments in Kit Form**



HEATH COMPANY BENTON HARBOR 20, MICH.

 a subsidiary of Daystrom, Inc.

NOTE: all prices and specifications subject to change without notice.

Enclosed find () check () money order. Please ship C.O.D. ()

On Express orders do not include transportation charges—they will be collected by the express agency at time of delivery.

On Parcel Post Orders include postage for weight shown. All prices are NET F.O.B. Benton Harbor, Michigan, and apply to Continental U.S. and Possessions only. 20% Deposit required on all C.O.D. orders.

Name _____
Address _____
City & Zone _____ State _____
(PLEASE PRINT)

SHIP VIA
 Parcel Post
 Express
 Freight
 Best Way

| QUANTITY | ITEM | MODEL NO. | PRICE |
|----------|------|-----------|---------|
| | | | |
| | | | |
| | | | |
| | | | |
| | | | POSTAGE |
| | | | TOTAL |

SEND FREE HEATHKIT CATALOG

HEATHKITS are also available at your Dealer

see listing
on next page



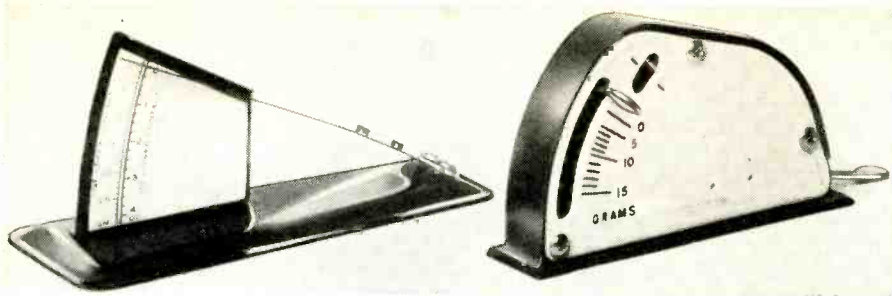

Fig. 2—Two types of stylus pressure gauges. Direct-measurement type (left): pickup arm is rested near fulcrum of spring-steel strip and pressure read directly on scale. Balance type (right): arm is rested on protruding platform, indicator is pushed downward with finger until pointer is centered in oval window.

(Continued from page 61)

with a reliable gauge (Fig. 2). Adjust it to within the limits specified by the cartridge manufacturer, neither more nor less. Make sure that no lead wires project below the arm to touch the record.

Check vertical alignment of stylus. Tilted pickup arms, improperly seated cartridges and bent stylus wires are common troublemakers that all too often go unobserved and uncorrected. If the turntable pad can be removed, do so. Make a stack of seven 25-cent pieces on the turntable, raise the arm and push the stack under the front of arm so that the needle may be placed on the back edge of the top quarter (Fig. 3-a). Set the long edge of a machinist's scale ($\frac{1}{2} \times 6$ inches) on the turntable, facing front, and check the cartridge and arm for tilt. Correct any deviation from parallel to the top edge of the scale.

Next, determine whether the vertical axis of the needle is at 90° to the turntable (Fig. 3-b). Use a strong front light or a forehead reflector, and magnification (a thread-count glass is best; its folding frame acts as a stand). With the scale held as before, use its end as a square to check alignment of the

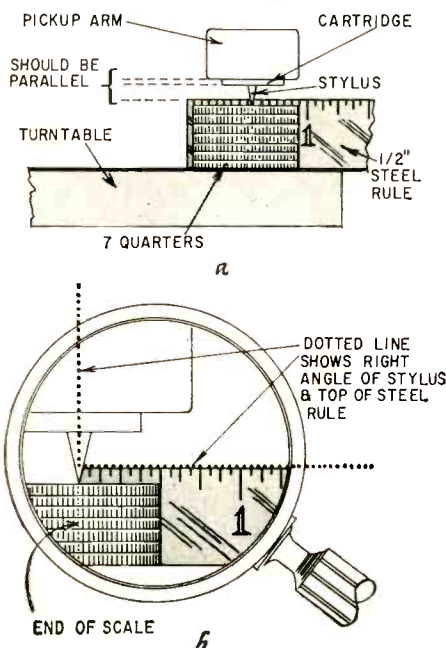

Fig. 3—Checking vertical alignment and tilt of stylus.

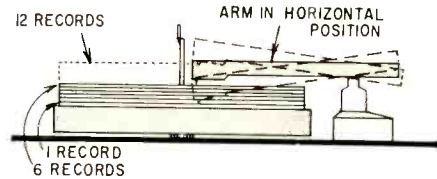

Fig. 4—Proper position for a cartridge is parallel to the record surface, as in professional type arms. Automatic changer arms can be parallel at only one point of the automatic load (in this case six records). Refer to manufacturer's recommended setting for each model.

needle. Correct any deviation, preferably with a new stylus. If bending is attempted, use needle-nose pliers, not tweezers, and grip only the stylus wire, not the needle point.

Check level of arm. Replace the turntable pad and put on a record. Professional type arms usually parallel the record surface. Automatic arms are customarily parallel when half the automatic load is on the table (Fig. 4), but, because of considerable variation with different makes, manufacturers' recommendations should be consulted for correct adjustment.

Check for tracking error. For proper tracking, the lateral or modulation motion of the stylus must be directly across each groove, at a right angle to the groove. Therefore, the stylus and the cartridge should align with the groove at every playing position (where the stylus is offset in the cartridge, only the stylus aligns). With pivot-mounted arms, this ideal can be only approximated.

To determine stylus-angle error, a simple template is useful (Fig. 5). Cut a 13-inch circle from light cardboard and draw a radial line. Measuring from exact center, mark points on the line at 2, $2\frac{1}{2}$, $4\frac{1}{4}$ and $5\frac{3}{4}$ inches. These points will be referred to as needle positions. At each needle position, align a protractor with the radial line, the reference point at the needle position. Mark dots at 88° , 90° and 92° . Draw heavy black lines at 90° $2\frac{1}{2}$ inches on either side of the radial line. Draw red lines at 88° and 92° , 2 inches on either side of the radial line. Carefully mark the center-hole radius of .0143 inch and punch it out.

Place the template on the turntable and set the needle on the outer needle position. The stylus should align with

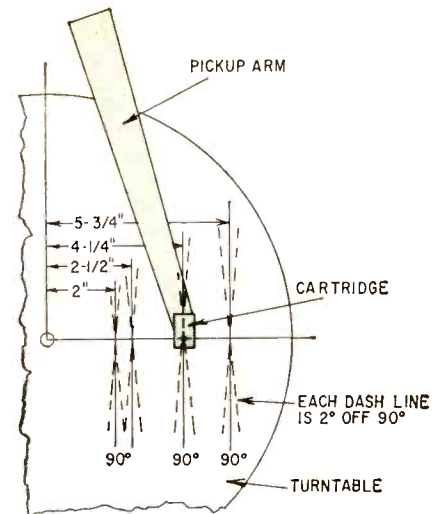

Fig. 5—Use of cardboard template to determine stylus tracking error. At all check points the stylus should align with the 90° tangent line, and in no case exceed the angle of dash lines.

the black tangent line. If its alignment exceeds either of the red angle lines at this or at any of the other three positions, there is undesirable error. The position nearest the center is the inner playing radius for 45-rpm records; the other three positions represent inner, midway and outer playing radii of 12-inch LP's. Points nearest the center require the highest accuracy of alignment. With some types of arms and cartridges it may be more accurate to use the arrangement recommended by Mr. Crowhurst and shown in Fig. 6.

(A more detailed discussion of record tracking was presented in RADIO-ELECTRONICS, October, 1957, pages 40-43.)

A straight arm should be replaced with a good offset arm. If an offset arm has error, try relocating the mounting point or substitute another arm with a more effective offset.

Test for mechanical feedback. Either play the record at minimum volume or turn off the amplifier and listen to needle talk. If there's no skip, probable speaker feedback through the cabinet can be proved by disconnecting set speakers and checking behavior with a remote speaker.

Remaking a "one-room cabinet" is more than a repair job, but how about suspending or cushioning the pickup table? Perhaps it's inadequate, or, if

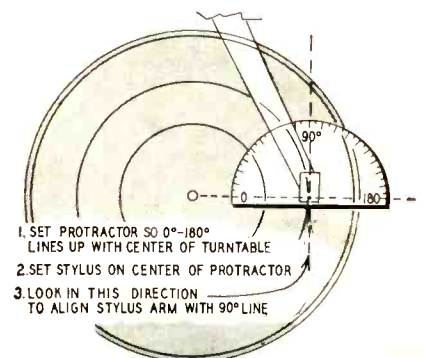

Fig. 6—Another method of checking tracking visually.

AUDIO—HIGH FIDELITY

the set was bought at "wholesale," maybe still bolted down!

Check pickup arm friction. Tie a loop about 2 inches in diameter at the end of an 18-inch piece of soft cotton string. Slide the loop over the pickup arm near the needle and hold the other end so that the needle clears the turntable.

Move the arm slowly over the playing area, while watching the angle of the string from perpendicular. Compare long and short arms, those of professional quality and those of changers, and you will soon get the feel of a friction-free arm. Those that show unusual resistance should be disassembled and bearing parts checked, cleaned and polished. On changers, additional friction is added when the reject trip levers are reached. When skipping cuts a single deep trench on the inside half of the record, the trip system is usually the cause. Run the changer through a cycle until arm is at the start position. Now *swing* the arm, with the string, over the outer quarter of the record radius. Gradually work the arm toward the center and listen for the slight click when the lever is first engaged.

If the groove was gouged at this point, there's your trouble. If not, kick the lever along a little at a time and notice (by the click) whether a similar swing always moves the lever an equal distance inward. Remember that the lever remains at the point to which it is pushed, until it triggers. If a harder kick is needed at a point where the record is gouged, there may be a burr on the lever or adjacent stampings. Remove the parts and rub over extra fine abrasive paper, laid on a smooth, flat surface. Wipe clean of oil or grease, and powder lightly with graphite.

Cartridge substitution. If all the foregoing factors are normal and skipping persists, the remaining sure cure is a more compliant cartridge. As compliance improves, output voltage usually decreases, so choose cartridges that are within the input requirements of the amplifier. Always check and adjust stylus pressure after changing a cartridge. If a crystal is in use, try a good ceramic. If a ceramic is in use, try a high-output magnetic. If a magnetic is in use, try one of somewhat less output. END

ELECTRONICS CONFERENCE

The Eleventh Annual Mid-America Electronics Conference (MAECON-1959) will be held this year in the Kansas City Municipal Auditorium and Hotel Muehlebach on Nov. 3, 4 and 5. Technical papers are wanted on engineering management, engineering education, astronautics, electromagnetics, nucleonics, airborne electronics, medical electronics and other electronic subjects.

Abstracts of approximately 100 words should be sent *not later than July 1* to: Dr. Sheldon L. Levy, Midwest Research Institute, 425 Volker Blvd., Kansas City 10, Mo., or Dr. Charles Halijak, Kansas State College, Manhattan, Kan.

Authorized HEATHKIT Dealers

Convenient "over-the-counter" delivery is now available through any of the Authorized Heathkit Dealers listed below. Although you will find the price of Heathkits slightly higher when buying locally, we're sure you'll agree that this increase is justified. Your dealer absorbs all transportation charges, carries a complete stock of kits for immediate de-

livery, provides demonstration facilities, offers you a reliable source for parts and fast service . . . and stands ready to counsel or advise you on any problem that might arise.

This new service does not affect your continued privilege to buy directly from Heath Company if you prefer.

NOW READY TO SERVE YOU...

- | | | |
|---|---|--|
| <p>CALIFORNIA BAKERSFIELD Kiesub Corporation 2615 "F" Street BERKELEY Sackit Corporation 2002 University Avenue CHICO Dunlap Radio & TV 928 Main Street EL CAJON Telrad Electronics 182 East Main Street FRESNO Dunlap Radio & TV 2617 Tulare Street LONG BEACH Kierulff & Company 1501 Magnolia LOS ANGELES Kierulff Sound Corporation 12024 Wilshire Boulevard LOS ANGELES Kierulff Sound Corp. (Capkit) 820 West Olympic Boulevard LOS ANGELES Kierulff & Company 6303 E. Corsair MARYSVILLE Dunlap Radio & TV 5th & "J" Street MERCED Dunlap Radio & TV 234 West 17th Street MODESTO Dunlap Radio & TV 419 10th Street NATIONAL CITY Telrad Electronics 639 National ONTARIO Kiesub Corporation 124 N. Benson OXNARD Kierulff & Company 508 E. Dale Street PALO ALTO Zack Electronics 654 High Street SACRAMENTO Dunlap Radio & TV 1800 22nd Street SAN BERNARDINO Kierulff & Company 399 South Mt. Vernon SAN DIEGO Telrad Electronics 3453 University Avenue SAN FRANCISCO Zack Electronics 1422 Market Street SANTA BARBARA Sackit Corporation 513 State Street STOCKTON Dunlap Radio & TV 27 North Grant Street TARZANA Kierulff Sound Corporation 18841 Ventura Boulevard VAN NUYS Kierulff & Company 14511 Delano VISALIA Dunlap Radio & TV 1725 Mooney Avenue</p> | <p>KENTUCKY LOUISVILLE Golden Ear, Incorporated 610 Third Street LOUISIANA LAFAYETTE Sterling Radio Products, Inc. 1005 Cameron Street MARYLAND SALISBURY Radio Electric Service Co. 736 South Salisbury Boulevard MASSACHUSETTS BOSTON Audionics, Incorporated 1348 Boylston Street MICHIGAN ALLEN PARK Volta Electronics 6716 Park Avenue DETROIT High Fidelity Workshop 16400 West Seven Mile Road MINNESOTA MINNEAPOLIS Audio King Company 913 West Lake Street NEW JERSEY ATLANTIC CITY Radio Electric Service Co. 452 North Albany Avenue CAMDEN Radio Electric Service Co. 513 Cooper Street MOUNTAINSIDE Federated Purchaser, Inc. 1021 U. S. Route #22 NEWARK Federated Purchaser, Inc. 114 Hudson Street NEW YORK BELLEROSE Cross Island Electronics, Inc. 247-40 Jericho Turnpike BROOKLYN Acme Electronics, Incorporated 59 Willoughby Street FARMINGDALE Gem Elec. Distributors, Inc. 34 Hempstead Turnpike FOREST HILLS Beam Electronics, Incorporated 101-10 Queens Boulevard HICKSVILLE Gem Elec. Distributors, Inc. 238 Broadway MINEOLA Arrow Electronics, Incorporated 525 Jericho Turnpike MT. VERNON Davis Radio Distributing Co., Inc. 70 East Third Street NEW YORK Arrow Electronics, Incorporated 65 Cortlandt Street NEW YORK Harvey Radio Company 103 West 43rd Street NO. CAROLINA CHARLOTTE Southeastern Radio Supply Co. 1200 W. Morehead Street GREENSBORO Southeastern Radio Supply Co. 404 N. Eugene Street FAYETTEVILLE Southeastern Radio Supply Co. 525 Gillespie Street KINSTON Southeastern Radio Supply Co. 408 N. Heritage Street RALEIGH Southeastern Radio Supply Co. 414 Hillsboro Street</p> | <p>OREGON PORTLAND Eccles Electric Company 237 Northeast Broadway SALEM Cecil Farnes Company 440 Church Street, Northeast PENNSYLVANIA ALLEN TOWN Federated Purchaser, Inc. 1115 Hamilton Street EASTON Federated Purchaser, Inc. 925 Northampton Street PHILADELPHIA Austin Electronics, Inc. 1421 Walnut Street PHILADELPHIA Radio Electric Service Co. 701 Arch Street PHILADELPHIA Radio Electric Service Co. 3412 Germantown Avenue PHILADELPHIA Radio Electric Service Co. 5930 Market Street WILLOW GROVE Radio Electric Service Co. 29 York Road YORK Radio Electric Service Co. 1114 Roosevelt Extension RHODE ISLAND PROVIDENCE Audionics, Incorporated 790 North Main Street TEXAS BEAUMONT Sterling Radio Products, Inc. 1160 Laurel Street BRYAN Sterling Radio Products, Inc. 2615 Texas Avenue DALLAS Hillcrest Records, Inc. 6309 Hillcrest Avenue HOUSTON Sound Equipment, Incorporated 2506 Crawford Street HOUSTON Sterling Radio Products, Inc. 1616 McKinney Avenue LUFKIN Sterling Radio Products, Inc. 428 Atkinson Street VIRGINIA ARLINGTON Key Electronics, Inc. 126 South Wayne Street WASHINGTON SEATTLE Seattle Radio Supply, Inc. 2117 Second Avenue WISCONSIN MADISON Hi-Fi Corner 401 State Street MADISON Satterfield Electronics, Inc. 1900 South Park MILWAUKEE Hi-Fi Center 4236 West Capitol Drive MILWAUKEE Netzow's 2630 North Downer Avenue</p> |
|---|---|--|

Careful selection of reliable qualified dealers is a slow process . . . so please bear with us if your area has not been covered. Thank you.

HEATH COMPANY
 Benton Harbor, Mich.

A Subsidiary of Daystrom, Inc.

ULTRA-STEERED-STEREO PROJECTOR

By MOHAMMED ULYSSES FIPS, IRE*



Photo A—Open air orchestra with inverted acoustical bowl which projects sounds over a large audience without electronic amplification.

This totally new technique, "elegant as simplicity," may render most of our stereo thinking—and equipment—obsolete

RECENTLY I visited the New York High Fidelity Show, which was a misnomer because the show was mostly stereo. The more I saw and heard, the more confused I became. The things that were going on completely flabbergasted me, so much so that I came away quite dazed.

The stereo demonstrations which I witnessed were, to my mind, only for the well heeled. Not only that, but most of the gadgets now in use are too cumbersome. Furthermore, why must stereo be so earsplittingly loud? What we need is a completely new approach to sound, *sound stereo*, and the thoughts aired here, I hope, will bring it about soon.

To begin with, why do we need electronic amplification? Have you ever been to an outdoor concert where the musicians sit in an inverted sound bowl and the music is thrown forward to reach the audience several hundred feet away? (See Photo A.) No electronic amplification here! The more I thought about this, the more convinced I became that any other approach was unsound. I then started to go back to

*Itinerant Radio Engineers.

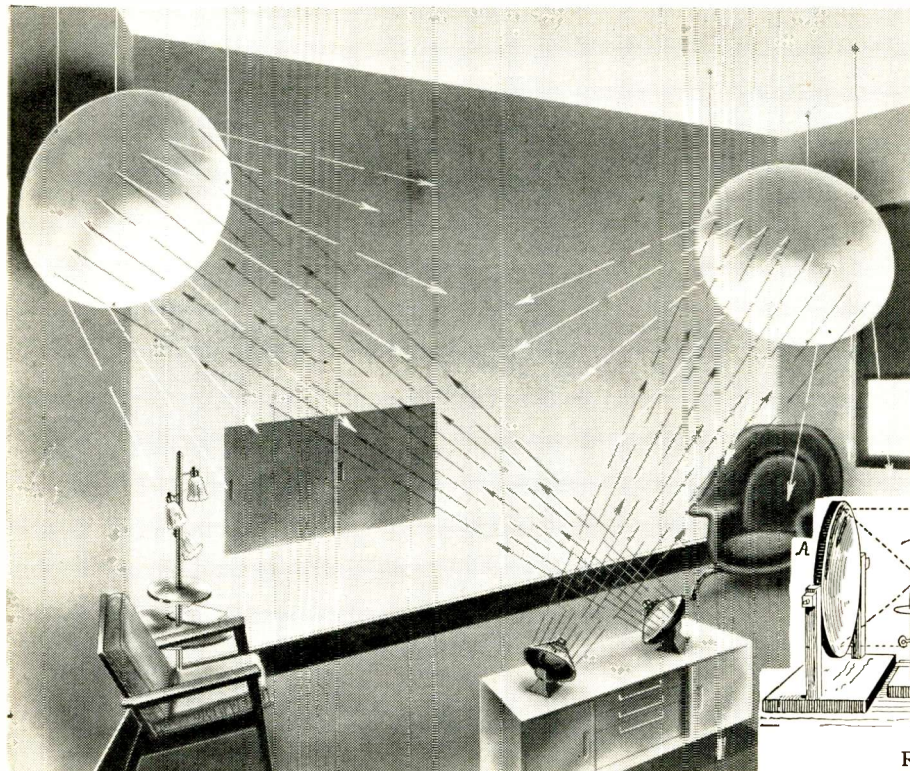
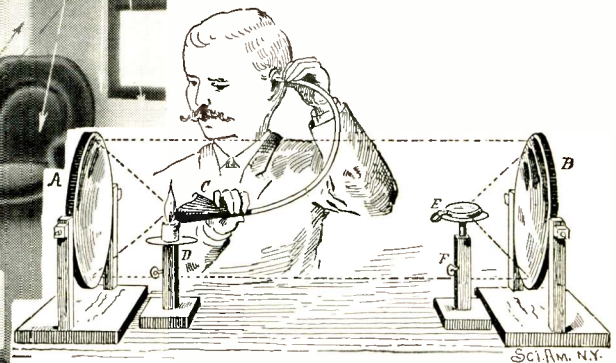

Photo B—Stereo arrangement for homes requires two 12" and two 25" parabolic aluminum reflectors. Loudspeakers throw sounds into large reflectors, then scatter sounds over the room.

FIG 163.



Reflection of Light and Sound.

Fig. 1—Sound of ticking watch in the focus of reflector B at right can be heard in focus of A, 35 feet away, without amplification.

acoustic fundamentals and soon came across what I was looking for.

This was an ancient book entitled "Experimental Science," by George M. Hopkins.† From this book, I reproduce Fig. 163 with the caption: "Reflection of Light and Sound," and a short description (Fig. 1).

"Place two reflectors, A and B, 4 or 5 feet apart, with their concave surfaces facing each other, as shown in Fig. 163. Place a short candle on the stand, D, so as to reflect a parallel beam that will cover the reflector, B, as nearly as possible. Then place a watch, E, in the focus of the reflector, B, upon the stand, F. Now hold the funnel, C, with its mouth facing the reflector, A, and immediately behind the candle, or, better, remove the candle and place the funnel in the position formerly occupied by the candle flame. With the funnel at this point the ticking of the watch will be distinctly heard, *but a slight movement of the funnel in either direction will render the ticking inaudible.* This experiment shows that the laws governing the reflection of light and sound are the same."

A similar illustration on the next page of the book shows the same setup with a large ear trumpet. The article concludes with this significant and almost unbelievable statement: "With this arrangement the watch may be heard twenty or thirty feet away." Mind you, this was all done 70 years ago, without benefit of electronic amplification. The Capitol in Washington, D. C., is well-known for its "whispering" acoustic phenomenon. If you stand on one marked spot and merely whisper, your friend standing on another marked spot 44 feet 6 inches away will hear you clearly. These experiments will give you food for thought, as they gave me. The result is shown in these pages.

I wanted to satisfy myself as to whether it would be possible to accomplish stereo in a revolutionary new manner, and I am pleased to state here that I succeeded. Furthermore, the cost of this new amplificationless stereo is piddling.

Some of the components needed must be made; namely, four reflectors. We require two 25-inch parabolic reflectors for the wall and two 12-inch loudspeaker reflectors for the console. I did not use expensive speakers, either, but secured two secondhand radio speakers. I found it quite unnecessary to match the speakers closely.

The arrangement which is shown in our illustration (Photo B) can be used anywhere. No placement dimensions have been given because they vary depending on the physical makeup of the room.

The secret of this new type of stereo lies in the focusing of the reflectors. It is quite critical! If it's not done correctly, the results will not be good.

Textbooks will tell you that the laws of sound and light are similar for experiments of this type. As the old

†Copyright 1889, 1893, 1895, Munn & Co. (Scientific American), New York.



Photo C—An actual photograph of large reflector, showing its size compared to girl, Larayne Limitone.

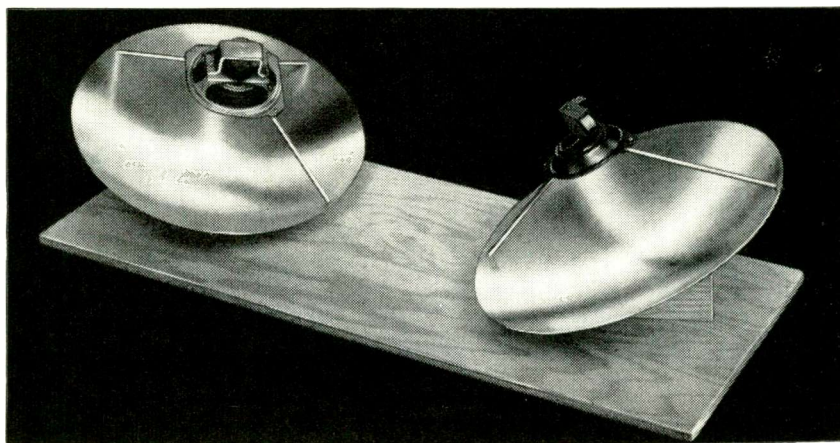

Photo D—This shows the the two loudspeakers as they are trained on the large wall reflectors. The blocks of supporting wood are mounted on metal straps so they can be moved in any direction and permanently fixed.

illustration shows, the candle must be adjusted in such a manner that by moving it closer or further away from the mirror, you hear the watch tick loudly, *even though it is 25 feet away.* With correct adjustments, the rays of the candle will be in the exact focus of mirror, A. The same is true of watch, E, and mirror, B. Here, too, the watch must be in the exact focus for best results.

Therefore, when you assemble the stereo outfit, you may use a watch and candle for correct focusing.

You will see from Photo B that *the two lower audio beams cross each other,* and you might wonder why this is done. The reason, again, is borrowed from the large outdoor orchestra inverted-bowl-sound amplifier. If a musician plays at the far right, the sound of his instrument is reflected not only from the right, but also goes to the far left, to be reflected out to the audience. I call this crossed-beam arrangement the "Audio Mixer," and in practice it works out perfectly. From this you will under-

stand that, when you do the focusing, the right speaker is focused with the left-wall reflector while the left loudspeaker is focused with the right-wall reflector.

The wall reflectors must be *sound-insulated* so they do not transmit extra frequencies by vibration to the wall. For that reason I used three heavy wool or nylon cords to suspend each wall reflector. The illustration shows the arrangement. The two small reflectors are mounted on a horizontal board, as shown (Photo D). To guard against extraneous sound transmission to the board, a heavy felt pad is placed between the wooden post and reflector to insulate the latter acoustically. This deadens the sound perfectly.

The arrangement gives excellent stereo reproduction without electronic amplification. Of course, such *natural* amplification does not give an ear-splitting output. It gives beautiful, soft, undistorted music.

Naturally there is nothing to prevent
(Continued on page 80)

build this great new **knight-kit**[®]

A PRODUCT OF ALLIED RADIO

never before such performance...such styling at so low a price...



tremendous value at only

\$44⁵⁰

only \$4.45 down

SAVE UP TO 50%...COMPARABLE IN EVERY WAY TO WIRED AMPLIFIERS COSTING TWICE AS MUCH

Includes two built-in preamplifiers for magnetic cartridges...

Single selector switch for instant choice of desired operation...

Separate bass and treble controls with boost and attenuation...

Concentric volume control adjusts balance on each channel—plus overall volume...

DC on all preamp filaments for hum-free operation...

Dual push-pull output circuitry for smooth, clear high-fidelity output...

knight-kit 20-watt stereo hi-fi amplifier

Newest complete stereo high-fidelity amplifier at an amazing low \$44.50—the most sensational value ever offered in a stereo amplifier kit. It's a pleasure to assemble. It's a truly fine instrument—the worthy heart of the finest stereo hi-fi music system. Ideal for use with newest stereo records or stereo radio broadcasts. Delivers 10 watts per channel into each of two speaker systems for 20 watts of stereo—or 20 watts into one or more speakers for monaural use. Includes two fully integrated built-in preamps to accommodate magnetic cartridges. Single switch selects phono, tuner or auxiliary stereo inputs, plus stereo reverse on each; also switches monaural input to both amplifier channels. Has separate bass and treble controls with both boost and attenuation for complete control of tonal color. Special clutch-type concentric volume control permits individual channel balance adjustment, plus overall volume control. RIAA equalized for stereo discs. Has four pairs of stereo inputs: magnetic cartridge, ceramic cartridge, tuner and auxiliary. With switched AC accessory outlet for added convenience. Response is 20-20,000 cps, ± 1.5 db. Hum and noise, better than 85 db below full output. Distortion less than 1½%. Simple point-to-point wiring for easy assembly—even without previous electronic experience. Custom cabinet attractively finished in French gray; aluminum front panel with ebony trim; 4¼ x 13¼ x 9". With case, tubes, all parts, wires, solder and instructions. Shpg. wt., 27 lbs.

Model Y-773. Knight-Kit 20-Watt Stereo Hi-Fi Amplifier Kit. Net only. **\$44⁵⁰**

Easy Terms: Only \$4.45 Down

order from **ALLIED RADIO**

the world's largest electronic supply house

stereo hi-fi amplifier

enjoy building the very best

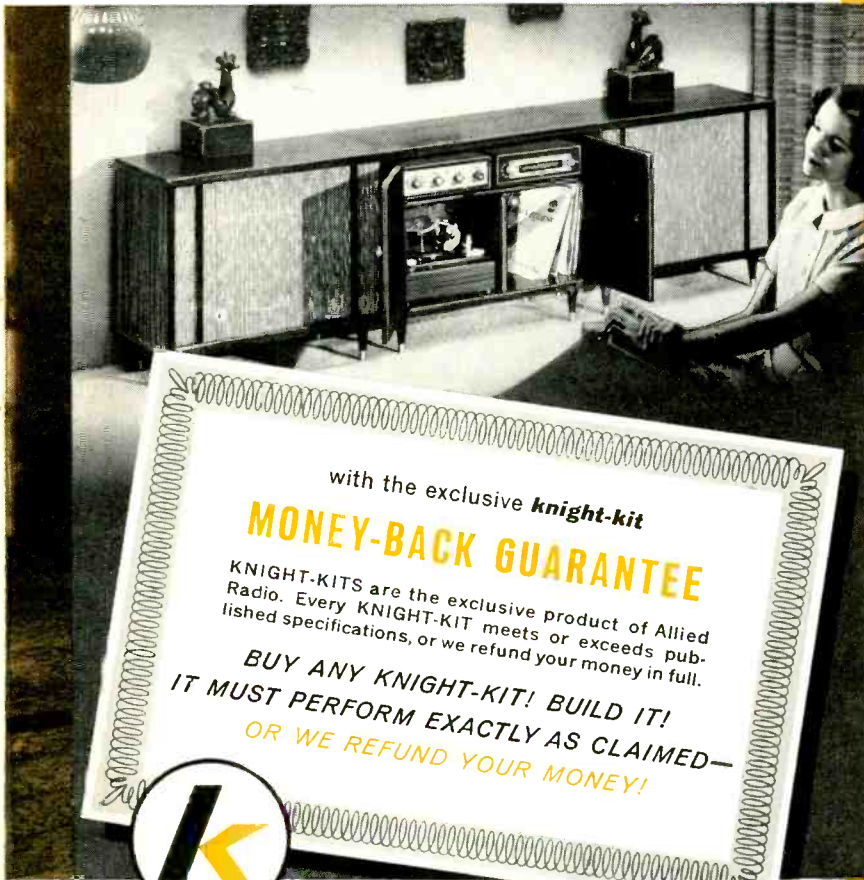

only **knight-kits** have
"CONVENIENCE ENGINEERING"
 for easiest building...no previous
 electronic experience needed

Exclusive in all Knight-Kits, "convenience engineering" means special attention to every detail: resistors are carded and numbered for ease of selection...all parts and hardware are packaged in clear plastic bags for easy identification...wire is precut, stripped and color-coded to save time. Finally, Knight-Kits are world-famous for their step-by-step instructions and wall-sized picture diagrams—assembly is a marvel of simplicity. Your final reward is proud enjoyment of the superior performance designed into your Knight-Kit.

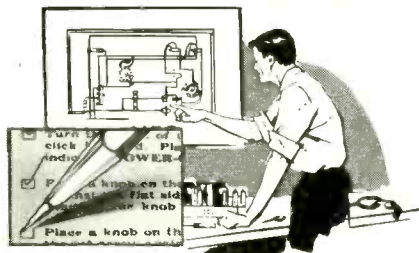
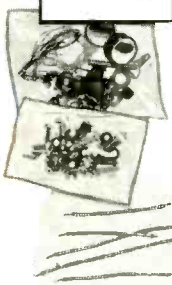
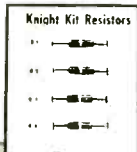

38 years of experience in electronic kit design



See over 50 other fine **knight-kits** in the 1959 Allied Catalog...send for it

FREE

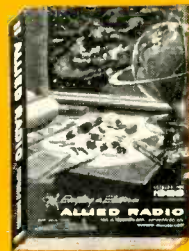

HI-FI KITS

- Stereo Deluxe Preamp
- 60-Watt Stereo Amplifier
- Stereo Control
- 30-Watt Amplifier
- 25-Watt Basic Amplifier
- 18-Watt Amplifier
- 12-Watt Amplifier
- FM-AM Tuner
- FM Tuner
- Hi-Fi Preamp
- Speaker Systems, etc.

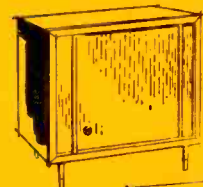

HOBBY KITS

- "Span-Master" 4-Band Receiver
- "Space-Scanner" Receiver
- "Ranger" Radio
- Clock-Radio
- Radio-Intercom
- "Ocean Hopper" Radio
- 5-Transistor Portable
- 2-Transistor Pocket Radio
- 1-Transistor Radio
- Electronic Lab Kits
- Photoelectric System, and many others

INSTRUMENT KITS

- VTVM
- VOM's
- Tube Checkers
- Oscilloscopes
- RF Signal Generator
- Signal Tracer
- Audio Generator
- Sweep Generator
- Capacity Checker
- R/C Tester
- Transistor Checker
- Flyback Checker
- Battery Eliminator
- Sub Boxes, etc.

AMATEUR KITS

- Communications Receiver
- 50-Watt Transmitter
- Self-Powered VFO
- 100 kc Crystal Calibrator
- RF "Z" Bridge
- Code Practice Oscillator

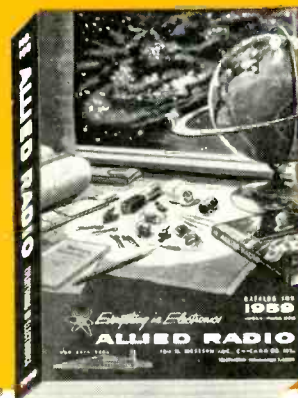

FREE

452-page 1959 ALLIED CATALOG

Send for this value-packed catalog featuring the complete KNIGHT-KIT line, as well as the world's largest stocks of *everything* in Electronics. Write today for this leading, money-saving Buying Guide.

ALLIED RADIO CORP., Dept. 156-D9
 100 N. Western Ave., Chicago 80, Ill.

- Ship me Model Y-773 20-Watt Stereo Hi-Fi Amplifier. \$_____ enclosed
- Send FREE ALLIED 1959 Catalog.

Name _____

Address _____

City _____ Zone _____ State _____

THERE'S GOLD IN THIS C-D TREASURE CHEST

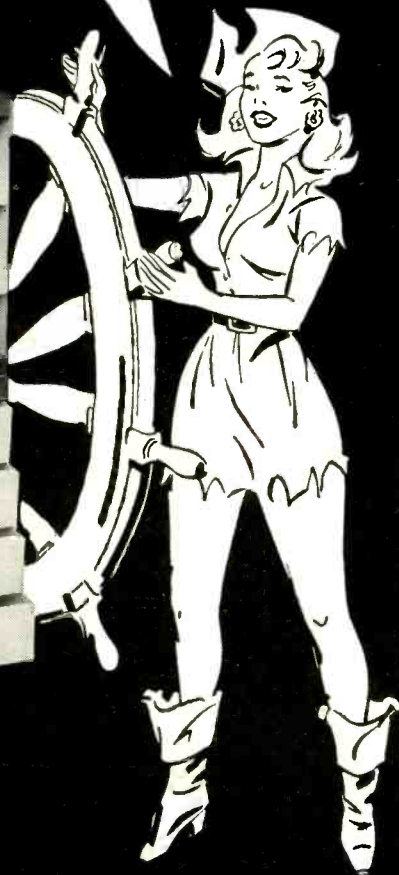

The modern way to stock and sell the world's most wanted capacitors. This efficient shop-chest tells you what's in stock and exactly where it is. No more digging for misplaced units. You get an assortment of the most popular C-D "Preferred" type twist-prongs, "Blue Beavers," and Mylar Tubulars—in handsome metal cabinets. Makes you look more efficient...makes work efficient! Best of all they're FREE with your purchase of capacitors.

See the "Treasure Chest" at your C-D distributor or write for Bulletins to Cornell-Dubilier Electric Corporation, South Plainfield, N.J.

Consistently Dependable
CORNELL-DUBILIER
SERVICE CAPACITORS

AUDIO—HIGH FIDELITY

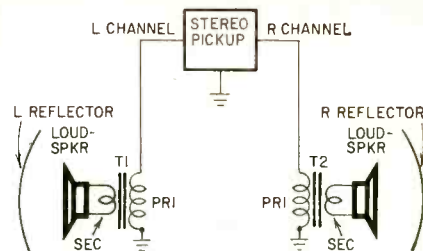

Fig. 2—A high-output pickup and two speakers with ordinary output transformers, hooked up as shown, constitute the whole circuit.

(Continued from page 77)

you from using an amplifier if you *must* have a *fortissimo* audio output. For my own purposes, I like soft mellow music, without the effects produced by large amounts of feedback.

The connections

If you wish to try the new improved system without electronic amplification, buy a ceramic type high-output stereo cartridge. Obtain two telephone type induction coils with high-ratio secondary. Hook them up with the secondary toward the cartridge and the primary toward the voice coil. Or you can use inexpensive replacement type output transformers that sell for 60 to 90 cents. Hook them up as in Fig. 2. Use *unshielded types*. With this arrangement, no power or batteries are required.

Practical hints

Small reflectors can be of almost any size in relation to diameter of large reflectors, but the larger the better.

Radius of curvature should be similar to that of large reflector; parabolic is best.

Small reflector does not have to be in exact focal line with large reflector, but should approximate it. Material of which reflectors are made should be thick enough so they do not vibrate at their own resonant frequency. I used aluminum No. 15 B & S gauge.

Beam of sound waves from small reflector will scatter sidewise so it will cover a good part of area of large reflector.

Small reflector should be placed at focal point of large reflector. This figures out to about 8 to 9 feet for 2-foot-diameter large reflector.

For electronic amplification, speakers to be connected in usual way to audio-frequency amplifier outputs.

Speaker units may be placed about 4 to 5 inches from center inner surface of small reflectors. Small reflectors used in setup here shown are 12 inches in diameter with center of curvature about 2 inches from chord of reflector, with similar proportions for large reflector.

Keep shifting all four reflectors until final sound suits you best.

Always remember the focusing of reflectors is very critical.

The reflectors cannot be bought readily, but any good metal spinner can make them. The reflectors shown were made in Brooklyn, cost only \$9, and are made of fairly stiff aluminum. On receipt of a reply postal card, we shall be pleased to give you the name of the spinner who makes such reflectors at low cost.

* * *

After I finished this article, I had some serious misgivings. I wondered how the boss would feel when he sees

AUDIO—HIGH FIDELITY

my latest effort. Fortunately, he's away on vacation, and I have considerable doubts that he would have allowed me to print the article, for these simple reasons:

First, he hasn't seen my demonstration—he always must stick his nose into everything! Then there is the Advertising Department, who haven't seen the article either. What will they say when they find out that you can get fine stereo results for only a few dollars? Finally, how will the speaker and amplifier manufacturers feel?

I know that, on the whole, people these days are amenable to reason and normally will not stand in the way of progress, even if it hurts their pocket-books temporarily. I am certain that they will welcome my effort. But for their protection (so I don't get into trouble), I felt it best not to publish as yet my most important later improvement, by which it is possible to flood the entire room with perfect stereo reproduction, which the system described here can't do. No more putting your head in a small stereo spot!

For these reasons, I know that my faithful readers will be patient for a little while. My new *Stereo Frequency Dispersion*, when attached to the two wall reflectors, will make four-dimensional stereo possible. It's great! *The most!* I intend to publish it next year, on

APRIL 1

DON'T LET THEM FOOL YOU



April Fool or any other time—make sure you know what you're getting when you buy tubes by mail order. Ever since January, 1956, RADIO-ELECTRONICS has insisted that mail-order advertisers tell you that their tubes are either new and unused—or that they are seconds, rejects or otherwise off-standard, if such is the case. In RADIO-ELECTRONICS they can't fool you—why take a chance elsewhere?



CRT 400 PROVES REAL MONEY-MAKER

Thousands of servicemen today make money and keep customer good-will by checking and correcting b&w picture tube troubles with the famous B&K CRT 400, right in the home without removing tube from set. Restores emission and brightness. Repairs inter-element shorts and open circuits. Checks leakage. Indicates picture quality customer can expect. Life Test checks gas content and predicts remaining useful life of picture tube. Makes new picture tube replacement sales easier!

Model 400 (without adapter) Net, **\$59⁹⁵**

B&K ADAPTERS FOR MODELS 400 and 350 CRT MAKE YOUR CRT MORE VALUABLE THAN EVER

Model C40 Adapter. Tests and rejuvenates TV color picture tubes and 6.3 volt filament 110° picture tubes. Tests and rejuvenates each gun of the color picture tube separately. Net, **\$9.95**

Model CR48 Adapter. Tests and rejuvenates the new 110° picture tubes with 2.34, 2.68, and 8.4 volt filaments. Net, **\$4.95**

See Your B&K Distributor, or Write For Bulletin ST21-E

Makers of CRT, DYNA-QUIK, DYNA-SCAN and CALIBRATOR

B & K MANUFACTURING CO.

3726 N. Southport Ave. • Chicago 13, Illinois



SUPER POWERED SINGLE CHANNEL AMPLIFIER

Minimum 20V—5 Watts on All Channels

This all new super powered unit has the highest output of any TV channel amplifier with sufficient power to cover large communities with ample signal voltage and deliver a strong signal thru many miles of cable. The unit was designed specifically for community television and is the only unit of its kind that does not produce power in fractions of a watt. For full rated output a high-powered commercial transmitting tube is used.

- C. C. S. Service
- Channels 2-13 as specified
- Co-axial input and output connectors for 75 OHM Line
- Linear class A operation
- 26 db min. gain
- 6-8 mcs. band width
- Requires only 1 V input
- Low Power Drain (1 Amp.)

Write for details today. Dept. 4

SEG Electronics • 1778-A Flatbush Ave., Brooklyn 10, New York

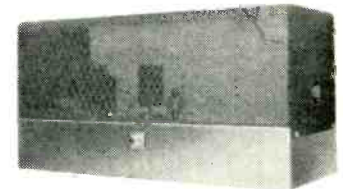

MODEL SPA
\$350

ALL ABOUT THE

REFLEX ENCLOSURE

Part II—Reflex enclosures are easy to tune, and tuning is needed for good results

By P. G. A. H. VOIGT

IN Part I* we took a look at the history and some of the basic principles behind the reflex enclosure. We ended by stating that "when we take the Helmholtz resonance into account we find that the motion of the air in the port builds up and helps the cone even more." The reasoning behind this statement is this:

If the drive is maintained at the appropriate frequency, the buildup continues until the losses balance the driving energy. Since a large part of the "loss" above is useful and in the form of sound output at the port, the resonance is one way of increasing the system's efficiency in that frequency region considerably.

The air-flow buildup at the port is accompanied by a corresponding pressure-variation buildup within the cabinet. This increases the load into which the rear of the cone is working and thus diminishes the cone's motion amplitude.

When cone motion becomes excessive, several undesirable things happen. First, the elastic support of the moving parts is rarely linear in its action. This nonlinearity introduces harmonics at large amplitudes. If the coil moves far enough to pass out of the region of maximum flux, there is further distortion of the low frequencies, and, should other frequencies be present just then, IM distortion as well. Lastly, since the cone is usually also the source of simultaneous higher frequencies, these are affected in another way. If they are emitted while the cone moves forward, the pitch rises slightly (Doppler effect) while, as it goes backward, the pitch drops. In this way, a high note is frequency-modulated by the lower one. The deviation depends on and gets worse as cone velocity increases.

The first group of undesirable effects decreases if cone displacement is reduced and the last if cone velocity

is reduced. Loading the cone, which decreases both displacement and velocity, is highly desirable.

It is at the natural resonance of the coil-cone system that it is most likely to move excessively and is most sensitive to the effects of extra loading. An accepted theory for optimum conditions in a reflex system is that the enclosure's natural resonant frequency (at which it provides maximum loading) should be made to agree with the speaker's natural resonant frequency.

With both resonances at the same frequency, you might expect serious trouble. Fortunately, things are not as bad as they seem. The load on the back of the cone diminishes cone excursion and velocity considerably, reducing troubles due to excess cone velocity and displacement. The sound output at the cone face is also reduced. This compensates to some extent for the sound output from the port.

There is also an interaction between the speaker and the air cushion. This produces an effect resembling the double-humped or double-peaked effect of an overcoupled bandpass circuit. The marked resonance of the speaker, which represented a prominent package of trouble, is replaced by two smaller ones, one above and one below the basic resonance frequency, each being far less offensive than the original. Finally, if the overall output is excessive at low frequencies, the Q (Quality) of the Helmholtz resonance can be reduced by damping.

In the early stages of the argument we assumed that cushion pressure was caused solely by the motion of the speaker cone. This was a simplification, for both the cone motion and the air flow at the port contribute to the total compression. At the frequency where the two motions synchronize, cone and air flow at the port share the compressibility of the air in the cavity. This makes the air cushion seem stiffer

(as though its volume had been reduced) and raises the resonant frequency. This corresponds to the upper "hump" or peak.

Next, if air is rushing in at the port and there is no signal at the speaker, instead of the air pressure in the enclosure backing up as it would in a simple Helmholtz resonator, it acts on the rear of the cone and drives that outward against the cone's control elasticity. To the air moving in at the port, this makes the air in the chamber seem more compressible (as though the volume were greater) and lowers the resonant frequency. Further, since the air in the cabinet is now flowing as a whole (from port to speaker and back as though these were in series), it is now moving in a way quite different from that effective at the upper peak when speaker and port acting in parallel share the air cushion between them.

With the series motion more of the air in the cabinet is moving, and the mass of the cone which the air is driving along with it has to be added in too. The overall increase of mass in motion lowers the frequency still further—down to that corresponding to the lower "hump" or peak.

At the frequency corresponding to this lower peak, cone motion does not synchronize with that of the air in the port. When the appropriate signal is applied to the cone, therefore, the two do not reinforce one another as effectively as at the higher frequency. You might even think that they would cancel one another and that the sound-producing efficiency would drop to zero.

Complete cancellation demands two equal sources 180° out of phase. At this lower frequency, the volume flow at the enclosure port, which is not limited by the elastic control of the cone, is dominant. Further, even if two sources are equal and 180° out of phase at the cabinet, it does not follow that they are 180° out of phase at the listener's ear.

*See also Correspondence page 24 this issue.

AUDIO—HIGH FIDELITY

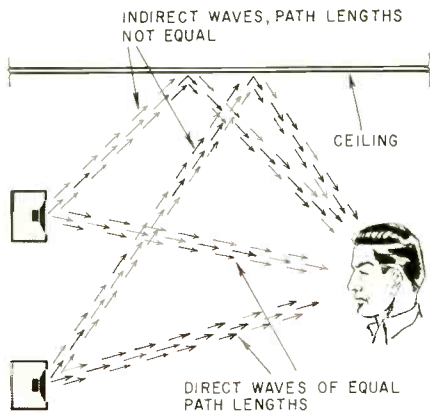

Fig. II-1—If two equal sources are 180° out of phase, but do not coincide in space, they will not cancel each other completely in all directions.

That will depend on the paths of sound. Even if the direct paths are of equal length, some reflected paths, say via the ceiling, might be different in length and thus introduce a time (phase) difference which prevents complete cancellation (see Fig. II-1).

Thus, while a high sound output is not expected at this lower frequency, the output is generally greater than that obtainable with the same speaker in a simple box baffle of equal volume. Therefore, the reflex boosts the response slightly at that lower frequency. Below this lower resonant frequency, the sound output drops off very rapidly indeed. The opening in the cabinet then permits air flow from one side of the cone to another and the disadvantages of the port come into effect. However, with a suitably designed reflex cabinet, this occurs at frequencies so low that the speaker was already very inefficient anyway and the extra loss there is a worth-while exchange for the gain higher up.

We can now summarize the reflex-cabinet designer's objective when trying to match the cabinet to a speaker. He tries to arrange matters so the reflex cabinet quenches the natural resonance of the speaker to some extent, reducing speaker amplitude buildup and possible distortion. Also, he wants to use the phase-reversal characteristic of the air-chamber system to help fill out, as much as possible, the general low-frequency region. Thus he kills two birds with one stone and produce a more acceptable overall result.

Matching speaker and enclosure

Now, our study of the theoretical background of reflex cabinet design is over. From it, the desirability of matching the cabinet to the speaker becomes obvious. What, then, should be said of the practice of many hi-fi salons of fitting a selection of speakers to a number of reflex cabinets, identical except for the diameter of the speaker opening, and then A-B testing from speaker to speaker?

Certainly most of the differences the
(Continued on page 88)

RADIO • TELEVISION • INDUSTRIAL ELECTRONICS

THIS professional TRAINING IS THE KIND THAT Really Pays Off!

... and it costs only a fraction of what you might expect to pay!

FIX ANY RADIO OR TV SET EVER MADE...easier...better...faster

Backed by the how-to-do-it methods so clearly explained in this one big 822-page book, you'll be prepared for fast, accurate service on any radio or television receiver ever made.

Radio & Television TROUBLESHOOTING AND REPAIR by Ghirardi & Johnson is far and away the world's best, most easily understood guide. Step by step, it takes you through each service procedure... from locating troubles with less testing to repairing them promptly by fully-approved professional methods.

COMPLETE SERVICE TRAINING IN ONE BIG BOOK

For beginners, this giant book is a complete service training course. For experienced servicemen, it is a quick, easy way to "brush up" on specific jobs: to

develop better methods and to find fast answers to tough jobs.

Here are just a few of the subjects covered: Components and Their Troubles; Basic Troubleshooting Methods; "Static" and "Dynamic" Testing; Practical Troubleshooting Tips and Ideas; AC/DC, 3-way Portable and Battery Set Troubleshooting Problems; Servicing Communications Receivers; a Complete Guide to Television Service; AM, FM, and TV Realignment Made Easy; Resistor, Capacitor, Inductor and Transformer Problems Explained; Servicing Tuning, Selector and Switching Mechanisms; Loudspeakers; Servicing Record-playing Equipment... and dozens more. 417 illustrations. Read TROUBLESHOOTING AND REPAIR for 10 days AT OUR RISK!

Price only \$7.50 (or see money-saving combination offer).

LEARN BASIC CIRCUITS FULLY... and watch service "headaches" disappear

It's amazing how much easier and faster you can repair radios, television sets and even industrial electronic equipment when you know all about circuits and what makes each one "tick."

You locate troubles in a jiffy because you know what to look for and where.

You make repairs lots faster, better, and more profitably!

Actually, there are only a comparatively few BASIC circuits in modern equipment. Radio & Television RECEIVER CIRCUITRY AND OPERATION by Ghirardi & Johnson gives you a complete understanding of these as well as their variations. It teaches you to recognize them... to under-

stand their peculiarities and likely "troublespots"... and shows how to eliminate useless testing and guesswork in making repairs.

A COMPLETE GUIDE TO MODERN RADIO-TV CIRCUITS

Throughout, this 669-page book with its 417 clear illustrations gives you the kind of above-average professional training that fits you for the better, big pay jobs in either servicing or general electronics. Covers all circuits in modern TV and radio receivers, amplifiers, phono-pickups, record players, etc. Price only \$6.75... or see money-saving offer in coupon. Examine it 10 days at our risk!

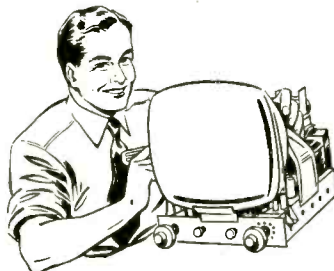

The books that explain SERVICE PROCEDURES so you can really understand them!

Almost 1300 pages and over 800 pictures and diagrams in these two new books explain things so clearly it's next to impossible for you to go wrong.

MODERN RADIO AND TELEVISION SERVICING LIBRARY

receiver troubles

SAVE \$1.25

Make your training library complete! Get both big books for only \$13.00. (You save \$1.25)

MODERN RADIO AND TELEVISION SERVICING LIBRARY

receiver circuitry &

FREE EXAMINATION...easy terms!

Dept. RE-49, RINEHART & CO., Inc.
232 Madison Ave., New York 16, N.Y.

Send books indicated for FREE EXAMINATION. In 10 days, I will either remit price indicated (plus postage) or return books and owe you nothing.

Radio & TV TROUBLESHOOTING AND REPAIR (Price \$7.50) Radio & TV CIRCUITRY AND OPERATION (Price \$6.75)

MONEY-SAVING COMBINATION OFFER... Both books only \$13.00. (Regular price \$14.25... you save \$1.25). Payable at rate of \$4 (plus postage) after 10 days and \$3 a month thereafter until \$13.00 has been paid. **SAVE!** Send full payment with order and we pay postage. Same 10-day return privilege with money refunded.

Name.....

Address.....

City, Zone, State.....

OUTSIDE U.S.A.—\$8.00 for TROUBLESHOOTING & REPAIR; \$7.25 for CIRCUITRY & OPERATION; \$14.00 for both. Cash with order, but money refunded if you return books in 10 days.

SUPERIOR'S NEW MODEL 77

VACUUM TUBE VOLTMETER

WITH NEW 6" FULL-VIEW METER



Model 77—VACUUM TUBE VOLTMETER
 . . . Total Price \$42.50—Terms: \$12.50 after 10 day trial, then \$6.00 monthly for 5 months if satisfactory. Otherwise return, No explanation necessary!

Compare it to any peak-to-peak V. T. V. M. made by any other manufacturer at any price!

- ✓ Model 77 completely wired and calibrated with accessories (including probe, test leads and portable carrying case) sells for only \$42.50.
- ✓ Model 77 employs a sensitive six inch meter. Extra large meter scale enables us to print all calibrations in large easy-to-read type.
- ✓ Model 77 uses new improved SICO printed circuitry.
- ✓ Model 77 employs a 12AU7 as D.C. amplifier and two 9006's as peak-to-peak voltage rectifiers to assure maximum stability.
- ✓ Model 77 uses a selenium-rectified power supply resulting in less heat and thus reducing possibility of damage or value changes of delicate components.
- ✓ Model 77 meter is virtually burn-out proof. The sensitive 400 microampere meter is isolated from the measuring circuit by a balanced push-pull amplifier.
- ✓ Model 77 uses selected 1% zero temperature coefficient resistors as multipliers. This assures unchanging accurate readings on all ranges.

SPECIFICATIONS

• DC VOLTS — 0 to 3/15/75/150/300/750/1,500 volts at 11 megohms input resistance. • AC VOLTS (RMS) — 0 to 3/15/75/150/300/750/1,500 volts. • AC VOLTS (Peak to Peak) — 0 to 5/10/200/400/800/2,000 volts. • ELECTRONIC OHMMETER — 0 to 1,000 ohms/10,000 ohms/100,000 ohms/1 megohm/10 megohms/100 megohms/1,000 megohms. • DECIBELS — -10 db to +18 db, +10 db to +38 db, +30 db to +58 db. All based on 0 db = .006 watts (6 mw) into a 500 ohm line (1.73v). • ZERO CENTER METER — For discriminator alignment with full scale range of 0 to 1.5/7.5/37.5/75/150/375/750 volts at 11 megohms input resistance.

AS A DC VOLTMETER: The Model 77 is indispensable in Hi-Fi Amplifier servicing and a must for Black and White and color TV Receiver servicing where circuit loading cannot be tolerated.

AS AN AC VOLTMETER: Measures RMS values if sine wave, and peak-to-peak value if complex wave. Pedestal voltages that determine the "black" level in TV receivers are easily read.

AS AN ELECTRONIC OHMMETER: Because of its wide range of measurement leaky capacitors show up glaringly. Because of its sensitivity and low loading, intermittents are easily found, isolated and repaired.

Model 77 comes complete with operating instructions, probe and test leads. Use it on the bench—use it on calls. A streamlined carrying case, included at no extra charge, accommodates the tester, instruction book, probe and leads. Operates on 110-120 volt 60 cycle. Only

\$42⁵⁰
NET

SUPERIOR'S NEW MODEL 79

SUPER-METER — WITH NEW 6" FULL-VIEW METER

A Combination VOLT-OHM MILLIAMMETER.

Plus CAPACITY, REACTANCE, INDUCTANCE AND DECIBEL MEASUREMENTS.

Also Tests SELENIUM AND SILICON RECTIFIERS, SILICON AND GERMANIUM DIODES.

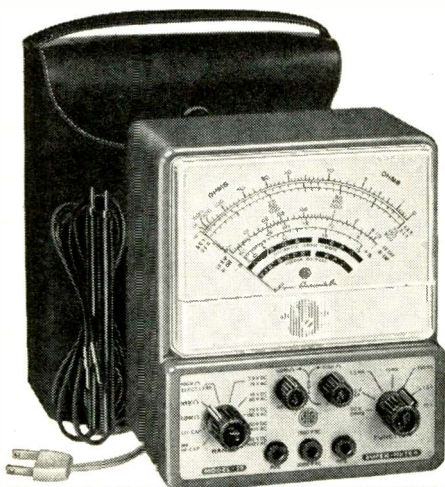

Model 79—SUPER-METER . . . Total Price \$38.50—Terms: \$8.50 after 10 day trial, then \$6.00 per month for 5 months if satisfactory. Otherwise return, no explanation necessary!

The Model 79 represents 20 years of continuous experience in the design and production of SUPER-METERS, an exclusive SICO development.

In 1938 Superior Instruments Co. designed its first SUPER-METER, Model 1150. In 1940 it followed with Model 1250 and in succeeding years with others including Models 670 and 670-A. All were basically V.O.M.'s with extra services provided to meet changing requirements.

Now, Model 79, the latest SUPER-METER includes not only every circuit improvement perfected in 20 years of specialization, but in addition includes those services which are "musts" for properly servicing the ever increasing number of new components used in all phases of today's electronic production. For example with the Model 79 SUPER-METER you can measure the quality of selenium and silicon rectifiers and all types of diodes—components which have come into common use only within the past five years, and because this latest SUPER-METER necessarily required extra meter scale, SICO used its new full-view 6-inch meter.

Model 79 comes complete with operating instructions and test leads. Use it on the bench—use it on calls. A streamlined carrying case included at no extra charge accommodates the tester, instruction book and test leads. Only

Specifications

D.C. VOLTS: 0 to 7.5/15/75/150/750/1,500.
 A.C. VOLTS: 0 to 15/30/150/300/1,500/3,000.
 D.C. CURRENT: 0 to 1.5/15/150 Ma. 0 to 1.5/15 Amperes.
 RESISTANCE: 0 to 1,000/100,000 Ohms. 0 to 10 Megohms.
 CAPACITY: 001 to 1 Mfd. 1 to 50 Mfd.
 REACTANCE: 50 to 2,500 Ohms, 2,500 Ohms to 2.5 Megohms.
 INDUCTANCE: .15 to 7 Henries, 7 to 7,000 Henries.
 DECIBELS: -6 to +18, +14 to +38, +34 to +58.

The following components are all tested for QUALITY at appropriate test potentials. Two separate BAD-GOOD scales on the meter are used for direct readings.

All Electrolytic Condensers from 1 MFD to 1000 MFD.
 All Selenium Rectifiers. All Germanium Diodes.
 All Silicon Rectifiers. All Silicon Diodes.

\$38⁵⁰
NET

SHIPPED ON APPROVAL
NO MONEY WITH ORDER—NO C.O.D.

Try for 10 days before you buy! If completely satisfied, send down payment after trial and pay balance at indicated monthly rate — **NO INTEREST OR FINANCE CHARGES ADDED.** If not completely satisfied, return to us, no explanation necessary.

SEE PAGE 87 FOR COMPLETE DETAILS

MOSS ELECTRONIC, INC.

3849 TENTH AVE., NEW YORK 34, N. Y.

For the first time ever: ONE TESTER PROVIDES ALL THE SERVICES LISTED BELOW!

**SUPERIOR'S NEW
MODEL 76**

ALL PURPOSE BRIDGE

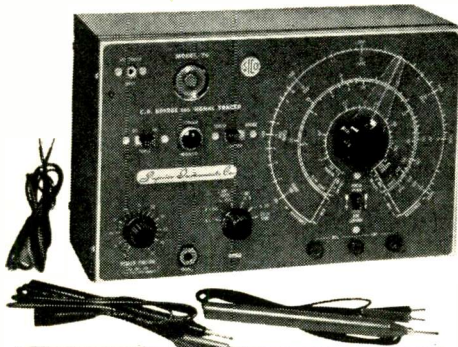

Model 76 BRIDGE . . . Total Price \$26.95—
Terms: \$6.95 after 10 day trial, then \$5.00
monthly for 4 months if satisfactory. Otherwise
return, no explanation necessary!

RESISTANCE BRIDGE SECTION

2 Ranges: 100 ohms to 5 megohms.
Resistance can be measured without discon-
necting capacitor connected across it. (Ex-
cept, of course, when the R C combination is
part of an R C bank.)

IT'S A CONDENSER BRIDGE

with a range of .00001 Microfarad to 1000 Microfarads
(Measures power factor and leakage too.)

IT'S A SIGNAL TRACER

which will enable you to trace the signal from antenna
to speaker of all receivers and to finally pinpoint the
exact cause of trouble whether it be a part or circuit
defect.

CAPACITY BRIDGE SECTION

4 Ranges: .00001 Microfarad to 1000 Micro-
farads. Will also locate shorts, and leakages
up to 20 megohms. Measures the power fac-
tor of all condensers from .1 to 1000 Micro-
farads. (Power factor is the ability of a con-
denser to retain a charge and thereby filter
efficiently.)

TV ANTENNA TESTER SECTION

Loss of sync., snow and instability are only
a few of the faults which may be due to a
break in the antenna, so why not check the
TV antenna first? 2 Ranges: 2' to 200' for 72
ohm coax and 2' to 250' for 300 ohm ribbon.

IT'S A RESISTANCE BRIDGE

with a range of 100 ohms to 5 megohms

IT'S A TV ANTENNA TESTER

The TV Antenna Tester section is used first to determine
if a "break" exists in the TV antenna and if a break does
exist the specific point (in feet from set) where it is.

SPECIFICATIONS:

SIGNAL TRACER SECTION

With the use of the R.F. and A.F. Probes in-
cluded with the Model 76, you can make
stage gain measurements, locate signal loss
in R.F. and Audio stages, localize faulty
stages, locate distortion and hum, etc. Pro-
vision has been made for use of phones and
meter if desired.

Model 76 comes complete
with all accessories includ-
ing R.F. and A.F. Probes;
Test Leads and operating
instructions. Nothing else
to buy. Only

\$26⁹⁵
NET

SUPERIOR'S NEW MODEL TV-50A

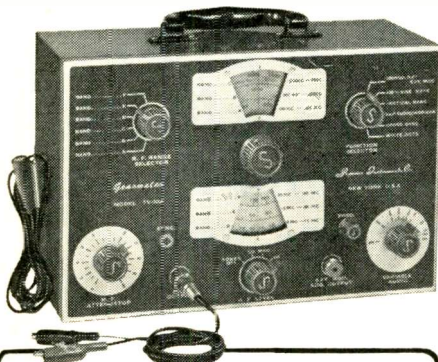

Model TV-50A GENOMETER . . . Total
Price \$47.50—Terms: \$11.50 after 10 day
trial, then \$6.00 monthly for 6 months
if satisfactory. Otherwise return, no ex-
planation necessary!

GENOMETER

7 Signal Generators in One!

- ✓ R.F. Signal Generator for A.M.
- ✓ R.F. Signal Generator for F.M.
- ✓ Audio Frequency Generator
- ✓ Bar Generator
- ✓ Cross Hatch Generator
- ✓ Color Dot Pattern Generator
- ✓ Marker Generator

A versatile all-inclusive GENERATOR which provides ALL the outputs for servicing:
**A.M. Radio • F.M. Radio • Amplifiers • Black and White TV
• Color TV**

Specifications

R. F. SIGNAL GENERATOR: The Model TV-50A Genometer provides complete coverage for A.M. and F.M. alignment. Generates Radio Frequencies from 100 Kilocycles to 60 Megacycles on fundamentals and from 60 Megacycles to 180 Megacycles on powerful harmonics.

CROSS HATCH GENERATOR: The Model TV-50A Genometer will project a cross-hatch pattern on any TV picture tube. The pattern will consist of non-shifting, horizontal and vertical lines interlaced to provide a stable cross-hatch effect.

VARIABLE AUDIO FREQUENCY GENERATOR: In addition to a fixed 400 cycle sine-wave audio, the Model TV-50A Genometer provides a variable 300 cycle to 20,000 cycle peaked wave audio signal.

DOT PATTERN GENERATOR (FOR COLOR TV) Although you will be able to use most of your regular standard equipment for servicing Color TV, the one addition which is a "must" is a Dot Pattern Generator. The Dot Pattern projected on any color TV Receiver tube by the Model TV-50A will enable you to adjust for proper color convergence.

BAR GENERATOR: The Model TV-50A projects an actual Bar Pattern on any TV Receiver Screen. Pattern will consist of 4 to 16 horizontal bars or 7 to 20 vertical bars.

MARKER GENERATOR: The Model TV-50A includes all the most frequently needed marker points. The following markers are provided: 189 Kc., 262.5 Kc., 456 Kc., 600 Kc., 1000 Kc., 1400 Kc., 1600 Kc., 2000 Kc., 2500 Kc., 3579 Kc., 4.5 Mc., 5 Mc., 10.7 Mc., (3579 Kc. is the color burst frequency)

THE MODEL TV-50A comes absolutely complete with shielded leads and operating instructions.

\$47⁵⁰
NET

SHIPPED ON APPROVAL
NO MONEY WITH ORDER—NO C.O.D.

Try for 10 days before you buy! If completely satisfied, send down payment after trial and pay balance at indicated monthly rate — NO INTEREST OR FINANCE CHARGES ADDED. If not completely satisfied, return to us, no explanation necessary.

SEE PAGE 87 FOR COMPLETE DETAILS

MOSS ELECTRONIC, INC.

3849 TENTH AVE., NEW YORK 34, N. Y.

SUPERIOR'S NEW MODEL TW-11

**STANDARD
PROFESSIONAL**

TUBE TESTER



- ★ Tests all tubes, including 4, 5, 6, 7, Octal, Lock-in, Hearing Aid, Thyatron, Miniatures, Sub-miniatures, Novals, Sub-minars, Proximity fuse types, etc.
- ★ Uses the new self-cleaning Lever Action Switches for individual element testing. Because all elements are numbered according to pin-number in the RMA base numbering system, the user can instantly identify which element is under test. Tubes having tapped filaments and tubes with filaments terminating in more than one pin are truly tested with the Model TW-11 as any of the pins may be placed in the neutral position when necessary.
- ★ The Model TW-11 does not use any combination type sockets. Instead individual sockets are used for each type of tube. Thus it is impossible to damage a tube by inserting it in the wrong socket.
- ★ Free-moving built-in roll chart provides complete data for all tubes. All tube listings printed in large easy-to-read type.
- ★ NOISE TEST: Phono-jack on front panel for plugging in either phones or external amplifier will detect microphonic tubes or noise due to faulty elements and loose internal connections.

EXTRAORDINARY FEATURE

SEPARATE SCALE FOR LOW-CURRENT TUBES. Previously, on emission-type tube testers, it has been standard practice to use one scale for all tubes. As a result, the calibration for low-current types has been restricted to a small portion of the scale. The extra scale used here greatly simplifies testing of low-current types.

The Model TW-11 operates on 105-130 Volt 60 Cycles A.C. Comes housed in a beautiful hand-rubbed oak cabinet complete with portable cover.

**\$47⁵⁰
NET**

Model TW-11—TUBE TESTER . . . Total Price \$47.50—Terms: \$11.50 after 10 day trial, then \$6.00 per month for 6 months if satisfactory. Otherwise return, no explanation necessary!

**SUPERIOR'S
NEW MODEL 83**

C.R.T. TESTER

Tests and Rejuvenates ALL PICTURE TUBES

ALL BLACK AND WHITE TUBES

From 50 degree to 110 degree types—from 8" to 30" types.

ALL COLOR TUBES



Test ALL picture tubes—in the carton—out of the carton—in the set!

Model 83—C.R.T. TUBE TESTER . . . Total Price \$38.50—Terms: \$8.50 after 10 day trial, then \$6.00 monthly for 5 months if satisfactory. Otherwise return, no explanation necessary!

- ✓ Model 83 is not simply a rehashed black and white C.R.T. Tester with a color adapter added. Model 83 employs a new improved circuit designed specifically to test the older type black and white tubes, the newer type black and white tubes and all color picture tubes.
 - ✓ Model 83 provides separate filament operating voltages for the older 6.3 types and the newer 8.4 types.
 - ✓ Model 83 employs a 4" air-damped meter with quality and calibrated scales.
 - ✓ Model 83 properly tests the red, green and blue sections of color tubes individually—for each section of a color tube contains its own filament, plate, grid and cathode.
 - ✓ Model 83 will detect tubes which are apparently good but require rejuvenation. Such tubes will provide a picture seemingly good but lacking in proper definition, contrast and focus. To test for such malfunction, you simply press the rej. switch of Model 83. If the tube is weakening, the meter reading will indicate the condition.
- Rejuvenation of picture tubes is not simply a matter of applying a high voltage to the filament. Such voltages improperly applied can strip the cathode of the oxide coating essential for proper emission. The Model 83 applies a selective low voltage uniformly to assure increased life with no danger of cathode damage.

Model 83 comes housed in handsome portable Saddle Stitched Texon case—complete with sockets for all black and white tubes and all color tubes. Only . . .

\$38⁵⁰

SHIPPED ON APPROVAL

NO MONEY WITH ORDER—NO C.O.D.

Try for 10 days before you buy! If completely satisfied, send down payment after trial and pay balance at indicated monthly rate — **NO INTEREST OR FINANCE CHARGES ADDED.** If not completely satisfied, return to us, no explanation necessary.

See following page for complete details

MOSS ELECTRONIC, INC.

3849 TENTH AVE., NEW YORK 34, N. Y.

SUPERIOR'S NEW MODEL 82A

Multi-Socket Type

TUBE TESTER

**TEST ANY TUBE IN
10 SECONDS FLAT!**

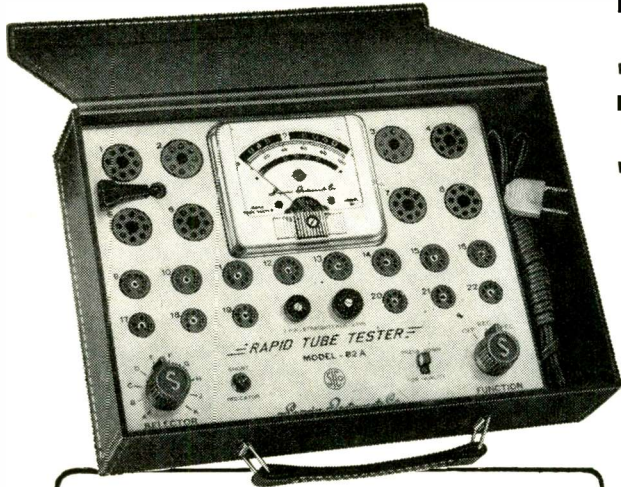

Model 82A — TUBE TESTER . . . Total Price \$36.50 — Terms: \$6.50 after 10 day trial, then \$6.00 monthly for 5 months if satisfactory. Otherwise return, no explanation necessary.

- ① Turn the filament selector switch to position specified.
- ② Insert tube into a numbered socket as designated on our chart (over 600 types included).
- ③ Press down the quality button —

THAT'S ALL!

Read emission quality direct on "BAD-GOOD" meter scale.

Specifications

Production of this Model was delayed a full year pending careful study by Superior's engineering staff of this new method of testing tubes. Don't let the low price mislead you! We claim Model 82A will outperform similar looking units which sell for much more — and as proof, we offer to ship it on our examine before you buy policy.

To test any tube, you simply insert it into a numbered socket as designated, turn the filament switch and press down the quality switch — THAT'S ALL! Read quality on meter. Inter-element leakage if any indicates automatically.

- Tests over 600 tube types
- Tests OZ4 and other gas-filled tubes
- Employs new 4" meter with sealed air-damping chamber resulting in accurate vibrationless readings
- Use of 22 sockets permits testing all popular tube types and prevents possible obsolescence
- Dual Scale meter permits testing of low current tubes
- 7 and 9 pin straighteners mounted on panel
- All sections of multi-element tubes tested simultaneously
- Ultra-sensitive leakage test circuit will indicate leakage up to 5 megohms

Model 82A comes housed in handsome, portable Saddle-Stitched Texon case. **\$36⁵⁰ NET** Only

**SHIPPED ON APPROVAL
NO MONEY WITH ORDER — NO C. O. D.**

MOSS ELECTRONIC, INC.
Dept. D-590 3849 Tenth Ave., New York 34, N. Y.

Please send me the units checked on approval. If completely satisfied I will pay on the terms specified with no interest or finance charges added. Otherwise, I will return after a 10 day trial positively cancelling all further obligation.

Name
Address
City Zone State
All prices net. F.O.B., N. Y. C.

- Model 77 Total Price \$42.50
\$12.50 within 10 days. Balance \$6.00 monthly for 5 months.
- Model 79 Total Price \$38.50
\$8.50 within 10 days. Balance \$6.00 monthly for 5 months.
- Model 76 Total Price \$26.95
\$6.95 within 10 days. Balance \$5.00 monthly for 4 months.
- Model TV-50A Total Price \$47.50
\$11.50 within 10 days. Balance \$6.00 monthly for 6 months.
- Model TW-11 Total Price \$47.50
\$11.50 within 10 days. Balance \$6.00 monthly for 6 months.
- Model 83 Total Price \$38.50
\$8.50 within 10 days. Balance \$6.00 monthly for 5 months.
- Model 82A Total Price \$36.50
\$6.50 within 10 days. Balance \$6.00 monthly for 5 months.



America's Fastest-Growing Service Capacitor Line...



NEW!

TOBE MYLAR* MOLDED TUBULAR CAPACITORS

- *Molded of DuPont Mylar*, one of the finest insulation materials ever developed.
- *Thermoset Case Construction* secures leads and sections firmly to withstand extremes of handling, vibration, shock and soldering temperatures.
- *High Insulation Resistance*: Average megohm values per unit 10,000 at 25°C. Small capacitance variation with thermal change.
- *Temperature Operating Range*: -55° to +130°C.
- *Moisture Resistant*: Exceeds JAN-C-91 requirements.
- *Non-Inductive*: Extended foil construction insures low resistance connections and low RF impedance.

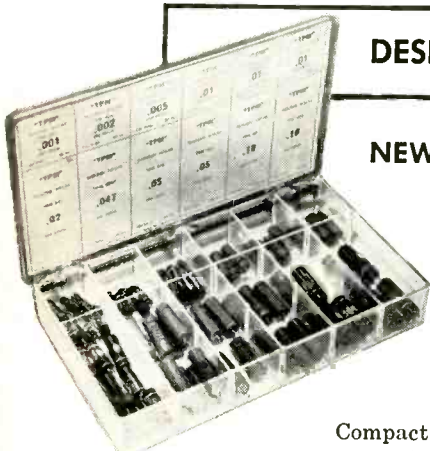

DESIGNED FOR SERVICE DEALERS

NEW TOBE MYLAR* CAPACITOR KIT

FREE KIT CONTAINS
80 CAPACITORS

ONLY
\$15⁸⁴

Compact, clear-plastic dispenser contains an assortment of 80 Tobe Mylar capacitors in the most popular sizes, ratings and quantities for quick, efficient servicing. Covers over 60 different ratings at 200, 400 and 600 working volts and from .0001 to 1.00 mfd. Dealer pays only for the Tobe Mylar capacitors, kit is free.

Today, order your Tobe Mylar Kit from your Tobe Distributor



TOBE
RADIART
CAPACITORS

AUDIO—HIGH FIDELITY

(Continued from page 83)

listener hears will be due to differences between the particular speakers being compared, but is it fair to any speaker to pair it with a cabinet which might not suit it at all? I, for one, certainly don't think so. The result of such tests may well be the selection of an inferior speaker, which gave better sound on that particular occasion simply because the cabinet matched it. A better speaker might have been rejected because the standard cabinet was so out of match it couldn't do its best.

Either good box baffles, large enough to be neutral in their effect should be used, or, with reflex cabinets, at the very least, each cabinet should be tuned to suit the speaker fitted in it.

Very little electronic equipment is needed. An audio generator, a 1,000-ohm

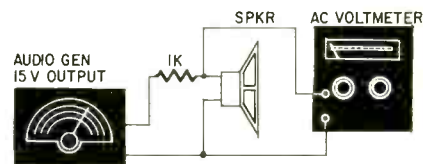

Fig. II-2—Simple circuit for locating main lower-speaker impedance peak.

resistor and a suitable ac voltmeter will do. Laboratory accuracy is not necessary. All that is needed is to show the approximate frequency and height of the main lower speaker impedance peak—first, when measured with the speaker in free air (no baffle at all, lay it on its back or hang it up on a wire) and again while in the cabinet.

The simple circuit for tuning is shown in Fig. II-2. The 1,000-ohm resistor and the speaker are in series across the audio generator. Keep the generator's output constant and slowly tune across the band of approximately 20 to 250 cycles while watching the meter for the sharp peak that shows the speaker's resonant frequency. If the generator delivers 15 volts and the speaker has a nominal impedance of about 16 ohms, the voltage across the speaker should be about 0.25. If the meter circuit has a resistance of 1,000 ohms or more, meter current will not disturb the reading significantly.

The speaker's impedance is partially due to the dc resistance of the coil and partially to the voltage generated when the coil moves in the magnet's gap. When the speaker is in free air (clear of any baffle or cabinet) and fed with constant current at various frequencies, coil motion builds up at the speaker's main lower resonance frequency. This drives the coil velocity up and the back emf generated in the coil peaks also. This shows up clearly on the voltmeter as a peak in the reading.

At the peak, the meter reading may be expected to rise to 1 or 2 volts, sometimes even higher. Thus the exact lower resonant frequency can be discovered. The voltmeter reading gives an idea of the peak's height.

If minor irregularities are ignored, a typical speaker has an impedance

MOST of us are familiar with the age old problem of checking an electrolytic capacitor. We have tried capacitor testers, in-circuit testers and circuit analyzers, only to find that the only real answer to checking any electrolytic accurately is to substitute it with another capacitor. Of course, this presents certain problems; the right value capacitor of the proper operating voltage is usually the one that you installed in the last repair job that you did and you don't have another around the shop for substitution. Then, too, there is always the discharge spark that does little good in creating good-will with your customer, to say nothing of the harm that it can do to the capacitor.

The intermittent electrolytic capacitor is the worst headache, especially where the trouble in the receiver is corrected when another capacitor is connected across it. This we call capacitor healing due to the sudden out-rushing current from the capacitor being paralleled. The ES-102 Electro-Sub is especially made to make substitution easy and is ideal for service shop, laboratory or any other place where design, service or experimenting is taking place.

WHY THE ELECTRO-SUB NOW?

The need for an electrolytic substitution unit has increased recently because of the sharp increase in the use of electrolytic capacitors. Hi-Fi amplifiers, for example, use up to 12 electrolytics. This increased again with the advent of stereo sound. One bad electrolytic will make a thousand dollar Hi-Fi sound like a ten dollar AC-DC radio. Portable TV receivers also use more electrolytic capacitors than conventional TV. The filter capacitors are more critical, especially when the portable uses a fuse resistor.

What Electrolytic Capacitors Will The ES-102 Substitute For?

The ES-102 is especially designed to substitute for all capacitors from 2 MFD to 400 MFD. The actual values selected and some of their uses are shown below.

- 4 MFD...especially handy for transistor radios
- 10 MFD...very handy for adding capacity to see if it will reduce hum
- 20 MFD...popular in many low cost AC-DC radios and TV bypass
- 40 MFD...used in most AC-DC radios and some TV receivers
- 60 MFD...used in many low cost TV receivers
- 80 MFD...used in most TV receivers and higher priced radios
- 100 MFD...used in many TV receivers and low cost Hi-Fi amplifiers
- 150 MFD...very prevalent in Hi-Fi amplifiers
- 225 MFD...used in some Hi-Fi amplifiers
- 350 MFD...used only in very high priced Hi-Fi and special applications. Very handy for design work and for trouble shooting hum.

When substituting for in between values, select the nearest value.

WHAT VOLTAGE CAN BE APPLIED TO THE ES-102?

Any voltage from 2 to 450 volts can be applied to the ES-102 capacitors without capacity change. This is because the capacitors used are special dry electrolytics.

[ADVERTISEMENT]

Time-Saver of the MONTH!

by Herb Bowden*

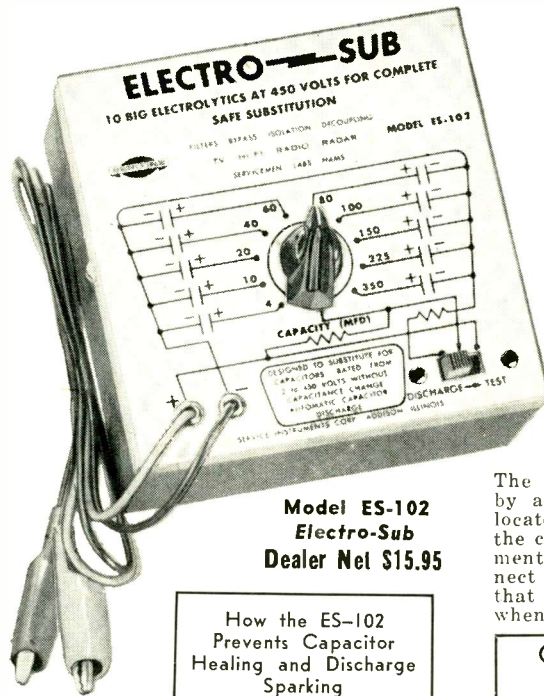

Model ES-102
Electro-Sub
Dealer Net \$15.95

How the ES-102 Prevents Capacitor Healing and Discharge Sparking

The ES-102 has a special charge and discharge circuit called a surge protector. This magic device is a development of Sencore and is very unique in operation. The surge protector action is shown in figure 1. Following the action of the surge protector, note the three positions of the switch as it slides from left to right. In position 1, the leads are connected to the circuit under test, but the substitute capacitor is not connected. In position number two, the capacitor is connected to the circuit through the 500 ohm resistor. Position number 3 shorts out the resistor and completes the substitution. The action is in reverse as the surge protector switch is released.

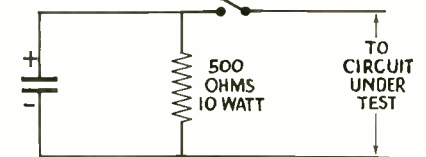

Fig. 1A. Position 1 places resistor across capacitor and only test leads connected to circuit.

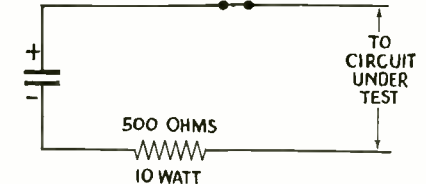

Fig. 1B. Position 2 showing resistor in series with capacitor to "slow down" current in-rush which may heal capacitor being paralleled.

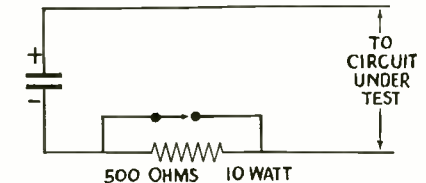

Fig. 1C. Position 3 of surge protector "shorts out" series resistor leaving only electrolytic in circuit.

[ADVERTISEMENT]

When it is returned to the extreme left, the 500 ohm resistor discharges the ES-102 capacitor completely within a few seconds. The remaining portion of the ES-102 schematic is screened on the front panel as shown.

Is The Surge Protector Critical In Operation?

It may appear that the surge protector switch must be moved to the right carefully in order to accomplish the connections described. However, this is not the case, as the switch can be compressed as fast as desired and as often as required. The connections and capacitor discharge are automatic.

Can The ES-102 Be Substituted Permanently?

The surge protector switch is returned by an external spring. This spring is located under the front panel. To use the capacitors for engineering or experimental work, you may want to disconnect the spring. Be sure to remember that the surge protector is not operating when the spring is disconnected.

CAN YOU GET A SHOCK FROM THE ES-102?

It is impossible to get a shock from the ES-102 as the test leads are disconnected and the capacitor discharged the instant that the surge protector switch is released. As a matter of fact, you can release the surge protector, disconnect the leads and then touch the leads to your hands without the possibility of shock. This is important, especially where customers or small children may get near your service bench.

DOES THE ROTARY SWITCH ARC WHEN SWITCHING CAPACITORS?

The rotary switch does not arc when switching capacitors because the surge protector switch disconnects the voltage source. This reduces switch wear greatly. One should be careful not to hold the surge protector to the right while changing capacitors.

IS IT NECESSARY TO DISCONNECT THE CAPACITOR BEING CHECKED?

If a capacitor is suspected of being open, you do not need to disconnect it from the circuit. If it is suspected of being shorted, it is necessary to disconnect it while substituting one of the capacitors from the ES-102.

WHERE TO PURCHASE THE ELECTRO-SUB

Over 1000 parts distributors in the United States and Canada carry the complete line of Sencore time savers. These distributors now carry the Electro-Sub in stock. Dealer net is \$15.95 (less than your cost of the electrolytic capacitors).

If, for some reason, your distributor does not carry the Sencore line, please drop us a note at the factory, 121 Official Road, Addison, Illinois. In Canada, please write . . . Active Radio and TV Dist., 58 Spadina Avenue, Toronto 2 B. Look for the colorful Sencore display.

*PRESIDENT SENCORE

General Instrument has

the **RIGHT RECTIFIER**

for every **TV set**



AUTOMATIC
PT5 Silicon
RECTIFIERS

RADIO RECEPTOR
Selenium
RECTIFIERS

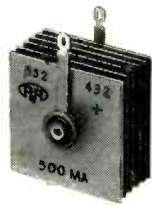

Don't be fooled by an "all or nothing at all" approach. Selenium and Silicon rectifiers both have a place in today's TV sets . . . and General Instrument supplies the very best!

Radio Receptor "Safe Center" selenium rectifiers have proved their reliability and long life in millions of circuits through the years. When your replacement calls for *selenium* there is no better rectifier.

AUTOMATIC PT5 Silicon rectifiers are the first choice of leading TV set manufacturers switching to silicon in their new models. When replacing or converting to *silicon*, install the PT5 for maximum performance and picture brightness.

Both these outstanding rectifiers are brought to you by GENERAL INSTRUMENT, your finest source of semiconductor components!

General Instrument Distributor Division
RADIO RECEPTOR COMPANY, INC.
Subsidiary of General Instrument Corporation
240 Wythe Avenue, Brooklyn 11, N. Y. EVergreen 8-6000



See us in May in Chicago at the Electronic Parts Distributor Show—Booth 590

AUDIO—HIGH FIDELITY

curve like that shown by the solid line in Fig. II-3.

If that speaker is fitted into a reflex enclosure, the vented air chamber affects matters by loading the rear of the cone. In the frequency range where the load is effective, cone and coil motion are diminished. The coil velocity drops, as do the impedance and the voltmeter reading. Therefore, the frequency at which the load is greatest can be ascertained easily, for at that frequency the speaker impedance drops substantially below its free-air level.

If both impedance curves are plotted (with the speaker in air and again in the cabinet) and the two curves are compared, it will seem almost as though the effect of the air resonance was to take a bite out of the impedance curve. The position of the bite indicates the frequency region of maximum cabinet load.

Tune the port

The maximum-load frequency can be made to agree with the speaker's resonance frequency if the cabinet is made so that the air resonance is adjustable. The hi-fi dealer using reflex cabinets needs the simplest method of tuning possible. He cannot alter the volume of his cabinets to adjust the resonance frequency. Instead, he will adjust the air inertia of the port. The simplest way is to alter the port area.

If the port is made as shown in Fig. II-4 and he obtains the inexpensive extra parts shown, he can do this easily.

A simple way of arriving at the correct adjustment is to leave the audio generator set at the speaker resonance frequency, and adjust the port opening while keeping an eye on the voltmeter. By this method it is not even necessary to know what the resonant frequency really is. Just leave the knob set where the free-air reading shows the peak. Now, when the voltmeter reading is at its lowest, the cabinet is adjusted for maximum loading.

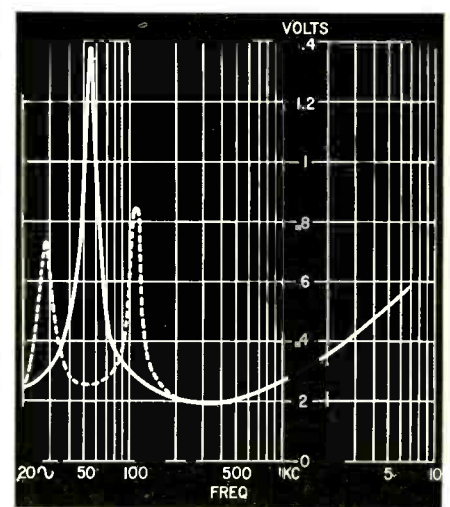

Fig. II-3—Typical speaker impedance curves: solid line for speaker in free air; dashed line for same speaker in small (0.66-cubic-foot) reflex enclosure.

JUST OFF THE PRESS!



NEWLY REVISED AND UP-TO-DATE

WHERE
Would You
be Today
in Radio-TV
Electronics
IF ...

you had sent for
this FREE Valuable Booklet 12 Months Ago

TAKE A MINUTE TO MAIL THIS COUPON FOR FREE BOOKLET!

Thousands of men *did* send for it. They read it. And now they are a full year ahead in their march toward:

- a better job
- better pay
- promotion
- greater security
- greater confidence
- better living for self and family

All these benefits can be yours . . . if you act now to see what the rapidly expanding field of Electronics offers you. Take that first big step this minute. No obligation whatsoever. Mail coupon today, or write: Capitol Radio Engineering Institute, 3224 16th St., N.W., Washington 10, D. C.

CAPITOL RADIO ENGINEERING INSTITUTE

ECPD Accredited Technical Institute Curricula • Founded 1927
144-F 3224 16th St., N.W. Washington 10, D. C.

113-F

Please send me your course outline and FREE illustrated Booklet "Your Future in the New World of Electronics" . . . describing opportunities and CREI home study courses in Electronic Engineering Technology.

- CHECK FIELD OF GREATEST INTEREST
- Radar, Servo and Computer Engineering Technology
 - Electronic Engineering Technology
 - Broadcast (AM, FM, TV) Engineering Technology
 - Television Engineering Technology
 - Aeronautical Electronic Engineering Technology
 - Automation and Industrial Electronics Engineering Technology

Name Age

Street

City Zone State

Check: Home Study Residence School Korean Veteran

To obtain fast immediate service and to avoid delay it is necessary that the following information be filled in:

EMPLOYED BY

TYPE OF PRESENT WORK

EDUCATION: YEARS HIGH SCHOOL

OTHER

ELECTRONICS EXPERIENCE

CREI prepares you quickly for success in

The future is in your hands!

The signs are plain as to the future of the trained men in the electronics industry. It is a tremendous industry, but—when there's a choice between a trained and untrained applicant, the trained man will get the job. Your biggest problem is to decide on—and begin—the best possible training program.

**CREI Home Study . . .
The Quick Way to Get There.**



Since 1927, CREI has given thousands of ambitious young men the technical knowledge that leads to more money and security. The time-tested CREI procedure can help you, too—if you really want to be helped. CREI lessons are prepared by experts in easy-to-understand form. There is a course of instruction geared to the field in which you want to specialize. You study at your convenience, at your rate of speed. Your CREI instructors guide you carefully through the material, and grade your written work personally (not by machine).

Industry Recognizes CREI Training.

CREI courses are prepared, and taught with an eye to the needs and demands of industry, so your CREI diploma can open

many doors for you. Countless CREI graduates now enjoy important, good-paying positions with America's most important companies. Many famous organizations have arranged CREI group training for their radio-electronics-television personnel. To name a few: All-American Cables and Radio, Inc.; Canadian Broadcasting Corporation; Columbia Broadcasting System; Gates Radio Company; Federal Electric Corporation; The Martin Company; Douglas Aircraft Co.; U.S. Information Agency (Voice of America); Trans-Canada Air Lines; United Air Lines. Their choice for training of their own personnel is a good cue for your choice of a school.

Benefits Felt Right Away.

Almost immediately you feel the benefits of CREI training. Your employer, when informed of your step toward advancement (only at your request), is certain to take new interest in you and in your future. What you learn in CREI Home Study can start helping you do a better job immediately.

CREI also offers Residence Training in Washington, D. C.

. . . at the same high technical level. Day and evening classes start at regular intervals. Qualified residence school graduates earn degree as "Associate in Applied Science." Check reply card if you prefer resi-

- BROADCASTING, AM, FM, TV
- MILITARY, NAVY CAA ELECTRONICS
- COMMUNICATIONS
- ELECTRONICS MANUFACTURING
- GUIDED MISSILES
- SERVO-MECHANISMS
- AUTOMATION
- COMPUTERS
- AERONAUTICAL ELECTRONICS

dence or home study information . . . or write Capitol Radio Engineering Institute, 3224 16th St., N.W., Wash. 10, D. C.

BRAND NEW COURSE ADDED: AUTOMATION & INDUSTRIAL ELECTRONICS ENGINEERING TECHNOLOGY. Complete course, covers all phases of automation. Special emphasis on theory, functioning and applications of servo-mechanisms and computers. Also note-worthy: Lessons on machine control, instrumentation, data-processing, and telemetry.

ELECTRONIC TECHNICIANS

Growing Peninsula Co. has openings for 1st class electronic technicians to work directly with engineering in development of new products. Only those with CREI or equal training and 3 years minimum commercial experience will be considered. Top salaries to qualified applicants. Call Mr. McQueeney, D.A. 4-4733 for appointment. ALTO SCIENTIFIC Co., Inc. 855 COMMERCIAL ST. PALO ALTO

ENGINEERING AIDES

AND
TECHNICIANS
Immediate Positions Available

CREI or other formal electronic training desirable.

Experienced in reading schematics, bread board construction of electronic circuits and chassis preparation.

EMERSON
RESEARCH
LABORATORY

Industry Calls for CREI Training by Name So Should You!

Here you see actual help wanted ads—one from a San Francisco newspaper, another seen in Washington. They are just two of many which specify "CREI or equal" education. This shows that industry approves CREI training, even insists on it. Experience has taught many, many companies that CREI students are taught what industry needs and wants them to know. Let this be your cue when you choose your educational program.

**Send card today for
this fact-packed
booklet. It's free.**



Take 2 minutes to send for this booklet right now. We'll promptly send your copy. The rest—your future—is up to you.

1st Class

Permit No. 288-R

Washington, D. C.

BUSINESS REPLY CARD

No Postage Stamp Necessary If Mailed in United States

4¢ Postage Will Be Paid By



3224 SIXTEENTH STREET, N.W.
WASHINGTON 10, D. C.

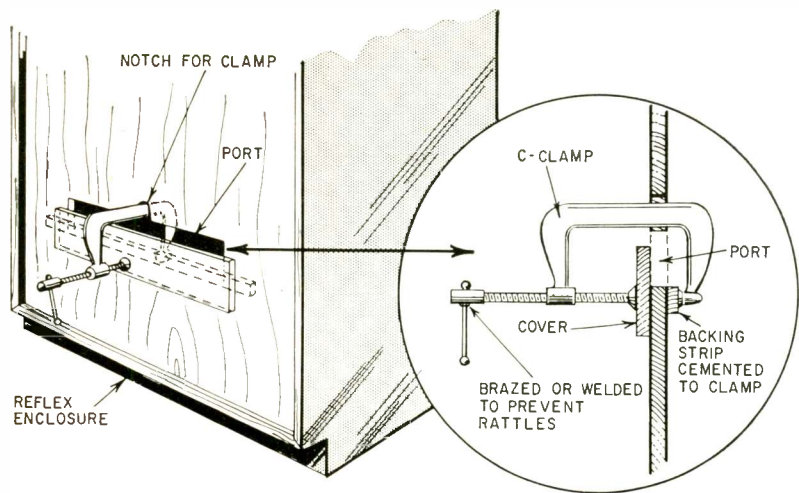

Fig. II-4—Simple method of tuning reflex enclosure calls for an adjustable port. Clamp fits into slot in port and cover is adjusted for best results. At this position, clamp is tightened and cover fixed in place.

If the speaker impedance curve is plotted now, it will look something like the dashed curve in Fig. II-3. In addition to taking a bite out of one frequency region, the neighboring regions above and below resonance are pushed up into minor peaks. These indicate increased cone velocity at their respective frequencies.

The region of lowest voltmeter reading lies in the trough between these peaks and is therefore not very precise. Fortunately the tuning accuracy required is not high and, if in doubt about the tuning, rocking a little to either side of the basic generator setting helps locate the middle of the trough.

It would be convenient if exact tuning was indicated by equal height of the two peaks. In practice this cannot be relied on, because damping (whether natural, accidental or deliberate) affects their individual heights. However, in a reflex system without special damping that is tuned to provide maximum load at speaker resonance, the lesser peak is usually at least half as high as the greater one. The peaks are also about equally spaced on either side of the speaker's free-air resonance frequency when plotted on the usual logarithmic graph paper.

Tune the cabinet

Cabinets can be tuned without fitting the speaker if the resonant frequency of the speaker to be used is known. (Don't go by published specifications. Speakers vary, measure it.)

If a cabinet, after the port has been cut but before the speaker opening is cut, is considered as a Helmholtz resonator, it has a resonant frequency. If the cabinet is placed with its port facing upward as in Fig. II-5, a carbon, crystal or other type of pressure-operated microphone¹ can be suspended so as to be within the enclosure. Now, suppose a sound of variable frequency

sweeps by. At the frequency of the Helmholtz resonance, there will be a considerable buildup of sound pressure inside the cabinet. (Relative to the pressure at the microphone in the absence of the cabinet, a buildup of between 10 and 30 times is normal.) Thus, by varying the frequency and watching the output from the mike amplifier on a scope or meter it is easy to determine the resonant frequency of the air system very accurately. By modifying the port, the frequency can then be adjusted as desired.

If the speaker opening has already been cut, the same method can be used, provided the speaker opening is sealed off by a reasonably airtight cover. If the speaker has already been fitted, it need not be removed as it will not disturb results appreciably as long as the cover over the speaker opening is effective.

The port and resonance

Experiments show that when a speaker and a reflex cabinet are married, a slight change in the Helmholtz tuning may be desirable for maximum effect. Therefore, the preceding method should be treated as a quick practical way of getting close to the

correct port area. The perfectionist, chasing subtleties, will take the impedance curve as well and then make further corrections if necessary.

The graph plots in Fig. II-6 show the kind of variations in the Helmholtz tuning frequency to expect when the port is changed. The graphs were taken for a well-built cabinet with a 3.25-cubic-foot internal volume.² Note that the tuning frequency is *not* inversely proportional to the port area or even to the square of the port area. At first, changes in port area for a given frequency change seem to be inconsistent and out of proportion. For instance, the graph of the 8-inch slot of varying width has a slope corresponding to a 15.5-to-1 area change per octave, while the 1-inch slot of varying length shows a 6.5-to-1 area change per octave.

This difference arises because the area of the port alone is not decisive. The shape of the port is involved, and

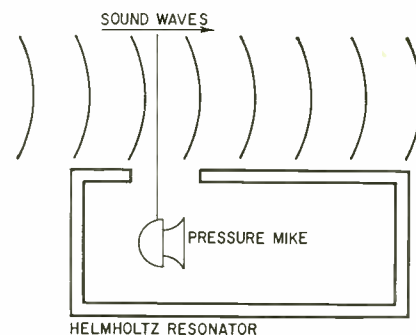

Fig. II-5—If a microphone is placed inside Helmholtz resonator, and sound at resonant frequency sweeps by, there will be considerable buildup of sound pressure inside.

in both graphs the shape was changing. Experiments show that for the same tuning frequency with a square port, a bigger area is used than with a slot-shaped port.

To eliminate variations due to port shape, rectangular ports having side dimensions in the ratio of 4 to 1 were used for each of the points plotted in

²I am indebted to Mr. O. C. Schwartz, trading as American Radio and T.V. Supply Co. of Toronto, Canada, for the use of lab facilities to obtain the experimental results shown in Figs. II-6 and II-7.

Fig. II-6—Effect of changing port area on the enclosure's resonant frequency. Graph for cabinet with 3.25-cubic-foot internal volume.

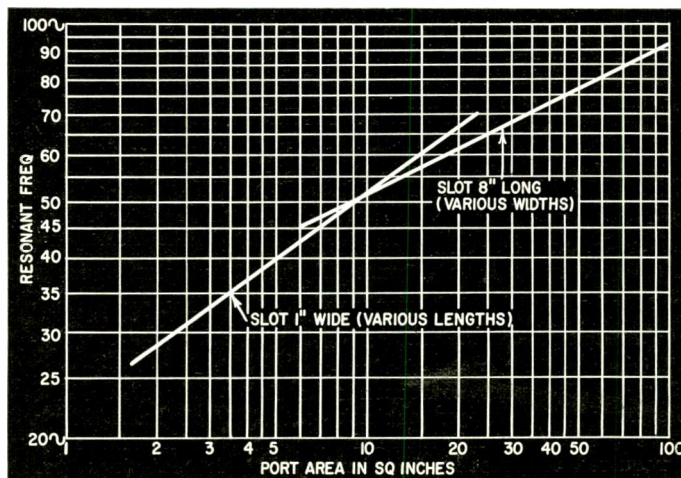

¹If no pressure microphone is available, a headphone earpiece will do.

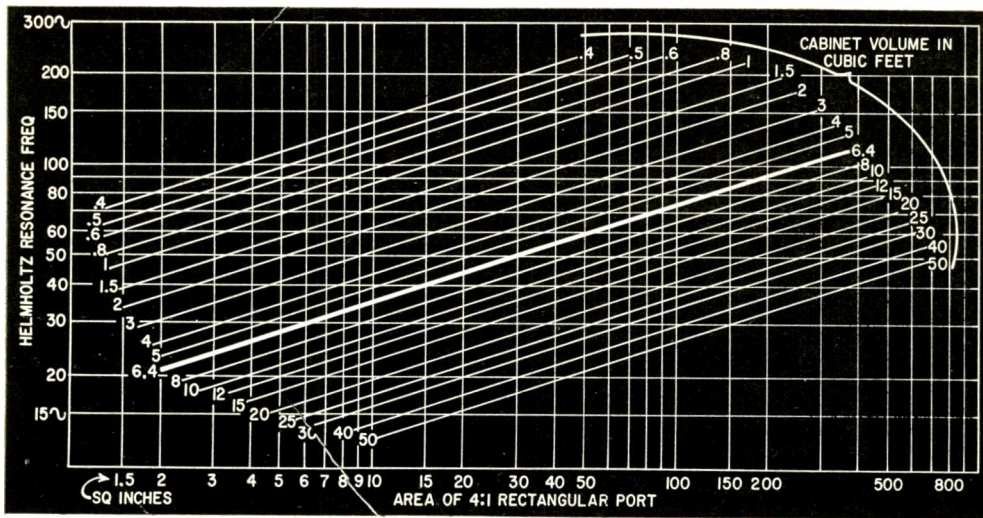

Fig. II-7—Chart showing relationships between Helmholtz resonance of reflex enclosures, port area and cabinet volume.

Fig. II-7 (heavy line). This relates to a well-built cabinet with an internal volume of approximately 6.4 cubic feet. The ports were located well clear of other surfaces as this affects the results. The experiments show that with constant port shape, a change of port area of between 8 and 9 to 1 is required for a 1-octave change in the Helmholtz resonance frequency.

In theory, information from one cabinet can be translated to cabinets of different volumes, if you remember while scaling up or down that volumes vary as the cube, areas as the square, resonant wavelength directly and frequency as the inverse of the linear change.

Another way of translating is to treat cabinet volume as equivalent to electrical capacitance. The tuning frequency then drops by an octave if the internal cabinet volume is quadrupled.

Theoretically, both ways of translating should give the same answers. However, in practice they don't quite and as the latter seems more accurate it was used to obtain the family of derived curves shown in Fig. II-7. From these, the Helmholtz resonance frequencies expected from larger or smaller cabinets with rectangular 4-to-1 ports can be read off. In practice, results are within about 10%, so for an initial design the port area should be made on the large side, and provided with some kind of adjustment.

From Fig. II-7 it will be noted that, if cabinet volume is increased and nothing else is changed, the tuning frequency drops. This will seem natural to those acquainted with electronic circuits, in which the tuning frequency drops when the capacitance (C) is increased. To retain the tuning frequency in the electronic circuit when C is increased, the inductance (L, the magnetic inertia) must be reduced.

Port area and air inertia

With reflex cabinets, the air-inertia factor at the port corresponds to L. Therefore, if a bigger cabinet (more C) is used, a lower air-inertia factor is required to preserve the tuning. It

might be expected that the port area would have to be reduced to obtain a lower air-inertia factor and keep the air resonance frequency constant. Yet, examination of Fig. II-7 shows that for the same Helmholtz resonance frequency, a larger cabinet requires a larger port. Also, from the results plotted in Figs. II-6 and II-7, we find that to raise the frequency (which requires a reduction of the air-inertia factor) port area has to be increased. All this seems rather odd!

More air is involved when a bigger port area is used, so one might expect that there will be a greater inertia factor. Sometimes first impressions are misleading and this is one of those times.

The air-inertia factor, though concerned with the inertia of the volume of air around the port, is also affected by other matters. It is really a measure of the energy of motion (kinetic energy) which is tied up when a given volume displacement oscillates in and out at the port.

If, instead of moving in and out through one port, that volume moves through two ports exactly like the first and therefore through double the area, each port handles only half the air flow. With half the air flow per port, the air velocity is halved. Kinetic energy is proportional to velocity squared when other things are equal. So the kinetic energy—that is, the energy tied up in air inertia—is only one-quarter at each of the two ports. The two ports together tie up a total of only half as much energy as a single similar port handling the same total volume. The overall air-inertia factor is halved. Thus, two similar ports in parallel and far enough apart not to affect one another appreciably resemble two similar air-core inductances in parallel and far enough apart for their fields not to interact.

With a single port, made by cutting an opening into the cabinet wall, the kinetic energy of motion is tied up partly in the slice of air occupying the port itself and partly in the surrounding air layers on both sides of the port. If that single port has its area doubled,

those surrounding layers are not increased in the same proportion. The air-inertia factor therefore does not vary inversely as the port area. But in a general way, the larger the port area the lower is the inertia factor. This is confirmed by experiments such as leading to those Figs. II-6 and II-7 and the experience that with a larger cabinet (greater C) a larger port (reduced L) is needed to keep the resonant frequency constant.

So, when a large cabinet is selected for a certain speaker, a relatively large port with a low inertia factor is needed for correct tuning. If a little cabinet is selected instead, correct tuning demands the higher inertia factor provided by a small port.

It should not be thought that correct adjustment of the port area alone automatically produces the best reflex system for a specific speaker. There are other ways of tuning—using multiple ports, ducted ports, etc. There is damping, and extremely important is the fact that cabinet volume has more effect than just to alter the tuning.

Ideally each speaker manufacturer should issue information regarding each of his speaker types and specify details of the perfect reflex cabinet to go with it. Dealer demonstrations without such a cabinet should then be prohibited.

Unfortunately there is no such thing as the perfect reflex cabinet. Reflex cabinets are necessarily a compromise, and the commercial designer tries to produce an overall system which is a multisided compromise between efficiency, unwanted hangover, response uniformity, size, appearance, weight, cost and perhaps a few other matters besides. What may be the best cabinet from one point of view cannot be the best from all the others. As the enthusiast becomes more discriminating, when he obtains a different speaker or perhaps moves to a new address with larger rooms, the best which he once thought so marvelous ceases to be acceptable, and this may well account for the succession of new designs that keep popping up as the years roll by.

TO BE CONTINUED

DO any spoils belong to the vector? A tentative answer is possible now that additional records have been released by Cook Laboratories in the so-called Vector-Stereo process. Although the idea was suggested by CBS Labs over a year ago, Cook is the first manufacturer to promote the process in his releases. Under the Cook system, the stereo cutter incorporates a reduction of vertical component through feedback. The first half dozen releases in Vector-Stereo exhibit some of the characteristics of Cook monophonic discs. In all instances, output is significantly greater and overall sound no longer has the bottled-up quality found in earlier stereo items. Comparison of the original stereo *King of Organs* record (Bill Floyd at the Paramount Theatre [New York] 1150) and the Vector-Stereo job revealed considerably more presence in the new release, especially in the upper mid-range and the highs. The Vector record includes room noise in passages where the first one did not. Two Vector symphonic albums, Brahms *First* (1060) and the Haydn *Military* and Mozart *40th* (10659), had little or no sign of compression. Unfortunately, review copies of these two releases had defective surfaces. Occasional distortion still exceeds that found on other labels' finest records.

Hugo Winterhalter Goes Latin
Winterhalter Orchestra

RCA Victor Stereo Tape CPS-156
(7-inch; playing time, 25 min. \$8.95)

My first impression on hearing this item was that something had gone haywire in my tape machine. The rest of the system sounded normal a few moments earlier when playing stereo discs. I then switched to an older RCA tape. It was normal. The following day, I carried the reel to the station where I tried it on the professional Ampex. Although flattered to some extent by the station's monitor speakers that are also widely used by the record industry, CPS-156 still sounded unlike any other 7.5-ips RCA tape I had ever encountered. The middles are so peaked that it is difficult to recognize individual instruments. Highs can barely be heard beyond the exaggerated mid-range. Output level is almost double that of average tapes. Perhaps someone goofed and applied to a 7.5 reel the 3.75 characteristic of the forthcoming quarter-track tape magazines designed for the consumer unfamiliar with two-track, open-reel stereo tapes.

DeFALLA: El Amor Brujo
ALBENIZ: El Polo
SURINACH: Sinfonietta Flamenca
Carlos Surinach conducting L'Orchestre
Radio-Symphonique de Paris

Montilla Stereo Record FMS-2042

The first Montilla classical releases go right to the top in technical features we now expect in stereo records. Distortion is held to a very impressive low. Extra mikes may account for the warmth and presence in the woodwinds, normally a shy and retiring lot. Yet the cohesion of the full orchestra is never lost. The seating arrangement of the players was carefully planned to bring out the inner sorcery of *El Amor Brujo* (*Love the Magician*). Surinach's *Sinfonietta Flamenca*, with its allusions to the flamenco music of the gypsies, also fares well under this setup. Highly recommended.

Damiron—Piano and Rhythm

Toreador Stereo Disc TS-534

The Toreador label is a lower priced subsidiary of Montilla Records. At \$3.98, it offers dance and folk music from Spain, Cuba, Mexico and other Latin American countries in stereo. Sound quality is surprisingly good, full range, fine output and quiet surfaces. Damiron, a Dominican pianist, plays with authority a collection of merengues, mambos, sones, guarachas and boleros.

Oklahoma! (Motion Picture Sound Track)

Capitol Stereo Record SWAO-595

A highly successful transfer to stereo disc of the movie's multiple-channel recording that features the familiar cast headed by Gordon MacRae and Shirley Jones. Intended for professional stereo playback in theatres, the original recording technique is first-rate. The sound of voices and orchestra takes to the air on huge sound stages that are ideal for stereo.

BEETHOVEN: Symphony No. 3 in E Flat (Eroica)
Bruno Walter conducting Columbia Symphony
Orchestra

Columbia Stereo Record MS-6036

This is the second release in a major project under way on the West Coast. The nine Beethoven symphonies are being recorded in stereo

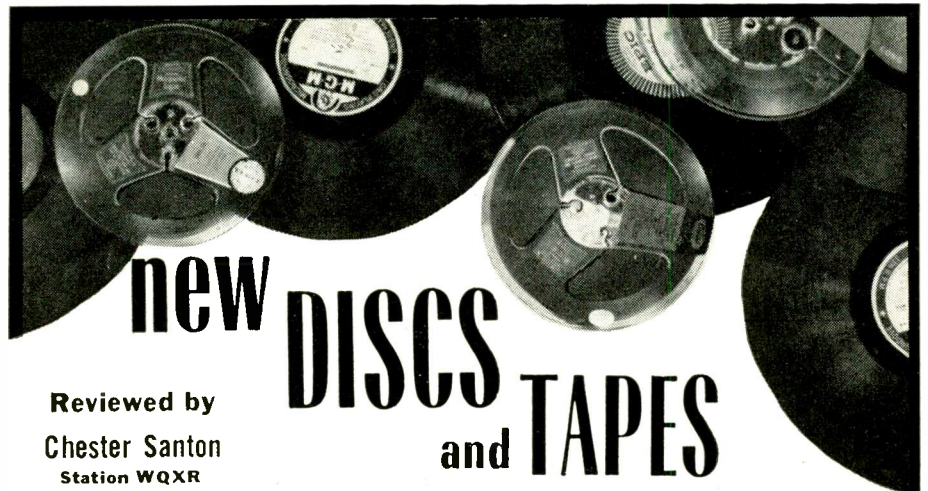

Reviewed by

Chester Santon

Station WQXR
New York City

new DISCS and TAPES

STEREO and MONO

by Bruno Walter. In this symphony and the *Pastoral* already released, smoothly spread stereo reveals his special skills. The interplay of instruments is guided with the sure touch of a conductor who has devoted a lifetime to the study of this music. The width of the sound source makes up for the slight restriction in frequency range that still distinguishes stereo disc from mono.

BACH: Harpsichord Concerto No. 1 in D Minor
Harpsichord Concerto No. 4 in A Major
Ruggiero Gerlin, Harpsichord
Victor Deszarzens conducting Cento Soli
Orchestra of Paris

Omega Stereo Disc OSL-13

There is fresh new bite in the sound of these concertos. This is the first time I've heard harpsichord and orchestra in stereo. The solo instrument emerges with far more body and character than it shows in mono. Gerlin is no stranger to recording microphones. In pre-LP days, he recorded a great deal of baroque keyboard music for French labels. If proof ever was needed that Bach spoke an international language, this crisp-sounding record provides it. The soloist is Italian. A Swiss conductor leads a predominantly French orchestra. Smart Americans will enjoy it.

RAVEL: Bolero
BIZET: Carmen Suite
Alfred Wallenstein conducting Virtuoso
Symphony Orchestra of London

Audio Fidelity Stereo Disc FCS-50,005

AF's first classical releases are aimed at the consumer with component equipment. Try the beginning of the *Carmen Suite* with a compliant pickup of good design. The bass drum on this record goes down to the region covered by only the best present-day woofers. The response reaches far below that of the bass drum on the recent Mercury stereo disc of the *Carmen Suite* (Paray and the Detroit Orchestra). Dynamic range is excellent. Overall response rivals that of a good mono disc. The miking is a bit closer than average but the hall maintains the stereo spread with ease. There is some overload in the climax of the *Bolero*. In several respects, this is the most impressive item of the month.

Stereo Test Record

Audio Fidelity FCS-50,000

This stereo test record is part of Audio Fidelity's release devoted to classical music. One side features symphonic excerpts (mis-labeled on my copy) from companion releases. The usual claim found on previous AF stereo discs decorates the jacket of this test record. The musical selections are still said to contain a frequency range extending to 25,000 cycles—using the RIAA curve. Yet the test tones on this record end at 15,000 cycles, and the RIAA curve is not used to reach even that relatively conservative test frequency. It is interesting to find that the only time RIAA is used above 1,000 cycles is in the two bands that test channel separation. These offer 3,000 cycles in the left channel and 800 cycles in the right. The procedure is reversed in the next band. Otherwise, all tones above 1,000 cycles are recorded in phase in both channels at a constant stylus velocity of 5 cm/sec. This calls for playback in a flat position. Frequencies below 1,000

cycles, including a sweep from 70 to 15 cycles, are recorded according to the RIAA curve.

Audio Test Record

Institute of High Fidelity IHF 473

The institute has released to subscribers a test record that offers a quick check of mono and stereo systems. One side (blue label) is mono; the other side (red label) is stereo. Essentially the same test material is found on each side. Tones include 15,000, 12,000, 10,000, 100, 70, 50 and 30 cycles. Frequency sweeps cover three areas—50 to 500, 500 to 5,000 and 5,000 to 10,000 cycles. The musical excerpts represent the work of four record firms.

Note: Records below are 12-inch LP and play back with RIAA curve unless otherwise indicated.

WAGNER: Die Gotterdammerung, Act 3:
Brunnhilde's Immolation
Tristan and Isolde: Prelude and Liebestod
Eileen Farrell, Soprano
Charles Munch conducting Boston Symphony
Orchestra

RCA Victor LM-2255

The middle of the recording curve used here is more than Wagnerian in scope. Owners of moving-coil pickups in particular may find that additional rolloff is required in the vicinity of the upper middles to tolerate the highs. Once the response is brought under control, the Farrell voice is a cargo of gold riding the vast sound of the Boston Symphony Orchestra.

TCHAIKOWSKY: Symphony No. 4 in F Minor
Leonard Bernstein conducting New York
Philharmonic

Columbia ML-5332

Lessons learned in the processing of stereo discs are being put to good use by Columbia in its recent mono records. This one is a beauty. Smoothly extended range with no recourse to artificial emphasis at either end. Bernstein's fresh outlook favors the score's inner voices.

DVORAK: Concerto for Cello and Orchestra
Pablo Casals, Cellist
George Szell conducting Czech Philharmonic
Orchestra

Angel COLH-30

Another valued reissue of a classic of the past in Angel's *Great Recordings of the Century* series. Recorded in 1937 and processed for maximum range in the recent transfer to LP, the Casals tone conveys an ardor that today's players cannot duplicate. The recent Angel recording by Janos Starker (35417) offers excellent contemporary sound and a splendid performance of this warm-blooded concerto.

GROFE: Grand Canyon Suite
Frederick Stark conducting Symphonic
Orchester Graunke

Disneyland Records WDL-4019

This is the mono disc version of the original sound track of the Disney film "Grand Canyon" as recorded in Munich, Germany. The pressing, although a shade beneath today's finest, conveys most of the characteristics of today's wide-range German recording techniques. END

Name and address of any manufacturer of records mentioned in this column may be obtained by writing Records, RADIO-ELECTRONICS, 154 West 14th St., New York 11, N. Y.

SHIPPED ON APPROVAL

an IN-CIRCUIT CONDENSER TESTER THAT DOES THE WHOLE JOB!

The CT-1 actually steps in and takes over where all other in-circuit condenser testers fail. The ingenious application of a dual bridge principle gives the CT-1 a tremendous range of operation . . . and makes it an absolute 'must' for every serviceman.

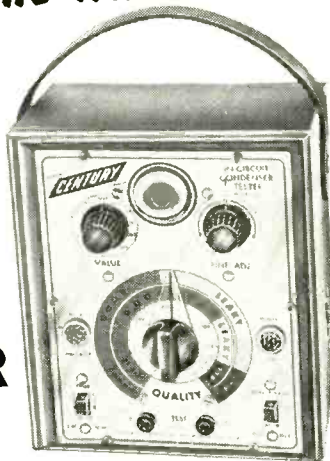

IN-CIRCUIT CONDENSER TESTER Model CT-1

Model CT-1 — housed in sturdy
hammertone finish steel case
complete with test leads . . . only **\$34.50** Net

in-circuit checks:

- ✓ Quality of over 80% of all condensers even with circuit shunt resistance present . . . (leakage, shorts, opens, intermittents)
- ✓ Value of all condensers from 200 mmfd. to .5 mfd.
- ✓ Quality of all electrolytic condensers (the ability to hold a charge)
- ✓ Transformer, socket and wiring leakage capacity

out-of-circuit checks:

- ✓ Quality of 100% of all condensers . . . (leakage, shorts, opens and intermittents)
- ✓ Value of all condensers from 50 mmfd. to .5 mfd.
- ✓ Quality of all electrolytic condensers (the ability to hold a charge)
- ✓ High resistance leakage up to 300 megohms
- ✓ New or unknown condensers . . . transformer, socket, component and wiring leakage capacity

OUTSTANDING FEATURES

- Ultra-sensitive 2 tube drift-free circuitry
- Multi-color direct scale precision readings for both quality and value . . . (in-circuit or out of circuit)
- Simultaneous readings of circuit capacity and circuit resistance
- Built-in hi-leakage indicator sensitive to over 300 megohms
- Cannot damage circuit components
- Electronic eye balance indicator for even greater accuracy
- Isolated power line

TRANSISTOR TESTER Model TT-2

Every day more and more manufacturers are using transistors in home portable and car radios . . . in hearing aids, intercoms, amplifiers, industrial devices, etc. Since transistors go bad the need for TRANSISTOR TESTER is great. They can

develop excessive leakage, poor gain, shorts or opens. The TT-2 is an inexpensive quality instrument designed for accurate and dependable tests of all transistors and diodes — quickly and accurately.

OUTSTANDING FEATURES

- Checks all transistors, including car radio, power output, triode, tetrode and unijunction types for current gain, leakage, opens, shorts, cut-off current
- Checks all diodes for forward to reverse current gain
- All tests can be made even if manufacturers' rated gain is not available
- Less than half a minute required for tests of either transistors or diodes
- Large 3" meter is extremely sensitive yet rugged . . . with multi-color scales designed for quick easy readings
- Power is supplied by an easy to replace 6-volt battery — current drain so small, service life almost equal to shelf life. Battery cannot be drained due to accidental shorting of test leads
- Cannot burn-out its own meter or damage transistor or diode under test
- Long test leads and insulated test clips enable tests without entirely removing transistor from circuit
- Test leads are identified by E.I.A. color code so that connection to the correct terminal is assured
- Comes complete with replaceable transistor set-up chart that fits into a special rear compartment.

IMPORTANT FEATURE: The TT-2 cannot become obsolete as the circuitry is engineered to enable you to check all new type transistors as they are introduced. New listings will be furnished at no cost.



Model TT-2 — housed in sturdy hammertone finish steel case complete with test leads . . . only **\$24.50** Net

Check all power rectifiers in-circuit

whether SELENIUM,
GERMANIUM,
SILICON, etc.

with the IN-CIRCUIT RECTIFIER TESTER Model SRT-1



Model SRT-1 — housed in sturdy hammertone finish steel case complete with test leads . . . only **\$29.50** Net

With the growing trend towards compactness, portability and low price, TV manufacturers are resorting more and more to producing series-string TV sets employing selenium, germanium or silicon power rectifiers. Now the need for an in-circuit rectifier tester is greater than ever.

THE SRT-1 CHECKS ALL POWER RECTIFIERS IN-CIRCUIT AND OUT-OF-CIRCUIT WITH 100% EFFECTIVENESS FOR:

- ✓ Quality ✓ Fading ✓ Shorts ✓ Opens ✓ Arcing ✓ Life Expectancy

OUTSTANDING FEATURES

- Checks all types of power rectifiers rated from 10 ma. to 500 ma. (selenium, germanium, silicon, etc.) both in-circuit or out-of-circuit.
- Will not blow fuses even when connected to a dead short.
- Large 3" highly accurate multi-color meter . . . sensitive yet rugged.
- Separate meter scales for in-circuit and out-of-circuit tests.
- Cannot damage or over heat rectifier being tested.

SIMPLE TO OPERATE

Just clip SRT-1 test leads across rectifier under test right in the circuit without disconnecting rectifier from circuit. Press test switch and get an instant indication on the easy-to-read three-color meter scales . . .

ALL CENTURY INSTRUMENTS ARE GUARANTEED FOR ONE FULL YEAR

The extremely low prices are made possible because you are buying direct from the manufacturer.

EASY TO BUY IF SATISFIED
see order form on facing page

FOR 10 DAY FREE TRIAL

try them for 10 days before you buy . . . only then, when satisfied, pay in easy-to-buy monthly installments — without any financing or carrying charges added.

Convince yourself at no risk that CENTURY instruments are indispensable in your every day work. Send for instruments of your choice without obligation . . . for instruments of your choice without obligation . . . financing or carrying charges added.

STILL THE BEST SELLING TUBE TESTER IN THE FIELD FAST-CHECK TUBE TESTER

Model FC-2

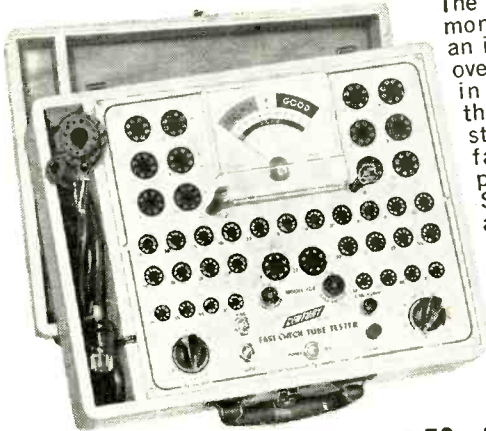

The greatest testimonial ever paid an instrument . . . over 20,000 sold in a little more than a year—and still selling as fast as we can produce them. See for yourself at no risk why so many servicemen choose the FAST-CHECK above all other tube testers — regardless of price.

Model FC-2 — housed in hand-rubbed oak carrying case complete with CRT adapter . . . only

\$69.50 Net

SIZE: W: 14⁵/₈"
H: 11¹/₄" D: 4³/₈"

Just 2 settings on the FAST-CHECK TUBE TESTER tests over 700 tube types completely, accurately — AND IN SECONDS!

PICTURE TUBE TEST ADAPTER INCLUDED WITH FAST-CHECK

Enables you to check all picture tubes (including the new short-neck 110 degree type) for cathode emission, shorts and life expectancy . . . also to rejuvenate weak picture tubes.

No other tube tester made at any price can match the value of the FAST-CHECK.

RANGE OF OPERATION

- ✓ Checks quality of over 700 tube types, employing the time proven dynamic cathode emission test. This covers more than 99% of all tubes in use today, including the newest series-string TV tubes, auto 12 plate-volt tubes, OZ4s, magic eye tubes, gas regulators, special purpose hi-fi tubes and even foreign tubes.
- ✓ Checks for inter-element shorts and leakage.
- ✓ Checks for gas content.
- ✓ Checks for life-expectancy.

IMPORTANT FEATURES

- No time consuming multiple switching . . . only two settings are required instead of banks of switches on conventional testers
- No annoying roll chart checking . . . tube chart listing over 700 tube types is located inside cover. New listings are added without costly roll chart replacement
- Checks each section of multi-section tubes and if only one section is defective the tube will read "Bad" on the meter scale
- 41 phosphor bronze beryllium tube sockets never need replacement
- 7-pin and 9-pin straighteners mounted on panel
- Large 4¹/₂" D'Arsonval type meter — most accurate type available . . . its greater sensitivity means more accuracy . . . its jewel bearing means longer life
- 17 long lasting phosphor bronze tube sockets
- Combination gas and short jewel indicator
- 9 filament positions
- Separate gas and short jewel indicators
- Line isolated — no shock hazards
- Long lasting etched aluminum panel.

NOTE: The Fast-Check positively cannot become obsolete . . . circuitry is engineered to accommodate all future tube types as they come out. New tube listings are furnished periodically at no cost.

NEW . . . For those looking for a real ECONOMY MULTIPLE SOCKET TUBE TESTER without sacrificing ACCURACY, SPEED and VERSATILITY MINI-CHECK TUBE TESTER

Model MC-1

Here is a multiple socket tube tester designed to meet limited budgets. Although low in price it boasts a unique circuitry that enables you to check over 600 tube types — and has a range of operation that far exceeds others in its price class.

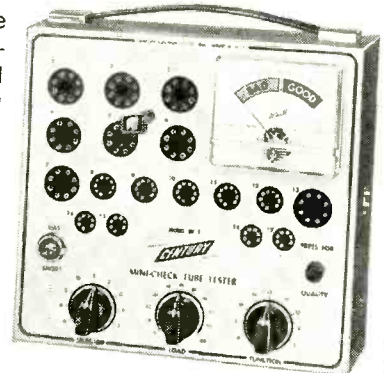

Model MC-1 — housed in sturdy wrinkle finish steel case . . . only

\$39.50 Net

SIZE: W: 9"
H: 8¹/₂"
D: 2³/₄"

OUTSTANDING FEATURES

- Checks emission, inter-element shorts and leakage of over 600 tube types. This covers OZ4s, series-string TV tubes, gas regulators, auto 12 plate volt, hi-fi and foreign tubes
- 3 settings enable a test of any tube in less than 10 seconds
- Employs dynamic cathode emission test principle
- 3¹/₂" D'Arsonval type meter — most accurate type available . . . its greater sensitivity means more accuracy . . . its jewel bearing means longer life
- 17 long lasting phosphor bronze tube sockets
- Combination gas and short jewel indicator
- 9 filament positions
- Handy tube chart contained in special back compartment
- New tube listings furnished periodically at no cost
- Detachable line cord

plus these BONUS FEATURES . . . found in no other low price tube tester

- ✓ Checks for cathode to heater shorts
- ✓ Checks for gas content
- ✓ Checks all sections of multiple purpose tubes . . . will pickup tubes with one "Bad" section
- ✓ Line isolated — no shock hazard
- ✓ Variable load control enables you to get accurate results on all tubes
- ✓ Positively cannot become obsolete as new tube types are introduced.

CONVENIENT TIME PAYMENT PLAN — NO INTEREST OR FINANCING CHARGES

CENTURY ELECTRONICS CO., INC.

CHECK INSTRUMENTS DESIRED

- | | | |
|--------------------------|--|---------|
| <input type="checkbox"/> | Model CT-1 In-Circuit Condenser Tester | \$34.50 |
| | \$9.50 within 10 days. Balance \$5 monthly for 5 months. | |
| <input type="checkbox"/> | Model SRT-1 In-Circuit Rectifier Tester | \$29.50 |
| | \$4.50 within 10 days. Balance \$5 monthly for 5 months. | |
| <input type="checkbox"/> | Model TT-2 Transistor Tester | \$24.50 |
| | \$4.50 within 10 days. Balance \$5 monthly for 4 months. | |
| <input type="checkbox"/> | Model FC-2 Fast-Check Tube Tester | \$69.50 |
| | \$14.50 within 10 days. Balance \$11 monthly for 5 months. | |
| <input type="checkbox"/> | Model MC-1 Mini-Check Tube Tester | \$39.50 |
| | \$9.50 within 10 days. Balance \$6 monthly for 5 months. | |

Prices Net F.O.B. Mineola, N. Y.

111 Roosevelt Avenue, Dept. 104, Mineola, New York

Please rush the instruments checked for a 10 day free trial. If satisfied I agree to pay the down payment within 10 days and the monthly installments as shown. If not completely satisfied I will return the instruments within 10 days and there is no further obligation. It is understood there will be NO INTEREST or FINANCING charges added.

Name Please print clearly

Address

City State



COLD-CATHODE— Revolutionary New Heaterless Tube

By ERIC LESLIE

LAST month this magazine announced that the Signal Corps and Tung-Sol Electric had unveiled, at a special demonstration, a new tube said to be "the first major breakthrough in tube design in more than 30 years." Outwardly, the tube that was demonstrated is conventional in appearance—for the very good reason that it was constructed in an existing tube envelope. Its internal construction (see Fig. 1) is less conventional, but old-timers

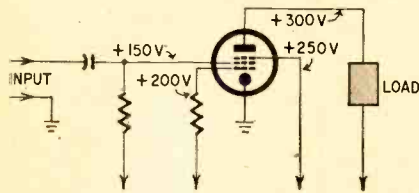

Fig. 1—Internal construction and basic circuit.

will recognize the space-charge circuit that enjoyed a slight popularity for a time in the '30's, using tetrodes such as the type 49.

It is the cold cathode that makes this tube a "major breakthrough." Almost since the triode was invented, people have wished for a tube that would not waste power heating the cathode. Dr. Dietrich Dobischek of the Signal Corps discovered in 1952 the effect that was to lead to such a cathode. He was bombarding a thin layer of magnesium oxide with an electron beam, to produce secondary emission. The emission was enhanced by maintaining a high positive field near the surface of the layer. Dr. Dobischek was startled to find that the emission continued after the bombarding beam was turned off. The magnesium oxide was emitting electrons on its own, under the influence of the positive field near its surface.

Experiments were immediately begun to see if the newly discovered phenomenon could be adapted to use in electronic tubes. Cathodes were made of various magnesium compounds (some good ones were actually made of drug-store milk of magnesia) and improved methods of preparing and applying the

oxide to the nickel sleeve that supports the cathode layer were developed. Tung-Sol scientists concentrated particularly on methods of making cathodes that could be adapted to mass production. The end result was a sprayed-on coating of porous pure magnesium oxide.

When bombarded by electrons to produce secondary emission, the surface of this layer becomes highly positive. It is suspected that this high electric charge draws electrons from the interior of the thin layer and that an avalanche effect similar to that in some semiconductor devices is produced. A characteristic blue glow develops and—with the help of the external field supplied in the new tube by the first grid—the emission continues till the external circuit is broken.

This brings us to the greatest disadvantage of the new tube—the emission is not self-starting. The disadvantage is not too serious—very little is required to start the tube working. In the tube demonstrated, part of the B-supply power was used to light (for less than a second) a tiny filament so placed that light and electrons emitted from it would strike the cathode. Other proposed methods include mixing a little radioactive substance with the cathode material, which would make it self-starting. Or a photoemissive material could be used, which would cause ordinary light to start the action.

Once the tube has been started, it could be maintained by a keep-alive circuit in many types of equipment. The emissive action continues down to less than $.01 \mu\text{a}$ per sq cm. A resistor in the order of megohms around the on-off switch would keep the tube at standby.

Another disadvantage cited against the tube is the high voltage—300 to 500—required to operate it. This voltage has already been reduced in some tubes, and it is believed that tubes will be built to use no more than 180 volts.

The great advantage is, of course, the power economy. In many receiver and industrial electronic applications, the heater consumes practically all the power used by the tube. Its almost instant starting is an important feature in many applications. And the cathode has an indefinite life, some cathodes having already run 14,000 hours with no signs of deterioration. The service technician will also note the impossibility of a cathode-heater short.

The only type so far constructed is a power amplifier tube. An amplifier (Fig. 2) using one of these sounded exactly like what would be expected from similar equipment using hot-cathode tubes. The tube was also used to operate relays at the Signal Corps-Tung-Sol demonstration. It flashed lights or closed relays in milliseconds, from a cold start.

Tung-Sol plans to put the new type on the market as soon as a complete line of tubes is worked out. Work is also under way on a cold-cathode electron gun for cathode-ray tubes (something which should bring true portable televisions even closer).

But the future of the new cathode material does not stop there. According to Dr. A. M. Skellet, Tung-Sol director of research, the material may make possible a flat picture-on-the-wall display device for TV or radar. It may also lead to great advances in amplifier tubes employing secondary emission multiplication. It may have applications even in the field of lighting, producing a lamp similar in appearance to present fluorescent types, but with greater brightness and longer life. It would work as well at 50° below zero as in the 100° -plus of the tropics. **END**

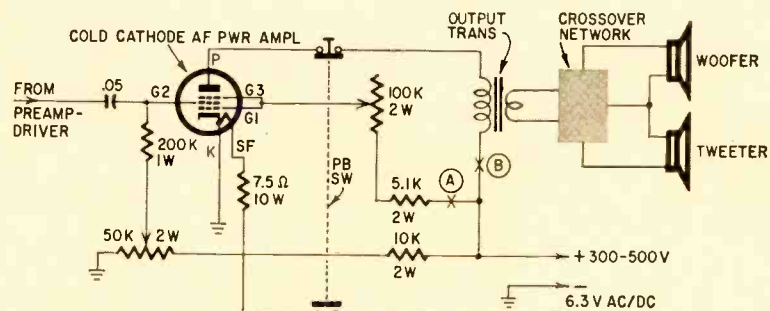

(A) Meter may be inserted to measure emission sustaining current.
(B) Meter may be inserted to measure plate current.
G1 Emission sustaining grid.

G2 Control grid.
G3 Screen grid.
SF Starter filament.
K Cathode.
P Plate.

Fig. 2—Typical circuit for cold-cathode audio power amplifier. Double-pole momentary switch is pressed to start cathode emission.

A team headed by electronics' most famous scientists and inventors has developed a system for complete guidance and control of automobiles on the highway, now ready for a full-scale road test



Electronics Guides Your Car

By **VLADIMIR K. ZWORYKIN***
and **LESLIE E. FLORY†**

DURING the past 5 years we have been giving increased attention to the problem of improving highway safety through the use of electronic controls. Our interest in this field has been stimulated by the obvious need to reduce traffic accidents, and the availability of electronic tools and techniques which may meet this need.

The need has become increasingly apparent as a direct consequence of improvements in road and vehicle engineering. Because they permit higher road speeds and eliminate mechanical causes of accidents, the importance of the human driver has been emphasized. The minimal effort demanded in guiding a modern car along turnpikes and limited-access roads makes it easier for the driver's attention to stray, and inadequate reaction speed, inattention and drowsiness have become major causes of accidents.

At the same time, the simplicity of the driving process suggests that it can be handled by a mechanical device, much more reliable and faster-acting

* Honorary vice president, Radio Corporation of America.

† Research engineer, RCA Laboratories.



**VLADIMIR K.
ZWORYKIN**



**LESLIE E.
FLORY**

The two-tube roadside detector unit used in the Nebraska test (left) has already been replaced by more compact and reliable transistor equipment (right).

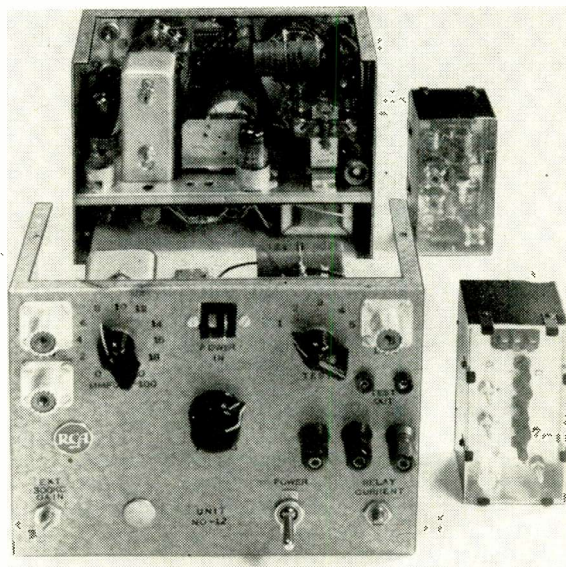

within its range than the human brain. This suggestion becomes even more reasonable since miniaturization and the transistor have put at our disposal components for control devices which excel in permanence, compactness and low power consumption.

In approaching the problem of vehicle control on the highways, we recognized two basic requirements.

The first is the visualization of an ultimate system of vehicle control, to which all intermediate steps must contribute. The development of gadgets to meet specific needs without a common goal is wasteful and can retard progress toward the final objective.

The second requirement is that the system can be introduced gradually and compatibly. It is obvious that neither our entire road system nor 100% of our motor vehicles can be converted to automatic operation in a single step. We must expect the co-existence of equipped and unequipped

roads as well as equipped and unequipped vehicles for many years after a program of automatic vehicle control has been initiated. Therefore, it is essential that every new road installation contribute to the safety and convenience of all vehicles, equipped or unequipped. Similarly, equipping vehicles with automatic control devices must not work to the disadvantage of unequipped vehicles.

Does three jobs

The functions of the ultimate vehicle control system are threefold: detection, guidance and collision prevention.

Detecting vehicles on the highway gives the traffic-control authority complete information on traffic conditions.

Guidance serves to keep vehicles centered in their traffic lanes, changing lanes or routes when required by external conditions or a preset program in the vehicle.

Collision prevention involves speed

ELECTRONICS

control and lane selection to prevent hitting other vehicles in following a preset route.

In practice, these functions are interlocked. The detection system does more than provide the authorities with a survey of the traffic situation. Its primary purpose is to provide the intelligence to actuate the collision-prevention system. Again, while it is the function of the guidance system to keep the car in its proper course, choices between alternate courses, such as staying in lane or switching to another lane to pass a slower vehicle, are determined by signals which form an integral part of the collision-prevention system.

In the system which we shall describe, as much of the control system as possible is part of the road. Since high-speed road systems—limited-access roads and turnpikes—are under continuous skilled supervision, this seems preferable to concentrating the equipment in the vehicle. We can visualize three stages in the development of the system.

In the first, only the roadway is modified—the vehicles are completely unequipped. Detectors in the roadway actuate warning lights on the side of the road which warn the driver of a car ahead of him in his own lane or of vehicles approaching in the opposite direction (Fig. 1). Such arrangements are especially valuable where visibility is obscured by a curve, a hill or some other obstacle and should be equally useful in areas subject to fog, smog, etc.

With the next stage, in which visual or auditory indicators are installed in the vehicle, the scope of the system is greatly extended. The detector system in the roadway now excites a "flying tail" of electromagnetic warning signals behind every vehicle on the road, which is picked up by radio receivers in vehicles following in line. The receiver translates the flying tail into a warning indication within the car, which replaces or supplements warning lights installed along the roadside. The signal within the car has the obvious advantage of being uninfluenced by external weather conditions and poor visibility.

Also, the signal which warns the driver he is getting too close to another vehicle or obstacle may be supplemented by a second indication showing his position with respect to the center of the lane. Thus, an auditory signal indicating departure from the center of the lane reduces the hazards of driving under conditions of poor visibility.

In the final, fully automatic stage, the collision-prevention signals act directly on the accelerating and braking systems in the vehicle and the guidance signals control the steering. Thus, as long as the vehicle is on the electronically controlled road system, the driver

¹Developed by a research group including the authors and Winthrop S. Pike and George W. Gray of RCA Laboratories.

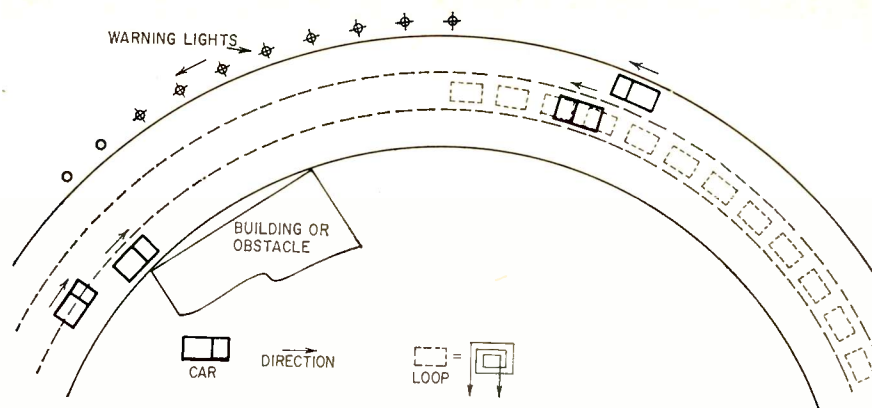

Fig. 1—An application of the electronic highway-control system for which no special equipment is required in automobiles. The diagram represents an overhead view of a curve in a three-lane highway. The approach of a vehicle in the center lane causes a sequential series of warning lights to flash on around the curve ahead of the car, warning approaching vehicles that the center lane is occupied. Dotted rectangles in center strip represent electronic detector units buried in the highway.

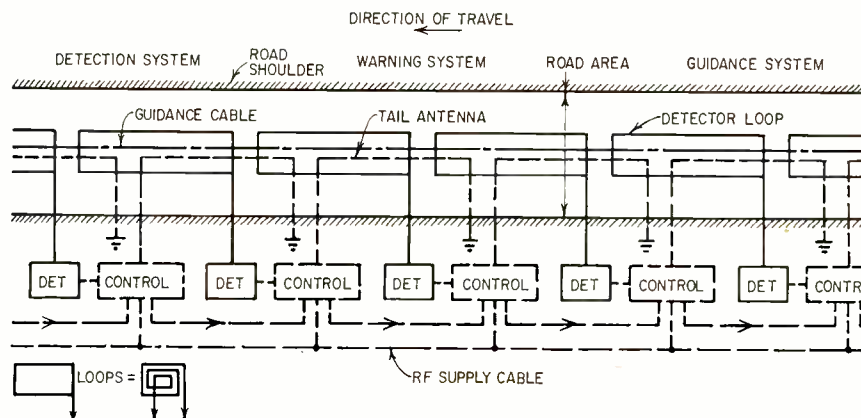

Fig. 2—Basic elements of the electronic control system.

is relieved of his responsibilities and the vehicle proceeds along a preset course. When the vehicle leaves the controlled road system, it shifts from automatic to manual control. The situation is essentially similar to the piloting of long-range aircraft, where the autopilot may take over except near takeoff and landing.

Of course, for many years these stages will overlap, with cars in all stages of automation using the highway simultaneously.

How it works

After this very brief description of the vehicle control system, let us examine its practical realization. Take a look at the road installation. A simplified diagram of a short, straight section of a single lane is shown in Fig. 2. Here we see the detection, warning (or collision-prevention) and guidance systems.

The most conspicuous element of the detection system is a sequence of rectangular loops, about the length of a car, which are inserted in the hardtop and form part of detection circuits whose active components are buried in capsules by the side of the road. The loops can be installed quite simply during road construction and have been

installed experimentally in existing roads by using a diamond-saw technique. Detector units used up to now have two vacuum tubes. Replacing tubes with transistors in new units now being designed will reduce power consumption and increase reliability greatly.

When a vehicle passes over a loop, it changes the loop's inductance. This change, acting through the detector, gates the roadside control unit so that warning signals are fed to a sequence of antennas buried in the roadway and extending some distance behind the vehicle in question. These signals, whose amplitude decreases as their distance behind the vehicle increases, constitute the "flying tail" for warning following cars. The same signals may also actuate warning lights by the side of the road, either behind the car or ahead of it. Fig. 3 illustrates the flying tail concept.

Power for the detection units and the flying-tail signals is supplied by a cable carrying high-frequency currents, buried alongside the road. However, these currents themselves, transmitted with an amplitude determined by the opening or closing of the detector gates, must not serve as the warning signal. Otherwise a failure in the road installation which would suppress the flying

tail altogether might be wrongly interpreted as a clear road ahead.

The difficulty is avoided by feeding the high-frequency currents continuously to the flying-tail antennas and impressing a suitable modulation on them through the detector gate. The receiver on a following vehicle will infer the distance from the source of the modulation from the modulation factor of the high-frequency carrier and correctly interpret the absence of the carrier as a system failure.

What about the danger of rear-end collision if a vehicle stalls on the electronic highway? The flying tail which extends behind the vehicle keeps operating, even when the vehicle stops, providing an automatic warning to the following cars. In the completely automatic system, this warning would be picked up by a receiver that would activate the brakes or steering mechanism of the following car, causing it either to stop or steer around the stalled vehicle by changing lanes.

Provision may also be made for an off switch that would let the driver of the following car cut off the automatic system and take control of the car himself to steer around the obstruction. As an additional safety factor, the complete system would include a supplemental warning in case another car were approaching in the passing lane.

The guidance system forms the last part of the road installation. Along a straightway it can take the form of a cable laid in the center of the lane, using the same construction techniques as for the detector loops. This cable may carry a high-frequency current of a frequency different from that of the flying-tail carrier although in a modification of the system the two functions may conceivably be combined.

Equipment in the vehicle

Let us now turn to the equipment of the vehicle. It must be stressed that essential equipment in the vehicle is passive. It consists of sensing devices

which are linked, either through the driver or directly, to the vehicle's mechanical controls. No signals are transmitted by it. The car influences following vehicles only through its presence, which, through the detectors in the roadway, modifies the electromagnetic fields radiated by the buried antennas for some distance to the rear—forms the flying tail. It follows that the flying tail of warning signals will be formed behind *any* car or similar obstacle, regardless of its equipment or what the driver does.

In early stages, the vehicle's equipment could be detachable and be installed in the car at the entrance gates to the controlled road system. Of course, more advanced equipment would necessarily form part of the vehicle construction.

The warning signal detector consists of an antenna attached to the undercarriage of the vehicle and a radio receiver whose rectified output may control a buzzer, warning light or other dashboard indicator or, in a fully automatic system, the car's power brakes. Automatic gain control makes the output signal independent of the precise relative location of the detecting antenna and flying-tail antennas in the roadway, and makes it proportional to the depth of modulation impressed by the presence of the obstacle on the high-frequency field. The warning and braking signal amplitude may, in addition, be amplified in a manner dependent on the speed of the vehicle and upon its speed relative to the obstacle. The latter may be derived from the rate of change of the flying-tail signal. Thus, car spacing is controlled by the actual as well as the relative speed of the vehicles. In addition, the overall modulation may be adjusted from the highway, permitting external control of spacing to conform to traffic or highway surface conditions.

In past experimental installations, the guidance signal has been obtained from two tuned antennas mounted on

the left and right sides of the front bumper. As the car deviates to the right or left of the lane's center, the current induced by the field of the guidance cable in the left antenna exceeds that induced in the right antenna and vice versa. The difference in the rectified signal from the two antennas controls either an indicator in the car or, in an automatic system, the hydraulic control valves of the steering mechanism.

Thus, with properly stabilized servo controls, the car proceeds down the center of the lane without wavering, unless the driver takes deliberate action which supersedes the automatic guidance mechanism.

Aural instructions to driver

The high-frequency carrier current in the guidance cable permits voice communication from highway control stations to the driver without any additional road installation. Thus the driver can be informed of route numbers, destinations and other pertinent data as he approaches an intersection. Warnings of weather changes, unfavorable road conditions and hazards along the route may contribute to traffic safety. Voice modulation of the guidance signal may also be used to transmit important news flashes and emergency orders and eventually, information regarding commercial facilities in the area, such as motels, restaurants or service stations.

Similarly, the detectors may do double duty as traffic counters and speed controllers. For instance, circuits measuring the time interval between the triggering of successive detector units can control illuminated signs informing the driver (and others) that he is exceeding the speed limit. In a more sophisticated system, the warning may equally well appear inside the offending car and, if desirable, might be used as a control signal to set the maximum speed.

Still another function is the timing of traffic signals at intersections so
(Continued on page 104)

Fig. 3—Illustration of the "flying-tail" warning signals that extend behind moving vehicles.

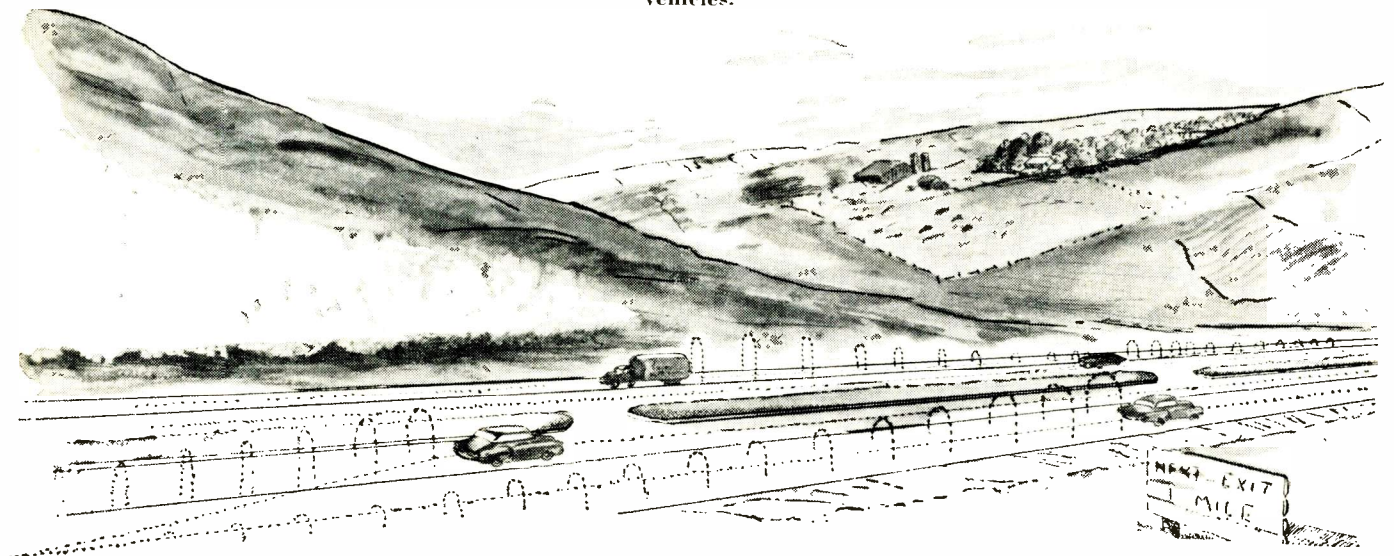

WHEN CUSTOMERS ASK—IS RCA provides you

ALL-NEW

RCA Silverama[®]

SILVERAMA is RCA's premium picture tube—that means *tops* in the industry! Manufactured with all-new glass and parts, it's the finest picture tube made—for the customer who prefers and *expects* the very best.

Command premium price and profits! Sell RCA SILVERAMA with *assurance that you are delivering a completely all-new picture tube.*

A CHOICE OF RCA PICTURE TUBES TO MEET THE DEMAND OF TWO MARKETS

If your customers want the best that money can buy, offer them RCA SILVERAMA...the picture tube that's ALL-NEW through and through. If they want the economy of a rebuilt tube, offer them RCA MONOGRAM...there's no finer rebuilt made. Either way, you provide the *quality* assurance of the RCA name...a real quality choice for your customers...a real opportunity for you to simplify both your buying and selling by offering the best in TV picture tubes.



GET FULL DETAILS FROM YOUR AUTHORIZED RCA DISTRIBUTOR TODAY

IT NEW OR REBUILT?

with a positive answer!

FACTORY-REBUILT

RCA Monogram

RCA MONOGRAM...no finer rebuilt picture tube made. Factory-rebuilt by RCA to quality standards, this tube assures dependable performance and fewer call-backs. It is backed by a brand name *you sell* with confidence—a brand name your customers *buy* with confidence.

Yes, top rebuilt quality at economy prices makes RCA MONOGRAM your best buy for picture tube replacements where price is the primary consideration.

**BACKED BY THE GREATEST
PRE-SELLING CAMPAIGN
IN PICTURE TUBE HISTORY!**

To make sure your customers know the *full* story...and all the advantages of using either RCA SILVERAMA or RCA MONOGRAM for replacement in their TV set, there's a big, big advertising program scheduled by RCA. Hard-hitting ads that pre-sell for *you* are appearing in LIFE, SATURDAY EVENING POST and TV GUIDE. You'll see hard-selling commercials on top TV shows. You'll hear regularly-scheduled radio commercials. And your RCA distributor can supply you with everything you need...from window displays to your own ad mats.



RADIO CORPORATION OF AMERICA
Electron Tube Division
Harrison, N. J.

TUBE PROBLEM:

An amplifier manufacturer was plagued by noise, microphonics and hum that developed in the high gain stages of his amplifiers. Sonotone engineers were consulted on the problem.

SONOTONE SOLVES IT:

Sonotone engineers discovered that they could correct *all three* complaints by redesigning just *one* tube.

RESULTS:

The heater element was changed to a coil heater, eliminating the hum. And rigid controls on the mount structure and processing reduced microphonics and noise. This resulted in the Sonotone reliable type 7025. It's now available for initial equipment and replacement purposes.

Let Sonotone help solve *your* tube problem, too.

Sonotone © 1959

Electronic Applications Division, Dept. TE-49
ELMSFORD, NEW YORK

Leading makers of fine ceramic cartridges, speakers, microphones, tape heads, electron tubes.

In Canada, contact Atlas Radio Corp., Ltd., Toronto

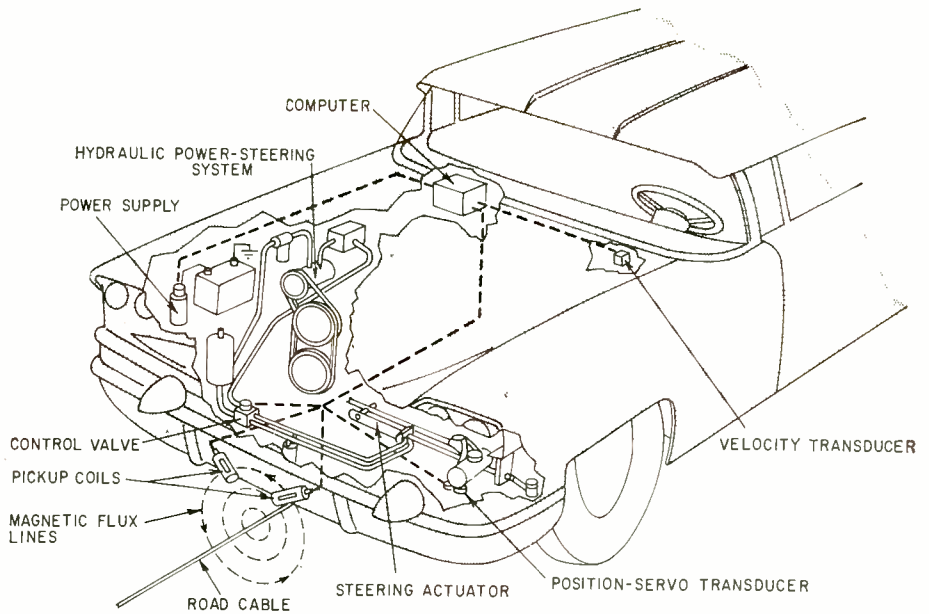

Fig. 4—Automatic steering equipment used by General Motors in test of the RCA guidance system. Glove compartment control-center computer is fed data on car location (from difference of voltages induced in pickup coils), wheel angle (from position servo transducer) and speed (from velocity transducer). When pickup-coil voltages are unequal, it develops a “command voltage” which activates the control valve, adjusting the angle of the wheels through the conventional hydraulic power steering system.

(Continued from page 101)
 green-light periods for the two roads are always proportional to the flow of traffic along each. Their use for pushing a row of lights ahead of a vehicle approaching a hill or curve to warn vehicles proceeding in the opposite direction against passing has already been mentioned. Other applications, of value particularly in the early stages of the system's development, will be apparent to anyone faced with practical problems of traffic control.

The basic features of the vehicle control system which we have described have recently been tested and demonstrated in cooperation with Mr. L. N. Ress, State Engineer of Nebraska's Department of Roads. The road installation was made on a 300-foot section at a newly constructed intersection in Lincoln, Neb.

The demonstration covered the operation of the vehicle detectors with buried loops, the tail warning system employing both lights and radio signals, and the guidance system. Dashboard indicators permitted a manually controlled car to be driven safely along the lane's center, adjusting its speed to that of preceding vehicles, even when the windshield was completely covered to simulate automatic-control conditions.

A similar system with automatic steering control of a standard 1958 Chevrolet has recently been demonstrated along a 1-mile check track at the General Motors Technical Center in Warren, Mich. The guidance cable had been inserted in the road surface by the diamond-saw technique already mentioned. The electrical signals derived from two bumper-mounted pickup coils controlled the steering by means of a hydraulic power piston (Fig. 4).

The results of these and earlier tests have confirmed our belief that a large measure of automatic control is technically possible. Furthermore, we are convinced that it is essential if the accident toll is to be materially reduced. The electronic techniques developed so far indicate a way to realize the desired objective. However, an optimized, workable system demands the cooperation of many groups, including as a minimum, highway engineers, automobile manufacturers and the electronics industry.

The results of their efforts must be tested on an enlarged test facility permitting the operation of controlled experimental vehicles at normal speeds. In this manner we can determine the optimum length and shape of the flying tail, the preferred dimensioning of the detector loops, the best ways of generating and applying the control signals within the car and many other factors which must be known before vehicle control systems are installed on public roads. Clearly, much remains to be done. The urgent need to reduce the accident toll on our highways demands that the work get under way.

END
 This is the second article of a series on highway safety and electronics, the first of which appeared in January. The next will appear in an early issue.

ADVANCE ANNOUNCEMENT

The 14th Annual Old-Timer's Nite Round-Up and Banquet will be held Saturday, April 18, 1959, in the Grand Ballroom of the Hotel Stacy-Trent in downtown Trenton. The party will be stag and a turkey dinner will be served. Contact Ed G. Raser, 19 Blackwood Drive, Trenton 8, N. J., for details. The sponsor is by the Delaware Valley Radio Association.

HOW TO PASS Your FCC Commercial LICENSE EXAMS*

We guarantee
to train you until you receive
Your FCC license
—or your money back

The Master Course in Electronics will provide you with the mental tools of the electronics technician and prepare you for a First Class FCC License (Commercial) with a radar endorsement. When you successfully complete the Master Course, if you fail to pass the FCC examination, you will receive a full refund of all tuition payments.

"License and Good Job . . . Thanks"

"After finishing your Master Course, I passed the FCC exam for the 1st class license. I had my ticket for only one week and I got a job at WOC-TV, AM-FM. Incidentally, WOC is the oldest radio station west of the Mississippi. I sincerely feel that if it weren't for taking your Master Course, I would not have received my 1st class ticket. So I want to take this occasion to again thank you for such a fine, complete and composite study for electronics work."

Francis J. McManus
Davenport, Iowa

Cleveland Institute training results in job offers like these:

Service Technician:

Man needed in Cleveland, Ohio to service and maintain electronic medical instruments and equipment. Must have a solid knowledge of electronic fundamentals. A car is required. Company benefits include retirement plan.

Radio Operators & Technicians

American Airlines — Chicago, Detroit, St. Louis, Cincinnati and Cleveland—has openings for radio operators and radio mechanics. Operators must have a 2nd class FCC license and ability to type 40 wpm. Many company benefits.

CLEVELAND INSTITUTE OF RADIO ELECTRONICS

Desk RE-28 4900 Euclid Avenue Cleveland 3, Ohio

Mail Coupon Now and get all three FREE

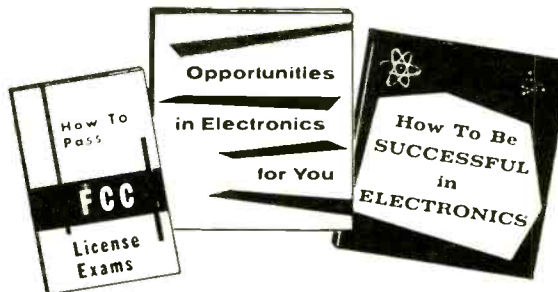

We can train you to pass your License Exams if you've had any practical experience — amateur, military, radio servicing, or other. Our proven plan can help put you on the road to success.

• Your FCC ticket will be recognized by employers as proof of your technical ability.

good training
doesn't cost
. . . it pays!

Accredited by the National Home Study Council

Cleveland Institute of Radio Electronics

Desk RE-28, 4900 Euclid Ave. Cleveland 3, Ohio

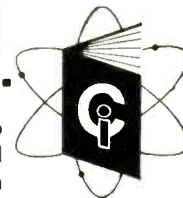

Please send Free Booklets prepared to help me get ahead in Electronics. I have had training or experience in Electronics as indicated below.

- | | |
|---|---|
| <input type="checkbox"/> Military | <input type="checkbox"/> Broadcasting |
| <input type="checkbox"/> Radio-TV Servicing | <input type="checkbox"/> Home Experimenting |
| <input type="checkbox"/> Manufacturing | <input type="checkbox"/> Telephone Company |
| <input type="checkbox"/> Amateur Radio | <input type="checkbox"/> Other _____ |

In what kind of work are you now engaged?

In what branch of Electronics are you interested?

Name _____ Age _____

Address _____

City _____ Zone _____ State _____

RE-28

Precision cutting... a simple job

with the new

Centralab

SK-2

SHAFT-KUT

TOOL



Now you can cut controls and control the cut . . . precisely and exactly. CENTRALAB's Shaft-Kut Tool is a precision instrument, *guaranteed* to make a really simple job of cutting shafts to the exact size you need.

With this tool you can cut any single or dual control . . . or switch shaft, and get cuts that are accurate to $\frac{1}{4}$ th of an inch! The tool and calibrated jig are made of case hardened tool steel, designed to last a lifetime.

You can't make a wrong cut with the CENTRALAB Shaft-Kut Tool! And the price is less than half what you'd expect to pay for a precision device of this kind . . . a low \$4.95 dealer net. Ask your distributor to show you how easy it is to use this new tool.

Centralab
B-5931

A DIVISION OF GLODE-UNION, INC.
922D E. KEEFE AVE. • MILWAUKEE 1, WIS.
IN CANADA: 804 Mt. Pleasant Rd. • Toronto 12, Ont.

**CONTROLS • ROTARY SWITCHES • CERAMIC CAPACITORS
PACKAGED ELECTRONIC CIRCUITS • ENGINEERED CERAMICS**

NEW TUBES and SEMI-CONDUCTORS

THE past month has provided us with an array of new units. Keeping step with transistor development are three vhf Mesa transistors. A high-frequency junction transistor, switching transistors and a 21-inch 110° picture tube are listed.

2N660

A high-frequency p-n-p fusion alloy junction transistor for computer and switching applications.

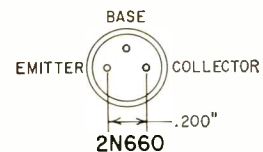

Maximum ratings of the Raytheon 2N660 are:

| | |
|-----------------------------|----|
| V_{CB} | 25 |
| V_{EB} | 12 |
| V_{CE} | 11 |
| V_{CE} ($V_{BE} = 0.1$) | 16 |
| I_C (amp) | 1 |

Average characteristics at 250°C are:

| | |
|---------------------|---------------------------------------|
| h_{FE} | 65 ($I_B = 10$ ma, $V_{CE} = 0.35$) |
| $f_{\alpha b}$ (mc) | 15 |

2N670

A p-n-p germanium alloy junction transistor intended for use in high-voltage pulse-amplifier and high-current switching circuits.

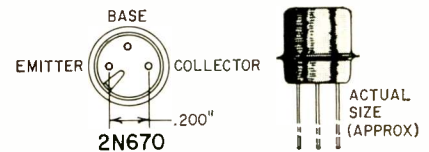

Maximum tentative ratings of the Philco 2N670 are:

| | |
|-----------------------------|-----|
| V_{CB} | 40 |
| V_{CE} ($V_{BE} = 1.5$) | 40 |
| V_{EB} | 40 |
| I_C (amps) | 2 |
| P_{total} (mw) (25°C) | 300 |

Typical electrical characteristics at 250°C are:

| | |
|---------------------|---------------------------------------|
| h_{FE} | 100 ($V_{CE} = 1.5$, $I_C = 1$ amp) |
| $f_{\alpha b}$ (kc) | 650 ($V_{CB} = 2$, $I_C = 100$ ma) |

6BQ5, 8BQ5

Power pentodes in a 9-pin miniature envelope intended for use in the audio output stage of radio and television

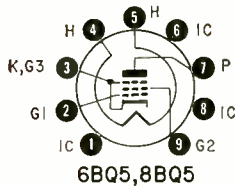

6BQ5, 8BQ5
IC=INTERNAL CONN (DO NOT USE)

receivers and in phonographs. The 6BQ5 has a 6.3-volt 760-ma heater. The 8BQ5 has an 8-volt 600-ma heater with controlled warmup for use in series-string heater circuits. All other specs hold for both tubes. The 6BQ5 is an exact replacement for the EL84.

The 6BQ5 and 8BQ5 are made by RCA. Maximum ratings in class-A1 amplifier service are:

| | |
|---------------------------|-----|
| V_p | 300 |
| V_{G2} | 300 |
| V_{G1} (pos bias value) | 0 |
| I_k (ma) | 65 |
| P_p (watts) | 12 |
| $G2_{input}$ (watts)* | 2 |

*must not exceed 4 watts under maximum-signal conditions.

2N1141, -142, -143

Three p-n-p germanium high-frequency Mesa transistors featuring alpha cutoff frequencies up to 750 mc and power dissipations of 750 mw. All are designed for reliable rf operation in the vhf range.

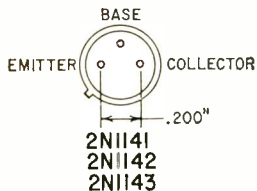

Maximum ratings of these Texas Instruments transistors are:

| | | | |
|------------------|--------|-----|-----|
| | 2N1141 | -42 | -43 |
| V_{CE} | 35 | 30 | 25 |
| V_{EB} | 1 | 0.7 | 0.5 |
| I_c (ma) | 100 | 100 | 100 |
| I_E (ma) | 100 | 100 | 100 |
| P_{total} (mw) | 750 | 750 | 750 |

Typical characteristics at 25°C are:

| | | | |
|---------------------|--------|-----|-----|
| | 2N1141 | -42 | -43 |
| $f_{\alpha b}$ (mc) | 750 | 600 | 480 |
| h_{ie} (db) | 12 | 10 | 8 |

($V_{CS} = 10$, $I_c = 10$ ma, $f = 100$ mc)

21EQP4

Another addition to the line of 110° picture tubes, the 21EQP4 is a 21-inch rectangular glass tube made byylvania. It has a spherical faceplate, aluminized screen and a straight gun

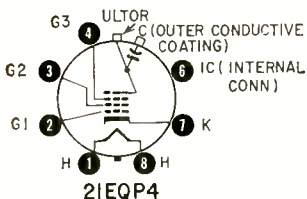

21EQP4

design which needs no ion trap. Its 6.3-volt 600-ma heater has an 11-second controlled warmup for use in series-string heater circuits.

Maximum ratings of the 21EQP4 are:

| | |
|-------------|--------|
| V_{ultor} | 20,000 |
|-------------|--------|

**a real sweet combination...
the new
FASTATCH FDK-100
Dual Control Kit**

**with the
Centralab[®] SK-2
Shaft-Kut Tool
FREE!**



If you have a birthday *any time this year*, CENTRALAB has a present for you NOW... a real money-saving offer that gives you a \$41.90 value for only \$32.70.

This \$9.20 saving is yours when you buy the new CENTRALAB Fastatch FDK-100 Dual Control Kit and SK-2 Shaft-Kut Tool combination. The handy kit contains 24 controls and 9 switches—that let you quickly snap together any of 720 different dual control combinations.

The Shaft-Kut Tool assures you of *precise* control or switch shaft length... accurate to $\frac{1}{64}$ th of an inch. It is available separately, at \$4.95, actually less than half the price you would expect to pay for it.

So don't waste any more time with special trips to your distributor when you need a dual-concentric. Have the control you need at your fingertips with this wonderful kit-and-tool combination. But don't delay... *this money-saving offer is for a limited time only!*

| | |
|----------------------------------|----------------------|
| HERE'S WHAT YOU GET | REGULAR PRICE |
| 24 controls and 9 switches..... | \$32.70 |
| all factory assembled and tested | |
| Sturdy steel cabinet..... | 4.25 |
| Shaft-Kut Tool..... | 4.95 |
| Actual value | \$41.90 |

You get all this for \$32.70—the cost of the controls alone! The Shaft-Kut Tool and steel cabinet are FREE!



A DIVISION OF GLOBE-UNION, INC.
922D E. KEEFE AVE. • MILWAUKEE 1, WIS.
IN CANADA: 804 Mt. Pleasant Rd. • Toronto 12, Ont.

**CONTROLS • ROTARY SWITCHES • CERAMIC CAPACITORS
PACKAGED ELECTRONIC CIRCUITS • ENGINEERED CERAMICS**

How to make
your **HI-FI**
LOOK AS GOOD
AS IT SOUNDS!

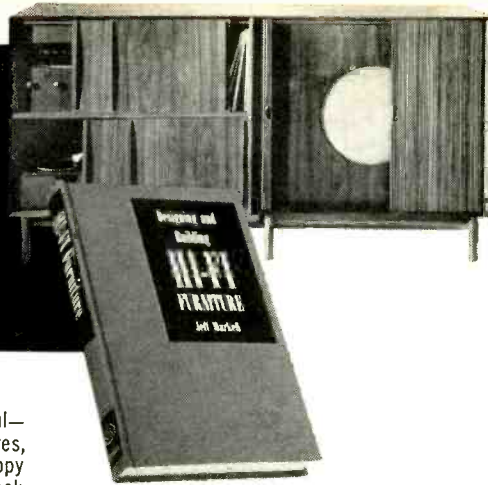

Your system probably sounds beautiful—but if you live in a jungle of dials, wires, lights, and boxes—you're not really happy with it. But you can be—and this book shows you how.

If you want to design and build, yourself, it tells you how—from choosing the right tools on up. If you want to buy—it tells you what to look for. If you want to have a cabinet custom built—or work with kits, it helps you there too. It explains design principles, types of wood, furniture styles, finishing, care and room arrangement for better appearance—and listening. Every hi-fi fan should own this one to make his system look better—and sound better.

SAVE \$1.25 ON THIS DELUXE BOOK!

You can buy **DESIGNING AND BUILDING HI-FI FURNITURE** and other luxuriously-

JOIN NOW, select **DESIGNING AND BUILDING HI-FI FURNITURE** or any one of these books already published.

AUDIO MEASUREMENTS—By Norman H. Crowhurst. Covers audio measurements from service shop to laboratory level. Shows how to make tests, what instruments to use, how to interpret results.

H. A. HARTLEY'S AUDIO DESIGN HANDBOOK—This expert explains design principles so the non-engineering hi-fi fan can design his own equipment.

ELEMENTS OF TAPE RECORDER CIRCUITS—By Herman Burstein and Henry C. Poliak. Answers all your questions about the electronic aspects of a tape recorder. What to look for when you buy—what various types will and will not do.

DESIGNING and BUILDING HI-FI FURNITURE

By Jeff Markell.

Deluxe gold stamped \$5.00
hard cover edition

bound \$5.00 books for only \$3.75—a saving of 25%—through the G/L Hi-Fi Book Club. Build a complete hi-fi library—one book at a time with no budget strain—and no risk. Look each book over in your own home before you buy. Keep and pay only for the books you want.

The greatest boon to hi-fi fans since LP records!

MAINTAINING HI-FI EQUIPMENT—By Joseph Marshall. Covers the specialized techniques necessary to repair hi-fi equipment. Includes acoustical and mechanical as well as electronic faults.

UNDERSTANDING HI-FI CIRCUITS—By Norman H. Crowhurst. Now have the system best suited to your tastes—and budget. Crowhurst tells you which phase inverter is best, weighs fixed vs. self bias, triode vs. pentode, answers hundreds of other questions.

BASIC AUDIO COURSE—By Donald C. Hoefler. Explains everything about audio from the theory of sound to disc and tape recording techniques.

HOW TO JOIN THE G/L AUDIO-HI FI BOOK CLUB

- Select one book from those listed on the coupon.
- **SEND NO MONEY**—we will send you the book on approval. If you like it send your remittance for the special club price of \$3.75.
- New books are released about every four months. You receive these automatically on the same no-risk plan.
- You may cancel any time after you have accepted four books—no time limit.

MAIL THIS COUPON NOW

Gernsback Library, Inc., Dept. 49 C
154 West 14th Street, New York 11, N. Y.



Enroll me in the G/L
AUDIO-HI FI BOOK CLUB.

Send me the book checked on approval.

(Please check one only)

- Designing and Building Hi-Fi Furniture
- Audio Measurements
- Audio Design Handbook
- Elements of Tape Recorder Circuits
- Maintaining Hi-Fi Equipment
- Understanding Hi-Fi Circuits
- Basic Audio Course

Name..... please print

Street.....

City..... Zone..... State.....

NEW TUBES & SEMICONDUCTORS (Cont'd)

| | |
|----------------------------|-----|
| V_{g3} | 700 |
| V_{g2} | 700 |
| V_{g1} (neg bias value) | 154 |
| (neg peak value) | 220 |
| (pos bias value) | 0 |
| (pos peak value) | 2 |
| R_{g1} circuit (megohms) | 1.5 |

2N561, 2N1014

Germanium, p-n-p, alloy-junction power transistors for applications in power-switching, voltage-regulator, multivibrator, dc-to-dc converter and power-supply circuits. They may also

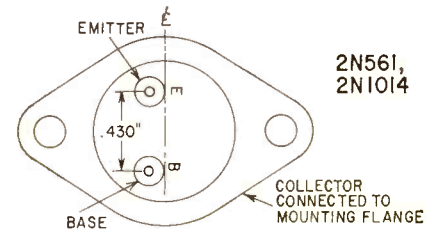

be used in audio oscillator service and in large-signal class-A or class-B push-pull audio amplifiers.

Typical ratings of these RCA tran-

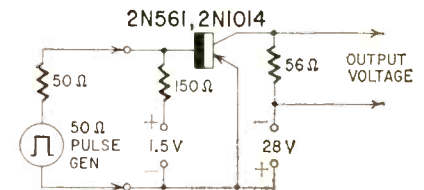

sistors in an on-off power-switching circuit (see diagram) are:

| | |
|------------------------|-----|
| V_{dc} supply | 28 |
| V_{dc} base bias | 1.5 |
| R_{gen} (ohms) | 50 |
| R_{base} bias (ohms) | 150 |
| R_c (ohms) | 56 |
| I_B (turn-on) (ma) | 6 |
| (turn-off) (ma) | 0 |

Switching time:

| | |
|------------------------|-----|
| T_{on} (μ sec) | 140 |
| T_{off} (μ sec) | 110 |

On condition:

| | |
|--------------------|------|
| I_C (amp) | 0.49 |
| V_{BE} | 0.36 |
| V_{CE} | 0.25 |
| $P_{driving}$ (mw) | 2.34 |
| P_{total} (mw) | 123 |
| Power gain (db) | 33.7 |
| Efficiency (%) | 99.3 |
| P_{out} (watts) | 13.1 |

The 2N1014 differs from the 2N561 in that it has a higher maximum peak collector-to-base and collector-to-emitter voltage rating.

| | | |
|-----------------|--------|-------|
| | 2N1014 | 2N561 |
| V_{CB} (peak) | 100 | 80 |
| V_{CE} (peak) | 65 | 50 |

END

CORRECTION

Through a printer's error, there are discrepancies between the diagram, parts list and text of the article "Duo-Rectifier Power Supply" on page 49 of the February issue. The values of R10 and R11 are correct on the diagram and incorrect in text and parts list.

We thank Mr. Sidney Wolin, Fort Wayne, Ind., and others for calling this to our attention.

'REALISTIC-ALLY' SPEAKING

Here's Why RADIO SHACK'S 1959 SOLO Speaker Is Worth Twice Our Price!

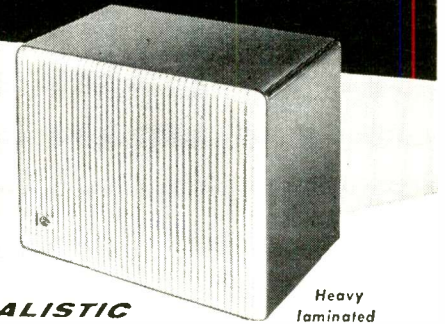

**REALISTIC
"SOLO"**
\$15.95

Heavy laminated mahogany cabinet

2 for Stereo \$29.50

If made in this country, Radio Shack's exclusive "SOLO" speaker system would cost more than twice its low price. Here at last is a VERY SMALL SPACE HI-FI speaker with real lows and clean highs. It's designed by the same Radio Shack engineering staff that created the world famous ELECTROSTAT-3 tweeter. And its magnificent performance is matched in appearance by its handsome furniture-finished dark mahogany enclosure with blending grill.

Size 14½" x 11" x 10½" deep; 8 ohms to match any hi-fi amplifier, console or TV set; sealed back with terminal strip; cabinet finished on four sides for horizontal, vertical or suspended use; 2 runners of matching mahogany included; response is 50-14,000 cps. Quality-wise, space-wise and budget-wise... there's no other speaker to compare with our "SOLO"!

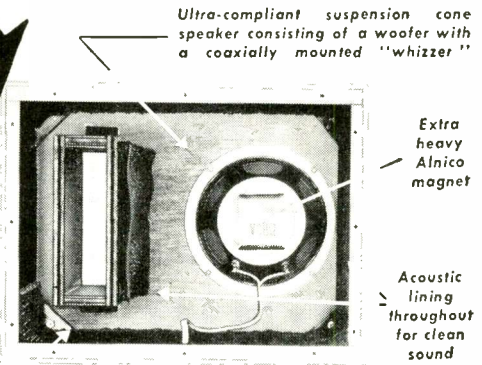

Ultra-compliant suspension cone speaker consisting of a woofer with a coaxially mounted "whizzer"

Extra heavy Alnico magnet

Acoustic lining throughout for clean sound

Tuned, vented, duct-type enclosure... Helmholtz resonator... especially designed to extend the range of the SOLO with REAL lows

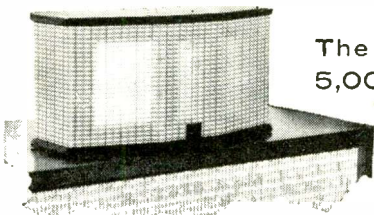

The World Famous
5,000-25,000 cps
TWEETER

**REALISTIC
"ELECTROSTAT-3"**
\$27.50

Radio Shack's REALISTIC ELECTROSTAT-3 adds a new acoustic brilliance to any speaker system... smooth, silky response from 5,000 cps to beyond the range of human hearing. It's the tweeter that's been getting the rave notices... the tweeter the whole world wants most, regardless of price. Mahogany, blond or walnut finish. Size 11¾" wide x 5¾" high x 4½" deep.

REALISTIC ELECTROSTAT-3 CROSSOVER NETWORK KITS include coils, condensers and L pad, complete with simple assembly instructions. Either 8 or 16 ohm kit... each \$4.95

**REALISTIC
"TRIO"**
\$44.50
2 for Stereo \$79.50

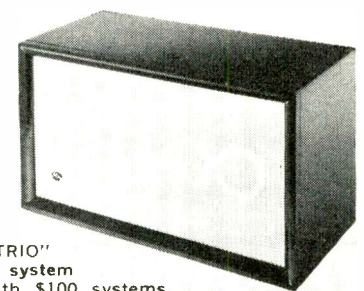

Radio Shack's REALISTIC "TRIO" is a magnificent 3-speaker system that compares brilliantly with \$100 systems... and includes features no other speaker system has... such as the patented center-mounted acoustic cut-off filter in the 8" woofer. This provides clean lows without h-f interference. The superbly engineered dual tweeters have a smooth wide range and are mounted at offset angles for dispersing the sound uniformly in all directions. In addition to being solidly encased, they are so mounted that they may be rotated 90° for maximum effectiveness in either up-right or lowboy positions. Dual hi-pass filter; response 35-17,500 cps; 8 ohms; laminated dark mahogany furniture-finished on 4 sides; size 22½" x 13" x 11½" deep; complete with 2 separate, matching runners.

Ask for our 64-page HI-FI BUYING GUIDE



RADIO SHACK CORPORATION

STORES { 167 Washington St., Boston 8, Mass.
730 Commonwealth Ave., Boston 17, Mass.
230-240 Crown St., New Haven 10, Conn.



RADIO SHACK CORPORATION, Dept. 4E
730 Commonwealth Ave., Boston 17, Mass.

Please send me the following:

| Quan. | REALISTIC | Sh. Wt. | Order No. | Sale |
|-------|---------------|---------|-----------|---------|
| | SOLO Speaker | 12 lbs. | 90LX250 | \$15.95 |
| | TRIO Speaker | 25 lbs. | 90LX210 | 44.50 |
| | ELECTROSTAT-3 | 7 lbs. | 36CX017Y | 27.50 |
| | 8-Ohm X-Over | 2 lbs. | 91L500 | 4.95 |

Radio Shack 1959 Hi-Fi Buying Guide
 Check Money Order C.O.D.
 Name _____
 Address _____
 City _____ Zone _____ State _____

APRIL SHOWER OF SAVINGS FOR ALL LEKTRON SHOPPERS! CASH DISCOUNT SALE!

VALUABLE COUPON
GOOD ONLY UNTIL MAY 1, 1959

Each \$10 Order Entitles You to a **\$1** DISCOUNT On Your Purchase

Example: With \$10 order, send only \$9 plus postage and this coupon. With \$20 order, only \$18 plus postage, etc.

TECHNICIANS' NEWS

FREE!

FULL YEAR'S SUBSCRIPTION
To Lektron's 24-Pg. "FAMILY SHOPPER"

Electronics • Tools
Jewelry • Novelties
Hi-Fi • Housewares
Write Today!

NOTE TO BONUS CARD HOLDERS
If you wish, purchases may be credited toward free Poly-Paks as usual. In that case, discount does not apply.

Lektron's Exclusive POLY-PAKS®

- SAVINGS FROM \$3 TO \$35 AND MORE! 88c EACH!**
- | | | |
|--|--|---|
| <p>40 HI-Q CONDENSERS Finest porcelain; NPO's too! 1 lb. 88c</p> <p>8 GERMANIUM DIODES Glass sealed, w/long leads. For all hobby projects. 88c</p> <p>30 DISC CONDENSERS Value-type. Reg. \$10. 88c</p> <p>40 PRECISION RESISTORS 1/2%, 1/2 & 1 W; carbon-loy & WW. 100 ohms to 1 meg. Reg. \$17. 88c</p> <p>10 POLY BOXES Clear plastic, hinged, w/snap locks. Ass'd. sizes. 1 lb. 88c</p> <p>40 TUBE SOCKETS 4 to 9-pin; ceramic, mica, shield-based incl. 88c</p> <p>6 SILICON DIODES Sylvania 1N22, 1N23, Reg. \$36. 88c</p> <p>"1-POUNDER" HAMMER Claw; 16-oz. steel, w/14" forged handle. die. Reg. \$2.50. 88c</p> <p>16-END WRENCH SET For home and auto. Box and open; 15/64 thru 7/16". 1 lb. 88c</p> <p>30 PILOT LITES Pop. flashite size; mini bay type. Reg. \$8. 88c</p> <p>5 ROLLS MICRO WIRE No. 24 thru 32; for transistor, sub-mini circuits. 1 lb. 88c</p> <p>2 MIKE XFMRs. Carbon, 100 to 100k ohms impedance. Leads: encased. 2 lbs. 88c</p> <p>100 RADIO PARTS Wide variety resistors, condensers, pots. 3 lbs. 88c</p> <p>SYLVANIA TV MIRROR 10x12" stainless steel. 2 lbs. 88c</p> <p>HOBBY BENCH VISE Clamp type. Fits tables, too. Steel. 1 lb. 88c</p> <p>70 HI-Q RESISTORS Carbon, IRC. Ohmite; 1/2%, 1% & 1 W; 10 ohms to 10 megs. 2 lbs. Reg. \$13. 88c</p> <p>HEARING AID PHONE Crystal, w/cord set & plug. 88c</p> <p>4 OUTPUT XFMRs. 50L6 etc. 3 lbs. 88c</p> | <p>POSTAGE STAMP MIKE Crystal, 100 to 8,000 cps. 1 lb. 88c</p> <p>75-FT. TV TWINLEAD 300 ohm, hanked, tinned. 3 lbs. 88c</p> <p>10 ELECTROLYTICS Radio, TV, 10,500 mf to 450 VDC. 3 lbs. Reg. \$12. 88c</p> <p>60 RADIO-TV KNOBS Ass'd. colors, insula-100. Some worth \$1 ea. 2 lbs. 88c</p> <p>4 POWER WOOD BITS 1/4" steel, 3/8, 1/2, 3/4, 1". 2 lb. 88c</p> <p>10 TUBULAR ELECTROS Ass'd. paper types, AC DC. Hobby. 3 lbs. Reg. \$15. 88c</p> <p>20 ARTISTS' BRUSHES 100% pure bristle; sizes 1-6. Reg. \$2.50. 88c</p> <p>75 MICA CONDENSERS .00025 to .01 to 1200 V; silver, top. 25 values. Reg. \$28. 88c</p> <p>15-PC DRILL SET 1/16" thru 1/4" by 64ths, w/eal. 88c</p> <p>75 RESISTOR SPECIAL! WW, freeston, carbon, variable, mini types. 3 lbs. 88c</p> <p>60 CONDENSER SPL! Shielded, paper, ceramic, oil, mica, discs. Variable. 2 lbs. 88c</p> <p>7 ROLLS WIRE 25-ft. each. No. 18 thru 22. Ass'd. stranding, insulation, colors. 2 lbs. Reg. \$5. 88c</p> <p>1500 PCS. HARDWARE Nuts, screws, washers, etc. 1 1/2 lbs. 88c</p> <p>6-PC. HACKSAW SET Six assorted blades. 1 lb. 88c</p> <p>70 TERMINAL STRIPS Solder lug & binding; to 20 terms. 88c</p> <p>60 COILS, CHOKES 1P, RF, ant., slug-tuned, top. 3 lbs. Reg. \$7. 88c</p> <p>300-FT. HOOKUP WIRE Tinned, ass'd. sizes, colors. 2 lbs. 88c</p> <p>100 HALF-WATERS Ass'd. value carbon resistors, incl. 5%. Reg. \$12. 88c</p> | <p>30 MOLDED COND'S'RS Asst'd. Finest make! 5C. 2 lbs. 88c</p> <p>15 ROTARY SWITCHES Ass'd. games. 3 lbs. 88c</p> <p>5-IN-1 DRILL BIT Reams, saws, copes, shapes, drills. Hand or power drill. 88c</p> <p>15 INSTR. KNOBS Knurled black bakelite, w/pointer; brass inserts. 2-l. screws. 88c</p> <p>10 PANEL SWITCHES Ass'd. 115VAC, power, multi-circuit & SPST DPST, DPDT. 2 lbs. Reg. \$5. 88c</p> <p>40 SUB-MINI RESIST'RS 1/4" long, 20 values; 1/2W to 10 megs. 88c</p> <p>5" HOBBY SPEAKER For radios, code osc., intercoms. 2 lbs. 88c</p> <p>TEN 2-SECOND TIMER Mechanisms; precision geared. 2 lbs. 88c</p> <p>2 TRANSISTOR IF'S Variable-tuned, only 1/2" square. 88c</p> <p>2 N-P-N TRANSISTORS Used in many pop. radio sets. Worth \$5. 88c</p> <p>2 P-N-P TRANSISTORS Popular make! dozens of hobby uses. 88c</p> <p>2 VARI-LOOPSTICKS Adj. 540-1500 kcs. Transistor radios. 88c</p> <p>RADIATION DETECTOR World's smallest, 100% of Atomic and Radiation uses. Reg. \$21. 88c</p> <p>0-60 MINUTE TIMER For kitchen, lab, shop, kitchen. Loud alarm. 88c</p> <p>0-15 VAC MINI-METER Hundreds of uses! Only 1 1/2". Reg. \$3.50. 88c</p> <p>70 TUBULAR CONDENSERS Paper, impregnated, oil, porcelain. 500 to 1000 V. 2 lbs. 88c</p> <p>WIRE STRIPPER Strips & cuts hook-up wire No. 16 thru 22. No. 1. 88c</p> <p>10 RCA PLUG-N-JACK SETS Matched. Most pop. ampps., tuners, phonos. 88c</p> |
|--|--|---|

HOW TO ORDER: Check items wanted. Return entire ad w/check or M.O. including sufficient postage; excess returned. C.O.D. Orders, 25% down; rated, net 30 days. Print name, address, WITH POSTAL ZONE NO., amount money enclosed, in margin. (Canada postage, 48c 1st lb., 28c ea. add'l lb.)

LEKTRON

131 Everett Ave.
CHELSEA 50, MASS.

SAVE TIME with

SENCORE

Transi-Pak

A "Twin" to the
SENCORE TRC4 Transistor Checker

See other SENCORE ads in this issue.

A Low Cost TRANSISTOR RADIO BATTERY ELIMINATOR

Here is a complete isolated power supply especially designed to replace batteries during repair time of all transistor radios.

- ★ Supplies up to 200ma
- ★ A must for Philco and Sylvania radios
- ★ Insures proper operating voltage and current for transistor radios

SERVICE Instruments Corp.

121 Official Road, Addison, Ill. AT LEADING PARTS DISTRIBUTORS



MODEL PS-103
\$17.95
DEALER NET

TWO ESFETA MEETINGS

The Empire State Federation of Electronic Technicians Associations was held February 8 at Syracuse, N. Y. A meeting of ESFETA delegates and representatives of TV set manufacturers to discuss printed circuitry in TV receivers was held the previous evening. The manufacturers' case was stated by Dan Creato of RCA, Steve Mihalic of G-E and Mac Romey of Westinghouse. At the end of the discussion, it was the unanimous opinion of ESFETA that printed circuitry is here to stay, even though at present it is the cause of considerable consternation to the service industry. It was felt that certain problems will be solved through cooperation between manufacturing and service, and that future development of printed circuits may advance both the servicing and manufacturing industry. ESFETA has established liaison with the manufacturers' service departments, through which it is hoped to be possible to supply proper service data to the membership.

Chief subject discussed at the regular business meeting was the proposed bill for certifying TV repair technicians, which was to be introduced to the New York State Legislature immediately. The meeting favored some changes and revisions in the bill proposed by the Attorney General. Most important of these were those referring to qualification of technicians and to the composition of the board that would administer the Act. The proposed bill would qualify technicians on the basis of a practical examination. The association feels that this might pass school graduates who would not be efficient service technicians and proposes a minimum of 1,000 hours of study in a recognized course plus the equivalent of 2,000 hours of experience under a qualified technician. (See "Guild Talks Certification," below.) However, the requirement of 1,000 hours of school might be dispensed with if the applicant had more than 4,000 hours' experience. ESFETA also feels that the administering board should include five men with at least eight years of servicing experience (proposed bill calls for two, with four years of experience each, on a three-man board).

GUILD TALKS CERTIFICATION

Differing views about TV service technician certification were the major topic for discussion at a recent meeting of the Radio & Television Guild of Long Island. The legislation, as proposed by the State Attorney General's office, would set up a certification board

At Your Service...
at big savings

arkay

Hi-Precision
TEST INSTRUMENTS
Kits and Wired

Designed and engineered in the Arkay tradition of highest professional quality at lowest cost.

NEW! ARKAY VT-10 6-INCH MULTI-PURPOSE VACUUM TUBE VOLTMETER

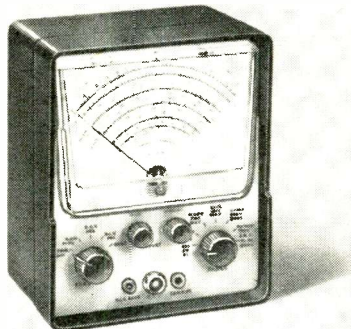

Advanced design and precision features make the Arkay VT-10 a truly sensational buy, unmatched at this price. You get exclusive larger 6-INCH 400 ua meter movement, within 2% accuracy, and edge-lighted for easier reading. 1% precision multiplier resistors are used throughout the range switch. There are 7 AC (RMS) and DC ranges, 0 to 1500 volts; also 7 AC (peak-to-peak) ranges, 0 to 2000 volts. Resistance of 0 to 1000 megohms, db and other essential ranges also included. Circuitry features 12AU7 for DC ranges, 6AL5 for AC, meter diodes rectifiers, and transformer operated selenium rectifier. Handsome durable plastic case.

Easy-to-build Kit **\$25.95**
Wired and tested **\$47.95**



ARKAY AV-20 6-INCH AUDIO VTVM PRE-AMPLIFIER

A7 Audio Vacuum Tube Voltmeter of extreme sensitivity, engineered for accurate measurements of RMS voltages.

Easy-to-build Kit **\$29.95**
Wired and tested **\$49.95**



ARKAY AW-30 6-INCH DIRECT READING AUDIO WATTMETER

Measures Audio Power Output with speed and precision. 0 to 500 watts in 6 ranges. For laboratory and general use.

Easy-to-build Kit **\$29.95**
Wired and tested **\$49.95**

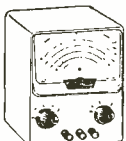

ARKAY CAP-40 6-INCH DIRECT READING CAPACITY METER

1% precision calibration capacitors and 6-inch 200 ua meter movement provide accurate readings. 0 to 1 mfd. in 6 ranges.

Easy-to-build Kit **\$29.95**
Wired and tested **\$49.95**



ARKAY MT-50 6-INCH 20,000 OHMS PER VOLT METER

A completely portable multimeter of high accuracy. Sensitivity is 20,000 ohms per volt DC, 5,000 ohms per volt AC.

Easy-to-build Kit **\$29.50**
Wired and tested **\$42.95**

All prices 5% higher west of Mississippi

See ARKAY completely wired Test Instruments at your dealer. Write for detailed specifications and catalog. Dept. RE

arkay



88-06 Van Wyck Expressway Richmond Hill 18, N.Y.

TECHNICIANS' NEWS (Continued)

to pass on the qualifications of service technicians. Those who met the board's requirements would be certified. However, a noncertified technician could still operate a shop, as the certification would be on a voluntary basis.

Among those opposed to the proposal is Max Leibowitz, a member of the Associated Radio-Television Servicemen of New York. He appears to feel that such a bill cannot prevent technicians—certified or not—from claiming that they are authorized dealers and fully qualified to service TV receivers.

On the other side is Murray Barlowe. A former Guild president, he says that, should the bill be passed, it will give TV technicians the same status enjoyed by certified public accountants.

Requirements of the proposed bill, which were worked out with the help of Robert Larsen, Guild president, are:

1. Service techs must have completed television studies totaling at least 1,000 hours.
2. Service techs must have worked under proper supervision for at least 2,000 hours.
3. They must pay a yearly fee of \$30.

The certification board of examiners would include two representatives of servicing with four years of experience, a representative of television education, a manufacturer's service manager, a dealer with five years' experience selling receivers, a licensed engineer and a representative for the public.

PROTEST CAPTIVE SERVICE

The Radio-TV Association of Santa Clara Valley (Calif.) moved against an invasion by Packard-Bell captive service, the *RTA Magazine* reported in a recent issue. A formal letter of protest was sent to P-B's regional manager, Kenneth R. Johnson, and George Gillespie, local P-B distributor.

The protest was sent after members learned in general meeting that P-B was getting ready to open a service company shop in San Jose.

The letter said, in part:

"Surveys have established quite clearly that the many fully equipped, well staffed service shops are well able to meet TV and radio service needs in this area.

"It is our firm conviction that Packard-Bell and its representatives do not wish to be responsible for introducing the problems attendant with captive service in Santa Clara Valley and environs. . . ."

SELF-REGULATION IS AIM OF CONNECTICUT GROUP

The Norwalk Association of Television Servicemen has adopted a plan for testing and certifying TV repair technicians, apprentices and installers. The plan was drawn up as an alternate to a proposal that the city adopt ordinances covering TV servicing. NATS believes that TV service regulation should come from within the industry

(Continued on page 114)

Pleasure Unlimited

... WHEN YOU BUY IT
... BUILD IT... HEAR IT

arkay STEREO

TODAY'S GREATEST VALUE IN
HI-FI KITS AND WIRED

Comparison proves Arkay is the best value on the market today for advanced hi-fi engineering, styling and performance. Arkay means STEREO at its best, within your budget.

NEW! MUSIC MASTERPIECE!

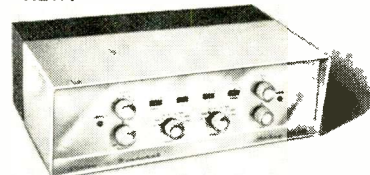

ARKAY CS-28 STEREO AMPLIFIER STEREO PRE-AMPLIFIER COMPLETE CONTROL CENTER

Presenting... the ultimate in total stereo! The versatile CS-28 is a superb product of Arkay's 20 years of advanced electronic engineering, with beauty of design that won the Fashion Foundation's coveted Gold Medal.

Identical dual 14 watt amplifiers convert to 28 watts for monaural operation. Full 28 watts, at flick of a switch, may be joined with an existing monaural amp for extended stereo, operated with the dual pre-amplifier.

"Reverse Stereo" switch interchanges channels. Balance Control compensates each channel for speaker system, room acoustics, etc. Gain Control operates both channels simultaneously.

Power Rating: 28 watts (two 14 watt channels); 60 watts peak. Frequency Response: 20-20,000 CPS. IM Distortion, 4 to 1. Harmonic Distortion, less than 1%, 30-20,000 CPS. Pre-amp Outputs 2V. Tape Recorder Outputs 10V. Speaker Outputs: 4, 8, 16 and 32 ohms.

Wired and tested **\$99.95** Easy-to-build Kit **\$64.95**

PERFECT COMPANION FOR THE CS-28



ARKAY ST-11 AM-FM STEREO TUNER

Unmatched by units costing twice the price, the Arkay ST-11 provides wide-range AM and FM tuning of remarkable clarity and drift-free stability. "Miracle Ear" sensitivity in FM channel, 4 uV. (2 uV. in AM) for 20 db quieting. Two distinctive receivers in one, for use singly in monaural reception or simultaneously for stereo broadcasts.

Wired and tested **\$74.50** Easy-to-build Kit **\$49.95**



ARKAY CS-12 STEREO PRE-AMP AND AMP

12 watts of clean power. Operates on ceramic or crystal cartridge, tape, tuners, auxiliary equipment.

Easy-to-build Kit **\$35.95**

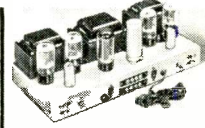

ARKAY SPA-55 STEREO AMP

Two 27 1/2 watt distortion-free hi-fi amplifiers. Or use as 55 watt monaural amplifier.

Easy-to-build Kit **\$64.95**
Wired and tested **\$79.95**

ARKAY SP-6 STEREO CONTROL CENTER



Completely self-powered sensitive dual pre-amp with unparalleled flexibility. Reverse position, hi lo filters, etc. Prices less cover.

Wired and tested **\$62.95** Easy-to-build Kit **\$39.95**

All prices 5% higher west of Mississippi

See and hear completely wired ARKAY Kits at your dealer. Write for detailed specifications & catalog. Dept. RE

arkay



88-06 Van Wyck Expressway Richmond Hill 18, N.Y.

How far can you go in electronics without a degree?

A few years ago, Lincoln E. Kitchin had no formal degree and knew nothing about electronic computers.

He still doesn't have a degree, yet today, he is a Field Engineer on one of America's biggest electronics projects. He helps maintain one of the largest computers in the world. He's doing work ordinarily done by engineers—an opportunity usually denied to men without a degree. This is a story of unusual significance to every technician who feels himself handicapped by lack of a formal degree.

"It all started back at the Base," Link recalls, "about two years ago. We were having lunch. One of my fellow Aircrewmembers described an interview he had just had—with IBM.

"It sounded good to me—particularly the field engineering aspects. I wasn't anxious to start my civilian electronics career stuck in a corner of some plant. Here was a chance to work in the field—with all the advantages of a permanent location. I made a note to add IBM to the companies I was considering for civilian work."

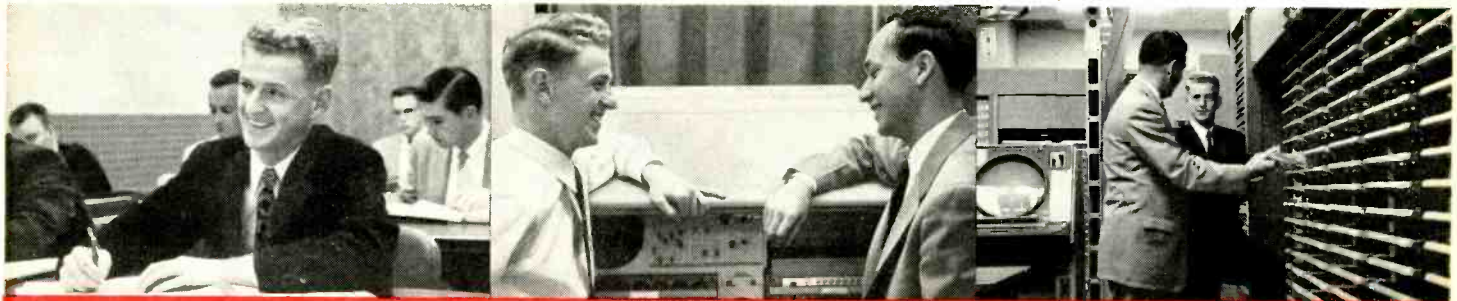

Taking notes in IBM Field Engineering class

Discussing a SAGE display console

Front view of computer frame

Interviewed by IBM

A month later, Link sat across the desk from an IBM interviewer. "Frankly," confesses Link, "I was scared at the thought of this interview. I didn't know the difference between an analog and a digital computer. I didn't expect to get the job."

The interviewer put Link quickly at his ease. A check of his background revealed Link's Service training—28 weeks of Class "A" aviation electronics plus Class "C" schooling in LORAN, RADAR and SONAR. He took a test, which indicated excellent aptitude for computer work.

Then Link learned how IBM would train him in electronics—for five months at full salary—to become a Field Engineer on the SAGE Program. He learned about SAGE, part of our nation's radar defense net, which is built around giant IBM computers—each containing 50,000 vacuum tubes plus 170,000 diodes. He heard about IBM's excellent company benefits, especially interesting to Link who had a wife and child. By the time the interview was over, Link had decided that IBM and the SAGE Program were what he was looking for. He decided then and there that he wanted to come with IBM.

Receives 20 weeks' training

Link reported to Kingston, N. Y., for training. In the IBM "school," he studied basic computer circuits, com-

puter logic and programming, card punch machines—all part of the twenty-week course a Computer Units Field Engineer takes. "The instruction was excellent," he recalls. "Our teachers, experienced field men, often made points not in the textbooks." Formal classroom lectures accounted for half his time, the other half being spent in the laboratories, where he worked on actual computer equipment for SAGE. During his training period, Link received a living allowance in addition to his salary.

Assigned to site in home state

His twenty weeks' training completed, Link was assigned to the SAGE site at Topsham, Maine. "IBM makes every effort to assign you to a location of your choice wherever possible," Link, who is a native State-o'-Mainer, points out.

At Topsham, Link has completed the installation phase of the computer. Now, his work consists of preventive maintenance and "keeping the customer happy"—the customer, in this case, being the Air Force personnel who man and operate the computer. "Installing this giant computer was a significant engineering feat," Link recalls. "First we ran 2,509 cables from 4 to 300 feet long. Then we bolted the computer sections together and hooked up the cables. Next came the testing phase in anticipation of Air Force acceptance tests.

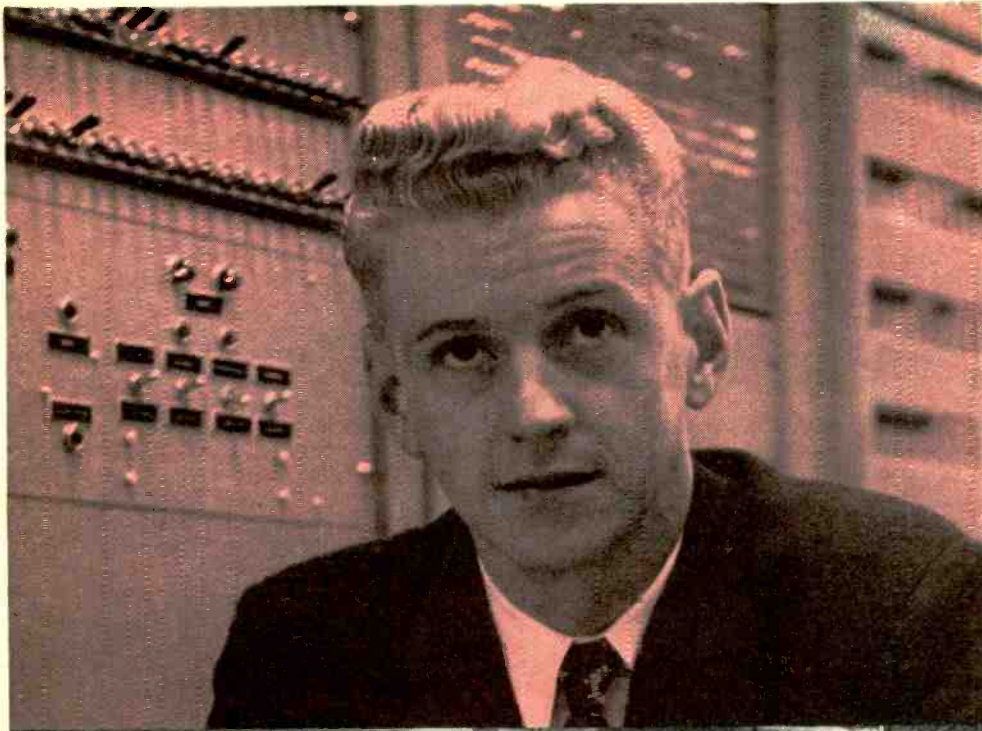

A problem in pluggable units

Working on manual input board of SAGE computer

Recording data on main core memory unit

"I'm in the Display Group," Link continues, "which has responsibility for over one hundred display consoles. Each of these has a 19-inch and a 5-inch cathode ray tube (similar to a TV tube) plus associated circuits. The knowledge of complex circuitry which we learned in the IBM school is essential for this work. We also maintain our own test equipment—oscilloscopes, meters, signal generators and specially designed pluggable unit test equipment."

What does the future hold?

Link looks forward to a rewarding career as a Computer Units Field Engineer. Promotion-wise, he could become, with further training, a Computer Systems Field Engineer, a Group Supervisor or Group Manager. Most important, however, he believes, is the excellent electronics background he's acquiring for the years ahead. "I've had a new engineering dimension added to my career—thanks to IBM's willingness to spend time and money training technicians to assume engineering responsibilities."

A career for you with IBM?

Since Link Kitchin joined IBM and the SAGE Program, opportunities are more promising than ever. This long-range program is destined for increasing national importance and IBM will invest thousands of dollars in the right men to insure its success.

If you have a minimum of 3 years' technical schooling—or equivalent experience—you may be eligible for advanced training for 5 months as a Computer Units Field Engineer. While training, you receive full pay plus living allowance before assignment to a permanent location. You are paid a salary, not hourly wages, plus overtime.

From then on, you can go as far as your abilities and ambition will take you. IBM is the leader in a field that offers you unlimited horizons. And, as you may already know, at IBM you receive company-paid benefits that set standards for industry today.

Mr. N. H. Heyer, Room 649 D

**WRITE TODAY TO: Military Products Division
IBM Corp., Kingston, N. Y.**

You will receive a prompt reply. Personal interviews arranged in all areas of the U. S.

IBM[®]
MILITARY PRODUCTS

SUCCESS SECRET NO. 1!

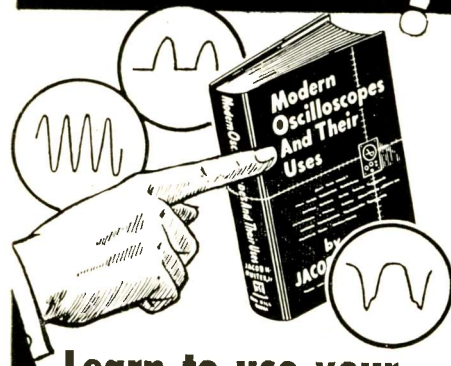

Learn to use your
OSCILLOSCOPE
fast & accurately
ON ALL TYPES
OF WORK!



A complete, easily understood guide to using the handiest service instrument of them all!

A good man with a 'scope is a valuable man indeed . . . and here is a famous book that gets right down to brass tacks in helping you be that fellow! In clear, easily understood terms **MODERN OSCILLOSCOPES AND THEIR USES** teaches

you when, where and how to use oscilloscopes . . . how to interpret patterns . . . how to handle all types of jobs lots better and faster.

No difficult mathematics! No complicated theory. It's a real "how to" book. First you learn all about 'scopes. Then you learn exactly how to use them in the lab, in teaching, and on all types of AM, FM, hi-fi and television service—from locating troubles in a jiffy to handling tough realignment jobs. *Even includes data on quantitative measurements—the slickest method for diagnosing many color TV troubles and aligning sets properly.*

HANDLE SERVICE JOBS BETTER . . . AND FASTER

Each operation is explained step by step. You learn to make the right connections. You learn to adjust circuit components for proper results. You learn to set the controls and how to analyze oscilloscope patterns. 370 clear illustrations including dozens of typical pattern photos explain problems plainer than words. Remember! 'Scope experts get better jobs . . . earn bigger pay. This is the book that can help you be one!

PRACTICE 10 DAYS—FREE!

Dept. RE-49, RINEHART & CO., INC.
232 Madison Ave., New York 16, N. Y.

Send MODERN OSCILLOSCOPES AND THEIR USES for 10-day FREE EXAMINATION. If I like the book, I will send \$6.50 (plus postage) promptly in full payment. If not, I will return it in 10 days and owe you nothing. (SAVE! Send \$6.50 with order and we pay postage. Same 10-day return privilege with money refunded.)

Name.....
Address.....
City, Zone, State.....

OUTSIDE U.S.A. — \$7.00 in cash with order. Money back if you return book in 10 days.

TECHNICIANS' NEWS (Continued from page 111)

instead of from without, says Ralph Boyle, president of the group. To this end, NATS has also named a grievance committee and a code of ethics committee.

1-HOUR SERVICE PULLS FOR FORT WORTH SHOP

"TV service while you wait" is offered by Advance TV Service of Fort Worth, Tex., according to the newspaper *Home Furnishings Daily*. The owners, John Turner and Dave Simon, say that many owners who hesitate to have sets removed from their homes bring them in willingly if they feel that the work can be done immediately and they can take their TV's home again.

Rates are \$6.50 per hour for bench work, plus cost of parts. When service calls are made, Advance TV charges \$4.50 per call.

OLD-TIMER HEADS PA. FEDERATION

Dave Krantz of Philadelphia was elected president of the Federation of Radio & Television Service Associations of Pennsylvania (FRTSAP) at their recent annual meeting. Krantz was one of the founders of the federation 12 years ago, and served as its president for the first 6 years of its life. Earlier, he had been active in the Philadelphia Radio ServiceMen's Association (PRSMA). Leon Helk of Carbondale, another veteran association worker, was elected corresponding secretary.

RAYTHEON AD NOTED BY COLUMBUS TECHS

The January issue of *Radio-Television Service Dealers' News* (Columbus, Ohio) calls attention to the Raytheon ad pictured here, which ran in *Time*, *Newsweek* and other magazines.



before you call a TV-Radio Service Dealer . . . ask yourself these 4 questions

1. DOES HE HAVE AN ESTABLISHED BUSINESS FACILITY?
It takes a big investment to set up a properly equipped TV-Radio service operation. When the Service Dealer has a place of business—preferably in your community—you can be certain he's planning to stay. Your business is important to him. As an independent small businessman in your community he's going to do everything he can to assure you it is the only way he can assure his own future.

2. DOES HE GUARANTEE HIS WORK AND PARTS?
It's standard practice to guarantee work and parts and most qualified dealers do so. Be sure to find out the duration of the guarantee so that you will know just how long you are protected. However, however, the guarantee covers only the parts replaced by the dealer, not everything in the set. If some other tube or component fails during the guarantee period the dealer cannot be held responsible.

3. DOES HE CHARGE A FAIR PRICE FOR A HOME SERVICE CALL?
Like any other businessmen, your Service Dealer has basic costs—overhead, taxes, insurance, rent, address, and his time and transportation—expenses that must be considered when he establishes his service call charge. Naturally you want no unreasonable charge to be levied against you, but you should remember his charges must cover all of these items.

4. DOES HE PROVIDE AN ITEMIZED BILL?
He should, for his own protection as well as yours. Then you know exactly what work was done, which parts were replaced and exactly how much each cost. You both know what replacements are covered by the guarantee in case of an early failure.

If the answer is yes to all four of these questions, the chances are you'll receive fast, competent, expert TV-Radio service at reasonable prices. What's more, the chances are he'll be a Raytheon-Rohlfed Electronic Technician and that's a added bonus for you. These expert technicians offer a 90 day work and parts guarantee that is backed by a bond issued through one of America's largest insurance companies. They check a strict 10-point Code of Business Ethics designed to protect you. For the safe, satisfactory solution to all TV-Radio servicing problems, call a Raytheon-Rohlfed Electronic Technician.

For Your Convenience
Raytheon TV-Radio Service Dealers
Are Here.

price for a home service call? 4. Does he provide an itemized bill?" "Get a copy of one of these magazines," says ARTSD News "and see what Raytheon is doing for you."

I.D.E.A. DISCUSSES TV SERVICE POLICIES

Communications from TV manufacturers on their plans or lack of plans to supply repair service directly to the user of home TV receivers constituted the most important business of the Chicago meeting of the Independent Dealers Electronic Activities Committee, held in January.

Robert Sickels of Indiana acted as chairman in place of Karl Heinzman, who was ill. Service association members representing 84 associations in 13 states were present.

Ten of 12 television manufacturers contacted replied to the request of I.D.E.A. for a statement. Though in some cases these statements were vaguely worded (resulting in occasional cries of "double-talk" from the delegates), the consensus was favorable to independent service. Replies ranged from Sylvania's "We have never been in captive service and do not plan any change" to "Our customers . . . depend upon the independent service dealer for the vast majority of service," but that "we cannot abdicate our service responsibility," which paraphrases the replies of two or three of the larger companies.

Committee officers for 1959, elected at the meeting, were Karl Heinzman, Detroit, president; Al Niehaus, San Antonio, vice president; John Perez, Columbus, secretary. A July meeting was decided upon; exact date and city to be set later.

PUBLISHER OFFERS OLD-TIME DIAGRAM

Supreme Publications announces the availability of schematics and service data on equipment dating back as far as 1926 and continuing to the present. Individual radio schematics will be available for 40c, TV data 75c per model. A manual covering the most-used sets of the 1926-38 period is also available at \$2.50.

Some of these sets are of purely historical interest, but a recent request for old photos by this magazine unearthed a surprising number of sets 25 and 30 years old that are described by their owners as "still operating perfectly."

SAN ANTONIO TRAINS HANDICAPPED WORKERS

Texas Electronics Association of San Antonio has completed a draft program for training handicapped individuals. Under the plan, according to the local technicians' paper *SARTA News*, each interested shop would take one or two of these state-supported people and train them in basic radio and television work. The state contributes \$40 monthly

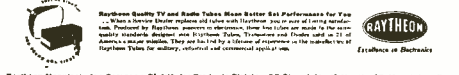

Raytheon Manufacturing Company, Distributor Products Division, 88 Chapel Street, Newton 22, Massachusetts

It pictures a housewife and states: "Before you call a TV-Radio Service Dealer ask yourself these four questions 1. Does he have an established business facility? 2. Does he guarantee his work and parts? 3. Does he charge a fair

to the shop owner and, for the first 9 months, the shop pays no salary.

"These men," says *SARTA News*, "will be screened by our own committee as to their aptitude and willingness to learn the trade, and then sent to the shop desiring to cooperate. After the 9-month training period, the shop may hire the man as a regular employee, but is not required to do so."

NEED THREE PARTS SHOWS, SAYS MOCH OF NATESA

The service industry would welcome and support three or more regional electronic parts shows a year, as proposed by the executive committee of the electronic reps association, in the opinion of Frank J. Moch, executive director of the National Alliance of Television and Electronic Service Associations (NATESA).

"Particularly attractive to service groups would be the feature of the proposed shows which would give service organizations an opportunity to participate in the event as customers of the distributors," Moch said.

"We have long felt that a single distributor show in Chicago to which the distributor's customers, the service business operator, is not admitted, is not, in any sense of the word, an all-industry show," he said. "We believe the pattern set at a recent independent regional parts show, to which service people were admitted, is the type of

industry exposition vitally needed at this time. The idea of holding shows in three or more markets is, in our opinion, a good beginning. At least it would bring a manufacturer's products to his customer, the distributor, instead of attempting to introduce such a show in one area to which manufacturer's customers must come, and to which the distributor's customer cannot come.

"As for the educational feature of these shows which now is being emphasized, it would provide the manufacturer and distributor with an ideal opportunity to conduct a service seminar where it would do the most good."

SOVIETS HAVE TROUBLES WITH TV REPAIRS

Some newspaper "exposés" would lead one to believe that sharp practices in TV repair were limited to this country. But the Soviet trade-union newspaper *Trud* came out with a blast at poor service and dishonest dealings.

The regimented employee of the state-owned repair shops was the target of *Trud's* denunciations. The newspaper stated that some TV and refrigerator repairmen just don't come through with service unless the customer slips them an illegal bonus. One man, says the newspaper, lugged his set from shop to shop, finally leaving it at one for 2 months, but was unable to get it fixed at the state-set price. He tipped the repairman—the job was done. END

RADIO Handbook

Fifteenth Edition
800 PAGES

| | |
|-------------------------------|--------------------|
| AC & DC Circuits | Radiation, |
| VT Principles | Propagation & |
| Transistors & Semi-Conductors | Transmission Lines |
| VT Amps. | Antennas |
| High Fidelity | HF A |
| RF VT Ampl. | |
| Oscilloscope | |

| | |
|----------------------|--------------------------------------|
| Generation | Receivers |
| RF Feedback | Low Power Transmitters & Exciters |
| Amplitude Modulation | HF Power Amps. Speech & AM Equipment |
| FM & Radio Teletype | Transmitter Construction |
| Sideband | Power Supplies |
| Transmission | Workshop Practice |
| Transmitter Design | Electronic Test Equipment |
| TV & BC | Radio Mathematics & Calculations |
| Interference | |
| Transmitter Keying | |

\$750 BUY FROM YOUR FAVORITE DISTRIBUTOR



COYNE
TRAINS YOU
IN SPARETIME
AT HOME

TELEVISION

RADIO-COLOR TV

Only from famous COYNE do you get this modern up-to-the minute TV Home Training. Easy to follow instructions—fully illustrated with 2150 photos and diagrams. Not an old Radio Course with Television tacked on. Includes UHF and COLOR TV. Personal guidance by Coyne Staff. *Practical Job Guides* to help you EARN MONEY QUICKLY IN A TV-RADIO SALES AND SERVICE BUSINESS—part time or full time. COSTS MUCH LESS—pay only for training—no costly "put together kits."

SEND TODAY FOR FREE BOOK
SEND COUPON or write to address below for Free Book and full details including EASY PAYMENT PLAN. NO COST OR OBLIGATION—NO SALESMAN WILL CALL.



B. W. COOKE, Jr., Pres.
COYNE ELECTRICAL SCHOOL
FOUNDED 1899

CHARTERED AS AN EDUCATIONAL INSTITUTION NDT FOR PROFIT
1501 W. Congress Pkwy. Dept. 49-H5, Chicago 7, Ill.

COYNE Television Home Training Div.
New Coyne Building, Dept. 49-H5
1501 W. Congress Pkwy., Chicago 7, Ill.

Send FREE BOOK and details of your Television Home Training offer.

Name _____

Address _____

City _____ State _____

**Enjoy Stereo Now!
at LOW COST!**

MAKE A STEREO SYSTEM
from any



PHONO
or Hi-Fi Record Player

AND



RADIO
ordinary broadcast AM
or AM-FM, or portables

WITH FABULOUS NEW

Stereo-Ette^{*}

GOLD BUG



Easy to Install!

Transistorized!

Top Fidelity!

No Drift! No Hum!

Compatible—Stereo/Mono!

No Extra Amplifiers or Speakers!

Model SDK-101. Less cartridge. List, \$16.75
Model SDK-102CS. With E-V 126ST dual sapphire compatible cartridge. List \$27.50
(above prices are less battery)

See it at your distributor, dealer or record store; or order direct. *Trade Mark

THE STEREO-ETTE CO.
4908 N. Lincoln, Chicago 25, Ill.

Send FREE Bulletin No. CS101-E

Send . . . Model . . . @ \$. . .

Check or M.O. for \$. . . enclosed. (No C.O.D.)

NAME _____

ADDRESS _____

CITY _____ ZONE _____ STATE _____

On the Market

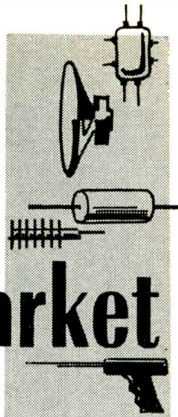

MOBILE POWER-SUPPLY KIT, model MP-1. Heavy-duty transistor supply furnishes 120 watts of dc power, up to 150 watts intermittently. Designed

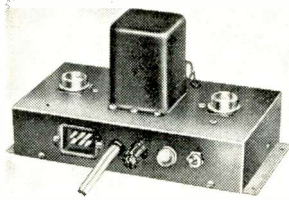

to power manufacturer's MT-1 transmitter and MR-1 receiver. Includes connecting-cables. Operates from 12-volt battery. Contains push-to-talk power-switching relay. 9 1/16 x 4 3/4 x 2 inches.—Heath Co., Benton Harbor, Mich.

TRANSISTOR POWER SUPPLY, Sencore Transi-Pac PS-103. Isolated power supply re-

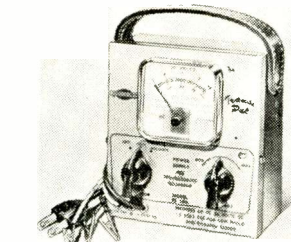

places batteries while repairing transistor radios. Provides 0-24 volts output with a 1.5-volt tap for radios with a tapped supply. Delivers up to 200 ma on peaks, 100 ma continuously. Meter gives continuous output indication.—Service Instruments Corp., 121 Official Rd., Addison, Ill.

CERAMIC CAPACITORS, Cerafil line. Ultra-miniature units; compared with standard capacitor in photo. Values from 10 μf to 1.0 μf in working



voltages of 30 and 100.—Aerovox Corp., New Bedford, Mass.

REPLACEMENT FLYBACKS Stancor HO-301 (shown) replaces Admiral parts 79D65-2 and 79D65-4. HO-300 for Wells



Gardner 53X355. HO-307 for Setchell-Carlson T-123, T-124, WF-14 and FW-70. HO-308 for Setchell-Carlson T-201, T-132, T-133, WF-71 and WF-80.—Chicago Standard Transformer Corp., 3501 W. Addison St., Chicago 18, Ill.

VERNIER VARIABLE RE-

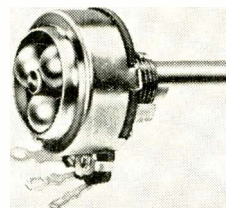

SISTOR. Contact arm rotates 1° for each 13.5° shaft rotation. Type VA-45 is 15/16-inch-diameter unit only 5/32 inch deeper than standard nonvernier type 45. Resistance range, 250 ohms through 5 megohms. Available in variety of resistance tapers.—Chicago Telephone Supply Corp., Elkhart, Ind.

AIR-CORE INDUCTORS for crossover networks. 80 values in No. 17 wire range from .05 to 12.0 mh. 52 values in No. 16 wire range from 5.0 to 20 mh. Inductors are oven-baked, calibrated and have spaghetti applied to a 7-inch tinned lead. Then they

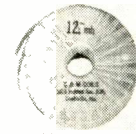

are cotton wrapped, dipped in varnish and baked.—C & M Coils, 3016 Holmes Ave. NW., Huntsville, Ala.

MOBILE HAM TRANSMITTER KIT, Cheyenne MT-1. 90 watts input on phone. Covers

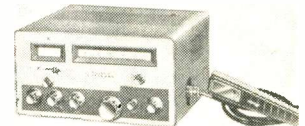

80, 40, 20, 15 and 10 meters. Built-in vfo, modulator, 4 rf stages, 6146 final and pi-network output coupling. Requires

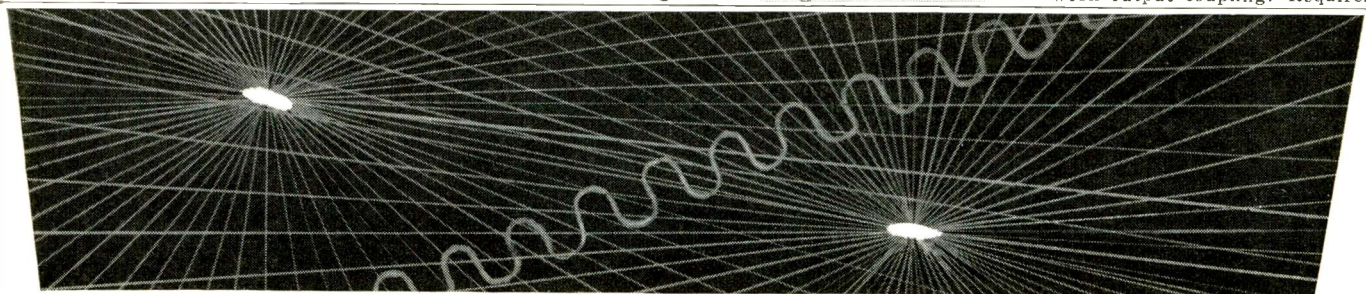

ELECTRONIC FIELD ENGINEERS FIELD SERVICE TECHNICIANS

Act fast for new, challenging assignments in U.S., Europe, Mediterranean, Far East, Alaska, Iceland and South America... including openings in

SPACE EXPLORATION PROGRAM

ELECTRONIC FIELD ENGINEERS

Engineering degree or equivalent experience in electronic systems required.

FIELD SERVICE TECHNICIANS

Technical school, plus three years experience required. Military service acceptable.

EXPERIENCED IN RADAR, GROUND COMMUNICATIONS, COMPUTERS, GCA

Obtain these advantages: • Prestige of representing the leader in its field • Opportunity for professional development and advancement • Excellent salary • Liberal field allowance • Both U.S. & overseas assignments

Drop us a line, briefly outlining your education and experience. Mail replies to MR. O. A. BOWMAN, DEPT. V, FIELD ENGINEERING.

"Our Laboratory... the Universe"

Bendix Radio

DIVISION OF BENDIX AVIATION CORP.
Owings Mills, Maryland

ON THE MARKET (Continued)

500-600 volts dc at 150 ma and 300 volts dc at 100 ma.—Heath Co., Benton Harbor, Mich.

COMMUNICATIONS RECEIVER, NC-400. AM, CW and SSB. 18-tube receiver has range

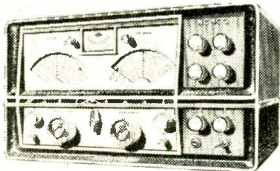

of 540 kc to 31 mc in 7 bands. Selectivity range of 16 kc to 150 cycles with if and crystal filters supplied. With accessory filters, selectivity range is 16 kc to 500 cycles. Sensitivity is approximate 1 μ v for a 10-db signal-to-noise ratio.—National Co., Inc., Malden, Mass.

MOBILE HAM RECEIVER KIT, Comanche MR-1. 8-tube superhet for AM, CW and SSB

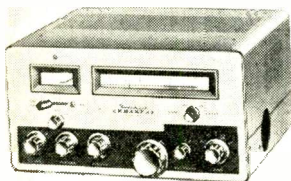

reception on the 80-, 40-, 20-, 15- and 10-meter Amateur bands. 3-mc lattice type if filter permits single conversion without image interference. Included are rf stage, converter, 2 if amplifiers, 2 detectors, noise lim-

iter, 2 audio stages and a voltage regulator. Sensitivity better than 1 μ v on all bands. Signal-to-noise 10 db down at 1 μ v input. 2-watts undistorted audio output.—Heath Co., Benton Harbor, Mich.

AMATEUR BEAM ROTATOR, HM 120 Powerotor. Low-cost precision-built unit with continuous-reading accurate direction indicator. Heavy-duty thrust bearing supports anten-

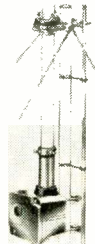

nas weighing up to 50 pounds.—Moran Products Co., 2925 E. 55 St., Cleveland 27, Ohio.

FM RADIO ANTENNA, model FM3T. Mounts on TV antenna

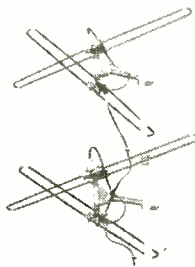

mast. 4 bays can be stacked with 300-ohm line. Anodized gold finish.—Winegard Co., 3000 Scotten Blvd., Burlington, Iowa.

TV ANTENNA MOUNT,

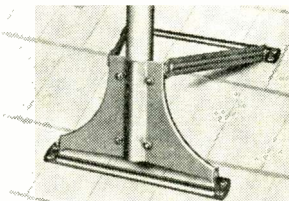

Fastmount TV Antenna Holder. Mount can be placed in any location on a roof, regardless of pitch. Eases one-man installations.—Vokar Co., 201 E. Catherine St., Ann Arbor, Mich.

STYLUS MICROSCOPES, MX1 (bottom) and MX-40. Used

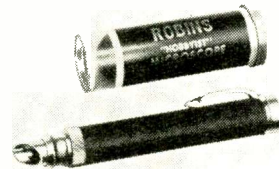

to check stylus wear.—Robins Industries, 36-27 Prince St., Flushing 54, N. Y.

MAGNETIC RECORDING TAPE, Continental Series. 5 1/4-inch tape reel holds 850 feet Brown-Band, 850 feet Green-Band, 850 feet Shamrock, 1,150 feet long-play (Mylar), 1,150 feet long-play (Acetate) or 1,650 feet double-play tape. In-

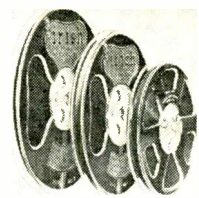

tended for use with European tape recorders.—ORRadio Industries Inc., Shamrock Circle, Opelika, Ala.

REPLACEMENT STYLI, for Columbia CD stereo phono cartridges. CD-1SMD is diamond



version. CD-1SMS sapphire.—Available through CBS-Hytron, Danvers, Mass. and Columbia Record distributors and dealers.

RECORD CLEANING KIT, Stardust. Aid for washing records in running water without



News of SUPREME Radio & TV Manuals

18 RADIO VOLUMES

RADIO DIAGRAMS

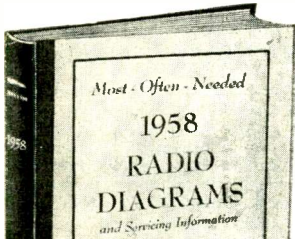

Supreme is your best source for all needed RADIO diagrams and service data. Covers everything from the most recent 1958 radios to pre-war old-timers; home radios, auto sets, combinations, changers, HI-FI, FM, and portables. Sensational values. Only \$2 for many volumes. Every manual has extra large schematics, all needed alignment facts, parts lists, voltage values, trimmers, dial stringing, and helpful hints. Volumes are large in size, 8 1/2 x 11 inches, about 190 pages. See coupon below for a complete list of these low-priced manuals.



TELEVISION SERVICING COURSE

Let this new course help you in TV servicing. Amazing bargain complete, only \$3, full price for all lessons. Giant in size, mammoth in scope, topics just like a \$200.00 correspondence course. Lessons on picture faults, circuits, adjustments, short-cuts, UHF, alignment facts, hints, antenna problems, trouble-shooting, test equipment, picture analysis. Special, only **\$3**

SIMPLIFIED RADIO SERVICING BY COMPARISON

Fix any radio easily. New, different COMPARISON method finds faults quickly. Covers every radio set—new and old models. Introductory training included. Simple picture suggestions tell you where to look for faults. No testers needed for most jobs. Data on all tubes. Manual form, 96 large pages, 8 1/2 x 11". Special price, only **\$1.50**



RADIO SERVICING COURSE

Here is your most amazing bargain in radio training. For only \$2.50 (full price) you can obtain a practical radio course of 22 easy-to-follow lessons. Covers every topic in radio. Review fundamentals, learn new servicing tricks, prepare for television. Compares lesson-by-lesson with the best \$150.00 home-study correspondence courses. With self-testing questions. Large size; 8 1/2 x 11". New 1959 edition. Amazing value at only **\$2.50**

Just Out

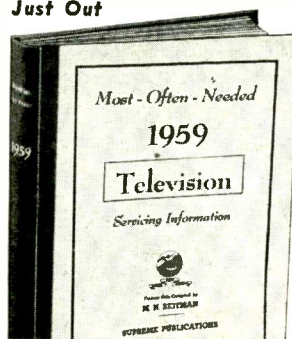

New 1959 TV manual covers all important sets of every make. Includes all data needed for faster TV servicing. Amazing bargain. A whole year of service material for only **\$3**

ALL NEEDED TV DATA

Use Supreme TV manuals for faster, easier repairs. All needed material on every popular TV set of every important make. Easy-to-use, practical, factory-prepared data simplify TV servicing and adjustment. These giant TV manuals have complete, large double-page schematics, all needed alignment facts, printed board views, recommended changes, waveforms, voltage charts, etc. Only \$3 per large volume. The choice of 126,000 wise servicemen.

AMAZING BARGAIN

Here are your error-free service instructions to help you do expert work quicker; and priced at only \$3 for a mammoth yearly manual. Greatest bargain in service data. Repair any TV model ever made by having in your shop all 14 volumes listed in coupon. Special price for all 14, only \$40. Or try the new 1959 TV manual for only \$3. See no risk coupon below.

NO-RISK TRIAL ORDER COUPON

SUPREME PUBLICATIONS, 1760 Balsam Rd., Highland Park, ILL.

Radio Diagram Manuals

- 1958 Radio Diagrams, \$2.50
- 1957 Radio Manual, \$2.50
- 1956 Radio Diagrams, \$2.50
- 1955 Radio Manual, only \$2
- 1954
- 1953
- 1952
- 1951
- 1950
- 1949
- 1948
- 1947
- 1946
- 1942
- 1941
- 1940
- 1939
- 1926-1938 Manual, \$2.50
- Radio & TV Master INDEX, 25¢

- Rush RADIO and TV manuals checked in coupon.
- New Television Servicing Course, complete... **\$3.**
- Simplified Radio Servicing by Comparison... **\$1.50**
- Radio Servicing Course (all 22 lessons)... **\$2.50**
- New 1959 Television Servicing Manual, only... **\$3.**
- 1958 Television Manual, \$3. Early 1957 TV, \$3.
- Additional 1957 TV, \$3. 1956 TV Manual, \$3.
- Early 1955 TV, \$3. Additional 1955 TV, \$3.
- 1954 TV, \$3. 1953 TV, \$3. 1952 TV, \$3.
- 1951 TV, \$3. 1950 TV, \$3. 1949 TV, \$3.
- 1948 TV, \$3. 1957-58 RCA Victor TV, \$1.50

THIS GROUP ONLY \$2 EACH

- I am enclosing \$..... Send postpaid.
- Send C.O.D. I am enclosing \$..... deposit.

Name: Address:

Supreme Publications
Sold by All Leading Parts Jobbers

DX-16 Super Deluxe TV KIT

70° or 90° — operating all 17", 21", 24" and 27" PICTURE TUBES

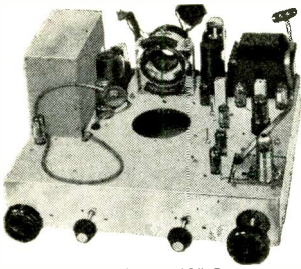

Dimensions 17 1/2" W x 16" D
Shipping weight 40 lbs.

NEW IN DESIGN—Mounts Horizontally or Vertically

- ★ Produces a 16-Tube Chassis with 30-Tube performance.
- ★ Latest Inter-carrier Circuitry and Multi-section Tubes.
- ★ Standard Neutrode Tuner for Selectivity & Fine Definition.
- ★ 5 Microvolts Sensitivity (20V peak to peak at CRT grid).
- ★ Fast Action AGC for Drift-Free Steady and Clear Pictures.
- ★ 3 Hi-gain Video I.F. Stages for fine Contrast and Details.
- ★ AGC Level Control, for adjusting reception to signal area.
- ★ All Video and I.F. Coils factory pre-aligned and tuned.
- ★ Large 250ma Power Transformer for dependable service.
- ★ 12" Speaker or Twin-cone 6" x 9" Speaker.

Includes LIFE-SIZE step-by-step Building Instructions
Most Up-To-Date and Practical Course in Television

COMPLETE KIT with SET of WESTINGHOUSE TUBES **\$79.97**
1—6CB6 and 6T8, 6T8, 6C4, 12BH7, 6SN7, 6B06, 6W4, 6K8, 1X2B, 5U4,
6BN4, and 6CG8 included in the Tuner (less CRT)

COMPLETE KIT Including WESTINGHOUSE PICTURE TUBE
17" 70° # 17HP4B \$99.42 21" 70° # 21YPA4 \$108.86 24" # 24DPA4 \$126.51
90° # 17AVPA4

Also sold on EASY-PAYMENT-PLAN Buy LIFE-SIZE Instructions \$2.49 —and buy Parts as you build.

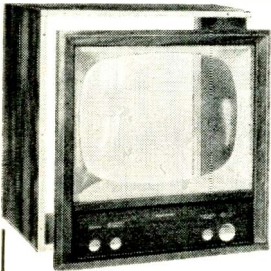

FRONT SECTION Only

BUILD YOUR OWN CABINET FOR ANY TV CHASSIS

Comparable to the type that Top Mfrs. use on high priced TV sets.
CABINET KIT with 90% of the job done, includes—

FRONT SECTION in Solid Mahogany, Walnut or Blond Korina. TOP, SIDES, BACK, MASK, SAFETY GLASS, ETC.
And EASY-TO-FOLLOW ASSEMBLY INSTRUCTIONS

Front, Top and Sides supplied in a beautiful Piano Finish • Knob panel undrilled • For tinting Mask specify type or number of CRT used. Same price—Mahogany, Walnut or Blond. (Shipping weight 36 lbs.)

21" CABINET KIT 26"H, 25"W, 22"D **\$24.95**

for WALL INSTALLATIONS Includes Mask 21" \$17.45 | 24" or 27" \$22.97
Safety Glass, Decals and Illustrated Instructions.
Complete as pictured (undrilled), ready to install in Mahogany, Walnut, Blond or Natural (unfinished) for your own color application, to match the decor of the room.

PULSE KEYED AGC KIT

Finest, most accurate and the easiest Kit to install—in any make TV RECEIVER Complete incl. 6AU6 Tube & Instructions. **\$4.59**

TV PLASTIC OPEN MASKS

21"—Rectangular 18" x 22 1/2" \$2.38
24"—Rectangular 21" x 26" 4.93
27"—Rectangular 21" x 26" 4.93
On 21" specify type number of CRT used

TV SAFETY GLASS IN HANDY SIZES

16" x 20" \$3.94 20 1/4" x 25" \$5.47
18" x 22 1/2" 5.16 21" x 26" 5.87

90° TV CONVERSION KIT

Convert any Size, any make TV RECEIVER to operate the 24" or ANY 90° PICTURE TUBE.

COMPLETE SET OF ESSENTIAL PARTS includes matched set of 90° YOKE & 18kv FLYBACK, 30kv FILTER, 6AX4 TUBE, BRACKETS, WIDTH CONTROL, CONDENSERS, RESISTORS, ETC.

Your Price **\$15.98** List Price \$39.75
Incl. CONVERSION MANUAL with Step-by-Step Instructions & Diagrams

Similar Kit for any 70° CRT **\$13.97**

STEREO — Selected as BEST for Quality, Performance & Price

- \$98 DeWald #M-1000 "AMBASSADOR AM-FM TUNER" both Stereo & Monaural..... \$71.95
- \$98 DeWald #M-1200 "CONCERTO 30-WATT AMPLIFIER" both Stereo & Monaural..... \$71.95
- \$59 BASS REFLEX CABINET for 12" or 15" Speaker, in Mahogany, Walnut or Blond..... \$32.82
- \$28 12" HI-FI UNIVERSAL TYPE SPEAKER woofer & tweeter range 50 to 15000 cps..... \$12.38
- \$49 DELUXE VM 4-SPEED RECORD CHANGER incl. Cartridge plays all Stereo & Monaural \$26
- \$332 "COMPLETE PACKAGE DEAL" includes ALL FIVE ITEMS as shown above..... for only \$199
- \$99 NORELCO #9762M HI-FI 12" SPEAKER \$35.97 GARRARD #RC-121 4-SPEED CHANGER \$32.49
- \$20 UNIVERSAL "BIG-12" HI-FI SPEAKER.. 6.97 GARRARD #RC-88 4-SPEED CHANGER. 46.82
- \$14 SONOTONE #8TS STEREO CARTRIDGE. 5.99 GARRARD #RC-98 4-SPEED CHANGER. 54.98

TUBULAR CONDENSERS—85°C TOP QUALITY—Equally as good for Radio or TV work.

.0047-400v, .01-400v, .02-400v, .047-400v, .001-600v, .0047-600v, .01-600v, .02-600v..... 5¢ ea.
1-400v, .25-400v, .47-400v, .047-600v, .1-600v, .25-600v, .001-1000v, .01-1000v..... 8¢ ea.
.035-1000v, .047-1000v, .1-1000v, .015-1600v, .03-1600v, .001-6000v, .005-6000v..... 14¢ ea.

ELECTROLYTIC CONDENSERS—85°C 1-50v, 1-150v, 2-450v, 5-150v, 8-150v... 19¢ ea.
20/20-150v, 50/30-150v, 40-150v, 10-450v, 20-450v, 30-450v, 40-450v, 60-450v, 80-450v..... 34¢ ea.

CARBON RESISTORS—Regular factory stock in Stackpole, I.R.C., Speer, etc.

1/2 WATT 10% 10, 39, 47, 100, 120, 150, 270, 330, 390, 470, 560, 680, 820, 1k, 1800Ω... 2¢ ea.
1/2 WATT 10% 2700, 3300, 3900, 4700, 5600, 6800, 8200, 10k, 15k, 18k, 22k, 27k, 33kΩ... 2¢ ea.
1/2 WATT 10% 39k, 47k, 50k, 56k, 68k, 82k, 100k, 120k, 150k, 180k, 220k, 270k, 330kΩ... 2¢ ea.
1/2 WATT 10% 390k, 470k, 560k, 680k, 820kΩ 1, 1.2, 1.5, 2.2, 6.8, 10, 15 MEGΩ... 2¢ ea.
1 WATT 10% 3.3, 10, 39, 100, 120, 150, 330, 470, 560, 680, 820, 1k, 1800, 2700, 4700Ω... 3¢ ea.
1 WATT 10% 6800, 10k, 15k, 22k, 27k, 33k, 39k, 47k, 68k, 82k, 100k, 150k, 470k, 680kΩ... 3¢ ea.
2 WATT 10% 3.9, 18, 22, 82, 100, 180, 2200, 4700, 6800, 8200, 18k, 22k, 100k, 470kΩ... 4¢ ea.
CERAMIC CONDENSERS 1, 2, 3, 5, 6, 10, 22, 25, 47, 50, 51, 56, 82, 100, 120, 200 mmmf... 3¢ ea.
CERAMIC CONDENSERS 220, 250, 270, 330, 470, 1k, 1200, 1500, 2k, 5k, 6800, 15k mmmf... 3¢ ea.
MICA CONDENSERS 5, 25, 50, 60, 68, 75, 100, 120, 150, 220, 330, 470, 510 mmmf... 3¢ ea.
MICA CONDENSERS 560, 680, 820, 1k, 1500, 2k, 2500, 3300, 4700, 6k, 6800, 8k, 10k mmmf... 3¢ ea.

"ONE DOLLAR" buys

As much as \$15 worth — Everything Brand New and sold to you with a money back guarantee.

DEDUCT 10% ON ANY ORDER OF \$10 OR OVER
(ON THESE DOLLAR BUYS)

Plus a FREE SURPRISE PACKAGE

- \$15 — "JACKPOT" TELEVISION PARTS.....\$1
- 4 — RCA #1U4 TUBES also serves as a 1T4.....\$1
- 1 — RCA 70° FLYBACK TRANS. #75240.....\$1
- 1 — \$11 TODD 60° DEFLECTION YOKE.....\$1
- 40 — ASST. PRECISION RESISTORS best sizes.....\$1
- 1 — 5" PM SPEAKER alnico #3 magnet.....\$1
- 20 — TUBULAR CONDENSERS .05-600v.....\$1
- 20 — TUBULAR CONDENSERS .001-1000v.....\$1
- 50 — ASSORTED FUSES popular sizes.....\$1
- 100 — ASST. 1/2 WATT RESISTORS some 50¢.....\$1
- 70 — ASSORTED 1 WATT RESISTORS some 50¢.....\$1
- 35 — ASSORTED 2 WATT RESISTORS some 50¢.....\$1
- 50 — ASST. TUBULAR CONDENSERS.....\$1
- 10 — 6' ELECTRIC LINE CORDS with plugs.....\$1
- 5 — TV CHEATER CORDS with both plugs.....\$1
- 4 — 50' SPOOLS HOOK-UP WIRE 4 colors.....\$1
- 50 — STRIPS ASST. SPAGHETTI best sizes.....\$1
- 100 — ASST. RUBBER GROMMETS best sizes.....\$1
- 100' — TWIN LEAD-IN WIRE 300' heavy duty.....\$1
- 50' — FLAT 4-CONDUCT. WIRE many purposes.....\$1
- 25' — INSULATED SHIELDED WIRE.....\$1
- 32' — TEST PROD WIRE deluxe (red or black).....\$1
- 1 — \$7 INDOOR TV ANTENNA hi-gain 3 section.....\$1
- 20 — ASST. TV KNOBS, ESCUTCHEONS, Etc.....\$1
- 3 — ASST. TOGGLE SWITCHES spst, dpdt, etc.....\$1
- 6 — ASST. SLIDE SWITCHES spst, dpdt, etc.....\$1
- 100' — FINEST NYLON DIAL CORD best size.....\$1
- 200 — SELF TAPPING SCREWS #8 x 1 1/2".....\$1
- 35 — ASST. RADIO KNOBS screw and push-on.....\$1
- 100 — KNOB SPRINGS standard size 3/8" x 1 1/2".....\$1
- 100 — ASSORTED KNOB SET-SCREWS.....\$1
- 25 — ASSORTED CLOCK RADIO KNOBS.....\$1
- 600 — ASST. H'DWARE screws, nuts, rivets, etc.....\$1
- 50 — ASST. SOCKETS octal, novak and miniature.....\$1
- 20 — ASSORTED TUBE SHIELDS best sizes.....\$1
- 50 — ASST. MICA CONDENSERS some hi-gain.....\$1
- 50 — ASST. CERAMIC CONDENSERS.....\$1
- 10 — ASST. VOLUME CONTROLS less switch.....\$1
- 5 — ASST. VOLUME CONTROLS with switch.....\$1
- 100 — VOLUME CONTROL HEX NUTS.....\$1
- 20 — ASST. PILOT LIGHTS popular types.....\$1
- 10 — PILOT LIGHT SKTS. bayonet type, wired.....\$1
- 50 — ASST. TERMINAL STRIPS 1, 2, 3, 4 lug.....\$1
- 10 — ASST. RADIO ELECTRO. CONDENSERS.....\$1
- 5 — ASST. TV ELECTROLYTIC CONDENSERS.....\$1
- 25 — ASST. MICA TRIMMER CONDENSERS.....\$1
- 2 — ELECTROLYTIC COND. 40-40-450v.....\$1
- 30 — PP CONDENSER MOUNTING WAFERS.....\$1
- 3 — ELECTROLYTIC CONDENSERS 80-450v.....\$1
- 3 — ELECTROLYTIC COND. 50-30-150v.....\$1
- 10 — HY TUBULAR CONDENSERS .006-1600v.....\$1
- 10 — HY TUBULAR CONDENSERS .001-6000v.....\$1
- 10 — HY TUBULAR CONDENSERS .005-6000v.....\$1
- 35 — MICA COND. 20-100 mmmf & 15-270 mmmf.....\$1
- 35 — MICA COND. 20-470 mmmf & 15-680 mmmf.....\$1
- 35 — MICA COND. 20-320 mmmf & 15-1000 mmmf.....\$1
- 35 — CERAMIC COND. 20-5 mmmf & 15-10 mmmf.....\$1
- 35 — CERAMIC COND. 20-25 mmmf & 15-47 mmmf.....\$1
- 35 — CERAMIC COND. 20-56 mmmf & 15-82 mmmf.....\$1
- 35 — CERAMIC COND. 20-100 mmmf & 15-150 mmmf.....\$1
- 35 — CERAMIC COND. 20-270 mmmf & 15-470 mmmf.....\$1
- 35 — CERAMIC COND. 20-1000 mmmf & 15-1500 mmmf.....\$1
- 35 — CERAMIC COND. 20-20 mmmf & 15-5000 mmmf.....\$1
- 50 — 100Ω 1/2 WATT RESISTORS 5%.....\$1
- 75 — 470KΩ 1/2 WATT RESISTORS 10%.....\$1
- 10 — ASST. WIRE'ND RES. 5, 10, 20 watt.....\$1
- 3 — AUDIO OUTPUT TRANS. 50L6 type.....\$1
- 3 — AUDIO OUTPUT TRANS. 6K6 or 6V6 type.....\$1
- 3 — I.F. COIL TRANSFORMERS 156 kc.....\$1
- 3 — I.F. COIL TRANSFORMERS 10.7 mc. FM.....\$1
- 4 — OVAL LOOP ANTENNAS ass't hi-gain types.....\$1
- 3 — LOOPSTICK ANT. new ferrite adjustable.....\$1
- 12 — RADIO OSCILLATOR COILS 456 kc.....\$1
- 3 — 1/2 MEG VOLUME CONTROLS with switch.....\$1
- 5 — 50K VOLUME CONTROLS less switch.....\$1
- 10 — SURE GRIP ALLIGATOR CLIPS.....\$1
- 1 — GOLD GRILLE CLOTH 14" x 14" or 12" x 18".....\$1
- 5 — SETS SPEAKER PLUGS wired.....\$1
- 10 — SETS PHONO PLUGS and PIN JACKS.....\$1
- 2 — \$2.50 SAPPHIRE NEEDLES 4000 playings.....\$1
- 5 — DIODE CRYSTALS 2-IN21 2-IN22 1-IN261.....\$1
- 3 — DIODE CRYSTALS 1-IN260, 1-IN269.....\$1
- 2 — SELENIUM RECTIFIERS 1-65ma & 1-150ma.....\$1
- 15 — ASST. TV COILS sync, peaking, width, etc.....\$1
- 6 — SPIN TIGHT SOCKET SET 3/16" to 7/16".....\$1
- 1 — LB. SPOOL ROSIN CORE SOLDER.....\$1
- 3 — TV ALIGNMENT TOOLS assortment #1.....\$1
- 3 — TV ALIGNMENT TOOLS assortment #2.....\$1
- 3 — TV ALIGNMENT TOOLS assortment #3.....\$1
- 3 — TV ALIGNMENT TOOLS assortment #4.....\$1
- 3 — TV ALIGNMENT TOOLS assortment #5.....\$1

EACH ALIGNMENT TOOL is different and valued at over \$1 each.

HANDY WAY TO ORDER—Simply tear out advertisement and pencil mark items wanted (X in square is sufficient); enclose with money order or check. You will receive a new copy of this ad for re-orders.

ON SMALL ORDERS—Include stamps for postage, excess will be refunded. Larger orders shipped express collect.

BROOKS RADIO & TV CORP., 84 Vesey St., Dept. A, New York 7, N.Y. TELEPHONE COrlland 7-2359

RADIO and ELECTRONICS TRAINING AT HOME

BUILD 16 RADIO

CIRCUITS with DELUXE
1959 Progressive
RADIO "EDU-KIT"®

Reg. U.S.
Pat. Off.

PRACTICAL only
HOME RADIO COURSE
\$22.95



NOW INCLUDES

- ★ 12 RECEIVERS
- ★ TRANSMITTER
- ★ SIGNAL TRACER
- ★ SIGNAL INJECTOR
- ★ CODE OSCILLATOR

- ★ No Knowledge of Radio Necessary
- ★ No Additional Parts or Tools needed
- ★ Excellent Background for TV
- ★ School Inquiries Invited
- ★ Attractively Gift Packed

FREE EXTRAS

- SET OF TOOLS • RADIO & ELECTRONICS TESTER • ELECTRIC SOLDERING IRON • TESTER INSTRUCTION MANUAL • MEMBERSHIP IN RADIO-TV CLUB; CONSULTATION SERVICE • HI-FI GUIDE • QUIZZES • TV BOOK • FCC AMATEUR LICENSE TRAINING • RADIO BOOK • PRINTED CIRCUITRY • PLIERS-CUTTERS • ALIGNMENT TOOL • WRENCH SET • CERTIFICATE OF MERIT • VALUABLE DISCOUNT CARD

WHAT THE "EDU-KIT" OFFERS YOU

The "Edu-Kit" offers you an outstanding PRACTICAL HOME RADIO COURSE at a rock-bottom price. Our kit is designed to train Radio & Electronics Technicians, making use of the most modern methods of home training. You will learn radio theory, construction servicing, basic Hi-Fi and TV repairs, code, FCC amateur license requirements.

You will learn how to identify radio symbols, how to read and interpret schematics, how to mount and layout radio parts, how to wire and solder, how to operate electronic equipment, how to build radios. Today it is no longer necessary to spend hundreds of dollars for a radio course. You will receive a basic education in radio, worth many times the small price you pay, only \$22.95 complete.

THE KIT FOR EVERYONE

The Progressive Radio "Edu-Kit" was specifically prepared for any person who has a desire to learn Radio. The "Edu-Kit" has been used successfully by young and old in all parts of the world, by many Radio Schools and Clubs in this country and abroad. It is used for training and rehabilitation of Armed Forces Personnel and Veterans throughout the world.

The Progressive Radio "Edu-Kit" requires no instructor. All instructions are included. Every step is carefully explained. You cannot make a mistake.

PROGRESSIVE TEACHING METHOD

The Progressive Radio "Edu-Kit" is the foremost educational radio kit in the world, and is universally accepted as the standard in the field of electronics training. The "Edu-Kit" uses the modern educational principle of "Learn by Doing." Therefore, you will construct radio circuits, perform jobs and conduct experiments to illustrate the principles which you learn.

You begin by examining the various radio parts included in the "Edu-Kit." You then learn the function, theory and wiring of these parts. Then you build a simple radio. With this first set, you will enjoy listening to regular broadcast stations, learn theory, practice testing and troubleshooting. Then you build a more advanced radio, learn more advanced theory and techniques. Gradually, in a progressive manner, and at your own rate, you will find yourself constructing more advanced multi-tube radio circuits, and doing work like a professional Radio Technician.

Included in the "Edu-Kit" course are sixteen Receiver, Transmitter, Code Oscillator, Signal Tracer and Signal Injector circuits. These are not unprofessional "breadboard" experiments, but genuine radio circuits, constructed by means of professional wiring and soldering on metal chassis, plus the new method of radio construction known as "Printed Circuitry." These circuits operate on your regular AC or DC house current.

In order to provide a thorough, well-integrated and easily-learned radio course, the "Edu-Kit" includes practical work as well as theory; troubleshooting in addition to construction; training for all, whether your purpose in learning radio be for hobby, business, or progressively-arranged material, ranging from simple circuits to well-advanced topics in Hi-Fi and TV. Your studies will be further aided by Quiz materials and our well-known FREE Consultation Service.

THE "EDU-KIT" IS COMPLETE

You will receive all parts and instructions necessary to build 16 different radio and electronics circuits, each guaranteed to operate. Our Kits contain tubes, tube sockets, variable, electrolytic, mica, ceramic and paper dielectric condensers, resistors, tie strips, coils, hardware, tubing, punched metal chassis, Instruction Manuals, hookup wire, solder, etc.

In addition, you receive Printed Circuit materials, including Printed Circuit chassis, special tube sockets, hardware and instructions. You also receive a useful set of tools, a professional electric soldering iron, and a self-powered Dynamic Radio & Electronics Tester. The "Edu-Kit" also includes Code Instructions and the Progressive Code Oscillator, in addition to the F-C-G-type Questions and Answers for Radio Amateur License training. You will also receive lessons for servicing with the Progressive Signal Tracer and the Progressive Signal Injector, and a High Fidelity Guide and Quiz Book. Everything is yours to keep.

J. Statistis, of 25 Poplar Pl., Waterbury, Conn., writes: "I have repaired several sets for my friends, and made money. The "Edu-Kit" paid for itself. I was ready to spend \$240 for a course, but I found your ad and sent for your Kit."

UNCONDITIONAL MONEY-BACK GUARANTEE

The Progressive Radio "Edu-Kit" has been sold to many thousands of individuals, schools and organizations, public and private, throughout the world. It is recognized internationally as the ideal radio course.

By popular demand the Progressive Radio "Edu-Kit" is now available in Spanish as well as English.

It is understood and agreed that should the Progressive Radio "Edu-Kit" be returned to Progressive "Edu-Kits" Inc., for any reason whatever, the purchase price will be refunded in full, without quibble or question, and without delay.

The high recognition which Progressive "Edu-Kits" Inc., has earned through its many years of service to the public is due to its unconditional insistence upon the maintenance of perfect engineering, the highest instructional standards, and 100% adherence to its Unconditional Money-Back Guarantee. As a result, we do not have a single dissatisfied customer throughout the entire world.

ORDER FROM AD—RECEIVE FREE BONUS RESISTOR AND CONDENSER KITS WORTH \$7.00

- Send "Edu-Kit" Postpaid. I enclose full payment of \$22.95.
- Send "Edu-Kit" C.O.D. I will pay \$22.95 plus postage.
- Send me FREE additional information describing "Edu-Kit."

Name.....

Address.....

Progressive "EDU-KITS" Inc.

1186 Broadway, Dept. 151G
Hewlett, N. Y.

ON THE MARKET (Continued)



Inc., High Fidelity Products
Div., 230 Duffy Ave., Hicksville,
N. Y.

STEREO TAPE HEAD, model
TLD-L. Laminated in-line record-playback unit. Pole pieces are laminated. For 4-track stereo tape systems. Records and reproduces frequencies between 30 and 15,000 cycles at tape speed of 3 3/4 ips. Performance nearly identical to single laminar heads at 7 1/2-ips tape speed. Gap thickness less than 100-millionths of inch.—Nortronics Co. Inc., 1015 S. 6th St., Minneapolis 4, Minn.

SLEEP TEACHER, *Electronic Educator*, is a self-contained tape recorder that uses endless tape cartridges. Can also be used as standard tape recorder

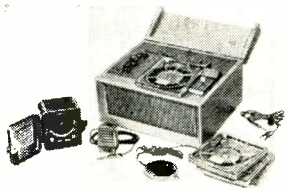

as it has record, playback and erase functions.—Sleep-Learning Research Association, P.O. Box 24, Olympia, Wash.

MUTUAL-CONDUCTANCE TUBE TESTER, model 800. Incorporates a transistor and

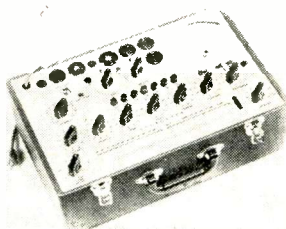

diode check. 5-inch meter. Tests tubes under simulated operating conditions.—Hickok Electrical Instrument Co., 10531 Dupont Ave., Cleveland 8, Ohio.

TUBE TESTER, *Mini-Check* model MC-1. Multiple-socket unit tests more than 600 tube types. Employs dynamic cathode-

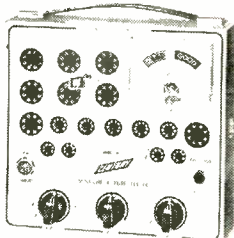

emission test, checking emission, interelement shorts and leakage. 3 settings, and tester is ready to check tube. 3 1/2-inch meter, detachable line cord.—Century Electronics Co. Inc.,

111 Roosevelt Ave., Mincola, N. Y.

REPLACEMENT TV KNOBS. Exact replacements for 1953

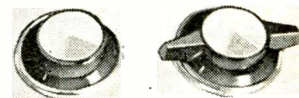

and 1954 RCA TV receivers are now part of this firm's line of replacement knobs.—Colman Electronic Products Inc., P.O. Box 7026, Amarillo, Tex.

SHIELDED EXTENSION JAX attaches to end of shielded cable. 3 models. Terminates cable in 2-conductor jack for 3/4-inch phone plugs; in 2-conductor jack for Tini-Plugs; in 3-conductor jacks for 1/4-inch

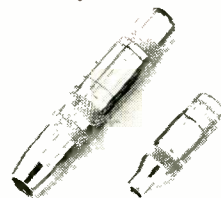

121
131
125

3-conductor phone plugs.—Switchcraft Inc., 5555 N. Elston Ave., Chicago 30, Ill.

4-INCH UNIMETERS. Obtain variety of panel meters by combining dial component with basic meter movement. Assembly slides together. Ac and dc

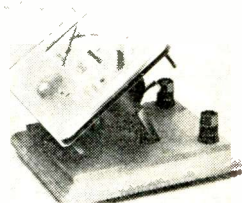

linear scales, dustproof construction.—Triplett Electrical Instrument Co., Bluffton, Ohio.

DOUBLE PLUGS. Model MDP, (top schematic) attaches to cable of user's choice. Plugs rated at 15 amps and 5 kv. Available in 10 colors. Model MDPS (bottom) has internal

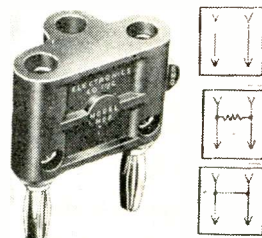

shorting bar. Model MDP (center) has precision 1% resistor molded in.—Pomona Electronics Co., Pomona, Calif.

OFFICIAL TUBE SURGE-GUARD reduces initial surge current when radio or TV receiver is turned on. Plugs into line outlet.—Alfred Barone Co., 488 E. Delvan Ave., Buffalo 11, N. Y.

All specifications on these pages are from manufacturers' data.

there's
nothing
like the
feel of the
right gun...

or
the right
TOOL!

WEN

POWER TOOLS
are "job-matched" for
easier handling, trustier performance!

Pick up a Wen tool. It fits in your hand like it grew there! Lightweight, streamlined Wen designs are extra easy-handling . . . quality-engineered to do the job right. Ask any Wen tool user. Your best dollar-for-dollar buy, too!

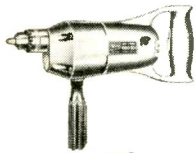

2-SPEED POWER DRILL
3/8" capacity in steel, up to 3/4" in hardwood. Smooth easy speed change, high torque motor. **\$29⁹⁵**



TOTER KIT
Perfect supplement to drill. 35 pieces including drill holder, Tote Box with tray. A whole workshop, only **\$9⁹⁵**



SOLDERING GUN KIT
Includes 4 tips for wide variety of uses, solder. "Quick-Hot" gun heats in only 2 1/2 seconds. A buy at **\$9⁹⁵**

See complete line of Wen power tools
at your favorite dealer!

WEN PRODUCTS, INC.
5810 Northwest Highway • Chicago 31, Illinois

APRIL, 1959



FILE CLEANING KINK

When files are used on soft materials such as plastic, aluminum, solder, copper and brass, the flutes have the tendency of becoming clogged with filings. This makes it almost impossible to clean fine smoothing files with an ordinary file card or wire brush, as the large bristles cannot reach deep enough into the gullets where the filings are imbedded. A small gob of modeling clay pressed firmly against the file will, however, remove the filings and restore the file's bite.

Kit builders, experimenters, service technicians and others who work with files will find this kink especially useful. —*John A. Comstock*

EXPERIMENTAL CONNECTORS

Old tube sockets can be taken apart and their contacts used as connectors for temporary experimental hookups. Just break the insulator away with

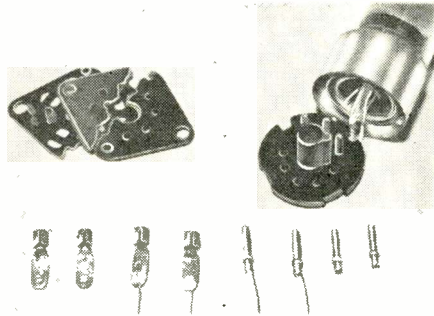

pliers and the contacts will fall free. Solder wires to the contacts and use them for making fast temporary connections to tube base pins or standard phone tips. Also use tube base pins removed from old tube bases as male connecting plugs.—*J. C. Alexander*

ERASER FIXES RECORD CHANGER

Ever run into a V-M changer with a missing rubber tip on the size index finger? This is a simple thing to repair. Cut the eraser off an ordinary pencil, punch a slot in it with a small screwdriver and mount it with a dab of cement.—*E. Slitsko*

SWITCHING WITH VIDAIRE MS-6

In the April, 1958, issue of RADIO-ELECTRONICS (page 36, Fig. 9), you show the wiring layout and equivalent circuit arrangement for six speakers connected in series-parallel. Switching

You learn more from
SAMS BOOKS

OVER 1,200,000 IN USE

JUST OUT!



"101 Ways to Use Your Oscilloscope"

by Bob Middleton

A practical and invaluable guidebook for anyone using oscilloscopes. Covers all standard uses of this instrument as well as many uncommon ones. Describes connections required, equipment needed, proper test procedures and evaluation of results for each scope use. Over 400 illustrations of waveforms and test setups are included. Invaluable for technicians, engineers, students and experimenters. 180 pages, 5 1/2 x 8 1/2". Only **\$2.50**
(Companion to Middleton's "101 Ways to Use Your Sweep Generator")

"Tape Recorder Manual"—Vol. 3



Complete analysis of 22 tape recorders produced in 1957-58, including Ampex, Geloso, Knight, RCA, Revere, Silvertone, Webcor, Wilcox-Gay, Wollensak. Includes general description, operation data, troubleshooting and maintenance facts, parts lists, diagrams, etc. Has special editorial section on basic types of tape transport mechanisms; with cumulative index. 160 pages, 8 1/2 x 11". Only **\$2.95**

"Servicing Hi-Fi" Series



SERVICING HI-FI AM-FM TUNERS. Complete service data analysis of 18 AM-FM tuners produced in 1957-58. Thorough coverage: diagrams, photo views, troubleshooting, parts lists, etc. Includes special editorial section "Highlights on FM", covering FM signal, AFC circuits, alignment. 160 p., 8 1/2 x 11". Only **\$2.95**



SERVICING HI-FI PREAMPS AND AMPLIFIERS. Covers 33 leading models made in 1957-58. Full technical analysis of each model (schematic, photos, charts, parts lists); special section on "Service Facts About Preamps and Amplifiers." 160 p., 8 1/2 x 11". Only **\$2.95**

HOWARD W. SAMS & CO., INC.

Order from your Sams Distributor today, or mail to Howard W. Sams & Co., Inc., Dept. D-29 2201 E. 46th St., Indianapolis 6, Ind.

- Send me the following books:
- "101 Ways to Use Your Oscilloscope" (TEM-2)
 - "Tape Recorder Manual" (TR-3)
 - "Servicing Hi-Fi AM-FM Tuners" (HF-3)
 - "Servicing Hi-Fi Preamps & Amplifiers" (HF-4)
- \$.....enclosed. Send Free Book List

Name.....
Address.....
City.....Zone.....State.....
(outside U.S.A. priced slightly higher)

DYNACO

STEREODYNE PHONO PICK UP

This new, unique pickup is made in Denmark by Bang and Olufsen. It features a push pull magnetic principle (patent pending) which permits realization of the full potentialities of the most modern recording techniques. The special attributes which make the Stereodyne an outstanding stereo pickup make it equally exceptional for monophonic discs. On any type of record the Stereodyne offers smooth and natural sound—firm clean bass and sparkling treble—while its light tracking pressure insures negligible record wear.

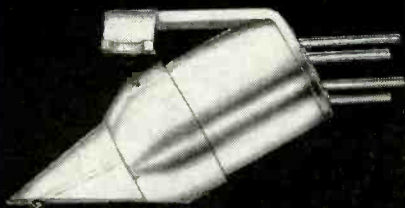

BEST in every way . . .

- **Wide frequency response**
Smooth peak free response from 30 cps to over 15 Kc
- **True Stereo**
Highest channel separation over entire audio spectrum—better than 22 db.
- **Precision balance**
Both channels identical
Same high compliance (5×10^{-9} cm/dyne) in all directions
- **No hum pickup**
Balanced coil structure plus low impedance plus complete shielding eliminate hum from external fields
- **High output**
7 millivolts per channel even on low level stereo discs provides gain to spare
- **No magnetic pull**
Special magnetic circuit eliminates attraction to steel turntables
- **Easy installation**
Compact size and standard mounting centers simplifies mounting. 4 terminals to avoid hum loops.
- **Low price**
Only \$29.95 net including .7 mil diamond stylus (replaceable in 2 seconds)

Available from leading high fidelity dealers everywhere

DYNACO INC.

617 N. 41st St., Phila. 4, Pa.
Export Division: 25 Warren St., New York, N. Y.

TRY THIS ONE (Continued)

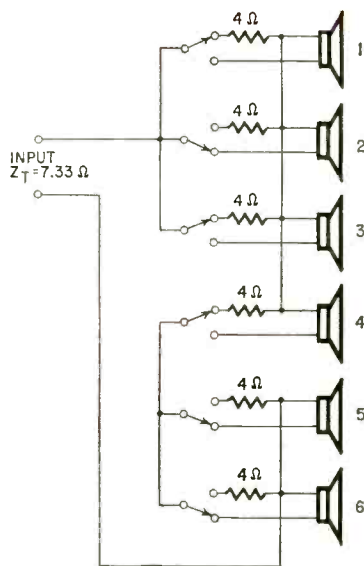

Fig. 1

facilities for substituting resistors let you cut out speakers and still maintain proper impedance matching to the amplifier's output.

As stated in your description of Fig. 9 "A different wiring arrangement is

EQUIVALENT CIRCUIT

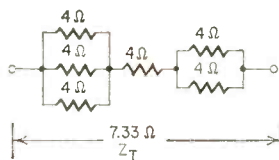

Fig. 2

needed" (see Fig. 1). Fig. 2 is the equivalent circuit. Here is just such a setup using the Vidair model MS-6 switching panel.

The resistor and voice coil for speaker No. 4 should have a wattage rating high enough to handle the total current in the circuit.—*John J. Haskell*

RECORD CHANGER HUM

Rubber washers are generally used between the motor mounting bolts and the changer base. If the rubber hardens or if the bolts are tightened excessively, motor vibration may be transferred to the changer's frame and thence through the turntable to the record and needle, causing hum. If the hum stops when you short the pickup terminals with a screwdriver while the needle is resting on a stationary record (speed selector in neutral), motor vibrations are the probable cause. Examine the motor mounting and replace the rubber washers if necessary.—*Warren J. Smith*

AIMING ANTENNAS

We find a trouble light in the form of a long extension cord a simple aid to aiming a TV antenna during installation. Poke the light out a window where it can be seen by the man on the roof.

The person watching the screen image flashes the light fast if the antenna is way off and slows the flashing to a stop as the correct orientation is reached.—*H. J. Miller*

END

RADIO AND TV SERVICEMEN

make more money with this

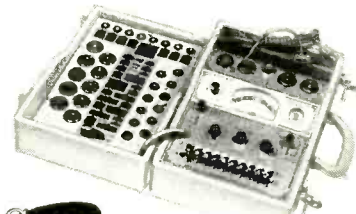

SECO Model 107 TUBE TESTER

3 complete tests in one handy instrument

Designed for outstanding performance and accuracy—provides 3 important tests: Dynamic Mutual Conductance Test of all popular radio and TV amplifier tubes—Cathode Emission Test for all tubes by free point selector system—nationally accepted Grid Circuit Test developed and patented by Seco. Saves the serviceman valuable time—quickly pays for itself by justifiably culling and selling more tubes for him!

Completely self-contained in compact portable carrying case. Furnished with handy flip-chart for fast, easy tube set-up data. **\$139.50 net**

Write today for free literature
SECO MANUFACTURING CO.
5015 Penn Ave. So., Mpls., Minn.



Restores Em All SERIES • PARALLEL CRT BRIGHTENER

One Model for All!
52° 60° 70° 90° and 110°

The Serviceman's Answer To The Multiple Booster "Stock" Problem
The Complete Booster "Kit" In One Compact Unit

- Replaces most types now in use
- Compact
- Guaranteed
- Easily installed

THIS DeRO DISPLAY . . . is colorful, small space counter display identifies DeRO's quality and engineering—guaranteed satisfaction.

THE MAN WHO "KNOWS" LOOKS FOR THIS!

Write for LATEST CATALOG



Model RPS—ALL°

List \$1.50

AT ALL LEADING DISTRIBUTORS

134 NASSAU ROAD, ROOSEVELT, N. Y.

RADIO-ELECTRONICS

Technotes

SYLVANIA CHASSIS I-518-1

Picture smear was evident on this set, on all stations and at all settings of the contrast control. Therefore, the

Shunting capacitor C146, a 0.22- μ f unit, removed the smear. Replacement was the final cure. C146 couples the

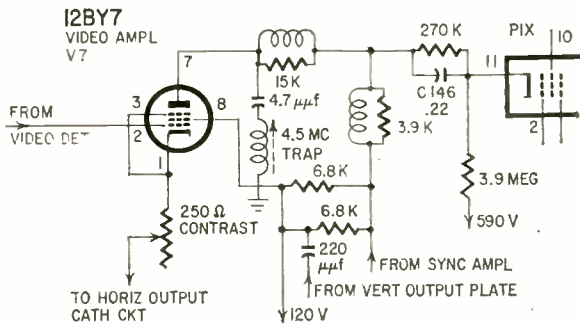

trouble was obviously due to poor response of the video amplifier and not in preceding sections of the set. Operating voltages of the video amplifier were tested and found normal. Tubes were checked by substitution. Next came a check of components.

plate of the video amplifier to the picture tube cathode. The lowered capacitance of this capacitor increased its reactance to low-frequency signals and resulted in smear. A capacitor checker showed its value had gone down to .0035 μ f.—*Eugene Rollins*

CROSLY MODEL F-24COLH

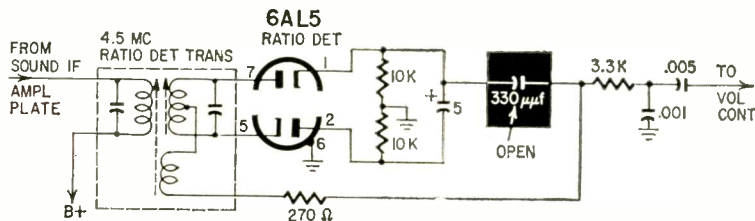

This set suddenly developed sync buzz. A check of the 5- μ f electrolytic in the ratio-detector circuit showed normal capacitance. Bridging the 330- μ f capacitor with a 250- μ f unit re-

duced the buzz. A check showed that the capacitor in the set was practically open. Replacing the open unit put a rapid end to the sync buzz.—*James A. McRoberts*

GREEN-GUN GUNK?

This was a large-screen RCA receiver. The setting of the green screen control was unstable, as if the control were faulty. However, the trouble was tracked to the picture tube.

When the neck of the tube was tapped, the green field fluctuated erratically. On a hunch, we tilted the cabinet forward and tapped the neck of

the picture tube sharply. This treatment corrected the trouble.

The green screen control response was normal, and the receiver has been operating several days with no sign of the trouble. Probably some gunk lodged in the green gun, which caused a leakage path. The treatment was effective.—*Robert G. Middleton*

TAPE RECORDER ROLLER REPAIR

When the rubber-covered pressure roller of a tape recorder has become glazed, dented and worn from use (Fig. 1) and there's no replacement available, here's a method that often works to renew its nonslip surface and shape. Start up the machine without tape on the spindles and set the controls for either playback or record. This will cause the roller to engage the capstan and start rotating. Now, while the roller is turning, hold a fine-cut file lightly to the roller to relevel the roller's uneven sur-

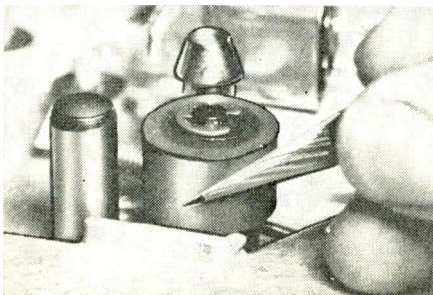
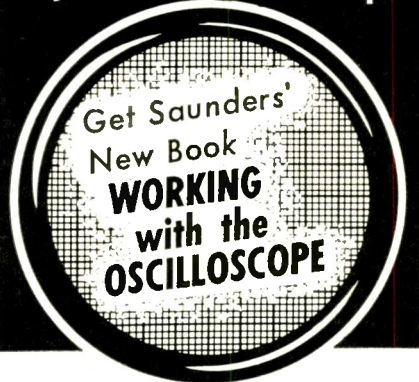

Fig. 1

Now! the fastest, easiest way to master the 'scope!



SEE HOW FAST YOU LEARN with BLOCK-O-MATICS!

Saunders' exclusive new look in schematics shows you how to master electronics' most versatile instrument quickly, easily.

SAUNDERS SHOWS YOU HOW STEP BY STEP with 26 Projects, 200 Diagrams

Actually demonstrating the 'scope's many uses in radio, TV, transistors, vacuum tubes, other work.

USE IT AT YOUR BENCH! Complete Working Manual!

Oscilloscope Checks, Calibration Procedures, Wave Form Analysis, Circuit Tests, Frequency Measurements, Crystal Diode and Transistor Analysis, etc. . . .

40 Years Oscilloscope Experience! NOTED AUTHOR-LECTURER, A.C.W.SAUNDERS

President, Saunders Radio & Electronic School, Boston. Author of CBS Transistor Course, Black & White and Color TV, Basic Points, numerous magazine articles.

SPECIAL INTRODUCTORY PRICE LIMITED TIME

only \$4.00 including postage

Order Now! Mail this Coupon Today!

ELECTRONIC TECHNICAL PUBLISHING CO.
P.O. BOX 306, ASTOR STATION
BOSTON 23, MASS. REA9

Enclosed is \$_____ for _____ copies @
\$4.00 of "Working with the
Oscilloscope".

NAME _____
STREET _____
CITY _____ STATE _____

XCELITE PLIERS

have a ...

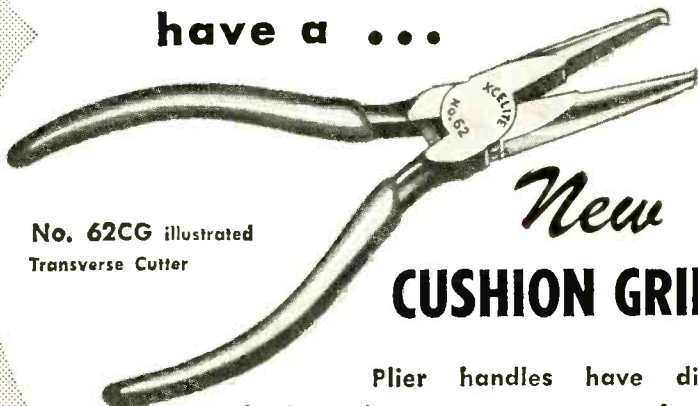

No. 62CG illustrated
Transverse Cutter

New
CUSHION GRIP!

Plier handles have dipped plastic coating ... permanent, comfortable. Heads polished and buffed to a "mirror finish". All pliers available ... See Your Distributor!

Gives pliers a "Feel" that inspires Craftsmanship!

XCELITE, INCORPORATED
ORCHARD PARK, NEW YORK
Canada: Charles W. Pointon, Ltd., Toronto

XCELITE
Quality Hand Tools
PREFERRED BY THE EXPERTS

TECHNOTES (Continued)



Fig. 2

face (Fig. 2). (Don't remove any more rubber than absolutely necessary and hold the file flat against the roller's surface.) The renewed roller will at least be satisfactory until an exact duplicate roller can be obtained for the machine.—John A. Comstock

WESTINGHOUSE MODEL H-600T16

The set had a thin vertical line on the screen. Tubes were OK. Voltage checks revealed no B plus at the horizontal output tubes. Circuit tracing led to an open width control. A quick replacement and the job was finished.—Carl Hennig

EMERSON 120087 D CHASSIS

Complaint: Vertical foldover at bottom of picture, poor vertical linearity, inadequate height after warmup.

The vertical oscillator's plate load resistor (R97), normally 470,000 ohms, had increased in value. Replace it with a 1-watt unit. Also, the 100,000-ohm resistor (R93) connected to the vertical oscillator transformer's secondary had gone up. Replace it with a 1-watt unit too.—Harry C. Keller

BENDIX MODEL 235M1

This receiver had a severe case of vertical jitter. After checking the vertical integrator and sync amplifier circuits half of a (6SN7) I noticed that the 6SN7 plate and decoupling resistors were charred. Replacing these resistors and the tube restored normal operation.—Wilbur J. Hantz END



GUARD YOUR FAMILY

FIGHT CANCER WITH A CHECKUP AND A CHECK!

AMERICAN
CANCER
SOCIETY

SAVE
TIME
with

SENCORE

New! Improved! TRANSISTOR CHECKER

America's newest, most popular test instrument

Simple to Operate. Controls are accurately set for each transistor by referring to replaceable set-up chart on rear. Test leads or socket provides for fast hook-up.



MODEL TRC4
\$17.95
DEALER NET

Cannot become obsolete. Approved by leading manufacturers.

NOW CHECKS:

- ★ Transistors for opens, shorts, leakage and current gain. Only tester that tests power transistors as used in car radio outputs.
- ★ Crystal Diodes checks forward to reverse current ratio on all diodes.
- ★ Selenium Rectifiers checks forward and reverse currents.

SERVICE INSTRUMENTS CORPORATION

123 OFFICIAL ROAD, ADDISON, ILLINOIS

See other SENCORE ads in this issue.

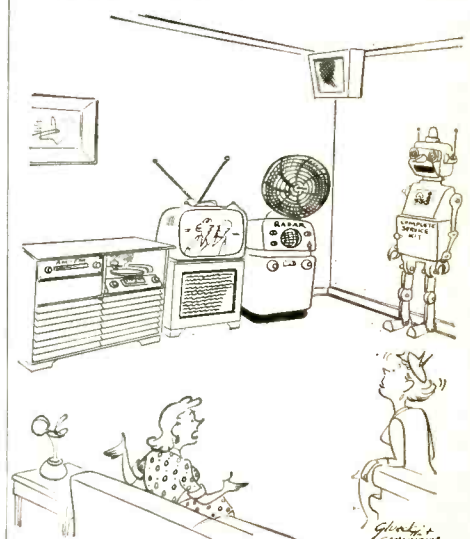

"This one came complete!"

NOTEWORTHY CIRCUITS

REGULATED POWER SUPPLY

This supply delivers a continuously variable output voltage at currents up to 4 amps. Maximum available output voltage is dependent on the battery, which acts as the voltage reference for

circuit used is commonly called an emitter-follower regulator in which V3 and V4 act as a variable resistor in series with the load.

The regulator's internal impedance

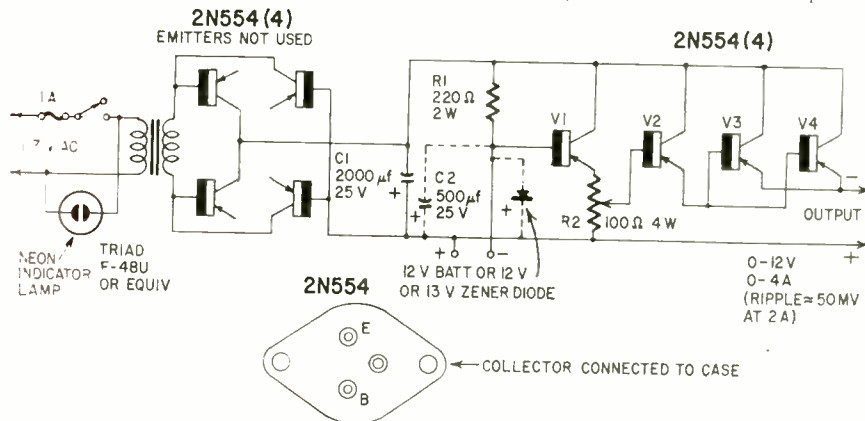

the supply. For better results, replace the battery with a 12 or 13-volt Zener diode.

Ac ripple at the output varies from 10-80 mv, depending upon the load. However, ripple is reduced by a factor of 3 by adding C2 (the 500-µf capacitor shown in dashed lines). The regulator

is about 0.5 ohm. V3 and V4 should be mounted on a suitable heat sink as they dissipate up to 60 watts at low output voltages and high output currents. V1 and V2 should also have small heat sinks as they dissipate approximately 1 watt apiece.—*Motorola Semiconductors*

DIFFERENT VOLTAGE DIVIDER

Re: "Stiffer Voltage Divider," by Leonard E. Geisler, Noteworthy Circuits, RADIO-ELECTRONICS, December, 1958, pages 121-22.

I'd like to submit a circuit that is very simple, yet rarely used by anyone except radio amateurs. It has been in use in my home station for several years. In one application it drops the high voltage down to supply the multiplier and driver stages of my transmitter. In another it acts as a screen control resistor and is used to vary the output power of my transmitter's final amplifier.

By far, the best application I've found for it is as a grid-controlled rectifier supplying various voltages for the many pieces of equipment I have around the shop.

The circuit requires only a resistor (a pot) and a capacitor and a tube. Although I use a 6AS7, just about any other tube will also work—excluding diode types.

The plate of the tube (a triode, or triode-connected tetrode or pentode) is connected to the supply voltage. The cathode is connected to the load. A 500,000-ohm pot is connected between the cathode and ground, with the

grid connected to the arm. This pot controls the output voltage. By varying the pot you vary the grid-cathode bias, which in turn varies the tube's conductance.

The *minimum* output voltage should not be less than the maximum allowable plate voltage of the tube. That is, if the maximum plate voltage is 400 and

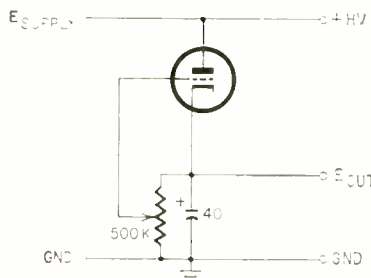

a 900-volt supply is used, the lowest permissible output voltage should not be less than 500 ($E_{out} = E_{supply} - E_{plate}$ or the tube will be damaged by excessive voltage).

The maximum current that can be drawn is limited only by the tube's maximum current rating. The 40-µf capacitor across the output smooths

get
this
brilliant,
new



Electro-Voice®

Monaural and Stereo
12 inch LP record

just
\$1.50



Side one: *The ABC's of High Fidelity*

Side two: *A Stereo Primer*

This tremendous demonstration record, produced by the foremost manufacturer of high-fidelity loudspeaker systems, explains briefly (and simply) the wonderful world of high-fidelity and the really easy-to-understand components required for the finest home music system. You'll be startled by the thrilling sounds on this record—many of them spectacular stereo "firsts."

Write for it now: Enclose either check or money order for \$1.50 and send to:

Electro-Voice, Inc.
Buchanan, Michigan

Dept. RED-4

Enclosed is \$1.50. Please send your fascinating Stereo-monaural 12" LP record.

To:

NAME _____

ADDRESS _____

CITY _____ ZONE _____ STATE _____

"TAB" Tubes Tested, Inspected, Boxed

Six Months Guarantee!! No Rejects!

NEW & Used Gov't & Mfrs. Surplus!

Orders \$10 or more, Receiving types only, oppd. 48 states

| | | | | | | | |
|------|------|------|------|-------|------|-------|-------|
| 0A2 | .80 | 6B8 | .72 | 12A7 | .89 | 11Z6 | 1.10 |
| 0B2 | .84 | 6BK7 | .99 | 12AU6 | .63 | 4-6SA | 16.00 |
| 0C3 | .80 | 6BN6 | .72 | 12B7 | .89 | 12A1 | 2.48 |
| 0D4 | 1.00 | 6BQ6 | 1.19 | 12AX7 | .79 | 3D23 | 5.00 |
| 1A7 | .75 | 6C5 | .69 | 12BA6 | .65 | 717A | 5/81 |
| 1B3 | .78 | 6CS | .69 | 12BD6 | .59 | 4-125 | 24.00 |
| 1R5 | .78 | 6CB6 | .80 | 12BE6 | .59 | 4E27 | 7.00 |
| 1S4 | .78 | 6CD6 | 1.49 | 12BF6 | .59 | 4PR60 | 29.50 |
| 174 | .80 | 6CG6 | .59 | 12BH7 | .99 | 4X150 | 7.50 |
| 1U4 | .80 | 6J5 | .59 | 12BY7 | 1.00 | 4X250 | 35.00 |
| 1X2A | .68 | 6Z6 | .59 | 12Z7 | .99 | 4X500 | 38.00 |
| 304 | .08 | 6K6 | .59 | 12C06 | 1.43 | 5BP1 | 4.98 |
| 305 | .08 | 6K7 | .79 | 12SA7 | 1.29 | 5BP4 | 4.98 |
| 354 | .08 | 6L6 | 1.19 | 12SQ7 | .89 | 35T | 4.00 |
| 3V4 | .08 | 6BE6 | .59 | 12SH7 | .89 | 100T | 7.00 |
| 5R4 | 1.25 | 6S8 | .99 | 12SJ7 | .75 | 250T | 20.00 |
| 5U4 | .59 | 6SA7 | .69 | 12SK7 | .94 | 38RA | 1.00 |
| 5V4 | .89 | 6S7 | 1.19 | 12ST7 | .86 | 418A | 14.00 |

Send \$5 for Catalog!

| | | | | | | | |
|------|------|-------|------|------|------|------|-------|
| 6AU4 | 1.29 | 6U8 | .98 | 35W4 | .52 | 629B | 8.00 |
| 6AU5 | 1.19 | 6V6 | 1.39 | 35Z4 | .69 | 832A | 7.00 |
| 6AU6 | .69 | 6W4 | .79 | 35Z5 | .89 | 866A | 1.75 |
| 6AX4 | .79 | 6W6 | .89 | 50A5 | .69 | 8146 | 4.00 |
| 6BA6 | .59 | 6X4 | .69 | 50C5 | .69 | 8149 | 1.20 |
| 6BA7 | 1.00 | 6X5 | .49 | 50C5 | .69 | 5881 | 2.70 |
| 6BD6 | .69 | 6Y6 | .89 | 50L6 | .69 | 6550 | 3.90 |
| 6BE6 | .59 | 6Z6 | .89 | 50N7 | 5.00 | 8342 | 11.00 |
| 6BG6 | 1.50 | 12AL5 | .59 | 5BP4 | 4.00 | 5654 | 1.00 |
| 6BH6 | .79 | 12AQ5 | .75 | 5CP1 | 3.95 | 5894 | 12.00 |

Wanted Surplus Electronics from schools & U.S. Gov't
 5Y3 .59 6SC7 .89 1986G 2.15 450T 43.00
 6AB4 .59 6SC7 .79 15T 1.18 607 1.29
 6AC7 .79 6SN7 .69 1986G .89 808 1.00
 6AG7 .89 6SJ7 .69 25L6 .72 809 3.00
 6AH6 .99 6SK7 .72 25W4 .77 4-400A 42.00
 6AL5 .69 6SL7 .89 25Z4 .72 812 3.00
 6ALS .59 6SN7 2/81 25Z6 .75 812 3.00
 6AQ5 .69 6SQ7 .74 EL34 3.49 813 9.00
 6AS7 3.00 6SR7 .89 300 2.94 814 2.00
 6AT6 .49 6TB .08 35L6 .59 815 3.95

Wanted 50¢ (tubes) Top \$\$\$ Paid
 6AU4 1.29 6U8 .98 35W4 .52 629B 8.00
 6AU5 1.19 6V6 1.39 35Z4 .69 832A 7.00
 6AU6 .69 6W4 .79 35Z5 .89 866A 1.75
 6AX4 .79 6W6 .89 50A5 .69 8146 4.00
 6BA6 .59 6X4 .69 50C5 .69 8149 1.20
 6BA7 1.00 6X5 .49 50C5 .69 5881 2.70
 6BD6 .69 6Y6 .89 50L6 .69 6550 3.90
 6BE6 .59 6Z6 .89 50N7 5.00 8342 11.00
 6BG6 1.50 12AL5 .59 5BP4 4.00 5654 1.00
 6BH6 .79 12AQ5 .75 5CP1 3.95 5894 12.00

TUBES WANTED! WE BUY! SELL & TRADE!

NEW SILICON 500MA/100°C/280VAC

/400 p.l.v. Rectifier M't Sealed. \$1.50
 @ 5 for \$6.50, 40 for \$46, 100 \$105.

SELENIUM RADIO & TV RECTIFIERS GTD.

TSF 1.5 AMP @ 315 AC 500 MA. 10/51 100/\$50.
 65MA 45¢ @ 5 for \$2; 100MA 59¢ @ 10/\$5.
 100/545; 250MA 79¢ @ 10/\$7; 100/57; 100/\$50;
 88¢ @ 10/\$8; 500 MA. 10/51 100/\$50.

Orders of \$10 or More, Postpaid 48 states!

NEW "TEKSEL" SELENIUM RECTIFIERS

FULL WAVE BRIDGE RECTIFIERS. 100/51 BAR GTD!
 AMP. 18VDC 36VAC 72VAC 144VAC
 CONT. 14VDC 28VDC 56VDC 118VDC

| | | | | |
|-------|---------|---------|---------|---------|
| 1AMP | \$ 1.30 | \$ 2.00 | \$ 4.90 | \$ 9.45 |
| 2AMP | 2.15 | 3.00 | 6.25 | 12.35 |
| 3AMP | 2.85 | 4.00 | 8.25 | 16.35 |
| 6AMP | 4.15 | 6.00 | 18.75 | 36.15 |
| 10AMP | 6.10 | 12.15 | 26.30 | 48.90 |
| 15AMP | 9.10 | 18.00 | 41.25 | 73.35 |
| 24AMP | 15.00 | 29.45 | 57.50 | 108.45 |

KITS! "TAB" THE BEST KITS!

All Kits Contain Most Popular Values & Sizes

- Kit 35 Precision Resistors
- Kit 10 Switches
- Kit 75 Resistors 1/2/1/2W
- Kit 150 Carbon Resistors
- Kit 25 Panel Lamps
- Kit 12 Electrolytic Cond's
- Kit 15 Volume Controls
- Kit 56 Tube Sockets
- Kit 65 Tubular Condensers
- Kit 500 Lugs & Eyelets
- Kit 10 Bathing Oil Cond's
- Kit 5 lbs. Surprise Soap
- Kit 10 XMTR Mica Cond.
- Kit 3 Phone Patch Xfms
- Kit 4 AN/Reflector Lites
- Kit 6 Inset Tuning Tools
- Kit 6 AN plugs & conntrs
- Kit 3 Searchlights
- Kit Circular Slide Rule
- Kit 12 Algr. Clip Ass't'd.
- Kit 2 Knife Pns 6x12"
- Kit 5 Pcs. Wrench Set
- Kit 3 Variable Cond's

BUY 10 KITS—GET ONE FREE! EACH KIT 99¢

NEW DC POWER FOR TRANSISTORS!!

New low-cost 25 volt one amp filtered 1% Ripple Power Supply

Same as specified in Transistor Manuals G.E., RCA, CBS. Ideal for powering transistor circuits, rugged & small in size! Preassembled kit U-build B25VIACK \$10, or assembled B25VACB \$12.

Transistors! Power Supply Kit Delivers 12 VDC at 2 AMPS filtered less than 0.3% ripple. 28VDC at 1A TPSK2 Kit \$18; TPS2W assembled & wired \$24.

115VAC Inpt. Transformer & Full Wave Bridge Rectifier for 12VDC @ 2AMPS. or RECTRAN KIT RT1K \$4.50

RT1W Assembled & Wired \$7.50

BATTERY CHARGER KIT 2 to 4 Amps. Charges 2-4-6 & 12 Volt Batteries. Kit BCK-1 \$11, Built \$12.75. Chgr 6&12v at 2A \$9.

AN-APR2 Rcvr less tubes, Gud Parts. \$1.89

RDZ 200 to 400Mc's Super/Super less tubes. \$30.00

RAX Rcvr 4 bands, 1.5 to 9 Mc's with tubes. \$24.00

AN/ART13 Xmtr/100 Watts less tubes. \$39.00

New photoFlash condens 525 mfd @ 450v 36 @ 2 for \$16

ARC5/BC696/3 to 4Mc's Xmtr with tubes. \$5.95

5" Test Picture Tube with Adapter. \$3.49

"ERIN" FINEST HI-FI RECORDING TAPE

So Good! We Cannot Use the Manufacturer's True Name!

1200 Ft.—7" Reel \$1.45 ea. Lots of 3 Money Back Gtd.

Singls \$1.50. Add 10¢ each Postpaid 48 States.

New 1st Quality "Mylar" 2400 Ft.—7" Reel Ferro

Erin Sheen Process Recording tape \$4.49, 3 for \$12

TRANSISTORIZED "TABSTAT"

DC to DC—XMTR & RCVR SUPPLY

New transistorized "TABSTAT" kit or built hi-efficiency DC to DC 12VDC

To 450VDC continuous duty power supply! 111 Output 450VAP 250-

VDC at up to 150MA/Up To 70-

Watts 80% efficiency; Ripple 0.2%;

Low idle current 1AMP silicon

rectifiers, oil condensers, toroid

transf. fused & short circuit proof.

Regulation 5% at 20to100% load! 1

Small in size! Quiet! Light Wgt!

Lo-Priced GIP "TABSTAT" Kit \$1245CB built \$35.

Pre-Assembled U-Built kit TR1245CK ONLY \$30.

for 250v @ 100 ma Tr 1225 CB. \$27

TERMS: Money Back Guarantee! Our 14th year, \$2 min order F.O.B. N.Y.C. Add ship charges or for C.O.D. 25% Dep. Prices shown subject to change.

111-GG LIBERTY ST., N.Y. 6, N.Y.

Send \$5. PHONE: RECTOR 2-6245 for Catalog

NOTEWORTHY CIRCUITS (Continued)

any minor voltage variations and presents a low-impedance source to the load. Several tubes may be paralleled for higher output currents, or placed in series for larger voltage drops or different output voltages. Any tube combination can be used for any output power desired. The tube type is dependent upon power and space considerations.

One novel feature of this circuit is that the grid can never go positive with respect to the cathode. This undoubtedly prevents damage to the tube and provides for longer life. The output voltage regulation is dependent upon, but no different than, the supply voltage regulation.—Leonard J. D'Airol

NOVEL NEON BLINKER

The output frequency of this circuit is obtained by multiplying a single lamp's repetition rate times the number of lamps used. Unfortunately, instability increases rapidly once you go

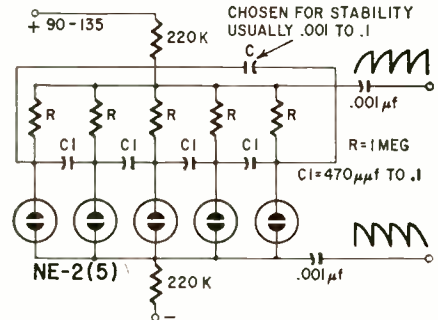

beyond five or six. I have tried using various capacitances between the lamps as shown, and the results are interesting. Where a single lamp will not oscillate past a certain frequency, five or seven of them will. Nothing special, just something to do when no one is looking.—Robert D. Holm

TRANSISTOR AMPLIFIER

With a 20-mv input this simple three-transistor circuit delivers a 100-mw output. It is of the complementary-symmetry type and uses one n-p-n and

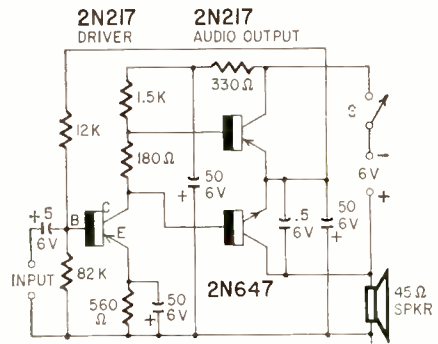

one p-n-p transistor in its push-pull output stage. The circuit provides a very low output impedance for the output stage, making it possible to drive a 45-ohm speaker directly—no output transformer is necessary.—RCA Transistor Spec Sheet

POWERING 4 OUT OF 5

of the world's greatest hi-fi amplifiers

the **Amperex® 6CA7/EL34**

HIGH-POWER OUTPUT PENTODE



No other comparable tube combines to the same degree the 6CA7's exceptional linearity, high power dissipation and low drive-voltage requirements. It is a true pentode design, with a separate suppressor grid that controls the space charge, resulting in greater linearity on reactive speaker loads than is possible with competitive beam-power tetrodes. A single pair of 6CA7's in push-pull has been successfully used in power amplifiers delivering up to 100 watts undistorted output.

Ask your Amperex distributor about Amperex voltage amplifier, rectifier and output tubes for hi-fi circuits



Amperex
 ELECTRONIC CORP.
 230 Duffy Avenue
 Hicksville, L. I., N. Y.

you CAN'T turn your back!

Cancer strikes two families out of every three.

Guard your family . . . fight cancer with a checkup and a check . . . today!

AMERICAN CANCER SOCIETY

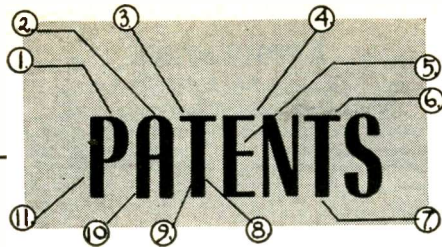

MULTIPLEXED STEREO

Patent No. 2,851,532

Murray G. Crosby, Riverhead, N. Y.

Stereo can be transmitted over a single FM channel with the help of a subcarrier (about 45 kc). See Fig. 1. The audio components are used. The difference between microphone sig-

much larger one, the resultant remains nearly equal to the latter. Thus the speakers have nearly equal noise output for true stereo. Furthermore, the poorer of the channels (A - B) is associated with a double-strength (2B) audio signal so there is a definite gain in signal-to-noise for it.

The system is compatible. The 2A component in the upper speaker would be used for monaural listening, so the A - B channel of Fig. 2 would not be needed.

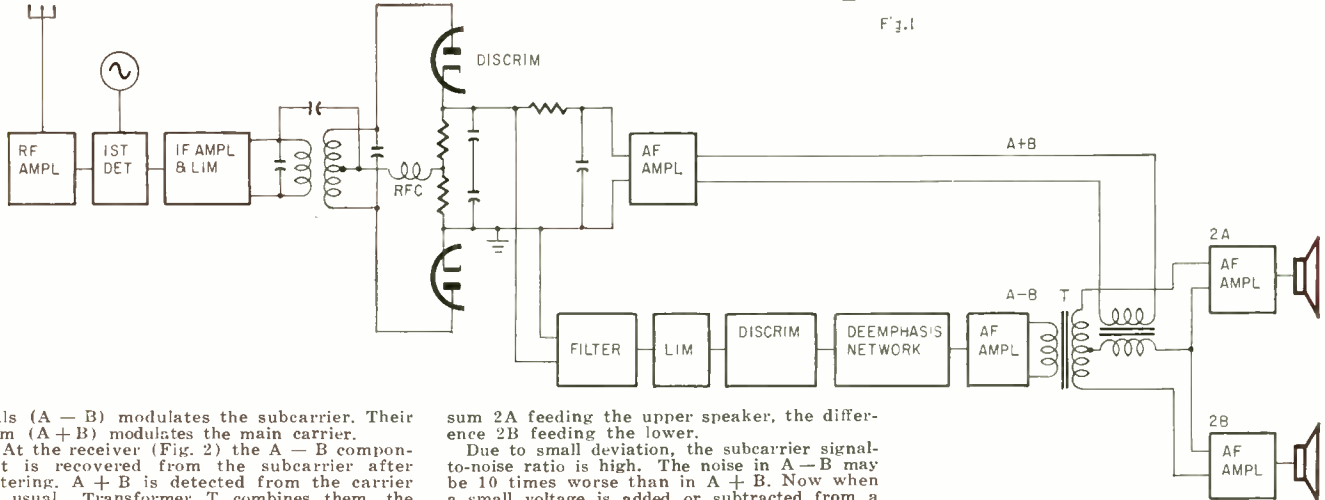
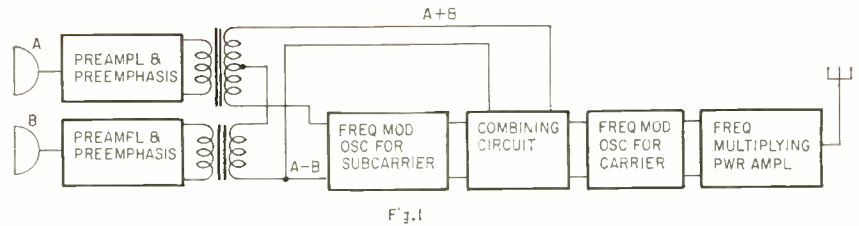

nals (A - B) modulates the subcarrier. Their sum (A + B) modulates the main carrier.

At the receiver (Fig. 2) the A - B component is recovered from the subcarrier after filtering. A + B is detected from the carrier as usual. Transformer T combines them, the

sum 2A feeding the upper speaker, the difference 2B feeding the lower.

Due to small deviation, the subcarrier signal-to-noise ratio is high. The noise in A - B may be 10 times worse than in A + B. Now when a small voltage is added or subtracted from a

Get This Valuable Book

FREE

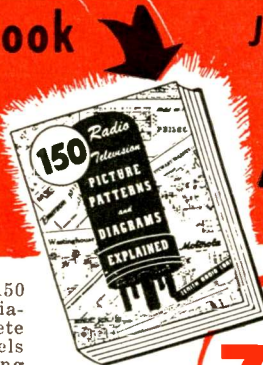

Just For Examining COYNE'S New Set

"Applied Practical Radio-Television"
on 7 DAY FREE TRIAL!

Yes, you get this big, brand new book, "150 Radio-Television Picture Patterns and Diagrams Explained", absolutely FREE! Complete 11x22" Schematic Diagrams on leading models Radio and TV Sets help cut your servicing time. Easy-to-read, large 8½x11" pages, with full instructions on how to use the diagrams. A "must" in every repair kit. You get this book as a FREE Gift for asking to see Coyne's new 7-book set, "Applied Practical Radio-Television"!

At Last! Money-Making "Know-How" On Transistors, Color TV and Servicing

Coyne's great 7-volume set gives you all the answers to servicing problems—quickly! For basic "know-how" that's easy to understand you'll find everything you want in Volumes 1 to 5 on over 5000 practical facts and data. Every step from fundamentals to installing, servicing and trouble-shooting all types of radio and TV sets. So up-to-date it includes the latest on COLOR TV and UHF. All this plus Volume 7—TRANSISTOR CIRCUITS—the most complete book ever published on the applications of transistors in electronics. *New!* Set has colorful design, washable covers.

EXTRA! 868-Page TV Cyclopeda Included!

For speedy on-the-job use, you also get Vol. 6—famous Coyne CYCLOPEDIA. Answers problems on servicing, alignment, installation, etc. in easy ABC order. Use this 7-volume TV-RADIO LIBRARY FREE for 7 days; get the Servicing Book FREE!

FREE!

5 Years Of Valuable Supplements



With your set you also get Coyne's annual Supplement Service FREE for 5 years. Keeps your set up-to-date on everything that will be new in radio, television, electronics and electricity.

NOW!
7 BIG BOOKS
IN ONE GREAT SET!

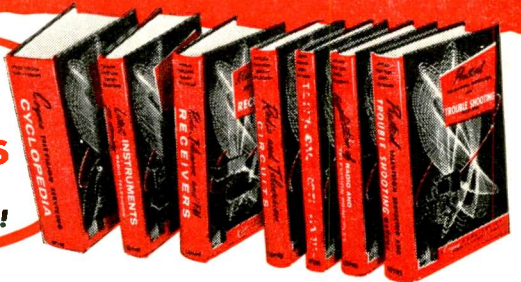

SEND NO MONEY! Just mail coupon for 7-volume set on 7 days free trial. We'll include book of 150 TV-Radio Patterns & Diagrams. If you keep the set, pay \$3 in 7 days and \$3 per month until \$27.25 plus postage is paid. (Cash price, only \$24.95). Or you can return the library at our expense in 7 days and owe nothing. **YOU BE THE JUDGE.** *Either way, the book of TV-Radio Patterns is yours FREE to keep!* Offer is limited. Act NOW!

FREE BOOK—FREE TRIAL COUPON!

Educational Book Publishing Division
COYNE ELECTRICAL SCHOOL, Dept. 49-T1
1501 W. Congress Pkwy., Chicago 7, Ill.

YES! Send 7-Volume "Applied Practical Radio-Television" for 7 days FREE TRIAL per your offer. Include TV-Radio Patterns & Diagram Book FREE.

Name Age

Address

City Zone..... State.....

Where Employed

Check here if you want library sent C.O.D. You pay postman \$24.95 plus C.O.D. postage on delivery. 7-day money-back guarantee.

Educational Book Publishing Division
COYNE ELECTRICAL SCHOOL
1501 W. Congress Pkwy., Dept. 49-T1, Chicago 7, Ill.

ANOTHER GREAT TRIO[®] TV ANTENNA FEATURE

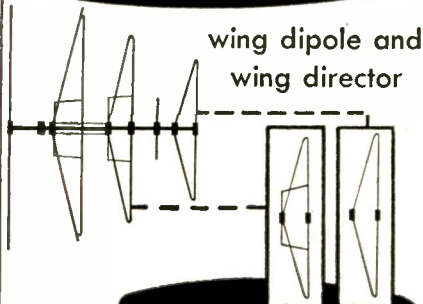

wing dipole and wing director

Today's most powerful combination. The Wing Dipole contains 3 active elements on the highs, forward Vee to the low band section, plus integrated director. The Wing Director obtains maximum results from the Wing Dipole.

Just one of the features that makes Trio the most advanced TV Antennas in the world. Choose from Trio's complete Zephyr and Color Series Antennas.

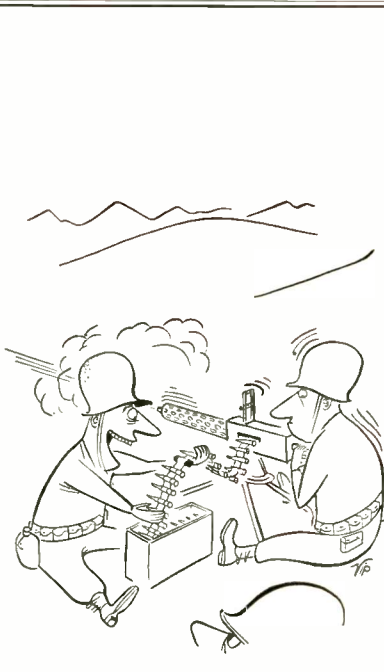

"Hold it, Ed! One of these cartridges is a JENSEN."

PATENTS (Continued)

RADIO KNIFE

Patent No. 2,835,254

William A. Coles, Upper Darby, Pa.

This patent discloses a method for making surgical incisions with a minimum of damage to live tissue. Shock hazard is minimized also.

Output leads include blocking capacitors. The dispersive element is a conductive plate which grounds the patient. The other lead is

866-A(2)

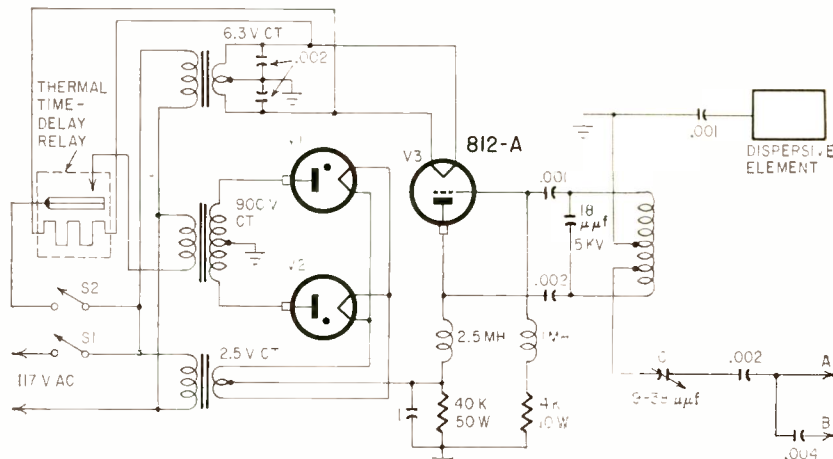

The cutting edge, which may be a needle, knife or wire loop, is fed with high-frequency current.

The diagram shows a full-wave rectifier pair, V1 and V2, which converts line power to dc. The dc is fed to triode V3's plate. V3 oscillates at about 3 mc. A Hartley circuit is used.

either A or B. The first delivers greater current if needed. Capacitor C is an output control.

Note that S1 turns on the filament circuits, but no rf is delivered until S2 is also thrown. All blocking capacitors are rated at 2.5 kv, but capacitor C has a breakdown rating of 5 kv.

ZENER DIODE TEST

Patent No. 2,847,646

Frank C. Marino, Montclair, N. J. (Assigned to Bell Telephone Labs, Inc.)

Here is a quick, convenient test that displays the diode characteristic on a scope. It is designed especially for diodes of the Zener type,

relay, and assures that diode D is forward-biased by the low-voltage ac when the relay arm is down. Diode current flows through R1, the

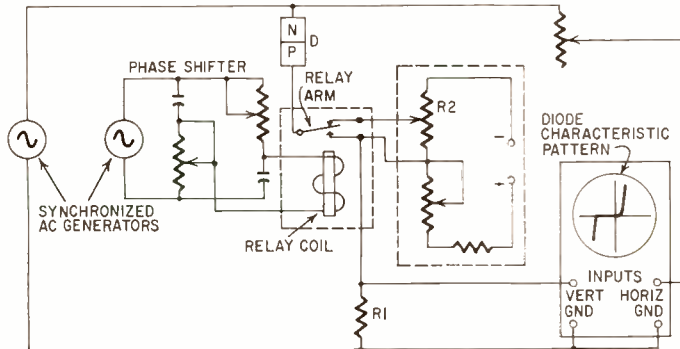

which require small forward voltage but relatively high bias in the reverse direction to reach breakdown.

The circuit switches automatically from low forward to high reverse voltage. A few volts of ac are applied to the scope's horizontal input terminals. Another voltage source, synchronized with the first, drives the relay coil through an R-C phase shifter. This synchronizes sweep and

voltage drop being applied to the scope's vertical terminals.

During the next alternation the relay arm moves up. This adds a large dc voltage in series with the ac to assure a high enough reverse bias on D. Now the reverse portion of the diode characteristic is scanned on the scope. Note that this portion corresponds to the negative half of the ac sweep.

SIGHT FOR THE BLIND

Patent No. 2,721,316

Joseph D. Shaw, Cincinnati, Ohio.

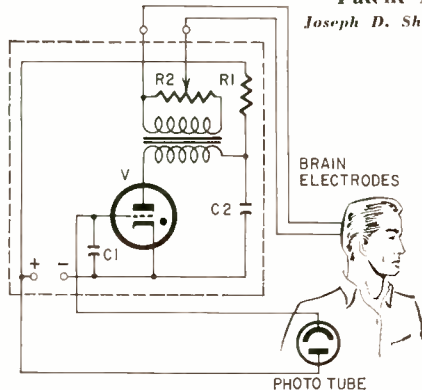

The December 1958 issue of this magazine described on page 53, actual experiments which make it possible for the blind to see. This patent describes somewhat similar instrumentalities.

A photo cell or phototube is held by the blind person and is biased with dc from a battery. Light falling on the cell charges C1. Upon reaching a predetermined voltage, thyatron V breaks down and permits C2 (previously charged through R1) to discharge through the transformer. The intensity of this pulse is controlled by R2.

The pulse is fed to a plastic socket attached by surgical means to the skull of the blind person. Conductors through tiny holes in the skull terminate at the vision area of the brain. Each pulse produces the sensation of sight.

The equipment shown in the diagram produces a single light spot at any time. If a light and shadow pattern is desired, multiple sets must be used, each terminating in a different part of the vision area of the brain.

BUSINESS and PEOPLE

Sprague Products, North Adams, Mass., is offering service technicians a



HE DIDN'T KNOW THE SET WAS LOADED!

series of newspaper advertising mats to discourage do-it-yourself TV repairs.

Electronic Instrument Co., Long Island City, N. Y., manufacturer of Eico

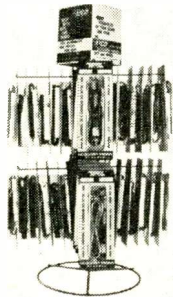

kits and other electronic products, is promoting its vtm and scope probes with a new package and display stand.

Curtis R. Hammond (left), assistant vice president of Raytheon Mfg. Co., Waltham, Mass., is now corporate director of regional commercial administration as part of a move to strengthen commercial sales by the establishment of six regional sales offices across the nation. Regional executives in Boston,



New York, Baltimore, Cleveland, Chicago and Los Angeles will report to him. Dr. W. Crawford Dunlap (right), former supervisor of solid-state research at Bendix Aviation, joined Raytheon Research Div. as director of semiconductor research. John L. Herre joined the Semiconductor Div., Needham Heights, Mass., as government and special accounts sales manager. He formerly supervised government sales activities for Philco.

From the pioneer in ceramics for electronics

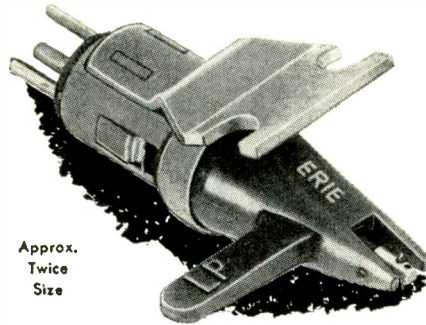

Approx. Twice Size

STERIEO

the new single ceramic element Stereophonic cartridge

DYNAMIC BALANCING MAKES THE DIFFERENCE

DYNAMIC BALANCING during manufacture provides full stereo reproduction. SINGLE ELEMENT DESIGN offers balanced outputs; excellent separation of 20 db over full audio-frequency range, with equal outputs from both channels. Compatible with stereo and monophonic discs.

SPECIFICATIONS

RESPONSE: 20 to 16,000 cps. OUTPUT VOLTAGE: 0.5 vrms at 1 KC each channel. COMPLIANCE: 3 x 10⁻⁶ cm/dyne, vertical & lateral. RECOMMENDED LOAD: 2 megohms. RECOMMENDED TRACKING PRESSURE: 5-6 grams. CHANNEL SEPARATION: 20 db. STYLE: Dual tip; 0.7 mil diamond or sapphire, and 3 mil sapphire. MOUNTING DIMENSIONS: EIA Standard 7/16" & 1/2" centers.

For additional information, see your Authorized ERIE Distributor

ERIE RESISTOR CORPORATION
MAIN OFFICES: ERIE, PA., U. S. A.

CARTOONS

RADIO-ELECTRONICS pays \$3.00 for good cartoon ideas and \$15 and up for finished work.

RADIO-ELECTRONICS
154 West 14th St. New York 11, N. Y.

Hi-Fi Living Stereo

COMPONENTS—TAPE RECORDERS
TAPE and RECORDS
ALL STANDARD BRANDS AT
TREMENDOUS DISCOUNTS

Quotations By Return Mail
Wholesale Catalog Free—
AUDIO FAIR
1799 R. 1st Ave. New York 28, N. Y.

TELEVISION

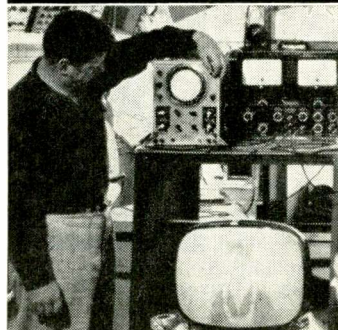

AT HEALDS YOU LEARN BY DOING IN MODERN ELECTRONICS LABORATORIES

HEALD ENGINEERING COLLEGE

Established 1863
Van Ness at Post, RE
San Francisco, Calif.

Never before in American history has the need been so great for Trained Engineers and Technicians. No other type of training can compare with actual shop practice you get at Healds under expert instructors.

Bachelor of Science Degree, 27 Months

- Radio-TV Technician including Color TV (12 Months)
- Electronics Technician (12 Months)
- Industrial Electronics Technician (12 Months)
- Electronics Engineering (B.S. Degree)
- Electrical Engineering (B.S. Degree)
- Mechanical Engineering (B.S. Degree)
- Civil Engineering (B.S. Degree)
- Architecture (B.S. Degree)

Heald College ranks FIRST West of the Mississippi in "Who's Who in America"

Approved for Veterans
DAY AND EVENING CLASSES
Write for Catalog and Registration Application.
New Term Starting Soon.

Your Name

Address

City

State

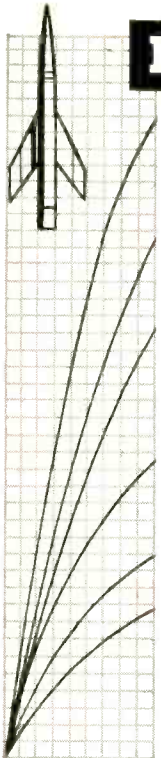

ENGINEERS

JUNIOR • SENIOR • PROJECT

STEP UP TO LEAR

Engineers, if you are experienced in the design and development of air and/or ground based communication and navigation equipment, here is the opportunity you have been looking for.

Lear, for twenty eight years a pioneer in aircraft radio communication, navigation equipment, automatic flight controls and flight indicators, is moving ahead in many new fields.

Lear offers unlimited opportunities for advancement and greater responsibilities to creative minded, electronic engineers.

If you would like to work in sunny Southern California on varied electronic projects, write to:

L. S. PECK, Manager
Industrial Relations

LEAR, INC., 3171 South Bundy Drive • Santa Monica, California

BUSINESS AND PEOPLE (Continued)

EIA Annual Unit Production and Sales

| | 1958 | 1957 |
|---------------------------------------|-------------|----------------|
| TV set production..... | 4,920,428 | 6,399,345 |
| Total radio production | 12,577,243 | 15,427,738 |
| FM radio production (July-Dec.) | 376,114 | not available† |
| TV retail sales | 5,140,082 | 6,560,220 |
| Radio retail sales..... | 8,631,344* | 9,721,285* |
| Receiving-tube factory sales | 397,366,000 | 456,424,000 |
| TV picture-tube factory sales | 8,252,480 | 9,721,008 |
| Transistor factory sales | 47,050,814 | 28,738,000 |

*Excluding auto sets
†Last available figure—1955—252,880 FM sets

J. Frank Leach (right) has been promoted to vice president and general manager of the Amphenol Connector Div. of the newly merged Amphenol-Borg Electronics Corp., Chicago. He had been vice president, manufacturing, of Amphenol Electronics Corp. Robert E. Svoboda, distributor sales manager of Amphenol, is now general manager of the Amphenol Distributor Div.



Frank P. Vendely (right) is now Eastern regional sales manager of the P. R. Mallory & Co., Inc., Distributor Div., Indianapolis, Ind. He started with the company as a distributor salesman and later served as merchandise manager. Leon Robbin, a Mallory vice president for the past 18 years, was elected to the board of directors and named president of the newly formed subsidiary, P. R. Mallory International, Inc.



Neal W. Turner (left), merchandising manager of Heath Co., Benton Harbor, Mich., was promoted to director of production planning. Robert K. Swan-



der advanced from purchasing agent to director of purchasing. Ellis Grear, assistant purchasing agent, succeeds him. William E. Johnson (right), former assistant advertising manager of Whirlpool Corp., joined Heath as dealer sales manager. John T. Caviezel, ex-Bell & Howell, joined Heath as dealer sales representative.

Charles Molitor is now with Electro-Voice, Inc., Buchanan, Mich., as chief industrial engineer. He comes to Electro-Voice from Allen Electric Equipment Co., where he was factory manager.



TV TUNERS REBUILT

All MAKES & MODELS

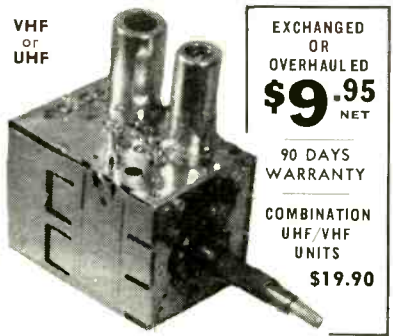

EXCHANGED OR OVERHAULED
\$9.95 NET
90 DAYS WARRANTY
COMBINATION UHF/VHF UNITS
\$19.90

ALIGNED TO ORIGINAL STANDARDS

Price includes worn parts only; defective tubes and damaged major parts are extra at net prices.

Forward defective tuner complete with tubes, shield cover and any damaged parts.

QUOTE MAKE AND MODEL

F.O.B. CHICAGO OR TORONTO
We will ship C.O.D.

CASTLE TV TUNER SERVICE

1723 W. LUNT AVE., CHICAGO 26, ILL.
152 MAIN ST., TORONTO 13, ONT.
U. S. A. • CANADA

Dave Rice's

OFFICIAL ORDER BOOK

for every TV-Radio service call



Triplicate forms serve as order form, invoice and office record with spaces for complete information on every job. Separate listings for receiving tubes, pix tube, parts, serial numbers, labor and tax charges, signatures, etc. 75c a book, \$6.50 for dust-proof box of 10.

... and for customer's prices on every replacement part, plus flat rate and hourly service charge data, regional and national, Dave Rice's

OFFICIAL PRICING DIGEST

listing over 63,000 items. \$2.50

In stock at your distributor, or write

ELECTRONIC PUBLISHING CO. INC.
180 North Wacker Drive Chicago 6, Illinois

Edward I. Flaxman (left), vice president in charge of sales for Service Instruments Corp., Addison, Ill., is shown presenting the Sencore "Rep of the

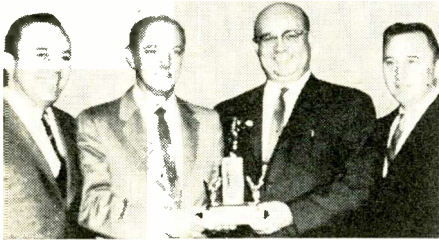

Year" award to John Havercamp and Jack Collins, as Sencore president Herb Bowden (right) looks on.

Thomas H. Moss has been appointed vice president of the Turner Co., Cedar Rapids, Iowa. He joined the company in 1952 and was appointed general sales manager in 1956, which position he still holds.



Hans D. Sylten, electronics research engineer, joined Winegard Co., Burlington, Iowa, as head of the expanding research dept.



Thomas L. Eckersley, radio pioneer with English Marconi from 1919 until

recent years, died in February at the age of 72. His work in wave propagation gave us much knowledge of the ionosphere and of the earth's resistivity. He was a Fellow of the Royal Society and of the IRE, and received the Faraday Medal in 1951. END

50 Years Ago
In Gernsback Publications

| | |
|--------------------------------------|------|
| HUGO GERNSBACK, Founder | |
| Modern Electrics | 1908 |
| Wireless Association of America..... | 1908 |
| Electrical Experimenter | 1913 |
| Radio News | 1919 |
| Science & Invention..... | 1920 |
| Television | 1927 |
| Radio-Craft | 1929 |
| Short-Wave Craft | 1930 |
| Television News | 1931 |

Some larger libraries still have copies of Modern Electrics on file for interested readers.

- In April, 1909, Modern Electrics
- Majorana Aerophone Work, by A. C. Marlowe.
 - Loud Talking Telephones, by the Berlin Correspondent.
 - New Experiments Producing Electric Sleep, by Frank C. Perkins.
 - 250-Watt Closed Core Transformer, by Carleton Haigis.
 - How to Make a Wireless Control Relay, by H. W. Secor.
 - Wireless Banquet.
 - French Wireless Telegraph and Aerophone Devices.
 - How to Make a Revolving Condenser, by A. Ward.
 - The Aerophone Automatic Signaling Device, by René Homer.
 - Condenser Phenomena, by C. C. Whittaker.
 - Wireless Registry.

Make over 150 Small
Computing and Reasoning
Machines with
BRAINIAC®
A BETTER ELECTRIC
BRAIN CONSTRUCTION KIT

Only \$17.95...
Why Pay More?



EQUALS THE ORIGINAL GENIAC® electric brain construction kit (1955) **PLUS** many improvements and additions: over 600 parts—including 116 improved patented wipers so that all switches work well. Instead of covering only 33 machines, BRAINIAC gives full specifications for 151 computing, reasoning, arithmetical, logical, puzzle-solving and game-playing machines... all 33 GENIACS (1955), and 118 BRAINIACS (1956-58), etc.

THIS IS BRAINIAC! With our Brainiac Kit K17, you can build over 150 small electric brain machines and toys which "think," compute, reason, and display intelligent behavior. Each one works on a single flashlight battery—is FUN to make, PTN to use and play with, and TEACHES you something new about electrical computing and reasoning circuits. All connections with nuts and bolts—no soldering required. Originated and produced exclusively by Berkeley Enterprises, Brainiac is the result of 8 years' design and development work with miniature mechanical brains including: Geniac (see "Geniacs: Small Electric Brain Machines and How to Make Them" by Edmund C. Berkeley, 64 pp., published by Geniac Project, a partnership with Oliver Garfield discontinued September 1955), Tyniac (1956), Relay Moe (automatic relay machine playing Tit-Tat-Toe—pictured in Lite Magazine, March 19, 1956), Simon (miniature automatic digital computer with 129 relays—see "Simple Simon" by E. C. Berkeley in Scientific American, November 1, 1950), Squee (electronic rook squirrel—see "Light Sensitive Electronic Beast" by E. C. Berkeley in Radio Electronics, December 1951), etc.

WHAT CAN YOU MAKE WITH BRAINIAC KIT K17? Over 150 machines including—LOGIC MACHINES: Syllogism Prover, Intelligence Test, Boolean Algebra Circuits, Douglas Macdonald's Will Analyzer, A Simple Kalin-Burkhardt Logical Truth Calculator, etc. GAME-PLAYING MACHINES: Tit-Tat-Toe, Nim, Wheeled Bandit, Black Match, Sundorra 21, etc. COMPUTERS: To add, subtract, multiply or divide using decimal or binary numbers. Forty-Year Calendar. Prime Number Indicator, Money-Changing Machine, etc. CRYPTOGRAPHIC MACHINES: Coders, Decoders, Lock with 15,000,000 Combinations, etc. PUZZLE-SOLVING MACHINES: The Missionaries and the Cannibals, Age-Guessing Machine, Submarine Rescue Chamber, Daisys Petal Machine, Fox-Hen-Cow, Hired Man, Uranium Space Ship and the Space Pirates, The Three Monkeys Who Spurred Evil, General Alarm at the Fortress of Dreadeerie, etc. QUIZ MACHINES: History, geography, trigonometry, grammar, statistics, calculus, etc.

WHO IS EDMUND C. BERKELEY? Author of "Giant Brains or Machines That Think," Wiley, 1949, 270 pp. (15,000 copies sold); Author of "Computers: Their Operation and Applications," Reinhold, 1956, 566 pp.; Editor & Publisher of the magazine, "Computers and Automation"; Maker and Developer of small robots; Fellow of the Society of Actuaries; Secretary (1947-53) of the Association for Computing Machinery; Designer of all the Tyniacs and Brainiacs, more than half of the 33 Geniacs (1955); Designer of the patented Multiple Switch Disc and other features in the 1955 Geniac Kit.

WHAT COMES WITH YOUR BRAINIAC KIT . . .
All Plans, Instructions, Explanations & Hardware:

- Every part needed to build Geniacs, Tyniacs & Brainiacs—over 600 pieces including control panel, multiple switch discs, jumpers, improved wipers, bulbs, sockets, washers, wire, battery and special tools.
- Complete descriptions of 151 experiments and machines.
- Over 160 circuit diagrams including 46 exact wiring templates.
- Manual "Tyniacs: Small Electric Brain Machines and How to Make Them" by Edmund C. Berkeley, 1956, 48 pages—includes Introduction to Boolean Algebra for Designing Circuits.
- "How to Go From Brainiacs and Geniacs to Automatic Computers" by Edmund C. Berkeley.
- Dr. Claude E. Shannon's historic 1938 paper given before the American Institute of Electrical Engineers: "A Symbolic Analysis of Relay and Switching Circuits," 12 pages.
- List of references to computer literature including "Minds and Machines" by W. Shuekin, published by Penguin Books (Baltimore), 1954, 233 pages, and other references.

BRAINIAC KIT (1958 Model) K17 . . . the kit with limitless possibilities—backed by an organization of 10 years standing in the computer field . . . \$17.95 (For shipment west of Mississippi, add 80¢; outside U. S., add \$1.80)

7-Day Full Refund Guarantee If Not Satisfactory

MAIL THIS COUPON
BERKELEY ENTERPRISES, Inc.
815 Washington St., R184, Newtonville 60, Mass.
Please send me Brainiac Kit K17. (Returnable in 7 days for full refund if not satisfactory—if in good condition) I enclose \$..... in full payment.
My Name and Address are attached

SENCORE "Fuse Safe" CIRCUIT TESTER

Save Time with SENCORE

Save costly call backs by testing the circuit before replacing fuse, fuse resistor or circuit breaker.

Individual scale for each value fuse resistor—no interpretation, just read in red or green area.

★ Measures line current and up to 1100 watts of power at 115 volts using line cord and socket. ★ Two convenient current ranges—0 to 2 amps and 0 to 10 amps. Test leads clip in place of fuse or fuse resistor. ★ 5 ohm, 10 watt resistor prevents TV circuit damage, simulates operating conditions.

SENCORE
As Recommended by Leading Manufacturers
SERVICE INSTRUMENTS CORPORATION
121 OFFICIAL ROAD, ADDISON, ILLINOIS
See other SENCORE ads in this issue

MODEL FS-3
\$8.95 DEALER NET
AC-DC or both as needed for Fuse Resistor Circuits

SUPER MAGNET SUPER SAVING!

Buy this Little Giant magnet, most powerful made, a sensational bargain! The low price of \$1.50 is less than 50% of what you'd pay for this magnet. Experimenters, hobbyists will find hundreds of uses for this powerful 4 oz. Alnico permanent magnet. LIFTS 5 lbs. EASILY. Limited quantity. Order several today. Measures 1 3/4 x 1 1/2".

Item No. 86 \$1.95
Special Bargain (Shp. Chgs. 10¢)

250 POWER TELESCOPE LENS KIT

Make your own high powered 6 ft. telescope! Kit contains 2" diam., 75" focal length, ground and polished objective lens and necessary eye pieces. Magnifies 50x to 250x. Full instructions.

ITEM NO. 123
\$3.45
(Shp. Chgs. 10¢)

AMAZING BLACK LIGHT

250-watt ultra-violet light source. Makes fluorescent articles glow in the dark. Fits any lamp socket. For experimenting, unusual lighting effects.

Shp. wt. 2 lbs.
ITEM NO. 87 **\$3.45**
(P. P. & Hdq. Chgs. 35¢)

HUDSON SPECIALTIES CO., 160 W. 14th St. Dept. RE-4-59, New York 7, N.Y.

I am enclosing full remittance for items circled below. (Be sure to include shipping charges.)

87 33 86 123

Name
Please Print Clearly

Address

City Zone State

WATTHOUR METER

Leading makes—reconditioned. Ideal for trailer parks. 100-110 volts, 60 cycles. 2-wire A.C. 5 amp. Heavy metal case 8 1/2" x 6 1/4" x 5". Easy to install. Shp. wt. 14 lbs.

ITEM NO. 33 **\$4.95**
NOW ONLY
(P.P. & Hdq. Chgs. \$1.25)

GET INTO ELECTRONICS
TODAY'S TOP OPPORTUNITY FIELD

ELECTRICITY

— ELECTRONICS

TELEVISION

RADIO — ELECTRONICS

TRAIN IN THE NEW SHOP-LABS OF
COYNE OLDEST, BEST
EQUIPPED SCHOOL
OF ITS KIND IN U.S.

in Chicago—Electronic Center of the World. Prepare for a better job and a successful future in TOP OPPORTUNITY FIELD. Train on real equipment —no advanced education or previous experience needed. Lifetime employment service to graduates. Finance Plan—enroll now, pay most of tuition later. Part time employment help to students.

FREE BOOK—Mail Coupon or write to address below for Big Free Illustrated Book—"Guide to Careers." Whether you prefer ELECTRICITY, ELECTRONICS, TELEVISION-RADIO ELECTRONICS OR COMBINED ELECTRONICS TRAINING, this book describes all training offered.

Information comes by mail. No obligation and NO SALESMAN WILL CALL.

B. W. Cooke, Jr., Pres. Founded 1899

COYNE ELECTRICAL SCHOOL

Chartered as an Educational Institution Not for Profit
1501 W. Congress Pkwy., Chicago 7, Ill., Dept. 49-5A

Coyne Electrical School
New Coyne Building, Dept. 49-5A
1501 W. Congress Pkwy., Chicago 7, Ill.

Send FREE book "Guide to Careers" and details of all training you offer.

Name _____
Address _____
City _____
State _____

(I understand no Salesman will call)

OPPORTUNITY ADLETS

Rates—50¢ per word (including name, address and initials). Minimum ad 10 words. Cash must accompany all ads except those placed by accredited agencies. Discount, 10% for 12 consecutive issues. Misleading or objectionable ads not accepted. Copy for May issue must reach us before March 15, 1959.

RADIO-ELECTRONICS,
154 West 14 St., New York 11, N. Y.

MONEY MADE with inventions! Valuable information. \$8. postpaid. ABC INVENTIONS, Box 302, West Covina, Calif.

HIGH-FIDELITY SPEAKERS REPAIRED. AMPRITE Speaker Service, 70 Vesey St., New York 7, N.Y. BA 7-2580.

CASH PAID! Sell your surplus electronic tubes. Want unused, clean transmitting, special purpose, receiving, TV types, magnetrons, klystrons, broadcast, etc. Also want military & commercial lab test and communications gear. We swap too, for tubes or choice equipment. Send specific details in first letter. For a fair deal write, wire or telephone: BARRY, 512 Broadway, New York 12, N.Y. Walker 5-7000.

RECORDERS, HI-FI, Tapes, Free Wholesale Catalogue. CARSTON, 215-T East 88th St., New York 28, N.Y.

STEREO TAPE RENTALS. For the very best at lowest prices. Write CALIFORNIA TAPED MUSIC ASSN., 730 El Camino Real, Redwood City, Calif.

NO HIGH VOLTAGE? IS IT A BAD YOKE?
DAMPER CIRCUIT? HORIZONTAL OSCILLATOR?
FLY BACK?



GET A
QUICK
ANSWER



MANCO
TRANSISTORIZED
FLYBACK & YOKE CHECKER

Why spend time and money locating a defective transformer by negative analysis? The new MANCO checks the impedance of the primary winding at the original frequency at which it is used. In this way a positive check with a measured impedance can be made.

Fully transistorized, the MANCO checker gives you a low cost direct reading either in the circuit or out. All instructions are practical and simplified. For example: Motorola TS 533 B in circuit flyback Z-1200 Ohms.

SPECIAL MAIL OFFER! For a limited time, an authoritative booklet on "Trouble Shooting High Voltage Networks" is yours FREE with each purchase.

\$14.95

Send check or money order to:
MANCO CO. 380 Union St., Manchester, N.H.

DISCOUNTS UP TO 50% on Hi-Fi amplifiers, tuners, speakers, tape recorders, individual quotations only, no catalogs. CLASSIFIED HI-FI EXCHANGE, 2375 East 65th Street, Brooklyn 34, N.Y.

APPLY FOR A PATENT Yourself and Save. Free "Form," MISS CLAIRIE ARDUIN, 806 Wm. Penn Annex, Philadelphia 5, Penna.

LABORATORY QUALITY equipment and Military Surplus Electronics bought, sold. ENGINEERING ASSOCIATES, 434 Patterson Road, Dayton 9, Ohio.

ALL MAKES OF ELECTRICAL INSTRUMENTS AND TESTING equipment repaired. HAZELTON INSTRUMENT Co., 128 Liberty Street, New York, N.Y.

TV AND RADIO SCHEMATICS. Send model number and \$1 for each TV, 75¢ for radio. STEVE STECKLER, 1648 Dahill Road, Brooklyn 23, N.Y.

PROFESSIONAL HI-FI REPAIRS. New precision method restores peak performance inexpensively. Laboratory test report included. Bring or ship defective components to BREMY ELECTRONICS, 394 East 18th Street, Paterson 4, N.J. Tel. Lambert 5-1191.

CAMERA Repairmen greatly needed! You can learn manufacturers' service methods at home, in your spare time! Free, big illustrated book tells how! Write today. NATIONAL CAMERA REPAIR SCHOOL, Dept. RE-4, Englewood, Colorado.

PROFESSIONAL Electronic Projects—Organs, Timers, Intercoms, Counters, etc. \$1 each. List Free. PARKS, Box 1665, Lake City Station, Seattle 55, Wash.

TAKE MAGAZINE SUBSCRIPTIONS. Good Profits. Special Offers. CASSELL AGENCY, Boynton Beach 25, Fla.

LITERATURE

Any or all of these catalogs, bulletins, or periodicals are available to you on request direct to the manufacturers, whose addresses are listed at the end of each item. Use your letterhead—do not use postcards. To facilitate identification, mention the issue and page of RADIO-ELECTRONICS on which the item appears. UNLESS OTHERWISE STATED, ALL ITEMS ARE GRATIS. ALL LITERATURE OFFERS ARE VOID AFTER SIX MONTHS.

WIRE-CABLE-TUBING of all types are described and illustrated in colorful catalog T-258. Everything from aerial and antenna wire through magnet wire to weatherproof cable.—Birnbach Radio Co. Inc., 145 Hudson St., New York 13.

ELECTRONIC COMPONENTS are offered in 2-color 4-page illustrated folder. Record changers, resistors, soldering guns, switches, wire, etc.—Brooks Radio & Television Corp., 82 Vesey St., New York 7, N. Y.

STEREO PHONO CARTRIDGES and how to use them is the topic of a 16-page booklet *Application Considerations in the Use of Stereo Cartridges*—publication EP-681. The illustrated text discusses factors influencing stereo performance, cartridge tracking force and loading, problem diagnosis, and cartridge connections and input wiring practices.—General Electric Co., Specialty Electronic Components Dept., West Genesee St., Auburn, N. Y.

HI-FI CABINETS, kits and assembled units including speaker enclosures, and equipment and record storage cabinets are shown in a colorful 4-page folder.—Stereo Craft, Div. of 20th Century Woodworking Co. Inc., 79 Clifton Pl., Brooklyn 38, N. Y.

STEREO SIMPLIFIED is a pocket-sized booklet that explains high-fidelity stereophonic reproduction of music in the home. Covers the entire process of stereo recording and reproduction.—Sonotone Corp., Elmsford, N. Y.

SOLDERING IRON TIPS are presented in an enlarged catalog sheet No. 601. Plug-in and screw-in types are illustrated. 124 shapes and sizes are covered.—Hexacon Electric Co., 186 W. Clay Ave., Roselle Park, N. J.

CORRECT STEREO GEOMETRY and optimum tonal range are described in an illustrated folder titled *Pocket Facts*. Circuitry for driving a third channel from the two stereo tracks is illustrated.—Klipsch & Associates Inc., 116 N. Louisiana St., Hope, Ark.

STEREO EDITION of *Understanding*

Save Time with
SENCORE LEAKAGE CHECKER

Check these outstanding New Features

The LC3 provides all these new improved features in addition to those employed in earlier leakage or "grid circuit" testers.

- ★ A must for any TV service technician.
- ★ Checks 156 different tube types—more than any other "grid circuit" type checker. Includes UHF and latest type tubes.
- ★ Checks picture tubes without removing tube from cabinet or chassis.
- ★ New Roll Chart prevents obsolescence—just dial the tube type and save time. Chart is easily replaced at no extra cost.
- ★ Provides instant filament checks on "Fil-Check" position—no need to carry a second filament checker. ★ Capacitor checks simplified.
- ★ Two spare preheating sockets to cut down testing time.

In stock at your local parts distributor.



Model LC-3
\$2895

DEALER NET

Really Whips
Tough Dogs

SENCORE

See other SENCORE ads in this issue

SERVICE INSTRUMENTS CORPORATION • 121 Official Road, Addison, Illinois

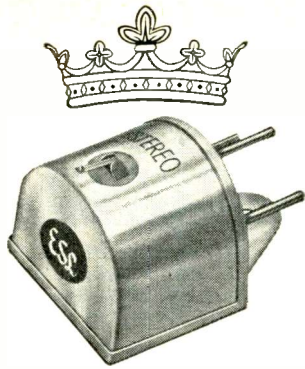

MONARCH of stereo cartridges:

ESL Gyro/jewel

The only stereo cartridge approved by the High Fidelity Consumer's Bureau of Standards. This true electrodynamic pickup is years ahead in performance. Insist on the ESL C-100 Series at only \$69.95.

FOR LISTENING AT ITS BEST



Dept E-35-54 36th St • Long Island City 6, N.Y.

PS: You'll want the new ESL Gyro/balance stereo arm that makes all cartridges sound better! Only \$34.95.

DIAGRAMS FOR REPAIRING RADIOS \$1. Television \$1. Give name, Model. DALE CO. 319 West 14th St., N. Y.

CIVIL SERVICE JOBS—mechanical, clerical, professional. List \$1. CIVIL SERVICE BULLETIN, 115D Haypath Road, Plainville, N.Y.

LITERATURE TO HELP You Pass FCC Phone Exams. Free Information. WALLACE COOK, 1614A Morson Road, Jackson 9, Miss.

MAKE MONEY Collecting Names. Stamp Brings Details. HAMILTON'S, Hatch, New Mexico.

UNUSUAL VALUES. Hi-Fi components, tapes and recorders. Free catalog RE. STEREO CENTER, 51 W. 35 St., New York 1, N. Y.

SONGPOEMS and LYRICS WANTED! Mail to: TYN PAN ALLEY, INC. 1650 Broadway, New York 19, N. Y.

HI-FI CONVERTER. Console sound from your radio, television set, or record player, with new speaker system kit. Write for free folder. WINDHAVEN RADIO, Box 147-74, Baroda, Mich.

WHOLESALE Appliance Parts Catalogue 25¢. SIMMONS, 26 South 20th Street, Birmingham 3, Ala.

SAVE MONEY! Get our list price on all types Radio and TV tubes at MFIS PRICES! 100% Guaranteed, all brand new and unused, no mechanical or electrical rejects, not washed or rebranded! 24-hour service! Write UNITED RADIO COMPANY, 58 Market St., Newark, N.J.

PRACTICAL SERVICING—Closed Circuit TV—Theatre Sound System—In Binder—\$3 yearly. WESLEY TROUT, ENGINEER, Box 575, Enid, Oklahoma.

ENGINEERING B. S. DEGREE IN 27 MONTHS



Prepare for unlimited opportunities of the Electronic Age! Students study engineering under accelerated program leading to B.S. degree in 27 mo.; or standard 4-yr program leading to B.E. degree in 36 mo. B.S. degree (36 mo.) in Math., Chem., Physics Year-round classes. Comprehensive training in electronics, television, advanced radio theory and design, math., nuclear physics and elec. eng. Also prep courses. Low rate. Earn board. G.I. approved. Enter June, Sept., Dec., March. Catalog.

INDIANA TECHNICAL COLLEGE

1749 E. Washington Blvd., Fort Wayne 2, Indiana

Please send me free information B.S. ENGINEERING DEGREE IN 27 MONTHS as checked.

Electronics Chemical Aeronautical
 Civil Mechanical Electrical
 B.E. DEGREE IN 36 MO. in: Electrical (Power or
 Aeronautical Chemical Electronics)
 Civil Mechanical Metallurgical
B.S. DEGREE IN 36 MO. in: Math. Chem. Physics

Name.....
Address.....

LITERATURE (Continued)

High Fidelity details the components required for a hi-fi system, and explains the difference between stereo and mono systems in terms of results to be expected. The 64-page booklet is well illustrated. Glossary of technical terms is included.—Bogen-Presto, Div. Siegler Corp., Box 500, Paramus, N. J., 25c.

FRACTIONAL-HORSEPOWER MOTORS, of all types are presented in *Motor Catalog M 159*. Complete specifications including a dimensional drawing for each type motor are included.—Carter Motor Co., 2711 W. George St., Chicago.

CORRECTION

Mr. Snader reports that he had listed the TONE EQUALIZATION control (R16R and R16L) as 250,000 ohms in the diagram and parts list of his "Tape Amplifier for Stereo" in the March issue. The correct value for each section of the dual control is 5,000 ohms. The control should be set to about 2,500 ohms for NAB equalization.

USING THE ECONOMY TUBE CHECKER

Mr. Jaski has received a number of requests for clarification of the operating instructions for his Experimenter's Economy Tube Checker, described in the December, 1958, issue and has supplied this additional information:

Testing rectifiers. Test each half of a full-wave rectifier separately. One section may be bad while the other is good. The load resistor in Figs. 2-b and 2-c provides a normal full load for the rectifier. Its value is determined by Ohm's law. The maximum continuous current delivered by the tube is listed in tube manuals. There is no standard test voltage. It depends on your meter. With a 1-ma meter, approximately 30 volts ac is often used. The voltage is a matter of choice.

Amplification tests are made with dc plate and screen voltages listed in the tube manual under "typical operating conditions." The load resistor must be determined from tube characteristics listed in the manual.

Noise tests are made with normal operating voltages on all elements. If the plate and screen are normally operated at 100 and 75 volts, respectively, match or approximate these voltages for the test.

Mr. Jaski also calls our attention to wiring errors in the connections to the plate- and screen-voltage selector switches in the diagram of his tube checker on page 33 of the December, 1958, issue. The 3- and 7.5-volt positions on S5 should connect to corresponding taps on transformer T2. The 10-volt position on S3 should go to the 7.5-volt tap on T2.

He also points out that he labeled the instrument's screen-voltage switch S5 with the ac voltage level applied to the rectifier and plate switch S3 with the dc output from the plate-supply filter, and that this notation was carried on to the schematic, causing some leads to have two voltage readings.

NEW TRANSISTOR ELECTRONICS & SOLID STATE PHYSICS

Basic Reference Library

AVAILABLE NOW FOR FREE EXAMINATION

These 5 fully illustrated volumes by outstanding authorities give you the most straightforward guidance you can get anywhere on every aspect of transistors and solid state physical electronics.

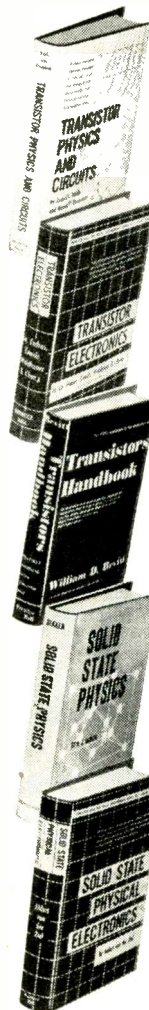

1 TRANSISTOR PHYSICS AND CIRCUITS

By Robert L. Riddle and Marlin P. Ristenbatt, Senior Engineers, Haller, Raymond and Brown

Bridging the gap between theory and application this book provides a new simplified approach to the operation and design of transistor circuits by way of familiar physical and electrical law without sacrificing technical fidelity.

2 TRANSISTOR ELECTRONICS

By Lo. Endres, Zawels, Waldhauser, Cheng

Here's an exhaustive run-down of many specialized areas of transistor work, from transistor operation and circuit analysis to practical circuit design. Full coverage of high frequency operation, oscillators, modulation, demodulation, switching circuits. Convenient tabular forms help bring out fine points of operation.

3 TRANSISTORS HANDBOOK

By William D. Bevirt, Transistor Applications Engineer, CBS-Hytron

Practical, on-the-job guide to all major types of transistor circuits with full data on 58 different transistors. Gives scores of circuit diagrams each with typical values of circuit elements—material that helps you take out, try, and adapt these tested circuits to your own needs.

4 SOLID STATE PHYSICS

Prof. A. J. Dekker, Electrical Engineering Dept., University of Minnesota

Thorough study of the physical properties of crystalline solids. Contains full information on properties of metallic lattices, ionic crystals, semiconductors, magnetic properties of solids, electronic properties of ionic crystals.

5 SOLID STATE PHYSICAL ELECTRONICS

By Prof. Aldert Van Der Ziel, Electrical Engineering Dept., University of Minnesota

Provides complete source of information on solid state devices being used and developed in the electronics industry. PLUS essential theory. Covers: structure of the solid state, theory of semiconductors, electron emission devices, semiconductor devices, dielectric and magnetic devices.

EXAMINE 10 DAYS WITHOUT RISK

Mail coupon below to examine this valuable 5-volume Library. You take no risk. But don't delay—mail coupon now.

Prentice-Hall, Inc., Dept. 5744-E1
Englewood Cliffs, N.J.

Please send me Transistor, Electronics & Solid State Physics Library (5 volumes) for which I enclose \$7.50 plus five cents postage as first payment. Then after I have examined the set for 10 days I will send \$8 a month for five months until full price of \$47.50 is paid. If not satisfied, I may return the set within 10 days and get immediate refund of my first payment.

Name.....
Address.....
City and State.....

ELECTRONIC ENGINEERS

for expanding Electronics Division

Positions open at all levels for men with electronic, electro-mechanical and mechanical experience. Top level positions in applications and sales for work on:

- Electronic components and equipment**
- Industrial process and quality controls**
- Nuclear reactor controls and instrumentation**
- Commercial aircraft simulation**
- Military flight and weapon system simulation**
- Space vehicle simulation**

and many other assignments for project, senior and junior engineers. Plant location in Carlstadt, N. J. makes commuting easy from New York City or northern New Jersey suburbs.

Send detailed resume including salary requirements to:
T. W. Cozine, Mgr., Executive & Technical Placement, Curtiss-Wright Corporation, Dept. ED-25, Wood-Ridge, N. J.

CURTISS-WRIGHT

CORPORATION • WOOD-RIDGE, N.J.

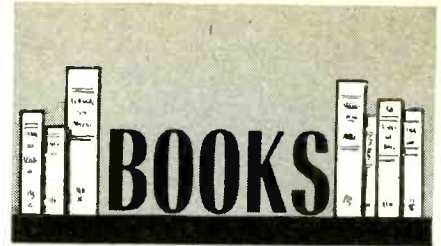

WORKING WITH THE OSCILLOSCOPE,
by Albert C. W. Saunders. Electronic
Technical Publishing Co., Inc., P.O. Box
306, Boston, Mass. 8 1/2 x 11 in., 93 pp. \$4.

This dean of electronic instructors has designed a book especially for the student, including all the facts necessary for the absolutely green beginner without being boring to the advanced student who is looking for a refresher. The book is divided into five parts. Part One discusses the electro-scope, beginning with some simple principles of electron optics, then describing the interior construction clearly, with the help of diagrams and photographs. Part Two is devoted to oscillographic patterns, showing the function of the tube elements in producing them. There are two sections on the time base and associated horizontal circuits, and one on the vertical deflection amplifier. The last part is a laboratory manual, describing 26 projects, ranging from voltage calibration to squaring the sine wave and measuring transistor characteristics. These 26 projects cover practically all the uses of the scope the student and technician are likely to need.

The value of the book is enhanced by the excellent readability, due to the large, heavy modern type on good paper, and the number and quality of the drawings, schematics and photographs.—FS

INTERNATIONAL RADIO TUBE ENCYCLOPEDIA. Bernards, Ltd., The Grampians, Western Gate, London, W.6, England. 7 1/2 x 9 3/4 in. 768 pp. 63 shillings.

This is a small world, but it has many thousands of tube types. This encyclopedia lists no less than 27,500, and in such a way that full specifications and ratings are available at once. The tubes are listed in groups. The first contains types released before 1949. The more recent types (including 1958) appear in several supplements, with a master index making it easy to locate any desired type. The same page contains all data and basing, so there is no need to turn over.

Among other information are: equivalent types, wartime tubes, manufacturers' names and addresses. Use of the book is explained in 15 languages.—IQ

IHFM STANDARD METHODS OF MEASUREMENT FOR TUNERS, prepared and published by Institute of High Fidelity Manufacturers, Inc., 125 E. 23 St., New York 10, N.Y. 7 x 10 in., 22 pp. \$1.

Ratings of AM and FM tuners have been so ambiguous that it has often been impossible to compare one with another from their specifications. To establish a uniform and unambiguous

REPLACEMENT SPEAKERS

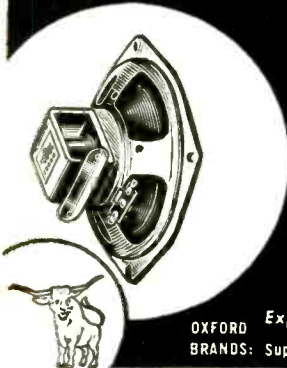

Stick with the "man who brung" you . . . order replacement speakers and specify OXFORD . . . the world's largest producers of SPEAKERS. Our seven factories are supplying the majority of original equipment manufacturers, assures you of exact replacements.

Leading distributors carry OXFORD . . . so should you.

OXFORD COMPONENTS, INC.

556 West Monroe Street
Chicago 6, Illinois

OXFORD Export: Roburn Agencies, New York • In Canada: Atlas Radio, Toronto
BRANDS: Supreme Transformers, Hudson Lamps, Tempo Hi-Fi, Oxford Speakers & Rear Deck Kits.

SAVE
TIME
with

SENCORE

See other SENCORE ads in this issue.

SERVICE INSTRUMENTS CORP. 121 Official Rd. • Addison, Ill.

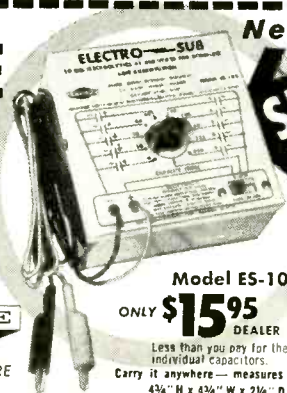

New!

SENCORE Electro-Sub

Check all
ELECTROLYTIC CAPACITORS
in Seconds!

Merely select the electrolytic and substitute it. 10 big electrolytics from 4 to 350 Mfd. to safely substitute in any circuit from 2 to 450 volts.

- ... COMPLETELY SAFE—no arc or spark when connecting or disconnecting.
- ... AUTOMATIC CAPACITOR DISCHARGE—within seconds after releasing test switch by, unique surge protector circuit.
- ... NO CAPACITOR HEALING—surge protector circuit prevents accidental healing of capacitor being "bridged" in service work.

Model ES-102
ONLY \$15.95
DEALER NET

Less than you pay for the individual capacitors.
Carry it anywhere—measures only 4 3/4" H x 4 3/4" W x 2 1/4" D

method of specifying such equipment, the institute has published this standard. Terms—both for AM and FM—are defined; operating conditions and requirements for testing apparatus are set forth, and test procedures are given separately for AM, FM and AM-FM tuners.—FS

TV AND OUR SCHOOL CRISIS. by Charles A. Siepmann. Dodd, Mead & Co., 432 Fourth Ave., New York, N. Y. 5 1/4 x 8 in., 198 pp. \$3.50.

Education by remote control has been tried and found desirable. Courses in foreign languages, science, history and other subjects are given successfully by TV. One physics course called "Continental Class," originating from the University of California, is broadcast weekday mornings to an estimated 270,000 students over TV.

In this book the chairman of the Department of Education at New York University reviews results of closed-circuit and open-circuit TV, and finds them highly satisfactory. He believes that the new medium will become even more important in the future.—IQ

MAGNETIC RECORDING TECHNIQUES. by W. Earl Stewart. McGraw-Hill Book Co., 330 W. 42 St., New York 36, N. Y. 6 x 9 in., 272 pp. \$8.50.

Distortionless magnetic recording is a recent development, but already has become important in science, entertainment and industry. Soon it will probably supplant films for recording movies and TV. This engineering book is well organized and complete in covering theory and practice. It describes processes, materials and mechanisms. It shows how to obtain optimum performance in recording.

Among paragraph headings are magnetic media, recording and reproducing processes and ferromagnetism. Typical test and amplifier circuits (tube and transistor) are illustrated and discussed. The book closes with a chapter on "standards" which give dimensions of tapes and films, terms and definitions, measurements, etc. Engineering equations appear in the appendices.—IQ

ELECTRONIC MEASURING INSTRUMENTS (Second Edition). by E. H. W. Banner. MacMillan Co., 60 Fifth Ave., New York 11, N.Y. 5 1/2 x 8 1/4 in., 496 pp. \$7.95.

Modern industry, science and medicine rely heavily on specialized types of measuring apparatus. This book discusses many kinds: voltmeters, electrometers, transducers, radiation detectors, counters, electrocardiographs, pyrometers, photometers, among others. Its information is useful for engineers, students and users of the equipment.

The first two parts discuss indicating meters, tubes, transistors, photocells and radiation meters. The last two describe instruments using these devices. Treatment is brief, but clear and complete. The author includes specifications, block diagrams, schematics and photos where helpful.—IQ

SCHOOL DIRECTORY

SENDING SPEED
CODE RECEIVING

Be a "key" man. Learn how to send and receive messages in International Morse code. Communicate with operators around the globe. Learn at home quickly through famous Candier System. Used by best operators. Qualify for Amateur or Commercial License. Write for FREE BOOK.

CANDLER SYSTEM CO.
Dpt. 3-D Box 9228, Denver 20, Colo. USA

ELECTRONICS ENGINEERING DEGREE IN 27 MONTHS

Prepare for unlimited opportunities in electronics!

B.S. Engineering degree (27 mo.); Mathematics, Electrical Engineering, TV, advanced Radio Theory and Design. B.E. (36 mo.); Aeronautical, Chemical, Civil, Electrical, Mechanical, Metallurgical Eng. B.S. (36 mo.); Math., Chem., Physics. Also preparatory courses. Earn board. G.I. approved. 20 bldgs., dorms, gym. Enter June, Sept., Dec., March. Catalog. Keeping pace with progress.

INDIANA TECHNICAL COLLEGE
1549 E. Washington Boulevard, Fort Wayne 2, Indiana

GET INTO ELECTRONICS

V.T.I. training leads to success as technicians, field engineers, specialists in communications, guided missiles, computers, radar and automation. Basic and advanced courses in theory and laboratory. Assoc. degree in electronics in 29 mos. B.S. in electronic engineering obtainable. ECPD accredited, G.I. approved. Graduates in all branches of electronics with major companies. Start September, February. Dorms, campus. High School graduate or equivalent. Catalog.

VALPARAISO TECHNICAL INSTITUTE
Dept. C Valparaiso, Indiana

ENGINEERING DEGREES

E.E.
Option Electronics or Power
Earned through

HOME STUDY
Resident Classes Also Available if Desired

PACIFIC INTERNATIONAL COLLEGE OF ARTS & SCIENCES
Primarily a Correspondence School
5719-M, Santa Monica Blvd., Hollywood 38, Calif.

ELECTRONICS

PREPARE FOR A GOOD JOB!
BROADCAST ENGINEER
RADIO SERVICING AUTOMATION

TELEVISION SERVICING
BLACK & WHITE-COLOR

APPROVED FOR VETERANS AND SURVIVORS OF VETERANS
BUILDING AIR CONDITIONED
SEND FOR FREE LITERATURE

BALTIMORE TECHNICAL INSTITUTE
1425 EUTAW PLACE, BALTIMORE 17, MD.

prepare for your career in ELECTRONICS RADIO-TV COMPUTERS

and other fields of
ELECTRICAL ENGINEERING

At MSOE, you can equip yourself for a career in many exciting, growing fields: **MISSILES**
RADAR • AUTOMATION
RESEARCH • DEVELOPMENT
ELECTRICAL POWER
AVIONICS • ROCKETRY

When you graduate from the Milwaukee School of Engineering, you are prepared for a dynamic career as an Electrical Engineer or Engineering Technician. Under a faculty of specialists, you gain a sound technical education in modern, completely equipped laboratories and classrooms. As a result, MSOE graduates are in great demand and highly accepted by industries nationally.

At MSOE you will meet men from all walks of life and all parts of the country — some fresh out of high school or prep school, others in their twenties — veterans and non-veterans.

You can start school in any one of four quarters and begin specializing immediately. Engineering technicians graduate in 2 years with an Associate in Applied Science degree. For a Bachelor of Science degree in Engineering, you attend 4 years. A 3-month preparatory course also is available.



FREE CAREER BOOKLET!
If you're interested in any phase of electronics, radio or television, be sure to look into the programs of study offered by the Milwaukee School of Engineering. Just mail the coupon.

MILWAUKEE SCHOOL OF ENGINEERING

Dept. RE 459, 1025 N. Milwaukee St., Milwaukee, Wisconsin

Please send FREE Career Booklet. I'm interested in Electronics Electrical Power Television Mechanical Engineering Radio Electrical Engineering Computers Industrial Electronics

PLEASE PRINT
Name..... Age.....
Address.....
City..... Zone..... State.....
 I'm eligible for veterans education benefits.

MS-123

NEW! "Do-It-Yourself" LAFAYETTE Kits



LAFAYETTE'S
1959 CATALOG
260 GIANT-SIZE
PAGES
FREE!

Complete listings of the **NEWEST** in Stereo and Monaural Hi-Fi, Short Wave, Audio, Transistor, and many other Lafayette electronic kits as well as thousands upon thousands of standard brand nationally advertised kits and electronic parts and components are described in LAFAYETTE'S GIANT NEW 260-PAGE CATALOG. SEND FOR IT—IT'S FREE! Just fill in coupon below and present it at any Lafayette store, or paste it on a postcard and send it to us. THAT'S ALL YOU HAVE TO DO to get your FREE 1959 LAFAYETTE CATALOG!

LAFAYETTE RADIO ELECTRONIC KITS

- Include the very latest electronic advances.
- Are constantly being modernized by Lafayette's own Engineering Department, by a leading consulting engineering firm, and by your own recommendations.
- Are a product of Lafayette's 38 years of Electronic Leadership.

EDUCATIONAL

"EXPLOR-AIR" 4-BAND RECEIVER ... KT-135 18.50

SUPER-SENSITIVE PHOTOCCELL ELECTRONIC RELAY ... KT-133 12.95

5-WATT PUSH-PULL AC-DC HI-FI AMPLIFIER KIT ... KT-92 10.95

4 TRANSISTOR TELEPHONE PICKUP AMPLIFIER ... KT-131 17.95

6 TRANSISTOR SUPERHET RECEIVER ... KT-119A 27.50

3 TRANSISTOR SUPERHET POCKET RADIO ... KT-116 14.95

3 TRANSISTOR HI-FI PREAMPLIFIER ... KT-117 16.95

"5-IN-1" TRANSISTOR EXPERIMENTER'S KIT ... KT-134 14.95

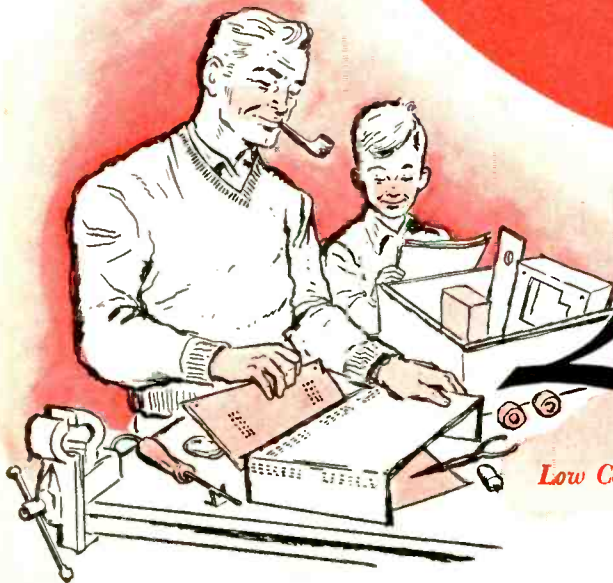

Low Cost Kits For Everyone!

Lafayette Radio

LAFAYETTE Kits Are FUN To Build!

LEARN ELECTRONICS BY BUILDING A LOW COST LAFAYETTE KIT

KITS FOR BEGINNERS • 10-In-1 Lab Kit • Transistor Code Practice Oscillator • AC-DC Broadcast Receiver • 3-Way Broadcast Receiver • 5-Watt Push-Pull AC-DC Amplifier • 7-In-1 Radio Lab Kit • 2-In-1 Kit • Germanium Diode Radio • 1-Transistor Pocket Radio • 2-Transistor Pocket Radio

HI-FI KITS • Stereo Master Audio Control Center & Preamplifier • Stereo Remote Control Center — Electronic Stereo Adapter • 36-Watt Basic Stereo Amplifier • AM-FM Stereo Tuner • Preamp-Audio Control Center • 70-Watt Power Amplifier • 4-Watt Stereo Amplifier • Speaker Enclosure Kits

ADVANCED KITS • Broadcast-Shortwave Receiver • Electric Brain Kit • 10-Watt Push-Pull Hi-Fi Amplifier • 15-In-1 Transistor Experimenter's Kit • 4-Band Broadcast-Shortwave Receiver • Photocell Electronic Relay • 6-Transistor Superhet Receiver • 3-Transistor Pocket Radio • 3-Transistor Hi-Fi Preamplifier • 2-Transistor Reflex Radio with Sun Battery • Transistor Code Practice Oscillator • Radio Control Transmitter • Transistor-Diode Checker • Multitester Semi-Kit • 4-Transistor Telephone Pickup Amplifier

PRACTICAL



36-WATT STEREO BASIC POWER AMPLIFIER KT-310 47.50

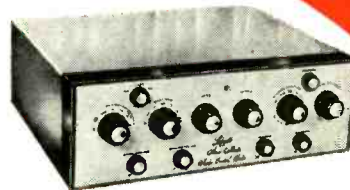

STEREO MASTER AUDIO CONTROL CENTER-PREAMP KT-600 79.50

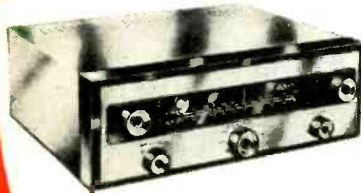

STEREO AM-FM HIGH FIDELITY TUNER KT-500 74.50

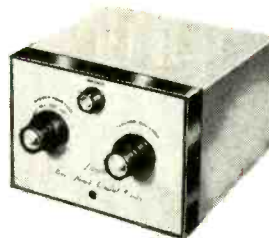

STEREO REMOTE CONTROL CENTER ELECTRONIC STEREO ADAPTER KT-315 27.50

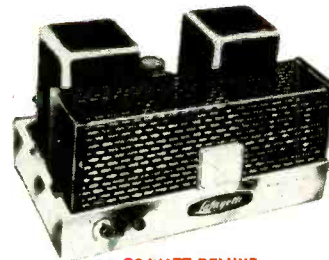

70-WATT DELUXE BASIC AMPLIFIER KT-400 69.50

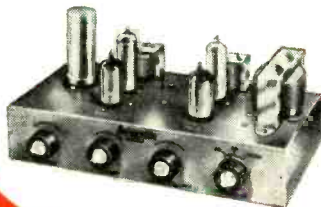

4-WATT STEREO PHONO AMPLIFIER KT-126 18.95

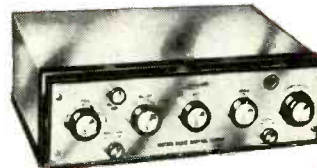

DELUXE MASTER AUDIO CONTROL CENTER-PREAMPLIFIER KT-300 39.50

EASY-TO-BUILD LAFAYETTE KITS

Enjoy and Save

LAFAYETTE KITS SAVE YOU REAL MONEY. You save up to 50% or more when you build a low-cost Lafayette kit as against factory-wired units of equal or even lesser quality. You save also because Lafayette manufactures these kits and sells them *direct to you*, eliminating the usual dealer's markup.

LAFAYETTE KITS ARE YEARS AHEAD. Every latest advance in electronics finds its way into educational and practical Lafayette Kits. Lafayette was **FIRST** in TRANSISTORS, and Lafayette is **now FIRST** in STEREO HI-FI!

LAFAYETTE KITS ARE EASY TO BUILD. Whether you are a beginner or an engineer, a novice or advanced amateur, there are Lafayette kits you can build, learn from, and use. Detailed instructions with clear, large blow-ups and dozens of illustrations describe minutely every step of the kit assembly so that there are seldom any questions.

LAFAYETTE KITS ARE AVAILABLE ON OUR EASY PAY PLAN. SEE OUR FREE GIANT-SIZED 260-PAGE 1959 CATALOG FOR DETAILS.

ASK FOR THE FREE 260-PAGE GIANT NEW 1959 LAFAYETTE CATALOG

Fill in and present the coupon below at any Lafayette store for your FREE Catalog, or simply paste the coupon on a postcard and mail it to the address on the coupon. Our catalog is FREE for the asking!

LAFAYETTE RADIO STORE LOCATIONS

JAMAICA 33, N. Y.
165-08 Liberty Ave.
AXtel 1-7000
Open FRIDAY
till 8:45 P.M.

NEW YORK 13, N. Y.
100 6th Ave.
Worth 6-5300
Open THURSDAY
till 8:45 P.M.

BRONX 58, N. Y.
542 E. Fordham Rd.
Fordham 7-8813
Open THURSDAY
till 8:45 P.M.

NEWARK 2, N. J.
24 Central Ave.
Market 2-1661
Open WEDNESDAY
till 8:45 P.M.

PLAINFIELD, N. J.
139 W. 2nd St.
Plainfield 6-4718
Open THURSDAY
till 8:45 P.M.

BOSTON 10, Mass.
110 Federal St.
Hubbard 2-7850
Open MON.-WED.
till 8:45 P.M.

FREE



CUT
OUT
AND
PASTE
ON
POST
CARD

LAFAYETTE RADIO, Dept. JD-9
P.O. Box 511, Jamaica 31, N. Y.

SEND FOR THE WORLD'S LEADING ELECTRONICS, RADIO, T.V., INDUSTRIAL, AND HI-FI GUIDE

Send FREE LAFAYETTE Catalog 590

Name

Address

City..... Zone..... State.....

WRITE FOR LATEST TUBE CATALOG FREE!

Receiving, transmitting, special purpose tubes, diodes, transistors, etc. We have a large, diversified stock at sensible prices. Tube cartons & stackers always in stock.

- **TRIMM COMMERCIAL HEADSETS.** Highest quality lightweight Trimm No. 157—double headsets—17,000 ohms impedance (reg. net \$17.60). Original Cartons—Unused. Special **\$6.50**
- **SNIPERSCOPE.** See in Dark! Attach to rifle. Mfd. by American Optical, Model M-3. With orig. power supply & cables. Comes with infra-red light source and filter. Orig. box. (Orig. cost \$2,000.00) Special Price. **\$120.00**
- **Raytheon Power Supply.** Input: 6 volts D.C. Output: 117 VAC under load @ 1/2 to 3/4 Amps AC (50 watts plus) new—original cartoned—heavy-duty unit—best parts (Original cost over \$100.00) Price **\$16.95**
- **Heavy-Duty Test Leads.** Tests to 10 KV for TV, etc. Red & Black Leads. ICA #4317. Price **\$1.25**
- **Signal Tracer Probe For VTVM, Etc.** ICA #4310. Price **\$1.75**
- **ICA 5 Way Binding Posts (Black or Red).** Price **22¢ Each**
- **Blk or Red Banana Plugs For Above, Etc.** 3" Long. (Specify Color). Price **15¢ Each**
- **Test Leads, Std. Set of Red & Blk Leads W/Banana Jacks & 5" Probes.** ICA #312. Price **50¢ Each**
- **FTR MINIATURE CHOKE. BRAND NEW!** Hermetically Sealed. 2 Hys. at 130 Ma. 2 3/4" H. x 1 1/2" W. x 1" D. Stock No. 3C315-127. Price **40¢ Each**
- **6 and 12 Volt (operates from either) Input Carter Duovolt Dynamotors: Medium Size Unit Puts out 400 Volts @ 375 Ma. \$15.95 Large Size Unit Puts out 620 Volts @ 280 Ma. \$19.95**
All Units are brand new, genuine Carter Dynamotors.
- **General-Radio Variac Type 200 CUH—**The original continuously adjustable autotransformer—Input voltage: 115 volts at output voltage of 0 to 270 volts @ 2 amps. Also will operate from 230 volts and deliver from 0 to 270 volts @ 2 amps. Brand new sealed in original cartons—only \$11.95 less knob & dial. With knob and dial **\$12.95**
- **Choke—Approx. 6 HY. @ 500 MA.—26 OHMS D.C. Resistance unused. Price \$6.00 2 for \$3.95**
- **Westinghouse Choke 10 HY. @ 200 MA.—77 OHMS D.C. resistance—5" x 5" x 3 1/2". Stock No. L1423117. Price \$1.90 2 for \$3.00**
- **University Labs 10 Watt Outdoor Loud-speaker, 8 Ohms—300-5000CPS—Brand New Boxed—with Mounting Bracket and 10 Foot Rubber Cord and Amphenol Connector made for Navy—Black finish—finest construction—Excellent for portable Megaphone Amplifier \$12.95**
- **HALF WAVE SELENIUM RECTIFIER.** Mfd. by Radio-Receptor. Ideal for voltage doubling mobile power supply circuits. 225 VAC input 200 MA. Dimensions: 1 1/2" x 1 1/2" x 1 1/4" deep. Net weight 2 oz. Catalog #10Q0749 **\$1.50**
- **Herm. Sealed FILAMENT XFMR115 VAC TAPPED SEC. 5V at 10 A. Hi-Volt. Ins.—Cat. #F90132. Price \$3.00**
- **Herm. Sealed FILAMENT XFMR115 or 230 PRIM. SEC. 5V at 10 A. Hi-Volt. Ins. Price \$3.75**

Authorized factory distributors for: ADJUST-A-VOLT, B & W, DRAKE, EIMAC, GELOSO, GENERAL ELECTRONICS, GLAS-LINE, GONSET, HAMMARLUND, HEXACON, E. F. JOHNSON, NATIONAL CO., NATIONAL ELECTRONICS, PENTA LABS, STACO, TECHNICAL MATERIEL CORP., TOBE, WESTINGHOUSE, VOCALINE, and Others. All prices F.O.B. N.Y.C. Specify method of shipment. All merchandise insured and guaranteed for cost of mdse. only. Send 25¢ for 1959 green sheet. Open Monday to Saturday—come in and browse—we are near Prince St./BMT Station—Spring St./IRT Station. 1 flight up—20,000 sq. feet of values. Thousands of unadvertised specials. Phone: Walker 5-7000.

BARRY ELECTRONICS CORP.

512 Broadway, Dept RE-3, N.Y. 12, N.Y.

ADVERTISING INDEX

Radio-Electronics does not assume responsibility for any errors appearing in the index below.

| | | | |
|--|---------------|---|------------------------|
| Allied Radio Corp. | 13, 78-79 | Dressner | 139 |
| Amperex Electronic Corp. | 126 | Dynaco Inc. | 122 |
| Arkay Radio Kits Inc. | 111 | Editors & Engineers | 115 |
| Audio Devices, Inc. | 10 | Electro-Sonic Labs | 133 |
| Audio Fair | 129 | Electro-Voice, Inc. | 125, Inside Back Cover |
| B & K Manufacturing Co. | 27, 81 | Electronic Instrument Co. (EICO) | 29, 30 |
| Barry Electronics Corp. | 138 | Electronic Publishing Co., Inc. | 130 |
| Bell Telephone Labs | 14 | Electronic Technical Publishing Co. | 123 |
| Bendix Radio | 116 | Erie Resistor Corp. | 129 |
| Berkeley Enterprises, Inc. | 131 | General Instrument Distributor Div. | 90 |
| Blonder-Tongue Labs | 12 | Gernsback Library, Inc. | 108, 138 |
| Bogen (David) Co., Inc. | 139 | Grantham School of Electronics. | 9 |
| Brooks Radio & Television Corp. | 119 | Heald Engineering College | 129 |
| CBS-Hytron | 28 | Heath Co. | 62-73, 75 |
| Capitol Radio Engineering Institute | 91-92 | Hudson Specialties Co. | 131 |
| Carston Studios | 139 | Indiana Technical College | 133 |
| Castle Television Tuner Service. | 130 | International Business Machines (IBM) | 112-113 |
| Centralab Div. of Globe Union. | 106-107 | International Correspondence Schools | 11 |
| Century Electronics Co., Inc. | 96-97 | Jensen Industries | 128 |
| Cleveland Institute of Radio Electronics | 105 | Key Electronics Co. | 139 |
| Cornell-Dubilier Electric Corp. | 80 | Lafayette Radio | 136-137 |
| Coyne Electrical School | 115, 127, 132 | Lansing (James B.) Sound, Inc. | 26 |
| Curtiss-Wright Corp. | 134 | | |
| Delco Radio Div. of General Motors Corp. | 23 | | |
| DeRo Electronics | 122 | | |
| Deutschmann (Tobe) | 88 | | |
| DeVry Technical Institute | 7 | | |

BE WISE... TRANSISTORIZE!

G/L books show you how

Transistors are coming on stronger and stronger. Want to learn more about them? Work with them? Play with them? Experiment? Gernsback Library has the book for you. Attractive low-priced paper-bound editions. Order the ones you want now.

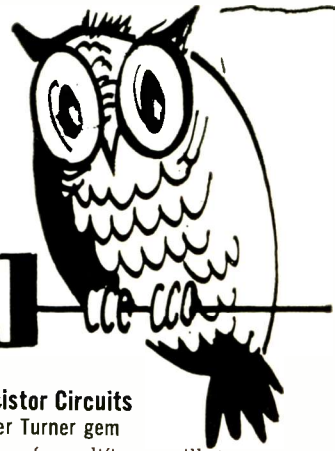

Transistors—Theory and Practice

By Rufus P. Turner (Second Edition)

THE book on the fundamentals of transistors for the practical man. Over 30,000 copies of the original edition sold. Now completely updated and enlarged. Covers—theory, characteristics, equivalent circuits, amplifiers, oscillators, tests and measurements. **No. 75—\$2.95**

Servicing Transistor Radios

By Leonard D'Airo

How to service these tricky sets—techniques, what instruments to use, pitfalls to avoid. Troubleshooting hints. Get this one now and watch your servicing income grow. **No. 76—\$2.90**

Transistor Techniques

A handbook for the practical man. Very little math or theory but lots of hints on testing, use, performance, measurements, construction. **No. 61—\$1.50**

Transistor Circuits

Another Turner gem

Scores of amplifier, oscillator, power supply and other circuits. Tested and debugged by the author. A great book for the man who wants to experiment, learn and have fun with transistors. **No. 63—\$2.75**

SEE YOUR DISTRIBUTOR OR USE THIS COUPON

Gernsback Library, Inc. Dept. 49
154 West 14th St., New York 11, N. Y.

My remittance of \$..... is enclosed.
Please send me the books checked below, postpaid.

76 75 63 61

name _____
please print

street _____

city _____ zone _____ state _____

| | |
|---|-------|
| Lear Inc. | 130 |
| Lektron Inc. | 110 |
| Mallory (P. R.) & Co., Inc. | 20 |
| Manco Manufacturing Co. | 132 |
| Moss Electronic Distributing Co., Inc. | 84-87 |

| | |
|-------------------------------|-------|
| National Radio Institute | 3, 15 |
| National Schools | 5 |

| | |
|------------------------------|----------|
| Opportunity Adlets | 132, 133 |
| Oxford Components, Inc. | 134 |

| | |
|---------------------------------|-----|
| Paco Electronics Co., Inc. | 18 |
| Philco Techrep Division | 140 |
| Picture Tube Outlet | 139 |
| Prentice-Hall, Inc. | 133 |
| Progressive Edu-Kits Inc. | 120 |

| | |
|---------------------------------|---------------------|
| RCA Electron Tube Division | 102-103, Back Cover |
| RCA Institutes | 21 |
| Radiart Corp. | 8 |
| Radio Receptor Co., Inc. | 90 |
| Radio Shack Corp. | 109 |
| Raytheon Manufacturing Co. | 16-17 |
| Rinehart & Co., Inc. | 83, 114 |

BRANCH ADVERTISING OFFICES: Chicago: 1025 Harlem Ave., Glenview, Ill., Glenview 4-6900. Los Angeles: Harker-Husted-Coughlin, 600 South New Hampshire, Tel. DU'nkirk 7-2228. San Francisco: Harker-Husted-Coughlin, 444 Market St., Tel. GArfield 1-2481.

FOREIGN AGENTS: Great Britain: Atlas Publishing and Distributing Co., Ltd., 18 Bride Lane, London E.C. 4. Printed in the United States of America

| | |
|---|----------------------------------|
| Sams (Howard W.) & Co., Inc. | 25, 121 |
| Seco Manufacturing Co. | 122 |
| Seg Electronics | 81 |
| Service Instruments Corp. | 89, 110, 124, 131, 132, 134, 139 |
| Sonotone Corp. | 104 |
| Sprayberry Academy of Radio Television | 19 |
| Stereo-Ette Co. | 115 |
| Supreme Publications | 117 |

| | |
|---|--------------------|
| Tab | 126 |
| Trio Manufacturing Co. | 128 |
| Triplett Electrical Instrument Co. | Inside Front Cover |
| Tri-State College | 118 |
| Tung-Sol Electric Co. | 24 |

| | |
|-----------------------------------|----|
| University Loudspeakers Inc. | 22 |
|-----------------------------------|----|

| | |
|------------------------|-----|
| Wen Products Inc. | 121 |
|------------------------|-----|

| | |
|-------------------|-----|
| Xcelite Inc. | 124 |
|-------------------|-----|

SCHOOL DIRECTORY PAGE 135

- Baltimore Technical Institute
- Candler System Co.
- Indiana Technical College
- Milwaukee School of Engineering
- Pacific International College of Arts & Sciences
- Valparaiso Technical Institute



IT'S TRUE WHAT THEY SAY ABOUT STEREO

Any stereo set-up—no matter what the cost—is only as good as the quality of the components that go into it. To put it another way, the quality you want can only be supplied by a company with the experience in sound engineering that the manufacture of superior stereo components requires.

Everyone agrees that the making of high-fidelity sound equipment is an extremely technical, highly specialized phase of the electronics industry. And that years of experience are required before a high degree of manufacturing excellence can be achieved. For over twenty-five years, Bogen has been making special sound systems of proven excellence for schools, theatres, offices and industrial plants—as well as hi-fi components.

Here is the business end of a typical Bogen school sound system.

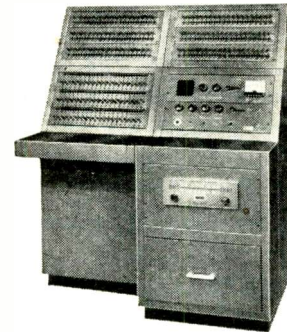

Wherever professional sound quality is needed—you'll find Bogen, the sound equipment made by professionals. Best of all, the same sound quality that engineers and musicians insist on is yours to supply—and enjoy—with Bogen stereo high-fidelity components.

ILLUSTRATED BOOKLET: 64-page explanation of hi-fi and stereo, "Understanding High Fidelity-Stereo Edition". Enclose 25c. BOGEN-PRESTO CO., Paramus, N.J. A Division of the Siegler Corporation.

BOGEN
HIGH FIDELITY COMPONENTS



TV PICTURE TUBES

At Lowest Prices

| | | | | | |
|-------------|---------|-------------|---------|------------|---------|
| 10BP4 | \$ 7.95 | 17BP4 | \$10.95 | 21AMP4 | \$19.95 |
| 12LP4 | 8.95 | 17CP4 | 17.00 | 21ATP4 | 20.95 |
| 14B/CP4 .. | 9.95 | 17GP4 | 17.60 | 21AUP4 | 20.95 |
| 16DP4 | 14.95 | 17HP4 | 13.60 | 21EP4 | 14.95 |
| 16EP4 | 15.90 | 17LP4 | 13.60 | 21FP4 | 15.95 |
| 16GP4 | 15.90 | 17QP4 | 11.95 | 21WP4 | 17.30 |
| 16KP4 | 10.95 | 17TP4 | 19.30 | 21YP4 | 15.95 |
| 16LP4 | 10.95 | 19AP4 | 19.30 | 21ZP4 | 14.95 |
| 16RP4 | 10.95 | 20CP4 | 13.90 | 24CP4 | 23.95 |
| 16WP4 | 15.20 | 20HP4 | 17.95 | 24DP4 | 26.95 |
| 16TP4 | 10.95 | 21AP4 | 22.10 | 27EP4 | 39.95 |
| 17AVP4 | 15.20 | 21ALP4 | 20.95 | 27RP4 | 39.95 |

1 year warranty

Aluminized Tubes \$5.00 more than above prices. Prices include the return of an acceptable similar tube under vacuum. These tubes are manufactured from reprocessed used glass bulbs. All parts and materials including the electron gun are brand new.

ALL PRICES FOB CHICAGO, ILLINOIS. Deposit required when old tube is not returned, refundable at time of return. 25% required on COD shipments. Old tubes must be returned prepaid. Tubes shipped Rail Express.

WRITE FOR COMPLETE LIST.

PICTURE TUBE OUTLET

3032 Milwaukee Ave., Chicago 18, Ill.
Dickens 2-2048

TAPE RECORDERS



HI-FI COMPONENTS SLEEP LEARN KITS

MERITAPE Low cost, high quality recording tape, in boxes or cans. UNUSUAL VALUES FREE 1959 CATALOG DRESSNER, 69-02RE 174 St., Flushing 65, N.Y.

LOOK
no further . . . if you're searching for hi-fi savings. Write us your requirements now.
Key Electronics Company
120-A Liberty St., N.Y. 6, N.Y.
EV 4-6071

MAIL ORDER HI-FI
You can now purchase all your HI-FI from one reliable source and be assured of perfect delivery. Carston makes delivery from NY stock on most HI-FI. Recorders and tape within 24 hours. SEND US A LIST OF YOUR HI-FI REQUIREMENTS FOR OUR WHOLESALE QUOTATION and our FREE wholesale catalogue.
CARSTON STUDIOS 215-RD E. 88 St. New York 28, N. Y.

SAVE TIME with SENCORE
SENCORE Handy "36" R C-Substitution Unit
"36"—Most Often Needed Components at YOUR Fingertips!
3 Pole, 12 position switch individually selects one of the "36" components for direct substitution.



- Contains:
- ★ 12—1 watt 10% resistors from 10 ohms to 5600 ohms
 - ★ 12—½ watt 10% resistors from 10K ohms to 5.6 megohms
 - ★ 10—600 volt capacitors from 100-mmf. to .5 mfd.
 - ★ 1—10 mfd., 450V Electrolytic ★ 1—40 mfd., 450V Electrolytic

★ For Shop, Lab, or outside service
SERVICE INSTRUMENTS CORPORATION
121 OFFICIAL ROAD, ADDISON, ILLINOIS

ONLY \$1295 Model H-36 DEALER NET

Completely Isolated Available at all Parts Distributors

See other SENCORE ads in this issue.

Learn TRANSISTOR, COMPUTER OR RADAR TECHNOLOGY at home

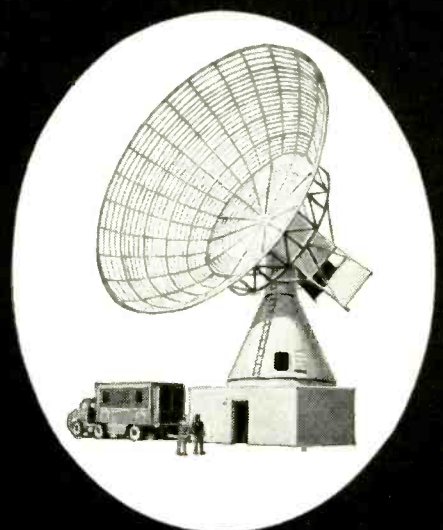
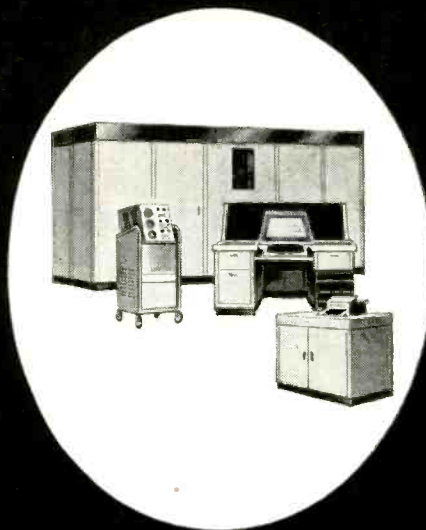

Prepare now for advancement...and for a secure and profitable career in one of these growing fields of electronics

CHOOSE FROM 6 PROVEN COURSES

1. **SEMICONDUCTORS**—Transistor Principles and Practices. Learn Theory, construction, application of all types of transistors.
2. **INTRODUCTION TO ANALOG COMPUTERS**—Covers theories and fundamentals of all makes of analog computers.
3. **ANALOG COMPUTER SYSTEMS (Advanced Level)**—Covers the analog system concepts and methods.
4. **AUTOMATIC DIGITAL COMPUTERS**—Digital computer theory, maintenance, installation, programming.
5. **PRINCIPLES OF RADAR CIRCUITS AND EQUIPMENT**—Introduction to, and detailed study of radar fundamentals.
6. **RADAR SYSTEMS PRINCIPLES AND PRACTICES (Advanced Level)**—Applications of radar components, systems, design... performance measurement.

MAIL COUPON TODAY FOR FULL INFORMATION

| | | |
|--|---|-------|
| PHILCO TECHNOLOGICAL CENTER 22nd and Lehigh Ave., Phila. 32, Pa. | | TCR-1 |
| Please send free booklet and complete course information on subjects checked below. (No obligation) | | |
| <input type="checkbox"/> 1. Semiconductors <input type="checkbox"/> 2. Intro. to Analog Comp. <input type="checkbox"/> 3. Analog Comp. Systems | <input type="checkbox"/> 4. Automatic Digital Comp. <input type="checkbox"/> 5. Principles of Radar <input type="checkbox"/> 6. Radar Systems | |
| NAME _____ | | |
| COMPANY _____ POSITION _____ | | |
| ADDRESS _____ | | |
| CITY _____ STATE _____ | | |

Expand your knowledge in one of these rapidly advancing fields of electronics and you'll be set for a secure and profitable future. Transistor technology is becoming one of the biggest fields in electronics. The use of automatic computers in automated factories, business offices and military systems is outpacing the technical manpower needed to build and maintain them. New developments in radar have given new life to this dynamic field. Electronics men are in demand, but it takes specialists to land the big jobs. Now's the time to prepare... advance and prosper in this new era.

Learn with proven home study courses from the Philco Technological Center

Get a practical, working knowledge with proven courses developed by experts in the electronics industry... men who know what kind of knowledge you need... specialists in electronics and training.

The Philco Technological Center is a department of Philco TechRep Division, one of the world's leading electronics field engineering organizations.

Send for full details. No salesman will call.



NOW... AN *Electro-Voice*[®] PUBLIC ADDRESS SPEAKER FOR ANY APPLICATION

For SUPERIOR SOUND . . . CONTROLLED COVERAGE

See Electro-Voice public address projectors. They offer perfect voice penetration and full-range "musicasting." They're weatherproof, splashproof and blastproof.



\$75.00
LIST

Model 848T Long Throw CDP* (With 1000-cycle concentrating horn). For projecting intelligible, extended-range sound over great distances.

*CDP (Compound Diffraction Projection) Design Patent 1,69,904. Additional Patent Pending.

Model 844 30-Watt Paging Unit. Compact, economical unit for quality, high-efficiency voice reproduction.

\$34.50
LIST

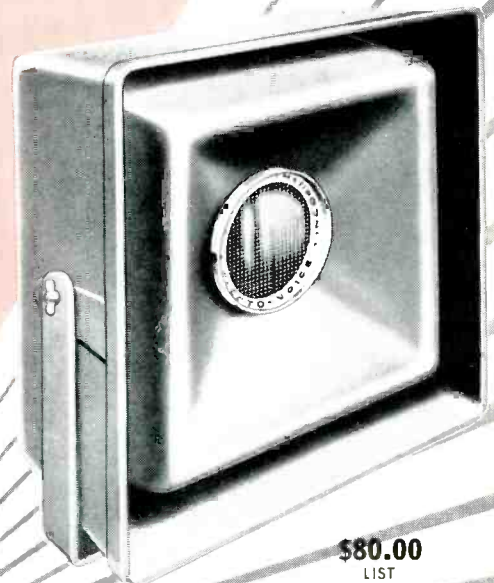

\$80.00
LIST

The New Electro-Voice Musicaster. Rugged, weatherproof high-fidelity speaker system for high-quality music reproduction.



Model 848 30-Watt CDP. For wide-angle coverage and extended range. Standard of the industry.

\$75.00
LIST



Model 847 25-Watt CDP. Smaller version of Model 848.

\$46.33
LIST



Model LS-12. For interior installations requiring full-range response.

\$32.50
LIST



Model LS-8. Smaller version of Model LS-12.

\$30.00
LIST

THESE ELECTRO-VOICE MICROPHONES ARE
ESPECIALLY OUTSTANDING FOR PUBLIC ADDRESS

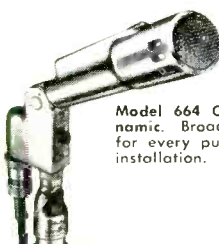

\$85.00
LIST

Model 664 Cardioid Dynamic. Broadcast-quality for every public address installation.



\$49.50
LIST

Model #51 Cardioid Crystal. Excellent, wide-range, all-purpose microphone.

The Sound of Electro-Voice . . . Assures Superior Installations, Customer Satisfaction, Your Reputation!

Electro-Voice[®]

ELECTRO-VOICE, INC.
BUCHANAN, MICH.

In Canada: E-V of Canada Ltd., 73 Crockford Blvd., Scarborough, Ontario
Cables: ARLAB



The familiar
RCA carton
is the hallmark of
a quality repair job.

You know, yourself, how comforting it is to see a familiar face among strangers. Well, to the majority of your customers, TV is strange, too. They don't understand it. They count on you to "keep 'em going". And, the "familiar face" is the famous RCA monogram. When they see it on that famous red/black carton, *they know you know your business...* and use the best replacement tubes and parts money can buy.

You can cash in on the built-in prestige of RCA. Make this best-known name your stock-in-trade. Your Authorized RCA Tube Distributor handles a complete line of RCA Tubes to meet your service needs.



RADIO CORPORATION OF AMERICA
Electron Tube Division

Harrison, N. J.