

Build an Accurate Transistor Tester

FEBRUARY 1959

# Radio-Electronics

HUGO GERNSBACK, Editor

Low-Cost Amplifier for Your Tweeter

All-Transistor 10-Meter Receiver

Standing Waves Kill Color

All About Reflex Enclosures

The Parametric Amplifier

(See Page 4)

EDWARD GURTOWSKI 3-60  
1452 KENNORST BLVD  
(KENNORST)  
READING PA

Canada

# Have 310 • Will Travel...

*Light!*

Burton Browne Advertising

- Hand size, but with the features of a full-size V-O-M.
- 20,000 ohms per volt DC; 5,000 AC.
- EXCLUSIVE SELECTOR SWITCH speeds circuit and range settings. The first miniature V-O-M with this exclusive feature for quick, fool-proof selection of all ranges.
- SELF-SHIELDED Bar-Ring Instrument; permits checking in Strong Magnetic Fields.
- Fitting interchangeable test prod tip into top of tester makes it the common probe, thereby freeing one hand.
- Unbreakable plastic meter window.
- BANANA-TYPE JACKS—positive connection and long life.



MODEL 100



The most comprehensive test set in the Triplet line is Model 100 V-O-M Clamp-On-Ammeter Kit, now available at distributors. The world's most versatile instrument—a complete accurate V-O-M plus a clamp-on-ammeter with which you can take measurements without stripping the wires. Handsome, triple-purpose carton holds and displays all the components: Model 310 miniaturized V-O-M, Model 10 Clamp-On-Ammeter, Model 101 Line Separator, No. 311 extension leads and a Leather Carrying-Case, which neatly accommodates all the components. Model 101 literally makes it possible to separate the two sides of the line when using Model 10. Extension leads permit use of Model 10 at a distance from the V-O-M. Complete Model 100 is only \$59.50.



For full information see your Triplet distributor  
or write

**TRIPLET ELECTRICAL INSTRUMENT COMPANY • BLUFFTON, OHIO**



PANEL METERS

AND A VOM FOR EVERY PURPOSE AND EVERY PURSE

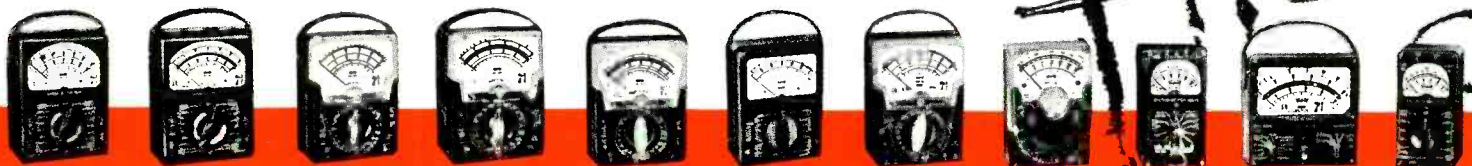

630 630-A 630-PL 630-APL 630-NA 630-T 631 310 666-HH 625-NA 666-R

# Here's a NEW Way to Reach the Top in TV SERVICING

**ALL PRACTICE METHOD—  
PROFESSIONAL TECHNIQUES**

**Includes 17" picture tube, all other tubes, components for TV receiver. Also 5 inch professional type Scope and highly accurate Signal Generator. Training low in cost; monthly terms.**



**I**F YOU HAVE some Television or Radio experience, or if you know basic Television-Radio principles but lack experience—NRI's Professional Television Servicing course can equip you to go places in TV servicing. This advertisement is your personal invitation to get a free copy of our booklet which describes this training in detail.

## You Get Color-TV Textbooks Early

The day you enroll, N.R.I. sends you special Color-TV books to speed your knowledge and understanding of this vast, growing phase of Television. Many full color pictures and diagrams help you recognize defects and help you learn how to correct them quickly and properly. To cash in on the coming Color-TV boom you'll need the kind of knowledge and experience this N.R.I. training gives.

## You Learn-By-Doing "All The Way"

This is 100% learn-by-doing, practical training. We supply all the components, all tubes, including a 17" picture tube, and comprehensive manuals covering a thoroughly planned program of practice. You learn how experts diagnose TV receiver defects quickly. You see how various defects affect the performance of a TV receiver—picture, sound and color; learn to know the causes of defects, accurately, easily, and how to fix them.

You do more than just build circuits. You get practice recognizing, isolating and fixing innumerable TV receiver troubles. You get actual experience aligning TV receivers, eliminating interference, using germanium crystals to rectify the TV picture signal, obtaining maximum brightness and definition by properly adjusting the ion trap and centering magnets, etc. There isn't room to list all the servicing experience you get.

**Graduate C. Dority of Silver Spring, Md., says:**

*"Your course is so thorough that anyone interested in the challenge of servicing shouldn't miss this opportunity. I can find my way around a TV Chassis as easy as I can my own home as a result of your course."*

**James D. McIngvale of Lake Cormorant, Miss., says:**

*"I have serviced about 95% of common Television complaints. A year ago I would not have known where to start. I can now fix a TV receiver defect in minutes when it used to take hours."*

## Get Details Free—Mail Coupon

Once again—if you want to go places in TV servicing, we invite you to find out what you get, what you practice, what you learn from NRI's course in Professional Television Servicing. See pictures of equipment supplied, read what you practice. Judge for yourself whether this training will further your ambition to reach the top in TV servicing. We believe it will. We believe many of tomorrow's top TV servicemen . . . for black and white, UHF and Color-TV . . . will be graduates of this N.R.I. training. Mail the coupon now. There is no obligation. National Radio Institute, Dept. 9BFT, Washington 16, D.C.

**Oldest and Largest Home Study  
Radio-Television School**

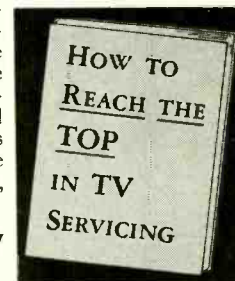

**National Radio Institute, Dept. 9BFT  
Washington 16, D.C.**

Please send my FREE copy of "How to Reach the Top in TV Servicing." I understand no salesman will call.

Name \_\_\_\_\_ Age \_\_\_\_\_

Address \_\_\_\_\_

City \_\_\_\_\_ Zone \_\_\_\_\_ State \_\_\_\_\_

*Accredited Member National Home Study Council*



FEBRUARY, 1959

# Radio-Electronics

Formerly RADIO-CRAFT ■ Incorporating SHORT WAVE CRAFT ■ TELEVISION NEWS ■ RADIO & TELEVISION

## EDITORIAL

- 35 US Wants Electronic Inventions—Hugo Gernsback

## AUDIO—HIGH FIDELITY

- 36 Amplifier for Your Tweeter—Robert G. Vaughn
- ✓ 38 All About the Reflex Enclosure, Part I—P. G. A. H. Voigt
- 40 Toy Electric Organ
- 41 Stabilizing Feedback Amplifiers, Part II—Herbert I. Keroes
- 44 New Discs and Tapes, Stereo and Mono—Reviewed by Chester Santon

## ELECTRONICS

- ✓ 46 Electronics in the Classroom—Sol D. Prensky
- 49 Duo-Rectifier Power Supply—Norman V. Becker
- 50 Electronics in Steel
- 52 Five Relays in One—Ed Bukstein
- 53 Man-Woman Detector

## WHAT'S NEW?

- 54 Pictorial Reports of New Developments

## TEST INSTRUMENTS

- ✓ 56 Direct-Reading Transistor Tester—Elliott A. McCready
- 58 Light-Powered Frequency Standard—Rufus P. Turner
- 60 Electronic Scope Switch—L. B. Hedge

## RADIO

- ✓ 64 Transistors for 10 Meters—Don Hall, W50BS
- 78 The Variable Reactance Amplifier—Fred Shunaman
- 83 ABC's of Mobile Radio, Part II—Leo G. Sands

## TELEVISION

- 94 Who Owns the Signal?—David Lachenbruch
- 100 TV Service Clinic—Conducted by Robert G. Middleton
- 109 New Sound Detector System for TV—Robert F. Scott
- 111 Standing Waves and No Color—Robert G. Middleton

- |                                  |                         |
|----------------------------------|-------------------------|
| 150 Books                        | 140 Noteworthy Circuits |
| 145 Business and People          | 134 On the Market       |
| 123 Correction                   | 126 Patents             |
| 18 Correspondence                | 118 Technicians' News   |
| 148 Literature                   | 143 Technotes           |
| 128 New Tubes and Semiconductors | 121 Try This One        |
| 6 News Briefs                    | 146 50 Years Ago        |

## ON THE COVER

(Story on page 78)

William Sichak, director of the radio communications laboratory of ITT Labs, is adjusting a variable reactance amplifier designed to operate at about 900 mc. In the insert is the variable-capacitance diode responsible for the amplifier action.

Color original by ITT Labs, research division of International Telephone & Telegraph Co.

- Hugo Gernsback .....Editor and Publisher
- M. Harvey Gernsback .....Editorial Director
- Fred Shunaman .....Managing Editor
- Robert F. Scott .....WZPWG, Technical Editor
- Larry Steckler .....Associate Editor
- I. Queen .....Editorial Associate
- Robert G. Middleton .....Television Consultant
- Elizabeth Stalcup .....Production Manager
- Cathy Coccozza .....Advertising Production
- Wm. Lyon McLaughlin .....Tech. Illustration Director
- Sol Ehrlich .....Art Director
- Fred Neinast .....Staff Artist
- Lee Robinson .....General Manager
- John J. Lamson .....Sales Manager
- G. Aliquo .....Circulation Manager
- Adam J. Smith .....Director, Newsstand Sales
- Robert Fallath .....Promotion Manager



Average Paid Circulation Over 199,000



RADIO-ELECTRONICS is indexed in *Applied Science & Technology Index* (Formerly *Industrial Arts Index*)

RADIO-ELECTRONICS, February, 1959, Vol. XXX, No. 2. Published monthly at Mt. Morris, Ill., by Gernsback Publications, Inc. Second-Class mail privileges authorized at Mt. Morris, Ill. Copyright 1959 by Gernsback Publications, Inc. All rights reserved under Universal, International and Pan-American Copyright Conventions.

SUBSCRIPTION RATES: U.S., U.S. possessions and Canada, \$4.00 for one year; \$7.00 for two years; \$10.00 for three years; single copies 35c, Pan-American countries \$5.00 for one year; \$9.00 for two years; \$13.00 for three years. All other countries \$5.50 a year; \$10.00 for two years; \$14.50 for three years.

SUBSCRIPTIONS: Address correspondence to Radio-Electronics, Subscription Dept., 154 West 14th St., New York 11, N.Y. When requesting a change of address, please furnish an address label from a recent issue. Allow one month for change of address.

GERNSBACK PUBLICATIONS, INC. Executive, Editorial and Advertising Offices, 154 West 14th St., New York 11, N.Y. Telephone Algonquin 5-7755. Hugo Gernsback, Chairman of the Board; M. Harvey Gernsback, President; G. Aliquo, Secretary.

BRANCH ADVERTISING OFFICES and FOREIGN AGENTS listed on page 157.

POSTMASTER: If undeliverable, send Form 3579 to: RADIO-ELECTRONICS, 154 West 14th St., New York 11, N.Y.

\*Trademark registered U. S. Pat. Office.

RADIO-ELECTRONICS

**GREATEST  
ADVANCE IN  
SHOP-METHOD  
HOME TRAINING**

# EARN MORE MONEY... GET INTO TELEVISION ELECTRONICS - RADIO

**Learn ALL 8 PHASES in ONE MODERN HOME-STUDY COURSE**  
At Home - In Spare Time

## YOU GET ALL THIS NEWEST PRACTICAL EQUIPMENT

- Parts to build a modern TV set, including all tubes plus a large screen Picture Tube
- Parts to build a powerful Superhet Receiver, standard broadcast and short wave
- Parts to conduct many experiments and build Continuity Checker, RF Oscillator, TV Circuits, Audio Oscillator, TRF Receiver, Signal Generator
- A Valuable Professional Multitester



**19 BIG KITS  
YOURS TO KEEP**

## YOUR NATIONAL SCHOOLS TELERAMA COURSE COVERS ALL 8 PHASES

- |                                    |                                |
|------------------------------------|--------------------------------|
| 1. TELEVISION, INCLUDING COLOR TV  | 5. PREPARATION FOR FCC LICENSE |
| 2. RADIO, FM AND AM                | 6. AUTOMATION                  |
| 3. INDUSTRIAL ELECTRONICS          | 7. RADAR AND MICRO WAVES       |
| 4. SOUND RECORDING AND HI FIDELITY | 8. COMMUNICATIONS              |

**YOU ARE NEEDED IN THE TELEVISION-ELECTRONICS-RADIO INDUSTRY!**  
You can build a secure future for yourself if you get into Electronics NOW! Today's shortage of trained technicians creates tremendous opportunities. National Schools Shop-Method trained technicians are in constant and growing demand for high-pay jobs in Broadcasting and Communications, Electronic Research, Servicing and Repair, and many other branches.

Let National Schools, a Resident Technical School for over 50 years train you for today's unlimited opportunities in electronics! Our Shop Method trains you to be a MASTER-TECHNICIAN. Completely up to date, developed by experienced instructors and engineers, your Telerama Course will teach you all phases of the industry quickly, clearly and correctly. You can master the most modern projects, such as Color TV, printed circuits - even prepare for FCC License without taking a special

course. You can handle sales, servicing, manufacturing, or make good money in your own business. SEND FOR FACTS TODAY!

**EARN AS YOU LEARN.** Many of our students earn their entire tuition and more in Spare Time jobs we show them how to do while learning.

**YOU GET EVERYTHING YOU NEED** - Clear, profusely illustrated lessons, shop-tested manuals, modern circuit diagrams, practical job projects - all the valuable equipment shown above

- many other materials and services - consultation privilege with our qualified staff, and Graduate Employment Service. EVERYTHING YOU NEED for outstanding success in Electronics

### RESIDENT TRAINING AT LOS ANGELES

If you wish to take your training in our Resident School at Los Angeles, the world's TV capital, start NOW in our big, modern Shops, Labs and Radio-TV Studios. Here you work with latest Electronic equipment - professionally installed - finest, most complete facilities offered by any school. Expert, friendly instructors. Personal attention. Graduate Employment Service. Help in finding home near school - and part time job while you learn. Check box in coupon for full information.



**FREE!** Fully illustrated "Career" Book in TV-Radio-Electronics. PLUS actual sample lesson - yours at no cost, no obligation. CLIP COUPON NOW... MAIL IT TODAY!

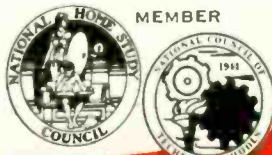

APPROVED FOR G. I. TRAINING  
**NATIONAL SCHOOLS**

4000 S. FIGUEROA ST., LOS ANGELES 37, CALIF.

## NATIONAL SCHOOLS

TECHNICAL TRADE TRAINING SINCE 1905  
LOS ANGELES 37, CALIFORNIA

### GET FAST SERVICE - MAIL NOW TO

NATIONAL SCHOOLS, DEPT. RG-29

4000 S. FIGUEROA ST.  
LOS ANGELES 37, CALIF.

Rush free TV-Radio "Opportunity" Book and sample lesson. No salesman will call.

NAME \_\_\_\_\_ AGE \_\_\_\_\_

ADDRESS \_\_\_\_\_

CITY \_\_\_\_\_ ZONE \_\_\_\_\_ STATE \_\_\_\_\_

Check if interested ONLY in Resident School training at Los Angeles.  
VETERANS: Give date of Discharge \_\_\_\_\_

# NEWS BRIEFS

**WORLD'S FASTEST** switching diode operates at a speed of about 50-trillionth of a second (.05 millimicrosecond) and is so tiny it's virtually invisible to the naked eye. Yet it can be mass-produced and already is being turned out in experimental quantities by the Sperry Semiconductor Div. of Sperry Rand Corp., South Norwalk, Conn.

The semiconductor, which measures 12/10,000 inch, is about half the thickness of a fine human hair, and is claimed to be 100 times faster than the most rapid switching diodes previously developed. It's designed to speed up computer operations, and, according to Sperry Semiconductor technical director B. J. Rothlein, may make possible computers which can complete in less than 3 days a problem which requires a full year of continuous operation in present computers.

The elements of the semiconductor are aluminum and silicon. A slight increase in voltage causes current to flow by means of the "avalanche effect," whereby each electron creates a chain reaction which almost instantly carries current across the four-millionths-of-an-inch junction. A slight decrease in the voltage reduces the speed of the electrons and stops the chain reaction.

**ERNST WEBER**, (left) president of the Polytechnic institute of Brooklyn, (N.Y.) and of the Polytechnic Research and Development Corp., was elected president of the Institute of Radio Engineers for 1959. He succeeds Donald G. Fink, research director of Philco Corp., Philadelphia. The new IRE vice president is Donald B. Sinclair (right), vice president and chief engineer of General Radio Co., West Concord, Mass., succeeding Carl-Eric Granqvist, director of Svenska Aktiebolaget Gas-accumulator, Stockholm-Lidingo, Sweden.



**"SUNKEN" RADIOTELESCOPE**, described as the world's largest, will be built by the University of Illinois and the Office of Naval Research near Danville, Ill.

The telescope will be built in a huge ravine, the sides and bottom of which will be smoothed and covered with metal, forming a giant reflector to focus radio waves into a line of receiving antennas about 150 feet above the bottom of the trough. These antennas will be supported by tall towers down the center of the reflector.

The radiotelescope which currently is the world's largest, Manchester University's observatory at Jodrell Bank, England (RADIO-ELECTRONICS, February, 1958, page 32) has been forced to turn to the public for funds to keep it in full-time operation. The telescope provided invaluable scientific data in tracking moonrockets and satellites. Because of financial troubles, its operation has been curtailed to 18 hours a day. The university is appealing for contributions from the British public to help make up the deficit.

**ELECTRONS WITH "NEGATIVE MASS"** are believed to have been discovered in recent solid-state experiments reported to the American Physical Society. The indication that there may be such a thing as "un-mass" is said by physicists to have no counterpart in previous scientific experience. It was said to be analogous to the discovery of materials which respond to gravity by "falling up" or which move the wrong way when pushed.

The discoveries were recorded during "cyclotron resonance" experiments in which a magnetic field was applied to germanium crystals cooled to  $-452^{\circ}\text{F}$ . When a few of the electrons whirling around the nuclei of the germanium atoms were lined up by the magnetic field, a rotating field of rf energy was

applied.

The presence of the orbiting electrons was measured through their absorption of energy when the applied rf wave had the same frequency as the rotating electrons. This is a relatively common cyclotron resonance experiment. The recent experiments, however, showed dips rather than peaks in the absorption pattern, indicating that electrons were rotating in the direction opposite from the rotation of the rf wave field. Physicists said this indicated that there may be electrons which behave as though they have negative mass, at least in some solids.

The experiments were conducted by Dr. George C. Dousmanis, Dr. Roscoe C. Williams, R. C. Duncan Jr. and J. J. Thomas of RCA Laboratories, Princeton, N. J., and a preliminary report was published in the American Physical Society's *Physical Review Letters*.

If the preliminary conclusions are verified, the discovery could lead to entirely new types of amplifiers and other electronic applications and perhaps to even more significant and basic applications of "un-mass" in other physical fields.

**AM STEREO BROADCASTING** has been proposed to the FCC by Philco Corp., Philadelphia, which has asked for permission to conduct extensive field tests of its compatible stereophonic system on the AM broadcast band.

Philco proposes a combination of amplitude and phase modulation and claims that receivers and converters can be produced economically, that stereo broadcasts can be received monophonically without distortion on present AM receivers and that its own test results have indicated excellent stereo and mono reception.

Here's a basic description of the Philco system:

For stereo broadcasting, the sum of left and right audio tracks would be transmitted by the conventional amplitude modulation method. A signal containing the stereophonic differences between the two audio tracks would be transmitted on the same carrier frequency, but using phase modulation. However, audio frequencies below 300 cycles would be identical on both tracks, because, Philco says, "we do not observe stereophonic effects to any marked extent at low audio frequencies."

Stereo-equipped receivers would contain a matrixing circuit which would separate the audio tracks and feed  
(Continued on page 10)



In Spare Time at Home—Prepare for a Better Job—or  
Your Own Business in One of the Many Branches of

# ELECTRONICS



You build and keep this valuable Vacuum Tube **VOLTMETER**

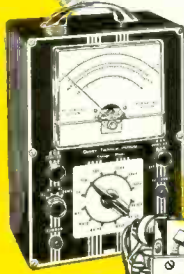

You build and keep this 5-inch **COLOR OSCILLOSCOPE**—almost a "must" for TV servicing

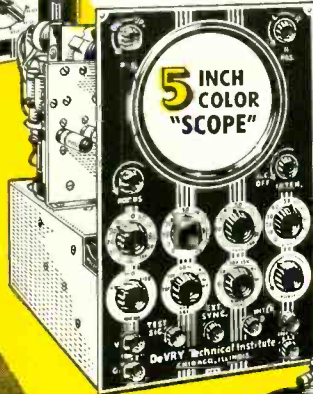

## RADIO - TELEVISION - RADAR

If you are seeking a better job or a business of your own, the appealing field of Television-Radio-Electronics offers **REAL PROMISE!**

In this fast-growing field, trained Electronic technicians find many good-paying, interesting jobs in manufacturing, installing, operating, servicing. Equally important is the fact that these are **GOOD JOBS**—offering the kind of a future that an untrained man often dreams about.

No previous technical experience or advanced education needed. Prepare for this profitable field in your spare time at home, or in our modern Chicago or Toronto Laboratories. Nothing else like it! Send for **FREE** details.



### HOME MOVIES . . .

. . . make important points crystal clear. Speeds your learning. It's almost like having an instructor at your side!

## COLOR TV

DeVry Tech's program also includes training in Color Television

### MILITARY SERVICE

If you are subject to military service, the information we have should prove very helpful. Mail coupon today.



**21 INCH**

Build and keep this **BIG DeVry Engineered TV set**—easily converted to U.H.F. (DeVry offers another home training, but without the TV set.)

### EARN WHILE YOU LEARN

After you get part of DeVry Tech's training with equipment at home, you may then in your spare time, begin to earn real money servicing Radio and Television sets.

## Your GUIDE

### to Profitable Job Opportunities

- TV-Radio Broadcast Technician
- Color Television Specialist
- Radar Operator • Laboratory Technician
- Airline Radio Man • Computer Specialist
- Quality Control Manager
- Your Own Sales & Service Shop
- . . . **PLUS MANY OTHERS**

## YOU GET THE SAME EMPLOYMENT SERVICE

that has helped thousands of our graduates toward fine careers in Electronics.



Send for **FREE BOOKLET TODAY!**

Accredited Member of National Home Study Council

"One of North America's  
Foremost Electronics  
Training Centers"



## DeVRY TECHNICAL INSTITUTE

Formerly DeForest's Training, Inc.  
CHICAGO 41, ILLINOIS



You work over  
**300**  
Learn-By-Doing  
projects

Build over 300 practical projects from many shipments of Radio-Electronic parts. You build and operate TV-Radio circuits . . . wireless microphone . . . and many other major projects—all designed to provide outstanding practical experience at home.

## ACT NOW!

Get information-packed publication **FREE!** Mail coupon today.

### DeVRY TECHNICAL INSTITUTE

4141 Belmont Ave., Chicago 41, Ill., Dept. RE-2-P

Please give me your **FREE** booklet, "Electronics and YOU," and tell me how I may prepare to enter one or more branches of Electronics.

Name \_\_\_\_\_ Age \_\_\_\_\_

PLEASE PRINT

Street \_\_\_\_\_ Apt. \_\_\_\_\_

City \_\_\_\_\_ Zone \_\_\_\_\_ State \_\_\_\_\_

Canadian residents address DeVry Tech of Canada, Ltd.  
626 Roselawn Ave., Toronto 12, Ontario

2044

# Independent TV-Radio Service Dealers:

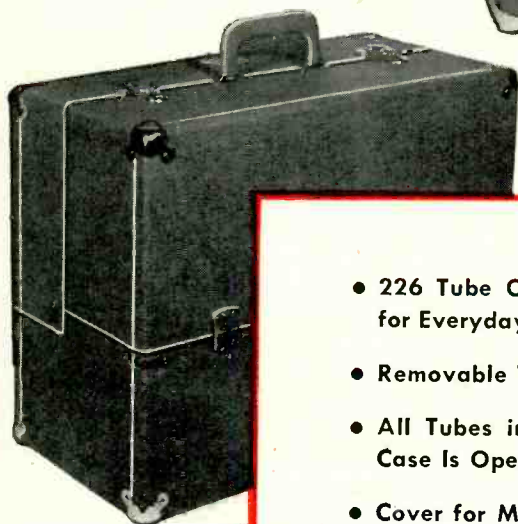

Here are a few of the reasons why the Raytheon Senior Tube Case is tops:

- 226 Tube Capacity — Perfect for Everyday Servicing
- Removable Tool Box Unit
- All Tubes in Full View when Case Is Open
- Cover for Miniature Tube Section
- Solid Wood, Locked Corner Construction
- Brass Finished Hardware
- Reinforced Stress Points
- Modern Airplane-Luggage Styling



**RAYTHEON MANUFACTURING COMPANY**  
**DISTRIBUTOR PRODUCTS DIVISION**  
**DEALER PRODUCTS DEPARTMENT**

Newton 58, Mass., 55 Chapel Street • Chicago, Ill., 9501 Grand Ave. (Franklin Park)  
 Atlanta 6, Ga., 1202 Zonolite Rd. N.E. • Los Angeles 16, Calif., 5057 W. Washington Blvd.





# Special Offer for you

# RAYTHEON TUBE CASE COMBINATIONS!

Your choice of any two of the Raytheon home servicing items shown, *plus a genuine Raytheon Senior Tube Case (SP-Q-7645)* — that's the special home servicing combination offered to you by your Raytheon Tube Distributor. And he's making it very easy for you to obtain these useful kits.

Take advantage of this excellent opportunity to equip your technicians and improve your home servicing efficiency: Call your Raytheon Tube Distributor and make arrangements to outfit every man in your shop. There'll never be a better time than now.



#### TRUCK DECAL (SP-Q-7587)

A heavy duty, outdoor type decal ideal for trucks, doors or panels.

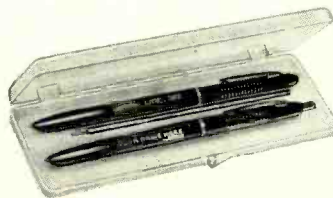

#### BALL POINT PEN AND PENCIL SET (SP-Q-7634)

A slim-line-styled pen with new push-top retractable action and a matching mechanical pencil.



#### TV SCREEN POLISHING CLOTH (SP-Q-7617)

Chemically treated to clean dust and dirt with a quick swipe over face of TV screen.



#### TV CUSHION (SP-Q-7639)

A foam plastic cushion faced with flexible Vinyl for longer life. Won't slip, ideal safeguard against marring TV case, floor, furniture.



#### DROP CLOTH (SP-Q-7542)

Protect your customers' floors and furniture when repairing TV sets in their homes.



#### SCREW DRIVER SET (SP-Q-7518)

Four-in-one Screw Driver Set. 4 blades — two sizes of standard heads, 1 Phillips head and 1 Punch. Interchangeable in quick adjusting, firm grasping chuck.

them to the proper amplifier-speaker combinations. Conventional mono receivers would simply detect the amplitude-modulated "sum" signal, reproducing both stereo tracks monophonically. When a broadcast station wishes to switch from stereo to mono programming, it would discontinue transmission of the phase-modulated (stereo-difference) channel.

The system differs markedly from the AM stereo method proposed by RCA, which would impose one complete stereo track on each sideband of the broadcast carrier (RADIO-ELECTRONICS, January, 1959, page 6).

**Calendar of Events**

- Indianapolis Hi-Fi Music Show, Jan. 30-Feb. 1, Hotel Antlers.
- San Francisco High Fidelity Show, Feb. 7-10, Cow Palace.
- Western Audio Engineering Convention Feb. 17-20, Biltmore Hotel, Los Angeles, Calif.
- Los Angeles High Fidelity Show, Feb. 18-22, Biltmore Hotel, RADIO-ELECTRONICS and the Gernsback Library will exhibit.
- Solid State Circuits Conference, Feb. 12-13, University of Pennsylvania, Philadelphia, Pa.
- Western Joint Computer Conference, March 3-5, Fairmont Hotel, San Francisco, Calif.
- Denver Hi-Fi Music Show, March 6-8, Hotel Cosmopolitan.
- British Electrical Engineers' Exhibition, March 17-21, London.
- Baltimore Hi-Fi Music Show, March 20-22, Lord Baltimore Hotel.
- IRE National Convention and Radio Engineering Show, March 23-26, Waldorf-Astoria Hotel (convention) and New York Coliseum (show).
- Symposium on Millimeter Waves, March 31-April 2, Engineering Societies Building, New York, N.Y.

**DIRECT COMPARISON** of the advertised characteristics of hi-fi components made by competing companies may soon be more meaningful, thanks to the industry standards now being formulated by the Institute of High Fidelity Manufacturers.

The difficulty in comparing current advertised characteristics is that the measurements are made by many different methods and sets of standards.

IHFMA's first set of standards—for measurement of tuners—is a 24-page document listing testing and measurement procedures agreed upon by manufacturer members of the institute. The standards aren't binding on any manufacturers, but the institute hopes they will meet industry-wide acceptance.

Substantial agreement has been reached on measurement standards for stereo and monophonic amplifiers and preamps, and a final document is due soon. Next on the schedule will be turntables and record changers, to be followed by loudspeakers standards and eventually by phono cartridges.

**10 NEW TV STATIONS** have started with the new year:

- WUFT, Gainesville, Fla..... 5
- KCIX, Nampa, Idaho..... 6
- KGLD, Garden City, Kans.....11
- WWOR-TV, Worcester, Mass.....14

(Continued on page 16)

# How to Pass

**An FCC License can be**

## Get Your FCC License

**We Guarantee  
to train you until you receive  
Your FCC License**

Completion of the Master Course (both Sections) will prepare you for a First Class Commercial FCC License with a radar endorsement. Completion of Section 1 only of the Master Course will prepare you for a Second Class Commercial FCC License. We guarantee to train and coach you, without any additional cost, until you receive the FCC License as indicated above. This guarantee is valid for the entire period of your enrollment agreement.

**Cleveland Institute Training Results in success with commercial FCC examinations . . . easily . . . and quickly.**

# Free!

**FIND OUT HOW:**

- 1. The new electronic devices can be handled by you**
- 2. To solve the problems that will stump your fellow technicians**
- 3. Training is Job Insurance when employment is tough to find . . . and more money for you when times are good**

**Mail Coupon NOW . . .**

(Commercial)

# FCC License Exams

## your Guarantee of Success in Electronics

## in a Minimum of Time

mail  
coupon  
NOW!

### here's proof of good jobs

Irving Laing:

"Your lessons are helping me a lot in my Navy work. You cover topics that were not presented by the Navy at the E.T. School. . . . Your course has helped greatly to get my 2nd class FCC ticket. I am now a radio and T.V. engineer at WTVS and WDTR in Detroit, Michigan."

*Irving L. Laing,  
15887 Robson,  
Detroit 27, Michigan*

## Get all 3 FREE



Accredited by The National Home Study Council

**Cleveland Institute of Radio Electronics**

Desk RE-26, 4900 Euclid Ave., Cleveland 3, Ohio



Please send FREE Booklets prepared to help me get ahead in Electronics. I have had training or experience in Electronics as indicated below:

- |   |   |
|---|---|
| <input type="checkbox"/> Military           | <input type="checkbox"/> Broadcasting       |
| <input type="checkbox"/> Radio-TV Servicing | <input type="checkbox"/> Home Experimenting |
| <input type="checkbox"/> Manufacturing      | <input type="checkbox"/> Telephone Company  |
| <input type="checkbox"/> Amateur Radio      | <input type="checkbox"/> Other.....         |

In what kind of work are you now engaged?.....

In what branch of Electronics are you interested?.....

Name..... Age.....

Address.....

City..... Zone..... State.....

Desk RE-26

## Receive All These Booklets FREE!

# A HYSTERISIS SYNCHRONOUS TURNTABLE KIT FOR 49<sup>50</sup>

✓ Check these outstanding features,  
they're exclusive with Gray at this LOW price

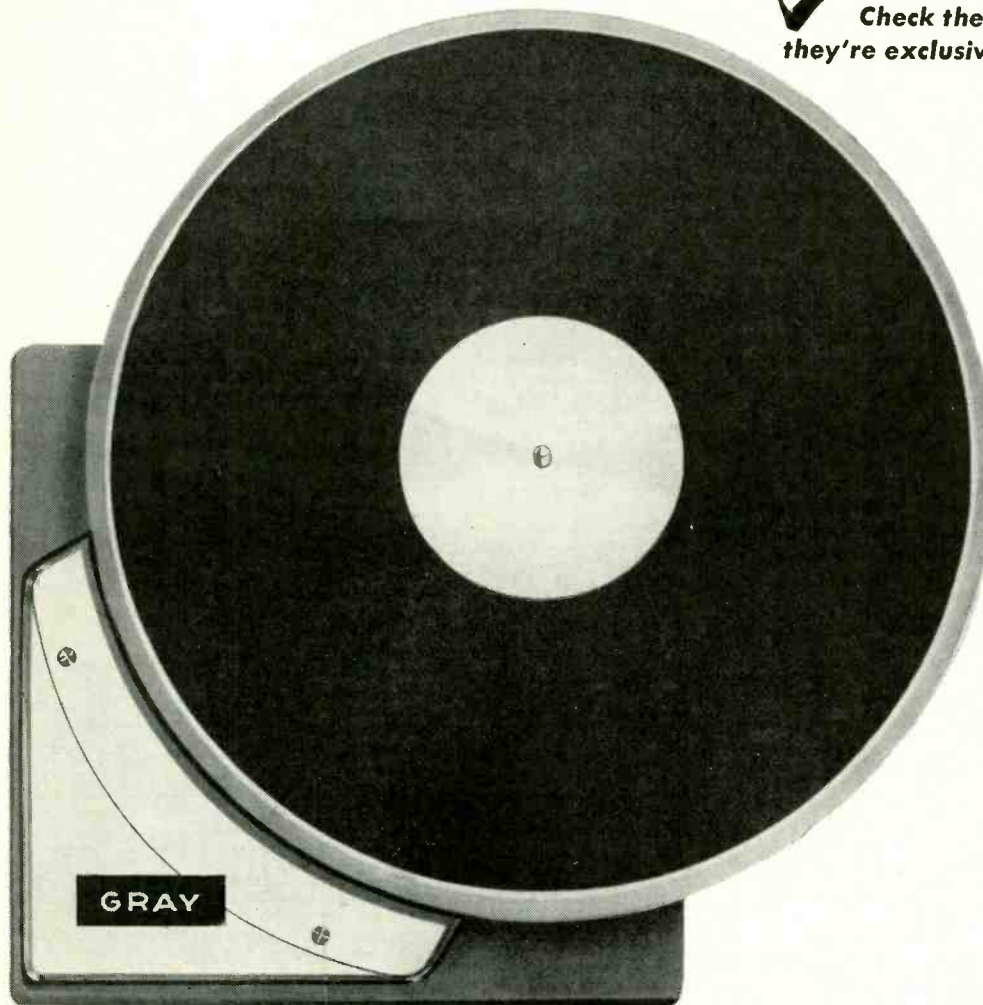

- Special hysteresis synchronous motor provides constant speed and lowest wow, flutter and rumble content.
- Heavy machine ground 12½" turntable platter with micro polished ⅞" shaft rotates in a super oilite bearing with noiseless nylon underfacing thereby guaranteeing freedom from vertical movement...a stereo prerequisite.
- Customized slip-proof, stretch-limited composite belt offers vibrationless link between motor and platter edge.
- Shock-proof motor mount is adjustable in 3 planes to compensate for lifetime movement and wear.
- Sturdy mounting plate offers maximum shielding. Easy to level and center because it extends past the platter and motor structure.
- Micro precision parts pretested for accuracy in sub assemblies.
- Assembly time 25 minutes or less with simple tools.

## GRAY 33⅓ RPM SINGLE SPEED HSK-33 TURNTABLE KIT

Here's an exciting project for anybody who wants professional performance at a low kit cost. Gray engineering and custom mass production techniques now make this wonderful value possible. You'll be pleasantly surprised at how easy it is to fully assemble—and have ready for monaural or stereo operation—this studio designed turntable.

**ALSO AVAILABLE:** TBK turntable base kit . . . prefinished and precision cut in walnut, mahogany, and blonde formica veneers . . . complete with all accessories for quick assembly . . . **only 14.95**



Manufacturers of  
the world famous  
Gray tone arm.

**GRAY** our 67th year in communications . . .  
**High Fidelity Division**  
DEPT. R5 • 16 ARBOR STREET, HARTFORD 1, CONN.

RADIO-ELECTRONICS

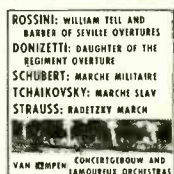
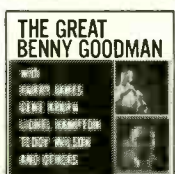
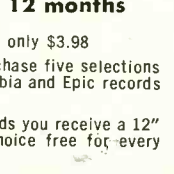
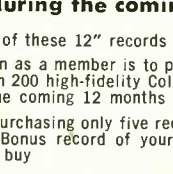
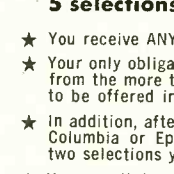
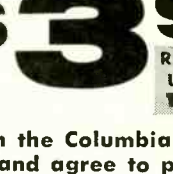
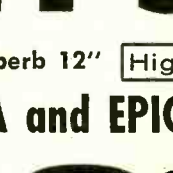
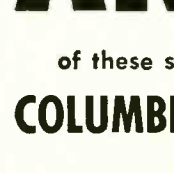
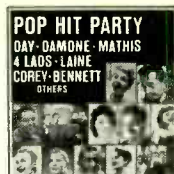
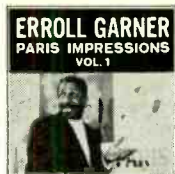

# ANY SIX

of these superb 12" High-Fidelity  
COLUMBIA and EPIC RECORDS

FOR ONLY **\$3.98** RETAIL VALUE UP TO \$2.98

if you join the Columbia Record Club now - and agree to purchase only 5 selections during the coming 12 months

- ★ You receive ANY 6 of these 12" records for only \$3.98
- ★ Your only obligation as a member is to purchase five selections from the more than 200 high-fidelity Columbia and Epic records to be offered in the coming 12 months
- ★ In addition, after purchasing only five records you receive a 12" Columbia or Epic Bonus record of your choice free for every two selections you buy
- ★ You enroll in any one of the four Club Divisions: Classical; Listening and Dancing; Broadway, Movies, Television and Musical Comedies; Jazz
- ★ Each month the Club's staff of musical experts selects outstanding recordings from every field of music... music that deserves a place in any well-planned library. These selections are fully described in the Club Magazine, which you receive free each month
- ★ You may accept or reject the selection for your Division, take any of the other records offered, or take NO record in any particular month
- ★ You may discontinue membership at any time after purchasing five records from the Club
- ★ The records you want are mailed and billed to you at the regular list price of \$3.98 (Classical Selections, \$4.98), plus small mailing charge
- ★ Mail coupon—without money—to receive your six records

SEND NO MONEY - Mail coupon to receive 6 records for \$3.98

COLUMBIA RECORD CLUB, Dept. 245-2  
TERRE HAUTE, INDIANA

I accept your offer and have indicated at the right the six records I wish to receive for \$3.98, plus small mailing charge. Enroll me in the following Division of the Club:

- (check one box only)
- Classical     Listening and Dancing     Jazz
- Broadway, Movies, Television and Musical Comedies

I agree to purchase five selections from the more than 200 to be offered during the coming 12 months, at regular list price plus small mailing charge. For every two additional selections I accept, I am to receive a 12" Columbia or Epic Bonus record of my choice FREE

Name..... (Please Print)

Address.....

City.....ZONE.....State.....

CANADA: Prices slightly higher, address 11-13 Soho St., Toronto 2B

If you wish to have this membership credited to an established Columbia or Epic record dealer, authorized to accept subscriptions, please fill in the following:

Dealer's Name.....

Dealer's Address..... 213

© Columbia Records Sales Corp., 1959

© "Columbia," "Epic," "Epic" Maracas Reg.

CIRCLE THE NUMBERS OF THE 6 RECORDS YOU WANT -

- Polly Bergen *Party's Over, But Not For Me, My Melancholy Baby* - 9 more
- 'S Marvelous Ray Conniff and Orch. *As Time Goes By, Where or When, etc.*
- Frankie Laine *Jezebel, High Noon, Jealousy*, 9 more
- Schweitzer-Bach *Includes 3 major Bach organ compositions*
- Johnny Mathis' *Greatest Hits No Love, Chances Are, Twelfth of Never, I Look at You*, 8 more
- Grofe: *Grand Canyon* This vivid musical painting has become an American classic
- Doris Day's *Greatest Hits Love Me or Leave Me, It's Magic, Que Sera*
- South Pacific *Mary Martin and Ezio Pinza star in this original Broadway Cast recording*
- Sing Along With Mitch Miller *You Are My Sunshine, Sweet Violets, Don't Fence Me In* - 16 favorites in all
- Schubert: *Unfinished Symphony; Mendelssohn: A Midsummer Night's Dream* Philadelphia Orchestra, Ormandy, cond.
- Desert Song *Romberg's operetta is still a joy to hear*
- Beethoven: *Emperor Concerto* Casadesus, piano; New York Philharmonic, Mitropoulos, cond.
- Eddy Duchin Story *Duchin plays The Man I Love, April Showers, Am I Blue?*, 12 more
- Dvorak: *New World Symphony* Philadelphia Orchestra, Ormandy, cond.
- \$64,000 Jazz *13 Jazz Greats performing Honeysuckle Rose, Perdido, etc.*
- Mozart: *Requiem* New York Philharmonic, Walter, cond.
- Tchaikovsky: *Nutcracker Suite; Ravel: Bolero, etc.* Philadelphia Orchestra, Ormandy, cond.
- Benny Goodman *Let's Dance, Sing Sing Sing, Adalon, Moon Glow* - 11 swing classics
- Romantic Music of *Rachmaninoff* Andre Kostelanetz and his Orchestra play this haunting music
- Roy Hamilton *The "Big Voice" sings Unchained Melody, Ebb Tide, I Believe*, 9 more
- Tchaikovsky: *Swan Lake Ballet Suite* Philadelphia Orchestra, Ormandy, cond.
- Ellington at Newport *Newport Jazz Festival Suite, Jeep's Blues, etc.*
- The Hymnal *Norman Luboff Choir sings 12 beloved hymns - Let Him In, Sweet Hour of Prayer, etc.*
- Firebird Suite; *Romeo and Juliet* A dozen scores - performed by Bernstein and N.Y. Philharmonic
- Pop Hit Party *A dozen hit tunes performed by 12 pop artists - Day, Mathis, Laine, Bennett, etc.*
- Erroll Garner - *Paris Impressions Moul'n Rouge, I Love Paris, Left Bank Swing* - 8 numbers in all
- My Fair Lady *Original cast recording with Rex Harrison and Julie Andrews*
- Waltzes of Strauss and Tchaikovsky *Philadelphia Orchestra, Ormandy, cond.*
- Front Row Center *September Song, House of Flowers, Bewitched, April in Paris*, 9 more
- Music of Victor Herbert - *Faith Dream Girl, A Kiss in the Dark, Gypsy Love Song*, 9 more
- Rossini: *William Tell Overture, etc.* Six stirring overtures and marches
- Frank Sinatra *A dozen songs - Blue Skies, The Nearness of You, Mean to Me, etc.*

From Bell Telephone Laboratories...

# Brainpower for the brawny Nike-Hercules

The Army's newest surface-to-air guided missile—the lethal Nike-Hercules—is now operational. Because it is, no unfriendly plane will be able to fly sufficiently high, fast or evasively to escape a fatal rendezvous with it.

For Hercules has a “brain”—an intellect that makes it a prodigy among today's electronic robots. Bell Telephone Laboratories developed it. Western Electric (prime contractor for the entire missile system) is producing it. Douglas Aircraft Company is giving it its body.

This “brain” is a fully integrated guidance system, almost entirely land-based. Only the vital signal-receiving apparatus is expendable within the missile itself. Other highly practical features: it defies “jamming,” is completely mobile, is designed in separate “building block” units which are replaceable in seconds—and is deadly accurate.

Bell Labs scientists and engineers designed the world's largest and most intricate telephone communications network for the Bell System. They developed about half of the Armed Forces' radar equipment during World War II. And they pioneered the nation's *first* successful air defense guided missile system—Nike-Ajax.

They were eminently qualified to give Hercules the brainpower it needed.



**BELL TELEPHONE LABORATORIES**

World center of communications research and development



Vigilant acquisition radar for Nike-Hercules first detects approach of distant aircraft, pinpoints its location and instantly signals to battery control.

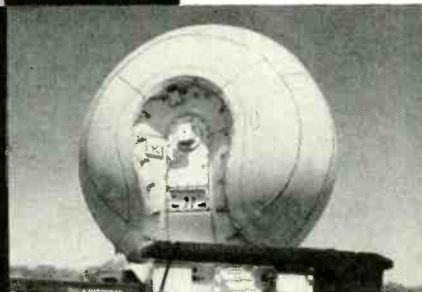

Two tracking-radar antennas, housed in radomes, take over. One feeds target azimuth, elevation, range data to computers; other tracks Hercules.



Two sets of radar data are electronically computed and plotted. Hercules is “steered” by radio signals, then detonated at precise point of interception.

# BIG REWARDS

for the most-wanted men in Radio-TV-Electronics



General Electronics Technician

Radio-TV Engineer

Radio-TV Service Manager

Industrial Electronics Technician

Electrical Engineering Technician

Electrical Draftsman

That's right! There *are* big rewards for the most-wanted men in Radio-TV-Electronics.

You can be one of these men. With the right training you can qualify for a big-pay job in a vital industry. You can start yourself on an exciting, rewarding career in a field that offers unlimited opportunities.

But you must be thoroughly trained. You must know more than wires and tubes. You must *think* in electronic terms.

There's no short-cut to success in Radio-TV-Electronics. But there is a simple, sure way... the I.C.S. way.

I.C.S. is the world's oldest and largest technical training school. Sixty-seven years of experience in training 6½ million students have made the I.C.S. system a success-proven method

of home study. Today, there are more trained men from I.C.S. in supervisory and management jobs than from any other school.

Up-to-the-minute I.C.S. Courses make electronic fundamentals clear, easy-to-follow. *Personalized* guidance helps you through each step.

You study at home—in your spare time—at your own pace. Everything you learn is practical, usable. Courses are prepared by experts who know what *you* need to know to go places.

Join the ranks of the most-wanted men in Radio-TV-Electronics. Your first step is to send for your free I.C.S. Career Kit. You have nothing to lose. You can gain an exciting career in the fastest-growing industry of all time.

## HOW WILL YOUR I.C.S. SUCCESS STORY SOUND ?

"I took my diploma from your school in Radio Operating in 1947. In 3 years I became chief engineer of WKOK in Sunbury, Pa. Then I came to California as Audio Engineer for ABC in Hollywood. I still hold this position. I will always be grateful for your help in getting me in the type of profession that has so much to look forward to."  
*William R. Dreese*

"I had been in the radio-repair business for 30 years, when I enrolled in the I.C.S. Television Servicing Course.

"Now I am able to approach a television job in a systematic manner, while others are still operating on the hit-or-miss level."  
*Kelsey G. Cobb*

"Up to the time I enrolled, my interest in electronics was purely a hobby, but before completing my course I was able to do a considerable amount of radio work. Now I have a good part-time business."  
*George A. Chase*

Send the coupon below for your free I.C.S. Career Kit!

- 1 "How to Succeed," 36-page guide to advancement.
- 2 Opportunity handbook for the field of your choice.
- 3 Sample lesson (Math) to demonstrate I.C.S. method.

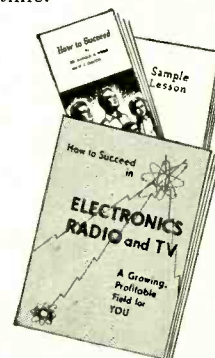

For Real Job Security—Get an I.C.S. Diploma!

I.C.S., Scranton 15, Penna.

Accredited Member,  
National Home Study Council

## INTERNATIONAL CORRESPONDENCE SCHOOLS



BOX 02465A, SCRANTON 15, PENNA.

(Partial list of 257 courses)

Without cost or obligation, send me "How to Succeed" and the opportunity booklet about the field BEFORE which I have marked X (plus sample lesson):

### RADIO TELEVISION ELECTRONICS

- General Electronics Tech.
- Industrial Electronics
- Practical Radio-TV Eng'r'g
- Practical Telephony
- Radio-TV Servicing

### BUSINESS

- Cost Accounting
- Managing a Small Business
- Purchasing Agent

### DRAFTING

- Electrical Drafting

### HIGH SCHOOL

- High School Diploma
- Good English
- High School Mathematics

### ELECTRICAL

- Electrical Engineering
- Elec. Engr. Technician
- Elec. Light and Power
- Practical Electrician
- Professional Engineer (Elec.)

### LEADERSHIP

- Industrial Foremanship
- Industrial Supervision
- Personnel-Labor Relations
- Supervision

Name \_\_\_\_\_ Age \_\_\_\_\_ Home Address \_\_\_\_\_

City \_\_\_\_\_ Zone \_\_\_\_\_ State \_\_\_\_\_ Working Hours \_\_\_\_\_ A.M. to \_\_\_\_\_ P.M. \_\_\_\_\_

Occupation \_\_\_\_\_

Canadian residents send coupon to International Correspondence Schools, Canadian, Ltd., Montreal, Canada. . . . Special tuition rates to members of the U. S. Armed Forces.

KNOP, North Platte, Neb.....	2
WKBW-TV, Buffalo, N. Y.....	7
WTOL-TV, Toledo, Ohio.....	11
KXAB-TV, Aberdeen, S. D.....	9
KVKM-TV, Monahans, Tex.....	9
KLOR-TV, Provo, Utah.....	11

Two stations, however, have closed down:

WHCT, Hartford.....	18
KTRX, Kennewick-Pasco, Wash.....	31

Consequently, our total of operating stations for the US is now 546, which figure includes 461 vhf and 85 uhf. The noncommercial is up to 35 (7 uhf).

WTAS, Albany - Schenectady - Troy, channel 35, has changed its call letters. It was formerly WTRI.

Our Hawaii listing in the January "Television Station List" should have read channel 7 for KALA in Wailuku. The channel 15 listing for Lebanon, Pa., should have been WLYH-TV.

**ELECTRONICS PRODUCTION** and sales in 1958 set a record, despite a slump in such consumer items as radios, TV sets and phonographs. David R. Hull, president of the Electronic Industries Association, estimated 1958 sales of all electronic products totaled about \$7.7 billion (factory prices), or \$100,000,000 more than the 1957 figure.

Military electronics accounted for \$4.1 billion, with 70% of this amount representing missile and aircraft electronics, compared with 1957's military electronics figure of \$3.9 billion, 55% missile and aircraft. Industrial electronic equipment was a \$1.4 billion market in 1958, up from \$1.3 billion in '57. Consumer equipment was the only category to show a decrease last year.

For 1959, he predicted about \$8.3 billion in electronic sales, with military orders totaling \$4.4 billion, industrial \$1.5 billion, consumer products \$1.4 billion and replacement parts \$1 billion.

He foresaw no mass sales of color TV in 1959 and little possibility of a technological breakthrough which would result in substantial reductions in the prices of color sets.

**RUSSIA** now has more than 60 TV stations and over 3,000,000 television sets in use, Soviet Ambassador Mikhail Menshikov told a New York audience recently. He said more than 100 new stations will go on to the air in the next few years. He conceded that most Russian television sets have been small-screen models, but asserted that 17- and 21-inch sets are "now coming in."

The Soviet newspaper *Trud* announced that a giant television tower—the world's tallest—would be built this year in Moscow. It would rise, 1,667 feet, topping the present tallest man-made structure—the 1,610-foot KSW-TV tower in Roswell, N. M.—by 57 feet.

The US Information Agency now estimates there are 639 TV stations and 21,585,000 sets in use outside of the US and Canada. The US has about 50,000,000 sets and 550 stations, Canada more than 3,000,000 sets and 55 stations. END

whether your plans are modest  
or unlimited...

you can  
build  
your ideal  
stereo system  
with the  
finest  
loudspeakers...



Compact, proportioned for bookshelf or table top, JBL Bel-Aires—a pair with components in mirror-image arrangement—will give you the clean, exquisitely detailed stereo reproduction that can only be achieved with transducers of the highest precision.

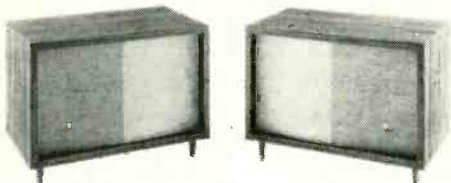

Now JBL enclosures are matched for stereo. If you own a JBL C34, C35, C37, C39, or C40, you can add a matching enclosure with speaker units arranged in a pattern that is a mirror image of your present system.



The JBL Ranger-Paragon is the ultimate stereo speaker system. Developed as a master monitor for use in perfecting stereo recording techniques, the Paragon adds to twin folded horns and professional driver units a radial refraction panel which integrates the two sound sources and disperses true stereo throughout the room.

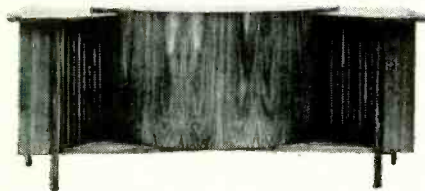

The JBL Ranger-Metregon incorporates the virtues of radial refraction in an enclosure of acceptable size for the average living room. No hole in the middle, no split soloists, but sound reproduction spatially proportional to its original source. The Metregon accepts seven different speaker system combinations; can be upgraded progressively.

Write for free catalog and data sheets.

**JAMES B. LANSING SOUND, INC.**  
3249 casitas avenue, los angeles 39, california



# What Does F. C. C. Mean To You?

## What is the F. C. C.?

F. C. C. stands for Federal Communications Commission. This is an agency of the Federal Government, created by Congress in 1934 to regulate all radio communication and radio and television broadcasting in the United States.

## What is an F. C. C. Operator License?

The F. C. C. requires that only qualified persons be allowed to install, maintain, and operate electronic communications equipment, including radio and television broadcast transmitters. To determine who is qualified to take on such responsibility, the F. C. C. gives technical examinations. Operator licenses are awarded to those who pass these examinations. There are different types and classes of operator licenses, based on the type and difficulty of the examination passed.

## What are the Different Types of Operator Licenses?

The F. C. C. grants three different types (or groups) of operator licenses—commercial radiotelePHONE, commercial radioteleGRAPH, and amateur.

**COMMERCIAL RADIOTELEPHONE** operator licenses are those required of technicians and engineers responsible for the proper operation of electronic equipment involved in the transmission of voice, music, or pictures. For example, a person who installs or maintains two-way mobile radio systems or radio and television broadcast equipment must hold a radiotelePHONE license. (A knowledge of Morse code is NOT required to obtain such a license.)

**COMMERCIAL RADIOTELEGRAPH** operator licenses are those required of the operators and maintenance men working with communications equipment which involves the use of Morse code. For example, a radio operator on board a merchant ship must hold a radioteleGRAPH license. (The ability to send and receive Morse is required to obtain such a license.)

**AMATEUR** operator licenses are those required of radio "hams"—people who are radio hobbyists and experimenters. (A knowledge of Morse code is necessary to be a "ham".)

## What are the Different Classes of RadiotelePHONE licenses?

Each type (or group) of license is divided into different classes. There are three classes of radiotelePHONE licenses, as follows:

(1) Third Class RadiotelePHONE License. No previous license or on-the-job experience is required to qualify for the examination for this license. The examination consists of F. C. C. Elements I and II covering radio laws, F. C. C. regulations, and basic operating practices.

(2) Second Class RadiotelePHONE License. No on-the-job experience is required for this examination. However, the applicant must have already passed examination Elements I and II. The second class radiotelePHONE examination consists of F. C. C. Element III. It is mostly technical and covers basic radiotelePHONE theory (including electrical calculations), vacuum tubes, transistors, amplifiers, oscillators, power supplies, amplitude modulation, frequency modulation, measuring instruments, transmitters, receivers, antennas and transmission lines, etc.

(3) First Class RadiotelePHONE License. No on-the-job experience is required to qualify for this examination. However, the applicant must have already passed examination Elements I, II, and III. (If the applicant wishes, he may take all four elements at the same sitting, but this is

not the general practice.) The first class radiotelePHONE examination consists of F. C. C. Element IV. It is mostly technical covering advanced radiotelePHONE theory and basic television theory. This examination covers generally the same subject matter as the second class examination, but the questions are more difficult and involve more mathematics.

## Which License Qualifies for Which Jobs?

The THIRD CLASS radiotelePHONE license is of value primarily in that it qualifies you to take the second class examination. The scope of authority covered by a third class license is extremely limited.

The SECOND CLASS radiotelePHONE license qualifies you to install, maintain, and operate most all radiotelePHONE equipment except commercial broadcast station equipment.

The FIRST CLASS radiotelePHONE license qualifies you to install, maintain, and operate every type of radiotelePHONE equipment (except amateur, of course) including all radio and television stations in the United States, and in its Territories and Possessions. This is the highest class of radiotelePHONE license available.

## How Long Does it Take to Prepare for F. C. C. Exams?

The time required to prepare for FCC examinations naturally varies with the individual, depending on his background and aptitude. Grantham training prepares the student to pass FCC exams in a minimum of time.

In the *Grantham Correspondence Course*, the average beginner with NO previous experience or training in radioelectronics should obtain his second class radiotelePHONE license after from 200 to 300 hours of study. This same student should then prepare for his first class FCC license in approximately 100 additional hours of study.

In the *Grantham Resident Course*, the time required to complete the course and get your license (under normal circumstances) is as follows:

In the DAY course (5 days a week) you should get your second class license at the end of the first 9 weeks of classes, and your first class license at the end of 3 additional weeks of classes. This makes a total of 12 weeks (just a little less than 3 months) required to cover the whole course, from "scratch" through first class.

In the EVENING course (2 nights a week) you should get your second class license at the end of the 22nd week of classes and your first class license at the end of 8 additional weeks of classes. This makes a total of approximately

7 months required to cover the whole course, from "scratch" through first class, in the evening course.

The Grantham course is designed specifically to prepare you to pass FCC examinations. All the instruction is presented with the FCC examinations in mind. In every lesson test and pre-examination you are given constant practice in answering FCC-type questions, presented in the same manner as the questions you will have to answer on your FCC examinations.

## Why Choose Grantham Training?

The Grantham Communications Electronics Course is planned primarily to lead to an F. C. C. license, but it does this by TEACHING electronics. This course can prepare you quickly to pass F. C. C. examinations because it presents the necessary principles of electronics in a simple "easy to grasp" manner. Each new idea is tied in with familiar ideas. Each new principle is presented first in simple, everyday language. Then after you understand the "what and why" of a certain principle, you are taught the technical language associated with that principle. You learn more electronics in less time, because we make the subject easy and interesting.

## Is the Grantham Course a "Memory Course"?

No doubt you've heard rumors about "memory courses" or "cram courses" offering "all the exact FCC questions". Ask anyone who has an FCC license if the necessary material can be memorized. Even if you had the exact exam questions and answers, it would be much more difficult to memorize this "meaningless" material than to learn to understand the subject. Choose the school that teaches you to thoroughly understand—choose Grantham School of Electronics.

## Is the Grantham Course Merely a "Coaching Service"?

Some schools and individuals offer a "coaching service" in FCC license preparation. The weakness of the "coaching service" method is that it presumes the student already has a knowledge of technical radio and approaches the subject on a "question and answer" basis. On the other hand, the Grantham course "begins at the beginning" and progresses in logical order from one point to another. Every subject is covered simply and in detail. The emphasis is on making the subject easy to understand. With each lesson, you receive an FCC-type test so you can discover daily just which points you do not understand and clear them up as you go along.

**HERE'S PROOF** that Grantham Students prepare for F. C. C. examinations in a minimum of time. Here is a list of a few of our recent graduates, the class of license they got, and how long it took them:

	License	Wks.
Robert H. Moore, 807 Grace St., Baldwin, L.I., N.Y.	1st	12
Otis A. Towns, 3638 Bates St., St. Louis, Mo.	1st	12
Robert A. Herrman, 608 Walker Ave., Baltimore, Md.	1st	14
Walter Mengel, Jr., 423 James St., Crystal Lake, Ill.	1st	8
Serge G. Miller, 1315 W. 15th St., San Pedro, Calif.	1st	12
John A. Hayes, 1519 Madison Ave., Memphis, Tenn.	1st	14
Franklin A. VanLeuven, 6061 Woodlawn Ave., Maywood, Calif.	1st	12
Robert A. Morgan, 25 Barrow St., New York, N.Y.	1st	9

**OUR GUARANTEE:** If you should fail the F. C. C. exam after finishing our course, we guarantee to give you additional training at NO ADDITIONAL COST. Read details in our free booklet.

## THREE COMPLETE SCHOOLS

To better serve our many students throughout the entire country, Grantham School of Electronics maintains three complete schools—in Washington, D.C., Hollywood, Calif., and Seattle, Wash. All schools offer the same rapid courses in F. C. C. license preparation, either home study or resident classes.

For further details concerning F. C. C. licenses and our training, send for our FREE booklet, "Careers in Electronics". Clip the coupon below and mail it to the School nearest you.

Get your First Class Commercial F. C. C. License Quickly by training at



**GRANTHAM SCHOOL OF ELECTRONICS**

821-19th Street, N.W.      1505 N. Western Ave.      408 Marion Street  
Washington 6, D.C.      Hollywood 27, Calif.      Seattle 4, Wash.  
(Phone: ST 3-3614)      (Phone: HO 7-7727)      (Phone: MA 2-7227)

## MAIL TO SCHOOL NEAREST YOU

To: **GRANTHAM SCHOOL OF ELECTRONICS**

821-19th, NW      1505 N. Western      408 Marion  
Washington • Hollywood • Seattle

Gentlemen:

Please send me your free booklet telling how I can get my commercial F. C. C. license quickly. I understand there is no obligation and no salesman will call.

Name \_\_\_\_\_ Age \_\_\_\_\_

Address \_\_\_\_\_

City \_\_\_\_\_ State \_\_\_\_\_

Interested in:  Home Study,  Resident Classes 94-B

**Mail This Coupon Now — No Salesman Will Call**

**Tung-Sol audio tubes**  
**now twin-packed**  
**in matched pairs**  
**by the manufacturer**

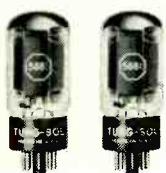
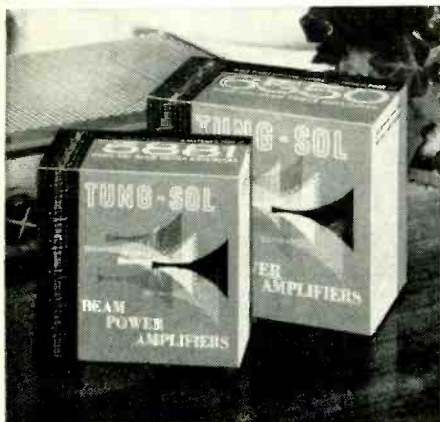

**5881** For service in amplifiers of up to 50 watts.

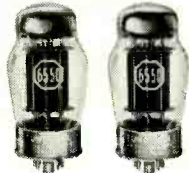

**6550** For service in amplifiers and commercial audio equipment of up to 100 watts.

**N**OW you can come as close to faultless sound reproduction as the design and circuitry of your hi-fi equipment will permit. Tung-Sol 5881 and 6550 beam-power amplifier tubes are factory-matched to very tight performance limits and twin-packed to help you achieve lowest distortion levels at all volume levels.

Use of Tung-Sol 5881 and 6550 tubes has long been associated with amplifiers of the very finest design. These tubes have always been produced to closest possible tolerances with cathode current ranges held to an absolute minimum.

Now, in twin-packed pairs, they assure the hi-fi enthusiast and the commercial sound engineer of replacement tubes that will provide new standards of performance—a feature of special importance with the newest amplifiers and loudspeakers, particularly binaural sound equipment. See your parts supplier.

Tung-Sol Electric Inc., Newark 4, New Jersey.



**ELECTROSTATIC SPEAKERS**

Dear Editor:

George Augspurger's article on the Ring Radiator in your December issue (page 43) prompts us to write in rebuttal on certain of his statements pertaining to the electrostatic high-frequency speaker.

First, Mr. Augspurger states that the electrostatic approaches the problem (of sound generating) by the use of a very large diaphragm. This is manifestly not so in the case of the JansZen, which uses the equivalent of many small diaphragms, achieving the end of keeping the acoustic load high on the vibrating surfaces, but at the same time avoiding the problem of poor control of those surfaces. Distortion is thus reduced to less than 0.5% (harmonic).

Second, the author refers to the electrostatic as expensive. Although this statement is somewhat justified, since proper electrostatic manufacture requires adherence to close tolerances and great attention to detail, it is not justified when comparing it to the Lansing 075 Ring Radiator which Mr. Augspurger is reviewing. That model sells for about \$60 (above \$100.00 with cabinet), compared to the JansZen Model 65 (with cabinet) at about \$90. In cabinet, this makes a price advantage in favor of the electrostatic, and the balance is further tipped when it is considered that the electrostatic is not just a tweeter, but a tweeter-mid-range designed for use with several woofers without the need or expense of a mid-range speaker.

Third, Mr. Augspurger writes of the "relative inefficiency" of the electrostatic, inferring that this is an inherent characteristic. Such is not the case. Efficiency limitations are imposed on the electrostatic only because its lower limits are extended flat to 900 cycles. The ring tweeter goes only to 2,500 cycles. Within those less stringent limits, the electrostatic can be made very efficient.

Further—and this is important—high efficiency was never a consideration (at least in Arthur Janszen's designs) in constructing an electrostatic; rather he was concerned with matching his unit with a woofer whose response was uniformly efficient throughout its entire range down to below 40 cycles. The only woofer meeting those requirements at that time was the Bozak, subsequently followed by the AR, KLH, Tannoy, and his own JansZen Dynamic. These speakers are by popular definition "inefficient," but are in fact very efficient if one considers the total energy distribution over the entire frequency range.

Fourth, we must take exception to the author's comments concerning certain reported unpleasant "crackling" sounds heard on the electrostatic in connection with some percussive sounds. We are pleased that he mitigates his emphasis by stating that the problem frequently may be caused by faulty associated components, but we can state categorically, with a very careful followup on our serialized units out in the field for over 4 years, that we have never found a properly installed JansZen that couldn't handle any percussive sounds perfectly, even using over 100 watts of amplification (except in the rare instance of component failure in the power supply).

Lastly, we feel that it is a bit unfair to speak generally of electrostatics as though they were all alike. Their designs vary widely and are as different as horn-loaded, cone and ring tweeters.

Speaking for the multiple-diaphragmed, sheathed-electrode JansZen design with which we have been working and have been producing for the past 4 years, we do not believe that any of the criticisms raised by Mr. Augspurger are valid today.

FRANCIS D. WETHERILL  
 President, Neshaminy Electronic Corp.  
 Neshaminy, Pa.

**USE A MICROSCOPE**

Dear Editor:

I have just finished reading the article titled "Sapphire Vs Diamond" (October, 1958, page 47).

It seems that the stylus experts are setting up a ridiculous standard for estimating the useful life of a stylus by basing this on the number of hours of playing. One gets the impression that it is merely necessary to count the hours—20, 100 or 1,000, if the stylus is of metal, sapphire or diamond, respectively, with the hope that it was of proper form originally, and that at some time during the time of use it did not get chipped. Some valuable records could be ruined in the interim. Also, how do the experts suggest that a record of the hours be kept?

Why not discard this ridiculous rule and recommend that styli be periodically inspected under one of the several microscopes now offered for \$3 to \$4? It may come as a surprise to many that they should have replaced the stylus long before the theoretical time to change came around. Ruined records can testify to the truth of this.

I am sure that the experts will agree that stylus wear is influenced to a great extent by stylus pressure, dust in the grooves, rough treatment and other factors.

# Learn TELEVISION-RADIO

## Servicing or Communications by Practicing at Home in Spare Time



NRI gives you kits to build these and other equipment

### NRI Has Trained Thousands for Successful Careers in TV-Radio

## Electronic Technicians Have High Pay, Prestige Jobs

People look up to and depend on the Technician, more than ever before. His opportunities are great, and are increasing. Become a Radio-Television-Electronic Technician. At home, and in your spare time, you can learn to do this interesting, satisfying work—qualify for important pay. A stream of new Electronics products is increasing the job and promotion opportunities for Television-Radio-Electronic Technicians. Right now, a solid proven field of opportunity for good pay is servicing the millions of Television and Radio sets now in use. The hundreds of Television and Radio stations on the air offer interesting jobs for Operators and Technicians. The military services reward qualified Technicians with higher rank and pay. Police, Aviation, Mobile Two-Way Radio are expanding. To ambitious men everywhere: here is rich promise of fascinating jobs, satisfaction and prestige, increasing personal prosperity.

## Make Extra Money Soon, \$10 to \$15 a Week in Your Spare Time

NRI students find it practical and profitable to start fixing sets for friends and neighbors a few months after enrolling. Picking up \$10, \$15 and more a week gives substantial extra spending money. Use the Tester built with parts NRI furnishes, to locate and correct Radio-TV receiver troubles. Many who start in spare time, soon build full time Television-Radio sales and service businesses; others enjoy profitable spare time businesses and the security of a source of income to fall back on in case of layoffs, hard times or other changes in regular job. Postage free card will bring you complete facts about the NRI tested way to better pay.



**Studio Engr., Station KATV**  
"I am now Studio Engineer at Television Station KATV. Before enrolling for the NRI Course, I was held back by limitation of a sixth grade education." **BILLY SANCHEZ**, Pine Bluff, Ark.



**Has All the Work He Can Do**  
"Since finishing NRI Course I have repaired more than 2,000 TV and Radio sets a year. NRI training certainly proved to be a good foundation." **H. R. GORDON**, Milledgeville, Ga.



**Has Good Part Time Business**  
"Quite early in my training I started servicing sets. Now have completely equipped shop. My NRI training is the backbone of my progress." **E. A. BREDA**, Tacoma, Wash.

**Cut Out and Mail Postage-Free Card NOW**

## Sample Lesson and Catalog Both FREE

SEE OTHER SIDE 

OLDEST & LARGEST HOME STUDY RADIO-TV SCHOOL  
**National Radio Institute**  
Dept. C Washington 16, D.C.

Please send me sample lesson of your Radio-Television Training and Catalog FREE. (No salesman will call.)

Name \_\_\_\_\_ Age \_\_\_\_\_

Address \_\_\_\_\_

City \_\_\_\_\_ Zone \_\_\_\_\_ State \_\_\_\_\_

ACCREDITED MEMBER NATIONAL HOME STUDY COUNCIL



**ACT NOW** FIND OUT WHAT NRI OFFERS YOU 

**NRI SUPPLIES LEARN-BY-DOING KITS WITHOUT EXTRA CHARGE**  
**Technical Know-How Pays Off in Interesting, Important Work**



**YOU BUILD AC-DC Superhet Receiver**

NRI Servicing Course includes all needed parts. By introducing defects you get actual servicing experience practicing with this modern receiver. Learn-by-doing.

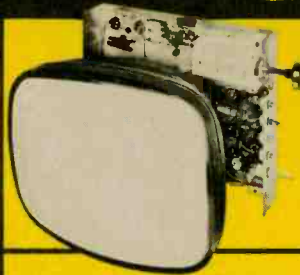

**YOU BUILD This 17 Inch Television Receiver**

As part of your NRI course you can get all components, tubes, including 17" picture tube, to build this latest style Television receiver; get actual practice on TV circuits.

**YOU BUILD Broadcasting Transmitter**

As part of NRI Communications Course you build this low power Transmitter, learn commercial broadcasting operators' methods, procedures. Train for your FCC Commercial Operator's License.

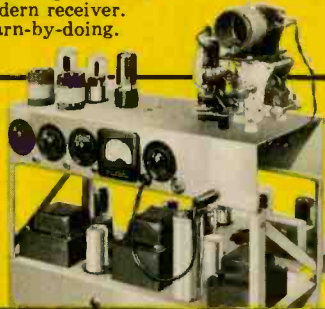

**YOU BUILD Vacuum Tube Voltmeter**

Use it to earn extra cash fixing neighbors' sets; bring to life theory you learn from NRI's easy-to-understand texts.



# For Higher Pay, Better Jobs Be a TV-Radio-Electronic Technician



**Servicing Needs More Trained Men**

Portable TV, Hi-Fi, Transistor Radios, Color TV are making new demands for trained Technicians. Good opportunities for spare time earnings or a business of your own.

**Broadcasting Offers Satisfying Careers**

4000 TV and Radio stations offer interesting positions. Govt. Radio, Aviation, Police, Two-Way Communications are growing fields. Trained Radio-TV Operators have a bright future.



J. E. Smith, Founder

**Train at Home the NRI Way Famous for Over 40 Years**

NRI is America's oldest and largest home study Television-Radio school. The more than 40 years' experience training men for success, the outstanding record and reputation of this school—benefits you in many ways. NRI methods are tested, proven. Successful graduates are everywhere, from coast to coast, in small towns and big cities. You train in your own home, keep your present job while learning. Many successful NRI men did not finish high school. Let us send you an actual lesson, judge for yourself how easy it is to learn.

**No Experience Necessary—NRI Sends Many Kits for Practical Experience**

You don't have to know anything about electricity or Radio to understand and succeed with NRI Course. Clearly written, well-illustrated NRI lessons teach TV-Radio-Electronic principles. You get NRI kits for actual experience. All equipment is yours to keep. You learn-by-doing. Mailing the postage-free card may be one of the most important acts of your life. Do it now. Reasonable tuition. Low monthly payments available. Address: NATIONAL RADIO INSTITUTE, Washington 16, D. C.

**NRI Graduates Do Important Work**



**Now Quality Control Chief**  
 "Had no other training in Radio before enrolling, obtained job working on TV amplifiers before finishing course. Now Quality Control Chief." T. R. FAVAROLO, Norwich, N. Y.

**NRI Course Easy to Understand**  
 "I opened my own shop before receiving my diploma. I have had to hire extra help. I am independent in my own business." D. P. CRESSEY, Stockton, Cal.

**Works on Color-TV**  
 "NRI changed my whole life. If I had not taken the course, probably would still be a fireman, struggling along. Now Control Supervisor at WRCA - TV." J. F. MELINE, New York, N. Y.

FIRST CLASS  
 Permit No. 20-R  
 (Sec. 34.9, P. L. & R.)  
 Washington, D.C.

**BUSINESS REPLY CARD**

No Postage Stamp Necessary if Mailed in the United States

POSTAGE WILL BE PAID BY

**NATIONAL RADIO INSTITUTE**  
 3939 Wisconsin Avenue  
 Washington 16, D.C.

**SAMPLE LESSON**  
**64-page CATALOG**  
**both FREE**

**SEE OTHER SIDE**

The only use that I can see for the rule based upon the number of hours of playing to be expected from a stylus is to give the buyer a guide by which he can know the approximate life of the stylus for the sole purpose of helping him to decide which stylus is the best buy in view of economy.

AXEL H. JOHNSON

Racine, Wis.

**MARINE SHORE STATIONS**

Dear Editor:

A reader has called my attention to an additional fact which should have been included in my series on "Radio for Weekend Sailors" (RADIO-ELECTRONICS, November and December, 1958).

While nongovernment shore stations operated in the 2-3-mc marine band are licensed almost exclusively to telephone companies and similar common carriers, shore-station licenses may be granted to others under some circumstances. These "limited" shore stations are sometimes permitted in areas not now covered by shore facilities. Some independent shore stations at inland lakes have been licensed as limited common carriers. Such stations are open to public correspondence, charging for services rendered, but on a limited basis.

LEO G. SANDS

Ridgewood, N. J.

**MINIATURE POWER PLANT**

Dear Editor:

Several radical improvements could be made in the electronic anemometer described on page 82 of your September issue by the substitution of one major component—the motor.

Almost every hobby shop sells tiny dc motors for use in model equipment. One is the *Mighty Midget*, an English-made unit which has been imported in large numbers. It is very small and weighs an ounce or less. I recently purchased one of these motors for a little less than \$3 to supply power to some experimental radio-controlled equipment. Knowing that almost any motor can also function as a generator, I decided to make a few rough tests and was pleasantly surprised. Depending upon the speed of rotation, the output voltage will vary from 0-3 volts with 1½-2 volts being a common voltage at a speed such as would be encountered if driven anemometer-style by a moderately stiff wind. Current output is over 150 ma at a high speed of rotation with a commonly generated current output of 30-90 ma.

Perhaps the above figures have already given you some idea of the possibilities of this little motor. It is obvious that an anemometer could be constructed which would indicate wind speed merely by hooking a common inexpensive 100-ma meter across the terminals, thus eliminating the cost of a transistor amplifier, battery and sensi-

(Continued on page 24)

**Now! The Most Important Product Announcement in the History of H. H. Scott!**

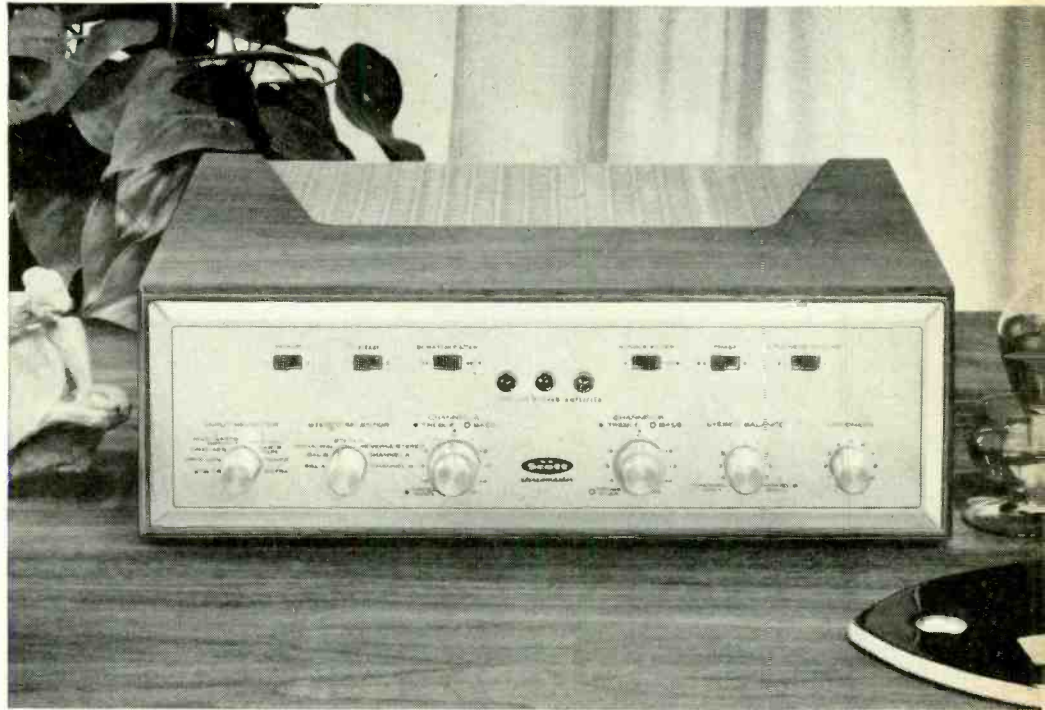

Here are the exciting details on

**The Stereo Amplifier that sets the Standards for the Next Decade!**

The H. H. Scott engineering laboratories proudly introduce the new Model 299 40 watt stereophonic amplifier and control center. It contains many advance features that not only meet the needs of today's stereophonic program sources, but anticipate the requirements of the future. Check the details of this new amplifier, and see for yourself why the new 299 is superior to any other amplifier available.

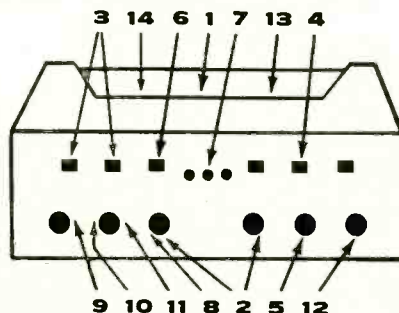

1 40 watt power stage consisting of dual 20 watt power amplifiers. You need this much power to meet the requirements of today's speaker systems. 2 Completely separate Bass and Treble controls on each channel so that different speakers may be matched. 3 Provision for connecting both a stereo phono cartridge and stereo

tape heads. 4 Phase reverse switch to compensate for improperly phased tape recordings or loudspeakers. 5 Special balancing circuit for quick and accurate volume balancing of both channels. 6 Separate record scratch and rumble filters. 7 Unique visual signal light control panel. Instantly indicates mode of operation. 8 Can be used as an electronic crossover (bi-amplifier). 9 Special compensation for direct connection of tape playback heads without external preamp. 10 Special switching lets you use your stereo pickup on monaural records. 11 You can play a monaural source such as an FM tuner through both channels simultaneously effectively doubling power. 12 Loudness compensation. 13 Stereo tape recorder output. 14 D.C. filament supply for preamp to virtually eliminate hum (80 db below full power output). 15 Distortion (first order difference tone) less than 0.3%.



Size in accessory walnut case: 15½w x 5h x 12½d. Price \$199.95. (West of Rockies \$204.95)

Write for complete technical specifications and new catalog RE-2



H. H. SCOTT, INC.  
111 POWDERMILL RD., MAYNARD, MASS.  
EXPORT: TELESCO INTERNATIONAL CORP.  
36 W. 40TH ST., N. Y. C.

Assignment: Capture Utah Quality\*



## THANK THE KEEN-EYED SNOOPER

As little as .0035 of an inch off in the dimensions of this Utah speaker basket—and a reject hits the bin! At Utah the quality of final performance in the speaker you buy is a jealously guarded value. If you could visit our Huntington plant you'd probably agree with Ace Photographer Lieberman that Utah speakers prove rejection is the foundation of perfection.

Pre-assembly, plating, coil winding, wiring . . . at every step down the production line stand the "keen-eyed snoopers." They search ruthlessly for the tiniest defect that could mar, even minutely, the response performance of a Utah.

Make certain your next speaker is a Utah. Know that your sound will be as perfectly reproduced as human skills, controlled by rigid inspection, can produce.

See the Utah Custom Line: a quality speaker for every system need.

\* ARCHIE LIEBERMAN, famous newsmagazine\* photographer, was given this assignment on a recent Utah plant tour: Photograph the essence of Utah quality as you see it. The photo shown here is the result. (\*Look, Life, Time, Pageant, Parade, Newsweek and many others)

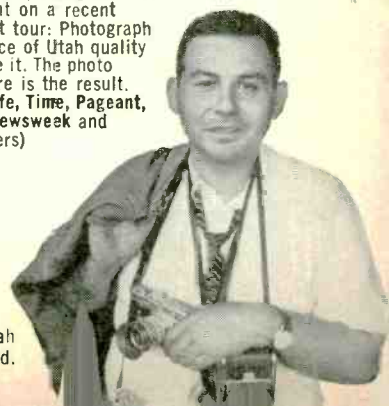

Let your ear decide **Utah** the ultimate choice

**SPEAKERS**

Send for the big Utah Catalog. Dept. 7, Utah Radio & Electronic Corp., Huntington, Ind.

[www.americanradiohistory.com](http://www.americanradiohistory.com)

# ownership of a **PHOTOFACT** SERVICE DATA LIBRARY SPELLS SUCCESS FOR SERVICE TECHNICIANS

here's actual proof from the men who know

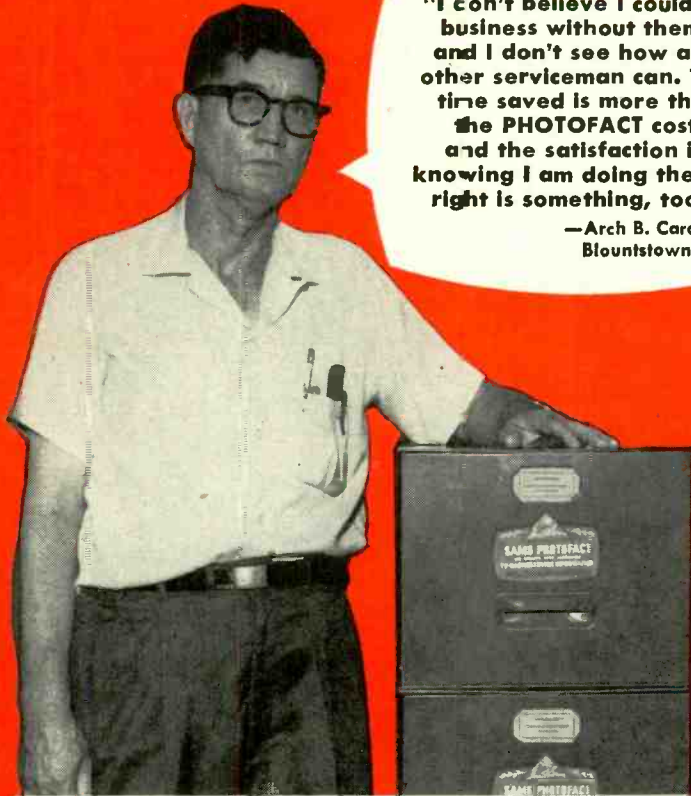

"I can't believe I could do business without them, and I don't see how any other serviceman can. The time saved is more than the PHOTOFACT cost and the satisfaction in knowing I am doing the job right is something, too."

—Arch B. Caraway  
Blountstown, Fla.



"PHOTOFACT is indispensable . . . a terrific aid in cutting down service time . . . One of your biggest helps is your listing of parts other than manufacturers' originals . . ."

—Victor V. Jasper  
Ross Radio & TV, Washington, Mo.

## HERE'S MORE PROOF...FROM COAST-TO-COAST

### CALIFORNIA

"We use PHOTOFACT daily. I can't believe we could conduct a first-class service shop without them. They are a time saver. With them, you can get to the base of your troubles in a hurry."

—P. W. Earls, *Fallbrook, Calif.*

### IOWA

"I would find it impossible to give consistently reliable service without a complete PHOTOFACT file of service information."

—Ralph L. Reints, *Ottumwa, Iowa*

### CONNECTICUT

"PHOTOFACT provides accurate information—convenient handling. Of necessity, repair with such information as a guide must be better repair."

—Lewis J. Smith, *Norwich, Conn.*

### OHIO

"With PHOTOFACT, I always have complete service data for any set that comes into my shop, at my fingertips."

—Earl J. Price, *Sciotoville, Ohio*

### PENNSYLVANIA

"I just can't seem to get a going without PHOTOFACT."

—Joseph F. Blahovic,  
*Barnesboro Pa.*

### NEW YORK

"They have saved time. This is the biggest factor. Also, they have built good will for me. I can find what tubes are needed for customers that come in to buy tubes . . . or even on telephone calls . . ."

—Fred C. Bcoth,  
*Poughkeepsie, N. Y.*

### WASHINGTON

"PHOTOFACTS save hours of probing in the dark."

—L. H. Bradbury, *Edmonds, Wash.*

### NEW YORK

"Gives quick, accurate, up-to-date facts on replacement parts. And, when a set needs to be taken out of a customer's home, you can more easily convince him if you have the PF Folder and explain you need special equipment to check out the circuits . . ."

—William Birdsell, *Fulton, N. Y.*

These are just a few of the hundreds of "Success with PHOTOFACT" letters in our files. Service Technicians everywhere are enjoying the profit-making advantages of a

complete PHOTOFACT Library. If you're not among them, see your Sams Distributor today, or write to Howard W. Sams for full details. Use coupon below.

**NEW EASY-BUY PLAN!** It's the money-saving way to buy your complete profit-making PHOTOFACT Library! NO INTEREST—NO CARRYING CHARGE—AS LITTLE AS \$10 DOWN

**FREE!** Valuable steel file cabinets for PHOTOFACT monthly subscribers and Library purchasers.



**FREE!**

Valuable booklet shows you how PHOTOFACT boosts your profit-capacity

Send for it!



**HOWARD W. SAMS & CO., INC.**

2205 E. 46th St., Indianapolis 6, Ind.

- Send me Free booklet "Your Guide To Maximum Profits"  
 I'm a Service Technician:  full-time;  part-time

My Distributor is: \_\_\_\_\_

Shop Name \_\_\_\_\_

Attn. \_\_\_\_\_

Address \_\_\_\_\_

City \_\_\_\_\_ Zone \_\_\_\_\_ State \_\_\_\_\_



"FELLAS—THERE'S GOLD IN THESE

# C-D TWIN TREASURE CHESTS"

- **FILLED WITH C-D CAPACITORS**  
the finest you can use to establish customer confidence.
- **FASTER CAPACITOR TURNOVER**  
because you'll always have the fast movers on hand.
- **SPEEDS UP YOUR WORK**  
because replacements are easy to identify, always handy.
- **HANDSOME METAL CABINETS**  
make shop neater, prevent misplaced pieces.



See C-D's "Treasure Chests" at your Cornell-Dubilier distributor or write to Cornell-Dubilier Electric Corporation, South Plainfield, N. J., Department RE-2.



## SUGGESTED CONTENTS:

**TWIST-PRONG SECTION CONTAINS** 12 popular C-D "Preferred Type" Twist-Prongs (and room for 6 more)

**TUBULAR SECTION CONTAINS** 16 popular C-D "Blue Beaver" Tubular Electrolytics

73 PM Mylar Tubulars

**BOTH CABINETS ARE FREE. YOU PAY ONLY FOR THE PREFERRED C-D CAPACITORS.**  
**YOUR COST: \$49.95**

CORRESPONDENCE (Cont'd from p. 21)

tive meter. Refinements such as a capacitor in parallel with the meter and a fixed or adjustable series resistance on the motor side of the capacitor could be employed to smooth the meter action. The diode is eliminated because the output is dc. You can't get things much simpler.

With a diode to prevent a back flow of current and one of the new rechargeable cells used in portable transistor radios, one would have a fine power supply for almost any kind of transistor equipment, as indicated by the liberal amounts of current and voltage which may be generated.

It would be suited especially to equipment which is run constantly, perhaps isolated from human attention for long periods, such as remote recording instruments of various types. There would be no worries about power-line failures or battery replacement. It could be used to power equipment for explorers and scientists working in uncivilized parts of the world far from power lines and a source of batteries. There is always some wind on even a "still" day, and the particular motor I mentioned has a 6-to-1 gear assembly which will cause it to turn very fast when the larger gear is turned at a moderate speed. This gives a built-in amplification of any motion imparted to the gear.

If there should not be sufficient wind to drive the unit, which isn't too likely, even turning it by hand for a while would be sufficient to charge small storage cells. If one were near a small stream, various arrangements of paddle wheels or propellers could be rigged up to provide a miniature hydroelectric power plant.

DORANCE RIGNEY  
Greenacres, Wash.

## CLEANING PLASTIC

Dear Editor:

In the October RADIO-ELECTRONICS, page 142, the item by E. Mayover on "Cleaning Plastic Safety Glass" requires some qualification—it won't always work!

It may be entirely possible that a penetrating oil will minimize the fog on the surface of some types of plastic safety windows; however, it most definitely should not be used on polystyrene lenses.

Oil, wax or grease of any kind will reduce the critical stress in polystyrene windows and ultimately result in worsening the fog or haze as well as causing the windows to check or craze. Try watching a set through such for a while. The writer would recommend using a plastic cleaner and polish preparation called "Polishine." This is produced by the Paint Products Laboratory in Chicago and does a good job.

J. C. CHOPSKIE

Cabinet Specialist  
Television Receiver Dept.  
General Electric Co.  
Syracuse, N. Y.

END



Consistently Dependable  
**CORNELL-DUBILIER**  
SERVICE CAPACITORS

www.americanradiohistory.com



# free! ALLIED'S 1959

## value-packed 452-page ELECTRONIC SUPPLY CATALOG

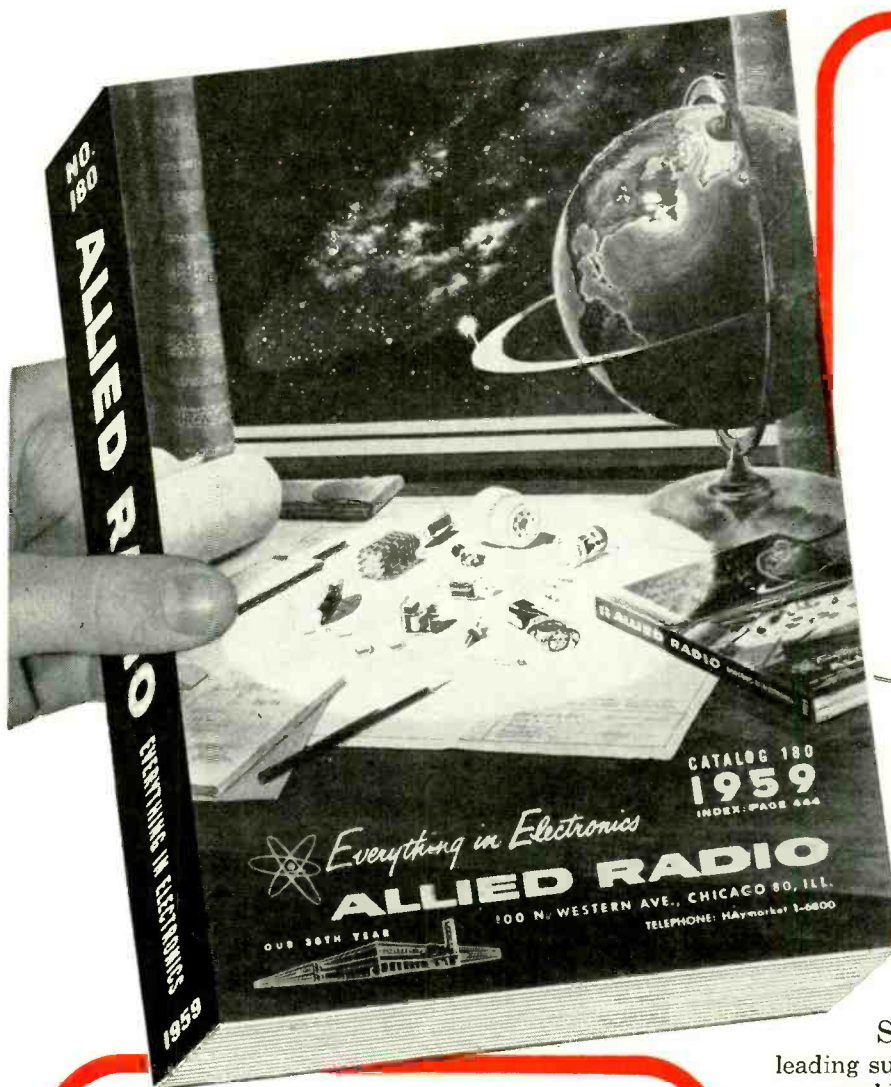

the only COMPLETE guide  
to everything in electronics

### WORLD'S LARGEST STOCKS

- Latest Stereo Hi-Fi Systems—  
Everything in Hi-Fi Components
- Money-Saving, Build-Your-Own  
KNIGHT-KITS—Latest Models
- Values in Recorders and Supplies
- Latest Public Address Systems,  
Paging and Intercom Equipment
- Amateur Receivers, Transmitters  
and Station Gear
- Test & Laboratory Instruments
- Specialized Electronic Equipment  
for Industrial Application
- TV Tubes, Antennas, Accessories
- Huge Listings of Parts, Tubes,  
Transistors, Tools, Books



### featuring:

**MONEY-SAVING knight-kits:** Finest electronic equipment in money-saving kit form. Complete selection of latest Hi-Fi amplifier, tuner and speaker kits (new Stereo units); Hobbyist kits; Test Instruments and Amateur kits. KNIGHT-KITS are an exclusive ALLIED product.

**HI-FI! STEREO!** See the world's largest selection of quality Hi-Fi music systems and famous name components. First with the latest in STEREO! Save on ALLIED-recommended complete systems. Own the best in Hi-Fi for less!

**EASY PAY TERMS:** Only 10% down; available on orders of \$20 or more. Fast handling—no red tape.

## ALLIED RADIO



Send for ALLIED's 1959 Catalog—it's the leading supply guide—452 pages packed with the world's largest selection of quality electronic equipment at lowest, money-saving prices. Get every buying advantage at ALLIED: fastest shipment, expert personal help, lowest prices, guaranteed satisfaction...

send for the leading  
electronic supply guide

**FREE!**

ALLIED RADIO CORP., Dept. 2-B9  
100 N. Western Ave., Chicago 80, Ill.

Send FREE 452-Page 1959 ALLIED Catalog

Name \_\_\_\_\_

Address \_\_\_\_\_

City \_\_\_\_\_ Zone \_\_\_\_\_ State \_\_\_\_\_

25,000,000 PEOPLE SAW THIS  
RECENT ADVERTISEMENT IN

# LIFE



**COACHES MIDGET-LEAGUE TEAM.** For the past two years, Theodore W. Fickert, TV technician of Hatfield, Pa., has shown his 25-boy club how to play baseball. Active in community causes, he helped organize the Hatfield Junior Chamber of Commerce, and served as its secretary and state director; participates in the Heart Fund and other worthy drives; and is on the planning committee of St. Peter's Lutheran Evangelical Church.



**A BRIGHTER, CLEANER CITY** owes much to Bryce McNeely's work in connection with the Kelso, Wash., program for civic beautification. Bryce is on the mayor's committee for school and city improvement, is state JC vice president, and promotes young men's leadership training.



**MAKES OTHERS' TROUBLES HIS OWN.** One of the few TV technicians in an 85-mile area, T. E. "Buck" Adams of Channing, Tex., often aids in roadside emergencies, helps pen run-away cows, and has worked to improve local Baptist Church, parsonage.

**CRIPPLED CHILDREN LEARN TO WALK** through fund-raising efforts of Vernon E. Brooks, Norristown, Pa., who helped obtain \$100,000 to build a school for spastic paralytics. Mr. Brooks (center) is a director of the Chamber of Commerce, and a prime mover in Red Cross, Community Chest, United Fund, and Salvation Army work. As national president of the American Business Club, he helped obtain more than 100 scholarships for the training of physical and speech therapists. He is chairman of the Muscular Dystrophy unit for the Tall Cedars of Lebanon.

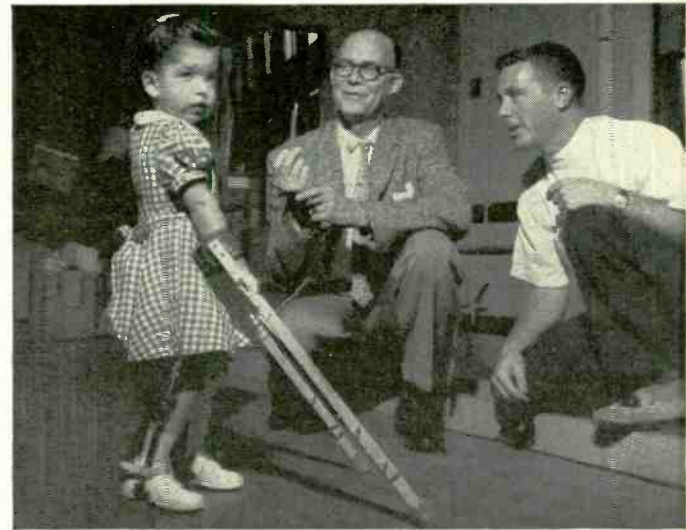

## All-American TV Technicians

**HELPED TORNADO VICTIMS.** When disaster struck the area around Menomonie, Wis., on June 4, Vernon Townsend quickly organized emergency radio facilities to speed relief to the sufferers. A leading member of the Radio Amateur Civil Emergency service, he is active in Dunn County civil defense work, and also maintains a radio entertainment service for the local city-county hospital.

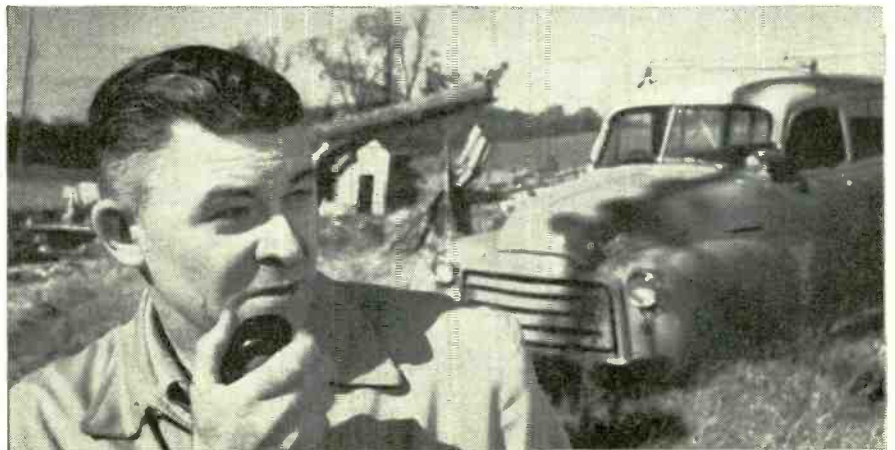



**TEACHES SCOUTS RADIO.** Boys in Brockton, Mass., learn Morse Code and the elements of electronics at an early age, from instruction by TV technician Albert P. Kazukonis. Much of the equipment he supplies without charge. A devoted youth and community worker, Mr. Kazukonis is treasurer and a past president of the Electronic Technicians Guild of Massachusetts, Brockton Chapter.



**DONATED LOUDSPEAKER SYSTEM.** The 1958 Centennial parade and pageant at Bloomington, Minn., owed much of its success to the fine amplifier system installed without charge by Edwin B. Haines. Ed is widely known for the time, effort, and equipment he has supplied for the 2,000 boys in Bloomington's sports program. He is a leader and counselor in Boy Scout work, and gives assistance to the Lions and the Bloomington Civic League.

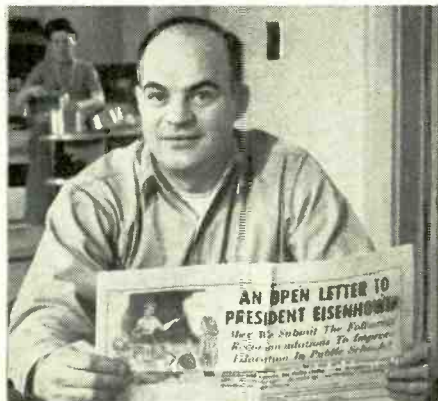

**SPENDS TO PROMOTE EDUCATION.** Out of his own pocket, A. George Catavolo, TV technician of Somerville, Mass., financed two full-page newspaper ads which presented to the President recommendations on public school education. Last year George contributed over 30 radios, plus his time, to teach boys electronics.

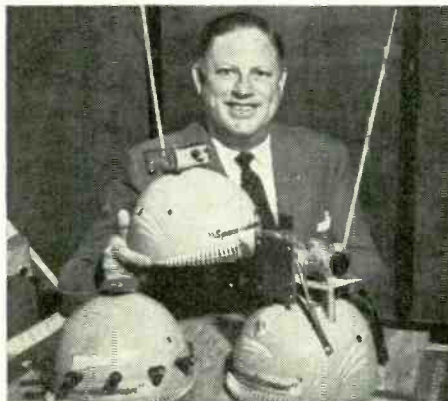

**WORLD OF TOMORROW!** This novel space radio-hat, invented by Stanley Everett of Alhambra, Cal., helped publicize many worthy drives. Stanley is president of the Los Angeles Electric League; a director of the Alhambra Chamber of Commerce; past president of Kiwanis and district chairman of the United Fund drive.



**COMMUNITY SERVICE** is a watchword with Wayne E. Lemons of Buffalo, Mo. An active Rotarian, he works with Boy Scouts, promotes Little League baseball, and has instructed TV technicians in surrounding cities. He is West Central vice-president of the National Alliance of Television Electronic Service Associations.

# Win General Electric Awards

PEOPLE the nation over nominated candidates for the 1958 All-American Awards, honoring TV service technicians. This broad response showed how important a place the television technician holds in our community life, and how widely esteemed are his efforts in aid of others.

The Award winners, shown here, were chosen by a panel of judges including John Sparkman, U. S. Senator and Chairman, Select Committee

on Small Business; Bennett Cerf, television panelist and head of Random House publishing firm; and Charles Shearer, 1957-58 president of the National Junior Chamber of Commerce.

With these Awards, General Electric pays tribute to the part played by the independent television technician in making this a better country for all. *General Electric Company, Receiving Tube Department, Owensboro, Kentucky.*



Winners received this trophy, \$500 for community benefit, and a trip to Wash., D.C., for luncheon with Senator John Sparkman.

*Progress Is Our Most Important Product*

**GENERAL  ELECTRIC**

2-111-231



Sylvania received Altoona's official welcome through front-page headlines and a special feature section filled with congratulations.

Why the whole town made such a fuss over

# Sylvania's new tube plant



For one thing—Altoona folks know that progress by an important resident company means the whole town progresses. Sylvania's President, Don Mitchell, at the multi-million-dollar plant's formal opening called it "the largest in the receiving tube industry—containing many innovations."

This is where you come in. Because most of these innovations affect your business profit. As the world's most modern tube plant, Altoona will be producing the world's most reliable tubes in both commercial and

military types. Two of the industry's biggest bugaboos, intermittent shorts resulting from dust and lint and unstable emission caused by contamination and humidity variations during tube manufacture, promise to be vastly improved. You'll be hearing more about these developments in the future.

The Altoona plant is as much a dedication to the independent serviceman as it is to the entire tube industry. It's a modern example of why profit-minded dealers are relying on Sylvania tubes.



# SYLVANIA

SYLVANIA ELECTRIC PRODUCTS INC.  
1740 Broadway, New York 19, N.Y.  
In Canada: P. O. Box 1190, Station "O,"  
Montreal 9

LIGHTING • TELEVISION • RADIO • ELECTRONICS • PHOTOGRAPHY • ATOMIC ENERGY • CHEMISTRY-METALLURGY

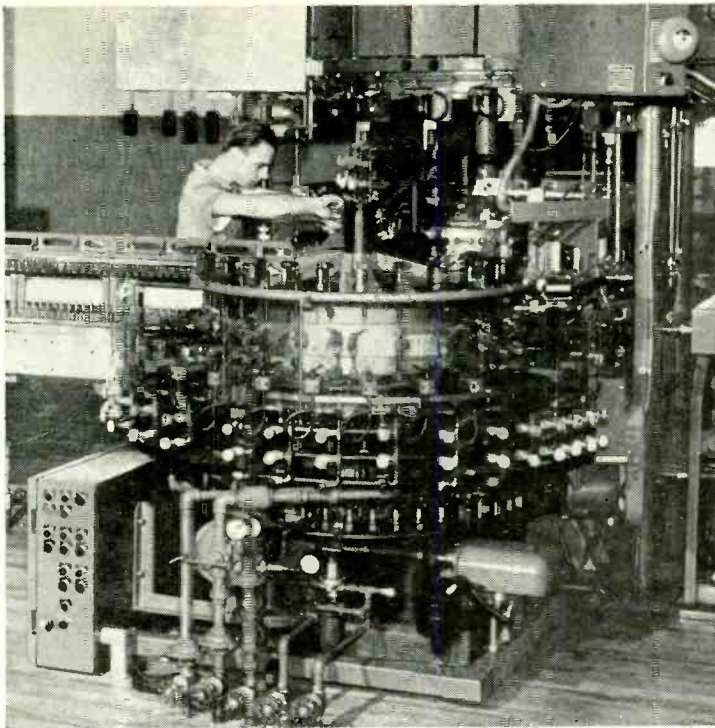

New concepts in tubemaking, which have been in development for the past decade, are put into high-speed production facilities at Altoona. The new concept bulb, in the making here, adds new tube reliability.

## in Altoona

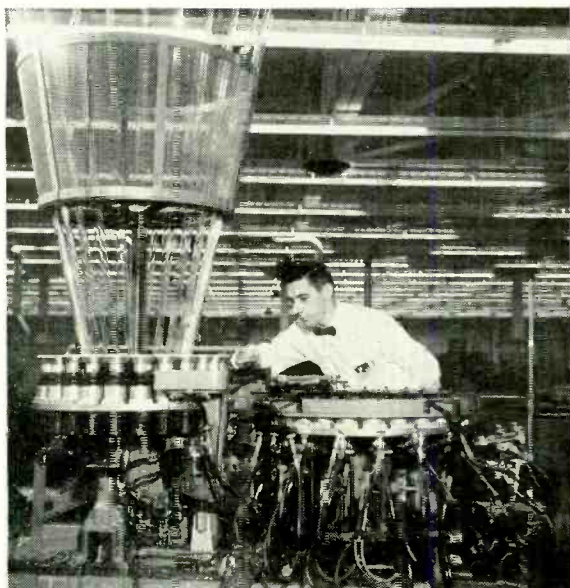

The new double-turret sealex is an important new development. Oil-diffusion pumps work in series with mechanical pumps to produce the most nearly perfect vacuum possible.

## New Transistor Servicing Course

Now you can get a thorough grounding in servicing transistorized equipment with Sylvania's new 12-lesson transistor Servicing Course. Specially prepared by Sylvania engineers and the Radio-Television Training Association, it will help you cash in on the fastest growing segment of the electronics industry.

Now is the time to prepare for your share of this fast-growing business. See your authorized Sylvania Distributor or mail the coupon below for complete information on the Sylvania—RTTA Transistor Servicing Course.



Sylvania Electric Products Inc.  
Dept. C35P  
1740 Broadway  
New York 19, N.Y.

Please send me full details on the new Sylvania—RTTA Transistor Servicing Course.

Name \_\_\_\_\_

Service Co. \_\_\_\_\_

Address \_\_\_\_\_

City \_\_\_\_\_ State \_\_\_\_\_

# Reduce record wear...

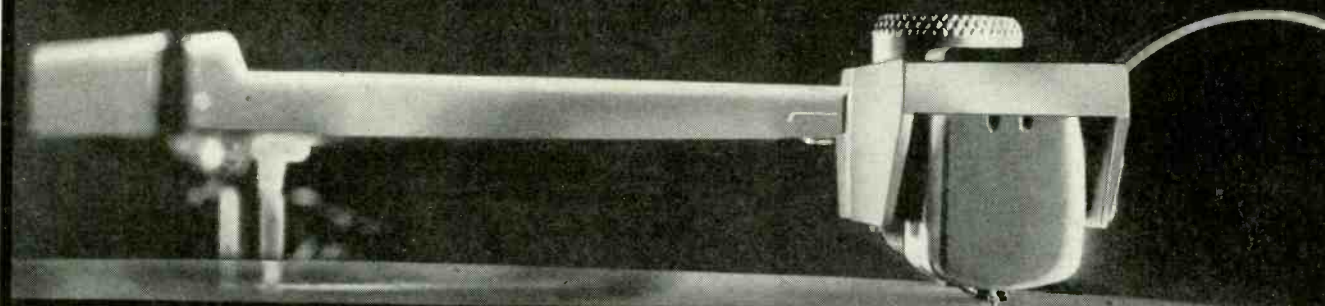

## Less mass, higher compliance with G.E.'s "Golden Classic" stereo-magnetic cartridge

The more moving parts, the more resistance to groove motion. General Electric's "Golden Classic" has only one moving part—the stylus—which "floats" freely in special-formula damping cushions. This means freer motion in the record groove. You get less wear on records and stylus, and superior sound at all frequencies. Hear the "Golden Classic" GC-5 or GC-7 soon. You'll agree they are a fitting climax to the famous General Electric cartridge tradition.

- Plays both stereo and monaural records
- Frequency response, 20 through 20,000 cycles
- Output 8 mv
- Effective mass of stylus about 2 milligrams
- Lateral compliance  $4 \times 10^{-6}$  cm/dyne; vertical compliance  $2.5 \times 10^{-6}$  cm/dyne
- Recommended tracking force with professional-type tone arm 2 to 4 grams. (Specifications for Madel GC-5.)

Model GC-5 (shawn) with .5 mil diamond stylus, **\$26.95**. Model GC-7 with .7 mil diamond stylus, **\$23.95**. Model CL-7 with .7 mil synthetic sapphire stylus **\$16.95** (Manufacturer's suggested resale prices).

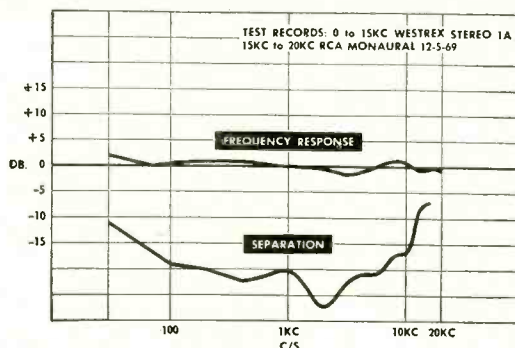

Smooth response on both stereo and monaural records. Consistently high channel separation, because the stylus is magnetically linked to the coils.

## TM-2G "Stereo Classic" tone arm



A professional-type tone arm designed for use with G-E stereo cartridges as an integrated pickup system. Unusual two-step adjustment permits precise setting of tracking force from 0 to 6 grams. Lightweight, brushed aluminum construction minimizes inertia. Statically balanced for minimum friction, reduced stylus and record wear **\$29.95** (Manufacturer's suggested resale price).



**GENERAL**  **ELECTRIC**

See and hear the G-E "Stereo Classic" cartridges and tone arm at your Hi-Fi dealer's now. For more information and the name of your nearest dealer, write General Electric Company, Specialty Electronic Components Dept., 4412 W. Genesee St., Auburn, New York.

**WE'RE MAKING IT EASIER THAN EVER TO BECOME A WELL PAID  
RADIO-TELEVISION SERVICE TECHNICIAN**

**NOW - Just \$6 Starts You Training in  
RADIO-TELEVISION**

**the SPRAYBERRY "Learn-by-Doing" Way...**

**25 BIG, COMPLETE KITS  
of PARTS & EQUIPMENT**

To help you learn *fast* the practical side of Radio-Television, we send you expertly engineered training kits to test and assemble for interesting, valuable shop-bench practice!

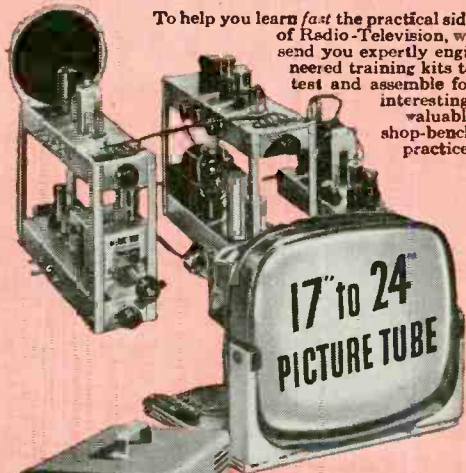

• The new Sprayberry Training Television Receiver, built and tested in 5 sections.

• Now offered... this fine modern oscilloscope.

• You build this powerful two-band superheterodyne radio receiver.



**Big New  
CATALOG  
AND  
Sample Lesson  
FREE!**

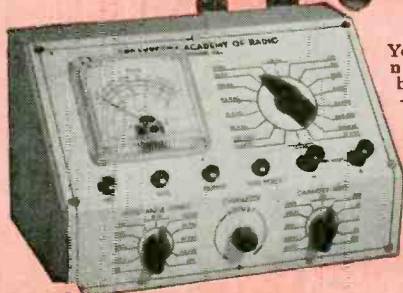

You build the new Sprayberry tester—a complete 18-range Volt-Ohm-Milliammeter test meter.

★ ★ ★ ★ This great industry is begging for trained men... to step into good paying jobs or a profitable business of their own! Our new plan opens the doors of Radio-Television wide to every ambitious man who is ready to act at once!

Men by the thousands... trained Radio-Television Service Technicians... are needed at once! Perhaps you've thought about entering this interesting, top paying field, but lack of ready money held you back. Now—just \$6 enrolls you for America's finest, most up to date home study training in Radio-Television! Unbelievable? No, the explanation is simple! We believe Radio-Television *must* have the additional men it needs as quickly as possible. We are willing to do our part by making Sprayberry Training available for less money down and on easier terms than ever before. This is your big opportunity to get the training you need... to step into a fine job or your own Radio-Television Service Business.

**Complete Facts Free—Act Now; Offer Limited**

Only a limited number of students may be accepted on this liberal and unusual basis. We urge you to act at once... mail the coupon below and get complete details plus our big new catalog and an actual sample lesson—all free. No obligation... no salesman will bother you.

**HOME STUDY TRAINING IN SPARE TIME**

Under world-famous 27-year old Sprayberry Plan, you learn entirely at home in spare time. You keep on with your present job and income. You train as fast or as slowly as you wish. You get valuable kits of parts and equipment for priceless shop-bench practice. And everything you receive, lessons and equipment alike, is all yours to keep.

**LET US PROVE HOW EASILY YOU CAN LEARN!**

Radio-Television needs YOU! And Sprayberry is ready to train you on better, easier terms, that any ambitious man can afford. Just \$6 starts you! Mail coupon today... let the facts speak for themselves. You have everything to gain. Let us prove the kind of opportunity that's in store for you!

**SPRAYBERRY Academy of Radio-Television**  
1512 Jarvis Avenue, Dept. 20-R, Chicago 26, Illinois

**Mail This Coupon Now—No Salesman Will Call**

**Sprayberry Academy of Radio-Television**  
Dept. 20-R, 1512 W. Jarvis Ave., Chicago 26, Ill.

Please rush all information on your ALL-NEW Radio-Television Training Plan. I understand this does not obligate me and that no salesman will call upon me. Include New Catalog and Sample Lesson FREE.

NAME..... Age.....

ADDRESS.....

CITY..... ZONE..... STATE.....



NEW  
REVISED  
EXPANDED



Still Only  
\$25<sup>00</sup> net

ELECTRON TUBES



SEMICONDUCTORS

# transistor course

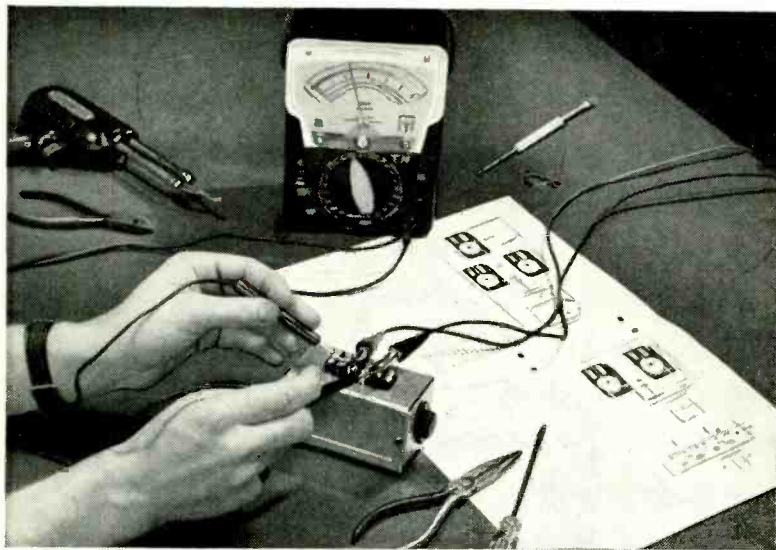

**Learn about transistors  
by using them**

Advancement opportunities await service-dealers, engineers and technicians who know about basic transistor fundamentals. The newly revised and expanded edition of this popular and economical Transistor Course can help you too. A CBS-Hytron first, it was especially written and illustrated by A. C. W. Saunders, well-known educator and author, to make it easy for you to learn about transistors by *using* them. What you learn you can be sure you will remember . . . by making for yourself the practical transistor devices described. Check the expanded features. Read how easy it is to start your fast, fascinating Transistor Course.

**Transistor Course Includes:**

- Ten intensive lessons (with 3-ring binder) . . . up-to-date, complete
- Simplified basic theory . . . how transistors work
- Practical experiments and servicing techniques for:
  - Amplifiers** . . . applications in all fundamental circuits
  - Oscillators** . . . a-f, r-f, relaxation, multivibrator, special TV
  - Rectifiers** . . . diode and transistor rectifiers and detectors
  - TV deflection circuits** . . . and Eccles-Jordan Trigger circuits
  - Practical commercial applications** . . . immediate and future

**HOW TO GET IT**

Call your CBS-Hytron distributor. He'll tell you how to get the CBS-Hytron Home-Study Transistor Course, PA-275. See him or write us . . . today!

**CBS-HYTRON**, Danvers, Mass.  
A Division of Columbia Broadcasting System, Inc.



# STEREO STEREO AND MONAURAL

the  
experts  
say...  
in HI-FI  
the best buys are



World-famous  
EICO advantages  
guarantee your complete satisfaction:

- Advanced engineering • Finest quality components
- "Beginner-Tested," easy step-by-step instructions
- LIFETIME service & calibration guarantee
- IN STOCK — Compare, then take home any EICO equipment—right "off the shelf"—from 1900 neighborhood EICO dealers.



Stereo Preamplifier HF85



FM Tuner HFT90

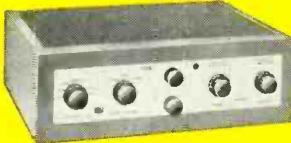

Stereo  
Amplifier-Preamp  
HF81



Bookshelf  
Speaker System  
HFS1



Speaker System HFS2  
36" H x 15 1/4" W x 11 1/2" D



Monaural Integrated Amplifiers:  
50, 30, 20, and 12-Watt  
(use 2 for Stereo)



Monaural Power Amplifiers:  
60, 50, 35, 30, 22 and 14-Watt  
(use 2 for Stereo)

Monaural Preamplifiers:  
HF65, HF61  
(stack 2 for Stereo)



Over 1 MILLION EICO instruments in use throughout the world.

## NEW STEREPHONIC EQUIPMENT

**HF85: Stereo Dual Preamplifier** is a complete stereo control system in "low silhouette" design adaptable to any type of installation. Selects, preamplifies, controls any stereo source—tape, discs, broadcasts. Superb variable crossover, feedback tone controls driven by feedback amplifier pairs in each channel. Distortion borders on unmeasurable even at high output levels. Separate lo-level input in each channel for mag. phono, tape head, mike. Separate hi-level inputs for AM & FM tuners & FM Multiplex. One each auxiliary A & B input in each channel. Independent level, bass & treble controls in each channel may be operated together with built-in clutch. Switched-in loudness compensator. Function Selector permits hearing each stereo channel individually, and reversing them; also use of unit for stereo or monophonic play. Full-wave rectifier tube power supply. 5-12AX7/ECC83, 1-6X4. Works with any 2 high-quality power amplifiers such as EICO, HF14, HF22, HF30, HF35, HF50, HF60. Kit \$39.95. Wired \$64.95. Includes cover.

**HF81: Stereo Dual Amplifier-Preamplifier** selects, amplifies & controls any stereo source—tape, discs, broadcasts—and feeds it thru self-contained dual 14W amplifiers to a pair of speakers. Monophonically: 28 watts for your speakers; complete stereo preamp. Ganged level controls, separate focus (balance) control, independent full-range bass & treble controls for each channel. Identical Williamson-type, push-pull EL84 power amplifiers, excellent output transformers. "Service Selector" switch permits one preamp-control section to drive the internal power amplifiers while other preamp-control section is left free to drive your existing external amplifier. "Its performance is excellent, and the operation is uncomplicated."—HI-FI MUSIC AT HOME. "Excellent"—SATURDAY REVIEW. Kit \$69.95. Wired \$109.95. Incl. cover.

**MONAURAL PREAMPLIFIERS (stack 2 for Stereo)**  
**NEW HF65:** superb new design, Inputs for tape head, microphone, mag-phono cartridge & hi-level sources. IM distortion 0.04% @ 2V out. Attractive "low silhouette" design. HF65A Kit \$29.95, Wired \$44.95. HF65 (with power supply) Kit \$33.95. Wired \$49.95.

**HF61:** "Rivals the most expensive preamps" — Marshall, AUDIOCRAFT. HF61A Kit \$24.95, Wired \$37.95, HF61 (with power supply) Kit \$29.95. Wired \$44.95.

## MONAURAL POWER AMPLIFIERS (use 2 for STEREO)

**HF60: 60-Watt Ultra Linear Power Amplifier** with Acro TO-330 Output Xfmr.; "One of the best-performing amplifiers extant; an excellent buy." AUDIOCRAFT Kit Report. Kit \$72.95. Wired \$99.95. Cover E-2 \$4.50.

**HF50: 50-Watt Ultra Linear Power Amplifier** with extremely high quality Chicago Standard Output Transformer. Identical in every other respect to HF60, same specs at 50W. Kit \$57.95. Wired \$87.95. Cover E-2 \$4.50.

**NEW HF35: 35-Watt Ultra-Linear Power Amplifier.** Kit \$47.95. Wired \$72.95. Cover E-2 \$4.50.

**HF30: 30-Watt Power Amplifier.** Kit \$39.95. Wired \$62.95. Cover E-3 \$3.95.

**NEW HF22: 22-Watt Power Amplifier.** Kit \$38.95. Wired \$61.95. Cover E-2 \$4.50.

**NEW HF14: 14-Watt Power Amplifier.** Kit \$23.50. Wired \$41.50. Cover E-6 \$4.50.

## MONAURAL INTEGRATED AMPLIFIERS (use 2 for STEREO)

**HF52: 50-Watt Integrated Amplifier** with complete "front end" facilities & Chicago Standard Output Transformer. "Excellent value"—Hirsch-Houck Labs. Kit \$69.95. Wired \$109.95. Cover E-1 \$4.50.

**HF32: 30-Watt Integrated Amplifier.** Kit \$57.95. Wired \$89.95. Both include cover.

**HF20: 20-Watt Integrated Amplifier.** "Well-engineered" — Stocklin, RADIO TV NEWS. Kit \$49.95. Wired \$79.95. Cover E-1 \$4.50.

**HF12: 12-Watt Integrated Amplifier.** "Packs a wallop"—POP. ELECTRONICS. Kit \$34.95. Wired \$57.95.

## SPEAKER SYSTEMS (use 2 for STEREO)

**HFS2:** Natural bass 30-200 cps via slot-loaded 12-ft. split conical bass horn. Middles & lower highs: front radiation from 8 1/2" edge-damped cone. Distortionless spike-shaped super-tweeter radiates omni-directionally. Flat 45-20,000 cps, useful 30-40,000 cps. 16 ohms. HWD 36", 15 1/4", 11 1/2". "Eminently musical; would suggest unusual suitability for stereo."—Holt, HIGH FIDELITY. Completely factory-built: Walnut or Mahogany. \$139.95; Blonde, \$144.95.

**HFS1: Bookshelf Speaker System,** complete with factory-built cabinet. Jensen 8" woofer, matching Jensen compression-driver exponential horn tweeter. Smooth clean bass; crisp extended highs. 70-12,000 cps range. Capacity 25 w. 8 ohms. HWD: 11" x 23" x 9". Wiring time 15 min. Price \$39.95.

## FM TUNER

**HFT90:** surpasses wired tuners up to 3X its cost. Pre-wired, pre-aligned, temperature-compensated "front end"—drift-free. Precision "eye-tronic" tuning. Sensitivity 1.5 uv for 20 db quieting — 6X that of other kit tuners. Response 20-20,000 cps ±1 db. K-follower & multiplex outputs. "One of the best buys you can get in high fidelity kits." — AUDIOCRAFT KIT REPORT. Kit \$39.95\*. Wired \$65.95\*. Cover \$3.95.

## BEFORE YOU BUY, COMPARE:

You may examine the complete EICO line at any of 1900 neighborhood EICO distributors coast to coast. Compare critically with equipment several times the EICO cost — then you judge. You'll see why the experts recommend EICO, kit or wired, as your best buy.

EICO, 33-00 NORTHERN BLVD., L. I. C. 1, N. Y.  
Fill out coupon on other side for FREE CATALOG

Copyright 1958 by Electronic Instr. Co., Inc. 33-00 N. Blvd., L. I. C. 1, N. Y.

Add 5% in the West.

\*FLES COVER, F. E. T. 11618

the specs prove it . . .  
your BEST BUY is

**EICO**®

for COLOR & Monochrome TV servicing

**FREE CATALOG**

shows you HOW TO SAVE 50%  
on 50 models of top quality  
professional test equipment.  
**MAIL COUPON NOW!**

**NEW!**  
**TV-FM SWEEP  
GENERATOR &  
MARKER #368**



**KIT \$69<sup>95</sup> WIRED \$119<sup>95</sup>**

Entirely electronic sweep circuit (no mechanical devices) with accurately-biased inductor for excellent linearity. Extremely flat RF output; new AGC circuit automatically adjusts osc. for max. output on each band with min. ampl. variations. Exceptional tuning accuracy: edge-lit hairlines eliminate parallax. Sweep Osc. Range 3-216 mc in 5 fund. bands. Variable Marker Range 2-75 mc in 3 fund. bands; 60-225 mc on harmonic band. 4.5 mc Xtal Marker Osc., xtal supplied. Ext. Marker provision. Sweep Width 0-3 mc lowest max. deviation to 6-30 mc highest max. dev. 2-way blanking. Narrow range phasing. Attenuators: Marker Size, RF Fine, RF Coarse (4-step decade). Cables: output, 'scope horiz., 'scope vertical. Deep-etched satin aluminum panel; rugged grey wrinkle steel cabinet.

**NEW! RF  
SIGNAL GENERATOR  
#324**



**KIT \$26<sup>95</sup> WIRED \$39<sup>95</sup>**

150 kc to 435 mc with ONE generator! Better value than generators selling at 2 or 3 times its cost! Ideal for IF-RF alignment, signal tracing & trouble-shooting of TV, FM, AM sets; marker gen.; 400 cps audio testing; lab. work. 6 fund. ranges: 150-400 kc, 400-1200 kc, 1.2-3.5 mc, 3.5-11 mc, 11-37 mc, 37-145 mc; 1 harmonic band 111-435 mc. Freq. accurate to  $\pm 1.5\%$ ; 6:1 vernier tuning & excellent spread at most important alignment freqs. Etched tuning dial, plexiglass windows, edge-lit hairlines. Colpitts RF osc. directly plate-modulated by K-follower for improved mod. Variable depth of int. mod. 0-50% by 400 cps Colpitts osc. Variable gain ext. amplifier: only 3.0 v needed for 30% mod. Turret-mounted coils slug-tuned for max. accuracy. Fine & Coarse (3-step) RF attenuators. RF output 100,000 uv; AF sine wave output to 10 v. 50-ohm output Z. 5-way jack-top binding posts for AF in/out; coaxial connector & shielded cable for RF out. 12AU7, 12AV7, selenium rectifier; xmfr-operated. Deep-etched satin aluminum panel; rugged grey wrinkle steel cabinet.

**NEW! DYNAMIC  
CONDUCTANCE  
TUBE & TRANSISTOR  
TESTER #666**



**KIT \$69<sup>95</sup> WIRED \$109<sup>95</sup>**

**COMPLETE with steel cover and handle.**

**SPEED, ease, unexcelled accuracy & thoroughness.** Tests all receiving tubes (and picture tubes with adapter). Composite indication of Gm, Gp & peak emission. Simultaneous set of any 1 of 4 combinations of 3 plate voltages, 3 screen voltages, 3 ranges of continuously variable grid voltage (with 5% accurate pot). New series-string voltages: for 600, 450, 300 ma types. Sensitive 200 ua meter. 5 ranges meter sensitivity (1% shunts & 5% pot). 10 SIX-position lever switches; freepoint connection of each tube pin. 10 pushbuttons: rapid insert of any tube element in leakage test circuit & speedy sel. of individual sections of multi-section tubes in merit tests. Direct-reading of inter-element leakage in ohms. New gear-driven rollehart. Checks n-p-n & p-n-p transistors: separate meter readings of collector leakage current & Beta using internal dc power supply. Deep-etched satin aluminum panel; rugged grey wrinkle steel cabinet. CIRA Adapter \$4.50

**COLOR  
and Monochrome  
DC to 5 MC LAB & TV  
5" OSCILLOSCOPE  
#460**



**KIT \$79<sup>95</sup> WIRED \$129<sup>50</sup>**  
• Features DC Amplifiers!

Flat from DC-4.5 mc, usable to 10 mc. VERT. AMPL.: sens. 25 rms mv/in; input Z 3 megs; direct-coupled & push-pull thruout; K-follower coupling bet. stages; 4-step freq-compensated attenuator up to 1000:1. SWEEP: perfectly linear 10 cps-100 kc (ext. cap. for range to 1 cps); pre-set TV V & H positions; auto. sync. ampl. & lim. PLUS: direct or cap. coupling; bal. or unbal. inputs; edge-lit engraved lucite screen; dimmer; filter; bezel fits std photo equipt. High intensity trace CRT. 0.06 usec rise time. Push-pull hor. ampl., flat to 400 kc, sens. 0.6 rms mv/in. Built-in volt. calib. Z-axis mod. Sawtooth & 60 cps outputs. Astig. control. Retrace blanking. Phasing control. 5" PUSH-PULL Oscilloscope = 425: Kit \$44.95, Wired \$79.95. 7" PUSH-PULL Oscilloscope = 470: Kit \$79.95, Wired \$129.50.

**NEW! PEAK-to-PEAK  
VTVM #232 & UNI-  
PROBE (pat. pend.)**



**KIT \$29<sup>95</sup> WIRED \$49<sup>95</sup>**

Half-turn of probe tip selects DC or AC-Ohms. Uni-Probe - exclusive with EICO - only 1 probe performs all functions! Latest circuitry, high sensitivity & precision, wide ranges & versatility. Calibration without removing from cabinet. New balanced bridge circuit. High Z input for negligible loading. 4 1/2" meter, can't burn-out circuit. 7 non-skip ranges on every function. 4 functions: +DC Volts, -DC Volts, AC Volts, Ohms. Uniform 3 to 1 scale ratio for extreme wide-range accuracy. Zero center. One zero-adj. for all functions & ranges. 1% precision ceramic multiplier resistors. Measure directly peak-to-peak voltage of complex & sine waves: 0-4, 14, 42, 140, 420, 1400, 4200. DC/RMS sine volts: 0-1.5, 5, 15, 50, 150, 500, 1500 (up to 30,000 v. with HVP probe & 250 mc with PRF probe). Ohms: 0.2 ohms to 1000 megs. 12AU7, 6AL5, selenium rectifier; xmfr-operated. Deep-etched satin aluminum panel, rugged grey wrinkle steel cabinet.

**New!**  
Series/Parallel  
R-C COMBINATION  
BOX #1140  
**KIT \$13.95  
WIRED \$19.95**



**TUBE TESTER  
#625**  
**KIT \$34.95  
Wired \$49.95**  
• tests 600 mil series string type tubes  
• illuminated roll-chart



Pix Tube Test Adapter ..... \$4.50

**6V & 12V BATTERY  
ELIMINATOR  
& CHARGER #1050**  
**KIT \$29.95  
WIRED \$38.95**  
Extra-filtered for transistor equipt.  
#1060 KIT \$38.95  
WIRED \$47.95



**New!**  
Miniaturized  
MULTI-SIGNAL  
TRACER #145A  
**KIT \$19.95  
WIRED \$28.95**



**20,000 Ohms/Volt  
V-D-M #666**  
**KIT 24.95  
Wired \$29.95**



**1000 Ohms/Volt  
V-O-M  
#536**  
**KIT \$12.90  
Wired \$14.90**



Reads 0.5 ohms  
-500 megs, 10  
mmfd-5000 mfd,  
power factor.

**R-C BRIDGE & R-C-L COMPARATOR  
#950B**



	KIT	Wired
VTVM PROBES		
Peak-to-Peak	\$4.95	\$6.95
RF	\$3.75	\$4.95
High Voltage Probe-1		\$6.95
High Voltage Probe-2		\$4.95
SCOPE PROBES		
Demodulator	\$3.75	\$5.75
Direct	\$2.75	\$3.95
Low Capacity	\$3.75	\$5.75

EICO, 33-00 Northern Blvd.,  
Long Island City 1, N. Y.

C-2

Show me HOW TO SAVE 50% on  Test Instruments  Hi-Fi  Ham Gear. Send me FREE Catalog and name of neighborhood dealer.

Name.....  
Address.....  
City.....Zone.....State.....

TURN PAGE  
FOR MORE  
EICO VALUES

**EICO**®

Send for  
**FREE CATALOG**  
now

Prices 5% higher on West Coast.

33-00 Northern Blvd., Long Island City 1, N. Y.

## US WANTS ELECTRONIC INVENTIONS

... Our Armed Forces Call for New Developments ...

IT IS a mistaken notion that our armed forces are responsible for *all* our military inventions. While many outstanding developments are made by Government personnel, many more are invented by civilians. Every once in a while, the Government, through the National Inventors Council, issues a call to inventors and technicians for basic inventions needed for the national defense program. In our May, 1957, issue, we published such a list of inventions; a new one, just issued, is partially reprinted here. We list only 26 electronic ones.

Anyone may submit proposals to the council. Each should be submitted separately, typewritten, if possible. Descriptions should be complete and include reference to the basic principles underlying the invention and a discussion of any experimental work or tests that have been conducted as well as the advantages of the invention as compared to existing devices or techniques. Sketches or drawings need not be professional.

Keep copies of all items presented and retain a copy which has been notarized with the exact date so you will always have proof of conception for patentability. Your original copy will not be returned.

In the list given below, due to the length of the description of certain items, the word *condensed* appears at the end. It is therefore suggested that you write for the booklet *Inventions Wanted by the Armed Forces, Supplement, November 1958* from the National Inventors Council, US Department of Commerce, Washington 25, D. C.

\* \* \*

395. (Revised) **ARTILLERY ORIENTATION SYSTEM.** A system of orientation of artillery to a reference independent of line of sight, the earth's magnetic field or rotation with azimuth accuracy of  $\frac{1}{4}$  mil. Present artillery fire control systems rely on an earth-reference device to aim the weapon. (Condensed)

541. (Revised) **MICROWAVE DIRECT STORAGE OR MEMORY CIRCUIT.** The need exists for a direct-viewing storage tube capable of handling demodulated pulse type signals encountered in field operations. Such a tube can provide an important assist in visual analysis of signal information, and also facilitate photographic recording of short-duration signal transmissions. (Condensed)

648. (Revised) **INFRA-RED TRANSMITTING MATERIALS.** Development of infra-red transmitting materials having the following properties: (1) 75% transmission from 0.8- to 8-micron wavelength in 1-cm thickness. (2) Melting or softening point above 500°C. (3) Capable of standing thermal shock of 100°C per second. (4) Be resistant to abrasion and solution by atmospheric fluids.

733. (Revised) **ACOUSTIC TRANSDUCER.** A sharply unidirectional device of small size compared to wavelength for sound detection on signals as low as 5 cycles per second.

742. (Revised) **POWER RECTIFIERS.** Power rectifiers to work in an ambient temperature of -20° to +500°C.

744. (Revised) **ELECTROMAGNETIC RADIATION RECEIVER.** A device for receiving electromagnetic radiation in the 9-14-micron region, which will have a response time of microseconds and will operate at normal temperatures.

822. (Revised) **TRANSISTORS.** Transistors capable of operating efficiently (greater than 50%) as oscillators and amplifiers at uhf.

829. (Revised) **RESISTORS.** Resistors in the 1-100-megohm range with positive temperature coefficients, preferably as high as 1000 parts per million per °C are needed for temperature compensation of circuits. It is desirable that they have a power rating of at least  $\frac{1}{4}$  watt and be no larger than  $\frac{1}{2}$ -watt commercial composition resistors.

858. (Revised) **TRANSISTORS.** Transistors which will oper-

ate satisfactorily in the hf, vhf and uhf ranges at temperatures well in excess of 150°C. There is also need for transistors which will function at the various microwave frequencies.

862. (Revised) **TELEVISION SYSTEM.** TV systems of improved resolution which will permit optical tracking of guided missiles. Quality of the images should approach that of a photograph. Present guided-missile tracking instrumentation, as related to this problem, is of both optical-photographic and electronic types. No successful application of television systems has yet been made in regular missile-range operations. (Condensed)

895. **COMMUNICATING OVER A BROKEN WIRE LINE** There is a need for means of communicating over a wire line, even though the line be physically broken.

899. **HIGH-ANGLE DIRECTION-FINDING TECHNIQUES.** A method is required to permit accurate direction finding (in azimuth) on steeply downcoming sky-wave signals in the frequency range 1-12 mc. Instrumental bearing accuracy required is of the order of 2° standard deviation on signals with a minimum field strength of 20 microvolts per meter. (Condensed)

902. **PHOTOMAGNETIC PROCESS.** A new method for converting light energy into magnetic energy without the intermediate step of electrical energy. Such a method would simplify the equipment for recording images on magnetic tape.

903. **NONREFLECTING OR ABSORBING SURFACES TO ELECTROMAGNETIC (INCLUDING RADAR) ENERGY.** Aircraft, missiles, artillery shells, military vehicles, etc. are normally metallic and good reflectors or targets to incident electromagnetic energy. Much effort is being expended to develop means of making the surfaces of these items non-reflecting or absorbing to such energy. It is important to solve this problem by means which will not adversely affect normal functioning.\*

904. **MICROWAVE SUPERGAIN ANTENNA.** The range of a radar set or communication equipment can be increased by having a highly directive antenna, especially in the microwave-frequency bands between 1,000 and 30,000 mc. Many techniques are being investigated to achieve supergain by using large numbers of current elements in a relatively small volume array rather than using a large unwieldy aperture, but to date the effort has been mostly theoretical rather than practical.

907. **VIDEO COMPRESSION.** Development of a method of bandwidth compression of 3.5-mc video signals, down to the order of 1 mc for transmission, and to re-create the original bandwidth signals after transmission.

908. **SECURE CABLE.** The universal integrated communications system (UNICOM) will provide secure cables between automatic switching centers and subscribers. The problem is to develop a cable which carries groups of four wires and which is secure against interception by the enemy. This requires invention of a warning alarm, to be activated—whenever the cable is disturbed in any fashion—to improperly read the messages passing through the cable.

909. **TIME SYNCHRONIZER.** A technique for synchronizing absolute time over distances of from 100 to 1,000 miles, to accuracies in the order of 1/10 microsecond or less. Present techniques require approximately 10 mc of bandwidth and many microwave relay stations, or very powerful low-frequency transmitters with complex associated equipment, both methods being undesirable.

911. **DATA TRANSMISSIONS.** A means for transmitting, at the instant of sensing, aerial photographic-mapping sensory presentations and allied data from an airborne vehicle to a ground station without loss of resolution or geometric fidelity. The system should be non-jammable and not limited to line-of-sight range.

914. **ELECTRONIC DISTANCE-MEASURING SYSTEM.** An accurate method of measuring geodetic distances up to 1,500

(Continued on page 133)

\* See also September, 1958, RADIO ELECTRONICS on same subject.

*For frequencies above 2,000 cycles only, this 3-tube audio amplifier puts you on the road toward a quality dual-channel hi-fi system*

# AMPLIFIER for your TWEETER

By ROBERT G. VAUGHN

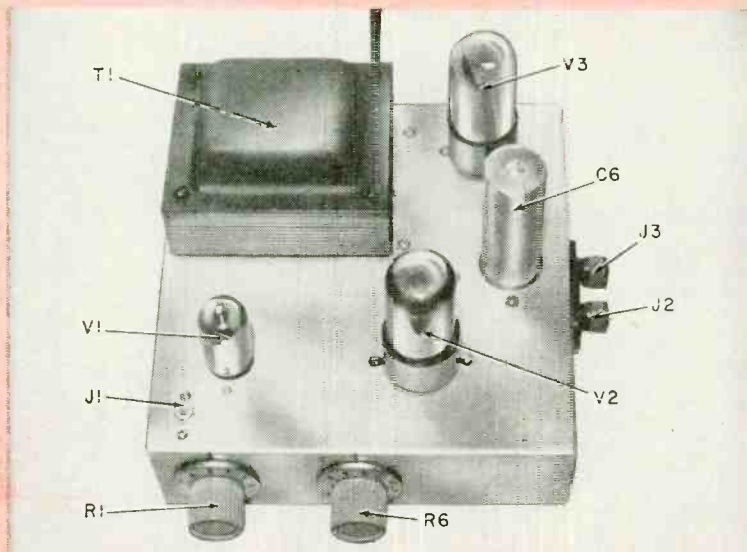

From the top the amplifier presents a very ordinary appearance.

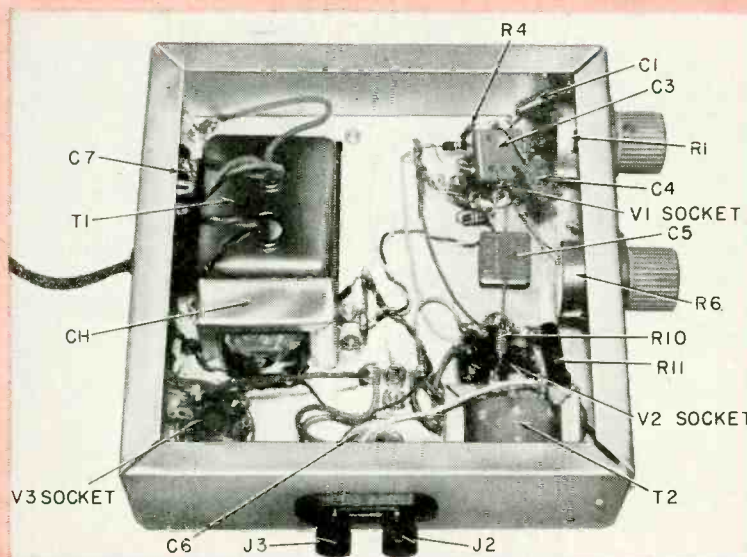

As few parts are used there is no crowding under the chassis.

**T**HIS amplifier is used to drive a high-frequency speaker. It is the product of 2 years of practical testing, in practical systems.

Nonessentials have been discarded, and the result is a unit that is simple, inexpensive, easy to construct, and does the specialized job required of it.

Despite its low cost, it will perform as part of a high-quality system of any power up to at least 25 watts. The crossover, at 2,000 cycles, is part of the amplifier's response characteristic.

Because of the amplifier's strictly high-frequency character, some problems found in low-frequency amplifiers are avoided. For example, with an output transformer costing about \$3, 20 db of feedback is used with complete stability under any signal or load condition.

Mainly, the unit's low cost is possible because little power is needed in its range. But there are other reasons not directly related to power. The advantages of push-pull operation are less apparent at the frequencies involved. A single output tube, especially with feedback, is not the disadvantage it is at very low frequencies. And, of course, the huge primary inductance of a low-frequency output transformer is unnecessary.

These things combine to make a unit (see Fig. 1) that works well in a quality system having a main or low-frequency amplifier, with many times the power output of the high-frequency one. Self-powered, it is only 7 inches square. Its three tubes are a 6V6-GT audio output, a 12AX7 two-stage voltage amplifier and a 5Y3-GT rectifier.

### Circuit features

The key to the circuit's design lies in using coupling values barely sufficient to maintain a flat response down to the crossover frequency, and no more. This provides a sharp drop below 2,000 cycles, even with feedback, which tends to flatten out the curve and avoids the need for special filters or networks in the high-frequency channel. Frequency response is shown by Fig. 2, plotted with 2,000 cycles as the reference frequency.

Since the amplifier is normally connected to the output of a preamp, or to an equalized source such as a tuner, large low-frequency voltages at its input have to be guarded against. Otherwise, a serious overload might result. The input capacitor, with a reactance of more than 3 megohms at 100 cycles, and the GAIN CONTROL effectively prevent this.

While further economy might seem possible in power supply filtering, it cannot be neglected simply because hum, which is inaudible in the output, may modulate the delicate high-frequency tones, destroying their brilliance and clarity.

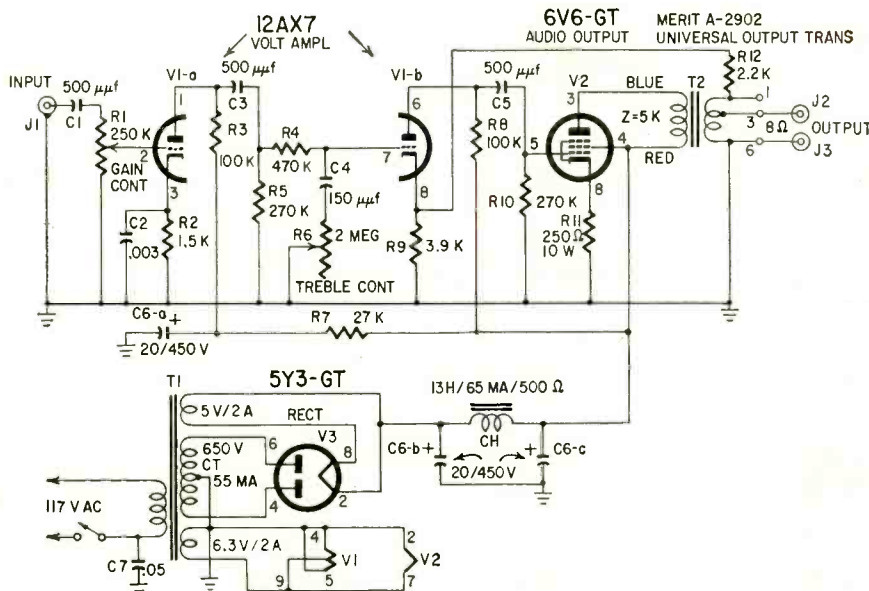

- R1—pot, 250,000 ohms, audio taper
- R2—1,500 ohms
- R3, 8—100,000 ohms
- R4—470,000 ohms
- R5, 10—270,000 ohms
- R6—pot, 2 megohms, audio taper
- R7—27,000 ohms
- R9—3,900 ohms
- R11—250 ohms, 10 watts
- R12—2,200 ohms
- All resistors 1/2-watt 10% unless noted
- C1, 3, 5—500 μμf, mica
- C2—0.003 μf, mica
- C4—150 μμf, mica
- C6—20-20-20 μf, 450 volts, electrolytic
- C7—.05 μf, 400 volts, paper

- CH—13 henrys, 65 ma, 500 ohms (Stancor C-1708 or equivalent)
- J1—phono jack
- J2, 3—binding posts
- T1—power transformer: primary, 117 volts; secondary, 650 volts ct, 55 ma; 5 volts, 2 amps; 6.3 volts, 2 amps (Stancor PM- or PC-8407 or equivalent)
- T2—universal output transformer, 10 watts (Merit A-2902 or equivalent)
- V1—12AX7
- V2—6V6-GT
- V3—5Y3-GT
- Switch, spst, optional
- Chassis, 7 x 7 x 2 inches
- Miscellaneous hardware

Fig. 1—Circuit of the compact high-frequency amplifier.

It may seem that the 470,000-ohm resistor (R4) in series with V2's grid, would normally degrade high-frequency response. The curve (Fig. 2) shows that this does not happen. There are two reasons why this is so.

First is the greatly reduced input capacitance of V2 because of feedback. The other is that the loss that does occur is compensated for by the effect of C2, the small cathode bypass capacitor in the first stage. Their effects are exactly opposite and tend to cancel each other.

Resistor R4 is needed for satisfactory operation of the high-frequency attenuator circuit which includes R6 and C4. Without R4, C4 would have to be so large to be effective that it would load V1's plate circuit and create serious distortion.

### Hooking into the system

There are several ways of hooking it into your present system, depending on the system itself and your desires. The ideal is a setup with separate main amplifier and preamplifier, already using two speakers and a crossover network. Two approaches are possible. The perfect one would be to insert an electronic crossover after the preamp, then attach the tweeter to the high-frequency amplifier and the woofer to the main amplifier.

A solution almost as satisfactory is to connect the high-frequency and main amplifiers in parallel at the output of the preamp, connect the tweeter to the high-frequency amplifier and connect a resistor of the same ohmage and approx-

imate wattage across the tweeter terminals of the crossover network.

If you are using an amplifier with the preamp built in and only one speaker, the problem is not so simple. You may not be sure just where the main amplifier begins. The best way to find out is possibly to trace the main feedback loop from the output, which nowadays in most cases runs back to the cathode of the first tube of the main amplifier. By connecting to the grid of that tube, you also avoid the danger of getting your input circuit inside the feedback loop, which was certainly not designed for its inclusion.

In a number of amplifiers it may be advisable to connect the high-frequency amplifier one stage still further toward the input. Many amplifiers have a frequency control in that stage. By connecting the high-frequency amplifier across or ahead of it, you can use it to keep higher notes out of the woofer and to control response in the upper part of the woofer's range to some degree. When set for maximum treble attenuation, it will act much like a low-frequency divider.

However, if the treble control is ahead of the high-frequency amplifier input, you may prefer to use it and leave off R6 and C4. It is best to leave R4, because it has a stabilizing influence.

The volume control of the main amplifier will in practically all cases be ahead of the high-frequency volume control, and may be used to control volume of the whole system, maintaining balance with the high-frequency ampli-

fier control. If, however, you want completely independent controls, the place to connect the amplifier is across the volume control of the main amplifier. Then balance is adjusted with both controls, but it will also be necessary to juggle both controls to raise or lower the overall level.

If you are among those who prefer the effect of wide separation between high- and low-frequency speakers, this unit fits in. The separate control of gain through each channel heightens the realistic effect. With this kind of system, using the main amplifier's treble control as suggested earlier has a more noticeable effect than when the speakers are close together.

The value of feedback resistor R12 is based on use of the Merit A-2902 transformer and may differ widely with any other for the same amount of feedback. Also, any substantial change in R12 calls for a change in R9, if V2 is to have the correct bias. The two in parallel should total about 1,500 ohms, but the ratio determines the amount of feedback. Keep this in mind when considering substitution.

The numbers 1 and 6 at the secondary terminals in the diagram refer to those on this transformer. These are the outside terminals, the whole winding being used for feedback. Consult the sheet that comes with the transformer for the nearest match to your speaker, this being a universal type unit. Most likely the 8- or 12-ohm terminals will prove best. This is convenient because these are terminals 3 and 6, and 2 and 6, respectively. Terminal 6 is grounded for feedback purposes.

If you are one of those who share the increasing interest in dual-channel systems, this unit has much to recommend it. If you stick to the values specified and to good construction practices, you can hardly have serious trouble. The circuit itself is little different from any other audio circuit. The coupling capacitor values will seem strange and perhaps wholly inadequate to anyone accustomed to low-frequency circuits. But as you have seen, they have a very definite purpose.

A 1/2 volt rms at 2,000 cycles drives the unit to full output—just over 4 watts at the clipping point. But don't let this fool you. At frequencies in this range, 4 watts, even into an inefficient speaker, is more than most people can stand indoors. END

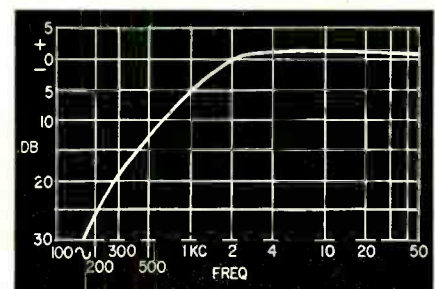

Fig. 2—Amplifier's response is almost flat from 2,000-20,000 cycles. Note sharp rolloff below 2,000 cycles.

# ALL ABOUT THE

# REFLEX ENCLOSURE

Part I—Development, resonance, air motion in the enclosure

By P. G. A. H. VOIGT

THE so-called reflex cabinet is, in effect, a box baffle with an extra feature. Therefore, practically everything which we discussed earlier applies and we will not waste time repeating what has already been said. (See "A Box for Your Speaker," RADIO-ELECTRONICS, January, 1959, page 48.)

The extra feature of the reflex cabinet is its port or vent. In its simplest form this is a rectangular or circular hole. Sometimes it consists of a number of small holes. The expression distributed port is then used to describe it. Sometimes a short pipe or "duct" is fitted internally at the opening.

When discussing the box baffle, we were concerned with preventing air flow from the back of the cone to the front. So making one or more holes in the enclosure seems a crazy thing to do, for surely it will permit some flow and diminish the baffle's effect? If everything is taken into consideration, the idea is not quite as absurd as it seems. Making the opening does introduce disadvantages, certainly, but there are also advantages, and to understand how these come about, we must go into fundamentals a bit more. We shall then discover something quite unexpected which is not obvious at first glance. So let us go back to the beginning.

## History behind the reflex

There are many famous names in the world of radio—Marconi, Fleming, Lee de Forest, Armstrong and many others. In each case the person concerned was responsible for one or more important developments, and if that person's name is mentioned his work immediately comes to mind. The reflex cabinet is an exception. No one person's name comes to mind when it is mentioned.

In 1933-34, I was very much concerned with trying to increase the amount of bass you can get from a speaker with a fairly small cone. That cone was already driving a short horn but the system was inefficient below the horn cutoff. Several cubic feet of

space were available in the cabinet below the horn, and the problem was to find a way to augment the lowest frequencies within the available volume. The method finally adopted used a tapered, folded pipe (rather like the neck of a horn) which exhausted near the floor. I named the bass department of the system a bass chamber and would certainly *not* have done so had I been aware of the impending introduction of what is now called the reflex cabinet. For that has a much better right to be called a chamber than my more complex tapered folded pipe system. In Britain, reflex cabinets were in circulation before the war (September, 1939). This places the arrival of reflex enclosures somewhere between 1934 and 1939.

Recently, I have been able to trace the arrival details properly, thanks to the cooperation of the library of the University, the Reference Library, Ontario Hydro and the Ryerson Institute of Technology, all in Toronto and the library of Queen's University, Kingston, Ontario.

Langford Smith's *Radiotron Designers Handbook*, Fourth Edition (1952), in a prolific source of references. Reflex cabinets are discussed there and indexed under "Baffles, Loudspeaker, Vented." Most references to reflex cabinets given in the text date after the outbreak of the war.

The two earliest refer to an article in *Radio Engineering* for October, 1936, and to "New Features in Broadcast Receiver Design" in the *RCA Review* for July, 1937. That review also refers

to the October, 1936, article in *Radio Engineering*, as does Olsen's book<sup>1</sup>. There was, however, a hint of things to come in a still earlier article on "Improving the L.F. Response" in *Radio Engineering* for June, 1936. This referred to the "recently announced" RCA receiver and gave a brief description of the system. So, with a first hint in June and the full story in October, the reflex cabinet became known to the technical public in 1936.

In connection with the October, 1936, article, three authors' names are given (all of RCA). They acknowledged the assistance of still more people. Evidently it was an RCA team effort with RCA signing the checks.

The article in the July, 1937, *RCA Review* discusses the next year's models and, in connection with the acoustical end, mentions work on the application of acoustic filter theory to single or multiple "tone chambers." It describes an enclosure with a curved enclosing panel and rows of holes near the bottom and elsewhere, "the holes being proportioned to produce the best acoustic effect, the combined inertia of the air resonating with the enclosed cavity."

So it seems that RCA deserves the credit. However, I have recently come across another reference: US Pat. No. 1,869,178 assigned to Bell Labs. The inventor, A. L. Thuras, bears an honored name among the early workers in electro-acoustics. He describes a system in which the cabinet has openings with short pipes internally. The date of filing Thuras' patent was Aug. 15, 1930! So, it seems that Thuras "fathered" the idea and RCA as "midwife," about 6 years later, helped to bring it before the public.

Jensen Manufacturing was also at work in 1936, though it seems that they did not publish anything that was made available to the enthusiast that year. However, the name Bass Reflex, which they gave to their infant has stuck ever

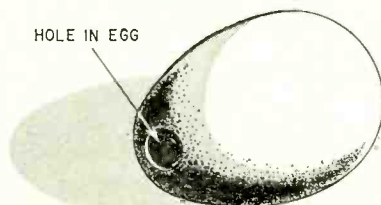

Fig. 1-1—The basic Helmholtz resonator consists of a hollow body with an aperture.

<sup>1</sup>Harry F. Olson, *Elements of Acoustical Engineering*, 2nd Edition, 1947. D. Van Nostrand Co., Inc.

since and has been adopted on a world-wide basis.<sup>2</sup>

Resonances produced in an enclosed cavity with one or more openings have been known for a very long time. Back in the 19th century an Austrian physicist named Helmholtz made a study of this type of resonator. Whether he did his work because of possible applications to musical instruments or just out of scientific curiosity is irrelevant. What matters is that he studied the subject in detail and worked out the mathematical equations for a resonator in which the moving part is air moving in and out of an opening and the elasticity is provided by the compressibility of the air in the cavity.

A simple form of Helmholtz resonator (see Fig. I-1) is an eggshell with a single hole in it (through which the contents have been drained). This leaves a hollow body having an aperture. By blowing across the hole in certain ways, it is possible to produce a musical tone. Another type of Helmholtz resonator is a bulbous flower vase in which the customary neck opening forms the aperture. Any container enclosing a body of air and having one or more openings can act as a Helmholtz resonator.

An eggshell and a flower vase are usually round, but the shape of the internal volume does not affect the resonance, so long as certain requirements are met. A rectangular volume resonates just as well. Therefore, if an opening (a port or vent) is made in one side of a box baffle such as we discussed before, the enclosure becomes a Helmholtz resonator capable of being excited at its resonant note.

The resonant frequency is determined by the inertia of the moving air in the aperture(s) and thereabouts, acting in combination with the compressibility of the air cushion inside the cavity. The natural resonant frequency can be adjusted by altering the volume of the air cushion. Doing something which affects the inertia of the air at the opening is another way of changing the frequency. Changing the area of the aperture does just this, and once the box has been built is a much easier way of varying the resonant frequency than by changing the volume.

In the 1920's, resonance was regarded as the "root of all evil" as far as speaker design was concerned and designers did what they could to get away from inherent resonances. From a theoretical point of view that is still correct. But in practice, if theoretical perfection is not attainable within a certain space or price range, it is good engineering to examine the various "not quite so perfect" possibilities and to select one of the next best. The reflex cabinet, especially when designed or adjusted to suit the speaker with which it is to be used, is perhaps the

simplest of these "next bests" and has become very popular.

It is this matter of matching the reflex cabinet to the speaker that makes the main difference between the best in reflex systems and the ordinary ones. However, before we can discuss adjusting reflex cabinets intelligently, a few comments on speakers have to be made.

A moving-coil speaker has a voice coil driving a cone. These moving parts have to be kept in their proper place with respect to the magnet. Axial motion, within certain limits, is necessary to produce the sound, but lateral motion should be negligible. In any normal system, the supports for the moving parts have some elasticity, which returns the coil and cone to a central point when no other forces are acting against it.

The coil and cone with their accessories all have mass. So there is combined mass under elastic control. When mass is under elastic control, there is a frequency at which resonance can occur. The extent to which this resonance builds up with a given stimulus at the resonant frequency depends on the losses.

Of the losses, the useful loss is the work done by the front face of the cone in creating the wanted sound output. There is also a loss because of the work done by the rear face of the cone. This may or may not be useful. Normally, there are various inherent molecular and air frictions and there is also the electromagnetic control of the voice coil. Properly speaking, this is not a loss but it is involved in the problem of the amplitude of motion produced.

If the coil is immersed in an intense magnetic field and is driven from a low-impedance source (such as a power triode), the electromagnetic control is fairly rigid and no great buildup occurs at the resonant frequency, for the back emf generated by motion opposes the applied voltage. However, if the magnetic field is weak, or the driving circuit has high impedance—as when a pentode is used without feedback—the control is slight and a relatively large amplitude may build up at the speaker's lower resonant frequency. At lower frequencies the mechanical forces tend to control and limit the cone's motion.

For a given sound output at the lower frequencies, the amplitude has to increase greatly as the frequency is reduced if the speaker is working in a baffle. The mechanical control below resonance prevents the required increase in amplitude and limits the speaker's low-frequency output. In general, therefore, a speaker cuts off rapidly below its own lower mechanical resonant frequency.

I mentioned earlier that, when we come to examine the way in which a reflex cabinet works, we would find something rather surprising. This interesting effect comes next.

Let us consider the sequence of

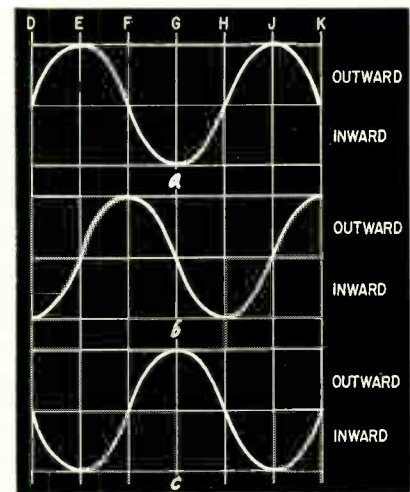

Fig. I-2—Why air displacement ends up out of phase with the speaker movement: a—accelerating force; b—port air velocity; c—air displacement.

events in reverse and begin by thinking of air rushing in and out at the port. That air will have some inertia; consequently, before it can attain any velocity it must be accelerated. When the air has experienced all its acceleration in one direction, it has acquired its maximum velocity in that direction. From that moment on deceleration (reverse acceleration) takes place, which, after stopping the air motion, reverses the direction of motion and in time produces the moment of maximum reverse velocity. By then the reverse acceleration has become zero and is replaced by acceleration in the initial direction. This continues cycle after cycle.

If, on the curve in Fig. I-2-a, we have outward acceleration between D and F, then from F to H the acceleration is reversed and from H to K it is outward again. Now how is this acceleration applied?

If we assume that the air outside the cabinet is still and at normal barometric pressure, acceleration can occur only if there is a higher or a lower pressure inside the cabinet. So long as the pressure in the cabinet is above that of the air outside, the acceleration is outward, but when the pressure in the cabinet is below that of the outside air, the acceleration is reversed and is now inward.

In our baffle box we knew that when the speaker was in operation, pressures and rarefactions were set up in the air cushion in the cabinet. It is the difference between this air-cushion pressure or rarefaction at any moment and the outside pressure which provides the accelerating force that sets up the oscillatory motion at the enclosure's port or vent.

With a sine wave of compression and rarefaction, the acceleration varies sinusoidally. The outward acceleration, starting at D (Fig. I-2-a) and stopping at F, reaches its maximum at E. The reverse acceleration starts at F and goes on to H. It reaches its maximum

<sup>2</sup>D. J. Plach and P. B. Williams, "Loudspeaker Enclosures," *Audio Engineering*, July, 1951.

P. B. Williams and J. F. Novak, "Improvement in 'Air Suspension' Speaker Enclosures With Tube Venting," *Audio*, November, 1958.

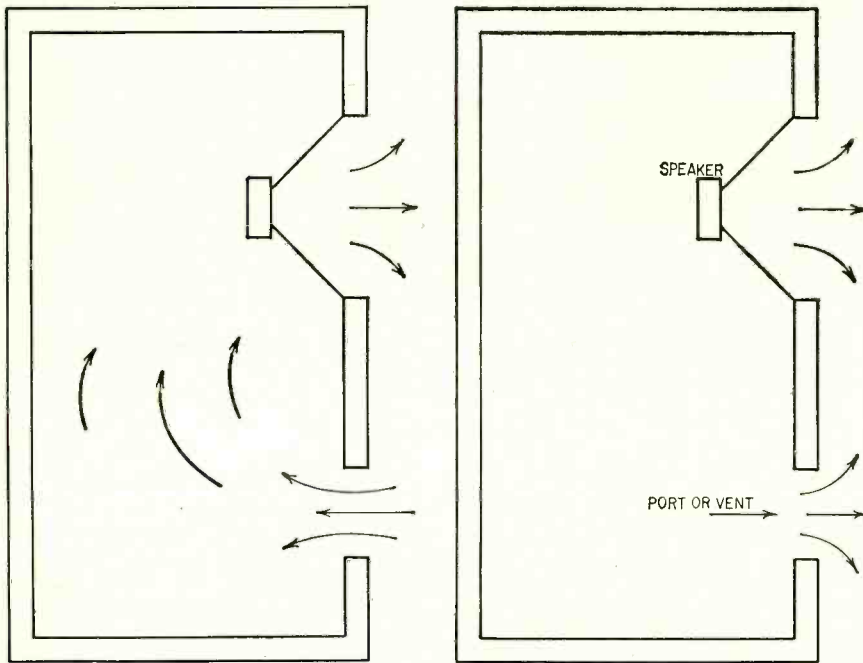

**Fig. 1-3—Because of the phase reversal, under certain conditions the air is rushing in and out of the port in sync with the speaker's cone motion.**

at G. Therefore, the air-cushion pressure is greatest at E and lowest (maximum rarefaction) at G.

To simplify things, assume for a moment that the pressures and rarefactions of the air cushion are produced solely by the motion of the speaker cone and that we are dealing with such low frequencies that the transit time of the sound within the cabinet can be neglected. Now, the pressure inside the cabinet is greatest when the cone has moved inward to the peak of its excursion. This corresponds to the moment of maximum acceleration force. That is at E in Fig. 1-2-a. Half a cycle later, the air in the cabinet is at its peak of rarefaction, and the cone is at the outward peak of its excursion. This occurs at G. Between E and G the cone has moved from its rearmost point to its foremost point. Obviously, its velocity was forward. Now look at the diagram of Fig. 1-2-b and see what the air velocity is doing. It also increases between E and G. The air moving through the port (Fig. 1-2-c) also moves forward between E and G, but is reversed in phase. The reversal is caused by the delay between the application of the accelerating force and the time this force starts air moving and the time the air does move. So instead of flowing out when the cone goes in, as one might expect, it is doing exactly the opposite.

Since air moves out of the port when the cone is moving forward, air cannot flow through the port from the front of the cone to the back. And the port, instead of being a disadvantage, actually helps under these conditions because of the phase reversal.

It so happens that the force which makes the air in the port move forward was initiated when the cone moved backward half a cycle earlier.

This half-cycle delay has no effect on a sustained note such as an organ pedal note, but it might cause an imperfection in the "attack" of a drum note. The important thing, however, is that this reinforces the cone's action in a certain low-frequency range. At higher frequencies at which standing waves might be set up inside the cabinet or where the transit time of the

air wave between the cone and the port affects the phase, all kinds of peculiar things might happen. But, as a rule, they are only minor and so of little consequence compared with the low-frequency gain.

The gain is even greater than you would expect because the assumption that the air outside the cabinet is undisturbed is not quite correct.

If the port opening is reasonably near the speaker (in fractions of the wavelength), the port does not exhaust into undisturbed free air, but into air which is disturbed by the speaker. If air in the port is moving outward when the external pressure is up a little because of the positive part of a sound pressure wave from the cone, the air emerging from the port works against an increased load (see Fig. 1-3).

The speaker cone is also affected by the action of the nearby port and, if reasonably close together, they load one another so *each* works more efficiently.

This, however, is only a part of the benefit. So far we have been considering matters in a simplified way. When we take the Helmholtz resonance into account, we find that the motion of the air in the port builds up and helps the cone even more.

So far, we have seen how the reflex enclosure came to be and a little about how it works. Next month we will finish our study of the basic theory behind the reflex and continue with detailed instructions on how to tune the bass reflex, after you have built one, to get the most from it. **TO BE CONTINUED**

## TOY ELECTRIC ORGAN

Here's an easy to build item that will keep the kids (6-60) amused for hours. It's a simple audio oscillator that is tuned so it covers one octave (eight notes) of the musical scale. For practical reasons middle C is the starting point. Standard capacitances inserted by key switches form the variable part of the circuit. Of course, you could wire up the keyboard of a toy piano so the piano keys would activate the oscillator. A BASS switch is included. It lowers the

scale by about one octave.

An all-transistor circuit means the unit is safe for children. The 7.5-volt battery is, of course, absolutely safe. It is made up of five series-connected flashlight batteries. The oscillator transistor may be a 2N653, 2N654, 2N655 or some other general-purpose audio unit. In the output stage a 2N544 is used. It produces about ¼ watt of audio, ample speaker volume for a toy instrument.—*Motorola Semiconductors*

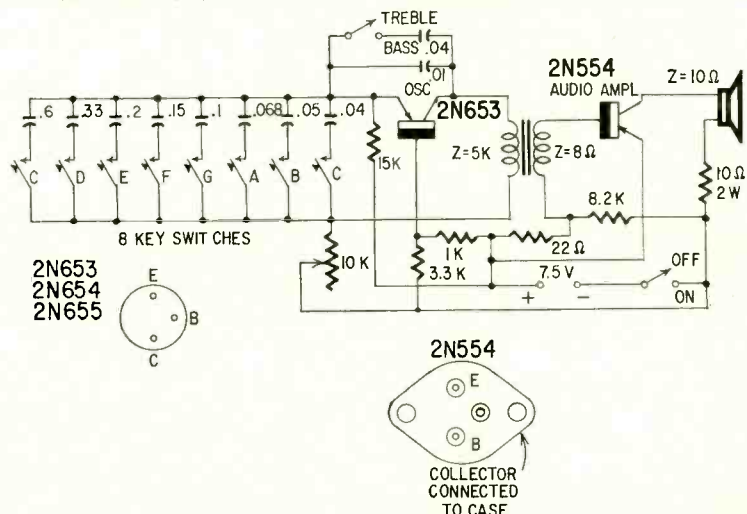



# STABILIZING FEEDBACK AMPLIFIERS

Part II—How to use voltage feedback without destroying stability

By HERBERT I. KEROES\*

INVARIABLY, voltage feedback is applied to high-fidelity amplifiers. This makes the relatively low output impedances which provide best speaker performance possible. The requirements of variable damping for optimizing output impedance make it desirable to include some kind of adjustable current feedback as well. However, with a variable damping control, the major share of feedback is still voltage feedback, and the stability of an amplifier may be analyzed on this premise. Simplified schematics of four types of feedback amplifiers are shown in Fig. 2. In Fig. 2-a, feedback is taken from the output transformer's primary. Since the output stage is push-pull, the feedback must be of the balanced type, each side being exactly 180° out of phase with the other at all frequencies. This is a very difficult requirement to meet. Moreover, this type of feedback does not correct for any possible distortion caused by nonlinearity of the output transformer core. The scheme does eliminate voltage phase shifts between the output transformer windings.

\* Arco Products Co., Philadelphia, Pa.

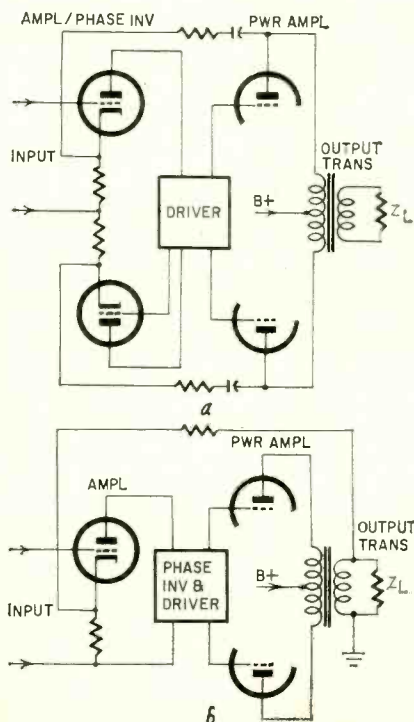

Fig. 2-b shows the conventional method of deriving feedback voltage used in most of today's high-fidelity amplifiers. Feedback voltage is taken across all or part of the output winding of the output transformer. An accurate sample of the output voltage, complete with total distortion content, is fed back to the input stage, where correction is made. However, the phase shift caused by the output transformer must be considered.

Fig. 3-a is the equivalent circuit of an output transformer. To simplify the circuit, all constants are referred to the secondary.  $L_{ep}$  is the primary leakage reactance,  $C_p$  the distributed capacitance across the primary and  $L_{es}$  the secondary leakage reactance. These parasitic elements form a single T-section low-pass filter in which the high-frequency response outside the useful band falls at the rate of 12 db per octave, with an ultimate phase shift of 180°. It is interesting to note that the Nyquist diagram for the output transformer alone will appear similar to Fig. 1-c, so the complete amplifier must finally be designed

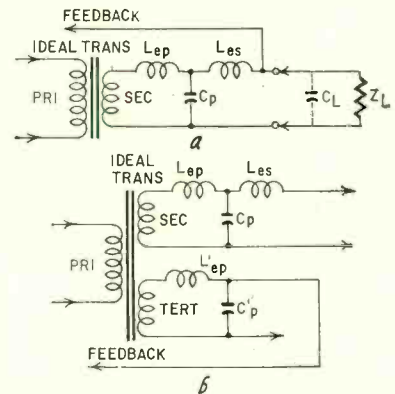

Fig. 3—Equivalent circuits of output transformers in feedback circuits; a—conventional feedback; b—tertiary feedback.

to produce a diagram similar to Fig. 1-d. (The Nyquist diagrams appeared last month in the first part of this article.) There is one further point of interest. If a capacitive load is connected to the terminals of the output transformer (dashed lines in Fig. 3-a), an additional half-section of filter is added, producing an additional 180° of phase shift. This has the effect of rotating the Nyquist plot into the position shown in Fig. 1-e. The point located at -1 is now enclosed, and the circuit oscillates. So, while Fig. 1-d predicts a rather wide stability margin on a resistive load, this condition is completely destroyed by introducing a capacitive load. Stability margin given in terms of db alone and taken for a resistive load is, therefore, an incomplete way to determine stability, and the phase angle between vector OB on the diagram and the negative real axis must also be considered. This is the angle  $\alpha$  shown in Fig. 1-d.

### Tertiary feedback

Other feedback arrangements are used to alleviate this situation. Fig. 2-c shows feedback taken from a special winding on the output transformer. This is commonly called a tertiary winding, and the arrangement is called tertiary feedback. The tertiary winding is tightly coupled to the output transformer's primary and the equivalent high-frequency circuit is shown in Fig. 3-b. At high frequencies the secondary

Fig. 2—Types of feedback arrangements: a—balanced feedback from output-tube plates; b—unbalanced feedback from output-transformer secondary; c—tertiary feedback; d—hybrid feedback.

## AUDIO—HIGH FIDELITY

circuit decouples out, including the load, so performance is relatively independent of load. The tertiary is lightly loaded by the feedback resistor and its leakage reactance produces only a very small phase shift. The equivalent circuit is, therefore, a simple half-section low-pass filter with a maximum phase shift of 180°.

Adding a load to the output winding has little effect on the tertiary voltage. Therefore, the Nyquist diagram of Fig. 1-d can be achieved and maintained more easily, and the amplifier has a higher order of stability. Note that nothing is lost by this device. The sample of voltage taken by the tertiary is still representative of the voltage in the output winding. The tertiary scheme was once used to a greater degree than now. However, its advantages were not fully appreciated, and it was discarded.

As the tertiary delivers no power to speak of, the winding may be quite small, with the design advantage of tighter coupling with the primary.

The conditions given for tertiary feedback, as outlined above, have been idealized. In practice, the tertiary must couple to some degree with the secondary, so some of the load variation in the secondary is reflected into the tertiary. Somewhat more than the 180° of maximum phase shift is induced into the tertiary winding, and feedback is not totally unaffected by the load.

### Hybrid feedback

A modified version of tertiary feedback gives practically complete independence of load variation. It is shown in Fig. 2-d and is called hybrid feedback. As in the tertiary arrangement, a separate winding on the output transformer is used. However, this winding is tightly coupled to both primary and secondary and is connected to the secondary series-aiding. Resistor  $R_a$  is located at the junction of the two windings and connected to ground. The load  $Z_L$  (voice coil) is connected between the top end of the secondary and ground. Another resistor,  $R_b$ , is connected between the open end of the hybrid winding and ground.

The arrangement forms, in effect, a balanced bridge with many interesting properties. If the primary of the transformer is matched to the impedance of the output tubes and a voltage is introduced in series with the load, the emf thus set up in the load section of the secondary, plus emf reflected from the primary, will prevent a voltage from appearing across  $R_b$ . This holds, of course, only for fairly critical settings of  $R_a$ . Since a variation in output impedance can be considered a generator which sets up a back emf, the back emf caused by the impedance variation is not reflected across  $R_b$ .

Another factor of lesser importance is that  $R_a$  can be adjusted to a value where the voltage across it is zero. Then all the load current flows through  $R_b$  and a certain amount of current feedback is obtained. By making  $R_a$  vari-

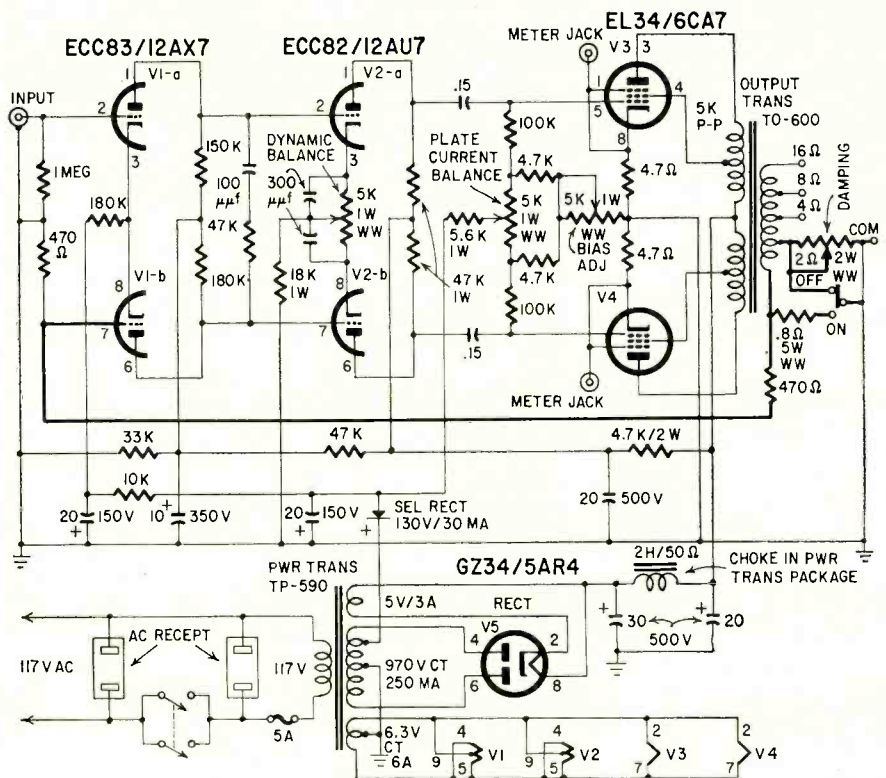

Fig. 4—Circuit of the Ultra-Linear II, a 3-stage 60-watt amplifier using hybrid feedback.

able various degrees of current feedback can be provided and used to control damping factor. If  $R_a$  is zero, the system reduces to tertiary feedback with a load on the tertiary winding, and the feedback is 100% voltage.

A simple example will show the high degree of stability of the system with large variations of output load. In the conventional system, with feedback voltage obtained across the output winding, a capacitive load will short the output winding at very high frequencies. At infinite frequency this reduces the voltage across the winding to zero. However, the phase shift will approach 180° long before the voltage reaches zero. In the hybrid system, a capacitor will short the load, placing all of the induced secondary voltage in series with the hybrid voltage, and the value of the feedback voltage will be constant. If this voltage is constant, there is no phase shift, because there must be attenuation to have phase shift. In this way complete isolation between feedback voltage and load in both magnitude and phase is obtained.

### Practical design applications

Hybrid feedback has been successfully applied to the circuit of the Ultra-Linear II, a 3-stage 60-watt amplifier. Its schematic is shown in Fig. 4. The first stage is a cathode-coupled phase inverter and amplifier which is direct-coupled to the driver stage. The driver is R-C-coupled to the output stage, which uses Ultra-Linear-connected EL34's. Fixed bias is used. At low frequencies there are two attenuating networks, the shunt inductance of the output transformer and the R-C net-

work between driver and output stage. The Nyquist diagram is of the form of Fig. 1-c. Therefore, the low-frequency stability is very high. A shunt R-C network is used in the plate circuit of the first stage to modify response, and this, combined with the cathode-degenerated driver stage, which is partially bypassed, gives a high-frequency plateau starting at about 140 kc to effect a phase reversal. The Nyquist diagram with damping control "off" is of the form of Fig. 1-d. Stability is such that a capacitive load has little effect on 15-kc square-wave response. With hybrid feedback "on," stability is even higher.

The output transformer, the Acrosound TO-600, contains the hybrid winding and has been specially designed to complement the circuit. The leakage reactance between primary and secondary is very low, in the order of 3.5 mh referred to the primary side. This provides extremely wide bandwidth and low phase shift. The secondary's hybrid section is wound of copper tape to obtain tight coupling with the load section.

It is interesting to examine what happens to a square wave under various conditions of loading. This is illustrated by the series of oscillograms in Fig. 5. Since the amplifier's low-frequency stability is practically perfect, the results are confined to a discussion of the high-frequency stability as illustrated by the response of the circuit to a 15-kc square wave. A qualitative conclusion regarding the stability can be made by comparing circuit response to the equivalent response given by a passive network composed of lumped

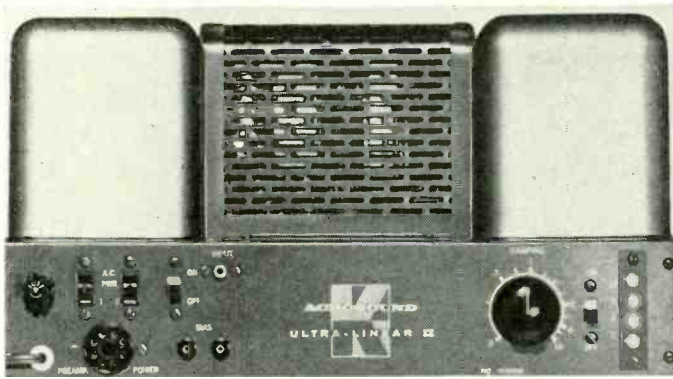

The Acrosound Ultra-Linear II amplifier.

obtained.

In all the previous cases, the amplifier's response does not differ from what one might expect from a circuit of passive elements, and stability is therefore of a very high order. Perhaps performance can best be summarized by using an apt British description—there is a complete lack of bullying of the listener. You can set the controls for a normal high or low listening level, according to individual preference, and a complete program can be enjoyed without feeling the need to reset controls for emphasis in individual passages.

[The editors built and tested one of these units and agree that it sounds excellent. Frequency response and IM distortion measurements met Acro's specs at all power levels. Particularly noteworthy was the lack of distortion on sine waves down to 20 cycles, and freedom from high-frequency peaking at any frequency up to 200 kc.] END

circuit elements. Any deviation from this would then be an imperfection introduced by feedback in the amplifier.

Fig. 5-a represents the normal amplifier response on a resistive load. There is little deviation from the ideal wave-shape. With the damping reduced, the wave shows a small amount of overshoot followed by a slight oscillatory wiggle, as in Figs. 5-b and -c. This is caused by the residual inductance in the load impedance and is typical of a load with a small inductive component.

Figs. 5-d, -e and -f show the response to a load of greater inductance. Note that the exponential length of the decay of the wave is lengthened with the increase in inductance. The overshoot of the wave with reduced damping factor is caused by the effective increase in generator impedance. At the beginning of the wave, the inductance of the load sets up a high back emf, and little current flows. All the generator emf is then applied across the load. As time increases, current starts to flow and there is an exponential drop in voltage across the load. This happens just as theory predicts.

Figs. 5-g, -h and -i are taken for a capacitive load. Of these, Fig. 5-g is a slight departure from what one would expect, since there is a small rise in voltage on the leading edge. The top of the wave is smooth and completely free of the ringing usually associated with a capacitive load. The rise time is decreased exactly in accordance with circuit theory, as the generator impedance is increased in Figs. 5-h and -i. In fact, Fig. 5-i is a perfect illustration of what happens when a square wave is fed to a capacitive load by a generator of relatively high internal impedance. In this instance, the effect is just the opposite of that of an inductive load—the back emf across the capacitor is initially zero, and high current

flows. The voltage slowly builds up and the charging current is correspondingly reduced until the peak value of the voltage is reached.

In Figs. 5-j, -k and -l the load is comprised of L, R, and C. Here damped oscillation is apparent and expected, since the output circuit contains a resonant frequency. When the generator impedance is low, greater oscillatory current flows, and oscillation is more pronounced. As the generator impedance is increased, the oscillation is damped out more rapidly and agreement with circuit theory is again

References

F. Langford-Smith and A. R. Chesterman, "Ultra-Linear Amplifiers," *Radiotronics*, May, June, July, 1955.  
 H. W. Bode, *Network Analysis and Feedback Design*, D. Van Nostrand Co., 1945.  
 C. G. Mayo and J. W. Head, "The Impedance Concept," *Wireless Engineer*, April, May, 1956.

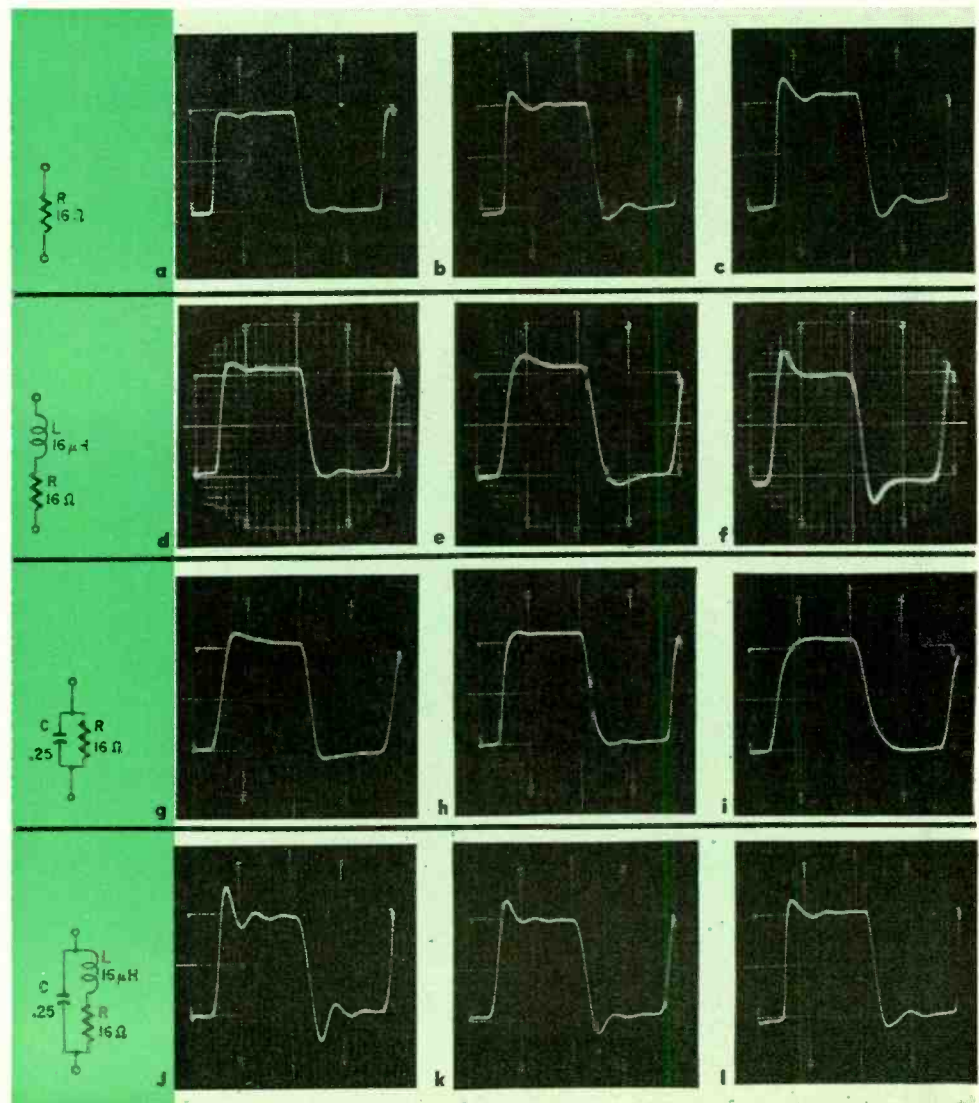

Fig. 5—Waveforms showing amplifier response to 15-ke square waves for various loads and damping.



Reviewed by  
**Chester Santon**  
 Station WQXR  
 New York City

# new DISCS and TAPES

STEREO and MONO

TOWARD the end of 1958 the stream of stereo is still full of cross currents. At moment of writing (early in December), observers are pondering the meaning of several new developments. RCA Victor's latest monthly release of classical records is entirely monophonic but other companies continue to offer a very high percentage of their current releases on stereo records. Several firms, notably Capitol and Mercury, are delving back into their outstanding monophonic albums of the last two years and bringing them out in stereo. These will be reviewed as space permits.

**Portraits in Sound**  
**Erich Leinsdorf Conducting Concert Arts Symphony Orchestra**

Capitol Stereo Tape ZF-96  
 (7-inch; playing time, 42 min. \$14.95)

Those on a diet of thin bass due to listening to stereo discs with a pickup of inferior response will find this tape a revelation. Even hardened tape fans should perk up when Leinsdorf sails into these light concert favorites. *España*, Russian Easter Overture, Moldau and Sorcerer's Apprentice, with the aid of good stereo, bring out every tonal resource of the orchestra. Put this one on your must-hear list.

**STRAVINSKY: Le Sacre du Printemps**  
**Leonard Bernstein Conducting New York Philharmonic**

Columbia Stereo Tape LMB-24  
 (7-inch; playing time, 35 min. \$12.95)

Columbia, in its latest classical stereo tapes, obviously does not intend to suffer from lack of highs. This tape and some of its immediate companions exhibit a steeply rising treble curve that begins to climb well in advance of the point at which a good tape head usually begins to roll off in response. Once treble has been reduced by those "cursed" with truly wide-range equipment, the sharp edges of Stravinsky's violent score stand out in new perspective. There is greater shock effect in the performance as recorded here than in the reading by Pierre Monteux on the RCA stereo tape.

**Concert In Rhythm**  
**Ray Conniff and His Orchestra and Chorus**  
 Columbia Stereo Tape GCB-36  
 (7-inch; playing time, 17 min. \$7.95)

This recent release has much flatter response than does the Stravinsky Columbia tape just mentioned. Overall sound is very clean. This adds greatly to the entertainment riding on this reel. I confess to having been skeptical about the contents of this reel when I read the liner notes before playing it. Popular adaptations of light classics such as these are old hat by now and can be quite dull. However, so fresh and imaginative are most of the ideas given the chorus and orchestra, I think you'll agree that these Conniff arrangements are a triumph of mind over material.

**Flamenco Fire**  
**Sabicas and Los Trianeros Flamenco Troupe**  
 DYNA Stereo Tape DY-3004  
 (7-inch; playing time, 28 min. \$11.95)

The great flamenco guitarist Sabicas sparks the excitement found on this wide-range tape. Crisp handling of the sound of castanets and the

heel clicks of gypsy dancers adds sharp detail to neatly spaced stereo. A most welcome feature of this new line of Dyna Tapes is a hiss level far below that commonly found on tapes one year ago. This reduction in noise level on the tape stems from a better duplicating process and a quality control more easily maintained by a small firm.

**SHOSTAKOVITCH: Symphony No. 6**  
**Sir Adrian Boult Conducting London Philharmonic**  
 Everest Stereo Record SDBR-3007

In its first batch of classical releases, Everest is breaking new ground in two directions. From a technical standpoint, their engineers are introducing new standards to the industry. The choice of repertory, moreover, is winning the plaudits of record collectors of every persuasion. Listen carefully to the string sections of the orchestra highlighted in the first movement of this modern, seldom-heard Russian symphony. The significantly lower noise level of the new equipment used is easily noticeable on a playback system of top design. Low-level detail in the string basses, usually masked by noise introduced during transfer from master tape to finished product, establishes this series as a product for the perfectionist. Stereo really has a chance to shine under these conditions.

**FALLA: Nights in the Gardens of Spain**  
**Gonzalo Soriano, Piano**  
**RODRIGO: Concerto for Guitar and Orchestra**  
**Narciso Yepes, Guitar**  
**Ataulfo Argenta Conducting National Symphony Orchestra**  
 London FFSS Stereo Record CS-6046

The long-established reputation of the atmospheric Falla work for piano and orchestra will draw many stereophiles to this record, but I suspect that the remarkable *Guitar Concerto* by Rodrigo will prove to be the most gratifying surprise. Those debating the extent of their investment in good components are advised to try this guitar selection on the best stereo equipment. You'll be tempted to splurge once you hear the transients on this disc—tiny wave fronts that are usually glossed over by inferior pickups, amplifiers and speakers. Delicately balanced, transparent stereo reveals orchestral detail I did not notice in the earlier, monophonic version (London FFRR LL-1738).

**DELIBES: Coppélia**  
**Ernest Ansermet Conducting L'Orchestre de la Suisse Romande**  
 London FFSS Stereo Record CSA-2201

If your stereo pickup delivers the optimum bass response available today on a first-rate system, you'll be pleased to discover that this stereo album actually calls for a bit of rolloff in the low end. Few of us who heard the first stereo discs and pickups over a year ago suspected that bass response such as this could be attained in so short a time. Ansermet's treatment of Delibes' familiar ballet score had a good reception in the mono version. It is doubly welcome in well-defined stereo.

**Paul Barbarin and His New Orleans Jazz**  
 Atlantic Stereo Disc SD-1215

The softer contours of authentic New Orleans jazz provide a new source of material for stereo

in this release. The New Orleans drummer Paul Barbarin is a veteran of the King Oliver, Louis Armstrong and Sidney Bechet bands. Most of the tunes are traditional New Orleans spirituals and marches played by musicians who have always specialized in the rhythms and tone colors of the first jazz style.

**DEBUSSY: La Mer**  
**RAVEL: Daphnis and Chloe Suite No. 2**  
**Erich Leinsdorf Conducting Los Angeles Philharmonic**

Capitol Stereo Record SP-8395

The occasional faint clicks typical of most microgrooves are the main ingredients identifying this stereo disc when it is A-B'd with the same performance on Capitol stereo tape ZF-25 (reviewed in the August, 1958, issue). The highs on the disc extend beyond those heard on a good home tape machine. The tape has a shade more separation between channels, slightly better signal-to-noise ratio and better weight of bass in the region below 200 cycles. The presence of some highs above 10 kc on the disc lends warmth to the sound of upper strings and woodwind passages in two of the most popular French orchestral works.

**Rhapsodies**  
**LISZT: Hungarian Rhapsodies Nos. 1 and 2**  
**ENESCO: Roumanian Rhapsodies Nos. 1 and 2**  
**Eugene Ormandy Conducting Philadelphia Orchestra**

Columbia Stereo Record MS-6018

Invite the Philadelphians into both channels, to discover what can be done with four of the flashier items in the orchestral repertoire. Hungarian-born Eugene Ormandy, heading a truly brilliant orchestra, staked out a claim in this type of music in monophonic days. Now Columbia cashes in with stereo that reveals the full talents of this ensemble. Slightly closer miking is evident in the *Roumanian Rhapsodies*. The sheen of the Philadelphia strings will verify the common sense of assigning your better tweeter to the left channel when forced to use unmatched speakers.

**The Play of Daniel**  
**New York Pro Musica**  
**Noah Greenberg, Director**  
 Decca Stereo Record DL-79402

The Middle Ages come alive again in this unique stereo recording. One of the earliest music dramas, the Biblical Play of Daniel dates back to the 12th century. The singers and musicians of the New York Pro Musica revived it in January, 1958, at the Cloisters, the medieval branch of the Metropolitan Museum of Art. Close miking brings out with startling realism the almost forgotten instruments of those days. The tale unfolds to the accompaniment of the straight trumpet, rebec (medieval fiddle), minstrel's harp, portative organ, miniature bagpipes, bells and recorders. Perhaps the most interesting aspect of the entire production is the percussion of Near Eastern origin—finger cymbals, Arabian nakers (tiny kettledrums) and Arabian Jingles.

**VICTORIA: Requiem Mass**  
**Choir of the Abbey of Mount Angel**  
**Portland Symphonic Choir**

RCA Victor Stereo Record LSC-2254

This mass for two choirs is totally dependent on stereo for proper effect under home listening conditions. A choir of monks on the right is heard in its chant proportions. The polyphonic or multi-voiced music is sung in the left channel by the men and women of the Portland Symphonic Choir. Excellent channel separation simulates actual conditions of performance back in the 16th century.

**SCHUBERT: Symphony No. 9 in C Major**  
**Ataulfo Argenta Conducting Cento Soli Orchestra of Paris**

Omega Stereo Disk OSL-12

Heard for the first time in well-distributed stereo, the great Schubert *Ninth* is a rewarding experience. The closer your familiarity with this magnificent work, the more interesting is the interplay among orchestral choirs. Miked in Paris by obviously knowledgeable engineers, the tonal mass of the symphony is serenely poised between loudspeakers of similar output.

**Chico Hamilton Trio**  
**Freddie Gambrell, Piano**  
 World Pacific Stereo Record 1008

A fine young pianist is introduced on this recording by the already famous Chico Hamilton. As part of the trio, Freddie Gambrell en-

hances the left channel with alert, sensitive piano work in two of his own compositions and favorites such as *Lullaby of the Leaves*, *These Foolish Things*, *In the Still of the Night* and *You're the Cream in My Coffee*. Miking favors the drums heard on the right.

**GILBERT and SULLIVAN: *The Mikado***  
London FFSS Stereo Records (2) OSA-1201  
**GILBERT and SULLIVAN: *The Pirates of Penzance***  
London FFSS Stereo Records (2) OSA-1202

Both of these definitive albums feature the celebrated D'Oyly Carte Opera Co. with the New Symphony Orchestra of London conducted by Isadore Godfrey. The gusto and style of the singers, the saucy melodies of Sir Arthur Sullivan and exemplary wide-range sound provided by the London FFSS process are an unbeatable combination. Stereo's extra dimension makes more intelligible the vital diction of soloists and chorus.

**Si Zentner and His Dance Band**  
Bel Canto Stereo Record SR-1007

Dual channeling adds impact to a big-band sound that might otherwise have been lost among the recent revivals of the band styles of the '30's and '40's. Formerly a lead trombonist with Dorsey, James and Brown, Si Zentner now leads an aggregation that eases Bel Canto's transition to stereo discs. Easy listening.

**Songs of Stephen Foster**  
John Halloran Choir  
Concert-Disc (Stereo) CS-30

Drawing upon its experience in the early days of stereo, Concertdiscs is turning out a fine stereo record. In this release, the rich melodies of Stephen Foster are sung with enthusiasm by the Halloran Choir. The handling of the acoustics is noteworthy. Concert-Disc preserves the bite and presence frequently found in studio miking. To this is added the free flight of sound in a naturally live auditorium. Better-than-average surfaces prove their value in the low-level selections.

**OFFENBACH: *The Tales of Hoffmann***  
Pierre-Michel Le Conte conducting Chorus and Orchestra of "Concerts de Paris"  
Epic Stereo Records (3) BSC-101

Epic's first opera in stereo features tenor Leopold Simoneau and soprano Mattiwilda Dobbs. Miss Dobbs is scheduled to repeat at the Metropolitan Opera one of the roles she performs in this album, that of Olympia the mechanical doll. A greater distance separates the singers than is usually found in stereo operatic recordings. Very smooth sound and quiet surfaces.

**The Herd Rides Again . . . In Stereo**  
Woody Herman Orchestra  
Everest Stereo Record SDBR-1003

A sufficient number of original Herdmen is featured in this new stereo release to capture the interest of all Woody Herman fans. Such fans will find it easier to overlook the slight distortion found in the final band on each side of the disc which appears to be cut at slightly higher than usual velocity.

**MONOPHONIC RECORDINGS**

Note: Records below are 12-inch LP and play back with RIAA curve unless otherwise indicated.

**HAYDN: *Salomon Symphonies, Vol. 1***  
Sir Thomas Beecham Conducting Royal Philharmonic  
Capitol-EMI GCR-7127

The first six of Haydn's "Salomon" symphonies (Nos. 93-104) are now set forth by Beecham in the most elegant combination of style and sound they have enjoyed on records. For maximum results, the listener may find it necessary to experiment with the cross-over control on his preamp. I found that an 800-cycle cross-over achieved better balance than did protracted fiddling with the bass and treble settings. Properly equalized, this is one of the most enjoyable albums issued in recent months.

**STRAUSS: *Don Quixote***  
Eugene Ormandy Conducting Philadelphia Orchestra  
Columbia ML-5292

The latest recording of the Richard Strauss narrative for cello, viola and orchestra finds the Philadelphia orchestra in tip-top form. The fantastic adventures of Don Quixote and Sancho Panza are much easier to follow in this framework. Few, if any, stereo discs have the frequency range and freedom from distortion displayed here. The current excitement caused by

stereo on discs has not impeded Columbia's progress in the mono medium.

**The Composer and his Orchestra**  
Howard Hanson Conducting Eastman-Rochester Orchestra  
Mercury MG-50175

On this record, the noted American composer and conductor, Howard Hanson, introduces the instruments of the orchestra, first individually and then in groups. He explains from the podium how and why he used their tonal and technical characteristics when composing his opera *Merry Mount* some years ago. The musical illustrations were selected from the orchestral suite from this opera. Exceptionally wide dynamic range distinguishes this unusual release.

**Buddy Cole Plays Cole Porter**  
Warner Bros. Records W-1226

Here's a chance to discover the recording techniques of a major film studio. I tried this disc on several systems. On average equipment, this piano and orchestra treatment of Cole Porter tunes had a lot of aural glamour. On other setups, the more accurate and "neutral" the playback system, the more apparent were the various tricks of the sound stage. Buddy Cole does an excellent job with music that never seems to fade.

**CHOPIN: *Les Sylphides***  
**IBERT: *Divertissement***  
Roger Desormière Conducting Paris Conservatory Orchestra  
Richmond B-19028

Originally available on London FFRR discs (LL-884) the Desormière version of these works was highly regarded by discerning record collectors. Now that London's major efforts are directed toward stereo discs, the earlier releases are an attractive bargain at \$1.98 on the Richmond label. Acceptable sound.

**Something Else!**  
Music of Ornette Coleman  
Contemporary C-3551

Alto sax player Ornette Coleman leads a group that includes Don Cherry, trumpet; Walter Norris, piano; Don Payne, bass, and Billy Higgins, drums, in the exceptionally free style called for in nine Coleman originals. Intimate yet very clean recording typical of today's finest California products.

**Merry Overtures**  
George Szell Conducting Cleveland Orchestra  
Epic LC-3506

The greatest happiness here is reserved for those with top playback equipment. All six familiar overtures are genuine display pieces in Epic's sure-fire sound. Sample the impact of the snare drum at the beginning of Auber's *Overture to Fra Diavolo* and you'll join the other converts to the Cleveland orchestra's present-day music making on records. The *Roman Carnival Over-*

*ture* of Berlioz and Rossini's *La Gazza Ladra* receive equally exciting treatment.

**The Cadet Chapel Organist, West Point**  
John A. Davis, Jr.  
Vox VX-25-800

The West Point Organ is rated the fourth largest in the world. The first Vox recording of this organ 2 years ago picked up considerable background noise created by the instrument's blowers. Subsequent alterations have minimized this problem. Its gigantic resources now mirror the imposing tonal structures found in the Meniells-ohn *Organ Sonata Number 3*, the Franck *Pièce Heroïque* and other compositions of the Romantic school.

**Famous French Fanfares and Marches**  
Band of the French Navy  
Epic LC-3516

Fanciers of military band music from France will welcome this release of 13 typical marches and parade steps. The price of this disc is a dollar less than those featuring the more famous Band of the Garde Républicaine, yet the sound here is truly outstanding. A very firm foundation of lows balances shimmering highs.

**Music of Delius**  
Sir Thomas Beecham Conducting Royal Philharmonic Orchestra  
Capitol-EMI G-7116

In the history of Delius on records, Sir Thomas Beecham has the first and last word. His early 78's first brought the music of Delius to fame. This latest recording sums up in luminous sound the case Beecham has set forth over the years. Many of the most popular Delius works are to be found here.

**HOVHANESS: *Concerto No. 1 for Piano and String Orchestra***  
***Concerto No. 2 for Violin and String Orchestra***

Maro Ajemian, Piano; Anahid Ajemian, Violin  
Carlos Surinach Conducting M-G-M String Orchestra  
M-G-M E-3674

These two concertos by a contemporary American composer immediately intrigue the ear. Born in Somerville, Mass., of Armenian and Scottish parents, Hovhaness has concentrated on unusual sound and rhythm in his music, Oriental, Indian and Armenian influences are to be found throughout his work. In the piano concerto, the solo instrument imitates a number of Armenian instruments: the tar; the kanoon, a zitherlike string instrument; the oud, an Arabic-like lute, and the saz, a simple peasant stringed instrument.

Recommended to the musical tourist who seldom writes home about the sound. END  
Name and address of any manufacturer of records mentioned in this column may be obtained by writing Records, RADIO-ELECTRONICS, 154 West 14 St., New York 11, N.Y.

# HONESTY

has taken a bit of a licking since George Washington established it as a national ideal with his little hatchet. But it's still regarded as a virtue in advertising at RADIO-ELECTRONICS. Ever since January 1956, we have insisted that mail order tube advertisers tell you either that their tubes are new and unused, or that they are seconds, rejects, or otherwise imperfect, if that's the case. You're safe when you buy tubes by mail from RADIO-ELECTRONICS, because our advertisers "can not tell a lie".

## ELECTRONICS

*Part I—\$600,000,000 for science education brings changes in texts and course of study. Part of these funds will be used for quantities of electronic demonstration equipment that will make classroom lectures clear and fascinating.*

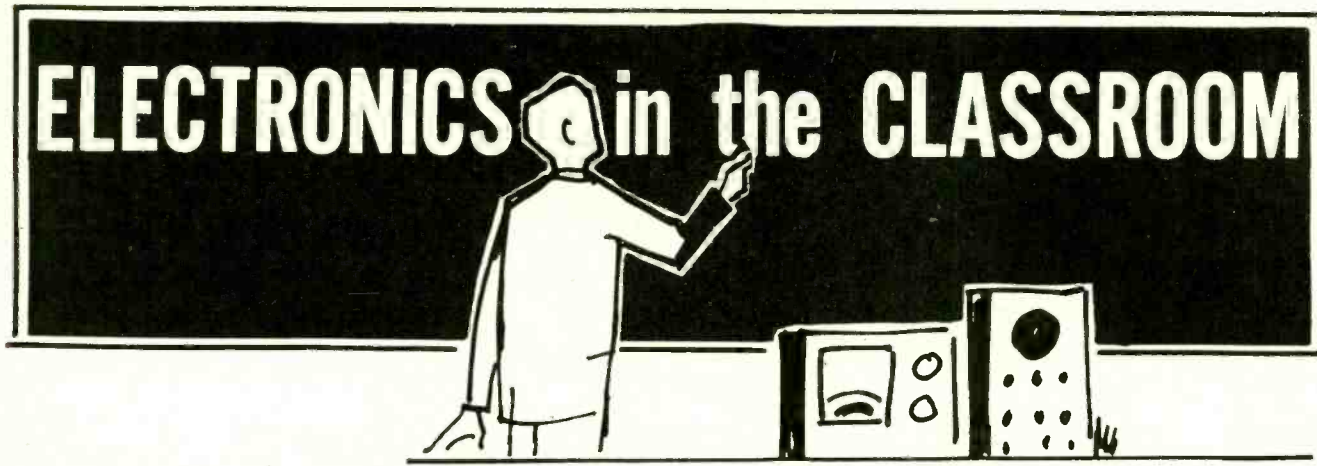

By SOL D. PRENSKY \*

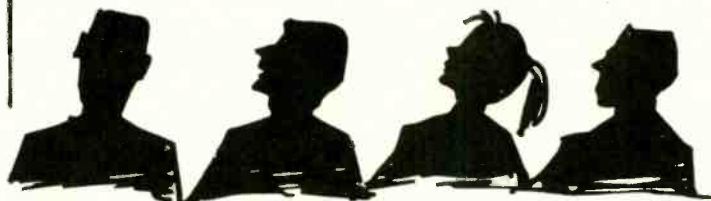

SECONDARY-school science instruction was given a thumping impetus by Congress with the passage of the Science Education Bill. Among other generous financial aids, the bill makes \$300,000,000 in Federal funds available to the nation's 27,000 high schools, to match an equal amount from the states, toward the cost of new equipment for revitalizing science study.

Many excellent ways to improve science classes are being considered. These involve both new courses of study and new texts. In the past, developing new methods for presenting science material has been hampered by the added expense of more effective equipment for demonstrations and laboratory work, or in making more extensive use of films and TV. Now, with funds specifically intended for improving science equipment, it is heartening to think of better ways to get science across and, particularly, to examine some of the many presentations that can be made with the help of the advanced electronic equipment now available.

Two outstanding groups are now working in this field. The Teachers College Curriculum Group at Columbia University has been active in considering new science-course content. At the same time, from the expertly staffed MIT Physical Science Study Committee (headed by Dr. Jerrold R. Zacharias as chairman and with Dr. Elbert P. Little as executive director) have come new texts and new teaching methods including the use of film and TV tech-

niques. For interested persons who wish to follow the activities of these and similar groups and for ambitious students who wish to pursue a given science field in greater detail, a list of references is given at the end of this article.

The articles in this series will present specific demonstrations showing how electronic equipment can be used to present more effectively the principles of a particular science topic. The demonstrations given will not necessarily be connected with any of the references cited. Instead, they will be

selected with a view toward representative learning situations.

### What can be taught?

Topic selection divides naturally into two directions. In one, we have the teaching of modern subject matter in electricity and electronics, topics that old textbooks cover very inadequately, if at all—new atom concepts, semiconductor and transistor action, analog and digital computer methods in telemetry applications, to mention just a few. In the other direction we have the less obvious but equally important

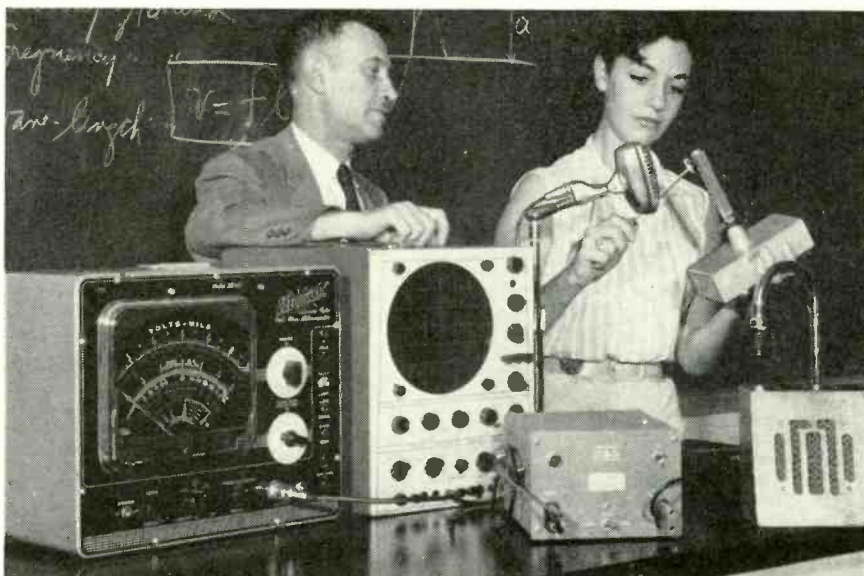

Vtvm, oscilloscope, amplifier and speaker as they are used to demonstrate the properties of sound.

\* Fairleigh Dickinson University, Teaneck, N. J.

help that electronics can give science students in such nonelectrical subjects as physics, biology, chemistry and astronomy. The scheme here is to study some nonelectrical property, using a transducer which lets the instructor present an electrical display of the properties being investigated.

The transducer method immediately brings the study of sound to mind. For example, a microphone can be used to pick up sound from a tuning fork or other sound source and convert it into electrical impulses. Once it is in electrical form, electronic equipment takes over, presenting the information in various forms—simultaneously if desired. Fig. 1 shows a setup that makes sound appear as a visible trace on a 8½-inch scope screen and as a voltage reading on a vtvm that has a 9-inch meter face. At the same time it is heard in amplified form from the loud-speaker.

Before going into the details of particular demonstrations, here are some examples of how other nonelectrical properties could be demonstrated electronically:

- Heat transfer—registered by thermocouple or thermistor action
- Velocity and acceleration—displayed by accelerometer action
- Mechanical vibration—displayed by pressure transducer action
- Light energy—indicated by photoelectric action

These and many other examples readily come to mind. The problem is not so much to find enough ways to use electronic presentation. Rather, it is one of carefully selecting those that are most practical and effective for teaching a desired topic.

**Properties of sound**

Fig. 1 shows the electronic apparatus used for studying a sound source, a tuning fork in this case. Only general-purpose electronic gear is used—vtvm, oscilloscope, speaker and amplifier. If speaker volume is not needed, the amplifier is unnecessary. However, the am-

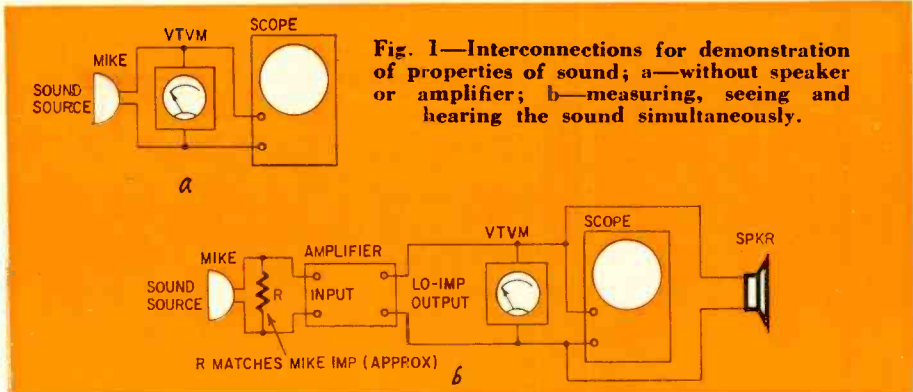

Mike: multi-impedance—Shure Dynamic model 51 or equivalent.  
 Amplifier: 20 and 40 db—Hewlett-Packard decade model 450A or equivalent.

Vtvm: 9-inch Hickok model 209A or equivalent.  
 Scope: 8½-inch—Precise model 308 or equivalent.  
 Speaker: between 3 and 45 ohms.

plifier offers some advantages, even if the speaker is not used. It provides an impedance match to the microphone and furnishes a low-impedance output to feed the various indicators, minimizing hum pickup. When using an amplifier,

only a moderate amount of gain is needed. If the amplifier is turned up too high, excessive gain appears as a feedback howl in the speaker. (This in itself is a good point to bring out.)

Of course, scopes with smaller

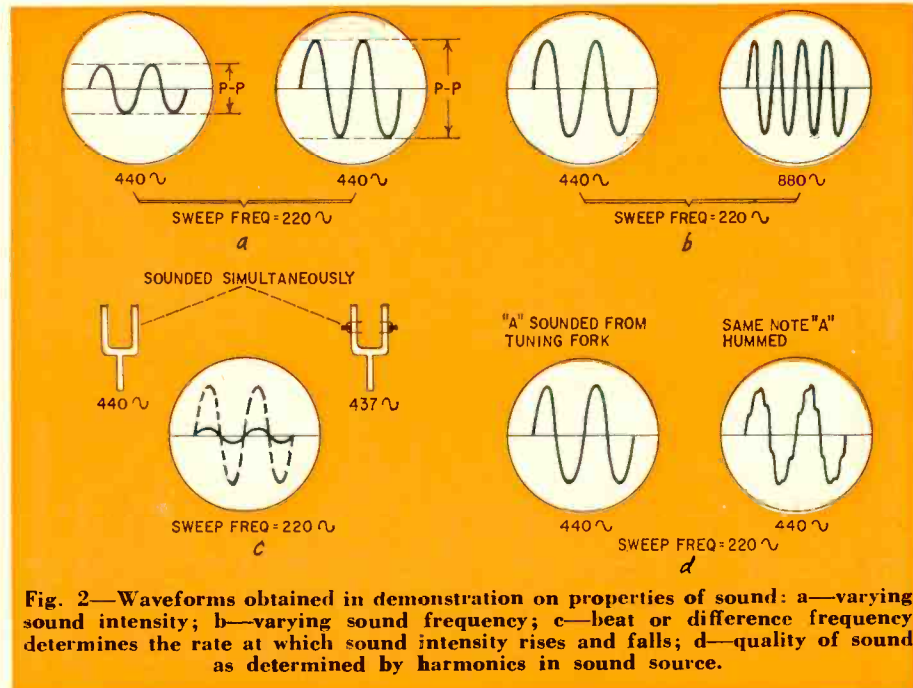
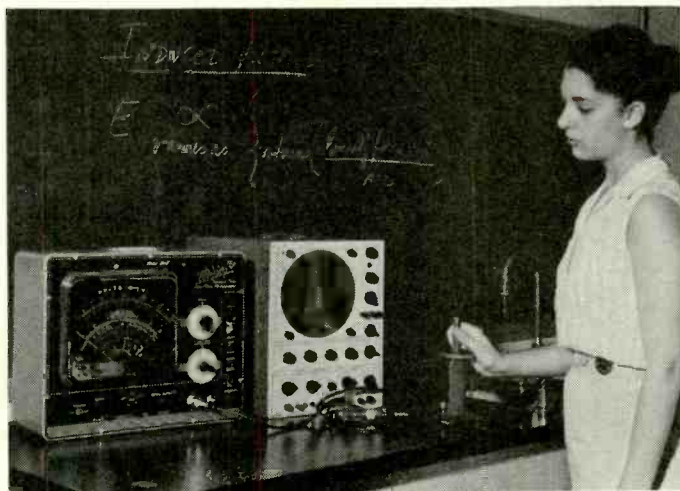
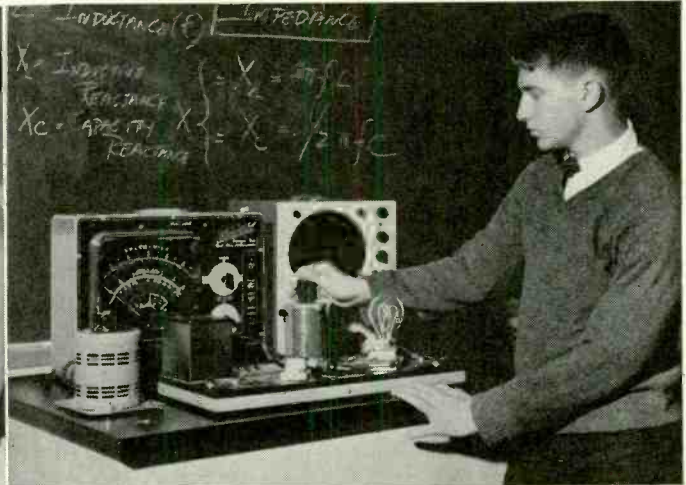

Fig. 2—Waveforms obtained in demonstration on properties of sound: a—varying sound intensity; b—varying sound frequency; c—beat or difference frequency determines the rate at which sound intensity rises and falls; d—quality of sound as determined by harmonics in sound source.



To demonstrate induced voltage only the scope and vtvm are needed.



Here's the setup for showing effects of impedance and inductance.

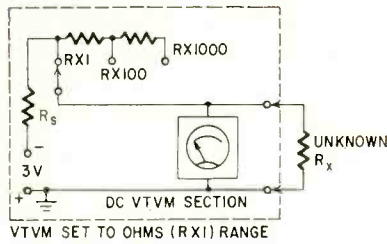

Fig. 3—Simplified circuit showing a vtvm used to read resistance.

screens and meters with smaller faces could be used, but to make the demonstration clear to all members of the class, the larger the displays the better.

Sound intensity may be measured on the vtvm and seen on the scope, using the arrangement in Fig. 2-a. First the tuning fork is given a light blow and the results observed. Then succeeding harder blows show increased readings.

The effect of different frequencies is shown by using tuning forks of progressively higher frequencies (Fig. 2-b).

Energy required for equal transmission at various frequencies is shown by using different forks, struck with the same intensity and held at a fixed distance from the microphone.

Beats can be produced in the usual way when two forks of slightly different frequencies are sounded together (Fig. 2-c.) When the frequencies are the same, resonance or sympathetic vibration can be shown.

The oscilloscope display will show the presence of complex waves that include the harmonics which determine the quality of various sounds, even though they have substantially the same intensity and fundamental frequency (Fig. 2-d). For this you can hum or whistle into the mike, use a musical instrument and, for greatest complexity, use a recorded program.

An interesting variation that shows a complex wave is to talk into the microphone through the revolving blades of an electric fan. The periodic breaking up of the sound vibrations in the air by the fan blades can be clearly demonstrated.

Another rich source of harmonics is the howl caused by acoustic feedback. Other possibilities will no doubt occur to the teacher using the microphone, oscilloscope, vtvm, amplifier, speaker demonstration.

**Resistance, voltage, current and phase**

Fig. 3 is the simplified circuit of a vtvm being used to measure resistance. On a meter with a 9-inch face, readings can be easily seen and resistances compared in clear sight of all members of the class.

When studying voltage and phase relations in ac circuits containing a combination of resistance and reactance, an all-resistive circuit is examined first, with the connections shown in Fig. 4-a.

The alternating current through  $R_x$  can be varied in a number of ways. A variable autotransformer connected to

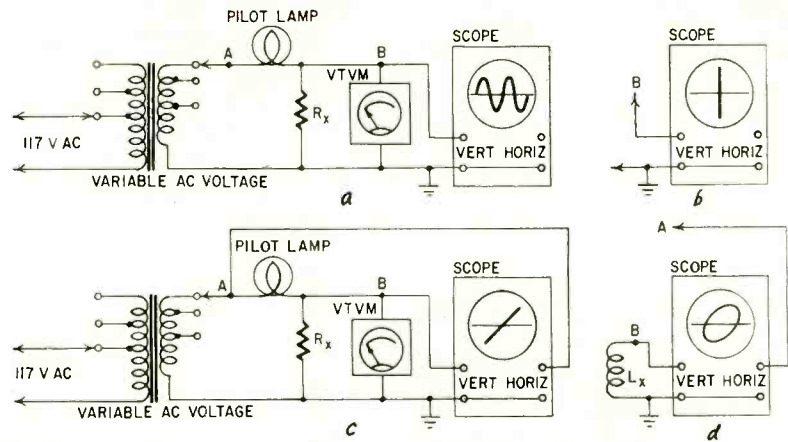

Fig. 4—Display of voltage and phase in resistive and reactive circuits: a—voltage across  $R_x$  displayed as a sine wave; b—same as a, but with sweep voltage turned down to zero; c—phase of  $R_x$  voltage with reference to input voltage; d—same as c, but  $R_x$  replaced by  $L_x$ .

a 60-cycle outlet is shown, but the variable current could also be obtained from a voltage-dividing potentiometer connected across the line or from the variable output of an af signal generator.

No matter which source you use, start with enough current to light the pilot lamp. Then the lamp serves as a rough current indicator and a protective fuse. (A No. 44 lamp needs 250 ma at 6.3 volts. A No. 47 lamp needs 150 ma at 6.3 volts; a No. 49 lamp, 60 ma at 2.0 volts.)

Initially, the scope's sweep and vertical controls are adjusted for a sine-wave display of convenient height, showing two full cycles on the screen (Fig. 4-a). As current through resistor  $R_x$  is reduced (and, correspondingly, the voltage drop across it), the decrease in vertical deflection is shown. To make this even clearer, set the scope's horizontal sweep at zero. This gives you a single vertical line as in Fig. 4-b.

The next step is to connect the scope's horizontal input terminals as in Fig. 4-c. Then, by adjusting the vertical and horizontal amplifiers for equal

deflection, the 45° straight line for the in-phase resistive condition is shown. The magnitude of the voltage across  $R_x$  is monitored with the vtvm.

When a power supply filter choke ( $L_x$ ) is substituted for  $R_x$  (Fig. 4-d), the output voltage is out of phase with the input voltage and shows up as an elliptical trace on the scope screen. This result can then be compared with that obtained by substituting a capacitor for  $R_x$ . Further work with reactances is covered in future demonstrations.

**Induced voltage**

Laws relating to voltages induced by relative motion between magnetic lines of force and a coil can be demonstrated using the vtvm as a zero-center high-impedance dc voltmeter. A scope display is used if meter movement is too sluggish to follow the action of the induced voltages.

Conventional experiments on induced voltages will not be described here. We will merely mention items like changing the number of turns in the coil, strength of the magnet or speed of motion, to show their effect on the induced voltage.

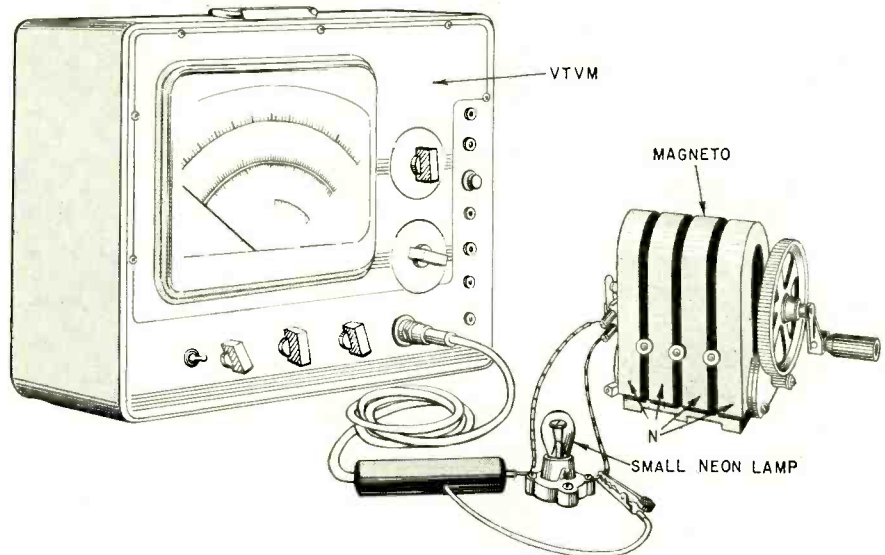

Fig. 5—Measuring induced voltage from a high-impedance source.



# Duo-Rectifier Power Supply

By NORMAN V. BECKER

Also the effect on the voltage induced in a secondary coil when current in the primary coil is changed. Details on these demonstrations are well covered in many physics texts.

As an interesting variation in standard methods, connect the familiar high-voltage hand-cranked magneto to a vtvm as shown in Fig. 5. In this way you can get an actual voltage reading as well as lighting the neon lamp. A vtvm must be used rather than the usual demonstration-table meter, whose low impedance would drain so much current from the magneto that the lamp might not light.

## About the references

The first reference, *Demonstration Experiments in Physics*, is a classic and a gold mine of ideas, containing more than 1,000 demonstrations. Although published in 1938, it lays down a basic philosophy as valid today as when it was written—"Logic and insight transform the commonplace rolling of a ball down an incline into a profound experiment. . . . We turn to demonstration experiments, which by their very number and variety, fill a real need and at the same time, provide one of the most helpful methods of selling physics to students. Above all, the instructor should investigate the possibilities of new commercial products as they appear on the market."

These quotes were never more true than they are today.

*Experiment Manual for Electronic Demonstration* concentrates on using the most recent electronic equipment for classroom demonstrations of electrical and electronic principles.

*The First Annual Report of the Physical Science Study Committee* gives an overall picture of the Monograph project of the MIT Physical Science Committee. The group also promises a reference list of many specific science topics for supplementary reading material that "would be usefully broadened to create a shelf of sound, readable science books, capable of doing far more than fill interstice of the (physics) course."

The remaining references are not intended to make up a comprehensive bibliography. However, they do comprise a list that will undoubtedly refresh the reader's mind, whether he or she is a teacher, student or technical worker, as to some familiar stand-by sources and perhaps also introduce him or her to some newer approaches. END

## REFERENCES

*Demonstration Experiments in Physics*, edited by Dr. R. M. Sutton, McGraw-Hill, 1938.

S. D. Presnky, *Experiment Manual for Electronic Demonstration*, Radiolab Publishing, 1946.

*First Annual Report of the Physical Science Study Committee* (1957-58), Dr. Elbert P. Little, executive director; PSSC, 94 Massachusetts Ave., Cambridge 39, Mass.

Rider and Presnky; *How to Use Meters*, (2nd edition), J. F. Rider Publisher; scheduled for 1958.

*Radio & TV Test Instruments*, Gernsback Library No. 49, 1957.

R. P. Turner, *Basic Electronic Test Instruments*, Rinehart Books, 1953.

Terman and Pettit; *Electronic Measurements*, McGraw-Hill, 1952.

In the design of certain audio amplifiers, the full output capabilities of the power tubes cannot be realized because the driver stage cannot supply enough voltage to drive them properly. This is probably more true of amplifiers that use such tubes as the 6V6 than of those that have higher-voltage output tubes. The voltage supplied to the plates of the earlier stage (driver or phase inverter) through the plate resistors is just not great enough to permit the required swing without distortion. A simple solution would be to provide a higher voltage source for the voltage amplifiers.

Fig. 1 shows a conventional audio amplifier using push-pull 6V6's in its output stage. They operate with a combined plate and screen supply of 250 volts. Transformer T1 has a high-voltage center-tapped secondary rated at 520 volts at 90 ma. This fulfills power requirements for the output stage, plus the additional current needed for the 12AY7 amplifier-driver. The driver, unfortunately, requires more plate voltage to deliver large-amplitude signals with minimum harmonic distortion.

Rather than use a larger power transformer and a conventional voltage-dropping arrangement, I solved this problem by adding RECT1 to the circuit. This selenium unit has a maxi-

mum input voltage of 260 rms and maximum current of 20 ma. It operates half-wave fashion from half of T1's high-voltage winding. Plate current drawn by V1 is under 10 ma. Therefore, RECT1 can deliver almost peak voltage from its 250-volt rms source by operating far below maximum current ratings.

Results of this arrangement netted 325 volts of well filtered dc for the 12AY7. This was sufficient to produce the low-distortion drive signal required. And since RECT1 is ahead of V4, voltage drop across the rectifier tube further decouples output from input. In effect, we have two independent B-plus supplies, and low-frequency stability is improved accordingly. Excessively large amounts of negative voltage feedback did not cause motor-boating in my amplifier. The only disturbances were high-frequency oscillations caused by electrical asymmetry of the output transformer. Feedback was reduced by adjusting the value of R3 to eliminate this condition.

Notice that the only power resistor is R10, a 47-ohm 1-watt carbon unit. It doesn't even get warm! Filtering is adequate, though, because of the ample capacitance of C3-c and C3-d. Residual hum of the overall amplifier was reduced to insignificance by negative feedback. An ac-dc choke can be used instead of R10 to provide better filtering.

Circuit of a conventional audio amplifier using a duo-rectifier power supply. Dashed lines show the negative feedback loop. R3 may vary widely. In the author's amplifier it was 10,000 ohms, connected to the 15-ohm output transformer tap.

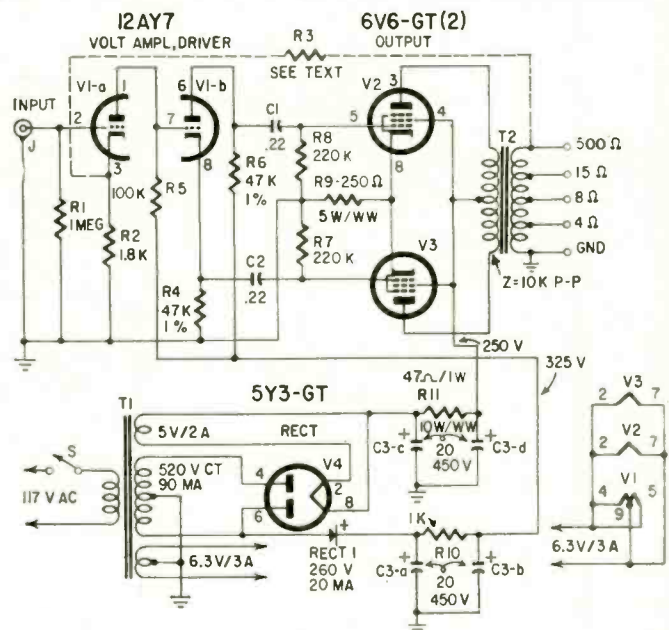

R1—1 megohm  
R2—1,800 ohms  
R3—see text  
R4, 6—47,000 ohms, 1%  
R7, 8—220,000 ohms  
R9—250 ohms, 5 watts, wirewound  
R10—47 ohms, 1 watt  
R11—1,000 ohms  
All resistors  $\frac{1}{2}$ -watt 10% unless noted  
C1, 2—0.22  $\mu$ f, 600 volts  
C3—20—20—20— $\mu$ f, 450 volts, electrolytic  
J—phono plug  
RECT1—selenium, 260 volts, 20 ma (Radio Receptor 16Y1 or equivalent)

S—sps toggle  
T1—power transformer: primary, 117 volts; secondary, 520 volts ct, 90 ma; 6.3 volts, 3 amps; 5 volts, 2 amps (Stancor PC-8404 or PM-8404 or equivalent)  
T2—output transformer: primary 10,000 ohms ct; secondary, 500, 15, 8, 4 ohms; 25 watts (Stancor A-3311 or equivalent)  
V1—12AY7  
V2, 3—6V6-GT  
V4—5Y3-GT  
Chassis  
Socket, 9-pin miniature, with shield  
Socket, octal (3)  
Miscellaneous hardware

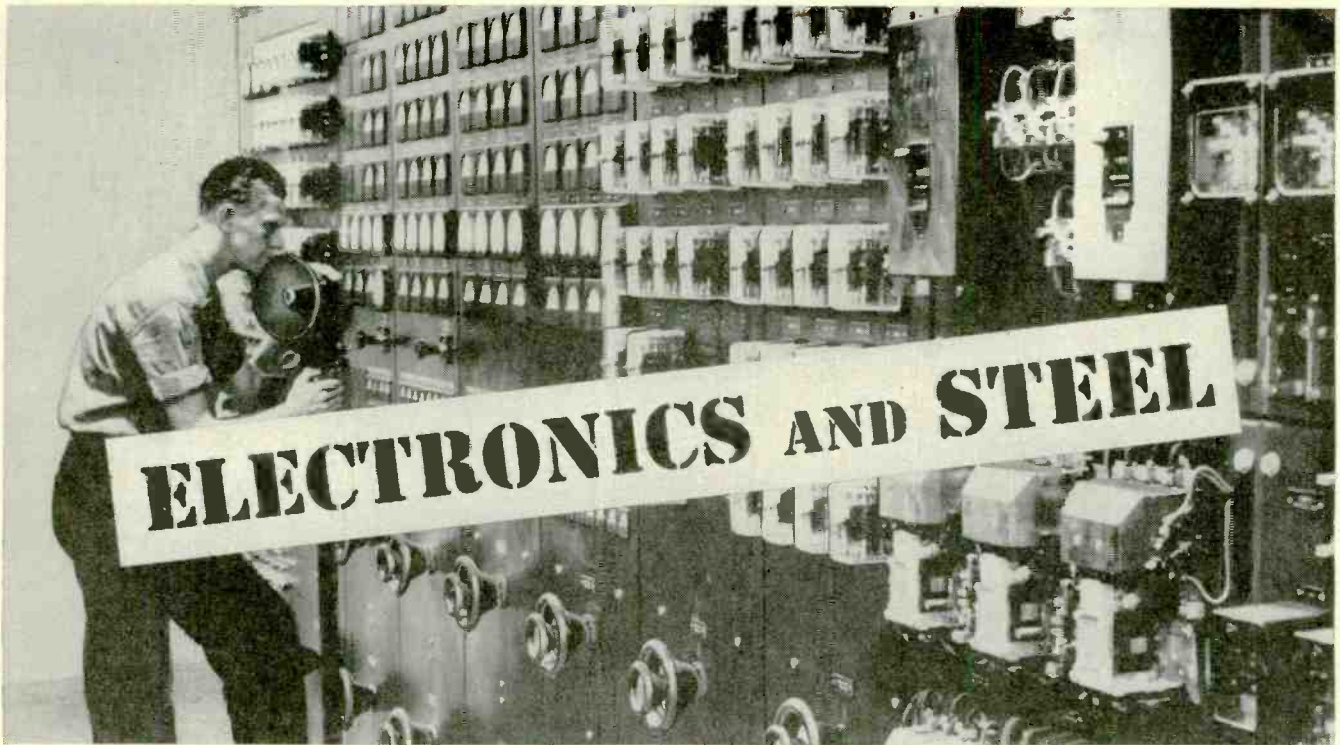

**E**LECTRONIC equipment plays an increasingly important part in modern industry. An excellent example of industrial electronics at work can be seen at the Weirton Steel Co., Weirton, W. Va., a division of National Steel Corp. In 1955, this firm established an electronics department, responsible for operating and maintaining electronic gear from intercoms to X-rays.

An electronic control and intercommunications system (top) directs operation of electrolytic tin-plating lines. This unit works

in conjunction with electronic oscillator units (bottom left) which produce 400,000 watts of rf. The plant's total oscillator capacity is 8,400,000 watts at frequencies of 100-200 kc. This power is used in an induction-heating process to reflow satin-finished tin-plated steel produced by the electrolytic lines, to a mirror-bright finish. The section of the production line where the power developed by the oscillators is used is shown at the bottom right. Power is controlled at the instrument board in the foreground.

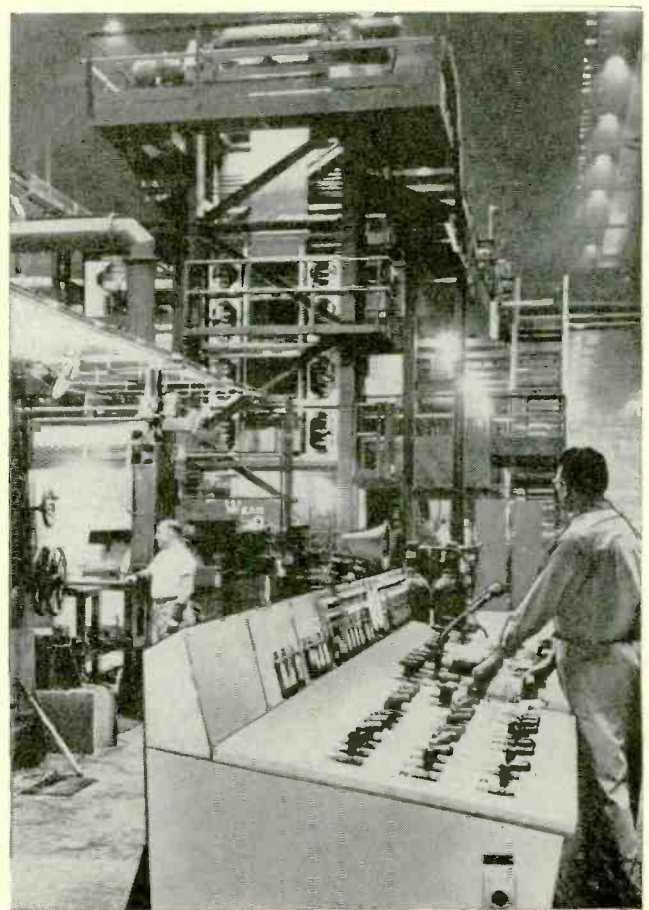
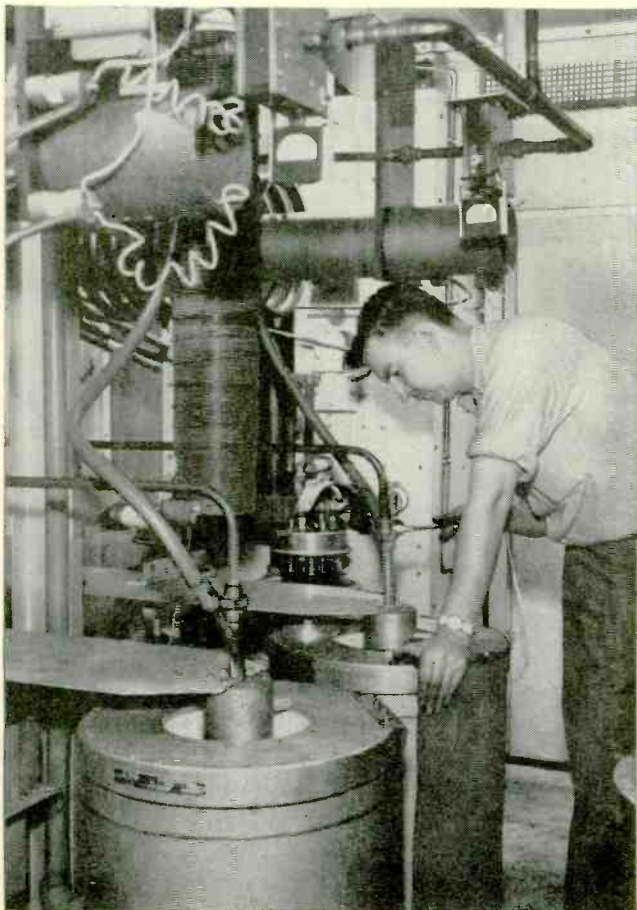



Electronic hole detectors on the Weirton tin mill cutting line detect holes as small as 1 millimeter in diameter (which can't be seen by the eye) and automatically reject defective sheets. The process is controlled by photoelectric cells.



X-ray machine at the No. 7 tandem mill controls the rolling operation of the 54-inch strip-steel department. The device automatically keeps the gauge of the steel being rolled within the desired tolerance.

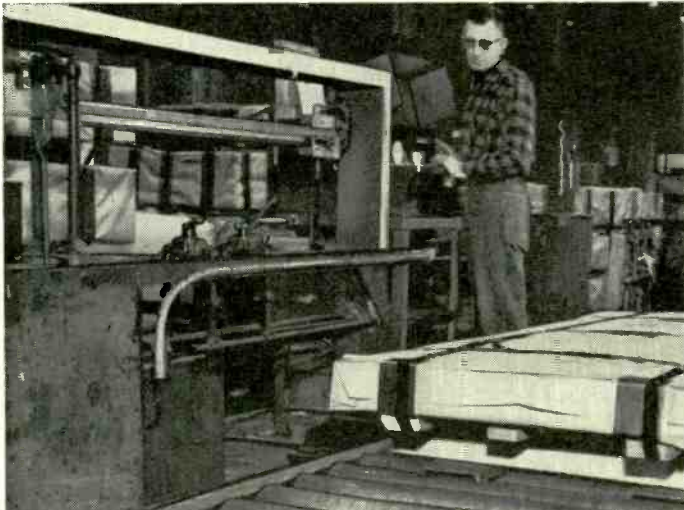

Employee is operating electronic scales, used for quick weighing of all material shipped from the cold-mill shipping department of the 54-inch strip-steel department. The scales have Baldwin-Lima-Hamilton load cells, which are strain-gauge devices. The change in position of the center core registers the weight.



Carrier (wired) radio system used on moving overhead cranes lets operators handling material within the plant talk to other operators and personnel at ground stations to coordinate all crane operations.

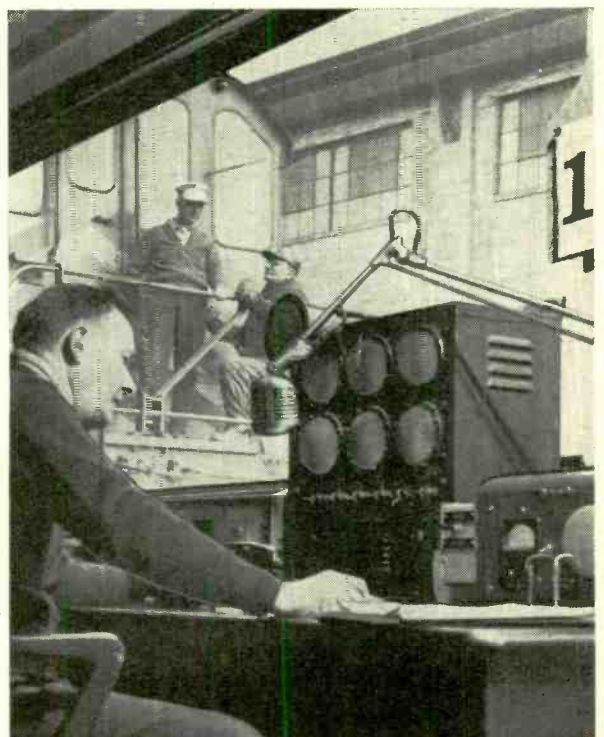

The yardmaster, who controls the interplant railroad system, directs the movement of all cars and 14 Diesel locomotives with the radio equipment shown here. Two-way 152.87-mc units are used so the yardmaster can speak to engineers on locomotives anywhere in the plant.

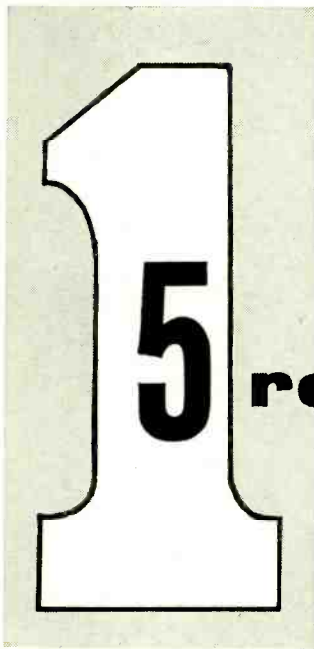

# 15 relays in ONE

*Forward- or reverse-acting photorelay, recycling or straight timer, or a sound-actuated unit*

By ED BUKSTEIN\*

**C**ERTAIN basic features are common to most types of relay circuits. The voltage drop across a sensing element (phototube, microphone, etc.) is applied to the grid of an amplifier, and the resulting change of plate current operates a relay. For some uses, the circuit should be self-latching: the relay once energized remains energized until the circuit is manually reset. For other applications, a self-repeating circuit may be required. This is one which will recycle or reset itself. These modes of operation were considered in designing the circuit shown in Fig. 1.

With suitable control circuits the relay can be used as a photoelectric control, a timing circuit or a sound-oper-

\* Northwestern Television and Electronics Institute, Minneapolis, Minn.

ated relay. When used as a photorelay, the circuit can be made either forward- or reverse-acting. In the former, the relay energizes when the phototube is illuminated. In the latter, the relay energizes when the light beam is blocked.

Only one tube, a 12AU7 duo-triode, is used. One triode section is diode-connected and operates as a half-wave rectifier. The other triode section functions as an amplifier to control the relay. The variable cathode resistor (R3) permits adjustment of sensitivity and operating point.

### Photorelay circuits

Fig. 2 shows the accessories needed for various circuit applications. In the forward-acting photorelay (Fig. 2-a) the current which flows when the photo-

tube is illuminated produces a voltage drop across resistor R6. This drop is of such polarity that the triode grid becomes positive and causes the relay to energize. A type 930 phototube is shown in the diagram but other types may be substituted.

To convert the circuit to a reverse-acting photorelay (Fig. 2-b), it is necessary only to interchange the positions of the phototube and resistor R6. The relay now energizes when a light beam to the phototube is obstructed. A good light source for this circuit can be made from a 21-candlepower headlight bulb operated from a 5- or 6-volt transformer. Operating the bulb at 5 volts will extend its lifetime without adversely affecting the circuit's sensitivity. A lens placed in front of the light source will increase circuit sensitivity

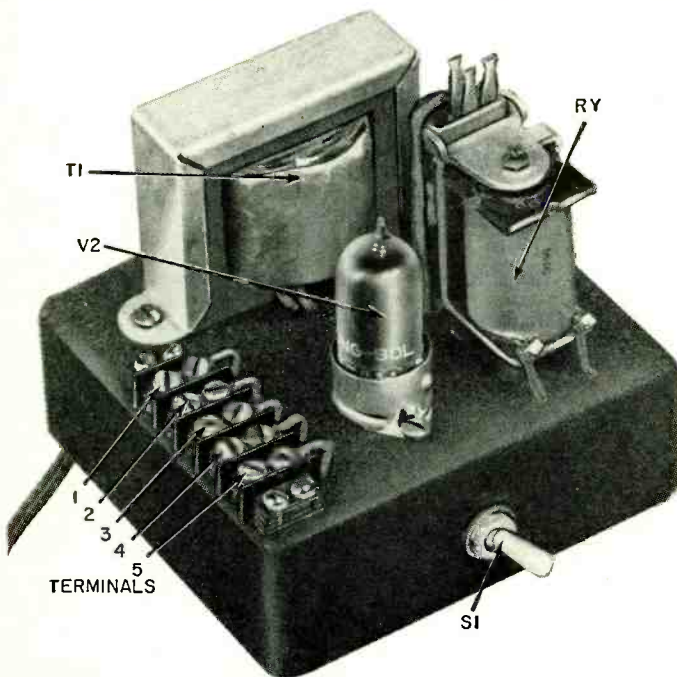

Relay chassis without control circuits attached.

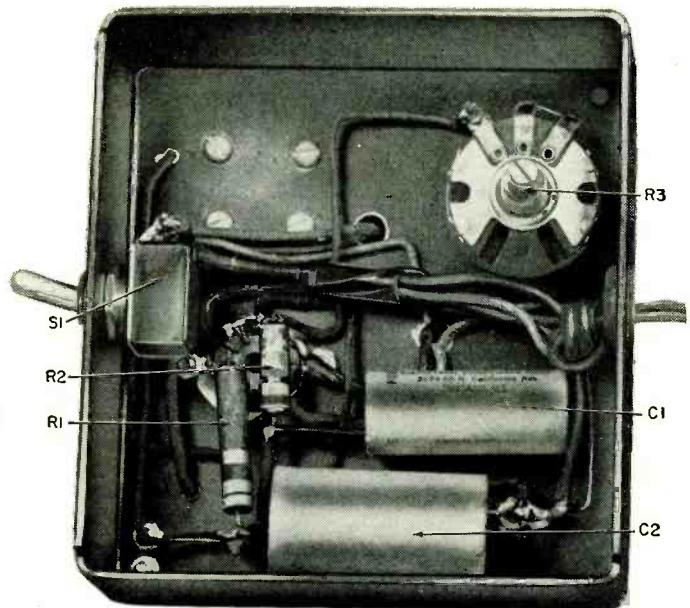

Underchassis view. Resistor R3 controls the tube's operating point and circuit's sensitivity.

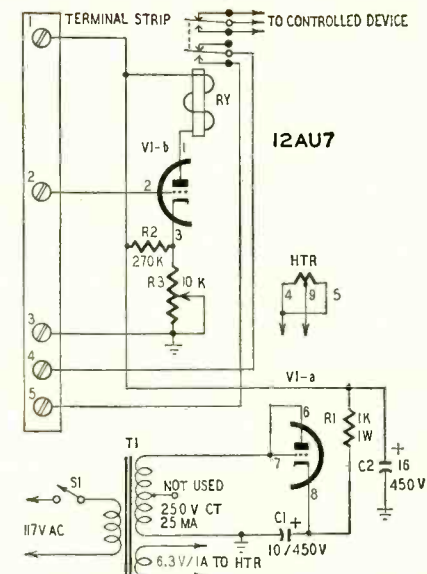

- R1—1,000 ohms, 1 watt
- R2—270,000 ohms
- R3—pot., 10,000 ohms
- R4, 5—47,000
- R6—10 megohms
- R7—pot., 10 megohms
- R8—100,000 ohms
- All resistors 1/2 watt unless noted
- C1—10  $\mu$ f, 450 volts, electrolytic
- C2—16  $\mu$ f, 450 volts, electrolytic
- C3—see text
- RY—dpdt plate relay, 2,000—10,000 ohms
- S1—spt toggle
- S2—dpdt toggle
- S3—spt, normally closed, microswitch
- T1—power transformer; primary, 117 volts; secondary, 250 volts, 25 ma ct; 6.3 volts, 1 amp (Stancor P58416 or equivalent)
- T2—microphone transformer for carbon mike: primary 200 ohms, 5,000 ohms secondary 60,000 ohms (Stancor A3833 or equivalent)
- V1—12AU7
- V2—930
- Chassis
- Socket, 9-pin miniature
- Terminal strip, 5 contacts, barrier type
- Carbon mike
- Battery, 3—12 volts
- Miscellaneous hardware

Fig. 1—Basic relay circuit.

and the distance over which the control will remain effective. Applications of photorelay circuits include opening garage doors, turning on lights at sundown or during overcast weather, burglar alarms, etc. When the circuit is used as a burglar alarm, an infra-red filter should be placed in front of the light source so the light beam is invisible to the intruder.

The circuit can be converted to a time-delay relay (Fig. 2-c) by connecting a 10-megohm variable resistor (R7) between terminals 1 and 2, and a capacitor (C3) between terminals 2 and 3. A dpdt switch (S2) is used; one section is connected in parallel with the capacitor and the other in series with the power line to the device to be controlled (a photographic printer or enlarger, for example). The time delay is initiated by opening the switch in parallel with the capacitor. The capacitor now charges through the variable resistor. As this charge builds up, the triode grid (V1-b) becomes increasingly positive until the plate current of the tube is sufficient to energize the relay. The normally closed control contacts of the relay open and remove power from the controlled device. Variable resistor R7 controls the charging

rate of the capacitor and therefore the length of the time delay. The capacitor's value depends on the range of time delay desired and is determined by experimentation. For most applications, this value will fall between 0.1 and 4  $\mu$ f.

When the circuit is used as a self-repeating timer, connect terminal 5 to terminal 3, and terminal 4 to terminal 2. With this arrangement, contacts 4 and 5 of the relay short out the capacitor after the time delay is completed. The circuit is restored to its starting condition and the time delay repeats. Such circuits are often used to control flashing signs and window displays.

### Contact relay

In another variation of the control circuit (Fig. 2-d), 100,000- and 47,000-ohm resistors are connected across terminals 1-2 and 2-3, respectively. A normally closed snap-action switch (S3) is connected in parallel with resistor R4. If the switch is opened, a positive voltage appears at the triode grid (V1-b) and the relay energizes. The circuit may be used as a burglar alarm by mounting the switch on a door or window. Several entrances may be protected by using more than one switch. The switches should be connected in series. Placing the switch under a spring-supported platform makes the circuit useful as a camera-shutter tripping device for photographing birds, squirrels and other hard-to-photograph subjects.

A carbon microphone connected through a transformer to terminals 2 and 3 will convert the circuit to a sound-operated relay (Fig. 2-e). When sound enters the microphone, a signal is impressed on the triode grid and the relay energizes. Contacts 4 and 5 of the relay short out the cathode bias resistor to keep the relay energized. This circuit may be used as an alarm to indicate to mother that baby is

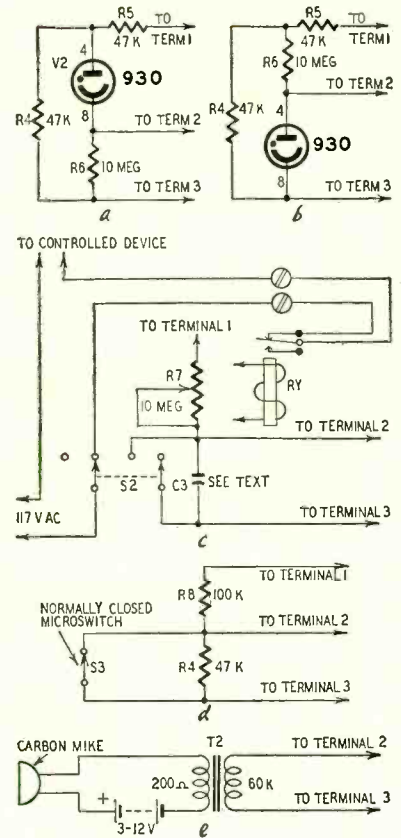

Fig. 2—Control circuits: a—forward-acting photorelay; b—reverse-acting photorelay; c—time delay; d—contact; e—sound-operated.

awake. It may also be used to open garage doors when an automobile horn is sounded.

Other applications are limited only by your ingenuity. In general, the relay and accessory circuits are used in applications where a relay is to operate in response to a change of light, sound, position (mechanical motion), or time.

END

## ELECTRONIC MAN—WOMAN DETECTOR

An unusual application of electronics, devised to demonstrate advanced infra-red techniques. This device can detect the sex of the person who stands on its platform and pushes a button. Displayed by Farnsworth Electronics Co. (ITT), it flashes a light indicating "man" or "woman." It was displayed at the 1958 Western Electronic Show and Convention (WESCON) in Los Angeles.

Here's how it works: A detector, located near the base of the unit, reacts to the amount of radiated body heat. Men's trousers inhibit heat radiation reaching the detector; women's stockings do not. Though it's completely reliable within its own frame of reference, all bets are off in the cases of such unsexed individuals as men wearing shorts or women wearing slacks.



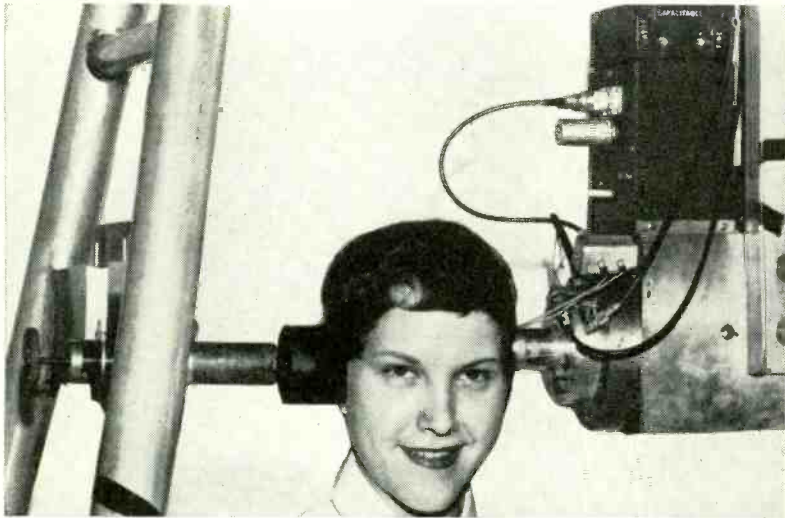

*United Press International Photo*

**HEAD IS HEARD** by this laboratory device at the National Bureau of Standards in Washington as part of a program to establish a standard of normal hearing by bone conduction. It measures the sound vibrations transmitted by the bones of the head, and is seen as a means whereby a physician could determine the possibility of correcting a person's hearing loss by surgery.

what's

new

?

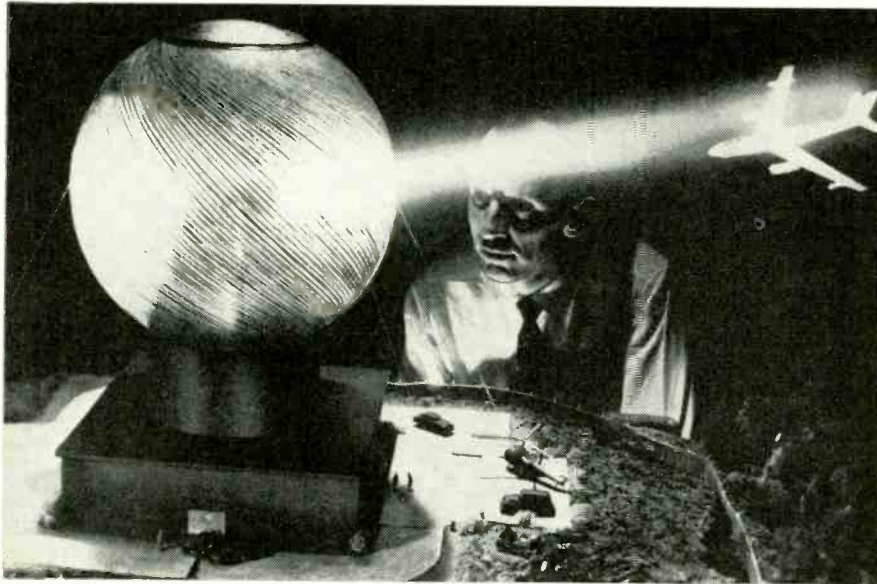

*United Press International Photo*

**HELISPHERE RADAR ANTENNA**, shown here in model form, represents a new concept in which a stationary globe is used as a parabolic antenna. In the photo above, a light beam is used to represent the rf energy emitted by the antenna. Radar waves from a rotating source are sprayed against the inside surface of the stationary globe (shown by brightly lighted section of sphere at left). The waves reflect through the opposite side of the sphere to emerge as an intense, narrow beam (illustrated by the light beam outlining the model plane at right). The antenna was developed at the Westinghouse Research Laboratories.

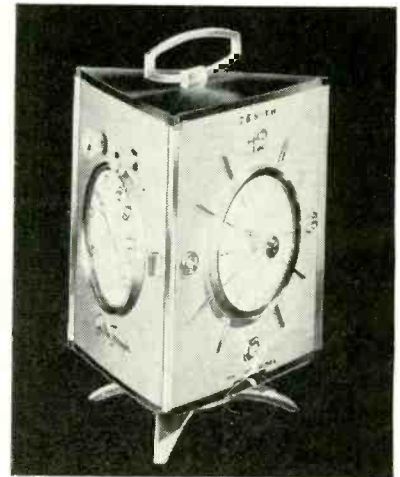

**LATEST INNOVATION** in radio receiver design is the introduction of cordless transistor clock radios by nearly all manufacturers. This unusual triangular model produced by Zenith has a clock, radio dial and speaker on its three sides. The clock operates for a year on a "D" flashlight cell and the receiver works for up to 400 hours on four mercury flashlight-size batteries.

**FRENCH SPEAKER DESIGNS:**

Double speaker at far left is proposed by *Cabasse* for good wide-angle coverage at high audio frequencies. A 4-inch and a 5-inch speaker are mounted in a molded aluminum casting so that their axes are slightly divergent. The back part of the casting constitutes a shell, and the back radiation is channelized by a simplified double acoustical horn and projected forward through the side openings. The long speaker at right, made by *Audax* (France), is designed for TV sets. It measures 2¾ x 10 inches, with a power rating of 3 watts. In front of it is a speaker for pocket receivers, 1½-inch square, 1 inch deep, rated at 300 milliwatts.

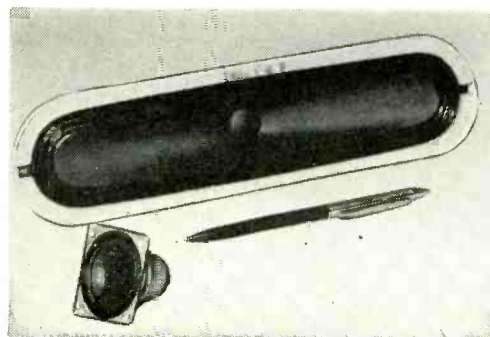
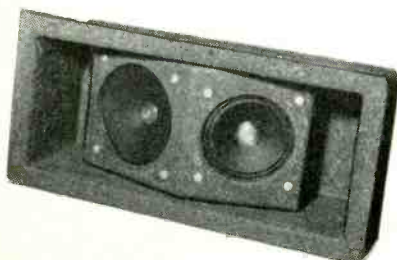

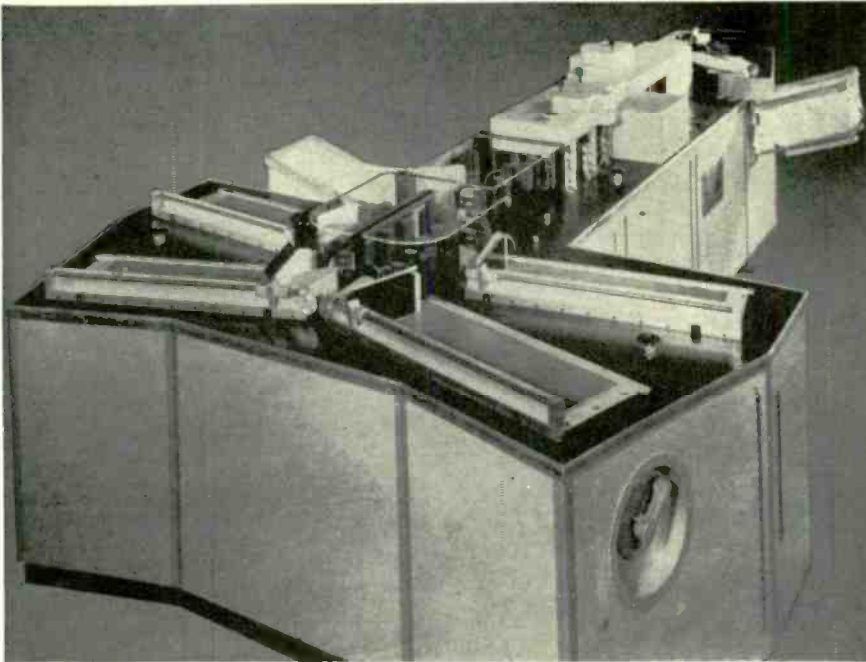

**MAIL CANCELLING MACHINE** now being tested in the main post office, Washington, D. C., processes 30,000 letters an hour. Shown above is the cancelling and facing section, which positions mail so it is right-side-up, detects presence and position of stamps, actuates the appropriate cancelling head and then guides letters to four different stackers. Flying-spot scanners used for detection can instantly tell the difference between a postage stamp and similar objects such as Christmas seals. The machine was developed by Emerson Research Laboratories, Silver Spring, Md.

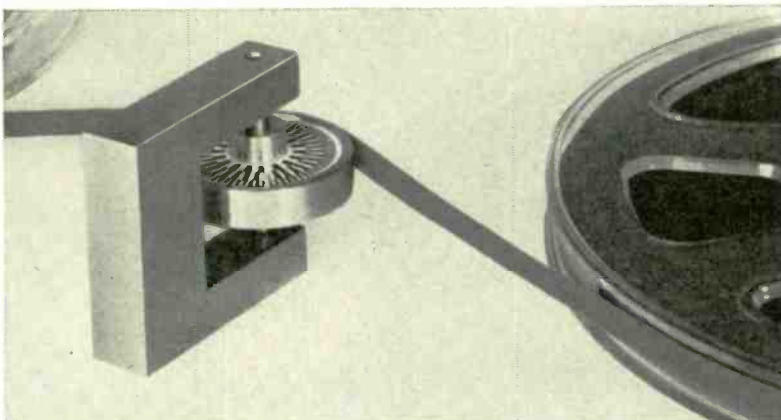

**TAPE SPEED** may be checked instantly and easily with *TapeStrobe*, recently placed on the market. Held on the tape deck so that the strobe wheel makes firm contact with the moving tape, the device shows any deviation from proper speeds under a 60-cycle light source. The outer scale is for checking 7½-ips speed, center for 15 and inner scale for 30 ips. It's manufactured by Scott Instrument Labs, New York.

*Courtesy Sankei Shimbun, Tokyo*  
**WORLD'S TALLEST** self-supporting TV tower is this new structure in Tokyo. Including antenna, its height is 1,091 feet, compared with the French Eiffel Tower's 984.25 feet. Highest man-made structure is still the 1,610-foot guy-wire-supported tower of KSWs-TV, Roswell, N. M. New York's Empire State Building rises 1,472 feet. The base of the Tokyo tower will house a 6-story studio building and science museum, and a restaurant will be built at the 396-foot level.



Simple circuit gives accurate measure of beta gain, a factor directly related to transistor quality

# DIRECT-READING

# TRANSISTOR TESTER

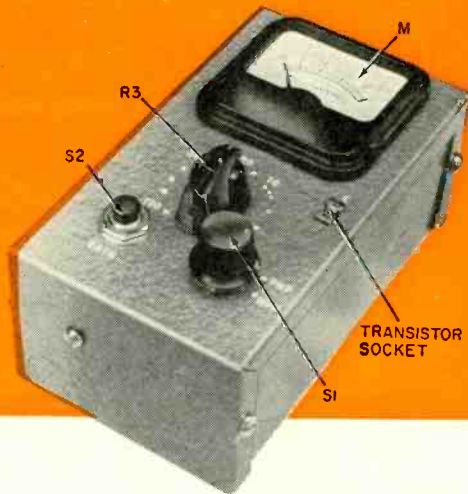

By ELLIOTT A. McCREADY

ONE of the simplest indicators of transistor quality is its current gain or beta. A transistor's beta is the ratio of output current to input current inducing it, and is a characteristic usually listed in the manufacturer's specifications.

If we find a way to determine quickly a transistor's current gain or beta, we can check it against the spec sheet and end up with a pretty good estimate of how the transistor will perform in a circuit. The transistor beta test, like the emission test of a vacuum tube, is not 100% infallible, but is a fairly reliable indication of quality.

The transistor tester described in this article can be built for less than \$10. It not only indicates open, shorted or excessively leaky transistors, but lets the operator read transistor beta directly from a calibrated control.

### Test circuit at work

The transistor under test is connected in a common-emitter configuration (Fig. 1) with a milliammeter in the collector circuit. When switch S is open, no current flows from base to emitter and the milliammeter indicates transistor leakage current which, in a good transistor, should be no more than a small fraction of a milliampere.

When switch S is closed, current flows between base and emitter. The amount of current is determined by the resistance of potentiometer R. The meter should now indicate an increased current—the amount of increase depending on the transistor's beta.

We can now calculate beta:

$$\text{Beta} = \frac{I_C}{I_B}$$

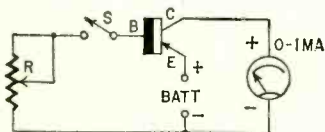

Fig. 1—Simplified circuit of the transistor tester.

where  $I_C$  is equal to the increase in collector current, and  $I_B$  is equal to the base current. In this circuit, the base current, for our purpose, is equal to the battery voltage divided by the resistance of potentiometer R.

Now, if we use a constant value of  $I_C$  in all tests and vary R's resistance to produce this predetermined constant, we can calibrate R in units of beta.

For example: suppose we use 1 ma as the constant increase in collector current, and adjust R to induce this value, then:

$$\text{Beta} = \frac{.001}{I_B}$$

But  $I_B$  is equal to the battery voltage divided by the resistance of R. We know the battery voltage (let's say 10 volts) and can measure the resistance of R (say 100,000 ohms). For this particular set of values:

$$\text{Beta} = \frac{.001}{10/100,000} = 10$$

Knowing this, every time we must set R to 100,000 ohms to get a collector current increase of 1 ma, we know the beta of the transistor we are testing is 10. It is now relatively simple to calibrate R for other values of beta.

Fig. 2 is the transistor tester's circuit. A 0-1 milliammeter is the indicating device, and a collector current increase of 0.5 ma is used in all tests. This much current increase, together with a 4-volt mercury battery, allows a variable resistance of 1 megohm to cover beta values between 5 and 125, which is adequate for all practical purposes.

R1 is a current-limiting resistor which keeps the meter from being damaged if the transistor being tested is shorted. R2 is an arbitrary resistance used to approximate actual in-circuit conditions. It gives a more realistic value of transistor leakage current than a floating base would. R4 is a current-limiting resistor which prevents trans-

istor damage when potentiometer R3 is set for minimum resistance.

Switch S1 is a multiple-pole unit used to reverse meter and battery polarities, eliminating the need for separate sockets for p-n-p and n-p-n transistors.

### Construction notes

The transistor tester is housed in a two-piece aluminum chassis measuring 5 1/4 x 3 x 2 1/2 inches. All components are mounted on the top half of the chassis, as shown in the photos. While the wiring is not critical, space is limited and all components should be located as illustrated.

Potentiometer R3 is wired so that clockwise rotation lowers the resistance. Although this results in a scale which runs counterclockwise, it agrees with the natural tendency to back off a control to reduce excessive meter readings. Be sure to use a control with the specified taper, as an audio taper will cause crowding at the low end of the scale.

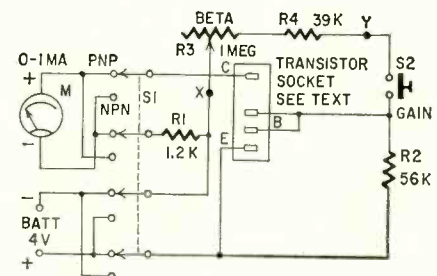

- R1—1,200 ohms
- R2—56,000 ohms
- R3—pot, 1 megohm, reverse log taper (IRC type Q17-137 or equivalent)
- R4—39,000 ohms
- All resistors 1/2 watt 10%
- M—0-1 ma
- S1—4-pole 2-position rotary
- S2—spst pushbutton, normally open
- Battery, 4 volts (RCA V5400 or equivalent)
- Socket, 5-pin miniature hearing aid Case, 5/4 x 3 x 2/8 inches
- Miscellaneous hardware

Fig. 2—Transistor checker tests n-p-n and p-n-p types. When adapter is used, power transistors can also be tested.



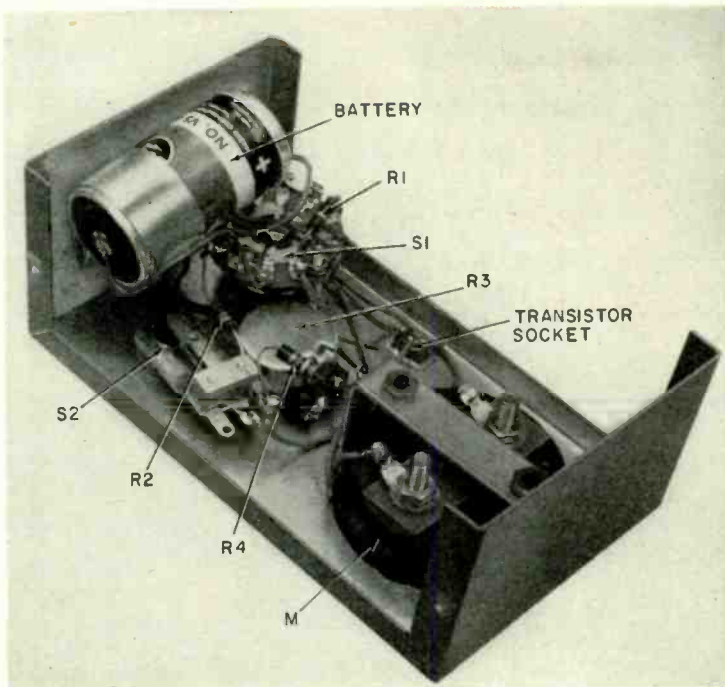

This layout lets you get all the parts into the small case.

The transistor socket is from a miniature hearing-aid socket. Remove pin 4 and plug the hole with a toothpick. Pin 1 is now the emitter connection, pins 2 and 3 the base, and pin 5 the collector. This type socket accommodates the two most common transistor bases. Of

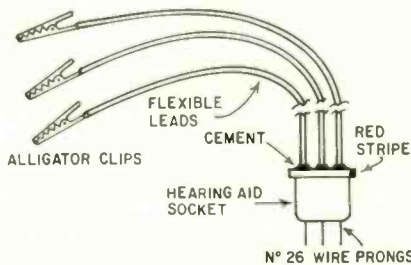

Fig. 3—Construction of the power-transistor adapter.

course, other sockets can be used if desired.

The power-transistor adapter is shown in Fig. 3. Remove all five contacts from a miniature hearing-aid socket. Solder flexible leads to three short lengths of No. 26 tinned wire and insert them into the socket as shown. *Caution: Wire much larger than No. 26 will spring the tester socket contacts.* I used the clipped excess leads of a transistor.

Clip the wires protruding from the socket base to about 1/4 inch and cement the flexible leads to the socket. Solder miniature alligator clips to the free ends of the flexible leads. To eliminate possible confusion, paint a stripe of red fingernail polish on the collector ends of both the tester and adapter sockets.

#### Calibration and operation

After the transistor tester is wired and checked, connect an ohmmeter between points X and Y as indicated in Fig. 2. Now adjust R3 until the ohm-

Resistance (X to Y)		Resistance (X to Y)	
Beta	(Ohms)	Beta	(Ohms)
5	40,000	30	240,000
6	48,000	40	320,000
7	56,000	50	400,000
8	64,000	75	600,000
9	72,000	100	800,000
10	80,000	125	1.0 megohm
15	120,000	150	1.2 megohms
20	160,000		

meter reads 40,000 ohms and mark this point 5 on R3's scale. Other resistance measurements together with their corresponding values of beta are shown in the table. The potentiometer used in my tester has a maximum resistance of 1.2 megohms, so I included this resistance in the table.

When calibration of the unit has been completed, plug a transistor into the socket, first placing switch S1 in either the PNP or NPN position, as necessary. Note the reading on the milliammeter. This reading should be a small fraction of a mil and indicates transistor leakage current. Now depress GAIN switch S2 and adjust R3 until the meter reads 0.5 ma plus the value of leakage current noted previously. R3 now indicates the beta of the transistor being tested. Compare this value with the manufacturer's specifications to determine its quality.

If, when the transistor is first plugged in, the meter reads 0.5 ma or more, the unit is either excessively leaky or shorted. An open transistor produces a zero reading when GAIN switch S2 is depressed.

When using the adapter to test power transistors, connect the alligator clips to the transistor before plugging the adapter into the tester. Failure to do this may result in pegging the meter if the clips inadvertently come in contact with each other. END

## NEXT MONTH

### SPECIAL STEREO ISSUE

Articles and data on all branches of the exciting new art. Will contain:

Stories and specs on stereo pickup cartridges and stereo control units. . . .

Articles on How to Get into Stereo on a Budget, Stereo and Near-Stereo Speaker Systems, What Is Compatible FM Multiplex, Special Features of Available Stereo Amplifiers, Is Your Stereo in Phase? . . . .

Construction Stories: Building a Miniature Stereo Tape Amplifier; Build Your Own Stereo Control Unit. . . .

With many others. Reserve your copy now!

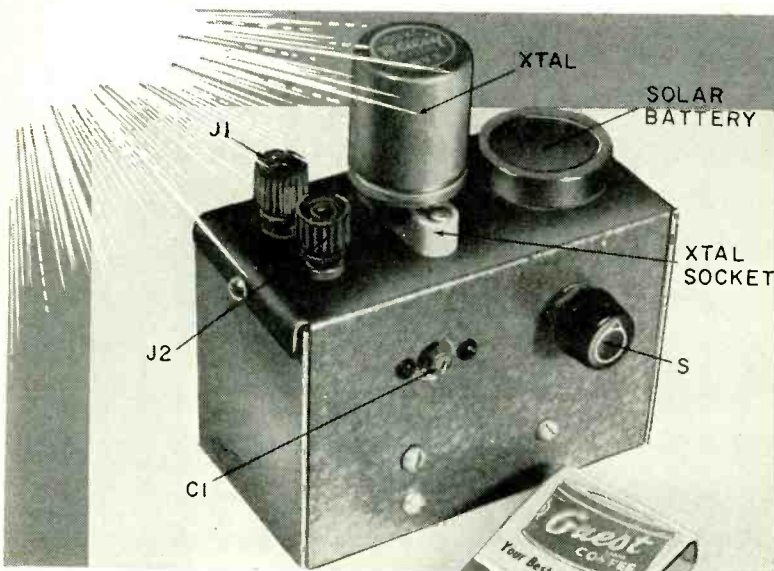

# LIGHT-POWERED FREQUENCY STANDARD

The finished unit weighs only 7 ounces.

By RUFUS P. TURNER

*100-ke crystal oscillator is powered by sunlight, artificial light, or an internal battery*

USING the 100-ke crystal oscillator described in this article, you can call on the sun to furnish the dc power for frequency check points. Indoors or at night, artificial light will do the job. When you must get along in dim light or darkness, the flip of a switch throws an internal battery into the circuit. Thus, this unit is always at your service, and the run-down battery is not as often a problem.

The idea of operating a transistor oscillator from a solar cell is not new. However, the circuit of this instrument (see Fig. 1) is different from most 100-ke crystal oscillators. It is a crystal-controlled multivibrator. No coils are required. The output signal is distorted in shape—it looks like something between a sine wave and square wave. So it is rich in harmonics—always an important point for 100-ke frequency-spotting oscillators, but more so when low dc voltage is used.

Two inexpensive n-p-n rf transistors (General Electric 2N168-A) are used. The circuit is that of an emitter-coupled multivibrator and resembles the cathode-coupled tube circuit. The common-emitter resistor R<sub>2</sub> corresponds to the common-cathode resistor in the tube circuit. The 100-ke crystal XTAL forms the transmission path between the output collector and input base and acts as a high-Q, sharply tuned filter. A 3.9-50-μmf air trimmer, C<sub>1</sub>, connected in parallel with the crystal permits a small amount of frequency variation for setting the oscillator to zero-beat with WWV or standard broadcast stations.

**Multivibrator operation**

The emitter-coupled multivibrator circuit\* is a transistor version of the

well-known cathode-coupled tube multivibrator. Fig. 2-a shows the tube circuit and Fig. 2-b the transistor circuit. The common-emitter resistor R<sub>E</sub> in the transistor circuit corresponds to the common-cathode resistor R<sub>K</sub> in the tube circuit. The grid of tube V<sub>1</sub> is grounded, but here a large capacitance, C<sub>1</sub>, is used to ground the transistor for pulses but not for dc. Both circuits differ from the conventional multivibrator only in that one of the capacitance-coupled paths has been replaced by the common-cathode (common-emitter) coupling.

When dc is applied, both transistors

start conducting collector current (I<sub>C1</sub> and I<sub>C2</sub>). Both collector currents flow through emitter resistor R<sub>E</sub>, across which they produce voltage drop V<sub>E</sub>, which is applied to both emitters. As collector current flows, the emitter-to-ground voltage increases. Closing the switch of the dc supply transmits a pulse through capacitor C<sub>2</sub> to the base of transistor V<sub>2</sub>. The resulting current flowing through V<sub>2</sub>'s base-emitter circuit causes the amplified collector current of that transistor to increase. This, in turn, causes an increase in V<sub>E</sub> which decreases the collector current I<sub>C1</sub> of V<sub>1</sub>. This action reduces the voltage drop across R<sub>C</sub>, causing the left side of capacitor C<sub>2</sub> to receive a still higher voltage. As C<sub>2</sub> approaches the supply potential, its charging current flowing through the base-emitter circuit of V<sub>2</sub> increases I<sub>C2</sub> still further and transistor V<sub>1</sub> is emitter-biased higher and higher. This action continues until V<sub>1</sub> is cut off and V<sub>2</sub> conducts maximum collector current.

At this point C<sub>2</sub> is charged and the charging current through the base-emitter path of V<sub>1</sub> ceases. The result is that I<sub>C2</sub> decreases. This lowers the voltage drop across the common-emitter resistor, and transistor V<sub>1</sub> draws more collector current. The voltage drop across R<sub>C</sub> also increases, lowering V<sub>1</sub>'s collector voltage. Capacitor C<sub>2</sub> is now able to discharge and, as it does so, I<sub>C2</sub> decreases still further as does its effect on the total emitter voltage. This action continues until transistor V<sub>2</sub> is cut off and V<sub>1</sub> is drawing maximum current. Thus, conduction has been switched from transistor V<sub>2</sub> to V<sub>1</sub>.

Now, capacitor C<sub>2</sub> may again begin charging through resistor R<sub>C</sub> and the base-emitter path of V<sub>2</sub>—and the cycle of events is repeated. In the operation

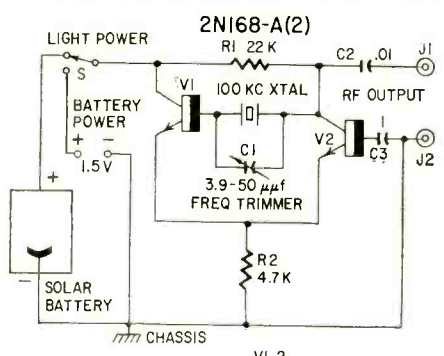

- R1—22,000 ohms, 1/2 watt
- R2—4,700 ohms, 1/2 watt
- C1—3.9-50-μmf trimmer (Hammarlund APC-50 or equivalent)
- C2—.01 μf, miniature metallized tubular
- C3—1 μf, miniature metallized tubular
- J1, 2—binding posts
- S—spdt miniature rotary
- V1, 2—2N168-A Crystal—100 kc
- Solar battery, silicon (Author used International Rectifier SA5-M)
- Case, 4 x 2 x 2 3/4 inches
- Crystal socket
- Knob
- Battery holder
- Barrier type terminal strips, 3 terminal (2)
- Miscellaneous hardware

Fig. 1—Circuit of 2-transistor unit.

\*Frank C. Alexander, Jr., "Transistors Use Emitter-Coupled Feedback," *Electronics*, December, 1954, page 188.

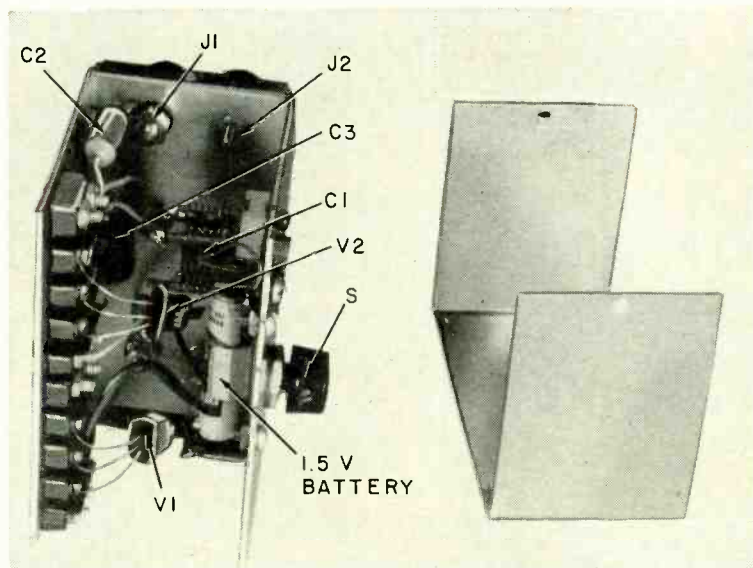

The few connections make this unit a simple one-evening project.

of this multivibrator, conduction is switched alternately from V1 to V2 as capacitor C2 charges and discharges. The switching rate is governed by the values of  $R_0$ , C2,  $R_E$ , V2's internal base-emitter resistance and V1's internal collector-emitter resistance. C1 is made large enough so that this unit is a virtual short circuit to ground at the operating frequency and does not figure into the frequency.

In the frequency standard (Fig. 1), capacitor C2 of the basic circuit has been replaced with the 100-kc crystal. This provides a highly selective coupling path and sets the multivibrator frequency to that of the crystal. Variable capacitor C1, shunting the crystal, has the prime purpose of serving as a frequency trimmer.

**Power for the oscillator**

When switch S is in the LIGHT POWER position, dc operating voltage is supplied by a silicon solar cell (International Rectifier type SA5-M). When switch S is in the BATTERY POWER position, the dc voltage is supplied by an internal 1.5-volt cell. As current drain is low, a penlight cell is used. For longer life and more stable voltage use a mercury cell.

The solar cell is 1 1/4 inches in diameter and 5/16 inch thick. It has a clear glass window. The crystal can is 1 inch in diameter and 1-5/16 inches high. The cell has two 6-32 terminal screws. The completed instrument weighs only 7 ounces.

In bright sunlight, the 100-kc rf output (developed across a 500,000-ohm load) is 0.15 volt rms. This output is the same with a 100-watt incandescent lamp 1 foot above the solar cell. Output when the 1.5-volt battery is used is 0.3 volt rms.

**Assembly and wiring**

The instrument is built in an alu-

minum chassis box 4 x 2 x 2 3/4 inches. While a plastic or wooden box could be used, metal is recommended to shield against hum pickup from ac power fields.

The photos show constructional details. The solar cell, crystal socket and output binding posts are mounted on the top of the box. The screwdriver-adjusted trimmer capacitor and the power changeover switch are mounted on one side.

Insulated binding posts are used for the RF OUT terminals. However, only J1 has to be insulated from the box—use a fiber shoulder washer. The ground post is attached directly to the case. A 1/4-inch clearance hole must be drilled for the fiber shoulder washer which insulates the top post. Use a flat fiber washer on the other side.

Similarly, the positive screw terminal of the solar cell must be insulated from the case with a fiber shoulder washer inserted into a 1/4-inch clearance hole. The negative terminal is fastened directly to the box.

A 3/8-inch-diameter clearance hole is required for the tuning screw of

trimmer capacitor C1. The ceramic body of this capacitor insulates it from the box. Two 1/4-inch clearance holes are required for the terminal lugs of the ceramic crystal socket. The shank of switch S requires a 3/8-inch clearance hole. A wafer type switch was chosen for its small size. However, a spdt toggle may be used if this type is preferred.

Two three-screw, barrier type terminal strips (Cinch-Jones 3-140) are used for mounting the transistors. Each transistor pigtail is held by one of the screws. This simple arrangement takes the place of soldering to the pigtails, which can be injurious to the transistor. Solder all connections to the strips before inserting the transistors. These terminal strips are mounted end to end along the lower edge of one inner wall of the box.

A bracket type battery holder is fastened to the opposite inside wall to hold the penlight cell. A solder lug on the wall just in front of the transistor-holding terminal strips receives the ground leads of capacitor C3 and resistor R2. Resistor R1 is soldered directly between the collector terminals of adjacent transistor-holding terminal strips. Coupling capacitor C2 is soldered directly between the output collector terminal and the top output binding post.

**Initial testing**

Carefully check all wiring before slipping the battery into its holder. Be particularly careful of battery, solar cell and transistor polarity. The crystal has no special polarity and will work whichever way it is plugged into its socket.

Connect an ac vtvm (preferably one with a 0.3-volt full-scale range) to the RF OUTPUT terminals. An oscilloscope may be used in place of this meter. Throw switch S to BATTERY POWER and note the rf output voltage as indicated by the meter or scope. Now, throw the switch to LIGHT POWER, expose the solar cell to the sun or to a nearby lamp, and again note the rf output voltage.

To check the signal tune a non-oscillating receiver to WWV or to a standard broadcast station operating on a frequency (such as 600, 700, 1000 kc) which is an exact multiple of 100 kc. Couple the frequency standard to the receiver by connecting the ground RF OUTPUT terminal to the receiver ground terminal and by loosely coupling the top RF OUTPUT terminal to the receiver antenna terminal. This usually can be done successfully by connecting a wire to the top terminal and winding several turns of its insulated length around the receiver antenna lead. With switch S set to BATTERY POWER, adjust trimmer capacitor C1 for zero beat with the WWV carrier (or broadcast carrier) during an interval when the signal is not being modulated. Throw switch S to LIGHT POWER and repeat the test, with the solar cell illuminated. END

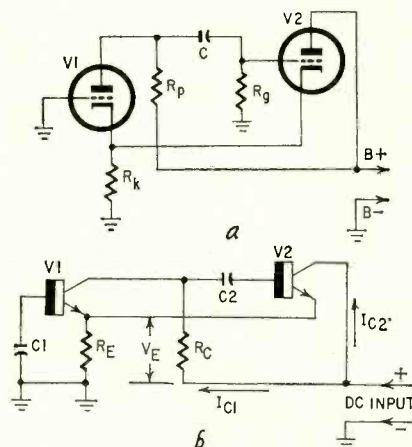

Fig. 2—Multivibrator detail: a—tube type, cathode-coupled; b—transistor type, emitter-coupled.

*How to build an electronic switch  
and how you can use it in  
making audio amplifier tests*

# ELECTRONIC SCOPE SWITCH

By L. B. HEDGE

**A**UDIO amplifier tests are primarily concerned with comparing the input and output signals of the amplifier under test. The earlier articles of this series<sup>1</sup> have described test instruments for checking gain, frequency response, harmonic distortion, intermodulation distortion and power output. Using an oscilloscope as an accessory to these tests and as the indicator for intermodulation measurements has also been covered. The master control unit described in the last article provides flexible interconnection of the test equipment and the amplifier under test and for switching the oscilloscope connections and those of an electronic switch.

An electronic switch is a device which permits a simultaneous display of two signals on a scope screen. (Special oscilloscopes with multiple-channel displays are made, but they are relatively expensive and complicated.) A scope in combination with an electronic switch provides a simple setup for testing phase-shift characteristics of amplifiers and makes an oscilloscope a more effective visual indicator of distortion and other abnormal amplifier action. The electronic switch also provides a square-wave signal output which can be used for a variety of purposes.

**Points to note**

The conventional electronic switch (Fig. 1-a) consists of two amplifier channels with paralleled outputs which are alternately switched on and off by a free-running variable-frequency multivibrator. Each channel has its own signal attenuator, and the relative (dc) potential of the zero-signal outputs of the two channels is adjustable.

The unit described here (see Figs. 1-b and 2) differs from the conventional unit that it includes a phase inverter

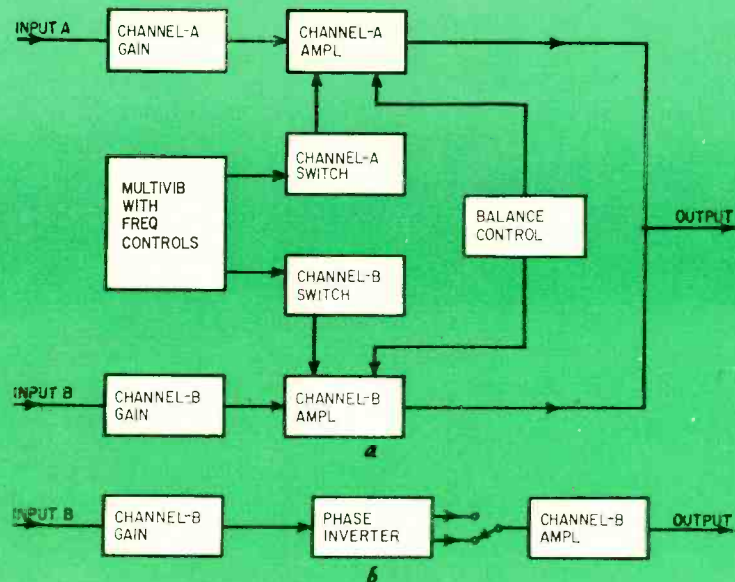

**Fig. 1-a**—Block diagram of a conventional electronic switch: **b**—the modified B channel in this unit includes a phase inverter.

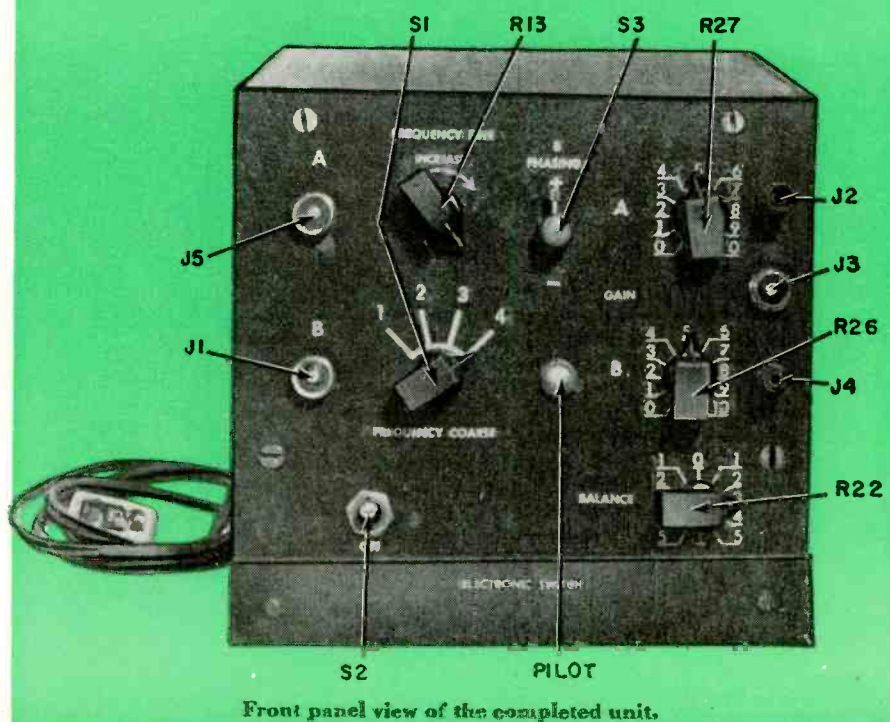

(V5) in the channel-B amplifier which can be switched in or out and a capacitor-coupled output (J2 and J4) as well as the direct-connected one (J3). The phase inverter makes it possible to compare directly the input and output signals of an amplifier whose output is in phase or 180° out of phase with its input. The direct-connected output avoids the distortion induced by capacitor coupling when the scope input includes a series capacitor. The capacitor-coupled output removes the dc plate voltage and is useful when the unit is used as a square-wave signal generator feeding an amplifier without a series input capacitor.

I used 7193's for V1, V2, V3 and V4 because their grid and plate terminals, being top caps, permit assembling the multivibrator and the switching couplings above the chassis. The cathode connections to the switched amplifier tubes (V6 and V7) are made under the chassis. The 954 pentodes (V6 and V7) and the triode-connected 954 (V5) provide above-chassis grid circuitry and below-chassis plate and cathode circuitry. This simplifies shielding and circuit separation problems that can arise in a unit in which circuit functions should be kept separate.

The 7193's and the 954's can be purchased from surplus houses at very low prices. However, current tube types which may be used instead are listed in the chart.

The resistor pairs R1-R2, R3-R4, R5-R9, R6-R10, R7-R11, R8-R12 and R16-R20, and capacitors C1 and C2 may be matched to provide a symmetrical square-wave output and uniform switching periods for the amplifier outputs. For all practical purposes, however, precise matching and exact uniformity of switching times are of little importance. Resistors R28 and R29 should be matched to provide uniform output from the B channel in the "-" and "+" phasing positions of S3.

The voltage regulation provided by R34 and V9 and V10 is an important feature of the circuit, since variations in the multivibrator's plate supply cause erratic variations in switching time. Variations in plate or screen supply voltages to V6 and V7 cause similarly erratic variations in amplitude and alignment of the channel outputs. Resistors R35, R36 and R37 provide a positive heater bias, balanced with respect to the heater supply, that suppresses the tendency toward heater-cathode leakage.

Aside from these elements, the only special feature in the unit's construction is the use of shielded leads from the input terminals (J1 and J5) to the gain-control potentiometers (R26 and R27) and from the phasing switch (S3) to the channel-B tubes (V5 and V6). The shielded leads reduce pickup of stray transients from the multivibrator. Without the shielded leads, pickup is not likely to be large but may tend to blur the channel output images near the switching points.

Grid and plate caps of V1 and V2 permit mounting multivibrator components above the chassis.

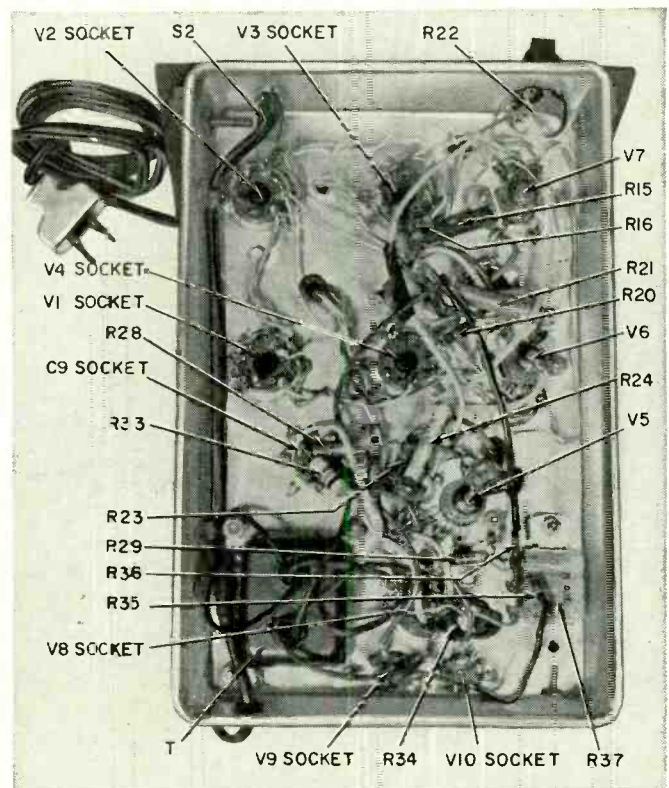
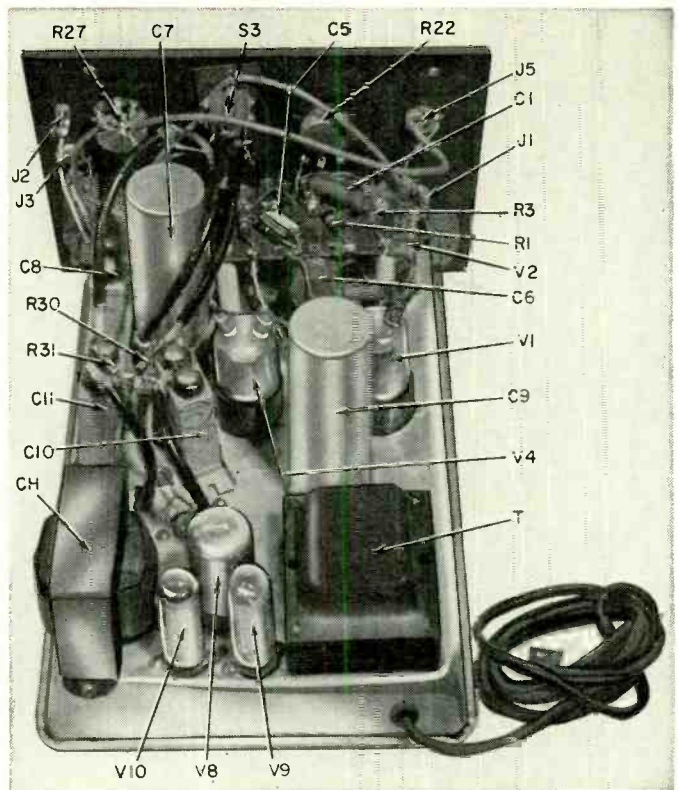

The Acorn tubes (V5, V6 and V7) are mounted upside down, under the chassis.

As shown in the photos, the electronic switch is built on a bread-pan chassis.<sup>2</sup> A Masonite panel is attached to one end and the works are enclosed in a cabinet with wood top and bottom and Masonite sides.

Checking the finished unit

When the electronic switch is com-

pleted, it can be checked by connecting the A- and B-channel inputs to an audio oscillator and watching the output of the switch on a scope. With the master control unit (March, 1958), connect the AMPLIFIER IN and OUT ungrounded terminals (J12 and J14) together and set the LOAD switch (S4) in the SPEAKER position with the

## TEST INSTRUMENTS

SPEAKER terminals free. With this setup and with the A- and B-channel gain controls (R26 and R27) of the electronic switch at zero, adjusting the BALANCE control (R22) should provide a single straight horizontal trace at the center position and square waves with the BALANCE control on either side of center position and square waves with is adjustable between approximately 10 and 2,000 cycles. The character of the square-wave images depends on the scope's amplifier and attenuator structure but it should be fairly good with the scope's gain set at maximum and the electronic switch BALANCE control adjusted to give a square wave of moderate amplitude on the screen of the scope.

For comparing the amplifier's channel outputs, the GAIN controls (R26 and R27) can be adjusted to give outputs of identical amplitude and the two patterns aligned (Fig. 3) or separated (Fig. 4) by adjusting the BALANCE control. For stationary patterns of this type, the scope's sync control should be set to the external position and the external sync terminal connected to the AMPLIFIER IN ungrounded terminal (J12) of the master control unit. This permits locking the scope's sweep to the frequency of the signal being observed, because using the internal

sync will often lock the sweep to the switching frequency of the electronic switch.

This effect can occur even in the balanced output position, due to small pulses which occur with the switching action. Switching the B PHASING (S3) from "+" to "-" reverses the phase of the B-channel output, providing a simple way to identify the two images being compared. The frequency controls (COARSE and FINE—S1 and R13) can be adjusted to give traces of varying length in each channel image. If the frequency is adjusted to some multiple of the sweep frequency, the switching pattern will be stationary, but slight frequency drifts in the switch multi-vibrator will usually cause such a

pattern to be unsteady. For effective comparison of the output images, a stationary switching pattern is a disadvantage. Adjustment of the FINE FREQUENCY CONTROL (R13) to provide minimum coincidence of switching patterns will give switched images of apparent continuity, with a very dim background haze, formed by the moving switching traces.

The frequency response of the amplifier channels of the electronic switch is moderately limited—approximately uniform from 10–10,000 cycles, and down less than 25% at 25,000 cycles. Although this may seem ineffective for high-quality amplifier checking, it is not—the two channels are essentially identical in response and can be used

TUBE CHART	
V1, V2, V3, V4	7193, 6J5, one half 6SN7, one half 6CG7
V5	954 (triode-connected), 6SJ7 (triode-connected), 6J7 (triode-connected), one half 6SN7, one half 6CG7, 6J5, 6C4.
V6, V7	954, 6SJ7, 6J7

- R1, 2, 24, 33, 35, 36—47,000 ohms, 2 watts
- R3, 4—12,000 ohms
- R5, 9—220,000 ohms
- R6, 10, 15, 19, 30, 31, 32—1 megohm
- R7, 11—3.9 megohms
- R8, 12—18 megohms
- R13, 22—pot, 100,000 ohms, 2 watts or higher, linear taper
- R14, 18—2.2 megohms
- R16, 20—2,200 ohms, 1 watt
- R17—10,000 ohms, 5 watts
- R21, 25—100,000 ohms, 1 watt
- R23—22,000 ohms, 1 watt
- R26, 27—pot, 500,000 ohms, 2 watts or higher, logarithmic taper
- R28, 29—1,500 ohms, 1 watt
- R34—1,000 ohms, 5 watts
- R37—200 ohms, ct or adjustable with slider, 10 watts
- All resistors 1/2-watt 10% unless noted
- C1, 2—.001  $\mu$ f
- C3, 6—0.25  $\mu$ f
- C4, 5—100  $\mu$ f
- C7—10–10  $\mu$ f, 450 volts, electrolytic
- C9—60–40–20  $\mu$ f, 450, electrolytic
- C8, 10, 11—1  $\mu$ f, 450 volts
- All capacitors 600 volts unless noted
- CH—16 h, 50 ma (Stancor C1003 or equivalent)
- J1, 3, 5—coaxial connectors
- J2, 4—binding posts
- S1—2-pole 4-position rotary
- S2—spst toggle
- S3—spdt nonshorting rotary
- T—power transformer: primary 117 volts; secondary 480 volts ct, 50 ma; 6.3 volts, 2.5 amps (Merit P3047 or equivalent)
- V1, 2, 3, 4—7193 (see text)
- V5, 6, 7—954 (see text)
- V8—7Y4
- V9—OA2
- V10—OB2
- Sockets, octal (4)
- Sockets, acorn (3)
- Sockets, 7-pin miniature (2)
- Socket, octal
- Pilot-lamp assembly with No. 47 bulb
- Chassis, bread pan 7x11 inches
- Miscellaneous hardware

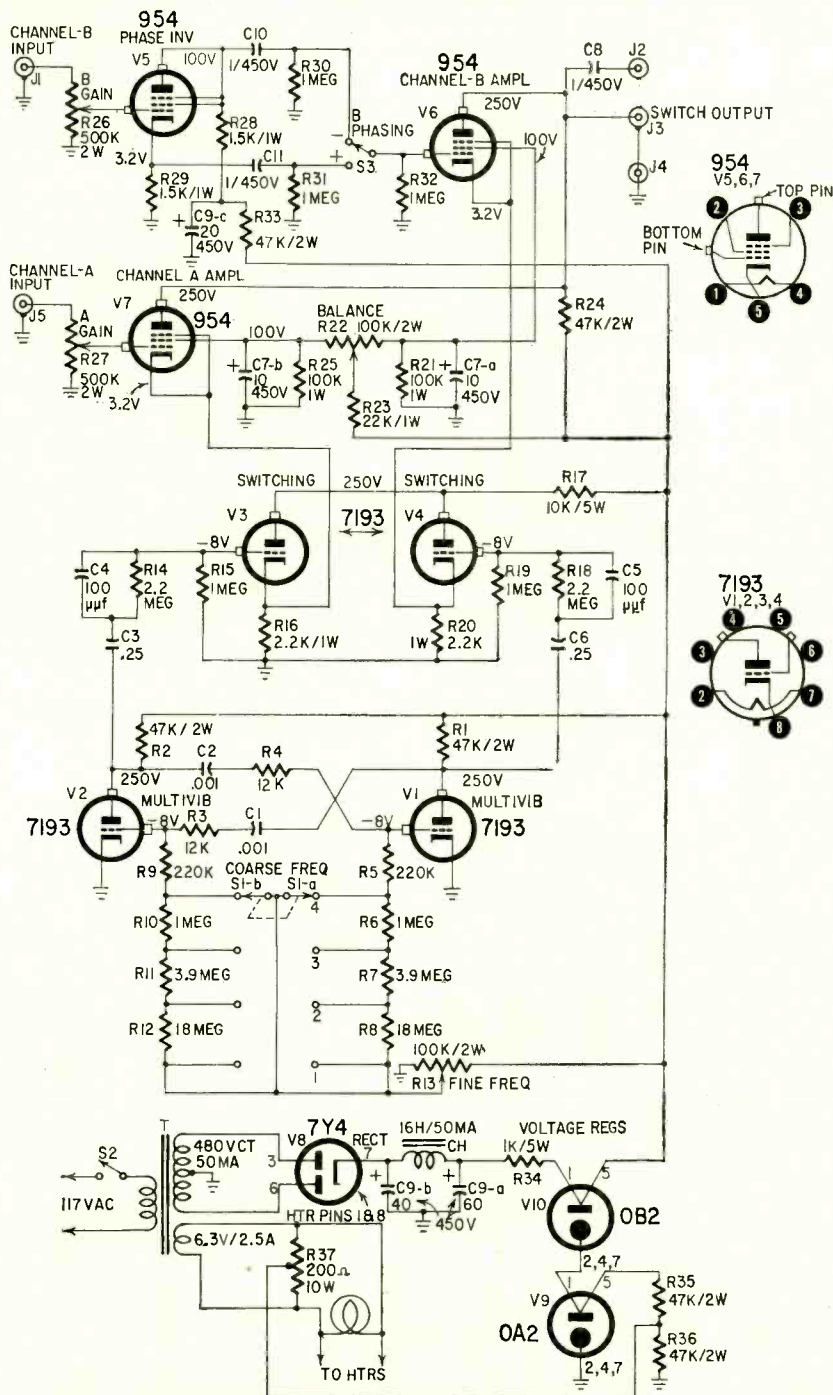

Fig. 2—Circuit of the 9-tube unit is straightforward

effectively for comparative display of sine-wave patterns at frequencies up to 150,000 cycles. Each amplifier channel can be checked by removing the switching tube (V3 and V4) and pentode (V6 or V7) of the channel not being checked. This is the only simple way to set up such a test since, under switched operating conditions, the inactive amplifier is biased to cutoff and the switching tube with its cathode connected to the active amplifier pentode cathode is cut off by a negative grid pulse from the multivibrator.

**Using the electronic switch**

With the electronic switch completed and checked out, it is incorporated into the amplifier test setup by connecting the CHANNEL A input to the input of the amplifier under test, the CHANNEL B input to the output of the amplifier (across its output load) and the SWITCH OUTPUT to the scope's vertical input. With the master control unit described in the March, 1958, article of this series, these connections are provided by connecting the three cable connection terminals to the corresponding master control terminals and setting the scope switch to the electronic switch position.

During any test, except intermodulation, the electronic switch, with GAIN, BALANCE and PHASING properly set, will provide input and output waveforms for visual comparison superimposed (Fig. 3) or separated (Fig. 4), in phase (Fig. 5) or with opposite phasing (Fig. 6). Distortion introduced by the amplifier—differences in waveform between input and output—are more easily recognized by this comparative display than by alternate viewing.

One basic test of amplifier performance—phase shift introduced by the amplifier—is easily made by using the electronic switch and an oscilloscope. The phase shift, in degrees, introduced at a given frequency is determined by measuring the horizontal displacement between the input and output wave images, dividing this displacement by the wavelength (length of the image of 1 cycle) of the images and multiplying the result by 360. These values are determined by adjusting the GAIN controls of the electronic switch to provide input and output images of identical amplitude, permitting both the wavelength and the displacement to be measured along any horizontal line on the oscilloscope pattern (see Figs. 7 and 8). If nonlinearity of the scope's sweep tends to compress part of the image, sweep frequency should be reduced and amplitude increased to provide patterns running over several cycles, and the measurements made in the portion of the image where sweep nonlinearity is minimum.

Phase shift in itself is of little significance with regard to an amplifier's sound-reproduction quality, but it is a critical element in the use of feedback which most high-quality amplifiers employ. In any amplifier, the phase shift

as well as the amplitude response varies with frequency and, to avoid oscillation in the amplifier, gain around the feedback loop (open, not closed loop) must be less than 1 at any frequency at which the phase shift is 180°. For definite stability this gain must remain less than 1 for all frequencies with phase shift above 180°.

Using the electronic switch as a square-wave generator for audio amplifier appraisal is possible with the help of the master control unit. Transfer the amplifier input leads from the master control terminals to the binding-post terminals of the electronic switch and set the OSCILLOSCOPE switch to the VOLTMETER position, and the VOLTMETER switch to the OUT position. No provision was made in the master control unit for switching the square-wave

output of the electronic switch into the amplifier input because square-wave testing<sup>1</sup> is essentially qualitative and is less accurate, less definitive and more complicated in interpretation than the specific tests described in this series. END

<sup>1</sup> Prior articles in this series—"Build This Amplifier-Rectifier Vtvm for Audio Testing," October, 1957; "Extended-Range Audio Oscillator," December, 1957; "Wien-Bridge Analyzer," January, 1958; "Master Control Unit for Audio Testing," March, 1958.

<sup>2</sup> L. B. Hedge, "The Bread-Pan Layout," *Audio Engineering*, August, 1953.

<sup>3</sup> F. E. Terman, *Radio Engineers Handbook*, 1943, page 396.

<sup>4</sup> F. Langford-Smith, *Radiotron Designer's Handbook*, 1952, pages 356-59.

<sup>5</sup> E. J. Thompson, "Square-Wave Analysis for Audio Amplifiers," *RADIO-ELECTRONICS*, July, 1950.

T. F. Crook, "Looking at Square Waves," *Wireless World*, August, 1956.

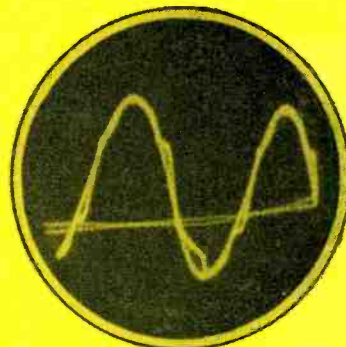

Fig. 3—Sine wave at amplifier input superimposed on distorted output waveform.

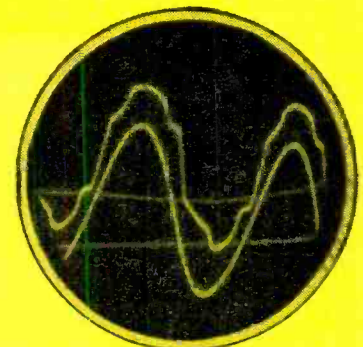

Fig. 4—Separated display of signals shown in Fig. 3.

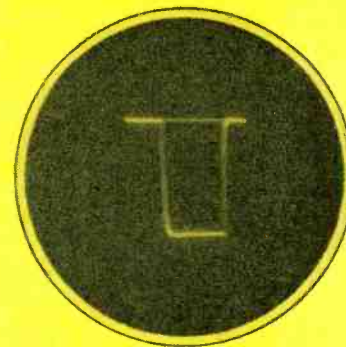

Fig. 5—Two signals exactly in phase appear as one trace.

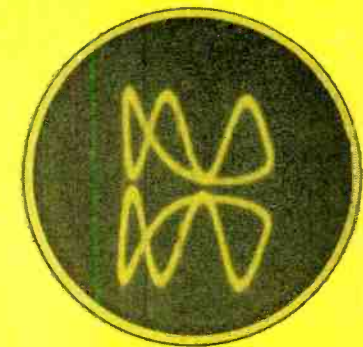

Fig. 6—Flipping the phase switch reverses the B channel signal.

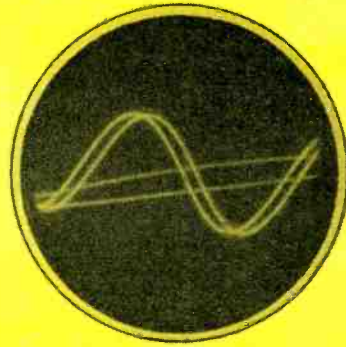

Fig. 7—Phase shift in this display is about 25°.

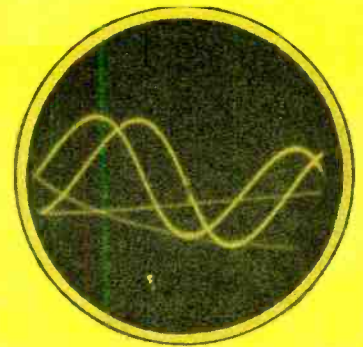
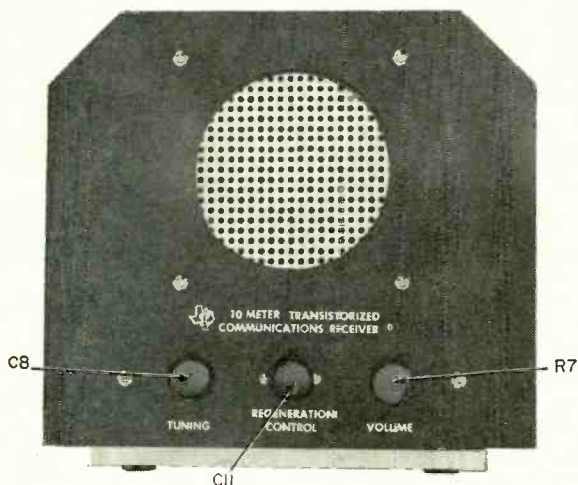

Fig. 8—Another phase-shift test display. The phase shift is about 68°.

# TRANSISTORS for 10 meters



*Five-transistor unit puts a portable 10-meter receiver in your hands*

By **DON HALL, W5OBS\***

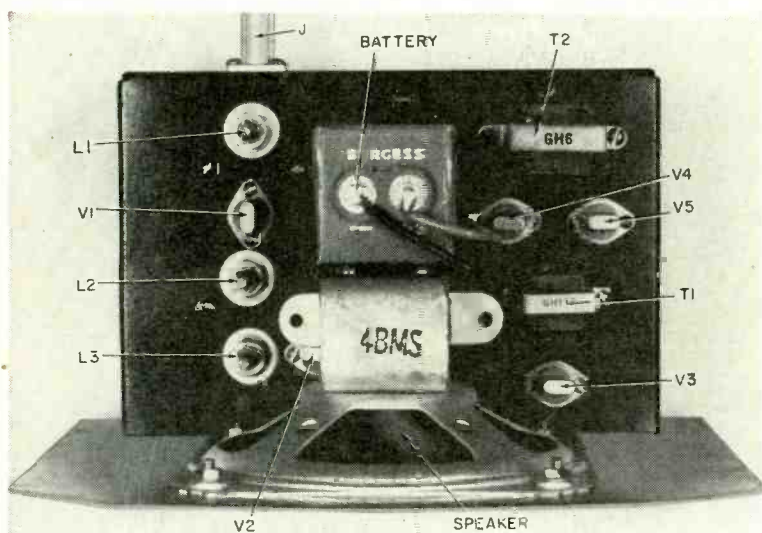

(Above) The finished unit. ↑ ↓ (Below) The preferred layout.

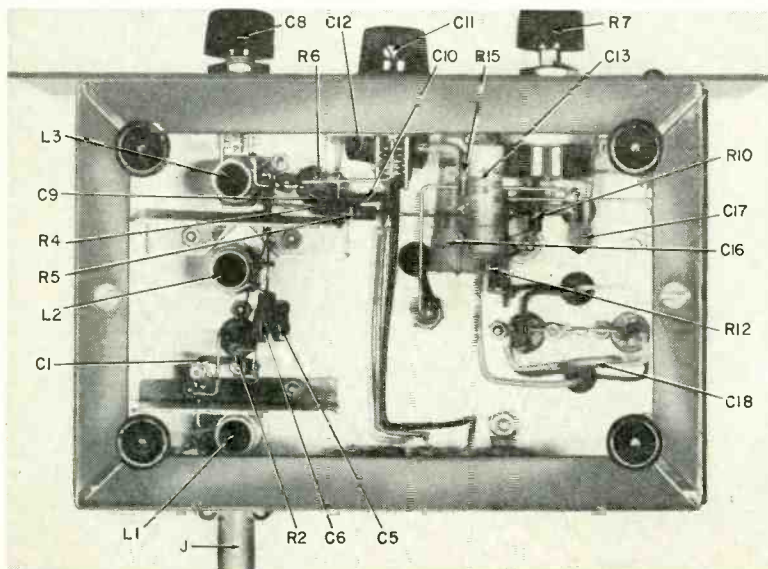

**A**FTER being confined to the laboratory, audio and broadcast radio, for the first few years of its life, the transistor is finding its way into the hamshack. Because it is a new device to the ham, many have hesitated to make full use of transistors in their gear.

This article describes a 10-meter receiver that uses low-cost readily available transistors. The set's performance is not equal to that of a large communications receiver, but is good enough to provide the builder with a useful unit. A 5- $\mu$ v signal is plainly audible, and the inherent limiting action of the superregenerative detector keeps the output constant over a wide range of input signals. Non-critical circuitry and ease of adjustment make this receiver ideal for the ham just getting started with transistor circuitry.

### Receiver circuit

A block diagram of the receiver is shown in Fig. 1. Functionally, it is no different than a comparable vacuum-tube set. The receiver consists of an

\* Circuit Development Engineer  
Texas Instruments, Inc.

**BENCH RE TESTED**

When conditions are right, there is no limit to the distance possible on the 10-meter band. Listening tests show that this little set can really reach out. Within a short time after starting it up, phone hams had been picked up coast to coast and from South America.

Selectivity is less favorable. A single strong station can completely blot out several weak ones on other frequencies. Also, the regeneration control affects frequency, so it should not be touched after being set to optimum.

During the tests, a noiselike kind of distortion made it impossible to understand strong stations. It was cured by placing a large electrolytic (250  $\mu$ f at 25 volts) across the battery.



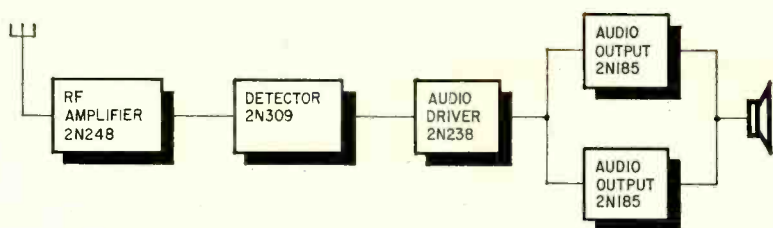

Fig. 1—Block diagram of the all-transistor set.

rf amplifier, superregenerative detector, audio driver and push-pull audio output stages.

Fig. 2 shows the receiver's circuit. The rf stage uses a 2N248 in a common-emitter amplifier circuit. The input from the antenna is connected to a tap on the coil in the base circuit. The coil's tuning is very broad because of the base circuit's input resistance. Resistors R1 and R3 set the base-bias voltage. R2 maintains the desired emitter current. The collector tuned circuit consists of L2 and C5.

Coils L2 and L3 are not inductively coupled. The shield shown in the schematic helps insure this. Capacitor C6 acts as a coupling between the two coils. As its value goes up, the coupling decreases.

The superregenerative detector uses an easily adjusted circuit that is very tolerant of transistors. A 2N309 is used here. Though intended for 455-ke if amplifier circuits, it works well as an oscillator in the 10-meter range. A 2N248 may also be used here if desired, but is more expensive. The circuit is basically a grounded-base oscillator with an R-C timing network (R5 and C9) providing the quench frequency for superregenerative operation. The capacitor from collector to emitter, C11, controls the feedback. It is adjusted to insure oscillation over the entire band. Audio output from

this stage is taken across the emitter resistor R6.

The audio signal contains a large amount of the quench frequency, which would tend to overload the following audio stages. A simple filter consisting of R15 and C13 removes most of the quench voltage and allows the desired audio to pass on to the volume control.

The audio driver stage uses a 2N238. Biasing network R8, R9 and R10 operates in the same manner as its counterpart in the rf stage. A transformer couples this stage to the push-pull output. Capacitor C17 helps to attenuate any quench-frequency signal which was not eliminated at the stage's input.

The output stage is operated class B to provide plenty of power when needed, while keeping the average battery drain low. Any size speaker may be used. The maximum audio output is 250 milliwatts, more than adequate for good room volume.

The TUNING, REGENERATION and VOLUME controls are mounted on the front panel. The REGENERATION control could be made a small trimmer capacitor since it is seldom touched in normal operation. A small speaker may be used, but will not be as efficient as somewhat larger ones.

Final steps

Adjusting of the receiver is simple.

With power on, a hiss should be heard from the speaker. If not, vary the REGENERATION control until you hear the hiss indicating the detector is operating. A 28-mc signal from either a grid-dip meter or other signal source should be applied to the antenna input. With C8 set for maximum capacitance, adjust the slug in L3 until the signal is heard. While tuning C8 through its entire range, the hiss should continue, indicating detector operation over the whole band.

Apply a 29-mc signal and tune it in. Adjust the slugs in L1 and L2 for maximum signal. This completes the alignment, making the receiver ready to use. A couple of details might be mentioned at this point. Varying the regeneration control will change the detector's frequency, but once this control is set it need not be changed. The tuning of L1, as mentioned previously, is very broad.

The set's performance is quite startling, considering its size and power consumption. Several types of antennas have been used, ranging from a mobile whip to a pair of TV rabbit ears. Good signals have been heard with all of them. The input is designed for a 50-ohm unbalanced line and the receiver works best with a good antenna.

This transistor set cannot compete with a good communications receiver, and loud signals tend to capture the set to some degree. A large amount of limiting gives AVC action which keeps very strong stations from "blasting" the speaker.

If you want to gain some experience with transistors and at the same time build a very useful addition to your ham gear, I highly recommend this little receiver. It will provide many hours of good 10-meter listening. END

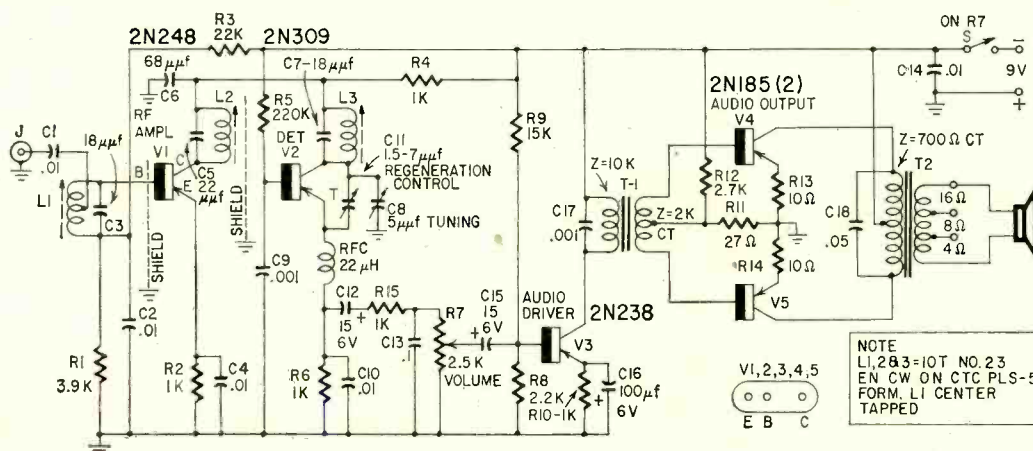

- R1—3,900 ohms
- R2, 4, 6, 10, 15—1,000 ohms
- R3—22,000 ohms
- R5—220,000 ohms
- R7—pot, 2,500 ohms, audio taper, with spst switch
- R8—2,200 ohms
- R9—15,000 ohms
- R11—27 ohms
- R12—2,700 ohms
- R13, 14—10 ohms
- All resistors 1/2-watt 10% unless noted
- C1, 2, 4, 10, 14—.01  $\mu$ f, ceramic
- C3, 7—18  $\mu$ f, mica or ceramic
- C5—22  $\mu$ f, mica or ceramic

- C6—68  $\mu$ f, mica or ceramic
- C8—5  $\mu$ f, variable
- C9, 17—.001  $\mu$ f, ceramic
- C11—1.5-7  $\mu$ f, trimmer
- C12, 15—15  $\mu$ f, 6 volts, electrolytic
- C13—0.1  $\mu$ f, paper
- C16—100  $\mu$ f, 6 volts, electrolytic
- C18—.05  $\mu$ f, ceramic
- J—coaxial connector
- L1—10 turns No. 23 enameled wire, close-wound, tapped at 5 turns, on Cambridge Thermionic PLS-5 form with green slug
- L2, 3—10 turns No. 23 enameled wire, close-wound on Cambridge Thermionic PLS-5 form with green slug

- T1—driver transformer: primary, 10,000 ohms; secondary, 2,000 ohms ct (Gramer-Halldorson GH117 or equivalent)
- T2—output transformer: primary, 700 ohms ct; secondary, 4, 8 or 16 ohms (Gramer-Halldorson GH6 or equivalent)
- V1—2N248 (Texas Instruments)
- V2—2N309 (Texas Instruments)
- V3—2N238 (Texas Instruments)
- V4, 5—2N185 (Texas Instruments)
- Speaker
- Metal shields (2)
- Transistor sockets (5)
- Battery, 9 volts (Burgess 2N6 or equivalent)
- Miscellaneous hardware

Fig. 2—Low power drain makes portable battery operation practical.

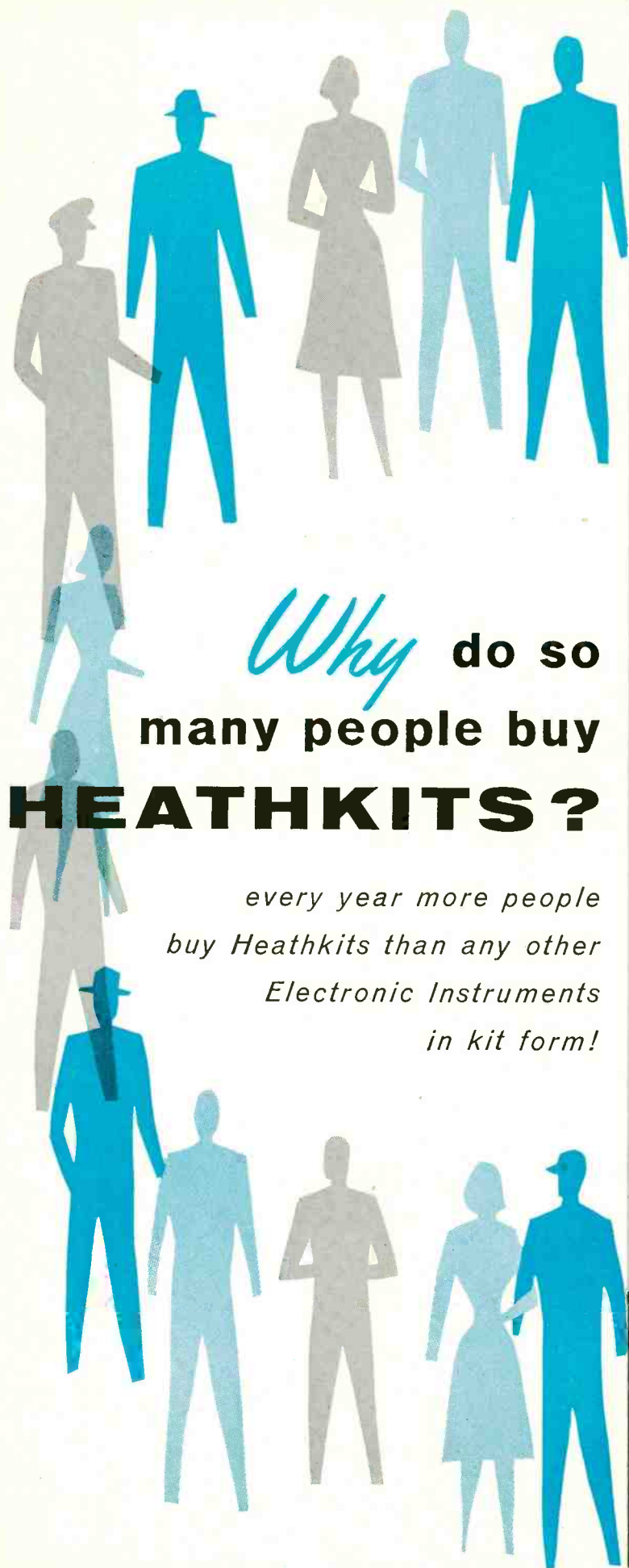

*Why* do so many people buy **HEATHKITS?**

*every year more people buy Heathkits than any other Electronic Instruments in kit form!*

**Here are a few reasons why...**

**EASY TO BUILD**

Heathkits are engineered for easy kit construction. You need no electronic or kit building experience whatsoever to successfully complete your own kit. Use of printed circuit boards and pre-wired, pre-aligned assemblies cut construction time. Manuals are carefully prepared, employing step-by-step instructions written in simple, non-technical language. Large pictorial diagrams and photographs show you exactly where each part goes.

**LASTING QUALITY**

Only top quality components go into Heathkits, assuring you of a finished product that is unsurpassed in performance, dependability and endurance. Rigid quality control standards are maintained at the Heath factory to see that each component lives up to its advertised specifications. Heathkits are conservatively rated. No performance claims are made that are not thoroughly proven and tested under the most stringent laboratory conditions.

**ADVANCED ENGINEERING**

Progress in electronics engineering never stands still at Heath. The latest developments in circuit design and components are exploited by Heath engineers, offering you superior performance at lower costs. New advances in all fields of electronics are carefully watched by Heath engineers to keep abreast of the rapidly growing industry. The modern, up-to-date styling of Heathkits make them a handsome addition to your home or workshop.

**WORLD-WIDE REPUTATION**

A pioneer in do-it-yourself electronics, Heath Company, over more than a decade, has established public confidence in its products both in the United States and abroad. Today, as the world's largest manufacturer of electronic kits, Heath stands as the leader in its field.

**GREATER SAVINGS**

Do-it-yourself Heathkits save you up to 1/2 the cost of equivalent ready-made equipment. Direct factory-to-you selling, eliminating middle-man profit, plus the tremendous Heath purchasing power mean even further savings to you. And the convenient Heath Time Payment Plan allows you to use and enjoy your Heathkit NOW, while you pay for it in easy installments.



**HEATH COMPANY**  
Benton Harbor 20, Michigan

 a subsidiary of Daystrom, Inc.

## TRANSISTOR PORTABLE RADIO KIT

Fun for the whole family, this easy-to-build 6-transistor portable radio is ready to go wherever you go. The modern molded plastic case with pull-out carrying handle and fully enclosed back add beauty and convenience to this splendid kit. Six name-brand (Texas Instrument) transistors are used for good sensitivity and selectivity. The 4" x 6" PM speaker with heavy magnet provides "big set" tone quality. Use of this large speaker and roomy chassis make it unnecessary to crowd components adding greatly to the ease of construction. Transformers are prealigned making the radio ready for use as soon as kit is assembled. A built-in rod-type antenna assures good reception in all locations. Six standard flashlight batteries are used for power, providing extremely long battery life (between 500 and 1,000 hours) and they can be purchased anywhere. Stylish cabinet is two-tone blue molded plastic with gold inlay and measures 9" L. x 7" H. x 3 3/4" D. Shpg. Wt. 6 lbs.

**MODEL XR-1L:** Identical to XR-1P except in handsome leather case instead of plastic case. Leather carrying strap included. Shpg. Wt. 7 lbs.

**LEATHER CASE:** Can be purchased separately if desired. Fits all XR-1P and earlier XR-1 chassis. No. 93-1. Shpg. Wt. 3 lbs. \$6.95.

HEATHKIT  
MODEL XR-1P  
**\$29<sup>95</sup>**



MODEL XR-1L **\$34<sup>95</sup>**

## NAVIGATE BY PORTABLE RADIO



HEATHKIT  
MODEL DF-2  
**\$69<sup>95</sup>**

## 2-BAND TRANSISTOR PORTABLE RADIO DIRECTION FINDER KIT

Enjoy the safety, convenience and entertainment of this self-contained, self-powered, six-transistor superheterodyne radio direction finder. It receives aeronautical and marine beacons as well as standard band broadcasts with startlingly clear tone reproduction over a long range. Covering the beacon band from 200 to 400 kc and broadcast band from 540 to 1620 kc, the DF-2 is designed to take directional "fixes" on both aircraft and marine beacons as well as standard broadcast stations, while providing the entertainment of a high quality transistor portable radio. You are able to receive aircraft weather reports every thirty minutes and constant Coast Guard beacons on the 200 to 400 kc band. A dial light is provided for night operation. Power is supplied by six standard flashlight batteries which will last you up to one year under normal operation. Shpg. Wt. 9 lbs.



## POWER CONVERTER KIT

Now you can operate your TV set, radio, razor, and other AC electrical equipment directly from your 12-volt boat or car battery. With the Heathkit Power Converter you can enjoy the convenience of home electricity whether boat cruising or on automobile trips. Two power transistors are employed for years of trouble-free, dependable service. No moving parts to wear out, no tubes to replace. Shpg. Wt. 8 lbs.

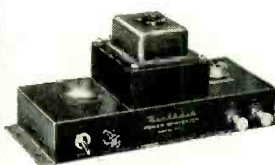

MODEL PC-1  
**\$24<sup>95</sup>**

## ELECTRONIC IGNITION ANALYZER KIT

Ideal for use on automobiles, boats, aircraft engines, etc., the IA-1 checks ignition systems with the engine in operation (400 to 5,000 RPM). Shows the condition of coil, condenser, points, plugs and ignition wiring. Shows complete engine cycle or just one cylinder at a time. Two test leads are supplied, each 10' long, which will enable you to reach either the breaker points or the spark plug wires. Shpg. Wt. 20 lbs.



MODEL IA-1  
**\$59<sup>95</sup>**

## ELECTRONIC TACHOMETER KIT

Useful on inboard and outboard boats, as well as in automobiles, the TI-1 operates directly from the spark impulse of the engine. Use on any spark ignited 2 or 4 cycle engine of any number of cylinders. Completely transistorized, it works with 6, 8, 12, 24 or 32 volt DC systems. Indicates revolutions-per-minute from 0 to 6,000. Calibration control provided for adjusting to engine type. Easy-to-build and easy-to-install. Shpg. Wt. 4 lbs.



MODEL TI-1  
**\$25<sup>95</sup>**

## PROFESSIONAL OSCILLOSCOPE KIT

Everything you could possibly want in an oscilloscope is found in the new Heathkit model OP-1. Featured are DC coupled amplifiers and also DC coupled CR tube un-blanking. The triggered sweep circuit will operate on either internal or external signals and may be either AC or DC coupled. The polarity of the triggering signal may also be selected, and any point on the waveform may be selected for the start of the sweep by using the "triggering level" control. An automatic position is also provided, in which the sweep recurs at 50 cycle rate, but can be driven over a wide range of frequencies with no additional adjustment. Prewired terminal boards are used for rapid, easy assembly of all critical circuits. Power supply is transformer operated utilizing silicon diode rectifiers and is fused for protection. Handsome cabinet features silver anodized front panel with red and black lettering and matching knobs. Shpg. Wt. 34 lbs.

HEATHKIT  
MODEL OP-1

**\$179<sup>95</sup>**



## VARIABLE VOLTAGE REGULATED POWER SUPPLY KIT

Invaluable in experimental and design work, the PS-4 eliminates the need for building up a separate power supply for each new circuit tried. It provides a convenient source of variable regulated B+, variable bias voltage and filament voltage for labs and work shops. The PS-4 supplies regulated B+ output continuously variable from 0 to 400 volts DC at up to 100 ma, bias voltage variable from 0 to -100 volts DC at 1 ma, and filament voltage of 6.3 volts AC at 4 amps. Separate panel meters continuously monitors voltage and current output. Rugged, top-rated components used throughout for long, reliable service. Shpg. Wt. 16 lbs.



HEATHKIT  
MODEL PS-4

**\$54<sup>95</sup>**

Your best  
dollar value...



**HEATH COMPANY** • Benton Harbor 20,  
Michigan  
a subsidiary of Daystrom, Inc.

## "EXTRA DUTY" 5" OSCILLOSCOPE KIT

Laboratory quality at utility scope price makes this instrument an unusual value. The Heath patented sweep circuit functions from 10 CPS to better than 500 kc in five steps, giving you five times the usual sweep obtained in other scopes. Vertical frequency response extends from 3 CPS to 5 mc +1.5 db -5 db without extra switching. An automatic sync circuit with self-limiting cathode follower provides excellent linearity and lock-in characteristics. Extremely short retrace time and efficient blanking action are characteristic of this scope. Frequency response of the horizontal amplifier is within ±1 db from 1 CPS to 200 kc. Horizontal sensitivity is 0.3 volts RMS-per-inch. Construction is simplified through the use of two etched metal circuit boards and precut, cabled wiring harness. Complete step-by-step instructions and large pictorial diagrams are supplied for easy assembly. An ideal scope for all service applications as well as in standard or color TV servicing. Shpg. Wt. 22 lbs.



HEATHKIT  
MODEL O-12

**\$65<sup>95</sup>**



HEATHKIT  
MODEL TO-1

**\$16<sup>95</sup>**

## TEST OSCILLATOR KIT

Provides the test frequencies most often used by servicemen in repairing and aligning modern broadcast receivers. Five fixed-tuned frequencies (262 kc, 455 kc, 465 kc, 600 kc and 1400 kc) are quickly selected for troubleshooting or alignment of the IF frequency and high and low end of the broadcast band for proper tracking. Shpg. Wt. 4 lbs.



MODEL SG-8 **\$19<sup>50</sup>**

## RF SIGNAL GENERATOR KIT

A "must" for any beginning serviceman, this indispensable instrument is used for aligning tuned circuits quickly and tracing signals in faulty RF, IF and audio circuits. Covers 160 kc to 110 mc on fundamentals in five bands and from 110 mc to 220 mc on calibrated harmonics. Coils are pre-wound and calibrated. Complete with output cable and instructions. Shpg. Wt. 8 lbs.



MODEL AG-9A **\$34<sup>50</sup>**

## AUDIO SIGNAL GENERATOR KIT

This unique generator uses three rotary switches to select two significant figures and a multiplier to determine audio frequency, allowing return to the exact frequency previously measured when making multiple frequency measurements. Covers 10 CPS to 120 kc with less than .1 of 1% distortion between 20 and 20,000 CPS. Shpg. Wt. 10 lbs.



MODEL TS-4A **\$49<sup>50</sup>**

## TV ALIGNMENT GENERATOR KIT

TV service technicians will appreciate the outstanding features found in this sweep generator. Provides essential facilities for aligning FM, monochrome TV or color TV sets. The all-electronic sweep circuit employs a trouble-free controllable inductor which varies frequency by magnetic means. An unusual buy at this low price. Shpg. Wt. 16 lbs.



MODEL CD-1 **\$59<sup>95</sup>**

## COLOR BAR AND DOT GENERATOR

The CD-1 combines the two basic color servicing instruments, a color bar and white dot generator in one versatile and portable unit, which has crystal controlled accuracy and stability for steady lock-in patterns. (Requires no external sync leads.) Easy-to-build and easy-to-use. No other generator on the market offers so many features at such a great price saving. Shpg. Wt. 13 lbs.

## ETCHED CIRCUIT VTVM KIT

Time proven for dependability, accuracy and overall quality, the V7-A is one of the wisest investments you can make for your electronic workshop or lab. Its multitude of uses will make it one of the most often used instruments in your possession. Use it to measure all operating voltages and potentials such as B+ and AC-DC, or straight AC power supplies, filament voltage, bias voltage, AVC voltage, line voltage, etc. Ideal for measurements in all types of AM, FM and TV circuits. Checks discriminator or detector operation, AVC or AGC performance, while the ohmmeter may be used to measure circuit continuity, circuit resistance, to test out individual components with resistance measurement, or to trace circuit wiring through cables or chassis openings. Front panel controls consist of rotary function switch and a rotary range selector switch, zero-adjust and ohms-adjust controls. Precision 1% resistors are used in the voltage divider circuit for high accuracy and an etched circuit board is employed for most of the circuitry. The circuit board not only simplifies assembly but permits levels of circuit stability not possible with ordinary conventional wiring methods. Shpg. Wt. 7 lbs.

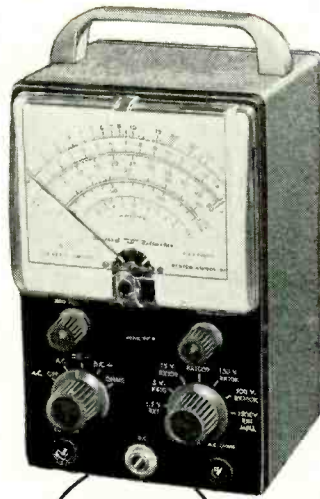

HEATHKIT  
MODEL V7-A

**\$25<sup>95</sup>**



HEATHKIT  
MODEL M-1

**\$17<sup>95</sup>**



HEATHKIT  
MODEL MM-1

**\$29<sup>95</sup>**

## HANDITESTER KIT

Ideal for use in portable applications when making tests away from the work bench or as an "extra" meter in the service shop. The combination function range switch simplifies operation. Measures AC or DC voltage from 0 to 10, 30, 300, 1,000 and 5,000 volts. Direct current ranges are 0 to 10 ma and 0 to 100 ma. Ohmmeter ranges are 0 to 3,000 and 0 to 300,000. Top quality, precision components used throughout. Small and compact, take it with you wherever you go. Very popular with home experimenters and electricians. Test leads and 1½ volt size C battery are included with the kit. Shpg. Wt. 3 lbs.

## 20,000 OHMS/VOLT VOM KIT

Portable and accurate, this kit features a 50 ua 4½" meter and 1% precision multiplier resistors for high accuracy. No external power required. Provides a total of 25 meter ranges on a two-color scale. Sensitivity is 20,000 ohms-per-volt DC and 5,000 ohms-per-volt AC. Measuring ranges are 0-1.5, 5, 50, 150, 500, 1,500 and 5,000 volts AC and DC. Measures direct current in ranges of 0-150 ua, 15 ma, 150 ma, 500 ma and 15 a. Resistance multipliers are X 1, X 100 and X 10,000. Covers -10 db to +65 db. Housed in an attractive bakelite case with plastic carrying handle. Batteries and test leads included. Shpg. Wt. 6 lbs.

## TUBE CHECKER KIT

Brand new in every respect, the TC-3 features outstanding performance and ease of operation. Sockets are provided for 4-pin, 5-pin, 6-pin, 7-pin, large, 7-pin miniature, 9-pin sub-miniature, octal, loctal, and 9-pin miniature tubes. Protection against obsolescence is provided by a blank socket to facilitate modification for checking newly added tube types. A 10-lever switch makes it possible to connect any element to any other element regardless of the pin numbers involved. A neon bulb indicator shows filament circuit continuity and leakage or shorts between elements. A specially designed spring loaded roll chart mechanism permits the roll chart to run freely throughout its entire length without binding. Thumb wheel drive knobs are provided on both sides of the panel to accommodate the left handed operator. Compact and small in size, the TC-3 is ideally suited for portable applications. Both the roll chart and the meter are illuminated to facilitate use in darkened areas. Shpg. Wt. 12 lbs.



HEATHKIT  
MODEL TC-3

**\$39<sup>95</sup>**

## AUDIO VTVM KIT

This vacuum tube volt meter emphasizes stability, broad frequency response and sensitivity for accurate measurement of critical AC voltages. Features a large 4½" 200 ua meter with increased damping in the meter circuit for stability in low frequency tests. Measures AC from a low value of 1 millivolt to a maximum of 300 volts AC (RMS). Voltage ranges are: 0-.01, .03, .1, .3, 1, 3, 10, 30, 100 and 300 volts. Db ranges cover -52 to +52 db. 1% precision multiplier resistors used for maximum accuracy. Frequency response is essentially flat from 10 CPS to 200 kc. Shpg. Wt. 6 lbs.



MODEL AV-3  
**\$29<sup>95</sup>**



## MODEL CT-1 \$7<sup>95</sup>

## IN-CIRCUIT CAPACI-TESTER KIT

This handy kit checks capacitors for "open" or "short" right in the circuit. Detects open capacitors from about 50 mmf, not shunted by an excessive low resistance value. Checks shorted capacitors up to 20 mfd (not shunted by less than 10 ohms). Checks all bypass, blocking and coupling capacitors of the paper, mica or ceramic types. (Does not detect leakage nor check electrolytic condensers.) Electron beam "eye" tube is used for quick indication. A 5-position function switch is featured which controls the power to the instrument and selects the test being made. Easy to build and easy to use. Test leads included. Shpg. Wt. 5 lbs.



MODEL BE-5 **\$39<sup>95</sup>**

## LOW RIPPLE BATTERY ELIMINATOR KIT

Completely up to date the BE-5 will power all the newest transistor circuits requiring 0 to 12 volts DC, and the new hybrid automobile radios using both transistors and vacuum tubes. An extra low-ripple filter circuit is employed holding AC ripple down to less than .3%. Doubles as a battery charger or marine converter. Shpg. Wt. 21 lbs.



MODEL T-4  
**\$19<sup>95</sup>**

## VISUAL-AURAL SIGNAL TRACER KIT

New in every respect the T-4 features a built-in speaker and electron beam "eye" tube for signal indication, and a unique noise locator circuit. Ideal for use in AM, FM and TV circuit investigation. Transformer operated for safety and high efficiency. Complete with test leads and informative construction manual. Shpg. Wt. 5 lbs.



MODEL C-3 **\$19<sup>50</sup>**

## CONDENSER CHECKER KIT

Check unknown condenser and resistor values quickly and accurately as well as their operating characteristics with this fine instrument. All values are read directly on a calibrated scale. An electron beam "eye" tube indicates balance and leakage. A valuable addition to any service shop or lab. Shpg. Wt. 7 lbs.



HEATHKIT  
MODEL TX-1  
**\$234<sup>95</sup>**

- Built-in cooling fan
- Rotating Slide Rule Dial
- Compact, Stable, VFO
- Provision for SSB Adapter

\$50.00 required on C.O.D. orders. Shipped motor freight unless otherwise specified.

## "APACHE" HAM TRANSMITTER KIT

This beautifully styled transmitter has just about everything you could ask for in transmitting facilities. The "Apache" is a high quality transmitter operating with a 150 watt phone input and 180 watt CW input. In addition to CW and phone operation, built-in switch selected circuitry provides for single-sideband transmission through the use of a plug-in external adapter. A completely redesigned, compact and stable VFO provides low drift frequency control necessary for SSB transmission. A slide rule type illuminated rotating VFO dial with full gear drive vernier tuning provides ample bandspread and precise frequency settings. The bandswitch allows quick selection of the amateur bands on 80, 40, 20, 15 and 10 meters (11 m with crystal control). This unit also has adjustable low-level speech clipping and a low distortion modulator stage employing two of the new 6CA7/EL34 tubes in push-pull class AB operation. Time sequence keying is provided for "chirpless" break-in CW operation. The final amplifier is completely shielded for greater TVI protection and transmitter stability. A formed one-piece cabinet with convenient access hatch provides accessibility to tubes and crystal socket. Die-cast aluminum knobs and front panel escutcheons add to the attractive styling of the transmitter. Pi network output coupling matches antenna impedances between 50 and 72 ohms. A "spotting" push button is provided to allow tuning of the transmitter before switching on the final amplifier. This feature also enables the operator to "zero-beat" an incoming frequency without placing the transmitter on the air. Equip your ham shack now for top transmitting enjoyment with this outstanding unit. Shpg. Wt. 110 lbs.

New Styling...  
New Features



**HEATH COMPANY**  
Benton Harbor 20, Michigan

a subsidiary of Daystrom, Inc.



HEATHKIT  
MODEL SB-10  
**\$89<sup>95</sup>**

## SINGLE SIDEBAND ADAPTER KIT

Designed as a compatible plug-in adapter for the model TX-1 it can also be used with transmitters similar to the DX-100 or DX-100-B by making a few simple circuit modifications and still retain the normal AM and CW functions. Easy to operate and tune, the adapter employs the phasing method for generating a single sideband signal, allowing operation entirely on fundamental frequencies. The critical audio phase shift network is supplied, completely pre-assembled and wired in a sealed plug-in unit. Features include single-knob bandswitching for operation on 80, 40, 20, 15 and 10 meters, an easy-to-read panel meter, built-in electronic voice control with anti-trip circuit. Enjoy the advantages of SSB operation by adding this fine kit to your ham shack now. Shpg. Wt. 14 lbs.

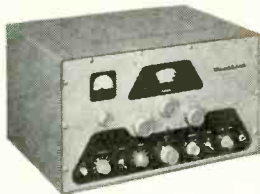

MODEL  
DX-100-B  
**\$189<sup>50</sup>**

\$50.00 deposit required on C.O.D. orders. Shipped motor freight unless otherwise specified.

### DX-100-B PHONE & CW TRANSMITTER KIT

The same fine performance of the time proven DX-100 is retained in the DX-100-B with improvements in the crystal and loading circuits. The one-piece formed cabinet has convenient access hatch for changing crystals, etc. and the chassis is punched to accept sideband adapter modifications. Features a built-in VFO, modulator and power supply, complete shielding to minimize TVI, and a pi network output coupling to match impedances from 50 to 72 ohms. RF output is in excess of 100 watts on phone and 120 watts on CW. Covers 160 through 10 meters. Single-knob bandswitching and illuminated VFO dial and meter face. RF output stage uses a pair of 6146 tubes in parallel, modulated by a pair of 1625's. Designed for easy assembly. Measures 11 $\frac{3}{8}$ " H. x 19 $\frac{1}{2}$ " W. x 16" D. Shpg. Wt. 107 lbs.



MODEL DX-40 **\$64<sup>95</sup>**

### DX-40 PHONE & CW TRANSMITTER KIT

Operates on 80, 40, 20, 15, 11 and 10 meters, using a single 6146 tube in the final for 75 watt plate power input CW, or 60 watts phone. Single-knob bandswitching, pi network output, complete shielding, provision for three crystals and VFO. D'Arsonval movement panel meter. Shpg. Wt. 25 lbs.



MODEL DX-20 **\$35<sup>95</sup>**

### DX-20 CW TRANSMITTER KIT

This fine unit covers 80, 40, 20, 15, 11 and 10 meters with single-knob bandswitching. Features a 6DQ6A tube in the final for 50 watt plate power input, pi network output, complete shielding to minimize TVI. Easy to build with complete instructions supplied. Shpg. Wt. 19 lbs.

## "MOHAWK" HAM RECEIVER KIT

Designed for ham band operation and for maximum stability and accuracy, the Heathkit "Mohawk" receiver will let you enjoy ham activities to the utmost. This 15-tube receiver features double conversion with IF's at 1682 kc and 50 kc and covers all the amateur frequencies from 160 through 10 meters on seven bands. An extra band is calibrated to cover 6 and 2 meters using a converter. The "Mohawk" is specially designed for single-sideband reception with crystal controlled oscillators for upper and lower sideband selection. A completely pre-assembled, wired and aligned front end coil/bandswitch assembly assures ease of construction and top performance. Many more important features are provided in this outstanding receiver for dependable and effective amateur communications. Ruggedly constructed with well rated components throughout. Shpg. Wt. 66 lbs. Matching accessory speaker kit; optional extra. Model AK-5. \$9.95. Shpg. Wt. 8 lbs.

- **Prewired and Aligned Coil/Bandswitch Assembly**
- **Crystal Controlled Oscillators for Drift-Free Reception**

HEATHKIT  
MODEL RX-1  
**\$274<sup>95</sup>**



HEATHKIT  
MODEL AR-3  
**\$299<sup>5</sup>**  
(LESS CABINET)

## ALL-BAND RECEIVER KIT

A fine receiver for the beginning ham or short wave listener. Frequency coverage is from 550 kc to 30 mc in four bands. Features include bandswitch, bandspread tuning, phone-standby-CW switch, antenna trimmer, noise limiter, RF and AF gain controls and head-phone jack. Easy to build. Shpg. Wt. 12 lbs.



MODEL  
QF-1  
**\$9<sup>95</sup>**

## "Q" MULTIPLIER KIT

Use with any receiver with IF frequency between 450 and 460 kc to add additional selectivity for separating two signals or to reject one signal and eliminate heterodyne. A great help on crowded phone and CW bands. Not for use with AC-DC type receivers. Simple to connect with cable and plugs supplied. Shpg. Wt. 3 lbs.



MODEL  
CA-1  
**\$13<sup>95</sup>**

## "AUTOMATIC" CONELRAD ALARM KIT

This easy-to-build device gives instant warning and cuts AC power to your transmitter when a monitored station goes "off-the-air". Use with any radio receiver having an AVC circuit. A sensitivity control adjusts to various AVC levels. Incorporates a heavy duty six-ampere relay and manual "reset" button to reactivate the transmitter. Complete instructions provided for connection to receiver. Shpg. Wt. 4 lbs.

## "SENECA" VHF TRANSMITTER KIT

Brand new in every respect, the model VHF-1 "Seneca" is the latest addition to our line of ham transmitters. This self-contained 6 and 2 meter transmitter features built-in VFO, modulator, and dual power supply. A pair of 6146 tubes are employed in the push-pull final amplifier stage and features up to 120 watts input on phone and 140 watts input on CW in the 6 meter band. Slightly less in the 2 meter band to prolong amplifier tube life. Panel controls allow VFO or crystal control, phone or CW operation on both amateur bands. Four switch-selected crystal positions. Complete RF shielding to minimize TVI. Spotting push-button provided. The VFO slide rule type dial features edge-lighting and vernier tuning. An ideal transmitter for the ham who wants to extend operation into the VHF region. Shpg. Wt. 56 lbs.



HEATHKIT  
MODEL VHF-1  
**\$159<sup>95</sup>**



MODEL AM-2 **\$15<sup>95</sup>**  
**REFLECTED POWER METER KIT**

Check the match of your antenna transmission system by measuring the forward and reflected power or standing wave ratio from 1:1 to 6:1. Handles a peak power of well over 1 kilowatt and may be left in antenna feed line. No external power required. 160 through 6 meters. For 50 or 75 ohm lines. Shpg. Wt. 3 lbs.



MODEL B-1 **\$8<sup>95</sup>**

## BALUN COIL KIT

Unbalanced coax lines can be matched to balance lines of either 75 or 300 ohms by using this balun coil kit. Use without adjustment from 80 through 10 meters at power up to 200 watts. May be located any distance from transmitter or antenna. Protective cover included. Shpg. Wt. 4 lbs.



MODEL VX-1 **\$23<sup>95</sup>**

## ELECTRONIC VOICE CONTROL KIT

This unique device lets you switch from receiver to transmitter merely by talking into your microphone. Provision is made for receiver and speaker connections and also for a 117 volt antenna relay. Adjustable to all conditions by sensitivity and variable time delay controls provided. Shpg. Wt. 5 lbs.



MODEL VF-1 **\$19<sup>50</sup>**

## VARIABLE FREQUENCY OSCILLATOR KIT

Far below the cost of crystals to obtain the same frequency coverage this VFO covers 160, 80, 40, 20, 15, 11 and 10 meters with three basic oscillator frequencies. Better than 10 volts RF output on fundamentals. Requires only 250 volts DC at 15 to 20 ma, and 6.3 VAC at 0.45 a. Illuminated dial reads direct. Shpg. Wt. 7 lbs.

Beautifully Styled With Plenty of  
Room For The Most Complete  
Stereo System



MODEL SE-1 (center unit) **\$149<sup>95</sup>** Shpg. Wt. 162 lbs.

MODEL SC-1 (speaker enclosure) **\$39<sup>95</sup>** each Shpg. Wt. 42 lbs.

**STEREO EQUIPMENT CABINET KIT**

This superbly styled cabinet ensemble is designed to hold your complete home stereo hi-fi system, consisting of a "stereo equipment center" flanked by two individual "stereo wing speaker enclosures". The unit has room for all the components required for stereo sound. Although designed to hold Heathkit stereo components, it is not frozen to this arrangement. The kit is supplied with mounting panels pre-cut to accommodate Heathkits, but interchangeable blank panels are also furnished so you can mount any equipment you may already have. The pre-cut panels accommodate the Heathkit AM-FM tuner (PT-1), stereo preamplifier (SP-1 & 2), and record changer (RP-3). Record changer chassis pulls out easily for convenient loading and unloading. Adequate space is provided for record storage and a pair of matching Heathkit power amplifiers (from 12 to 70 watts). The stereo wing speaker enclosures are open backed, cloth grilled cabinets designed to hold the Heathkit SS-2 or similar speaker systems. The cabinets are available in beautifully grained 3/4" solid core Phillipine mahogany or select birch plywood suitable for the finish of your choice. The matched grain sliding tape deck access door on top pops-up flush when closed. Entire top features a shaped edge. Hardware and trim of brushed-brass and gold finish. Rich toned grille cloth is flecked in gold and black. No woodworking experience required. All parts pre-cut and predrilled for easy assembly. Maximum overall dimensions (all 3 pieces): 82 3/4" W. x 36 1/2" H. x 20" D. Center Cabinet: 47 1/2" W. x 36 1/2" H. x 20" D.

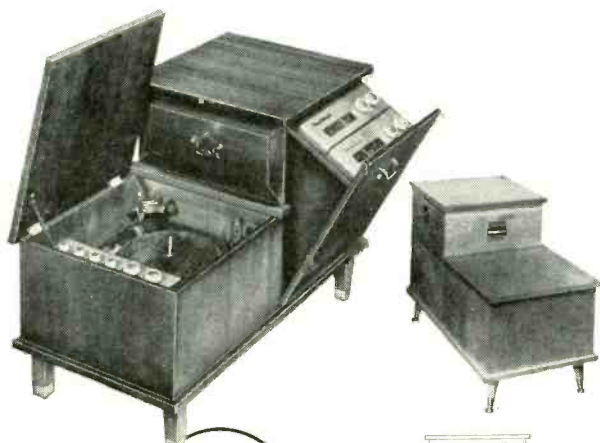

HEATHKIT  
MODEL CE-1  
**\$43<sup>95</sup>**  
each

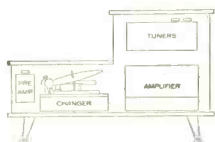

**CHAIRSIDE ENCLOSURE KIT**

Combine all of your hi-fi equipment into one compact control center and, at the same time add a beautiful piece of furniture to your home. The CE-1 is designed to house AM and FM tuners (BC-1A and FM-3A) and the WA-P2 preamplifier along with the majority of record changers which will fit in the space provided. Changer compartment measures 17 3/4" L. x 16" W. x 9 3/8" D. Adequate space is provided in the rear of the unit to house any of the Heathkit amplifiers designed to operate with the WA-P2. Good ventilation is achieved through properly placed slots in the bottom and back of the enclosure. Overall dimensions are 18" W. x 24" H x 35 1/2" D. All parts are pre-cut and predrilled for easy assembly. The Contemporary cabinet is available in either mahogany or birch, and the Traditional cabinet is available in mahogany suitable for the finish of your choice. Beautiful hardware supplied. Shpg. Wt. 46 lbs.

Plan your own  
Hi-Fi System... 

**HEATH COMPANY** • Benton Harbor 20,  
Michigan  
a subsidiary of Daystrom, Inc.

HEATHKIT  
MODEL RP-3  
**\$64<sup>95</sup>**



**HIGH FIDELITY  
RECORD CHANGER KIT**

Every outstanding feature you could ask for in a record changer is provided in the Heathkit RP-3, the most advanced changer on the market today. The unique turntable pause during the change cycle saves wear and tear on your records by eliminating the grinding action caused by records dropping on a moving turntable or disk. Record groove and stylus wear are practically eliminated through proper weight distribution and low pivot point friction of the tone arm. Clean mechanical simplicity and precision parts give you turntable performance with the automatic convenience of a record changer. Flutter and wow, a major problem with automatic changers, is held to less than 0.18% RMS. An automatic speed selector position allows intermixing 33 1/3 and 45 RPM records regardless of their sequence. Four speeds provided: 16, 33 1/3, 45 and 78 RPM. Changer is supplied complete with GE VR II cartridge with diamond LP and sapphire 78 stylus, changer base, stylus pressure gauge and 45 RPM spindle. Shpg. Wt. 19 lbs.



## "BASIC RANGE" HI-FI SPEAKER SYSTEM KIT

The popularity of this modestly priced speaker system attests to its high fidelity performance. The SS-2 provides an ideal basic speaker for your home hi-fi system. Flexibility of design allows it to be used as a table top model or as an attractive consolette with optional legs. May also be used as a supplementary speaker in more advanced systems or as replacement speaker for TV sets, etc. The specially designed tweeter horn rotates 90 degrees allowing you to use the speaker in an upright position if desired, as in the Heathkit stereo wing speaker enclosures. Total frequency range is from 50 to 12,000 cycles-per-second. An 8" mid-range woofer covers from 50 to 1,600 CPS while a compression-type tweeter with flared horn covers 1,600 to 12,000 CPS. Both speakers are by Jensen. A variable balance control allows level adjustment of the high frequency speaker. Power rating is 25 watts. Constructed of 1/2" veneer-surfaced plywood suitable for light or dark finish. All wood parts are pre-cut and predrilled for simple, quick assembly. An added feature of the SS-2 is that, although an outstanding performer in its own right, it may be combined with the SS-1B "range extending" speaker system later to extend the frequency range at the high and low ends of the audio range. Build in just one evening for many years of listening enjoyment. Shpg. Wt. 26 lbs.

ATTRACTIVE BRASS TIP ACCESSORY LEGS convert SS-2 into handsome consolette. 14" legs screw into brackets provided. All hardware included. Shpg. Wt. 3 lbs. No. 91-26. \$4.95.

Assemble it in  
Just One Evening



HEATHKIT  
MODEL SS-2

\$39<sup>95</sup>

OPTIONAL LEGS  
NO. 91-26 \$4.95

### DIAMOND STYLUS HI-FI PICKUP CARTRIDGE

MODEL MF-1 \$26<sup>95</sup>

Replace your present pickup with the MF-1 and enjoy the fullest fidelity your library of LP's has to offer. Designed to Heath specifications to offer you one of the finest cartridges available today. Nominally flat response from 20 to 20,000 CPS. Shpg. Wt. 1 lb.

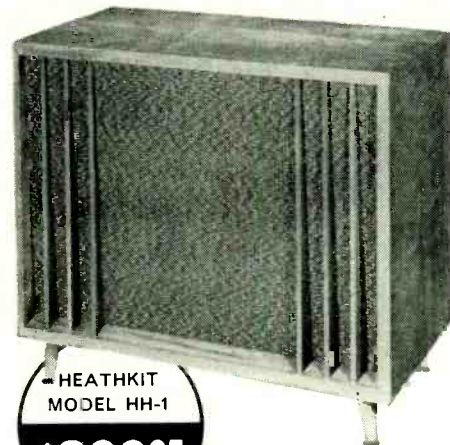

HEATHKIT  
MODEL HH-1

\$299<sup>95</sup>

### "RANGE EXTENDING" HI-FI SPEAKER SYSTEM KIT

Designed exclusively for use with the SS-2, the SS-1B employs a 15" woofer and a super tweeter horn to extend the range of the SS-2 to an overall response of  $\pm 5$  db from 35 to 16,000 CPS. When used together the two units form an integrated four-speaker system and are designed to combine into a single piece of attractive furniture. Impedance of the SS-1B is 16 ohms and power rating 35 watts. A control is provided to limit the output of the super tweeter. Constructed of beautiful 3/4" veneer-surfaced plywood suitable for light or dark finish of your choice. All parts are pre-cut and predrilled for simple assembly. No woodworking experience required. All hardware included. Shpg. Wt. 80 lbs.

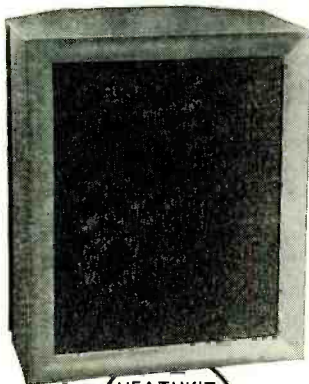

HEATHKIT  
MODEL SS-1B

\$99<sup>95</sup>

Extended  
Frequency Range  
for Your SS-2

### "LEGATO" HI-FI SPEAKER SYSTEM KIT

It is difficult to describe in words the performance of this magnificent speaker system. You may never find absolute perfection in reproduced sound, but the Legato comes as close to achieving it as anything yet devised. Perfect balance, precise phasing, and adequate driver design combine to produce the superb quality of reproduction inherent in this instrument. The crisp, clear high frequencies and rich full bass engulf you in a sea of life-like tone. Two 15" Altec Lansing low frequency drivers cover frequencies from 25 to 500 CPS while a specially designed exponential horn with high frequency driver covers 500 to 20,000 CPS. The unique crossover network is built-in making electronic crossovers unnecessary. The Legato emphasizes simplicity of line and form to blend with modern or traditional furnishings. Constructed of 3/4" veneer-surfaced plywood in either African mahogany or white birch suitable for light or dark finishes of your choice. All parts are pre-cut and predrilled for easy assembly. Shpg. Wt. 195 lbs.

Easy to buy...

Easy to build

Easy to use...



**HEATH  
COMPANY**

Benton Harbor 20,  
Michigan

High Fidelity AM  
and FM reception  
in a Single Set

HEATHKIT  
MODEL PT-1  
**\$89<sup>95</sup>**



### Professional Stereo-Monaural AM-FM Tuner Kit

Enjoy stereophonic broadcasts as well as outstanding individual AM and FM radio reception with this deluxe 16-tube AM-FM-stereophonic tuner combination. Features include three etched circuit boards for high stability and ease of construction, prewired and prealigned FM front end, built-in AM rod antenna, tuning meter, FM-AFC (automatic frequency control) with on-off switch, and flywheel tuning. A multiplex jack is also provided. AM and FM circuits are tuned individually making it ideal for stereo applications since both AM and FM can be used at the same time. A switch selected tuning meter functions on either AM or FM. Cathode follower outputs with individual level controls are provided for both AM and FM. Other features include variable AM bandwidth, 10 kc whistle filter, tuned-cascade FM front end, FM AGC and amplified AVC for AM. Anywhere from 1 to 4 limiters or IF's assure smooth, non-flutter reception on weak or strong stations alike. The silicon diode power supply is conservatively rated and is fuse-protected assuring long service life. Flywheel tuning combined with new edge-lighted slide-rule dial provide effortless tuning. Use of three printed circuit boards greatly simplifies construction. Vinyl-clad steel cover is black with inlaid gold design. Shpg. Wt. 20 lbs.



MODEL FM-3A  
**\$26<sup>95</sup>**

### HIGH FIDELITY FM TUNER KIT

The Heathkit FM-3A Tuner will provide you with years of inexpensive hi-fi enjoyment. Features broad-banded circuits for full fidelity and better than 10 uv sensitivity for 20 db of quieting. Covers the complete FM band from 88 to 108 mc. Stabilized, temperature-compensated oscillator assures negligible drift after initial warmup. Employs a high gain cascode IF amplifier and has AGC. Power supply is built-in. IF and ratio transformers are prealigned as is the front end tuning unit. Two outputs provided, one fixed, one variable, with extra stage of amplification. Shpg. Wt. 8 lbs.

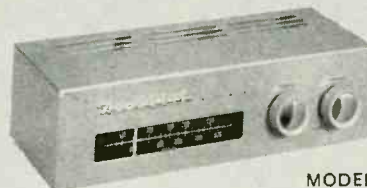

MODEL BC-1A  
**\$26<sup>95</sup>**

### HIGH FIDELITY AM TUNER KIT

The BC-1A incorporates many features not usually expected in an AM circuit particularly in this low price range. It features a special detector using crystal diodes and broad band-width IF circuits for low signal distortion. Audio response is  $\pm 1$  db from 20 CPS to 9 kc with 5 db of pre-emphasis at 10 kc to compensate for station rolloff. Covers the complete broadcast band from 550 to 1600 kc. Prealigned RF and IF coils eliminate the need for special alignment equipment. Incorporates AVC, two outputs, two antenna inputs and built-in power supply. Shpg. Wt. 9 lbs.



MODEL W-6 **\$109<sup>95</sup>**

### "HEAVY DUTY" 70 WATT HI FI AMPLIFIER KIT

Designed for "rugged duty" called for by advanced hi-fi systems and P.A. networks. Silicon diode rectifiers assure long life and heavy duty transformer provides excellent power supply regulation. Variable damping control provides optimum performance with any speaker system. Quick change plug selects 4, 8 and 16 ohm or 70 volt output and the correct feedback resistance. Shpg. Wt. 52 lbs.



MODEL W-5 **\$59<sup>75</sup>**

### 25 WATT HI FI AMPLIFIER KIT

Enjoy the distortion-free high fidelity sound from one of the most outstanding hi-fi amplifiers available today. Features include a specially designed Peerless output transformer and KT66 tubes. Frequency response is  $\pm 1$  db from 5 to 160,000 CPS at 1 watt and within 2 db 20 to 20,000 CPS at full 25 watts output. Hum and noise are 99 db below 25 watts. Shpg. Wt. 31 lbs.



MODEL W-4AM **\$39<sup>75</sup>**

### SINGLE CHASSIS 20 WATT HI FI AMPLIFIER KIT

A true Williamson-type high fidelity circuit, the W-4AM features 5881 push-pull output tubes and a special Chicago-Standard output transformer to guarantee you full fidelity at minimum cost. Harmonic distortion is 1.5% and IM distortion is below 2.7% at full 20 watt output. Hum and noise are 95 db below full output. Taps are 4, 8 or 16 ohm speakers. Shpg. Wt. 28 lbs.



MODEL W-3AM **\$49<sup>75</sup>**

### DUAL CHASSIS 20 WATT HI FI AMPLIFIER KIT

Another famous Williamson-type high fidelity circuit, the W-3AM features the famous Acrosound TO-300 "ultralinear" output transformer and 5881 tubes. The power supply and main amplifier are on separate chassis for installation flexibility. Harmonic distortion is less than 1% and IM distortion is less than 1.2% at 20 watts. Shpg. Wt. 29 lbs.



HEATHKIT  
MODEL SP-2  
(STEREO)  
**\$56<sup>95</sup>**

**Monaural-Stereo Preamp Kit  
(2-Channel Mixer)**

This unique kit allows you to purchase it in the monaural model if desired and then add the second or stereo channel later. The SP-2 features 12 separate inputs, six on each channel, with input level controls. Six dual concentric controls consist of: two 8-position selector switches, two bass, two treble, two volume level and two loudness controls, a scratch filter switch and a 4-position function switch. A separate on-off switch is provided. The function switch provides settings for stereo, 2-channel mix, channel A or B for monaural use. Inputs consist of tape, mike, mag phono and three high-level inputs. NARTB equalization and RIAA, LP, 78 record compensation are provided. A remote balance control is included. Printed circuit boards for easy assembly. Built-in power supply. Shpg. Wt. 15 lbs.



MODEL SP-1 (MONAURAL)  
**\$37<sup>95</sup>** Shpg. Wt. 13 lbs.

MODEL C-SP-1 (CONVERTS SP-1 TO SP-2)  
**\$21<sup>95</sup>** Shpg. Wt. 5 lbs.



HEATHKIT  
MODEL WA-P2  
**\$19<sup>75</sup>**

**"MASTER CONTROL"  
PREAMPLIFIER KIT**

Control your hi-fi system with this compact unit. Features 5 switch-selected inputs to accommodate a record changer, tape recorder, AM tuner, FM tuner, TV receiver, microphone, etc., each with level control. Provision also for a tape recorder output. Equalization for records through separate turnover and rolloff switches for LP, RIAA, AES and early 78's. Shpg. Wt. 7 lbs.

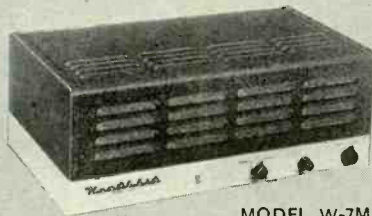

MODEL W-7M  
**\$54<sup>95</sup>**

**"EXTRA PERFORMANCE" 55 WATT  
HI FI AMPLIFIER KIT**

Enjoy this high fidelity power amplifier at less than a dollar per watt. Full audio output and maximum damping is conservatively rated at 55 watts from 20 CPS to 20 kc with less than 2% total harmonic distortion throughout the entire range. Features famous "bas-bal" circuit, EL-34 output tubes and special 70 volt output. Shpg. Wt. 28 lbs.



MODEL  
XO-1  
**\$18<sup>95</sup>**

**ELECTRONIC  
CROSSOVER KIT**

This unique instrument separates high and low frequencies and feeds them through 2 amplifiers into separate speakers. Located ahead of the main amplifier, it virtually eliminates IM distortion and matching problems. Note: Not for use with Heathkit Legato speaker system. Shpg. Wt. 6 lbs.



MODEL UA-1  
**\$21<sup>95</sup>**

**"UNIVERSAL" 12 WATT HI FI  
AMPLIFIER KIT**

The versatility and economy of this fine kit make it a truly "universal" hi-fi amplifier. An ideal basic amplifier for any hi-fi system or a perfect addition to gear your present hi-fi system to stereo sound. Uses 6BQ5/EL84 push-pull output tubes for less than 2% harmonic distortion throughout the entire audio range. Shpg. Wt. 13 lbs.



MODEL A-9C **\$35<sup>50</sup>**

**GENERAL-PURPOSE  
20 WATT AMPLIFIER KIT**

Designed for home installation as well as for PA requirements, the A9-C combines a preamplifier, main amplifier and power supply all on one chassis. Four switch-selected inputs are provided as well as separate bass and treble tone controls offering 15 db boost and cut. Detachable front plate allows for custom installation. Shpg. Wt. 23 lbs.



MODEL SW-1 **\$24<sup>95</sup>**

**SPEEDWINDER KIT**

A real timesaver, the SW-1 leaves your tape recorder free for operation while rewinding tape at the rate of 1200 feet in 40 seconds. Prevents unnecessary wear to the tape and recorder. Handles up to 10 1/2" tape reels. Handles 800' reels of 8 and 16 millimeter film as well. Automatic shutoff prevents whipping at end of rewind. Shpg. Wt. 12 lbs.



NO. 401-6  
**\$7<sup>50</sup>**

**12" UTILITY SPEAKER KIT**

Replace inferior speakers in radio or TV sets to obtain better tone quality or set up an auxiliary speaker for testing purposes with this convenient, high quality speaker. The speaker will handle up to 12 watts with a frequency response of ±5 db from 50 to 9,000 CPS. Speaker impedance is 8 ohms and has a 6.8 oz. magnet. An outstanding dollar value. Shpg. Wt. 7 lbs.



MODEL TK-1 **\$9<sup>95</sup>**

**COMPLETE TOOL SET**

These basic tools are all you need to build any Heathkit. The pliers, diagonal side cutters, 2 screwdrivers, and soldering iron are all of top quality case hardened steel for hard duty and long life. Pliers and side cutters are equipped with insulated rubber handles for safety. A good example of just how easy Heathkit building really is. Shpg. Wt. 3 lbs.

## HIGH FIDELITY TAPE RECORDER KIT

The model TR-1A tape deck and preamplifier combination provides all the facilities you need for top quality monaural recording /playback with fast forward and rewind functions.  $7\frac{1}{2}$  and  $3\frac{3}{4}$  IPS tape speeds are selected by changing belt drive. Flutter and wow are held to less than 0.35%. Frequency response at  $7\frac{1}{2}$  IPS  $\approx 2.0$  db 50-10,000 CPS, at  $3\frac{3}{4}$  IPS  $\approx 2.0$  db 50-6,500 CPS. Both units may be mounted together or separately affording high flexibility in every application. Features include NARTB playback equalization—separate recording and playback gain controls—cathode follower output and provision for mike or line input. Signal-to-noise ratio is better than 45 db below normal recording level with less than 1% total harmonic distortion. A filament balance control allows adjustment for minimum hum level. Complete instructions provided for easy assembly. Overall dimensions of tape deck and preamp is  $15\frac{1}{2}$ " W. x  $13\frac{1}{2}$ " H. x 8" D. Shpg. Wt. 24 lbs.



Includes tape deck assembly, preamplifier and roll of tape.

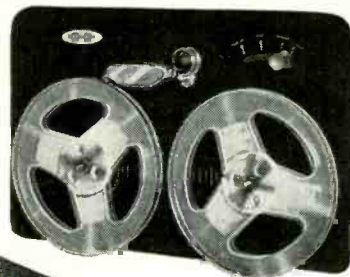

HEATHKIT  
TE-1  
\$39.95

Tape preamplifier sold separately if desired. Shpg. Wt. 10 lbs.



## Many more Heathkits to choose from

**hi-fi:** Amplifiers—Preamplifiers—Speaker Systems—AM/FM Tuners—Equipment Cabinets—Record Player—Tape Recorder—Electronic Crossover—Stereo Equipment.

**test:** Oscilloscopes—Voltmeters—RF Signal Generators—AF Generators—Analyzers—Battery Eliminators—Tube Checkers—Condenser Checkers—Computer—Color Bar & Dot Generator—Sweep Generator—Impedance Bridge—Power Supplies—Probe Kits—R/C Decade & Substitution Kits.

**ham radio:** Transmitters—Receivers—Antenna Accessories—Voice Control—Conelrad Alarm—Variable Frequency Oscillator—SSB Adapter—"Q" Multiplier.

**marine:** Direction Finders—Marine Converter—Rudder Position Indicator—Fuel Vapor Detector—Charge Indicator—Power Meter.

**general:** Tool Set—6-Transistor Portable Radio—Radiation Counter—Electronic Timer—Crystal Receiver—Superheterodyne Receiver.

*Send for Catalog* describing over 100 easy-to-build electronic instruments in kit form. Complete specifications and detailed information on Hi-Fi—Test—Ham and Marine kits.

**Save with Heathkits...the quality name in kit form electronics.**



**"BOOKSHELF" 12 WATT  
AMPLIFIER KIT**

Here are a few of the reasons why this attractive amplifier is such a tremendous dollar value. You get rich, full range, high fidelity sound reproduction with low distortion and noise . . . plus "modern styling". The many features include full range frequency response 20 to 20,000 CPS  $\pm 1$  db with less than 2% distortion over this range at full 12 watt output—its own built-in preamplifier with provision for three separate inputs: mag phono, crystal phono, and tuner—RIAA equalization—separate bass and treble tone controls—special hum control—and it's easy-to-build. Complete instructions and pictorial diagrams show where ever part goes. Cabinet shell has smooth leather texture in black with inlaid gold design. Cabinet measures 12½" W. x 8¾" D. x 4¾" H. Output transformer has taps at 4, 8 and 16 ohms to match the speaker of your choice. An ideal unit to convert your present hi-fi system to stereo sound. Shpg. Wt. 15 lbs.

An Amplifier, Preamplifier  
all in one!



HEATHKIT  
EA-2  
**\$28<sup>95</sup>**

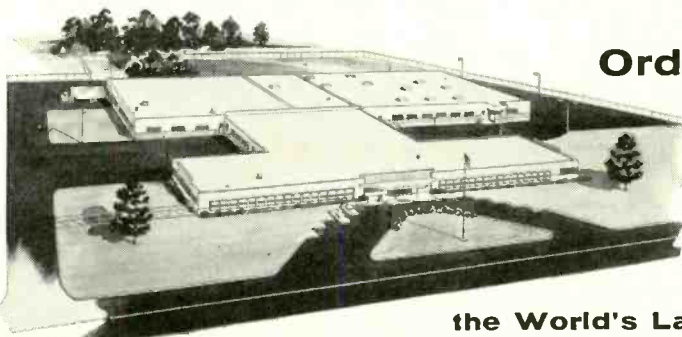

**Order direct by mail...**

Save ½ or more over equivalent ready-made products by buying direct and assembling them yourself. Heathkit Style, Performance and Quality are unsurpassed!

**the World's Largest Manufacturer  
of Electronic Instruments in Kit Form**



**HEATH COMPANY BENTON HARBOR 20, MICH.**

 a subsidiary of Daystrom, Inc.

*NOTE: all prices and specifications subject to change without notice.*

Enclosed find  check  money order. Please ship C.O.D.

*On Express orders do not include transportation charges—they will be collected by the express agency at time of delivery.*

*On Parcel Post Orders include postage for weight shown. All prices are NET F.O.B. Benton Harbor, Michigan, and apply to Continental U.S. and Possessions only. 20% Deposit required on all C.O.D. orders.*

Name \_\_\_\_\_  
Address \_\_\_\_\_  
City & Zone \_\_\_\_\_ State \_\_\_\_\_  
(PLEASE PRINT)

SHIP VIA

- Parcel Post
- Express
- Freight
- Best Way

QUANTITY	ITEM	MODEL NO.	PRICE
<input type="checkbox"/> SEND FREE HEATHKIT CATALOG		POSTAGE	
		TOTAL	

**HEATHKITS are also available at your Dealer**

see listing on next page



# The VARIABLE Reactance Amplifier

*Now an experimental laboratory development, this may become the practical amplifier for the uhf's and beyond.*

By **FRED SHUNAMAN**  
MANAGING EDITOR

**T**HE variable-reactance—often called parametric—amplifier is possibly today's most important development in the electronic field. It is so named because it uses a variation in one of the (reactive) elements, or parameters, of the circuit. A descendant of magnetic and dielectric amplifiers—which also amplify by means of a variable reactance—it offers promise of amplification with less noise than can be obtained with tubes. This is especially true at the ultra-high and super-high frequencies, where it becomes difficult to make low-noise tubes, and it is at these frequencies that the greatest amount of research is being done.

The amplifier will work at lower frequencies, and an experimental one has been built to operate at 1 megacycle. At this frequency, tubes are more effective, both electronically and economically, and it is likely that practical uses of parametric amplifiers will be confined to frequencies above the ultra-high. The amplifier on our cover was designed to operate at 900 mc. It was developed by ITT Labs (research divi-

sion of International Telephone and Telegraph Corp.) and is pictured with William Sichak, director of the radio communication laboratory, who was responsible for the research on and development of the amplifier.

What is a parametric amplifier? Let us look first at a dielectric amplifier, one of its simpler ancestors (Fig. 1). Looking at the right half of the figure, we see an ac supply, a nonlinear capacitor (one whose capacitance varies as the voltage across it is increased or decreased) and a load resistor. The amount of current—and therefore power—in the load depends on the voltage of the ac supply and the amount of capacitance in series with it.

Note that the capacitor is biased by a battery in the left half of the circuit. Its voltage is applied across the capacitor through the signal source (which must obviously offer little resistance to dc) and the two choke coils, which confine the ac to the right side of the circuit.

If we vary the bias with a signal low enough in frequency (compared with

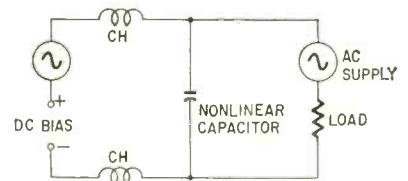

Fig. 1—A dielectric amplifier circuit.

that of the ac supply) to meet no significant opposition from the choke coils, we can modulate the higher-frequency ac supply.

As the signal voltage becomes more positive, the capacitance becomes larger and more current flows through the load. On the negative half of the signal cycle, the capacitance becomes smaller and the load current goes down. Thus—within the limits set by the nonlinearity of the capacitor—the load current is modulated in the form of the signal voltage. If the ac voltage is high enough, this modulated output power is greater than the input power, and the circuit amplifies.

The dielectric amplifier, then, am-



Assembling equipment for testing a four-stage reactance amplifier.

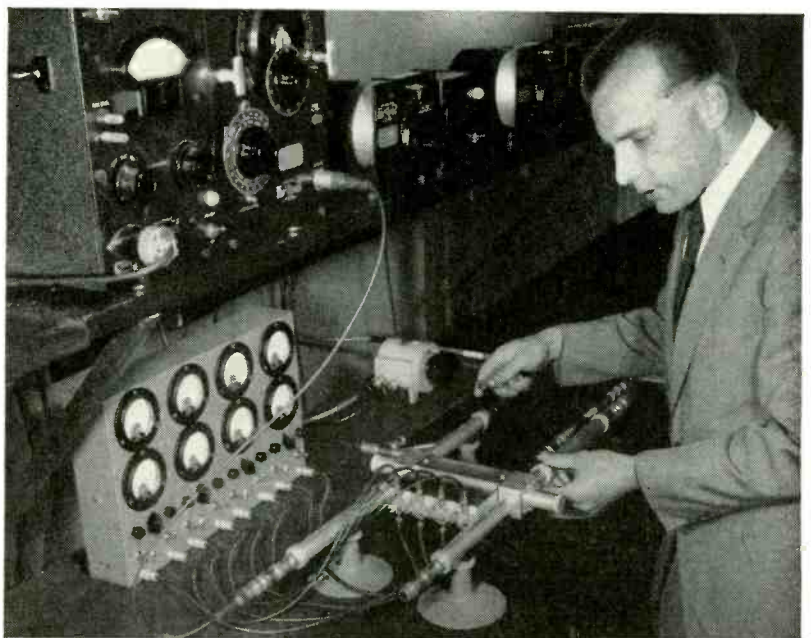

Studying the amplifying properties of a capacitor diode.

Photos by Bell Telephone Labs.

## RADIO

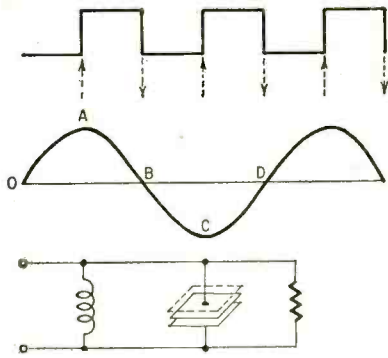

Fig. 2—A varying capacitance can be made to amplify a signal.

plifies by causing an alternating current to flow through a variable reactance, the value of which is changing at the modulation frequency, considerably lower than that of the supply. The parametric amplifier uses very similar circuitry, but the effect reminds one more of the transconductance gain in a superheterodyne converter than of simple modulation.

In the modulator type (the magnetic or dielectric amplifier), the signal is the active factor. It varies the impedance of the reactive element to the considerably higher supply frequency. In the parametric amplifier, it is the supply voltage that varies the reactive element, at a frequency related to and higher than the signal frequency. In the dielectric or magnetic amplifier, power in the output load increases as the reactive element offers less opposition to the supply voltage; in the parametric amplifier, output power is increased by increasing the reactance of the variable element.

How is this done? One way to visualize it is to assume a capacitor of two plates, with one plate so mounted that the distance between it and the other—and thus the capacitance—can be varied mechanically. For example, the upper plate could be mounted on a crankshaft so its spacing from the lower plate could be varied at a fixed rate.\*

Let us suppose we are trying to amplify the sine-wave signal of Fig. 2. As the signal reaches point A, the charge on the capacitor becomes greatest. At this point the top plate is suddenly lifted (top waveform of Fig. 2), increasing the spacing from the bottom plate and decreasing the capacitance. The voltage increases, since the voltage across a capacitor is equivalent to the charge (in coulombs, for example) divided by the capacitance

$$(Q = CE, \text{ or } E = \frac{Q}{C}).$$

As C becomes smaller with Q constant, E increases. The higher voltage with the same charge represents greater power in the circuit—the result of work done in separating the plates

\*The explanations following draw largely for information on a paper, "A Review of Solid State Parametric Amplifiers," read by E. D. Reed of the Bell Telephone Laboratories, at a recent conference on electron devices.

Authorized

HEATHKIT

Dealers

Convenient "over-the-counter" delivery



... is now available through any of the Authorized Heathkit Dealers listed below. Although you will find the price of Heathkits slightly higher when buying locally, we're sure you'll agree that this increase is justified. Your dealer absorbs all transportation charges, carries a complete stock of kits for immediate delivery, provides demonstration facilities, offers you a reliable source for parts and fast service... and stands ready to counsel or advise you on any problem that might arise.

This new service does not affect your continued privilege to buy directly from Heath Company if you prefer.

NOW READY TO SERVE YOU...

**CALIFORNIA**  
**ZACK KIT CORPORATION**  
 2002 University Avenue  
 Berkeley 4, California  
**DUNLAP RADIO & TV**  
 928 Main Street  
 Chico, California  
**TELRAD ELECTRONICS**  
 128 East Main Street  
 El Cajon, California  
**DUNLAP RADIO & TV**  
 2617 Tulare Street  
 Fresno, California  
**BUSHNELL SOUND CORP.**  
 12024 Wilshire Boulevard  
 Los Angeles, California  
**KIERULFF SOUND CORP.**  
 820 West Olympic Boulevard  
 Los Angeles, California  
**DUNLAP RADIO & TV**  
 5th & "J" Street  
 Marysville, California  
**DUNLAP RADIO & TV**  
 419 10th Street  
 Modesto, California  
**DUNLAP RADIO & TV**  
 234 West 17th Street  
 Merced, California  
**TELRAD ELECTRONICS**  
 639 National  
 National City, California  
**ZACK RADIO SUPPLY**  
 654 High Street  
 Palo Alto, California  
**DUNLAP RADIO & TV**  
 1800 22nd Street  
 Sacramento, California  
**TELRAD ELECTRONICS**  
 3453 University Avenue  
 San Diego, California  
**ZACK RADIO SUPPLY**  
 1422 Market Street  
 San Francisco, California  
**DUNLAP RADIO & TV**  
 27 North Grant Street  
 Stockton, California  
**VALLEY SOUND CORPORATION**  
 18841 Ventura Boulevard  
 Tarzana, California  
**DUNLAP RADIO & TV**  
 1725 Mooney Avenue  
 Visalia, California

**DELAWARE**  
**RADIO ELECTRIC SERVICE**  
 Third & Tainall Streets  
 Wilmington, Delaware

**FLORIDA**  
**THUROW DISTRIBUTORS, INC.**  
 540 St. Johns Street  
 Cocoa, Florida  
**THUROW DISTRIBUTORS, INC.**  
 1800 Northwest 23rd Street  
 Miami, Florida

**INDIANA**  
**GOLDEN EAR, INCORPORATED**  
 15 East 16th Street  
 Indianapolis, Indiana  
**GOLDEN EAR, INCORPORATED**  
 24 West Washington  
 Indianapolis, Indiana  
**GOLDEN EAR, INCORPORATED**  
 108 Northwestern  
 West Lafayette, Indiana

**KENTUCKY**  
**GOLDEN EAR, INCORPORATED**  
 610 Third Street  
 Louisville, Kentucky

**LOUISIANA**  
**STERLING RADIO PROD., INC.**  
 1005 Cameron Street  
 LaFayette, Louisiana

**MARYLAND**  
**RADIO ELECTRIC SERVICE**  
 736 South Salisbury Blvd.  
 Salisbury, Maryland

**MASSACHUSETTS**  
**AUDIONICS, INCORPORATED**  
 1348 Boylston Avenue  
 Boston 15, Massachusetts

**MICHIGAN**  
**VOLTA ELECTRONICS**  
 6716 Park Avenue  
 Allen Park, Michigan  
**HIGH FIDELITY WORKSHOP**  
 16400 West Seven Mile Road  
 Detroit 35, Michigan

**MINNESOTA**  
**AUDIO KING COMPANY**  
 913 West Lake Street  
 Minneapolis 8, Minnesota

**NEW JERSEY**  
**RADIO ELECTRIC SERVICE**  
 452 North Albany Avenue  
 Atlantic City, New Jersey  
**RADIO ELECTRIC SERVICE**  
 513 Cooper Street  
 Camden, New Jersey  
**FEDERATED PURCHASER, INC.**  
 1021 U.S. Route #22  
 Mountainside, New Jersey  
**FEDERATED PURCHASER, INC.**  
 114 Hudson Street  
 Newark, New Jersey

**NEW YORK**  
**CROSS ISLAND ELEC., INC.**  
 247-40 Jericho Turnpike  
 Belleroose, New York  
**ACME ELECTRONICS, INC.**  
 59 Wloughby Street  
 Brooklyn, New York  
**GEM ELECTRONICS, INC.**  
 34 Hempstead Turnpike  
 Farmingdale, New York  
**BEAM ELECTRONICS, INC.**  
 101-10 Queens Boulevard  
 Forest Hills, New York

**GEM ELECTRONICS, INC.**  
 236 Broadway  
 Hicksville, New York  
**ARROW ELECTRONICS, INC.**  
 525 Jericho Turnpike  
 Mineola, New York  
**DAVIS RADIO DIST. INC.**  
 70 East Third Street  
 Mt. Vernon, New York  
**ARROW ELECTRONICS, INC.**  
 65 Cortlandt Street  
 New York, New York  
**HARVEY RADIO COMPANY**  
 103 West 43rd Street  
 New York, New York

**OREGON**  
**ECCLES ELECTRIC CO.**  
 237 Northeast Broadway  
 Portland, Oregon  
**Cecil Farnes Company**  
 440 Church Street, Northeast  
 Salem, Oregon

**PENNSYLVANIA**  
**FEDERATED PURCHASER, INC.**  
 1115 Hamilton Street  
 Allentown, Pennsylvania  
**FEDERATED PURCHASER, INC.**  
 925 Northampton Street  
 Easton, Pennsylvania  
**AUSTIN ELECTRONICS, INC.**  
 1421 Walnut Street\*  
 Philadelphia, Pennsylvania  
**RADIO ELECTRIC SERVICE**  
 701 Arch Street  
 Philadelphia, Pennsylvania  
**RADIO ELECTRIC SERVICE**  
 3412 Germantown Avenue  
 Philadelphia, Pennsylvania  
**RADIO ELECTRIC SERVICE**  
 5930 Market Street  
 Philadelphia, Pennsylvania  
**RADIO ELECTRIC SERVICE**  
 29 York Road  
 Willow Grove, Pennsylvania  
**RADIO ELECTRIC SERVICE**  
 1114 Roosevelt Ext.  
 York, Pennsylvania

**RHODE ISLAND**  
**AUDIONICS, INCORPORATED**  
 790 North Main Street  
 Providence, Rhode Island

**TEXAS**  
**STERLING RADIO PROD., INC.**  
 1160 Laurel Street  
 Beaumont, Texas  
**STERLING RADIO PROD., INC.**  
 2615 Texas Avenue  
 Bryan, Texas  
**HILLCREST RECORDS, INC.**  
 6309 Hillcrest Avenue  
 Dallas, Texas  
**SOUND EQUIPMENT, INC.**  
 2506 Crawford Street  
 Houston, Texas  
**STERLING RADIO PROD., INC.**  
 1616 McKinney Avenue  
 Houston, Texas  
**STERLING RADIO**  
 428 Atkinson Street  
 Lufkin, Texas

**VIRGINIA**  
**KEY ELECTRONICS, INC.**  
 126 South Wayne Street  
 Arlington, Virginia

**WASHINGTON**  
**SEATTLE RADIO SUPPLY**  
 2117 Second Avenue  
 Seattle 1, Washington

**WISCONSIN**  
**HI-FI CORNER**  
 401 State Street  
 Madison, Wisconsin  
**SATTERFIELD ELEC., INC.**  
 1900 South Park  
 Madison, Wisconsin  
**HI-FI CENTER, INC.**  
 4236 West Capitol Drive  
 Milwaukee, Wisconsin  
**NETZOW'S**  
 2630 North Downer Avenue  
 Milwaukee, Wisconsin

Careful selection of reliable qualified dealers is a slow process... so please bear with us if your area has not been covered. Thank you.

**HEATH COMPANY**  
 Benton Harbor, Mich.

A Subsidiary of Daystrom, Inc.



# You learn more from SAMS BOOKS

OVER 1,200,000 IN USE

**JUST OUT!**

**"Record Changer Manual" —  
New Vol. 11**



Complete analysis of 40 record changers produced in 1957-58 including: Admiral Collaro, Glaser-Steers, Monarch, Perpetuum-Ebner; RCA Victor, Sylvania, V.M. Zenith. Provides general description, operating instructions, exploded views, parts photos, change cycle data, adjustments, trouble chart, parts list, etc. Includes index for Vols. 1 through 11. Invaluable for service work. 160 p.; 8½ x 11". Only \$2.95

adjustments, trouble chart, parts list, etc. Includes index for Vols. 1 through 11. Invaluable for service work. 160 p.; 8½ x 11". Only \$2.95

**"Auto Radio Manual" — New Vol. 8**



Covers 48 auto radio models produced in 1957-58: American Motors, Becker, Biaupunkt, Buick, Cadillac, Chevrolet, Edsel, Ford, International, Lincoln, Mercury, Mopar, Motorola, Oldsmobile, Pontiac, Studebaker-Packard. Gives complete, accurate service data, schematics, chassis photos, alignment, pushbutton adjustments, parts lists and replacement data. 240 p.; 8½ x 11". Only \$3.95

chassis photos, alignment, pushbutton adjustments, parts lists and replacement data. 240 p.; 8½ x 11". Only \$3.95

## CURRENT BEST-SELLERS

**"Know Your Oscilloscope"**



This know-how, show-how book covers oscilloscope circuitry, adjustment, operation, application and servicing. Describes: Power Supplies; Sweep Systems; Synchronization; Amplifiers; Special Features; Accessories; Adjusting & Servicing; Frequency & Phase Measurements; Amplifier Testing with

Square Waves and Sweep Signals; Radio and TV Alignment; Service Procedures, etc. 160 pages, 5½ x 8½". Only \$2.00

**"101 Ways to Use Your Sweep Generator"**



Each application covered includes full data on connections required, proper test procedure and evaluation of results. Specific sections cover use of the sweep generator for checking and calibrating test equipment, antenna measurements, RF and IF

alignment and measurements, special uses in color receiver tests, etc. Over 250 illustrations. 148 p., 5½ x 8½". Only \$2.00

## HOWARD W. SAMS & CO., INC.

Order from your Sams Distributor today, or mail to Howard W. Sams & Co., Inc., Dept. B-29 2201 E. 46th St., Indianapolis 6, Ind.

Send me the following books:

- "Record Changer Manual" Vol. 11 (RC-11)
- "Auto Radio Manual" Vol. 8 (AR-8)
- "Know Your Oscilloscope" (KOS-1)
- "101 Ways to Use Your Sweep Generator" (TEM-1)

\$.....enclosed.  Send Free Book List

Name.....

Address.....

City.....Zone.....State.....

(outside U.S.A. priced slightly higher)

## RADIO

against the mutual attraction due to the opposite charges on them.

To get the greatest power increase, it would of course be desirable to pull the plates apart when the voltage across them is greatest. A in Fig. 2 is one of those points, C another. But we have to get the plates back to their original separation if we are to pull them apart again, and this must be done without returning to the circuit the energy gained by separating them. We can do this by bringing the plates together when there is no voltage across them, as at points B and D.

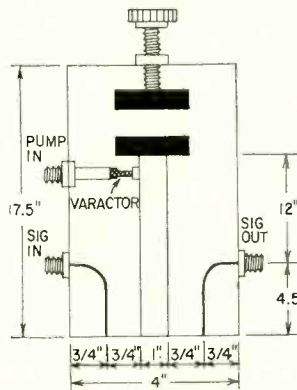

**Fig. 3—Drawing of a parametric amplifier used on the 144-mc band.**

Fig. 2 shows us that the pulling and pushing (called pumping) frequency should be twice that of the signal. And, of course, the "pump" that moves the plates back and forth will have to be electronic. A crystal diode with its bias varied at the right frequency by a "pumping" voltage will act as the type of variable capacitor we need. (See "Using the Varicap," RADIO-ELECTRONICS, May, 1958, page 57, and—for the theory underlying the variation of capacitance—*Electrons and Holes in Semiconductors*, by Shockley, page 100.) Biased in the reverse direction, an increase in voltage decreases the capacitance. Thus, it is necessary only to have a pumping frequency act on such a diode capacitor, to which the signal is also applied, to have a true parametric amplifier.

While all diodes vary in capacitance with variation in the voltage across them, some are more applicable to the job than others. Silicon diodes are universally used, and research workers at Bell Laboratories and other places are attempting to tailor new types of diodes to this special application.

### A practical amplifier?

This simple type of parametric amplifier is described rather as an example of fundamental principles than as a practical circuit. Yet it will work after a fashion, and practical amplifiers have been built up on it. One such was described by W1FZJ (F.S. Harris, Medfield, Mass.) in the November, 1958, issue of *CQ*. A drawing and the dimensions of the amplifier are shown in Fig. 3. It is built around a coaxial tuner or line filter, and is intended to

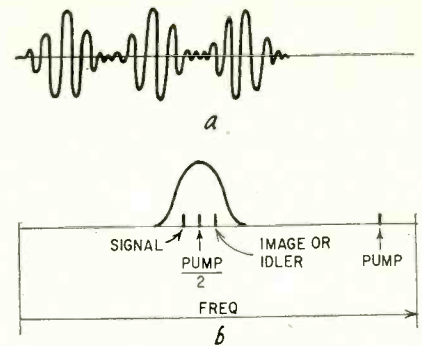

**Fig. 4-a—Effect of pump frequency not exactly twice that of signal; b—position of image or idler signal.**

operate on the 144-mc amateur band. The *varactor*, or voltage-sensitive diode, is a Microwave Associates MA-450. Amplification was reported as 10 db, with a very low noise figure. The author pointed out that a pumping frequency of exactly twice the signal frequency (2s) is not the only one that will work, and states that he has used 3s and 5s with even better results than 2s.

A look at the waveforms of Fig. 2 indicates that, as soon as we leave a pumping frequency of 2s, we cannot expect maximum efficiency. Part of the time the reduction in capacitance will occur at exactly the signal peak, then the pump will get out of time and a little later will change capacitance while the signal is zero. From here it will catch up until it is again changing capacitance at the best point of gain. This will introduce a beat effect (Fig. 4-a), another point reminiscent of the superhet. Another even more reminiscent note is that, as soon as the pump departs from 2s, we find an image—or *idler*—frequency (Fig. 4-b) at  $p - s$ . (The pump frequency of 2s is just a special form of this situation,  $s$  and  $p - s$  being equal.) The idler frequency is just as strong as the signal frequency, and cannot be suppressed without suppressing the entire amplification.

### The up converter

Another type of amplification—one which bids fair to become the practical parametric amplifier circuit—uses the sum frequency of pump and signal, as did the ancient Remler *Infradyne* broadcast receiver and some recent European broadcast and shortwave circuits. This type of amplifier is called an *up converter* and the sum frequency is referred to as the *upper sideband*. The circuit of Fig. 5 was built up by Dr. B. Salzberg and E. W. Sard of the Airborne Instruments Laboratory, Mineola, N. Y., to demonstrate this type of amplification. It is especially interesting in that it operates on the very low (for this type of amplifier) input signal frequency of 1 mc, and thus uses the coils and capacitors more familiar to many electronic technicians than the waveguide circuitry found in most of these amplifiers. Output is 21 mc.



# Use Delco Radio Service Parts!

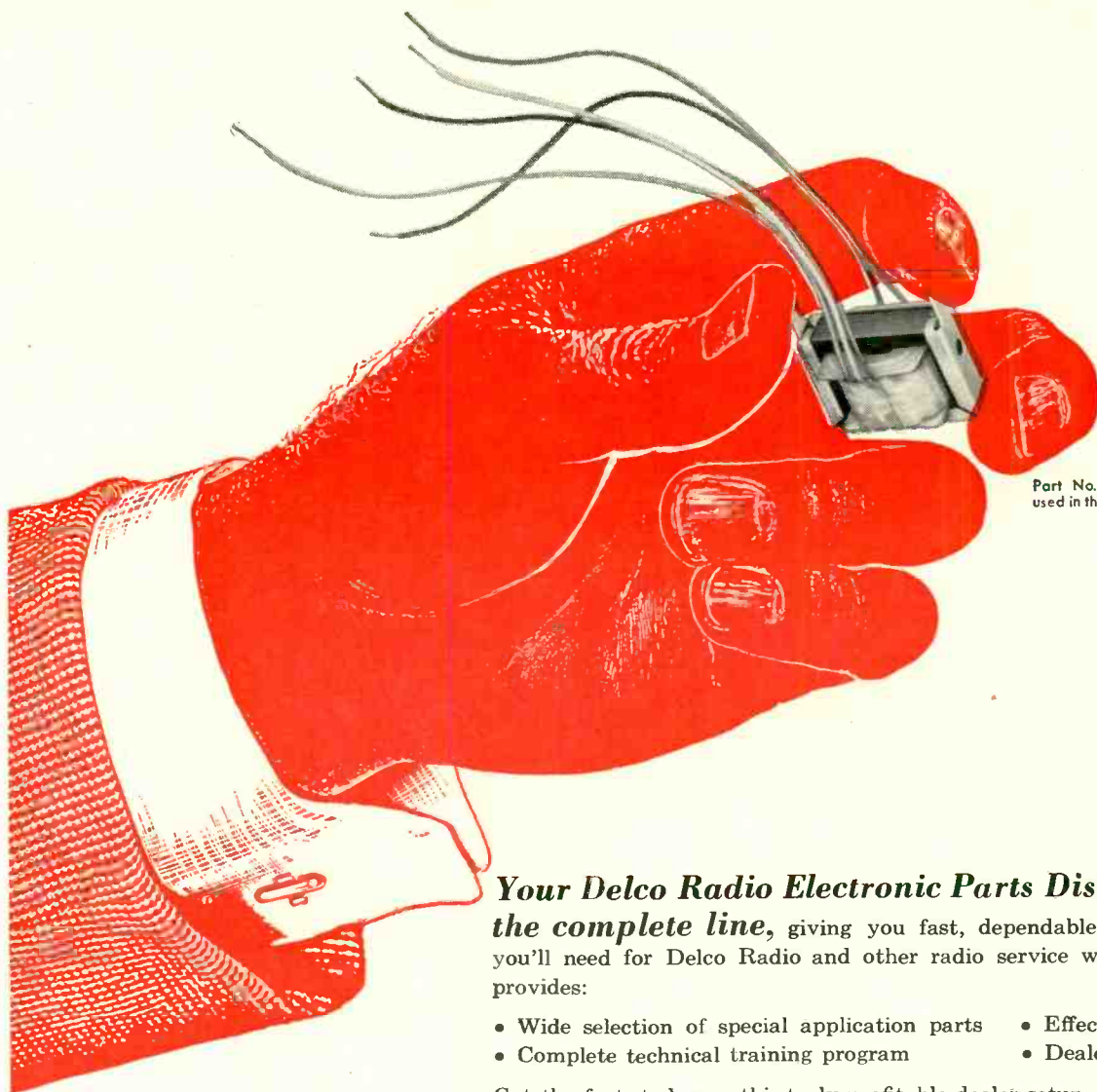

Part No. 7270804—output transformer used in the new Delco Portable Car Radio.

**Your Delco Radio Electronic Parts Distributor carries the complete line**, giving you fast, dependable service on the items you'll need for Delco Radio and other radio service work. Delco Radio also provides:

- Wide selection of special application parts
- Complete technical training program
- Effective warranty program
- Dealer identification signs

Get the facts today on this truly profitable dealer setup, and grow with General Motors!

Available everywhere through Electronic Distributors associated with . . .



## DELCO RADIO

DIVISION OF GENERAL MOTORS, KOKOMO, INDIANA

<p><b>SPEAKERS</b></p>	<p><b>TUNER PARTS</b></p>	<p><b>TUBES</b></p>	<p><b>IRON CORES</b></p>
<p><b>TRANSISTORS</b></p>	<p><b>COILS</b></p>	<p><b>RESISTORS</b></p>	<p><b>CAPACITORS</b></p>
	<p><b>VIBRATORS</b></p>	<p><b>CONTROLS</b></p>	

now you can easily  
assemble your own  
professional tone arm



with the new **GRAY**  
12" stereo-monophonic  
**TONE ARM**  
**KIT** only **23<sup>95</sup>**

Exclusive slide assembly for quick cartridge change without rewiring.

Dual viscous damping in lateral and vertical pivots eliminates resonance distortion.

Adjustable static balance control provides maximum tracking stability.

Accommodates all cartridges: monophonic, 3 or 4 wire stereo.

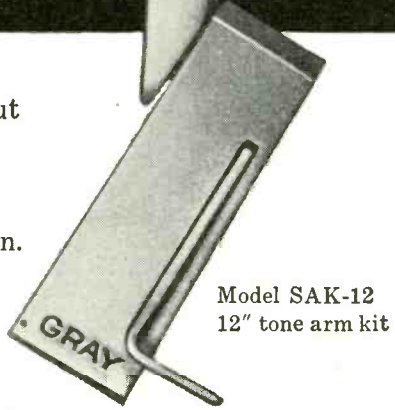

Model SAK-12  
12" tone arm kit

**GRAY** For new literature on GRAY RECORD PLAYING EQUIPMENT write to:  
**High Fidelity Division**  
DEPT. R-6 • 16 ARBOR STREET, HARTFORD 1, CONN.

**RADIO**

Complete constants are given in the diagram. The designers, however, suggest that it might be optimistic to expect to build a working model of this reactance amplifier simply by following the circuit, and supplied a number of

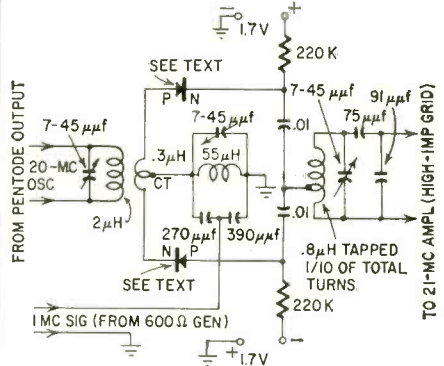

Fig. 5—Experimental amplifier with 1-mc input and 21-mc output.

comments that might help any experimenters who would like to attempt it.

The diodes are the most important part of the circuit, and should be a matched pair. Either Pacific Semiconductor type V39 Varicaps or Hughes type HC 7008 silicon capacitors are suggested. For the Varicaps, two in parallel are required on each side, giving a net capacitance of about 110  $\mu\text{f}$ . The (reverse) dc bias should be about 1.7 volts and the amplitude of the 20-mc input—critically related to the dc bias—about 1.1 volt to ground from each end of the secondary of the 20-mc transformer.

Inductances should be good—very low-noise operation requiring low-loss input and output circuits with unloaded Q's in the order of 300. A swept frequency input signal and a scope on the (detected) output are valuable in alignment. If the output should be tuned to the difference frequency of 19 mc rather than the sum of 21 mc, the amplifier will regenerate and may even oscillate at 1 and 19 mc with only the 20-mc pump applied. In true sum-frequency operation the amplifier behaves like a double-tuned transformer with the 1- and 21-mc tuning adjustments interacting.

In the up converter, the gain is equivalent to the ratio of the upper sideband to the signal frequency. Thus the amplifier of Fig. 5 would have a gain of 20.

The reactance amplifier is fairly new, and still other forms have been announced, including one by RCA in which the pumping frequency can be lower than that of the signal. Another interesting development is a parametric amplifier tube, designed by Dr. Robert Adler of Zenith, which gives promise of being able to amplify with less noise than any other tube. The future may see variations, in directions unthought-of today, but enough is known to make it certain that the variable reactance (parametric) amplifier will be one of the most important semiconductor devices of the future. **END**

# ABC's of MOBILE RADIO

Part II—Frequencies, range, and licensing

LEO G. SANDS

At present, nongovernment mobile radio systems operate in the 25-50, 152-162, 450-460 and 460-470-mc Citizens bands. Certain commercial operations use frequencies between 1.6 and 5 mc. Mobile radio systems licensed for ground communications in the aviation radio services at airports can operate on frequencies between 118 and 132 mc. The spectrum between 132 and 144 mc and 162 and 174 mc is reserved for use by the Government.

The 72-76-mc band, while allocated for use by the same kinds of services as are eligible in the other mobile radio bands, is restricted to point-to-point service. This band can be used only in certain geographical areas and only when the license applicant can show that harmful interference to television reception on channels 4 and 5 will not be caused.

### Communicating range

Range depends upon frequency, transmitter power, receiver sensitivity, antenna elevation and noise conditions. Base-to-mobile communication over 800 miles and mobile-to-mobile communication between vehicles 200 miles apart have been reported by operators of mobile radio systems in the 1.6-5-mc band. Such a great range is made possible by skip transmission, which occurs mostly after dark. Ordinarily, reliable daytime range is in the order of 25-50 miles. Operation at these relatively low frequencies is reserved for specific industries and is not open for general mobile communications.

The former so-called 30-40-mc band has been expanded and is now known as the 25-50-mc band. It is generally used where regional or county-wide coverage is required. Communicating

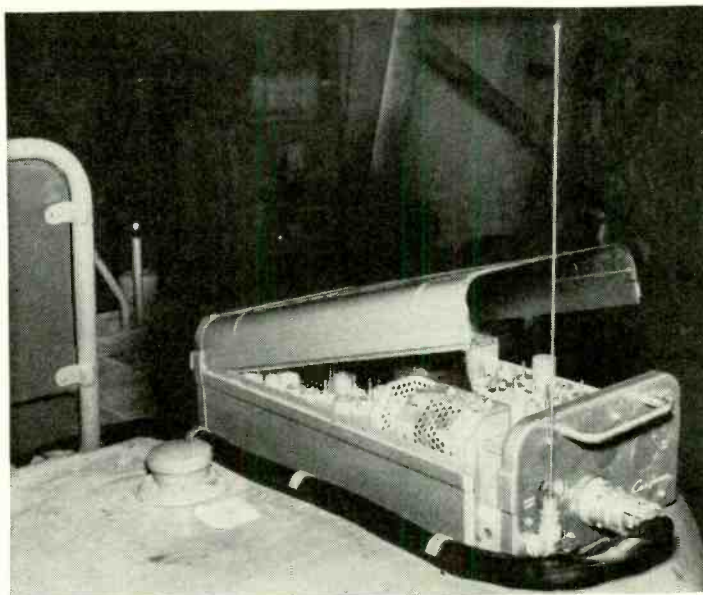

Courtesy RCA Carphone

152-162-mc band mobile unit mounted on a materials handling truck. Note the plug-in antenna.

range varies from 10 to 60 miles, and in some instances may extend farther. However, this band is subject to skip interference, particularly during periods of heavy sunspot activity. Signals from stations on the same frequency located on the other side of the continent sometimes blast in like a local station. Because of the 2-to-1 frequency spread of this band, the low end generally gives longer range.

The radio spectrum between 118 and 132 mc is used by the aeronautical radio services. Mobile radio systems are operated on channels assigned to aviation services for land communication at airports. For example, the airport control tower can communicate with crash, maintenance, fire and other radio-equipped vehicles at an airdrome. Since the airport towers use AM equipment, only AM mobile units can be employed.

The communicating range in the 118-132-mc aeronautical and the 132-144-mc Government bands is approximately the same as in the popular 152-162-mc band—from 5 to 30 or more miles. This is the band in which taxi radio systems, city police and other services which require city-wide coverage generally operate. Communication range is generally considered line-of-sight, but because of the reflection characteristics of radio signals at these frequencies, greater range and communication behind intervening objects are ordinarily attained.

Hams can operate mobile radio systems in the 144-148-mc band, using standard 152-162-mc mobile radio equipment which is tunable to the ham frequencies.

In the 450-470-mc band, communi-  
(Continued on page 88)

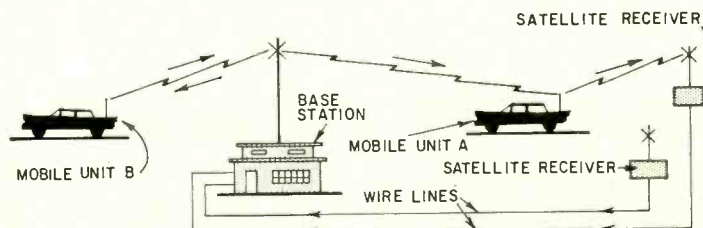

For adequate coverage, satellite receivers are sometimes needed. The base-station transmitter blankets the area. Mobile units, which do not have as great a range, are picked up by the nearest satellite, from which the signal is relayed by wire line to the base station.

**YOUR FUTURE MAY REST BETWEEN  
THIS PAGE AND THE NEXT!**

use the  
prepaid  
post card  
to send for  
the data  
that has  
launched  
thousands  
of careers  
in...

**This  
Fact-  
Packed  
Booklet  
FREE  
on  
request**

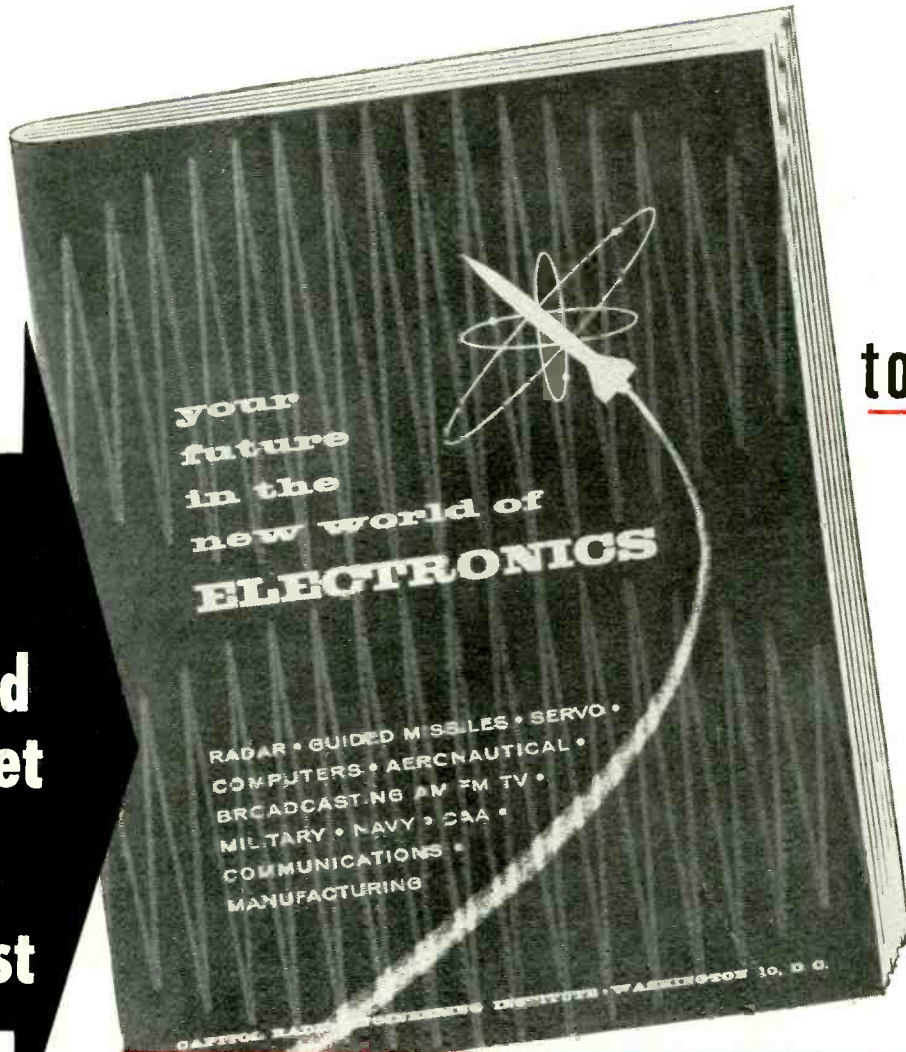

**ELECTRONICS**

INCLUDED: *information about CREI's  
BRAND-NEW home study course in*

**AUTOMATION**

and industrial **ELECTRONICS** engineering technology

- Machine Control Systems ● Data Processing Systems
- Instrumentation Techniques ● Digital & Analogue Computers
- Servo-mechanism Systems ● Telemetry ● Industrial Processes

# CREI prepares you quickly for success in ELECTRONICS including:

**AUTOMATION • INSTRUMENTATION • INDUSTRIAL ELECTRONICS • COMMUNICATIONS • TELEVISION AERONAUTICAL ELECTRONICS • GUIDED MISSILES SERVOMECHANISMS • COMPUTERS • ASTRONAUTICS TELEMETERING • MANUFACTURING**

Qualify for a secure career, not just another job. Enjoy the increased income, the job security and satisfaction that come only to trained men. It takes just one \$10-a-week raise to repay your investment in CREI training, and leave you a substantial bonus the first year. What you do in the next few months may well decide your success in the electronics field. One thing's certain—the longer you delay, the longer you defer the sure rewards that come to trained electronics personnel. You have everything to gain by requesting this booklet, "Your Future in the New World of Electronics." It's free—and it places you under no obligation. And it may be an eye-opener.

**CREI HOME STUDY—PROVED SINCE 1927**—CREI has provided thousands of ambitious young men with the technical knowledge that leads to more money and better jobs. Once you start home study you feel the benefits of CREI training almost immediately. Your employer takes new interest in you and your future (we disclose your training only if you authorize it). You speak—and act—with more authority. Your associates gain new respect for your ability.

**PRACTICAL COURSES**—Your work is under the supervision of a regular staff instructor who knows and teaches what industry needs. Training is accomplished on your own time, during hours chosen by you. Lessons are prepared by experts, presented in easy-to-understand form, kept up to date. The active student body today numbers more than 10,000 professional electronics engineers and engineering technicians, all over the world, and in every phase of military and civilian electronics.

**INDUSTRY RECOGNIZED**—As a graduate of CREI you'll find your diploma the key to success, a door-opener to the vast complex that is the electronics industry today. At your service is the CREI Placement Bureau which helps advanced students and graduates find positions. No jobs are guaranteed—but requests for CREI-trained personnel arrive regularly. This is the era of electronic careers; one of them may as well be yours!

**COLLEGE DEGREE NOT ESSENTIAL**—This is professional training, but you don't have to be a college graduate to benefit. You do have to be willing to study at home. You can do it while holding down a full-time job. Thousands have. If you have had electronic education, or experience in electronics—and realize the need of a high-level technical knowledge to make good in the better electronic jobs—you can qualify for CREI home study training. Electronics experience is not required for admission to CREI Residence School offered in Washington, D. C. at the same high technical level. Day and evening classes start at regular intervals. Qualified graduates earn degree as "Associate in Applied Science."

This can be your big year. Write today for "Your Future in the New World of Electronics." Use post card at left. Tuition is reasonable, terms are easy. Available to veterans under GI bill.

## CAPITOL RADIO ENGINEERING INSTITUTE

ECPD Accredited Technical Institute Curricula  
Dept. 142-F 3224 16th St., N.W., Washington 10, D. C.

FEBRUARY, 1959

**WILL THIS BE YOU?**

**Mail card for free booklet**

**Decide on home study**

**Put knowledge to work as you go**

**Gain attention of management**

**Complete training**

**Enjoy secure future**



Photos by Cyril Glunk

Airport maintenance firms use two-way radio for communicating with the control tower. Maintenance vehicles obtain clearance to cross busy runways as well as instructions.

Low-power industrial base station at a Los Angeles paper container plant. System consists of two base stations and four radio-equipped fork-lift trucks.

(Continued from page 83)

ating range is generally considered to be about two-thirds as great as in the 152-162-mc band. This is not always true. Sometimes the range is less, sometimes greater. At these frequencies, range is essentially line-of-sight. However, it is decreased by hills and foliage and often increased by reflections. The range is often difficult to predict, particularly in hilly terrain, and a field survey may be required to determine what coverage can be attained.

Pet theories and guesswork are sometimes proved wrong when it comes to estimating the anticipated range of a 450-470-mc mobile radio system. While it is considered to be shorter than when operating in the 152-162-mc band, a taxi operator in a large Eastern city who switched from the 152-162-mc vhf band to the 450-470-mc uhf band found that he could communicate with his cabs in some spots at the extreme limits of his service area which the lower frequency band could not reach. Sometimes the opposite was true.

Uhf signals are more readily reflected by hard surfaces. This makes it possible to communicate with radio-equipped vehicles inside of tunnels, for a short distance at least. Usually, when a 152-162-mc mobile unit goes inside a tunnel, communication with a base station outside of the tunnel ceases. In the 450-470-mc uhf band, it has often been reported that communication under similar circumstances continues. Tests conducted in the Lincoln Tunnel, which joins New York City with New Jersey, revealed that communication in the 450-mc band could be maintained between two mobile units for distances up to 0.4 mile while both vehicles were inside the tunnel. This leads to the conclusion that subway trains and other vehicles regularly operated underground could use uhf radio for base-to-mobile and mobile-to-mobile com-

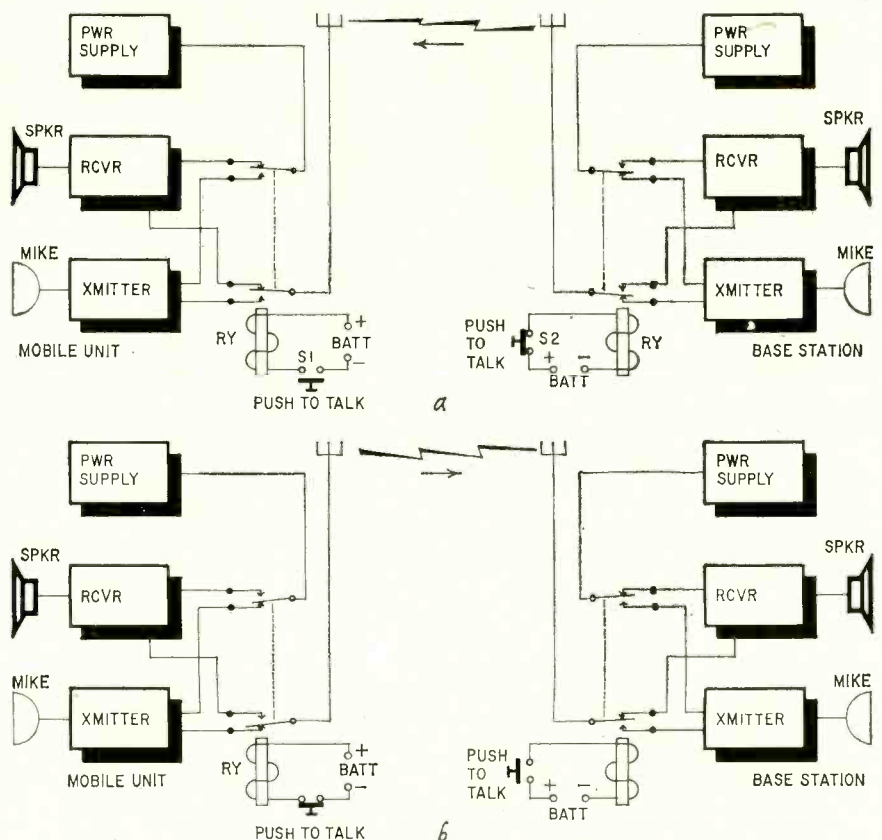

a—Circuit conditions when the base station is transmitting and the mobile unit is receiving. b—Circuit conditions when the mobile unit is transmitting and the base station is receiving.

munications over limited and controllable ranges.

**Mobile-to-mobile range**

Ordinarily, the direct communicating range between mobile units is considerably shorter than the base-to-mobile range because of the lower effective antenna elevation of both stations. Car-to-car range may be only 2 to 5 miles. However, a mobile unit on a hilltop can sometimes communicate with

another mobile unit 50 or 60 miles away because of the elevation of the antenna of the mobile unit on the hill.

A *relay* or *repeater* station is sometimes used to increase the mobile-to-mobile communicating range. Two-channel operation is required since the relay station picks up radio signals on one channel and retransmits the intercepted intelligence on another channel. The relay station consists of a receiver and a transmitter connected so that

# ready, willing and able



**"TAB-MOUNT" CARBON POTS**  
SERIES B-47

Designed to meet the fast-growing tab-mounted carbon pot replacement needs. A wide selection of the most popular resistance values. Rated at ½ watt. Universal-type phenolic knurled shaft, slotted, 1" long. Easily cut or altered to suit individual needs.

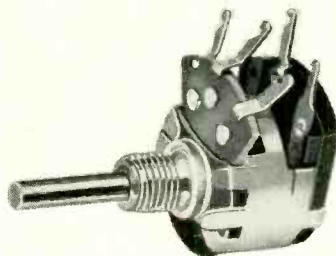

**MINIATURIZED CARBON POTS**  
SERIES 44 & 44S

The right replacement for transistorized circuits, portable radios, hearing aids, and other miniaturized applications. 0.2 watt. 2½" diameter. Available with or without switch. Made in most popular values and tapers. ⅛" diameter shaft, ½" long.



more good reasons for  
always saying:



CLAROSTAT MFG. CO., INC., DOVER, NEW HAMPSHIRE

## RADIO

the audio output of the receiver is fed to the audio input of the transmitter. The transmitter is turned off until activated by a carrier-operated relay which is energized when a signal is picked up by the receiver.

The relay station is an automatically operated base station and, because of its better antenna system (higher effective antenna elevation) its signal may be picked up by mobile units 10 to 30 miles or farther away. Suppose that mobile unit A is located 30 miles west of the relay station. Ordinarily, it could not communicate with mobile unit B, 60 miles to the east and 30 miles east of the relay station. However, if the relay station-to-mobile range is 30 miles, mobile unit A can communicate with B through the relay station.

### Licenses

A radio-station license is required for all transmitters except those with extremely limited range which do not exceed the limits of the FCC low-power rule. Generally, a single license covers both the base station and the mobile units. At present, there is no charge for radio-station licenses.

A license is not required for a transmitter whose total electromagnetic field does not exceed 15 microvolts per meter at a specified distance which varies with frequency. The distance in feet is computed by dividing the wavelength

by  $2\mu$ ,  $\left(\frac{\lambda}{2\mu}\right)$ , or by dividing 157,000 by the frequency in kilocycles,  $\left(\frac{157,000}{F}\right)$ .

For example, at 157 kc, the distance is 1,000 feet; at 1,570 kc, 100 feet; at 15,700 kc, 10 feet, and at 157 mc, 1 foot. There are other FCC restrictions which should be carefully studied since low-power transmitters must not interfere with licensed stations.

Such low-power transmitters have very few practical applications. Most are used as remote controls or in wireless record players. The rule also covers wire-line carrier transmitters which

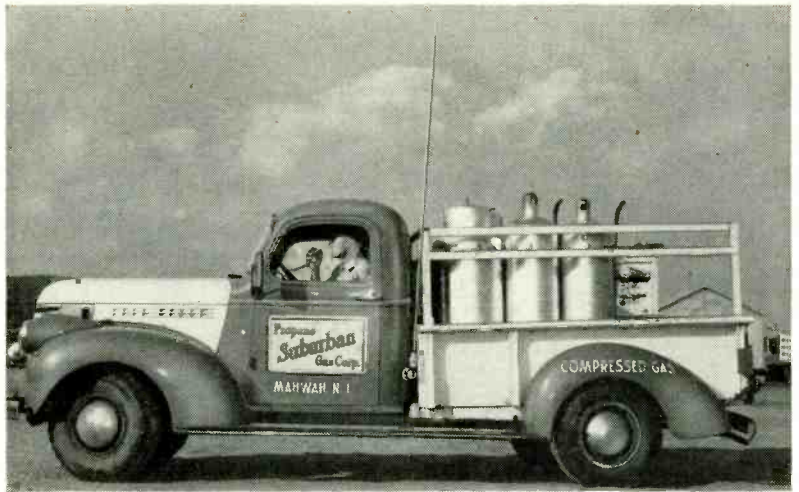

Suburban bottled-gas companies may have their trucks out all day. Mobile radio lets the main office tell a driver "Mrs. Jones, 555 Eight Street is out of gas. Drop off a bottle."

power were used.

An operator's license is not required by persons using radiotelephone transmitters licensed in the Citizens Radio Service. In other mobile radio services, operators of mobile units do not require operator's licenses. However, the base-station operator must hold a restricted radiotelephone permit. To qualify for this license, the applicant must be familiar with FCC rules regarding the proper operation of a radio station and must be able to read and write some language that can be readily translated into English. Railroad employees, specifically appointed to serve as base-

station operators, do not have to possess an operator's license.

A first- or second-class radiotelephone operator's license is required by persons who make adjustments to radio transmitters. However, an unlicensed person may work on transmitters when under the direct supervision of a licensed operator. To qualify for these licenses, an applicant must pass a written test which covers electron theory and FCC rules and regulations.

At the end of the fiscal year 1957, the FCC reported 1,304,300 commercial operators' licenses outstanding. Of these, 1,119,228 were restricted permits.

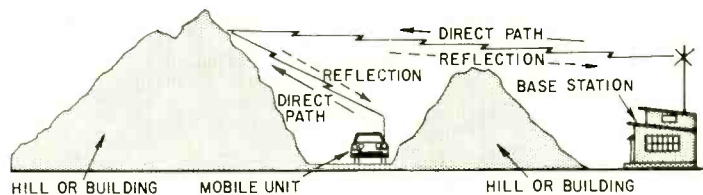

While vhf and uhf signals generally travel a line-of-sight path, communication in normally dead spots can exist. Signal reflections off some solid surface, such as a building or side of a hill, are used.

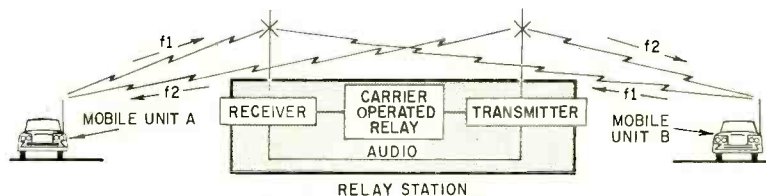

When a relay station is used to extend mobile-to-mobile range, mobile units transmit on f1 and receive on f2. The relay station picks up signals on f1 and retransmits the intercepted message on f2.

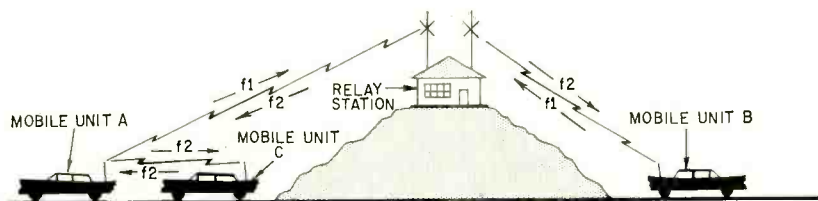

When mobile unit A cannot communicate directly with B because it is out of range and behind a hill, A can get in touch with B via the relay station. If mobile units are equipped with two-channel transmitters, A can communicate with C by switching his transmitter to f2, without going through the relay station. Mobile unit C also switches to f2 for contact with A.

### Frequencies Available to Mobile Radio Services

Band (mc)	Communicating Range (miles)	Eligible Services
1.6-5.0	50 (often more)	Highly restricted
25-50	30-60	Land transportation Industrial Public safety
26.965-27.225	1-5	Any citizen over 18 years of age.
118-132	15-25	Airport services
152-174	15-25	Land transportation Industrial Public safety
450-470	10-15	Land transportation Industrial Public safety Remote broadcast pickup
460.05-460.95 462.55-466.45	10-15	Any citizen over 18 years of age
465	100 feet to several miles (power limited to 5 watts input)	Any citizen over 18 years of age



# Time-Saver of the MONTH!

by Herb Bowden\*

## TRC4 TRANSISTOR and RECTIFIER CHECKER

The transistor is now ten years old and is fast becoming the most talked about and used component in the electronic industry. Nearly everyone involved in electronics is finding it necessary to associate himself with the transistor and to equip his shop or laboratory with a limited amount of transistor testing equipment. The first tester that enters one's mind is one that will accurately test the transistor.

### Is a Transistor Tester Necessary?

Probably the first question that you ask is whether or not a Transistor Tester is really necessary.

Actually, the answer to this is that, a serviceman or engineer can get by without a transistor tester in much the same manner as one can get by without a tube tester. You can do without it, but it saves a world of time if you have it.

Firstly, if you do not have a transistor tester, you must know the circuit that you are working on very thoroughly. Secondly, you must understand the characteristics of the transistors that are in this circuit. Thirdly, you must have the characteristic curves of each transistor that you are working on.

The TRC4 Sencore transistor tester does all of these things for you. You only need to know the number of the transistor that you want tested. The \$17.95 paid for this tester can be saved after using it only a few times by preventing this wasted time.

### Can an Ohmmeter or Voltmeter Be Used to Check a Transistor?

Many articles and service notes have been written on how to check transistors with an ohmmeter and others on how to check circuit voltages to determine whether or not the transistor is operating properly. The only difficulty in these procedures is that the precautions are about as lengthy as the steps themselves.

Also, the results must be interpreted properly or the checks mean nothing. Transistors can easily be ruined by accidentally applying 22½ volts to the transistor or by applying the voltage in reverse on ohmmeter checks.

Both ohmmeter and voltmeter checks are difficult to make on small portable radios. It is much easier to test the transistors first to be sure that the circuit is faulty, and not the other way around.

### How Should a Transistor Be Tested?

The most scientific way to test a transistor is under a complete dynamic check with signal applied. This is impractical in many respects. To be absolutely accurate, the transistor must be checked over the range of frequencies that it is to be operated at. These frequencies may vary greatly, thus making this test very time consuming.

Also, this type tester would be very costly compared to the TRC4 shown above at only \$17.95 dealer net.



FIG. 1. SENCORE TRC4 Transistor Rectifier Checker. Used and recommended by leading distributors and dealers all over the world.

In the early days of television, many TV engineers insisted that the same type check was necessary for all vacuum tubes used in TV receivers. Time has proved this theory to be obsolete as no service type tube tester was ever designed that would check tubes at their operating frequency.

The TRC4 tester works in the same manner as a quality tube tester. It applies the proper operating currents (can be considered voltage) to the transistor and measures the current gain. A second check for leakage results in a complete check of the transistor. Opens or shorts in any segment of the transistor are clearly indicated during the leakage or gain checks.

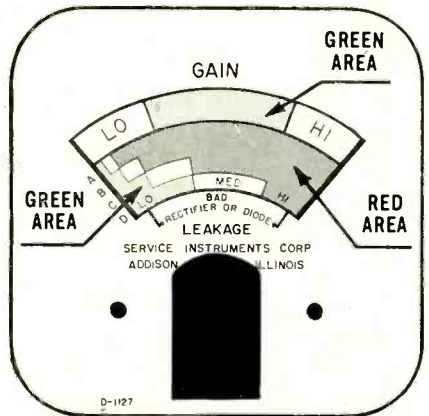

FIG. 2. Full size TRC4 meter scale.

### Will the TRC4 Test All Transistors?

The TRC4 transistor and rectifier checker is designed to accurately test all types of transistors for opens, shorts, leakage and current gain. This includes the High Power transistors as used in car radio output stages as well as the small transistors as used in hearing aids. The TRC4 is the only tester designed to test all transistors both large and small.

### How to Check Transistors

1. Preset the SELECTOR switch and GAIN SET controls according to the charts in the rear. See Fig. 1

2. Preset the RANGE switch to the position as indicated in the chart.
3. Plug the transistor into the socket or, if necessary, connect the test leads as shown in the base diagram at the lower right of the panel.
4. Read leakage on the scale indicated in the chart. An average transistor should read in the green area of the scale indicated. See Fig. 2
5. Depress the Gain button. An average transistor should indicate in the green area of the GAIN scale.
6. A shorted transistor will be indicated by maximum leakage reading. An open transistor will be indicated by zero gain. Unfavorable readings for both leakage and gain should be indicated before rejecting a transistor.

### How to Check Rectifiers and Crystal Diodes

1. Set the SELECTOR Switch to RECT-DIODE position and the RANGE switch to the ALL OTHER TESTS position.
2. Connect the red lead to the positive end of the rectifier or diode and the black lead to the negative end.
3. A rectifier or diode with good forward current will indicate to the right of the arrow on the lowest scale on the meter. See Fig. 2
4. Depress the GAIN button. A good rectifier or diode will read to the left of the left arrow. A shorted rectifier or diode will read about mid scale. An open rectifier or diode will not read on either test.

The new dual silicon diodes should be checked with both sections in parallel. If either section is bad, the checker will detect it.

### Why the TRC4 Uses a Set-Up Chart

The TRC4 uses a set-up chart in the same manner as a tube tester uses a set-up chart for different tubes. Transistors with higher current gain are biased with less base current so as to provide the same average collector current for every transistor. In this way, a single Gain scale can be used to indicate low, medium, or high gain.

The TRC4 is the only commercially available transistor tester using a set-up chart and therefore, the only tester designed to test all transistors accurately.

### How to Get New Charts

New charts are printed periodically. Sencore will mail charts directly to the user upon request. A more satisfactory system of distribution is available through a registration service. If you send one dollar to Sencore, Addison, Illinois, you will receive the next six mailings of the latest transistor set up charts. This means that you will get them before your distributor.

### Where to Buy a TRC4 Checker

The TRC4 Checker is available from electronic parts distributors throughout America, Canada and other parts of the world. Three out of four Industrial and Service type distributors in America have it in stock.

Over 100 are sold every working day. You can recognize them by the blue and yellow cartons and by the colorful Sencore time saver displays. Price is \$17.95 Dealer Net.

\*PRESIDENT SENCORE  
121 Official Rd. • Addison, Illinois

# You Can Advance Your Career on Semiconductor Frontiers . . .

## WITH TEXAS INSTRUMENTS

... A MAJOR MANUFACTURER OF TRANSISTORS  
AND OTHER ELECTRONIC COMPONENTS—

one of the 500 largest industrial companies in the country. Our planned expansion has created positions with exceptional advancement potential and increased responsibility for:

### ELECTRONIC TECHNICIANS

... To work closely with our engineering staff on original design programs in

- Testing, development circuits, recording of test data, etc.
- Testing and trouble shooting of electro-mechanical assemblies.
- Fabrication of electronic experimental models and test equipment.

You can qualify if you are a high school graduate with good technical background, including experience in the above areas.

These are Permanent Positions with Unusual Growth Potential

Excellent benefit program includes company paid profit-sharing, educational assistance (90% company paid), retirement, vacations and semi-annual salary reviews. You will be working in our modern facility, near fine residential areas yet only 11 freeway miles from downtown Dallas.

### ANALYTICAL TECHNICIANS

... This is addressed to you if you have an intense interest in electronic components—and some experience in specification interpretation, as well as in writing of test procedures using specifications. Requires a minimum of 3 years of college or comparable experience and preferably a degree in Math, Statistics or Economics (with Military electronics experience). Data analysis methods experience helpful.

Interviews in your area will be arranged in the near future. Please send resume to Charles Clark, Dept. CC 2093

SEMICONDUCTOR-COMPONENTS DIVISION

## TEXAS INSTRUMENTS INCORPORATED

P.O. BOX 312, DALLAS, TEXAS

## RADIO

There were, as of that date, 61,502 first-class and 40,803 second-class licensed radiotelephone operators.

### What the future holds

At present, operators of mobile radio systems as well as equipment manufacturers are keenly interested in the movement to make more communications channels available by splitting the present fairly wide channels. This means that much of the equipment now in use will be modified or replaced by equipment which will meet the operating requirements of the tightened technical standards. Some manufacturers offer conversion kits which users can install in existing mobile-radio equipment to make it suitable for split-channel operation.

Other technological improvements are hurrying the replacement of older models with new equipment designed for split-channel operation. All-transistor power supplies, for example, which eliminate the need for vibrators and dynamotors, offer the user greater reliability and lower operating cost. While the eventual introduction of low-cost, all-transistor mobile radio equipment looms on the horizon, sales of equipment using both tubes and transistors are not lagging for fear of early adolescence.

Interest in selective calling has zoomed during the past year. Before the mobile radio channels became so congested, only token interest in selective calling was apparent. Now, however, the privacy and convenience of the dial telephone has accelerated interest in dial and pushbutton selective calling systems. Base-station operators can dial mobile units individually without alerting any of the others. They can also dial mobile units in groups, or all at once, when necessary. In addition, mobile units can dial other mobile units as well as alert specific base-station control points without disturbing others. Already, mobile units can dial into land-based telephone systems as simply as dialing long-distance calls without the aid of a human operator.

The next article in this series will discuss the circuitry and technical aspects of equipment used in mobile radio systems. **TO BE CONTINUED**

[Because March RADIO-ELECTRONICS will be a SPECIAL STEREO ISSUE, Part III of "ABC's of Mobile Radio" will appear in April.]



"Our outside man is sick. I'm the bench man."

RADIO-ELECTRONICS

# SUDDENLY... the whole world discovers there's NO FINER TWEETER than RADIO SHACK'S \$27.50 "Realistic" ELECTROSTAT-3!



This is the tweeter that set the hi-fi world on its ear... the tweeter that's been getting the *rave notices*... the tweeter that makes ANY hi-fi system a *BETTER* hi-fi system! ELECTROSTAT-3 adds a never-before-possible smooth and silky response from 5,000 cycles to beyond 25,000 cycles... *beyond the range of human hearing*. And its wide dispersion angle carries its new world of acoustic brilliance to *all corners* of the room! 11 $\frac{1}{8}$  wide, 5 $\frac{7}{8}$  high, 4 $\frac{1}{2}$  deep; mahogany, walnut or blond. 110V AC.

Order No. 36CX017Y **\$27.50**  
\$3.50 Down, \$5 Monthly

### REALISTIC CROSSOVER NETWORK KIT

Includes coils, condensers and L pad; with simple assembly instructions and diagram.

8 OHMS — Order No. R-4850 **\$4.95**  
16 OHMS — Order No. R-4851



Radio Shack Introduces an Unbelievable Tuner Bargain!

### 1959 REALISTIC HI-FI FM-3 TUNER



Order No. 36CX027Y **\$44.50**  
\$5 Down, \$5 Monthly

Specifications Guaranteed by Custom Alignment! Sensitivity: 2 uv for 20 db quieting at 30% modulation; 2 uv for 30 db quieting at 100% modulation, and over all bandwidth — including RF and IF stage — sufficient to accept 100% modulation with signal as low as 5 uv at less than 1% total distortion! Hi-Fi Features: Tuned RF stage; Armstrong Circuit; AFC and Defeat; Freq. Resp. 20 20,000 cps 1 db; Cascade front end; 3 Gang condenser; Handsome gold, mahogany and ivory cabinet — 9 $\frac{1}{2}$  x 4 $\frac{3}{4}$  x 6 $\frac{1}{2}$ .

## Complete "ELECTROSTAT-3" Speaker Systems Now Available by MAIL!

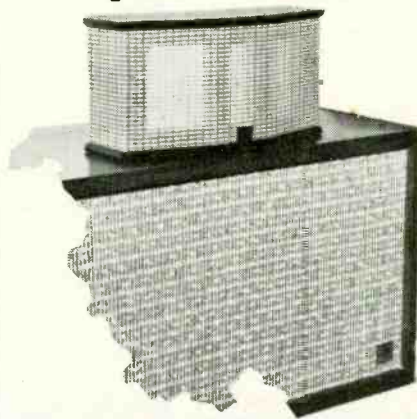

### AR-2 WITH ELECTROSTAT-3

SPECIAL LOW PRICE for AR-2 system! Includes unfinished AR-2 speaker, unfinished ELECTROSTAT-3 and 8-ohm crossover network kit.

Order No. RX20025Y **\$111.95**  
\$12 Down, \$10 Monthly  
Mahogany or blond, add \$6; walnut \$13

### AR-1 WITH ELECTROSTAT-3

FABULOUS AR-1 system includes unfinished AR-1 speaker in cabinet, unfinished ELECTROSTAT-3 and 8-ohm crossover network kit.

Order No. RX20029Y **\$189.50**  
\$20 Down, \$14 Monthly  
Mahogany or birch, add \$10; walnut \$19

## RADIO SHACK CORPORATION

730 Commonwealth Ave., Boston 17, Mass. 167 Washington St., Boston 8, Mass.  
230-234 Crown St., New Haven 10, Conn.

### Realistic 15-WATT HI-FI AMP



Order No. 33CX005Y **\$39.95**  
\$5 Down, \$5 Monthly

Stereo-Ready Hi-Fi Amplifier at less than "kit price"! Specs: at 1 watt:  $\pm 1$  db from 20 cps to 70KC. at 15 watts:  $\pm 1$  db from 30. cps to 30 KC. Total R.M.S. harmonic dist. less than 1/2% @ 15 watts measured @ 400 cps. Reg. \$66.95.



### 2 for STEREO with STEREO-MASTER

R-7243CAF15 **\$89.95**  
\$9 Down, \$8 Mon.



### REALISTIC MARK-VII Hysteresis - Motor TURNTABLE

\$64.50 Value **\$49.50**

Order No. RX-7903; \$5 Down, \$5 Monthly  
Meets NARTB speed and wow requirements for broadcast industry use. Wow and flutter content below 0.2%, noise level 50 db below average record level. 3-speeds, 33 $\frac{1}{3}$ , 45 and 78 rpm. Size: 13" d. x 15" w. x 4 $\frac{1}{2}$ " below chassis. (Arm and base not included).

### STEREO TURNTABLE SYSTEM

16" Tone Arm, G-E GC-7 Diamond Cartridge, Mark-VII Turntable, Maple Base, Regular \$101.87.

Order No. RX-TS16Y **\$79.50**  
\$8 Down, \$7 Monthly

RADIO SHACK CORPORATION, Dept. 2E  
730 Commonwealth Avenue, Boston 17, Mass.  
Please send me

Quan.	Realistic Desc.	Wt.	Order No.	Sale
	Electrostat-3	7 lbs.	36CX017Y	\$27.50
	FM TUNER FM-3	11 lbs.	33CX027YF	44.50
	AR 2 with Elec. 3	50 lbs.	RX20025Y	111.95
	AR-1 with Elec. 3	70 lbs.	RX20029Y	189.50
	15-watt Amplifier	15 lbs.	33CX005Y	39.95
	Stereo Master with		R-7243CAF15	
	2-15-Watt Amps.	33 lbs.		89.95
	Mark VII Trntble.	16 lbs.	R-7903	49.50
	St. Mark VII Sys.	30 lbs.	RX-TS16Y	79.50

- 232 page 1959 Radio Shack Catalog  
 Radio Shack 1959 Hi-Fi Buying Guide

Name \_\_\_\_\_  
Address \_\_\_\_\_  
City \_\_\_\_\_ Zone \_\_\_\_\_ State \_\_\_\_\_

# WHO OWNS the Signal?

*Growth of television in small communities is being hampered by the question of signal "ownership." Legislation may be needed to break this roadblock*

By DAVID LACHENBRUCH

A second-hand television picture looks just like a first-hand one. The signal's electronic characteristics are identical. But there's an important difference—and this difference is stunting the growth of television service in some small communities.

Most people, of course, receive their TV signals first-hand from one or more of the 550 stations now operating in the US—that is, from station to TV set without any intermediate electronic steps. But many isolated areas, distant or shadowed from TV stations, are forced to use in-between devices to soup up or repeat the signal. If they want TV at all, they must get it second-hand. Three techniques are used to bring second-hand television from hilltop reception points to communities which otherwise would have little or no TV:

1. Uhf translators. There are now nearly 175 of these 10- to 100-watt repeaters on the air. Licensed and carefully regulated by the FCC, they receive signals from distant TV stations, "translate" them (without demodulation) to uhf channels between 70 and 83 and rebroadcast them.

2. Boosters or "reflectors." Perhaps 1,000 of these are in operation, despite

**Community antenna systems distribute programs by cable for a monthly fee. Since they're not classed as "broadcast services," they need not obtain permission to repeat station's signals**

efforts of the FCC to shut them down and keep them off the air. These unlicensed stations bring their communities bootleg TV—even though they are often constructed and operated by civic-minded individuals or cooperative groups—as they operate without regard to FCC standards or licensing. A booster receives and amplifies programs of one or more distant stations and beams them to the community on the same channel as the originating station.

The FCC objects to boosters because—being on the transmitter's own frequency—they often cause interference to direct reception of TV stations. Usually the booster installations are of the most rudimentary type and, ac-

ording to FCC officials, may emit radiation which could interfere with vital radio services such as aircraft beacons.

3. Community antenna TV (CATV) systems. Charging subscribers for installation and monthly service, these privately owned systems use hilltop receiving antennas or microwave relays to bring in the signal, which is distributed to subscribers' homes by cable.

All three systems bring programs to families which otherwise would not have TV. They result in business for TV manufacturers, retailers and service technicians. A recent FCC survey of 102 translators showed that 72 were owned by nonprofit cooperatives set up for the purpose, 8 by TV broadcasting stations to improve their coverage, 8



Unlicensed boosters bring television to isolated areas despite the FCC's efforts to close them down. They rebroadcast the programs of other stations without regard to legal niceties.

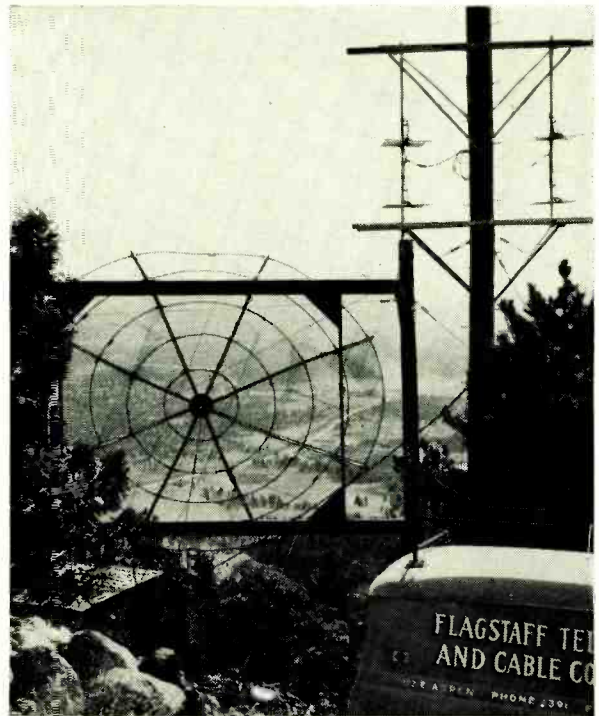

Non-profit translator stations, encouraged by the FCC, are required by law to obtain permission from the stations they rebroadcast. An economic squeeze sometimes forces stations to withhold permission.

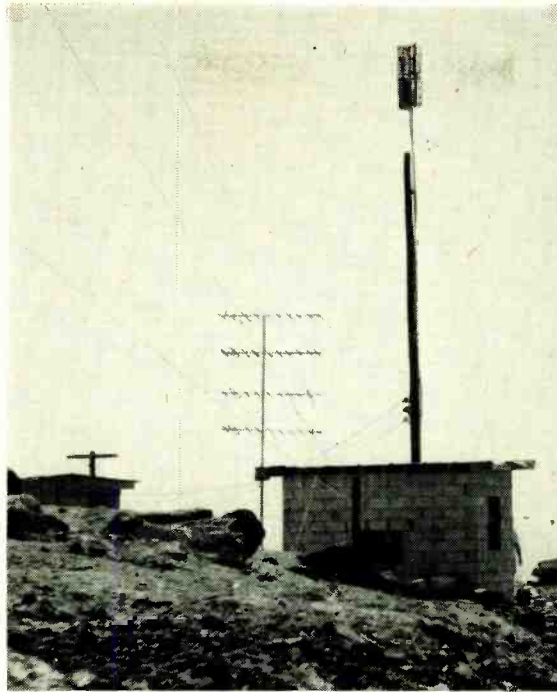

by private individuals or firms as a public service and 14 by local civil governments. TV technicians and dealers often are prime movers in the translator cooperatives. Obviously, the more people reached by TV, the more TV sales and service business.

It's FCC policy to encourage the construction of translators to extend free, lawful TV service to small and remote communities. But community-minded groups in several areas have hit a stone wall in their efforts to put translators on the air. In at least one town, a large sum raised by public subscription may have to be refunded.

The roadblock: "Ownership" of TV signals.

There's only one Federal law which directly regulates pickup and redistribution of TV programs—the Federal Communications Act, under which the FCC operates, and which was written long before the advent of television. Among its many provisions, it bans the rebroadcasting of television or radio programs without permission of the originating station.

"Rebroadcasting" is the key word. How does this apply to each of the three types of "second-hand" television systems?

Community antenna systems don't need permission. They don't "rebroadcast." State courts have ruled that CATV is merely "an extension of the receiving set." The FCC has not assumed jurisdiction over CATV and commission members and staff experts informally agree that community antenna distribution can't be considered "rebroadcasting" by any stretch of the imagination.

Unlicensed boosters rebroadcast without permission. They're already regarded as outside the law—so what difference does another violation make?

Translators *must* have permission to rebroadcast or lose their authority to

operate—it's written into their FCC charter.

All of the translators now in operation have permission from the originating stations, of course. But plans for many a translator have been scuttled by withholding of rebroadcast rights.

Stations refusing rebroadcast rights usually do so for economic reasons which are hard to pin down—sometimes because of friendly relations with a CATV system in the area, sometimes because TV film program distributors or broadcast unions want additional payment for "rebroadcasts." Often there are more complex, sometimes personal—or even political—reasons.

In the long run, it pays a station to have its programs rebroadcast by translators. Since both stations and program owners are paid according to the size of the audience reached, anything that increases their audience also boosts their revenues.

How to break the log jam?

Borrowing from another field of Federal regulation, one possible solution is suggested by a law which already exists in the patent field. A patent owner *must* license others to use his invention (for a reasonable fee) if withholding it would tend to produce monopoly.

A somewhat similar regulation could be added by Congress to the Communications Act. It would require telecasters to permit rebroadcasting of their programs by nonprofit repeaters in communities which have no TV stations of their own.

Such a law would take the broadcasters off the hot seat—and many of them would be happy to be relieved of the stigma of responsibility for denying TV service to small communities.

But more important, it would give equal program access to the only "second-hand" TV system which is both free and legal. END

These men are getting practical training in...

# Electronics

## ELECTRICITY ELECTRONICS

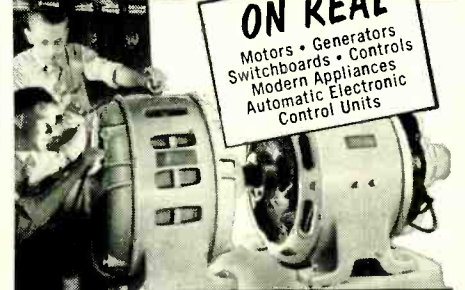

**ON REAL**  
Motors • Generators  
Switchboards • Controls  
Modern Appliances  
Automatic Electronic  
Control Units

## TELEVISION RADIO ELECTRONICS

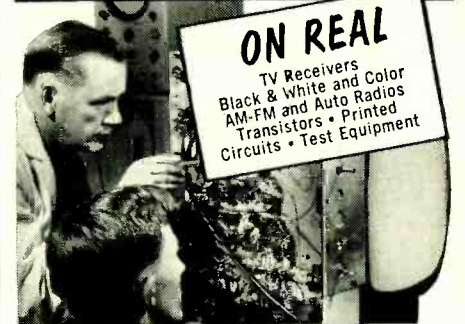

**ON REAL**  
TV Receivers  
Black & White and Color  
AM-FM and Auto Radios  
Transistors • Printed  
Circuits • Test Equipment

# Train in NEW Shop-Labs of COYNE

**in Chicago — Electronic Center of the World.** Prepare for a better job and a successful future in TOP OPPORTUNITY FIELD. Train on real full size equipment at COYNE where thousands of successful men have trained for 60 years—largest, oldest, best equipped school of its kind. Professional and experienced instructors show you how, then do practical jobs yourself on more than a quarter of a million dollars worth of equipment. No previous experience or advanced education needed. Employment Service to Graduates.

**Start Now — Pay Later**—Liberal Finance and Payment Plans. Pay most of tuition after graduation. Part-time employment help for students. Choose from nine yearly Starting Dates.

**Mail Coupon or Write to Address Below for Free Book**—“Guide to Careers.” Whether you prefer ELECTRICITY-ELECTRONICS, TELEVISION-RADIO ELECTRONICS or COMBINED ELECTRONICS TRAINING, this book describes all training offered.

**Information comes by mail. No obligation and NO SALESMAN WILL CALL.**

B. W. Cooke, Jr., Pres. Founded 1899  
**COYNE ELECTRICAL SCHOOL**  
Chartered as an Educational Institution Not For Profit  
1501 W. Congress Pkwy., Chicago 7, Ill., Dept. 29-5A

### MAIL COUPON OR WRITE TO ADDRESS BELOW

COYNE ELECTRICAL SCHOOL  
New Coyne Building Dept. 29-5A  
1501 W. Congress Pkwy., Chicago 7, Ill.  
Send BIG FREE book and details of all the training you offer.

Name .....

Address .....

City.....State.....

*(I understand no Salesman will call)*



# Build the Best... build **knight-kits**

A PRODUCT OF ALLIED RADIO

with exclusive "CONVENIENCE ENGINEERING" for easiest building

SAVE UP TO  
**50%**

KNIGHT-KIT design goes beyond handsome styling, advanced circuitry and guaranteed specifications. KNIGHT-KIT "convenience engineering" means just that...it goes deep-down, with special attention to those small but vital details that count...details such as carded and identified resistors, plastic-bagged hardware, pre-cut and stripped wire—details that make assembly far easier, that assure absolute accuracy, and finally reward you with proud enjoyment of the superior performance designed into your KNIGHT-KIT.



*America's Low-Cost HI-FI anyone can afford—THERE'S NOTHING FINER*

## STEREO High Fidelity...build your own at great savings



Tremendous Value! ONLY **\$44.50**

### **NEW** 20-Watt Stereo Amplifier Kit

Newest complete Stereo high-fidelity amplifier at an amazing low \$44.50. Includes built-in magnetic cartridge preamps. Tandem controls for simplified operation. Single switch selects phono, tuner or auxiliary stereo inputs, plus stereo reverse on each; also switches monaural input to both amplifier channels. Bass and treble controls boost and attenuate. Special clutch-type concentric volume control permits adjusting balance on each channel, then controls overall volume. Total output is 20 watts (10 watts per channel at less than 1½% distortion). Response, 20-20,000 cps, ± 1.5 db. Four pairs of stereo inputs: magnetic cartridge, ceramic cartridge, tuner, auxiliary. Hum-free (DC on preamp tube filaments). Custom case, 4¼ x 13¼ x 9". Shpg. wt., 27 lbs.

Model Y-773. Net only.....

Easy Terms: Only \$4.45 Down

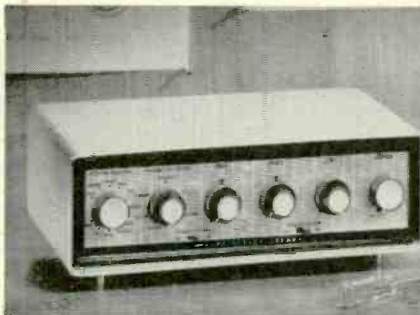

### Stereo Preamp Control Center Kit

In a class by itself—a control center that will do **anything** and **everything** you want. Features complete input flexibility—5 Stereo inputs (including tape heads), additional 4 inputs for monaural. Six record equalizations for monaural; RIAA for Stereo. Volume, bass and treble controls on concentric shafts with special clutch for both individual channel and overall control. Single switch selects straight Stereo; Stereo Reverse, either channel separately, or either channel into monaural output. Continuously variable loudness control; hum-free (DC on all tube filaments); cathode follower output and special recorder output. Exclusive printed-circuit switches and boards. Custom styled case, 4¼ x 13 x 8". Shpg. wt., 17½ lbs.

Model Y-776. Net only.....

Easy Terms: Only \$6.25 Down



### 60-Watt Stereo Basic Amplifier Kit

Absolutely the finest dual amplifier you can build—equal to highest-priced factory-built units. Ideal for use with the KNIGHT-KIT preamp, either as two 30-watt stereo amplifiers or 60-watt monaural amplifier. Exceptional response from 10 cps to 42,000 cps. Phenomenal 0.08% distortion at full 60 watts. Includes static plate current balancing adjustments for each channel; absolute stability under all operating conditions; custom-quality transformers. Also has special built-in circuitry, with easy external adjustment, for precise balance of gain on each channel to achieve perfect monaural performance. Two printed-circuit boards for easy assembly. Beautiful black and chrome; 9 x 14 x 8½". (Cover extra, \$6.50.) 36 lbs.

Model Y-777. Net only (less cover) ...

Easy Terms: Only \$8.45 Down



NOW WITH JACK FOR FM STEREO MULTIPLEX ADAPTORS

**\$49.95**

Only \$5.00 Down

### Deluxe FM-AM Hi-Fi Tuner Kit at Lowest Cost

The best-looking, best-performing FM-AM tuner kit for the money. You'll enjoy building and owning it. FM sensitivity is a remarkable 2.5 microvolts for 20 db of quieting. AM is 3 microvolts for 10 db signal-to-noise ratio. Outstanding features include: single large printed-circuit board with most critical wiring already done; AFC (with disabling feature); flywheel tuning; precisely pre-aligned RF and IF coils—no further alignment needed; tuned RF stage on FM; drift-compensated oscillator; neon glow tuning pointer; cathode follower output; rotatable built-in AM antenna. Beautiful French-gray case, 4¼ x 13¼ x 8". Shpg. wt., 12 lbs.

Model Y-787. Deluxe FM-AM Hi-Fi Tuner Kit. Net only....

**\$49.95**



*True Hi-Fi for only*

**\$19.95**

(less cover)  
Only \$2.00 Down

### Top-Value 12-Watt Complete Amplifier Kit... Best Buy in Hi-Fi

Never before has there been so much solid hi-fi value and quality performance at such low cost. Features smooth, clean output for truly rich reproduction. **Guaranteed specifications:** frequency response, 30-15,000 cps ± 1½ db at half power; less than 1% distortion at full power. Has 15 db of inverse feedback. Has preamp stage equalized for magnetic cartridges; inputs for phono and tuner; separate bass and treble controls with both boost and attenuation, push-pull EL84 output tubes; virtually hum-free performance. Size with cover, 5 x 9¼ x 7". (Cover extra, \$3.95.) 7½ lbs.

Model Y-784. 12-Watt Amplifier Kit, less cover. Net only..

**\$19.95**

**EASY TERMS ON knight-kit ORDERS AS LOW AS \$20**

# the kits with the **GUARANTEED\*** specifications



## SEE ALLIED'S 1959 CATALOG FOR COMPLETE DETAILS

For full descriptions of the KNIGHT-KITS below, see the 452-page 1959 ALLIED Catalog. If you haven't a copy, send for it today—use coupon on following page.

there's a money-saving knight-kit for every quality Hi-Fi need



### Universal Stereo Control Kit

Provides full centralized stereo control (volume, balance and channel selection) for use with any two amplifiers. Handles up to 20 watts program material. Unit simply connects between speakers and output terminals of amplifiers (no amplifier rewiring needed). Lets you balance speaker system volume; provides master gain control for overall volume (can be used remotely); lets you play either channel monaurally through one or both speakers; provides channel reversal; phase reversal switch for best overall performance. 4½ x 7½ x 4". 3½ lbs. Model Y-778. Net only...\$9.95



### Deluxe Hi-Fi Preamplifier Kit

Quality audio control center. 16 combinations of equalization; 8 inputs including tape head; DC on all tube filaments; printed-circuit switches and boards. Custom-styled. 12½ lbs.

Model Y-754. Net only...\$39.95

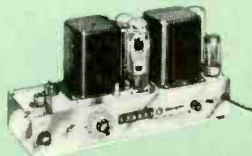

### 25-Watt Hi-Fi Basic Amplifier Kit

Williamson-type circuit. Response, ±0.5 db, 9-70,000 cps at half power. Includes balance control; calibrated damping control; potted output transformer. Shpg. wt., 25 lbs.

Model Y-793. Net only...\$44.50



### 2-Way "Ducted Port" Hi-Fi Speaker System Kit

Pre-finished enclosure; easy to assemble. Hi-fi response, 45-14,000 cps. Includes 12" woofer and horn-type tweeter. Available in mahogany, blonde or walnut (specify finish). 26 x 29 x 14" Shpg. wt., 33 lbs.

Model Y-789. Net only...\$49.95



### Deluxe "Ducted Port" 3-Way Speaker System Kit

Pre-finished enclosure, ready for quick assembly. Includes famous KNIGHT 3-way, 12" speaker. Response, 35-15,000 cps. Features "ducted port" for excellent bass response. Available in mahogany, blonde or walnut finish (specify). Shpg. wt., 47 lbs.

Model DZ-262. Net only...\$73.45

## \*MONEY-BACK GUARANTEE

Every KNIGHT-KIT meets or exceeds published specifications, or we refund your money in full.



### 18-Watt Hi-Fi Amplifier Kit

Superb hi-fi specifications; deluxe custom styling. Includes 8 inputs for every desired signal source; full equalization; printed-circuit switches and boards for easy assembly. Shpg. wt., 15 lbs.

Model Y-797. Net only...\$39.95

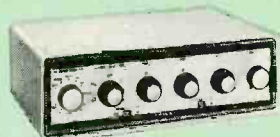

### 30-Watt Hi-Fi Amplifier Kit

Linear-deluxe Williamson-type circuit. Clear, rich 30 watts output; full equalization; 8 inputs; level and loudness controls; DC on filaments of preamp tubes; rumble filter; variable damping. Exclusive printed-circuit switches and boards. Custom-styled. 32 lbs.

Model Y-762. Net only...\$76.95



### Hi-Fi Basic FM Tuner Kit

Authentic Hi-Fi FM response. Includes AFC; flywheel tuning; pre-aligned RF and IF coils. 4 microvolt sensitivity guaranteed. With jack for FM stereo multiplex adaptors. Printed circuit board. Shpg. wt., 12 lbs.

Model Y-751. Net only...\$38.95

## knight-kits for the Radio Amateur

with designed-in value *Hours appreciate*

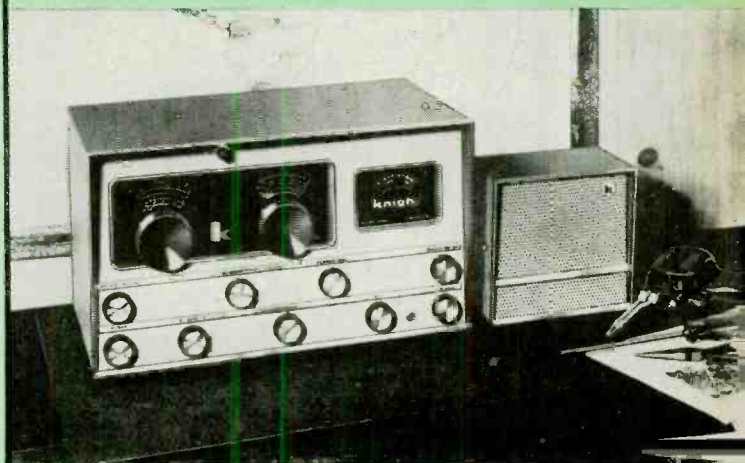

### Amateur Communications Receiver Kit

IT'S THE BEST • BUILD IT YOURSELF AND SAVE!

Has all the selectivity, sensitivity and features of high-priced commercial units. Covers 540 kc to 31 mc in 4 ranges; calibrated, electrical bandspread on 80-10 meter Ham bands; slug-tuned Hi-Q coils; continuous, VR tube-regulated B+ applied to HF oscillator; built-in Q-multiplier; delayed AVC; provision for Y-256 crystal calibrator (below). Sensitivity, 1.5 microvolts for 10 db signal-to-noise ratio. Selectivity: variable from 300 cps to 4.5 kc at 6 db down. Exalted BFO injection for SSB. Controls: Main tuning, bandspread, band selector, BFO pitch, RF gain, AF gain, BFO-MVC-AVC-ANL, off-stby-rec-cal, ant. trim.—plus Q mult. controls: null-off-peak, selectivity, tune. Phone jack on front panel. Exclusive printed-circuit bandswitch; printed-circuit boards. Handsome metal cabinet, 10 x 10 x 16½". (Less speaker and S-meter.) 23 lbs.

Model Y-726. Net only...\$104<sup>50</sup>

Easy Terms: Only \$10.45 Down

Y-727. S-Meter Kit for above. 1 lb. Net...\$10.75

Y-728. 4" speaker in matching cabinet. 3½ lbs. Net...\$7.50

## POPULAR AMATEUR knight-kit VALUES!

### 50-Watt CW Transmitter Kit

Ideal for the novice. Convenient band-switching, 80 through 10 meters. Efficient pi-network antenna coupler; effective TVI suppression. Uses 807 in final. Shpg. wt. 18 lbs.

Model Y-255. Net only...\$38.95

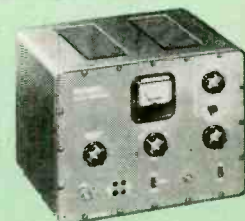

### Self-Powered VFO Kit

With built-in power supply. High stability; excellent keying; full TVI suppression. Planetary vernier drive. Calibrated for 80, 40, 20, 15 and 10 meters; output on 80 and 40 meters. Shpg. wt., 11 lbs.

Model Y-725. Net only...\$29.50



### Z-Bridge Kit

Accurately measures SWR from 1 mc to 150 mc. Also measures antenna impedance. Has coax input and output. Invaluable for attaining peak antenna efficiency. Shpg. wt., 1½ lbs.

Model Y-253. Net only...\$5.85



### 100-kc Crystal Calibrator Kit

Crystal frequency standard for any receiver, at very low cost. Gives marker every 100 kc up to 22 mc. Trimmer for zero-beating with WWV. With crystal. Shpg. wt. 1 lb.

Model Y-256. Net only...\$10.95

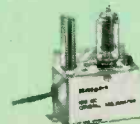

ORDER FROM ALLIED RADIO • 100 N. WESTERN AVE. • CHICAGO 80, ILL.



# Fascinating knight® kits for Hobbyists



Fun to build... with performance you'll proudly demonstrate  
 KNIGHT-KITS are the first choice of hobbyists, experimenters and students because they're truly "convenience-engineered" for easiest assembly, absolute dependability and finest performance. You'll have more building fun, you'll have more enjoyable performance, you'll save more with KNIGHT-KITS.

with exclusive  
*"Convenience Engineering"*  
 for assured build-your-own success...



## "Span-Master" 4-Band World-Wide Receiver Kit

Imagine the thrill of hearing overseas broadcasts on a precision receiver you've built yourself! At the flip of the bandswitch, you tune in the world—continuous 4-band coverage from Broadcast to 30 mc—fascinating foreign broadcasts, ships-at-sea, aircraft, police and marine radio, amateur reception on 80, 40, 20, 15 and 10 meters—all this wonderful short-wave, plus enjoyable local broadcast reception. Features sensitive regenerative circuit; easy bandspread tuning; built-in 4" Alnico V speaker; head-phone terminals; speaker cutout switch. Controls: Main Tuning, Bandspread, Bandswitch, Volume, Coarse and Fine Regeneration. Easy to build from marvelous instruction manual. Handsome cabinet; 6 1/4" x 13 3/4" x 6 1/4". For 110-125 v. AC. Shpg. wt., 7 lbs. **\$24<sup>95</sup>**

Model Y-258. Net only...  
*Easy Terms: Only \$2.50 Down*



## "Space Spanner" Receiver Kit

Thrilling 2-band receiver, easy to build, fun to operate—a terrific value. Bandswitch selects exciting short-wave, including foreign broadcasts, amateur, aircraft, police and marine radio (5.5 to 17 mc), and standard broadcast. Highly sensitive regenerative circuit. Built-in 4" PM speaker and beam-power output for strong volume. Has head-phone jacks and switch to cut out speaker. Easy to assemble from step-by-step instructions. Handsome cabinet, 7 x 10 1/2 x 6". AC or DC operation. Shpg. wt., 7 1/2 lbs.

Model Y-259. Net only... **\$18<sup>95</sup>**

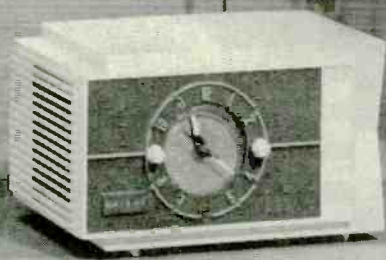

## "Ranger" Clock-Radio Kit

You'll be proud of the performance of this easy-to-build clock-radio. Provides wonderful broadcast band reception. Includes Telechron clock with sleep-switch timer plus automatic radio wake-up/alarm switch. Radio automatically shuts off at night and wakes you in morning; also turns on appliances automatically. Module plug-in circuits and printed-circuit board for quick, easy assembly. Beautiful blue and white plastic cabinet. 6 x 9 1/2 x 5 1/2". For 60 cycle AC only. Shpg. wt., 5 lbs. **\$24<sup>95</sup>**

Model Y-737. Net only...  
*Easy Terms: Only \$2.50 Down*

## 12-In-1 Electronic Lab Kit

Fascinating way to learn electronics—build any one of 12 practical circuits! Change circuits just by relocating a few wires. Safety-designed; no voltage exceeds 25v. Makes any one of the following: AM radio, amplifier, code oscillator; home "broadcaster"; electronic timer, switch or flasher; voice-operated, capacity-operated or photoelectric relay; CW "transmitter"; light control oscillator. With all parts, mike, phototube, instructions for each project. For 110-125v. AC. Shpg. wt., 3 1/2 lbs. **\$14<sup>95</sup>**

Model Y-272. Net only...

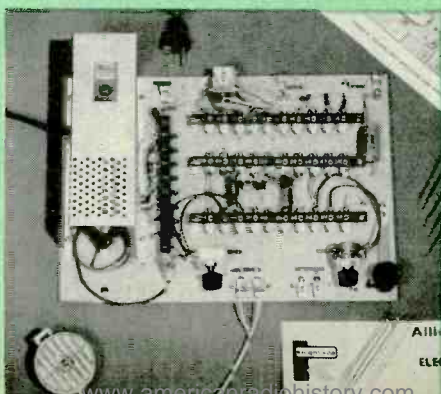

## Widest choice of quality Hobbyist Kits

### "Ranger III" AC-DC Radio Kit



Superhet broadcast band receiver. Built-in antenna; AVC; Alnico V speaker. Black plastic cabinet. AC or DC. Shpg. wt., 4 1/2 lbs.

Model Y-736. Net only... **\$16.95**

### "Ocean Hopper" Receiver Kit



Regenerative receiver for broadcast, long wave and short wave reception from 155 kc to 35 mc. With coil for broadcast band. For AC or DC. Shpg. wt., 7 lbs.

Model Y-749. Net only... **\$15.95**  
 Y-748. Set of plug-in long wave and short wave colls. Net... **\$2.95**

### "Ranger III-PC" AC-DC Radio Kit



Printed-circuit broadcast band superhet. Easy to assemble. Has AVC, built-in loop antenna, Alnico V speaker. Ivory plastic cabinet. AC or DC. Shpg. wt., 4 lbs.

Model Y-738. Net only... **\$18.95**

### "Ranger" Radio-Intercom Kit



It's a broadcast band radio—it's an efficient 2-way intercom—both in one! Ivory plastic case for Master station/Radio; smartly styled Remote station. With 50-ft. cable. AC or DC. Shpg. wt., 8 lbs.

Model Y-739. Net only... **\$27.50**

### "Trans-Midge" Radio Kit



Tiny 1-transistor radio for local broadcast reception. Works for months from single penlight cell supplied. Handsome plastic case. Fascinating to build. (Requires headphones and antenna.) 3 oz. Model Y-767. Net only... **\$2.45**

### 10-Circuit Transistor Lab Kit

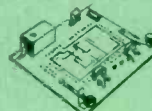

Builds any of 10 favorite projects. Entire kit on a printed circuit board. Just plug in leads to change from project to project. 3 lbs. Model Y-299. Net only... **\$15.75**

### 1-Transistor Radio Kit

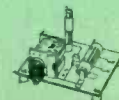

Offers fine local broadcast head-phone reception. Printed circuit board for easy assembly. Works for months from penlight cell supplied. (Antenna and headphones required.) Shpg. wt., 1 lb. Model Y-765. Net only... **\$3.95**





BETTER BY FAR...ADVANCED DESIGN...GUARANTEED SPECS

DO THE EASY ASSEMBLY...SAVE OVER **50%**

**MONEY-BACK GUARANTEE**

Every KNIGHT-KIT meets or exceeds published specifications—or we refund your money in full.

EASY TERMS on orders as low as \$20

**5-Transistor Superhet Radio Kit**



Quality personal portable. Printed circuit for easy assembly. Built-in antenna; 3 1/2" speaker; prealigned IF's; phono jack; 200-hour battery playing life. Handsome ivory and gold styling. Less battery (\$1.43). 2 lbs. Model Y-771. Net only... \$25.95

**2-Transistor Pocket Radio Kit**

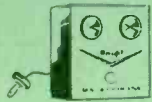

Excellent for local broadcast reception. Newest printed-circuit board for easy assembly. Built-in antenna; miniature dynamic earphone; plays for months from single battery. In handsome carrying case; only 4 x 3 3/4 x 1 1/4". Less battery (\$1.25). 1 1/4 lbs. Model Y-263. Net only... \$11.50

**2-Way Intercom System Kit**



Complete 2-station system; low-cost, easy to assemble. High gain, clear toned, sensitive. Has 2-stage amplifier and 4" PM speakers. Handsome metal cabinets. Includes master, remote and 50-ft. cable. AC or DC. 8 lbs. Model Y-297. Net only... \$14.95

**Electronic Photoflash Kit**



Fast 1/700th-of-a-second flash; 50 watt/second output. Synchronizes with any camera with X or O shutter. Less battery. Shpg. wt., 4 lbs. Model Y-244. Net only... \$29.50

**Wireless Broadcaster—Amplifier Kit**

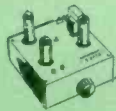

Play music or make announcements through your radio set, using mike or phono—no connection to set needed. Use also as audio amplifier. Has built-in preamp. AC or DC. Shpg. wt., 3 lbs. Model Y-706. Net only... \$11.95

**Transistor Code Practice Kit**



Ideal for beginners learning code. 500 cps tone. Single penlight cell supplied operates unit for months. Jacks for headphones; screw terminals for key. Shpg. wt., 1 lb. Model Y-239. Net only... \$3.95

**Crystal Set Kit**



Gives clear headphone reception of local broadcast stations. Sensitive crystal diode; efficient "Hi-Q" coil. (Antenna and headphone required.) Shpg. wt., 1 lb. Model Y-261. Net only... \$2.35

**Photoelectronic Relay Kit**



Ultra-sensitive relay at very low cost. Fine for automatic control of lights, door openers, as a burglar alarm, etc. Shpg. wt., 3 1/2 lbs. Model Y-702. Net only... \$13.50  
Y-703. Light Source only... \$ 6.75

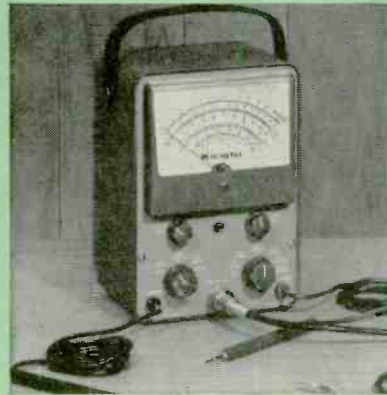

**Vacuum Tube Voltmeter Kit**

Top buy in a quality VTVM. Entire chassis is printed-circuit board—easy to assemble. Balanced-bridge, push-pull circuit; 1% film-type resistors; 200  $\mu$  movement; 4 1/2" meter; includes zero center scale and direct-reading db scale. Polarity reversing switch. Input Res.: 11 megs. DC and AC rms, 0-1.5-5-15-50-150-500-1500; AC Peak-to-Peak, 0-4-14-40-140-400-1400-4000; Response, 30 cycles to 3 mc; Ohms, 0-1000-10K-100K and 0-10-100-1000 megs; db, -10 to +5. Includes battery and test leads. For 110-125v., 50-60 cycles. Shpg. wt., 6 lbs. Model Y-125. Net only... **\$25.75**

Easy Terms: Only \$2.58 Down



**Lowest Cost Tube Checker Kit**

A really tremendous value in a quality tube checker. Checks over 400 tubes. Features "Flip-Card" charts with tube settings in loss-proof pull-out storage drawer. Has sockets for 7-pin miniature, 9-pin miniature, octal and loctal base tubes. Checks for cathode emission, filament continuity, shorted elements. Meter has "Replace-Good" scale and special scale for checking diodes. With quick-setting, universal-type selector slide switches. Includes "Hi-Lo" line-voltage regulator switch. Compact and light—use anywhere. With tube charts. 6 1/2 lbs. Model Y-707. Net only... **\$19.95**

Easy Terms: Only \$2.00 Down

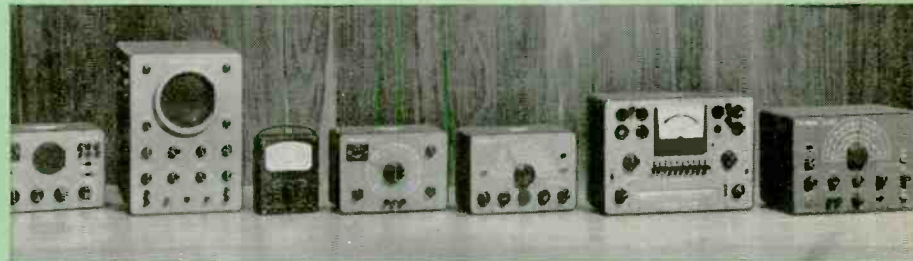

**there is a knight-kit to fill every test equipment need**

For detailed descriptions, see the 1959 Allied Catalog.

5" Wide-Band 'Scope Kit	\$65.75	High-Gain Signal Tracer Kit	\$26.50
5" General Purpose 'Scope Kit	42.00	Audio Generator Kit	32.95
20,000 Ohms/Volt VOM Kit	29.50	Resistor-Capacitor Tester	19.50
1,000 Ohms/Volt VDM Kit	16.95	"In-Circuit" Capacitor Checker Kit	12.50
'Scope Voltage Calibrator Kit	12.75	Flyback Checker Kit	19.50
Counter Tube Checker Kit	29.75	Transistor & Diode Checker Kit	8.50
Portable Tube Checker Kit	34.75	Resistance Substitution Box Kit	5.95
TV-FM Linear Sweep Generator	44.95	Capacitance Substitution Box Kit	5.95
RF Signal Generator Kit	19.75	6V-12V Battery Eliminator Kit	32.95

**ORDER BLANK**

**ALLIED RADIO** Dept. 132-B-9

100 N. Western Ave., Chicago 80, Ill.

Ship me the following KNIGHT-KITS:

Quantity	Description	Model No.	Price

\$..... enclosed. (For parcel post include postage; express is shipped collect.) All prices Net F.O.B. Chicago

My Down Payment in the amount of \$..... is enclosed. Send Time Payment form

Send FREE 452-Page 1959 Allied Catalog

Name \_\_\_\_\_  
Address \_\_\_\_\_  
City \_\_\_\_\_ Zone \_\_\_\_\_ State \_\_\_\_\_

*Free!* 1959  
**452-PAGE  
ALLIED CATALOG**

See pages 241-273 for detailed descriptions of all KNIGHT-KITS: Hi-Fi, Hobby, Test Instrument, Amateur. The 1959 Allied Catalog is your complete Buying Guide to the world's largest stocks of everything in Electronics.



38 years of experience in  
electronic kit design

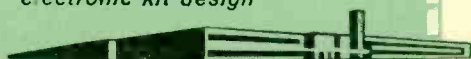

  
**TV Service**  
**CLINIC**  
 conducted by  
**ROBERT G. MIDDLETON**  
 RADIO-ELECTRONICS TELEVISION CONSULTANT

**C**AUSES of poor picture quality have been pointed out in previous Clinic columns, but the mailbag indicates that this is a continuing bench problem. Hence, we are going a bit farther into this subject.

Poor picture quality is often seated in the video amplifier. This circuit looks simple. On the other hand, a sweep-frequency check often shows that off-value or faulty components are causing peaked response or loss of low- or high-frequency response.

Fig. 1 shows how excessive shunt capacitance across a point in the video amplifier circuit causes loss of high-frequency response. Leads to the picture tube are a case in point. Press the video signal lead against the chassis or lengthen it arbitrarily, and you will see high-frequency response slump off. Pictures lose their sharpness and become blurry.

Loss of high-frequency response is also caused by load resistors too high in value or by faulty decoupling capacitors. Loss of low-frequency response is caused by load resistors too low in value or by grid-coupling (also screen-bypass) capacitors which are too small. (See Fig. 2.)

Sharp peaks in the video amplifier frequency response cause circuit ghosts in the picture. Peaks result from faulty bypassing or from careless replacement of peaking coils. Improperly spaced peaking coils couple into each others'

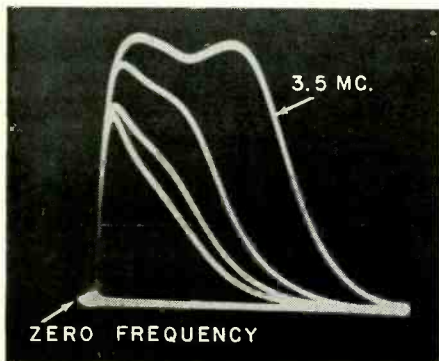

Fig. 1—If the video signal lead to the picture tube is progressively lengthened, the video frequency response curve slumps off at the high-frequency end.

fields and cause peaks in the response curve.

Defective decoupling capacitors often permit the entry of spurious ac voltages into the video amplifier. This not only shows up as interference in the picture background, but can also cause loss of interlacing, which is generally blamed on the integrator. Fig. 3 shows a well-interlaced raster, compared with line pairing from spurious video voltages.

**630 conversion**

*I would like to convert an RCA 630 to use a 21AMP4-A picture tube. I have a Merit HVO-55 flyback, MFD-91 yoke and a Stancor A-8150 vertical output transformer. What circuit should be*

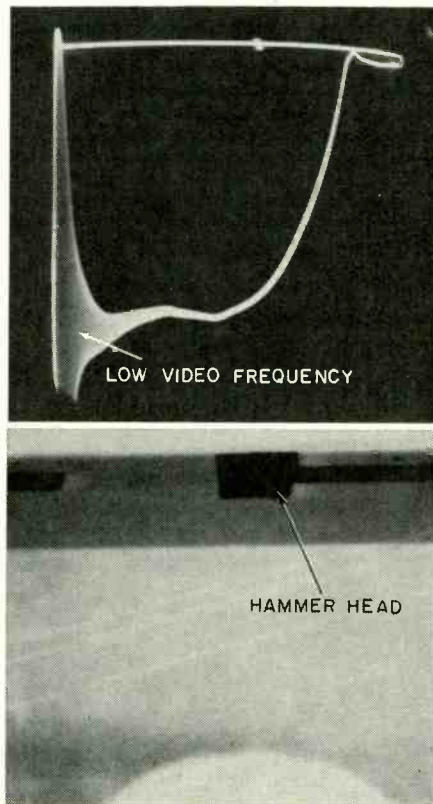

Fig. 2-top—Scope pattern showing poor low-frequency response; bottom—a good hammer head, blacker than the background, indicates good low-frequency response in video circuits.

*used in making this conversion?—S. W. F., Camden, N. J.*

We would not advise this conversion as a paying proposition. However, as a hobby project, in which cost is not the governing factor, it can be done. It would be advisable to rewire the sweep circuits and sync section in accordance with the circuit used in the RCA KCS-92 receiver. Tube changes will be required. We would point out that several versions of the 630 were on the market, some of which had no agc. If yours is of this vintage, it would be advisable

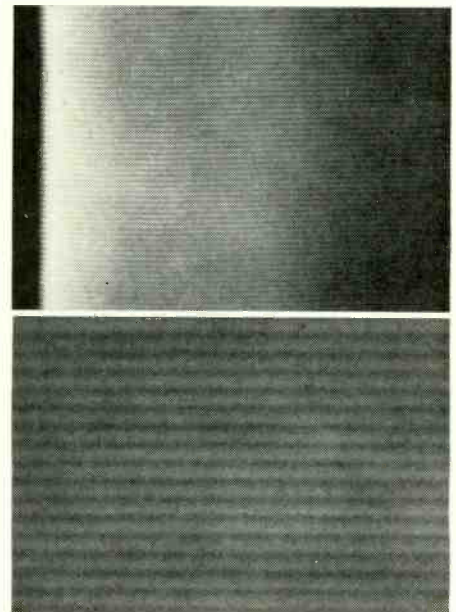

Fig. 3—(Top) Good interlacing; (bottom) line pairing.

also to wire in a keyed-age circuit as in the KCS-92 diagram. A better solution, making for a much simpler job, is to use a 21EP4 as in the following item.

**21-inch conversion**

*I would like to convert a 10-inch RCA 630-TS receiver to a 21-inch tube. What is the best picture tube to use?—B. C., New York, N. Y.*

We would suggest a 21EP4 for this conversion. It is relatively easy to sweep and is economically priced. You will have to get a matching yoke and flyback. Your present vertical output transformer will probably serve OK. If there is insufficient height, try shunting a 50- $\mu$ f capacitor from cathode to chassis in the 6K6 vertical output circuit.

**Aluminized substitute**

*What aluminized tube could be substituted for a 21KP4-A?—J. D. K., Gary, Ind.*

A 21FP4-C can be used here. Note however, that unless rated second-anode voltage is available, there will be no advantage in contrast and brightness. The 21FP4-C has "automatic" focus. A 100,000-ohm resistor between its cathode and focus electrode will probably give good focus. However, for sharpest

## TELEVISION

focus, wire in a 500,000-ohm pot and adjust for best results.

### Adjacent-channel rejection

I would like to obtain greater adjacent-channel rejection on a Zenith 22R20. I have tried adding another 47.25-mc trap in parallel with the trap

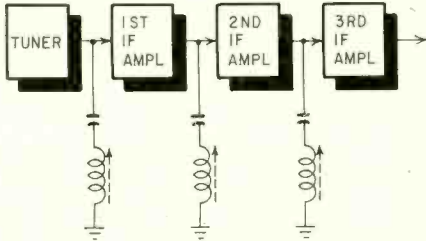

Fig. 4—Correct method of adding traps to boost adjacent-channel rejection.

at the first if grid, but rejection is not increased. A strong channel 3 signal interferes with a fringe station on channel 4. Other sets with higher rejection perform satisfactorily.—(initials withheld by request)

Adding another trap in parallel with one of the same frequency is not an effective method of obtaining increased rejection at a given frequency. The second trap should be added at the grid of the second if amplifier (see Fig. 4). Tune this trap to the picture-carrier frequency of channel 3. If interference still persists, use another trap at the grid of the third if amplifier. Tune the trap to either the picture-carrier or sound-carrier frequency of channel 3, as required. A good sweep and marker generator will be very useful here.

### No high voltage

I have an unusual problem with a Philco 52T1810. It came in for no high voltage. The width coil was burned out. I used a Merit MWC2 width coil and the set worked OK. On a callback next day, the trouble was identical. I replaced the coil with a Philco 33-4486-6 unit, but it runs too hot. The coil takes 35 ma dc, which is normal for another receiver. All associated capacitors have been replaced. The 6CD6 cathode current is OK. The flyback and yoke have been replaced. Operating voltages are normal. Can you give me any help with this problem?—M. S., Saddle River, N. J.

This is evidently a problem of excessive alternating-current flow through the width coil and flyback, rather than too much direct current. Excessive ac results from unfortunate stray parallel resonances in the system. The condition should be investigated with a scope. A simple and effective method of correcting the condition would be to operate without the width coil, or with a considerably larger width coil, to "kill" this apparent resonance. Then, if the picture is too wide, slide an aluminum-foil sleeve under the yoke.

### Slow warmup?

An RCA 7T122 has a very dull picture for the first 5 minutes after being

Announcing . . . A BRAND-NEW Home Study Program  
— Equips you to enter the exciting, new and booming field of

# AUTOMATION and Industrial ELECTRONICS Engineering Technology

Automation: "Second industrial revolution" . . . latest and most exciting development in our amazing world of electronics. Current needs: 3,000 specialists per year, well-trained in automation and industrial electronics . . . to fill new jobs and draw top pay.

CREI's new complete home study course covers all phases of automation and industrial electronics, including fundamentals of electronic engineering technology and a specialization in: Machine control systems . . . Data processing systems . . . Instrumentation techniques . . . Digital and Analogue Computers . . . Servomechanism systems . . . Telemetry systems . . . Industrial processes.

Leads to jobs like these:

NOW A TELEMETRY TECHNICIAN AT RCA MISSILE TEST PROJECT . . . "On December 31 I will be working for RCA at the Missile Test Project in Florida as a Telemetry Technician. I don't mind telling you that CREI

and your encouragement helped a lot in getting this job."—John S. Trefl, Box 133, Beulah, Mississippi

NOW ASSISTANT CHIEF ENGINEER OF RADAR INSTRUMENTATION STATION . . . "Five years ago I started to work for my present employer as a Radio Repairer and Installer. I also started my CREI course at this time. Three years later I was a supervisory electronic engineer and a year later I was promoted to the position I now hold as assistant chief engineer of a large radar instrumentation station at White Sands Proving Grounds."—Ralph Leo Gagnon, 1255 Gardner Ave., Las Cruces, N. M.

If you have had a high school education, and experience in electronics—and realize the need of high-level technical knowledge to make good in the better electronic jobs — you can qualify for this brand-new CREI Home Study course. Write to Capitol Radio Engineering Institute, Dept. 142-X, 3224-16th St., N.W., Wash. 10, D. C.

## MAIL THIS COUPON FOR FREE BOOKLET!

### CAPITOL RADIO ENGINEERING INSTITUTE

ECPD Accredited Technical Institute Curricula • Founded 1927  
Dept. 142-X, 3224 - 16th Street, N.W., Washington 10, D. C.

Please send me without cost or obligation your brochure describing your brand-new home study course in Automation and Industrial Electronics Engineering Technology.

Name.....Age.....

Street.....

City.....Zone.....State.....

To obtain fast, immediate service and to avoid delay, it is necessary that the following information be filled in:

Employed By.....

Type of Present Work.....

Education:  
Yrs. High School.....

Other.....

Electronics Experience.....

SAVE  
TIME  
with

SENCORE

### NOW CHECKS:

- ★ Transistors for opens, shorts, leakage and current gain. Only tester that tests power transistors as used in car radio outputs.
- ★ Crystal Diodes checks forward to reverse current ratio on all diodes.
- ★ Selenium Rectifiers checks forward and reverse currents.

SERVICE INSTRUMENTS CORPORATION  
121 OFFICIAL ROAD, ADDISON, ILLINOIS

See other SENCORE ads in this issue.

## New! Improved! TRANSISTOR CHECKER

America's newest, most popular test instrument

Simple to Operate. Controls are accurately set for each transistor by referring to replaceable set-up chart on rear. Test leads or socket provides for fast hook-up.



MODEL TRC 4

\$17.95

DEALER NET

Cannot become obsolete. Approved by leading manufacturers.

# SHURE

presents the dramatic new

## Commando

a rugged controlled magnetic microphone that provides unusual versatility and excellent performance...

For Public Address and Home Recording

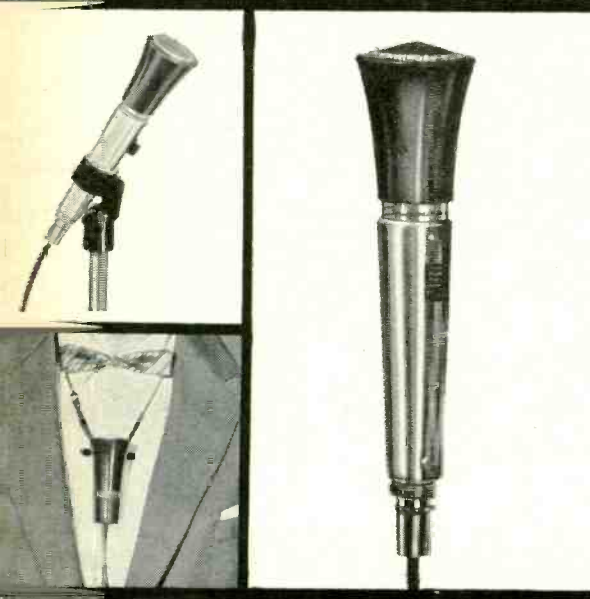

This striking, streamlined unit gives you fine voice and music reproduction in a multiplicity of public address and home recording applications. Whether you use it indoors or out, in the hand or on a desk or floor stand, you'll be delighted by its fine response, high output and beauty of design. The Commando offers you such important features as dual impedance, on-off switch, and cable connector.

The Commando is sturdy and rugged. Of patented controlled magnetic construction, it is unaffected by extremes of temperature and humidity; and it can be depended on to maintain its high level of quality through tough, sustained usage, year after year.

The Commando is available in three models:

### DELUXE Model "430"

A dual-impedance unit with A25 swivel adapter, on-off switch, cable connector LIST PRICE \$38.50

### LAVALIER Model "420"

A dual-impedance unit with lavalier cord and clip assembly LIST PRICE \$30.00

### STANDARD Model "415"

A high impedance unit with A25 swivel adapter LIST PRICE \$27.50

# SHURE

The Mark of Quality



IN ELECTRONICS SINCE 1925

SHURE BROTHERS INC., 222 HARTREY AVE., EVANSTON ILL.

## TELEVISION

turned on. Contrast and brightness controls have no effect. Then the receiver suddenly starts operating properly. The picture tube is old. Would you suspect the picture tube, or look for some kind of circuit trouble?—W. W. S., New York City

A quick check can be made by monitoring the voltages at the picture-tube socket, with the socket unplugged from the tube. If these voltages are normal when the receiver is turned on, the picture tube is causing the trouble. Otherwise, the fault will be found in the circuit (or circuits) which are supplying the incorrect picture-tube voltages.

### Self-oscillation

On a Muntz 17B6, when I make a service call, all I need to do is to touch the top of the 1B3 or the 6BQ6, and the picture comes in OK. It works for about 4 months and the same condition returns. Do you have any suggestions that may help?—C. F. W., Detroit, Mich.

This is a typical condition of self-oscillation of the sweep section with other receiver sections. First, shunt

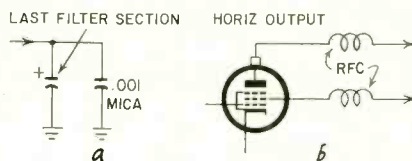

Fig. 5—Marginal instability caused by electrolytic capacitors can be corrected by shunting with .001- $\mu$ f mica capacitors; b—rf chokes at plate and screen of the horizontal output tube often help. Use about 100  $\mu$ h.

the large electrolytic in the flyback section with a .001- $\mu$ f capacitor. Also shunt a .001- $\mu$ f capacitor across the output filter capacitor. This will probably kill the marginal feedback causing the trouble. However, should further attention be required, connect rf chokes in series with the plate and screen terminals of the horizontal output tube (see Fig. 5).

### Color trouble

I have had somewhat the same problem as J. H. C. (RADIO-ELECTRONICS, August, 1958, page 49) on an RCA CT-100 color receiver. It is a fault which shows up only on color reception. Large red areas appear green, with severe trailing greens on the entire picture. Also, after 2 hours there is vertical sync drift. Your help will be appreciated.—E. M., Jr., Rochester, N. Y.

The trouble appearing as green in large red areas, with trailing smear, should be analyzed with a scope and low-capacitance probe. The CT-100 is an I-Q receiver. Since there is no evidence of blue chroma trouble, start checking at the red and green matrices, with a standard NTSC color bar signal applied to the receiver. The circuit at fault will show up as a long-drawn-out

# MORE SERVICING HELP

from "Mr. TV Service Clinic"



If you enjoy and profit from Bob Middleton's TV SERVICE CLINIC in RADIO-ELECTRONICS every month, you'll want to read his books on advanced servicing techniques. You know his friendly style, practical approach and clear way of getting across his point. You'll find that same direct practical method in his two GERNSBACK LIBRARY servicing books.

**SERVICING COLOR TV** — No. 72—224 pages. Paper cover edition \$2.90. Hard cover edition \$4.60.

Answers all your questions on this up-and-coming new phase of servicing. You're going to be asked to service color sets soon. Make sure you're ready. Middleton covers chroma circuits, matrix testing, the flyback system, test equipment, techniques and all the other things you want to know about color servicing.

Special troubleshooting charts help you find tough troubles fast.

### SWEEP AND MARKER GENERATORS FOR TELEVISION AND RADIO—

No. 55—224 pages. Paper cover edition \$2.90. Hard cover edition \$4.60.

Another Middleton "ace." Takes you behind the dials of these instruments and shows you what makes them tick, their uses and limitations. Learn about the importance of flatness of output from a sweep generator and other considerations in the effective application of generators in alignment work and other complex servicing problems! Get this book now—make sure your generators are doing all they can for you.

See your distributor or use this coupon

Gernsback Library, Inc. Dept. 29

154 West 14th Street, New York 11, New York

My remittance of \$\_\_\_\_\_ is enclosed.

Please send me the books checked below postpaid.

No. 65 Servicing Color TV

Hard cover ed. \$4.60  Paper cover ed. \$2.90

No. 55 Sweep and Marker Generators

Hard cover ed. \$4.60  Paper cover ed. \$2.90

name \_\_\_\_\_

please print

street \_\_\_\_\_

city \_\_\_\_\_ zone \_\_\_\_\_ state \_\_\_\_\_

RADIO-ELECTRONICS

## TELEVISION

decay of the square wave corresponding to the red bar. You may also find this fault in the green matrix. Follow the distorted waveforms back through the I and Q channels with the probe and scope. Note the first point at which this distorted square wave appears. Then, check out the individual circuit components in the faulty circuit.

### Poor picture

A Sentinel 3V500 came into the shop with a complaint of poor picture. The if strip is out of alignment. I can adjust the if coils to get a peaked response curve with about a 2-mc bandwidth, but picture and sound are not good (see Fig. 6). I find it impossible to align according to specifications. All if components check out OK.—S. H., Arlington, Minn.

This is a fairly common difficulty, and there are several possible causes which must be eliminated one by one.

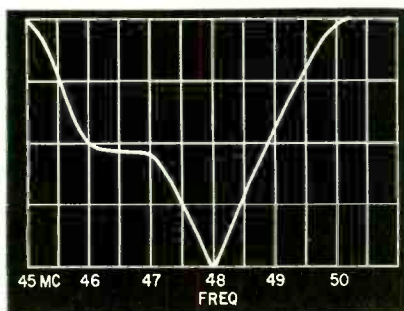

Fig. 6—The if response curve has a stubborn, sharp peak and inadequate bandwidth. Possible causes of regeneration should be checked.

A sharp peak in the response curve points to regeneration. If the override bias is increased during alignment, the peak usually disappears and a fairly normal curve can be obtained. But when the bias is reduced, the peak pops right up again. It can be caused by use of incorrect high-frequency grounding points when replacing bypass capacitors or if coils. Poorly soldered ground connections or disturbed high-frequency lead dress can also be responsible. Bypass capacitors which are not open but which have low capacitance are sometimes the culprit. Sometimes the leads on replacement capacitors are left too long. Heater wiring is critical in some cases. It should be dressed closely against the chassis. Sometimes a replacement tube has been used which has too high  $g_m$  for the circuit.

### Sync buzz

A Motorola TS-174-B has a stubborn sync buzz. The brightness and contrast controls must be full on to get a fair picture, and some channels are washed out. The buzz changes with the setting of the fine tuning. Traps were adjusted and a new crystal diode installed. Tubes, including the picture tube, are presumably good.—J. R. Z., Aliquippa, Pa.

Sync buzz is often caused by misalignment. It is advisable to use a  
(Continued on page 108)

General Instrument has  
the **RIGHT RECTIFIER**  
for every TV set

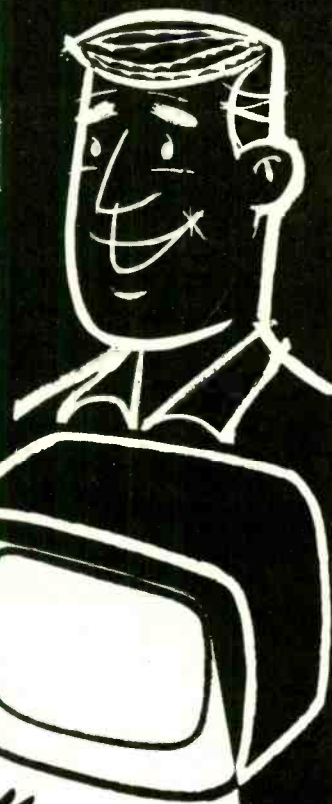

**AUTOMATIC**  
**PT5 Silicon**  
**RECTIFIERS**

**RADIO RECEPTOR**

**Selenium**  
**RECTIFIERS**



Don't be fooled by an "all or nothing at all" approach. Selenium and Silicon rectifiers both have a place in today's TV sets . . . and General Instrument supplies the very best!

Radio Receptor "Safe Center" selenium rectifiers have proved their reliability and long life in millions of circuits through the years. When your replacement calls for *selenium* there is no better rectifier.

AUTOMATIC PT5 Silicon rectifiers are the first choice of leading TV set manufacturers switching to silicon in their new models. When replacing or converting to *silicon*, install the PT5 for maximum performance and picture brightness.

Both these outstanding rectifiers are brought to you by GENERAL INSTRUMENT, your finest source of semiconductor components!

General Instrument Distributor Division  
**RADIO RECEPTOR COMPANY, INC.**  
Subsidiary of General Instrument Corporation  
240 Wythe Avenue, Brooklyn 11, N. Y. EVergreen 8-6000



SUPERIOR'S NEW MODEL TW-11

# STANDARD PROFESSIONAL TUBE TESTER



- ★ Tests all tubes, including 4, 5, 6, 7, Octal, Lock-in, Hearing Aid, Thyatron, Miniatures, Sub-miniatures, Novals, Sub-minars, Proximity fuse types, etc.
- ★ Uses the new self-cleaning Lever Action Switches for individual element testing. Because all elements are numbered according to pin-number in the RMA base numbering system, the user can instantly identify which element is under test. Tubes having tapped filaments and tubes with filaments terminating in more than one pin are truly tested with the Model TW-11 as any of the pins may be placed in the neutral position when necessary.
- ★ The Model TW-11 does not use any combination type sockets. Instead individual sockets are used for each type of tube. Thus it is impossible to damage a tube by inserting it in the wrong socket.
- ★ Free-moving built-in roll chart provides complete data for all tubes. All tube listings printed in large easy-to-read type.
- ★ NOISE TEST: Phono-jack on front panel for plugging in either phones or external amplifier will detect microphonic tubes or noise due to faulty elements and loose internal connections.

### EXTRAORDINARY FEATURE

SEPARATE SCALE FOR LOW-CURRENT TUBES. Previously, on emission-type tube testers, it has been standard practice to use one scale for all tubes. As a result, the calibration for low-current types has been restricted to a small portion of the scale. The extra scale used here greatly simplifies testing of low-current types.

The Model TW-11 operates on 105-130 Volt 60 Cycles A.C. Comes housed in a beautiful hand-rubbed oak cabinet complete with portable cover.

**\$47<sup>50</sup>**  
NET

Model TW-11—TUBE TESTER . . . Total Price \$47.50—Terms: \$11.50 after 10 day trial, then \$6.00 per month for 6 months if satisfactory. Otherwise return, no explanation necessary!

SUPERIOR'S NEW MODEL 82A



# Multi-Socket Type TUBE TESTER

## TEST ANY TUBE IN 10 SECONDS FLAT!

- 1 Turn the filament selector switch to position specified.
- 2 Insert tube into a numbered socket as designated on our chart (over 600 types included).
- 3 Press down the quality button —

**THAT'S ALL!** Read emission quality direct on bad-good meter scale.

Model 82A — TUBE TESTER . . . Total Price \$36.50 — Terms: \$6.50 after 10 day trial, then \$6.00 monthly for 5 months if satisfactory. Otherwise return, no explanation necessary.

Primarily, the difference between the conventional tube tester and the multi-socket type is that in the latter, the use of an added number of specific sockets (for example, in Model 82A the noval is duplicated eight times) permits elimination of element switches thus reducing testing time and possibility of incorrect switch readings.

To test any tube, you simply insert it into a numbered socket as designated, turn the filament switch and press down the quality switch—THAT'S ALL! Read quality on meter. Inter-element leakage, if any indicates automatically.

Production of this Model was delayed a full year pending careful study by Superior's engineering staff of this new method of testing tubes. Don't let the low price mislead you! We claim Model 82A will outperform similar looking units which sell for much more — and as proof, we offer to ship it on our examine before you buy policy.

### ...FEATURES...

- Tests over 600 tube types.
- Tests O24 and other gas-filled tubes.
- Employs new 4" meter with sealed air-damping chamber resulting in accurate vibrationless readings.
- Use of 22 sockets permits testing all popular tube types and prevents possible obsolescence.
- Dual Scale meter permits testing of low current tubes.
- 7 and 9 pin straighteners mounted on panel.
- All sections of multi-element tubes tested simultaneously.
- Ultra-sensitive leakage test circuit will indicate leakage up to 5 megohms.

Model 82A comes housed in handsome, portable, Saddle-Stitched Texon case. Only .....

**\$36<sup>50</sup>**  
NET

**SHIPPED ON APPROVAL**  
**NO MONEY WITH ORDER — NO C.O.D.**

Try for 10 days before you buy! If completely satisfied, send down payment after trial and pay balance at indicated monthly rate — **NO INTEREST OR FINANCE CHARGES ADDED.** If not completely satisfied, return to us, no explanation necessary.

SEE PAGE 107 FOR COMPLETE DETAILS

MOSS ELECTRONIC, INC.

3849 TENTH AVE., NEW YORK 34, N. Y.

SUPERIOR'S  
NEW MODEL 83

# C.R.T. TESTER

**Tests and Rejuvenates ALL PICTURE TUBES**

**ALL BLACK AND WHITE TUBES**

From 50 degree to 110 degree types—from 8" to 30" types.

**ALL COLOR TUBES**



Model 83—C.R.T. TUBE TESTER . . . Total Price \$38.50—Terms: \$8.50 after 10 day trial, then \$6.00 monthly for 5 months if satisfactory. Otherwise return, no explanation necessary!

Model 83 comes housed in handsome portable Saddle Stitched Texon case—complete with sockets for all black and white tubes and all color tubes. Only

**\$38<sup>50</sup>**

Test ALL picture tubes—in the carton—out of the carton—in the set!

- ✓ Model 83 is not simply a rehashed black and white C.R.T. Tester with a color adapter added. Model 83 employs a new improved circuit designed specifically to test the older type black and white tubes, the newer type black and white tubes and all color picture tubes.
- ✓ Model 83 provides separate filament operating voltages for the older 6.3 types and the newer 8.4 types.
- ✓ Model 83 employs a 4" air-damped meter with quality and calibrated scales.
- ✓ Model 83 properly tests the red, green and blue sections of color tubes individually—for each section of a color tube contains its own filament, plate, grid and cathode.
- ✓ Model 83 will detect tubes which are apparently good but require rejuvenation. Such tubes will provide a picture seemingly good but lacking in proper definition, contrast and focus. To test for such malfunction, you simply press the rej. switch of Model 83. If the tube is weakening, the meter reading will indicate the condition.

Rejuvenation of picture tubes is not simply a matter of applying a high voltage to the filament. Such voltages improperly applied can strip the cathode of the oxide coating essential for proper emission. The Model 83 applies a selective low voltage uniformly to assure increased life with no danger of cathode damage.

SUPERIOR'S NEW  
MODEL TV-12

# TRANS-CONDUCTANCE TUBE TESTER



Model TV-12—TUBE TESTER . . . Total Price \$72.50—Terms: \$22.50 after 10 day trial, then \$10.00 monthly for 5 months if satisfactory. Otherwise return, no explanation necessary!

**ALSO TESTS  
TRANSISTORS!**

## TESTING TUBES

- ★ Employs improved TRANS-CONDUCTANCE circuit. An in-phase signal is impressed on the input section of a tube and the resultant plate current change is measured. This provides the most suitable method of simulating the manner in which tubes actually operate in Radio & TV receivers, amplifiers and other circuits. Amplification factor, plate resistance and cathode emission are all correlated in one meter reading.
- ★ NEW LINE VOLTAGE ADJUSTING SYSTEM. A tapped transformer makes it possible to compensate for line voltage variations to a tolerance of better than 2%.
- ★ SAFETY BUTTON — protects both the tube under test and the instrument meter against damage due to overload or other form of improper switching.
- ★ NEWLY DESIGNED FIVE POSITION LEVER SWITCH ASSEMBLY. Permits application of separate voltages as required for both plate and grid of tube under test, resulting in improved Trans-Conductance circuit.

## TESTING TRANSISTORS

A transistor can be safely and adequately tested only under dynamic conditions. The Model TV-12 will test all transistors in that approved manner, and quality is read directly on a special "transistor only" meter scale.

The Model TV-12 will accommodate all transistors including NPN's, PNP's, Photo and Tetrades, whether made of Germanium or Silicon, either point contact or junction contact types.

**\$72<sup>50</sup>**  
NET

Model TV-12 housed in handsome rugged portable cabinet sells for only

**SHIPPED ON APPROVAL**  
**NO MONEY WITH ORDER—NO C.O.D.**

Try for 10 days before you buy! If completely satisfied, send down payment after trial and pay balance at indicated monthly rate — NO INTEREST OR FINANCE CHARGES ADDED. If not completely satisfied, return to us, no explanation necessary.

SEE PAGE 107 FOR COMPLETE DETAILS

MOSS ELECTRONIC, INC.

3849 TENTH AVE., NEW YORK 34, N. Y.

SUPERIOR'S NEW MODEL 77

# VACUUM TUBE VOLTMETER

**WITH NEW 6" FULL-VIEW METER**



Model 77—VACUUM TUBE VOLTMETER  
 . . . Total Price \$42.50—Terms: \$12.50 after  
 10 day trial, then \$6.00 monthly for 5  
 months if satisfactory. Otherwise return,  
 No explanation necessary!

- Compare it to any peak-to-peak V. T. V. M. made by any other manufacturer at any price!
- ✓ Model 77 completely wired and calibrated with accessories (including probe, test leads and portable carrying case) sells for only \$42.50.
- ✓ Model 77 employs a sensitive six inch meter. Extra large meter scale enables us to print all calibrations in large easy-to-read type.
- ✓ Model 77 uses new improved SICO printed circuitry.
- ✓ Model 77 employs a 12AU7 as D.C. amplifier and two 9006's as peak-to-peak voltage rectifiers to assure maximum stability.
- ✓ Model 77 uses a selenium-rectified power supply resulting in less heat and thus reducing possibility of damage or value changes of delicate components.
- ✓ Model 77 meter is virtually burn-out proof. The sensitive 400 microampere meter is isolated from the measuring circuit by a balanced push-pull amplifier.
- ✓ Model 77 uses selected 1% zero temperature coefficient resistors as multipliers. This assures unchanging accurate readings on all ranges.

**SPECIFICATIONS**

• DC VOLTS — 0 to 3/15/75/150/300/750/1,500 volts at 11 megohms input resistance. • AC VOLTS (RMS) — 0 to 3/15/75/150/300/750/1,500 volts. • AC VOLTS (Peak to Peak) — 0 to 8/40/200/400/800/2,000 volts. • ELECTRONIC OHMMETER — 0 to 1,000 ohms/10,000 ohms/100,000 ohms/1 megohm/10 megohms/100 megohms/1,000 megohms. • DECIBELS — -10 db to + 18 db, + 10 db to + 38 db, + 30 db to + 58 db. All based on 0 db = .006 watts (6 mw) into a 500 ohm line (1.73v). • ZERO CENTER METER — For discriminator alignment with full scale range of 0 to 1.5/7.5/37.5/150/375/750 volts at 11 megohms input resistance.

AS A DC VOLTMETER: The Model 77 is indispensable in Hi-Fi Amplifier servicing and a must for Black and White and color TV Receiver servicing where circuit loading cannot be tolerated.

AS AN AC VOLTMETER: Measures RMS values if sine wave, and peak-to-peak value if complex wave. Pedestal voltages that determine the "black" level in TV receivers are easily read.

AS AN ELECTRONIC OHMMETER: Because of its wide range of measurement leaky capacitors show up glaringly. Because of its sensitivity and low loading, intermittents are easily found, isolated and repaired.

Model 77 comes complete with operating instructions, probe and test leads. Use it on the bench—use it on calls. A streamlined carrying case, included at no extra charge, accommodates the tester, instruction book, probe and leads. Operates on 110-120 volt 60 cycle. Only

**\$42<sup>50</sup>**  
NET

SUPERIOR'S NEW MODEL 79

## SUPER-METER — WITH NEW 6" FULL-VIEW METER

*A Combination* VOLT-OHM MILLIAMMETER.

*Plus* CAPACITY, REACTANCE, INDUCTANCE AND DECIBEL MEASUREMENTS.

*Also Tests* SELENIUM AND SILICON RECTIFIERS, SILICON AND GERMANIUM DIODES.



Model 79—SUPER-METER . . . Total Price \$38.50—Terms: \$8.50 after 10 day trial, then \$6.00 per month for 5 months if satisfactory. Otherwise return, no explanation necessary!

The Model 79 represents 20 years of continuous experience in the design and production of SUPER-METERS, an exclusive SICO development.

In 1938 Superior Instruments Co. designed its first SUPER-METER, Model 1150. In 1940 it followed with Model 1250 and in succeeding years with others including Models 670 and 670-A. All were basically V.O.M.'s with extra services provided to meet changing requirements.

Now, Model 79, the latest SUPER-METER includes not only every circuit improvement perfected in 20 years of specialization, but in addition includes those services which are "musts" for properly servicing the ever increasing number of new components used in all phases of today's electronic production. For example with the Model 79 SUPER-METER you can measure the quality of selenium and silicon rectifiers and all types of diodes—components which have come into common use only within the past five years, and because this latest SUPER-METER necessarily required extra meter scale, SICO used its new full-view 6-inch meter.

Model 79 comes complete with operating instructions and test leads. Use it on the bench—use it on calls. A streamlined carrying case included at no extra charge accommodates the tester, instruction book and test leads. Only

*Specifications*

D.C. VOLTS: 0 to 7.5/15/75/150/750/1,500.  
 A.C. VOLTS: 0 to 15/30/150/300/1,500/3,000.  
 D.C. CURRENT: 0 to 1.5/15/150 Ma. 0 to 1.5/15 Amperes.  
 RESISTANCE: 0 to 1,000/100,000 Ohms. 0 to 10 Megohms.  
 CAPACITY: 001 to 1 Mfd. 1 to 50 Mfd.  
 REACTANCE: 50 to 2,500 Ohms, 2,500 Ohms to 2.5 Megohms.  
 INDUCTANCE: .15 to 7 Henries, 7 to 7,000 Henries.  
 DECIBELS: -6 to +18, +14 to +38, +34 to +58.

The following components are all tested for QUALITY at appropriate test potentials. Two separate BAD-GOOD scales on the meter are used for direct readings.

All Electrolytic Condensers from 1 MFD to 1000 MFD.  
 All Selenium Rectifiers. All Germanium Diodes.  
 All Silicon Rectifiers. All Silicon Diodes.

**\$38<sup>50</sup>**  
NET

**SHIPPED ON APPROVAL**  
**NO MONEY WITH ORDER — NO C.O.D.**

Try for 10 days before you buy! If completely satisfied, send down payment after trial and pay balance at indicated monthly rate — **NO INTEREST OR FINANCE CHARGES ADDED.** If not completely satisfied, return to us, no explanation necessary.

See following page for complete details

MOSS ELECTRONIC, INC.

3849 TENTH AVE., NEW YORK 34, N. Y.



**SUPERIOR'S NEW MODEL TV-50A**

# GENOMETER

## 7 Signal Generators in One!

- ✓ R.F. Signal Generator for A.M.
- ✓ R.F. Signal Generator for F.M.
- ✓ Audio Frequency Generator
- ✓ Bar Generator
- ✓ Cross Hatch Generator
- ✓ Color Dot Pattern Generator
- ✓ Marker Generator

A versatile all-inclusive GENERATOR which provides ALL the outputs for servicing:  
**A.M. Radio • F.M. Radio • Amplifiers • Black and White TV • Color TV**

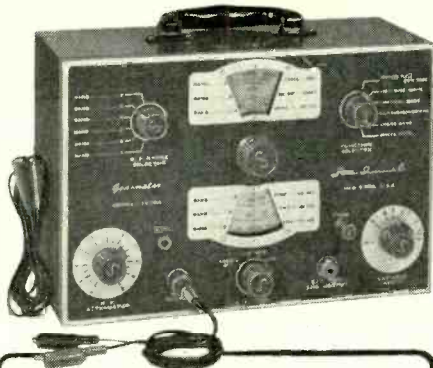

**Model TV-50A GENOMETER . . . Total Price \$47.50—Terms: \$11.50 after 10 day trial, then \$6.00 monthly for 6 months if satisfactory. Otherwise return, no explanation necessary!**

### Specifications

**R. F. SIGNAL GENERATOR:** The Model TV-50A Genometer provides complete coverage for A.M. and F.M. alignment. Generates Radio Frequencies from 100 Kilocycles to 60 Megacycles on fundamentals and from 60 Megacycles to 180 Megacycles on powerful harmonics.

**VARIABLE AUDIO FREQUENCY GENERATOR:** In addition to a fixed 400 cycle sine-wave audio, the Model TV-50A Genometer provides a variable 300 cycle to 20,000 cycle peaked wave audio signal.

The Model TV-50A comes complete with shielded leads and operating instructions. Only

**BAR GENERATOR:** The Model TV-50A projects an actual Bar Pattern on any TV Receiver Screen. Pattern will consist of 4 to 16 horizontal bars or 7 to 20 vertical bars.

**CROSS HATCH GENERATOR:** The Model TV-50A Genometer will project a cross-hatch pattern on any TV picture tube. The pattern will consist of non-shifting, horizontal and vertical lines interlaced to provide a stable cross-hatch effect.

**DOT PATTERN GENERATOR (FOR COLOR TV)** Although you will be able to use most of your regular standard equipment for servicing Color TV, the one addition which is a "must" is a Dot Pattern Generator. The Dot Pattern projected on any color TV Receiver tube by the Model TV-50A will enable you to adjust for proper color convergence.

**MARKER GENERATOR:** The Model TV-50A includes all the most frequently needed marker points. The following markers are provided: 189 Kc., 262.5 Kc., 456 Kc., 600 Kc., 1000 Kc., 1400 Kc., 1800 Kc., 2000 Kc., 2500 Kc., 3579 Kc., 4.5 Mc., 5 Mc., 10.7 Mc., (3579 Kc. is the color burst frequency).

**\$47.50 NET**

**For the first time ever: ONE TESTER PROVIDES ALL THE SERVICES LISTED BELOW!**

**SUPERIOR'S NEW MODEL 76**

# ALL PURPOSE BRIDGE

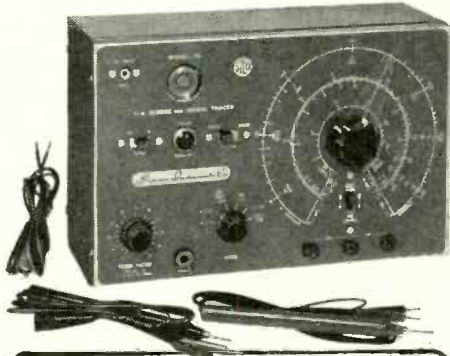

**Model 76 . . . Total Price \$26.95—Terms: \$6.95 after 10 day trial, then \$5.00 monthly for 4 months if satisfactory. Otherwise return, no explanation necessary!**

### IT'S A CONDENSER BRIDGE

with a range of .00001 Microfarad to 1000 Microfarads (Measures power factor and leakage too.)

### IT'S A SIGNAL TRACER

which will enable you to trace the signal from antenna to speaker of all receivers and to finally pinpoint the exact cause of trouble whether it be a part or circuit defect.

#### CAPACITY BRIDGE SECTION

4 Ranges: .00001 Microfarad to 1000 Microfarads. Will also locate shorts and leaks up to 20 megohms. Measures the power factor of all condensers from .1 to 1000 Microfarads. (Power factor is the ability of a condenser to retain a charge and thereby filter efficiently.)

#### SIGNAL TRACER SECTION

With the use of the R.F. and A.F. Probes included with the Model 76, you can make stage gain measurements, locate signal loss in R.F. and Audio stages, localize faulty stages, locate distortion and hum, etc. Provision has been made for use of phones and meter if desired.

Model 76 comes complete with all accessories including R.F. and A.F. Probes, Test Leads and operating instructions. Nothing else to buy. Only

### IT'S A RESISTANCE BRIDGE

with a range of 100 ohms to 5 megohms

### IT'S A TV ANTENNA TESTER

The TV Antenna Tester section is used first to determine if a "break" exists in the TV antenna and if a break does exist the specific point (in feet from set) where it is.

#### RESISTANCE BRIDGE SECTION

2 Ranges: 100 ohms to 5 megohms. Resistance can be measured without disconnecting capacitor connected across it. (Except, of course, when the R C combination is part of an R C bank.)

#### TV ANTENNA TESTER SECTION

Loss of sync., snow and instability are only a few of the faults which may be due to a break in the antenna, so why not check the TV antenna first? 2 Ranges: 2' to 200' for 72 ohm coax and 2' to 250' for 300 ohm ribbon.

**\$26.95 NET**

# SHIPPED ON APPROVAL NO MONEY WITH ORDER — NO C. O. D.

**MOSS ELECTRONIC, INC.**  
 Dept. D-571 3849 Tenth Ave., New York 34, N. Y.

Please send me the units checked on approval. If completely satisfied I will pay on the terms specified with no interest or finance charges added. Otherwise, I will return after a 10 day trial positively cancelling all further obligation.

Name .....

Address .....

City ..... Zone ..... State .....

All prices net, F.O.B., N. Y. C.

- Model TW-11 Total Price \$47.50  
\$11.50 within 10 days. Balance \$6.00 monthly for 6 months.
- Model 82A Total Price \$36.50  
\$6.50 within 10 days. Balance \$6.00 monthly for 5 months.
- Model 83 Total Price \$38.50  
\$8.50 within 10 days. Balance \$6.00 monthly for 5 months.
- Model TV-12 Total Price \$72.50  
\$22.50 within 10 days. Balance \$10.00 monthly for 5 months.
- Model 77 Total Price \$42.50  
\$12.50 within 10 days. Balance \$6.00 monthly for 5 months.
- Model 79 Total Price \$38.50  
\$8.50 within 10 days. Balance \$6.00 monthly for 5 months.
- Model TV-50A Total Price \$47.50  
\$11.50 within 10 days. Balance \$6.00 monthly for 6 months.
- Model 76 Total Price \$26.95  
\$6.95 within 10 days. Balance \$5.00 monthly for 4 months.

a quarter-century of **PRECISION**\* know-how  
is now yours in

**P A C O**

quality electronic equipment in **KIT FORM**

FOR:

electronic hobbyists  
and amateur radio

hi-fi custom building  
and service

science education and  
technical schools

industrial testing and  
quality control

PACO is the only line of  
test instrument kits engi-  
neered and produced  
under the auspices of a  
leading test equipment  
and meter manufacturer.

and, you pay nothing  
extra for the convenience  
of buying PACO kits di-  
rectly from your own  
local parts distributor.

COMPARE PACO against  
any other kits for per-  
formance, appearance,  
ruggedness, ease of op-  
eration and simplicity of  
assembly and wiring.

COMPARE PACO's su-  
perbly detailed, step-by-  
step instruction manuals  
and giant size wiring dia-  
grams, against any you  
have ever seen.

SEE HOW PACO sets an  
entirely new standard in  
electronic instrument kit  
design and kit assembly  
instruction.

► Available and on display  
at leading  
electronic parts distributors.

► Write for free  
descriptive bulletin.

 <p><b>MODEL B-10</b> Battery Eliminator Kit • less than 0.3% ripple output • no external filters required Kit Net Price: .....\$41.95 Factory Wired: .....\$49.50</p>	 <p><b>MODEL S-55</b> Wideband 5" Oscilloscope • response DC to 5 Mc • push-pull V and H amplifiers Kit Net Price: .....\$87.50 Factory Wired: .....\$139.50</p>
 <p><b>MODEL C-20</b> Res-Cap-Ratio Bridge Kit • 10 mmfd to 2000 mfd • 1/2 ohm to 200 megohms Kit Net Price: .....\$20.95 Factory Wired: .....\$31.50</p>	 <p><b>MODEL T-60</b> Tube Checker Kit • full free-point lever selector system • built-in roll chart Kit Net Price: .....\$38.75 Factory Wired: .....\$54.50</p>
 <p><b>MODEL G-30</b> RF Signal Generator Kit • 160 Kc to 240 Mc in 8 bands • 120 Mc fundamental output Kit Net Price: .....\$28.50 Factory Wired: .....\$39.95</p>	 <p><b>MODEL T-65</b> Transistor and Crystal Diode Tester Kit • tests I<sub>CEO</sub>, gain, leakage, etc. • tests both p-n-p and n-p-n types Kit Net Price: .....\$39.95 Factory Wired: .....\$59.50</p>
 <p><b>MODEL M-40</b> High Sensitivity V-O-M Kit • 20,000 ohms/volt DC • 10,000 ohms/volt AC Kit Net Price: .....\$31.50 Factory Wired: .....\$37.50</p>	 <p><b>MODEL V-70</b> Vacuum Tube Voltmeter Kit • wide-range • peak-to-peak Kit Net Price: .....\$31.50 Factory Wired: .....\$47.50</p>
 <p><b>MODEL S-50</b> 5" Cathode Ray Oscilloscope Kit • push-pull vertical and horizontal amplifiers Kit Net Price: .....\$49.50 Factory Wired: .....\$84.50</p>	 <p><b>MODEL Z-80</b> RF-AF Signal Tracer Kit • high gain RF and AF amplifier • visual and audible indicator Kit Net Price: .....\$29.50 Factory Wired: .....\$42.50</p>

**P A C O** ELECTRONICS  
CO., INC.  
70-31 84th Street, Glendale 27, L. I., New York  
Export: 458 B'way, N. Y. 13, U.S.A., Canada: Atlas Radio Corp., Toronto 19.

\* A DIVISION OF **PRECISION** APPARATUS COMPANY, INC.

## TELEVISION

(Continued from page 103)

good sweep and marker generator, and put the rf and if sections in good alignment. Also check the ratio-detector alignment. If you need to go farther, check C52—this is the ratio-detector charging capacitor. Low capacitance or high power factor here can cause buzz. Since the sound signal is passed through the video amplifier, nonlinearity of amplifier operation can cause buzz. Your report does not give voltages, but these should be checked in the video amplifier circuit.

### Flyback replacement

*I have a Mirrortone chassis 9049 with a burnt-out horizontal output transformer. Could you tell me what transformer I can use and how to rewire the chassis?—E. B., Buffalo, N. Y.*

You can use a Stancor A-8144, Merit A-3038, Triad A-99X, Halldorson Z1802 or Thordarson 26553. You will have to drill one new mounting hole and connect the primary and secondary in series as an autotransformer. To connect the transformer, compare the schematic in the carton with the schematic diagram of the receiver, and wire accordingly.

### Vertical weaving

*A Stromberg-Carlson 119C shows a weaving vertically on network programs. There is no weaving on local programs. How can this trouble be localized?—A. M. D., Glen Burnie, Md.*

The weaving is caused by power hum which is not synchronized with the local utility frequency. The filtering is probably inadequate in the receiver, which causes a fairly high ripple in the plate supply voltages. Improving the power supply filtering will probably correct the trouble. There is also a possibility that 60-cycle hum is getting into the signal from a tube heater-cathode leak, or a circuit fault equivalent to it. However, first check the B-supply line with a scope. END

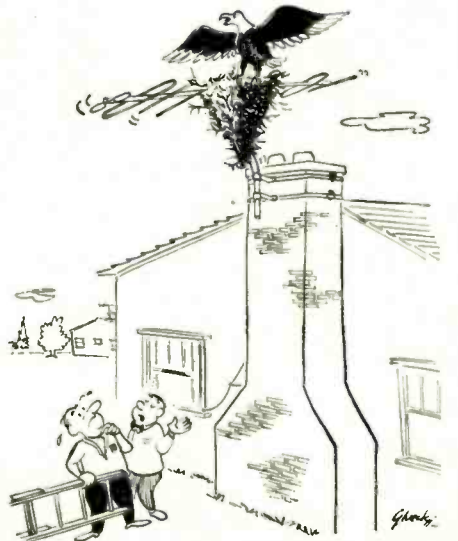

"You're the service technician—so you handle the problem!"

# new SOUND DETECTOR SYSTEM for TV



*This simplified FM demodulator circuit converts the signal to AM before detection*

By **ROBERT F. SCOTT**  
TECHNICAL EDITOR

**T**HE 1958 Hotpoint 14S208 and 14S209, 14-inch portable TV sets using the Q3 chassis, feature a radically different type of FM audio detection, called the *Delta Sound System*, that keeps cost down without degrading audio quality. In this system, the commonly used ratio detector, gated-beam and Foster-Seeley discriminators have been replaced by a circuit that converts the FM signal to AM before detection. A special circuit has been added to cancel out any AM interference or noise that may ride in on the FM carrier. The frequency discriminator used here is a time-rate demodulator—commonly called a slope detector. It produces an rf output voltage whose amplitude is directly proportional to the frequency swing of the FM signal. See Fig. 1.

Fig. 2-a shows the resonance curve of a parallel-tuned circuit. The voltage is maximum at resonance and falls off as frequency is shifted to either side of resonance. In slope detection of an FM signal, the circuit is adjusted so that the carrier frequency falls on the linear portion of one of the slopes—point A or B, for example. Now, as the frequency of the FM carrier varies

with modulation, the voltage across the tank circuit swings in amplitude. A linear swing of the FM carrier produces a linear change in the amplitude of the rf signal developed across the circuit. This is shown in Fig. 2-b.

Assume that the carrier at rest (4.5 mc) develops 10 volts. If it swings 10 kc to 4.49 mc and develops 15 volts, a 10-ke swing in the opposite direction to 4.51 mc will develop 5 volts across the circuit. Thus the voltage across the tank is converted from a constant-amplitude FM signal to an amplitude-modulated signal with the same carrier frequency. The resulting signal is then fed to any convenient type of AM detector for demodulation.

There are two good reasons why this simple discriminator is suitable for modern TV sets but not for tunable FM sets. First of all, the resonant tank responds to signals falling on either slope of the curve. The overall selectivity of the average receiver is not great enough to prevent interference from other incoming signals that may produce an intermediate frequency falling on the discriminator's curve.

This problem seldom exists in an intercarrier TV receiver because the

4.5-mc intercarrier sound signal is generated in the set's video detector as the result of the beat between the video and sound carriers and not the result of heterodyning a single incoming signal in the set's mixer. Also, the sound if response is sharper in a TV set than in an FM broadcast receiver because of the lower intermediate frequency and the narrower carrier TV sound swing.

Secondly, the desired FM carrier must be centered on a linear portion of the discriminator's curve to provide good linearity and distortion-free reception. In an FM receiver, slight mistuning or oscillator drift may cause the if signal to swing over a nonlinear portion of the discriminator curve and produce distortion. This doesn't happen in a TV receiver because the 4.5-mc carrier frequency is constant regardless of receiver tuning or oscillator drift.

## How the Delta Sound System works

In this circuit (Fig. 1), the 4.5-mc intercarrier sound carrier signal is tapped off the plate of the video amplifier and fed to the grid of the 4.5-mc sound if amplifier V108. The output of this amplifier is developed across the primary of T301, a bifilar-wound 4.5-mc

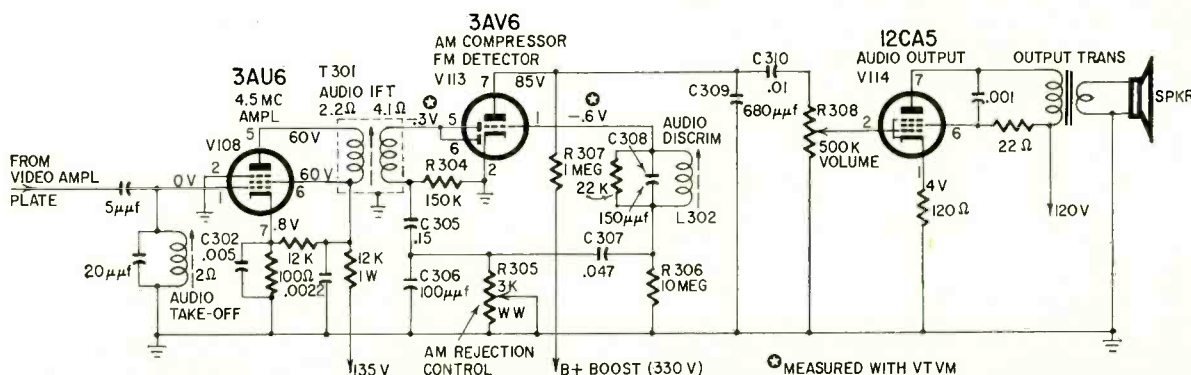
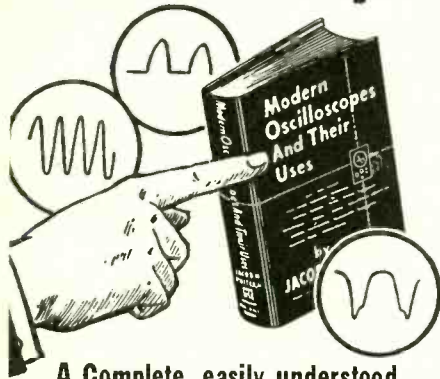

Fig. 1—Circuit of Delta Sound System used in two Hotpoint portable TV receivers.

# Here's how to GET MORE WORK OUT OF YOUR Oscilloscope!



A Complete, easily understood guide to using the handiest service instrument of them all

## MODERN OSCILLOSCOPES AND THEIR USES

By Jacob H. Ruiter, Jr.

### Enlarged 2nd Edition

... contains the latest data ... everything you need to know about 'scopes!

### MORE THAN 30 NEW PICTURES

... plus 50 more pages including data on quantitative measurements—the slickest method of diagnosing many color TV troubles and aligning sets properly.

it gets right down to "brass tacks" in explaining how oscilloscopes operate. Then you learn exactly how to use them in lab work and on all types of AM, FM and television service—from locating troubles to handling tough realignment jobs.

### 'SCOPES ARE "GOLD MINES"

When You Learn to Use Them Right!

Each operation is explained step by step. You learn to determine just where and how to use the 'scope on specific jobs; how to make connections and adjust circuit components; how to set the controls; and HOW TO ANALYZE PATTERNS fast and accurately.

370 illustrations including pattern photos make things doubly clear.

No other type of specific service training can mean so much to you in boosting your efficiency and earning power! Send coupon NOW for 10-day examination!



'SCOPE EXPERTS  
get better jobs  
... bigger pay!

### PRACTICE 10 DAYS—FREE!

Dept. RE-29, RINEHART & CO., Inc.  
232 Madison Ave., New York 16, N.Y.

Send MODERN OSCILLOSCOPES AND THEIR USES for 10-day FREE EXAMINATION. If book is satisfactory, I will then send you \$6.50 (plus postage) promptly in full payment. If not, I will return book postpaid and owe you nothing. (Save! Send \$6.50 cash with order and we pay postage. Same 10-day return privilege with money refunded.)

NAME .....

ADDRESS .....

CITY, ZONE, STATE .....

OUTSIDE U.S.A. \$7.00 cash only. 10-day Money-back guarantee

## TELEVISION

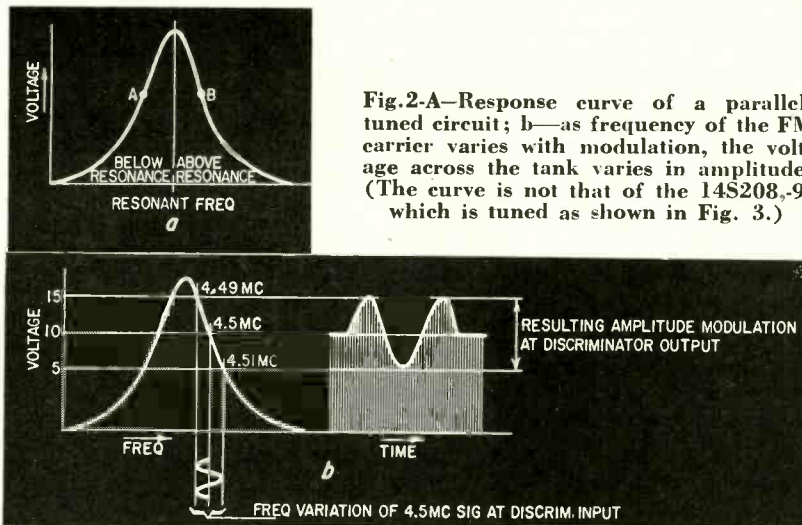

Fig. 2-A—Response curve of a parallel-tuned circuit; b—as frequency of the FM carrier varies with modulation, the voltage across the tank varies in amplitude. (The curve is not that of the 14S208.-9, which is tuned as shown in Fig. 3.)

if transformer. The signal voltage on the secondary side of T301 appears across the winding, C305 and the parallel combination of C306 and R305. The signal thus developed is applied to the diode (AM compressor) plates of V113.

When the diode is conducting, it loads the plate circuit of V108 and compresses the signal envelope, thus limiting the signal and reducing the percentage of modulation of any stray noise, sync pulses and automotive ignition interference that may appear as amplitude modulation on the 4.5-mc FM carrier.

The dc component of the rectified signal returns to the cathode of V113 and ground through R304. A small predetermined portion of the compressed FM carrier and any residual AM interference appear across C306. This signal is fed to the grid of V113 through coupling capacitor C307 and the 4.563-mc tank circuit (L302-C308).

The tank circuit and the input capacitance of the triode section of V113 form a discriminator whose resonant frequency is such that the 4.5-mc carrier falls on the linear portion of one of its slopes. See Fig. 3. As explained earlier, a linear deviation in carrier frequency produces a linear change in its amplitude. This 4.5-mc AM signal is applied to V113's grid.

During the first few cycles of the 4.5-mc AM signal, V113's triode acts as a grid detector, rectifying the signal in the grid-cathode circuit. Grid current flows through R306 and develops a voltage drop that charges C307 and biases the grid almost to cutoff. This is the correct condition for plate detection.

With the grid biased to cutoff, V113 now acts very much like a class-B amplifier. Positive swings of the 4.5-mc AM grid signal are amplified, producing pulses in the plate circuit. The average value of these 4.5-mc pulses corresponds to the modulation envelope. The 4.5-mc rf signal is bypassed to ground through C309 and the audio component is developed across plate load resistor R307. (The plate detector is also called a bias or power detector.)

The audio voltage developed in V113's plate circuit is applied to the volume control through C310. Filter capacitor C309, volume control R308, plate resistor R307 and V113's internal plate resistance together form a deemphasis network. The signal across the volume control is applied to the grid of the audio output tube V114 which develops 0.7 watt undistorted and 1 watt maximum output.

### Cancelling residual AM

The unwanted AM signal that remains on the 4.5-mc sound carrier after com-

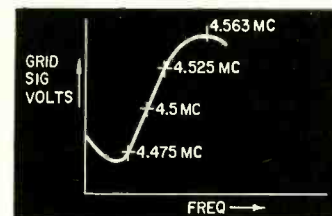

Fig. 3—A discriminator peaked at 4.563 mc lets the 4.5-mc carrier fall on the linear portion of the slope.

pression in V108's plate circuit is cancelled out so it does not appear in the output. Positive-going AM noise pulses on the FM sound carrier envelope are rectified by the compressor diode and appear as negative-going spikes across R305. These negative spikes are applied to V113's grid and produce positive-going pulses in the plate circuit.

Simultaneously, the original positive-going pulses on the carrier envelope produce negative-going pulses in the plate circuit of V113 when applied to the grid. Thus, interference on the FM carrier envelope produces simultaneous negative- and positive-going pulses in the detector output. The AM REJECTION CONTROL (R305) may be adjusted so the noise pulses at V113's plate are of equal amplitude so they cancel out and do not appear in the audio output. The control must never be set in the full clockwise position (resistance shorted out) because this will shunt the 4.5-mc signal to ground and prevent it from reaching the discriminator circuit. END

# STANDING WAVES and NO COLOR

By **ROBERT G. MIDDLETON**  
RADIO-ELECTRONICS TELEVISION CONSULTANT



*Fuzz runs into an unusual problem—color on some channels and none on another*

**W**HAT have you been doing for excitement lately?" asked Fuzzball, as he dropped into a chair near the door.

"It was a nice day," Bess replied. "What'll you have, boy?"

"Scramble two, on toast," Fuzz ordered.

Bess raised her voice 15 db. "Adam and Eve on a raft—wreck 'em!" she called to the cook.

Red set down his cup and leaned back grinning. "Bess learned her trade in the old school," he observed.

"Say, Red."

"Shoot."

"You'll figure I'm off my rocker when I tell you about this one."

"Now where would I ever get that idea?" Red asked innocently.

"I been beating the devil around the stump so long on that saloon job that I've just about had it."

"What's the general complaint?"

"Well, on the rainbow generator, the set works OK. Get a good pattern. On channel 5 the color broadcast comes in OK. But on 2 I get black-and-white with no color."

An amused smile spread over Red's face.

"What are you using for an antenna—a wet finger?" he asked.

"Try again," Fuzz replied. "We got a conical on the roof of the saloon."

"Conical's a good one for color in this area," Red agreed. "Well, maybe you might have noticed something, and again maybe you didn't."

"Such as?"

"Can you get color on 2 if you slide a hunk of tinfoil along the lead-in, or trim it to a critical length?"

"I never thought to try," Fuzzball replied.

"Do you see what I'm driving at?" asked Red.

"I'd make a wild guess you're hinting that there's standing waves on the lead-in."

"Eggsactly," Red replied, "and you can eat your eggs now, if you want to—Bess brought 'em, you know."

"No. I didn't know," Fuzz admitted, "you got me so confused."

"You're confused over a case of standing waves?" Red groaned.

"I'm buffaloed," Fuzzball admitted.

"Maybe I should draw you a diagram," Red suggested. "But here's the pitch. If the front end doesn't match the lead-in, there's going to be reflections back from the set. Then, if the antenna don't match the lead-in, there's re-reflections from the antenna. Take a bad case, with certain lengths of lead-in, and the color signal gets cancelled out. Now do you see the picture?"

Fuzzball's fork stopped halfway to his mouth. "I got you, Red," he replied. "The color signal can get knocked down without knocking the black-and-white signal."

"Absolutely! You'll even see cases where the contrast is built up on the black-and-white, and the color signal is weakened so much that the color killer won't kick out."

"I suppose I could put in a new tuner strip on 2," Fuzz suggested.

"Probably would help some," Red agreed. "But quite a bit depends on the signal strength, too, with some of these tuners."

"What's signal strength got to do with it?" Fuzzball demanded.

"Simply this," explained Red. "A weak signal puts little or no a/c bias on the rf amplifier, but a strong signal puts a high bias on the grid."

"So tell me something I don't know," Fuzz replied scornfully.

"Now hear this," grinned Red, "the input impedance of the rf amplifier tube depends on the grid bias unless the stage is neutralized."

"What are you trying to tell me, then?"

"Well, if the input impedance of the tube goes up or down, that impedance is reflected back through the coupling coils to the input terminals of the set."

"That makes sense," Fuzzball admitted.

"Glad I'm getting through to you," Red replied.

"If the input impedance don't stay put, then it's impossible to cure the trouble," Fuzzball suggested.

## Use a pad

"Not at all," Red replied. "In fact, it's usually very easy. On a strong signal, you can cure an impedance symptom by padding the lead-in. Hand me that napkin. I'll sketch a couple pads and their formulas."

"I never thought of that," Fuzz mused.

"Some resistor outfits make neat little 300-ohm H-pads to give 3-, 6-, 12-, and 15-db losses," Red advised him. "Printed circuit."

"Just one thing," Fuzz protested.

"What's that?"

"There's a couple channels where the set wouldn't take much of any loss."

# SHIPPED ON APPROVAL

## an IN-CIRCUIT CONDENSER TESTER THAT DOES THE WHOLE JOB!

The CT-1 actually steps in and takes over where all other in-circuit condenser testers fail. The ingenious application of a dual bridge principle gives the CT-1 a tremendous range of operation . . . and makes it an absolute 'must' for every serviceman.

### IN-CIRCUIT CONDENSER TESTER Model CT-1



Model CT-1—housed in sturdy hammer-tone finish steel case complete with test leads...only **\$34<sup>50</sup>** Net

#### in-circuit checks:

- ✓ Quality of over 80% of all condensers even with circuit shunt resistance present . . . (leakage, shorts, opens, intermittents)
- ✓ Value of all condensers from 200 mmfd. to .5 mfd.
- ✓ Quality of all electrolytic condensers (the ability to hold a charge)
- ✓ Transformer, socket and wiring leakage capacity

#### out-of-circuit checks:

- ✓ Quality of 100% of all condensers . . . (leakage, shorts, opens and intermittents)
- ✓ Value of all condensers from 50 mmfd. to .5 mfd.
- ✓ Quality of all electrolytic condensers (the ability to hold a charge)
- ✓ High resistance leakage up to 300 megohms
- ✓ New or unknown condensers . . . transformer, socket, component and wiring leakage capacity

#### OUTSTANDING FEATURES

- Ultra-sensitive 2 tube drift-free circuitry
- Multi-color direct scale precision readings for both quality and value . . . (in-circuit or out of circuit)
- Simultaneous readings of circuit capacity and circuit resistance
- Built-in hi-leakage indicator sensitive to over 300 megohms
- Cannot damage circuit components
- Electronic eye balance indicator for even greater accuracy
- Isolated power line

## TRANSISTOR TESTER Model TT-2

Every day more and more manufacturers are using transistors in home portable and car radios . . . in hearing aids, intercoms, amplifiers, industrial devices, etc. Since transistors go bad the need for TRANSISTOR TESTER is great. They can

develop excessive leakage, poor gain, shorts or opens. The TT-2 is an inexpensive quality instrument designed for accurate and dependable tests of all transistors and diodes — quickly and accurately.

#### OUTSTANDING FEATURES

- Checks all transistors, including car radio, power output, triode, tetrode and unijunction types for current gain, leakage, opens, shorts, cut-off current
- Checks all diodes for forward to reverse current gain
- All tests can be made even if manufacturers' rated gain is not available
- Less than half a minute required for tests of either transistors or diodes
- Large 3" meter is extremely sensitive yet rugged . . . with multi-color scales designed for quick easy readings
- Power is supplied by an easy to replace 6-volt battery — current drain so small, service life almost equal to shelf life. Battery cannot be drained due to accidental shorting of test leads
- Cannot burn-out its own meter or damage transistor or diode under test
- Long test leads and insulated test clips enable tests without entirely removing transistor from circuit
- Test leads are identified by E.I.A. color code so that connection to the correct terminal is assured
- Comes complete with replaceable transistor set-up chart that fits into a special rear compartment.

**IMPORTANT FEATURE:** The TT-2 cannot become obsolete as the circuitry is engineered to enable you to check all new type transistors as they are introduced. New listings will be furnished at no cost.

## Check all power rectifiers in-circuit

whether SELENIUM,  
GERMANIUM,  
SILICON, etc.

### with the IN-CIRCUIT RECTIFIER TESTER Model SRT-1



Model SRT-1—housed in sturdy hammer-tone finish steel case complete with test leads.....only **\$29<sup>50</sup>** Net

With the growing trend towards compactness, portability and low price, TV manufacturers are resorting more and more to producing series-string TV sets employing selenium, germanium or silicon power rectifiers. Now the need for an in-circuit rectifier tester is greater than ever.

#### THE SRT-1 CHECKS ALL POWER RECTIFIERS IN-CIRCUIT AND OUT-OF-CIRCUIT WITH 100% EFFECTIVENESS FOR:

- ✓ Quality ✓ Fading ✓ Shorts ✓ Opens ✓ Arcing ✓ Life Expectancy

#### OUTSTANDING FEATURES

- Checks all types of power rectifiers rated from 10 ma. to 500 ma. (selenium, germanium, silicon, etc.) both in-circuit or out-of-circuit.
- Will not blow fuses even when connected to a dead short.
- Large 3" highly accurate multi-color meter . . . sensitive yet rugged.
- Separate meter scales for in-circuit and out-of-circuit tests.
- Cannot damage or over heat rectifier being tested.

#### SIMPLE TO OPERATE

Just clip SRT-1 test leads across rectifier under test right in the circuit without disconnecting rectifier from circuit. Press test switch and get an instant indication on the easy-to-read three-color meter scales . . .

#### ALL CENTURY INSTRUMENTS ARE GUARANTEED FOR ONE FULL YEAR

The extremely low prices are made possible because you are buying direct from the manufacturer.



Model TT-2—housed in sturdy hammer-tone finish steel case complete with test leads . . . only

**\$24<sup>50</sup>** Net

**EASY TO BUY IF SATISFIED**  
see order form on facing page

# FOR 10 DAY FREE TRIAL

try them for 10 days before you buy . . . only then, when satisfied, pay in easy-to-buy monthly installments — without any financing or carrying charges added.

## STILL THE BEST SELLING TUBE TESTER IN THE FIELD FAST-CHECK TUBE TESTER

Model FC-2



The greatest testimonial ever paid an instrument . . . over 20,000 sold in a little more than a year—and still selling as fast as we can produce them. See for yourself at no risk why so many service-men choose the FAST-CHECK above all other tube testers — regardless of price.

Model FC-2 — housed in hand-rubbed oak carrying case complete with CRT adapter . . . only

**\$69.50**  
Net

SIZE: W: 14<sup>5</sup>/<sub>8</sub>"  
H: 11<sup>1</sup>/<sub>4</sub>" D: 4<sup>3</sup>/<sub>8</sub>"

Just 2 settings on the FAST-CHECK TUBE TESTER tests over 700 tube types completely, accurately — AND IN SECONDS!

### PICTURE TUBE TEST ADAPTER INCLUDED WITH FAST-CHECK

Enables you to check all picture tubes (including the new short-neck 110 degree type) for cathode emission, shorts and life expectancy . . . also to rejuvenate weak picture tubes. No other tube tester made at any price can match the value of the FAST-CHECK.

### RANGE OF OPERATION

- ✓ Checks quality of over 700 tube types, employing the time proven dynamic cathode emission test. This covers more than 99% of all tubes in use today, including the newest series-string TV tubes, auto 12 plate-volt tubes, OZ4s, tubes, auto 12 plate-volt tubes, special magic eye tubes, gas regulators, special purpose hi-fi tubes and even foreign tubes.
- ✓ Checks for inter-element shorts and leakage.
- ✓ Checks for gas content.
- ✓ Checks for life-expectancy.

### IMPORTANT FEATURES

- No time consuming multiple switching . . . only two settings are required instead of banks of switches on conventional testers
  - No annoying roll chart checking . . . tube chart listing over 700 tube types is located inside cover. New listings are added without costly roll chart replacement
  - Checks each section of multi-section tubes and if only one section is defective the tube will read "Bad" on the meter scale
  - 41 phosphor bronze beryllium tube sockets never need replacement
  - 7-pin and 9-pin straighteners mounted on panel
  - Large 4<sup>1</sup>/<sub>2</sub>" D'Arsonval type meter is the most sensitive available, yet rugged — fully protected against accidental burn-out
  - Special scale on meter for low current tubes
  - Compensation for line voltage variation
  - 12 filament positions
  - Separate gas and short jewel indicators
  - Line isolated — no shock hazards
  - Long lasting etched aluminum panel.
- NOTE: The Fast-Check positively cannot become obsolete . . . circuitry is engineered to accommodate all future tube types as they come out. New tube listings are furnished periodically at no cost.

NEW . . .

## For those looking for a real ECONOMY MULTIPLE SOCKET TUBE TESTER without sacrificing ACCURACY, SPEED and VERSATILITY MINI-CHECK TUBE TESTER

Model MC-1

Here is a multiple socket tube tester designed to meet limited budgets. Although low in price it boasts a unique circuitry that enables you to check over 600 tube types — and has a range of operation that far exceeds others in its price class.



Model MC-1 — housed in sturdy wrinkle finish steel case . . . only

**\$39.50**  
Net

SIZE: W: 9"  
H: 8<sup>1</sup>/<sub>2</sub>"  
D: 2<sup>3</sup>/<sub>4</sub>"

### OUTSTANDING FEATURES

- Checks emission, inter-element shorts and leakage of over 600 tube types. This covers OZ4s, series-string TV tubes, gas regulators, auto 12 plate volt, hi-fi and foreign tubes
- 3 settings enable a test of any tube in less than 10 seconds
- Employs dynamic cathode emission test principle
- D'Arsonval type meter — most accurate type available . . . its greater sensitivity means more accuracy . . . its jewel bearing sockets
- 17 long lasting phosphor bronze tube filament positions
- Combination gas and short jewel indicator
- 9 back compartment
- Handy tube chart contained in special at no cost
- New tube listings furnished periodically
- Detachable line cord

plus these BONUS FEATURES . . . found in no other low price tube tester

- ✓ Checks for cathode to heater shorts
- ✓ Checks for gas content
- ✓ Checks all sections of multiple purpose tubes . . . will pickup tubes with one "Bad" section
- ✓ Line isolated — no shock hazard
- ✓ Variable load control enables you to get accurate results on all tubes
- ✓ Positively cannot become obsolete as new tube types are introduced.

## CONVENIENT TIME PAYMENT PLAN — NO INTEREST OR FINANCING CHARGES

# CENTURY ELECTRONICS CO., INC.

### CHECK INSTRUMENTS DESIRED

- |                          |  |         |
|--------------------------|--|---------|
| <input type="checkbox"/> | Model CT-1 In-Circuit Condenser Tester . . . . .           | \$34.50 |
|                          | \$9.50 within 10 days. Balance \$5 monthly for 5 months.   |         |
| <input type="checkbox"/> | Model SRT-1 In-Circuit Rectifier Tester . . . . .          | \$29.50 |
|                          | \$4.50 within 10 days. Balance \$5 monthly for 5 months.   |         |
| <input type="checkbox"/> | Model TT-2 Transistor Tester . . . . .                     | \$24.50 |
|                          | \$4.50 within 10 days. Balance \$5 monthly for 4 months.   |         |
| <input type="checkbox"/> | Model FC-2 Fast-Check Tube Tester . . . . .                | \$69.50 |
|                          | \$14.50 within 10 days. Balance \$11 monthly for 5 months. |         |
| <input type="checkbox"/> | Model MC-1 Mini-Check Tube Tester . . . . .                | \$39.50 |
|                          | \$9.50 within 10 days. Balance \$6 monthly for 5 months.   |         |

Prices Net F.O.B. Mineola, N. Y.

111 Roosevelt Avenue, Dept. 102, Mineola, New York

Please rush the instruments checked for a 10 day free trial. If satisfied I agree to pay the down payment within 10 days and the monthly installments as shown. If not completely satisfied I will return the instruments within 10 days and there is no further obligation. It is understood there will be NO INTEREST or FINANCING charges added.

Name

Please print clearly

Address

City  State

# COLUMBIA CD the better stereo cartridge ... because it sounds better

There are many reasons why you'll find the Columbia Constant Displacement cartridge sounds better. It's superior in:

- LINEARITY
- SEPARATION
- COMFLANCE
- LOW MASS
- FREEDOM FROM HUM
- OUTPUT LEVEL
- RUGGEDNESS

Curves, facts and figures prove these advantages. But they all boil down to one simple fact. The Columbia CD stereo cartridge sounds better than other ceramic or magnetic cartridges.

Before you buy your stereo cartridge, ask your CBS-Hytron distributor to let you hear the Columbia CD. Discover for yourself the one thing that counts... the Columbia CD simply sounds better.



**COLUMBIA**

Model SC-1D  
Cost \$24.25

**CBS-HYTRON**, Danvers, Massachusetts  
A Division of Columbia Broadcasting System, Inc.

## TELEVISION

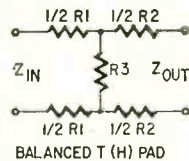

$$R1 = R2 = Z_{IN} \frac{\sqrt{K}-1}{\sqrt{K}+1}$$

$$R3 = \frac{2Z_{IN}\sqrt{K}}{K-1}$$

WHEN  $Z_{IN} = Z_{OUT}$  AND  $K = \frac{\text{POWER IN}}{\text{POWER OUT}}$

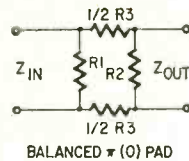

$$R1 = R2 = Z_{IN} \frac{\sqrt{K}+1}{\sqrt{K}-1}$$

The pads Red recommended. The resistors may be 1/4-watt or smaller when used in TV receiving antenna circuits.

"So, you mount your H-pad inside the turret—connect it just to the channel-2 strip."

"That's pretty clever," Fuzzball said, opening his eyes.

"Think so?" asked Red. "You'll find it's got whiskers," he replied acidly.

"But how does the blamed pad work on standing waves?" Fuzzball demanded.

"Look at it this way," Red suggested. "The signal has to go through the pad to get to the set. Cuts the signal down to half, we'll say, just to take a practical example. There is a reflected signal that goes back through the pad the other way. The reflected signal is cut down by half."

"I see it all, now," Fuzzball said excitedly. "The reflection is cut down half before it gets back to the antenna. Then, the re-reflection gets cut down half again, going back to the set."

"Absolutely right," Red agreed. "The re-reflection ends up much weaker in proportion to the desired signal. And there's another advantage, too."

"What's that?"

"The signal strength is half as strong at it was. The age bias decreases and the input impedance of the tuner changes. You get yourself a new operating point."

"So I could try out several different pads on a strong signal, to get normal color," Fuzzball suggested.

"Right again."

"What would I do if the signal is on the weak side and I run into standing-wave trouble?" Fuzz asked next.

"Then, you got to put in a better antenna and bring the signal up," Red advised.

"What about cutting the lead-in to a critical length, like you said before?" Fuzz queried.

"It's a sloppy way of getting the color in," Red replied, "and we would never do it unless the set owner is tighter than the bark on a tree and won't buy the right antenna."

"What's your reason?" Fuzzball asked with a puzzled look.

"Lead-ins that work only at a critical length are always troublemakers," Red advised him. "Get a stiff wind, and the color is likely to pop in and out of the picture. Any change in the operating conditions and you've had it."

"I see what you mean," Fuzzball agreed. "I always figured that imped-

ance matching was a bit of a joke."

"It's a lesser evil in black-and-white reception," Red replied, "but when it raises its ugly head in color TV you can have yourself a problem."

"That brings up something else," Fuzz remarked, "sort of along the same line. On a black-and-white program, the picture can be real lousy and nobody complains much. But when color comes on, they squeal like a stuck pig if there's just a little distortion in the image."

"Not all our customers," Red corrected him, "but there is a definite percentage of them that react just like you say."

"Maybe those extra-fussy ones will quiet down after they get used to color," Fuzzball suggested.

"Yes and no," Red replied. "Some of it is due to the novelty of color, of course. These people will be perfectly satisfied with a Technicolor movie, and then turn around and squawk if the color TV show isn't just as good or better. Then, on the other hand, there's a built-in human demand for perfection in color pictures. Ever do any color photography?"

"A little," Fuzzball admitted.

"How do you like your shots?" Red asked.

"To tell you the strict truth," Fuzzball replied, "there's always something somewhere in the picture that doesn't look quite natural to me."

"OK, guinea pig," Red replied, "so you see how it is."

"But I still like my color photos," Fuzzball protested.

"Of course," Red replied, "and our fussy customers will still like color TV shows when they understand these things."

"They should know that nothing is perfect in this world, and probably won't be in the next one either."

"You said a mouthful," Red agreed.

"But we shouldn't use that as an excuse to cover up for ourselves," Fuzzball suggested.

"You're in the right ballpark," Red agreed quickly. "We must never be satisfied with our own performance. Each day on the job, we got to try to do better than we did yesterday."

"Can't I ever sit back and coast a little?" asked Fuzzball plaintively.

"Look, buddy," Red said sharply, "you don't stand still in this racket. The minute you think you're standing still, you're just kidding yourself. You are really advancing to the rear, my friend."

"You're right, of course," Fuzz agreed. "This electronics business is moving so fast you can't even lie fast enough to keep up with it." Fuzz looked very smug.

"You could," Bess corrected him. "There ain't no bull in Mexico could throw you."

Fuzzball opened his mouth to reply.

"We got to get on our horse and shovel off," Red said loudly. "Come on, Fuzz." END





# New Mallory *Diffused*



**Type T . . . for most economical replacement.** Encapsulated in Mallo-Seal\*, this lowest-priced model can stand 500 hours in boiling water. Available in handy packs of five each for mounting by leads, and in kits using plug-in rectifiers, with mounting hardware. 400 and 365 volt ratings, 0.5 ampere. Also available from 50 to 600 P.I.V. inclusive.

\*Trademark of P. R. Mallory & Co. Inc.



**Type P . . . for plug-in replacement.** Fuse model fits sets already converted to this type of silicon unit. Available in 5-packs, and as conversion kits for half-wave, full-wave or doubler application, with fuse clip and mounting hardware. 400 and 365 volt ratings, 0.5 ampere. Also available from 50 to 600 P.I.V. inclusive.



**Type E . . . for higher reliability.** Military grade "top hat" rectifier, hermetically sealed for jobs where you want the absolute peak in life and dependability. Two to a pack; rating is 400 volts, 0.75 ampere. Also available from 50 to 600 P.I.V. inclusive.

# *Junction* Silicon Rectifiers

A completely new concept in silicon rectifier design gives these new Mallory models reliability never before possible. At the heart of each is a unique diffused junction silicon element, product of extensive Mallory research in semiconductors, which has these characteristics:

- Low reverse leakage**.....less than 250 microamperes
- Low forward drop**.....less than 0.5 volt
- Exceptional life**.....takes over 2000 hours at 85 C, with 1.5 million switching operations without failure
- Moisture-proof**.....exceeds humidity requirements by four times (MIL 202A)
- High reliability**.....100% testing eliminates premature failures, protects you against call-backs

Three different models, each designed for specific service applications, are now available to fit all television and radio circuits as replacements for metallic rectifiers.

See this display on your Mallory distributor's counter—a complete assortment—in handy see-through packs—of the full line of Mallory silicon rectifiers.

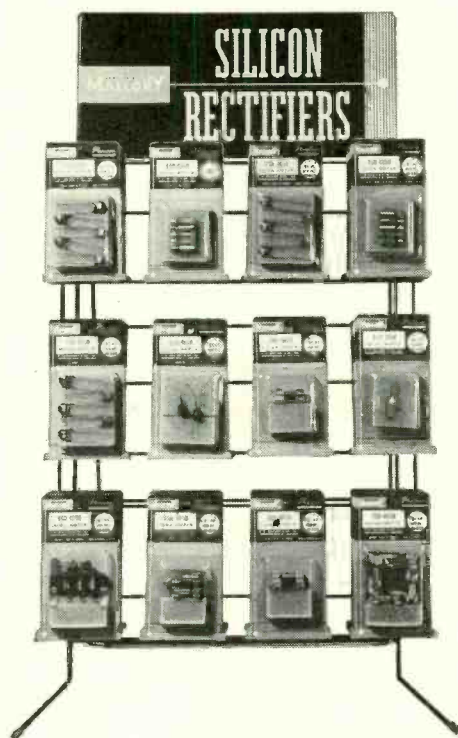

P. R. MALLORY & CO. Inc.  
**MALLORY**

P. R. MALLORY & CO. Inc., INDIANAPOLIS 6, INDIANA

**COYNE** offers  
**LOW COST**

# TELEVISION

Training in  
Spare Time **AT HOME**

## The future is YOURS in TELEVISION—RADIO COLOR TV!

A fabulous field—good pay—fascinating work—a prosperous future! Good jobs, or independence in your own business!

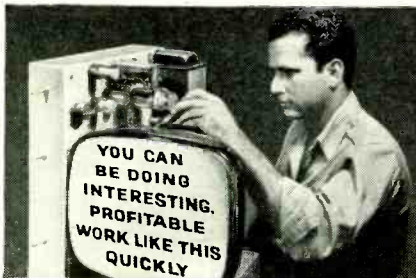

Coyne brings you MODERN—QUALITY Television Home Training; training designed to meet Coyne standards. Includes RADIO, UHF and COLOR TV. No previous experience needed. Practical Job Guides to show you how to do actual servicing jobs—make money early in course. You pay only for your training, no costly “put together kits.”

Send coupon or write to address below for **FREE Book**

and full details including easy Payment Plan. No obligation, no salesman will call.



B. W. Cooke, Jr., President

Coyne — the Institution behind this training... the largest, oldest, best equipped residential school of its kind now in its new home pictured here... Founded 1899.

## COYNE ELECTRICAL SCHOOL

1501 W. Congress Pkwy., Chicago, Dept. 29-H5  
Chartered as an Educational Institution  
Not For Profit

COYNE Television, Home Training Division  
Dept. 29-H5—New Coyne Building  
1501 W. Congress Pkwy., Chicago 7, Ill.  
Send Free Book and details on how I can get Coyne Quality Television Home Training at low cost and easy terms.

Name \_\_\_\_\_

Address \_\_\_\_\_

City \_\_\_\_\_ State \_\_\_\_\_

(It is understood no salesman will call)

**TECHNICIANS'**

# NEWS



### IDEA REPORTS PROGRESS

A drive to put every television set manufacturer “on the record” with regard to captive and factory service is making headway, the newly formed Independent Dealers’ Electronic Activities (IDEA) committee reported after its central committee met in Kansas City.

Karl Heinzman, president of Television Service Association (TSA) of Detroit, was elected 1959 chairman of IDEA, which now claims the support of approximately 100 independent service association in 40 states and Canada.

The group is currently receiving replies to its letters to manufacturers asking about their service policies and programs. The replies to date were to be released at IDEA’s Jan. 11 meeting in Chicago, held too late for coverage in this issue.

Tillman Babb of Texas Electronics Association (TEA) heads the industry relations committee whose task involves contact with set manufacturers; Jack Barton of TSA—Michigan heads the intra-industry relations committee; Bob Steers, Television Service Association (TELSA) of Connecticut, heads the finance committee, and John Hemak, Minnesota Television Service Engineers (MINTSE), is chairman of the legislative committee.

### TV SERVICE A LA CARTE

The credit-card fever is spreading to the field of repairs and services for the homeowner. At least three such groups are now in the process of organization or operation in various localities, to provide customers with services from fuel oil to TV repairs.

Probably the most ambitious of these is Mr. Service Club, Inc., recently formed in Chicago, with a goal of 100,000 members within the next 6 months. Mr. Service Club is frankly a business organization which plans to provide 24-hour-a-day service for householders in virtually every imaginable field, billing its members at the end of the month with one single statement.

RADIO-ELECTRONICS asked the club’s president, Eddie Richmond, to describe how his organization works—with particular emphasis on TV—radio service. Membership costs householders \$7.24 a year, he explained, which he said can be made up through discounts on fuel oil and other items.

Discounts on TV service? Not at all, insists Richmond. TV and other repair services will be sold to the customer at prevailing prices, with premiums for Sundays, holidays and evenings.

How does Mr. Service Club make its money, then? By charging its “repair contractors” a fixed commission on each job. In the case of TV—radio servicing, this fee is 10% of the bill. However, Richmond quickly points out, his contractors will be saved the task of billing and collecting (the club does that), and they should be kept so busy with Service Club calls that their volume will go up.

When a consumer calls the club for TV repairs, an operator consults a map showing the geographic location of the member and the nearest TV service contractor, who is phoned and dispatched on the call.

Screening potential contractors is a big job. TV technicians are being selected on the basis of reliability, brands of equipment used, fees for service calls and price per hour, and number of employees, Richmond said.

### FREE TUBE TESTS URGED

Technicians were urged to win back their customers by testing tubes professionally, willingly—and free. The Television Service Association of Delaware Valley’s *TSA News* gave members this advice:

“Fight back for what is yours by virtue of years of time and money spent and the know-how acquired. Exert that extra effort for a slice of the 25,000,000-tube pie. Make it easy for the customer to come into your shop. Make him feel wanted. Impart a little advice regarding his radio and TV problems. Test his tubes professionally. . . . You may spend a little time, but the likelihood is you will sell him more tubes.”

*TSA News* reports that one Philadelphia parts distributor, Albert Steinberg & Co., is offering 4 x 3-foot signs free to technicians, for use as window streamers, announcing that all TV and radio tubes are tested free on finest testing equipment by qualified technicians, and that all tubes and parts are fully warranted.

TSA reports increasing success in its “P.T.R.” (“promote the repair”) campaign—which has as its objective the repair of TV sets which otherwise would be discarded for new ones. Some TSA members reportedly have adopted a flat “overhaul charge” with a new set guarantee; others are offering a special discount for overhaul jobs and counting on high volume to offset the lower profit.

### BARTON HEADS TELECTRO

Telectro Service Associates, Inc., independent service contract company organized by members of Television



NOW! A SOLDERING GUN WITH

# DUAL HEAT

... switches instantly from 90 to 125 watts

**\$795**  
ONLY list  
MODEL 8200K



**NEW** *Weller*<sup>®</sup>

## “EXPERT” SOLDERING KIT

### only Weller features DUAL HEAT

Saves time, adds convenience and greatly increases tip life. Trigger-matic control switches instantly to low (90 watt) or high (125 watt) heat as the job requires.

### only Weller has a HIGH EFFICIENCY TIP

Utilizes the advantages of copper for superior heat transfer, plus iron-plating for durability and long life. Flat cross-section design adds strength and rigidity.

### only Weller has such COMPACT DESIGN

The compact “feel” and comfortable balance aid precision soldering. And the housing in new, modern design is extremely rugged.

- New Dual Heat gun also features instant heat and prefocused spotlight. Guaranteed for 1 year.
- Kit also includes all-purpose Solder, Cleaning Brush and Soldering Aid.

**DUAL HEAT INSTANTLY ADAPTS GUN TO VARYING NEEDS...** Two position switch feature has never before been available at such a low price. Use first trigger position for soldering components and precise heat control for delicate jobs. Second trigger position gives higher heat for soldering to chassis and similar work.

Available Now From Your Electronic Parts Distributor

WELLER ELECTRIC CORP., 601 Stone's Crossing Road, Easton, Pa.



## America's Fastest-Growing Service Capacitor Line...



# NEW!

### TOBE MYLAR\* MOLDED TUBULAR CAPACITORS

- *Molded of DuPont Mylar*, one of the finest insulation materials ever developed.
- *Thermoset Case Construction* secures leads and sections firmly to withstand extremes of handling, vibration, shock and soldering temperatures.
- *High Insulation Resistance*: Average megohm values per unit 10,000 at 25°C. Small capacitance variation with thermal change.
- *Temperature Operating Range*: -55° to +130°C.
- *Moisture Resistant*: Exceeds JAN-C-91 requirements.
- *Non-Inductive*: Extended foil construction insures low resistance connections and low RF impedance.

#### DESIGNED FOR SERVICE DEALERS

#### NEW TOBE MYLAR\* CAPACITOR KIT

FREE KIT CONTAINS  
80 CAPACITORS

ONLY  
**\$15<sup>84</sup>**

Compact, clear-plastic dispenser contains an assortment of 80 Tobe Mylar capacitors in the most popular sizes, ratings and quantities for quick, efficient servicing. Covers over 60 different ratings at 200, 400 and 600 working volts and from .0001 to 1.00 mfd. Dealer pays only for the Tobe Mylar capacitors, kit is free.

Today, order your Tobe Mylar Kit from your Tobe Distributor



# TOBE RADIART CAPACITORS

\*DuPont trademark

#### TECHNICIAN'S NEWS (Continued)

Service Association (TSA) of Michigan, elected 1959 officers at its annual stockholders meeting in Detroit.

The new president is E. J. (Jack) Barton, of Barton Radio & TV, succeeding Karl Heinzman, who declined to run for re-election. Harold Chase, Chase TV Service, is vice president. Phil Fabian was re-elected secretary and Ed Brown, treasurer.

Telectro was formed to promote and contract service for the independent service industry and is currently handling warranty service on Sylvania, Philco and Hotpoint TV as well as receiver service for several large dealers.

#### "FAIR PRACTICES" PROBE

An investigation of methods to eliminate "fraudulent practices" in the TV service and tube supply industries was mapped by an industry committee at a meeting in the office of New York State Attorney General Louis J. Lefkowitz in New York City.

One of the two technicians' associations represented on the committee—the Empire State Federation of Electronic Technicians Associations (ESFETA)—ignored the meeting. A spokesman explained later that ESFETA objected to the presence on the committee of the National Tube Testers Association, which was described as an organization of do-it-yourself tube-tester owners. ESFETA also charged that an earlier organizational meeting had shown little promise (RADIO-ELECTRONICS, January, 1959, page 114).

The committee decided to investigate: (1) how the industry can "inspire greater confidence" in TV technicians, (2) how to meet the problem of deceptive advertising by "some TV servicemen," and (3) how to cope with the problem of defective tubes on the market.

Organizations represented at the meeting were Associated Radio & Television Servicemen of New York (ARTSNY), Electronic Industries Association (EIA), National Electronic Distributors Association (NEDA), Better Business Bureau of New York, Metropolitan Electrical Appliance Dealers Association, RCA, Fordham Radio Supply Co. and the tube-tester group.

#### TV LECTURE SERIES

A free program of three lectures on new TV circuits and techniques is being offered to technicians' associations by Westinghouse. The lectures, which can be presented separately or at a single three-hour session, discuss printed circuits, transformerless power supplies, receiver descriptions, special circuitry and automatic fine tuning. One lecture deals with customer relations and is illustrated by a motion picture "Adding Sell to Service." Arrangements are being handled through the TV-Radio Div. at Metuchen, N. J., and its regional service managers and the Electronic Tube Div., Elmira, N. Y. END

At Your Service...  
at big savings

# arkay

Hi-Precision  
**TEST INSTRUMENTS**  
Kits and Wired

Designed and engineered in the Arkay tradition of highest professional quality at lowest cost.

**NEW!** ARKAY VT-10 6-INCH  
MULTI-PURPOSE  
VACUUM TUBE VOLTMETER

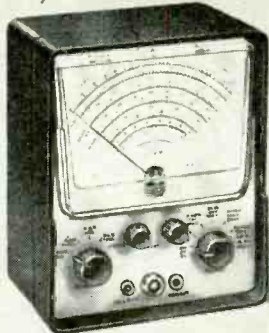

Advanced design and precision features make the Arkay VT-10 a truly sensational buy, unmatched at this price. You get exclusive larger 6-INCH 400 ua meter movement, within 2% accuracy, and edge-lighted for easier reading. 1% precision multiplier resistors are used throughout the range switch. There are 7 AC (RMS) and DC ranges, 0 to 1500 volts; also 7 AC (peak-to-peak) ranges, 0 to 2000 volts. Resistance of 0 to 1000 megohms, db and other essential ranges also included. Circuitry features 12AU7 for DC ranges, 6AL5 for AC, meter diodes rectifiers, and transformer operated selenium rectifier. Handsome durable plastic case.

Easy-to-build Kit **\$25.95**  
Wired and tested **\$47.95**



ARKAY AV-20 6-INCH  
AUDIO VTVM  
PRE-AMPLIFIER

An Audio Vacuum Tube Voltmeter of extreme sensitivity, engineered for accurate measurements of RMS voltages.

Easy-to-build Kit **\$29.95**  
Wired and tested **\$49.95**



ARKAY AW-30 6-INCH  
DIRECT READING  
AUDIO WATTMETER

Measures Audio Power Output with speed and precision. 0 to 500 watts in 6 ranges. For laboratory and general use.

Easy-to-build Kit **\$29.95**  
Wired and tested **\$49.95**



ARKAY CAP-40 6-INCH  
DIRECT READING  
CAPACITY METER

1% precision calibration capacitors and 6-inch 200 ua meter movement provide accurate readings. 0 to 1 mfd. in 6 ranges.

Easy-to-build Kit **\$29.95**  
Wired and tested **\$49.95**



ARKAY MT-50 6-INCH  
20,000 OHMS  
PER VOLT METER

A completely portable multimeter of high accuracy. Sensitivity is 20,000 ohms per volt AC, 5,000 ohms per volt DC.

Easy-to-build Kit **\$29.50**  
Wired and tested **\$42.95**

All prices 5% higher west of Mississippi

See ARKAY completely wired Test Instruments at your dealer. Write for detailed specifications and catalog. Dept. RE

**arkay** **PACE**  
88-06 Van Wyck Expressway Richmond Hill 18, N.Y.



### STUFF THAT PLUG

Broken plugs and loose dangling wires at the ends of appliance cords are old-hat to the electrical-appliance repairman. Although it is true that breakable bakelite plugs are no longer part of newly purchased electric appliances, they are still used for replace-



ments and are still found on older appliances.

When an appliance bearing the older type plug comes in to the shop for repair, I stuff it with plastic wood before the appliance is allowed to leave the shop. Once the wood stuffing has set, it's next to impossible to pull the cord from the plug. What's more, the stuffing supports the plug's outer shell, reducing the chance of its breaking should the plug be stepped on.—*J. A. Comstock*

### SCREW EYES FOR TV SAFETY

Many TV service technicians leave the backs off their own sets to facilitate repair work. A less dangerous method, but one that lets you remove the back without running for a nutdriver, is to use screw eyes to hold the back on. This permits rapid and easy removal, yet it keeps the children away from dangerous voltages.—*John Urbanowicz*

### HACKSAW BLADE REPAIR

Many service technicians have discovered that the spiral-(drill-) blade hacksaws work more efficiently than standard types for cutting control shafts and other odd sawing jobs. They have only one drawback—the blades are rather thin and tend to break off easily near either end.

When a blade breaks near the end, it can be easily restored to a usable length with a ring type terminal lug, as shown in the drawing. Put the end of the blade into the lug as you would

Pleasure Unlimited  
... WHEN YOU BUY IT  
... BUILD IT ... HEAR IT

# arkay

## STEREO

TODAY'S GREATEST VALUE IN  
HI-FI KITS AND WIRED

Comparison proves Arkay is the best value on the market today for advanced hi-fi engineering, styling and performance. Arkay means STEREO at its best, within your budget.

**NEW! MUSIC MASTERPIECE!**

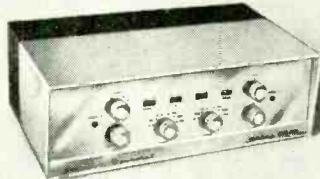

ARKAY CS-28 STEREO AMPLIFIER  
STEREO PRE-AMPLIFIER  
COMPLETE CONTROL CENTER

Presenting... the ultimate in total stereo! The versatile CS-28 is a superb product of Arkay's 20 years of advanced electronic engineering, with beauty of design that won the Fashion Foundation's coveted Gold Medal.

Identical dual 14 watt amplifiers convert to 28 watts for monaural operation. Full 28 watts, at flick of a switch, may be joined with an existing monaural amp for extended stereo, operated with the dual pre-amplifier.

"Reverse Stereo" switch interchanges channels. Balance Control compensates each channel for speaker system, room acoustics, etc. Gain Control operates both channels simultaneously.

Power Rating: 28 watts (two 14 watt channels); 60 watts peak. Frequency Response: 20-20,000 CPS. IM Distortion, 4 to 1. Harmonic Distortion, less than 1%. 30-20,000 CPS. Pre-amp Outputs 2V. Tape Recorder Outputs 10V. Speaker Outputs: 4, 8, 16 and 32 ohms.

Wired and tested **\$99.95** Easy-to-build Kit **\$64.95**

PERFECT COMPANION FOR THE CS-28



ARKAY ST-11  
AM-FM  
STEREO TUNER

Unmatched by units costing twice the price, the Arkay ST-11 provides wide-range AM and FM tuning of remarkable clarity and drift-free stability. "Miracle Ear" sensitivity in FM channel, 4 uV. (2 uV. in AM) for 20 db quieting. Two distinctive receivers in one, for use singly in monaural reception or simultaneously for stereo broadcasts.

Wired and tested **\$74.50** Easy-to-build Kit **\$49.95**



ARKAY CS-12  
STEREO PRE-AMP  
AND AMP

12 watts of clean power. Operates from ceramic or crystal cartridge, tape, tuners, auxiliary equipment.

Easy-to-build Kit **\$35.95**



ARKAY SPA-55  
STEREO AMP

Two 27 1/2 watt distortion-free hi-fi amplifiers. Or use as 55 watt monaural amplifier.

Easy-to-build Kit **\$64.95**  
Wired and tested **\$79.95**

ARKAY SP-6  
STEREO  
CONTROL CENTER



Completely self-powered sensitive dual pre-amp with unparalleled flexibility. Reverse position, hi to filters, etc. Prices less cover.

Wired and tested **\$62.95** Easy-to-build Kit **\$39.95**

All prices 5% higher west of Mississippi

See and hear completely wired ARKAY Kits at your dealer. Write for detailed specifications & catalog. Dept. RE

**arkay**  
88-06 Van Wyck Expressway Richmond Hill 18, N.Y.

# NEW HICKOK TRANSISTOR-RADIO TESTER



Model 810

## 3 TESTERS IN 1

- ★ Tuned Receiver
- ★ AM Generator
- ★ Transistor Tester

Specifically designed with all necessary features for complete troubleshooting of transistor radios. Almost all portables made today are transistorized. With the 810 you can profit immediately from service in this large, new field. The instruction book included contains an easy-to-learn course in transistor radio servicing. Now, any serviceman can quickly troubleshoot and profitably repair transistor radios.

**TUNED RECEIVER**—200 to 500 KC for troubleshooting IF. 550 to 1600 KC for troubleshooting RF. A cathode follower input probe minimizes loading. Loudspeaker indicator for signal tracing.

**AM SIGNAL GENERATOR**—200 to 575 KC for IF alignment. 550 to 1600 KC for RF alignment. 400 cycle audio output for signal injection.

**TRANSISTOR TESTER**—Test circuit for checking transistors—leakage and gain.

The 810 will pay for itself in a short time . . . and give you many years of accurate, dependable service.

**\$109<sup>90</sup>  
NET**

Now is the time to...  
**TRADE UP TO A HICKOK**

Ask for a demonstration of the new 810 from your Authorized Hickok Distributor.

**THE HICKOK ELECTRICAL INSTRUMENT CO.**  
10514 Dupont Ave. • Cleveland 8, Ohio

TRY THIS ONE (Continued)

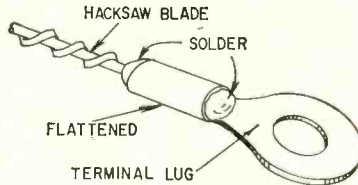

a wire, flatten the lug and solder to strengthen the joint. You can make several repeated repairs in this way until about only half the blade remains.  
—J. C. Alexander

### GLOVE FINGERS INSULATE CLIPS

When you have to insulate test clips that will be connected to live circuits and there aren't any insulating jackets handy, cut insulating covers from the

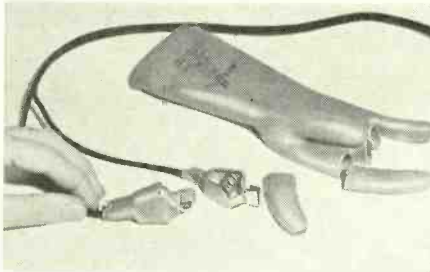

fingers of old rubber gloves and slip them over the clips. Make a small hole in the tip of the glove's finger to slip it over the test lead. You may have to stretch the covers some to get them to

fit over large size clips like the ones shown.—John A. Comstock

### TUBE TAPPER AND WIRE PUSHER

Two, three or four rubber grommets placed on a 7- or 8-inch dowel section make a handy tube tapper. Form a dimple in the other end of the dowel with a small twist drill. The dimple

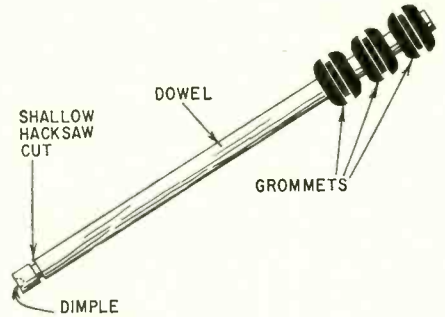

stops the dowel from slipping off lug and wire ends when it is used as a pusher to dress lugs, etc.

Ring the dimpled end with a shallow hacksaw cut to be used for pushing leads into better dress.—Frank W. Dresser

### MINI-GATOR CLIPS

The new Mini-Gator clips, not much larger than a transistor, are ideal for fast setups of experimental transistor circuits. Unlike other clips, these easily hang onto the smallest transistor leads

SAVE  
TIME  
with

SENCORE

See other SENCORE ads in this issue.

## SENCORE Handy "36"

### R C-Substitution Unit

"36"—Most Often Needed Components at YOUR Fingertips!

3 Pole, 12 position switch individually selects one of the "36" components for direct substitution.

Contains:

- ★ 12—1 watt 10% resistors from 10 ohms to 5600 ohms
- ★ 12—½ watt 10% resistors from 10K ohms to 5.6 megohms
- ★ 10—600 volt capacitors from 100-mmf. to .5 mfd.
- ★ 1—10 mfd., 450V Electrolytic ★ 1—40 mfd., 450V Electrolytic

★ For Shop, Lab, or Outside service

**SERVICE INSTRUMENTS CORPORATION**  
121 OFFICIAL ROAD, ADDISON, ILLINOIS



ONLY  
**\$1295**  
DEALER NET

Model H-36  
Completely Isolated  
Available at all  
Paris Distributors

### SUPER MAGNET SUPER SAVING!

Buy this Little Giant magnet, most powerful made, a sensational bargain! The low price of \$1.50 is less than 50% of what you'd pay for this magnet. Experimenters, hobbyists will find hundreds of uses for this powerful 4 oz. Alnico permanent magnet. LIFTS 5 lbs. EASILY. Limited quantity. Order several today. Measures 1 1/2 x 1 1/4". Item No. 86 \$1.50

Special Bargain (Shp. Chgs. 10c)



### 250 POWER TELESCOPE LENS KIT

Make your own high powered 6 ft. telescope! Kit contains 2" diam., 75" focal length, ground and polished objective lens and necessary eye pieces. Magnifies 50x to 250x. Full instructions.

ITEM NO. 123  
**\$2.95**  
(Shp. Chgs. 10c)



### AMAZING BLACK LIGHT

250-watt ultra-violet light source. Makes fluorescent articles glow in the dark. Fits any lamp socket. For experimenting, entertaining, unusual lighting effects.



Shp. wt. 2 lbs.  
ITEM NO. 87  
**\$2.95**  
(P. P. & Hdlg. Chgs. 35c)

HUDSON SPECIALTIES CO., 160 W. 14th St. Dept. RE-2-59, New York 7, N.Y.  
I am enclosing full remittance for items circled below. (Be sure to include shipping charges.)  
87 33 86 123

Name ..... Please Print Clearly

Address .....

City ..... Zone ..... State .....

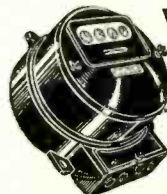

### WATHOUR METER

Leading makes—reconditioned. Ideal for trailer parks. 100-110 volts, 60 cycles. 2-wire A.C. 5 amp. Heavy metal case 8 1/2" x 6 1/4" x 5". Easy to install. Shp. wt. 14 lbs.

ITEM NO. 33  
NOW ONLY  
**\$4.50**  
(P.P. & Hdlg. Chgs. \$1.25)



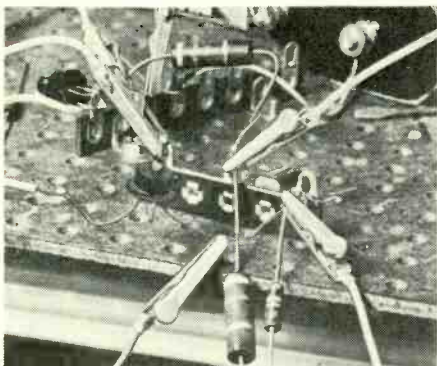

without sliding along or slipping off.

Small sections of flexible stranded wire with Mini-Gators on each end can be used for hurry-up wiring of bread-board circuits. Lead lengths of 3 to 6 inches seem to be the most useful.

Insulating sleeves available for these clips guard against accidental shorts.—*Edwin Bohr*

### INSULATE ELECTROLYTICS

Many subminiature electrolytic capacitors do not have insulated cases. However, such insulation is often needed when the capacitor is used for inter-stage coupling, for example, and when the positive terminal is grounded and the case is hot. Also some have a metal case that is not connected to either terminal but must be insulated from the chassis to prevent noise.

A satisfactory solution to this prob-

lem without covering capacitance and voltage markings is to coat the capacitor with polystyrene coil dope. The coil dope should be thin enough to drip slowly. If it is too thin the coating will be too thin and if too thick it will be impossible to make a neat job. Use polystyrene coil dope thinner to get the right consistency. To apply, simply dip the capacitor in the coil dope and hold it under a 60-watt lamp for about a minute while rotating it with the fingers to obtain an even coat. Then hang it from a convenient support until dry.—*J. E. Pugh, Jr.*

### HANGER TOPS FOR TUBES

Those tubes of radio-TV servicing chemicals that lay around on the bench and eventually become punctured won't if you hang them up out of the way.

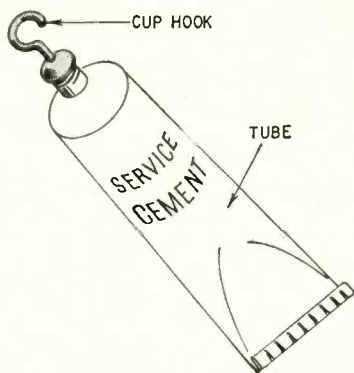

Remove the tube's original cap and screw a cup hook into the opening. This way you can hang the tubes on brads driven into the edge of a shelf or the service bench.—*John A. Comstock*

### PLASTIC TAPE KINK

Before I go outdoors to splice TV lead-in in cold weather, I put a roll of electrician's plastic tape in an inside pocket to keep it warm. I find the warm tape sticks better than cold, and that a warm roll goes farther because it has more stretch inch per inch.—*J. C. Alexander*

### HANDY MAGAZINE KINK

When I have to dump radio-TV parts from a container to find the one that I need, I open up a copy of RADIO-ELECTRONICS and pour the parts out on it. Once I've found the part needed, I grab the magazine by its outer edges and "funnel" the parts back into their container.—*Scott Mack* END

### CORRECTION

The cathode bias on the EL84/6BQ5 output stage in Fig. 2 of "The Hi-Fi Amplifier Abroad" (page 33, September, 1958) is erroneously shown as 79 volts. The correct bias is 7.9 volts.

We thank Mr. Angelo Lathes, of New York, N.Y., for bringing this to our attention.

Just Out

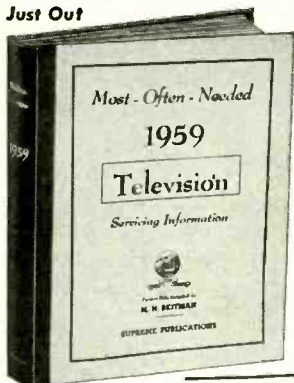

# New SUPREME 1959 TV Manual

## AMAZING BARGAIN

The new 1959 TV manual is the bargain of the year. Covers all important sets of every make in one giant volume. Your price for this mammoth manual is only \$3. This super-value defies all competition. Other annual volumes at only \$3 each. Factory service material simplifies repairs. Includes all data needed for quicker TV servicing. Practically tells you how to find each fault and make the repair. More pages, more diagrams, more service data per dollar of cost.

## TELEVISION SERVICING COURSE

Let this new course help you in TV servicing. Amazing bargain, complete, only \$3, full price for all lessons. Giant in size, mammoth in scope, topics just like a \$200.00 correspondence course. Lessons on picture faults, circuits, adjustments, short-cuts, UHF, alignment facts, hints, antenna problems, trouble-shooting, test equipment, picture analysis. Special, only **\$3**



## Companion RADIO COURSE, Introduction to TV

Here is your complete radio training in 22 easy-to-follow lessons. Covers fundamentals, fault finding, use of test equipment. Everything in radio, introduction to TV. Self-test questions. New 1959 edition. Special, only **\$2.50**

## 18 RADIO VOLUMES

## RADIO DIAGRAMS

Supreme is your best source for all needed RADIO diagrams and service data. Covers everything from the most recent 1958 radios to pre-war old-timers; home radios, auto sets, combinations, changers, HI-FI, FM, and portables. Sensational values. Only \$2 for many volumes. Every manual has extra large schematics, all needed alignment facts, printed boards, voltage values, trimmers, dial stringing, and helpful hints. Volumes are large in size, 8 1/2 x 11 inches, about 190 pages. See coupon at right for a complete list of these radio manuals. →



## COVERS ALL POPULAR SETS

Here is your service data for faster, easier TV repairs. Lowest priced. Best by comparison. *Supreme TV* manuals have all needed service material on every popular TV set. Helpful, practical, factory-prepared data that will really make TV servicing and adjustment easy for you. Benefit and save with these amazing values in service manuals. Only \$3 per large volume. Now used by 163,000 wise servicemen.

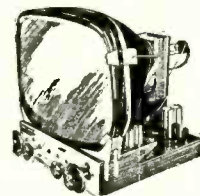

The repair of any television set is really simple with *Supreme TV* service manuals. Every set is covered in a practical manner that will simplify troubleshooting and repair. This is the help you need to find toughest faults in a jiffy. Each \$3 TV volume covers a whole year of service material. New *Television Servicing Course* will aid you in learning TV. Be wise, buy *Supreme Manuals* only once each year instead of spending dollars every week.

## SIMPLIFY ALL TV REPAIRS

These giant TV manuals have complete circuits, needed alignment facts, printed boards, servicing hints, production changes, voltage charts, waveforms, and double-page schematics. Here are your authentic service instructions to help you do expert work quicker; and priced at only \$3 per large annual manual. Repair **any TV model** ever made by having in your shop all 14 volumes as listed in coupon. Your special price for all, only \$40. Or try the new 1959 TV manual to see what an amazing bargain you get for \$3. Send no-risk trial coupon today.

## NO-RISK TRIAL ORDER COUPON

SUPREME PUBLICATIONS, 1760 Balsam Rd., Highland Park, ILL.

- Radio Service Course, \$2.50
- 1958 Radio Diagrams, \$2.50
- 1957 Radio Manual, \$2.50
- 1956 Radio Diagrams, \$2.50
- 1955 Radio Manual, only \$2
- 1954
- 1953
- 1952
- 1951
- 1950
- 1949
- 1948
- 1947
- 1946
- 1942
- 1941
- 1940
- 1939
- 1926-1938 Manual, \$2.50
- Radio & TV Master INDEX, 25¢

These annual RADIO volumes specially priced at only **\$2.50** each...  
**THIS GROUP ONLY \$2 EACH**

Rush today TV manuals checked  below and Radio manuals at left. Satisfaction guaranteed.

- New 1959 Television Servicing Manual, only... \$3.
- 1958 Television Manual, \$3.  Early 1957 TV, \$3.
- Additional 1957 TV, \$3.  1956 TV Manual, \$3.
- Early 1955 TV, \$3.  Additional 1955 TV, \$3.
- 1954 TV, \$3.  1953 TV, \$3.  1952 TV, \$3.
- 1951 TV, \$3.  1950 TV, \$3.  1949 TV, \$3.
- 1948 TV, \$3.  1957-58 RCA Victor TV, \$1.50
- New Television Servicing Course, complete... \$3.

- I am enclosing \$..... Send postpaid.
- Send C.O.D. I am enclosing \$..... deposit.

Name: .....  
Address: .....

**Supreme Publications**  
Sold by All Leading Parts Jobbers

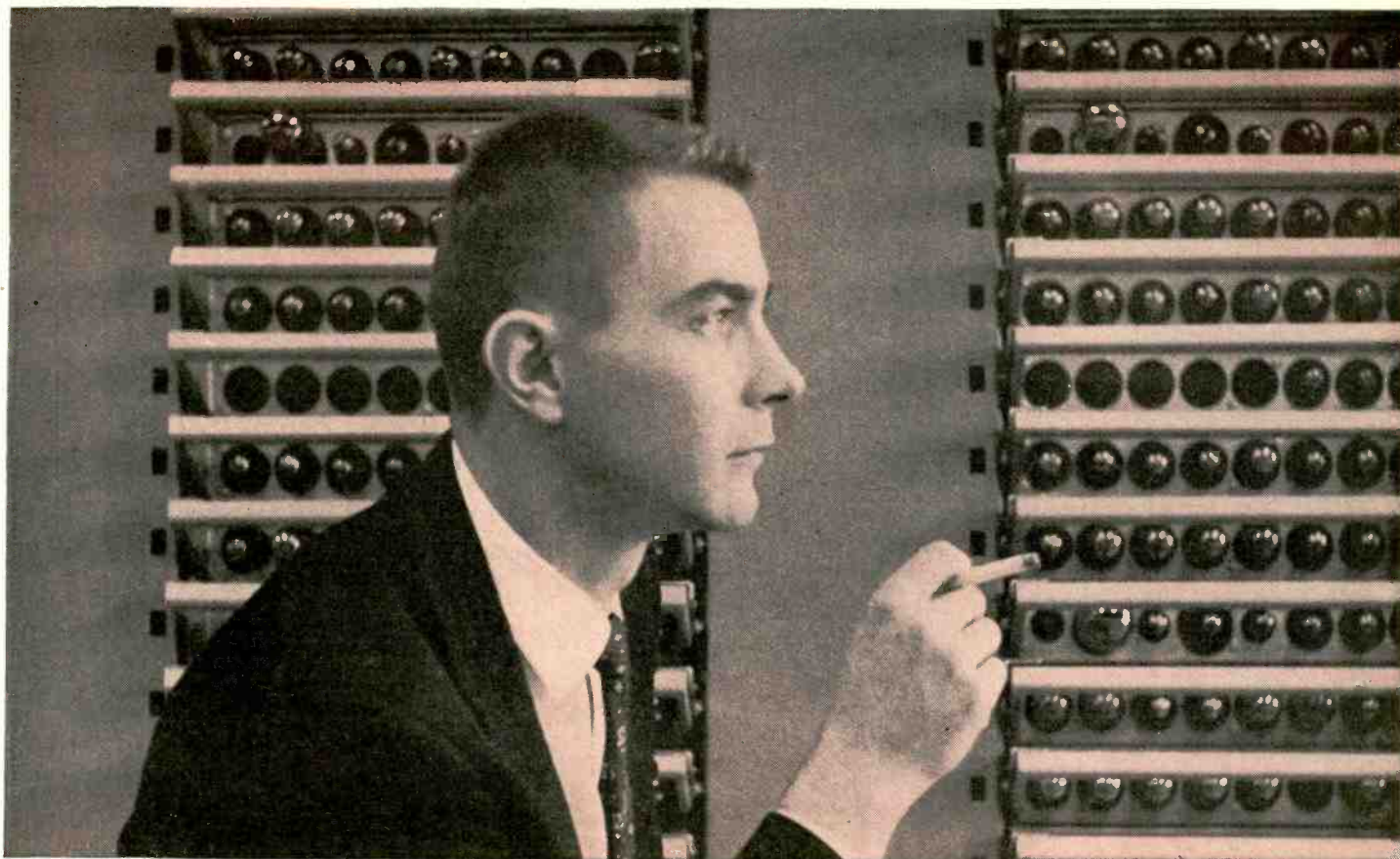

## How far can you go in electronics .

**“Just being called a Field Engineer—an impressive title for a man without a degree—that really gives me a lift.”**

This is Jim Pieratt talking. With a high school education and Navy Technical training behind him, Jim holds a key job in one of America's most important electronic projects. He's an IBM Computer Units Field Engineer on Project SAGE.

Jim is 25, lean, crew-cut and soft-spoken. He smiles modestly when you ask him about his accomplishments. We were curious to know whether he had been technically inclined when he was a youngster.

“The truth is that I didn't become interested in electronics until I joined the Navy,” says Jim. “Before that, the only technical thing I might have done was to take a couple of alarm clocks apart. I chose electronics in the Navy because I thought there was a future in it.”

### **Change of attitude**

“A lot of fellows may think, as I did, that a computer is too complicated for anybody but an Einstein to understand. It's not so. Even the largest computers like SAGE, which occupies space equivalent to a city block, can be comprehended by the ordinary man. But I didn't know this when I went for my employment interview—and I wondered if the algebra and trig I'd taken at Kalamazoo Central High would qualify me. Then my interviewer told me a little about computers . . . how they work and what my job would be after I finished IBM school. I made up my mind right then; I wanted this job.”

### **Training school**

Soon, Jim and 21 other fellows like himself started training in Kingston, New York, getting on real intimate terms with IBM's electronic giant. Marvel of complexity though it is, when it sits on the floor and you study it part by part, the computer loses its mystery. Little by little, you begin to understand the whole from the sum of the components.

“The 25 weeks I spent in training were very happy,” says Jim. “It's interesting all the way. They encourage you to think for yourself and you're rewarded for your effort. Field Engineers can merit salary increases based on school performance.”

### **Strategic job on Project SAGE**

Jim is stationed in Virginia, near Richmond. His duties include installing, checking and testing out computer units. The giant electronic computers are the very heart and mind of Project SAGE (Semi-Automatic Ground Environment). To the in-put section of the computer comes data from radar sites, ships, reconnaissance planes and ground observer posts throughout the country. The display consoles give a visual representation of the complete air defense situation. Jim's prime responsibility is to keep the display consoles running.

### **8 pleasant hours a day**

“I'm essentially my own boss and I'm encouraged to think for myself. For me, this is an ideal environment.

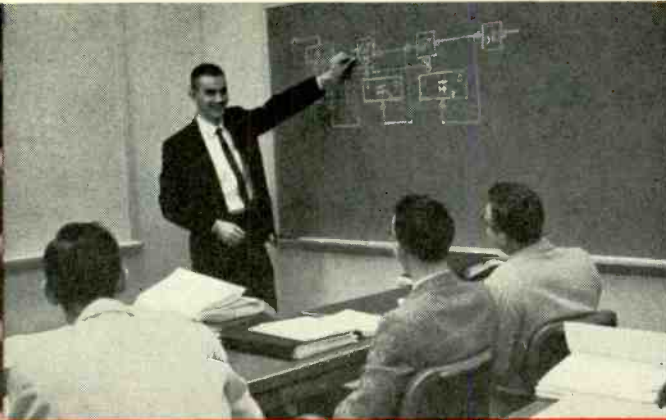

*Jim discusses block diagram in class*

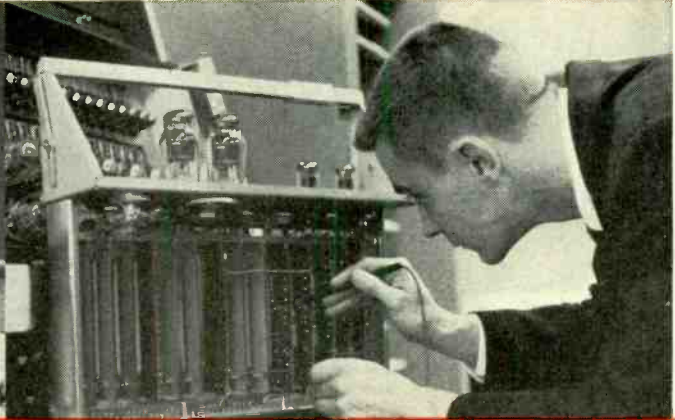

*Fixing console assembly*



*He's repairing a pluggable unit*

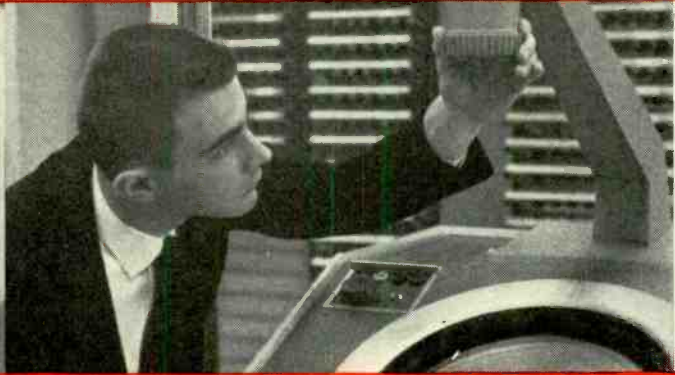

*Adjusting console photo cell*

## **. without a degree?**

What do I like best about my job? Trouble-shooting, I think. I enjoy being able to repair anything that isn't working properly. As a Field Engineer, I have opportunities to assume other engineering functions. For instance, while I have nothing to do with design engineering, I do suggest changes for review by the Design Engineers. I also rewrite engineering procedures."

### **Where do you go from here, Jim?**

"There's plenty of room for me to grow at IBM. My next step up should be to Systems Engineer. This calls for more headwork. After that, if I display enough initiative, I may become a Group Supervisor."

### **Family, friends, recreation**

Jim, his wife and three-year-old daughter live in a pleasant ranch home, just a few miles from the site. Social life? "We've made quite a few friends here," says Jim. "Mostly among the IBM fellows and their wives. We play golf together."

### **Where do you go from here?**

Can you look ahead, as Jim Pieratt does, and see yourself as a man on the way up? Maybe you should give some thought to IBM Military Products and the Project SAGE program. Opportunities are greater than ever. IBM's long-range program will continue to grow in importance and vast sums will be invested in hiring the right men to accomplish its vital objectives.

If you have a minimum of 3 years' technical schooling—or equivalent experience—you may be eligible for advanced training for 5 months as a Computer Units Field Engineer. While training, you receive full pay plus living allowance before assignment to a permanent location. You are paid a salary, not hourly wages, plus overtime.

From then on, you can go as far as your abilities and ambition will take you. IBM is the leader in a field that offers you unlimited horizons. And, as you may already know, at IBM you receive company-paid benefits that set standards for industry today.

**Mr. N. H. Heyer**  
Dept. No. 649A  
Military Products Division  
IBM Corp., Kingston, N. Y.

**WRITE TODAY TO:**

You'll get a prompt reply. Personal interviews arranged in all areas of the United States.

# **IBM**

## **MILITARY PRODUCTS**



  
**VIBRATOR**  
 TYPE  
**5301**  
 BASE INPJ  
 CIRCUIT VOLTAGE  
**A 6**

# The Greater Vibrator

Radiart Vibrators are unaffected by bounce, jounce, heat, cold, moisture. There's a replacement type for every 6- and 12-volt application. Ask your Radiart Distributor for a free Radiart Vibrator Replacement Guide or write The Radiart Corporation, 2900 Columbia Avenue, Indianapolis 5, Indiana.



# RADIART TOBE Vibrators

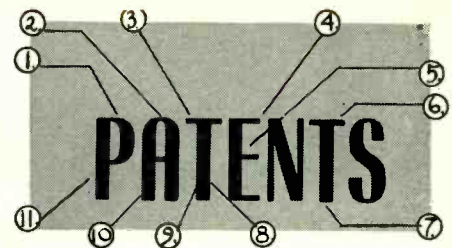

## FREE-RUNNING MULTIVIBRATOR

Patent No. 2,827,568

Ernst R. Altschul, New York, N. Y. (Assigned to United States of America as represented by Secy. of the Navy)

This is one of the simplest multivibrators. With the values shown its frequency is 1,000 cycles. The output terminal may be at either

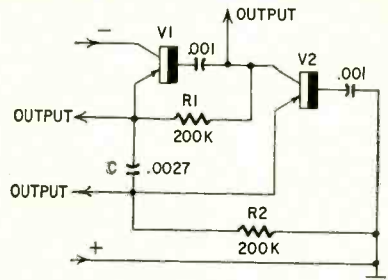

end of capacitor C or at V2's collector, the other terminal being ground.

To show the action, assume that V1 conducts. Current flows through R2 and V1 to charge C. Note that the drop across R2 blocks V2. When C is charged, the voltage drop disappears and V2 starts to pass current. Now, C can discharge through R1 and V2, and the drop across R1 blocks V1.

When C is completely discharged, V1 conducts again, and the cycle repeats.

## FLAT KINESCOPE TUBE

Patent No. 2,795,729

Dennis Gabor, London, England (Assigned to National Research Development Corp., London, England)

Undoubtedly, the flat tube will in time revolutionize the TV industry. Here is one type that shows considerable promise. The description given here is limited, but more details appeared on page 43 of the March, 1957, issue.

See the side view of the tube. An electron gun,

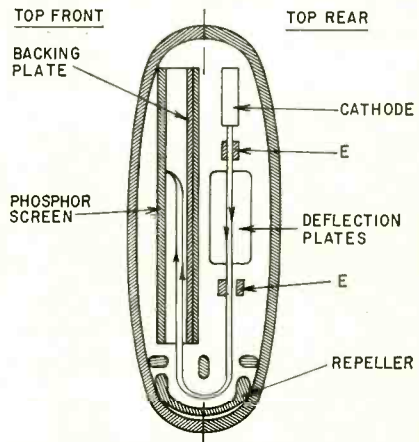

including cathode and deflection plates, sends the beam on its way down the rear of the tube. At the bottom, an electronic "mirror" (repeller) repels the beam to return it upward between the phosphor screen and the backing plate, at the front of the tube. The backing plate holds an array of insulated horizontal conductors which can charge (positively) or discharge through distributed capacitance, by means not shown here.

When the wires are charged, the beam can move freely to the very top of the screen. Wires that are discharged repel the beam toward the screen. The charge-discharge cycle is a sawtooth-voltage wave, thus providing the required vertical scan. The deflection plates control horizontal scanning.

If the device has a three-gun cathode and a mask behind the screen, it becomes a color

tube. In that case, electrodes E are provided (as shown) to displace the beams so they pass through appropriate openings in the mask.

### RELAXATION OSCILLATOR

Patent No. 2,831,113

David C. Waller, Luke Mohawk, N. J. (Assigned to Bell Telephone Labs, Inc.)

This is a high-powered self-excited oscillator. Fig. 1 shows some of the waveforms it delivers. They are: (a) voltage across C2, (b) voltage across C1, and (c) voltage at V2's collector.

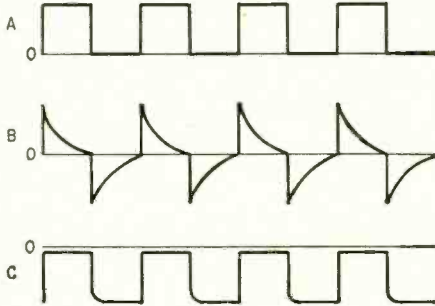

Fig. 1

V1 is a low-power control transistor in the oscillator's circuit (see Fig. 2). V2 may be a high-power transistor capable of handling a few watts output. When V1 conducts, it biases V2 in the forward direction, so both transistors conduct (or block) at the same time.

R1, R2 bias V1 for normal conduction. When the battery is switched on, V1 begins to pass current so V2 also conducts. Voltage at V2's

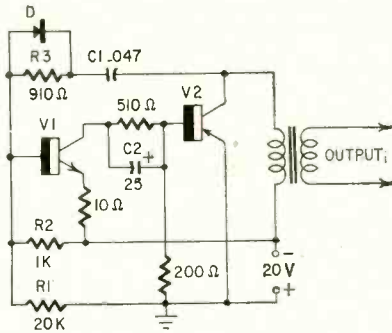

Fig. 2

collector goes more positive and feeds back power to V1's base. This increases conduction in both transistors, and they soon both reach saturation.

Saturation is maintained until C1 begins to discharge through D and R2. This reverses bias on V1. A chain of events (like that described above) soon results in both transistors being blocked. The cycle continues indefinitely.

The circuit shown is adjusted to oscillate at about 3 kc. Output power is limited only by the transistor used for V2. END



"And this gadget fouls up the radar traps."

# YOU CAN'T HEAR A 'SPEC' SHEET!

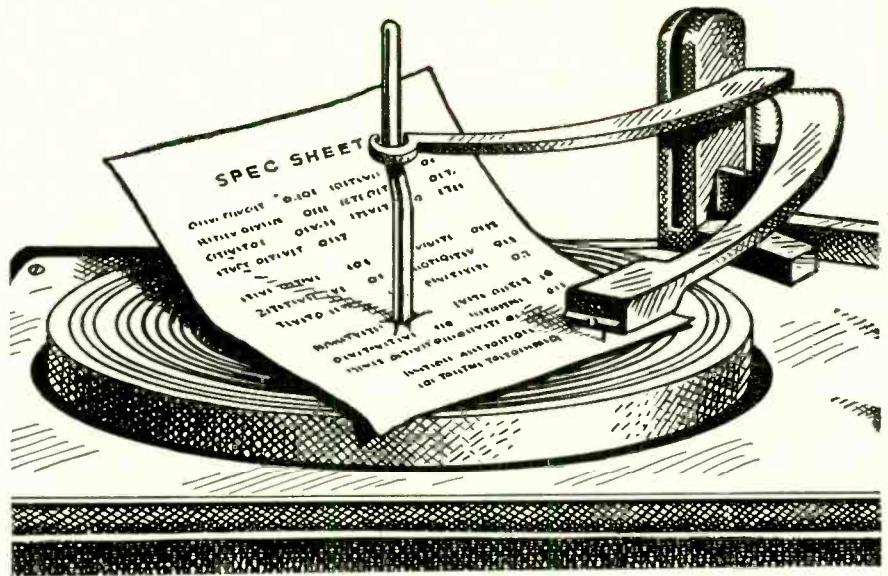

Sonotone's stereo cartridge has more than just good specs... it gives brilliant performance! More phono makers specify Sonotone for the top of their line—here's why:

Only Sonotone gives true sound *without* distortion...high frequency response *without* record cutting! Sonotone stereo gives a performance so superior you can truly *hear* the difference. The secret? Sonotone's four exclusive *operating* features:

1. Extremely high compliance.
2. Amazingly clean wide range frequency response.
3. Wide channel separation, due to Sonotone's pantagraph yoke.
4. Rumble filter to screen out vertical turntable noise.

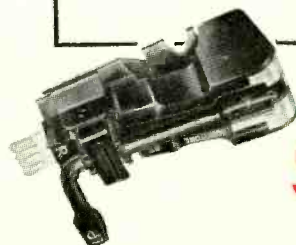

SPECIFY...STOCK...SELL...

## Sonotone

Electronic Applications Division, Dept. CE-29

ELMSFORD, NEW YORK

CORP.

# COSMOTRON\*

- MINIATURE ATOM SMASHER
- PRODUCES 75,000 VOLTS
- ABSOLUTELY SAFE



In no sense of the word a toy or a gadget. The COSMOTRON\* is a scientific instrument capable of producing 75,000 volts—makes sparks up to 2" long—yet is absolutely safe because the current is infinitesimal. The science teacher—science lover—or hobbyist can perform experiments to astound students—friends—family. Makes smoke disappear—defy gravity—turns propellers at a distance—transforms atomic energy into light—makes artificial lightning—demonstrates ionic space ship drive—and many other experiments. Constructed of the finest materials. Will do exactly—for instruction purposes—what generators that cost 3 to 10 times more will do. The perfect device to teach the secrets of atomic physics and electricity. Will hold an audience spellbound as it performs trick after amazing trick. Includes an experiment kit and illustrated experiment manual. Manual explains the "how" and "why." You will invent many new experiments of your own. A fine research tool that will give years of beneficial service to the institution or individual who owns one. In kit form or assembled.

\*TM Pending

Kit form .....\$14.95  
Assembled .....\$19.95

## GENIAC COMPUTER KIT

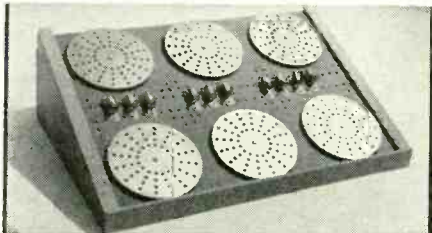

### Control Panel of GENIAC® set up to do a problem

You can construct over 125 different circuits and different machines that compute, reason, solve puzzles and demonstrate a wide variety of basic computer circuits with the GENIAC® electric brain construction kit. 30,000 schools, colleges, industrial firms and private individuals have bought GENIACS since we first brought them on the market.

We have recently added a circuit for composing music, which gives us special pleasure because it was designed by a 16 year old boy who learned about computers from his GENIAC. Dozens of other youngsters have created their own designs for computing circuits, used GENIACS in their school projects and established a solid foundation of information on computers with GENIACS.

Each kit comes complete with Beginners Manual, Study Guide, instructions for building all the machines and circuits (exclusive with our GENIAC), parts tray, and our complete question answering service. When you buy a GENIAC you are buying a first course in computer operation.

Each kit comes with a one week money back guarantee if you are not satisfied.

Price of Kit complete with parts tray, rack, all components, manuals and texts \$19.95 (post-paid in U.S., add 80¢ west of Mississippi). (\$2.00 outside United States.)

### MAIL THIS COUPON

(Please be sure to include your name & address)  
**OLIVER GARFIELD CO., Inc., Dept. RE-29**  
108 E. 16th St., New York 3, N.Y.

Please send me:

1 GENIAC® Electric Brain Construction Kit and Manual. ....

Add 44¢ for postage in U.S.;  
\$1.00 abroad.

1 COSMOTRON Atom Smasher and Manual.  
\$19.95 (Complete assembled) .....

\$14.95 (In kit form)

Add 80¢ for postage and handling  
in U. S.; \$1.00 abroad.

# NEW TUBES and SEMI-CONDUCTORS

A WIDE range of interesting types appears this month. There are a high-voltage rectifier for TV receivers, a germanium power transistor, a dual beam-power tetrode, a high-frequency tetrode transistor and other semiconductor devices among them.

### 2N696

An n-p-n diffused-silicon transistor designed for high-frequency switching, amplifier and oscillator applications. In switching, it has a 150-ma rating

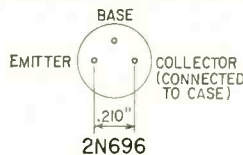

with an 80-millisecond rise time. As an amplifier, it features 15-db neutralized gain at 30 mc. As an oscillator it produces 0.6 watt at 70 mc.

Maximum ratings of this Fairchild Semiconductors unit are:

$V_{CE}$	40
$V_{CBO}$	40
$V_{EBO}$	5
$P_{total}$ at 25°C	
(watts)	2

### 2N386

A hermetically sealed, p-n-p germanium power transistor for high-voltage use in high-power amplifiers,

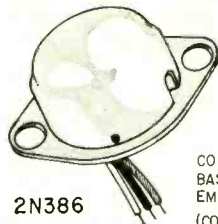

2N386

COLLECTOR-RED  
BASE-BLACK  
EMITTER-YELLOW  
(COLLECTOR CONNECTED TO CASE)

servo amplifiers, power converters and switches. It will deliver 5 watts of undistorted power output (class A) with a typical power gain of 33 db. Typical cutoff frequency is 10 kc.

Maximum tentative ratings of this Philco transistor are:

$V_{CE}$ ( $V_{BE}=1.5$ , $I_C=5$ ma)	60
$V_{CB}$ ( $I_C=5$ ma, $I_E=0$ ma)	60
$I_C$ (amps)	3
$P_{total}$ (watts)	12.5

there's nothing like the feel of the right gun...

or the right TOOL!

WEN

POWER TOOLS are "job-matched" for

easier handling, trustier performance!

Pick up a Wen tool. It fits in your hand like it grew there! Lightweight, streamlined Wen designs are extra easy-handling... quality-engineered to do the job right. Ask any Wen tool user. Your best dollar-for-dollar buy, too!

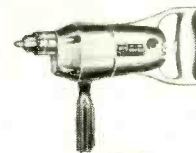

**2-SPEED POWER DRILL**  
3/8" capacity in steel, up to 3/4" in hardwood. Smooth easy speed change, high torque motor. \$29<sup>95</sup>



**TOTER KIT**  
Perfect supplement to drill. 35 pieces including drill holder, Tote Box with tray. A whole workshop, only \$9<sup>95</sup>



**SOLDERING GUN KIT**  
Includes 4 tips for wide variety of uses, solder. "Quick-Hot" gun heats in only 2 1/2 seconds. A buy at \$9<sup>95</sup>

Burton Browne Advertising

See complete line of Wen power tools at your favorite dealer!

WEN PRODUCTS, INC.

5810 Northwest Highway · Chicago 31, Illinois

RADIO-ELECTRONICS

**3DK6, 4DK6, 6DK6**

A series of pentode amplifiers designed for if service in TV receivers. The heaters in these tubes have a con-

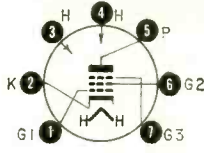

3DK6, 4DK6, 6DK6

trolled warmup for series-string circuits. All are identical except for heater ratings. These are: 3DK6—3.15 volts, 600 ma; 4DK6—4.2 volts, 450 ma; 6DK6—6.3 volts, 300 ma.

Characteristics of these CBS tubes in class-A amplifier service are:

$V_p$	125
$G_3$	connect to cathode at socket
$V_{G2}$	125
$R_{cathode\ bias}$ (ohms)	56
$R_p$ (approx) (k ohms)	350
$g_m$ ( $\mu$ mhos)	9800
$I_p$ (ma)	12
$I_{G2}$ (ma)	3.8
$V_{G1}$ (approx)	-6.5

**2N658**

This is a medium-frequency p-n-p fusion-alloy junction transistor in-

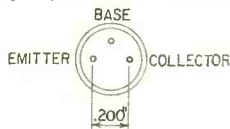

2N658

tended for computer and switching applications requiring good current gain at current levels up to 1 amp.

Made by Raytheon, maximum ratings of the unit are:

$V_{CBO}$	25
$V_{EBO}$	12
$V_{CEO}$	16
$V_{CE}$ ( $V_{BE}=0.1$ )	24
$I_c$ (amp)	1

**6DY7**

A dual beam-power pentode designed for use in stereophonic sound systems. The tube has a single cathode, and  $G_2$ 's are connected internally. The 6DY7 heater is rated at 6.3 volts, 1.2 amperes.

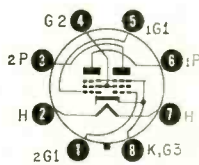

6DY7

Typical operating characteristics of this Sylvania tube as a class-AB1 amplifier (two sections in push-pull) are:

$V_p$	250	400
$V_{G2}$	250	250
$V_{G1}$	-16	-20
$V_{peak\ of\ grid\ to\ grid}$	32	40
$I_p$ (zero sig) (ma)	77	58
$I_p$ (max sig) (ma)	74	74
$I_{G2}$ (zero sig) (ma)	3.5	1.7
$I_{G2}$ (max sig) (ma)	15.5	14.0
$R_L$ (plate to plate)		

(ohms) 9,000 14,000

(Continued on page 132)

**RESIDENT SCHOOL COURSES**

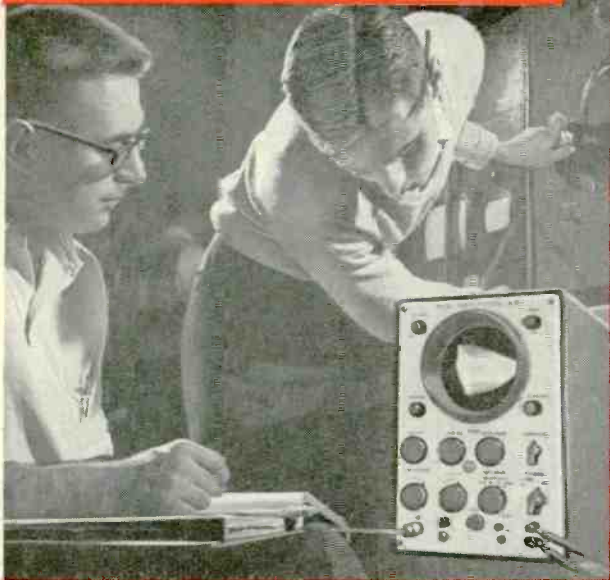

Industry needs Electronic Technicians!

# Let RCA train you in Advanced Electronics

This is the college-level training you need to work with professional engineers on research, development or production projects in such fields as: automation, guided missiles, radar, television, computers and other advanced electronic applications.

RCA Institutes Resident School in New York City offers this comprehensive course that prepares you for any field of electronics you may choose. Other courses in TV & General Electronics, Radio & TV Servicing, and Radio Telegraph Operating.

Classes start four times each year. Applications now being accepted. Approved for Veterans.



**RCA INSTITUTES, INC.**  
SCHOOL OF TELEVISION  
AND ELECTRONIC TECHNOLOGY  
A Service of Radio Corporation of America



RCA INSTITUTES, DEPT. RER-29  
350 W. Fourth St., N. Y. 14, N. Y.

Please send me your FREE catalog of Resident School courses in New York.

NAME ..... please print

ADDRESS .....

CITY ..... ZONE ..... STATE .....

**HOME STUDY COURSES**

**course I**

**Electronic Fundamentals**

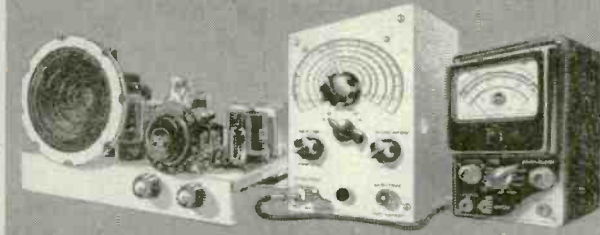

**course II**

**Television Servicing**

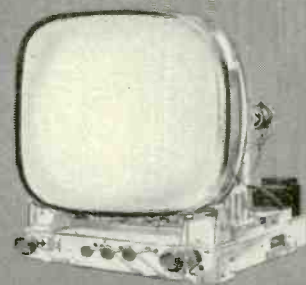

**course III**

**Color Television**

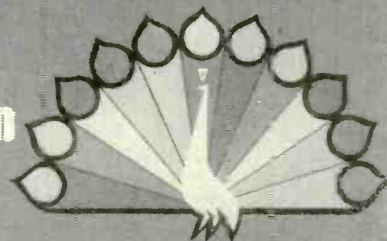

RCA Institutes offers you the finest of Home Study training. The equipment illustrated and text material you get with each course is yours to keep. Practical work with very first lesson. Courses for the beginner and the advanced student. Pay-as-you-learn. You need pay for only one study group at a time.

Send for Our Complete Catalog **FREE**





# RCA INSTITUTES proudly announces a new home study course ... ELECTRONICS for AUTOMATION

Nucleonics, Photoelectronics, Digital Techniques, Synchros and Servomechanisms, Data Recorders, Automatic Process Controllers, Telemetry and Remote Control, Ultrasonics, and Automatic Control Systems . . . these are just a few of the many Industrial Electronics subjects covered in the new Electronics for Automation course.

RCA Institutes — now celebrating 50 years of electronic training — adds this new home study course to prepare you for a career as an electronic technician. Pay-as-you-learn. You need pay for only one study group at a time.

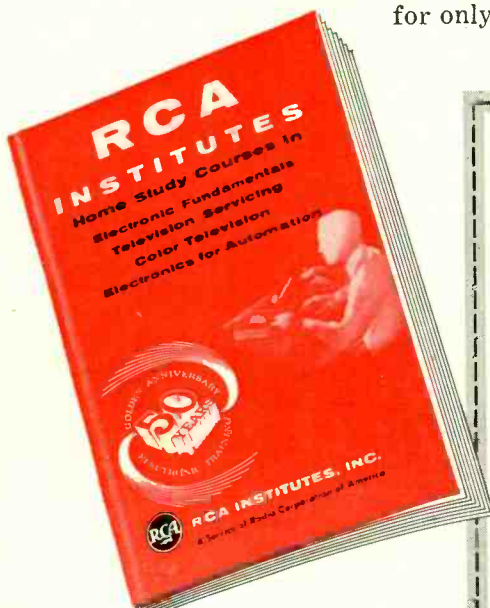

## RCA INSTITUTES, INC., Home Study School RE-29

A Service of Radio Corporation of America • 350 West Fourth Street, New York 14, N. Y.

Without obligation, send me the FREE catalog of Home Study Courses. No salesman will call.

NAME .....

PLEASE PRINT

ADDRESS .....

CITY ..... ZONE ..... STATE .....

Korean Vets! Enter discharge date .....

**CANADIANS** Take advantage of these same RCA Courses at no additional cost. No postage, no customs, no delay. Send coupon to:

RCA VICTOR COMPANY, LTD. • 5001 Cote de Liesse Rd., Montreal 9, Que.

TO SAVE TIME. PASTE COUPON ON POSTCARD.

**HUGE SPECIAL PURCHASE! 1,000,000  
RADIO/TV PARTS FOR LEKTRON'S**

# GIANT PENNY SALE!

**EIGHT OF OUR MOST POPULAR POLY-PAKS**

- |                       |                                     |                                      |
|-----------------------|-------------------------------------|--------------------------------------|
| GERMANIUM DIODES      | <input type="checkbox"/> 6 for 88c  | <input type="checkbox"/> 12 for 89c  |
| * CERAMIC CONDENSERS  | <input type="checkbox"/> 75 for 88c | <input type="checkbox"/> 150 for 89c |
| * PRECISION RESISTORS | <input type="checkbox"/> 30 for 88c | <input type="checkbox"/> 60 for 89c  |
| DISC CONDENSERS       | <input type="checkbox"/> 30 for 88c | <input type="checkbox"/> 60 for 89c  |
| CARBON RESISTORS      | <input type="checkbox"/> 75 for 88c | <input type="checkbox"/> 150 for 89c |
| * POLY BOXES          | <input type="checkbox"/> 10 for 88c | <input type="checkbox"/> 20 for 89c  |
| TUBE SOCKETS          | <input type="checkbox"/> 30 for 88c | <input type="checkbox"/> 60 for 89c  |
| LOOPSTICK CORES       | <input type="checkbox"/> 4 for 88c  | <input type="checkbox"/> 8 for 89c   |

**FREE!**

**BUY TEN POLY-PAKS<sup>®</sup> LISTED BELOW,  
PICK ELEVENTH FREE!**

- |   |  |   |  |
|---|--|---|--|
| <b>4 SUB-MINI VARIABLES</b><br><input type="checkbox"/> Condensers, 1/2" sq., 1" long shaft. For transistor, submini work. Wt. 1 lb. Reg. \$8. <b>88c</b> | <b>15 VOLUME CONTROLS</b><br><input type="checkbox"/> Incl. duals; some w/ switch. To 1 meg. 2 lbs. Reg. \$12. <b>88c</b>                          | <b>2 TRANSISTOR IF'S</b><br><input type="checkbox"/> Double-tuned only 1/2" sq., 456 Kcs. <b>88c</b>                        | <b>15 ROTARY SWITCHES</b><br><input type="checkbox"/> Ass'd. gangs, 3 lbs. Reg. \$12. <b>88c</b>   |
| <b>70 TUBULAR CONDENSERS</b><br><input type="checkbox"/> Paper, molded, oil, pore. .0002 to .5 mf to 1000V. 2 lbs. Reg. \$14. <b>88c</b>                  | <b>MINI-METER</b><br><input type="checkbox"/> 0-6 Amps. AC 1 1/4" dia. 1 lb. Reg. \$3. <b>88c</b>  | <b>20 PRINTED CIRCUITS</b><br><input type="checkbox"/> Built-in RC circuits, incl. integrals. 1 lb. Reg. \$7. <b>88c</b>    | <b>70 TERMINAL STRIPS</b><br><input type="checkbox"/> Solder lug & binding; to 20 terminals. 2 lbs. <b>88c</b>   |
| <b>0 TO 60 MIN. TIMER</b><br><input type="checkbox"/> For darkroom, lab, shop, kitchen. Loud alarm. 2 lbs. Reg. \$6. <b>88c</b>                           | <b>20 CAMEL HAIR BRUSHES</b><br><input type="checkbox"/> 100% pure bristle; sizes 1-6. Reg. \$2.50. <b>88c</b>                                     | <b>POSTAGE STAMP MIKE</b><br><input type="checkbox"/> Crystal, 100 to 8,000 cycles per sec. 1 lb. Reg. \$7. <b>88c</b>      | <b>65 COILS, CHOKES</b><br><input type="checkbox"/> IF RF ant. slug-tuned, too. 3 lbs. Reg. \$15. <b>88c</b>   |
| <b>1500 PCS. HARDWARE</b><br><input type="checkbox"/> Nuts, screws, washers, etc. 1 1/2 lbs. <b>88c</b>   | <b>40 SUB-MINI CONDENSERS</b><br><input type="checkbox"/> For transistor, printed circuit work. 1 lb. Reg. \$7. <b>88c</b>                         | <b>HOBBY BENCH VISE</b><br><input type="checkbox"/> Clamp type, fits tables, too. Steel. 1 lb. <b>88c</b>                   | <b>15-PC. TWIST DRILL SET</b><br><input type="checkbox"/> 1/16" thru 1/4" by 64ths. w/ calibrated case. Reg. \$3. <b>88c</b>                                 |
| <b>WIRE STRIPPER</b><br><input type="checkbox"/> Strips and cuts wire sizes #16 thru #22. Wt. 1 lb. <b>88c</b>  | <b>2 MIKE TRANSFORMERS</b><br><input type="checkbox"/> Carbon, imp. 100 to 100K ohms. Leads, enclosed. 2 lbs. Reg. \$10. <b>88c</b>                | <b>40 HI-Q CONDENSERS</b><br><input type="checkbox"/> Finest porcelain; NPO's too! 1 lb. <b>88c</b>                         | <b>75 MICA CONDENSERS</b><br><input type="checkbox"/> .00025 to .01 to 1200 V; silver, too. 25 1/2" values. Reg. \$28. <b>88c</b>                            |
| <b>70 ONE-WATTERS</b><br><input type="checkbox"/> Ass'd. value carbon resistors. 5%, too. <b>88c</b>  | <b>70 HI-Q RESISTORS</b><br><input type="checkbox"/> Carbon, 1/4", Ohmrite, 1% tol. 1/2, 1 & 2 W; 10 ohms to 10 megs. 2 lbs. Reg. \$13. <b>88c</b> | <b>TV PIC BOOSTER</b><br><input type="checkbox"/> Parallel, 6-wire. Excludes picture tube life. 1 lb. <b>88c</b>            | <b>60 KNOBS, RADIO, TV</b><br><input type="checkbox"/> Ass'd. colors, insulation. Some worth \$1 ea. 2 lbs. Reg. \$17. <b>88c</b>                            |
| <b>100 HALF-WATTERS</b><br><input type="checkbox"/> Ass'd. value carbon resistors, incl. 5%. Reg. \$12. <b>88c</b>  | <b>2 VARI-LOOPSTICKS</b><br><input type="checkbox"/> Adj. 510-1500 Kcs. Transistor radios, etc. 1 lb. <b>88c</b>                                   | <b>6 SILICON DIODES</b><br><input type="checkbox"/> Sylvania, 1N22, 1N23. Reg. \$36 <b>88c</b>                              | <b>4 OUTPUT TRANSFORMERS</b><br><input type="checkbox"/> 50L6, etc. 3 lbs. Reg. \$8. <b>88c</b>  |
| <b>7 ROLLS WIRE</b><br><input type="checkbox"/> 25 ft. each, #18 thru #22. Ass'd. insulation, stranding colors. 2 lbs. Reg. \$5. <b>88c</b>               | <b>5-IN-1 DRILL BIT</b><br><input type="checkbox"/> Reams, saws, shapes, drills, copes, for hand or electric drill. <b>88c</b>                     | <b>8 TRANSISTOR SOCKETS</b><br><input type="checkbox"/> Mica-filled; for sub-mini tubes, too. <b>88c</b>                    | <b>35 POWER RESISTORS</b><br><input type="checkbox"/> WW, 1 to 50 W to 10,000 ohms. Vitreous incl. 3 lbs. Reg. \$15. <b>88c</b>                              |
| <b>10 ELECTROLYTICS</b><br><input type="checkbox"/> Radio, TV, 10-500 mf to 450 VDC. 3 lbs. Reg. \$12. <b>88c</b>   | <b>60 SUB-MINI RESISTORS</b><br><input type="checkbox"/> 1/4" long, 20 values; 1/2" W, to 10 megs. <b>88c</b>                                      | <b>3 AC-DC CHOKES</b><br><input type="checkbox"/> For power supplies. 50 to 200 ma. Open frame. 3 lbs. Reg. \$9. <b>88c</b> | <b>8-PC. NUTDRIVER SET</b><br><input type="checkbox"/> \$3 value, plastic handles, 2 1/2" x 7/16" socket wrenches. 1 lb. <b>88c</b>                          |
| <b>4 POWER WOOD BITS</b><br><input type="checkbox"/> Hi-Q Steel, 3/8, 1/2, 3/4 & 1". For drills, presses, 5" long. Reg. \$3. <b>88c</b>                   | <b>75-PC. RESISTOR SPECIAL!</b><br><input type="checkbox"/> WW, precision, carbon, variable, mini types. 3 lbs. Worth \$15. <b>88c</b>             | <b>4 TRANSISTOR OSC. COILS</b><br><input type="checkbox"/> For printed circuit, transistor portables. <b>88c</b>            | <b>\$25 SURPRISE PACK!</b><br><input type="checkbox"/> Large, varied assortment radio, TV parts. 3 lbs. <b>88c</b>   |
| <b>FILAMENT TRANSFORMER</b><br><input type="checkbox"/> 115/160 cycles to 6.3 VCT @ 1.5A. 2 lbs. Reg. \$4. <b>88c</b>                                     | <b>300-FT. HOOKUP WIRE</b><br><input type="checkbox"/> Tinned, ass'd. sizes, colors. 2 lbs. <b>88c</b>   | <b>SUN BATTERY</b><br><input type="checkbox"/> Similar famed B2M. 1" long. Reg. \$2.50. <b>88c</b>                          | <b>8 SCREWDRIVERS &amp; RACK</b><br><input type="checkbox"/> Ass'd. screwdrivers w/ plastic handles; wall rack. 1 lb. List, \$3.50. <b>88c</b>               |
| <b>30 MOLDED CONDENSERS</b><br><input type="checkbox"/> Ass'd. Finest made! Wt. 2 lbs. <b>88c</b>   | <b>60-PC. CONDENSER SPECIAL!</b><br><input type="checkbox"/> Molded, paper, ceramic, oil, mica, discs, variable. 2 lbs. <b>88c</b>                 | <b>2 P-N-P TRANSISTORS</b><br><input type="checkbox"/> Popular make. Hunt-dies of uses. \$5 value! <b>88c</b>               | <b>WORLD'S SMALLEST RADIO</b><br><input type="checkbox"/> 2 x 1 1/2" Kit includes loopstick, ticks, diode, etc., w/ instructions. 1 lb. Reg. \$3. <b>88c</b> |
| <b>5 ROLLS MICRO WIRE</b><br><input type="checkbox"/> Sizes 24 thru 32; for transistor & sub-mini circuits. 1 lb. <b>88c</b>                              | <b>TEN 3-SECOND TIMER</b><br><input type="checkbox"/> Mechanisms. Precision geared. 2 lbs. Reg. \$5. <b>88c</b>                                    | <b>TEN 3-SECOND TIMER</b><br><input type="checkbox"/> Mechanisms. Precision geared. 2 lbs. Reg. \$5. <b>88c</b>             |  |
|   | <b>10 PANEL SWITCHES</b><br><input type="checkbox"/> Ass'd. 115 VAC, power, multi-circuit & SPST, DPST, DPDT. 2 lbs. Reg. \$5. <b>88c</b>          |   |  |

**HOW TO ORDER:** Check items wanted. Return entire ad w/ check or M.O. including sufficient postage; excess returned. C.O.D. orders, 25% down; rated, net 30 days. Print name, address WITH POSTAL ZONE NO., amount money enclosed, in margin. (Canada postage, 48c 1st lb., 28c ea. add'l lb.)

**LEKTRON** 131 Everett Ave. CHELSEA 50, MASS.



**FREE! SURPRISE GIFT FREE WITH EVERY ORDER**

**FREE 12-PAGE BARGAIN FLYER**  
Hi-Fi, Electronics, Jewelry, Gifts

NEW TUBES & SEMICONDUCTORS (Cont'd)

Output (max sig) (watts)	11	20
Harmonic distortion (total) (%)	2.5	2.0

**3N35**

A grown-diffused silicon tetrode transistor which has a typical 20-db power gain at 70 mc. It is designed for use in high-frequency if, rf and

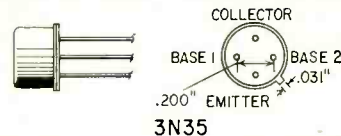

video amplifiers, and high-frequency oscillators. It is made by Texas Instruments.

Maximum ratings of the 3N35 tetrode transistor are:

I <sub>c</sub> (ma)	20
I <sub>c</sub> (ma)	20
I <sub>B1</sub> (ma)	5
I <sub>B2</sub> (ma)	5
P <sub>c</sub> (mw)	125

Minimum breakdown voltages are:

BV <sub>CEO</sub> (I <sub>c</sub> =50 μa, I <sub>B2</sub> =0, I <sub>E</sub> =0)	30
BV <sub>EBO</sub> (I <sub>c</sub> =50 μa, I <sub>B2</sub> =0, I <sub>E</sub> =0)	1
BV <sub>CEO</sub> (I <sub>c</sub> =1 ma, I <sub>B2</sub> =0, I <sub>B1</sub> =0)	30

**2N1010**

This is an n-p-n germanium-alloy junction transistor intended for use in the input stages of audio amplifiers

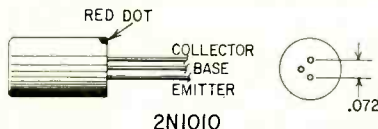

such as high-fidelity preamps, tape recorders, microphone preamps and hearing aids, where low noise is important. Maximum noise factor is 5 db.

Maximum ratings of the RCA 2N1010 in class-A audio amplifier service are:

V <sub>CB</sub> (peak)	10
V <sub>CE</sub> (peak)	10
V <sub>EB</sub> (peak)	10
I <sub>c</sub> (peak) (ma)	2
I <sub>E</sub> (peak) (ma)	2
P <sub>total</sub> (mw) (at 55°C)	20

**2N331**

A p-n-p germanium alloy-junction transistor intended for use in low-power audio-frequency applications.

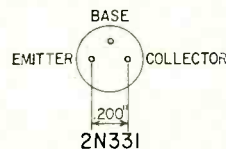

Maximum ratings of this RCA transistor in class-A af amplifier service are:

V <sub>CB</sub>	30
V <sub>EB</sub>	12
I <sub>c</sub> (ma)	200
I <sub>E</sub> (ma)	200
P <sub>c</sub> (mw)	200
(25°C)	60
(55°C)	25
(71°C)	25

**1H2**

This is a miniature heater-cathode type diode designed for use in TV

**SENCORE**

## LEAKAGE CHECKER

Check these outstanding New Features

The LC3 provides all these new improved features in addition to those employed in earlier leakage or "grid circuit" testers. A must for any TV service technician.

- ★ Checks 156 different tube types—more than any other "grid circuit" type checker. Includes UHF and latest type tubes.
- ★ Checks picture tubes without removing tube from cabinet or chassis.
- ★ New Roll Chart prevents obsolescence—just dial the tube type and save time. Chart is easily replaced at no extra cost.
- ★ Provides instant filament checks on "Fil-Check" position—no need to carry a second filament checker.
- ★ Capacitor checks simplified.
- ★ Two spare preheating sockets to cut down testing time.

In stock at your local parts distributor.

**Model LC-3**  
**\$2895**

DEALER NET  
Really Whips  
Tough Dogs

**SERVICE INSTRUMENTS CORPORATION • 121 Official Road, Addison, Illinois**

receivers as the high-voltage rectifier. It is primarily intended for use in fly-back type power supplies.

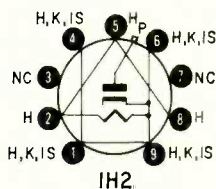

Maximum ratings of this General-Electric tube are:

PIV <sub>p</sub> (dc component)	24,000
(total dc and peak)	30,000
I <sub>p</sub> (steady state peak) (ma)	50
Dc output current (ma)	0.5

**Miscellaneous**

The 6EM5 and 8EM5, beam power tubas for vertical-deflection amplifier service in 110° system, were announced by RCA.

The 1N2069, 1N2070, 1N2071 diffused silicon rectifiers made by Texas Instruments handle 750-ma average rectified current.

1N1763 and 1N1764 silicon rectifiers for use in power supplies of color TV receivers have been introduced by RCA.

A duo-triode pulse tube, the 6955, is being made by CBS-Hytron. END

**US Wants Electronic Inventions**

(Continued from page 35)

miles. Continuous wave phase-comparison systems can now measure distances up to 250 miles over sea water at 1-to-45,000 accuracy and up to 100 miles over land to 1-to-35,000 accuracy. (Condensed)

**915. ULTRA-LONG-RANGE RADAR SET.** A set having an over-the-horizon capability extending to perhaps 2,000 miles. This capability would be based on the intentional utilization of superrefractive ducts in the atmosphere and would provide penetration of very remote areas for target location and tracking.

**917. OPTIMUM STABILIZATION DEVICE FOR AIRBORNE RADAR ANTENNAS.** A size-weight device for mechanically or electronically stabilizing very long radar antennas for aircraft motions in tip, tilt, or yaw.

**918. COMPOUNDED AIRBORNE SENSOR.** A device to accept inputs from airborne optical, infra-red and radar sensors and display them compatibly on a single medium with redundant images eliminated.

**924. IMAGE-INTENSIFICATION DEVICE.** A hand-held device capable of amplifying starlight to twilight level or higher to provide "daylight seeing" at night.

**926. DISPLACEMENT TIME GAUGE.** Develop a simple inexpensive electronic radar type displacement gauge. This gauge should be able to measure relative displacement between itself and some object on the order of 10 to 20 feet away with an accuracy of .01 inch, and a time resolution of .001 second. (Condensed)

**942. DETECTION AND TRACKING OF SUBMARINES FROM AIRCRAFT.** The detection and tracking of submarines still exists as a difficult problem, particularly under adverse weather conditions. Dependable, accurate and simple devices are needed. —H.G.

**Auto Radio Control Replacement is Child's Play**

with new **Centralab**®

**Exact Replacement Controls**

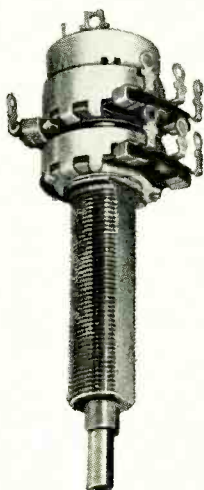

Now one source can fill all your needs for auto radio replacement controls. CENTRALAB has a new line of exact replacements for every popular radio in use today. This is the first time in history that you have been able to get the auto radio control you need—from a control manufacturer.

It's easy to handle more auto radio repair business—and handle it profitably—when you install exact replacement controls bought from your *regular* supplier. No need to run all around town looking for the right unit—you can now be sure that your CENTRALAB distributor has it!

A complete and thorough guide listing all auto radio controls in use today, and their CENTRALAB equivalents, is now available. Pick up your free copy from your distributor—or write direct to CENTRALAB.



A DIVISION OF GLOBE-UNION INC.  
922 B. E. KEEFE AVE. • MILWAUKEE 1, WIS.  
IN CANADA: 804 Mt. Pleasant Rd. • Toronto 12, Ont.

**CONTROLS • ROTARY SWITCHES • CERAMIC CAPACITORS  
PACKAGED ELECTRONIC CIRCUITS • ENGINEERED CERAMICS**

# On the Market

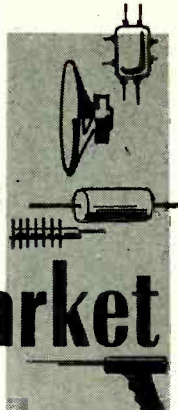

## PRINTED-CIRCUIT SOCKETS. Precision molded. 8 types,

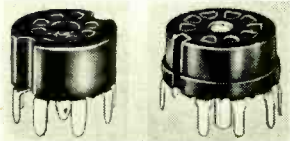

various sizes, from 7 to 9 pins with center shields.—Waldom Electronics Inc., 4625 W. 53 St., Chicago 32, Ill.

**SILICON RECTIFIERS**, type TSR (encapsulated), type PSR (plug-in), type ESR (top-hat), type SSR (stud). New design

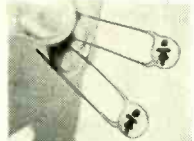

cuts reverse leakage current and forward voltage drop. Freedom from premature failure guaranteed. All units automatically tested at factory. Encapsulated in new Mallo-Seal coating.—P. R. Mallory & Co. Inc., 3029 E. Washington St., Indianapolis 6, Ind.

## RELIABLE ELECTROLYTICS, type QE. Computer-grade,



for precision and industrial equipment. Useful life expectancy more than 10 years. Rated for operation from -20° to 85° C. Drawn aluminum cases in 4 diameters, 4½ inches high.—Aerovox Corp., New Bedford, Mass.

**FLYBACKS**, exact replacement. *Stancor HO-291* (shown) replaces Hoffman part 5118A; *HO-292*, Hoffman 5154A and 5154-3; *HO-294*, Emerson

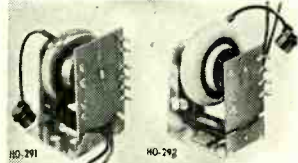

738103 and 738109; *HO-295*, Emerson 738106, 738107 and 738111; *HO-296* replaces Emerson 738119, 738122, 738128, 738129 and 738140.—Chicago Standard Transformer Corp., 3501 Addison St., Chicago 18, Ill.

## FM ANTENNA, Taco G 600. Turnstile type. Gold anodized.

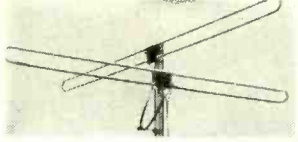

Folded-dipole terminals connected by tuned transmission line. Terminal impedance 300 ohms. For strong-to-medium signal-strength areas.—Technical Appliance Corp., Sherburne, N. Y.

**MARINE PORTABLE RADIO. Model 88m** tunes marine (1.7-3.2-mc), 80-meter and broadcast bands. *Model 88* tunes broadcast band only. Operates on own battery or 12-volt boat system.



Dash-mounting brackets and external battery harness furnished. 8 transistors and diodes, push-pull output, 4-inch speaker.—CAS Mfg. Co., 413 E. Hubbard St., Mineral Wells, Tex.

## AUTO RADIO CONTROLS, exact replacements. New line

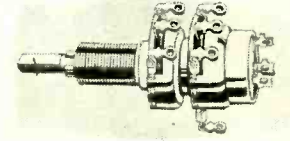

covers all popular makes and models in use today, including private brands.—Centralab Div., Globe-Union Inc., 900 E. Keefe Ave., Milwaukee 1, Wis.

## AUTO RADIO CONTROLS, exact replacement. 98 controls



to fit 199 auto makes and models.—G-C Electronics Mfg. Co., 400 S. Wyman St., Rockford, Ill.

## GARAGE-DOOR OPERATOR. Controlled from auto or house.

**10 Day FREE Trial Proves—You Can GAIN QUICK MASTERY OF**

# TRANSISTOR CIRCUIT DESIGN and OPERATION

Here is the easiest, most straight-forward approach to transistor amplifiers and oscillator circuits ever published. Far more than just a "handbook" or "primer" it manages the tough job of combining simplicity of operation with full technical fidelity. And the only math requirement is High School Algebra!

## TRANSISTOR PHYSICS & CIRCUITS Over 200 Topics—628 Information-Packed Pages by Riddle and Ristenhall, Sr. Engineers, Haller, Raymond & Brown

Divided into two main sections: physical operation of transistors and basic circuit theory of transistors... all material explained in terms of familiar principles with wide use of diagrams to aid visualization. Text includes special "brush-up" section on physics and electrical principles. Only one set of equations is needed for any type of transistor amplifier, grounded base, grounded emitter, and grounded collector with or without feedback. Contents include extensive coverage of: Semiconductors, Transistor types, Small Signal Amplifiers, Power Amplifiers, The Transistor as a circuit element, Cascade Amplifiers, Feedback, Bias Stability and Direct Current Amplifiers, Transistor Oscillators and Multivibrators.



**SEND NO MONEY**  
Mail coupon for 10-day FREE EXAMINATION copy right away. **SEND NO MONEY.**

Prentice-Hall, Inc., Dept. 5744-B1 Englewood Cliffs, N.J.

Send me TRANSISTOR PHYSICS AND CIRCUITS for 10 days' FREE examination. At the end of that time I'll either remit \$10.00, plus small postage, or return the book and owe nothing.

Name.....  
Address.....  
City..... Zone..... State.....  
**SAVE!** Send \$10.00 now and we'll pay postage. Refund and return privilege guaranteed.

## SENCORE "Fuse Safe" CIRCUIT TESTER

Save Time with SENCORE

Save costly call backs by testing the circuit before replacing fuse, fuse resistor or circuit breaker.

Individual scale for each value fuse resistor—no interpretation, just read in red or green area.

★ Measures line current and up to 1100 watts of power at 115 volts using line cord and socket. ★ Two convenient current ranges—0 to 2 amps and 0 to 10 amps. Test leads clip in place of fuse or fuse resistor. ★ 5 ohm, 10 watt resistor prevents TV circuit damage, simulates operating conditions.

**SENCORE**

As Recommended by Leading Manufacturers  
**SERVICE INSTRUMENTS CORPORATION**  
121 OFFICIAL ROAD, ADDISON, ILLINOIS  
See other SENCORE ads in this issue



MODEL FS-3

**\$8.95** DEALER NET  
AC-DC or both as needed for Fuse Resistor Circuits

**Special Stereo Issue**  
**March**  
**RADIO-ELECTRONICS**  
**On Sale Feb. 26**

## ENGINEERING B. S. DEGREE IN 27 MONTHS

Prepare for unlimited opportunities of the Electronic Age! Students study engineering under accelerated program leading to B.S. degree in 27 mo.; or standard 4-yr. program leading to B.E. degree in 36 mo. B.S. degree (36 mo.) in Math., Chem., Physics. Year-round classes. Comprehensive training in electronics, television, advanced radio theory and design, math., nuclear physics and elec. eng. Also prep courses. Low rate. Earn board. G.I. approved. Enter March, June, Sept., Dec. Catalog.

**INDIANA TECHNICAL COLLEGE**  
1729 E. Washington Blvd., Fort Wayne 2, Indiana

Please send me free information B.S. ENGINEERING DEGREE IN 27 MONTHS as checked.

Electronics     Chemical     Aeronautical  
 Civil     Mechanical     Electrical

B. E. DEGREE IN 36 MO. in:     Electrical (Power or Electronics)  
 Aeronautical     Chemical     Metallurgical  
 Civil     Mechanical     Electronics

B. S. DEGREE IN 36 MO. in: Math.     Chem.     Physics

Name.....  
Address.....

What articles would you like to see published in

## RADIO-ELECTRONICS?

Maybe you're the man to write them. Ask for an author's guide.

## RADIO-ELECTRONICS

154 West 14th St.    New York 11, N.Y.

# BUILD 16 RADIO

## CIRCUITS AT HOME

with the New Deluxe 1959

PROGRESSIVE RADIO "EDU-KIT"®

only

# \$22<sup>95</sup>



### A COMPLETE RADIO COURSE

Now Also Includes

★ TRANSMITTER

★ SIGNAL TRACER

★ SIGNAL INJECTOR

★ CODE OSCILLATOR

★ No Knowledge of Radio Necessary

★ No Additional Parts or Tools Needed

★ EXCELLENT BACKGROUND FOR TV

★ School Inquiries Invited

★ Attractively Gift Packed

### FREE EXTRAS

#### • SET OF TOOLS

• SOLDERING IRON  
• ELECTRONICS TESTER  
• TESTER INSTRUCTION MANUAL • HIGH FIDELITY GUIDE • QUIZZES • TELEVISION BOOK • RADIO TROUBLE-SHOOTING BOOK • MEMBERSHIP IN RADIO-TV CLUB; CONSULTATION SERVICE • FCC AMATEUR LICENSE TRAINING • PRINTED CIRCUITRY • PLIERS-CUTTERS • ALIGNMENT TOOL • CERTIFICATE OF MERIT • VALUABLE DISCOUNT CARD • WRENCH SET

### NO NEED TO SPEND HUNDREDS OF DOLLARS FOR A RADIO COURSE

The "Edu-Kit" offers you an outstanding PRACTICAL HOME RADIO COURSE at a rock-bottom price. Our Kit is designed to train Radio & Electronics Technicians, making use of the most modern methods of home training. You will learn radio theory, construction practice and servicing.

You will learn how to build radios, using regular schematics; how to wire and solder in a professional manner; how to service radios. You will work with the standard type of punched metal chassis as well as the latest development of Printed Circuit chassis.

You will learn the basic principles of radio. You will construct, study and work with RF and AF amplifiers and oscillators, detectors, rectifiers, test equipment. You will learn and practice code, using the Progressive Code Oscillator. You will learn and practice trouble-shooting, using the Progressive Signal Tracer, Progressive Signal Injector, Progressive Dynamic Radio & Electronics Tester and the accompanying instructional material.

You will receive training for the Novice, Technician and General Classes of F.C.C. Radio Amateur Licenses. You will build 16 Receiver, Transmitter, Code Oscillator, Signal Tracer and Signal Injector circuits, and learn how to operate them. You will receive an excellent background for Television.

Absolutely no previous knowledge of radio or science is required. The "Edu-Kit" is the product of many years of teaching and engineering experience. The "Edu-Kit" will provide you with a basic education in Electronics and Radio, worth many times the complete price of \$22.95. The Signal Tracer alone is worth more than the price of the entire Kit.

### THE KIT FOR EVERYONE

You do not need the slightest background in radio or science. Whether you are interested in Radio & Electronics because you want an interesting hobby, a well paying business or a job with a future, you will find the "Edu-Kit" a worth-while investment.

Many thousands of individuals of all ages and backgrounds have successfully used the "Edu-Kit" in more than 79 countries of the world. The "Edu-Kit" has been carefully designed, step by step, so that you cannot make a mistake. The "Edu-Kit" allows you to teach yourself at your own rate. No instructor is necessary.

### PROGRESSIVE TEACHING METHOD

The Progressive Radio "Edu-Kit" is the foremost educational radio kit in the world, and is universally accepted as the standard in the field of electronics training. The "Edu-Kit" uses the modern educational principle of "Learn by Doing." Therefore you construct, learn schematics, study theory, practice trouble-shooting—all in a closely integrated program designed to provide an easily-learned, thorough and interesting background in radio.

You begin by examining the various radio parts of the "Edu-Kit." You then learn the function, theory and wiring of these parts. Then you build a simple radio. With this first set you will enjoy listening to regular broadcast stations, learn theory, practice testing and trouble-shooting. Then you build a more advanced radio, learn more advanced theory and techniques. Gradually, in a progressive manner, and at your own rate, you will find yourself constructing more advanced multi-tube radio circuits, and doing work like a professional Radio Technician.

Included in the "Edu-Kit" course are sixteen Receiver, Transmitter, Code Oscillator, Signal Tracer, and Signal Injector circuits. These are not unprofessional "breadboard" experiments, but genuine radio circuits, constructed by means of professional wiring and soldering on metal chassis, plus the new method of radio construction known as "Printed Circuitry." These circuits operate on your regular AC or DC house current.

### A COMPLETE RADIO COURSE—NOTHING ELSE TO BUY

You will receive all parts and instructions necessary to build 16 different radio and electronics circuits, each guaranteed to operate. Our Kits contain tubes, tube sockets, variable, electrolytic, mica, ceramic and paper dielectric condensers, resistors, tie strips, coils, hardware, tubing, punched metal chassis, Instruction Manuals, wire, solder, etc.

In addition, you receive Printed Circuit materials, including Printed Circuit chassis, special tube sockets, hardware and instructions. You also receive a useful set of tools, a professional electric soldering iron, and a self-powered Dynamic Radio & Electronics Tester. The "Edu-Kit" also includes Code Instructions and the Progressive Code Oscillator, in addition to F.C.C.-type Questions and Answers for Radio Amateur License training. You will also receive lessons for servicing with the Progressive Signal Tracer and the Progressive Signal Injector, a High Fidelity Guide and a Quiz Book. You receive all parts, tools, instructions, etc. There is nothing else to buy. Everything is yours to keep.

### SERVICING LESSONS

You will learn trouble-shooting and servicing in a progressive manner. You will practice repairs on the sets that you construct. You will learn symptoms and causes of troubles in home, portable and car radios. You will learn how to use the professional Signal Tracer, the unique Signal Injector and the dynamic Radio & Electronics Tester. While you are learning in this practical way, you will be able to do many a repair job for your friends and neighbors, and charge fees which will far exceed the price of the "Edu-Kit." Our Consultation Service will help you with any technical problems you may have.

J. Stataitis, of 25 Poplar Pl., Waterbury, Conn., writes: "I have repaired several sets for my friends, and made money. The "Edu-Kit" paid for itself. I was ready to spend \$240 for a Course, but I found your ad and sent for your Kit."

### FROM OUR MAIL BAG

Ben Valerio, P. O. Box 21, Magna, Utah: "The Edu-Kits are wonderful. Here I am sending you the questions and also the answers for them. I have been in Radio for the last seven years, but like to work with Radio Kits, and like to build Radio Testing Equipment. I enjoyed every minute I worked with the different kits; the Signal Tracer works fine. Also like to let you know that I feel proud of becoming a member of your Radio-TV Club."

Robert L. Shuff, 1534 Monroe Ave., Huntington, W. Va.: "Thought I would drop you a few lines to say that I received my Edu-Kit, and was really amazed that such a bargain can be had at such a low price. I have already started repairing radios and phonographs. My friends were really surprised to see me get into the swing of it so quickly. The Troubleshooting Tester that comes with the Kit is really swell, and finds the trouble, if there is any to be found."

### Unconditional Money-Back Guarantee

The Progressive Radio "Edu-Kit" has been sold to many thousands of individuals, schools and organizations, public and private, throughout the world. It is recognized internationally as the ideal radio course.

By popular demand, the Progressive Radio "Edu-Kit" is now available in Spanish as well as English.

It is understood and agreed that should the Progressive Radio "Edu-Kit" be returned to Progressive "Edu-Kits" Inc. for any reason whatever, the purchase price will be refunded in full, without quibble or question, and without delay.

The high recognition which Progressive "Edu-Kits" Inc. has earned through its many years of service to the public is due to its unconditional insistence upon the maintenance of perfect engineering, the highest instructional standards, and 100% adherence to its Unconditional Money-Back Guarantee. As a result, we do not have a single dissatisfied customer throughout the entire world.

- Send "Edu-Kit" Postpaid. I enclose full payment of \$22.95.
- Send "Edu-Kit" C.O.D. I will pay \$22.95 plus postage.
- Send me FREE additional information describing "Edu-Kit."

Name .....

Address .....

### PROGRESSIVE "EDU-KITS" INC.

1186 Broadway, Dept. 149G, Hewlett, N.Y.

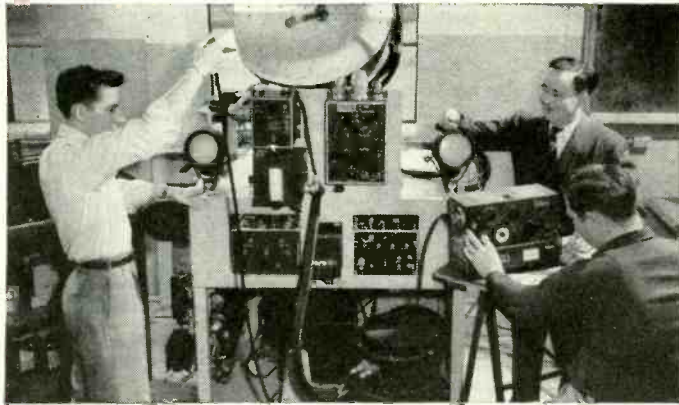

radiation check on radar transmitter in Tri-State lab

# realize your dream... "electronic engineer"

Unlock your talents through college education. Then promotion will not pass you by. You will have an exciting career and share the rewards awaiting college graduates . . . higher income, rapid advancement. Important firms visit Tri-State campus to interview seniors.

## in only 27 months

Bachelor of Science Degree in Electrical Engineering with either an Electronics or Power major . . . also in Mechanical, Civil, Chemical, Aeronautical Engineering. *In 36 Months* a B. S. degree in Business Administration (General Business, Accounting, Motor Transport Management majors). Veteran approved.

**Electronic Engineers**  
Excellent opportunity for professional growth and advancement.  
Interesting and *div.*

## intensive program

More professional class hours. Year-round operation enables you to save time, money . . . start earning the salary of a college graduate much sooner. Enrollment limited. *Beautiful campus.* Well-equipped labs. *Modest costs.* Enter March, June, September, January. Write J. G. McCarthy, Director of Admissions, 2429 College Avenue, Angola, Indiana, for book "Your Career in Engineering and Commerce" and Catalog.



**TRI-STATE COLLEGE**

### ON THE MARKET (Continued)

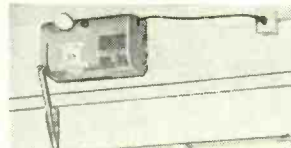

Simple installation. Radio controlled (200-400-kc band). Transmitter sends out 2 radio frequencies interlocked with an audio frequency; door opens only when both rf signals are equal in strength. — Paxton Products, 929 Olympic Blvd., Santa Monica, Calif.

**GARAGE-DOOR OPERATOR**, Genie 400. Requires 50% less in-

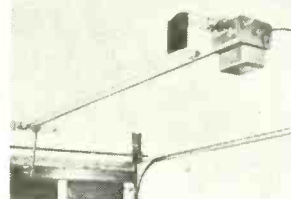

stallation time. Mounting brackets preattached and assembled. 1/8-hp motor. — Alliance Mfg. Co., Alliance, Ohio.

**TUBE TESTER**, model 3414. All switch settings can be made before warmup for speed.

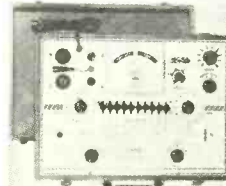

Burned-out tubes rejected instantly. New rapid neon-indicator short test. Continuity test circuit also tests appliances for shorts or opens. Nonobsolescence design. — Triplett Electrical Instrument Co., Bluffton, Ohio.

**ELECTROLYTIC SUBSTITUTOR**, Sencore Electro-Sub model ES 102. Substitutes in any circuit operating at 2-450



volts. Capacitance range includes 10 separate electrolytics from 4 to 350  $\mu$ f. Surge-protector circuit prevents arcing and healing of intermittent capacitor being paralleled. — Service Instruments Corp., Addison, Ill.

**TUBE CHECKER KIT**, Knight-Kit 400. Checks for filament continuity, shorted ele-

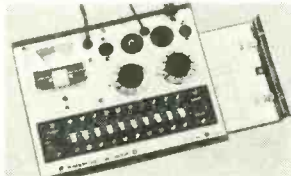

ments and cathode emission of 400 tube types. Compact and portable; weight 5 1/4 pounds. Selector slide switches. Flip cards. 7- and 9-pin miniature, octal and loctal sockets. — Allied

Radio Corp., 100 N. Western Ave., Chicago 80, Ill.

**TUBE TESTER**, self-service model A-1000F. Fully tests prac-



tically all tubes now in use. Also tests auto radio vibrators, 0Z4 tubes, fuses and lamps. Single "test" button. — American Scientific Development Co., Box 109, Redlands, Calif.

**R-C BRIDGE**, model RC-1. Portable tester checks capaci-

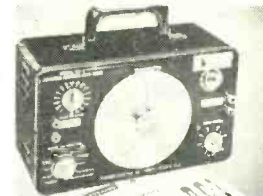

tances of 10  $\mu$ f to 2,000  $\mu$ f in 4 ranges, 0.5 ohm to 200 megs in 4 ranges; tests capacitor leakage, reactance ratio between any 2 capacitors, inductors or resistors. Capacitor test voltage continuously variable 0-500 volts dc. — Pyramid Electric Co., 1445 Hudson Blvd., North Bergen, N. J.

**VOLTOHMYST KIT**, model WV-77E. Measures ac rms from 0.1 to 1,500 volts; dc from .02 to 1,500 volts; peak to peak ac from 0.2 to 4,000 volts; resist-



ance values from 0.2 ohm to 1,000 megohms. Fuse-protected divider network resistors. — RCA, Electron Tube Div., Harrison, N. J.

**AM-FM TUNER**, model EM-085-ER. Etched wiring board and PAC units used. 2 if stages,

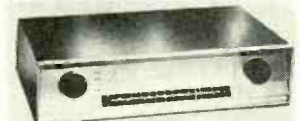

limiter, Foster-Seeley discriminator; afc. — Erie Resistor Corp., 644 W. 12 St., Erie, Pa.

**NEW AUDIO LINE**. Model R-98 FM-AM radio (shown) features rf amplification on both FM and AM, age, 2 if stages,

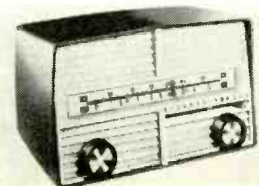

RADIO-ELECTRONICS

ON THE MARKET (Continued)

rear-mounted speaker, built-in antennas. Also available: tuners, amplifiers, speakers in matching cabinets. — **Blonder-Tongue Laboratories Inc.**, 9 Alling St., Newark 2, N. J.

**COAXIAL SPEAKER, CA-12A**, 12-inch. Range 35-20,000

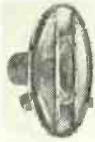

cycles. Inductor-capacitor crossover network at 2,000 cycles. Elliptical tweeter. Rated at 40 watts, average program material. — **Sonotone Corp.**, Elmsford, N. Y.

**EXTENSION SPEAKER.** Compact cabinet, 50-foot cable,



clips. No special tools required. — **Hank & Bert**, Box 8338, Denver 10, Colo.

**ERASE HEADS**, double-gap, laminated, high-efficiency type

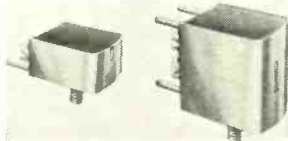

for magnetic tape equipment. **Model ME-100** is 2-track head; **SE-50**, 4-track stereo; **SE-100**, 2-track stereo. All produce 56-db erasure. — **Nortronics Co.**, 1015 S. 6 St., Minneapolis 4, Minn.

**RECORDER MIKE, model M-150.** Replacement unit for tape recorders. Output —44 db. Range 30-10,000 cycles. Crystal type.



5-foot shielded cable. — **Astatic Corp.**, Conneaut, Ohio.

**TAPE RECORDER KIT, model TR-1A.** Tape deck; 2-speed,

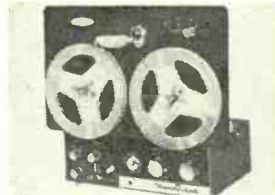

belt drive unit. Response 50-5,000 cycles within 2 db at 7½ ips. Single-control lever operation. Electron-ray tube recording-level indicator. Separate erase and combination record/playback heads. — **Heath Co.**, Benton Harbor, Mich.

**RECORD CLEANER KIT, Stereo/Hi-Fi Discleaner.** Con-



tains cleaning solution, applicator pad, dusting pad. Solution removes static charges. Velvet pads have pile sheared to match .045-inch groove depth of stereo discs. — **Walco Products Inc.**, 60-RE Franklin St., East Orange, N. J.

**HI-FI CABLE KIT, HK 510.** 36-inch shielded cable with



phono plug and pigtales, 18-inch shielded cable with 2 phono plugs, double phono jack adapter, phono plug adapter, in plastic box. — **Anchor Products Co.**, 2712 W. Montrose Ave., Chicago 18, Ill.

**STEREO TUNER KIT, Heath-kit PT-1.** 16-tube AM-FM com-



bination. 3 circuit boards. Pre-wired, prealigned FM front end. Built-in AM rod antenna. Tuning meter; afc. Flyheel tuning. AM and FM circuits can be used simultaneously. Cathode-follower outputs with individual level controls. Variable AM bandwidth. 10-ke whistle filter. Tuned-cascade FM front end. FM agc and amplified avc for AM. Silicon diode power supply. — **Heath Co.**, Benton Harbor, Mich.

**STEREO ENCLOSURE, 217-Duo.** 2-speaker stereo in single

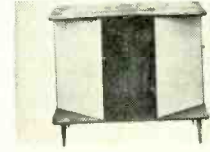

cabinet 3 feet wide. Speakers arranged for 160° deflection of sound. 30 inches high, including 6-inch legs. Walnut, mahogany, blond or unfinished birch. — **Hartley Products Co.**, 521 E. 162 St., New York 51, N. Y.

**STEREO ENCLOSURE, Catalina TSE-1,** for bookshelf or floor use in limited space. Takes 8-inch coaxial speaker or 8-inch

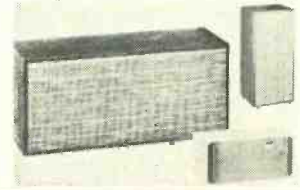

Get This Valuable Book

**FREE**



Just For Examining COYNE'S New Set

**"Applied Practical Radio-Television"**  
on **7 DAY FREE TRIAL!**

Yes, you get this big, brand new book, "150 Radio-Television Picture Patterns and Diagrams Explained", absolutely FREE! Complete 11x22" Schematic Diagrams on leading models Radio and TV Sets help cut your servicing time. Easy-to-read, large 8½x11" pages, with full instructions on how to use the diagrams. A "must" in every repair kit. You get this book as a FREE Gift for asking to see Coyne's new 7-book set, "Applied Practical Radio-Television"!

**At Last! Money-Making "Know-How" On Transistors, Color TV and Servicing**

Coyne's great 7-volume set gives you all the answers to servicing problems—quickly! For basic "know-how" that's easy to understand you'll find everything you want in Volumes 1 to 5 on over 5000 practical facts and data. Every step from fundamentals to installing, servicing and trouble-shooting all types of radio and TV sets. So up-to-date it includes the latest on COLOR TV and UHF. All this plus Volume 7—TRANSISTOR CIRCUITS—the most complete book ever published on the applications of transistors in electronics. New! Set has colorful design, washable covers.

**EXTRA! 868-Page TV Cyclopeda Included!**

For speedy on-the-job use, you also get Vol. 6—famous Coyne CYCLOPEDIA. Answers problems on servicing, alignment, installation, etc. in easy ABC order. Use this 7-volume TV-RADIO LIBRARY FREE for 7 days; get the Servicing Book FREE!

**FREE!**

5 Years Of Valuable Supplements

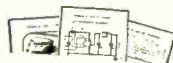

With your set you also get Coyne's annual Supplement Service FREE for 5 years. Keeps your set up-to-date on everything that will be new in radio, television, electronics and electricity.

**NOW!**  
**7 BIG BOOKS**  
IN ONE GREAT SET!



**SEND NO MONEY!** Just mail coupon for 7-volume set on 7 days free trial. We'll include book of 150 TV-Radio Patterns & Diagrams. If you keep the set, pay \$3 in 7 days and \$3 per month until \$27.25 plus postage is paid. (Cash price, only \$24.95). Or you can return the library at our expense in 7 days and owe nothing. **YOU BE THE JUDGE.** Either way, the book of TV-Radio Patterns is yours FREE to keep! Offer is limited. Act NOW!

**FREE BOOK—FREE TRIAL COUPON!**

Educational Book Publishing Division  
**COYNE ELECTRICAL SCHOOL, Dept. 29-T1**  
1501 W. Congress Pkwy., Chicago 7, Ill.

**YES!** Send 7-Volume "Applied Practical Radio-Television" for 7 days FREE TRIAL per your offer. Include TV-Radio Patterns & Diagram Book FREE.

Name ..... Age .....

Address .....

City ..... Zone ..... State .....

Where Employed .....

Check here if you want library sent C.O.D. You pay postman \$24.95 plus C.O.D. postage on delivery. 7-day money-back guarantee.

Educational Book Publishing Division  
**COYNE ELECTRICAL SCHOOL**  
1501 W. Congress Pkwy., Dept. 29-T1, Chicago 7, Ill.

ON THE MARKET (Continued)

woofer and tweeter. Legs included.—Argos Products Co., 310 Main St., Genoa, Ill.

**STEREO SPEAKER SYSTEMS, Stereorama series.** 30° angular separation in single

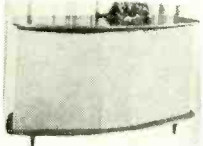

contemporary enclosure. May be used with 12-watt amplifier. Choice of woods. *Stereorama II* combines 2 *Frazier Mark II* speaker systems. *Stereorama I* uses *F-8-3X Black Box* systems.—**Frazier, International Electronics Corp.**, 2649 Brenner Dr., Dallas 20, Tex.

**STEREO WOOFER, model C-12SW,** 12-inch. Dual voice coil

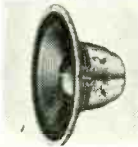

eliminates need for isolation network or control filter when used as single bass speaker for stereo system. 1½-lb. Alnico 5 magnet. Response 40-6,000 cycles overall. Built-in adjustable response limiter can be set for 700-, 2,500-, or 5,000-cycle cutoff to suit requirements of most tweeters. Power rating 25 watts integrated program. Impedance 8 ohms.—**University Loudspeakers**

**Inc.**, 80 S. Kensico Ave., White Plains, N. Y.

**SPEAKER BAFFLE, model DFI 8.** Nonresonant Fiberglass in folded infinite ceiling baffle. May be mounted on ceiling or

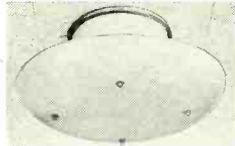

atop post for outdoor installations. Choice of 2-tone color combinations.—**Fourjay Industries**, 2360 W. Dorothy Lane, Dayton 39, Ohio.

**STEREO PREAMP control center, Knight KN-700A.** Sepa-

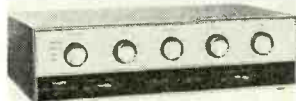

rate bass and treble controls for each channel. 10 inputs (5 pairs), all controlled from front panel. Dc on all tube heaters. Provision for remote control. Response 20-20,000 cycles ±1 db. Hum level 55 db. below full output on tape channels, 60 db below on magnetic, 80 db on auxiliary.—**Allied Radio Corp.**, 100 N. Western Ave., Chicago 80, Ill.

**STEREO CONVERTER.** Contains phono oscillator to use any broadcast-band radio for second channel of stereo system without wiring. Volume controls for



both channels and balance control. Ceramic stereo phono cartridge included.—**Bard Record Co. Inc.**, 66 Mechanic St., New Rochelle, N. Y.

**BASIC STEREO AMPLIFIER KIT, KT-310.** May be used as dual 18-watt stereo amplifier,

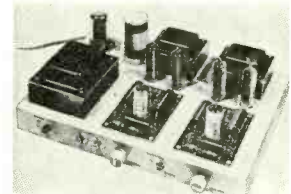

36-watt mono amp or as 2 separate 18-watt mono amplifiers. Dual inputs, each with separate volume control. Speaker output impedances of 4, 8, 16 and 32 ohms. Input sensitivity 0.45 volt per channel for full output. Response 35-30,000 cycles ± ½ db at 18 watts. Harmonic and IM distortion below 1%. 7 tubes including rectifier.—**Lafayette Radio**, 165-08 Liberty Ave., Jamaica 33, N. Y.

**STEREO AMPLIFIER KIT, Qual-Kit model STA-24.** Stereo preamp and dual 12-watt stereo amplifiers or single 24-watt mono amplifier. Williamson type with special output transformers

tapped for 4-, 8- and 16-ohm speakers. Dual ganged bass, treble and loudness controls, balance control, mode and se-

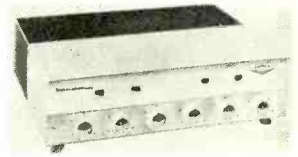

lector switches.—**Quality Electronics Inc.**, 319 Church St., New York 13, N. Y.

**STEREO AMPLIFIER, SA-3.** 2-channel, inverse feedback, 3-watt (1.5 watts per channel). Input 0.3 to 1 volt for ceramic cartridge, tuner or tape. 3-meg input impedance, 8-10 ohms output impedance. Individual tone

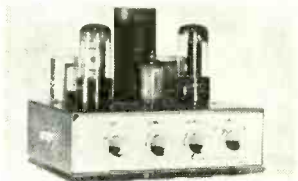

and volume controls for each channel. 3 tubes plus silicon rectifier. Also available: *SA-7* 7-watt stereo amplifier.—**Continental Manufacturing Inc.**, 1612 California St., Omaha, Neb.

**STEREO AMPLIFIER, Masco "Torulf" SA-202.** 4 watts output. Includes preamp. Output impedance 4 ohms each channel. Tuner and phono input impedance 470,000 ohms. Input sensi-



**ELECTRONIC FIELD ENGINEERS  
FIELD SERVICE TECHNICIANS**

*Act fast for new, challenging assignments in U.S., Europe, Mediterranean, Far East, Alaska, Iceland and South America... including openings in*

**SPACE EXPLORATION PROGRAM**

**ELECTRONIC FIELD ENGINEERS**

Engineering degree or equivalent experience in electronic systems required.

**FIELD SERVICE TECHNICIANS**

Technical school, plus three years experience required. Military service acceptable.

EXPERIENCED IN RADAR, GROUND COMMUNICATIONS; COMPUTERS, GCA

Obtain these advantages: • Prestige of representing the leader in its field • Opportunity for professional development and advancement • Excellent salary • Liberal field allowance • Both U.S. & overseas assignments

Drop us a line, briefly outlining your education and experience. Mail replies to MR. O. A. BOWMAN, DEPT. V, FIELD ENGINEERING.

"Our Laboratory... the Universe"



DIVISION OF BENDIX AVIATION CORP.  
Owings Mills, Maryland





tivity 0.2 volt for rated output. Response 50-15,000 cycles  $\pm 1$  db. Treble cut type tone controls. Hum and noise 70 db below 2-watt level.—Mark Simpson Mfg. Co., 32-28 49 St., Long Island City 3, N. Y.

**ACRYLIC-CASE METERS.** Clear plastic-case meters which can be painted to match any

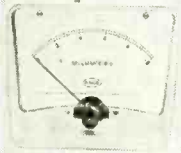

color equipment by spraying with acrylic lacquer. Model 25-LP is 2½-inch rectangular; 35-LP, 3-inch rectangular; 45-LP, 4½-inch rectangular.—PACE Electrical Instruments Co., 70-31 84 St., Glendale, N. Y.

**SERVICING AIDS.** C-ring servicing tool (shown) is de-

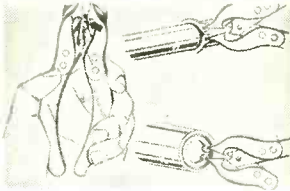

signed for insertion and removal of C washers and retaining rings on tuners, detents, control and switch shafts, etc. Silver Print and Copper Print are new compounds for repairing and touching up printed circuits around eyelets, parts, etc.—Walsco Electronic Mfg. Co., 100 W. Green St., Rockford, Ill.

**POWER-SAW KIT, model 505K.** Contains model 505 Uni-

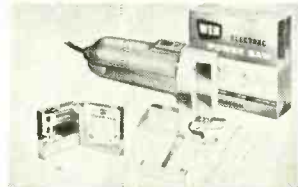

versal power saw in heavy gauge metal kit with 5 assorted blades. Can be used as rip, jig, cross-cut, coping, scroll, keyhole and hacksaw.—Wen Products Inc., 5806 Northwest Hwy., Chicago 31, Ill.

**PHONO PIN-PLUG, Grip-A-Lip model PPP-1.** Finger-grip

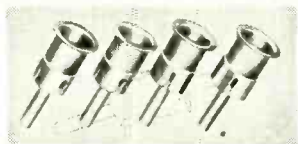

lip permits removal of plug without pulling on cable.—DeRo Electronics, 134 Nassau Rd., Roosevelt, N. Y.

**STAPLE GUN-KIT, T-50** Contains heavy-duty gun-tacker, screen, wire and window shade attachments, 5,000 staples and

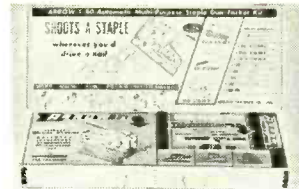

staple lifter.—Arrow Fastener Co., 1 Junius St., Brooklyn, N.Y.

**STEREO ADAPTER, Knight KN-750.** To control stereo systems using two separate amplifiers rated up to 12-watts each. Installed between speakers and amplifiers the unit controls: balance, volume, phasing, channel



reversal and selection of stereo or mono.—Allied Radio Corp., 100 N. Western Ave., Chicago, Ill.

**POWER AMPLIFIER, model 250.** Rated at 40 watts, 80 watts instantaneous peak. Flat frequency response from 12-40,000

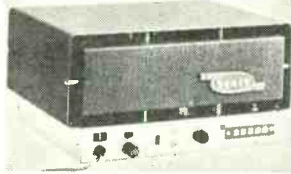

cycles. Less than 0.5% harmonic distortion at rated power output.—H. H. Scott, 111 Powder Mill Rd., Maynard, Mass.

**STEREO TAPE RECORDER, Stereo Continental.** Twin-track, 3-speed unit. Push-button controls. Response 40-16,000 cycles

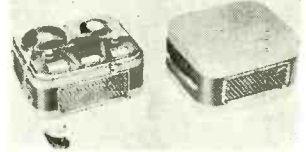

at 7½ ips; 50-12,000 cycles at 3¾ ips; 60-6,000 cycles at 1½ ips. Inputs for recording from tuner, phono, microphone and mixing (recording two signals simultaneously or in sequence). With dual preamps, one power amplifier and built-in speaker. Second power amplifier and second channel speaker available in matching case.—North American Phillips Co., High Fidelity Products Div., 230 Duffy Ave., Hicksville, N.Y.

**MODULE TYPE CABINETS** for hi-fi components. Equipment and speaker cabinets measure either 18 or 36 inches wide, 29 inches high and 16 inches deep. Mobile shelving to accommodate amplifier, tuner, turntable or changer, tape deck and associated equipment. Mahogany or walnut finish.—Sherwood Electronic Labs., 4300 N. California Ave., Chicago 18, Ill. END

All specifications on these pages are from manufacturers' data.

**New TV SERVICE CRADLE SPEEDS REPAIRS • BRINGS BIGGER SERVICE PROFITS**

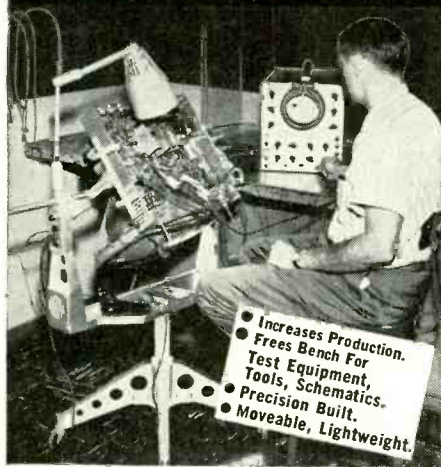

- Increases Production.
- Frees Bench For Test Equipment, Tools, Schematics.
- Precision Built.
- Moveable, Lightweight.

**PAYS FOR ITSELF WITH LABOR SAVINGS ON FIRST FEW JOBS**

TEL-A-TURN ends in-repair damage, propping and struggling with hard to handle TV chassis. Holds sets up to 200 lbs. and 9" to 25" wide. Places every component in sight and reach. Built-in speaker, outlets, cheater cord, pilot light and switch. Stand and bench models. Ideal too for servicing record changers, amplifiers and other electronic equipment. See TEL-A-TURN at your jobber or write today for free details. Dept. RE-29.

**ROGERS MANUFACTURING CO. LINDSEY, OHIO, U.S.A.**



**UNMISTAKABLY - THE FINEST NAME IN COMMUNITY TV**

**NEW-"QUAD"**

Tube powered 4 way splitter. Amplifies T.V. and F.M. Connects up to 4 sets. 300 ohm ribbon or 75 ohm co-ax. \$28.50 U.S. Dealer net.

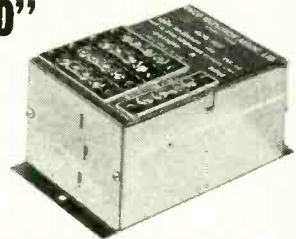

**COMPLETELY NEW CIRCUIT**

**"SUPER-30" BROAD BAND AMPLIFIER**

\*Untuned toroidal transformer coupling between stages eliminates alignment problems throughout life of amplifier. Circuitry incorporated in the Super-30 provides a unit no more critical than a good quality audio amplifier.

- Correct matching over whole range, no smears or ghosts from standing waves.
- Covers complete VHF spectrum ch. 2-13 including F.M., etc.
- 27 db gain, only \$56.50 U.S. dealer net.

\*Patent pending.

Also available "UNIBAND" amplifier using same circuit with 37 db gain, \$85.25 U.S. dealer net.

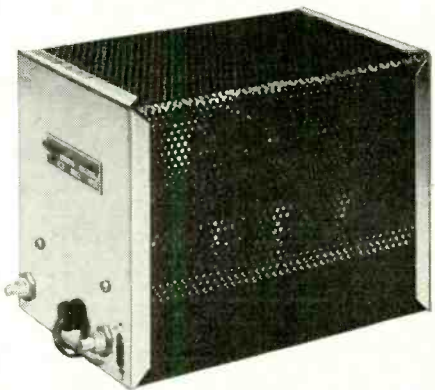

**BENCO TELEVISION ASSOCIATES LTD. 27 Taber Rd., Rexdale, Ontario, Canada**

Please send me full details on the  Quad  S-30  Uniband  Other equipment for Hotels, Apartments, Community Systems

Name .....  
Address .....  
City..... State or Prov.....

**NOW READY! McGraw-Hill's New**

**Train-Yourself Course**

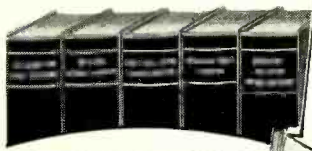

**6 BIG VOLUMES**  
Including HOME COURSE OUTLINE!  
Shows how to Get Ahead Fast.

**FIX TV RADIO**

**AND RECORD CHANGERS RIGHT AWAY**

**AT LAST—at Amazing LOW COST—The Most Complete TV-Radio Repair Course Ever Published. TELLS and SHOWS How to Do Every Job Quickly and Easily—Make GOOD MONEY, Full or Spare Time**

**AFTER 10 YEARS OF PREPARATION**—McGraw-Hill's new 6-Volume Course brings you everything you need to know to "cash in" on the TV-RADIO boom. Over 2,350 pages of money-making "know-how" by top factory engineers and electronic experts. **THREE** giant REPAIR MANUALS tell and show how to FIX every trouble the easy way. **TWO TROUBLESHOOTER MANUALS** tell exactly WHERE to begin, WHAT tools to use. **HOW** to increase your professional speed. Complete Home Study Volume guides you every step of the way, tells how to get ahead fast—build up your own business, full or spare time.

**BIG MONEY—Spare or Full Time**

No previous training needed. NO complicated formulas. **PLAIN ENGLISH**, pictures and directions cover ANY kind of job on EVERY set—tubes, circuits, speakers, new a-c/d-c portables, Color TV, even what to charge for typical jobs!

**SEND NO MONEY**

Try Course 10 days FREE. (We pay shipping!) If you don't agree it can get you started in a money-making repair business—return it, pay nothing. Otherwise keep it! Earn while you learn, and pay the low cost on easy terms. Mail coupon NOW. McGraw-Hill Book Co., Dept. RE-2, 327 West 41st St., N. Y. City 36.

**PARTIAL CONTENTS**

- 1 Television and Radio Repairing — 566 pages. 700 pictures, diagrams. By John Markus, Feature Ed., Electronics Magazine.
- 2 Practical Radio Servicing — 599 pages. 473 illus. By William Marcus, Alex Levy, Electronic Training Experts.
- 3 Profitable Radio Troubleshooting — 330 pages. 153 "how-to" illus. By William Marcus, Alex Levy.
- 4 Profitable TV Troubleshooting—Short-cuts to spot and fix every trouble. By Eugene A. Anthony, Service Consultant, General Elec. Company.
- 5 Repairing Record Changers — 278 pages. 202 A-B-C pictures. By Eugene Ecklund, Eng. DuMont Lab., Inc.
- 6 Complete Home Course Outline — How to get the most out of your Course. By John Markus.

**FREE** THREE Valuable Repair Aids TV, RADIO and CIRCUIT Detect-O-Scopes. Total Retail Value \$3.00

**FREE—THREE** amazing DETECT-O-SCOPE Charts. TV and RADIO Scopes enable you to spot tube troubles in a jiffy. CIRCUIT Scope spots circuit troubles. Make fix-it jobs easier, faster. ALL THREE (worth \$3) FREE.

**THIS COUPON SAVES YOU \$11.85**

McGraw-Hill Book Co., Dept. RE-2, 327 West 41st St., New York 36, N. Y.

Send me—postpaid—for 10 days FREE TRIAL the 6-Vol. McGraw-Hill TV, Radio and Changer Servicing Course. If okay, I'll remit only \$4.95 in 10 days; then \$5.00 monthly for 5 months. (A total saving of \$11.85 on the regular price of the Course and Detect-O-Scopes.) Otherwise, I'll return Course in 10 days; pay nothing.

ALSO send FREE (to keep whether or not I keep the Course) the 3 TV, RADIO, and CIRCUIT DETECT-O-SCOPE CHARTS,—total value \$3.00.

Name.....  
(Please Print Clearly)  
Address.....  
City..... Zone No. .... State.....  
(If any).....

CHECK HERE if you prefer to enclose first payment of \$4.95 with coupon. Same easy pay plan; same 10-day return privilege for full refund.

RE-2

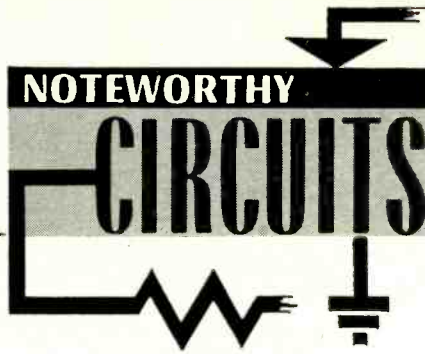

**TWO REFLEX RECEIVERS**

Two reflex trf circuits that have become popular in England are shown in Figs. 1 and 2. The first was described in *Practical Wireless* and uses one tube,

Two rf pentodes are again used both as rf and push-pull output stages. SP61's are high-gain rf pentodes, somewhat similar to 6AC7's but with a

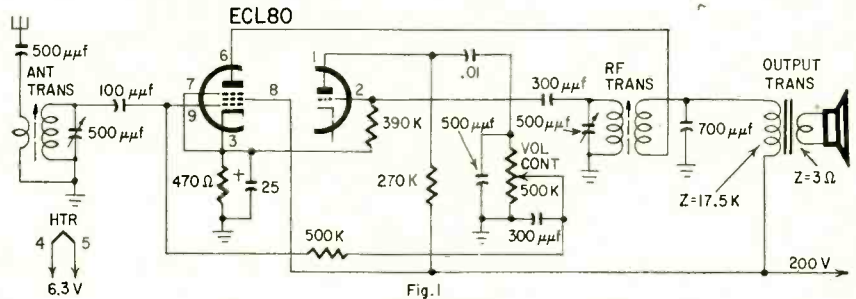

Fig. 1

an ECL80, which is a triode and output pentode in one envelope. The pentode section is used as an rf amplifier and the triode as a detector. The output from the detector is fed back to the rf

gm of 8.5 ma/v (8,500 µmhos). If a 6H6 is used in place of the crystal diode, the 100,000-ohm detector load should be increased to 470,000 ohms.—A. W. J. March

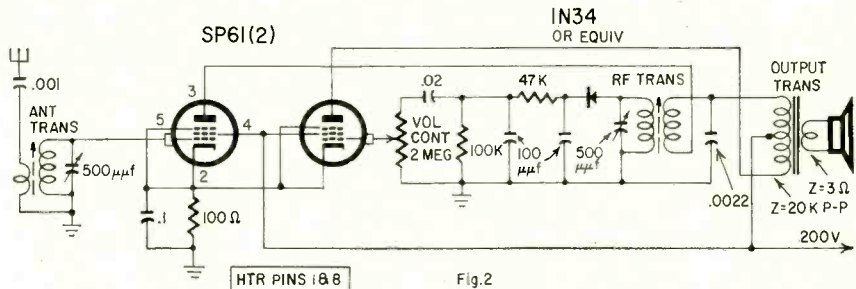

Fig. 2

section and used as the output tube. The circuit's performance is equivalent to that of the usual three-tube trf midget receiver.

The second receiver was shown in *Wireless World* and is slightly more novel as it has a push-pull output.

(The European type tubes used in these circuits may be obtained from Amperex Electronic Corp., 230 Duffy Ave., Hicksville, L. I., N. Y., International Electronics Corp., 81 Spring St., New York, N. Y. and from distributors of European radios.—Editor)

**AUTOMATIC BRIGHTNESS AND CONTRAST CONTROL**

An interesting automatic brightness and contrast-control circuit is used on the latest models of German Metz television receivers. A somewhat simplified version is shown in the diagram. It shows the video amplifier and the horizontal output tube—the first providing the video signal and the second a negative bias—and a double triode which is used in the automatic circuit.

V1-b is the contrast control tube, a variant of the familiar keyed-tube circuit, with its cathode tied to the cathode of the video amplifier. Its plate is fed by pulses coming from the flyback transformer. Its cathode re-

ceives the video signal. The age voltage developed on its plate can be adjusted with contrast pot R1. However, it is also controlled by the grid bias, which is obtained from the negative voltage on the grid of the horizontal output tube through the resistance of a selenium photocell. This cell measures the ambient light in the room and increases the grid bias as the ambient light decreases. As a result, the contrast setting for the receiver is automatically adjusted to suit room lighting conditions.

V1-a receives a fraction of the video signal at its grid, and works as a grid detector. The dc plate voltage is applied

# DX-16 Super Deluxe TV KIT

70° or 90°—operating all 17", 21", 24" and 27" PICTURE TUBES

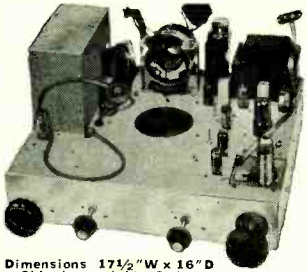

Dimensions 17 1/2" W x 16" D  
Shipping weight 40 lbs.

NEW IN DESIGN—Mounts Horizontally, Vertically

- ★ Produces a 16-Tube Chassis with 30-Tube performance.
- ★ Latest Inter-carrier Circuitry and Multi-section Tubes.
- ★ Standard Neutrode Tuner for Selectivity & Fine Definition.
- ★ 5 Microvolts Sensitivity (20V peak to peak at CRT grid).
- ★ Fast Action AGC for Drift Free, Steady and Clear Pictures.
- ★ 3 Hi-gain Video I.F. Stages for fine Contrast and Details.
- ★ AGC Level Control, for adjusting reception to signal area.
- ★ All Video and I.F. Coils factory pre-aligned and tuned.
- ★ Large 250ma Power Transformer for dependable service.
- ★ 12" Speaker or Twin-cone 6" x 9" Speaker.

Includes LIFE-SIZE step-by-step Building Instructions  
Most Up-To-Date and Practical Course in Television

COMPLETE KIT with SET OF WESTINGHOUSE TUBES **\$79.97**

4—6CB6 and 6U8, 6TS, 6C4, 12BH7, 6SN7, 6B06, 6W4, 6K6, 1X2B, 5U4  
6BN4 and 6CG8 included in the Tuner (less CRT)

Also sold on EASY-PAYMENT-PLAN—buy LIFE-SIZE Instructions \$2.49 and buy Parts as you build.

## Westinghouse ALUMINIZED PICTURE TUBES

BRAND NEW in Factory Sealed Cartons—With a Full Year Guarantee

17" 17AVP4A	21" 21ALP4A	24" 24ALP4A	27" 27EP4A
17BP4B	21AMP4A	24ALP4A	27LP4A
17CP4A	21AUP4A	24ALP4A	27RP4A
17HP4B	21EP4B	24DP4A	
17LP4A	21YP4A	24VP4A	
17QP4A	21ZP4B	24YP4A	

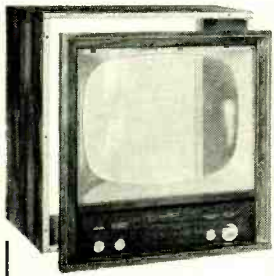

## BUILD YOUR OWN CABINET FOR TV CHASSIS

Comparable to the type that Top Mfrs. use on high priced TV sets.

CABINET KIT with 90% of the job done, includes—

FRONT SECTION in Solid Mahogany, Walnut or Blond Korina. TOP, SIDES, BACK, MASK, SAFETY GLASS, ETC.

And EASY-TO-FOLLOW ASSEMBLY INSTRUCTIONS

Front, Top and Sides supplied in a beautiful Piano Finish • Knob panel undrilled • For matching Mask specify type or number of CRT used. Same price—Mahogany, Walnut or Blond. (Shipping weight 36 lbs.)

**2 1/2" CABINET KIT** 26" H. 25" W. 22" D **\$24.95**

FRONT SECTION Only for WALL INSTALLATIONS Includes Mask. 21" \$17.45 | 24" or 27" \$22.97  
Safety Glass. Decals and Illustrated Instructions.  
Complete as pictured, ready to install—in Mahogany, Walnut, Blond or unfinished.

## PULSE KEYED AGC KIT

Finest, most accurate and the easiest Kit to install—in any make TV RECEIVER Complete—including 6AUG Tube & Instructions **\$4.59**

## TV PLASTIC OPEN MASKS

21"—Rectangular 18" x 22 1/2"	\$2.38
24"—Rectangular 21" x 26"	4.93
27"—Rectangular 21" x 26"	4.93

On 21" specify type number of CRT used

## TV SAFETY GLASS IN HANDY SIZES

16" x 20"	\$2.94	20 1/4" x 25"	\$5.47
18" x 22 1/2"	5.16	21 1/4" x 26"	5.87

## 90° TV CONVERSION KIT

Convert any Size, any make TV RECEIVER to operate the 24" or ANY 90° PICTURE TUBE.

COMPLETE SET OF ESSENTIAL PARTS includes matched set of 90° YOKE & 18kv FLYBACK, 30kv FILTER, 6AX4 TUBE, BRACKETS, WIDTH CONTROL, CONDENSERS, RESISTORS, ETC.

Your Price **\$15.98** List Price \$39.75  
Incl. CONVERSION MANUAL with Step-by-Step Instructions & Diagrams  
Similar Kit for any 70° CRT... **\$13.97**

## STEREO — Selected as BEST for Quality, Performance & Price

- \$98 DeWald #M-1000 "AMBASSADOR AM-FM TUNER" both Stereo & Monaural ..... \$68
- \$98 DeWald #M-1200 "CONCERTO 30-WATT AMPLIFIER" both Stereo & Monaural ..... \$68
- \$59 BASS REFLEX CABINET for 12" or 15" Speaker, in Mahogany, Walnut or Blond ..... \$34
- \$28 12" HI-FI UNIVERSAL TYPE SPEAKER woofer & tweeter range 50 to 15000 cps ..... \$14
- \$49 DELUXE VM 4-SPEED RECORD CHANGER incl. Cartridge plays all Stereo & Monaural ..... \$26
- \$332 "COMPLETE PACKAGE DEAL" includes ALL FIVE ITEMS as shown above.....for only \$199

## TUBULAR CONDENSERS — 85°C TOP QUALITY—Equally as good for Radio or TV work.

.0047-400v, .01-400v, .02-400v, .047-400v, .001-600v, .0047-600v, .01-600v, .02-600v ..... 5¢ ea.  
.1-400v, .25-400v, .47-400v, .047-600v, .1-600v, .25-600v, .001-1000v, .01-1000v ..... 8¢ ea.  
.035-1000v, .047-1000v, .1-1000v, .015-1600v, .03-1600v, .001-6000v, .005-6000v ..... 14¢ ea.

## ELECTROLYTIC CONDENSERS — 85°C 1-50v, 1-150v, 2-450v, 5-150v, 8-150v .. 19¢ ea.

20/20-150v, 50/30-150v, 40-150v, 10-450v, 20-450v, 30-450v, 40-450v, 60-450v, 80-450v..... 34¢ ea.

## CARBON RESISTORS — Regular factory stock in Stackpole, I.R.C., Speer, etc.

1/2 WATT 10%	10, 39, 47, 100, 120, 150, 270, 330, 390, 470, 560, 680, 820, 1k, 1800Ω	2¢ ea.
1/2 WATT 10%	2700, 3300, 3900, 4700, 5600, 6800, 8200, 10k, 15k, 18k, 22k, 27k, 33kΩ	2¢ ea.
1/2 WATT 10%	39k, 47k, 50k, 56k, 68k, 82k, 100k, 120k, 150k, 180k, 220k, 270k, 330kΩ	2¢ ea.
1/2 WATT 10%	390k, 470k, 560k, 680k, 820kΩ	2¢ ea.
1 WATT 10%	3.3, 10, 39, 100, 120, 150, 330, 470, 560, 680, 820, 1k, 1800, 2700, 4700Ω	3¢ ea.
1 WATT 10%	6800, 10k, 15k, 22k, 27k, 33k, 39k, 47k, 68k, 82k, 150k, 470k, 680kΩ	3¢ ea.
2 WATT 10%	3.9, 18, 22, 82, 100, 180, 2200, 4700, 6800, 8200, 18k, 22k, 100k, 470kΩ	4¢ ea.

CERAMIC CONDENSERS 1, 2, 3, 5, 6, 10, 22, 25, 47, 50, 51, 56, 82, 100, 120, 200 mmf ..... 3¢ ea.

CERAMIC CONDENSERS 220, 250, 270, 330, 470, 1k, 1200, 1500, 2k, 5k, 6800, 15k mmf ..... 3¢ ea.

MICA CONDENSERS 5, 25, 50, 60, 68, 75, 100, 120, 150, 220, 270, 390, 470, 510, 10k mmf ..... 3¢ ea.

MICA CONDENSERS 560, 680, 820, 1k, 1500, 2k, 2500, 3300, 4700, 6k, 6800, 8k, 10k mmf ..... 3¢ ea.

# "ONE DOLLAR" buys

As much as \$15 worth—Everything Brand New and sold to you with a money back guarantee. **DEDUCT 10%** ON ANY ORDER OF \$10 OR OVER

(ON THESE DOLLAR BUYS)  
Plus a FREE SURPRISE PACKAGE

- \$15 — "JACKPOT" TELEVISION PARTS.....\$1
- 1 — RCA 70° FLYBACK TRANS. #75240 .....\$1
- 1 — \$11 TODD 60° DEFLECTION YOKE.....\$1
- 4 — RCA TUBES #1U4 also serves as a 1T4.....\$1
- 10 — TV CARTWHEEL CONDENSERS 10kv.....\$1
- 40 — ASST. PRECISION RESISTORS best sizes \$1
- 35 — ASST. DISC CERAMICS 10kv best numbers.....\$1
- 2 — ELECTRIC MOTORS 1 1/2 volt, 100I uses.....\$1
- 1 — 5" PM SPEAKER alnico #5 magnet.....\$1
- 20 — TUBULAR CONDENSERS .05-.600v.....\$1
- 20 — TUBULAR CONDENSERS .001-1000v.....\$1
- 100 — ASSORTED FUSES popular sizes.....\$1
- 100 — ASSORT. 1/2 WATT RESISTORS some 5%.....\$1
- 70 — ASSORTED 1 WATT RESISTORS some 5%.....\$1
- 35 — ASSORTED 2 WATT RESISTORS some 5%.....\$1
- 50 — ASST. TUBULAR CONDENSERS.....\$1
- 10 — 6' ELECTRIC LINE CORDS with plugs.....\$1
- 5 — TV CHEATER CORDS with both plugs.....\$1
- 4 — 50' SPOOLS HOOK-UP WIRE 4 colors.....\$1
- 50 — STRIPS ASST. SPAGHETTI best sizes.....\$1
- 100 — ASST. RUBBER GROMMETS best sizes.....\$1
- 100' — TWIN LEAD-IN WIRE 300Ω heavy duty.....\$1
- 50' — FLAT 4-CONDUCT. WIRE many purposes.....\$1
- 25' — INSULATED SHIELDED WIRE.....\$1
- 1 — \$7 INDOOR TV ANTENNA hi-gain 3 section.....\$1
- 50' — ANTENNA ROTOR 4-CONDUCT. WIRE.....\$1
- 20 — ASST. TV KNOBS, ESCUTCHEONS, Etc.....\$1
- 3 — ASST. TOGGLE SWITCHES spst, dpdt, etc.....\$1
- 15 — ASST. ROTARY SWITCHES \$15 worth.....\$1
- 100' — FINEST NYLON DIAL CORD best size.....\$1
- 200 — SELF TAPPING SCREWS #8 x 1/2".....\$1
- 35 — ASST. RADIO KNOBS screw and push-on.....\$1
- 100 — KNOB SPRINGS standard size 3/8" x 1/4".....\$1
- 100 — ASSORTED KNOB SET-SCREWS.....\$1
- 25 — ASSORTED CLOCK RADIO KNOBS.....\$1
- 600 — ASST. H'DWARE screws, nuts, rivets, etc.....\$1
- 50 — ASST. SOCKETS octal, novel and miniature.....\$1
- 20 — ASSORTED TUBE SHIELDS best sizes.....\$1
- 50 — ASST. MICA CONDENSERS some in 5%.....\$1
- 50 — ASST. CERAMIC CONDENSERS ".....\$1
- 10 — ASST. VOLUME CONTROLS less switch.....\$1
- 5 — ASST. VOLUME CONTROLS with switch.....\$1
- 100 — VOLUME CONTROL HEX NUTS.....\$1
- 20 — ASST. PILOT LIGHTS popular types.....\$1
- 10 — PILOT LIGHT SKTS. bayonet type, wired.....\$1
- 50 — ASST. TERMINAL STRIPS 1, 2, 3, 4 lug.....\$1
- 10 — ASST. RADIO ELECTRO. CONDENSERS.....\$1
- 5 — ASST. TV ELECTROLYTIC CONDENSERS.....\$1
- 25 — ASST. MICA TRIMMER CONDENSERS.....\$1
- 2 — ELECTROLYTIC COND. 10/40 — 450V.....\$1
- 30 — FP CONDENSER MOUNTING WAFERS.....\$1
- 3 — ELECTROLYTIC CONDENSERS 80-450v.....\$1
- 3 — ELECTROLYTIC COND. 50/30-150v.....\$1
- 10 — HV TUBULAR CONDENSERS .001-6000v.....\$1
- 10 — HV TUBULAR CONDENSERS .005-6000v.....\$1
- 35 — MICA COND. 20-100 mmf & 15-270 mmf.....\$1
- 35 — MICA COND. 20-470 mmf & 15-680 mmf.....\$1
- 35 — MICA COND. 20-820 mmf & 15-1000 mmf.....\$1
- 35 — CERAMIC COND. 20-5 mmf & 15-10 mmf.....\$1
- 35 — CERAMIC COND. 20-25 mmf & 15-47 mmf.....\$1
- 35 — CERAMIC COND. 20-56 mmf & 15-82 mmf.....\$1
- 35 — CERAMIC COND. 20-100 mmf & 15-150 mmf.....\$1
- 35 — CERAMIC COND. 20-270 mmf & 15-470 mmf.....\$1
- 35 — CERAMIC COND. 20-1000 mmf & 15-1500 mmf.....\$1
- 35 — CERAMIC COND. 20-2000 mmf & 15-5000 mmf.....\$1
- 50 — 100Ω 1/2 WATT RESISTORS 5%.....\$1
- 75 — 470kΩ 1/2 WATT RESISTORS 10%.....\$1
- 3 — VARIABLE CONDENSERS 420/162 mmf.....\$1
- 10 — ASST. WIRE'ND RES. 5, 10, 20 watt.....\$1
- 3 — AUDIO OUTPUT TRANS. 50L6 type.....\$1
- 3 — AUDIO OUTPUT TRANS. 6K6 or 6V6 type.....\$1
- 3 — I.F. COIL TRANSFORMERS 456 kc.....\$1
- 3 — I.F. COIL TRANSFORMERS 10.7 mc FM.....\$1
- 4 — OVAL LOOP ANTENNAS asst hi-gain types.....\$1
- 3 — LOOPSTICK ANT. new ferrite adjustable.....\$1
- 12 — RADIO OSCILLATOR COILS 456 kc.....\$1
- 3 — 1/2 MEG VOLUME CONTROLS with switch.....\$1
- 5 — 50K VOLUME CONTROLS less switch.....\$1
- 10 — SURE GRIP ALLIGATOR CLIPS.....\$1
- 1 — GOLD GRILLE CLOTH 14"x14" or 12"x18".....\$1
- 15 — SETS SPEAKER PLUGS wired.....\$1
- 10 — SETS PHONO PLUGS and PIN JACKS.....\$1
- 2 — \$2.50 SAPPHIRE NEEDLES 4000 playings.....\$1
- 5 — DIODE CRYSTALS 1-IN81 2-IN82 1-IN84.....\$1
- 3 — DIODE CRYSTALS 1-IN80, 1-IN84, 1-IN89.....\$1
- 2 — SELENIUM RECTIFIERS 1-65 ma & 1-150 ma.....\$1
- 15 — ASST. TV COILS sync, peaking, width, etc.....\$1
- 5 — TV CRT. SOCKETS with 18" leads.....\$1
- 5 — HI-VOLT. ANODE LEADS with 18" leads.....\$1
- 1 — LB. SPOOL ROSIN CORE SOLDER 40/60.....\$1
- 6 — SPIN TIGHT SOCKET SET 3/16" to 7/16".....\$1
- 3 — TV ALIGNMENT TOOLS 5", 7", 12".....\$1

HANDY WAY TO ORDER—Simply tear out advertisement and pencil mark items wanted (X in square is sufficient); enclose with money order or check. You will receive a new copy of this ad for re-orders.

ON SMALL ORDERS—Include stamps for postage, excess will be refunded. Larger orders shipped express collect.

**BROOKS RADIO & TV CORP., 84 Vesey St., Dept. A, New York 7, N.Y.** TELEPHONE Cortland 7-2359

**SPECIAL  
PRE-PUBLICATION OFFER  
SAVES YOU \$3.00**

## ENCYCLOPEDIA ON CATHODE-RAY OSCILLOSCOPES & THEIR USES

(2nd edition)

by JOHN F. RIDER &  
SEYMOUR USLAN

On May 1st, 1959, the second edition of this famous book—completely revised, updated and expanded—will be available. The price will be \$21.95 for this 1100 page (8½x11") 'bible' of oscilloscopes. However, you pay only \$18.95 a savings of \$3.00 by reserving your copy at your bookstore, jobber or at the publisher before April 30, 1959. The second edition of the fabulously successful book—the first was considered a classic of useful oscilloscope information by engineers, educators, lab technicians and service technicians—has been greatly expanded to include many new types of oscilloscopes and their applications. It is completely up-to-date!

Whatever your field—geophysics, aviation, automotive, medical research, television, audio, computers, automatic control or any other branch of industrial and communication electronics—you'll find the cathode-ray oscilloscope today's basic instrument. The newly revised 2nd edition of this best-selling classic begins with cathode-ray tube construction and theory, then carries you through a thorough analysis of modern oscilloscope circuitry, commercial scope types and maintenance, to a detailed treatment of how the scope is operated for all applications.

The 2nd edition includes more than twice as many new scope applications. It covers the latest in special purpose cathode-ray tubes, new data on probes, related information on scope photography. A new section on pulse measurements has been added and also a new illustrated section on square wave testing. The chapter on "Commercial Oscilloscopes and Maintenance" covers the latest commercial types.

### COVERS EVERY PHASE OF OSCILLOSCOPES

*Cathode-ray tubes—theory of operation and basic construction—*

*Basic Characteristics of Cathode-Ray Tubes; Principles of Focusing and Deflection; Deflection Systems in Cathode-Ray Tubes; Screens of Cathode-Ray Tubes.*

### *Oscilloscope Circuitry and Operation—*

*The Basic Oscilloscope; Vertical and Horizontal Amplifiers; Time Bases; Sweep Circuits; Synchronization; Power Supplies; Auxiliary Equipment and Accessories; Commercial Cathode-Ray Oscilloscopes and Maintenance; Special Purpose Cathode-Ray Tubes.*

### *Oscilloscope Applications—*

*Basic Signal Observation and Pulse Measurement; Phase and Frequency Measurements; Audio Frequency Circuit Testing; Transmitter Testing; Visual Alignment of A-M, F-M, and Television Receivers; Waveform Observation in Television Receivers; Electrical Testing; Medical, Scientific and Engineering Applications; Oscilloscope Photography.*

### *Waveform Analysis—*

*Complex Waveforms; Square Waveforms.*

Reserve your copy by April 30th at your jobber, bookstore or at the publisher—and pay only \$18.95, a saving of \$3.00.

JOHN F. RIDER PUBLISHER, INC. RE-2  
116 West 14th Street, N. Y. 11, N. Y.

Enclosed is \$\_\_\_\_. Please send me \_\_\_\_ copies at \$18.95 each.

ENCYCLOPEDIA ON CATHODE-RAY OSCILLOSCOPES & THEIR USES (2nd edition, revised) by Rider & Uslan

Pre-publication price of \$18.95 good until April 30, 1959. After that date, \$21.95. All books returnable within 10-days for full refund.

Name.....  
Address.....  
City.....Zone.....State.....

in Canada 5% higher; add state & city taxes where applicable

### NOTEWORTHY CIRCUITS (Continued)

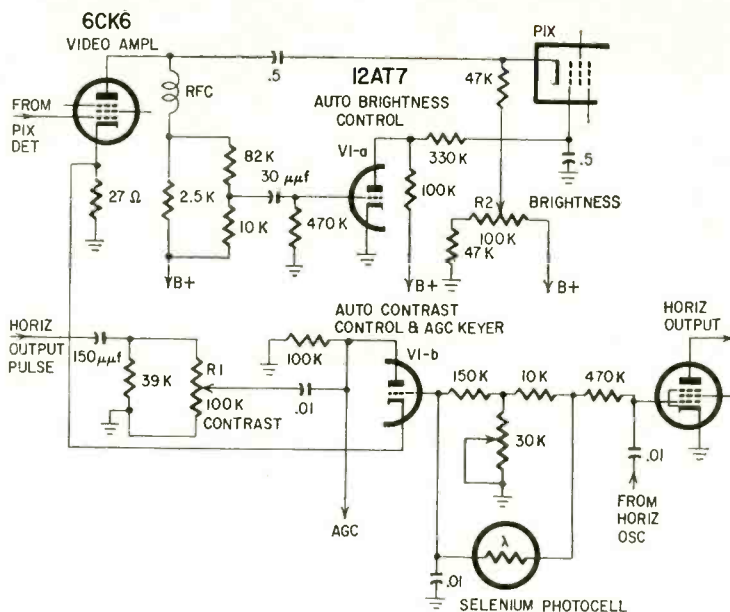

to the picture-tube grid through a filter circuit. The positive plate voltage decreases when the video signal decreases, so this circuit acts as an amplified black-level clamping stage and provides a sensitive adjustment of brightness as a function of the video signal level.

Since this level is controlled by the automatic contrast circuit—the video amplifier and VI-b have a common

cathode return—the photocell indirectly provides for automatic brilliance control. Potentiometer R2 is the conventional manual brightness control.—A. V. J. Martin

(This circuit performs the same basic function as the automatic contrast-ratio control used in the Westinghouse model 846K21 receiver and described on page 29 of the August, 1953, issue.—Editor) END

*Dave Rice's*  
**OFFICIAL  
ORDER BOOK**  
for every TV-Radio  
service call



Triplicate forms serve as order form, invoice and office record with spaces for complete information on every job. Separate listings for receiving tubes, pix tube, parts, serial numbers, labor and tax charges, signatures, etc. 75c a book, \$6.50 for dust-proof box of 10.

... and for customer's prices on every replacement part, plus flat rate and hourly service charge data, regional and national, Dave Rice's

**OFFICIAL PRICING DIGEST**  
listing over 63,000 items. \$2.50

In stock at your distributor, or write

**ELECTRONIC PUBLISHING CO. INC.**  
180 North Wacker Drive Chicago 6, Illinois

**Write for  
Complete Details  
ABOUT THE  
GERNSBACK  
Technicians' And Hi-Fi  
Book Club Plans**

◆  
**Gernsback Library Inc.**  
154 W. 14th St.  
New York 11, N.Y.

**TAPE RECORDERS**

HI-FI COMPONENTS  
Sleep Learn Kits

MERITAPE Low cost, high quality recording tape, in boxes or cans.	UNUSUAL VALUES FREE 1959 CATALOG DRESSNER, 69-02RE 174 St., Flushing 65, N.Y.
--	---

**LOOK**

no further . . . if you're  
searching for hi-fi sav-  
ings. Write us your re-  
quirements now.

**Key Electronics Company**  
120-A Liberty St., N.Y. 6, N.Y.  
EV 4-6071

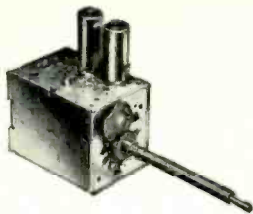

## Now YOU can get TUNERS

repaired, or replaced,  
in a hurry!

**Send them to TARZIAN!**

● Sarkes Tarzian, Inc., announces a new tuner repair service and factory replacement program for Tarzian-manufactured tuners. Distributors, dealers and servicemen will welcome this direct factory service program which is designed to take delay and confusion out of the tuner repair business.

We're set up to offer a 48 hour service from the date of receipt to shipment to you.

Cost is reasonable, too. Only \$7.50 per unit (\$15 for UV combinations) and that includes ALL replacement parts! Both repaired—or exchange units if available from stock—carry a 90 day warranty against defective workmanship and part failure.

Replacements will be offered at these current prices\* on units not repairable:

VHF 12 position tuner...	\$17.50
VHF 13 or 16 position tuner.....	19.50
VHF/UHF combination.	25.00
UHF only.....	15.50

\*Subject to change

When inquiring about tuner service, always refer to tuner by part number. When inquiring about direct replacements for tuners other than Sarkes Tarzian-manufactured, please indicate tube complement, shaft length, filament voltage, series or shunt heater. Use this address for quickest service:

### SARKES TARZIAN, Inc.

Att: Service Mgr., Tuner Division  
East Hillside Drive  
Bloomington, Indiana



TARZIAN Electronic Product and Services include TELEVISION TUNERS . . . SELENIUM AND SILICON RECTIFIERS . . . BROADCAST EQUIPMENT . . . AIR TRIMMERS . . . TV STATIONS WTTV and WPTA, and RADIO STATION WTTs.



### WIND COILS EVENLY

Winding small coils with enameled or similar wire is hampered by the fact that it becomes increasingly difficult to distinguish between layers. Apply a thin coating of white fast-drying paint evenly over the layer preceding the layer being wound, and let the paint dry for a moment before wrapping the next layer of wire. Performance of the coil won't be affected by the paint, and the coil will have a factorylike evenness.—Harry J. Miller

### SERVICING TAPE RECORDERS

When a tape recorder comes in for repair with the complaint that it fails to operate properly on playback (or playback and record if it has a single head with a dual-purpose winding), the trouble invariably can be traced to an open winding in the head. But don't use an ohmmeter to check continuity! If the winding isn't open, you

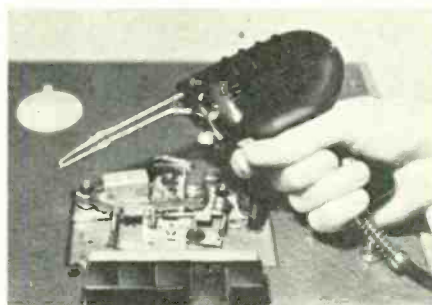

may magnetize the head with direct current from the meter. Instead, turn the recorder on, set the controls for playback and inject a hum signal into the head by holding a soldering gun near the head. The field set up by the gun's transformer will induce a signal into the playback winding and appear as hum from the recorder's speaker if the winding is not open. This is a fast accurate check for head continuity. Absence of hum from the speaker indicates an open winding (assuming the playback switching and amplifiers have been tested and already found operative).—John A. Comstock

### PHILCO MODEL 52-2224

Complaint: Intermittent sound. The volume would drop after a period of time. It might or might not come back to normal. While it was low, a crackling could be heard from the speaker. A complete check of tubes, parts and voltages revealed nothing that might be at fault.

The trouble was in the sound discriminator transformer. A simple replacement cured a troublesome problem.—Wilbur J. Hantz

## From any Point of View, more Experts choose ACROSOUND ULTRA-LINEAR II 60 watt amplifier

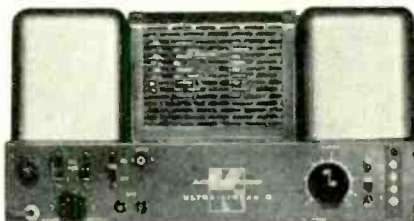

**DESIGN** The combination of patented ULTRA-LINEAR circuitry—plus new HYBRID FEEDBACK principle—VARIABLE DAMPING control, and ULTRA STABILITY, represents a new high in the art of amplifier design... an example of ACROSOUND'S latest achievement in AMERICAN Know-How. This superiority of design now enables anyone with or without any previous knowledge of electronics to assemble for himself or herself... (yes! it's that easy!)... the finest of amplifiers and at a most reasonable cost, in only two hours!

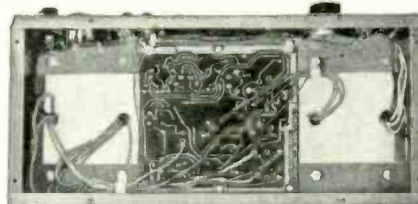

**PERFORMANCE** By listening test, or by instruments... second to none in clarity and frequency response. Normal level distortion is virtually unmeasurable—IM 1% or less at 60 watts, 120 watts peak. Completely stable... unaffected by loads, perfect square waves.

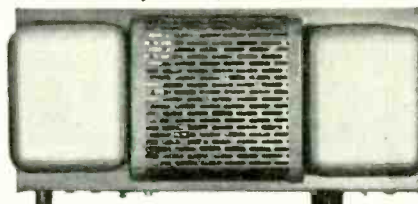

**QUALITY** Every part going into the assembly of critical and even non-critical circuitry is tested and checked to allow no more than  $\pm 1/2\%$  variation from ACROSOUND'S standards. Specialized test equipment unavailable commercially was designed in ACROSOUND'S laboratories to achieve this result. Every printed circuit board is placed in trial operation on a laboratory amplifier. Output tubes are matched by trial and double checked.



**COMPONENTS** ACRO'S newest TO-600 output transformer with special hybrid winding—separates functions of output circuit and feedback circuit. Heavy duty, completely assembled, and thoroughly tested, printed circuit board assures uniformity of performance. Low distortion EL34 output tubes are operated well within their ratings ensuring long tube life and optimum performance.

**PRICE** In preassembled kit form so that you may save money, learn while doing, and have the proud satisfaction you built the best for only \$79.50 net... or if you feel you would prefer it laboratory assembled it still represents a bargain at \$109.50 net.

**HEAR IT AT YOUR DEALER NOW!**

**BE READY FOR ACROSOUND DISTORTIONLESS PRE-AMP DESIGNED FOR THE STEREO-PHILE**

*Experts know why ACRO is best!  
Others... Learn why! Write to*

**ACRO PRODUCTS**  
369 SHURS LANE  
PHILA. 28. PA.

better reception on  
1, 2 or 3 tv sets...  
with one antenna

NEW **B-T LABS** B-23

## TWO-SET BOOSTER

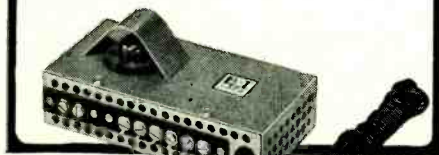

only \$23.95

From B-T comes the most important advance in better TV reception for 1958—a broadband TV amplifier that boosts signal strength on all VHF channels and operates 1, 2 or 3 TV sets with one antenna—no tuning required.

### Combines two functions in one —

- BOOSTS signal strength on 1 or 2 TV sets—up to 6 db gain operating two TV sets from one antenna.

- COUPLES 2 or 3 TV sets—using the present antenna. Outperforms non-powered couplers in any reception area by more than 2 to 1.

### Check these B-23 features:

- Ideal for color—add a color TV set and keep present black-and-white set, use the same antenna—the result, sharper, clearer pictures on both sets
- Low noise figure—designed to work with new VHF sets
- Reduces interference
- Easily installed at antenna terminals of set
- Automatically amplifies channels 2-13
- Ideal small TV system

For operating 3 to 8 TV sets, use the B-T Labs DA8-B—more than 10 db gain on all VHF channels.

The DA8-B Distribution Amplifier is a broadband, all-channel unit that requires no tuning, impedance matching devices, pre-amps or other special fittings. Ideal for all small TV systems (garden apartments, motels, TV showrooms). Approved for color. Only \$94.50

The B-23, the DA8-B, and other B-T quality engineered products, are available at electronic parts distributors.

For further information, use coupon.

RE-2

**B-T LABS** BLONDER-TONGUE LABS., INC.  
9 Alling Street, Newark 2, New Jersey

Please send me literature covering:

B-T B-23       B-T TV Accessories

Name \_\_\_\_\_

Address \_\_\_\_\_

City \_\_\_\_\_ Zone \_\_\_\_\_ State \_\_\_\_\_

## TECHNOTES (Continued)

### OLDSMOBILE AUTO RADIO

After about a week, the owner of an Oldsmobile auto radio model 982543 returned with the same complaint—a weak signal and the usual “You just fixed it . . . Why? . . . etc.!”

Again the set was pulled and the last if transformer returned, just like the previous case history from the file card. No looseness was observed in either slug, but tapping the transformer eventually produced another detune with its associated signal loss.

Before replacing the transformer, the technician looked it over under a magnifying glass. All joints were good, but he noticed a PC unit containing two capacitors was cracked. The PC was replaced and the trouble ended. —James A. McRoberts

### ADMIRAL T104N TUNER

Several Admiral T104N tuners have revealed trouble with the channel selector. Typical complaints have been, “Something is loose in the channel selector . . . a short.” “It won’t hold stations.”

This model has a disk type switch for channel selection and in some receivers the oscillator (top) disk comes loose on the shaft and doesn’t ride correctly above the switch contacts when stations are changed.

The solution to this problem is simple. Remove the tuner cover and, using a

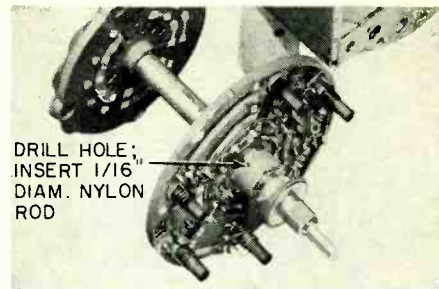

1/16-inch or smaller bit, drill a hole through the disk retaining ring and shaft, making sure that the disk is in the proper position. Before drilling, place a piece of cloth in and around the tuner shaft just below where the drilling operation will take place, to catch as many metal scraps as possible.

After the hole has been made, use a nylon or fiber rod to pin the disk to the channel-selector shaft. If a metal pin is used the shaft will be hot.—Admiral Service Data Supplement

### PHILCO MODEL C-5709

When this auto radio is first turned on, it may motorboat for a short period. Any technician having this problem with this set should connect his ammeter in series with the output transistor’s collector. For perfect operation, current should be about 60 ma. A 10-ma variation in either direction is normal. Greater variation usually means a bad transistor.—A. Von Zook      END

## HERE'S HOW TO GET YOUR START in Radio-Electronics!

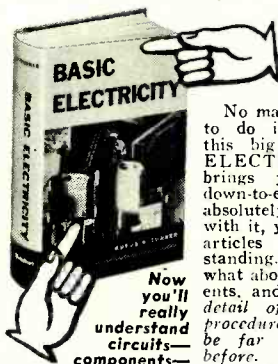

The most important training of all!

Now you'll really understand circuits—components—equipment!

No matter what you want to do in radio-electronics, this big 396-page BASIC ELECTRICITY manual brings you the kind of down-to-earth training you absolutely must have. Backed with it, you'll read technical articles with new understanding. You'll know what's what about circuits, components, and equipment. Every detail of electric-electronic procedure and operation will be far clearer than ever before.

BASIC ELECTRICITY covers the entire field—from circuits and currents to polyphase and phone principles . . . from tubes to transistors . . . from batteries, instruments and measurements to motors, generators, transformers and all the rest. More than 300 pictures and set-up diagrams make things doubly clear. Then, to top off your basic training, it includes an easily understood 61-page INTRODUCTION TO ELECTRONICS. Read it for 10 days at our risk!

### 10-DAY FREE EXAMINATION

Dept. RE-29, RINEHART & CO., Inc.,  
232 Madison Ave., New York 16, N.Y.

Send BASIC ELECTRICITY training manual for 10-day free examination. If I like book, I will then send you \$6.50 (plus postage) in full payment. Otherwise I will return book and owe you nothing. (Save! Send \$6.50 with order and we pay postage. 10-day money-back guarantee.)

Name \_\_\_\_\_

Address \_\_\_\_\_

City, Zone, State \_\_\_\_\_

OUTSIDE U.S.A. \$7.00 cash. 10-day money-back guarantee

## CRYSTALS, Inc.

Accuracy, Dependability,  
Quality and ONE DAY SERVICE

### AMATEUR BAND CRYSTALS

Not surplus! New quartz ground and etched to your exact specified frequency. Checked on HP cycle counters.

1500 KC to 2000 KC. . . . \$2.00 ea. postpaid  
2001 KC to 8995 KC. . . . \$1.50 ea. postpaid  
8996 KC to 11000 KC. . . . \$2.50 ea. postpaid

### SSB FILTER CRYSTALS

Plated type in FT-241A holders. All channels 370 to 534 KC (Except 500 KC) \$1.00 ea. postpaid. 500 KC . . . \$1.75 ea. postpaid. Channel groups accurately matched. No extra charge.

### MARINE FREQUENCIES

All channels. Guaranteed accuracy. Supplied in MC7 or FT243 holders (Specify which type) \$3.75 ea. postpaid.

### VERY THIN CRYSTALS

Supplied in very thin FT243 holders. Order by fundamental frequency. \$2.00 ea. postpaid.

MINIMUM ORDER \$2.00 NO CODs

Satisfaction guaranteed or your money back! Illinois orders . . . please include sales tax.

## CRYSTALS, Inc.

ODELL, ILLINOIS

# BUSINESS and PEOPLE

R. L. Triplett, chairman of the board and founder of the Triplett Electrical Instrument Co., Bluffton, Ohio, displays some of the many congratulatory messages from industry leaders as he ob-

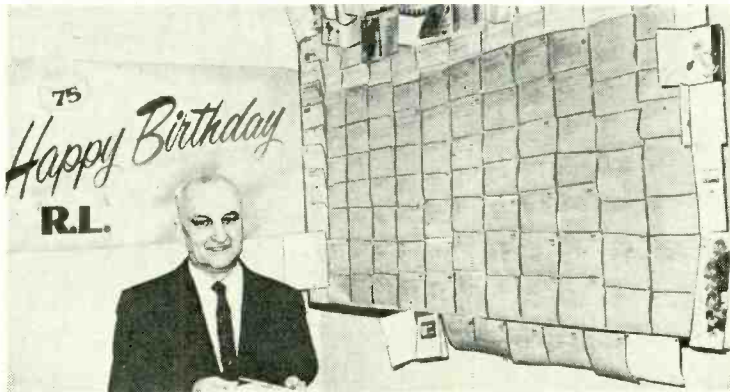

serves his 75th birthday. Widely known as an electronics industry pioneer, he founded in 1904 the test equipment company which bears his name.

Howard W. Sams chairman of the board of Howard W. Sams & Co., Indianapolis technical publisher, also became chairman of the 120-year-old book publishing firm Bobbs-Merrill Co. of Indianapolis, with the purchase of Bobbs-Merrill by the Sams company.



J. Gerald Mayer is the new president of Radio Receptor Co., Brooklyn, N. Y., subsidiary of General Instrument Corp. He has been with Radio Receptor since 1957 and previously was executive vice president of Micamold Electronics Manufacturing Corp., another General Instrument subsidiary. Monte Cohen, president of General Instrument, had been acting president of Radio Receptor.



Mogens E. Christiansen, former assistant sales manager, has been appointed general sales manager of the Mallory Battery Co., Cleveland, Ohio, a division of P. R. Mallory & Co., Indianapolis. He's been in the battery industry 19 years.



John J. Graham has been appointed general manager, Communications and Industrial Electronics Products Div., and Charles H. Colledge general manager, Broadcast and Television Equipment

Div., RCA Industrial Electronic Products. Graham was formerly manager, operations administration, RCA Industrial Electronic Products, and Colledge was vice president, facilities operations, National Broadcasting Co.

Fred A. Martin was named general sales manager for the Parts Div. of Sylvania Electric Products Inc., with headquarters at Warren, Pa. He had been field sales manager for the division since 1951. He will be responsible for all Sylvania field offices.



Two pioneers in the electronic tube industry died late in 1958. Harvey W. Harper, founder and chairman of the board of Tung-Sol Electric Inc., Newark, N. J., died Nov. 23 at his home in Belleair, Fla. at the age of 80. Roy Burlew, founder of the Ken-Rad Lamp & Tube Co., died at 75, Dec. 5 at his home in Owensboro, Ky.

John R. Howland joined Philco Corp., Philadelphia, as sales manager—closed-circuit television and product control equipment, Government and Industrial Div. For the last three years he was general sales manager of Dage Television Div., Thompson Products Inc.

Lewis E. Gillingham, former marketing director of Remler Co., has been appointed marketing director and advertising manager of Altec Companies Inc., Anaheim, Calif.

Alfred Wish, former secretary, has been elected vice president of the Recoton Corp., Long Island City, N. Y., succeeding Jack Karns, resigned. Recoton

performance  
proven in more  
than 500,000  
homes



## UHF CONVERTERS

No matter where you are — primary or fringe area — there's a B-T UHF converter that makes any TV set a modern, powerful 82-channel receiver.

New FCC tuner standards\* are met by these B-T Converters.

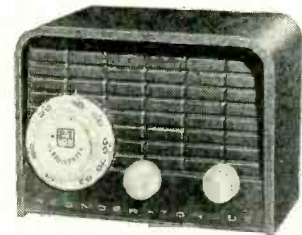

for superior reception  
in fringe areas the

### BTU-2<sub>R</sub>

precise 300-ohm impedance match; high gain—high stability; low noise factor; double tuned input; dual speed channel selector for easy, accurate tuning only 39.95



for primary areas — top  
performance at low cost

### MODEL 99<sub>R</sub>

precise 300 ohm impedance match; double tuned RF section; one knob tuning; drift-free performance only 22.95

B-T converters are UL approved, CSA approved and approved by actual performance in more than 500,000 American homes.

Sold by Electronic Parts Distributors

Blonder-Tongue Laboratories, Inc.  
9 Alling Street RE-2 Newark 2, N. J.

\*Models 99r and BTU-2r comply with tuner limits of FCC rules, Part 15, of 1000 UV/M — Hazeltine Research Corp. — report #57041.

**FAST!  
ACCURATE!**

**SECO Test Equipment**

**Saves time . . . makes  
more money for you!**

WRITE TODAY FOR COMPLETE  
SPECIFICATIONS AND FEATURES!

- Outstanding Reliability and Performance!
- Unique, Time-Saving Features!
- Low First Cost Makes You Money From the Start!

**107 TUBE TESTER—**

Outstanding performance and accuracy—provides 3 important tests: amplifier types tested for gain by Dynamic Mutual Conductance method—power types tested for cathode current by Cathode Emission method—all types tested for shorts and grid error by Grid Circuit Test developed and patented by Seco. Dynamic Mutual Conductance Test pre-wired to eliminate elaborate set-up. Cathode Emission Test done by free point pin-selector method—will not be obsolete. Completely self-contained in portable carrying case. Furnished with handy flip chart for fast tube set-up data.



MODEL 107 . . . . . \$139.50 NET



**GCT-8 GRID CIRCUIT TUBE TESTER**  
—Perfect companion to any tester—checks critical “control grid” condition of vacuum tubes fast, accurately. Electron eye tube indicates faults at a glance. As many as eleven simultaneous checks—automatically.

MODEL GCT-8—Kit . . . . . \$19.95 NET

MODEL GCT-8—Wired & tested . . . 29.95 NET



**208VTVM**—“Fool-proof”—many new features! Easy-to-read 4½” 200 microamp meter mounted on sloping panel—7 DC, 7 AC, 7 ordinary Ohm ranges, plus RETMA (EIA) Ohm scale to check standard color-coded resistance values and tolerance limits. Specially designed “shift-lever” type function switch identifies and automatically connects proper probe. With stand, 40” leads, and common lead with clip.

MODEL 208 . . . . . \$74.50 NET

Leather, felt-lined carrying case. \$9.95 NET



**PS-2 BATTERY ELIMINATOR**—Compact unit takes place of battery normally used to operate and service low-powered transistorized equipment. Supplies clean, filtered DC—can't be damaged by a short. Quickly spots faulty batteries by substitution. Output continuously variable from 0 to 15 V.—ideal for experimenters. Complete with jacks, leads, and clips.

MODEL PS-2 . . . . . \$13.95 NET

**FB-4 FLYBACK CIRCUIT AND INDUCTANCE ANALYZER**—Quick “yes” or “no” answer on condition of flyback transformer and yoke—100% accuracy!

MODEL FB-4 . . . . . \$38.95 NET

**NEW! HC-6 CURRENT CHECKER**

Provides positive, on-the-spot method of checking TV horizontal output circuits—fast, accurate way to adjust horizontal drive and linearity. Easy to use—can be placed in circuit in seconds—compact size. Complete, ready to use.

MODEL HC-6 . . . . . \$12.95 NET

Get the complete story on Seco's exciting line of test equipment. See your distributor—or write for complete information today!

**SECO MANUFACTURING CO.**  
5015 Penn Avenue So.  
Minneapolis, Minn.

**BUSINESS AND PEOPLE (Continued)**

also promoted Hank Miller from Midwest sales manager to national sales manager.

Officers of Service Instruments Corp., Addison, Ill. (below), inspect one of the new window streamers designed to keep technicians and distributors informed of Sencore test equipment. This new point-of-sale aid is part of a merchandising and advertising schedule in RADIO-

for demonstration of the new Stereo Director feature of its loudspeaker line. The Center display includes background drapes and special signs.

RCA Electron Tube Div. is now marketing two separate lines of black-and-white TV picture tubes. The premium line is constructed from all-new materials, while the economy line features factory-rebuilt tubes.



ELECTRONICS for 1959, which will include 84 separate advertisements. Reproductions of Sencore's new series of full-page editorial type advertisements, written by president Herb Bowden (right), will be available for point-of-sale use. Others in the photo are (left to right) Sencore sales vice president Ed Flaxman; S. Rodkin, president of Sander Rodkin Advertising Agency, Chicago, and Sencore engineering vice president Robert Baum.

Jensen Manufacturing Co., Chicago, is furnishing its hi-fi retailers with a

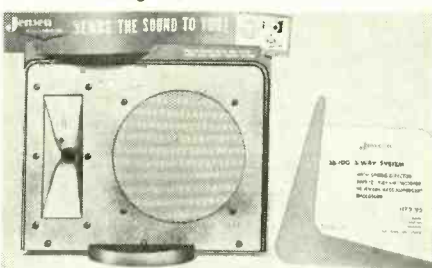

Stereo Center merchandising display

Jerrold Electronics Corp., Philadelphia, is offering dealers a store display which does more than just sit there. Featuring the TV-FM Amplified Home Antenna System, the 3 x 4-foot wall-mounted display contains five plug-in outlets and can be used by the dealer as a fully operational master TV antenna system.

**Unit production and sales  
First 10 months**

	1958	1957
TV Set Production	4,067,806	5,251,158
Radio Set Production	9,489,544	11,945,534
FM Radio Production (July-Oct.)	235,647	unavailable
TV Retail Sales	3,991,530	5,024,670
Radio Retail Sales*	5,647,044	6,764,221
TV Picture Tube Sales	6,801,706	8,304,181
Receiving Tube Sales	333,258,000	388,738,000
Transistor Sales	36,072,133	21,396,300

\*Excluding auto receivers

Source — EIA

END

**50 Years Ago  
In Gernsback Publications**

**HUGO GERNSBACK, Founder**

Modern Electrics	1908
Wireless Association of America	1908
Electrical Experimenter	1913
Radio News	1919
Science & Invention	1920
Television	1927
Radio-Craft	1929
Short-Wave Craft	1930
Television News	1931

Some larger libraries still have copies of Modern Electrics on file for interested readers.

In February, 1909, Modern Electronics

The High Tension Transformer, by M. A. Deviny.  
Wireless by Compulsion.  
Society of Wireless Telegraph Engineers.  
Tuned Wireless Telegraphy.  
Operator Binn's Wireless Log.  
Navigation by Wireless.

New Method of Securing Wollaston Wire, by H. Gernsback.  
Spark Gap Muffler, by L. Spangenberg.  
Development in Wireless Telephony, by William Maver, Jr.  
A Simple Antenna Switch, by A. C. Austin, Jr.  
Wireless Registry.



## OPPORTUNITY ADLETS

Rates—50c per word (including name, address and initials). Minimum ad 10 words. Cash must accompany all ads except those placed by accredited agencies. Discount, 10% for 12 consecutive issues. Misleading or objectionable ads not accepted. Copy for March issue must reach us before February 15, 1959.

**RADIO-ELECTRONICS,**  
154 West 14 St., New York 11, N. Y.

**HIGH-FIDELITY SPEAKERS REPAIRED.** AMPRITE Speaker Service, 70 Vesey St., New York 7, N.Y. BA 7-2580.

**CASH PAID!** Sell your surplus electronic tubes. Want unused, clean transmitting, special purpose, receiving, TV types, magnetrons, klystrons, broadcast, etc. Also want military & commercial lab test and communications gear. We swap too, for tubes or choice equipment. Send specific details in first letter. For a fair deal write, wire or telephone: **BARRY,** 512 Broadway, New York 12, N.Y. Walker 5-7000.

**RECORDERS, Hi-Fi, Tapes.** Free Wholesale Catalogue. **CARSTON,** 215-T East 88th St., New York 28, N.Y.

**STEREO TAPE RENTALS.** For the very best at lowest prices. Write **CALIFORNIA TAPE'D MUSIC ASSN.,** 763 El Camino Real, Redwood City, Calif.

**DISCOUNTS UP TO 50%** on Hi-Fi amplifiers, tuners, speakers, tape recorders, individual quotations only, no catalogs. **CLASSIFIED HI-FI EXCHANGE,** 2375 East 65th Street, Brooklyn 34, N.Y.

**LABORATORY QUALITY** equipment and Military Surplus Electronics bought, sold. **ENGINEERING ASSOCIATES,** 434 Patterson Road, Dayton 9, Ohio.

**ALL MAKES OF ELECTRICAL INSTRUMENTS AND TESTING** equipment repaired. **HAZELTON INSTRUMENT CO.,** 128 Liberty Street, New York, N.Y.

**TELEVISION Tuner Repairs.** **DAN'S TELEVISION LABORATORY,** 619A Sunrise Highway, Babylon, N.Y.

**CAMERA Repairmen** greatly needed! You can learn manufacturers' service methods at home, in your spare time! Free, big illustrated book tells how! Write today. **NATIONAL CAMERA REPAIR SCHOOL,** Dept. RE-12, Englewood, Colorado.

**PROFESSIONAL Electronic Projects—Organs, Timers, Intercoms, Counters, etc.** \$1 each. List Free. **PARKS,** Box 1665, Lake City Station, Seattle 55, Wash.

**FM TUNERS, 88-108 megacycles, 4 tubes complete,** \$12.95. **GRUTMAN,** 1 E. 167 St., Bx. 52, N. Y.

**TRADE-IN TV \$6 up,** also color. Write **JUSTIS,** Newport, Wilmington, Delaware.

**MOTOR GENERATOR SETS—200,000 volt, 2 micro-ampere Van de Graaf type.** Shipped knock down, assemble in 20 min. \$19.50 postpaid. **MORRIS AND LEE,** 439 Elm, Buffalo 3, N. Y.

**LEARN WHILE ASLEEP!** Exciting details free. **RESEARCH ASSOCIATION,** Box 24-111, Olympia, Washington.

**NEW TUBES;** not mechanical or electrical rejects; not washed and/or rebranded. 80% famous brands. **SONORRET,** 36 Woodbury, Wilkes-Barre, Penna.

**UNUSUAL VALUES, Hi-Fi components, tapes and tape recorders.** Free catalog RE. **STEREO CENTER,** 51 W. 35 St., New York 1, N. Y.

**SONGPOEMS and LYRICS WANTED!** Mail to: **TIN PAN ALLEY, INC.** 1650 Broadway, New York 19, N. Y.

**INVENTIONS WANTED** for manufacturers. Free Details. Write **ALLEN,** Dept. M, 712 Davis Bldg., Dallas 2, Tex.

**GUIDED MISSILES,** new Air Force electronic publication. 575 pages, \$3.50 Postpaid. **FOSTER,** Box 703, Silver Spring, Md.

**SAVE MONEY!** Get our list price on all types Radio and TV tubes at **MFRS PRICES!** 100% Guaranteed, all brand new and unused, no mechanical or electrical rejects, not washed or rebranded! 24-hour service! Write **UNITED RADIO COMPANY,** 58 Market St., Newark, N.J.

**HI-FI, STEREO Components, Recorders, Tape, Records.** Wholesale Catalog Free. **AUDIO FAIR,** 1799E First Ave., New York 28, N.Y.

**RUBBER STAMPS—Indexed and cushioned.** Three lines \$1.50. Additional line 25 cents. **STULLS,** 5790 So. Hickory, Littleton, Colo.

**TRANSISTOR RADIO KIT.** Contains: Transistor Electronics Booklet, Miniature Radio Cabinet, Ferrite Antenna Coil, Transistor Amplifier, Variable Capacitor, Diode Detector, Headphone, Antenna. Educational. Special \$4.95 from manufacturer. Two-transistor kit \$5.95. **TOYTRONIC DEVELOPMENT CO.,** 1690 S. Raritan St., Denver, Colo.

**1,000 NAME-ADDRESS GUMMED LABELS** and 3-line personalized Rubber Stamp only \$1.98. **GEORGE R. NEMITZ,** Cedarburg, Wis.

**INDUCTORS** for crossover networks. 118 types in stock. Send for brochure. **C & M COILS,** 3016 Holmes Ave., N.W., Huntsville, Ala.

FEBRUARY, 1959

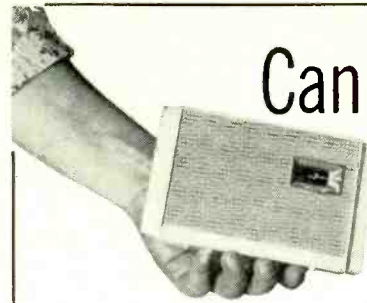

# Can you fix this radio?

Well can you? You're going to get more and more calls to service transistor radios. They're small—but tricky if you don't know the technique. But it's easy to learn how with this new G/L Technicians' Club book—**SERVICING TRANSISTOR RADIOS** by Leonard D'Airo. The author runs a successful servicing shop and is a transistor technician with a well known instrument manufacturer. So when he tells you how to service transistor sets—he's giving you tips you know will work, not just theory or text book stuff. Add to your income. Learn how to service transistor sets now. This book retails for \$4.60—but you can get it at a saving of 27%!

### HOW TO GET THIS \$4.60 BOOK FOR ONLY \$3.35

This brand-new book in a new beautifully designed hard-cover edition is sold nationally for \$4.60. But through the **G/L TECHNICIANS' BOOK CLUB** you can get it and others equally valuable for only \$3.35.

### THE G/L TECHNICIANS' BOOK CLUB

has helped thousands of service technicians everywhere

- Learn More
- Do Faster Servicing
- Earn More Money
- Save money on the books they need to get ahead.

Here's how it can help you!

This unique club offers deluxe hard-cover editions of today's best practical servicing and theory books by well known authors **AT A DISCOUNT OF 27%**! Through mass printing and

direct distribution we can offer you these \$4.60 books **AT THE WHOLESALE PRICE OF \$3.35**—and we pay the postage!

### How the Club Works

- To enroll, select the book you want on the coupon below. **SEND NO MONEY.** Please select only one book! The one you choose will be sent to you on a No-Risk 10-day inspection plan.
- If you like the book keep it and send us your remittance. If you don't

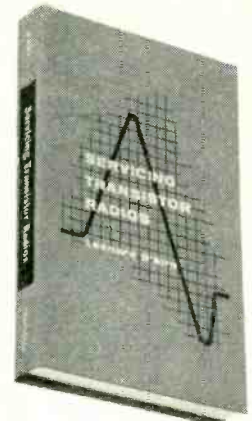

### SERVICING TRANSISTOR RADIOS

By Leonard D'Airo  
224 pages. Deluxe gold-stamped hard cover.

List price \$4.60

just send it back.

- A new book is published every three months—you receive your personal copy on the same No-Risk inspection plan as soon as it comes off the press.
- Keep only the books you want—pay only for those you keep.
- You agree to take a minimum of only 4 books—over the whole enrollment period. You may cancel anytime after that. No time limit—no contract to sign.

### If you prefer—

select any one of these previously published books instead of **SERVICING TRANSISTOR RADIOS**

**Oscilloscope Techniques—By Alfred Haas.** Photos of hundreds of scope patterns—and their significance.

**TV and Radio Tube Troubles—By Sol Heller.** New symptom analysis technique shows you how to track down tube troubles in minutes.

**Rapid TV Repair—By G. Warren Heath.** How to get to the heart of tough TV troubles in minutes. Lists hundreds of troubles alphabetically—gives causes, symptoms, cures. No theory—all practical data. Time-saving trouble-shooting charts.

**Servicing Color TV—By Robert G. Middleton.** Answers all your questions about chroma circuits, matrix testing, the flyback system, test equipment and much more. Helpful trouble-shooting charts.

**TV—It's a Cinch—By E. Aisberg.**

All about TV theory from studio to picture tube. Written in breezy conversational style illustrated with hundreds of specially-drawn humorous sketches.

**Servicing Record Changers—By Harry Mileaf.** Make extra money servicing changers.

**The V.T.V.M.—By Rhys Samuel.**

Get more out of this versatile instrument.

**Sweep and Marker Generators for Television and Radio—By Robert G. Middleton.**

A must for television servicing.

**Probes—By Bruno Zucconi and Martin Clifford.**

How to use probes for better servicing with today's complex test instruments.

**The Oscilloscope—By George Zwick.**

Are you getting full use of your 'scope? This book shows you how!

**SEND NO MONEY!  
MAIL THIS COUPON TODAY!**

**You have nothing to lose — everything to gain! Examine the books at our risk.**

Stay ahead in servicing—keep up with new techniques, circuits, devices. New books on timely topics now in preparation.

### SEND IN THIS COUPON TODAY

**GERNSBACK LIBRARY, INC., Dept. 29C**  
154 West 14th St., New York 11, N.Y.

Enroll me in the **G/L TECHNICIANS' BOOK CLUB.** Begin my membership with the book checked below. Please check one only.

- |   |   |
|---|---|
| <input type="checkbox"/> <b>SERVICING TRANSISTOR RADIOS</b> | <input type="checkbox"/> <b>TV—IT'S A CINCH</b>             |
| <input type="checkbox"/> <b>OSCILLOSCOPE TECHNIQUES</b>     | <input type="checkbox"/> <b>THE V.T.V.M.</b>                |
| <input type="checkbox"/> <b>TV and RADIO TUBE TROUBLES</b>  | <input type="checkbox"/> <b>SWEEP AND MARKER GENERATORS</b> |
| <input type="checkbox"/> <b>RAPID TV REPAIR</b>             | <input type="checkbox"/> <b>SERVICING RECORD CHANGERS</b>   |
| <input type="checkbox"/> <b>SERVICING COLOR TV</b>          | <input type="checkbox"/> <b>PROBES</b>                      |
|   | <input type="checkbox"/> <b>THE OSCILLOSCOPE</b>            |

Name..... please print

Street.....

City..... Zone..... State.....

**GIANT NEW 1959 B-A**

**180 PAGE FREE CATALOG**



**COMPLETE GUIDE TO EVERYTHING IN RADIO, TV, ELECTRONICS**

**100'S OF BRAND NEW ITEMS LISTED HERE FOR THE VERY FIRST TIME**

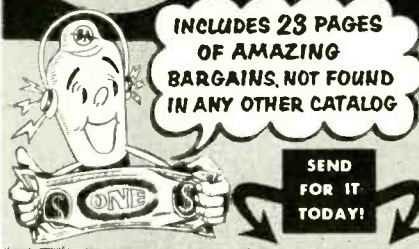

**BURSTEIN-APPLEBEE CO. Dept. 5, 1012-14 McGee St., Kansas City 6, Mo.**

Send Free 1959 B-A Catalog No. 591.

NAME \_\_\_\_\_

ADDRESS \_\_\_\_\_

CITY \_\_\_\_\_ STATE \_\_\_\_\_

**ANOTHER GREAT TRIO® TV ANTENNA FEATURE**

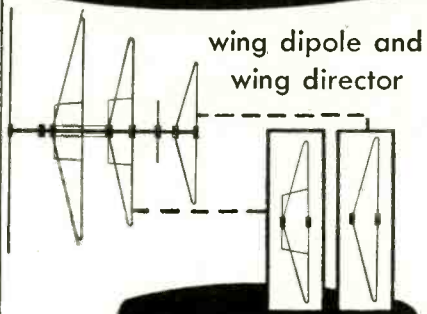

Today's most powerful combination. The Wing Dipole contains 3 active elements on the highs, forward Vee to the low band section, plus integrated director. The Wing Director obtains maximum results from the Wing Dipole.

Just one of the features that makes Trio the most advanced TV Antennas in the world. Choose from Trio's complete Zephyr and Color Series Antennas.



**THERMO-ELECTRONICS**  
Successor to Thermo-Electricity  
Change heat to electricity DIRECTLY—no acids, liquids, chemicals moving parts or sunlight! Build or buy a thermo-electronic battery. Mail quarter today for information and sample thermo-electronic alloy.

**HERMON E. COTTER**  
Dept. O  
15766 Blackstone Detroit 23, Mich.

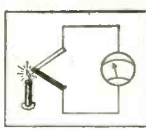

**MAIL ORDER HI-FI**

You can now purchase all your HI-FI from one reliable source and be assured of perfect delivery. Carston makes delivery from NY stock on most HI-FI recorders and tape within 24 hours. **SEND US A LIST OF YOUR HI-FI REQUIREMENTS FOR OUR WHOLESALE QUOTATION and our FREE wholesale catalogue.**

**CARSTON STUDIOS** 215-RD E. 88 St. New York 28, N. Y.

**LITERATURE**

Any or all of these catalogs, bulletins, or periodicals are available to you on request direct to the manufacturers, whose addresses are listed at the end of each item. Use your letter-head—do not use postcards. To facilitate identification, mention the issue and page of RADIO-ELECTRONICS on which the item appears. UNLESS OTHERWISE STATED, ALL ITEMS ARE GRATIS. ALL LITERATURE OFFERS ARE VOID AFTER SIX MONTHS.

**PHONO NEEDLE CHART**, 17½ x 33 inches for wall mounting, lists needles and styli for every brand and model of cartridge, stereo and monophonic. The chart is also available in a Spanish edition. — Jensen Industries, Forest Park, Ill.

**STANDARD RESISTANCE** values can be determined at a glance from the official MIL-Bell decade table for precision film resistors.—Texas Instruments Inc., Box 312, Dallas, Tex.

**HI-FI CATALOG No. 510** contains 16 pages of stereo and mono amplifiers, tuners and phonographs, comprising the manufacturer's complete line.—David Bogen Co., Advertising Dept., Box 500, Paramus, N. J.

**STEREO CATALOG**, pocket size, illustrates line of stereo and convertible-to-stereo components. Separate booklet describes the Stereo-Daptor control center and how it may be used.—H. H. Scott Inc., 111 Powder Mill Rd., Maynard, Mass.

**LAMP BOOKLET** lists all available panel, flashlight, neon glow, automotive and multi-purpose lamps made by American manufacturers, in 24 pages.—United Catalog Publishers Inc., 60 Madison Ave., Hempstead, N. Y. 10c. Free from Radio-Electronic Master distributors.

**EUROPEAN TUBE CHART**, listing more than 250 type numbers and their American counterparts, both exact replacements and nearest substitute. Available from tube distributors.—Sylvania Electric Products Inc., 1740 Broadway, New York 19, N. Y.

**WIRE CATALOG No. 859** contains 382 new items and lists wires by type and application for all electronic uses.—Belden Manufacturing Co., 415 S. Kilpatrick St., Chicago 44, Ill.

**STEREO CONVERSION CHART** for tape recorders lists over 200 models and indicates which type of stereo head should be used with each, for 2- or 4-track conversions.—Nortronics Co., Inc., 1015 S. 6 St., Minneapolis 4, Minn.

**PORTABLE TV ANTENNAS**. Exact dupli-

**SAVE TIME with**

**SENCORE Electro-Sub**

Check all **ELECTROLYTIC CAPACITORS** in Seconds!

Model ES-102 **ONLY \$15.95** DEALER NET

Less than you pay for the individual capacitors. Carry It anywhere—measures only 4¾" H x 4¾" W x 2¼" D

Merely select the electrolytic and substitute it. 10 big electrolytics from 4 to 350 Mfd. to safely substitute in any circuit from 2 to 450 volts.

- ... COMPLETELY SAFE—no arc or spark when connecting or disconnecting.
- ... AUTOMATIC CAPACITOR DISCHARGE—within seconds after releasing test switch by, unique surge protector circuit.
- ... NO CAPACITOR HEALING—surge protector circuit prevents accidental healing of capacitor being "bridged" in service work.

**SENCORE**

See other SENCORE ads in this issue.

SERVICE INSTRUMENTS CORP. 121 Official Rd. • Addison, Ill.

LITERATURE (Continued)

ates are listed by set manufacturer and model number in new 4-page 1959 catalog.—JFD Electronics Corp., 6101 16 Ave., Brooklyn 4, N. Y.

**STEREO SIMPLIFIED** is a 16-page booklet, with illustrations and diagrams, describing stereo recordings and reproduction in nontechnical language.—Sonotone Corp., Electronic Applications Div., Elmsford, N. Y.

**TUBE SUBSTITUTION GUIDE** in convenient 4-page chart form lists 150 of the most commonly used tubes and shows possible substitutions for each.—Vis-U-All Products Co., 303 Fuller Ave. N.E., Grand Rapids 3, Mich.

**MAGNETIC CIRCUIT Sketch Book**, by Charles A. Maynard. Applications of magnets for attraction, holding or repulsion uses are given with sketches and description. Ask for Vol. 6, No. 1 of *Applied Magnetics*.—Indiana Steel Products Co., Valparaiso, Ind.

**SPECIALIZED TUBES** for industry and communications are listed in 6-page *Catalog 2220*. Application and performance data are given for power triodes, rectifier and clipper diodes, gas noise source tubes, TR tubes, pressurized waveguide windows and ionization gauge tubes.—Central Electronic Manufacturers, Denville, N. J.

**SPEAKER ENCLOSURES** and wall and corner baffles in kit and prebuilt form are featured, with complete measurements and descriptions, in *Catalog C-58*, which also describes the 6 models of Tube Caddy.—Argos Products Co., 301 Main St., Genoa, Ill.

**TAPE RECORDER BROCHURE** and catalog for consumers describes 5 recorder models and accessories.—Telectronic Corp., 35-16 37 St., Long Island City 1, N. Y.

**SPEAKER CATALOG**, 20 pages in 3 colors, shows a complete line of loudspeakers, with enclosures depicted in decorator settings. Booklet also contains discussions on how to select a speaker system and the requirements for realistic stereo.—R. T. Bozak Sales Co., Darien, Conn.

**ELECTRONIC CABINETS**, sheet-metal products and components are illustrated and described in large-format 48-page *Catalog 159*.—Bud Radio Corp., 2118 E. 55 St., Cleveland 13, Ohio.

**INSTRUMENT RECTIFIER GUIDE**, seventh edition, is a sturdy 45-page book listing replacement rectifiers for a wide variety of test equipment and other instruments made by nearly all manufacturers. It also lists authorized repair stations for most makes of test instruments.—Conant Laboratories, 6500 O St., Lincoln, Neb.

**LINE CORDS**, plugs and cord sets for frypans, roasters, vacuum cleaners, dryers, ranges and other types of electrical equipment are featured in complete new *Catalog 1758*.—Belden Manufacturing Co., 415 S. Kilpatrick Ave., Chicago 44, Ill. END

# TELEVISION

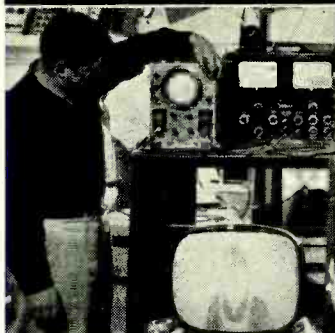

AT HEADS YOU LEARN  
BY DOING IN MODERN  
ELECTRONICS LABORATORIES

## HEALD ENGINEERING COLLEGE

Established 1863  
Van Ness at Post, RE  
San Francisco, Calif.

Never before in American history has the need been so great for Trained Engineers and Technicians. No other type of training can compare with actual shop practice you get at Healds under expert instructors.

### Bachelor of Science Degree, 27 Months

- Radio-TV Technician including Color TV (12 Months)
- Electronics Technician (12 Months)
- Industrial Electronics Technician (12 Months)
- Electronics Engineering (B.S. Degree)
- Electrical Engineering (B.S. Degree)
- Mechanical Engineering (B.S. Degree)
- Civil Engineering (B.S. Degree)
- Architecture (B.S. Degree)

Heald College ranks FIRST West of the Mississippi in "Who's Who in America"

Approved for Veterans  
DAY AND EVENING CLASSES

Write for Catalog and Registration Application.  
New Term Starting Soon.

Your Name \_\_\_\_\_  
Address \_\_\_\_\_  
City \_\_\_\_\_  
State \_\_\_\_\_

SAVE  
TIME  
with  
**SENCORE**  
®

NOW —  
Check Vibrators  
in ANY  
Tube Checker

## 2 Adaptors in 1

### SENCORE

#### "VIBRA-DAPTOR"

Checks Both Three and Four Prong Vibrators

- Merely plug into any tube checker. Set for 6AX4 (or 6SN7) for 6 Volt Vibrators and 12AX4 (or 12SN7) for 12 Volt Vibrators. • Two lamps viewed through top of adaptor indicate whether or not Vibrator needs replacing. Rugged—Made of steel. • Replaceable but unbreakable #51 indicating Lamps. Operates easily with Sencore LC-3 Leakage Lamps. Operates easily with Sencore LC-3 Leakage Checker. Complete instructions screened on front.

*In stock at your local parts distributor.*  
**SERVICE INSTRUMENTS CORPORATION**  
121 Official Road, Addison, Illinois

MODEL VB-2  
**\$ 275**  
DEALER NET

See other SENCORE ads in this issue.

Ab...  
that's my driver!

It's a  
VACO®

Service men all across the country agree . . . there's no other screw driver or nut driver with the built-in comfort of the VACO "comfordome" handle. Makes service work easy! Enjoy the luxury grip of a VACO . . . the driver that gives plenty of power, yet is always kind to hands. Next time choose a VACO and *feel the difference!*

Manufactured and Unconditionally Guaranteed by  
**VACO PRODUCTS CO., 317 E. Ontario Street, Chicago 11, Illinois**  
In Canada: ATLAS RADIO CORP., Toronto 19, Ont.

# COMPLETE TRAINING FOR BETTER RADIO-TV SERVICE JOBS

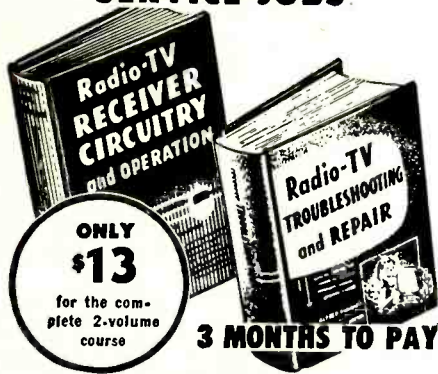

Let these two world-famous Ghirardi training books teach you to handle all types of AM, FM and TV service jobs by approved professional methods—and watch your efficiency and earnings soar!

Completely modern, profusely illustrated and written so you can easily understand every word, these books pave the way to fast, accurate service on any type of home radio-TV-electronic equipment ever made. Each book contains the latest data on the latest methods and equipment—NOT a rebash of old, out-of-date material. Each is co-authored by A. A. Ghirardi whose famous RADIO PHYSICS COURSE and MODERN RADIO SERVICE were, for 20 years, more widely used for military, school and home study training than any other books of their type!

## THE NEW Ghirardi RADIO-TV SERVICE LIBRARY

Almost 1500 pages and over 800 clear illustrations show step-by-step how to handle every phase of modern troubleshooting and servicing.

### 1—Radio and Television Receiver TROUBLESHOOTING & REPAIR

A complete guide to profitable professional methods. For the novice, it is a comprehensive training course. For the experienced serviceman, it is a quick way to "brush up" on specific jobs, to develop improved techniques or to find fast answers to puzzling service problems. Includes invaluable "step-by-step" service charts. 820 pages, 417 illus., price \$7.50 separately. See combination offer!

### 2—Radio and Television Receiver CIRCUITRY AND OPERATION

This 669-page volume is the ideal guide for servicemen who realize it pays to know what really makes modern radio-TV receivers "tick" and why. Gives a complete understanding of basic circuits and circuit variations; how to recognize them at a glance; how to eliminate guesswork and useless testing in servicing them. 417 illus. Price separately \$6.75.

### New low price . . . You Save \$1.25!

If broken into lesson form and sent to you as a "course," you'd regard these two great books as a bargain at \$50 or more! Together, they form a complete modern servicing library to help you work faster, more efficiently and more profitably.

Under this offer you buy them both for only \$13.00. You save \$1.25 on the price of the two books—and have the privilege of paying in easy installments while you use them.

### 10-DAY FREE TRIAL

Dept. RE-29, RINEHART & CO., Inc.  
232 Madison Ave., New York 16, N.Y.

Send book(s) below for 10-day FREE EXAMINATION. In 10 days, I will either remit price indicated (plus postage) or return books postpaid and owe you nothing.

- Radio & TV Receiver TROUBLESHOOTING & REPAIR. (Price \$7.50 separately)
- Radio & TV Receiver CIRCUITRY & OPERATION (Price \$6.75 separately)

Check here for MONEY-SAVING COMBINATION OFFER . . . Save \$1.25.

Send both of above big books at special price of only \$13.00 for the two (Regular price \$14.25) . . . you save \$1.25. Payable at rate of \$4 (plus postage) after 10 days if you decide to keep books and \$3 a month thereafter until \$13 has been paid.

Name.....

Address.....

City, Zone, State.....

Outside U.S.A.—\$8 for TROUBLESHOOTING & REPAIR; \$7.25 for CIRCUITRY & OPERATION; \$14 for both. Cash with order only, but same 10-day return privilege.

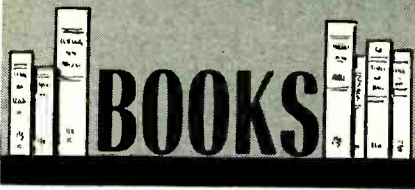

**MOST-OFTEN-NEEDED 1959 TELEVISION SERVICING INFORMATION (Vol. TV-15).** Compiled by M. N. Beitman. Supreme Publications, 1760 Balsam Rd., Highland Park, Ill. 8 1/2 x 11 in. 192 pp. \$3.

A volume of original manufacturers' circuit diagrams and servicing information for over 600 models and chassis of early 1959 TV receivers of 12 brands.

**HOW TO BECOME A PROFESSIONAL ENGINEER.** by John Constance. McGraw-Hill Book Co., Inc., 330 W. 42 St., New York 36, N.Y. 5 1/2 x 8 in. 272 pp. \$5.50.

A professional engineer is one who is registered or licensed by the state where he works. There are over 200,000 professional engineers in this country. The license marks an engineer as an expert and proves his capability to handle advanced engineering projects.

The author has helped prepare engineers for licensing for many years. Here he lists qualifications state by state, discusses the written exams and tells how to pass them. In general, these requirements include college education plus 4 years of professional experience. This may be design or con-

### MAKE OVER 150 SMALL COMPUTING AND REASONING MACHINES WITH

## BRAINIAC®

A BETTER ELECTRIC BRAIN CONSTRUCTION KIT

Only \$17.95 . . . Why Pay More?

EQUALS OUR ORIGINAL GENIAC® electric brain construction kit (Dec. 1955) PLUS many improvements and additions—over 100 parts including 116 patented wipers so that all switches work well. Instead of covering only 33 machines, BRAINIAC gives full specifications for 151 computing, reasoning, arithmetical, logical, puzzle-solving and game-playing machines . . . all 33 GENIACS (1955) and 118 BRAINIACS (1956-58). Each machine works on a single flashlight battery—all connections with nuts and bolts—no soldering required. . . IS FUN to make—FUN to use and play with—and TEACHES you something new about computing and reasoning circuits.



ORIGINATED AND PRODUCED EXCLUSIVELY by Berkeley Enterprises. BRAINIAC is the result of 8 years' design and development work with miniature mechanical brains including: Geniac (see "Geniacs: Small Electric Brain Machines and How to Make Them" by E. C. Berkeley, 64 pp., published 1955 by Geniac Products, a partnership with Oliver Garfield discontinued September 1955); Relay Moe (automatic machine playing tic-tat-toe pictured in Life Magazine, March 1954); etc. Berkeley is Author of "Giant Brains or Machines that Think" (Wiley, 1948), and other books & papers; Editor of the magazine "Computers and Automation"; Designer of all the Brainiacs and more than half of the 33 Geniacs (1955); etc.

WHAT CAN YOU MAKE WITH BRAINIAC KIT K 17? LOGIC MACHINES: Syllogism Prover, Intelligence Test, Boolean Algebra, Chess, etc. GAME-PLAYING MACHINES: Tic-Tat-Toe, Nim, Black Match, Wheel and Bandit, etc. COMPUTERS: To add, subtract, divide, multiply using decimal or binary numbers. FORTY-YEARLY MACHINES: Cryptographic Machines: Ciphers and Decoders, Lock with 15,000,000 Combinations, etc. PUZZLE-SOLVING MACHINES: The Missionaries and the Cannibals, Submarine Rescue Chamber, The Uranium Rocket Ship and the Space Pirates, etc. QUIZ MACHINES: History, geography, mathematics, etc. . . . AND MANY MORE!

WHAT COMES WITH YOUR BRAINIAC KIT? Complete descriptions of 151 experiments • Manual of explanation (Instruction by E. C. Berkeley) • Over 600 pieces including control panel, multiple switch discs, jumpers, improved wipers, bulbs, sockets, wire, etc. • Over 160 circuit diagrams including 46 exact wiring templates • "How to Go from Brainiacs and Geniacs to Automatic Computers" by E. C. Berkeley • Claude Shannon's historic 1938 paper "A Symbolic Analysis of Relay and Switching Circuits" • List of references to computer literature, etc.

BRAINIAC KIT (1958 Model K 17) . . . the kit with limitless possibilities backed by an organization of 10 years' standing in the computer field. . . \$17.95 (For shipment west of Mississippi, add \$6; outside USA, add \$1.50) 7-DAY FULL REFUND GUARANTEE IF NOT SATISFACTORY —MAIL THIS COUPON— BERKELEY ENTERPRISES, Inc. 815 Washington St., #173, Newtonville 60, Mass. Please send me Brainiac Kit K 17 (Returnable in 7 days for full refund if not satisfactory and the same condition.) I enclose \$..... in full payment. My Name and Address are attached.

struction supervision, major responsibility in research, college teaching, etc. Repair, installation or operation of electronic devices or machines, work as an assistant in research or design, etc. do not count.

The author has definite ideas on how a professional should behave. He refers to certain engineers who "come to work in old clothes or bring lunch pails . . . act like tradesmen, not like professional engineers."—IQ

**PIN-POINT RECORD CHANGER TROUBLES IN 5 MINUTES.** by P. Sheneman. Book Publishing Div., Coyne Electrical School, 500 S. Paulina St., Chicago 12, Ill. 6 x 8 1/4 in., 292 pp. plus index. \$3.95.

If you have ever suffered through a trial-and-error record changer repair job, you should examine this text closely. With a series of charts, photos and detailed diagrams, repairing record changers is made "almost nice." Several hundred models are listed, making the text a troubleshooting guide that saves hours of labor during a week of service work.—LS

**ELECTRONIC CIRCUITS.** by RCA Service Co. Howard W. Sams & Co., Inc., 221 E. 46 St., Indianapolis 6, Ind. 8 1/2 x 11 in., 66 pp. \$1.

There are so many radio-TV and electronic circuits that beginners may well be perplexed. Actually (and fortunately), there are very few basic oscillators, amplifiers, power supplies, etc. A repair expert must know, under-

# CLOSE-OUT!

MOLDED "CENTRALAB" CERAMIC DISC Hi-Kaps TYPE MD CAPACITORS

HURRY!

ORDER NOW—WHILE THEY LAST!

QUANTITY	CAPACITY MMF.	QUANTITY	CAPACITY MMF.	QUANTITY	CAPACITY MMF.
125	4.7	300	82	300	820
450	5	200	91	6300	1000
125	6	4600	100	1550	1200
225	7.5	850	120	4300	1500
75	8.2	550	150	325	1800
2200	10	200	180	300	2000
1100	12	200	200	500	2200
1750	15	1200	220	475	2500
1300	18	700	250	400	2700
275	20	300	270	225	3000
525	22	325	300	300	3300
2100	25	1100	330	75	4000
450	27	250	390	300	4700
450	33	250	400	2200	5000
1000	39	2300	470	350	5600
1400	47	500	500	225	6800
950	50	550	560	350	7500
450	56	300	600	325	10000
700	68	400	680		
350	75	350	750		

NOW

ONLY 5¢ each

SEND CHECK OR M. O. TO  
**Almo RADIO CO.**  
913 ARCH STREET  
PHILADELPHIA, PENNA. WA 2-5918

# SCHOOL DIRECTORY

**CODE SENDING RECEIVING SPEED**

Be a "key" man. Learn how to send and receive messages in International Morse code. Communicate with operators around the globe. Learn at home quickly through famous Candler System. Used by best operators. Qualify for Amateur or Commercial License. Write for FREE BOOK.

**CANDLER SYSTEM CO.**  
Dpt. 3-B, Box 9226, Denver 20, Colo. USA

**ELECTRONICS ENGINEERING DEGREE IN 27 MONTHS**

Prepare for unlimited opportunities in electronics!

B.S. Engineering degree (27 mo.); Mathematics, Electrical Engineering, TV, advanced Radio Theory and Design, B.E. (36 mo.); Aeronautical, Chemical, Civil, Electrical, Mechanical, Metallurgical Eng. B.S. (36 mo.); Math., Chem., Physics. Also preparatory courses. Earn board, G.I. approved, 20 blgs., dorms, gym. Enter March, June, Sept., Dec. Catalog, Keeping Pace with Progress.

**INDIANA TECHNICAL COLLEGE**  
1529 E. Washington Boulevard, Fort Wayne 2, Indiana

**ENGINEERING DEGREES**

E.E.  
Option Electronics or Power

Earned through **HOME STUDY**

Resident Classes Also Available if Desired

**PACIFIC INTERNATIONAL COLLEGE OF ARTS & SCIENCES**

Primarily a Correspondence

5719-M, Santa Monica Blvd., Hollywood 38, Calif.

**EARN MORE MONEY— BE A PROFESSIONAL TELEVISION SERVICE TECHNICIAN**

**UHF—COLOR—VHF**

Master the latest up-to-the-minute TV, Radio & Hi-Fi practices

**WESTERN** offers real experience on live equipment in our **BIG SHOPS AND LABORATORIES** in the shortest practical time under expert instructors. Graduates are in big demand because they have the "field experience" necessary for immediate "bench" or supervisory positions. You learn every phase of Radio and TV servicing (AM, FM, VHF, UHF). WEI men win fast promotion... can demand better pay... develop highly profitable businesses of their own with the latest and most **PRACTICAL PERSONALIZED TRAINING BEHIND THEM.** You concentrate all your time on being a **PROFESSIONAL TV SERVICE TECHNICIAN**—non-essential math and engineering theory omitted. **YOU CAN EARN WHILE YOU LEARN AT WESTERN.** Special Finance Plan.

**APPROVED FOR VETERANS.** Find out how you can get into the **TOP PAY GROUP**—Send for this **FREE FACT-PACKED** book NOW! OR, GET INTO—

**ELECTRONICS**

Train at an industry-recognized school—approved by Los Angeles Electronics Industry Advisory Committee—for better job opportunities & higher income.

Intensive one-year Electronic Technician Course prepares for employment in research, development & design in computer, radar, radio, transistor, industrial electronics, guided missile, broadcasting & other related fields. No experience needed. Easy pay-as-you-go plan for non-veterans. Vets financed until VA checks received. Send for free Booklet on Electronic Technician Course.

**WESTERN ELECTRONICS INSTITUTE**  
5119 Sunset Blvd., Dep't 2-ET  
Los Angeles 27, Calif.

**ELECTRONICS**

**PREPARE FOR A GOOD JOB!**

**BROADCAST ENGINEER**  
**RADIO SERVICING AUTOMATION**

**TELEVISION SERVICING**  
**BLACK & WHITE—COLOR**

**APPROVED FOR VETERANS AND SURVIVORS OF VETERANS**  
**BUILDING AIR CONDITIONED SEND FOR FREE LITERATURE**

**BALTIMORE TECHNICAL INSTITUTE**  
1425 EUTAW PLACE, BALTIMORE 17, MD.

**GET INTO ELECTRONICS**

V.T.I. training leads to success as technicians, field engineers, specialists in communications, guided missiles, computers, radar and automation. Basic and advanced courses in theory and laboratory. Assoc. degree in electronics in 26 mos. B.S. in electronic engineering obtainable. ECPD accredited, G.I. approved. Graduates in all branches of electronics with major companies. Start February, September, Dorms, campus. High School Graduate or equivalent. Catalog.

**VALPARAISO TECHNICAL INSTITUTE**

Dept. C Valparaiso, Indiana

**YOUR CAREER IN AVIONICS!**

**AVIATION - ELECTRONICS**  
**JETS - ROCKETS - MISSILES**  
**SPACE TECHNOLOGY**

*Jet Airliners; Guidance Systems; Space Studies; Moon Landings—All this means just one thing to a Northrop educated man — OPPORTUNITY!*

**Graduate in two short years**

Thousands of successful Northrop Institute graduates are now employed by leading companies in the fields named above. They hold important, responsible, highly-paid positions, and their Engineering Technology training at Northrop required only 24 months to complete.

**EARN A BACHELOR OF SCIENCE DEGREE**

If you elect, you may continue your study an additional year and earn a B.S. degree in the fields of Aeronautical Engineering, Electronics Engineering, or Aircraft Maintenance Engineering.

**GET COMPLETE FREE INFORMATION**

Fill out this coupon and mail today. Check the training which most interests you.

**APPROVED FOR VETERANS**

**NORTHROP AERONAUTICAL INSTITUTE**  
1181 W. Arbor Vitae Street, Inglewood 1, Calif.

Please send me immediately the Northrop catalog, employment data, and schedule of class starting dates. I am interested in:

Electronic Engineering Technology  
 Aeronautical Engineering Technology  
 Aircraft Maintenance Engineering Technology  
 Master Aircraft and Engine Mechanic  
 Jet Engine Overhaul and Maintenance

Name..... Age.....  
Address.....  
City..... Zone..... State.....  
Veterans: Check here  for Special Veteran Training Information.

# prepare for your career in ELECTRONICS RADIO-TV COMPUTERS

and other fields of **ELECTRICAL ENGINEERING**

At MSOE, you can equip yourself for a career in many exciting, growing fields: **MISSILES • RADAR AUTOMATION • RESEARCH DEVELOPMENT • ELECTRICAL POWER • AVIONICS ROCKETRY**

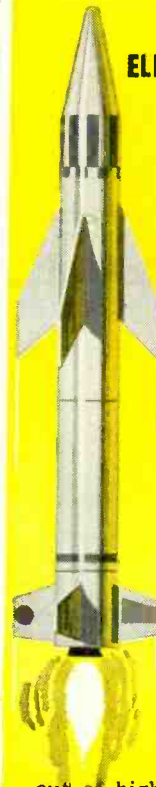

When you graduate from the Milwaukee School of Engineering, you are prepared for a dynamic career as an Electrical Engineer or Engineering Technician. Under a faculty of specialists, you gain a sound technical education in modern, completely equipped laboratories and classrooms. As a result, MSOE graduates are in great demand and highly accepted by industries nationally.

At MSOE you will meet men from all walks of life and all parts of the country—some fresh out of high school or prep school, others in their twenties—veterans and non-veterans.

You can start school in any one of four quarters and begin specializing immediately. Engineering technicians graduate in 2 years with an Associate in Applied Science degree. For a Bachelor of Science degree in Engineering, you attend 4 years. A 3-month preparatory course also is available.



**FREE CAREER BOOKLET!**

If you're interested in any phase of electronics, radio or television, be sure to look into the programs of study offered by the Milwaukee School of Engineering. Just mail the coupon.

**MILWAUKEE SCHOOL OF ENGINEERING**

Dept. RE 259, 1025 N. Milwaukee St. Milwaukee, Wisconsin

Please send FREE Career Booklet. I'm interested in  Electronics  Electrical Power  Television  Mechanical Engineering  Radio  Electrical Engineering  Computers  Industrial Electronics

Name..... Age.....  
PLEASE PRINT

Address.....

City..... Zone..... State.....  
 I'm eligible for veterans education benefits

**"TAB" Tubes Tested, Inspected, Boxed**

Six Months Guarantee! No Rejects!  
**NEW & Used Gov't & Mfgs. Surplus!**

Orders \$10 or more. Receiving types only ppd. 48 states

0A2	.80	6BJ6	.72	12AT6	.59	1851	1.00
0B2	.72	6BK7	.99	12AT7	.89	11726	1.10
0C2	.84	6L7	1.84	12BY7	.69	4374	16.00
0D3	.60	6BN6	1.08	12AU7	.69	2021	.68
0Z4	.50	6BQ6	1.19	12AX7	.79	3223	5.00
1A7	1.00	6BD6	1.81	12BE7	.69	4174	6.81
1B3	.78	6C4	.49	12BA7	.99	4-125	29.00
1R5	.78	6CS	.69	12BD6	.59	4-250	35.00
1S4	.78	6CB6	.89	12BE6	.59	527	7.00
174	.78	6GD6	.49	6D6	.59	4FF60	29.50

Send \$5 for Catalog!

1U4	4/81	6H6	.59	12BH7	.99	4X150	7.50
1U5	.59	6J5	.59	12BY7	1.49	4X250	35.00
1X2A	.88	6J6	.59	12BR7	.99	4X500	38.00
3Q4	.88	6K6	.59	12CU6	1.45	58P1	4.98
3Q5	.88	6K7	.78	12SA7	1.28	58A4	4.98
3S4	.69	6L6	1.19	12SQ7	.89	35T	4.00
3V4	.99	654	.59	12SH7	.89	100T	7.00
5B4	1.25	658	.99	12SJ7	.75	250T	20.00
5U4	.89	657	.79	12SK7	.69	388A	1.00
5V4	.89	6587	1.19	12SQ7	.99	418A	14.00

Wanted Surplus Electronics from schools & U.S. Gov't

5Y3	.59	6X6	.89	19C7	2.15	450T	43.00
6AB4	.59	6SQ7	.79	19T8	1.16	807	1.29
6AC7	.79	6SH7	.69	25R6	1.39	808	1.00
6AG7	.89	6S17	.69	25L6	1.73	809	1.00
6AH5	.89	6SK7	.79	25K7	1.74	400A42	2.00
6AK5	.69	6SL7	.89	25Z5	.72	811	3.00
6AL5	.59	6SN7	2/81	25Z6	.75	812	3.00
6B6	.86	6SQ7	.79	25Z7	3.44	813	3.00
6AS7	3.00	6SR7	.79	EL37	2.40	814	2.45
6B6	.49	6T8	.98	35L6	.59	815	3.95

Partial 50¢ U.S. label. Top \$5 & \$8

6AU4	1.20	6U8	.98	35W4	.52	829B	8.00
6AU5	1.19	6V6	1.39	35Y4	.69	832A	7.00
6AU6	.69	6W4	.79	35Z5	.89	866A	1.75
6AX4	.79	6W6	.89	50B5	.69	146	4.00
6BA6	.59	6X4	.39	50B5	.69	5879	1.20
6BA7	1.00	6X5	.40	50C5	.69	5881	2.70
6BD6	.69	6V6	.89	50L6	.69	650	30.00
6BE6	.59	7N7	.89	KT66	3.20	5842	11.00
6BG6	1.50	12AL5	.59	75	.89	5654	1.00
6BH6	.79	12AQ5	.79	80	.89	5654	12.00

**TUBES WANTED! WE BUY! SELL & TRADE!**

New transistorized "TABSTAT" kit or built hi-efficiency DC to DC 12VDC to 450VDC continuous duty power supply! Output 450W. Tap 250VDC at up to 150MA. Efficiency 80%. Watts 80% efficiency. Ripple 0.2%. Low idle current 1AMP silicon rectifiers. All components, 100% tested, used & short circuit proof. Regulation 5% at 20to100% load! Small in size! Quiet! Light! Low-Priced! "TABSTAT" TR1245CB only \$35. Pre-Assembled U-Built kit TR1245CK only \$30.

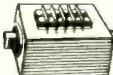

**NEW DC POWER FOR TRANSISTORS!!**

New low-cost 25 volt one amp filtered 1% ripple power supply. Same as specified in Transistor Manuals G.E., RCA, CBS. Ideal for powering transistor circuits, rugged & small in size! Pre-assembled kit U-Built B25V1ACK \$10, or assembled B25V1-ACB \$12.

Transistors! Filtered Power Supply Kit used to power transistor circuits, amplifiers, etc. Delivers 12VDC at 2 AMPS filtered less than 0.5% ripple or 28VDC at 1A TPS2 Kit \$18; TPS2W assembled & wired \$24.

115VAC Input Transformer & Full Wave Bridge Rectifier for 12VDC @ 2AMPS, or

RECTRAN KIT RT1K .....\$4.50  
 RT1V Assembled & Wired.....\$7.50

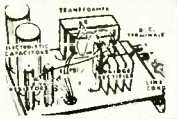

**BATTERY CHARGER KIT 2 to 4 Amps.** Charges 2-4-8 & 12 Volt Batteries. KIT BCK-1 \$11, Built \$12.75.

5" USN-MUMETAL SCOPE SHIELD .....\$4.00  
 AN-ARR2 RCVR AS IS/GOOD FOR PARTS .....\$1.89  
 RDZ/USN RCVR 200 to 400Mc 5 LES'S TUBES 539  
 RAY/MPN RCVR COVERS 4 BANDS .5 to 10Mc's, 8 TUBES HAS BFO-SUPERHET .....\$24

**"ERIN" FINEST HI-FI RECORDING TAPE**  
 So Good! We Cannot Use the Manufacturer's True Name!  
**1200 Ft.—7" Reel \$1.45 ea.** Lots Money Back Gtd. of 3

Singly \$1.59. Add 10c each Postpaid 48 States.  
 New 1st Quality "Mylar" 2400 Ft.—7" Reel Ferro Erin Sheen Process Recording Tape \$4.49, 3 for \$12

**NEW SILICON 500MA/100°C/280VAC**  
 /400 p.l.v. Rectifier Hmt Sealed. \$1.50  
 @ .5 for 56.50, 40 for 56, 100/\$105.

**SELENIUM RADIO & TV RECTIFIERS! GTD.**  
 65MA 45¢ @ .5 for \$2; 100MA 59¢ @ 10/\$55,  
 100/\$45; 250MA 79¢ @ 10/\$75, 100/\$60; 300MA  
 85¢ @ 10/\$90, 100/\$70; 400MA 1.10 @ 10/\$10,  
 100/\$85; 500MA, 10/\$11, 100/\$90.

Orders of \$10 or More, Postpaid 48 states!

**NEW "TEKSEL" SELENIUM FULL WAVE**  
 BRIDGE RECTIFIERS, ONE YEAR GTD!  
 AMP. 18VAC 36VAC 72VAC 144VAC  
 CONT. 14VDC 28VDC 56VDC 118VDC

1AMP	\$ 1.30	\$ 2.00	\$ 4.90	\$ 9.45
2AMP	2.15	3.00	6.25	12.30
3AMP	2.90	4.00	8.60	16.75
6AMP	4.15	8.00	18.75	36.15
10AMP	6.10	12.15	26.30	48.90
15AMP	9.90	19.00	40.00	66.60
24AMP	15.00	29.45	57.50	108.45

**KITS! "TAB" THE BEST KITS!**  
 All Kits Contain Most Popular Values & Sizes

Kit 2 Eng. Parallel Rules	Kit 5 Sub-Min Tubes
Kit 35 Precision Resistors	Kit 40 Standoff Insulators
Kit 10 Switches	Kit 25 Potentiometers
Kit 75 Resistors 1/2 1/2W	Kit 75 Mica Condensers
Kit 150 Carbon Resistors	Kit 5 Crystal Diodes
Kit 25 Panel Lamps	Kit 100 Feet Assorted
Kit 12 Electrolytic Cond's	Kit 100 Ceramic Cond's.
Kit 15 Volume Controls	Kit 50 Coil Forms
Kit 56 Tube Sockets	Kit 5 FT23 Heat Lamps
Kit 65 Tubular Condensers	Kit 65 Inductors & Coils
Kit 500 Lugs & Eyelets	Kit 5 Microswitches
Kit 10 Bathub Oil Cond's	Kit 4 Ass'd Rectifiers
Kit 5 lbs. Surprise Pkgs.	Kit 2 Vendor Counters
Kit 10 XMTR Mica Cond.	Kit 8 Xtal Osc-Blanks
Kit Glyptal & Cement	Kit 4 Ass'd Rectifiers
Kit 3 Phone Patch Xfms	Kit 5 U-G. Condensers
Kit 4 AN/Reflector Lites	Kit 100 Self-Tap Screws
Kit 6 Instd Tuning Tools	Kit 8X25 Ft. Hookup Wire
Kit 6 AN plugs & cncntrs	Kit 2 Vendor Counters
Kit 3 Searchlights	Kit 2-Computer Toroids
Kit Circular Slide Rule	Kit 8 Pc. Nut Driver Set
Kit 12 Algr. Clip Ass'd.	Kit High Gain XTL Mike
Kit 2 Bkite Pnls 6x12"	Kit 5 Jeweler Screwdr'vs
Kit 5 Pcs. Wrench Set	Kit 6 ea. Phone Plgs, Jaks

BUY 10 KITS—GET ONE FREE! EACH KIT 99c

**"TAB" TERMS:** Money Back Guarantee! Our 4th year. 22 min. order F.O.B. N.Y.C. Add ship charges or for C.O.D. 25% Dep. Prices shown subject to change.

111-1B LIBERTY ST., N.Y. 6, N.Y.  
 Send \$5c. PHONE: RECTOR 2-6245 for Catalog

**BOOKS (Continued)**

stand and be able to recognize them in any device he may encounter.

This handy book illustrates and describes the operation of the basic circuits in receivers, transmitters, radar, filters and control instruments. It analyzes common defects and tells how to deal with them. Originally written for RCA technicians, it will be found useful for reference and training.—IQ

**TRANSISTORS, THEORY AND PRACTICE. Second Edition, by Rufus P. Turner. Gernsback Library, 154 W. 14 St., New York 11, N.Y. 5 1/2 x 8 1/2 in., 160 pp. \$2.95.**

Expanded, updated and completely revised, describes the changes made in this second edition of a most popular text on transistors. Three full chapters on transistor theory get the reader off to a sound start. Then several chapters showing and describing many types of transistor circuits reveal potentialities of the transistor. Among the types of circuits shown are amplifiers, oscillators, triggers and switches, and broadcast receivers. Closing chapters discuss tests and measurements, related devices, and care and handling of transistors.—LS

**CONDUCTANCE CURVE DESIGN MANUAL, by Keats A. Pullen. John F. Rider Publisher, Inc., 116 W. 14 St., New York 11, N.Y. 8 1/2 x 11 in., 128 pp. \$4.25.**

This manual can be a designer's best assistant. It contains "G-curves" for 71 tube types. They show actual mutual

and plate conductance values over various regions of a tube characteristic, so it isn't necessary to rely on a single average value. For pentodes, the values apply for a 2-to-1 ratio of plate-screen voltage, but correction curves appear for other ratios. Each graph also shows curves of constant plate dissipation, making it more convenient to combine maximum gain with minimum distortion and dissipation in designing a circuit.

An important section of the manual deals with formulas for gain, output, load, distortion, etc. These formulas are derived and the author then shows how to apply them in practical examples using data from the curves.—IQ

**THE EXPLORATION OF SPACE BY RADIO, by R. Hanbury Brown and A. C. B. Lovell. John Wiley & Sons, Inc., 440 Fourth Ave., New York, N.Y. 6 x 9 in., 207 pp. \$6.50.**

This work, by two University of Manchester (England) experts on radio astronomy, presents an interesting discussion of radio astronomy and the radio telescope, a new but powerful scientific tool which can receive and pinpoint faint radio noise from distant stars and galaxies. Properly interpreted, the noise can tell much about its source and about space.

The book begins with theories and facts about the universe and how waves travel through space. It explains the specialized techniques needed to receive

**WALSCO**

FIRST NEW PUNCH DEVELOPMENT IN 20 YEARS... OBSOLETES EVERY OTHER PUNCH NOW ON THE MARKET

**"L.T." LOW TORQUE CHASSIS PUNCH**

**CUTS a cleaner hole with 50% less effort!**

A brand-new electro-coating process (which can't wear off) reduces friction, thus lowers torque. You get a much cleaner hole with much less effort. The WalSCO "L.T." Chassis Punch requires no lubrication of any kind and will give perfect service almost indefinitely. Available in a wide variety of sizes, round, square, key and D shapes.

Full information on these extra-easy to use "L.T." punches is available from your WalSCO distributor or by writing direct to WalSCO.

**WALSCO ELECTRONICS MFG. CO.**  
 A Division of Tectron Inc.  
 West Coast Plant: Los Angeles 18, California  
 Main Plant: 110 WEST GREEN STREET  
 ROCKFORD, ILLINOIS, U.S.A.

**ORDER by MAIL and SAVE!**

**TV PICTURE TUBES**

10BP4	\$ 7.95	17BP4	\$10.95	21AMP4	\$19.95
12LP4	8.95	17CP4	17.00	21ATP4	20.95
14B/CP4	9.95	17GP4	17.60	21AUP4	20.95
16DP4	14.95	17HP4	13.60	21EP4	14.95
16EP4	15.90	17LP4	13.60	21FP4	15.95
16GP4	15.90	17QP4	11.95	21WP4	17.30
16KP4	10.95	17TP4	19.30	21YP4	15.95
16LP4	10.95	19AP4	19.30	21ZP4	14.95
16RP4	10.95	20CP4	13.90	24CP4	23.95
16WP4	15.20	20HP4	17.95	24DP4	26.95
16TP4	10.95	21AP4	22.10	27EP4	39.95
17AVP4	15.20	21ALP4	20.95	27RP4	39.95

27"—6 month guarantee—all others 1 year. Aluminized Tubes \$5.00 more than above prices. These prices are determined to include the return of an acceptable similar tube under vacuum.

ALL PRICES FOB CHICAGO, ILLINOIS. Deposit required, when old tube is not returned, refundable at time of return. 25% required on COD shipments. Old tubes must be returned prepaid. We ship anywhere.

WRITE FOR COMPLETE LIST.

**PICTURE TUBE OUTLET**  
 3032 Milwaukee Ave., Chicago 18, Ill.  
 Dickens 2-2048

**The March Special Stereo Issue of Radio-Electronics on Sale Feb. 26**

**We Specialize in REPAIR of STANDARD COIL TUNERS**

All Model Tuners Repaired  
**\$8 plus parts costs**

**Television Tuner Service Co.**  
 133 N. Overhill  
 Bloomington, Indiana

and record the very low power at high frequencies.

The authors investigate two phases of radio astronomy: The first deals with energy received directly from a distant galaxy, star, planet or the sun. Such information adds greatly to knowledge of the universe. The second concerns radio echoes from the moon, meteors or planets. This study has great practical value in measuring distance, tracking artificial satellites and extending long-distance radio communication (with the help of a space target to reflect energy from the transmitter to receiver). Dr. Lovell, the co-author, is director of the Jodrell Bank Radio Telescope (RADIO-ELECTRONICS, February, 1958, page 32).—IQ

**AUDIO MEASUREMENTS**, by Norman H. Crowhurst. Gernsback Library, 154 W. 14 St., New York 11, N.Y. 5½ x 8½ in., 224 pp. \$2.90.

Many people today have high-fidelity equipment, but of this group how many know what their equipment is doing—how well is it performing? To test such a system and find out how well it works and how close it is to what it should be, a series of specialized tests are needed. Such tests are analyzed in this profusely illustrated text.

The author, after discussing measurement techniques and test equipment needed, goes on to the various types of equipment that will be tested and care-

fully details each of the tests that might be used for each type of audio equipment—amplifiers, preamps, pickups, arms, turntables, changers, tape recorders and microphones.—LS

**ELECTRONIC ENGINEER'S REFERENCE BOOK**, L. E. C. Hughes, General Editor. MacMillan Co., 60 Fifth Ave., N.Y. 11, N.Y. 4¾ x 7¼ in., 1311 pp. \$18.

This book holds a vast amount of information and data on the more recent applications of electronics. Radio, TV, radar and test equipment are mentioned only briefly. Major chapters include photoelectricity, heating by rf, radiations, tube design, magnetic circuits, acoustics, computers and automation. The reader will find such topics as airport recording, magnetic ink, automatic train control, lubricants, printed circuits, nonlinear resistors and many others.

Hundreds of illustrations, charts and photos are included. There are nearly 1,000 topics.—IQ

**IMPEDANCE MATCHING**, by Alexander Schure. John F. Rider Publisher, Inc., 116 W. 14 St., N. Y. 11, N. Y. 5½ x 8½ in., 128 pp. \$2.90.

Deals with problems of impedance matching at audio and radio frequencies, including a wide range of equipment used as the generator or load in electrical and electronic circuits. A previous knowledge of electronics is needed to get the most out of this text.—LS

# NOW Service Any TV Set Like a "PRO"!

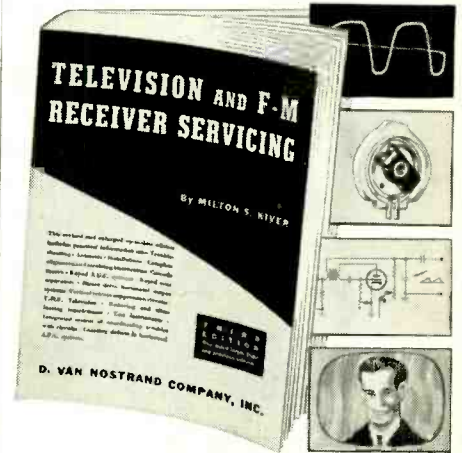

Brand-New Edition of Famous Shop Manual Will Lick "Tough Dogs," Save You Time, Increase Your Income 25% to 65%!



MAN, if you've ever cussed over a tough repair . . . if you've ever wanted more money . . . if you've ever wanted your business and reputation to grow . . . here's a powerful shove in those directions—the new *Television Receiver Servicing!*

Everything and that means every new idea, every technique, every profitable practice . . . collected from little repair shops, part-time servicemen, big research centers . . . all the "red meat" of TV maintenance, repair and service has been collected into this big 300-page guide and manual.

Huge . . . Yet So Easy to Use!

You want quick facts on how to deal with tough antenna installations and ghost problems? Turn to Chapter 1 and get many field tested suggestions. What frequency an antenna should be cut to? Turn to page 6 and get 4 columns of clear explanation, with examples. What does an ideal video amplifier response curve look like? Page 127 illustrates it for you. What should you know about servicing color television receivers? Read the simple text from page 281 to page 300. Antennas (30 pages) . . . installing TV receivers (12 pages) . . . test equipment (27 pages) . . . RF, IF and video detector stages (45 pages) . . . video amplifiers (12 pages) . . . AGC systems (10 pages) . . . picture tubes, test patterns, deflection systems (83 pages) . . . receiver alignment (20 pages) . . . UHF . . . Color (32 pages) . . . there's even an easy-reference trouble-shooter's chart, and end-of-chapter questions, plus a complete, subject-by-subject index to put everything at your fingertips fast! With all this material, 421 pictures, 15 chapters, explained in A-B-C fashion, it's no wonder that TV Receiver Servicing is the "Bible" of the industry!

10-Day FREE Examination for Readers of Radio-Electronics Magazine

Use this for ten full days at our expense. Put its good sense to work on your toughest problems. If you're not 100% sure it's the biggest profit-making and time-saving friend you ever had, return it. You owe nothing. But nail coupon now. Once this printing is gone, it will take months to rush out another.

D. VAN NOSTRAND CO.

Dept. 182, 120 Alexander St. Princeton, N.J.

Mail This for Free-Use Copy

D. VAN NOSTRAND CO., Dept. 182, 120 Alexander St., Princeton, N.J. (In Canada: 25 Hollinger Rd., Toronto 16)

Please send me—for 10 days' FREE USE—a copy of the new 4th Edition of *Television Receiver Servicing*. If I'm not completely sure it will increase my income by at least 25%, I'll return it within 10 days and owe nothing. Otherwise I'll pay \$2.50 down, plus small delivery charge, then \$2.00 a month for two months as full payment.

Name \_\_\_\_\_  
Street \_\_\_\_\_

City \_\_\_\_\_ Zone \_\_\_\_\_ State \_\_\_\_\_

SAVE POSTAGE by enclosing \$6.50 with this coupon. Same return privileges, money back if not completely satisfied.

**ALL SERVICE DEALERS LOOK TO**

**D&RO**

**HI-FI and STEREO ADAPTERS**

**PHONO JACK TO PHONE PLUG ADAPTER**—Provides a convenient means of connecting RCA phono plug to standard ¼" Phone jack. ¼" dia. x 2¾" long. Model PPH1. List \$ .95

**"Grip-A-Lip" PIN PLUG**—A phono pin plug with a sure finger-grip lip. Easy to remove. Simple to solder. Model PPI-1. List \$ .69 (4 to a pkg.)

**FEED-THROUGH PHONO PIN-PLUGS**—With Grip-A-Lip feature. Mates with RCA Phono Pin Jacks. Model PTP-1. List \$ .39

**FEED-THROUGH PHONO TIP-JACKS**—Mates with RCA Phono Pin Plug at each end. Positive noise-free connections. List \$ .95. Model PTP-2.

**PHONE JACK TO PHONO PIN PLUG ADAPTER**—Converts standard ¼" Phone Plug to RCA phono pin plug. Model PPHJ. List \$1.25

**AT ALL LEADING JOBBERS**

Write for LATEST CATALOG

**D&RO Electronics**

134 NASSAU ROAD, ROOSEVELT, N. Y.

**ANOTHER GREAT TRIO TV ANTENNA FIRST**

no-strip lead-in connector\*

Requires no stripping, no soldering, no wire holders—holds the complete insulated wire.

Just one of the features that makes Trio the most advanced TV Antennas in the world. Only the Trio Zephyr and Color Series Antennas have the no-strip Connector.

**TRIO Manufacturing Company**  
GRIGGSVILLE, ILLINOIS

\*Patent Pending

# NEW! "Do-It-Yourself" LAFAYETTE Kits



**LAFAYETTE'S**  
**1959 CATALOG**  
**260 GIANT-SIZE**  
**PAGES**  
**FREE!**

Complete listings of the NEWEST in Stereo and Monaural Hi-Fi, Short Wave, Audio, Transistor, and many other Lafayette electronics kits as well as thousands upon thousands of standard brand nationally advertised kits and electronic parts and components are described in LAFAYETTE'S GIANT NEW 260-PAGE CATALOG. SEND FOR IT—IT'S FREE! Just fill in coupon below and present it at any Lafayette store, or paste it on a postcard and send it to us. THAT'S ALL YOU HAVE TO DO to get your FREE 1959 LAFAYETTE CATALOG!

## LAFAYETTE RADIO ELECTRONIC KITS

- Include the very latest electronic advances.
- Are constantly being modernized by Lafayette's own Engineering Department, by a leading consulting engineering firm, and by your own recommendations.
- Are a product of Lafayette's 38 years of Electronic Leadership.

## EDUCATIONAL

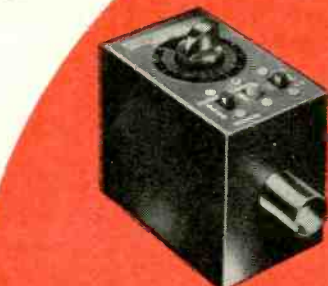
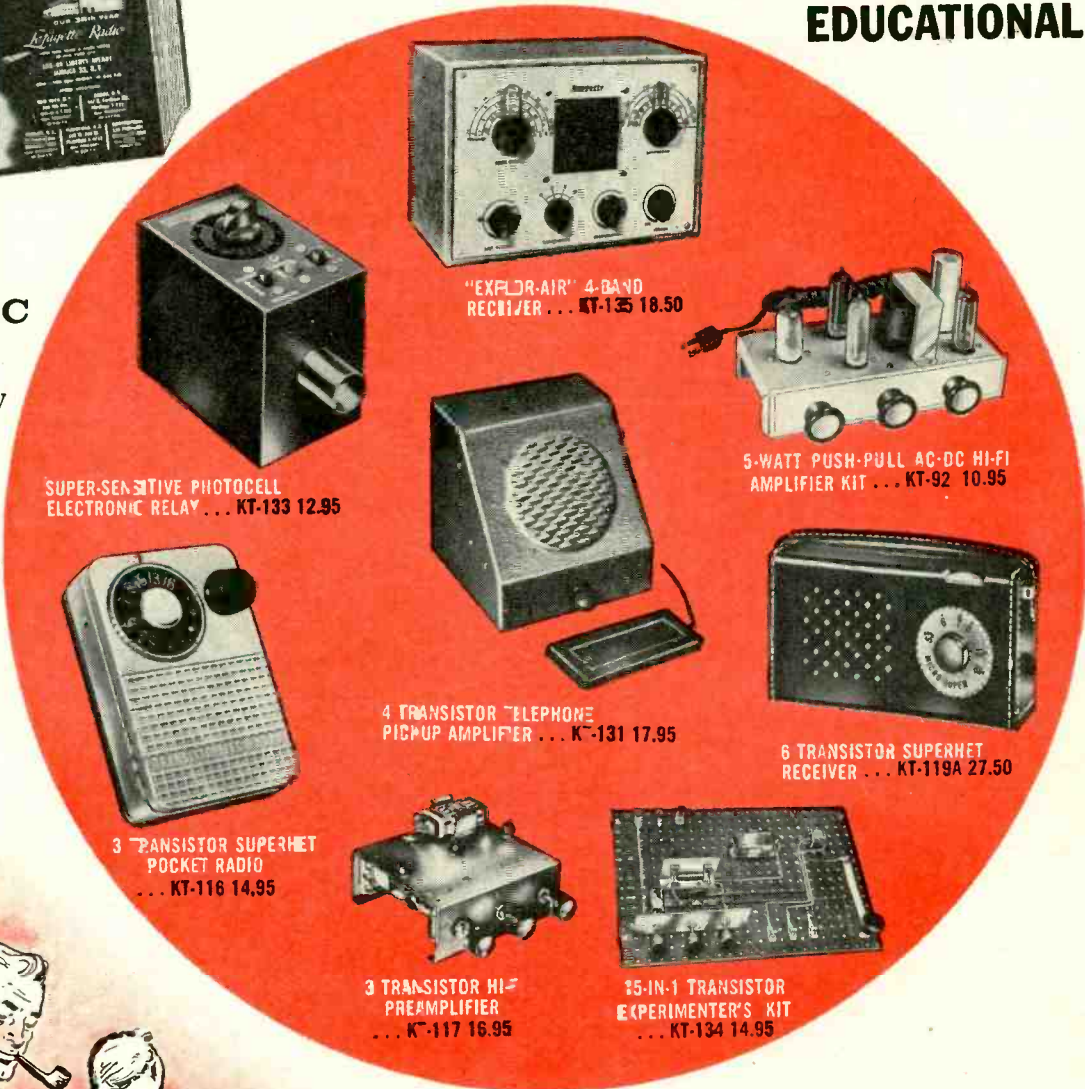

SUPER-SENSITIVE PHOTOCCELL ELECTRONIC RELAY ... KT-133 12.95



"EXPLOR-AIR" 4-BAND RECEIVER ... KT-135 18.50

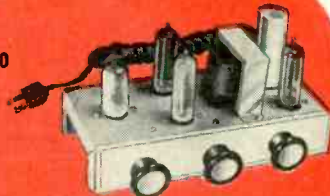

5-WATT PUSH-PULL AC-DC HI-FI AMPLIFIER KIT ... KT-92 10.95



3 TRANSISTOR SUPERHET POCKET RADIO ... KT-116 14.95



4 TRANSISTOR TELEPHONE PICKUP AMPLIFIER ... KT-131 17.95



6 TRANSISTOR SUPERHET RECEIVER ... KT-119A 27.50

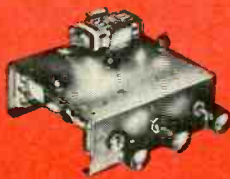

3 TRANSISTOR HI-FI PRE-AMPLIFIER ... KT-117 16.95

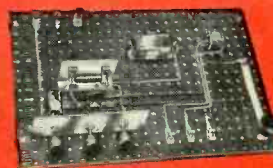

15-IN-1 TRANSISTOR EXPERIMENTER'S KIT ... KT-134 14.95

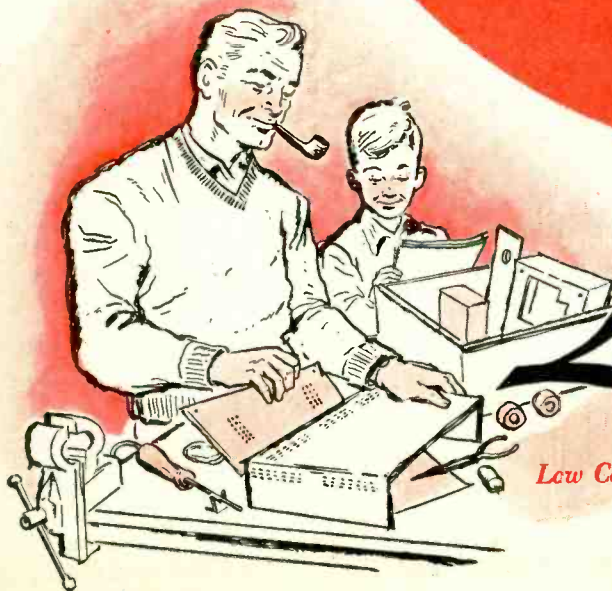

Low Cost Kits For Everyone!

# Lafayette Radio

RADIO-ELECTRONICS



# LAFAYETTE Kits Are FUN To Build!

## LEARN ELECTRONICS BY BUILDING A LOW COST LAFAYETTE KIT

**KITS FOR BEGINNERS** • 10-In-1 Lab Kit • Transistor Code Practice Oscillator • AC-DC Broadcast Receiver • 3-Way Broadcast Receiver • 5-Watt Push-Pull AC-DC Amplifier • 7-In-1 Radio Lab Kit • 2-In-1 Kit • Germanium Diode Radio • 1-Transistor Pocket Radio • 2-Transistor Pocket Radio

**HI-FI KITS** • Stereo Master Audio Control Center & Preamplifier • Stereo Remote Control Center — Electronic Stereo Adapter • 36-Watt Basic Stereo Amplifier • AM-FM Stereo Tuner • Preamp Audio Control Center • 70-Watt Power Amplifier • 4-Watt Stereo Amplifier • Speaker Enclosure Kits

**ADVANCED KITS** • Broadcast-Shortwave Receiver • Electric Brain Kit • 10-Watt Push-Pull Hi-Fi Amplifier • 15-In-1 Transistor Experimenter's Kit • 4-Band Broadcast-Shortwave Receiver • Photocell Electronic Relay • 6-Transistor Superhet Receiver • 3-Transistor Pocket Radio • 3-Transistor Hi-Fi Preamplifier • 2-Transistor Reflex Radio with Sun Battery • Transistor Code Practice Oscillator • Radio Control Transmitter • Transistor-Diode Checker • Multitester Semi-Kit • 4-Transistor Telephone Pickup Amplifier

### PRACTICAL

### EASY-TO-BUILD LAFAYETTE KITS

#### Enjoy and Save

**LAFAYETTE KITS SAVE YOU REAL MONEY.** You save up to 50% or more when you build a low-cost Lafayette kit as against factory-wired units of equal or even lesser quality. You save also because Lafayette manufactures these kits and sells them *direct to you*, eliminating the usual dealer's markup.

#### LAFAYETTE KITS ARE YEARS AHEAD.

Every latest advance in electronics finds its way into educational and practical Lafayette Kits. Lafayette was **FIRST** in **TRANSISTORS**, and Lafayette is now **FIRST** in **STEREO HI-FI!**

#### LAFAYETTE KITS ARE EASY TO BUILD.

Whether you are a beginner or an engineer, a novice or advanced amateur, there are Lafayette kits you can build, learn from, and use. Detailed instructions with clear, large blow-ups and dozens of illustrations describe minutely every step of the kit assembly so that there are seldom any questions.

LAFAYETTE KITS ARE AVAILABLE ON OUR EASY PAY PLAN. SEE OUR FREE GIANT-SIZED 260-PAGE 1959 CATALOG FOR DETAILS.

ASK FOR THE FREE 260-PAGE GIANT NEW 1959 LAFAYETTE CATALOG. Fill in and present the coupon below at any Lafayette store for your FREE Catalog, or simply paste the coupon on a postcard and mail it to the address on the coupon. Our catalog is FREE for the asking!



### LAFAYETTE RADIO STORE LOCATIONS

<b>JAMAICA 33, N. Y.</b> 165-08 Liberty Ave. AXtel 1-7000 Open FRIDAY 'till 8:45 P.M.	<b>NEW YORK 13, N. Y.</b> 100 6th Ave. Worth 6-5300 Open THURSDAY 'till 8:45 P.M.	<b>BRONX 58, N. Y.</b> 542 E. Fordham Rd. Fordham 7-8813 Open THURSDAY 'till 8:45 P.M.
<b>NEWARK 2, N. J.</b> 24 Central Ave. Market 2-1661 Open WEDNESDAY 'till 8:45 P.M.	<b>PLAINFIELD, N. J.</b> 139 W. 2nd St. Plainfield 6-4718 Open THURSDAY 'till 8:45 P.M.	<b>BOSTON 10, Mass.</b> 110 Federal St. Hubbard 2-7850 Open MON.-WED. 'till 8:45 P.M.

**FREE**

**LAFAYETTE RADIO, Dept. J.B.9.**  
 P.O. Box 511, Jamaica 31, N. Y.

SEND FOR THE WORLD'S LEADING ELECTRONICS, RADIO, T.V., INDUSTRIAL, AND HI-FI GUIDE

Send FREE LAFAYETTE Catalog 690

Name .....

Address .....

City..... Zone..... State.....

Sounds

a

new

note

in

STEREO

Radio-Electronics

A FEW  
STEREO ISSUE  
FEATURES  
LINED UP  
FOR YOU...

- ☆ *A Review of Stereo Cartridges*
- ☆ *How to Get Started with Stereo*
- ☆ *Stereo Test Records*
- ☆ *Pitfalls of Phasing*
- ☆ *Will Multiplexing bring us FM Broadcasts?*
- ☆ *Features of Stereo Amplifier Circuits*
- ☆ *Building a Stereo Tape Amplifier*
- ☆ *Plus many other articles by top hi-fi writers. Charts, tables, diagrams, photos*
- ☆ *AND A BALANCE of good selections on TV, radio, electronics and all the popular regular departments*

STEREO  
ISSUE

In its March issue, RADIO-ELECTRONICS takes a long look at stereo—yesterday, today, tomorrow—through the eyes of some of today's best regarded hi-fi experts. The Stereo Issue catches all the excitement of this new dimension in sound. It does more. With the clinical eye of the technician it observes, tabulates, guides.

If you've walked with stereo since its first faltering steps, or if you're just getting off the ground now, RADIO-ELECTRONICS Stereo Issue is your road map to fuller understanding, better performance. It shows you how to get started, how to convert, avoid pitfalls, interpret data, choose test records. It answers the technical man's questions about stereo.

Louis Armstrong—Photo courtesy Columbia Records

**NO INCREASE IN PRICE!** *This is an issue you'll read, reread, show to friends, and refer to over and over again. Don't miss it. Better reserve a copy now at your newsstand or parts distributor.* **ON SALE FEBRUARY 26**

SUBSCRIPTION RATES 3 years \$10 2 years \$7 1 year \$4

Radio-Electronics

154 West 14th Street • New York 11, N. Y.

# ADVERTISING INDEX

Acro Products Co. ....	143	McGraw-Hill Book Co., Inc. ....	140
Allied Radio Corp. ....	25, 96-99	Moss Electronic Distributing Co. Inc. ....	104-107
Almo Radio Co. ....	150	National Radio Institute ....	9, 19-20
Arkay Radio Kits Inc. ....	121	National Schools ....	5
B & K Mfg. Co. ....	115	Opportunity Adlets ....	147
Barry Electronics Corp. ....	157	Paco Electronic Co. Inc. ....	108
Bell Telephone Labs ....	14	Picture Tube Outlet ....	152
Benco Television Associates Ltd. ....	139	Prentice-Hall, Inc. ....	134
Bendix Radio Corp. ....	138	Progressive "Edu-Kits" Inc. ....	135
Berkeley Enterprises, Inc. ....	150	Radiart Corp. ....	126
Blonder-Tongue Labs ....	144-145	RCA Electron Tube Division. ....	Back Cover
Brooks Radio & Television Corp. ....	141	RCA Institutes ....	130-131
Burstein-Applebee Co. ....	148	Radio Receptor Co. ....	103
CBS-Hytron ....	32, 114	Radio Shack Corp. ....	93
Capitol Radio Engineering Institute. ....	84-87, 101	Raytheon Mfg. Co. ....	8, 9
Carston Studios ....	148	Rider (John F.) Publisher Inc. ....	142
Centralab Div. of Globe Union. ....	133	Rinehart & Co., Inc. ....	110, 144, 150
Century Electronics Co., Inc. ....	112, 113	Rogers Mfg. Co. ....	139
Clarostat Mfg. Co., Inc. ....	89	Sams (Howard W.) & Co., Inc. ....	23, 80
Cleveland Institute of Radio Electronics ....	10, 11	Scott, Inc. ....	21
Columbia Record Club ....	13	Seco Mfg. Co. ....	146
Cornell-Dublier Electric Corp. ....	24	Service Instruments Corp. .....	91, 101, 122, 132, 134, 148, 149
Cotter (Hermon E.) ....	148	Shure Brothers, Inc. ....	102
Coyne Electrical School .95, 118, 137		Sonotone Corp. ....	127
Crystals Inc. ....	144	Sprayberry Academy of Radio-Television ....	31
Delco Radio Div. of General Motors Corp. ....	81	Supreme Publications ....	123
DeRO Electronics ....	153	Sylvania Electric Products Inc. 28, 29	
Deutschmann (Tobe) ....	120	Tab ....	152
DeVry Technical Institute ....	7	Tarzian (Sarkes) Inc. ....	143
Dressner ....	142	Television Tuner Service Co. ....	152
Electro-Voice, Inc. Inside back cover		Texas Instruments Inc. ....	92
Electronic Instrument Co. (EICO) ....	33, 34	Trio Mfg. Co. ....	129, 148, 153
Electronic Publishing Co., Inc. ....	142	Triplet Electrical Instrument Co. ....	Inside front cover
Garfield (Oliver) Co. ....	128	Tri-State College ....	136
General Electric Co.-Electronics Components Div. ....	26, 27, 30	Tung-Sol Electric Co. ....	18
Gernsback Library, Inc. ....	102, 147	University Loudspeakers, Inc. ....	158
Grantham School of Electronics ..	17	Utah Radio Products Corp. ....	22
Gray Mfg. Co. Inc. ....	12, 82	Vaco Products Company ....	149
Heald Engineering College ....	149	Van Nostrand (D.) Co., Inc. ....	153
Heath Company ....	66-77, 79	Walsco Electronics Mfg. Co. ....	152
Hickok Electrical Instrument Co. ....	122	Weller Electric Corp. ....	119
Hudson Specialties Co. ....	122	Wen Products, Inc. ....	128
Indiana Technical College ....	134	Xcelite, Inc. ....	129
International Business Machines —IBM ....	124, 125		
International Correspondence Schools ....	15		
Jensen Industries ....	129		
Key Electronics Co. ....	142		
Lafayette Radio ....	154, 155		
Lansing (James B.) Sound, Inc. ....	16		
Lektron Inc. ....	132		
Mallory (P.R.) & Co., Inc. ....	116, 117		

## SCHOOL DIRECTORY PAGE 151

Baltimore Technical Institute  
Candler System Co.  
Indiana Technical College  
Milwaukee School of Engineering  
Northrop Aeronautical Institute  
Pacific International College of Arts & Sciences  
Valparaiso Technical Institute  
Western Electronics Institute

BRANCH ADVERTISING OFFICES: Chicago: 1025 Harlem Ave., Glenview, Ill., Glenview 4-6900. Los Angeles: Harker-Husted-Coughlin, 600 South New Hampshire, Tel. DUnkirk 7-2328. San Francisco: Harker-Husted-Coughlin, 44 Market St., Tel. GARfield 1-2481.  
FOREIGN AGENTS: Great Britain: Atlas Publishing and Distributing Co., Ltd., 18 Bride Lane, London E.C. 4. Printed in the United States of America

## WRITE FOR LATEST TUBE CATALOG FREE!

Receiving, transmitting, special purpose tubes, diodes, transistors, etc. We have a large, diversified stock at sensible prices.

- 150 Watts Autotransformer. Input 94 to 260 V, 50/60 cps, in 8 steps. Output 115V. Mfd. by Acme. With line cord and plug and built-in AC receptacle @ \$4.00
- 250 Watts Autotransformer. Input 95 to 260V, 50/60 cps, in 8 steps. Output 115V. Mfd. by Franklin. With line cord and receptacle \$7.00
- 500 Watts Isolation Transformer for outdoor use or indoor use. 240 Volts input to 240 Volts or 120 Volts output. 50/60 CPS. Mfd. by American Xfmr. @ \$10.00
- VARIABLE TRANSFORMER — POWERSTAT (MADE BY SUPERIOR ELECTRIC) Special surplus purchase allows us to offer this completely brand new, original cartoned Powerstat at a special price of only \$13.50 each. Primary: from 0 to 115 VAC @ 60 cycles. Secondary: variable from 0 to 115 VAC @ 7½ Amperes continuous. Price \$13.50 each Catalog #S-620.

### METER SPECIALS

- Decibel Meter—2" Round—Westinghouse \$5.95
- 0-500 Ma. AC—2" Round—GE (AC Mills) 2.95
- 0-750 Ma AC—2" Round—GE 3.95
- 0-10 Ma—4" Round—Westinghouse 3.95
- 0-2 Kilovolts DC—3" Round—GE & West. 4.00
- 0-3.5 KV DC—3" Round—West. 4.95
- 0-1 AMP DC—3" Round—West. 4.95
- 0-5 Ma DC—2" Square—Eldico 1.50
- 0-150 VAC—2" Round—GE & West. 3.50
- 0-800 Ma DC—3" Round—Roller-Smith 3.95
- TRIPLET 0-100 MICROAMPS DC 3" ROUND METER. Hermetically sealed. In original carton w/hardware. Triplet Model 321-HR. @ \$4.95

## NEW—UNUSED BUYS!

- GE 16 MFD. at 660 VAC (2000 VDC) CAPACITOR. Dim. 5¼" H x 4½" x 3¾". Cat. #692X48. PRICE: \$3.00
- Herm. Sealed FILAMENT XMFR 115 or 230 PRIM. SEC. 5V at 10 A. Hi-Volt. Ins. 6300 working volts. Excellent for 872A. PRICE: \$3.75
- TAPPED SEC. 5V at 10 A. Hi-Volt. Ins. 6300 working volts. Excellent for 872A. Cat. #F90132. PRICE: \$3.00
- HEAVY-DUTY TEST LEADS. Tests to 10 KV for TV, etc. Red & Black Leads. ICA #4317. PRICE: \$1.25
- SIGNAL TRACER PROBE FOR VTVM, Etc. ICA #4310. PRICE: \$1.75
- ICA 5 WAY BINDING POSTS (Black or Red) PRICE: 22¢ Each
- BANANA PLUGS FOR ABOVE, black or red, Etc. 3" Long. (Specify Color) PRICE: 15¢ Each
- TEST LEADS. STD. SET OF RED & BLK. LEADS W/Banana Jacks & 5" Prods. ICA #312. PRICE: 50¢ Each
- RAYTHEON POWER SUPPLY Input 6 Volts DC. Output: 117 VAC under load @ ½ to ¾ Amps AC (50 watts plus) new—original cartoned—heavy-duty unit—best parts (Original cost over \$100.00) Price. \$16.95
- SPRAGUE 50,000 Ohms KOOLOHM BLEEDER RESISTOR @ 120 WATTS 75¢ each
- X-BAND SIGNAL GENERATOR—TS-147A 8430 to 9660 MCS.—has built-in attenuator. Clean lab-checked O.K.—(Price new about \$1800) Our price \$325.00
- ELDICO 2 meter mobile foundation chassis with many of basic parts mounted. Instruction book! Snap these up @ only \$3.50
- SPECIAL! MICROWAVE UHF XMTR & PULSE MODULATOR. Many usable parts for UHF experimenters. Push-pull 6J6 oscillator tunable from 275 to 340 MCS. Contains low-capacity type filament xmfr. (6.3 VAC to 6.3 VAC). Also butterfly capacitor. Coax cable length w/PL-59 connector. Mounted on standard 19" relay-Rack panel. (Less tubes and power supply) Only \$3.95 w/schematic. Stock #PLU-5001.

We are factory distributors for Vocaline, Gonset, E. F. Johnson, Eimac, B&W, Hexacon, Adjust-A-Volt, CBS, Hammarlund, Technical Material Corp. (TMC), National and Getoso. Trade-ins accepted. All prices F.O.B. N.Y.C. Specify method of shipment. All merchandise insured and guaranteed for cost of mds. only.

Open Monday to Saturday—Come in and Browse—We are near Prince St./BMT Station—Spring St./IRT Sta. 1 flight up—20,000 sq. feet of values. Thousands of unadvertised specials.

## BARRY ELECTRONICS CORP.

512 Broadway, Dept. RE-2, N.Y. 12, N.Y.  
Phone: WALKER 5-7000

Designed to meet the requirements of every specific space, budget, or decor problem—and every listening preference...



FAMOUS MEN OF MUSIC CHOOSE UNIVERSITY



1



2

University  
offers  
four  
ways  
to  
stereo



3



4

**1** Leading Metropolitan Opera Star Leonard Warren converted to stereo quickly, easily and inexpensively... using a compact Stereoflex-2\* "add-on" speaker with his University "Troubadour"

This approach solves many problems for those already possessing a full-range monophonic system, as well as those planning to buy one now with an eye to stereo later. Thanks to the *exclusive dual voice coil woofer* used in all University stereo-adapted systems, only one such woofer is needed to reproduce the *combined* bass below 150 cycles† of both stereo channels. Thus all three models of University "add-on" speakers provide a perfect match by *direct* connection to the original speaker system. Stereoflex-1\* is well suited for bookshelf installations. Stereoflex-2, with its narrow silhouette, makes a fine end table. Model SLC\* can be affixed to a wall or "lite-pole," its decorative fibreglas housing blending smartly with modern furnishings. Each can also be used with any brand monophonic system *not* having a dual voice coil woofer, by using a University Stereo Adapter Network Model A-1.

**2** Discriminating music lovers may also enjoy magnificent stereo by simply connecting two University "add-on" stereo speakers to a single dual voice coil woofer\* in a suitable enclosure

This approach offers great versatility. Since the woofer's position in the room is uncritical for stereo†, it may be installed wherever most convenient... in a small suitable enclosure, or in a wall, closet, etc. The two "add-on" speakers can then be placed to provide optimum stereo reproduction, without upsetting existing room decor.

**3** Noted maestro Fred Waring chose a pair of University RRL\* Ultra Linear Response speakers for his stereo system

When planning his recent cross country concert tour, *Hi Fi Holiday*, Fred Waring turned to University engineers for a compact, quality high fidelity speaker system that could overcome the acoustical deficiencies of the theatres and auditoriums in which The Pennsylvanians would be playing. The performance of the S-11 Ultra Linear Response speakers, mainstays for the system, proved so outstanding that Mr. Waring chose two of them for his own home. Two such identical speakers are an excellent stereo solution in rooms where they can be placed in reasonably symmetrical positions. All University systems are ideally suited for this purpose, because they are stereo-matched in production to within 1 db.

**4** Internationally famed violinist Mischa Elman prefers his stereo all-in-one... he selected the fabulous TMS-2\*, 'Trimensional' stereo speaker that in his words... "approaches the authenticity of concert hall performance."

A totally integrated single-cabinet system, the TMS-2 literally adds a third dimension to stereophonic sound... the perception of *depth*. Designed to utilize the acoustical properties of the surrounding walls of the room, the TMS-2 performs far beyond the scope of other single-cabinet stereo speakers. Its ingenious combination of electrical and acoustical principles permits placement in a corner or *anywhere* along a wall... lets you and any number of friends enjoy exciting stereophonic sound from almost any position in the room.



WHICH WAY TO STEREO IS IDEAL FOR YOU?

You'll find all the answers in University's FREE *Informative guide to high fidelity stereo and monophonic speaker systems and components*. Here, you'll find complete information on: how to select and place the four major types of stereo speaker systems... how to adapt your present monophonic system to stereo... how to choose a monophonic system *now* for most efficient conversion to stereo *later*... how to plan economical "do-it-yourself" monophonic/stereo speaker systems. See your dealer today or write Desk J8, University Loudspeakers, Inc., 80 So. Kensico Ave., White Plains, N. Y.

\*Trademark and Patent Pending.

†Bass frequencies below 150 cycles do not contribute to the stereo effect.



the case of the stereo

**HUMMMMINGBIRD**

## or MAGNETIC vs CERAMIC

You may have been reading many controversial advertisements as to the merits of various stereo cartridges... namely, the magnetic version vs. the ceramic version. Qualified claims are made by their manufacturers... and most are accurate. But how a specific cartridge *sounds* in your stereo system is really the criterion. Let's consider the real facts:

.....: Audio Engineers agree that magnetic  
**IT'S A FACT!** .....: stereo cartridges are excellent, costly  
 ... but burdened with *hum*. Tests prove that the new Electro-Voice Magneramic cartridge is completely hum-free. No motor or line hum can possibly be introduced to mar soft record passages, because the Magneramic is *non-inductive*.

.....: The simpler the  
**IT'S AN ENGINEERING AXIOM!** .....: design of a precision product, the less chance there is of manufacturing defect. Magnetic stereo cartridges are far more complicated than the comparable Electro-Voice Magneramic stereo cartridge. With E-V, you are assured years of trouble-free, high fidelity stereo performance.

.....: When the Electro-Voice corps of  
**IT'S POSITIVE!** .....: 60 engineers began intensive scientific stereo studies, they had the choice of either designing a magnetic or a ceramic cartridge. Knowing that two of the most vital factors for true audio reproduction were lack-of-hum and trouble-free performance, they took the positive approach and produced a stereo cartridge incorporating simple elements permitting positive, stable control for uniform output.

And so, with the advent of stereo, Electro-Voice introduced an entirely new concept in ceramic cartridges... a true high-fidelity series...

### THE E-V MAGNERAMIC



which will consistently outperform the best magnetics and do away with the "hummingbird" in your stereo system.

Choose the Magneramic... a new improved E-V stereo cartridge which plugs directly into magnetic inputs. See why it's the choice of so many FM stations for critical stereo broadcasts:

- ✓ NO HUM
- ✓ BEST CHANNEL SEPARATION  
*Over 25 db isolation between channels*
- ✓ HIGHEST COMPLIANCE  
*Horizontal and vertical compliance equal to or surpasses the best magnetic cartridges*
- ✓ WIDEST RANGE FREQUENCY RESPONSE  
*Far in excess of any monaural (monophonic) or stereo record*
- ✓ FLATTEST RESPONSE TO WESTREX 1A VELOCITY CURVE  
*From 20 cps to beyond audibility*
- ✓ HIGH 20 MILLIVOLTS OUTPUT  
*All the voltage you need... and then some*
- ✓ PROVEN SUPERIOR  
*for conventional monophonic records as well as stereo records*
- ✓ SOLD ON MONEY-BACK GUARANTEE  
*We invite you to try an E-V Magneramic, with E-V's unqualified guarantee backed by over 30 years as a manufacturer.*

Give the Magneramic a thorough listening test. If for any reason you aren't completely convinced of its superiority, your FRANCHISED Electro-Voice dealer is authorized to give you a full refund.

Step up to the excitement of stereo... step up to Electro-Voice Stereo... the industry's standard. Over a half-million in use, more than the total of all other stereo cartridges combined, attest to its acceptance as stereo's standard. Choose either the E-V Magneramic for magnetic inputs or the E-V Standard Stereo Cartridge for non-magnetic inputs.

21 MD with 0.7 Mil Diamond Stylus, net \$19.50; 26 MDST Turnunder with 0.7 Mil Diamond Stylus, and 3-Mil Sapphire Stylus for 78 R.P.M.'s, net \$22.50; 21 MS with 0.7 Mil Sapphire Stylus, net \$9.90; 26 MST Turnunder with 0.7 Mil Sapphire Stylus, and 3-Mil Sapphire Stylus for 78 R.P.M.'s, net \$12.90.

GOOD STEREO DEPENDS ON THESE VITAL FEATURES: FREQUENCY RESPONSE, 20-16,000 cps flat (Westrex 1A); ELEMENTS, 2 PZT Ceramic; OUTPUT VOLTS, 20 mv. Nominal; COMPLIANCE, 2 x 10<sup>-6</sup> cm/dyne; WEIGHT, 3.4 Grams; TRACKING FORCE, 4-6 Grams; CHANNEL SEPARATION, 25 db at 1 KC; MOUNTING, EIA (RETMA) Standard 1/2"-7/16" Center; STYLUS, .7 Mil (Diamond or Sapphire); OUTPUT TERMINALS, Standard .050 Connectors; IMPEDANCE OR LOAD, 22,000 ohm or higher magnetic input.

See your High Fidelity Specialist or write Dept. RE-2



**Electro-Voice**

INC., BUCHANAN, MICHIGAN

Over 1/2 Million In Use...  
 MORE THAN ALL OTHERS COMBINED

They know  
he's good  
because he's using the best...



## ...RCA RECEIVING TUBES

The public doesn't look *behind* a TV set very often. But when they watch you at work, it's reassuring to see the familiar red and black carton with that RCA trademark. The one thing the public *does* know about electronics and electronic products is that RCA is the outstanding name and company in the field. To benefit from the confidence that lesser known brands could never instill in your customers, latch on to RCA's "built-in" reputation—your calling card to customer good-will. Your RCA Distributor carries a full line. Next time you order tubes, specify...RCA.



**RADIO CORPORATION OF AMERICA**  
Electron Tube Division Harrison, N. J.