

Stereo Amplifiers and Preamplifiers

OCTOBER 1958

Radio-Electronics

TELEVISION • SERVICING • HIGH FIDELITY

HUGO GERNSBACK, Editor

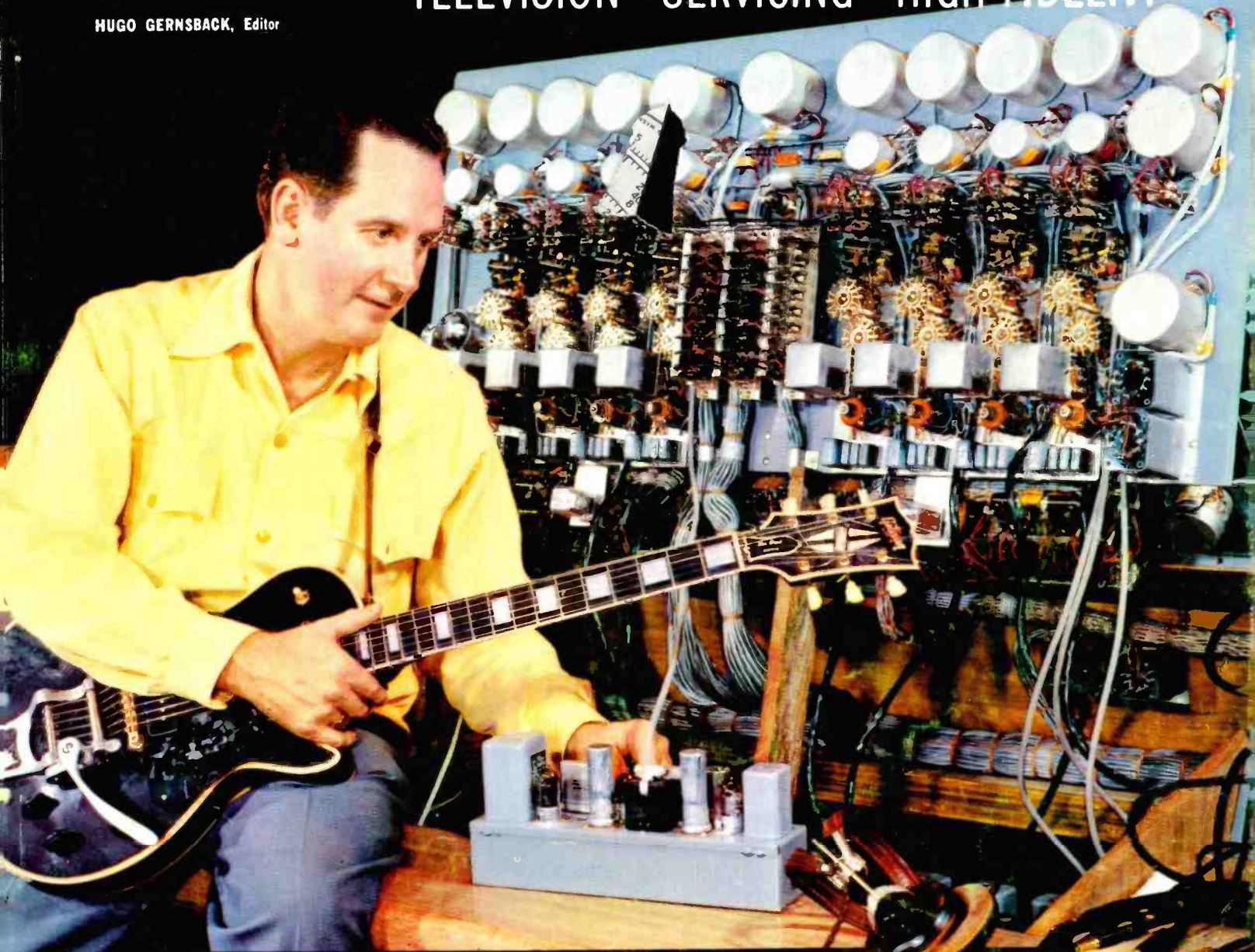

Les Paul and the Monster

(See page 38)

Ready for Stereo?

FM Tuner Is Easy
To Build

Stereo Tuner Features
Multiplex Output

More on Stereo
Cartridges

35c

U.S. and
Canada

a **VOM** ■■■ plus a **VTVM** when you need it.
DOUBLE USE...HALF THE PRICE
TRIPLETT MODEL 631—In one year accepted as the
 standard **COMBINATION VOM-VTVM**



Battery operated

- 1** Just flip the switch.
- 2** Standard sensitivities as used in servicing manuals.
- 3** 34 ranges—with the famous Triplett single knob control.
- 4** Extra long scales —unobstructed visibility.

\$64.50

By using the Volt-Ohm-Mil-Ammeter for all general testing (90% of your testing) and the Vacuum Tube Voltmeter only when you need it, you have the advantage of a VTVM with extremely long battery life. Batteries are used only about one-tenth as much as in the ordinary battery-operated VTVM. Features: Ohms, 0-1500-15,000 (6.8-68 center scale. First division is 0.1 ohm.)

Megohms: 0-1.5-150 (6,800-680,000 ohms center scale.) Galvanometer center mark “-0+” for discriminator alignment. RF Probe permits measurements up to 250 MC. \$7.00 net extra. Featured by leading electronic parts distributors everywhere.



TRIPLETT ELECTRICAL INSTRUMENT COMPANY • 52 years of experience • BLUFFTON, OHIO

Triplett design and development facilities are available for your special requirements for meters and test equipment.

NOW—A Faster Way to Reach the Top in TV SERVICING

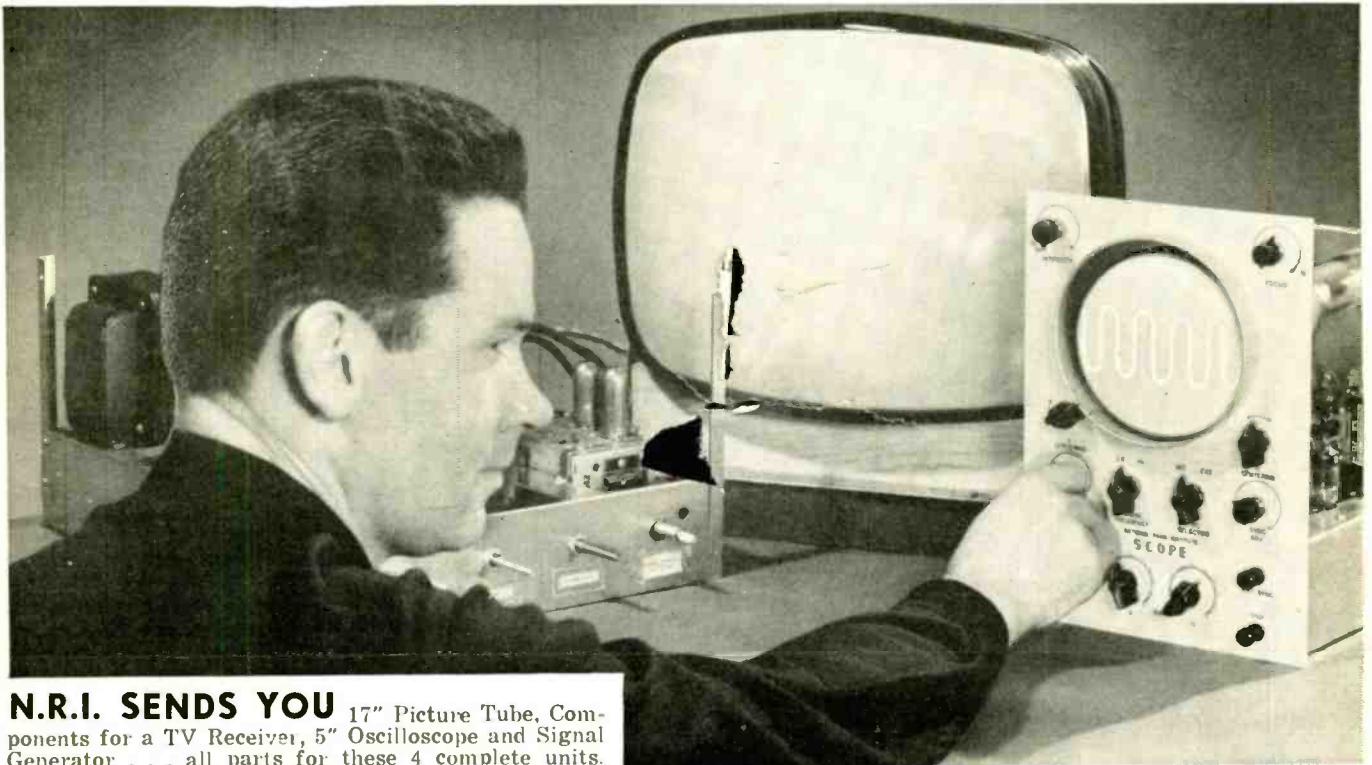

N.R.I. SENDS YOU 17" Picture Tube, Components for a TV Receiver, 5" Oscilloscope and Signal Generator . . . all parts for these 4 complete units.

N. R. I. All-Practice Method Trains You at Home in Spare Time to Fix TV Sets, Quickly, with Confidence

The man who knows the answers—the Professional TV Technician enjoys the prestige, gets the better jobs, the higher pay. Here is the learn-by-practice training to be a Professional TV Technician. It shows you the way to be the boss, to earn top pay. Television Servicing needs more well trained men. If you have a basic knowledge of radio and electronics you can make some Television repairs simply by trial and error. But sooner or later you will face TV Service problems you can not solve. And you can't get the training you need while customers wait.

NRI Is Oldest and Largest Home Study Radio-TV School

Over forty years' experience and the record and reputation of NRI back up this learn-by-doing Professional TV Servicing Course. Instead of just reading about TV problems, you build and conduct experiments on circuits in a TV receiver. You learn methods, "Tricks of the trade" proved by top TV Servicemen. You learn to fix any set, any model with confidence.

You Get COLOR TV Textbooks Early

The day you enroll, NRI sends you special Color-TV books to speed your knowledge and understanding of this vast, growing phase of Television.

Many full color pictures and diagrams help you recognize defects and help you learn how to correct them quickly and properly. To cash in on the coming Color TV boom, you'll need the kind of knowledge and experience this NRI training gives.

This is 100% learn-by-doing, practical training. Here is a course for men who know basic theory, either from Radio or TV Servicing experience or planned training but realize the need for more knowledge to forge ahead. Here is what one graduate, G. G. Stethem of Belpre, Ohio, says, "I can not praise NRI's Professional TV Course highly enough. I have my own

spare time shop and all the Radio-TV work I can handle."

Another graduate, Edward Ravitsky of Northumberland, Pa., says, "I have taken your course in Professional TV Servicing. It takes the kind of experience you offer to really learn." If you want to go places faster in TV Servicing, make your future more secure as the industry develops, we invite you to find out what you get, what you practice, what you learn from NRI's Course in Professional TV Servicing. Mail the coupon now. There is no obligation. NATIONAL RADIO INSTITUTE, Dept. 8KFT, Washington 16, D. C.



Send for FREE BOOK →

NATIONAL RADIO INSTITUTE

Dept. 8KFT, Washington 16, D. C.

Please send FREE copy of "How to Reach the Top in TV Servicing." I understand no salesman will call.

Name.....Age.....

Address.....

City.....Zone.....State.....

ACCREDITED MEMBER NATIONAL HOME STUDY COUNCIL



OCTOBER, 1958

Radio-Electronics

Formerly RADIO-CRAFT ■ Incorporating SHORT WAVE CRAFT ■ TELEVISION NEWS ■ RADIO & TELEVISION

EDITORIAL

35 Atypical Television—Hugo Gernsback

AUDIO—HIGH FIDELITY

- 36 Ready for Stereo?—Donald Carl Hoeffler
- 38 Les Paul, Technician and Musician (Cover Feature)—Eric Leslie
- 40 Amplifiers for Stereo—Herman Burstein
- 46 400 Loudspeakers—H. Gernsback
- 48 Stereo Phono Cartridges, Part II—Julius D. Hirsch
- 51 New Records and Tapes, Stereo and Mono—Reviewed by Chester Santon

WHAT'S NEW

52 Pictorial Report of New Developments

RADIO

- 53 Stereo Tuner Features Multiplex Output—Louis E. Garner, Jr.
- 56 Sensitive FM Tuning Indicator—Darwin H. Harris
- 57 Radio on Your Wrist
- 58 Sweet FM Tuner—Duane H. Sweet
- 60 Service Makes Sales
- 61 Parallel Resistance Chart—Rudolph Wellsand

TEST INSTRUMENTS

- 62 Measure Millivolts With Your Vtvm—Remi Riendeau
- 64 Check Electrolytics in Circuit—Joel H. Levitt

TELEVISION

- 82 Choosing a Multiset Coupler—Donald H. Rogers
- 91 Harmonics Work for You in New Convergence Circuit—Robert G. Middleton
- 98 TV Service Clinic—Conducted by Robert G. Middleton

ELECTRONICS

- 102 New Neon Bulb Acts Like a Thyatron—Tommy N. Tyler
- 105 Mind Reading Furnace Control—James A. McRoberts
- 111 The Old-Timer Diversifies—Jack Darr
- 121 Transistor Quiz—Ed Bukstein

- | | |
|----------------------------------|-------------------------------|
| 150 Books | 140 Radio-Electronic Circuits |
| 145 Business and People | 148 Technical Literature |
| 17 Correspondence | 125 Technicians' News |
| 131 New Devices | 122 Technotes |
| 128 New Tubes and Semiconductors | 142 Try This One |
| 6 News Briefs | 130 50 Years Ago |
| 138 Patents | |

ON THE COVER

Story on page 38

Les Paul looks for a noisy contact in one of the "Monster's" numerous amplifiers.

Color original by Hans Knopf

- Hugo Gernsback Editor and Publisher
- M. Harvey Gernsback Editorial Director
- Fred Shunaman Managing Editor
- Robert F. Scott W2PWG, Technical Editor
- Larry Steckler Associate Editor
- David Lachenbruch Associate Editor
- I. Queen Editorial Associate
- Robert G. Middleton Television Consultant
- Elizabeth Stalcup Production Manager
- Cathy Coccozza Advertising Production
- Wm. Lyon McLaughlin Tech. Illustration Director
- Sol Ehrlich Art Director
- Fred Neinast Staff Artist
- Lee Robinson General Manager
- John J. Lamson Sales Manager
- G. Aliquo Circulation Manager
- Adam J. Smith Director, Newsstand Sales
- Robert Fallath Promotion Manager



Average Paid Circulation Over 195,000



RADIO-ELECTRONICS is indexed in *Applied Science & Technology Index* (Formerly *Industrial Arts Index*)

RADIO-ELECTRONICS, October, 1958, Vol. XXIX, No. 10. Published monthly at Mt. Morris, Ill., by Gernsback Publications, Inc. Second-class mail privileges authorized at Mt. Morris, Ill. Copyright 1958 by Gernsback Publications, Inc. All rights reserved under Universal, International and Pan-American Copyright Conventions.

SUBSCRIPTION RATES: U. S. possessions and Canada, \$4.00 for one year; \$7.00 for two years; \$10.00 for three years; single copies 35c. Pan-American countries \$4.50 for one year; \$8.00 for two years; \$11.50 for three years. All other countries \$5.00 a year; \$9.00 for two years; \$13.00 for three years.

SUBSCRIPTIONS: Address correspondence to Radio-Electronics, Subscription Dept., 154 West 14th St., New York 11, N.Y. When requesting a change of address, please furnish an address label from a recent issue. Allow one month for change of address.

GERNSBACK PUBLICATIONS, INC., Executive, Editorial and Advertising Offices, 154 West 14th St., New York 11, N.Y. Telephone Algonquin 5-7755. Hugo Gernsback, Chairman of the Board; M. Harvey Gernsback, President; G. Aliquo, Secretary.

BRANCH ADVERTISING OFFICES and FOREIGN AGENTS listed on page 153.

POSTMASTER: If undeliverable, send Form 3579 to: RADIO-ELECTRONICS, 154 West 14th St., New York 11, N.Y.

*Trademark registered U. S. Pat. Office.

RADIO-ELECTRONICS

NOW!
at a price
you can afford!

MAKE MORE MONEY in TELEVISION RADIO-ELECTRONICS

**BETTER...MORE COMPLETE...LOWER COST...
WITH NATIONAL SCHOOLS SHOP-METHOD
HOME TRAINING!**

BETTER... Training that is proved and tested in Resident School shops and laboratories, by a School that is the **OLDEST** and **LARGEST** of its kind in the world.

MORE COMPLETE... You learn **ALL PHASES** of *Television-Radio-Electronics*.

LOWER COST... Other schools make several courses out of the material in our **ONE MASTER COURSE**... and you pay more for less training than you get in *our course* at **ONE LOW TUITION!**

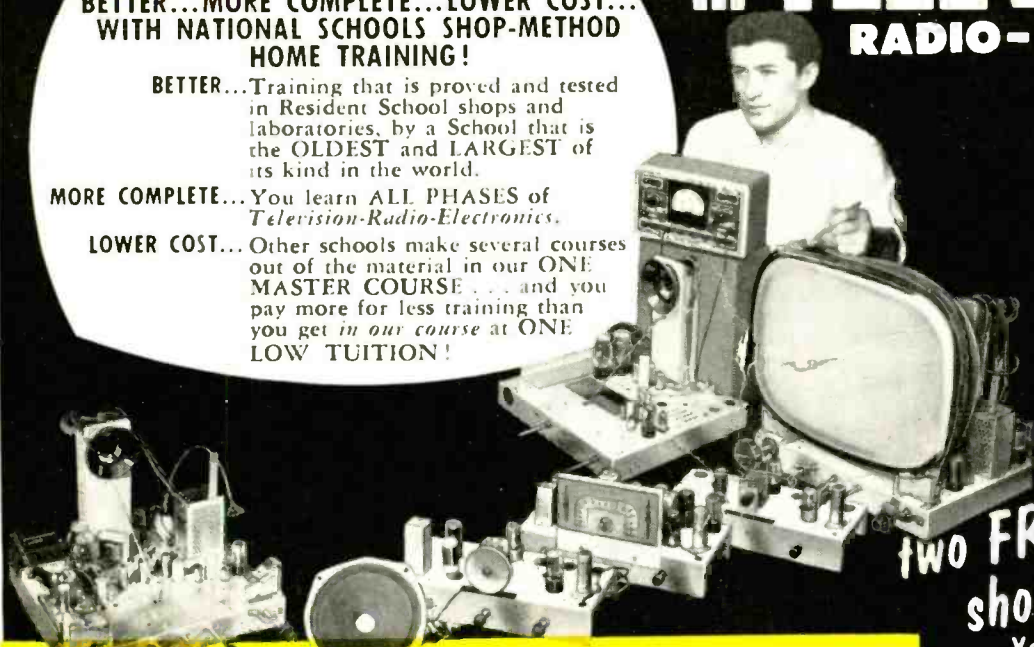

These **two FREE** books will show you how!

You get all information by mail... You make your own decision... at home! **NO SALESMAN WILL CALL**

TOP PAY... UNLIMITED OPPORTUNITIES LIFETIME SECURITY CAN BE YOURS!

You are needed in the Television, Radio, and Electronics industry! Trained technicians are in growing demand at excellent pay—in **ALL PHASES**, including Servicing, Manufacturing, Broadcasting and Communications, Automation, Radar, Government Missile Projects.

NATIONAL SCHOOLS SHOP-METHOD HOME TRAINING, with newly added lessons and equipment, trains you in your spare time at home, for these unlimited opportunities, including many technical jobs leading to supervisory positions.

YOU LEARN BY BUILDING EQUIPMENT WITH KITS AND PARTS WE SEND YOU. Your National Schools course includes thorough *Practical* training—**YOU LEARN BY DOING!** We send you complete standard equipment of professional quality for building various experimental and test units. You advance step by step, perform more than 100 experiments, and you build a complete TV set from the ground up, that is yours to keep! A big, new TV picture tube is included at no extra charge.

EARN AS YOU LEARN. We'll show you how to earn extra money right from the start. Many of our students pay for their course—and more—while studying. So can you!

RESIDENT TRAINING AT LOS ANGELES

If you wish to take your training in our Resident School at Los Angeles, the world's TV capital, start **NOW** in our big, modern Shops, Labs and Radio-TV Studios. Here you work with latest Electronic equipment -- professionally installed -- finest, most complete facilities offered by any school. Expert, friendly instructors. Personal attention. Graduate Employment Service. Help in finding home near school -- and part time job while you learn. Check box in coupon for full information.

LESSONS AND INSTRUCTION MATERIAL ARE UP-TO-DATE, PRACTICAL, INTERESTING. Every National Schools Shop-Method lesson is made easy to understand by numerous illustrations and diagrams. All instruction material has been developed and tested in our own Resident School Shops, Laboratories and Studios.

SEND FOR INFORMATION TODAY... it can mean the difference between **SUCCESS** and failure for you! Send for your **FREE BOOK** "Your Future in Television-Radio-Electronics" and **FREE** Sample Lesson. Do it **TODAY**, while you are thinking about your future. It doesn't cost you anything to investigate!

GET THE BENEFITS OF OUR OVER 50 YEARS EXPERIENCE

Approved for
GI Training



NATIONAL SCHOOLS

Los Angeles 37, Calif.

YOU GET...

- 19 Big Kits—**YOURS TO KEEP!**
- Friendly Instruction and Guidance
- Job Placement Service
- Unlimited Consultation
- Diploma—Recognized by Industry
- **EVERYTHING YOU NEED FOR SUCCESS!**

**SHOP-METHOD HOME TRAINING
COVERS ALL PHASES OF INDUSTRY**

1. Television, including Color TV
2. Radio AM & FM
3. Electronics for Guided Missiles
4. Sound Recording and Hi-Fidelity
5. FCC License
6. Automation and Computers
7. Radar & Micro-Waves
8. Broadcasting and Communications

NATIONAL TECHNICAL SCHOOLS
WORLD-WIDE TRAINING SINCE 1905

MAIL NOW TO

NATIONAL SCHOOLS, Dept RG-108

4000 S. FIGUEROA ST. LOS ANGELES 37, CALIF.

Rush free TV-Radio "Opportunity" Book and sample lesson. No salesman will call.

NAME _____ AGE _____

ADDRESS _____

CITY _____ ZONE _____ STATE _____

Check if interested **ONLY** in Resident School training at Los Angeles.
VETERANS: Give date of Discharge _____

FOR
A **brighter**
TV picture

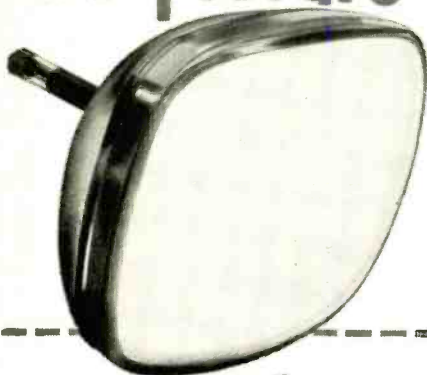

FOR
A **brighter**
profit.
picture



Keep your customers sold on you! Use the exact same tubes leading independent set makers specify. Tell your supplier you'd rather have Tung-Sol Tubes.

Tung-Sol Electric Inc., Newark 4, N. J.

TUNG-SOL
MAGIC MIRROR ALUMINIZED
PICTURE TUBES
RECEIVING TUBES

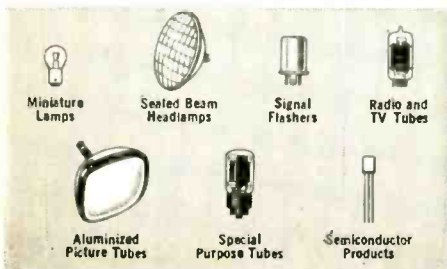

News Briefs



STEREO BROADCASTING has taken a sudden upsurge with the increased availability of stereo FM-AM tuners and dual amplifier systems. A survey by the Institute of High Fidelity Manufacturers indicates that at least 50 stations—and probably considerably more—were broadcasting FM-AM stereo last summer.

A questionnaire answered by 319 FM stations showed that 24% of those which had AM affiliates were broadcasting FM-AM stereo. Stations with AM affiliates totaled 67% of those responding. Of stations not affiliated with AM outlets, 6 said they are now transmitting multiplexed FM stereo, while 26% of the respondents said they plan to begin multiplexing in the near future, either for stereo, point-to-point background music or both.

NEW INTERNATIONAL (shortwave) broadcast station, the first to be authorized by the FCC in 20 years, is beginning transmissions on 17.8 mc in Belmont, Calif. Its call letters will be KGEI and it will use the transmitter and buildings formerly used by General Electric's old shortwave station with the same call letters. KGEI expects to beam 47½ hours of programming weekly to Central and South America, using a 50-kw transmitter and with ERP of about 600 kw.

The only other privately operated international broadcasting operation in the US is WRUL, Scituate, Mass., which operates five transmitters. All others are operated by the Government.

NO PAY TV will be authorized until next summer at the very earliest, the FCC has assured Congress. Replying to a request by Chairman Oren Harris (D.-Ark.) of the House Interstate and Foreign Commerce Committee to give Congress further time to study the entire issue of pay TV, the commission stated it would refrain from approving any applications for broadcast subscription TV until the adjournment of the next session of Congress, probably in July or August, 1959.

This applies to on-the-air pay TV only, and not closed-circuit wired systems, over which the FCC has no jurisdiction.

TV SAFETY GLASS as a dust-catching reflection producer in front of the picture tube may soon become a thing of the past. Two glass companies have announced new implosion plates bonded to the tube itself, and they claim 8-10% more brightness and virtual elimination of reflections, plus the possibility of reducing cabinet depth still further.

Pittsburgh Plate Glass Co. calls its development the "safety tube." It consists of a lightweight glass window curved to fit the tube face and acid-etched to a satin finish to diffuse light reflections. It's laminated directly to the face of the picture tube with a layer of transparent polyester resin.

Corning Glass Works achieves a similar effect with its "contoured twin panel tube." It uses a curved glass plate with a flange which is cemented around the edge of the picture tube. The space between the tube face and the glass plate is filled with clear mineral oil (1 quart is used in a 21-inch tube). The oil can be tinted and is intended to provide clear viewing and reduce or eliminate the possibility of implosion.

TELEEDUCATION—use of closed-circuit TV systems in teaching—is now incorporated in the curricula of 119 schools and colleges. A survey by the Joint Council on Educational Television, Washington, revealed that 133 closed-circuit systems are in use in the 119 institutions, about twice as many installations as there were 2 years ago.

161,000,000 RADIOS are now in use in the United States, or nearly 3 for each of America's 50,000,000 homes. This represents 3½ radios in use to every one of the country's 48,300,000 television sets. These estimates are from *Television Factbook*, which reports 103,000,000 radios in homes, 40,000,000 in autos and 10,000,000 in public places.

Sylvania market research director Frank W. Mansfield estimates that 320,000 color TV sets are now in use, and that a total of 11,279,000 TV sets have been scrapped since the first sets were introduced after World War II.

In another survey, a research organization, A. C. Nielsen Co., found that the uhf television band is regularly used in 3,563,960 households. This is a slight decline from 3,865,560 two years ago. But the survey indicated that 68% of the TV homes in areas with uhf stations now watch uhf, as compared with 60% in 1956. While more than 8,000,000 all-channel TV's have been sold, the uhf tuners in many of these are used rarely or never.

RADIO-CONTROL MODEL builders and enthusiasts gained some badly needed frequencies—but amateurs lost the 11-meter band—in a reallocation of the Citizens radio service by the FCC.

Overruling the protests of hams, the commission formally removed the 29.96-27.23-mc band from amateur use and
(Continued on page 10)



Now! Work Over
300 PRACTICAL
PROJECTS with these
PARTS AT HOME!



to help You learn
ELECTRONICS
RADIO - TELEVISION - RADAR

NOW . . . at home in your spare time you can get the very kind of training and subsequent Employment Service you need to get started toward real earnings in one of today's brightest opportunity fields—TELEVISION-RADIO-ELECTRONICS. Now that Electronics is entering so many new fields, here is a chance of a lifetime to prepare to cash in on its remarkable growth.

DeVry Tech's amazingly practical home method enables you to set up your own HOME LABORATORY. You spend minimum time to get maximum knowledge from over 302 practical projects, using the same type of basic equipment used in our modern Chicago and Toronto Training Centers!

DeVry Tech Provides EVERYTHING YOU NEED . . .

—to help you master TV-ELECTRONICS. In addition to the home laboratory and easy-to-read lessons, you even use HOME MOVIES—an exclusive DeVry Tech advantage. You watch hidden actions . . . see electrons on the march. Movies help you to learn faster . . . easier . . . better.

LABORATORY TRAINING

Full time day and evening training programs in our modern Chicago and Toronto Laboratories are also available. MAIL COUPON TODAY for facts.



BUILD and KEEP Valuable TEST EQUIPMENT

As part of your training, you build and keep a fine Jewel-Bearing Vacuum Tube VOLTMETER and a 5-inch COLOR OSCILLOSCOPE—both high quality, needed test instruments.

EFFECTIVE EMPLOYMENT SERVICE

Get the same Employment Service that has helped so many DeVry Tech graduates get started in this fast-growing field.



"One of North America's Foremost Electronics Training Centers"

Accredited Member
of National Home
Study Council



DeVRY TECH INSTITUTE
Formerly DeForest's Training, Inc.
CHICAGO 41, ILLINOIS

EARN WHILE YOU LEARN

DeVry Tech's practical training helps you toward spare time income servicing Radio and Television sets.



VACUUM
TUBE
VOLTMETER

5-INCH
COLOR
OSCILLOSCOPE



21 INCH

Build and keep this BIG DeVry Engineered TV set—easily converted to U.H.F. (DeVry offers another home training, but without the TV set.)

- TV-Radio Broadcast Technician
- Color Television Specialist
- Radar Operator
- Laboratory Technician
- Airline Radio Man
- Computer Specialist
- Quality Control Manager
- Your Own Sales & Service Shop
- . . . PLUS MANY OTHERS

MAIL COUPON TODAY!

DeVRY TECHNICAL INSTITUTE
4141 Belmont Ave., Chicago 41, Ill., Dept. RE-10-O

Please give me your FREE booklet, "Electronics and YOU," and tell me how I may prepare to enter one or more branches of Electronics.

Name _____ Age _____
PLEASE PRINT
Street _____ Apt. _____
City _____ Zone _____ State _____
Canadian residents address DeVry Tech of Canada, Ltd.
2045 626 Roselawn Ave., Toronto 12, Ontario

a RAYTHEON designed tube



the OZ4

has set the most spectacular record in receiving tube history

Way back in 1937, the Raytheon Manufacturing Company introduced and produced the Raytheon OZ4 — a gas-filled rectifier tube designed specifically for car radios. So nearly perfect is this tube in design, construction and operating ability, that it has never been equalled. For more than 21 years it has withstood performance challenges from many prototypes, but, one by one, all have fallen by the wayside and the Raytheon designed OZ4 remains the ideal tube for the job it was designed to do.

We point with pride to the OZ4 triumph because it is engineering and design know-how like this, teamed with production skill and craftsmanship, that goes into the design and manufacture of the complete line of Raytheon TV and Radio Tubes. That's why you can use Raytheon Tubes for replacement work with complete confidence that you are giving your customers tubes that are second to none in design, in quality, in performance — tubes that are truly RIGHT...for SOUND and SIGHT!

And Now From Raytheon, The "Voice" of The Satellites

Today, as yesterday, Raytheon leads the way. Raytheon Transistors help send coded messages from America's Satellites to receiving stations on earth. 14 of America's major guided missiles use Raytheon Tubes and Semiconductors — further proof of the superior performance, dependability and manufacturing excellence of Raytheon products.



RAYTHEON MANUFACTURING COMPANY
DISTRIBUTOR PRODUCTS DIVISION

NEWTON 58, MASS. CHICAGO, ILL. ATLANTA 6, GA. LOS ANGELES 7, CALIF.
55 Chapel Street 9501 Grand Ave. (Franklin Park) 1202 Zonolite Rd. N.E. 2419 So. Grand Ave.

Raytheon makes all these } Receiving and Picture Tubes, Reliable Subminiature and Miniature Tubes, Semiconductor Diodes and Transistors, Nucleonic Tubes, Microwave Tubes.



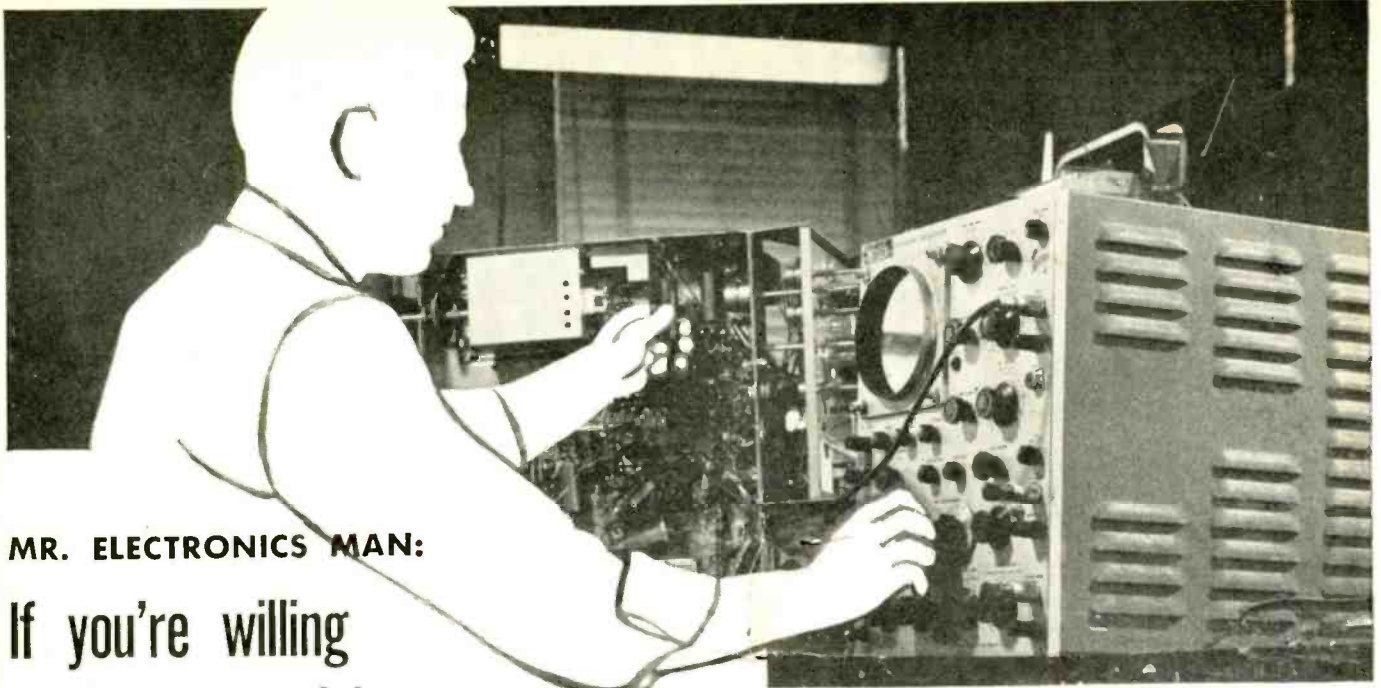

MR. ELECTRONICS MAN:

**If you're willing
to lose your job tomorrow
to a technically-trained man,
turn the page, mister**

Many of the men currently on the street are there for a reason. "As many as 8 out of 10 are dead-wood," estimates the chief engineer of a medium-sized Philadelphia firm; the problem is to find the live ones. —from *ELECTRONICS MAGAZINE*

If you're interested in an honest-to-goodness career in the vigorous young electronics industry, here's how you can step ahead of job-competition, move up to a better job, earn more money, **AND BE SURE OF HOLDING YOUR TECHNICAL JOB, EVEN WHEN THE "DEADWOOD" IS BEING CLEANED OUT.**

The "how" is advanced, professional home study training in Electronic Engineering Technology including **SERVOMECHANISMS; COMPUTERS; RADAR; AUTOMATION; AERONAUTICAL ELECTRONICS; BROADCASTING; COMMUNICATIONS AND MANUFACTURING**, and the **ELECTRONIC PRINCIPLES ASSOCIATED WITH GUIDED MISSILES, TELEMETERING, ASTRONAUTICS** and **INSTRUMENTATION**. You don't have to be a college graduate. You *do* have to be willing to study—at home. You can do it while holding down a full-time job. Thousands have. Since 1927 CREI has provided alert young men with the technical knowledge that leads to more responsibility, more job security, more money. And CREI has constantly kept pace with the rapid expansion and progress in electronic achievement.

Remember this: CREI starts with fundamentals and takes you along at your own speed. You are not held back by a class, not pushed to keep up with others. You set your own pace. CREI instructors guide you through the lesson material and *grade* your written work personally. You master the fundamentals, then get into more advanced phases of electronics engineering principles and practice. Finally you may elect training in highly specialized principles of electronic engineering technology as applied to guided missiles, servomechanisms, radar, computers, telemetering, automation, instrumentation and other applications.

Look at this partial listing of organizations that recommend CREI training for their own personnel: United Air Lines, Canadian Broadcasting Corp., Trans-Canada Airlines, Douglas Aircraft Co., The Martin Co., Columbia Broadcasting System, All-American Cables and Radio, Inc., Gates Radio Co., Canadair Ltd., Federal Electric Corp., and U.S. Information Agency (Voice of America).

What's the next step? *Certainly get more information than we can cram into one page. Fill out and mail the coupon below today, or write Capitol Radio Engineering Institute, Dept. 1410-E, 3224 16th St., N.W., Washington 10, D. C.*

CREI ALSO OFFERS RESIDENCE TRAINING at the same high technical level in Washington, D. C. Classes start at regular intervals. Qualified residence school graduates earn degree, "Associate in Applied Science." You can qualify for CREI home study training if you have had electronic education, or experience in electronics—and realize the need of a high level technical knowledge to make good in the better electronic jobs. (Electronics experience is not required for admission to CREI Residence School.)

VETERANS: If eligible for training under the new G.I. Bill of Rights, check the coupon for full information.

MAIL THIS COUPON FOR FREE BOOKLET!

CAPITOL RADIO ENGINEERING INSTITUTE
 ECPD Accredited Technical Institute Curricula • Founded 1927
 Dept. 1410-E, 3224 Sixteenth St., N.W., Washington 10, D. C.

Please send me your course outline and FREE illustrated Booklet "Your Future in the New World of Electronics" . . . describing opportunities and CREI home study courses in Practical Electronic Engineering Technology.

CHECK FIELD OF GREATEST INTEREST } Radar, Servo and Computer Engineering Technology **13**
 Electronic Engineering Technology
 Broadcast (AM, FM, TV) Engineering Technology
 Television Engineering Technology
 Aeronautical Electronic Engineering Technology

Name..... Age.....
 Street.....
 City..... Zone..... State.....
 Check: Home Study Residence School Korean Veteran

To help us answer your request intelligently, please give the following information:

Employed By.....
 Type of Present Work.....
 Education:
 Yrs. High School.....
 Other.....
 Electronics Experience.....

allocated it for remote model control and other Citizens radio uses. The FCC stated that amateurs hadn't made heavy use of this band, that modelers were in "dire and immediate need" of additional frequencies and that most people who were both amateurs and modelers supported the reallocation.

CANADA has upped its TV station total to 53 with the addition of:
 CFCL-TV-2, Elk Lake, Ont. 2
 which is the second unmanned automatic repeater for CFCL-TV, Timmins, Ont., channel 6, the first being CFCL-TV-1, Kapuskasing, Ont., channel 3.

In the US, 4 stations have changed call letters:

KEYC-TV, Mankato, Minn. 12
 (formerly KMNF-TV)
 KREY-TV, Montrose, Colo. 10
 (formerly KFXJ-TV)
 KHVH-TV, Honolulu, Hawaii. 4
 (formerly KULA-TV)
 WIRN, Ironwood, Mich. 12
 (formerly WJMS-TV)

The US count remains 538 (447 vhf and 91 uhf). Of these, 30 are non-commercial.

PERCEPTION, the first machine which can perceive its surroundings and "think" without any human priming, has been developed for the US Navy and demonstrated in preliminary form.

Patterned after the human brain by a Cornell Aeronautical Laboratory team headed by research psychologist Dr. Frank Rosenblatt, Perception doesn't have to be "fed" information but teaches itself to recognize objects the first time it "sees" them.

Perception "sees" through a camera lens, and a brainlike electrical impulse system interprets the information. In one experiment Perception was shown 100 cards with squares printed on them and correctly reported whether the squares were on the right or left in 97 cases, actually teaching itself the difference between left and right.

The Perception concept was demonstrated on an IBM 704 computer. An actual working model will be completed within a year. Future models are expected to be able to receive their orders from printed pages, longhand letters and spoken commands.

TV PICTURE 13 MILES UP was viewed by Minneapolis residents when the Navy's "Strato-Lab" set a manned-balloon ascent record of 82,000 feet. Installed in the 7-foot-wide gondola was a transistor vidicon camera and a 30-watt transmitter tuned to uhf channel 14. The television pictures, which were relatively uninspiring views of the inside of the gondola, were televised live over station KSTP-TV from the 60,000- and 70,000-foot levels.

NEWS IN BRIEF

A radar-radio network that can detect and track even silent satellites passing over the US is under construction and will be in operation by the end of the year, the Defense Department says.

Signals from Sputnik I on the 15-meter
 (Continued on page 14)

How to Pass

An FCC License can be

Get Your FCC License

We Guarantee
 to train you until you receive
Your FCC License

Completion of the Master Course (both Sections) will prepare you for a First Class Commercial FCC License with a radar endorsement. Completion of Section 1 only of the Master Course will prepare you for a Second Class Commercial FCC License. We guarantee to train and coach you, without any additional cost, until you receive the FCC License as indicated above. This guarantee is valid for the entire period of your enrollment agreement.

Cleveland Institute Training Results in success with commercial FCC examinations . . . easily . . . and quickly.

every month our trainees get jobs like these:



Boyd Daugherty:

"I recently secured a position as Test Engineer with Melpar, Inc. A substantial salary increase was involved. My Cleveland Institute training played a major role in qualifying me for this position."

*Boyd Daugherty
 105 Goodwin Ct., Apt. C
 Falls Church, Va.*

Top Grade Employers Like These Look

Bendix Radio: "We shall look forward to receiving completed applications from your students."

Philco: "We have employed a great number of well qualified electronics personnel who were graduates of Cleveland Institute."

Westinghouse: "We would appreciate your listing our current openings in your monthly Job Opportunities."

(Commercial)

FCC License Exams

your Guarantee of Success in Electronics

in a Minimum of Time

mail
coupon
NOW!

here's proof of good jobs

Irving Laing:

"Your lessons are helping me a lot in my Navy work. You cover topics that were not presented by the Navy at the E.T. School. . . . Your course has helped greatly to get my 2nd class FCC ticket. I am now a radio and T.V. engineer at WTVS and WDTR in Detroit, Michigan."

*Irving L. Laing,
15887 Robson,
Detroit 27, Michigan*

James Glen:

When Jim enrolled, he was a temporary employee of the City of Tacoma, Washington. In the space of 14 months, he completed the Master Course and received his first class license. He is now installing and maintaining mobile and microwave equipment.

*James S. Glen, Jr.
2920 Knob Hill Road
Tacoma, Washington*



Get all 3 FREE

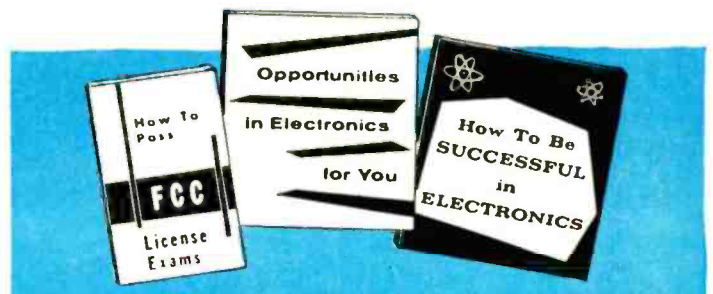

Accredited by The National Home Study Council

Cleveland Institute of Radio Electronics

Desk RE-22, 4900 Euclid Ave., Cleveland 3, Ohio



Please send FREE Booklets prepared to help me get ahead in Electronics. I have had training or experience in Electronics as indicated below:

- | | |
|---|---|
| <input type="checkbox"/> Military | <input type="checkbox"/> Broadcasting |
| <input type="checkbox"/> Radio-TV Servicing | <input type="checkbox"/> Home Experimenting |
| <input type="checkbox"/> Manufacturing | <input type="checkbox"/> Telephone Company |
| <input type="checkbox"/> Amateur Radio | <input type="checkbox"/> Other..... |

In what kind of work are you now engaged?.....

In what branch of Electronics are you interested?.....

Name..... Age.....

Address.....

City..... Zone..... State.....

Special Tuition Rates to Members of Armed Forces

To Cleveland Institute

Aerojet-General
American Airlines
American Telephone & Telegraph Co.
Bendix Radio
Braniff Airways
Burroughs Corp.
Capital Airlines
Continental
Air Lines, Inc.
Convair
General Electric
Glenn L. Martin Co.

Goodyear Atomic Corp.
IBM
International Telephone & Telegraph Co.
Mohawk Airlines
Motorola
North American Aviation, Inc.
Northwest Airlines
Philco
RCA
Ryan Aeronautical Co.
*Plus many others

The Most Advanced TV ANTENNAS in the World!

TRIO®

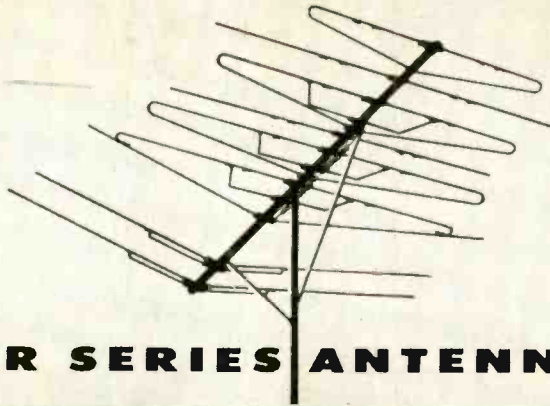

ZEPHYR AND COLOR SERIES ANTENNAS

Look for these 4 Great Features in 1959

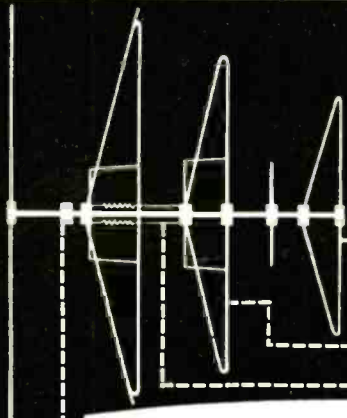

Wing Dipole

Today's most powerful dipole! Contains three active elements on the high—forward Vee to the low band section—plus integrated director.

Wing Director

Today's most powerful director! A composite director designed to obtain results from the powerful Wing Dipole.

no-strip

lead-in connector

Requires no stripping, no soldering, or wire holders—holds the complete insulated wire.

dyna-coil phasing

Increased performance from uniform transmission of signal strength of each active dipole in a multi-dipole system—AND MAKES POSSIBLE COMPLETE FACTORY ASSEMBLY.

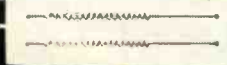

Choose from . . . TRIO'S COMPLETE LINE

COLOR ROYAL—The ultimate in color television reception—or black and white.

ZEPHYR ROYAL—Extraordinary power and sensitivity.

ZEPHYR PIONEER—For extreme distance.

COLORITE—For color and black and white in areas formerly using conicals.

Sharpshooters, Conicals and Yagis

Patents: U.S. 2772413—Canada 541670

Copyright 1958, Trio Mfg. Co.



TRIO Manufacturing Company GRIGGSVILLE, ILL.

Now here's the actual proof: ownership of a complete and currently maintained **PHOTOFACT** Service Data Library **SPELLS SUCCESS FOR SERVICE TECHNICIANS!**



"We depend on **PHOTOFACT for correct time-saving information; without them we'd have to go out of business!"**

—Anthony Fernandez, Brooklyn, New York
(Operator of "Rainbow TV"—
in business for over 10 years)

HERE'S MORE PROOF...FROM COAST-TO-COAST

CALIFORNIA	TEXAS	COLORADO
<p>"It would be pretty tough to operate a business like mine without PHOTOFACT. They are a time-saver. ..."</p> <p>—James C. Johnson <i>Blythe, California</i></p>	<p>"Our service department would not be where it is today without the help of Sams PHOTOFACT... and I have the best radio and TV service in the county. ..."</p> <p>—A. C. Bowen <i>Beaumont, Texas</i></p>	<p>"PHOTOFACT helps me make faster and better repairs and that means a lot in the service business. ..."</p> <p>—Warren G. Kunkle <i>Denver, Colorado</i></p>
ILLINOIS	OHIO	INDIANA
<p>"I couldn't get along without them—I depend on Sams PHOTOFACT entirely for all shop repairs—they're just what I need."</p> <p>—Raymond D. Easley <i>Chicago, Illinois</i></p>	<p>"Life would be rugged without PHOTOFACT. Puts all television facts at our fingertips—gives us all the information we need to do a good job without guesswork."</p> <p>—Albert F. Mirus <i>Cincinnati, Ohio</i></p>	<p>"Without PHOTOFACT, servicing is almost impossible. It's a great technical help to have diagrams and information for sets on hand as needed."</p> <p>—J. S. Kleby <i>South Bend, Indiana</i></p>
PENNSYLVANIA	FLORIDA	MASSACHUSETTS
<p>"Gives us accurate information on 99% of sets we work on. We like to have the format of data same on all sets. Saves time and consequently money."</p> <p>—John H. Robbins <i>Westfield, Pa.</i></p>	<p>"PHOTOFACT has made it possible for me to give same-day service on pulled sets and delivery the same evening..."</p> <p>—David Issensky <i>Miami, Florida</i></p>	<p>"PHOTOFACT makes possible big savings in time. Time saved is money earned."</p> <p>—Austin Radio & TV <i>Quincy, Mass.</i></p>

(These are just a few of the hundreds of "Success with PHOTOFACT" letters in our files)

**SEE YOUR SAMS DISTRIBUTOR TODAY;
OR WRITE TO HOWARD W. SAMS FOR FULL DETAILS**

HOWARD W. SAMS & CO., INC.
2205 E. 46th St., Indianapolis 6, Ind.



- Send details on PHOTOFACT Easy-Buy Plan and FREE File Cabinet offer.
- I'm a Service Technician: full-time; part time

My Distributor is: _____

Shop name _____

Attn. _____

Address _____

City _____ Zone _____ State _____

NEW! EASY-BUY PLAN
—the money-saving way to build your complete profit-making PHOTOFACT Library!
NO INTEREST—NO CARRYING CHARGE—AS LITTLE AS \$10 DOWN

FREE! VALUABLE STEEL FILE CABINETS FOR REGULAR PHOTOFACT SUBSCRIBERS AND PHOTOFACT LIBRARY PURCHASERS

GET THE FULL DETAILS

ADDS INCOME 2 WAYS

1. Tests and Repairs Picture Tubes
(110° Tubes and Color Tubes too, with new C40 Adapter)

2. Makes New Tube Sales Easier

CATHODE REJUVENATOR TESTER

CRT 400 PROVES REAL MONEY-MAKER

Thousands of servicemen today make money and keep customer good-will by checking and correcting b/w picture tube troubles with the famous B&K CRT 400, right in the home without removing tube from set. Restores emission and brightness. Repairs inter-element shorts and open circuits. Checks leakage. Indicates picture quality customer can expect. Life Test checks gas content and predicts remaining useful life of picture tube. Makes new picture tube replacement sales easier!

Model 400 (without adapter).....Net, \$59⁹⁵

NEW MODEL C40 ADAPTER DOUBLES VALUE OF B&K CRT

Designed for use with all B&K Models 400 and 350 CRT's. Makes it easy to test and rejuvenate TV color picture tubes and 110° picture tubes. Isolates and detects difficult color troubles. Tests and rejuvenates each gun of the color picture tube separately the same way as a black & white tube.

Model C40 Adapter.....Net, \$9⁹⁵

See your B&K distributor, or write for Bulletin AP12-E

New C40 Adapter for
110° Tubes and Color Tubes



Makers of CRT, DYNA-QUIK, DYNA-SCAN and CALIBRATOR

B & K MANUFACTURING CO.

3726 N. Southport Ave. • Chicago 13, Illinois



Wanna' Sell? ... Buy? ... Trade?



For best results use

Radio-Electronics

Opportunity Adlets

Rates as low as \$5.

50¢ a word—10 word minimum

Radio-Electronics 154 West 14th Street • New York 11, N. Y.

band traveled all the way around the world when the satellite approached the highly ionized F2 layer of the ionosphere the Russian magazine *Radio* reported. It added that signals in the 7.5 meter band traveled only as far as direct line-of-sight.

Conelrad warning system, originally developed for air-raid alerts, is now being used by more than 3,000 radio broadcasting stations to alert the public to tornadoes and other weather emergencies. Conelrad receivers, installed in radio stations and other locations, are activated by a 1,000-cycle tone transmitted by one station in each area preceding the emergency message.

A 1,640-foot concrete TV tower is being built for Moscow's television center, Moscow Radio reports. It will be assembled from 200 hollow prefabricated sections 13 feet long and 6 feet in diameter. Two elevators will carry 100 people each to a sightseeing platform on top. **END**

Calendar of Events

High-Fidelity Show, Sept. 30-Oct. 4, Trade Show Bldg., New York, N. Y. (RADIO-ELECTRONICS and the Gernsback Library will exhibit in Room 525.)

Symposium on Engineering Writing and Speech, Oct. 1-2, Biltmore Hotel, New York.

Conference on Radio Interference Reduction, Oct. 1-2, Armour Research Institute, Chicago, Ill.

Upper Midwest Electronic Trade Exposition, Oct. 2-4, Minneapolis Auditorium, Minneapolis, Minn.

Hi-Fi Music Show, Oct. 3-5, Multnomah Hotel, Portland, Ore.

American Industrial Electronics Exposition, Oct. 3-12, Planten un Blomen Exposition Park, Hamburg, Germany.

IRE Canadian Convention, Oct. 8-10, Exhibition Park, Toronto, Canada.

Hi-Fi Music Show, Oct. 10-12, Benjamin Franklin Hotel, Philadelphia, Pa.

Hi-Fi Music Show, Oct. 10-12, Sheraton-Gibson Hotel, Cincinnati, Ohio.

National Electronics Conference, Oct. 13-15, Hotel Sherman, Chicago, Ill.

Hi-Fi Music Show, Oct. 17-19, Hotel Statler, Detroit, Mich.

New England Hi-Fi Show, Oct. 17-19, Hotel Touraine, Boston, Mass.

SMPTE Convention, Oct. 19-24, Sheraton Cadillac Hotel, Detroit, Mich.

Symposium of Aeronautical Communications, Oct. 20-22, Hotel Utica, N. Y.

URSI Fall Meeting, Oct. 21-22, Penn State, Univ., University Park, Penna.

Hi-Fi Show, Oct. 23-26, Wisconsin Hotel, Milwaukee, Wis.

High Fidelity Show, Oct. 24-26, Bellevue Hotel, Kansas City, Mo.

Radio-Fall Meeting, Oct. 27-28, Sheraton Hotel, Rochester, N. Y.

East Coast Aeronautical and Navigational Electronics Conf., Oct. 27-29, Lord Baltimore Hotel, Baltimore, Md.

Hi-Fi Show, Oct. 29-Nov. 1, Windsor Hotel, Montreal, Canada.

Electron Devices Meeting, Oct. 30-Nov. 1, Shoreham Hotel, Washington, D. C.

International Hi-Fi Show, Nov. 7-9, Detroit Leland Hotel, Detroit, Mich.

Hi-Fi Musical Show, Nov. 7-9, Hotel Paxton, Omaha, Neb.

Conference on Electrical Techniques in Medicine and Biology, Nov. 12-14, Nicolle Hotel, Minneapolis, Minn.

Northeast Electronics Research and Engineering Meetings, Nov. 19-20, Mechanics Hall, Boston, Mass.

Hi-Fi Show, Nov. 21-23, New Washington Hotel, Seattle, Wash.

Electronic Computer Exhibition, Nov. 28-Dec. 4, Olympia, London, England.

Do you WISH you were EMPLOYED in ELECTRONICS?

F.C.C. License — the Key to Better Jobs

An FCC *commercial* (not amateur) license is your ticket to higher pay and more interesting employment. This license is Federal Government evidence of your qualifications in electronics. Employers are eager to hire *licensed* technicians.

Which License for Which Jobs

The **THIRD CLASS** radiotelephone license is of value primarily in that it qualifies you to take the second class examination. The scope of authority covered by a third class license is extremely limited.

The **SECOND CLASS** radiotelephone license qualifies you to install, maintain, and operate most all radiotelephone equipment except commercial broadcast station equipment.

The **FIRST CLASS** radiotelephone license qualifies you to install, maintain, and operate every type of radiotelephone equipment (except amateur, of course) including all radio and television stations in the United States, its Territories and Possessions. This is the highest class of radiotelephone license available.

The Grantham Communications Electronics Course

prepares you for a **FIRST CLASS** FCC license, and it does this by **TEACHING** you electronics. Each point is covered simply and in detail, with emphasis on making the subject easy to understand.

OUR GUARANTEE

If you should fail the FCC exam after finishing our course, we guarantee to give you additional training at **NO ADDITIONAL COST**. Read details in our free booklet.

FCC-TYPE EXAMS

FCC-type tests are used throughout the Grantham course. Constant practice with these FCC-type tests helps you prepare for the actual FCC examination.

THREE COMPLETE SCHOOLS: To better serve our many students throughout the entire country, Grantham School of Electronics maintains three complete schools—one in Washington, D. C., one in Hollywood, Calif., and one in Seattle, Wash. All schools offer the same rapid courses in FCC license preparation, either home study or resident classes.

Get Your First Class Commercial F.C.C. LICENSE in 12 Weeks!

Learn by Correspondence or in Resident Classes

Grantham School of Electronics *specializes* in F.C.C. license preparation. Correspondence training is conducted from Washington, Hollywood, and Seattle; also, resident **DAY** and **EVENING** classes are held in all three cities. Either way, by correspondence or in resident classes, we train you quickly and well. A beginner may qualify for his first class F.C.C. license in as little as 12 weeks!

This booklet **FREE!**

This free booklet gives details of our training and explains what an F.C.C. license can do for your future. Send for your copy today.

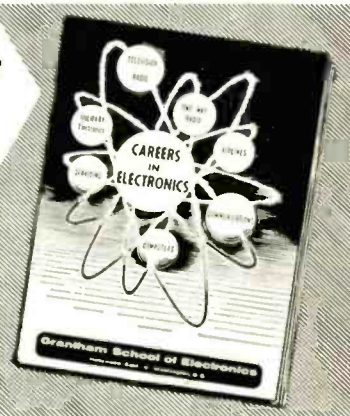

Here's Proof...

that Grantham Students prepare for FCC examinations in a minimum of time. Here is a list of a few of our recent graduates, the class of license they got, and how long it took them:

	License	Weeks
Henry M. Best, 1003 Vermont St., Fremont, N.C.	1st	11
Harold V. Jones, P.O. Box 705, Alamogordo, N. Mex.	1st	13
Michael F. Aperio, 916 Townsend St., Chester, Pa.	1st	12
Norman R. Cook, 130 Olive St., Neodeska, Kan.	1st	12
Antone Mello, 68 Union Street, Nantucket, Mass.	1st	10
John Ward, 407 E. Cowden Ave., Midland, Texas	1st	10
F. T. Verga, 538 - 7th Street, Buffalo, N. Y.	1st	12
Philip J. Hooks, 4825 N. Capitol, N.W., Washington, D. C.	1st	12
Anthony Giacinta, 404 Dale Dr., Silver Springs, Md.	1st	12
J. Milton Condit, 1312 N. 78th Street, Seattle, Wash.	1st	8
James W. Reichard, 707 Arlington Street, Tamaqua, Pa.	1st	8
G. Carl Patschke, 3220 Conn. Ave., NW, Washington, D.C.	1st	12

Grantham School of Electronics

Hollywood Division

1505 N. Western Ave.
Hollywood 27, Calif.
(Phone: HO 7-7727)

Washington Division

821-19th Street, N.W.
Washington 6, D. C.
(Phone: ST 3-3614)

Seattle Division

408 Marion Street
Seattle 4, Wash.
(Phone: MA 2-7227)

MAIL COUPON TO SCHOOL NEAREST YOU

(Mail in envelope or paste on postal card)



To: **GRANTHAM SCHOOL OF ELECTRONICS**
Desk 84-R • Washington • Hollywood • Seattle

Gentlemen:

Please send me your free booklet telling how I can get my commercial F.C.C. license quickly. I understand there is no obligation and no salesman will call.

Name _____ Age _____

Address _____

City _____ State _____

I am interested in: Home Study, Resident Classes

An important announcement for everyone considering a small-space wide-range speaker system . . . monaural or stereo

ACTUAL TESTS PROVE University RRL* SUPERIOR

ULTRA LINEAR RESPONSE SYSTEMS

Compared with competitive widely publicized high compliance small-space systems

AT \$40 to \$85 SAVING



RRL systems use a specially designed acoustic coupler to load the new University high compliance woofer, enabling it to radiate tremendous bass energy with only small cone excursions. This achieves greater linearity and virtually eliminates distortion. Tweeter response, carefully matched to the woofer's acoustic output, is smooth and flat to beyond 20,000 cps. Result: better bass, cleaner treble, smoother response than any competitive small-space, high compliance units based on totally sealed enclosures using "air spring" capacitance loading.

*RRL — Radiation Resistance Loading

PROOF OF SUPERIORITY

. . . as demonstrated by actual comparative measurements* of University Model S-10 RRL ultra linear response system . . . and widely publicized competitive brands X and Y, under identical conditions.

75% LESS BASS DISTORTION

Distortion measured at 30 cycles with equal sound output for all systems.

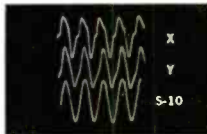

Brand X	15%
Brand Y	10%
RRL S-10	3 1/2%

The highly efficient S-10 requires only 1/4 of the cone excursion of Brands X and Y to produce the same sound output. Result: greater inherent linearity and 75% less distortion.

Brands X and Y reach overload conditions 4 times sooner (6 db) than the S-10. Bass distortion at higher sound levels is therefore considerably greater with X and Y than with the S-10.

LOWER POWER REQUIREMENTS

Measured average of acoustic energy in 30-100 cps range, demonstrated that Model S-10 performed . . .

4 db better than Brand X
2 db better than Brand Y

This test shows that the S-10 is, in effect, 100% more sensitive. (The ultra linear response systems will fill any average room with sound above normal listening level, using any high quality low power high fidelity amplifier.)

* HOW TESTS WERE CONDUCTED

Frequency response was obtained in an anechoic chamber, using a calibrated Western Electric 640AA Microphone and RA-1095 Amplifier, a General Radio Model 1304B Beat Frequency Oscillator and a Sound Apparatus Model FRA Graphic Recorder.

Distortion was measured with a Hewlett-Packard Model 330B Distortion Analyzer. The speakers were driven from a Hewlett-Packard Model 200AB Audio Oscillator, feeding a McIntosh 50-watt Power Amplifier.

GREATER SAVINGS WITH STEREO!

These RRL systems incorporate an exclusive University woofer feature . . . a *dual voice coil* . . . that receives the fully separated bass energy from both stereo channels and provides authentic full bass response without need for expensive or complicated networks, or an additional woofer and woofer enclosure. Thus you can have a complete stereo speaker system consisting of one RRL S-10 and a matching stereo adapter (speaker system with bass response attenuated below the 150 to 200 cycle range) for approximately the same cost as a single monaural Brand X and less than a single monaural Brand Y.

WIDER FREQUENCY RESPONSE

Brand X	7 db down at 15,000 cps
Brand Y	2 db down at 15,000 cps
RRL S-10	flat to beyond 20,000 cps

Measured average acoustic energy, 7000-20,000 cps, for equal power inputs, demonstrates that Model S-10 performs . . .

5 db better than Brand X
2 db better than Brand Y

Ultra linear response systems are not handicapped by the treble deficiencies common to competitive systems. With clean program material, the remarkably flat response and exceptionally true reproduction of upper harmonics by the S-10 result in amazingly realistic reproduction without "harshness." A Program Distortion Filter is provided which can be switched into the circuit to correct for inferior radio programs, worn records, tapes, etc.

NO "DAMPING FACTOR" PROBLEMS

Model S-10 RRL will work at maximum effectiveness with any modern (low internal impedance) high fidelity amplifier. No damping factor adjustment at all is needed, whereas both Brands X and Y require optimum settings. If an amplifier does not have this control the performances of Brands X and Y may be adversely affected.

ALL THIS... AND MAJOR COST SAVINGS TOO!

You don't pay a premium for RRL's improved quality and performance. University's superior design and manufacturing know-how has resulted in substantial cost savings to the consumer. Compare for yourself!

Brand X	over \$180
Brand Y	over \$220
RRL Model S-10	\$139

ALREADY THE ACCEPTED LEADER

At WFUV-FM, pioneering stereo in New York City via FM-Multiplex, RRL systems have been selected for studio monitoring and public demonstrations. Fred Waring chose RRL systems for his latest nationwide high fidelity concert tour. "Research House, 1958" of Beverly Hills, California, awarded its Seal of Research Approval to the RRL systems for their beautiful design as well as quality performance. The undeniable superiority of the RRL ultra linear response speaker systems has been recognized by all authorities who *know* music and whose work *demand*s the finest in speaker systems.

Hear these magnificent speaker systems at your dealer . . . soon!



UNIVERSITY LOUDSPEAKERS, INC., 80 SO. KENSICO AVE., WHITE PLAINS, N. Y.

RADIO-ELECTRONICS

**ONLY FROM UNIVERSITY... A
FULL LINE OF RRL ULTRA LINEAR
RESPONSE SYSTEMS AND KITS**

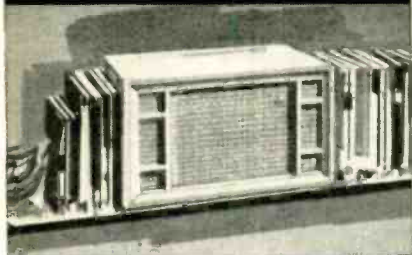

**Outstanding for monaural—ideal as a stereo pair
Model S-10 2-WAY SYSTEMS**

Components of the S-10 comprise the new 12" C-12HC high compliance, dual voice coil woofer, employed with the UL/HC 2500 cps tweeter and the special matched-level HC-2 crossover network. Also includes the Program Distortion Filter to correct for stridency of inferior radio programs, worn records, tapes, etc. The enclosure is constructed of extra heavy 3/4" furniture hardwoods. Gracefully styled to harmonize with any decor. Model S-10H is for upright use; S-10L, lowboy. Legs on base are removable for shelf, bookcase, or built-in applications. 24" x 14" x 14 1/2" deep. Shpg. wt., 51 lbs. User net: Mahogany—\$139.00, Blond or Walnut—\$143.00.

**...And greater efficiency, greater RRL advantages
Model S-11 3-WAY SYSTEMS**

The S-11 truly stands *alone* in its field! It cannot be compared with any other existing high compliance system... but only with the most elaborate speaker systems, such as University's famed "Classic." Its handsome compact RRL enclosure houses the new heavy duty high compliance 15" C-15HC dual voice coil woofer. The new HC-3 network provides 500 cps crossover to the 2-way Diffusione-8 Diffaxial for mid-range and 2500 cps crossover to the special UL/HC Hypersonic Tweeter for response to beyond audibility. The unique Program Distortion Filter and "balance" control complete this magnificent system. Model S-11H is for use as upright; Model S-11L, as lowboy. 26 3/8" x 19 1/2" x 17 1/2" deep. Shpg. wt., 80 lbs. User net: Mahogany—\$245.00, Blond or Walnut—\$249.00.

FOR EVEN GREATER SAVINGS...

Ultra Linear component kits **CUL-10, CUL-11** Enjoy the satisfaction of assembling your own superb Ultra Linear Response system along with the added savings thus made possible. Speaker Kit CUL-10 comprises the identical components of Model S-10; speaker kit CUL-11, the components of Model S-11. Both kits are furnished with all wiring cables and complete easy-to-follow instructions for building and installing your own RRL enclosure. User net: CUL-10 — \$88.50, Shpg. wt., 15 lbs. CUL-11 — \$164.50. Shpg. wt., 37 lbs.

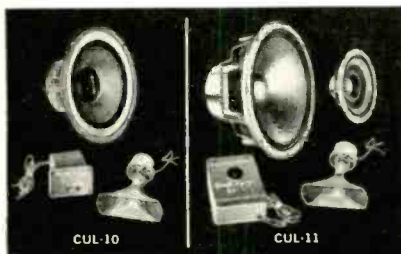

UNIVERSITY LOUDSPEAKERS, INC., WHITE PLAINS, N.Y.

Correspondence



HANDS OFF FM BAND!

Dear Editor:

I was pleased to note that you are proposing to run a column in your magazine devoted to FM (RADIO-ELECTRONICS, July, 1958, page 46). There apparently is an unusual ignorance of this wonderful medium; it deserves better treatment in the current literature.

There is, even, a proposal before the FCC to interfere with or attenuate the already small FM band (88-108 mc) in the interest of some commercial outfits.

FM is performing a magnificent job in the hi-fi music and educational areas, and is improving every month. With the development of multiplexing systems, it will be a natural for stereo broadcasting. The FM band must be kept intact.

I believe we should all be on the alert and do all we can, not only to protect this almost ideal system, but to promote it and help it along.

JAMES A. CASEY

Springfield, Mass.

STEREO TEST DISTORTION

Dear Editor:

I feel I must bring to your attention a possible misconception which may arise in the minds of many of the readers of Mr. Crowhurst's article, "How the Stereo Disc Works" (RADIO-ELECTRONICS, July, 1958, page 26).

In the first column on page 29, Mr. Crowhurst uses a Fairchild stereo cartridge to illustrate a problem inherent in the reproduction of stereo information from phonograph discs. Mr. Crowhurst refers to this as a "Doppler effect," and the implication would seem to be that it is something peculiar to the Fairchild pickup, which of course it is not. Whether we call it a "Doppler effect" or distortion, it is inherent in any playback system which has freedom to move both laterally and vertically, and is therefore common to *all* stereo pickups.

Unfortunately, Mr. Crowhurst neglected to mention that, because this condition does exist, stereo cutters are made with a compensating angle so that "vertical information" is not referred to a true vertical direction, but to an angle selected for best performance with available stereo pickups of all types.

Thus, for example, the Westrex cutter with which most stereo disks are produced in this country at the present time uses an angle of 24°.

NOW MAGNETIC TAPE RECORDING HEADS

- FOR DIRECT REPLACEMENT
- FOR UP-GRADING EQUIPMENT
- FOR STEREO CONVERSION



M

M

LEADING SUPPLIER TO THE TAPE RECORDER INDUSTRY

Now replacement heads are available from the biggest supplier to tape recorder manufacturers... heads for most makes and models... the finest components for every replacement or conversion job. Erase, record and 4-track stereo... complete specifications to help you cash in on the demand for tape recorder service.

**FREE...BOOKLET
ON 4-TRACK STEREO
USE COUPON**

MICHIGAN MAGNETICS, INC.
DISTRIBUTOR DIVISION
203 N. Wabash Avenue
Chicago 1, Ill.

Please rush me information on 4-track stereo... also details on heads for direct replacement and up-grading.

- I am a Service Dealer I am a Hi Fi Dealer
 I own a Recorder I am a Parts Jabber

NAME _____

ADDRESS _____

CITY _____ STATE _____

This Man is Using an Electronic Crystal Ball

The H. H. Scott advance development team must foresee the future. They must design new products so that they stay current for many years. Hermon Hosmer Scott insists on this as a protection to your investment.

The new 130 Stereo preamp is an example of the way Scott engineers work ahead. Engineering of this brand new product was started when stereo was nothing more than a hobbyist's delight. This allowed time for thorough testing of its many advanced features.

Every H. H. Scott component is designed to defy obsolescence. Careful planning, fine engineering, exceptional quality mean your investment in the new H. H. Scott stereo-preamp . . . or any H. H. Scott product . . . is an investment in a component that will still be up-to-date many years from now.

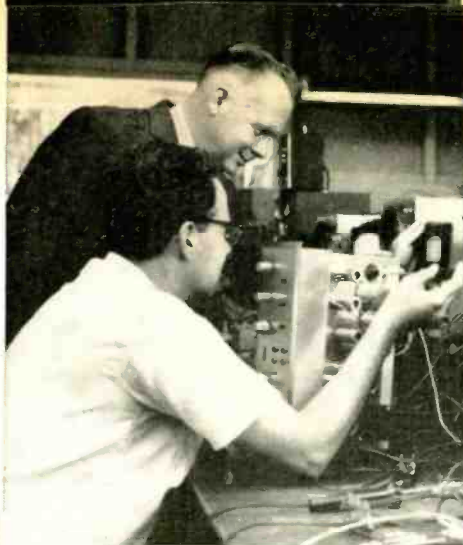

17 reasons why you should buy the New H. H. Scott Stereo-Preamp

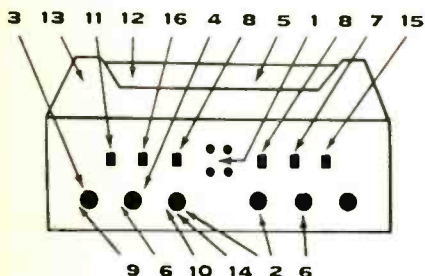

1 Visual signal light display panel shows mode of operation at a glance. 2 Completely separate bass and treble controls on each channel so that different speakers may be matched. 3 Play stereo from any source — Records, FM-AM Tuner, Tape. 4 Reverse channels instantly, or play monaural from any source through both channels doubling your power. 5 Play Trereo — a center channel output lets you use your present speaker as a middle channel. 6 Special circuitry lets you balance channels quickly and accurately. 7 Reverse the phase of one of your channels 180 degrees instantly. Lets you correct for improperly recorded tapes. 8 Separate 12 db/octave rumble and scratch filters. 9 Complete record equalizer facilities.

10 Use as an electronic crossover at any time. 11 Two stereo low-level inputs. You can connect both a stereo phono pickup and stereo tape head. 12 Stereo tape recorder inputs and outputs. 13 Provision for operating stereo tape heads without external preamps. 14 Quick-set dot controls allow any member of your family to use equipment. 15 Loudness-volume switch. 16 Stereo tape monitor switch. 17 The exceptional quality of all H. H. Scott components . . . PLUS all the features and specifications long associated with H. H. Scott monaural preamplifiers.

Sensitivity $1\frac{1}{2}$ millivolts on tape head input, 3 millivolts on phono for full output. Hum level 80 db below full



output on high level outputs. Size in accessory case 15 $\frac{1}{2}$ "w x 5h x 12 $\frac{1}{2}$ "d. Model 130. Price \$169.95 (\$172.95, West of Rockies).

Write for complete technical specifications and new catalog RE-10.



H. H. SCOTT, INC., 111 POWDERMILL RD., MAYNARD, MASS.
EXPORT: TELESKO INTERNATIONAL CORP., 36 W. 40TH ST., N. Y. C.

CORRESPONDENCE (Continued)

The Fairchild stereo cutter uses an angle of 30°, based on a survey of present designs of stereo pickups and of those likely to be produced in the future. So far as we have been able to determine, the distortion introduced by slight variations in pickups from this cutter angle is entirely negligible.

To put it another way (referring to Fig. 7 on page 29), Mr. Crowhurst has incorrectly indicated "vertical modulation," which is actually inclined counterclockwise by some 24°–30°, because of the cutter itself. Hence, the "error," or "Doppler effect" as Mr. Crowhurst calls it, is the result of the component of a component. Or again, if a pickup could be made with a truly horizontal stylus arm, it would play back "vertical" signal with a 24°–30° error, because of the way the record was cut.

There are enough new problems to solve and difficulties with any new process to confuse the user, and I feel we should not confuse the public unnecessarily by introducing additional difficulties for his consideration which do not actually exist.

RUBEN E. CARLSON
Vice president, Fairchild Recording
Equipment Co.,
Long Island City, N. Y.

MR. CROWHURST'S REPLY

(Mr. Carlson's letter was referred to Mr. Crowhurst for comment.—Editor)

Dear Editor:

While I agree with Mr. Carlson in the general tenor of his letter, I cannot agree that the difficulty to which I drew attention does not exist or that it is of no consequence. With the same objective as Mr. Carlson expresses, I plead guilty to the neglect he mentions of not stating that the cutter uses a stylus beam angle.

But Mr. Carlson's implication seems to be that any angle is all right, so long as the difference between cutter and pickup angle is small. This I cannot concede. If you extend the angle upward to 90°, the fallacy becomes obvious, because then lateral and "vertical" components of modulation coincide. It is evident that "vertical" motion should be as little as possible out of perpendicular.

In the IRE paper presented this spring by M. S. Corrington and T. Murakami, "Tracing Distortion in Stereophonic Recording," consideration was given to the simplest orders of distortion with idealized lateral and vertical motions. Longitudinal (or "Doppler") deviation from vertical, due to the styli beams being at an angle to horizontal, will produce second-order distortions (third harmonic and similar byproducts of intermodulation and cross-modulation), which can be minimized by keeping the angle *small* (so far assuming cutter and pickup angle to be the same).

It would seem to me that use of an angle smaller than 15° would be striving for an order of perfection that

(Continued on page 28)

Learn TELEVISION-RADIO

Servicing or Communications

by Practicing at Home in Spare Time

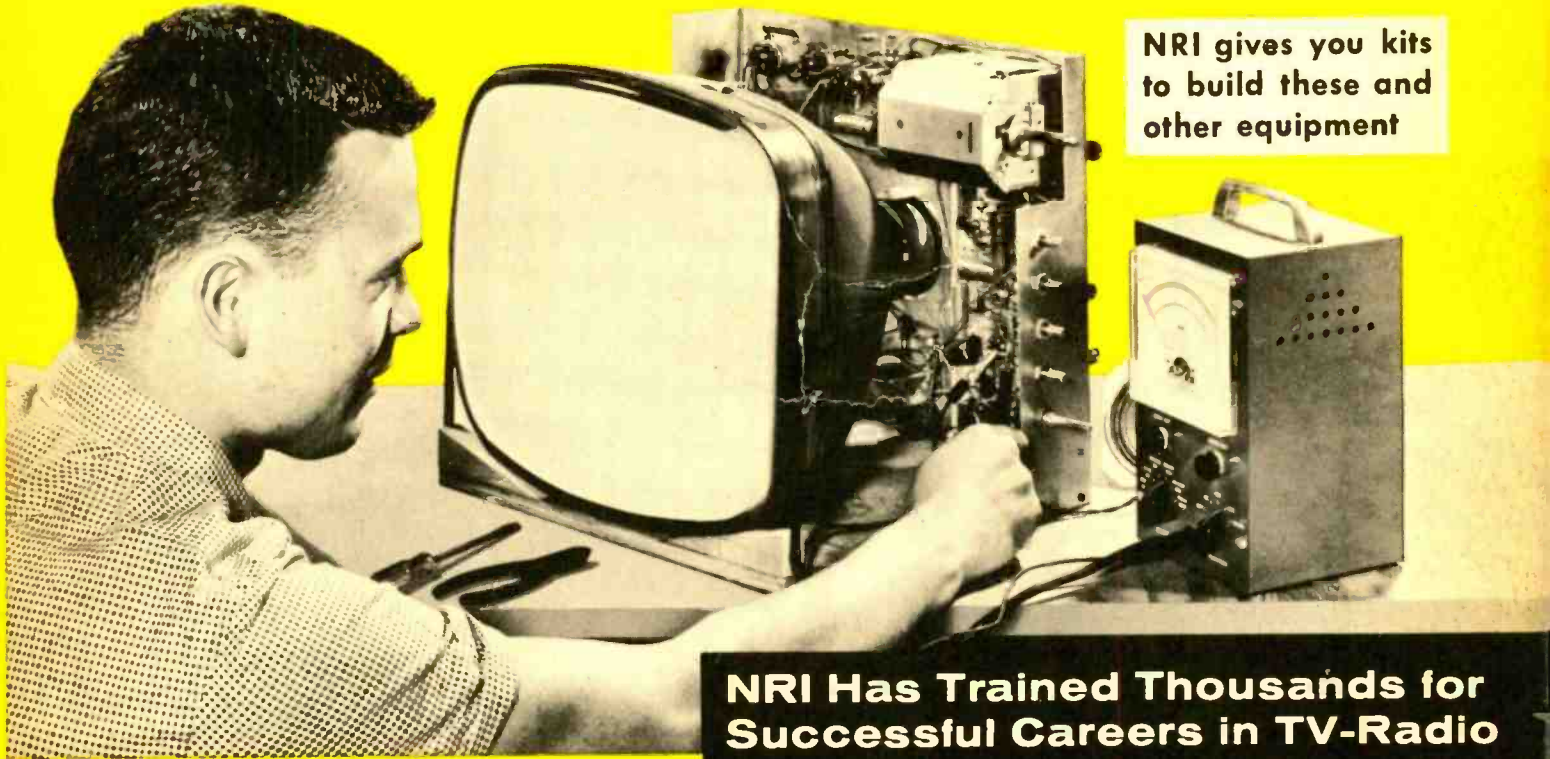

NRI gives you kits to build these and other equipment

NRI Has Trained Thousands for Successful Careers in TV-Radio

Electronic Technicians Have High Pay, Prestige Jobs

People look up to and depend on the Technician, more than ever before. His opportunities are great, and are increasing. Become a Radio-Television-Electronic Technician. At home, and in your spare time, you can learn to do this interesting, satisfying work—qualify for important pay. A stream of new Electronics products is increasing the job and promotion opportunities for Television-Radio-Electronic Technicians. Right now, a solid, proven field of opportunity for good pay is servicing the millions of Television and Radio sets now in use. The hundreds of Television and Radio stations on the air offer interesting jobs for Operators and Technicians. The military services reward qualified Technicians with higher rank and pay. Police, Aviation, Mobile Two-Way Radio are expanding. To ambitious men everywhere: here is rich promise of fascinating jobs, satisfaction and prestige, increasing personal prosperity.

Make Extra Money Soon, \$10 to \$15 a Week in Your Spare Time

NRI students find it practical and profitable to start fixing sets for friends and neighbors a few months after enrolling. Picking up \$10, \$15 and more a week gives substantial extra spending money. Use the Tester built with parts NRI furnishes, to locate and correct Radio-TV receiver troubles. Many who start in spare time, soon build full time Television-Radio sales and service businesses; others enjoy profitable spare time businesses and the security of a source of income to fall back on in case of layoffs, hard times or other changes in regular job. Postage free card will bring you complete facts about the NRI tested way to better pay.



Studio Engr., Station KATV
"I am now Studio Engineer at Television Station KATV. Before enrolling for the NRI Course, I was held back by limitation of a sixth grade education." **BILLY SANCHEZ**, Pine Bluff, Ark.



Has All the Work He Can Do
"Since finishing NRI Course I have repaired more than 2,000 TV and Radio sets a year. NRI training certainly proved to be a good foundation." **H. R. GORDON**, Milledgeville, Ga.



Has Good Part Time Business
"Quite early in my training I started servicing sets. Now have completely equipped shop. My NRI training is the backbone of my progress." **E. A. BREDA**, Tacoma, Wash.

Cut Out and Mail Postage-Free Card NOW

Sample Lesson and Catalog Both FREE

SEE OTHER SIDE

OLDEST & LARGEST HOME STUDY RADIO-TV SCHOOL

National Radio Institute

Dept. C, Washington 16, D.C.

Please send me sample lesson of your Radio-Television Training and Catalog FREE. (No salesman will call.)

Name..... Age.....

Address.....

City..... Zone..... State.....

ACCREDITED MEMBER NATIONAL HOME STUDY COUNCIL



ACT NOW FIND OUT WHAT NRI OFFERS YOU

NRI SUPPLIES LEARN-BY-DOING KITS WITHOUT EXTRA CHARGE
Technical Know-How Pays Off in Interesting, Important Work



YOU BUILD AC-DC Superhet Receiver

NRI Servicing Course includes all needed parts. By introducing defects you get actual servicing experience practicing with this modern receiver. Learn-by-doing.



YOU BUILD This 17 Inch Television Receiver

As part of your NRI course you can get all components, tubes, including 17" picture tube, to build this latest style Television receiver; get actual practice on TV circuits.

YOU BUILD Broadcasting Transmitter

As part of NRI Communications Course you build this low power Transmitter, learn commercial broadcasting operators' methods, procedures. Train for your FCC Commercial Operator's License.

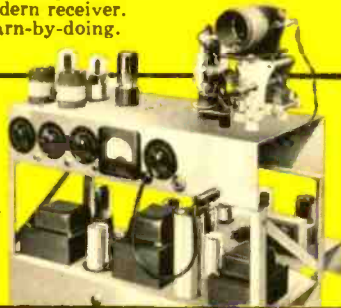

YOU BUILD Vacuum Tube Voltmeter

Use it to earn extra cash fixing neighbors' sets; bring to life theory you learn from NRI's easy-to-understand texts.



For Higher Pay, Better Jobs Be a TV-Radio-Electronic Technician



Broadcasting Offers Satisfying Careers

4000 TV and Radio stations offer interesting positions. Govt. Radio, Aviation, Police, Two-Way Communications are growing fields. Trained Radio-TV Operators have a bright future.

Servicing Needs More Trained Men

Portable TV, Hi-Fi, Transistor Radios, Color TV are making new demands for trained Technicians. Good opportunities for spare time earnings or a business of your own.



J. E. Smith, Founder

Train at Home the NRI Way Famous for Over 40 Years

NRI is America's oldest and largest home study Television-Radio school. The more than 40 years' experience training men for success, the outstanding record and reputation of this school—benefits you in many ways. NRI methods are tested, proven. Successful graduates are everywhere, from coast to coast, in small towns and big cities. You train in your own home, keep your present job while learning. Many successful NRI men did not finish high school. Let us send you an actual lesson, judge for yourself how easy it is to learn.

No Experience Necessary—NRI Sends Many Kits for Practical Experience

You don't have to know anything about electricity or Radio to understand and succeed with NRI Course. Clearly written, well-illustrated NRI lessons teach TV-Radio-Electronic principles. You get NRI kits for actual experience. All equipment is yours to keep. You learn-by-doing. Mailing the postage-free card may be one of the most important acts of your life. Do it now. Reasonable tuition. Low monthly payments available. Address: NATIONAL RADIO INSTITUTE, Washington 16, D. C.

NRI Graduates Do Important Work



Now Quality Control Chief
 "Had no other training in Radio before enrolling, obtained job working on TV amplifiers before finishing course. Now Quality Control Chief." T. R. FAVAROLO, Norwich, N. Y.

NRI Course Easy to Understand
 "I opened my own shop before receiving my diploma. I have had to hire extra help. I am independent in my own business." D. P. CRESSEY, Stockton, Cal.

Works on Color-TV
 "NRI changed my whole life. If I had not taken the course, probably would still be a fireman, struggling along. Now Control Supervisor at WRCA-TV." J. F. MELINE, New York, N. Y.

FIRST CLASS
 Permit No. 20-R
 (Sec. 34.9, P. L. & R.)
 Washington, D.C.

BUSINESS REPLY CARD

No Postage Stamp Necessary if Mailed in the United States

POSTAGE WILL BE PAID BY

NATIONAL RADIO INSTITUTE
 3939 Wisconsin Avenue
 Washington 16, D.C.

SAMPLE LESSON
64-page CATALOG
both FREE

SEE OTHER SIDE

NEW REALISTIC 15-WATT AMPLIFIER AND 30-WATT STEREO SYSTEM HI-FI



**COMPLETE 30-WATT STEREO
SYSTEM WORTH \$280.00**

\$179⁹⁵ \$18
Down!
\$13 Monthly

TWO (2) Realistic 15-Watt Amplifiers	\$133.90
ONE Realistic Stereo Master Control	19.50
ONE Garrard 121 Record Changer with G-E Stereo Diamond Cartridge	65.12
TWO (2) University UXC-122 Speakers	64.68
TOTAL SEPARATE PARTS VALUE	\$283.28

Order No. RX-SS15Y10E, 58 lbs., Express Only

NOTE: The Realistic Stereo Master included in the system above features full stereo/reverse/monaural/gain control, plus a switch that puts both channels of a stereo cartridge in parallel for the ultimate in reproduction of monaural records. Exclusive at Radio Shack, designed by Radio Shack, patented by Radio Shack!

**COMPLETE 15-WATT WIRED
AMPLIFIER AT A KIT PRICE**

NEW FOR '59, the Realistic AF-15 amplifier is clearly the "best buy" in the 15 watt field by far. And here's why: **OUTPUT** 15 watts (30 peak) under 1% distortion; **RESPONSE** 18-30,000 cps \pm 1 db; **PREAMP** features RIAA phono and Ampex (NARTB) tape head equalization, separate loudness and level, separate full \pm tone controls; **CIRCUIT** features 6-tube AC circuit with push-pull EL-84s; **SPEAKER FACILITIES** include a unique 7-way selector for handling up to 7 units or systems 4/8/16 ohms; **STEREO FEATURE** — the AF15 is pre-wired for stereo with a built-in terminal strip for the new Realistic Stereo Master Control unit which couples two AF15s (story at left) for superbly flexible stereo — now, or later! **AND WE INCLUDE FREE** the complete cage for the AF15, so there's nothing else to buy. Very compact 9 $\frac{1}{2}$ " x 4 $\frac{1}{2}$ " x 6 $\frac{1}{8}$ ", gold, maroon and white.

Reg. ~~\$66.95~~
\$39⁹⁵

Only \$5 Down, \$5 Monthly
Order No. 33CX005Y10E, 15 Lbs.

TRANSISTOR PORTABLE PRICE BREAK-THROUGH!



\$19⁹⁵
Order No.
R-7231-10E
3 lbs.

It's New! REALISTIC "Hi-Fiver" Radio!

COMPLETE WITH BATTERY, the new Realistic "Hi-Fiver" all transistor pocket portable measures a mere 5 $\frac{1}{4}$ " x 3" x 1 $\frac{1}{2}$ " but it out-plays and out-pulls many a set in the \$40-\$60 price range. Built-in PM speaker plus earphone jack (earphone \$1 extra, R-7231A), full-size tuning condenser, hi-impact molded case with golden metal grille. Radio Shack has over 25,000 transistor-radio customers, so you know we've got something special. Great for office, den, car, study, and a treasured gift.

RADIO SHACK CORP.
Stores: 730 COMMONWEALTH AVENUE • BOSTON 17, MASS
167 WASHINGTON STREET • BOSTON 8, MASSACHUSETTS
230-240 CROWN STREET • NEW HAVEN 10, CONNECTICUT

New! FREE! 232-Page 1959 Mail-Order Catalog

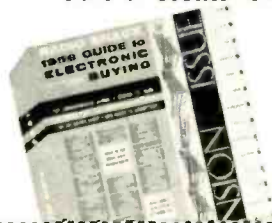

- ★ Stereo Hi-Fi
- ★ Parts, Kits
- ★ Ham Gear
- ★ Electronics
- ★ Lower Prices

MAIL ORDERS TO: } **RADIO SHACK** Dept. 10E
730 COMMONWEALTH AVENUE, BOSTON 17

- Please send FREE 232-page 1959 catalog
- One AF-15 amplifier, 33CX005Y10E
- One Stereo System, RX-3315Y10E

Name

Address

City Zone State

see what's new in electronic kits...

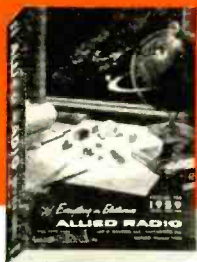

SEE THEM IN ALLIED'S 1959 CATALOG... THE WORLD'S

FREE send for it!

typical **knight-kit** values... see these and dozens of



knight-kit Stereo Adapter Control Kit..... Model Y-778 \$9⁹⁵

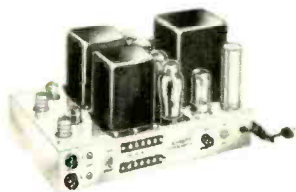

knight-kit 60-Watt Stereo Hi-Fi Amplifier Kit.... Model Y-777 \$84⁵⁰



knight-kit "Space Spanner" 2-Band Receiver Kit..... Model Y-259 \$18⁹⁵

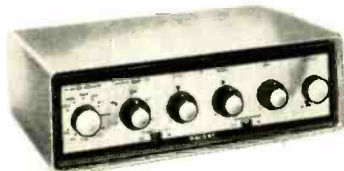

knight-kit Stereo Deluxe Preamp Kit..... Model Y-776 \$62⁵⁰

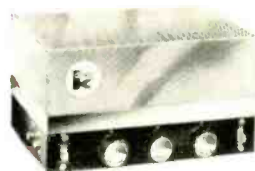

knight-kit 12-Watt Hi-Fi Amplifier Kit..... Model Y-784 \$19⁹⁵

(less case)



knight-kit "Ranger III" AC-DC Radio Kit..... Model Y-736 \$16⁹⁵

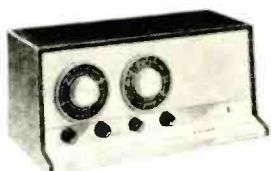

knight-kit "Span-Master" 4-Band Receiver Kit..... Model Y-258 \$24⁹⁵



knight-kit "Ranger" Clock-Radio Kit..... Model Y-737 \$24⁹⁵



knight-kit "Ranger" Radio-Intercom Kit..... Model Y-739 \$27⁵⁰

EASY TERMS AVAILABLE ON knight-kit ORDERS AS LOW AS \$20



there's a money-saving **knight-kit**

SEE PAGE AFTER PAGE OF FASCINATING KITS, INCLUDING:

HI-FI KITS

- 18-Watt Amplifier
- 30-Watt Amplifier
- FM-AM Tuner
- FM Tuner
- Hi-Fi Preamplifier
- 25-Watt Basic Amplifier
- 2-Way Speaker Systems
- 3-Way Speaker Systems

HOBBY KITS

- Printed Circuit Radio
- "Ocean-Hopper" Radio
- 5-Transistor Portable
- 2-Transistor Pocket Set
- Transistor Lab Kit
- 1-Transistor Radio
- 2-Way Intercom
- Photoelectronic System
- Crystal Receiver
- Wireless Broadcaster
- Electronic Photoflash

INSTRUMENT KITS

- 5" Oscilloscopes
- Vacuum Tube Voltmeter
- Tube Testers
- Volt-Ohm-Milliammeters
- RF Signal Generator
- Signal Tracer
- Audio Generator
- Sweep Generator
- Capacitor Checker
- R/C Tester

ALLIED RADIO

see the outstanding 1959 **knight-kits**

AN ALLIED RADIO PRODUCT

LEADING ELECTRONIC SUPPLY GUIDE



DO-IT-YOURSELF
WITH QUALITY
knight-kits
SAVE UP TO 50%

other EASY-TO-BUILD kits

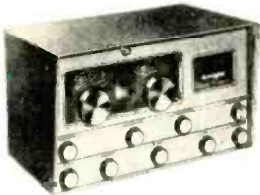

knight-kit Amateur Communications Receiver, Model Y-726 \$104.50

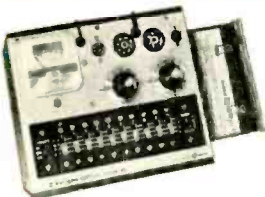

knight-kit "400" Tube Checker Kit, Model Y-707 \$19.95

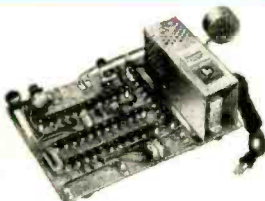

knight-kit 12-in-1 Electronic Lab Kit, Model Y-272 \$14.95



LOWEST IN COST: ALLIED'S giant buying power passes biggest savings on to you—you do the easy assembly yourself and your finished equipment equals the performance, appearance and quality of factory-built units selling for several times the low KNIGHT-KIT price. You save most with KNIGHT-KITS.

EASIEST TO BUILD: KNIGHT-KIT "Step-and-Check" instruction manuals with wall-sized picture diagrams are marvels of clarity—it's like having a good instructor at your side, guiding you every step of the way. You don't have to be an "expert" to enjoy building a KNIGHT-KIT; all parts are clearly marked and identified; wires are pre-cut to size, stripped and colored for easy proper use; printed circuitry and printed-circuit switches eliminate complex wiring. You'll have only the highest praise for KNIGHT-KIT ease of assembly. You'll be proud of your work.

LATEST DESIGN: We design the latest circuitry into our KNIGHT-KITS to achieve top-quality performance. We field-test each kit to assure perfection. We apply quality control standards to every step of our kit manufacturing process. Tried and proved professional design, precise manufacturing skill and premium quality parts help to insure your building success.

THE KITS WITH THE MONEY-BACK GUARANTEE

EASY TERMS ON ORDERS OF \$20 OR MORE

for every need

- Transistor Checker
- Flyback Checker
- R/C Substitution Boxes
- Voltage Calibrator
- Battery Eliminator

AMATEUR KITS

- 50-Watt Transmitter
- Self-Powered VFO
- 100 kc Crystal Calibrator
- RF "Z" Bridge
- Code Practice Oscillator

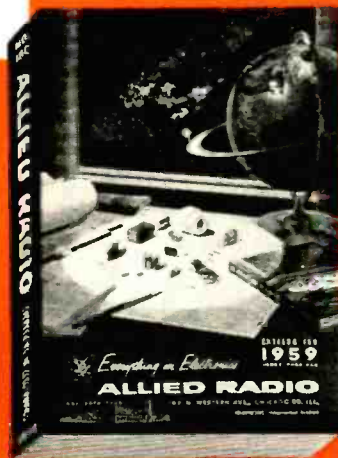

the world's largest
electronic supply house

FREE

send for the 452-page
1959 ALLIED CATALOG

Send for the value-packed 1959 ALLIED Catalog featuring the complete KNIGHT-KIT line. See this leading Buying Guide for everything in Electronics. Write for your FREE copy today.

ALLIED RADIO CORP., Dept. 132-K8
100 N. Western Ave., Chicago 80, Ill.

Send FREE ALLIED 452-Page 1959 Catalog

Name _____

Address _____

City _____ Zone _____ State _____

Our 38th Year



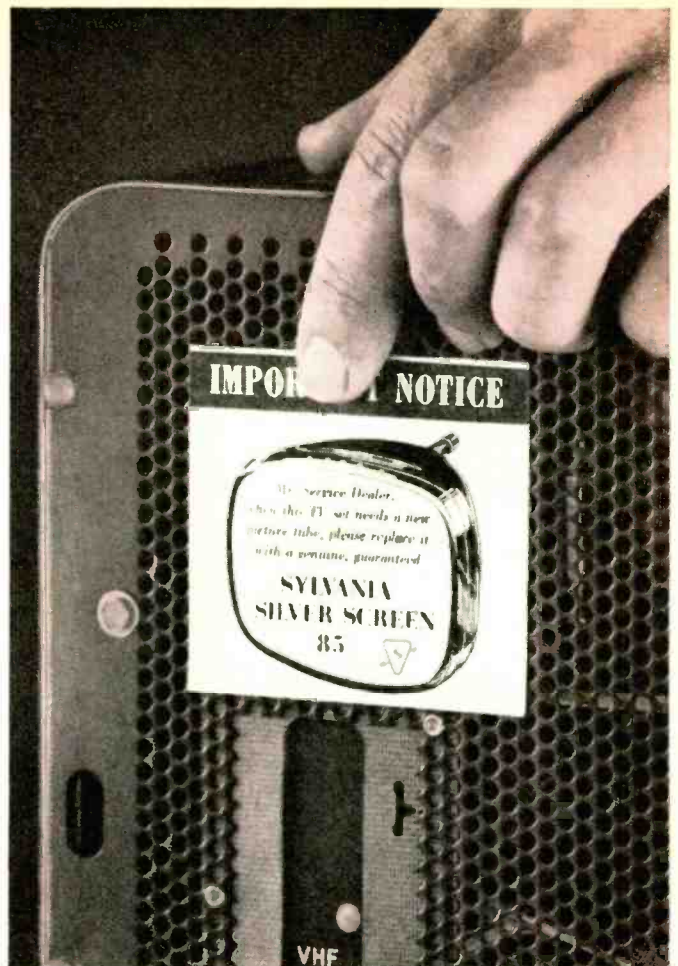
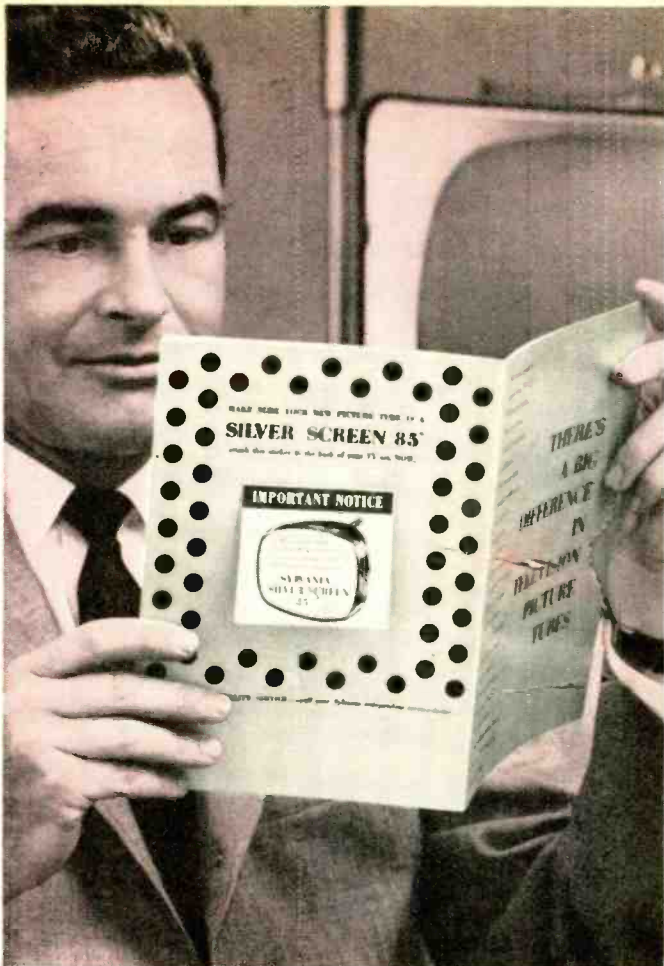

This label is your signal that a value-minded customer has been sold up to Silver Screen 85.

New consumer booklet from Sylvania helps you

SELL UP TO SILVER SCREEN 85

Free booklet tells the story of Silver Screen 85's superior performance—detachable sticker lets the consumer tell you he's *presold* on Silver Screen 85

Leave a copy on every service call or make a complete mailing to your customers and prospects. Either way, Sylvania's new booklet, "There's A Big Difference In Television Picture Tubes," can help you sell up to more profits through more Silver Screen 85 sales.

In layman's language, this booklet details the difference between Silver Screen 85 and cut-rate off-brand tubes. It's chock-full of facts as they were revealed in Sylvania's recent test of a

nationwide sample. What's more, there's a handy sticker on the back of each booklet for the customer to attach to the back of his TV set. This is your signal that he's *presold* up to Silver Screen 85.

Get on the bandwagon. Let Sylvania help you sell up. Give each of your customers and prospects a copy of this new booklet. It's available free, complete with mailing envelope, from your Sylvania Distributor. Or write for a sample copy.



Bill Shipley's your No. 1 Salesman in the industry's biggest consumer advertising campaign.

 **SYLVANIA**

SYLVANIA ELECTRIC PRODUCTS INC.
1740 Broadway, New York 19, N. Y.
In Canada: Sylvania Electric (Canada) Ltd.
University Tower Bldg., Montreal

LIGHTING • TELEVISION • RADIO • ELECTRONICS • PHOTOGRAPHY • ATOMIC ENERGY • CHEMISTRY-METALLURGY

**WE'RE MAKING IT EASIER THAN EVER TO BECOME A WELL PAID
RADIO-TELEVISION SERVICE TECHNICIAN**

**NOW - Just \$6 Starts You Training in
RADIO-TELEVISION**

the SPRAYBERRY "Learn-by-Doing" Way . . .

**25 BIG, COMPLETE KITS
of PARTS & EQUIPMENT**

To help you learn *fast* the practical side of Radio-Television, we send you expertly engineered training kits to test and assemble for interesting, valuable shop-bench practice!

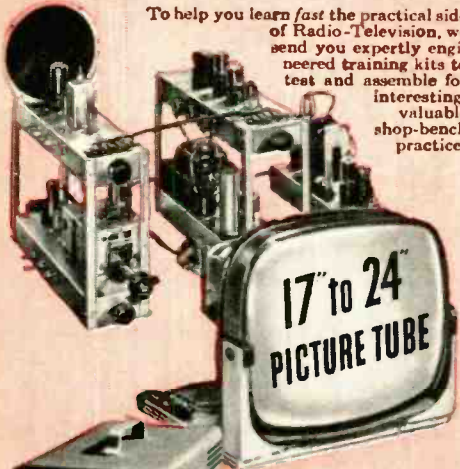

• The new Sprayberry Training Television Receiver, built and tested in 5 sections.

• Now offered . . . this fine modern oscilloscope.

• You build this powerful two-band superheterodyne radio receiver.

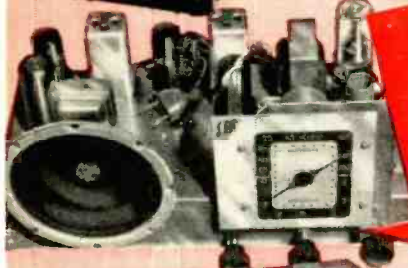

**Big New
CATALOG
AND
Sample Lesson,
FREE!**



You build the new Sprayberry tester—a complete 18-range Volt-Ohm-Milliammeter test meter.

***** This great industry is begging for trained men . . . to step into good paying jobs or a profitable business of their own! Our new plan opens the doors of Radio-Television wide to every ambitious man who is ready to act at once!

Men by the thousands . . . trained Radio-Television Service Technicians . . . are needed at once! Perhaps you've thought about entering this interesting, top paying field, but lack of ready money held you back. Now—just \$6 enrolls you for America's finest, most up to date home study training in Radio-Television! Unbelievable? No, the explanation is simple! We believe Radio-Television *must* have the additional men it needs as quickly as possible. We are willing to do our part by making Sprayberry Training available for less money down and on easier terms than ever before. This is your big opportunity to get the training you need . . . to step into a fine job or your own Radio-Television Service Business.

Complete Facts Free—Act Now; Offer Limited

Only a limited number of students may be accepted on this liberal and unusual basis. We urge you to act at once . . . mail the coupon below and get complete details plus our big new catalog and an actual sample lesson—all free. No obligation . . . no salesman will bother you.

HOME STUDY TRAINING IN SPARE TIME

Under world-famous 27-year old Sprayberry Plan, you learn entirely at home in spare time. You keep on with your present job and income. You train as fast or as slowly as you wish. You get valuable kits of parts and equipment for priceless shop-bench practice. And everything you receive, lessons and equipment alike, is all yours to keep.

LET US PROVE HOW EASILY YOU CAN LEARN!

Radio-Television needs YOU! And Sprayberry is ready to train you on better, easier terms, that any ambitious man can afford. *Just \$6 starts you!* Mail coupon today . . . let the facts speak for themselves. You have everything to gain. Let us prove the kind of opportunity that's in store for you!

SPRAYBERRY Academy of Radio-Television
1512 Jarvis Avenue, Dept. 20-M, Chicago 26, Illinois

Mail This Coupon Now—No Salesman Will Call

Sprayberry Academy of Radio-Television
Dept. 20-M, 1512 W. Jarvis Ave., Chicago 26, Ill.

Please rush all information on your ALL-NEW Radio-Television Training Plan. I understand this does not obligate me and that no salesman will call upon me. Include New Catalog and Sample Lesson FREE.

NAME..... Age.....

ADDRESS.....

CITY..... ZONE..... STATE.....



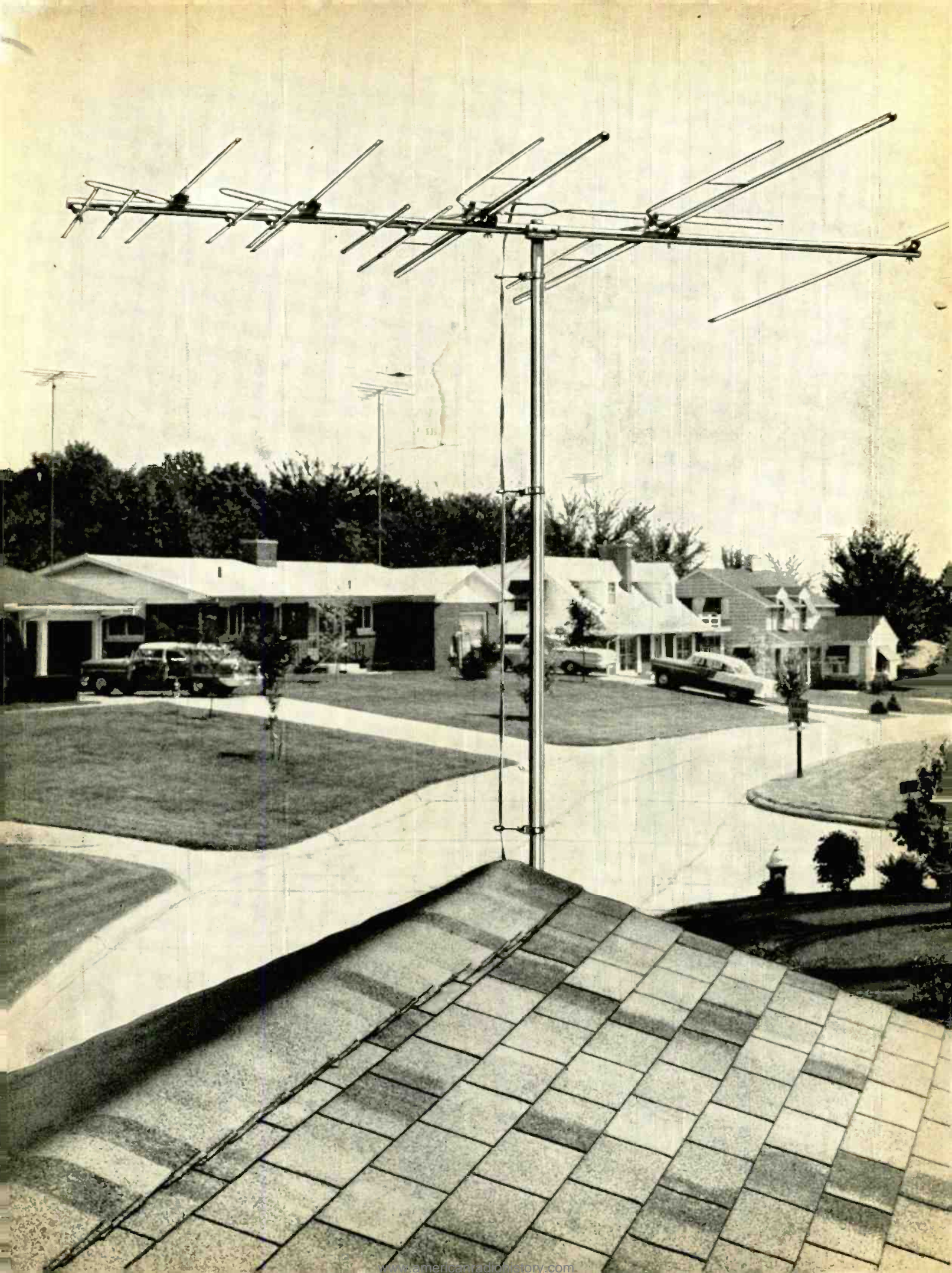

Winegard Antennas are Changing the American Rooftop Scene!

*Introduced three years ago, the Winegard Color'Ceptor antenna is
outselling them all... Here's why—*

More Color'Ceptor's are being installed today by more service technicians than any other all channel yagi for both black and white and color. The reasons—Color'Ceptor performs better, looks better and is built better.

If you live near strong stations, install Color'Ceptor, not for its power but because of its ghost-cutting, unilobe directivity. Get clear, high definition pictures, free of fuzz.

If you live a great distance from stations, your installations need the tremendous all channel gain of the Color'Ceptor that knocks the snow out of those weak signals. Color'Ceptor has highest, all channel gain of any antenna made, is the most efficient antenna you can install.

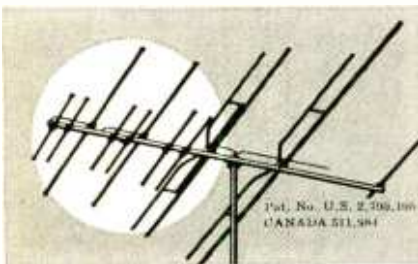

The patented Electro-Lens director design builds up weak signals then concentrates these signals on the driven elements—works the same way a powerful magnifying glass focuses light.

For maximum power, try a pair of Color'Ceptors with Power Packs stacked. Power Pack is a plug-in unit that adds 7 extra elements to the 11 element Color'Ceptor, makes it a super-powerful 18 element all channel yagi.

If you want to solve your co-channel problems, use a Color'Ceptor with Power Pack. This gives you one regular reflector plus two additional reflectors (total 3), really blocks out signals from the back and sides. It gives you a smooth yagi type response lobe on every channel—completely free of minor lobes. Unlike antennas composed of mostly driven elements, Color'Ceptor has

zero side pick-up. If needed, the back two reflectors can be tuned to give a rear null on any one low band channel without affecting the gain on the other channels.

If you are selling and installing color sets, the Color'Ceptor meets all the rigid requirements for a perfect color antenna. It has high gain, sharp directivity, low VSWR (less than 1.5 to 1 any channel), high immunity from off angle signals and flat frequency response. It has no suckouts or resonance peaks and does not have the usual all channel antenna frequency fall-off on end channels 2, 6, 7 or 13.

If you want the best looking, strongest installations, Color'Ceptor is loaded with appeal, built to last and made as precisely as a fine watch. All the elements are perfectly aligned, made from reinforced high tensile aluminum. The hardware is an exclusive Winegard design, for fast easy assembly, keeps your installation straight, neat and streamlined

Winegard Exclusive *Bright Gold Anodizing Process*

Color'Ceptor's distinctive *Bright Gold Anodized Finish* is more than a beauty treatment. Plain aluminum won't rust but does corrode and corrosion not only ruins an antenna's performance but weakens an antenna so that elements droop and eventually break. ANODIZING won't corrode, chip or peel like plastic coatings or paint. ANODIZING is actually part of the metal itself, stays new many times longer than raw metal antennas.

Winegard bright gold anodizes the Color'Ceptor elements and boom, inside and out—not a quick dull dip process. This is the most expensive weather protection that can be given aluminum but it is worth every penny of manufacturing cost. The Color'Ceptor goes through 7 electro-chemical baths, takes 42 minutes for a complete cycle. It's the only antenna made that is *bright gold anodized*, won't fade or rub off.

... no droop or sag on any element. Color'Ceptor is engineered to be lightweight, yet super-strong. Wind tested to 100 m.p.h. Not bulky, easy to install. Perfect balancing at the mast clamp puts no strain on rotor when used.



To help you sell Winegard Color'Ceptors, you can have full color displays with a miniature 1/3 scale model of the Color'Ceptor, silk wall banners, giant full color posters, hang tags, counter cards, decals, newspaper mats, radio commercials, spec sheets, full color stuffers, and postcards—plus unlimited co-op advertising to tie-in with Winegard's big national magazine program... ads in LIFE... BETTER HOMES AND GARDENS... HOUSEHOLD... TV GUIDE... SUCCESSFUL FARMING... SUNSET. More national advertising than all other antenna manufacturers combined... more dealers sales helps.

Only Winegard gives a written guarantee of 100% satisfaction on every Color'Ceptor you sell. If your customer isn't happy, Winegard will satisfy his complaint or return list price. You still get your full profit from the sale.

If you want to make money—and who doesn't—switch to Color'Ceptor. Get your fair share of the big antenna market... have satisfied customers who will sell for you by word of mouth. This fall, join Winegard's Dealer Double Profit program. Ask your jobber or write for full details, today.

Down with the old! Up with the Gold!

Copyright 1958 — Winegard Co., 3013-10 Scotten Blvd., Burlington, Iowa. Cable address JRWCO.

Two ways to be sure that you

DON'T RUIN

your
stereo
records:



1) **ESL GYRO BALANCE** stereo arm

- ▶ Do you realize that vertical stylus forces which are satisfactory for standard records may easily destroy stereo discs? A .7 mil stereo stylus at 6 grams produces approximately the same pressures between record and stylus as a one mil standard LP stylus at 12 to 14 grams. With a high quality cartridge such as the triumphant new ESL GYRO/JEWEL electrodynamic stereo cartridge, the GYRO/BALANCE arm will track properly at only 2 grams, greatly prolonging the life of your records and styli.
- ▶ Your stereo discs deserve the GYRO/BALANCE—the only true stereo arm. Unlike so-called stereo arms which are but slightly altered monophonic arms, the GYRO/BALANCE is all-new. It is the only arm which the independent, objective High Fidelity Consumer's Bureau of Standards approves at this time for high-performance stereo use.
- ▶ Look for the dramatically different new ESL GYRO/BALANCE at your audio dealer's. It's magnificent with monophonic cartridges, too! Only \$34.95, complete with quick-change shell.



2) **ESL Dust Bug**

- ▶ Do you realize that stereo records are even more vulnerable to dust and dirt than standard LP's are? Those pops and clicks due to dust particles are much louder on stereo and therefore even more annoying than on standard discs. Still worse, permanent and expensive damage to your stereo records may result from this oft-overlooked enemy.
- ▶ The ESL Dust Bug is world-famed as the safe, effective record groove cleaner. It cleans record grooves automatically while they are played, and eliminates the static charge present in all records which would attract more dust.
- ▶ Insist on the reliable ESL Dust Bug at your audio dealer's. The standard model is only \$5.75 complete: the Record Changer Dust Bug is only \$4.75 complete. Both are magnificent with monophonic records, too!



FOR LISTENING AT ITS BEST
Electro-Sonic Laboratories, Inc.
Dept. E • 35-54 Thirty-sixth Street • Long Island City 6, N.Y.

CORRESPONDENCE (Continued from p. 18)

might impose severe difficulties for the pickup maker. At the same time I feel that an angle greater than 30° would be building the system into a distortion situation that would later be regretted.

I agree that making both angles (cutter and pickup) identical will minimize (but not eliminate) this distortion, and that deviation between the angles will produce more distortion. However, I apparently do not agree with Mr. Carlson on what constitutes a "slight" variation. Admittedly, too, a disc cut with a cutter having an angle of 24° will produce more distortion if played with a pickup of 0°. But let's put in some comparative figures.

Of course the distortion is dependent on the groove velocity used and is related to pinch effects, discussed in the analysis referred to. But the factor relating this effect is a tangent-squared term. First, using a theoretical 45° angle for both cutter and pickup as reference: a 30° angle cuts distortion to 1/5, 20° to about 1/8 and 15° to 1/14 (using nearest round numbers).

Now, suppose 24° becomes the cutter standard. A deviation in pickup angle from this to 14° in one direction and 32° in the other will produce a further increment of distortion equal to that caused by both at 24°. These would seem to be logical limits from such a standard. An angle of 45° produces about 2.75 times the additional component, while 0° (horizontal) produces about 2.25 times.

So with 24° as an assumed standard (one has not yet been set) 45° is about 2.75 times beyond the logical limit, in terms of distortion.

Finally, the author had no intention of implying that this problem is peculiar to the Fairchild pickup. But this pickup was an early—and creditable—entry in the field that well illustrated the problem. I had understood, in verbal conversation with Fairchild people, that later models would reduce this angle, thereby eliminating any critical inference that might be implied from my presentation. I believe the angle has been reduced from that shown in the article, although I have no specific data.

NORMAN H. CROWHURST
New York, N. Y.

RINGS THE BELZ

Dear Editor:

Congratulations and huzzahs for Dr. D. C. Belz! His new concept in sound (Correspondence, RADIO-ELECTRONICS, July, 1958) has revolutionized my hi fi. I had been having trouble with cabinet resonances in my system. Now, however, all that is past. I can sit back and listen to my glorious new Belz no-speaker hi fi—no resonances anywhere, no shrillness, no boom bass. Magnificent!

JIM BOYK, K8HWB
Toledo, Ohio

END

free! ALLIED'S 1959

value-packed 452-page
ELECTRONIC SUPPLY CATALOG

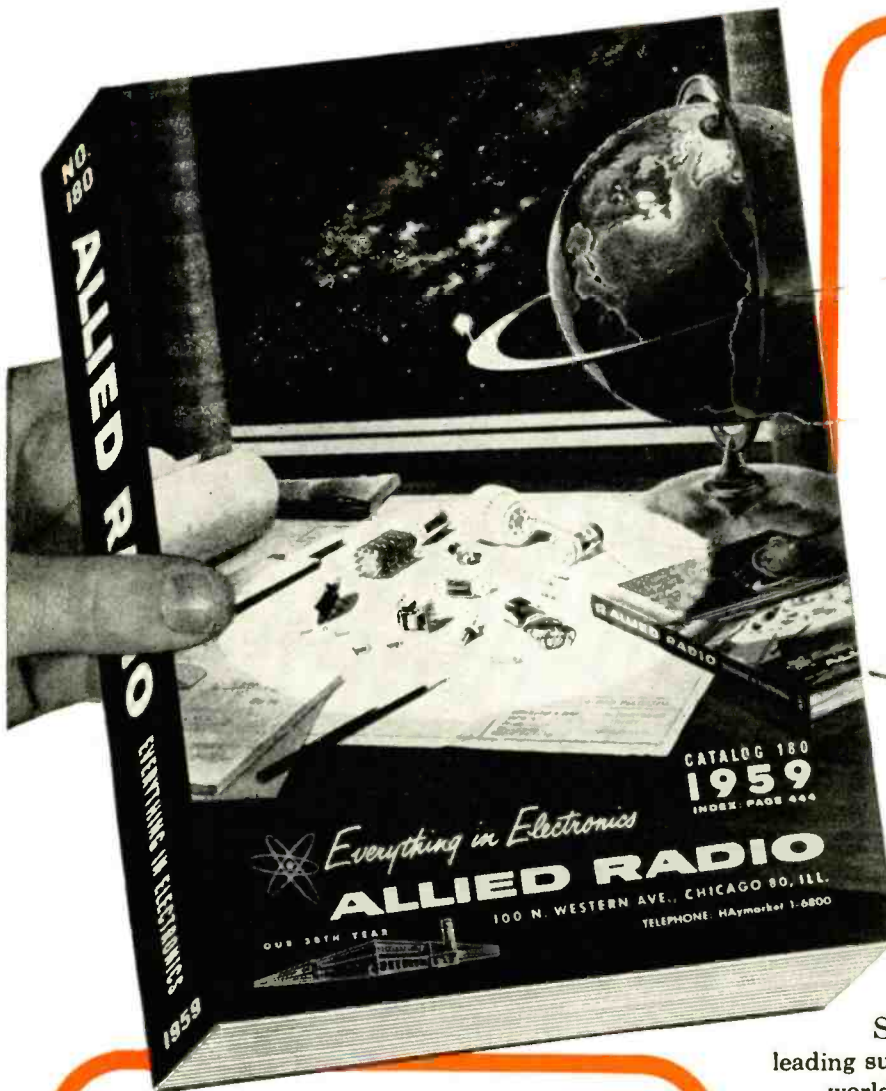

the only COMPLETE guide
to everything in electronics

WORLD'S LARGEST STOCKS

- Latest Stereo Hi-Fi Systems—
Everything in Hi-Fi Components
- Money-Saving, Build-Your-Own
KNIGHT-KITS—Latest Models
- Values in Recorders and Supplies
- Latest Public Address Systems,
Paging and Intercom Equipment
- Amateur Receivers, Transmitters
and Station Gear
- Test & Laboratory Instruments
- Specialized Electronic Equipment
for Industrial Application
- TV Tubes, Antennas, Accessories
- Huge Listings of Parts, Tubes,
Transistors, Tools, Books

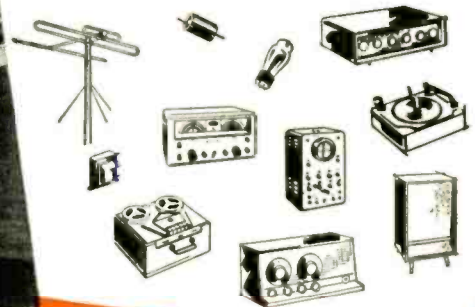

featuring:

MONEY-SAVING knight-kits: Finest electronic equipment in money-saving kit form. Complete selection of latest Hi-Fi amplifier, tuner and speaker kits (new Stereo units); Hobbyist kits; Test Instruments and Amateur kits. KNIGHT-KITS are an exclusive ALLIED product.

HI-FI! STEREO! See the world's largest selection of quality Hi-Fi music systems and famous name components. First with the latest in STEREO! Save on ALLIED-recommended complete systems. Own the best in Hi-Fi for less!

EASY PAY TERMS: Only 10% down; available on orders of \$20 or more. Fast handling—no red tape.

ALLIED RADIO

 our 38th year
World's Largest Electronic Supply House

Send for ALLIED'S 1959 Catalog—it's the leading supply guide—452 pages packed with the world's largest selection of quality electronic equipment at lowest, money-saving prices. Get every buying advantage at ALLIED: fastest shipment, expert personal help, lowest prices, guaranteed satisfaction...

send for the leading
electronic supply guide



.....
ALLIED RADIO CORP., Dept. 2-K8
100 N. Western Ave., Chicago 80, Ill.

Send FREE 452-Page 1959 ALLIED Catalog

Name _____

Address _____

City _____ Zone _____ State _____
.....

Join the Fabulous HARVEST OF PROFITS



JFD is cracking the untapped placement market wide open with the most massive sales promotion drive in TV antenna history!

**NEW MARKETS! NEW PROMOTIONS!
NEW CUSTOMERS!
NATIONAL ADVERTISING!**

More than 15,000,000 prospective antenna buyers will see big hard-hitting ads like these in mass-media such as

Progressive Farmer
IN '58 AND '59

shrinks the miles...
flattens the mountains!



The powerful new all-channel TV antenna that pulls in brilliant pictures in far fringe areas!

JFD SATELLITE-HELIX

Discovered here JFD Satellite-Helix TV antenna handles the range from 10 to 100 miles. It is the only antenna that can be used in all areas. It is the only antenna that can be used in all areas. It is the only antenna that can be used in all areas. It is the only antenna that can be used in all areas.

shrinks the miles...
flattens the mountains!



The powerful new all-channel TV antenna that pulls in brilliant pictures in far fringe areas!

JFD SATELLITE-HELIX

Discovered here JFD Satellite-Helix TV antenna handles the range from 10 to 100 miles. It is the only antenna that can be used in all areas. It is the only antenna that can be used in all areas. It is the only antenna that can be used in all areas. It is the only antenna that can be used in all areas.

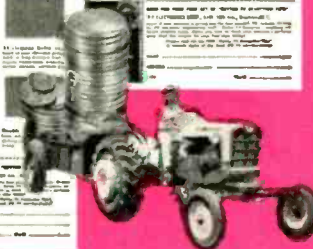

FANTABULOUS INCENTIVES!



Luxurious vinyl card table and chair sets, beautiful hand-painted portraits of your loved ones, aluminum chaise lounge and folding chair suites. FREE . . . to JFD Satellite-Helix Colortenna service-dealers. No coupon collecting, no waiting for premiums. Pick your gift up, right then and there, when you order from your J F D distributor.

DRAMATIC SALES HELPS!

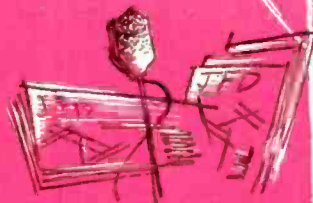

Door knob hangers, TV and radio commercials, banners, displays, antenna check-up booklets, envelope enclosures, newspaper mats—each advertising *your* store as headquarters for TV antenna replacements.

CO-OP PROMOTION FUNDS!



The *biggest* advertising allowances ever for *your* use in promoting TV antenna replacements in your local trading area.

**TIE IN WITH THE GOLDEN HARVEST OF PROFITS—
TODAY'S BOLD NEW CONCEPT IN ANTENNA MERCHANDISING**

Start your own Operation Upturn. See your JFD distributor today and reap a Harvest of Profits starting now.

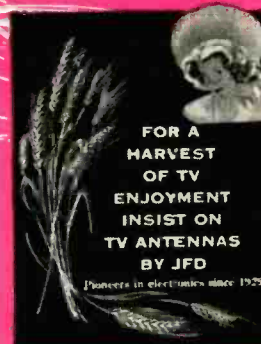

sell the



SATELLITE-HELIX

the TV antenna that **shrinks the miles...**
flattens the mountains!

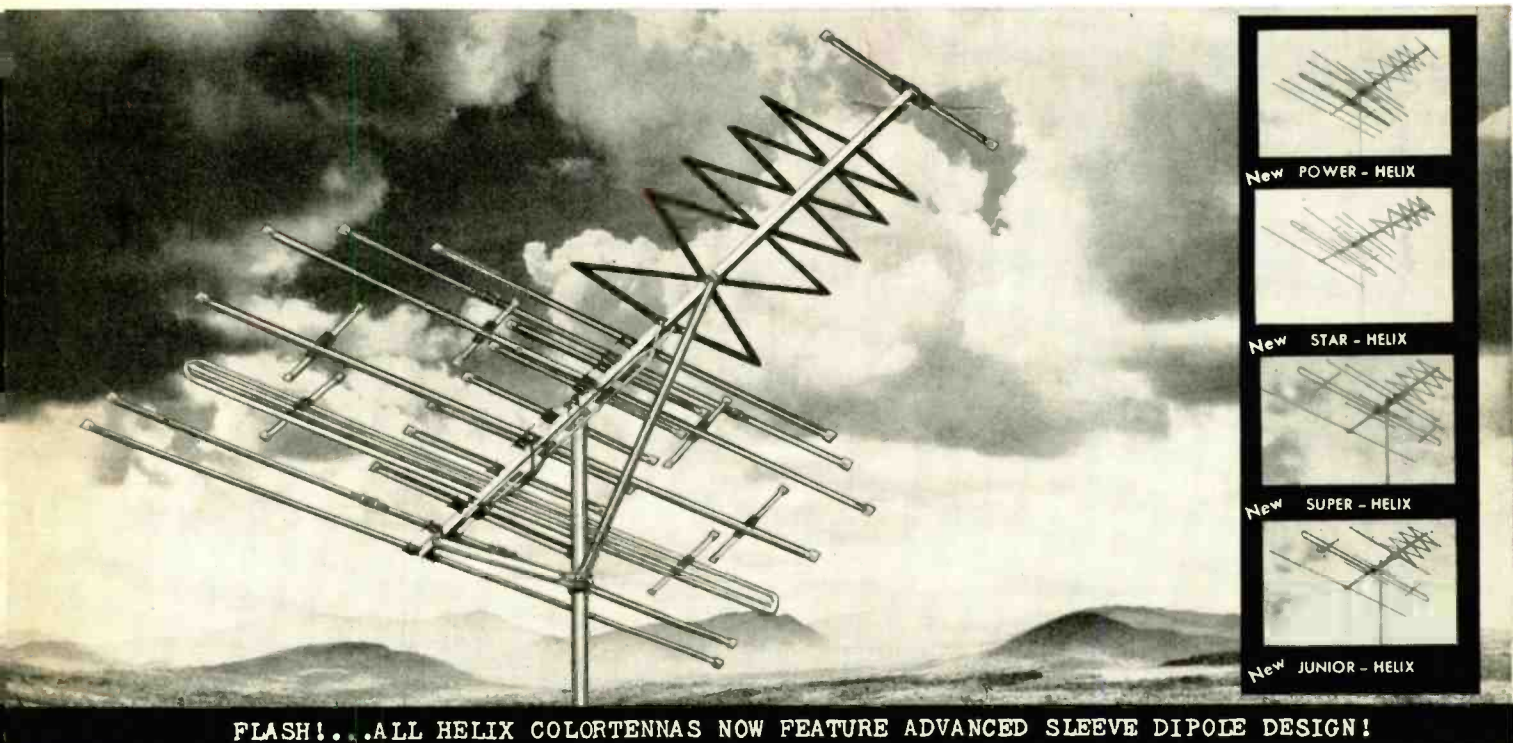

FLASH!... ALL HELIX COLORTENNAS NOW FEATURE ADVANCED SLEEVE DIPOLE DESIGN!

No other fringe TV antenna has ever captured the imagination of service-dealers like the exciting Satellite-Helix. *Proof is the fact that more Satellite-Helices have been sold in the last 6 months than any other deep-fringe TV antenna!*

Profit-squeezed servicemen, installers and dealers know that here at last is the antenna that gives their customers the reasons to buy *now*—performance and construction features with the dramatic *difference* they can *show* and *sell!*

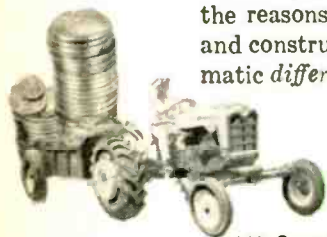

- * 28 WORKING ELEMENTS THAT CONQUER DISTANCE!
- * ALL-NEW BALANCED SLEEVE DIPOLE DESIGN!
- * ROCK-OF-GIBRALTAR RUGGEDNESS!
- * HONEST ANTENNA VALUE AT A REALISTIC PRICE!
- * A HARVEST OF PROFITS FOR YOU!
- * A HARVEST OF TV ENJOYMENT FOR YOUR CUSTOMERS!

Plus OTHER POPULAR-SELLING HELIX COLORTENNAS NOW WITH NEW SATELLITE SLEEVE DIPOLE DESIGN (REGULAR OR GOLD ANODIZED) TO GUARANTEE LEADERSHIP IN EVERY MARKET! POWER-HELIX • STAR-HELIX • SUPER-HELIX • JUNIOR-HELIX

It all adds up to the most dynamic product and promotion package ever put to work in the TV antenna industry—*your HARVEST OF PROFITS* in '58 and '59.

SEE YOUR JFD DISTRIBUTOR NOW! GET YOUR FAIR SHARE OF TODAY'S 40 MILLION DOLLAR ANTENNA REPLACEMENT MARKET!

JFD Canada Ltd.
51 McCormack Street
Toronto, Ontario, Canada

JFD International
15 Moore Street
New York, New York

Pioneers in electronics since 1929
JFD ELECTRONICS CORPORATION
BROOKLYN 4, NEW YORK



1 in 35,000,000

How the telephone switching system sorts numbers in seconds

When you dial out of town, the telephone switching system performs an amazing feat. It sorts out the one other number in 35 million you want, and connects you to it in seconds. The other telephone may be thousands of miles away.

Bell Laboratories engineers endowed this great switching network with almost superhuman capabilities. As you dial, the machine listens, remembers, figures out the best route, makes connections, alerts, reports, even corrects itself. If it detects trouble on the way, it files a report, then chooses other circuits and goes on to complete your call. All you are aware of is the end product—the completed call.

Yet at Bell Telephone Laboratories, switching engineers see the present system as only a beginning. Ahead they see—and are developing—new systems vastly more flexible and capable than today's. Nowhere in telephone technology is the challenge greater. Nowhere are dreams coming true faster.



BELL TELEPHONE LABORATORIES

WORLD CENTER OF COMMUNICATIONS RESEARCH AND DEVELOPMENT

These Bell Telephone System directories list some of the 35,000,000 telephones now linked by the Direct Distance Dialing system developed at Bell Laboratories. In seconds, this unique machine sorts out and connects you with precisely the number you want.

STEREO STEREO AND MONAURAL

the
experts
say...
in HI-FI
the best buys are



World-famous
EICO advantages
guarantee your complete satisfaction:

- Advanced engineering • Finest quality components
- "Beginner-Tested," easy step-by-step instructions
- LIFETIME service & calibration guarantee
- IN STOCK — Compare, then take home any EICO equipment—right "off the shelf"—from 1900 neighborhood EICO dealers.



Stereo Preamplifier HF85



FM Tuner HFT90



Stereo
Amplifier-Preamp
HF81



Bookshelf
Speaker System
HFS1



Monaural Integrated Amplifiers:
50, 30, 20, and 12-Watt
(use 2 for Stereo)



Speaker System HFS2
36" H x 15 1/4" W x 11 1/2" D



Monaural Power Amplifiers:
60, 50, 35, 30, 22 and 14-Watt
(use 2 for Stereo)



Monaural Preamplifiers:
HF65, HF61
(stack 2 for Stereo)



Over 1 MILLION EICO instruments in use throughout the world.

NEW STEREOGRAPHIC EQUIPMENT

HF85: Stereo Dual Preamplifier is a complete stereo control system in "low silhouette" design adaptable to any type of installation. Selects, preamplifies, controls any stereo source—tape, discs, broadcasts. Superb-variable crossover, feedback tone controls driven by feedback amplifier pairs in each channel. Distortion borders on unmeasurable even at high output levels. Separate lo-level input in each channel for mag. phono, tape head, mike. Separate hi-level inputs for AM & FM tuners & FM Multiplex. One each auxiliary A & B input in each channel. Independent level, bass & treble controls in each channel may be operated together with built-in clutch. Switched-in loudness compensator. Function Selector permits hearing each stereo channel individually, and reversing them; also use of unit for stereo or monophonic play. Full-wave rectifier tube power supply. 5-12AX7/ECC83, 1-6X4. Works with any 2 high-quality power amplifiers such as EICO, HF14, HF22, HF30, HF35, HF50, HF60. Kit \$39.95. Wired \$64.95. Includes cover.

HF81: Stereo Dual Amplifier-Preamp selects, amplifies & controls any stereo source—tape, discs, broadcasts—& feeds it thru self-contained dual 14W amplifiers to a pair of speakers. Monophonically: 28 watts for your speakers; complete stereo preamp. Ganged level controls, separate focus (balance) control, independent full-range bass & treble controls for each channel. Identical Williamson-type, push-pull EL84 power amplifiers, excellent output transformers. "Service Selector" switch permits one preamp-control section to drive the internal power amplifiers while other preamp-control section is left free to drive your existing external amplifier. Kit \$69.95. Wired \$109.95. Incl. cover.

MONAURAL PREAMPLIFIERS (stack 2 for Stereo)
NEW HF65: superb new design, inputs for tape head, microphone, mag-phono cartridge & hi-level sources. IM distortion 0.04% @ 2V out. Attractive "low silhouette" design. HF65A Kit \$29.95, Wired \$44.95. HF65 (with power supply) Kit \$33.95. Wired \$49.95.

HF61: "Rivals the most expensive preamps" — Marshall, AUDIOCRAFT. HF61A Kit \$24.95, Wired \$37.95, HF61 (with power supply) Kit \$29.95. Wired \$44.95.

MONAURAL POWER AMPLIFIERS (use 2 for STEREO)

HF60: 60-Watt Ultra Linear Power Amplifier with Acro TO-330 Output Xfmr.; "One of the best-performing amplifiers extant; an excellent buy." AUDIOCRAFT Kit Report. Kit \$72.95. Wired \$99.95. Cover E-2 \$4.50.

HF50: 50-Watt Ultra Linear Power Amplifier with extremely high quality Chicago Standard Output Transformer. Identical in every other respect to HF60, same specs at 50W. Kit \$57.95. Wired \$87.95. Cover E-2 \$4.50.

NEW HF35: 35-Watt Ultra-Linear Power Amplifier. Kit \$47.95. Wired \$72.95. Cover E-2 \$4.50.

HF30: 30-Watt Power Amplifier. Kit \$39.95. Wired \$62.95. Cover E-3 \$3.95.

NEW HF22: 22-Watt Power Amplifier. Kit \$38.95. Wired \$61.95. Cover E-2 \$4.50.

NEW HF14: 14-Watt Power Amplifier. Kit \$23.50. Wired \$41.50. Cover E-6 \$4.50.

MONAURAL INTEGRATED AMPLIFIERS (use 2 for STEREO)

HF52: 50-Watt Integrated Amplifier with complete "front end" facilities & Chicago Standard Output Transformer. "Excellent value"—Hirsch-Houck Labs. Kit \$69.95. Wired \$109.95. Cover E-1 \$4.50.

HF32: 30-Watt Integrated Amplifier. Kit \$57.95. Wired \$89.95. Both include cover.

HF20: 20-Watt Integrated Amplifier. "Well-engineered" — Stocklin, RADIO TV NEWS. Kit \$49.95. Wired \$79.95. Cover E-1 \$4.50.

HF12: 12-Watt Integrated Amplifier. "Packs a wallop"—POP. ELECTRONICS. Kit \$34.95. Wired \$57.95.

SPEAKER SYSTEMS (use 2 for STEREO)

HF52: Natural bass 30-200 cps via slot-loaded 12-ft. split conical bass horn. Middles & lower highs: front radiation from 8 1/2" edge-damped cone. Distortionless spike-shaped super-tweeter radiates omni-directionally. Flat 45-20,000 cps, useful 30-40,000 cps. 16 ohms. HWD 36", 15 1/4", 11 1/2". "Eminently musical; would suggest unusual suitability for stereo."—Mott, HIGH FIDELITY. Completely factory-built: Walnut or Mahogany. \$139.95; Blonde, \$144.95.

HFS1: Bookshelf Speaker System, complete with factory-built cabinet. Jensen 8" woofer, matching Jensen compression-driver exponential horn tweeter. Smooth clean bass; crisp extended highs. 70-12,000 cps range. Capacity 25 w. 8 ohms. HWD: 11" x 23" x 9". Wiring time 15 min. Price \$39.95.

FM TUNER

HFT90: surpasses wired tuners up to 3X its cost. Pre-wired, pre-aligned, temperature-compensated "front end" — drift-free. Precision "eye-tronic" tuning. Sensitivity 1.5 uv for 20 db quieting — 6X that of other kit tuners. Response 20-20,000 cps ± 1 db. K-follower & multiplex outputs. "One of the best buys you can get in high fidelity kits." — AUDIOCRAFT KIT REPORT. Kit \$39.95*. Wired \$65.95*. Cover \$3.95.

EICO, 33-00 Northern Blvd., L. I. C. 1, N. Y. C-10

SHOW ME HOW TO SAVE 50% on 60 models of top-quality equipment as checked below. Hi-Fi
 Test Instruments Ham Gear.
Send FREE literature & name of neighborhood EICO dealer.

NAME.....
ADDRESS.....
CITY..... STATE.....

Copyright 1958 by Electronic Instr. Co., Inc. 33-00 N. Blvd., L. I. C. 1, N. Y.

Add 5% in the West.

* LESS COVER, P. C. T. INC.

the specs prove it...
your BEST BUY is

EICO®

for COLOR & Monochrome TV servicing

FREE CATALOG

shows you HOW TO SAVE 50%
on 50 models of top quality
professional test equipment.
MAIL COUPON NOW!

SEE OUR "HAM" AD ON PAGE 136

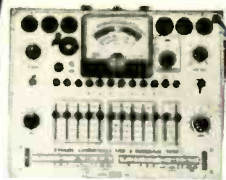

**NEW! DYNAMIC
CONDUCTANCE
TUBE & TRANSISTOR
TESTER #666**
KIT \$69⁹⁵ WIRED \$109⁹⁵

COMPLETE with steel cover and handle.

SPEED, ease, unexcelled accuracy & thoroughness. Tests all receiving tubes (and picture tubes with adapter). Composite indication of Gm, Gp & peak emission. Simultaneous sel of any 1 of 4 combinations of 3 plate voltages, 3 screen voltages, 3 ranges of continuously variable grid voltage (with 5% accurate pot). New series-string voltages: for 600, 450, 300 ma types. Sensitive 200 ua meter. 5 ranges meter sensitivity (1% shunts & 5% pot). 10 SIX-position lever switches: freepoint connection of each tube pin. 10 pushbuttons: rapid insert of any tube element in leakage test circuit & speedy sel. of individual sections of multi-section tubes in merit tests. Direct-reading of inter-element leakage in ohms. New gear-driven rollover. Checks n-p-n & p-n-p transistors: separate meter readings of collector leakage current & Beta using internal dc power supply. Deep-etched satin aluminum panel; rugged grey wrinkle steel cabinet. CRA Adapter \$4.50



New!
Series/Parallel
R-C COMBINATION
BOX #1140
KIT \$13.95
WIRED \$19.95



**TUBE TESTER
#625**
KIT \$34.95
Wired \$49.95
• tests 600
mil series
string type
tubes
• illuminated
roll-chart

Pix Tube Test Adapter\$4.50



**6V & 12V BATTERY
ELIMINATOR
& CHARGER #1050**
KIT \$29.95
WIRED \$38.95
Extra-filtered for
transistor equip.
#1060 KIT \$38.95
WIRED \$47.95



NEW!
TV-FM SWEEP
GENERATOR &
MARKER #368
KIT \$69⁹⁵ WIRED \$119⁹⁵

Entirely electronic sweep circuit (no mechanical devices) with accurately-biased inductor for excellent linearity. Extremely flat RF output: new AGC circuit automatically adjusts osc. for max. output on each band with min. ampl. variations. Exceptional tuning accuracy: edge-lit hairlines eliminate parallax. Swept Osc. Range 3-216 mc in 5 fund. bands. Variable Marker Range 2-75 mc in 3 fund. bands: 60-225 mc on harmonic band. 4.5 mc Xtal Marker Osc., xtal supplied. Ext. Marker provision. Sweep Width 0-3 mc lowest max. deviation to 0-30 mc highest max. dev. 2-way blanking. Narrow range phasing. Attenuators: Marker Size, RF Fine, RF Coarse (4-step decade). Cables: output, 'scope horiz., 'scope vertical. Deep-etched satin aluminum panel; rugged grey wrinkle steel cabinet.



**COLOR
and Monochrome
DC to 5 MC LAB & TV
5" OSCILLOSCOPE
#460**
KIT \$79⁹⁵ WIRED \$129⁵⁰
• Features DC Amplifiers!

Flat from DC-4.5 mc, usable to 10 mc. VERT. AMPL.: sens. 25 rms mv/in; input Z 3 megs; direct-coupled & push-pull thruout; K-follower coupling bet. stages; 4-step freq-compensated attenuator up to 1000:1. SWEEP: perfectly linear 10 cps-100 kc (ext. cap. for range to 1 cps); pre-set TV V & H positions; auto. sync. ampl. & lim. PLUS: direct or cap. coupling; bal. or unbal. inputs: edge-lit engraved lucite screen; dimmer; filter; bezel fits std photo equip. High intensity trace CRT. 0.06 usec rise time. Push-pull hor. ampl., flat to 400 kc, sens. 0.6 rms mv/in. Built-in volt. calib. Z-axis mod. Sawtooth & 60 cps outputs. Astig. control. Retrace blanking. Phasing control. 5" PUSH-PULL Oscilloscope = 425; Kit \$44.95, Wired \$79.95. 7" PUSH-PULL Oscilloscope = 470; Kit \$79.95, Wired \$129.50.



New!
Miniaturized
MULTI-SIGNAL
TRACER #145A
KIT \$19.95
WIRED \$28.95



20,000 Ohms/Volt
V-O-M #666
KIT \$24.95
Wired \$29.95



1000 Ohms/Volt
V-O-M
#536
KIT \$12.90
Wired \$14.90

**NEW! RF
SIGNAL GENERATOR
#324**
KIT \$26⁹⁵ WIRED \$39⁹⁵



150 kc to 435 mc with ONE generator! Better value than generators selling at 2 or 3 times its cost! Ideal for IF-RF alignment, signal tracing & trouble-shooting of TV, FM, AM sets; marker gen.; 400 cps audio testing; lab. work. 6 fund. ranges: 150-400 kc, 400-1200 kc, 1.2-3.5 mc, 3.5-11 mc, 11-37 mc, 37-145 mc; 1 harmonic band 111-435 mc. Freq. accurate to ±1.5%; 6:1 vernier tuning & excellent spread at most important alignment freqs. Etched tuning dial, plexiglass windows, edge-lit hairlines. Colpitts RF osc. directly plate-modulated by K-follower for improved mod. Variable depth of int. mod. 0-50% by 400 cps Colpitts osc. Variable gain ext. amplifier: only 3.0 v needed for 30% mod. Turret-mounted coils slug-tuned for max. accuracy. Fine & Coarse (3-step) RF attenuators. RF output 100,000 uv; AF sine wave output to 10 v. 50-ohm output Z. 5-way jack-top binding posts for AF in/out; coaxial connector & shielded cable for RF out. 12AU7, 12AV7, selenium rectifier; xmfr-operated. Deep-etched satin aluminum panel; rugged grey wrinkle steel cabinet.



**NEW! PEAK-to-PEAK
VTVM #232 & UNI-
PROBE (pat. pend.)**
KIT \$29⁹⁵ WIRED \$49⁹⁵

Half-turn of probe tip selects DC or AC-Ohms.
Uni-Probe - exclusive with EICO - only 1 probe performs all functions!

Latest circuitry, high sensitivity & precision, wide ranges & versatility. Calibration without removing from cabinet. New balanced bridge circuit. High Z input for negligible loading. 4 1/2" meter, can't burn-out circuit. 7 non-skip ranges on every function. 4 functions: ±DC Volts, -DC Volts, AC Volts, Ohms. Uniform 3 to 1 scale ratio for extreme wide-range accuracy. Zero center. One zero-adj. for all functions & ranges. 1% precision ceramic multiplier resistors. Measure directly peak-to-peak voltage of complex & sine waves: 0-4, 14, 42, 140, 420, 1400, 4200. DC/RMS sine volts: 0-1.5, 5, 15, 50, 150, 500, 1500 (up to 30,000 v with HVP probe & 250 mc with PRF probe). Ohms: 0.2 ohms to 1000 megs. 12AU7, 6AL5, selenium rectifier; xmfr-operated. Deep-etched satin aluminum panel, rugged grey wrinkle steel cabinet.



Reads 0.5 ohms
-500 megs, 10
mmfd-5000 mfd,
power factor.

R-C BRIDGE & R-C-L COMPARATOR
#950B



VTVM PROBES	KIT	Wired
Peak-to-Peak	\$4.95	\$6.95
RF	\$3.75	\$4.95
High Voltage Probe-1		\$6.95
High Voltage Probe-2		\$4.95
SCOPE PROBES		
Demodulator	\$3.75	\$5.75
Direct	\$2.75	\$3.95
Low Capacity	\$3.75	\$5.75

TURN PAGE
FOR MORE
EICO VALUES

EICO®

Send for
FREE CATALOG
now

Prices 5% higher on West Coast.

33-00 Northern Blvd., Long Island City 1, N.Y.

EICO, 33-00 Northern Blvd.
Long Island City 1, N. Y. C-10
Show me HOW TO SAVE 50% on Test Instruments Hi-Fi Ham Gear. Send me FREE Catalog and name of neighborhood dealer.

Name.....
Address.....
City.....Zone.....State.....

ATYPICAL TELEVISION

... *The Vast Field of TV Outside Home Entertainment* ...

A RECENT book, *Television in Science and Industry*,* by three outstanding authors brings home to us the great strides TV has been and is making in the closed-circuit field. V. K. Zworykin, EE, PhD, DSc (honorary), pioneer inventor of the iconoscope and the kinescope is vice president and technical consultant of RCA; E. G. Bamberg, PhD, is research physicist of RCA Laboratories; L. E. Flory, BS (EE), has pioneered in industrial TV and is research engineer of RCA Laboratories.

It would be physically impossible in this space to list all the hundreds of TV applications enumerated in words, profuse illustrations and diagrams in this book.

According to the authors, closed-circuit television has been defined as follows: "Whenever it is too dangerous; too difficult; too expensive; too inconvenient; too inaccessible; too far; too hot; too cold; too high; too low; too dark; too small to observe directly, use television."

In industry, safety is paramount. Television permits close visual control of remote handling of high explosives, radioactive materials and other dangerous processes without the complexity of mirror systems, periscopes, etc., for direct viewing. . . . In mines, TV cameras in explosion-proof housings protect the lives of mine crews by monitoring instruments that indicate atmospheric conditions in shafts. . . . In aircraft, TV watches jet exhausts, controlled surfaces of the plane as well as landing gear. This avoids many accidents. . . . On large airplanes, a TV camera directly under the fuselage, facing the wheels, provides the pilot with an accurate check of his altitude prior to touchdown. . . . Industrial inspection, wherever X-rays are utilized in detection of flaws in metal parts and proper filling of opaque containers, now has TV as an essential accessory. . . . In the motion-picture industry, combining TV cameras with film cameras will show the director the scene precisely as viewed from the usual array of camera positions. . . . Closed-circuit television will soon be a must for all workers with radioactive substances and explosives. It works behind massive walls and shockproof barriers interposed between operator and the work. With color TV the finest details and depth can be added to the image.

In biology and medicine, recently devised television microscopes with ultra-violet illumination are most significant in cell structure study, since organic materials generally exhibit great differences in absorption in the ultra-violet spectrum. Infra-red illumination also greatly helps in the study of structures hidden by material that is normally opaque but transparent in the infra-red. . . . A new medical application uses television in conjunction with fluoroscopy, for direct examination of patients to be X-rayed. This method also has the advantage of not exposing the radiologist to extensive radiation. The method uses an image intensifier tube coupled to a television camera or a special X-ray pickup tube. The picture is viewed at a high light level on a monitor. . . . In dentistry, television aids dentist and patient. The dentist points out the dental defects to the patient, who sees them on a monitor directly in his line of vision.

In commerce, new products are launched from a central

office to a gathering of agents and distributors in various geographical areas. It does away with the traveling representative and, better yet, all districts receive the information simultaneously. . . . In hotels and motels, which already have television receivers, the unused television channels can be used to inform guests by giving them local news, showing menus, floor shows, etc. . . . Department stores, supermarkets and large shops now use TV cameras spotted around the premises to apprehend pickpockets and shoplifters. The presence of TV cameras has a salutary effect in preventing thefts. . . . One of the best silent burglar alarms is the placing of specially designed television cameras sensitive to invisible infra-red radiations for night use in guarding property. . . . The same apparatus and equipment can be used for military purposes. TV cameras and transmitters carried by scouts or mobile units or in planes transmit views of battle operations from the front lines to the command in the rear. . . .

Recently a new TV camera has been constructed with water cooling for thermal protection. This prevents the temperature of the camera lens from going above 65°C, even when the furnace interior near which it is used stays at 1,600°C.

A new French closed-circuit TV camera uses spiral scanning. It produces a rotating deflection field which increases gradually in amplitude until, at the end of the frame period, it collapses to zero and returns the scanning spot to the center of the picture. A number of advantages are claimed for this camera: high resolution at the center of the picture and no resolution at the edge. For special purposes this is often advantageous. Then, also, the almost purely sinusoidal scanning wave reduces power requirements and allows transmission over a simple wire from the control unit of the camera.

Industrial smokestacks are now observed by TV from a distance in the abatement of smoke nuisance. . . . A closed-circuit TV assembly at the United States Steel plant in Gary, Ind., now scans 395 feet of white-hot steel strip while a distant operator at the finishing stand checks the strip on a monitor. . . . The Douglas Aircraft Co., by means of a microalignment telescope, observes its new airplane assembly on a 17-inch-screen television monitor, greatly easing the always necessary alignment procedure. . . . We have now deep-sea underwater TV cameras that operate at depths to 3,000 feet, in deep-sea diving, exploration, etc. . . . In the city jail in Houston, Tex., television chains are used in the supervision of cell corridors, workshops and recreation areas. . . . Field-sequential cameras now observe tail cones of jet-engine afterburners in testing of jet planes.

The authors, who admit that up to now the high cost of wide-band video cable has been a material obstacle to closed-circuit television, forecast that this obstacle will soon be overcome by the development of simpler, cheaper wide-band linkages. They also foresee a marked reduction in personal contacts. Visual and voice communication will replace social calls. Stores as we now know them will all but disappear. They will be converted to warehouses especially designed for videophone purchases. As you now shop by phone, you will shop by color television and select whatever merchandise you see in front of the camera.

—H.G.

* See also page 150 of this issue, as well as editorial "Closed-Circuit Television," June, 1953, RADIO-ELECTRONICS.

READY FOR

STEREO ?

Confused about stereo? This series is designed to help you select a stereo system or convert your existing hi fi—and as a guide to the proper installation and operation of equipment which reproduces stereophonic sound from discs, tapes and radio

Part I—The fundamentals of stereo hearing

By DONALD CARL HOEFLER*

THE widespread confusion concerning stereo sound and methods for its recording, transmission and reproduction seems to indicate the need for a second look at the basic fundamentals. Such a pause might give us a better understanding of where we've been, what we're trying to do and why.

Sound recording was hardly out of the tinfoil stage when primitive efforts were made to use it for stereo, notably at the Paris Exposition of 1881. In the 1930's, there were numerous stereo experiments and demonstrations by organizations such as the National Broadcasting Co., Bell Telephone Laboratories and several Hollywood film studios. Yet these several efforts were quite divergent, both in theory and application. Obviously, ever then the term "stereophonic sound" had a variety of meanings.

The quest for a stereophonic system has come about because we hear with two ears, while conventional methods of sound recording and transmission are monaural or "one-eared." The familiar analogy is stereo photography, which simply uses two pictures, exposed by lenses which are separated by the distance between the eyes. The explanation is handy, but it falls short of the mark.

Viewing a subject with only one eye does not appreciably change the visual effect. The scene does lose some depth and roundness and it becomes a little more difficult to judge speeds and distances, but for the most part the differences are rather subtle. Certainly the shading, tonal quality or contrast of the view is not affected.

Sound and hearing

But when one listens to sounds with one ear covered, there is a marked effect. *It sounds different.* A small part of this may be accounted for by differences in the hearing abilities of the two ears. But there are other differences at work here as well.

Remember that sound is a wave motion in air, and as such it goes through periodic peaks and valleys just like any cyclical variation. Now, since the two human ears are several inches apart, a given sound will travel over two slightly different paths in reaching them.

If the lengths of these two paths are not equal, there is a *time* difference for the arrival of the sounds at each ear. This occurs whenever the sound source is not either directly in front of or directly behind the listener, that is at 0° or 180°. Thus the time differential is nearly always present.

Furthermore, there may be a *phase*

difference between the sounds reaching each ear. While the right ear may be receiving a positive pressure peak, the left ear may simultaneously hear a negative peak. At any rate, it is extremely unlikely that both sound pressures will be at exactly the same point in the cycle as they strike the two eardrums. Since this phase relationship may be constantly changing, in the case of pure tones there can be an alternate addition and subtraction that will cause audible beats or heterodynes.

These differences in time and phase provide the ears with important clues, enabling them to estimate quite accurately both the *distance* and *direction* from which a sound originates. The directional characteristics of the human hearing mechanism are illustrated in Fig. 1. Here we see how each of the ears responds as a sound of constant intensity is rotated around *one side of the head* from front to back.

Notice that the ear on the same side as the sound source has almost a semi-cardioid pattern, with greatest sensitivity when the sound arrives from about 75°. On the other hand, the opposite ear hears loudest when the sound strikes from almost directly opposite it, at about 85°.

The left ear seems to be most hard of hearing when the sound arrives from about 4 o'clock, or 125°.

For sounds arriving from the left side, the two curves would simply be inverted, with the large lobe on the left and the small one on the right.

Steps to stereo

Now what does all this mean to us in terms of an audio system? Well, we can see that the hearing system is

*Author Basic Audio Course, Gernsback Library No. 66

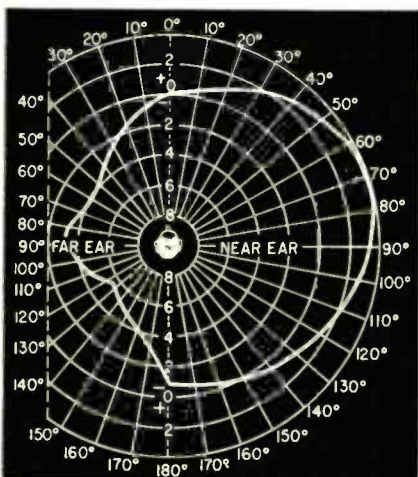

Fig. 1—The directivity characteristics of the ear clearly show the importance of binaural hearing.

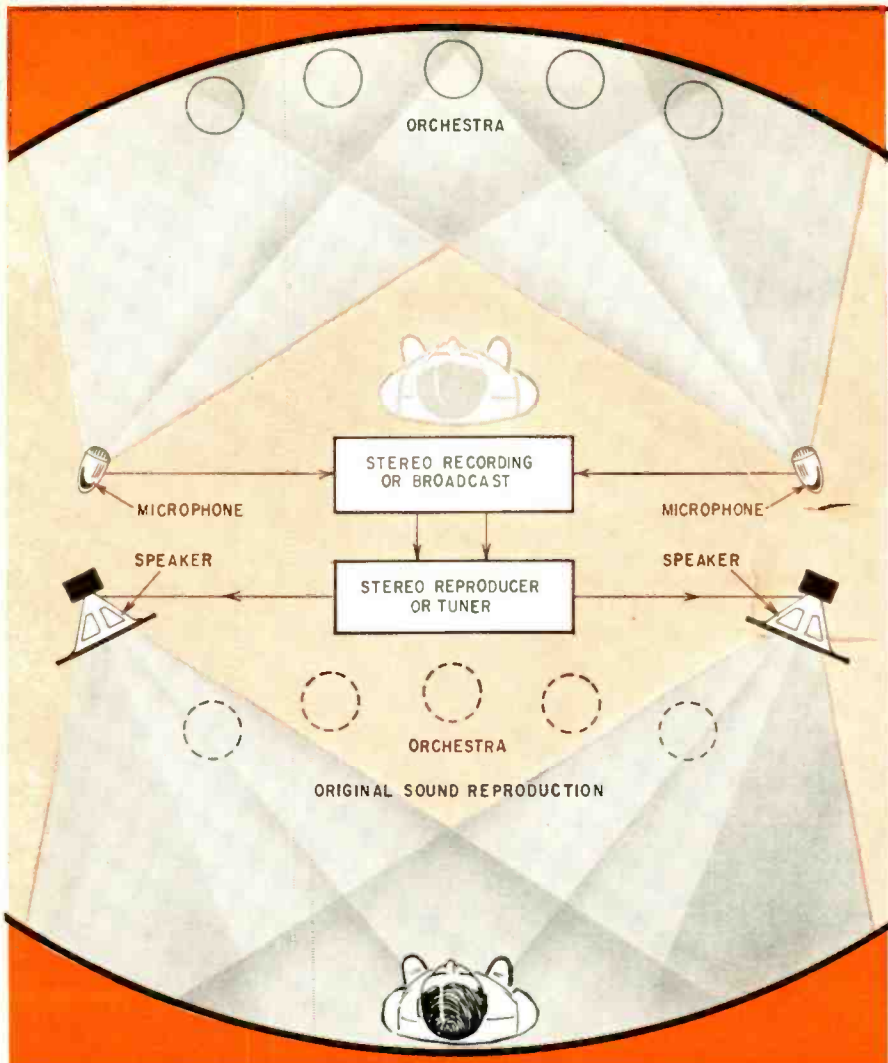

Fig. 2—Idealized drawing of stereo action incorrectly equates it with true binaural.

indeed quite perceptive of changes in direction. The intensity as noted by the nearest ear varies as much as 4 db, while that of the opposite ear can vary nearly 6 db.

But in the conventional audio system the sound comes from only one single direction—from practically a point source—the loudspeaker. The answer to that is very simple, you say. Just add more speakers.

This is being done every day, of course. It even has a name, "spread sound." But it still doesn't tell us whether the violins are right or left. Instead, they now seem to be right and left, or in exactly as many locations as there are speakers.

Let's try another approach. Suppose we have a separate microphone for each performer, a separate channel for each mike and a separate speaker for each channel. Then if we put the speakers in the same physical setup as the mikes were, we should now have true stereophony.

This is the principle of the "electronic orchestra" and it has worked well in experiments with small groups. But, for a symphony orchestra, such an elaborate arrangement is still in the dream stage.

But perhaps this idea can be scaled

down to practical size. How about a channel for every section or voice in the orchestra or every two sections or even larger and fewer chunks? Continuing that line of reasoning we soon get down to the seven channels of Cinemascope or the three of Fantasound.

Even three channels impose a number of problems in home entertainment systems, but the art has progressed to the point where we can use two channels quite handily. From this development it should be very obvious that two-channel stereo is far from the ultimate, and it certainly is not as ideal as represented by the typical "explanation" of stereo shown in Fig. 2.

Two-channel stereo

The fallacy of such a representation becomes painfully apparent when we examine Fig. 3, which shows quite a different approach to the problem. Thirty years ago, the then acoustical research director of the Bell Telephone Laboratories stated: "Any variation from this ideal transmission system will produce results which are different from those ordinarily produced by direct listening."⁸

This ideal transmission system is known as *true binaural* and requires

two microphones placed in something which is acoustically the equivalent of the human head. Even the facial features must be reproduced and the microphones must be placed in replicas of ears.

Two separate transmission channels are used, terminated in split headphones. Under these conditions the listener has the auditory sensation of being present in the exact location of the dummy microphone head. From a psycho-acoustic viewpoint this system is ideal, but as a practical matter the headphones are a nuisance, and for group listening the problem is even more complex.

Since we see now that two-channel stereo is merely a compromise between true binaural and multichannel stereo, either of which can do the job better, the question naturally arises whether present stereo is worth the bother at all. This writer would say that the answer is a definite *yes*.

The technical bugs have been ironed out of two-channel stereo, and many recordings are readily available on both tape and disc. Two-station stereo broadcasts, either AM-FM, FM-FM, AM-AM, even AM-TV and FM-TV are now a reality. FM multiplex stereo is still in the experimental stage, not because of engineering problems, but only because standards have not yet been adopted.

Theoretically all of these methods could be engineered for more stereo channels, with the possible exception of the disc recording. But if such improvements do come, conversion of existing equipment will be no more difficult than the changeover from monaural to stereo. We'll see next month just how easy that is. TO BE CONTINUED

⁸Harvey Fletcher, "Speech and Hearing," D. Van Nostrand Co., Inc., New York, 1929.

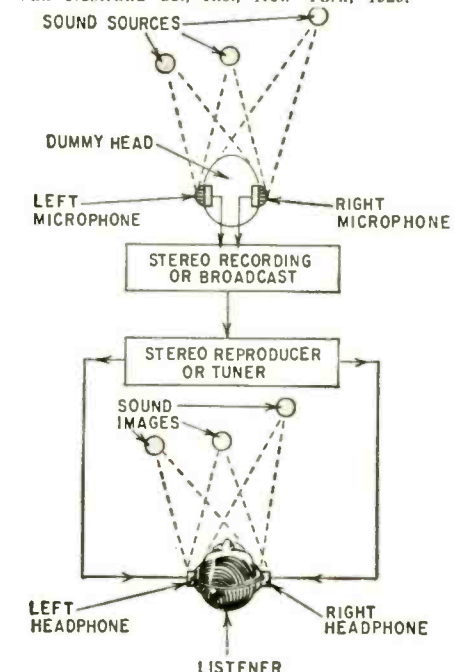

Fig. 3—True binaural requires dummy-head microphone setup and listening with headphones.

Les Paul

TECHNICIAN and MUSICIAN

By ERIC LESLIE

A tour through the popular guitarist's studio home reveals some of the equipment and techniques he uses to blend the electronic and musical arts into his exciting "New Sound"

THE scene on our cover might well have been photographed in a large metropolitan broadcast studio—but it wasn't! This ultra-modern setup is in a conventional-looking country home literally nestled in one of the mountain-hills of northern New Jersey. It is part of the workshop-home of Les Paul and Mary Ford, that pair who enthral music lovers and enthuse audio technicians by using electronics to multiply their talents.

The visitor's first impression is that of more mikes than he has ever seen in a broadcast studio. Then he views to his left a large control room on the other side of a plate-glass partition, several broadcast type tape recorders, an ancient piano (obviously from an early movie theater), a couple of vintage phonographs (Edison and Gem) and several guitars.

But the technician is struck chiefly by the big control console that dominates the center of the photograph on this page, and even more by Les'

attitude toward it. Referring to it affectionately as "The Monster," he swings the panel up on its hinges, props it with an old piece of board kept inside and points out the 19 low-level amplifiers in its belly.

The console—a complete control for stereo with a third channel if needed—has a complete set of filters to attenuate any part of the audio spectrum, and a fantastically flexible switching and patching system. An audio oscillator (for checking) forms part of the console, and a vibrato unit (built, incidentally, from the RADIO-ELECTRONICS article on page 57 of the March, 1957, issue) is built into one end of the console.

Les Paul is an artist who has made his way to success by making practical electronics part of his art. His "New Sound" (sometimes called "the Les Paul effect" by audio technicians) is, of course, an application of electronic techniques. What is not so well known is that Les Paul has been a researcher

and experimenter in the electronic end of the recording field since early in his career—even before his career.

His first venture into electronic music was at the age of 13 in his boyhood home in Waukesha, Wis. Fascinated by the family's radio-phono combination—a Kolster—and discontented with the volume level of his first guitar, he decided to combine the two. The phono cartridge was taped to the body of the guitar, with the sharp needle embedded in the wood and the output fed into the phonograph input. The experiment was successful, and Les had a guitar that would play at any level he liked, to the limit of the set's volume control.

From this crude contact pickup to home recording was just a step. A trip to Milwaukee netted another pickup and a Western Electric double-button mike. An old spring-wound console Victrola became the recorder. The 13-year-old experimenter placed the new pickup in its tone arm and connected the new mike and old guitar pickup to the amplifier input. The record blanks were, of course, the pregrooved type available to experimenters before World War II. Les was not too satisfied with the recordings, but remembers that his mother used it later to record him over the air from WHAD in Milwaukee, where he started to play in 1930, at the age of 14.

The first recording assignment for which he was actually paid, however, did not come till 1931, when he made his first commercial record (*Deep-Elm Blues* on one side and *Just Because* on the other) for Champion Records.

Throughout his early recording career, Les always sensed something not quite right in his recordings. Possibly the horrible quality of some of his own boyhood efforts had revealed to him that—the engineers to the contrary—a recording setup need not be automatically perfect.

Finally, in 1942, during a recording session with Bing Crosby, he declared his opinion. The stuff just wasn't right, he said. A singer shouldn't sound as if he had his head in a rain barrel. The recording engineer was too much



A small portion of the studio. At left are two standard Ampex tape recorders; center is the Monster; at its right the Octopus, flanked by its eight amplifiers and—at the extreme right—the power supplies for the equipment.

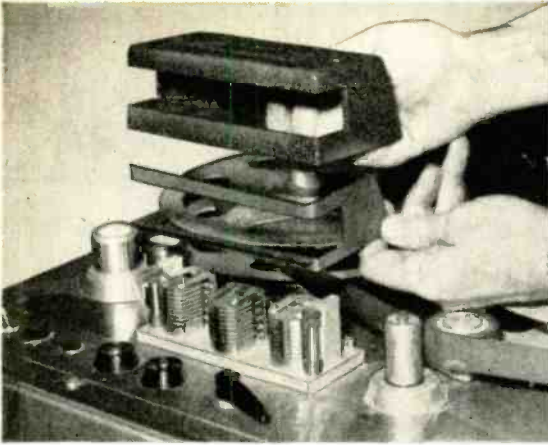

Closeup of Octopus shows width of tape and the eight-track heads.

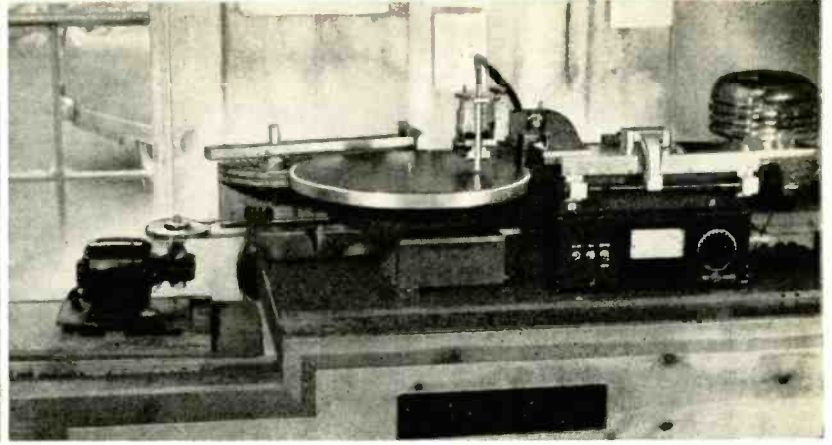

The Les Paul cutter, plus a playback arm. The two flat slabs under motor and cutter are iron plate.

amused at this outbreak from a mere musician to be insulted, but his recording partner took the matter seriously and invited Les to do something about it—if he was convinced that something could be done.

And Les was. Forsaking the profitable side of recording, he set up in a Hollywood garage a studio to be devoted to research. The recorder—still used occasionally—was a home-built job, with a Cadillac flywheel for the turntable and airplane surplus parts for much of the rotating machinery. The bed of 3/16-inch boiler plate adds to its "built-like-a-battleship" appearance. Les says it's completely vibrationless, and the idea seems plausible.

(In spite of its virtues, and even though some of his best records have been made on it, Les is ordering one of the better commercial cutters for such records as he may find it expeditious to cut himself. Most of his records, however, are cut from tapes forwarded from the New Jersey studio.)

In this garage studio Les worked from 1944 to 1950, always searching for better sound. At first the research represented a steady expenditure, but toward the end of the period its reputation grew till it threatened to become a commercial success and Les had to hire two other people to take care of the work.

Possibly the most successful result of the research period was that of multiple sound on a record. After much experimenting with adding parts—the "Les Paul effect" of decaying echo—and the expenditure of more than 500 recording blanks, *Lover* and *Brazil* were produced. An auto accident at this time put Les in the hospital for nearly 2 years and ended the garage period. During the latter part of his hospitalization he had time to study his problems further, and one of the results was a switch to tape as the recording medium for the New Sound.

Tape was a natural for the job. Les added an extra playback head just before the erase head. Then he recorded one of the parts of the projected piece of music on the tape. When the tape

was rewound and played back, the pick-up head picked up the signals from the tape just before it entered the erase head and re-recorded them an inch or two down the tape, combined with the second part which Les, monitoring with headphones, was playing. The tape would now have two parts on it, and the process could be continued as long as desired so that the finished tape might have Les playing a dozen or more guitars. (The maximum number of parts recorded on a single tape was 24, and 21 parts were recorded on a disc in the pre-tape period.)

With the new tape machine, Les and Mary settled down temporarily in Jackson Heights, N. Y., and with it recorded some of their greatest successes. Here for the first time Les ran into a new technical difficulty—neighbor trouble. Their life in show business had conditioned them to "getting up early in the evening" and doing most of their serious work after the show closed. To avoid eviction, they had to modify those hours somewhat. Even then, some work was done to the accompaniment of tenants pounding the ceiling. One recording, *Just One More Chance*, was actually made with Mary singing with her head under a blanket, apparently without adding any new effect that could be noted.

The only disadvantage of the tape machine was that each recording was necessarily erased in making the next, so that an accident in, say, the 11th part would make it necessary to do the first 10 all over again. This was the reason for "The Octopus"—it cured that weakness.

That instrument is another Ampex tape recorder, but with a tape 1 inch wide. Eight parts can be recorded side by side on its eight tracks. They can be blended as required, or one or more can be rejected and new parts substituted, without losing recordings that may be useful. They can be mixed on the control console and a trial tape made up. If the composite recording is not all that might be desired, it is a simple matter to erase it and try another arrangement. The original eight

tracks can still be drawn on at will.

The Octopus sits at the right of the control console in the photograph. To the left of the Monster are two conventional Ampexes, and to the right of the Octopus are its eight amplifiers. The tall rack at the edge of the picture contains the power supply for the whole equipment.

But this is not the whole story. Once the visitor has recovered somewhat from the overwhelming effect of all this equipment, Les takes him out to the "new studio," which was apparently the old barn. The inside is a complete television studio, two stories high, with a control room on the mezzanine at one end and garage doors at one side wide enough to admit a fleet of trucks driving abreast.

One might wonder how—with all this electronic equipment to keep in order—Les gets any serious work done without the help of a full-time engineer. But the Les Paul and Mary Ford fan need not worry—even while this article was being written, word of their new contract with Columbia Records came out, and we can expect soon to hear a number of their records under the Columbia label. END



"Yes, George, that's a fine stereo system you have there."

A survey of the stereo preamps and preamp-amplifier combinations you can find on your dealer's shelves today

AMPLIFIERS FOR STEREO

By HERMAN BURSTEIN

A YEAR ago scarcely a stereo preamp or amplifier was to be had, despite the fact that stereo tapes were already well established. Today, a spate of stereo amplifiers—some purely control units, others including power amplifiers as well—are coming off the production lines.

Considering the newness of the stereo amplifier, we can expect to find considerable variation in the controls and features of the units produced by different manufacturers. This is all to the good, for it permits a field evaluation as to the best ways of coping with the special problems raised by stereo—problems involving control of gain, bass, treble, loudness, balance between channels, etc.

Based on replies to a questionnaire sent to manufacturers of high-fidelity amplifiers, a listing of principal features and characteristics of a number of representative stereo amplifiers has been made. The data appear in the tables. Several of the listed units include dual power amplifiers, while the rest are purely stereo control amplifiers. Some of the manufacturers, whose product is listed in the tables, make other stereo items as well. For the sake of conciseness, however, just one representative unit was selected for the present discussion.

Inputs and outputs

Conceivably, the stereophile could use three high-level inputs—that is, pairs of inputs.

One pair would be for two tuners. At present, most stereocasting is of the FM-AM variety: an FM station and its AM adjunct broadcast the two channels of a stereo program. Eventually, stereocasting will probably be all-FM in nature, employing the multiplexing technique that permits one FM station to transmit two signals (see page 53).

The second pair would be for a piezoelectric stereo cartridge. A substantial number of such pickups are already on the market, those of Astatic, Electro-Voice, Ronette, Sonotone, etc. (see "Stereo Phono Cartridges, Part I," RADIO-ELECTRONICS, September, 1958).

The third pair of high-level inputs would be for a stereo tape amplifier. While the stereo disc is making today's headlines, there is no reason to believe that stereo tape will fade away. Developments such as the four-track stereo

head, permitting more to be recorded on a given-size tape reel, indicate that the price of stereo tape will come down appreciably from its present rather lofty height.

Looking at Table I, which summarizes input and output facilities of the stereo amplifiers surveyed here, we find that most of the units provide at least three high-level inputs, including one for piezoelectric cartridges, while a couple have four high-level inputs.

In monaural equipment separate low- and high-level inputs for magnetic cartridges are usually provided to accommodate the substantially different output levels of various magnetic cartridges, thereby preventing possible overload of the input stage. While all the stereo amplifiers have magnetic phono inputs, it is the exception rather than the rule to find separate low- and high-level magnetic phono inputs. This is understandable in view of the complexity of stereo amplifiers and the resultant desire to keep such inputs to a minimum.

It is interesting to note that all the amplifiers listed in Table I are designed to accept a signal directly from a tape head, saving the stereophile the cost of tape playback amplifiers. In every case but one, the manufacturer claims to provide NARTB equalization—a 23-db boost at 50 cycles with reference to 1,000 cycles, and about a 10-db cut at 15,000 cycles. The sole exception is the Leak Point One, a British amplifier, which incorporates the CCIR equalization curve standard in Europe. This provides somewhat less bass boost and treble cut than the NARTB characteristic.

Worthy of special note is the ap-

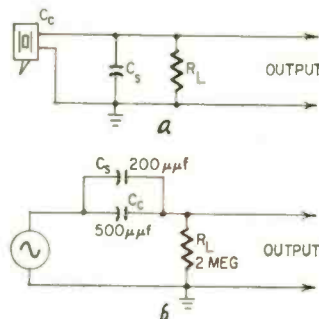

Fig. 1—**a**—Circuit of a piezoelectric phono cartridge; **b**—Equivalent circuit of the same cartridge showing the high-pass filter formed by the circuit elements.

proach to tape equalization in the Sargent-Rayment amplifier. Three playback curves are provided: the NARTB curve for 15-ips or 7.5-ips tapes played with a head having a .00015-inch gap; the NARTB curve, modified by the addition of treble boost reaching 11 db at 10,000 cycles, for playing 7.5-ips tapes, with a head having a .0005-inch gap and a curve for 3.75-ips tapes.

Only a couple of the listed amplifiers permit the tape output jacks to be switched out of the circuit when the signal source is a tape amplifier. In some tape amplifiers a feedback path can be set up so the signal from the tape amplifier's output jack goes to the control amplifier's input jack, into the tape amplifier's input jack, again to the tape amplifier's output jack, etc. The result is an intolerable howl, squeal or sputter, unless one of the connections is broken. Hence the desirability in some cases of having the control amplifier disconnect the tape output jack when the control amplifier is receiving a signal from the tape amplifier. With most modern tape recorders this is not a problem. The switching is handled at the recorder.

The piezoelectric cartridge has special loading problems, and the majority of the amplifiers in Table I, according to the questionnaire replies, recognize this by providing a special jack for such a cartridge. This type of pickup inherently responds to groove amplitude, as contrasted with the magnetic pickup, which responds to groove velocity. Hence, in playing an RIAA recording, the piezoelectric cartridge requires bass *cut* and treble *boost*. The treble boost is incorporated in the cartridge itself in the form of mechanical resonance. The bass is cut by feeding the cartridge into a load resistor of proper value. The cartridge capacitance plus other circuit capacitances form a high-pass filter in conjunction with the load resistance, as in Fig. 1. If the time constants of the circuit capacitances and the load resistance are correct, the proper amount of bass droop takes place. Taking into account the capacitance of his cartridge and the probable range of values of other circuit capacitances, the manufacturer recommends the necessary load resistance, which lies between 500,000 ohms and 3 megohms. Values around 2 megohms are typical.

Another solution is to convert the piezoelectric cartridge into a velocity-

TABLE I
INPUTS AND OUTPUTS

MANUFACTURER	MODEL	TYPE	SEPARATE HIGH- AND LOW-LEVEL MAGNETIC PHONO INPUTS	HARTS EQUALIZ FOR TAPE HEAD INPUTS	TAPE OUTPUT SWITCHED OUT OF CIRCUIT	PIEZO-ELECTRIC PHONO INPUT	NUMBER OF HIGH-LEVEL INPUTS (EXCEPT PIEZO)	OTHER INPUTS
ALLIED RADIO	KNIGHT KN734	DUAL AMP-PREAMP	NO	YES	NO	YES	3	—
ALTEC LANSING	445A	DUAL PREAMP	YES	YES	NO	YES	4	MICROPHONE
AMPEX	Control Center	DUAL PREAMP	NO	YES	NI	YES	3	—
ARKAY RADIO KITS	SP-6	DUAL PREAMP	NO	YES	NO	YES	2	—
BELL SOUND SYSTEMS	3030	DUAL AMP-PREAMP	NO	YES	NO	YES	2	—
BOGEN, DAVID	DB212	DUAL AMP-PREAMP	NO	YES	NO	YES	3	—
DeWALD	M-1200	DUAL AMP-PREAMP	YES	YES	YES	YES	2	—
DYNAKIT	DSC-1	STEREO ADAPTER	NA	NA	NA	NA	NA	—
ELECTRONIC INSTRUMENTS CO. EICO	HF81	DUAL AMP-PREAMP	NO	YES	NO	YES	3	MICROPHONE MULTIPLEX
FAIRCHILD RECORDING EQUIP	248	DUAL PREAMP	YES	YES	NO	NO	2	MICROPHONE
FISHER RADIO	X-101	DUAL AMP-PREAMP	YES	YES	NO	YES	2	—
GENERAL ELECTRIC	MS-4000	DUAL AMP-PREAMP	NO	YES	NO	YES	2	—
GROMMES PRECISION ELECTRONICS	208	DUAL PREAMP	NO	YES	NO	YES	3	—
HARMAN KARDON	A-250	DUAL AMP-PREAMP	YES	YES	NO	YES	3	—
HEATHKIT	SP-2	DUAL PREAMP	NO	YES	YES	YES	3	MICROPHONE
KNIGHT KIT	Y-776	DUAL PREAMP	NO	YES	YES	YES	2	MICROPHONE
LAFAYETTE RADIO	KT-600	DUAL PREAMP	NO	YES	YES	YES	3	MICROPHONE
LEAK	POINT ONE	DUAL PREAMP	NO	NO USES CCR	NO	YES	2	MICROPHONE
MADISON FIELDING	320	DUAL AMP-PREAMP	NO	YES	NO	YES	2	—
MARANTZ	6	STEREO ADAPTER	NA	NA	NA	NA	3	—
McINTOSH LABORATORIES	C85	PREAMP MONAURAL WITH STEREO CONTROLS	YES	YES	NO	YES	2	—
NEWCOMB AUDIO PRODUCTS	3012	DUAL AMP-PREAMP	YES	NO	NO	YES	2	—
PILOT	SP-210	DUAL PREAMP	NO	YES	NO	YES	3	MICROPHONE MULTIPLEX
SARGENT-RAYMENT	SR-17-17	DUAL AMP-PREAMP	NO	YES	NO	YES	3	—
SCOTT, H. H.	299	DUAL AMP-PREAMP	YES	YES	NO	YES	2	—
SHERWOOD ELECTRONIC LABS	S-5000	DUAL AMP-PREAMP	NO	YES	NO	YES	3	—
STROMBERG-CARLSON	ASR-433	DUAL AMP-PREAMP	NO	YES	NO	NI	2	—
TECH-MASTER ALL TRANSISTOR	41	DUAL PREAMP	YES	NI	NO	YES	2	—
VIDEO INSTRUMENTS ALL TRANSISTOR	88	DUAL AMP-PREAMP	NO	YES	NO	YES	2	MICROPHONE

NI—No information from manufacturer
NA—Not applicable

responding device, either by feeding its output into a small load resistor (47,000 ohms is typical) or by placing it in series with a small capacitance. An example of the latter technique, used by Sargent-Rayment, appears in Fig. 2. Either method—small load resistor or small series capacitor—produces high-pass filter action through all or substantially all of the audio range, so the signal from the piezoelectric

cartridge rises with frequency in the same manner as the signal obtained from a magnetic cartridge, assuming constant groove velocity at all frequencies. Hence the piezoelectric pickup, when converted into a velocity-responding device, can be treated—its output equalized and amplified—just like a magnetic cartridge. The advantage is that various equalization curves can then be applied to the cartridge output;

whereas when the piezoelectric cartridge is treated as an amplitude device and fed into a high-level input jack, only RIAA equalization can be achieved.

Stereo controls

When using a monaural source such as an FM tuner, the stereophile may want to feed the signal into both channels so both power amplifiers and both speakers are operating, producing a

AUDIO—HIGH FIDELITY

quasi-stereo effect. Table II shows that all the amplifiers for which there is information permit the user to feed one signal to both channels. This is also useful for balancing the levels of the two speakers with respect to each other—using a monaural signal. Proper balance would occur when the sound appears to come from a point midway between the speakers.

The stereophile may also want to combine two signals so both amplifiers and both speakers reproduce the combined signal. This situation is apt to occur when playing a monaural disc with a stereo cartridge. Each section of the cartridge puts out the same signal. By combining the signals from each section, two advantages are obtained: greater output from the car-

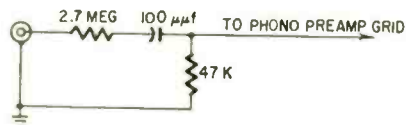

Fig. 2—Input network for converting a piezoelectric cartridge into a velocity device.

tridge, giving a higher signal-to-noise ratio, and cancellation of vertical rumble. The two sections of the stereo cartridge are phased so that their outputs are in phase with respect to lateral motion, representing the audio information, and out of phase with respect to vertical motion, representing rumble. Hence by combining the outputs from the two sections of the stereo cartridge, the audio signals are added in phase, while the rumble signals are added out of phase, giving an appreciable degree of cancellation. All of the amplifiers for which there is information permit two signals to be combined.

At least in the early days of stereo, a channel-reversal switch was considered a necessary feature, permitting the left-channel signal to be fed to the right speaker and vice versa in the event the channels had been reversed in the original program source—tape, disc or FM-AM stereocast. Yet a number of amplifiers do not include a channel-reversal switch. Apparently it is felt by their manufacturers that the left-right distinction has been sufficiently standardized to let them omit the channel-reversal feature. However, there is some question as to whether such standardization has been reached in the case of FM-AM stereocasting, although it does exist with tapes and discs. For tape, the left channel is on the upper half of the tape when it moves from left to right. In the stereo disc, the left channel is inscribed on the left groove wall as one looks head on at the record in normal playing position.

A phase-reversal switch has also been considered a necessity by many—it lets you shift one of the signals 180° with respect to the other. Incorrect phasing of the speakers in relation to each other causes an improper spatial

orientation of sounds, particularly sounds supposed to emanate from a point between the two speakers. Some of the listed amplifiers permit the user to reverse phase at the amplifier, although this can be done at the speaker by reversing its leads.

Balance, tone and volume

A balance control also is widely thought an important feature of a stereo amplifier, yet some of the listed amplifiers do not contain one. Instead, they have individual gain controls for each channel, which are adjusted to bring the speaker outputs into balance. The balance control employed in the remaining units alters the levels of the two channels in relation to each other, at the same time maintaining their total output nearly constant. At the extreme setting of the balance control, as shown in Table II, the difference between channel levels ranges from as little as 6 db to as much as infinity—complete silencing of one channel.

Proper balance may vary with the listener's accustomed position in the room. However, when he is in this position, he may not be within reach of the balance control, so he has to have someone else manipulate the balance control or get up several times to adjust it himself. Heath has solved this problem by placing its balance control at the end of a 20-foot cable.

An unusual balancing feature is provided by the Madison Fielding series 320, employing a 6AF6 dual indicator tube. The amplifier has a built-in tone generator consisting of a 2-ohm resistor in series with the center tap of the power transformer, as shown in Fig. 3. This provides a 120-cycle tone. There are two controls marked "calibrate," one for the left channel and one for the right. When turned on, these feed the 120-cycle tone to the left and right amplifiers. The output from each amplifier is amplified by a triode and fed to the two grids of the 6AF6, as in Fig. 4. The listener balances the two sections of the stereo amplifier by adjusting the gain control of each channel (there is no balance control) until the shadow of each half of the eye barely closes. This assures that the left and right

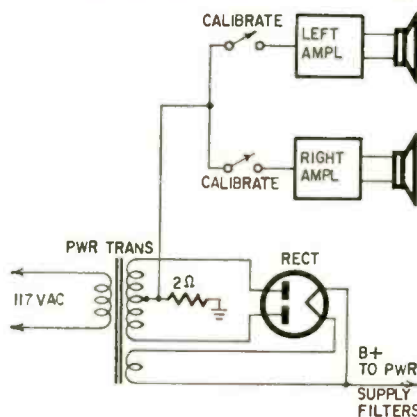

Fig. 3—Tone generator for channel balancing used in Madison-Fielding Series 320.

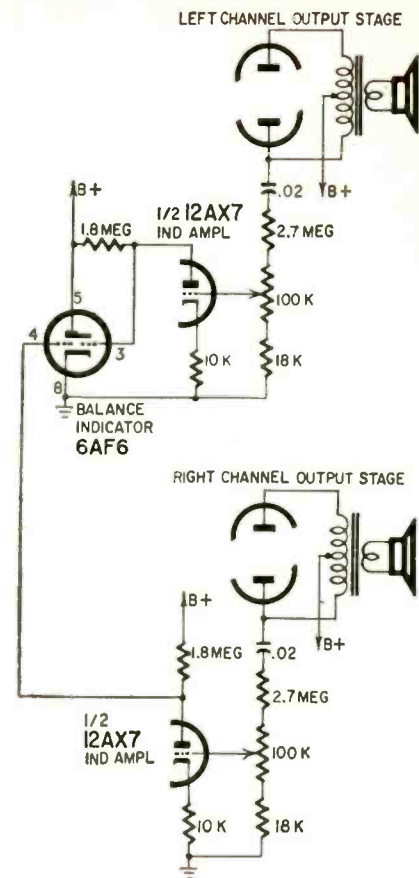

Fig. 4—The 6AF6 dual indicator tube is used with half of a 12AX7 as a balance indicator to show when both channels are properly balanced.

sections of the stereo amplifier produce equal amounts of power for equal incoming signals. This is very desirable when using matched speaker systems and equal inputs. However, when using dissimilar speaker systems or dissimilar inputs—as in FM-AM stereocasts—the value of this magic-eye balancing feature would appear to be limited.

The majority of the stereo amplifiers have a master gain control which simultaneously varies the gain of both channels. In the Heath SP-2, separate controls are provided. However, these are concentric with each other and have a locking feature so they can operate as one. So Heath actually provides both ganged and separate operation.

As volume is reduced or increased with the master gain control, it is vital that the relative levels of the two channels do not change significantly as volume is reduced or increased. Such relative change as does occur is referred to as tracking error. Information on tracking error was supplied by eight of the manufacturers listed in Table II. Various methods are used to keep this error to a minimum. Some of these, citing from replies to the questionnaire, are: "Controls are manufactured to specification." "Close tolerance controls—anti-backlash." "Quality control on the part of the control manufacturer." "Special taper on control." "10% potentiometers with external resistive correction where necessary" (10%

**TABLE II
STEREO CONTROLS**

MANUFACTURER	MODEL	CHANNEL REVERSAL SWITCH	PHASE REVERSAL SWITCH (COMBINATIONS ONLY)	BALANCE CONTROL		MASTER GAIN CONTROL		TYPE BASS AND TREBLE CONTROLS	TYPE LOUDNESS CONTROL (IF ANY)
				YES OR NO	MAX. DIFFERENCE BETWEEN LEVELS (DB)	YES OR NO	MAX. TRACKING ERROR (DB)		
ALLIED RADIO	KNIGHT KN734	YES	YES	YES	INFINITE	YES	1	SEPARATE	SWITCH IN*
ALTEC LANSING	445A	YES	NA	YES	13.5	YES	1.6	SEPARATE	SEPARATE
AMPEX	Control Center	YES	NA	NO	NA	NO	NA	GANGED	SEPARATE
ARKAY RADIO KITS	SP-6	YES	NA	YES	20	YES	2	GANGED	SEPARATE
BELL SOUND SYSTEMS	3030	YES	NO	YES	INFINITE	YES	2	GANGED	SEPARATE
BOGEN DAVID	DB212	YES	YES	YES	12	YES	1	GANGED	NONE
DeWALD	M-1200	YES	YES	YES	NA	YES	2	SEPARATE	SWITCH IN
DYNAKIT	DSC-1	YES	NA	YES	20	YES	1	ON PREAMPS	SWITCH IN
ELECTRONIC INSTRUMENTS CO. (EICO)	HF81	YES	NO	YES	12	YES	NI	SEPARATE	NONE
FAIRCHILD RECORDING EQUIP.	248	NO	NA	YES	INFINITE	YES	1	SEPARATE	SWITCH IN
FISHER RADIO	X-101	YES	NO	YES	14	YES	1.5	GANGED	SWITCH IN
GENERAL ELECTRIC	MS-4000	YES	YES	YES	INFINITE	YES	3	GANGED	SEPARATE
GROMMES (PRECISION ELECTRONICS)	208	NO	NA	YES	12	YES	1	GANGED	SWITCH IN
HARMAN-KARDON	A-250	YES	NO	YES	INFINITE	YES	1	GANGED	SWITCH IN
HEATHKIT	SP-2	NO	NA	YES	7	YES	NA	SEPARATE	SEPARATE
KNIGHT KIT	Y-776	YES	NA	YES	INFINITE	YES	1.6	SEPARATE	SEPARATE
LAFAYETTE RADIO	KT-600	YES	YES	YES	INFINITE	NO	NA	SEPARATE	SEPARATE
LEAK	POINT ONE	YES	NA	YES	INFINITE	YES	NI	GANGED	NONE
MADISON-FIELDING	320	NO	NO	NO	NA	YES	NI	SEPARATE	SEPARATE
MARANTZ	6	YES	NA	NO	NA	YES	1	ON PREAMPS	ON PREAMPS
McINTOSH LABORATORIES	C85	YES	NA	YES	12	YES	1	GANGED	SEPARATE
NEWCOMB AUDIO PRODUCTS	3D12	YES	NO	YES	NA	YES	NI	GANGED	SEPARATE
PILOT	SP-210	YES	NA	YES	NI	YES	NI	SEPARATE	NONE
SARGENT RAYMENT	SR-17-17	YES	NO	YES	26	YES	4	GANGED	SWITCH IN
SCOTT, H. H.	299	YES	YES	YES	40	YES	1	SEPARATE	SWITCH IN
SHERWOOD ELECTRONIC LABS	S-5000	YES	YES	YES	40	YES	1	GANGED	GANGED
STROMBERG-CARLSON	ASR-433	NO	NO	NO	INFINITE	YES	NI	SEPARATE	SWITCH IN
TECH-MASTER	41	YES	NA	YES	INFINITE	YES	2	SEPARATE	NONE
VIDEO INSTRUMENTS	88	YES	YES	YES	INFINITE	YES	2	GANGED	SWITCH IN

NI—No information from manufacturer

NA—Not applicable

*Switch In means that compensation is added to standard volume control switching it to a loudness control

accuracy means deviation of no more than 1 db). "Padding of control taps."

Fig. 5 is a good illustration of how one manufacturer, Precision Electronics (Grommes), minimizes tracking error in the master gain control by shunting resistors across taps on the potentiometer for each channel. Through these resistors, the two potentiometers are brought into correspondence not only at maximum and minimum rotation but also at two intermediate points. This limits the amount of tracking error that can occur at other intermediate points.

While the majority of stereo amplifiers have ganged bass and ganged treble controls, a significant number use separate tone controls for each channel. There is room for argument in behalf of either practice. The ganged tone control simplifies operation and appearance. The individual control for

each channel is more versatile. To illustrate, if the stereophile has different speakers for each channel, he may want corrective bass boost in one but not in the other or he may want different degrees of such boost in each speaker. Similarly, he may seek different treble correction in one speaker than in the other. Even when using matched speaker systems, their location and orientation with respect to the listener may call for different degrees of tone adjustment. Furthermore, the need for different tone correction in each channel may arise from differences in the signal source.

Almost all the listed amplifiers give the user the option of introducing loudness compensation. Sometimes this consists only of bass boost to compensate for the apparent loss of low frequencies to the ear at reduced volume. In others, some treble boost is also

provided. In most units loudness compensation is switched in—the gain control is converted to a loudness control. Sometimes the switch has more than two positions, so varying degrees of loudness compensation are supplied. In the Bell and Heath units, the loudness controls are of the more conventional kind: a continuously variable control simultaneously adjusts the level and introduces loudness compensation, while a separate control governs level only.

Table II does not have room for all the features found in the amplifiers listed. Some units incorporate rumble or scratch filters or both, and sometimes these are ganged while other times there are individual ones for each channel—as many as four filter switches in all. Some amplifiers provide for their use as electronic crossovers or, where they include power amplifiers, as bi-amplifiers. Two of the amplifiers

AUDIO—HIGH FIDELITY

(Tech-Master and Video Instruments) are all-transistor units. Hum adjustments are included in many, and one of them (Harmon-Kardon) has two.

Specifications

The stereophile is interested in purchasing quality performance as well as stereo functions and features. Therefore, Table III lists various specifications supplied by the manufacturers concerning input resistance, sensitivity, signal-to-noise ratio and, where power amplifiers are included, power output.

With respect to high-level sources such as tuners, which nowadays generally have a cathode-follower output, input resistances of 100,000 ohms and up are generally satisfactory. However, as indicated earlier, input resistance for piezoelectric cartridges is fairly critical and may require a load resistance ranging from 500,000 ohms to 3 megohms, depending upon the make of cartridge. About 25% variation from the value prescribed by the manufacturer is tolerable.

Turning to the low-level inputs, specifically magnetic phono, we find that the load resistances range from 47,000 to 150,000 ohms. One unit, the Madison Fielding, provides variable resistance from 3,000 to 50,000 ohms. While any value above a few hundred or a few thousand ohms is satisfactory for the moving-coil type of magnetic cartridge, which has very low inductance, the load value is fairly critical for the other types of magnetic cartridges (variable reluctance, moving magnet, etc.) having high inductance. In the latter, cartridge inductance and winding capacitance plus circuit capacitance (cable, input tube) produce electrical resonance within or slightly above the audio range, causing an audible peak. Hence a relatively small load resistance is required to damp this peak. But if the load resistance is too small, there will be a droop in treble response because of the low-pass filter action produced by the cartridge inductance in series with the load resistance. So you can see why the load resistance is on the critical side for magnetic pickups other than the moving-coil type. It would seem that the best way to provide correct load resistance on the part of the amplifier manufacturer is to incorporate an accurately calibrated variable resistance.

The sensitivity figures for high-level inputs (tuner input is taken as a representative case) appear very adequate. High-level sources typically produce at least 500 mv on peaks. More often they turn out 1 or 2 volts. The sensitivities of the listed amplifiers range from 50 to 400 mv on tuner input. The sensitivity figures also appear exceptionally good for magnetic phono cartridges, most of which can produce at least 10 or 15 mv on peaks, and some as much as 100 mv. By comparison, the listed sensitivities range from 1 to 5.5 mv. When we come to inputs

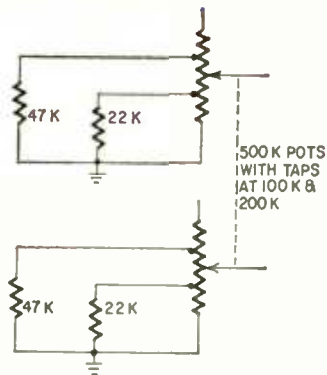

Fig. 5—How tracking error is reduced in a master gain control (Grommes Model 208) by using shunt resistors.

intended for tape heads, the sensitivities for the most part appear adequate, but without any great margin to spare, as the maximum output expected from a tape head is usually below 5 mv—2 or 3 mv is typical. With the four-track tapes, scheduled to make their appearance soon (they may have done so by the time this is published), only half as much output will be obtained as before, since each track covers only about half as much space. Consequently, a number of the amplifiers listed in Table III may have somewhat inadequate sensitivity on tape-head input for some users' needs.

In all cases the distortion ratings appear to qualify the instruments as high fidelity. In some instances the distortion figures are exceptionally low.

For truly high-fidelity performance, minimum signal-to-noise ratio should be about 55 db. All the units meet this standard on high-level inputs, generally with a very good margin to spare. Most of them also meet this standard on magnetic phono input, but with a smaller margin.

Other units

Considering the rapid pace of developments in stereo, a considerable number of manufacturers in addition to those listed in this article will have come out with stereo amplifiers by the time this appears in print. However, the ones described here are representative. Details of future units will be presented as they become available.

At the same time there are a number of variations in stereo amplifiers. On the market today are stereo control amplifiers with one power amplifier, such as the Harmon-Kardon AX20, permitting the audiophile to make use of his present monaural power amplifier. Also, there are dual power amplifiers, such as the Altec Lansing 345A, the Pilot SA-260 and SA-232 and the Sargent-Rayment SR-534. Then there is a combination such as the Sargent-Rayment SR-380, which incorporates an FM-AM tuner (non-stereo) with a stereo control amplifier virtually identical to that in the model SR-17-17 listed in the tables.

Finally, it should be mentioned that there are passive units, such as the

H. H. Scott Stereo-Daptor (see "An Expand to Stereo Unit," RADIO-ELECTRONICS, July, 1958, page 36) for adapting two separate monaural systems to stereo use. The Stereo-Daptor is inserted between two preamplifiers and two power amplifiers or at a proper internal point in Scott combined control and power amplifiers. It provides a master gain control, which can be switched to act as a loudness control, and affords a choice of operation—stereo, reverse stereo (channel reversal), either channel or both channels combined. It also contains facilities for feeding a tape recorder and accepting a signal from a tape amplifier.

The individual now planning to "go stereo" has a great deal to choose from with respect to stereo amplifiers, and there is more to come. While it is possible that no one amplifier will give him 100% of what he desires, the units on the market offer sufficient variety so that he has an excellent chance of finding one that comes very close to his requirements, both in terms of stereo features and quality of performance. END

MANUFACTURERS

- ALLIED RADIO CORP., 100 N. Western Ave., Chicago 80, Ill.
- ALTEC LANSING CORP., 1515 S. Manchester, Anaheim, Calif.
- AMPEX AUDIO INC., Sunnyvale, Calif.
- ARKAY RADIO KITS INC., 120 Cedar St., New York 6, N. Y.
- BELL SOUND SYSTEMS INC., 555 Marion Rd., Columbus, Ohio.
- BOGEN, DAVID CO., Rt. 4 at Forest Ave., Paramus, N. J.
- DeWALD, Div. of United Scientific Labs., Inc., 35-15 37th Ave., Long Island City 1, N. Y.
- DYNAKIT, Dynaco Inc., 617 N. 41 St., Philadelphia 4, Pa.
- ELECTRONIC INSTRUMENTS CO. (EICO), 33-00 Northern Blvd., Long Island City 1, N. Y.
- FAIRCHILD RECORDING EQUIP. CO., 10-40 45th Ave., Long Island City, N. Y.
- FISHER RADIO CORP., 21-21 44th Dr., Long Island City, N. Y.
- GENERAL ELECTRIC, Specialty Electronic Components Dept., W. Genesee St., Auburn, N. Y.
- GROMMES, Precision Electronics Inc., 9101 King St., Franklin Park, Ill.
- HARMAN-KARDON INC., 520 Main St., Westbury, N. Y.
- HEATHKIT, Heath Co., Benton Harbor, Michigan
- KNIGHT-KIT, Allied Radio Corp., 100 N. Western Ave., Chicago 80, Ill.
- LAFAYETTE RADIO, 165 08 Liberty Ave., Jamaica 33, N. Y.
- LEAK, British Industries Corp., 80 Shore Rd., Port Washington, N. Y.
- MADISON-FIELDING CORP., 5 Lorimer St., Brooklyn 6, N. Y.
- MARANTZ CO., 25-14 Broadway, Long Island City 6, N. Y.
- McINTOSH LABORATORIES INC., 4 Chambers St., Binghamton, N. Y.
- NEWCOMB AUDIO PRODUCTS CO., 6824 Lexington Ave., Hollywood 38, Calif.
- PILOT RADIO CORP., 37-06 36th St., Long Island City 1, N. Y.
- SARGENT-RAYMENT CO., 4926 E. 12th St., Oakland 1, Calif.
- SCOTT, H. H. INC., 111 Powder Mill Rd., Maynard, Mass.
- SHERWOOD ELECTRONIC LABS. INC., 4300 N. California Ave., Chicago 18, Ill.
- STROMBERG-CARLSON, Div. of General Dynamics, 1700 University Ave., Rochester 3, N. Y.
- TECH-MASTER CORP., 75 Front St., Brooklyn, N. Y.
- VIDEO INSTRUMENTS CO. INC., 3002 Pennsylvania Ave., Santa Monica, Calif.

TABLE III
SPECIFICATIONS

MANUFACTURER	MODEL	HIGH-LEVEL INPUTS				POWER OUT PER CHAN- NEL (Watts)	LOW-LEVEL INPUTS					
		INPUT RESISTANCE		DISTORTION AT 1-VOLT OR 10-WATT OUTPUT	SIGNAL-TO-NOISE RATIO AT 1-VOLT OR 10-WATT OUTPUT (DB)		INPUT RESISTANCE	SENSITIVITY AT 1,000 CYCLES: FOR 1 VOLT OR 10 WATTS OUT		SIGNAL-TO-NOISE RATIO AT 1,000 CYCLES AT 1 VOLT OR 10 WATTS OUT		
		TUNER	PIEZO					MAG PHONO	TAPE HEAD		MAG PHONO (MV IN)	TAPE HEAD (MV IN)
ALLIED RADIO	KNIGHT KN734	500K	3 MEGS	320	0.7% HARMONIC	75	0-250K	500K	4.0	3.6	53	48
ALTEC LANSING	445A	100K		250	0.45% HARMONIC	75	50K	50K	3.3	1.8	59	54
AMPEX	Control Center	500K	NI	800	IM UNMEASURABLE	UNMEASURABLE	4.42K	330K	4.0	0.8	55	55
ARKAY RADIO KITS	SP-6	1 MEG	1 MEG	80	LESS THAN 0.25% IM	90	47K	100K	1.5	1.5	70	70
BELL SOUND SYSTEMS	3030	250K	7 MEG @ 1KC	220	0.5%	71	110K	110K	2.4	2.4	53	49
BOGEN, DAVID	DB212	250K	NI	400	NI	75	75K	100K	4.0	4.0	55	55
OPAWALD	M-1200	500K	500K	NI	1.5%	NI	100K	100K	1.5	NI	50	50
DYNAKIT	OSC-1	NA	NA	NA	NA	NA	NA	NA	NA	NA	NA	NA
ELECTRONIC INSTRUMENTS CO. EICO	HF81	500K	500K	500	1% IM	75	100K	1 MEG	3.5	1.75	60	50
FAIRCHILD RECORDING EQUIP.	248	100K	NA	200	LESS THAN .09% IM	86	47K	1 MEG	2.0	1.5	72	74
FISHER RADIO	X-101	250K	1 MEG	150	0.8% IM	70	100K	100K	2.0	1.5	64	57
GENERAL ELECTRIC	MS-4000	500K	100K	120	0.5% IM	75	100K	100K	2.5	2.2	68	65
GROMMES PRECISION ELECTRONICS	208	500K	NI	250	0.1% IM	85	47K	47K	4.0	3.0	70	70
HARMAN-KARDON	A-250	500K	100K	300	LESS THAN 0.2% HARMONIC	90	100K	100K	1.0	1.0	80	70
HEATHKIT	SP-2	600K	600K	100	0.1% IM	75	47K	100K	1.8	2.2	65	50
KNIGHT-KIT	Y-776	500K	2.5 MEG	150	LESS THAN 0.15% HARMONIC	80	5-105K	68K	2.5	2.5	60	60
LAFAYETTE RADIO	KY-800	250K	100K with 120 ohm in series	87	LESS THAN 0.1% IM	80	100K	100K	1.78	1.78	62	62
LEAK	POINT ONE	300K	NI	100	LESS THAN 0.1% HARMONIC	NI	100K	100K	5.0	4.5	NI	NI
MADISON-FIELDING	320	500K	NI	200	1% IM	80	3.3-50K	100K	2.0	1.2	60	60
MARANTZ	6	350K	NA	NA	NA	NA	NA	NA	NA	NA	NA	NA
McINTOSH LABORATORIES	C8S	500K	COMPENSATED	200	LESS THAN 0.2% HARMONIC	72	VARIABLE	500K	0.2	0.2	60	60
NEWCOMB AUDIO PRODUCTS	3D12	500K	NI	100	LESS THAN 1%	80	50K	NA	7.0	NA	NI	NA
PILOT	SP-210	250K	100K	110	LESS THAN 1% HARMONIC	80	100K	100K	3.0	2.0	80	80
SARGENT-RAYMENT	SR-17-17	500K	2.7K	110	0.5% IM	70	47K	47K	5.0	2.0	60	55
SCOTT, H. H.	299	300K	NI	400	LESS THAN 0.2% HARMONIC	80	47K	47K	2.0	2.0	OVER 65	60
SHERWOOD ELECTRONICS LABS.	S-5000	500K	15 MEG @ 100 CYCLES	200	LESS THAN 1% IM	80	47K	220K	2.0	2.0	60	60
STROMBERG-CARLSON	ASR-433	500K	100K	200	LESS THAN 1% HARMONIC	63	100K	100K	2.5	1.8	50	48
TECH-MASTER	41	1 MEG	500K	NA	LESS THAN 0.1% HARMONIC	72	5K	1.5K	5.0	0.5	80	80
VIDEO INSTRUMENTS	88	100K	2 MEG	200	0.5% IM AND HARMONIC	100	47K	47K	3.0	3.0	60	60

NA—Not applicable
NI—No information from manufacturer
All specifications given on these pages are from manufacturers' data available as of Aug. 20, 1958.
* 1-volt output refers to diaphragm;
10-watt output to combined diaphragm-amps.

"Heroic Stereophony" is the term the editor uses to describe the world's most impressive and ambitious audio demonstration

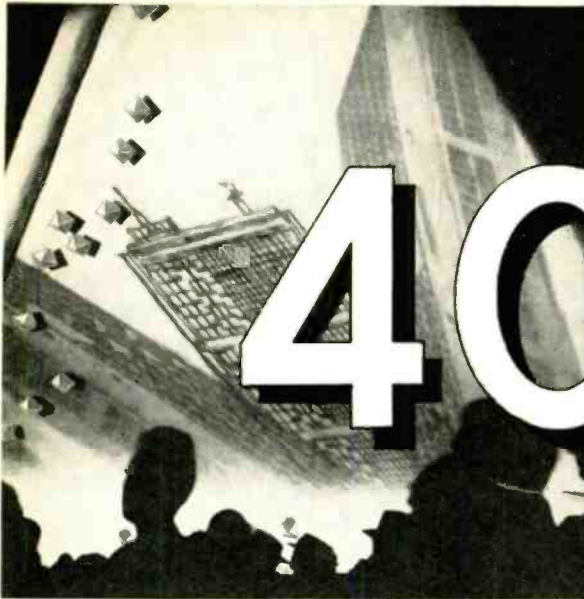

4000 LOUDSPEAKERS

By H. GERNSBACK

Western civilization — represented by American skyscrapers—is depicted on the giant screen formed by two inclined inside surfaces of the Philips pavilion. The diamond-shaped objects on left are a few of the loud speakers.

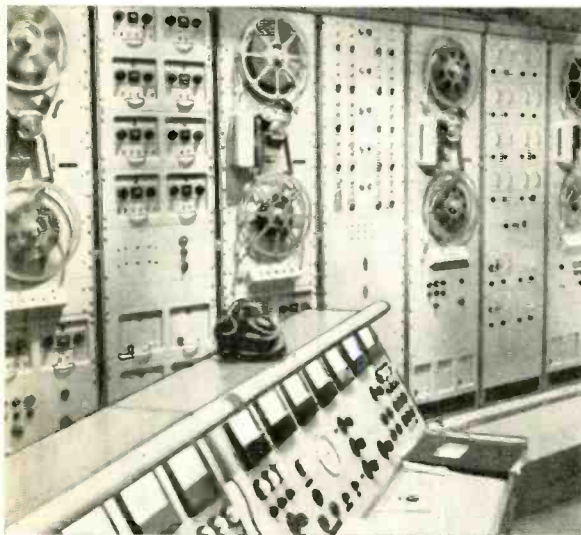

It was possible to get only a portion of the equipment — 3-channel tape players, 15-channel control tape apparatus, sound amplifiers and automatic switching and control racks — into a single photograph.

The main control desk. The man in the background is S. L. de Bruin, pavilion manager. He designed the automation equipment and is "captain of the ship" in the performance of the *Poeme Electronique*.

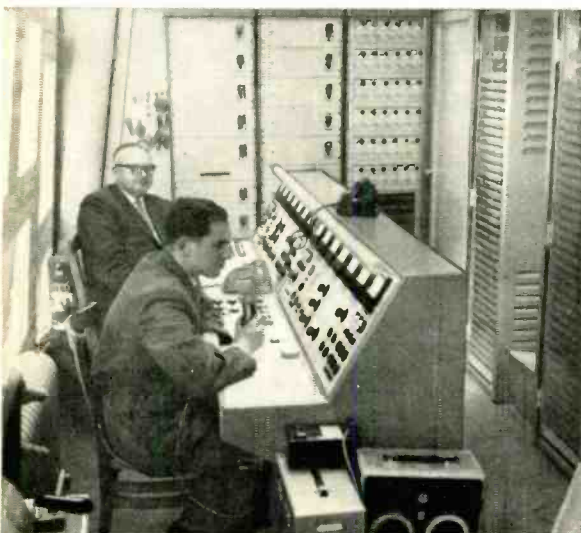

AT the Brussels Universal Exposition, the outstanding feature in electronics is probably the Philips *Electronic Poem*.

It is possibly the most heroic stereophonic sound presentation in existence.

The Philips Radio Corp. of Holland, employing over 160,000 people in 58 countries, used its best electronic engineering talent to put together the electronic poem. It was two years in the making. First, they engaged world-famed architect Le Corbusier to build a 6-story concrete and steel tepee-shaped auditorium that stands—not seats—500 people. He also wrote the script of the "poem." Next they engaged Edgar Varèse, France's inventor of *musique concrète* ("concrete music") to write the extraordinary music to accompany Le Corbusier's script. This took over a year. The Philips people gave the two geniuses *carte blanche* and the two artists went the limit, if not beyond!

A number of Philips engineers arranged a private hearing of the poem for us in the auditorium so we could report it to the readers of RADIO-ELECTRONICS.

The poem is comparatively simple in scope. On the stark concrete walls are flashed, in quick succession, unrelated huge colored pictures of life on this planet—the genesis of the earth and the various creatures that populate it. Then man and his accomplishments, down to modern times, are recorded. The pictures, a riot in color, flash by at express speed, often bewilder the onlooker, but they tell a connected story once you get the drift.

But it is the stereophonic sound that is the nucleus of the show. First, there are 400—four hundred—loudspeakers, nearly all going simultaneously for most of the performance. The speakers are placed all around the auditorium in

SAPPHIRE VS DIAMOND

How long should a stylus last?

various strategic positions, all of them turned toward the concrete walls on which the sound impinges and from which it is reflected. Placement of the 400 speakers was a long arduous task. The *musique concrète* was recorded on a three-track magnetic tape and can be varied in intensity and quality. Other startling sound effects are produced, from a large console operated by three sound-musician technicians.

The music—if one can call it really music—can best be described as highly sophisticated sound. It comes at you in staccato, often explosive effects. Shrieks, groans, auditorium-shaking, wrenching sounds. Sound flares, sound blobs, driving whistle sounds, rustling broken-glass effects for pianissimos, followed by battering-ram crashing fortissimos. Like the pictorial counterpart of the poem, the music is seldom connected into a musical phrase or rhythm—mostly there are stark concrete staccatos. Often, the intense spine-tingling reverberations overwhelm you as the sound impinges on you from all directions at once, only to numb you in turn with extremely high shrieking, whistling eerie echos.

As man becomes more civilized and his modern inventions are depicted, the *musique concrète* rises to a cacophony of mechanical sounds: harsh grinding metal upon metal, clanking-gnashing gears, shrieking brakes, the elegant click-clack of precision machinery, clock noises in profusion—in fact, every type of industrial sound is woven into a remarkable tapestry of rhythmic poetry of tonal reverberance.

From this wholly inadequate word picture of sound, one might get the impression that the whole performance was only a rendition of jumbled sound. Nothing could be more wrong. The electronic poem is truly a highly coordinated work of art. Nor do the 400 loudspeakers decibellow you out of the auditorium—even when going fortissimo. Here the engineers performed a miracle of sorts.

And while at the end you are wrung acoustically numb, your eardrums were never painfully hurt. For the electronic poem creates a deep emotional effect—it is an experience you will never forget.

The impression on the large audience varies widely. Some people are apparently stunned and leave, talking in subdued whispers. Others are plainly bewildered—some look angered. Some laugh hysterically, others shake their heads. Curiously, according to the director, there has never been any applause in the auditorium. The initiates, however, leave wildly enthusiastic and come back several times.

The director reacted favorably to our urgent suggestion to have the Electronic Poem shown in a few selected US cities in specially equipped film houses. We hope that Philips will do it soon. Audio fans are certain to patronize these shows.

END

Dear Editor:

In the article, "Hi-Fi Record Care" (RADIO-ELECTRONICS, July, 1958, page 30), the author, Arthur A. Hundley, makes the statement: "As a general estimate, a metal needle should be replaced after about 20 hours of actual use and a sapphire after about 100 hours, and a diamond should last at least 10 times longer than the sapphire."

This statement is in strong contradiction to information given by the better needle manufacturers and by independent critics. For example, in a study entitled *The Wear and Care of Records and Styli* by Harold D. Weiler (Climax Publication Co., 1954), the following statements occur:

"The opinion [of experts] varied. But all were in agreement that a sapphire stylus should be replaced after it had been in use between 10–30 hours on long-playing records. . . . To create a flat on a diamond-tipped stylus which is equal in size to the one shown in Fig. 31 (.00075") the average use required was 143½ hours against 3½ hours for the sapphire under the same test conditions."

According to Mr. Weiler, the following comparison between sapphire and diamond needles resulted from his study:

Flat: (Inches)	Sapphire: (Hours)	Diamond: (Hours)	Ratio, Diamond to Sapphire:
.001	7½	307½	41:1
.00125	17	697	41:1
.0075	38	1538	40.5:1

The ratio arrived at by a famous British expert, Stanley J. Kelly, was 42 to 1. In other words, the diamond stylus lasts 42 times as long as a sapphire.

In view of the above, I think it is important to hear Mr. Hundley's explanation of the figures given. If the experts cited above are right—and their observations are backed up by experiments involving thousands of cases—then Mr. Hundley has given your readers misleading information regarding the relative value of sapphire and diamond needles. This information might very well result in spoiling a lot of good hi-fi records by using a sapphire needle long after it was worn to the point where it can damage the grooves of the LP's.

L. E. MADISON

Dusseldorf, Germany

MR. HUNDLEY'S REPLY

(Mr. Madison's letter was referred to Mr. Hundley for his comment, which follows—Editor.)

Dear Editor:

After having read Mr. Madison's letter, I am not sure whether he is

disagreeing with the expected life of a sapphire stylus, the ratio between diamond and sapphire life, or both.

It seems like a case of oversimplification to say that "a diamond lasts 42 times as long as a sapphire." Considering the varying qualities available in both types, it does not seem possible that a definite ratio would hold true in every case. The figures are also based on a rather short playing time for the sapphire. In my article, "Hi-Fi Record Care," I stated that "a diamond should last at least 10 times longer than the sapphire." The "10 times" is a minimum, and the statement "at least 10" also includes 42.

The following quote is from *Guide to Audio Reproduction* by David Fidelman (John F. Rider Publisher, 1954) "A 1-mil sapphire stylus should be satisfactory for about 100 to 300 12-inch 33½-rpm sides . . . while the diamond stylus should last for about 10 to 20 times longer."

From *The Recording and Reproduction of Sound* by Oliver Read, page 165 (Howard W. Sams & Co., 1952): "The use of sapphire playback styli (needles) is recommended for all types of soft disc materials, due to the ability of the stylus to maintain a correct shape for hundreds of playings."

From *High Fidelity Techniques* by John H. Newitt, (Rinehart & Co., 1953): "The harder points (sapphire, etc.) are usually suitable for 300 to 1,000 plays on an ordinary 78-rpm record and considerably more if used on a vinylite or polystyrene record. . . . A diamond stylus has about 10 times the life of a sapphire."

For the past 5 years I have used a G-E variable-reluctance cartridge (8 grams pressure) equipped with sapphire styli. I have used each stylus about 6 months and each received over 100 hours of wear with no adverse results perceptible. One recording (London LL624) has been played numerous times over the past 5 years and the high-frequency portions do not seem to have been damaged at all. I have owned a copy of Columbia ML 4895 for almost that long, and recently I had a chance to compare it with a new copy. I couldn't tell the difference.

I will agree that replacement before 100 hours of wear might be more desirable because the user would be taking less chances. But considering time, trouble and costs, the longer figure is more desirable for the average hi-fi owner. I appreciate Mr. Madison's interest and do not question Mr. Weiler's results, but one test cannot tell the entire story.

ARTHUR A. HUNDLEY
Franklin Park, Ill.

STEREO PHONO

CARTRIDGES

PART II—The cartridges discussed this month include the Duotone ACOS Hi-g; Electro-Sonic C-100 Gyro-Jewel; Fairchild XP-4; General Electric Stereo Classic and Pickering's Stanton 45 x 45 Fluxvalve model 371. All are magnetic types except the Duotone

By JULIAN D. HIRSCH

IN last month's article, a number of low-cost ceramic and crystal stereo cartridges were described. Most of the makers of monophonic magnetic cartridges have also announced stereo models, and it is likely that more will be forthcoming in future months.

As with monophonic cartridges, magnetic stereo cartridges tend to be more expensive than ceramic types. In general, they have higher compliances, lower tracking forces and, in some cases, wider frequency response than the ceramic types.

The following cartridges are listed in alphabetical order by manufacturer's name. All are magnetic, except the piezoelectric Duotone, details on which arrived too late for Part I of this series.

Duotone ACOS Hi-g

The ACOS Hi-g, type GPS80-1, is a piezoelectric stereo cartridge imported from England by Duotone. Its elements are driven by two compliant couplings which form a V, visible in the photograph. The cylindrical stylus bar rests in a notch at the apex of the V. Modulation of either groove wall is transferred by the stylus through the corresponding coupling to one of the elements, leaving the other element unaffected.

Frequency response of the ACOS type GPS80-1 is 20–17,500 cycles within 2 db (referred to the RIAA curve). The nominal output is 1 volt. It is available only with a 0.7-mil stylus, either diamond or sapphire. The compliance is 2×10^{-6} cm/dyne, and recommended tracking force is 6 grams. Channel separation is stated to be a minimum of 20 db through the audio spectrum.

The net price of this cartridge is \$12 with a sapphire and \$18.75 with a diamond stylus.

Electro-Sonic C-100 Gyro-Jewel

Electro-Sonic Laboratories, who are known for their D'Arsonval-movement moving-coil cartridges, has announced a stereo cartridge employing the same basic type of construction. The ESL cartridges contain a long, narrow coil mounted between the pole pieces of a powerful magnet and pivoted in latex blocks at both ends. In the monophonic cartridges, the stylus drives one end of the coil via a cantilever shoe, rotating it about its long axis. The latex end

Cylindrical stylus bar transfers stylus movement through two compliant couplings to elements of Duotone cartridge

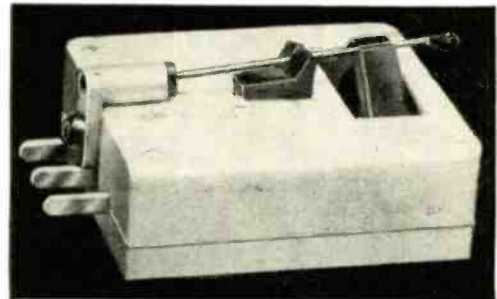
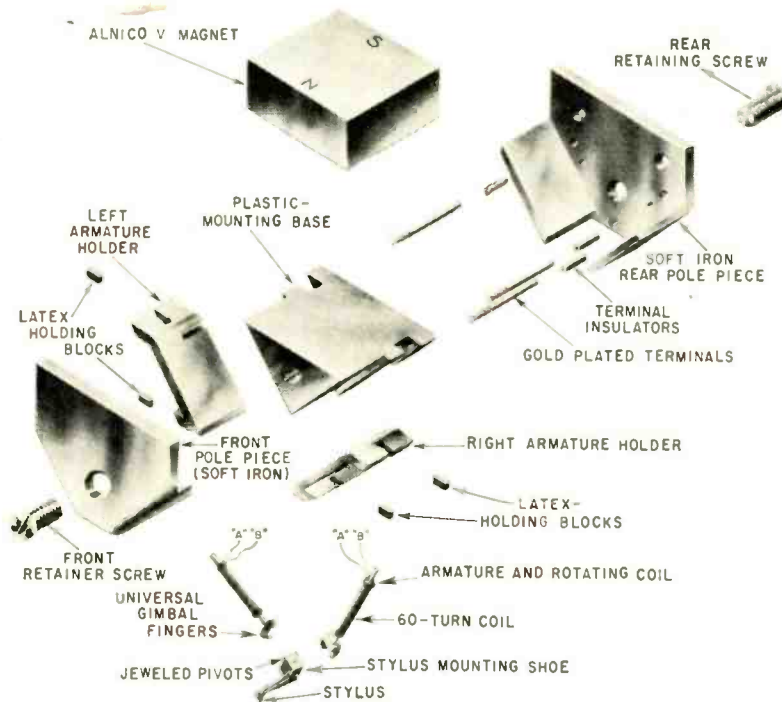

Fig. 1—View of magnet-coil-stylus assembly in ESL C-100 stereo pickup.



blocks prevent any appreciable vertical motion, and any which does occur cannot produce electrical output because of the orientation of the coil and the magnetic field.

Applying the same design philosophy to a stereo cartridge has required an ingenious mechanical solution to the requirement of driving two coils at right angles to each other without interaction. The ESL C-100 stereo cartridge contains a miniature gimbal structure, similar to the ones used in gyroscopes, to let the rotor move freely in any plane.

The two coils, each containing 60 turns of wire whose diameter is only one-quarter that of a human hair, are mounted at a 90° angle between a V-shaped pair of pole pieces. A single Alnico V magnet supplies the flux to both sets of pole pieces. Each coil is clamped at top and bottom with latex

holding blocks, similar to those used in the ESL monophonic cartridges. At the bottom of each coil is a yoke, identified in Fig. 1 as "universal gimbal fingers."

The stylus mounting shoe is formed into a square frame at its inner end and equipped with four tiny jeweled pivots. The ends of the universal gimbal fingers have small holes which engage these jewels, and the two sets of gimbals interleave to allow independent movement of the two coils. The stylus mounting shoe floats—it is supported only by the jewel pivots and gimbal fingers and ultimately by the latex blocks which clamp the coils.

Fig. 2, which shows the detailed stylus, gimbal and coil assembly, also illustrates the manner in which the modulation of the two groove walls produces independent outputs from the two coils. Modulation of the inner groove wall (Fig. 2-a) is coupled

directly to coil A, which rotates and produces an electrical output just as a monophonic cartridge would do. The gimbal structure allows the moving system to pivot and, since coil B is constrained from moving along its axis, the stylus assembly is effectively pivoted on the end of the universal gimbal fingers attached to coil B.

Similarly, modulation of the *outer* groove wall (Fig. 2-b) rotates coil B while coil A remains stationary and its universal gimbal fingers serve as pivots for the stylus and coil B. Normally, of course, both groove walls are modulated and the two coils are in complex motion at all times.

The ESL C-100 cartridge is equipped for mounting on 1/2-inch centers in any standard pickup arm. The coils are internally connected and three terminals are brought out. When playing ordinary monophonic LP records, the series-connected output of both coils is used, which results in the cancellation of the vertical components of the individual coil outputs. The C-100 weighs 25 grams, which is considerably heavier than most other cartridges.

Frequency response of the C-100 is 30–15,000 cycles, within 3 db. Its output is very low (2 mv per channel at a stylus velocity of 10 cm/sec) so a pair of matched transformers (ESL TM100) are provided with each C-100 cartridge. These step up the output some 10 times, which is adequate for any preamplifier.

The vertical and lateral compliance are each 5×10^{-6} cm/dyne, and the recommended tracking force is 2–4 grams. The dynamic mass of the moving system referred to the stylus is 3 milligrams. Channel separation is 20–25 db.

The ESL C-100 Gyro-Jewel cartridge sells for \$85, including the TM100 step-up transformers.

Fairchild XP-4

Fairchild had the distinction of marketing the first commercial stereo pickup, the model 603. Since it sold for \$250, it understandably did not achieve widespread popularity.

Fairchild now offers the model XP-4 stereo cartridge as well as a modified tone arm (model 282) with wiring for stereo outputs. The internal structure of the XP-4 is illustrated in "How the Stereo Disc Works" by Norman H. Crowhurst, *RADIO-ELECTRONICS*, July, 1958, page 28. It contains two small moving coils, mounted at right angles to each other in a common magnetic field, and at a 45° angle to the record surface.

The XP-4's coils are connected individually to the four output terminals. This allows complete flexibility in connecting the two outputs for stereo or monophonic reproduction, or for phasing the two outputs at the cartridge instead of at the speaker.

The XP-4 weighs 12 grams, which is the same as many monophonic cartridges including the Fairchild 225

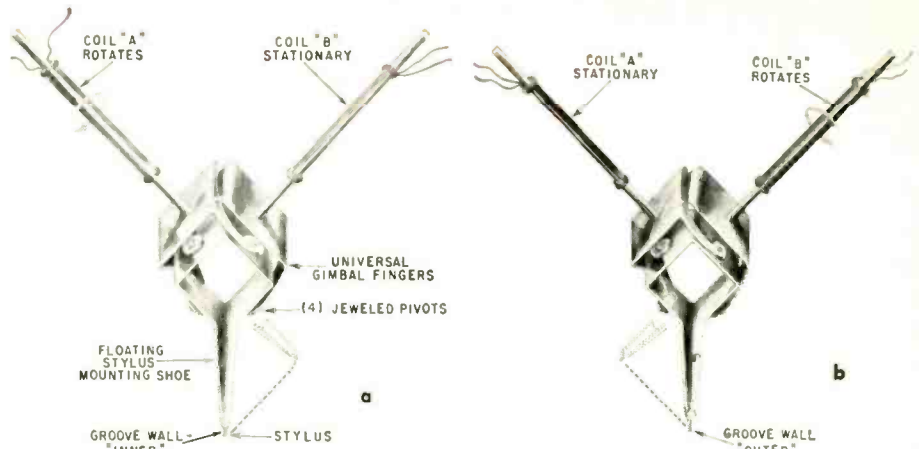

Fig. 2—Diagram shows how independent coil movement is attained through set of universal gimbals.

series. Frequency response is not stated, but the sound quality of each channel is said to approach that of the 225 series. Nominal output is 3 mv per channel at 7 cm/sec recorded velocity, which is about half as much as the Fairchild 225A monophonic cartridge delivers. A transformer, such as the Fairchild model 235, will step up the voltage if the preamplifiers do not have sufficient gain.

The stylus of the XP-4 is a 0.6-mil diamond. The compliance is not stated, but Fairchild states that it will track recorded velocities of 30 cm/sec at 1,000 cycles with a tracking force of 4 grams or less. This implies a rather high-compliance stylus assembly. Rated tracking force of the XP-4 in the 282 arm is 3–4 grams.

Channel isolation is 28 db at 400 cycles. This is one of the better figures claimed for a stereo cartridge.

The XP-4, unlike other current Fairchild cartridges, has an external magnetic field which will exert an attraction for a steel turntable. The manufacturer recommends keeping the cartridge from 1/4 to 3/8 inch above a magnetic turntable surface, either by using a foam-rubber pad on the turntable or by leaving three old 12-inch records on the turntable under the one being played.

When connecting the XP-4 to preamplifiers, Fairchild recommends carrying the two outputs through separate shielded cables, keeping the grounds isolated. This prevents the possibility of a ground loop between the two preamps, which can introduce a severe hum problem.

The net price of the Fairchild XP-4 is \$79.50. The stereo arm, model 282, sells for \$42.50.

General Electric Stereo Classic

General Electric, whose name has become practically synonymous with the variable-reluctance cartridge, has developed a stereo version.

It is available in three models, all of which use the same basic cartridge but differ in stylus dimensions and material. The Stereo Classic, model CL-7, has a 0.7-mil sapphire stylus, and the Golden Classic, model GC-7,

has a 0.7-mil diamond stylus. Their performance is identical. A premium stylus assembly is also available for the Golden Classic, with a 0.5-mil diamond and improved performance. When equipped with the 0.5-mil stylus, the cartridge is known as model GC-5.

The frequency response of the GC-7 and CL-7 is 20–17,000 cycles. The output is 6 mv nominal per channel at a stylus velocity of 5.5 cm/sec. The recommended load resistance for flattest response is 100,000 ohms per channel. The minimum load per channel is 47,000 ohms.

Fig. 3 is a cutaway view of the G-E Stereo Classic magnetic cartridge showing its construction. In Fig. 4 the details of how groove modulation is coupled to the cartridge elements are revealed. Modulation is separated into two channels right at the stylus.

The stylus is mounted on a Mu-metal arm suspended between two pole pieces. As you can see in Fig. 4-a, movement in one 45° direction changes the gap in that direction and produces an output from the right-hand coil. At the same time, the gap of the other pole piece does not change and there is no output from the left-hand coil.

Similarly, movement in the other 45° direction (see Fig. 4-c) produces an output from the left-hand coil and none from the right-hand one. Of course, when playing a stereo disc, the complex stylus movement produces an output from both coils.

The stylus assembly may be easily replaced by the user. G-E states that the stylus is inserted directly through the armature, which floats in damping cushions. The effective mass of the stylus is approximately 2 milligrams.

The lateral compliance of the GC-7 and CL-7 is 3×10^{-6} cm/dyne. The recommended tracking force is 3.5 to 7 grams. G-E has also announced the model TM-2G stereo pickup arm, which will accept only G-E cartridges (including the monophonic VR II) to form an integrated system.

Channel separation of the G-E cartridges is nominally 20 db between 100 and 7,000 cycles.

The 0.5-mil diamond stylus used in the model GC-5 has a lateral compli-

AUDIO—HIGH FIDELITY

G-E Stereo Classic line includes 0.5- and 0.7-mil styli.

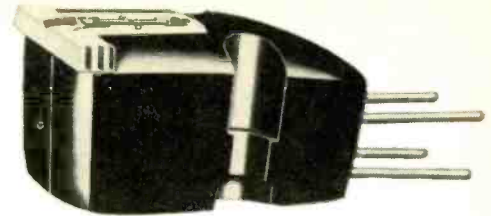
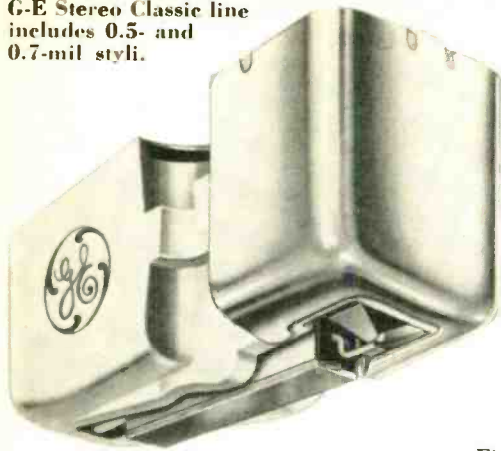

(Above) Pickering's Fluxvalve features isolated elements and can be phased at cartridge.

(Left) Fairchild XP-4 is low-cost version of early model 603.

ance of 4×10^{-6} cm/dyne and a vertical compliance of 2.5×10^{-6} cm/dyne. It tracks at 2-4 grams and has a frequency response of 20-20,000 cycles.

The model GC-7, with 0.7-mil diamond, is priced at \$23.95, and the model CL-7 with 0.7-mil sapphire sells for \$16.95. The model GC-5, with the high-performance 0.5-mil stylus, sells for \$26.95. The model GC-5 may be used only in a good pickup arm, while the other two models are suitable for record-changer applications.

The G-E cartridges feature a four-terminal output system, which may be used with separate grounds for the two channels or connected as a three-wire system with a common ground.

Stanton 45X45 stereo Fluxvalve

The Pickering Fluxvalve cartridge is now available in a stereo model (actually in two forms). The model 371 is a variable-reluctance type which will fit any pickup arm with standard 1/2-inch mounting centers. A cartridge of similar design is also sold as part of the integrated Unipoise pickup, model 196.

The model 371 cartridge weighs 9 grams. Its frequency response is rated as flat within 2 db throughout the stereo recording range (limits not specified). The output voltage is comparable to that of the monophonic Fluxvalve or the G-E magnetic cartridges (approximately 10-20 mv).

The stereo Fluxvalves use the T-Guard replaceable stylus assembly which may be easily removed without tools by the user. They are available only with a 0.7-mil diamond stylus. The compliance of the stylus is not stated.

Recommended tracking force for the model 371 is 3-6 grams. The model 196 Unipoise pickup will track from 2-4 grams. Nominal channel separation is 20 db.

The stereo Fluxvalve cartridges should be terminated in 27,000-47,000 ohms for flattest response. The maximum permissible cable capacitance per channel is 250 μmf , which is equivalent to a 4-6-foot length of the usual shielded cable. Longer lengths will

Fig. 3 (right) — Cut-away photo of G-E Stereo Classic cartridge: A—highly permeable laminations. B—Coils for left and right channels. C—Alnico V magnet. D—Stylus channel assembly. E—Ground strap (rear section of mu-metal shield). F—Terminals. G—Stylus jewel. H—Dual mu-metal shield. I—Magnetic pole piece. J—Plastic body. K—Mu-metal stylus arm.

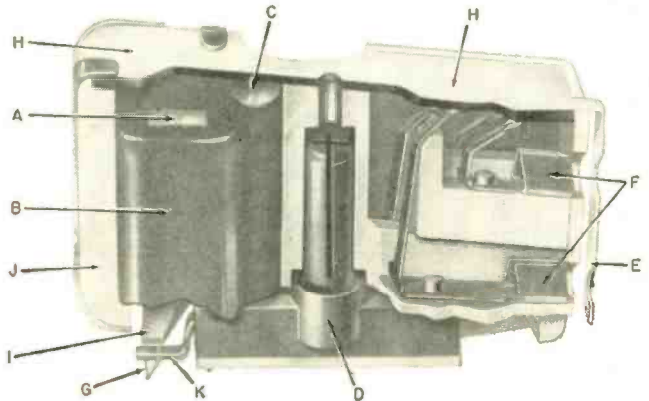

cause a loss of high-frequencies.

The audiophile net price of the model 371 cartridge is \$29.85, and the complete model 196 pickup sells for \$59.85.

Summary

Unlike the ceramic stereo cartridges, which are generally cheaper than their monophonic counterparts, magnetic stereo cartridges are appreciably more expensive than their predecessors (with the notable exception of the Stanton).

The overall performance level of the magnetic stereo types seems to be somewhat better than the monophonic ones, especially in regard to stylus compliance. This is, of course, a prime requirement of any stereo cartridge. As nearly as can be judged from the manufacturers' specifications, the magnetic cartridges are somewhat superior to the ceramic types, but the price

differential between the better magnetic cartridges and the better ceramic cartridges is large.

The magnetic stereo cartridge situation is still in a state of flux (pun unintentional), and there can be no doubt that we will see a number of new, improved and probably cheaper types in the months to come. The dyed-in-the-wool audiophile who has to keep abreast of the latest developments will probably spend the added amount for the higher performance of a magnetic cartridge, particularly if he is starting an extensive stereo disc collection. On the other hand, it seems likely that the average person, who does not have a full-fledged stereo system at this time but is considering one for the future, will prefer to experiment more economically with a less expensive ceramic cartridge initially.

TO BE CONTINUED

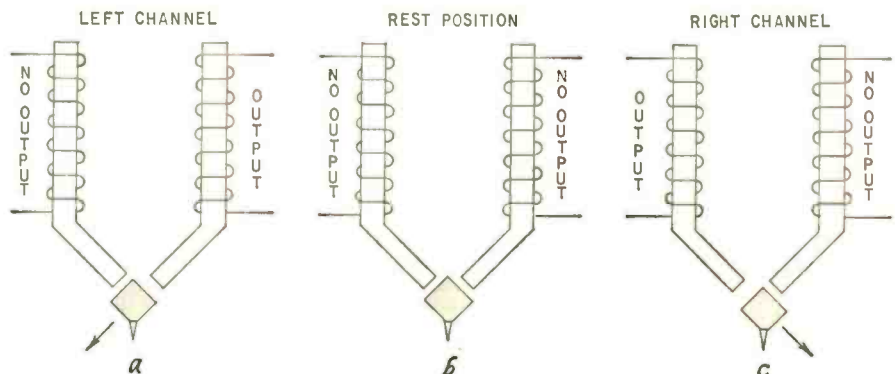

Fig. 4—Stylus movement and voltage output relationship in G-E stereo cartridge: a—45° movement to left; b—rest position; c—45° movement to right.

new STEREO and MONO

RECORDS and TAPES

Reviewed by
Chester Santon
Station WQXR
New York City

NOW that more record companies have released stereo discs, the problems of playback can be tackled on a more comprehensive level. A primary question facing the stereo enthusiast is the ability of the stereo disc to stand up under home use. Seeking an informal answer, I set aside a recent stereo record and subjected it to repeated playback. Equipment used included an exceptionally expensive turntable and a hand-made, moving-coil stereo cartridge in its own arm. Stylus pressure was the legal maximum—4 grams. A Glen Gray selection on Capitol stereo disc SW-1055 (*Big Band Stereo*) was selected because it had similar instrumentation throughout, a quiet original surface and a playback volume midway between the higher-level pops and the low-level classical items. The first half of the record band was played repeatedly and a brief sampling of the unused portion was made every 10 plays. First signs of distortion became evident in the brass section after 40 playings. Surface noise showed very slight increase. No cleaning preparations or devices were used before or during the trial run. These results compare quite favorably with monaural record wear on some medium-price equipment. Momentum of progress is sufficient at the present time to solve the remaining problems showing up under home use—warped records and occasional recorded rumble. Unlike tape, stereo on records shows no sign of hesitation.

Muskrat Ramble
Doc Evans and his Dixieland Band
Audiophile Stereo Record AP-56

Arriving in time for the New York High Fidelity Show, the first Audiophile stereo disc has everything it takes to become a star attraction at this year's affair. On top equipment, its frequency range and transient response resemble that of many an average 15-ips master tape. If you design expensive stereo cartridges, demonstrate them or merely listen to them, this is the best Dixieland test record to date.

My Fair Lady
Shelly Manne and His Friends
Stereo Records S-7002

This recording's right channel convinces me that it is possible to engrave on a stereo disc the fundamental lows of a jazz group's string bass. An AKG C-12 condenser mike is used at close range. The confident jazz artistry of drummer Shelly Manne, pianist Andre Previn and bass player Leroy Vinnegar is doubly effective in a very clean stereo recording. Piano is on the left; drums and bass share the right channel. If you prefer closer spacing of instruments, try turning one speaker toward your listening position.

Re-Percussion
Richard Schory conducting Percussive Art Ensemble
Concert-Disc (stereo) CS-21

Concertapes has entered the record field, offering in this stereo release over 100 percussion instruments used with great imagination. All levels of dynamic range are explored in these shimmering original compositions. Exceptional illusion of depth. Any medium able to withstand this onslaught of sound has a secure future.

I'll Remember April
Raoul Poliakin Orchestra with Stereo Choral
Everest Stereo Record SDBR-1001

This new label is the product of a division of the Belock Instrument Corp., which is entering the recording field with recently designed equip-

ment. The stereo level is similar to that of monaural discs, yet the distortion is below that of many stereo records. Strings, woodwinds and mixed chorus are neatly blended. The stereo tape version (STBR-1001), while superior to most commercial tapes, surpasses this disc only in channel isolation and weight of the lowest bass. Tasteful arrangements of lush mood music.

RIMSKY-KORSAKOV: Scheherazade
Sir Thomas Beecham conducting Royal Philharmonic Orchestra
Angel Stereo Record S-35505

While somewhat less powerful in the climaxes than the monaural version reviewed earlier, the first stereo pressing of this work places Angel at the head of the list in one category. The EMI stereo mike technique offers the widest sweep of unbroken sound in picking up a symphony orchestra. Here, and in the new Rachmaninoff-Ravel piano concerto disc (Angel S-35567), the broad effect is stunning.

STRAVINSKY: Petrushka
Ernest Ansermet and L'Orchestre de la Suisse Romande
London FFSS Stereo Record CS-6009

Containing more music per side than the London PS-100 reviewed last month, the stereo *Petrushka* does not possess on top equipment all the biting highs and lows found on the monaural disc. However, typical London presence and crisp stereo wipe out most of the loss suffered at the ends of the spectrum. Ideal demonstration of what stereo can do for name artists. Other initial stereo releases such as *Symphonic Fantastique* and *Images* can be instantly recognized as London products.

BERLIOZ: Requiem
Hermann Scherchen conducting Radiodiffusion Chorus and Orchestre de l'Opera
Westminster Stereo Record WST-201

The release of long works in stereo is now feasible on the two-channel disc. This composition calls for a tremendous mixed choir, orchestra, four brass bands and eight pairs of kettledrums. Recorded in Paris in the Chapel of the Hôtel des Invalides, the scene of the work's first performance in 1837, the cathedral acoustics alone place it above the recent Vanguard stereo *Requiem*. Excellent separation of the brass bands spaced apart by Berlioz in the *Tuba Mirum*. The most ambitious project so far available on stereo discs.

The Magic Islands
Alfred Newman orchestra and Ken Derby Singers
Decca Stereo Record DL-9048

Just about every Hollywood sonic resource has been marshaled for this stereo impression of the Hawaii celebrated in song. The deep whistle of the arriving ocean liner, the cries of gulls, the surf heard throughout the album are all set in deep space that should enhance the performance of medium-price stereo units.

Tafoo
Exotic Sounds of Arthur Lyman
HI FI Record (stereo) R-806

This disc demonstrates that any novel percussion instrument found in today's Hawaiian sphere of sound can be transferred to stereo disc at high level and minimum distortion. The wide frequency range helps in spotting the location of the conch shell, guido, tymbali, boobams, congas, bongos and a half-dozen conventional percussion units. A different demonstration item.

The Reiner Sound
Fritz Reiner conducting Chicago Symphony Orchestra
RCA Victor Stereo Record LSC-2183

The monaural edition of this recording was praised in the July issue. Stereo provides the basic advantage of panoramic spread. Unfortunately, the excellent audio quality in monaural has been sacrificed in the range of dynamics suffering the greatest loss.

Introduction to Stereo
Westminster Stereo Record WSS-1

These 12 samples of Westminster's disc stereo range from classical to pops with a few sound effects along the way. More convincing sound effects may be found on the Capitol and London stereo sampler discs. The popular excerpt featuring the Latin rhythms of Ralph Font's orchestra exhibits the best sound.

Destination Moon
Heinz Sandauer conducting Omega Orchestra
Omega Stereo Tape ST-3015
(7-inch; playing time 40 min. \$14.95)

Without stereo, this one would never get off the ground. Leith Stevens composed this score in 1950 for a science-fiction film depicting a flight to the moon. The music might have been written yesterday. Details include an orchestral countdown and widely separated tonal effects of varied intensity to suggest outer space. The stereo record makes the same flight on less financial fuel.

Invitation to Roseland
Wendell Tracy and His Orchestra
Concertapes (Stereo) 24-6
(7-inch; playing time 29 min. \$11.95)

Better sound here than usually found on dance tapes carrying labels of greater fame. Exceptionally wide frequency response—about 20% more highs than typical production runs. Lows, too, are cleaner. Solid work by the Tracy band sews up a neat bundle.

Oklahoma!
George Feyer at The Piano
RCA Victor Stereo Tape APS-145
(7-inch; playing time 14 min. \$6.95)

In his debut on the RCA label, George Feyer's famous keyboard style is examined under new closeup. On stereo equipment of good presence, the listener shares the piano bench as Feyer personalizes seven tunes from the *Oklahoma!* score.

The Mighty Wurlitzer and the Roaring Twenties
Leonard Leigh, Organist
RCA Victor Stereo Tape CPS-137
(7-inch; playing time 26 min. \$10.95)

This full-voiced theatre organ is now housed in the studios of station KSTP in Minneapolis. Controlled studio acoustics and wide-range pickup by recording engineer John Norman of RCA's Chicago crew. Tape's inherent ability to carry a heavy burden of sound still makes it the ideal medium for organ work.

Note: Records below are 12-inch LP and play back with RIAA curve unless otherwise indicated.

Cook's Tour of High Fidelity
Cook 1079

Here is an opportunity to A-B the sound of solo instrument recorded under two different methods. The first involves the conventional use of master tape. The second technique bypasses tape and the sound of a violin is fed directly to the master disc. Slight improvement is apparent but hardly enough to overthrow the current tape method. The pianist on the record, Lee Hambro of the WQXR staff, tells me that his solo was recorded directly to master disc from a garden apartment studio scarcely larger than the piano.

Star Dust
Pat Boone With Orchestra and Chorus Conducted by Billy Vaughn
Dot DLP-3118

One of the last strongholds of the monaural disc may be the popular vocalist. Dot Records lavishes great care and skill miking its most valuable property, Pat Boone. His 45-rpm records have adhered to technical specifications far above those of the typical devices used in playing them. Judicious use of echo chamber on voice provides excellent illusion of depth when fed to two channels. END

Name and address of any manufacturer of records mentioned in this column may be obtained by writing Records, RADIO-ELECTRONICS, 154 West 14 St., New York 11, N.Y.

what's

new

?

POCKET PHONOGRAPH with no turntable is being manufactured in England by Camp Bird Industries and is scheduled to be available in this country. The entire unit, when folded, measures 4 x 8 x 2 inches, weighs 2 pounds. It plays LP and 45-rpm records. The pickup arm is part of the case and the on-off switch is activated by moving the arm into playing position. The unit contains its own printed-circuit transistor amplifier and a 6-volt motor. It is designed for 30 hours of continuous operation on a single set of batteries.

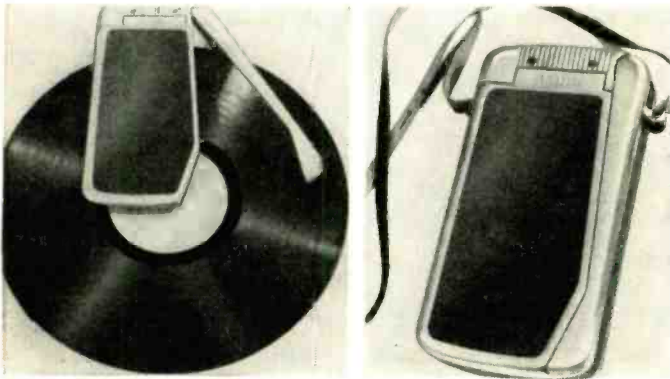

ELECTRONIC EARMUFFS which use sound to destroy unwanted noises have been developed by the Army and RCA. The experimental earphones create artificial silence by the use of a miniature microphone which creates a second noise, just as loud but 180° out of phase. When the two sounds meet in the earcup, they cancel each other, muffling a loud roar to a whisper. Developed to aid communication in the roar of combat, they are based on experiments conducted by RCA Laboratory's Dr. Harry F. Olson, described in **RADIO-ELECTRONICS**, August, 1954. The earphones are used with an inverter and amplifier unit which can be miniaturized to fit in a soldier's pocket.

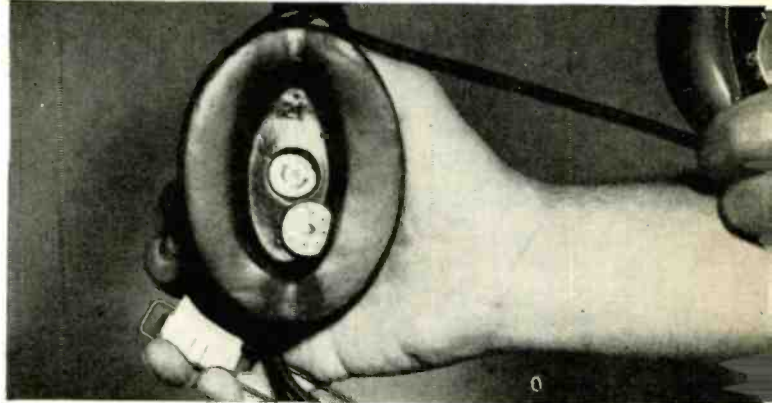

"HIGHWAY IN THE SKY" is delineated on the cathode-ray screen of a new air navigation instrument aimed at making flying almost as simple as driving a car. Inventor George H. Balding adjusts the pilot model of this visual flight-orientation device which relieves the pilot of watching a vast array of instruments. It provides a well-defined "ribbon," clear as a section of highway, along which the pilot directs his ship. Line across the center is a permanent horizon; actual horizon (gray tone) shows plane is banked slightly to left. The round dots represent terrain and their distance apart tells height above the earth's surface. The device will be produced by Kaiser Aircraft & Electronics Corp., Palo Alto, Calif.

Wide World Photos

NO ELECTRICITY? TRY KEROSENE. A transistor radio is operated by power from a thermopile in an oil lamp in the course of developmental work on devices to produce electricity from heat at Philips Research Laboratories, Eindhoven, Netherlands.

Courtesy Philips Technical Review

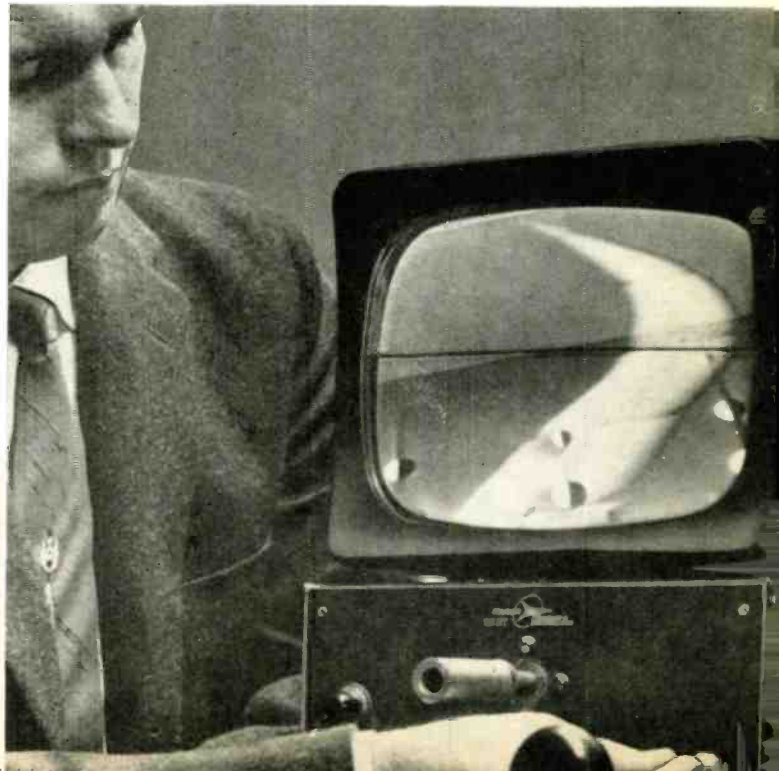

STEREO TUNER features

MULTIPLEX OUTPUT

An AM-FM tuner that won't have to be replaced when multiplex gets rolling

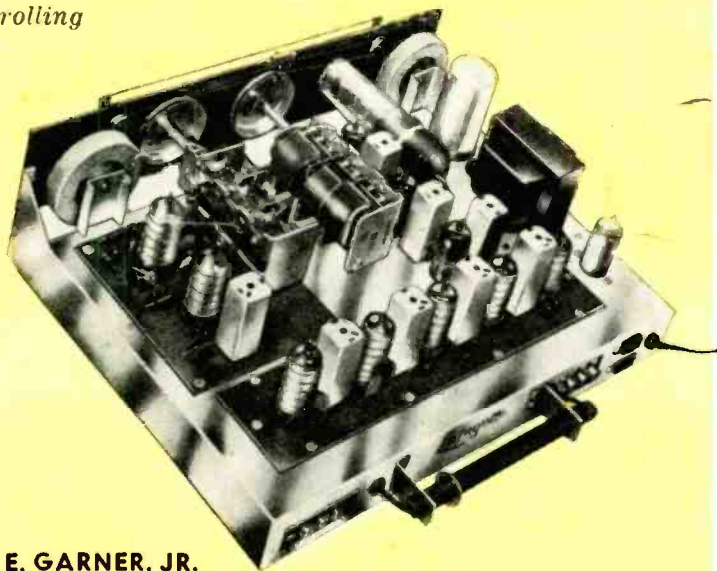

By LOUIS E. GARNER, JR.

WITH the development of a practical disc stereo system, there has been a noticeable resurgence of interest in stereophonic sound among audiophiles, experimenters, good music lovers, and, for the first time, an awakening of interest in stereo on the part of the general public. Stereo has played a prominent part in audio shows across the nation and is receiving more and more mention in the popular press as well as on radio and television.

This is quite natural, for once an enthusiast has set up his basic two-channel stereo system to play discs or tapes, all he needs to receive stereophonic broadcasts is the proper type of radio tuner(s).

Since the broadcast of stereophonic program material requires the simultaneous use of at least two separate channels, such broadcasts, in the past at least, have used entirely distinct radio channels; for example, an AM and a FM, two AM or two FM channels. An FM channel and the audio carrier of a TV channel, or some similar combination, has also been used. Such a system is wasteful of the radio spectrum. After all, essentially the same material is broadcast, even though two complete channels are occupied.

Multiplex FM broadcasting

A comparatively new system for

broadcasting stereo program material has been undergoing experimental tests for some time. Known as *multiplex* FM broadcasting, this system permits a *single* FM station to broadcast two or more independent programs. (See "Multiplexing and You," by Don Lewis in RADIO-ELECTRONICS, October, 1957.)

For some time, various FM stations have been permitted to increase their revenue by offering a "commercial music" service to paying subscribers. To broadcast general programs while, at the same time, offering a background music service to restaurants, hotels and other firms, the stations employed a technique called the *simplex* system.

In operation, the FM station broadcasts a general musical program interspersed with commercials, news and similar vocal announcements. Subscribers to the music service are supplied with specially designed FM receivers, and the stations use an ultrasonic control signal to cut out the unwanted vocal messages.

On Dec. 31, 1953, the FCC proposed a new system for handling the distribution of background music to paying subscribers by FM broadcast stations. Known as the *multiplex* system, it lets a single FM station broadcast two (or more) *different* types of program material over a single channel without interference.

In the multiplex system, the station's

carrier is modulated in conventional fashion with regular material. Simultaneously, however, the carrier is modulated with a high-frequency *subcarrier*. This subcarrier, in turn, is frequency-modulated with the special program material—be it commercial-free background music or the second channel of a stereo program.

After arguments had been presented for and against the proposed system, it was decided that the multiplex method made more efficient use of the available radio spectrum, and the FCC permitted FM broadcast stations distributing background music to switch over to the multiplex system, with the proviso that all FM stations distributing such programs were to have shifted to the multiplex system by March 31, 1958. A number of individual stations, with a large investment in the now-obsolete simplex equipment, have been granted extensions past this deadline. However, by the end of 1958 all FM stations distributing commercial music should be using the multiplex system.

Since this system lets a single FM station broadcast two or more types of material, it is ideal for stereophonic programs. Naturally, a number of the stations which had experimented with stereo broadcasts in the past wanted to try this new method. As a result, the FCC has granted permission to individual stations to use the multiplex system for broadcasting stereo programs on an *experimental* basis. In the future, the use of this system will probably increase and one day we may find that *all* stereo programs are broadcast with the multiplex technique.

According to current FCC regulations, the instantaneous frequency of the FM subcarrier must be not less than 20 nor more than 75 kc away from the assigned carrier frequency. As long as it stays within these limits, the individual station is not required to use a specific subcarrier frequency. Most FM stations use subcarriers between 30 and 65 kc.

In many cases, a "standard" FM tuner *cannot* be modified to receive *multiplexed* FM programs. Many older FM tuners, for example, do not have the if bandwidth needed to pass the high-frequency subcarrier signals with-

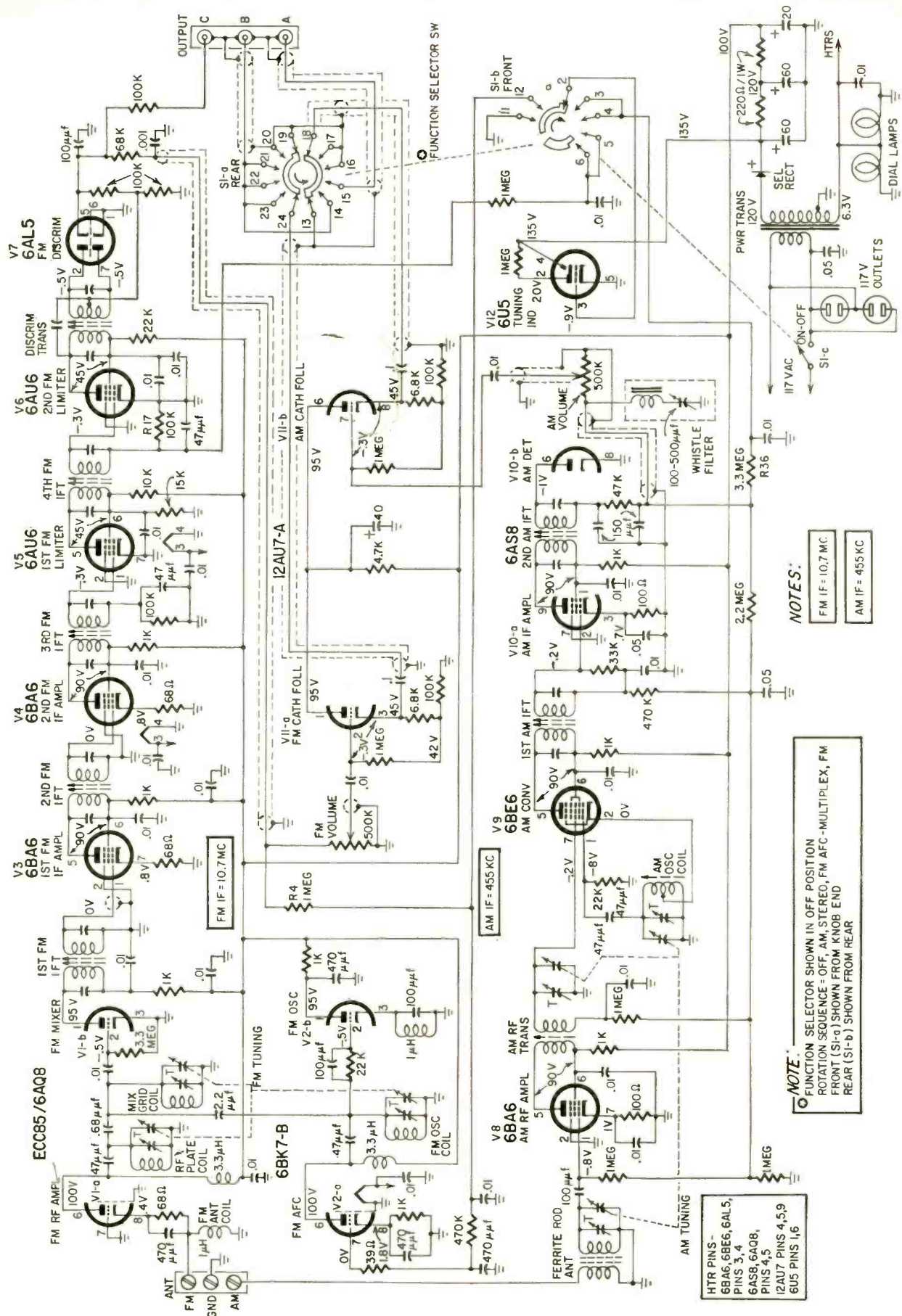

NOTES:
 FM IF = 10.7 MC
 AM IF = 455 KC

NOTE:
 FUNCTION SELECTOR SHOWN IN OFF POSITION
 ROTATION SEQUENCE - OFF, AM, STEREO, FM AFC - MULTIPLEX, FM
 FRONT (SI-a) SHOWN FROM KNOB END
 REAR (SI-b) SHOWN FROM REAR

HTR PINS -
 6BA6, 6BE6, 6AL5,
 PINS 3, 4
 6AS8, 6AQ8,
 PINS 4, 5
 12AU7 PINS 4-5, 9
 6U5 PINS 1, 6

Circuit of the stereo tuner.

out appreciable attenuation. In others, the modulated subcarrier which carries the special program material (second stereo channel, for example) is filtered out by the receiver's de-emphasis network.

A stereo-engineered tuner

The KT-500 stereo tuner, a new general-purpose hi-fi tuner recently introduced in kit form by Lafayette Radio (165-08 Liberty Ave., Jamaica 33, N. Y.), is designed specifically to receive both "conventional" stereo broadcasts using separate AM and FM channels and the newer multiplex FM stereo programs (when used with a basic adapter). This tuner kit incorporates several interesting design and construction features.

Since the KT-500 has adequate bandwidth and a signal takeoff point ahead of its de-emphasis network (see circuit diagram), the only accessory needed to receive multiplex FM programs with it, whether the second channel of a stereo broadcast or commercial-free background music, is a multiplex adapter.

Basically, a multiplex adapter consists of a high-pass filter, one or more high-frequency amplifiers, one or more broad-band circuits tuned to the subcarrier frequency, an FM detector whose center frequency is that of the subcarrier and, in some cases, one or more audio amplifier stages with, perhaps, a cathode-follower output stage. Generally, a multiplex adapter will include its own power supply and volume control.

To receive multiplex programs with the KT-500, the multiplex adapter is simply connected to output jack C, and the FUNCTION SELECTOR switch is set either to the FM AFC-MULTIPLEX or FM positions. The audio signal obtained from the adapter is connected to a standard audio amplifier and loud-speaker system. If stereo programs are to be received, the signal from the multiplex adapter is connected to one channel of a stereo audio system, while the output signal obtained from output jack B is connected to the other audio channel.

Unfortunately, multiplex adapters are not commercially available at the time of writing. There are several reasons for this.

Current multiplex service, except for those stations experimenting with stereo, is confined essentially to FM stations broadcasting commercial-free background music on their subcarriers. Such stations lease the necessary multiplex receivers to the firms or individuals subscribing to their music service.

While a number of FM stations across the nation are broadcasting the second channel of a stereo program on a multiplexed subcarrier, there has not, as yet, been any standardization as to subcarrier frequency. In some cases, the subcarrier may have a frequency of around 40 kc; in others, 50 or 60 kc. Until there is a general agreement as

to the subcarrier frequency to be used for stereo, it will be difficult for a manufacturer to offer a suitable adapter. However, as soon as multiplex stereo programming passes from an experimental to a regular service, there will probably be a standardization to one or two subcarrier frequencies. At that time, a number of firms will probably offer suitable adapters. Of course, the skilled experimenter can have a good deal of fun assembling his own!

Circuit description

Basically, the KT-500 consists of separate high-quality AM and FM tuners assembled on a single chassis with a common power supply. Thus, the AM and FM sections may be operated either independently or together, and the instrument may be used as an AM tuner, an FM tuner, as a stereophonic AM-FM tuner or as a FM multiplex tuner.

AM section: Covering the AM broadcast band (530-1650 kc), the tuner's AM section employs conventional circuitry, including a tuned rf amplifier, a converter, an if amplifier, a diode type second detector and a cathode-follower output stage. A 10-kc whistle filter reduces the effects of adjacent-station interference.

FM section: Designed to use an external antenna, this section covers the FM broadcast band (88-108 mc) and has adequate bandwidth for the reception of the high-frequency subcarriers used in multiplex stereo and background-music broadcasting. The unit has sufficient sensitivity to provide 30-db quieting with a 2- μ v input signal.

Common circuits: The tuning indicator tube, V12, and the FUNCTION SELECTOR switch, S1, are common to both the AM and FM sections. S1 has five positions—OFF, AM, STEREO, FM AFC-MULTIPLEX and FM. The spst power switch is ganged to it and is open when S1 is in its OFF position. In all other positions, the power switch is closed.

When S1 is in the AM position, the AM audio output signal obtained from V11-b is applied to output jack B and the AM avc control voltage obtained through R36 is applied to V12's grid. The 6U5's "eye" closes as AM stations are tuned in. On individual stations, closure is maximum when the station is properly tuned. On stronger local stations, the "tuning eye" may overlap slightly.

The AM avc connection to the tuning indicator remains unchanged when S1 is switched to the STEREO position. However, the AM audio output signal is transferred to output jack A, while the FM audio output signal from V11-a is applied to output jack B.

When S1 is switched to the FM AFC-MULTIPLEX or FM positions, the FM audio output signal remains connected to output jack B, while the dc signal obtained from the FM second limiter's grid resistor (R17) is applied to tuning indicator V12 in place of the AM avc voltage. With this connection, the tuning

SPECIFICATIONS

Model KT-500 AM-FM Stereo Tuner Kit

AM SECTION

Frequency coverage: 530-1650 kc
Sensitivity: 5 μ v
Selectivity: 8-kc bandwidth, 6 db down
Image rejection: 30 db
IF rejection: 50 db
Frequency response: 20-5,000 cycles, \pm 3 db
Harmonic distortion: under 1% for up to 80% modulation
Output: cathode follower; level approximately 1 volt on average signal

FM SECTION:

Frequency coverage: 88-108 mc
Sensitivity: 2 μ v for 30-db quieting
Selectivity: 200-kc bandwidth, 6 db down
Image rejection: 40 db
IF rejection: 70 db
Frequency response: 20-20,000 cycles, \pm 1/2 db
Harmonic distortion: under 1%
Output: cathode follower; level approximately 1 volt for 30% modulation, 2.5 volts for 100% modulation

eye closes as various FM stations are tuned in. Again, on individual stations, closure is maximum when the station is properly tuned. In the FM position, the avc voltage supplied through R4 is shorted to circuit ground, disabling the avc circuit and making it easier for the operator to tune in weaker FM stations in close proximity (channel-wise) to stronger ones.

A single ac-operated power supply, controlled by the ON-OFF switch, furnishes heater and B-plus voltages for the entire tuner. Dc voltages are supplied to the entire instrument at all times, even when the FUNCTION SELECTOR switch is in the AM or FM positions. This insures a steady drain on the power supply and hence better voltage regulation.

Special features

Aside from a design permitting reception of multiplex FM broadcasts when used with a suitable adapter, the KT-500 tuner has a number of other interesting construction and design features not usually found in moderately priced tuner construction kits. One of these is the 10-kc whistle filter in the AM tuner section. Another is the relatively low B voltage (100). This minimizes the chance of component breakdown due to excessive dc voltages and thus insures longer service life for coupling and bypass capacitors.

To minimize the chances of trouble when the tuner is wired by a less advanced worker, the critical FM front-end and if circuits are assembled on etched-circuit boards. In addition, all coils and if transformers furnished with the kit are prealigned. Only a slight touchup for peak performance is needed when the instrument is assembled.

The assembled tuner can be used with any hi-fi system which includes an amplifier and speaker. Of course, for stereo reception a dual-channel hi-fi installation—one having two independent amplifiers and speakers—is needed. With separate volume controls for both the AM and FM sections, it is a comparatively simple task for the operator to achieve proper balance when receiving "conventional" stereo programs (those broadcast over AM and FM stations simultaneously). END

A tenth of a volt tuning sensitivity from an electron-ray-tube tuning circuit which can be used with FM discriminators or balanced ratio detectors

Sensitive **FM** Tuning indicator

By DARWIN H. HARRIS

THIS circuit was developed for accurately tuning a ratio detector with a narrow linear range. The sensitivity is about 0.1 volt, using a high- μ triode to drive a 6AF6-G electron-ray tube.

The 6SF5-GT is biased so the shadow is exactly closed with zero input signal. A negative voltage (from mistuning) causes an overlap of the lighted seg-

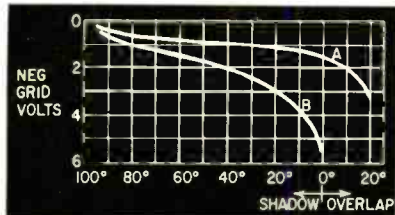

Fig. 1—Eye response; grounded cathodes, 190 volts B-plus. Curve A for 6SF5-6AF6. Curve B for 6E5.

ments, and a positive voltage results in the shadow opening. Over a small range, the segment angle, either overlap or shadow, varies linearly with the applied signal. The indicator is equally adaptable to a discriminator or a balanced ratio detector.

Originally I used a 6AL7-GT indicator tube. This is an ingenious device but, because of the small pattern and some edge fuzziness, its sensitivity is low.

When the tube wore out, I tried to develop a more sensitive electron-ray circuit to replace the 6AL7-GT hookup and give improved performance.

A 6E5 biased to eye closure was first. Unexpectedly, its sensitivity was very low and I almost dropped the eye-tube idea right then. Happily, the project was continued long enough to check the performance of a 6SF5-6AF6 combination. With grounded cathodes, negative voltages were applied to the indicator's grid and the resulting shadow angles measured, using two straightedges and a protractor. The experiment was repeated with a 6E5 for comparison. Fig. 1 shows the results in terms of shadow angle vs negative grid volts.

The marked curvature in the 6E5 line near 0° apparently indicates a moderate remote-cutoff grid design in its triode section. The 6SF5-6AF6 graph is nearly linear at this point, the

curvature in the overlap region being caused by the eye-tube characteristic.

My indicator arrangement

When the circuit was set up in final form (Fig. 2), with bias adjusted to close the eye, angles were measured as before, this time using voltages of both polarities. The graph (Fig. 3) shows somewhat less sensitivity than before, but is remarkably linear over a range of about ± 1 -volt input signal. The slope is about 22° per volt. Since a change of 1° or 2° is discernible, sensitivity is better than 0.1 volt.

The eye of an electron-ray tube is closed when the shadow-control electrode is held at a certain fraction of the target voltage. The ratio is the same at all target levels. (The fraction

was measured as 0.63 on the 6AF6-G, target 100 to 250 volts.) Thus the basic sensitivity is greater at low target voltages.

A shadow appears and increases to about 100° as the control electrode is decreased from the critical value, while the lighted sectors overlap up to about 25° when the electrode exceeds critical. The light emission varies directly with the target level, but operation is possible at less than 100 volts. In practice,

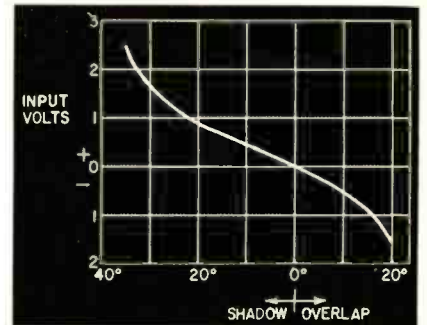
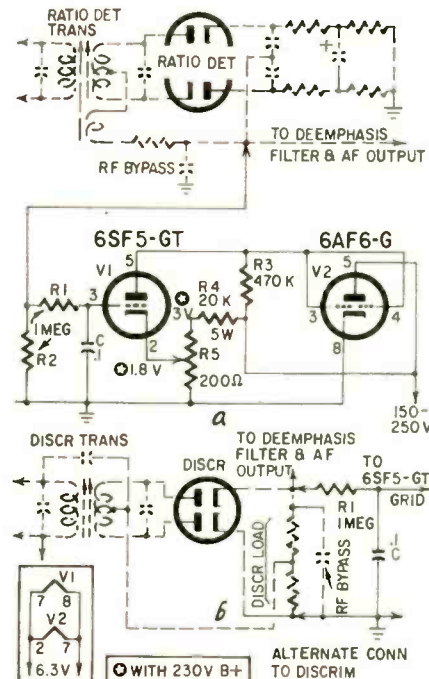

Fig. 3—Eye response of the 6SF5-6AF6 circuit. 1 megohm in series with grid, B-plus 160 volts.

the shadow electrode voltage is always controlled by a triode dc amplifier, which may be considered as the lower half of a voltage divider, the plate load (0.5 or 1 megohm) being the upper half.

The triode might be biased in the grid or cathode circuit to close the eye, but, as the former has several disadvantages, cathode bias is used. Self-bias causes a loss of sensitivity because of feedback. To minimize feedback, the steady current through the potentiometer (R5) is made much larger than the plate current and the cathode then remains constant as the grid varies. Surprisingly, the bias setting never needed adjustment, as long as the same tubes were used. Thus a resistor with screw-clamp slider could be used for R5.

The connection to a discriminator is made at the audio output point or directly to the load resistor. For use with a ratio detector add a 1-megohm resistor to ground at the connection point for grid leak. This lowers the detector output slightly, but is otherwise harmless. Incidentally, the ground point of a balanced or symmetrical ratio detector is midway between the diodes.



- R1, 2—1 megohm
- R3—470,000 ohms
- R4—20,000 ohms, 5 watts
- R5—pot, 200 ohms
- All resistors 1/2-watt 10% unless noted
- C—0.1 μ f
- V1—6SF5-GT
- V2—6AF6-G
- Sockets, octal (2)
- Miscellaneous hardware

Fig. 2—The two-tube indicator circuit hooked up: a—to a balanced ratio detector; b—to discriminator.

The control electrodes of the 6AF6 may be joined (as shown) but as the two sections may not be exactly the same, the correct bias setting for one will not be right for the other. One electrode could be left open (eye wide open) or joined to the target, or it could be made part of a separate indicator system to read limiter input voltage, for example. In the latter case, a triode-connected 6K7 or 6SK7 would be advisable for remote-cutoff action.

The 6SF5-GT in the present circuit can be replaced by any other high-mu triode if desired—particularly the miniature 6AV6. I used a small chassis for the 6SF5, mounted on the tuner chassis, with a cable for connections between the triode and eye tube. The only "trouble" found in several years of use is the normal gradual dimming of the eye tube. It should be replaced every 2 years, but in dim light can be kept longer.

Other circuits

It is interesting to survey briefly various other meterless FM tuning aids. The popular 6AL7-GT is described in the Sylvania tube manual and the hookup is discussed in detail by Keim¹. A biased 6E5 similar to the circuit treated here is illustrated by Kiver²; it seems to have been designed for low sensitivity. Kiver also figures an elaborate "balanced-rectifier indicator" applicable only to discriminators³. The input of a biased 6E5 is derived from a duo-diode network so arranged that detuning in either direction opens the eye. The basis is that the ends of the discriminator load resistor are positive with respect to the center.

In an audible-alarm type described by Smith⁴, the output of a noise generator (a blocking-transformer oscillator) is applied to the tuner's antenna lead, and the resulting hash is tuned out. This one is adapted to ratio detectors only.

Sonocraft's neon-tube indicator is simple but not exactly sensitive⁵. An NE-51 between the plates of a 6J6 having one grid grounded and the other connected to the tuner is lighted when the latter goes sufficiently positive or negative. Since firing an NE-51 requires about 60 volts across it, and assuming a gain of 20, a 3-volt operating signal, or a total range of 6 volts, is predicted. A test I made (B-plus 300 volts, other values as published) gave 3.6 volts for the strike, off at 2.9 volts. (A 12AX7 required 1.8 and 1.4 volts, respectively.) The same article includes a British circuit which employs a neon tube in series with each plate of a 12AX7. The neons remain lighted throughout the tuning range, but are unequally bright except at the center point. END

References

- ¹ L. B. Keim, "FM Tuning Indicator," *Audio Engineering*, September, 1948.
- ² Milton S. Kiver, *F-M Simplified*, 2nd edition, 1951, page 187 (D. Van Nostrand Co., N. Y.).
- ³ *Ibid.*, page 190.
- ⁴ Warren J. Smith, "FM Tuning Aid," *RADIO-ELECTRONICS*, November, 1956, page 127.
- ⁵ "FM Tuning Indicator," *Question Box*, *RADIO-ELECTRONICS*, February, 1956, page 125.

RADIO on your WRIST

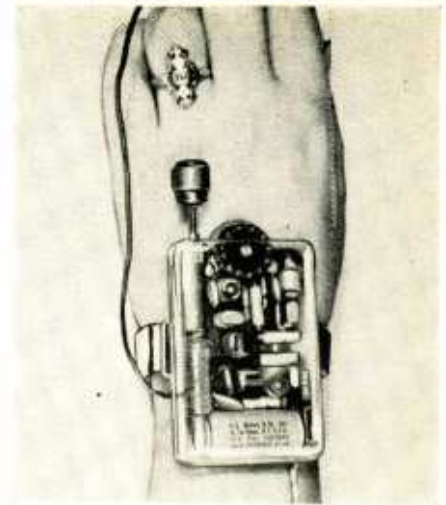

WITH the growth of transistor popularity and techniques, radios have steadily grown smaller. The new, portable transistor models easily slip into a pocket or purse.

The other day something even smaller and more portable than usual was brought into the RADIO-ELECTRONICS office. It is a three-transistor radio that you wear on your wrist, very reminiscent of the experimental job the Signal Corps made a few years ago, or the one popularized by Dick Tracy. Attached to an expansion band, the type found on some wristwatches, the 2 3/4 x 1 3/4 x 3/4-inch receiver is truly a wristwatch radio. Its 2 1/2-ounce weight is hardly noticeable. And you don't need a long external antenna.

The unit can be purchased in kit form or factory-wired. It is produced by Barlowe Electronics, Bethpage, N. Y. The only tool needed to assemble it is a low-wattage soldering iron. This is made possible through the use of a printed-circuit board and easily attached components. Resistors, capacitors, transistors, transformers and coil leads slip into prepunched holes in the circuit board. A touch of solder and the part is fixed in place.

A regenerative detector feeds a transformer-coupled two-stage audio amplifier operated in a common-emitter circuit. The circuit provides a sensitivity of 200 μv per meter and an output of 2.5 mw. No antenna is needed, unlike most crystal and one-transistor

receivers. A GT760 acts as the detector and GT20 and GT81 transistors fill out the audio stages.

A 7.5-volt Mallory mercury battery powers the radio. As the receiver draws only 4.5 ma, battery life is likely to be long. A hearing-aid type earpiece provides private listening. END

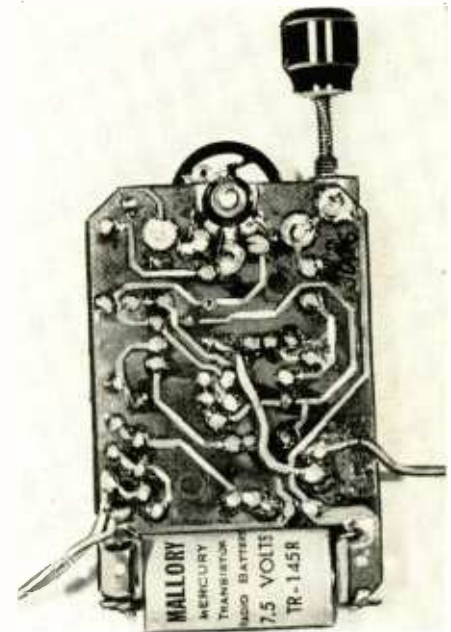

This printed-circuit board makes construction easy.

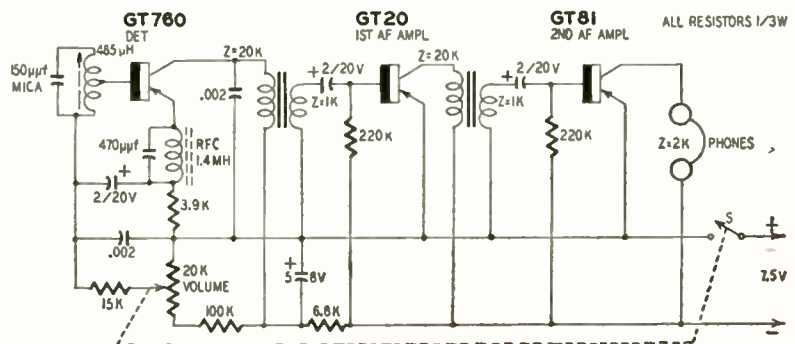

Circuit of the regenerative receiver.

Sweet FM Tuner

*Seven-tube unit is easy to build and align.
Pulls in stations more than 50 miles distant*

By DUANE H. SWEET

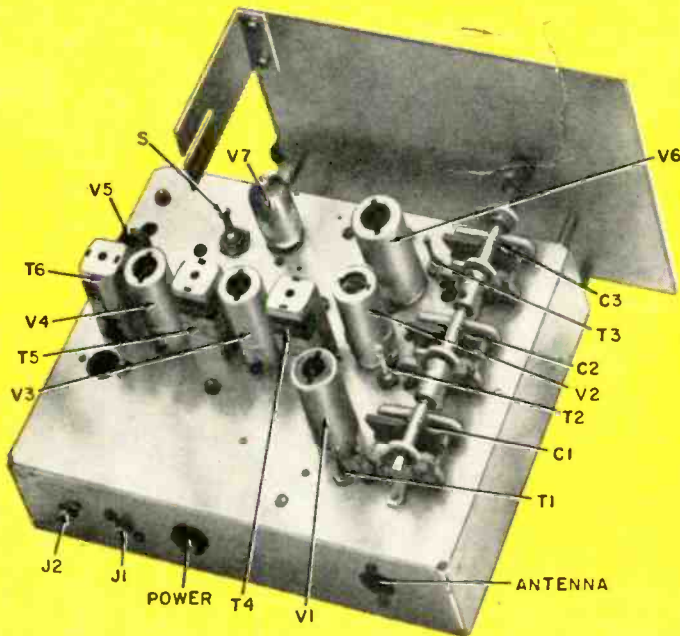

Top view of the tuner. Rf and if sections are perpendicular.

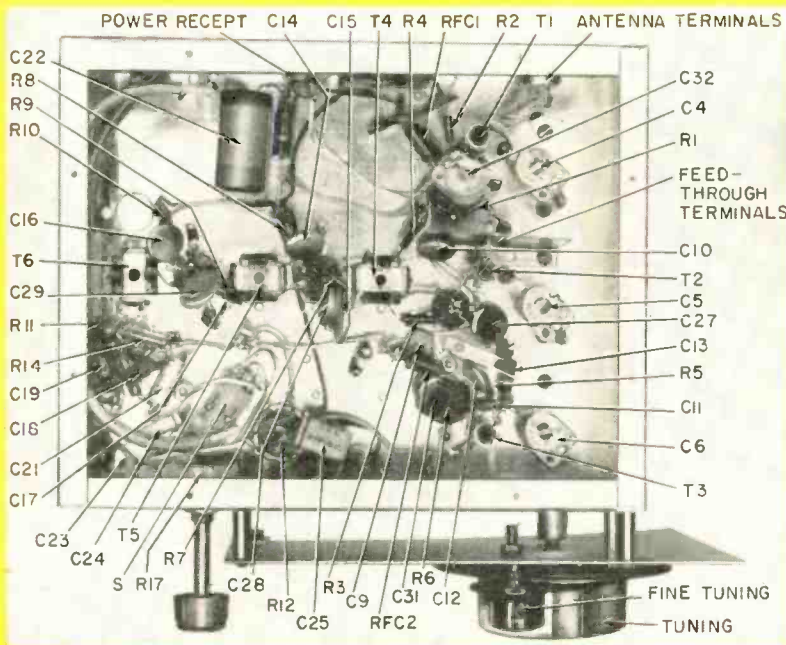

The large chassis makes crowding unnecessary.

POOR AM reception prompted the design and construction of this FM tuner. How it was developed need not be discussed. Only information needed to build a similar unit is presented.

A pentode rf amplifier and a separate grounded-plate Hartley oscillator feed a triode mixer, giving a very good signal-to-noise level (Fig. 1). The if strip is made up of stable 10.7-mc amplifiers of straightforward design. Detection is handled by a balanced ratio detector which has excellent symmetry and is easy to align. To isolate the LEVEL control from the connecting cable and amplifier input impedance, a cathode follower was added. Avc was considered unnecessary and, since drift is negligible, afc is not included.

Assembling the tuner

A T-type construction is used, with the if strip perpendicular to the rf section on a 7 x 9 x 2-inch chassis. Three Hammarlund MC-20-S capacitors are ganged with solid brass couplings for rigidity. The terminals on the capacitors are clipped off and new ones soldered on. They project down through 1/2-inch holes drilled in the chassis directly under the capacitor terminals. Two aluminum shields, one between the rf and mixer coils and the other between the oscillator and mixer coils, prevent interaction and allow all three coils to be mounted in the same plane.

The if strip is in a straight line perpendicular to the rf section and slightly offset to the rear of the chassis with respect to the mixer tube, keeping the plate lead short and direct. The detector and cathode follower are brought forward on the chassis to keep them near the volume control so high-impedance leads are short, preventing hum pickup. The output coupling capaci-

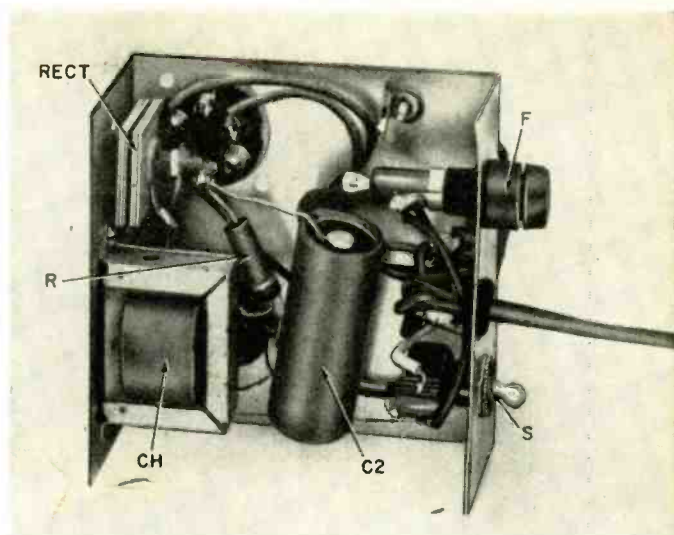
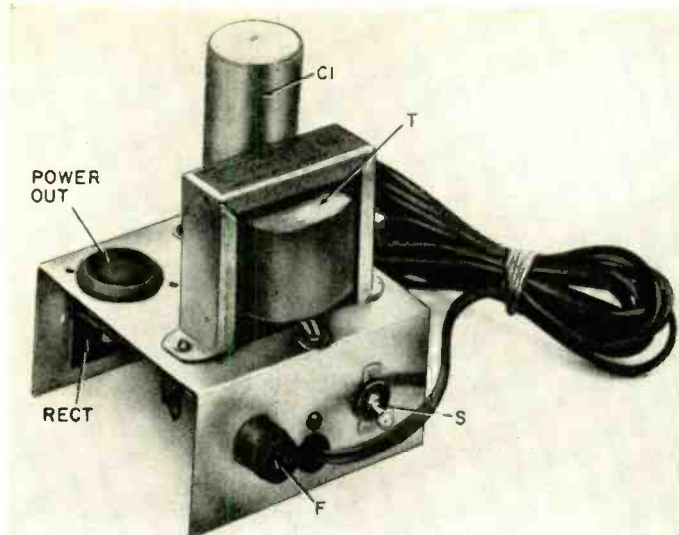

The power supply (left) on its tiny chassis. (right) Parts are kept to a minimum. You can use a three-section electrolytic and save still more room.

tor (C25) may be omitted if there is a capacitor in the amplifier input.

RFC1 and 2 are 0.8 μ h, approximately, and can be purchased commercially or made by close-winding 25 turns of No. 26 or 27 enameled wire on a 1-watt 47,000-ohm resistor and connecting the two in parallel. All other coils are available commercially. I have found that the rf coils can be purchased from most supply houses, even though they may not be listed in the catalogs.

[The author's unit uses a power receptacle. For safety this should be a chassis-mounted plug (on the tuner, not the power supply)—Editor.]

Receiver alignment

Alignment is not difficult if you have an rf signal generator and a vtvm. This is true, to a great extent, because the coils are all wound commercially. Remove the oscillator tube and, with the generator set to 10.7 mc, apply an unmodulated signal from mixer grid to ground. The vtvm is set to measure a small dc voltage from point A to ground. Adjust the primary and secondary of T4, T5, and the primary of T6 (bottom slug) for maximum indication. Change the vtvm from point A to point B and adjust the secondary of T6 for zero (top of can). Repeat this

procedure with the lowest generator output that will give about a 1-volt deflection on the vtvm.

Replace the oscillator tube and turn the tuning capacitor all the way out. Set the generator at 108 mc and apply to the antenna terminals. The vtvm should be between point A and ground. Adjust C6, C5 and C4, in that order, for maximum indication.

Close the tuning capacitor and set the generator for 88 mc. Adjust T1, T2 and T3 for maximum indication. Repeat if adjustment with the generator set to give a 1-volt reading on the vtvm. The tuner is now ready to use. Connect an

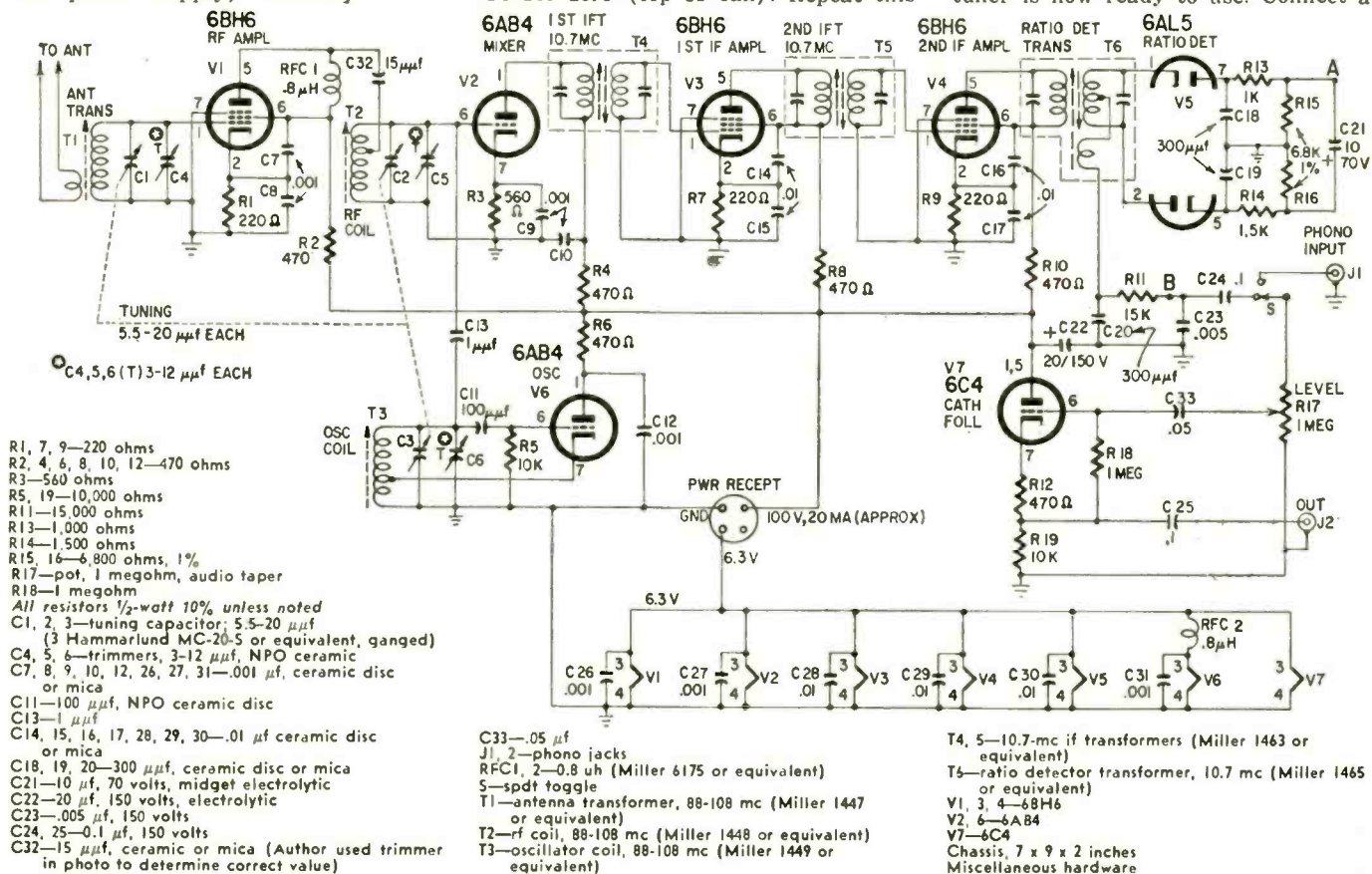
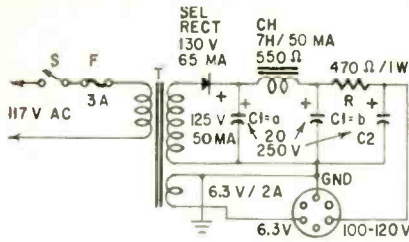

Fig. 1—Circuit of the Sweet tuner. Note heaters of tubes V1 through V6 are bypassed.



- R—470 ohms, 1 watt
- C1—20-20 μ f, 250 volts, electrolytic
- C2—20 μ f, 250 volts, electrolytic
- CH—7 henrys, 50 ma, 550 ohms (Stancor C-1707 or equivalent)
- F—3 amps
- RECT, selenium, 130 volts, 60 ma
- S—split toggle
- T—power transformer: primary, 117 volts; secondary, 125 volts, 50 ma; 6.3 volts, 2 amps (Stancor PA-8421 or equivalent)
- Chassis, to suit
- Miscellaneous hardware

Fig. 2—Selenium supply provides power for the tuner.

antenna and power supply and let it go.

With a pair of rabbit ears on top of my cabinet, I can get all the New York stations (30 air miles), four Philadelphia stations (56 air miles) and all the local New Jersey stations.

The tuner illustrated is shown for layout reference only and is not to be

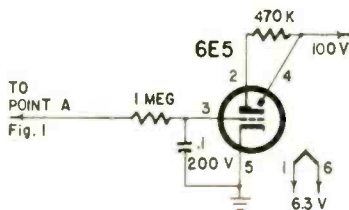

Fig. 3—Tuning-eye circuit gives a visual indication of proper tuning.

mistaken as a finished project. Dials and cabinets can be purchased or constructed according to individual tastes.

My amplifier had enough reserve power to run the tuner, which requires 20 ma at 100 volts and 1.2 amperes at 6.3 volts. For those who need a power supply, the values and schematic are shown in Fig. 2. Fig. 3 shows a tuning-eye circuit that can be added to the set. END



"He was checking the TV antenna, but he'll be right with us."

SERVICE MAKES SALES

How important is service—and that forgotten man, the service technician? The rash of sensationalized articles "exposing" technicians as incompetents and crooks is one proof, though a negative one, of the increasing importance of the man who keeps the home tubes burning.

It now appears that the "serviceman-will-gyp-you" articles may have run their course. A more positive recognition of the importance of service is reflected in the lead article of a recent issue of the influential *Wall Street Journal*. The article specifically deals with home appliance servicing, but its comments and conclusions are perhaps even more valid in the TV-radio-hi-fi field where service is more important because more of it is required.

Ever conscious of the balance sheet, the *Wall Street Journal* cites specific examples of appliance retailers whose profits have soared—despite the current cutthroat competition in consumer goods—because of their new emphasis on good and competent service.

"In the competitive times existing today," Frigidaire general manager Herman F. Lehman is quoted, "service becomes a bigger and more important asset than ever before." These examples are cited to show the new stress on service as an instrument for profit and goodwill:

To insure expert repair jobs, some stores—such as Ace Washer & Dryer Co. of Chicago—are now specializing on repairs of certain appliances only, switching from the jack-of-all-trades approach. To make sure that each technician does know his stuff about the appliances that he does service, Ace keeps them in shop training for about a year before letting them make

home calls. The company's appliance sales are 20% ahead of last year.

Many dealers are now relying on technicians to supply leads on sales prospects. Frank Kirby of Anniston, Ala., estimates he made 35 major appliance sales last year resulting from tips turned in by his technicians.

Manufacturers are stepping up their aids to technicians. Service manuals for new models are being rushed to dealers and technicians, instead of straggling along six months or so after the models are out. The *Journal* gives these examples of how appliance makers are also stepping up service training:

Norge is going to spend \$35,000 on repair training this year, a 40% increase over 1957, and has opened a new school in River Grove, Ill. Frigidaire will have 30 appliance repair training centers and is increasing its appliance training manpower by 15%. Sears Roebuck has boosted the minimum training requirement for its 7,500-man service force from 2 to 4 hours a month.

Manufacturers are now speeding deliveries of replacement parts to distributors. Westinghouse, G-E and Hotpoint now use computers to get orders filled in less than half the time formerly required.

The new recognition of the technician's vital role is summed up this way by the *Wall Street Journal*:

"Even where appliance sales have been especially hard hit by recession layoffs, advocates of increased service report they're doing better than competitors who offer little or no repair service. . . . Dealers who play down the importance of service these days do so at some peril." END

YOU'RE SAFE!



You're safe when you buy tubes by mail from advertisers in RADIO-ELECTRONICS. These advertisers meet RADIO-ELECTRONICS requirements for mail order tube advertising by telling you specifically in the ads that the tubes they are selling are new and unused. If the tubes are seconds, rejects, or otherwise not perfect, they tell you that too. When you buy their tubes—you know what you're getting—and you get what you pay for.

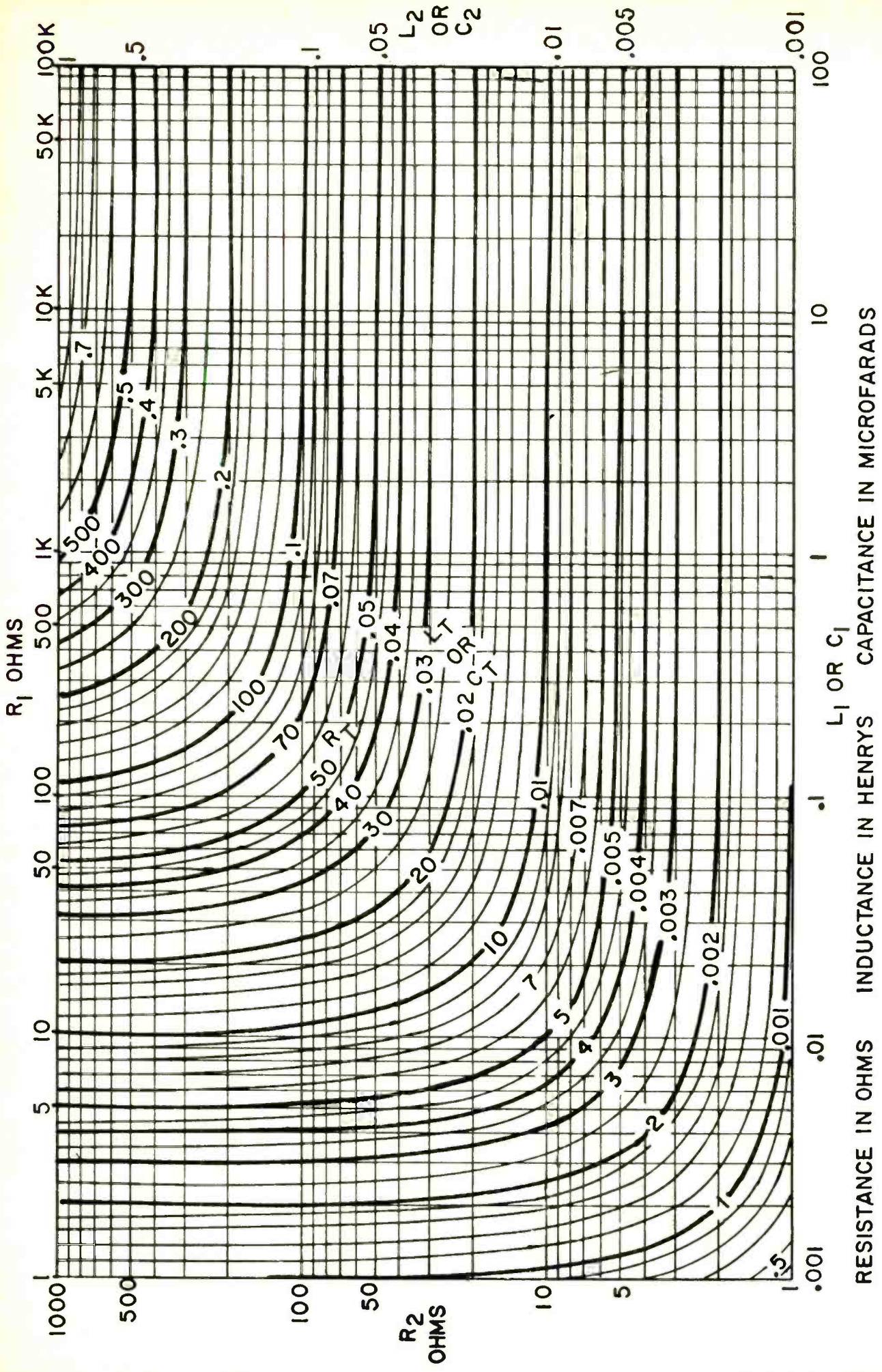

PARALLEL RESISTANCE CHART

By RUDOLPH WELLSAND

RESISTANCE IN OHMS INDUCTANCE IN HENRY'S CAPACITANCE IN MICROFARADS

To use the chart locate R_1 along the top scale and R_2 on the left-hand scale. Find the point where they meet on a curve. Trace the curve to the R_2 scale and read the answer. For total values of parallel inductance and series capacitance use the scales at the bottom and right hand edges. To extend the ranges of the scales, either multiply or divide each value in every scale by 1,000.

TEST INSTRUMENTS

Add a preamp with 50-db gain and a voltage divider to a vacuum-tube voltmeter and you can measure voltages down to 1 mv and decibels down to -60

Measure Millivolts with your VTVM

By REMI RIENDEAU

THERE is no denying that today's service technician needs a vtvm and, in fact, most technicians have one. Another instrument he should also always have on hand is a millivoltmeter, especially if he works on hi-fi equipment, microphones, turntables, cartridges, etc. If a vtvm is converted to measure millivolts, its usefulness will be greatly increased.

It took me about 10 hours and \$5 to add a preamp, which lets me measure voltages in the milli range, to my Heathkit V-6 vtvm. Similar modifications should work with other types of vtvm's.

The lowest full-scale readings on the Heath V-6 are 1.5 volts and 5 db. After adding a preamp with about 50-db gain (voltage gain equals 300), I can now measure 5 mv or -45 db full scale and 1 mv or -60 db at the lowest usable readings on the meter face. Connecting a voltage divider at the preamp's input provides five low-range scales. These are 500, 150, 50, 15 and 5 mv or, respectively, -10, -20, -30, -40 and -50 db.

Mechanical changes

First remove the meter from the front panel of the vtvm and drill a

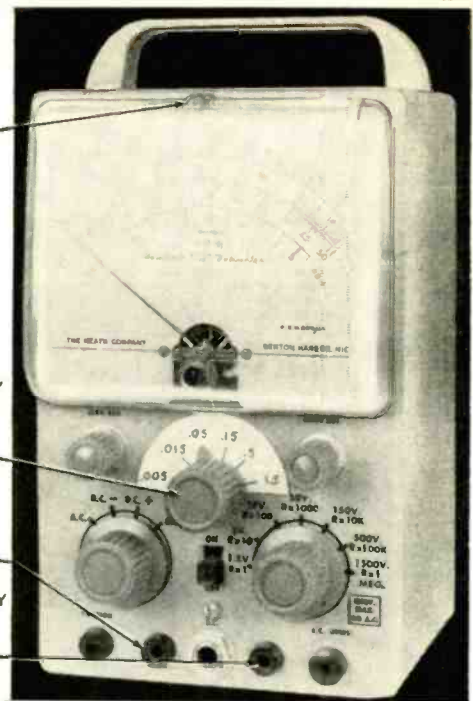

Fig. 2—New front panel of the vtvm after the modification.

3/16-inch hole in the center of the panel above the hole for the meter. Now replace the meter. Move the pilot-light assembly to the new position shown in Fig. 1. It is held in place by the meter mounting screw.

Slip the flashlight cell out of its clip and unfasten the bracket and the three-lug terminal mounted on the bracket from the chassis. The bracket is discarded. Fasten the terminal lug to the chassis with the same nut and bolt used for two-lug terminal D. Be sure that the three-lug terminal V does not ground to the nut holding control F (AC BALANCE) in position.

Next, drill a hole in the chassis near the power transformer for the noval socket for the preamp tube. The position of this tube is also shown in Fig. 1.

Drill a hole in the chassis between the 6H6 tube and calibrate controls J and K to install the clamp for the flashlight cell. The 9.2-ohm precision resistor (R17 in the original circuit) is soldered directly to the positive terminal of the battery and a wire is connected between the negative pole of the battery and the COMMON terminal of the meter. Drill a hole in the front panel for mounting jack J1 as shown in Fig. 2.

The capacitor-tester input jack on the front panel is the result of an earlier modification.

Switch S1 (HIGH-SENSITIVITY RANGE) is also mounted on the front panel (see Fig. 2). The dial plate for this switch is made from a piece of cardboard and held in place between the panel and the mounting nut of the switch.

The preamplifier

The preamp is a standard R-C coupled two-stage unit giving 50-db gain (see Fig. 3). With the addition of

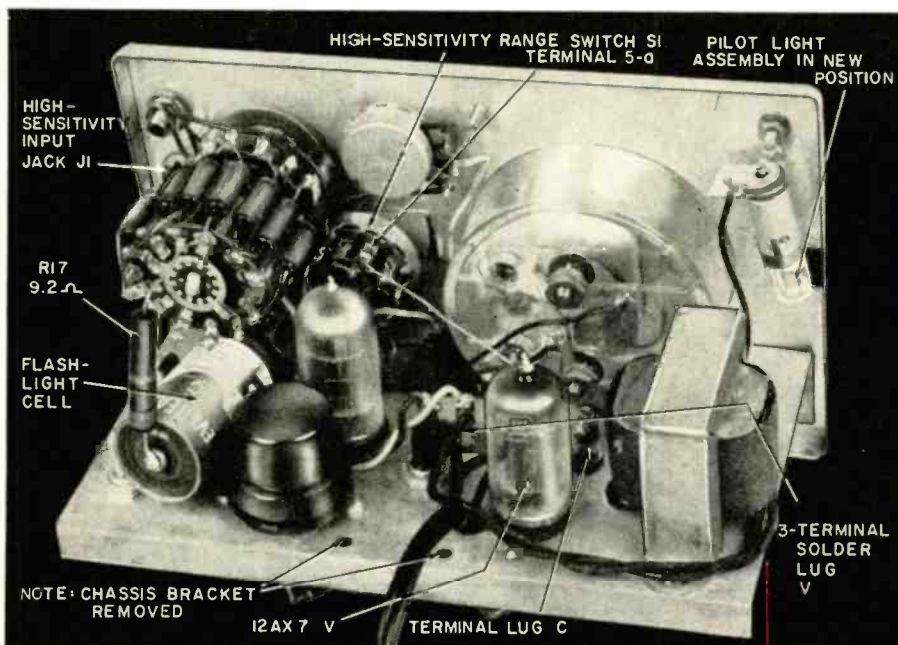

Fig. 1—The new positions of some parts and the location of the added components are shown in this behind-the-panel view.

an overall feedback loop, frequency response is maintained within 2 db from 30 to 50,000 cycles.

The tube is a 12AX7, high-mu twin triode. Heater pins 4 and 5 are tied together and connected to pin 7 of the 6H6 in the vtvm. Heater pin 9 of the 12AX7 is connected to the nearest grounded terminal lug.

B-plus is taken directly from the selenium rectifier. Referring to Fig. 4, note that a 20- μ f 150-volt filter capacitor (C4) is added to the original power supply to provide additional filtering. This is necessary as the preamp is very sensitive and ripple cannot be tolerated in its B-plus supply.

Another change made in the vtvm circuit is to replace the .01- μ f 2,000-volt capacitor in the input (plate) circuit of the 6H6 with a 0.1- μ f 1,600-volt unit. This change increases the frequency response of the vtvm considerably.

Range switch wiring

The range switch, S1, when wired and connected into the circuit, acts as a voltage divider in the input of the preamp. The switch is a single-gang two-

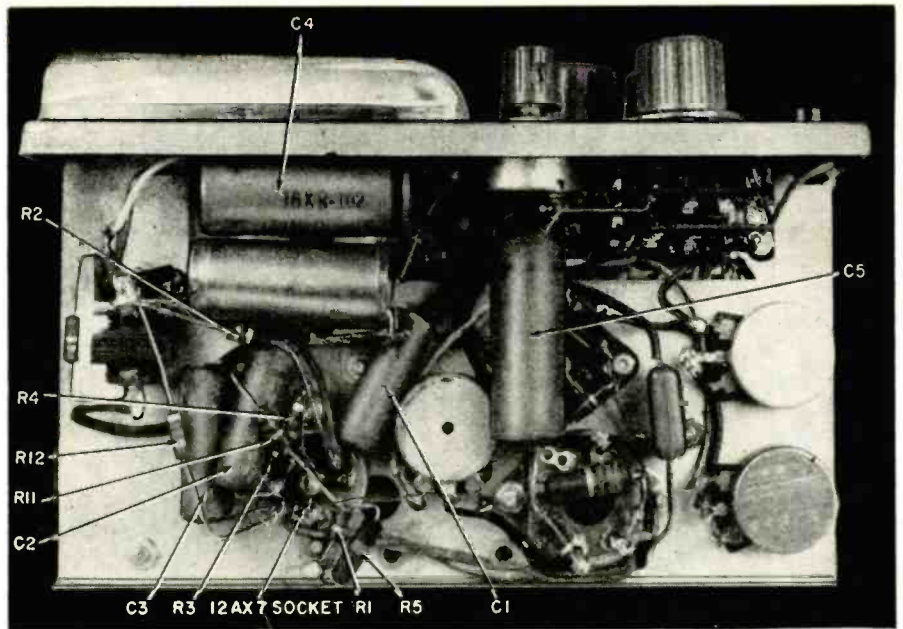
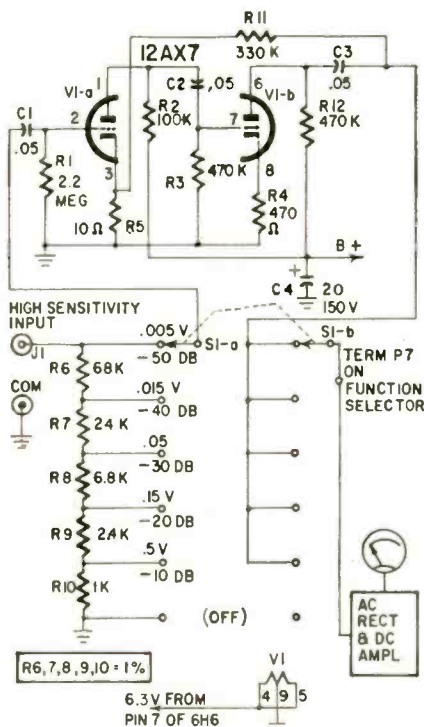

Fig. 4—Recommended parts placement for preamp components.



- R1—2.2 megohms
- R2—100,000 ohms
- R3—12—470,000 ohms
- R4—470 ohms
- R5—10 ohms
- *R6—68,000 ohms
- *R7—24,000 ohms
- *R8—6,800 ohms
- *R9—2,400 ohms
- *R10—1,000 ohms
- R11—330,000 ohms
- *1% or better, selected with a resistance bridge
- All resistors 1/2-watt 10% unless noted
- C1, 2, 3—.05 μ f
- C4—20 μ f, 150 volts, electrolytic
- C5—.01 μ f, 1,600 volts; to replace unit now in cathode circuit of 6H6
- J1—red banana jack
- S1—single gang, 2 poles, 6 positions, rotary switch (Mallory 3226J)
- V1—12AX7 Socket, 9-pin miniature

Fig. 3—Circuit of the preamp and high-sensitivity range switch.

pole six-position unit made by Mallory (No. 3226J). Fig. 5 shows that one pole of the switch is used as a continuously make contact so the output of the preamp is always connected to the input of the vtvm circuit. The other pole of the rotary switch selects the voltage divider range.

Selected 10% resistors (use a resistance bridge) are used for the voltage divider. The more precise the values of these resistors the more accurate the millivolt readings will be.

As the switch is mounted in a hard-to-get-at location, it is best to wire it before mounting. Fig. 5 shows the wiring.

First locate terminals 0 and 00. Connect a 6-inch length of wire to terminal 1. Connect resistors R6, R7, R8, R9 and R10. Connect a 5-inch length of wire to terminal 00 and another to 5-a. Then join terminals 1-a, 2-a, 3-a, 4-a and 5-a together with a bare wire.

Now mount S1 on the front panel. Connect the free lead of capacitor C1 to terminal 0. Solder the lead from terminal 6 to the COMMON jack (ground) of the vtvm. Cut to length and connect the lead from terminal 5-a to terminal lug C (see Fig. 1). The wire from terminal 1 is connected to the HIGH-SENSITIVITY INPUT jack J1. The lead from terminal 00 is soldered to P7 of the vtvm's selector switch.

Calibrating the new ranges

To calibrate the new ranges, short jack J1 to ground and adjust the electrical zero of the meter in the usual way. Then, put the vtvm's range switch in the 1.5-volt position. This position is used for all high-sensitivity measurements. Set the selector switch for ac. Feed a known voltage to jack J1—500 mv is good. Set the HIGH-SENSITIVITY RANGE switch for 0.5 volt. The meter needle should deflect to 50 volts. If the reading is not exactly 50 (500 mv), vary the value of cathode resistor R4

slightly. Usually, trying a few 470-ohm resistors will uncover one that will give the proper results. These are 10% tolerance units and therefore give you a reasonable range. This sets the preamp's voltage gain at 300.

Now check the other high-sensitivity ranges. Any further inaccuracies are caused by incorrect values for the voltage-divider resistors—they should be 1% or better.

Now the conversion is complete. You are equipped to measure millivolts, have a wide db range and fairly flat frequency response. Using the meter you can now determine frequency response of audio amplifiers and gain of each stage. Use it to measure the output of microphones and phono cartridges, to check ripple voltage in filter circuits and as a sensitive null indicator. The modified V-6 vtvm can be used anywhere high-ac sensitivity is required. END

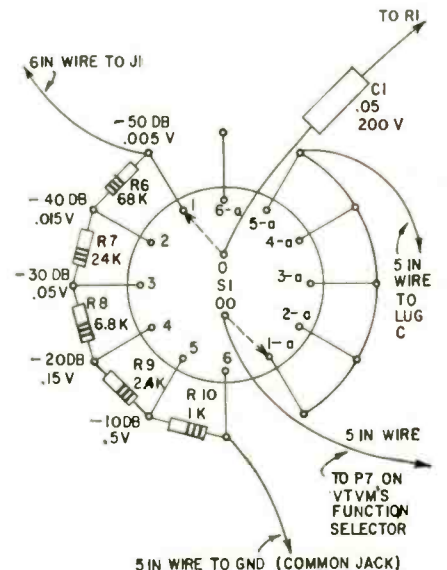
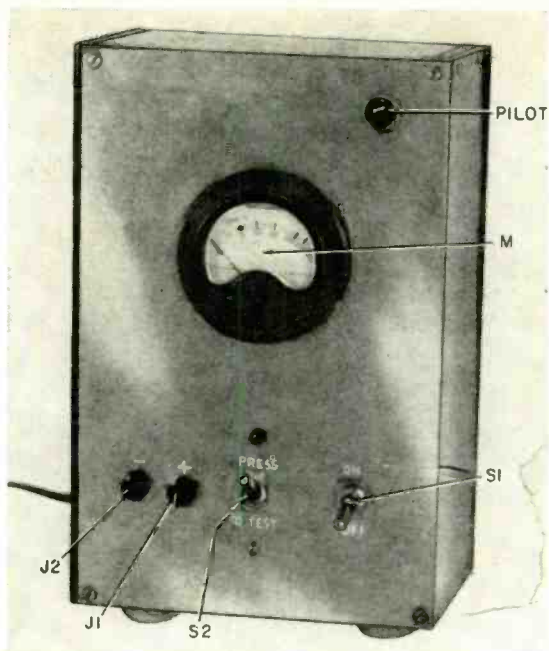

Fig. 5—Sketch of back of range switch shows wiring details.



Measure the capacitance of electrolytics without snipping leads

CHECK ELECTROLYTICS IN CIRCUIT

By JOEL H. LEVITT

D ID you ever spend hours checking a set only to find that the trouble was an electrolytic capacitor whose capacitance had dropped slightly? Now you can check electrolytics in the set, actually getting an approximate reading of their capacitance, without clipping any leads. The tester is easy to assemble, inexpensive, and as easy to use as an ohmmeter. Unlike a leakage tester, it actually measures the ability of a capacitor to hold a charge, which is what determines its performance in the set. Since the test voltage is moderate and the set's power is turned off while testing, it is impossible to get a shock using the unit.

A basic circuit for measuring capacitance is shown in Fig. 1. Switch S is thrown to position A and the capacitor under test (C) charges (amount of charge in coulombs equals the capacitance of the capacitor in farads times the charging voltage, $Q = CV$). If

switch S is now thrown to position B, the capacitor will discharge through the meter, causing the needle to swing up to some peak reading and then drop back. If switch S is switched back and forth rapidly, the needle will not have time to drop back but will indicate some average current. If we calibrate the meter in microfarads and replace the switch with a commutator driven by a precision motor, we have the basis of a capacitance-measuring instrument.

What we are interested in on the service bench, however, is a compact, all-electronic device which will allow an electrolytic to show that it can hold a charge, even if it is connected in parallel with a low resistance. The solution and complete circuit is shown in Fig. 2. During the part of the ac cycle when the selenium rectifier conducts, the capacitor under test (C) charges. During this half cycle, current flow through the meter is blocked by V. Phasing of transformers T1 and T2 is

arranged so that when the rectifier is conducting, T1 supplies a voltage that makes the grid of V negative with respect to its cathode, thus keeping the tube cut off. During the other half cycle, the rectifier blocks and C discharges through V (which now has a positive bias on its grid) and the meter. The capacitor also discharges through resistor R1, but it is the presence of this low-value (90-ohm) resistor in the circuit which permits testing in the receiver.

If the meter is calibrated for out-of-set electrolytics, a 10,000-ohm resistor in the set, in parallel with the electrolytic to be tested, will not have much effect on the 90-ohm impedance circuit. If the parallel load drops below 1,000 ohms, the reading *does* drop appreciably. As you become more familiar with the tester's operation, you will find it easy to make a mental correction in the few cases where such circuits are encountered. (If absolutely necessary of course, one lead can be clipped.)

If you are willing to go to the added expense, the loading effect can be minimized by increasing the current ratings of the transformer and rectifier and lowering R1's value. (The peak ac voltage divided by R1 gives the minimum current rating for T2 and RECT when a good electrolytic is under test.) Using the values given in the parts list, you will have a highly efficient tester.

If you don't want to purchase a meter for the tester, you can use the 0-1-ma scale of any standard multimeter. A vtvm set to the 1.5-volt position with a 1,500-ohm resistor across its terminals also makes a fine 0-1-ma meter for this application. (However, you can't always use this trick, since the low internal resistance of a regular dc milliammeter is a must in some current measurements

The effective capacitance range is

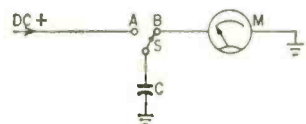
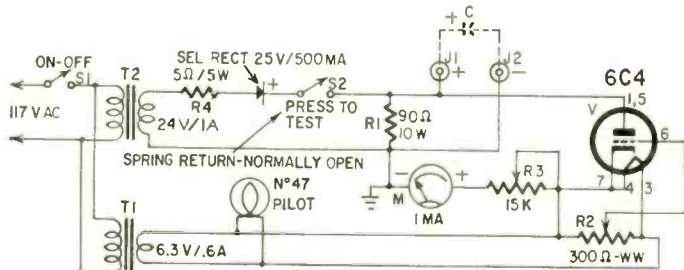

Fig. 1 (left)—Basic capacitance measuring circuit needs a mechanical switch.

Fig. 2 (below)—Circuit of the in-set capacitance tester.



- R1—90 ohms, 10 watts
- R2—pot, 300 ohms, wirewound
- R3—pot, 15,000 ohms
- R4—5 ohms, 5 watts
- J1, 2—pin jacks
- M—0-1-ma meter
- RECT—selenium, 25 volts, 500 ma (International Rectifier M1H or equivalent)
- S1—spst toggle
- S2—spst spring-return toggle, normally open

- T1—filament transformer: primary 117 volts; secondary 6.3 volts, 0.6 ma
- T2—filament transformer: primary, 117 volts; secondary, 24 volts, 1 amp approximately (Triad F-40X or equivalent)
- V—6C4
- Socket, 7-pin miniature
- Pilot-lamp assembly with No. 47 bulb
- Chassis and case to suit
- Miscellaneous hardware

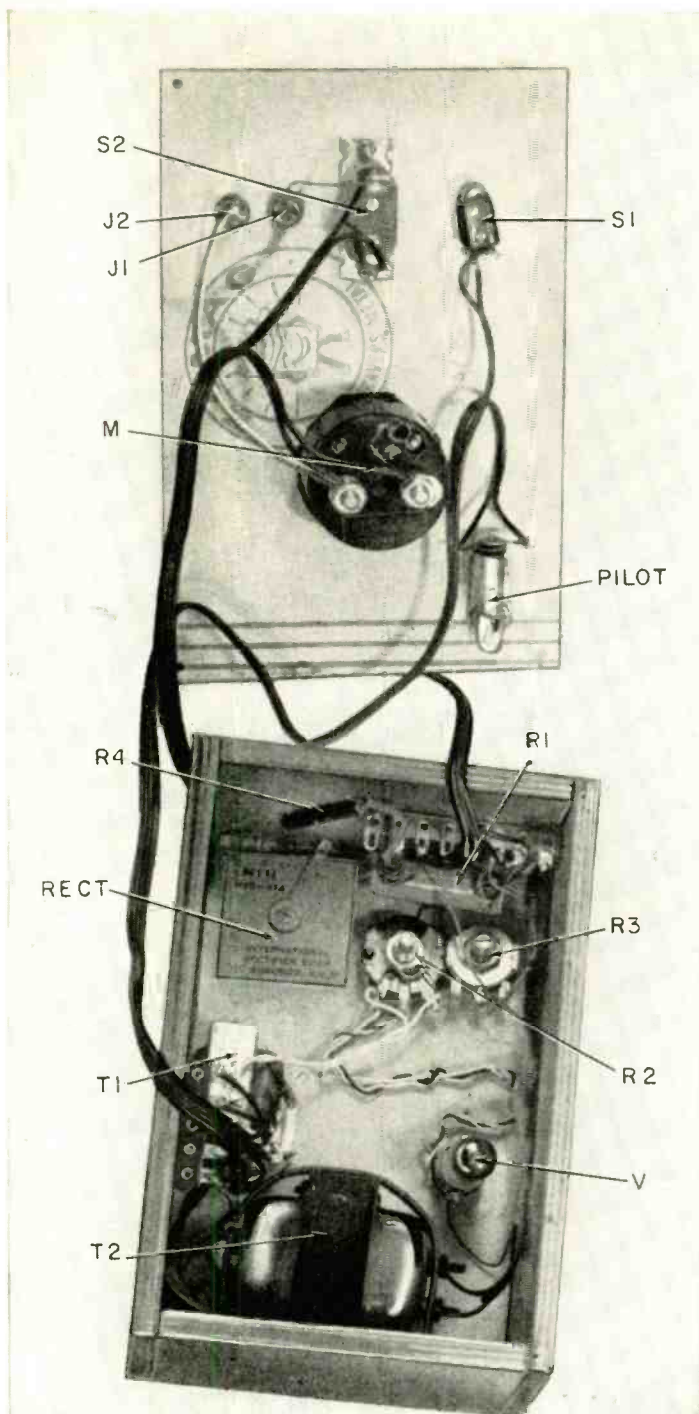

Lifting off the front panel shows how the author mounted parts inside the wooden cabinet.

approximately 10–100 μf . For accurate calibration, you will need either high-capacitance oil capacitors or electrolytics whose capacitance has been checked recently on a conventional capacitance bridge. New electrolytics will have more or less capacitance than their ratings indicate, but they will suffice for a useful calibration if, for instance, you try several 50- μf units before determining the 50- μf point on the meter.

The first step in calibration is to set R3 to its maximum value. Then turn the unit on without any electrolytic connected, and depress the spring-return test switch. Holding this down, adjust R2 until the meter current is just cut

off. Excessive drive can ruin linearity, even here! If the meter reads full scale for all positions of R2, reverse the leads to one of the windings on one of the transformers. Adjust R3 so the meter reads full scale for 100 μf . Then use the standard capacitors to determine the intermediate points.

If a capacitor gives no reading do not hold test switch S2 down for more than a few seconds, since a direct short will overload the rectifier. Also be sure to observe correct polarity.

This instrument should make a welcome addition to your test equipment. You probably have enough parts lying around to throw together a breadboard model. Why not try it right now? **END**

NEXT MONTH

LOW-FREQUENCY AUDIO OSCILLATOR

Covers the range that the common ones can't reach — from approximately 3 to 30 cycles. By Tom Jaski.

INSTALLING COMMERCIAL ANTENNAS

First of a series on the special problems of antennas for multiple installations, the staff of Scala Engineering discuss Yagis and dipoles from the installer's viewpoint.

RELAY ADJUSTMENTS

Relays are extremely important in the growing industrial service field, and are even invading that of TV and auto radio. J. A. McRoberts covers both the theoretical and practical aspects.

"HEATHKITS®

gave me my start and I'm still sold!"

"... they are my lowest cost way to real quality and dependability in electronic equipment of any kind . . .

. . . The clean, modern styling of HEATHKITS make me proud to own them. They make a handsome and useful addition to my workshop.

. . . Rigid quality standards of components used in HEATHKITS assure me of performance equal to or surpassing instruments costing many times more.

. . . after assembling a HEATHKIT myself, I know what "makes it tick". . . I know that the thoughtful circuitry design and name-brand components used throughout guarantee me years of trouble-free service.

. . . HEATHKITS cost me half as much as ordinary equipment . . . and I get so much more. In assembling my own instruments I am sure of the quality that goes into them. Plus the complete assembly and operating instructions as well as detailed schematics that are at my fingertips for future reference."



HEATH COMPANY Benton Harbor 20, Michigan

 a subsidiary of Daystrom, Inc.

NEW: Stereophonic Sound for your home with the new HEATHKIT STEREO CENTER. This, and other exciting new high fidelity developments are now available from the world's largest maker of "do-it-yourself" electronic kits.

NEW: For the Ham Radio fans—an all new Ham Transmitter and companion Receiver—featuring all the latest developments in Ham communication—including single-sideband operation.

NEW: A completely up-to-date Oscilloscope answering the long felt needs of electronic engineers and servicemen everywhere.

NEW: A host of newly developed marine instruments for the safety and convenience of the boat owner.

The HEATH TIME PAYMENT PLAN allows you to outfit your whole workshop at one time with needed test instruments while you pay in easy monthly installments.

PROFESSIONAL OSCILLOSCOPE KIT

An exciting development in the Heathkit test instrument line is the introduction of the Heathkit model OP-1 Professional Oscilloscope. Emphasizing complete flexibility in any application, the OP-1 features DC coupled amplifiers and also DC coupled CRT tube un-blanking. The triggered sweep circuit will operate on either internal or external signals and may be either AC or DC coupled. The polarity of the triggering signal may also be selected, and any point on the wave form may be selected for the start of the sweep by using the "triggering level" control. An automatic position is also provided, in which the sweep recurs at a 50 cycle rate, but can be driven over a wide range of frequencies with no additional adjustments. The sweep frequencies are provided by switch-selected base rates of 2 and .2 milliseconds/CM, and 20, 2, and 1 microseconds/CM, in conjunction with a continuously variable 10 to 1 multiplier. Sweep frequencies are calibrated to within 10% at all control settings, and the sweep frequency may be reduced by adding capacity to the "ext. cap" binding post on the front panel. A 5ADP2 flat face CR tube is used for accurate readings on an edge lighted grid screen. A high quality conetic-ferretic CR tube shield prevents stray AC fields from distorting trace. A 12-position vertical attenuator is calibrated in volts-per-CM and the horizontal sweep is calibrated in time-per-CM. Prewired terminal boards are used for rapid, easy assembly of all critical circuits. Simply install and connect the color coded leads. Power supply is transformer operated utilizing silicon diode rectifiers and is fused for protection. Under development for over a year the OP-1 promises outstanding results in any application requiring the use of an oscilloscope.



HEATHKIT
OP-1

\$179⁹⁵

*Here's the scope you've
been waiting for!*



**Laboratory
Performance At Less
Than Utility Scope
Price**

HEATHKIT
O-12 **\$65⁹⁵**



**A Scope You Will Be
Proud To Own**

HEATHKIT
OM-3 **\$39⁹⁵**

"EXTRA DUTY" 5" OSCILLOSCOPE KIT

Top quality features at half the cost of ordinary equipment sum up the advantages of this popular kit. Critical observations in your laboratory or shop are handled easily, with clear, sharp pattern displays in every application. Vertical frequency response extends from 3 CPS to 5 mc ± 1.5 db -5 db without extra switching. Response is down only 2.2 db at 3.58 mc. The Heath patented sweep circuit functions effectively from 10 CPS to better than 500 kc in five steps, giving you 5 times the usual sweep obtained in other scopes. An automatic sync circuit with self-limiting cathode follower provides excellent linearity and lock-in characteristics. Extremely short retrace time and efficient blanking action. Both vertical and horizontal output amplifiers are push-pull and the scope incorporates a 1 V peak-to-peak calibrating source, step attenuated and frequency compensated vertical input, plastic molded capacitors and top quality parts throughout. The 11-tube circuit features a 5UP1 cathode ray tube, and provision is made for Z-axis input for intensity modulation of the beam. Frequency response of the horizontal amplifier is within ± 1 db from 1 CPS to 200 kc. Horizontal sensitivity is 0.3 volts RMS per inch. Construction is simplified through the use of two metal circuit boards and pre-cut, cable wiring harness. Shpg. Wt. 22 lbs.

GENERAL PURPOSE 5" OSCILLOSCOPE KIT

For servicing and routine laboratory work this fine kit is a favorite with technicians throughout the country. It incorporates many extras not expected at this low price. Features wide vertical amplifier frequency response, extended sweep generator operation, and improved stability. Frequency response of the vertical amplifier is within ± 3 db from 4 CPS to 1.2 mc. Vertical sensitivity is .09 volts RMS per inch at 1 kc. Sweep generator functions reliably from 20 CPS to over 150 kc. A modern etched circuit board is featured for high stability and reduces assembly time considerably. Standard components are mounted on this board with each position clearly marked preventing wiring errors. Both vertical and horizontal amplifiers are push-pull types. Uses a 5BP1 CRT. Provision for external or internal sweep or sync, built in 1 V peak-to-peak reference voltage and calibrated grid screen. An adjustable "spot shape" control is provided to insure a sharp trace. Input to the vertical amplifiers is through a step attenuated, frequency compensated circuit. The OM-3 is an extremely versatile instrument and has a multitude of practical uses in electronic testing fields. Particularly useful in alignment of television receivers, for testing audio amplifiers and circuits, and checking the quality of modulated RF signals in Ham Radio transmitters. Shpg. Wt. 22 lbs.



Equip Your Service Bench...



HEATHKIT
CD-1 **\$59⁹⁵**

Cash In Now On Color TV

- ★ 10 VERTICAL COLOR BARS
- ★ CRYSTAL CONTROLLED ACCURACY
- ★ CHOICE OF 6 DIFFERENT PATTERNS

COLOR BAR AND DOT GENERATOR KIT

Colored television is now a reality and as the number of these sets increase the need for a reliable service instrument is apparent. Nothing on the market... in this type of generator has as many features as the CD-1 at such a tremendous price saving. This unit combines two basic color service instruments, a color bar generator, and white dot generator in one versatile portable unit which has crystal controlled accuracy and stability for steady locked-in patterns (requires no external sync leads). Color receivers converged with the CD-1 will still be converged properly on a television program from the station. The 13-tube circuit has been carefully laid out for ease of assembly and provides choice of six different patterns. Produces white-dots, cross hatch, horizontal and vertical bars, ten vertical color bars, and a new shading bar pattern for screen and background adjustments. Variable RF output on any channel from 2 to 6. Positive or negative video output, variable from 0 to 10 volts peak-to-peak. Crystal controlled sound carrier with off-on switch. Voltage regulated power supply uses long-life silicon rectifiers. Kit includes three crystals and test lead, plus an information packed instruction manual covering convergence, and screen and background adjustments of a color TV set. Compare with other generators on the market and you will see that this instrument is loaded with extras and top quality all the way through. Shpg. Wt. 13 lbs.



HEATHKIT
TS-4A **\$49⁵⁰**

For fast,
easy alignment
of TV sets



HEATHKIT
AG-10 **\$49⁹⁵**

Sine and
square waves for
countless uses



HEATHKIT
MM-1
\$29⁹⁵

High accuracy
in a
portable meter



HEATHKIT
M-1
\$17⁹⁵

An all-round
meter of
many uses

TV ALIGNMENT GENERATOR KIT

This generator has many special design features for flexible, easy operation and reliability. The all-electronic sweep circuit insures stability and covers 3.6 mc to 220 mc in four bands. Sweep deviation is controllable from 0 to 42 mc. Crystal and variable marker oscillators are built in. Crystal (included with kit) provides output at 4.5 mc and multiples thereof. Variable marker provides output from 19 to 60 mc on fundamentals and from 57 to 180 mc on harmonics. Effective two-way blanking and phasing control also provided. A truly outstanding number of features at a tremendous price saving. Shpg. Wt. 16 lbs.

SINE-SQUARE GENERATOR KIT

High quality sine and square waves are produced by this generator over a wide range. Frequency response is ± 1.5 db from 20 CPS to 1 mc on both sine and square waves, with less than .25% sine wave distortion, 20 to 20,000 CPS. Output impedance is 600 ohms on sine wave and 50 ohms on square wave (except on 10 volt range). Square wave rise time less than .15 microseconds. Five-position bandswitch—continuously variable tuning—shielded oscillator circuit—separate step and variable output attenuators in ranges of 10, 1 and .1 volts with extra range of .01 volt on sine wave. Shpg. Wt. 12 lbs.

20,000 OHMS/VOLT VOM KIT

This meter is ideal for use in field applications where accuracy is important. Employs a 50 μ a $4\frac{1}{2}$ " meter, and features 1% precision multiplier resistors for high accuracy. Requires no external power for operation (batteries supplied). Sensitivity is 20,000 ohms-per-volt DC and 5,000 ohms-per-volt AC. Measuring ranges are 0-1.5, 5, 50, 150, 500, 1500 and 5,000 volts AC and DC. Measures direct current in ranges of 0-150 μ a, 15 ma, 150 ma, 500 ma and 15 a. Resistance multipliers are x 1, x 100 and x 10,000. Covers -10 db to +65 db. Batteries and test leads are also included with this kit. Shpg. Wt. 6 lbs.

HANDITESTER KIT

Small enough to carry with you wherever you go, this fine handitester is ideal for use in portable applications when making tests away from the work bench or as an "extra" meter in the service shop, when the main instruments are occupied. The combination function-range switch simplifies operation. Measures AC or DC voltage from 0-10, 30, 300, 1000 and 5000 volts. Direct current ranges are 0-10 ma and 0-100 ma. Ohmmeter ranges are 0-3000 and 0-300,000. Top quality precision components employed throughout. Very popular with home experimenters and electricians. Shpg. Wt. 3 lbs.

with Low-Cost Dependable Heathkits

HEATHKIT

ETCHED CIRCUIT VTVM KIT

The fact that this instrument is outselling all other VTVM's says a great deal about its accuracy, reliability, and overall quality. The precision and quality of the components used in this VTVM cannot be duplicated at this price through any other source. Its attractive appearance as well as its performance will make you proud to own it. A large 4½" panel meter is used for indication, with clear, sharp calibrations for all ranges. Front panel controls consist of a rotary function switch and a rotary range selector switch, zero-adjust and ohms-adjust controls. Precision 1% resistors are used in the voltage divider circuit. An etched circuit board is employed for most of the circuitry, cutting assembly time and eliminating the possibility of wiring errors. It also assures duplication of laboratory instrument performance. This multi-function VTVM will measure AC voltage (RMS), AC voltage (peak-to-peak), DC voltage and resistance. There are 7 AC (RMS) and DC voltage ranges of 1.5, 5, 15, 50, 150, 500 and 1500. In addition there are 7 peak-to-peak AC ranges of 0-4, 14, 40, 140, 400, 1400 and 4,000. Seven ohmmeter ranges providing multiplying factors of x 1, x 10, x 100, x 1000, x 10 k, x 100 k and x 1 megohm. Center scale resistance readings are 10, 100, 1000, 10 k, 100 k ohms, 1 megohm and 10 megohms. A zero-center scale db range is also provided. Battery and test leads included with kit. Shpg. Wt. 7 lbs.



HEATHKIT
V-7A
\$25⁹⁵

World's largest selling
VTVM kit

- ★ LARGE EASY-TO-READ 4½" 200 UA METER
- ★ 1% PRECISION RESISTORS EMPLOYED FOR HIGH ACCURACY



HEATHKIT
C-3
\$19⁵⁰

Checks all types of
condensers accurately

CONDENSER CHECKER KIT

Check unknown condenser and resistor values quickly and accurately. Capacity measurements are made in four ranges of .00001 mfd-.005 mfd; .001 mfd-.5 mfd; .1 mfd-50 mfd; 20 mfd-1,000 mfd. Checks paper, mica, ceramic, and electrolytic condensers. Leakage test provides switch selection of five polarizing voltages, 25 volts to 450 volts DC to indicate condenser operating quality under actual load conditions. Electron beam "eye" tube indicates balance and leakage. A spring return test switch automatically discharges condenser under test and eliminates shock hazard to the operator. Measures resistance from 100 ohms to 5 megohms in two ranges. Shpg. Wt. 7 lbs.



HEATHKIT
T-4
\$19⁹⁵

Locate faults quickly
by tracing signals

VISUAL-AURAL SIGNAL TRACER KIT

Here is a brand new signal tracer completely redesigned with compact dimensions and new circuit layout. Features built-in speaker and electron beam "eye" tube for signal indication and a unique noise locator circuit. Ideal for use in AM, FM and TV circuit investigation. RF and audio inputs are provided in one convenient probe with switch on probe to select either input. Useful for checking microphones, phono cartridges, record changers, tuners, etc. Makes a handy substitution speaker for servicing TV sets at the shop. Transformer operated for safety and high efficiency. Complete with test leads and informative construction manual. Shpg. Wt. 6 lbs.



HEATHKIT
SG-8
\$19⁵⁰

Easy-to-build—prewound
and calibrated coils

RF SIGNAL GENERATOR KIT

Save valuable time in aligning RF tuned circuits of all kinds with this easy-to-use kit. Also a quick way to trace signals in faulty RF, IF and audio circuits. Designed for general service applications—the SG-8 covers 160 kc to 110 mc on fundamentals in five bands, and from 110 mc to 220 mc on calibrated harmonics. The entire oscillator circuit is built on a special sub-chassis, using prewound and calibrated coils. No further calibration is required so it is ready to use as soon as construction is completed. RF output is in excess of 100,000 microvolts, controlled by both step and continuously variable controls. Complete with output cable and instructions. Shpg. Wt. 8 lbs.

HEATH COMPANY • a subsidiary of Daystrom, Inc. • Benton Harbor 20, Mich.

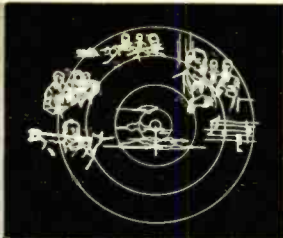

Enjoy Rich 3 Dimension Sound...

Beautifully Styled with Plenty of Room for the Most Complete Stereo System

AVAILABLE IN THE FOLLOWING MODELS:

- Model SE-1B - Stereo Equipment Cabinet (birch)
- Model SE-1M - Stereo Equipment Cabinet (mahogany)

\$149⁹⁵ ea.

- Model SC-1BR - Stereo Wing Speaker Enclosure (birch - right end)
- Model SC-1BL - Stereo Wing Speaker Enclosure (birch - left end)
- Model SC-1MR - Stereo Wing Speaker Enclosure (mahogany - right end)
- Model SC-1ML - Stereo Wing Speaker Enclosure (mahogany - left end)

\$39⁹⁵ ea.

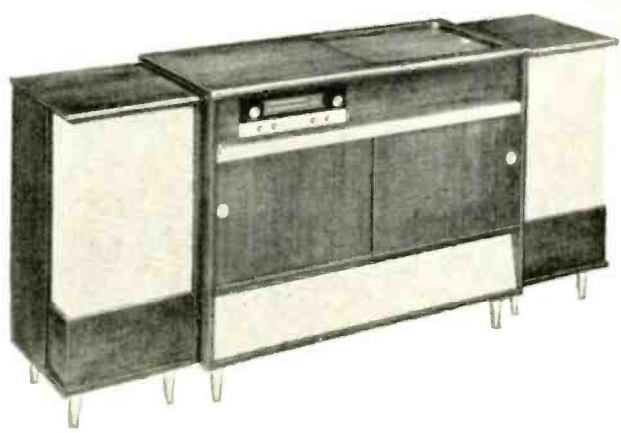

STEREO EQUIPMENT CABINET KIT

Imagine!... Stereophonic sound in your own home. This superbly designed cabinet holds all of your hi-fi stereo equipment and lends striking elegance to your living room. The attractive gold and black panels, trim and hardware brilliantly highlight the overall effect. Rich toned grille cloth, flecked in gold and black, complement the cabinet. The unit has ample room provided for an AM-FM tuner, tape deck, stereo pre-amplifier, amplifiers, record changer, record storage and speakers. Beautifully grained 3/4" solid core Philippine mahogany or select birch plywood is used for construction. The top features a shaped edge and sliding top panel for easy access to the stereo tape deck and stereo preamplifier. Sliding doors are employed for convenient front access to the

changer and record storage compartment. All parts of the cabinet are pre-cut and pre-drilled for simple assembly. The speaker wings and center cabinet may be purchased separately if desired. Note: the kit is delivered equipped with panels pre-cut to accommodate Heathkit components and also blank panels to cut out for your own equipment. Measurements of the individual component areas follow: tape deck and pre-amplifier area 20 3/4" L. x 17 3/4" W. x 10" D., record changer area 21" W. x 16" D. x 9 5/8" H., record storage area 22 5/8" W. x 14 1/2" H. x 12 1/2" D., speaker wing area (inside) 14" W. x 29 1/2" H. x 15 3/4" D., AM-FM Tuner area 20 1/2" W. x 5 1/4" H. x 14" D., amplifier (2 areas) 15 1/4" W. x 10 3/4" H. x 13 1/4" D.



Model HH-1B Birch
Model HH-1M Mahogany
Now only **\$299⁹⁵** each

The Same Superior Performance At a New Low Price



HEATHKIT SS-2 **\$39⁹⁵**

OPTIONAL LEGS EXTRA

Economical Hi-Fi For Your Home

"LEGATO" HI-FI SPEAKER SYSTEM KIT

The increasing sales of the Legato has made more economical quantity production possible so we are passing the savings on to you by offering you this magnificent speaker system at a reduced price. Truly a "queen" among hi-fi speaker systems, the Legato was specially designed to meet and surpass the most stringent requirements of high fidelity sound reproduction. Two 15" Altec Lansing low frequency drivers cover frequencies of 25 to 500 CPS while a specially designed exponential horn with high frequency driver covers 500 to 20,000 CPS. A unique crossover network is built in making electronic crossovers unnecessary. Internal reflections are absorbed by splayed back panel and a 3" fiber glass lining. The Legato emphasizes simplicity of line and form to blend with modern or traditional furnishings. Cabinet construction is 3/4" veneer surface plywood in either African mahogany or white birch and measures 41" L. x 22 1/4" D. x 34" H. All parts are pre-cut and pre-drilled for easy assembly. Shpg. Wt. 195 lbs.

"BASIC RANGE" HI-FI SPEAKER SYSTEM KIT

True high fidelity performance at modest cost make this basic speaker system a spectacular buy for any hi-fi enthusiast. The amazing performance of this popular kit is made possible by the use of high quality speakers in an enclosure specially designed to receive them. The cabinet is a ducted port bass reflex type enclosure 11 1/2" H. x 23" W. x 11 3/4" D. It features an 8" mid range woofer to cover 50 to 1600 CPS and a compression-type tweeter with flared horn covering 1600 to 12,000 CPS. Both speakers are by Jensen. The adjustable flared tweeter horn allows speaker to be used in either upright or horizontal position. The cabinet is constructed of 1/2" veneer surfaced plywood suitable for light or dark finish of your choice. All wood parts are pre-cut and pre-drilled for easy assembly. Shpg. Wt. 25 lbs.

Attractive brass tip accessory legs convert SS-2 into attractive console. Legs screw into brackets provided. All hardware included. Shpg. Wt. 3 lbs. No. 91-26 \$4.95

with a Heathkit Stereo System



HIGH FIDELITY TAPE RECORDER KIT

Popular request for high quality, low cost tape recording and playback facilities have prompted the addition of this fine unit to our line. The TR-1A provides monaural record/playback with fast forward and rewind functions. Incorporates separate erase and combination record/playback heads. Two speeds, $7\frac{1}{2}$ and $3\frac{3}{4}$ IPS, are selected by changing belt drive. Flutter and wow are held to less than 0.35%. Frequency response at $7\frac{1}{2}$ IPS ± 2.0 db 50-10,000 CPS, at $3\frac{3}{4}$ IPS ± 2.0 db 50-65,000 CPS. The extremely simple mechanical assembly is ideally suited to kit construction. One control lever selects all functions on deck, greatly simplifying operation. Mount in vertical or horizontal position. The model TE-1 record/playback tape pre-amplifier, supplied with the mechanical assembly, provides NARTB playback equalization. A record interlock prevents accidental tape erasure. Recording level is indicated by a 6E5 "magic eye" tube. A two-position input selector switch provides for mike or line input. Separate record and playback gain controls. Filament balance control allows adjustment for minimum hum level. Cathode follower output from playback channel is approximately 600 ohms impedance. Two circuit boards are used for easy assembly. Templates and instructions are provided to cut out panels for mounting. Overall dimensions of tape deck and preamp are $15\frac{1}{2}$ " W. x $13\frac{1}{2}$ " H. x 8" D. Signal-to-noise ratio is better than 45 db below normal recording level with less than 1% total harmonic distortion. (Tape mechanism not sold separately.) Shpg. Wt. 22 lbs.



HEATHKIT
TR-1A **\$99⁹⁵**

(Includes tape deck, tape recorder electronics, mike and roll of tape.)

**Make Your Own
Home Recordings**

TAPE RECORDER ELECTRONICS KIT

The model TE-1 Electronics Kit can be purchased separately to replace the electronics in your present tape recorder, or used in addition to it for stereo playback of pre-recorded tapes where a second playback channel is required. Circuit may be modified for use with different head types. Shpg. Wt. 9 lbs.

HEATHKIT
TE-1
\$39⁹⁵



HEATHKIT
SS-1B
\$99⁹⁵

**Fill out the Hi-Fi Range
of Your SS-2 Speaker**



HEATHKIT
SW-1 **\$24⁹⁵**

Save Time Rewinding Tape



HEATHKIT
TK-1 **\$99⁹⁵**

**All The Tools You Need For
Building Heathkits**

"RANGE EXTENDING" HI-FI SPEAKER SYSTEM KIT

This is not a complete speaker system in itself, but is designed to extend the range of the SS-2. The SS-1B uses a 15" woofer and a small super tweeter to supply the very high and very low frequencies to fill out the response of the basic SS-2. The SS-2 and SS-1B when used together, form an integrated four speaker system. The SS-2 and SS-1B combination provide an overall response of ± 5 db from 35 to 16,000 CPS. The kit includes circuit for crossover at 600, 1600 and 4,000 CPS. Impedance is 16 ohms and power rating is 35 watts. A control is also provided to limit output of super tweeter. The handsome cabinet measures 29" H. x 23" W. x $17\frac{1}{2}$ " D. Constructed of beautiful $\frac{3}{4}$ " veneer surface plywood. Complete step-by-step instructions make this kit easy to build. No wood-working experience required. Shpg. Wt. 80 lbs.

"SPEEDWINDER" KIT

This handy device leaves your tape recorder free for operation while it rewinds tape at the rate of 1200' in 40 seconds. Prevents unnecessary wear to the tape and recorder by eliminating wear against guides and heads. It will handle up to $10\frac{1}{2}$ " tape reels as well as 800' reels of 8 and 16 millimeter film. A very useful aid to operators of movie projection equipment. The Heathkit Speedwinder features an automatic shutoff which prevents whipping of tape when it has rewound. A manual shutoff is also provided. An automatic braking device is built in for protection against power failure. Driven by a heavy duty four pole motor. Handsome cabinet is constructed of furniture grade plywood. Step-by-step instructions are provided to make this kit easy to assemble even by one with no experience. Shpg. Wt. 12 lbs.

COMPLETE TOOL SET

A clear illustration of just how easy Heathkit building is. The pliers, diagonal sidecutters, two screw drivers and soldering iron are all the basic tools you need for building practically any Heathkit. Pliers and sidecutters are equipped with insulated rubber handles. The American Beauty soldering iron has a replaceable tip to facilitate cleaning. All the tools are of top quality case hardened steel for rugged duty and long life. With these simple, inexpensive tools in your hand you need not be afraid to tackle the most elaborate kit. The manual included with this handy kit provides you with many useful tips on the use and care of your tools. It shows the all important step of making proper solder connections. A truly worthwhile investment for the beginner in electronic kit building. Shpg. Wt. 3 lbs.

HEATH COMPANY • a subsidiary of Daystrom, Inc. • Benton Harbor 20, Mich.



Plan Your Hi-Fi System...



**HEATHKIT
SP-2** **\$56⁹⁵**
 Model SP-1 (monaural) **\$37.95**
 Model C-SP-1 (converts SP-1 to SP-2) **\$21.95**

Control both stereo channels simply and conveniently

MONAURAL-STEREO PREAMPLIFIER KIT

This expertly designed preamplifier provides all the controls required for either standard monaural (single channel) or stereo (dual channel) sound reproduction. Features building block design... you can start with a basic preamplifier and add a second channel for stereo later on, without rewiring. Second channel plugs in for fast conversion. The complete model SP-2 (stereo) features twelve separate inputs, six on each channel with input level controls. Six dual-concentric controls consist of: two 8-position selector switches, two bass, two treble, two volume level and two loudness controls, a scratch filter switch and a 4-position function switch (separate on-switch). The function switch provides settings for stereo, two-channel mix, channel A or B for monaural use. Inputs consist of tape, mike, mag phono and three high-level inputs. Tape input has NARTB equalization and input selector provides for RIAA, LP, 78 record compensation. EF86 tubes are used in the input stages along with hum balance controls to assure low hum and noise. Two cathode follower outputs with level controls provided in addition to two separate tape outputs for stereo recording. A remote balance control with twenty feet of cable allows balancing the stereo system from listening position. Construction is greatly simplified through the use of two printed circuit boards (one in each channel) and encapsulated printed circuits. The beautiful vinyl clad steel cover has leather texture in black with inlaid gold design. Built-in power supply.



**HEATHKIT
WA-P2** **\$19⁷⁵**

Finger-tip controls for your operating convenience



**HEATHKIT
UA-1** **\$21⁹⁵**

A low cost versatile performer

"MASTER CONTROL" PREAMPLIFIER KIT

Designed as a control center for basic amplifiers the WA-P2 provides you with true high fidelity performance for the finest audio systems. Five switch-selected inputs accommodate a record changer, tape recorder, AM-FM tuner, TV receiver, microphone, etc., each with level control. Provision is also made for a tape recorder output. Ideal for "remote" installations, the WA-P2 features a low impedance cathode-follower output circuit allowing greater length of output lead. Full frequency response is obtained within $\pm 1\frac{1}{2}$ db from 15 to 35,000 CPS and will do full justice to the finest available program sources. Equalization is provided for records through separate turnover and rolloff switches for LP, RIAA, AES, and early 78's. A special hum balance control allows setting for minimum hum level. Power for operation is required from basic amplifier or external source. Shpg. Wt. 7 lbs.

"UNIVERSAL" 12-WATT AMPLIFIER KIT

A true high fidelity performer in every sense of the word, the UA-1 makes an ideal basic amplifier for any hi-fi system and is a perfect addition to gear your present hi-fi system for stereo sound. Uses 6BQ5/EL84 push-pull output tubes for less than 2% harmonic distortion throughout the entire audio range (20 to 20,000 CPS) at full 12 watt output. The on-off switch is located right on the chassis and an octal socket is provided for connecting a preamplifier for remote control operation. The specially designed output transformer provides excellent stability and frequency response. Taps for 4, 8 and 16 ohm speakers, with switched damping for "unity" or "maximum" on the 16-ohm tap. An input level control is provided for use in wired music systems where a preamplifier is not required. This versatile unit is the latest addition to the fine line of Heathkit basic amplifiers. Shpg. Wt. 13 lbs.

With Flexible Heathkit Components



DELUXE AM-FM TUNER KIT

Outstanding features in both styling and circuitry are combined in this 16-tube deluxe AM-FM combination tuner to bring you the very finest in program sources, for your listening enjoyment. Features include three circuit boards for easy construction and high stability—prewired, prealigned FM front end—built-in AM rod antenna—tuning meter—AFC (automatic frequency control) with on-off switch and flywheel tuning. AM and FM circuits are separate and individually tuned making it ideal for stereo applications. Cathode follower outputs with individual controls are provided for both AM and FM. Other features include variable AM bandwidth, 10 kc whistle filter, tuned-cascode FM front end, FM AGC and amplified AVC for AM. The unique IF limiter design automatically provides the number of limiting and IF stages required for smooth non-flutter reception. The silicon diode power supply is extremely conservatively rated and is fuse protected assuring long service life. A tuning meter shows when the station is tuned-in for clearest reception on AM or FM. Use of three circuit boards greatly simplifies construction of circuit, you do only a minimum of wiring. All IF transformers and coils are prealigned so it will be ready to operate as soon as construction is completed. Appearance of this top-quality unit is further enhanced by the vinyl-clad steel cover in black with inlaid gold design. A multiplex jack is provided for addition of converter unit to receive multiplex stereo broadcasts on FM. A top dollar value.



HEATHKIT
PT-1 **\$89⁹⁵**

***A deluxe AM-FM
tuner combination
loaded with extras!***

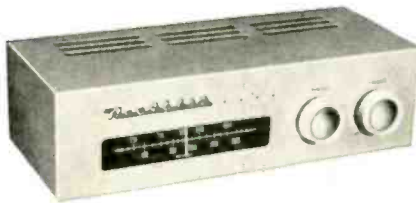

HEATHKIT
BC-1A
\$26⁹⁵

Wide range broadcast reception



HEATHKIT
FM-3A
\$26⁹⁵

Enjoy static-free FM entertainment

HIGH FIDELITY AM TUNER KIT

This AM tuner was designed especially for high fidelity applications. It incorporates a special detector using crystal diodes, and the IF circuit features broad bandwidth to assure low signal distortion. Audio response is ± 1 db from 20 CPS to 9 kc, with 5 db of pre-emphasis at 10 kc to compensate for station rolloff. Sensitivity and selectivity are excellent and the tuner covers the entire broadcast band from 550 to 1600 kc. Quiet performance is assured by a 6 db signal-to-noise ratio at 2.5-uv. Prealigned RF and IF coils eliminate the need for special alignment equipment. Incorporates AVC, two outputs, two antenna inputs, and built-in power supply. Edge-lighted glass slide rule dial for easy tuning. Your "best buy" in an AM tuner. Shpg. Wt. 9 lbs.

HIGH FIDELITY FM TUNER KIT

FM programming, your least expensive source of high fidelity will provide you with years of real enjoyment. This beautifully styled FM tuner features broad-banded circuits for full fidelity and better than 10 uv sensitivity for 20 db of quieting to pull in stations with clarity and full volume. Covers the complete FM band from 88 to 108 mc. Stabilized, temperature-compensated oscillator assures negligible drift after initial warmup. A ratio detector provides high-efficiency demodulation without sacrificing hi-fi performance. IF and ratio transformers are prealigned, as is the front end tuning unit, making special alignment equipment unnecessary. Edge-lighted glass slide rule dial for easy tuning. You need not wait to have FM in your home at this low price. Shpg. Wt. 8 lbs.

HEATH COMPANY • a subsidiary of Daystrom, Inc. • Benton Harbor 20, Mich.



You can be sure you're buying High Fidelity



HEATHKIT
W-7M **\$54⁹⁵**

**55 watts of hi-fi power at
only \$1 per watt**

- ★ BEAUTIFULLY STYLED IN BLACK AND GOLD
- ★ UNITY OR MAXIMUM DAMPING

**"EXTRA PERFORMANCE"
55 WATT HI-FI AMPLIFIER KIT**

Another Heathkit first! An honestly rated high power amplifier with many top quality features at less than a dollar per watt. Full audio output is conservatively rated at 55 watts from 20 CPS to 20 kc with less than 2% total harmonic distortion throughout the entire range. Unique paired output connections permit instant switch selection of "unity" or "maximum" damping factors for all 4, 8 or 16 ohm speakers. Each output has an optimized current feedback circuit for unity damping so that there will be no compromise in performance when any of the impedances is used. This current feedback circuitry is entirely shorted out when not in use to obtain the highest possible damping factor. Features include level control and "on-off" switch right on the chassis plus provision for remote control from preamp, etc. Famous "bas-bal" circuit conveniently balances EL-34 output tubes. These heavy duty push-pull tubes operate into a high quality tapped-screen transformer designed especially for this unit. A 70-volt output on the transformer provides for P.A. or large music systems. The silicon diode power supply features a protection device that controls current until tubes have warmed up, greatly increasing service life of all components. The stylish black and gold case measures 6" H. x 8½" D. x 15" W. Convenient pilot light on the chassis. Thoughtful circuit layout makes this kit easy to build. Dollar for watt you can't beat this buy. Shipped express only. Shpg. Wt. 28 lbs.

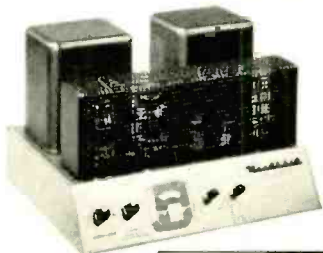

HEATHKIT
W-6M **\$109⁹⁵**

**Plenty of Reserve Power
Without Distortion**

"HEAVY DUTY" 70-WATT HI-FI AMPLIFIER KIT

Here is an amplifier that will provide the extra "push" needed to drive any of the fine speaker systems available today, for truly fine performance at any power level. Silicon-diode rectifiers are used to assure long life and a heavy duty transformer gives you extremely good power supply regulation. Variable damping control provides optimum performance with any speaker system. Quick change plug selects 4, 8 and 16 ohms or 70 volt output and the correct feedback resistance. Frequency response at 1 watt is from 5 CPS to 80 kc with controlled HF rolloff above 100 kc. At 70 watts output harmonic distortion is below 2%, 20 to 20,000 CPS and IM distortion is below 1%, 60 and 6,000 CPS. Hum and noise 88 db below full output. Metered balance circuit. Designed especially for easy assembly and years of dependable service. Shipped express only. Shpg. Wt. 52 lbs.



HEATHKIT
W-5M **\$59⁷⁵**

**Top-Flight Performance
for the Critical Listener**

25-WATT HI-FI AMPLIFIER KIT

Considered top value in its power class by leading independent research organizations, the W-5M incorporates all the design features required by the super critical listener. Features include a specially designed Peerless output transformer and KT66 tubes. The circuit is rated at 25 watts and will follow instantaneous power peaks of a full orchestra up to 42 watts. A "tweeter saver" suppresses high frequency oscillation and a new type balancing circuit facilitates adjustment of the "dynamic" balance between output tubes. Frequency response is ±1 db from 5 CPS to 160,000 CPS at 1 watt and within 2 db from 20 to 20,000 CPS at full 25 watts output. Harmonic distortion is less than 1% at 25 watts and IM distortion is 1% at 20 watts (60 and 3,000 CPS, 4:1). Hum and noise are 99 db below 25 watts for truly quiet performance. Rich black and gold colored styling. Shipped express only. Shpg. Wt. 31 lbs.

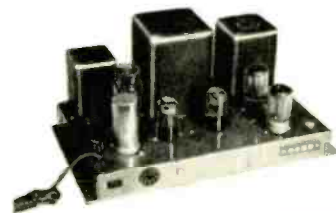

HEATHKIT
W4-AM **\$39⁷⁵**

**Faithful Sound Reproduction
with Minimum Investment**

20-WATT HI-FI AMPLIFIER KIT

This fine amplifier will amaze you with its outstanding performance. It features a true Williamson circuit with extended frequency response, low distortion, and low hum levels. Enjoy true hi-fi with only a minimum investment compared to other units on the market. 5881 tubes and a special Chicago-Standard output transformer are employed to give you full fidelity at minimum cost. Frequency response extends from 10 CPS to 100 kc within ±1 db at 1 watt assuring you of full coverage of the audio range. Clean, clear sound amplification takes place in circuits that hold harmonic distortion at 1.5% and IM distortion below 2.7% at full 20 watt output. Hum and noise are 95 db below full output. Taps on the output transformer are at 4, 8 or 16 ohms to match the speaker system of your choice. An outstanding performer, this investment will bring you years of listening enjoyment. Shipped express only. Shpg. Wt. 28 lbs.

All basic amplifiers recommended for use with model WA-P2, SP-1 or SP-2 preamplifiers

...When You Buy Heathkits



"BOOKSHELF" 12-WATT AMPLIFIER KIT

The model EA-2 combines eye-pleasing style and color with many extra features for high quality sound reproduction. This fine amplifier provides full range frequency response from 20 to 20,000 CPS within ± 1 db. Harmonic distortion is less than 1% at full 12 watt output over the entire range (20-20,000 CPS). IM distortion is less than 1.5% at 12 watts with low hum and noise. Miniature tubes are used throughout the advanced circuitry, including EL84 output tubes in a push-pull tapped-screen output circuit using a special designed output transformer. Transformer has taps at 4, 8 and 16 ohms. The model EA-2 has its own built-in preamplifier with provision for three separate inputs, mag phono, crystal phono and tuner. The mag phono input features RIAA equalization. Separate bass and treble controls are provided with boost and cut action. A special hum-balance control assures quiet operation. The luxury styled cabinet has a smooth simulated leather texture in black with inlaid gold design and is constructed of vinyl plastic bonded to steel. It resists scuffing, wear, abrasion, and chemicals. The front panel features brushed-gold trim and buff knobs with gold inserts for a very pleasing appearance. An amber neon pilot lamp indicates when the amplifier is on. Cabinet measures $12\frac{1}{2}$ " W. x $3\frac{3}{16}$ " D. x $4\frac{3}{8}$ " H. making it suitable for use on a bookshelf, end table, etc. High quality is emphasized throughout for performance matching amplifiers costing many times more. Shpg. Wt. 15 lbs.



HEATHKIT
EA-2 **\$28⁹⁵**

**Combines beauty, style
and quality**

- ★ LESS THAN 1% DISTORTION AT FULL OUTPUT OVER ENTIRE AUDIO RANGE.
- ★ BUILT-IN PREAMPLIFIER



HEATHKIT
A9-C **\$35⁵⁰**

**A Bargain Package of
Power and Performance**



HEATHKIT
AV-3 **\$29⁹⁵**

**Invaluable for
Hi-Fi Testing**

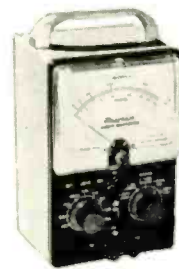

HEATHKIT
AW-1 **\$29⁵⁰**

**Measure Exact
Power Output**

GENERAL-PURPOSE 20-WATT AMPLIFIER KIT

The A9-C combines a preamplifier, main amplifier and power supply all on one chassis providing a compact unit to fill the need for a good high fidelity amplifier with a moderate cash investment. Designed primarily for home installations, it is also capable of fulfilling P.A. requirements. The preamplifier section features four separate switch selected inputs. Separate bass and treble tone controls offer 15 db boost and cut. A true high fidelity performer, the A9-C covers 20 to 20,000 CPS within ± 1 db. Front panel is detachable, and can be installed on the outside of a cabinet where the chassis comes through, for custom installations. A fine unit with which to start your hi-fi system. Shpg. Wt. 23 lbs.

AUDIO VTVM KIT

Critical AC voltage measurements are made easy with this high quality vacuum tube voltmeter which emphasizes stability, broad frequency response and sensitivity. Features large $4\frac{1}{2}$ " 200 microampere meter, with increased damping in the meter circuit for stability in low frequency tests. Extremely high voltage range handles measurements from a low value of 1 millivolt to a maximum of 300 volts. AC (RMS) voltage ranges are: 0-01, .03, .1, .3, 1, 3, 10, 30, 100 and 300 volts. Db ranges cover -52 to $+52$ db. Employs 1% precision multiplier resistors for maximum accuracy. High input impedance (1 megohm at 1,000 CPS). Frequency response is essentially flat from 10 CPS to 200 kc. Shpg. Wt. 6 lbs.

AUDIO WATTMETER KIT

Here is a fine meter to accurately measure output wattage. Five power ranges cover 0-5 mw, 50 mw, 500 mw, 5 w and 50 w full scale. Five switch selected db ranges cover -10 db to $+30$ db. All indications are read directly on the large $4\frac{1}{2}$ " 200 ua meter. Frequency response is ± 1 db from 10 CPS to 250 kc. External or internal load resistors are selected with convenient front panel switch. Non-inductive load resistors are built in for 4, 8, 16 or 600 ohms impedance. Precision multiplier resistors are used for high accuracy and incorporates a crystal diode bridge for wide-range frequency response. Modern styling and convenient front panel design. Cabinet is ventilated to allow efficient cooling of load resistors. Shpg. Wt. 7 lbs.

HEATH COMPANY • a subsidiary of Daystrom, Inc. • Benton Harbor 20, Mich.

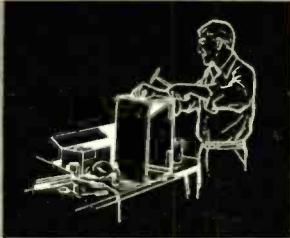

Easy to Buy - Easy to Build - Easy to Use...



CONTEMPORARY
Model CE-1B Birch
Model CE-1M Mahogany

HEATHKIT
CE-1
\$43⁹⁵
each



TRADITIONAL
Model CE-1T Mahogany

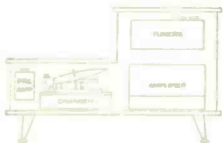

Combine all your Hi-Fi equipment
in this attractive cabinet

CHAIRSIDE ENCLOSURE KIT

This Chairside Enclosure lets you combine all of your hi-fi equipment into one compact control center and, at the same time add a beautiful piece of furniture to your home. The CE-1 is designed to house the AM and FM tuners (BC-1A and FM-3A) and the WA-P2 preamplifier along with the majority of record changers which will fit into the space provided. Adequate room is available in the rear of the unit to house any of the Heathkit amplifiers designed to operate with the WA-P2. The enclosure is flexible enough to give you a large choice in component installation. If only one tuner and the preamplifier are used, the two units can be installed in the tilt-out drawer, or if more convenient, either unit can be placed in the space provided in front of the changer compartment. The tilt-out shelf can be installed on either right or left side and the lift-top lid is similarly designed to lift from either side depending on your choice during construction! Good ventilation is achieved through appropriately placed slots in the bottom and back of the enclosure. Overall dimensions are 18" W. x 24" H. x 35½" D. The changer compartment measures 17¾" L. x 16" W. x 9⅝" D. All parts are precut and predrilled for easy assembly and attractive hardware is supplied to match each style. The contemporary cabinet is available in either mahogany or birch and the traditional cabinet is available in mahogany only. Furniture grade plywood can be finished to your taste. Shpg. Wt. 46 lbs.



HEATHKIT
AG-9A **\$34⁵⁰**

Your own source of
Hi-Fi audio signals



HEATHKIT
AA-1 **\$49⁹⁵**

3 Audio test instruments
in one compact unit



HEATHKIT
HD-1 **\$49⁵⁰**

Check amplifier
distortion quickly

AUDIO SIGNAL GENERATOR KIT

The model AG-9A is "made to order" for high fidelity applications, and provides quick and accurate selection of low-distortion signals from 10 CPS to 100 kc. Three rotary switches select two significant figures and a multiplier to determine audio frequency. Incorporates step-type and a continuously variable output attenuator. Output indicated on large 4½" panel meter, calibrated in volts and db. Attenuator system operates in 10 db steps, corresponding to meter calibration, in ranges of 0-.003, .01, .03, .1, .3, 1, 3 and 10 volts RMS. "Load" switch permits use of built-in 600-ohm load, or external load of different impedance. Output and frequency indicators accurate to within ±5%. Distortion less than .1 of 1% between 20 and 20,000 CPS. Shpg. Wt. 8 lbs.

AUDIO ANALYZER KIT

Complete high fidelity testing facilities are yours in the AA-1. It combines the functions of three separate instruments; an AC VTVM, audio wattmeter and a complete IM analyzer with filters and high and low frequency oscillators built in. VTVM ranges are: 0-.01, .03, .1, .3, 1, 3, 10, 30, 100 and 300 volts (RMS). Db scale reads from -65 to +52 dbm. Wattmeter ranges are: .15 mw, 1.5 mw, 15 mw, 150 mw, 1.5 w, 15 w and 150 w. IM scales are 1%, 3%, 10%, 30% and 100% full scale. Provides internal load resistors of 4, 8, 16 or 600 ohms. Combining and consolidating functions reduces the number of test leads and controls required for the same test. Complete instructions are provided for easy assembly, also valuable information on use of instrument. Shpg. Wt. 13 lbs.

HARMONIC DISTORTION METER KIT

Valuable in both designing and servicing of audio circuits, the HD-1 used with an audio signal generator, will accurately measure harmonic distortion at any or all frequencies between 20 and 20,000 CPS. Distortion is read on panel meter in ranges of 0-1, 3, 10, 30 and 100% full scale. Full scale voltage ranges of 0-1, 3, 10 and 30 volts are provided for the initial reference settings. Signal-to-noise ratio is measured on a separate meter scale calibrated in db. Features high input impedance (300,000 ohms) and 1% precision resistors in the VTVM voltage divider circuit for excellent sensitivity and accuracy. High quality components insure years of dependable service. Complete instructions provided for easy assembly and operation. Shpg. Wt. 13 lbs.

Heathkits are Your Best Dollar Value



TRANSISTOR PORTABLE RADIO KIT

The overwhelming sales of this outstanding transistor portable have made a substantial price reduction possible... in addition, an all new plastic molded case adds the finishing touch to the exceptional circuitry. Six name-brand (Texas Instrument) transistors are used for extra good sensitivity and selectivity. The 4" x 6" PM speaker with heavy magnet provides excellent tone quality. Use of this large speaker and roomy chassis make it unnecessary to crowd components adding greatly to the ease of construction. Transformers are prealigned so it is ready for service as soon as construction is completed. A touchup in alignment is easily accomplished on a station by following simple instructions in manual. Alignment tool furnished. Has built-in rod-type antenna for reception in all locations. Six standard size "D" flashlight cells are used for extremely long battery life (between 500 and 1000 hours) and they can be purchased almost anywhere. Cabinet is two-tone blue molded plastic with pull-out carrying handle. Dimensions are 9½" L. x 7¼" H. x 4" D. Shpg. Wt. 6 lbs.

Model XR-1-L: Identical to XR-1-P except in genuine leather case. Rich, warm sun-tan tone. Leather carrying strap included. Shpg. Wt. 7 lbs.

Leather Case: can be purchased separately if desired. Fits all XR-1-P's and XR-1's. No. 93-1. Shpg. Wt. 3 lbs. \$6.95.



MODEL XR-1-L
\$34⁹⁵

HEATHKIT
XR-1-P **\$29⁹⁵**

Newly designed plastic case . . . new low price!

- ★ 4" X 6" SPEAKER FOR "BIG SET" TONE
- ★ LONG BATTERY LIFE (500 to 1000 Hours)



HEATHKIT
CT-1
\$7⁹⁵

Test condensers right in the circuit



HEATHKIT
DF-1 **\$54⁹⁵**

Pin-point your exact location



HEATHKIT
FD-1 **\$35⁹⁵ each**
(6 volt model FD-1-6)
(12 volt model FD-1-12)

Detects gas fumes



HEATHKIT
MC-1
\$42⁹⁵

Save your boat batteries

IN-CIRCUIT CAPACI-TESTER KIT

Check most capacitors for "open" or "short" right in the circuit with this handy kit. Detects open capacitors from about 50 mmf up, not shunted by an excessively low resistance value. Checks shorted capacitors up to 20 mfd (not shunted by less than 10 ohms). (Does not detect leakage nor check electrolytic condensers.) Employs a 60-cycle frequency for the short test and a 19 megacycle frequency for the open test. Uses electron beam "eye" tube for quick indication. Test leads included. Shpg. Wt. 5 lbs.

TRANSISTOR RADIO DIRECTION FINDER KIT

This transistor radio compass will double as a portable radio. Covers the standard broadcast band from 540 to 1600 kc. Ideal for use aboard boats and also on land by hunters, hikers, etc. A directional high-Q ferrite antenna rotates from the front panel to obtain a fix on a station. A 1 ma meter serves as null and tuning indicator. Prealigned IF transformers—six transistor circuit. Powered by tiny 9-volt battery with spare included. Dimensions 7½" W. x 5¾" H. x 5¾" D. Shpg. Wt. 5 lbs.

FUEL VAPOR DETECTOR KIT

Protect your boat and passengers against fire and explosion with one of these fuel vapor detector kits. Indicates the presence of fumes on a three-color "safe-dangerous" meter scale and immediately shows if it is safe to start the engine. A pilot lamp shows when the detector is operating. Easy to build and install, even by one not having previous experience. Operates from your boat battery. The kit is complete with heavy-duty neoprene insulated cable and includes spare detector unit. Shpg. Wt. 4 lbs.

MARINE CONVERTER KIT

Charge 6 or 12 volt batteries with this marine converter and battery charger. A panel mounted 25 ampere meter continuously monitors the charging current. Moisture and fungus proofed for rugged marine use. Convection cooling prevents unsafe temperature rise. The MC-1 has no moving parts, tubes nor blowers to wear out or break. Mounting brackets are supplied for easy installation on any boat. Ideal for keeping batteries fully charged or to supply extra current for appliances. Shpg. Wt. 16 lbs.

HEATH COMPANY • a subsidiary of Daystrom, Inc. • Benton Harbor 20, Mich.



New Styling - New Features...



HEATHKIT
TX-1 **\$229.50**

**Complete Versatility for Top-
Notch Amateur Communications**

- ★ NEWLY DESIGNED VFO—ROTATING SLIDE RULE DIAL
- ★ MODERN STYLING—PROVISION FOR SSB ADAPTER

"APACHE" HAM TRANSMITTER KIT

Fresh out of the Heath Company laboratories, the brand-new "Apache" model TX-1 ham transmitter features modern styling and the latest in circuitry for extra fine performance. The "Apache" is a high quality transmitter operating with a 150 watt phone input and 180 watt CW input. In addition to CW and phone operation, built-in switch selected circuitry provides for single-sideband transmission through the use of a plug-in external adapter. These SSB adapters will be available in the near future. A compact, stable and completely redesigned VFO provides low drift frequency control necessary for SSB transmission. A slide rule type illuminated rotating VFO dial with vernier tuning provides ample bandspread and precise frequency settings. The bandswitch allows quick selection of the amateur bands on 80, 40, 20, 15 and 10 meters. (11M with crystal control). This unit also has adjustable low level speech clipping and a low distortion modulator stage employing two of the new 6CA7/EL-34 tubes in push-pull class AB operation. Time sequence keying is provided for "chirpless" break-in CW operation. The final amplifier is completely shielded for greater TVI protection and transmitter stability. Die-cast aluminum knobs and front panel escutcheons add to the attractive styling of the transmitter. Pi network output coupling matches antenna impedances between 50 and 72 ohms. Shpg. Wt. 107 lbs.

\$50.00 deposit required on C.O.D. orders. Shipped motor freight unless otherwise specified.



HEATHKIT
DX-20 **\$35.95**

**An Ideal
Code Transmitter**



HEATHKIT
DX-100 **\$189.50**

**You'll be Proud to Own
This Outstanding Performer**



HEATHKIT
DX-40 **\$64.95**

**Phone & CW Facilities
at Low Cost**

DX-20 CW TRANSMITTER KIT

Designed especially for CW work, the DX-20 features high efficiency at low cost. An ideal rig for the novice or advanced-class CW operator. Plate power input is 50 watts, and covers 80, 40, 20, 15, 11 and 10 meters with single knob bandswitching. Features a single 6DQ6A tube in the final amplifier stage and a 6CL6 as a crystal oscillator. Pi network output circuit matches various antenna impedances between 50 and 1000 ohms and reduces harmonic output. Top-quality parts are featured throughout, including "potted" transformers, etc., for long service life. Complete shielding to minimize TVI. Removable metal pull-out plug on left end of cabinet provides access for crystal changing. Very easy to build with complete instructions supplied. Shpg. Wt. 19 lbs.

DX-100 PHONE AND CW TRANSMITTER KIT

Well known for its high quality and fine performance the DX-100 features a built-in VFO, modulator, and power supply, complete shielding to minimize TVI, and a pi network coupling to match impedances from 50 to 600 ohms. RF output is in excess of 100 watts on phone and 120 watts on CW, for clean strong signals on all ham bands from 10 to 160 meters. Single knob bandswitching and illuminated VFO dial and meter face add real operating convenience. RF output stage uses a pair of 6146 tubes in parallel, modulated by a pair of 1625's. High quality components are used throughout, such as potted transformers, silver-plated or solid coin silver switch terminals, aluminum-heat dissipating caps on the final tubes, copper plated chassis, etc. Shpg. Wt. 107 lbs.

\$50.00 deposit required on C.O.D. orders. Shipped motor freight unless otherwise specified.

DX-40 PHONE AND CW TRANSMITTER KIT

An outstanding buy in its power class the DX-40 provides both phone and CW operation on 80, 40, 20, 15, 11 and 10 meters. A single 6146 tube is used in the final amplifier stage to provide full 75 watt plate power input on CW, or controlled carrier modulation peaks up to 60 watts for phone operation. Modulator and power supplies are built in and single-knob bandswitching is combined with the pi network output circuit for complete operating convenience. Complete shielding to minimize TVI. Provision is made for three crystals. A four-position switch selects any of the three crystals or a jack for external VFO. Crystal sockets are reached through access door in rear of cabinet. High quality D'Arsonval movement panel meter. Shpg. Wt. 25 lbs.

For Real Ham Enjoyment



"MOHAWK" HAM RECEIVER KIT

Here is a ham receiver that any radio operator would be proud to own. The "Mohawk" has all the functions required for high quality communications with clear, rock-steady reception on all bands. This 15-tube receiver features double conversion with 1F's at 1682 kc and 50 kc and covers all of the amateur frequencies from 160 through 10 meters on seven bands with an extra band calibrated to cover 6 and 2 meters using a converter. Receiver accommodations are provided for these converters which will be available in Heathkits soon. The "Mohawk" is specially designed for single-sideband reception with crystal controlled oscillators for upper and lower sideband selection. A completely preassembled, wired and aligned front end coil assembly assures ease of construction and top performance of the finished unit. Other features include five selectivity positions from 5 kc to 500 CPS, bridged T-notch filter for maximum heterodyne rejection, and a built-in 100 kc crystal calibrator. The set provides a 10 db signal-to-noise ratio at less than 1 microvolt input. Front panel features S meter, separate RF, IF and AF gain controls, T-notch tuning, T-notch depth, ANL, AVC, BFO, bandswitch, tuning, antenna trimmer, calibrate set, calibrate on, CW-SSB-AM, receive-standby, upper-lower sideband, selectivity, phone jack and a wide band rotating slide rule type vernier tuning dial with easy to read calibrations. Shpg. Wt. 67 lbs. \$50.00 required on C.O.D. orders. Shipped motor freight unless otherwise specified.



HEATHKIT
RX-1 **\$274⁹⁵**

Now in Kit Form a Top Quality Ham Band Receiver

- ★ PREWIRED AND ALIGNED FRONT END COIL ASSEMBLY.
- ★ CRYSTAL CONTROLLED OSCILLATORS FOR DRIFT-FREE RECEPTION.



HEATHKIT
B-1 **\$8⁹⁵**

**Get Proper Match
Between Transmitter
and Antenna**

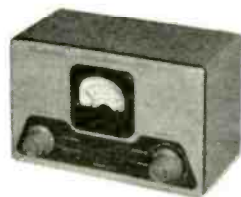

HEATHKIT
AM-2 **\$15⁹⁵**

**Measure Standing
Wave Ratio**



HEATHKIT
VX-1 **\$23⁹⁵**

**Eliminates Hand
Switching**

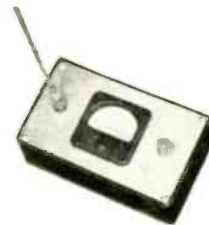

HEATHKIT
PM-1 **\$14⁹⁵**

**Quick Check of
Transmitter Operation**

BALUN COIL KIT

Unbalanced coax lines used on the most modern transmitters can be matched to balance lines of either 75 or 300 ohms impedance by using the model B-1 Balun Coil Kit. Can be used with transmitters and receivers without adjustment over the frequency range of 80 through 10 meters, and will handle power inputs up to 200 watts. Cabinet size is 10" square by 5" D. and may be located any distance from the transmitter or antenna. A protective cover is supplied to prevent damage in outdoor installations. Shpg. Wt. 4 lbs.

REFLECTED POWER METER KIT

The match of your antenna transmission system can be checked by measuring the forward and reflected power or standing wave ratio from 1:1 to 6:1 with this fine unit. Designed to handle a peak power of well over 1 kilowatt of energy the AM-2 may be left in the antenna system feed line at all times. Band coverage is 160 meters through 2 meters. Input and output impedances for 50 or 75 ohm lines. No external power required for operation. Cabinet size is 7 3/8" x 4 1/8" x 4 3/8". Shpg. Wt. 3 lbs.

ELECTRONIC VOICE CONTROL KIT

This unique device allows you to switch from receiver to transmitter merely by talking into your microphone... you get the advantage of "telephone-type conversation" as in single sideband but with regular AM transmission. The unit is adjustable to all conditions by sensitivity controls provided. A variable time delay control changes the "hold" time. Provision is made for receiver and speaker connections and also for a 117 volt antenna relay. Built-in power supply. Complete instructions provided. Shpg. Wt. 5 lbs.

RF POWER METER KIT

This self contained unit requires no power for operation. You simply place it close to the transmitter antenna to sample the RF field which is then indicated on the panel meter. Operates with any transmitter having an output frequency between 100 kc and 250 mc, regardless of power. Sensitivity is 0.3 volts RMS full scale, and a special control on the panel allows for further adjustment of the sensitivity. Measures 3 3/4" W. x 6 1/4" L. x 2" D. An easy way to put your mind at ease concerning transmitter operation. Shpg. Wt. 2 lbs.

HEATH COMPANY • a subsidiary of Daystrom, Inc. • **Benton Harbor 20, Mich.**

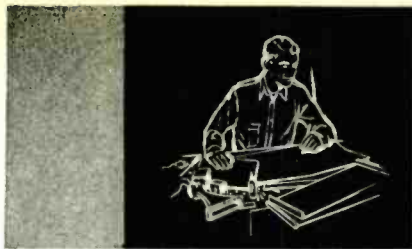

Choose from a wide variety of Heathkits

DUAL-CHASSIS 20 WATT HI-FI AMPLIFIER KIT

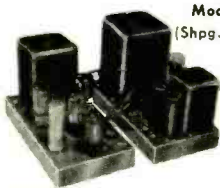

Model W3-AM
(Shpg. Wt. 29 lbs.)
\$49⁷⁵

12" UTILITY SPEAKER



Model 401-6
(Shpg. Wt. 7 lbs.)
\$7⁵⁰

ALL-BAND RADIO KIT



Model AR-3
(Shpg. Wt. 12 lbs.)
\$29⁹⁵
(less cabinet)

CRYSTAL RADIO KIT



Model CR-1
(Shpg. Wt. 3 lbs.)
\$7⁹⁵

BROADCAST BAND RADIO KIT



Model BR-2
(Shpg. Wt. 10 lbs.)
\$18⁹⁵
(less cabinet)

ELECTRONIC CROSSOVER KIT



Model XO-1
(Shpg. Wt. 6 lbs.)
\$18⁹⁵

"Q" MULTIPLIER KIT



Model QF-1
(Shpg. Wt. 3 lbs.)
\$9⁹⁵

"AUTOMATIC" CONELRAD ALARM KIT



Model CA-1
(Shpg. Wt. 4 lbs.)
\$13⁹⁵

GRID DIP METER KIT



Model GD-1B
(Shpg. Wt. 4 lbs.)
\$21⁹⁵

VIBRATOR POWER SUPPLY KIT



6 volt Model VP-1-6
12 volt Model VP-1-12
(Shpg. Wt. 4 lbs.)
\$7⁹⁵
ea.

VARIABLE FREQUENCY OSCILLATOR KIT



Model VF-1
(Shpg. Wt. 7 lbs.)
\$19⁵⁰

PROFESSIONAL RADIATION COUNTER KIT



Model RC-1
(Shpg. Wt. 8 lbs.)
\$79⁹⁵

ISOLATION TRANSFORMER KIT



Model IT-1
(Shpg. Wt. 9 lbs.)
\$16⁵⁰

ELECTRONIC SWITCH KIT



Model S-3
(Shpg. Wt. 8 lbs.)
\$21⁹⁵

REGULATED POWER SUPPLY KIT



Model PS-3
(Shpg. Wt. 17 lbs.)
\$35⁵⁰

VOLTAGE CALIBRATOR KIT



Model VC-3
(Shpg. Wt. 4 lbs.)
\$12⁵⁰

DIRECT-READING CAPACITY METER KIT



Model CM-1
(Shpg. Wt. 7 lbs.)
\$29⁵⁰

TUBE CHECKER KIT

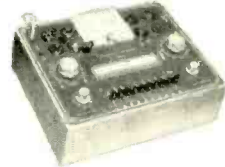

Model TC-2
(Shpg. Wt. 12 lbs.)
\$34⁹⁵

EASY TIME PAYMENTS AVAILABLE FOR YOUR CONVENIENCE...

Any order totaling \$90 or more can be paid for in small monthly payments (send for complete details).

RESISTANCE SUBSTITUTION BOX KIT



Model RS-1
(Shpg. Wt. 2 lbs.)
\$5⁵⁰

CONDENSER SUBSTITUTION BOX KIT



Model CS-1
(Shpg. Wt. 2 lbs.)
\$5⁵⁰

CATHODE RAY TUBE CHECKER KIT



Model CC-1
(Shpg. Wt. 10 lbs.)
\$24⁹⁵

LABORATORY RF GENERATOR KIT

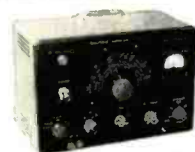

Model LG-1
(Shpg. Wt. 16 lbs.)
\$48⁹⁵

"Q" METER KIT



Model QM-1
(Shpg. Wt. 14 lbs.)
\$44⁵⁰

DECADE CONDENSER KIT

Model DC-1
(Shpg. Wt. 3 lbs.)
\$16⁵⁰



DECADE RESISTANCE KIT



Model DR-1
(Shpg. Wt. 4 lbs.)
\$19⁵⁰

...to Fill Your Exact Needs



PORTABLE TUBE CHECKER KIT

Model TC-2P
(Shpg. Wt. 15 lbs.)
\$38⁹⁵

TV PICTURE TUBE TEST ADAPTER FOR TC-2 AND TC-2P

Model 355
(Shpg. Wt. 1 lb.)
\$4⁵⁰

BINDING POST KIT

Model 362
(Shpg. Wt. 1 lb.)
\$4⁰⁰

BATTERY TESTER KIT

Model BT-1
(Shpg. Wt. 2 lbs.)
\$8⁵⁰

ELECTRONIC IGNITION ANALYZER KIT

MODEL IA-1
(Shpg. Wt. 20 lbs.)
\$59⁹⁵

SCOPE PROBES

Scope Demodulator Probe Kit

Model 337-C
(Shpg. Wt. 1 lb.)
\$3⁵⁰

Low Capacity Probe Kit
Model 342
(Shpg. Wt. 1 lb.)

\$3⁵⁰

VTVM PROBES

30,000 Volt DC HV
Probe Kit No. 336
Shpg. Wt. 2 lbs. **\$4.50**

Etched Circuit RF
Probe Kit No. 309-C
Shpg. Wt. 1 lb. **\$3.50**

Peak-to-peak Voltage
Probe Kit No. 338-C
Shpg. Wt. 2 lbs. **\$5.50**

ENLARGER TIMER KIT

Model ET-1
(Shpg. Wt. 3 lbs.)
\$11⁵⁰

IMPEDANCE BRIDGE KIT

Model IB-2A
(Shpg. Wt. 12 lbs.)
\$59⁵⁰

"LOW RIPPLE" BATTERY ELIMINATOR KIT

Model BE-5
(Shpg. Wt. 21 lbs.)
\$39⁹⁵

ELECTRONIC ANALOG COMPUTER KIT Full Computer Group C

\$945⁰⁰

Write for free folder.

Free Catalog



Send for this informative booklet describing these and many other do-it-yourself kits.

ORDER DIRECT BY MAIL . . . from the WORLD'S LARGEST MANUFACTURER OF ELECTRONIC INSTRUMENTS IN KIT FORM

Save 1/2 or more over equivalent ready-made products by buying direct and assembling them yourself. You gain priceless knowledge through complete and informative construction manuals.

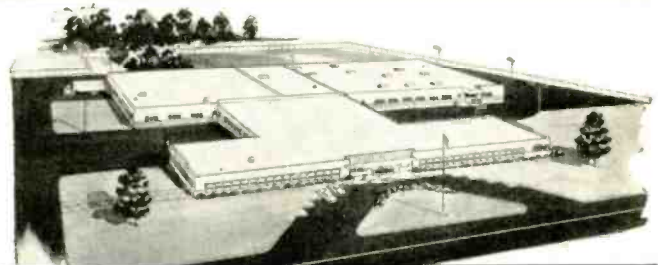

HEATH COMPANY A Subsidiary of Daystrom, Inc. BENTON HARBOR 20, MICH.

ORDER BLANK

NOTE: All prices and specifications subject to change without notice.

Enclosed find () check () money order for _____ Please ship C.O.D. () postage enclosed for _____ pounds.

On Express orders do not include transportation charges—they will be collected by the express agency at time of delivery.

On Parcel Post Orders include postage for weight shown. All prices are NET F.O.B. Benton Harbor, Michigan, and apply to Continental U.S. and Possessions only.

Name _____

Address _____

City & Zone _____ State _____

(PLEASE PRINT)

SHIP VIA

- Parcel Post
- Express
- Freight
- Best Way

QUANTITY	ITEM	MODEL NO.	PRICE
		POSTAGE	
		TOTAL	

SEND FREE Heathkit Catalog

Choosing A MULTISET COUPLER

A look at several multiset antenna couplers—Y-network, V-network, transformer, elevator-coil, and transmission-line types—with a view toward where and when to use which

By DONALD H. ROGERS *

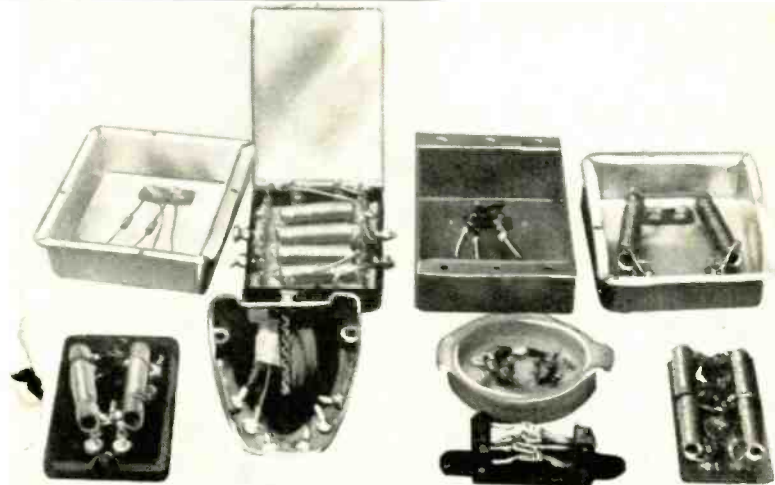

The "works" of an assortment of antenna couplers: upper left—Penn model 77, direct connection to one set, resistive to the other; left center—Dynamic T-130, a 3-set coupler; right center—Epcor AC-1, resistive type 2-set unit; upper right—Penn Twin-Tenna TC-374. Lower left—Brach No. 477 2-set coupler; left center—unidentified; right center, forward—Mosley 902 2-set; behind it—Gemco All-Weather, a transformer type; lower right—Amphenol 4-set coupler.

MANY families now have two or more TV sets in constant use, one in the living room and another in the rumpus room or bedroom. Two sets require two separate antennas or branching the lead-in to divide the signal.

This job calls for a multiset coupler. It is a small resistance or transformer network arranged to divide the signal and isolate the sets without degrading reception. Its loss should be as low as possible.

A perfect coupler appears to attenuate the signal because it divides it. The theoretical minimum loss is 3 db for a two-set coupler, 4.8 db for a three-set coupler and 6 db for a four-set unit. Practical couplers measure a little more, about 3.5, 5.5 and 7 db respectively.

Minimum loss is not always best. More may be introduced to increase isolation between sets or to improve the impedance match. But we cannot tolerate losses caused by impedance mismatch, a common weakness in coupler design.

Impedance matching

A 300-ohm transmission line cannot deliver maximum signal power to more than one 300-ohm TV set unless the combination of sets is made to look like 300 ohms by inserting a suitable coupler. In a transmission line, the portion of the signal not transferred to a mismatched load is reflected, with the resultant formation of standing waves by interference between the direct signal and the reflected one.

Under these conditions, line loss is

higher than normal. The effective length of the line is also critical. On a line with bad standing waves you can often dip the picture from clarity to snow or vice versa by running your hand along the line. For best reception you have to go away from the set and leave your hand in a different place for each channel.

Reflections also produce smears and ghosts. If the lead-in is short so time delay is slight, each vertical line in the picture is softened, blurred or smeared a bit. If your lead-in is longer, the delayed picture will separate into a distinct ghost.

The remedy is to make sure that your line is terminated in the proper impedance. A TV set terminates the channel to which it is tuned, but in multiset installations the sets are often tuned to different channels, with each branch poorly terminated for the other channel.

Fortunately, a line needs to be terminated well at one end and the usual broadband antenna is a fairly good source, having a vswr (voltage standing-wave ratio) between 1.5 and 2.0 to 1 (1.0 would be perfect; 1.2 is excellent). Then comes the coupler, which must have a matched input to accept all the antenna signal. Each of its output circuits should present a 300-ohm source to the branch line because the receiver end of the branch is terminated on only one channel at a time. Many couplers do not do this, although they are advertised as having 300-ohm outputs. The claim means only that they are designed to *work into* 300-ohm circuits, not to present them with a matched source.

Isolation

Isolation between branches keeps one set from interfering with the other. This is more important with older sets having a 21-mc if, whose oscillator radiation can fall in a working channel and clobber someone else's reception. Isolation also keeps the tuning of one set from reacting on another, through the antenna and lead-in system, by impedance changes or reflections. Color reception is more sensitive to these factors than black-and-white.

A good rule is to get all the isolation you can afford. It won't do any harm, and it might help. Isolation up to about 10 or 15 db is pretty cheap. Above that, it means extremely high loss or expensive balanced circuits such as hybrid transformers.

Let's get down to cases

The simplest couplers are made with resistors. These are the only ones likely to work well over all of the vhf and uhf bands. Fig. 1 shows a Y-network model which has a nominal 6-db loss and provides 6 db of isolation. Both outputs and the input are matched. Fig. 2 shows a V-network model which also matches all three ways. It has a nominal 9-db loss and provides 18 db of isolation. Both may be called pad types.

The lowest-loss couplers use transformers. (One color set manufacturer says not to use the transformer type for color receivers—use only the resistive type coupler.) The one shown in Fig. 3 is typical. The input is matched by transforming the parallel impedance of the outputs from 150 up to 300 ohms. The outputs are not

* Engineer, Jerrold Electronics Corp.

**Best for
Conversion
or Replacement**

COLUMBIA CD
...by design the
most linear Stereo Cartridge

Now is the time to profit from stereo. And for stereo conversion or replacement, Columbia CD cartridges are designed to be your best choice. Note the advantages of their constant displacement design. Check specifications.

Ask your CBS-Hytron distributor or write us for helpful free bulletins: An Introduction to Stereophonic Sound, E-305; Hints on Using the Columbia CD Stereo Cartridge, E-306; Instruction Sheet for the CD, E-289. Order these bulletins and your Columbia CD cartridges . . . today.

RESPONSE OF COLUMBIA CD CARTRIDGE

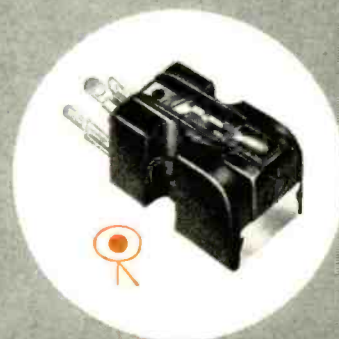
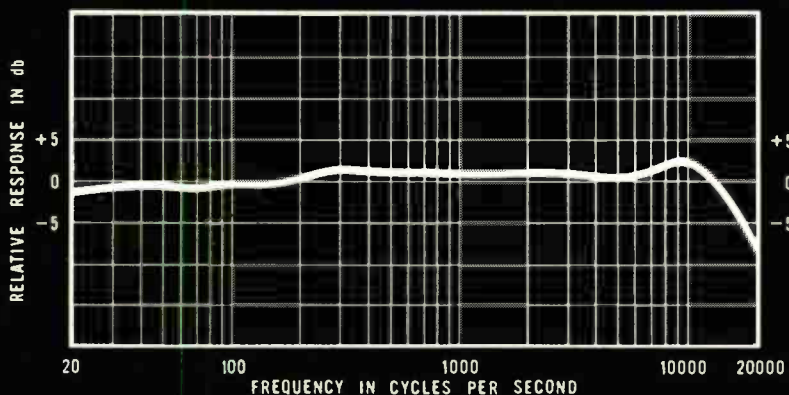

COLUMBIA CD Linkage

In Columbia Constant Displacement cartridges, motion of the stylus is transmitted directly to the two wafers that generate the output voltages. This is accomplished by a simple lever, frictionless and featherweight. The precise mechanical design assures that, regardless of frequency, the output voltage is essentially constant for a given displacement of the stylus.

Ask to hear the CD. Discover for yourself that Columbia Constant Displacement cartridges are designed to reproduce all the exciting breadth, depth and realism of stereo records. Remember, the Columbia CD was designed by CBS-Hytron's sister division Columbia Records drawing on its over 60 years of recording experience. Get the best. Insist on Columbia Constant Displacement cartridges.

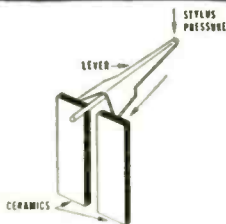

SPECIFICATIONS

- Diamond stylus 0.0008 inch radius
- Recommended needle force 5 to 7 grams
- High compliance. superior tracking and reproduction
- Open-circuit voltage 0.5 volts
- Extended stereo range, ± 2.5 db . . . 20 to 16,000 cps
- Channel separation in excess of 20 db
- Complete compatibility stereo and monaural
- 4 speeds 33 $\frac{1}{3}$, 45, 78 and 16 $\frac{2}{3}$

CBS-HYTRON, Danvers, Massachusetts
A Division of Columbia Broadcasting System, Inc.

COLUMBIA CD REPLACEMENT STYLI TOO
... Ask your CBS-Hytron distributor

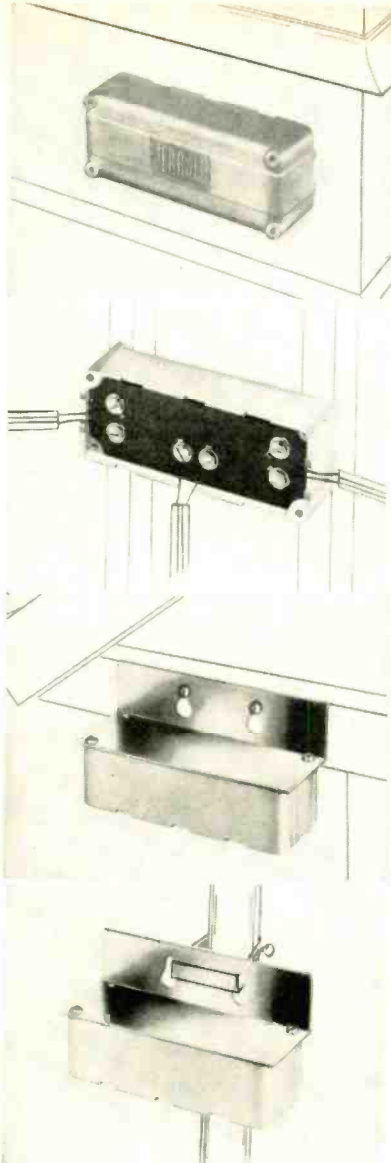

Courtesy Jerrold Electronics Corp.

Four ways of mounting an antenna coupler (top to bottom): baseboard, attic or basement, cave, mast.

matched, and isolation is secured through this mismatch. Forward loss is about 3.5 db for a two-set model, with 6-db isolation.

An excellent compromise is that shown in Fig. 4, where a stepdown transformer followed by padding resistors is used to match the outputs. In a two-set model it has a loss of 4.75 db, with 9.5-db isolation. In a four-set model it has an 8.5-db loss with 17-db isolation. The input and all outputs can be matched to a vswr of 1.3 or better with ease, on a production basis.

Another group of couplers uses those small, coiled transmission lines called elevator coils. They may be made in any convenient length and impedance, but the kinds most readily available are a quarter-wave long at channel 4 (middle of the low band) and three-quarter-wave long at channel 10 (middle of the high band). They are made by winding parallel wires on a small coil form. Wire size and spacing are chosen for

a 150-ohm characteristic impedance.

One of these coils may be used as a quarter-wave transmission-line transformer. Here, the product of the input and output impedances will equal the square of the characteristic impedance. Thus, a 150-ohm coil may serve as a transformer between 75 and 300 ohms. Fig. 5 shows a four-set coupler which uses four elevator coils in this manner, with the 75-ohm input impedances shown by the four coils connected in series to present a 300-ohm load to the antenna. Since a quarter-wave transforming section is essentially a single-frequency device, such a coupler is better in the middle of each band than it is at the edges. And the outputs are not matched looking back in.

Bandwidth difficulties can be resolved by replacing each coil with two coils connected as a flat 75-300-ohm elevator transformer. This is done by connecting

the two 150-ohm lines in parallel at one end to make 75 ohms, and in series at the other end to make 300 ohms. Each line then works at its natural impedance and has very wide frequency characteristics, failing only at low frequencies where it is too short and at high frequencies where the stray reactance of terminals and leads is important. The improvement is shown in Fig. 6 and is applied in a much simpler configuration in Fig. 7 with electrical performance almost as satisfactory.

Two- and three-set couplers cannot be easily made with the 150-ohm elevator coils—the numbers won't come out right for even a one-way impedance match. Such arrangements require coils wound to a different impedance chosen for the particular circuit.

A hybrid transformer two-set coupler, capable of exceptionally good per-

(Continued on page 90)

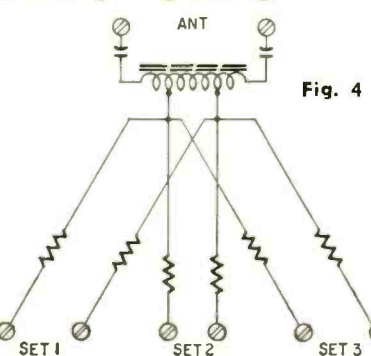
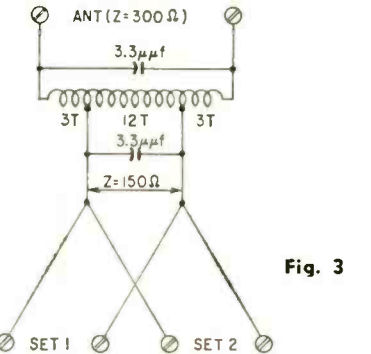
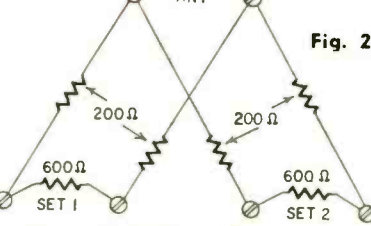
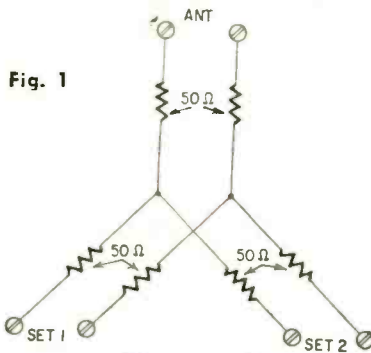

Fig. 1—2-set coupler using Y network.

Fig. 2—V network, 2-set coupler.

Fig. 3—Transformer type 2-set coupler. Coil is 18 turns of No. 24 nylon-coated wire wound on a 0.285-inch-diameter paper tube, tapped 3 turns from each end.

Fig. 4—Compromise circuit for 2-, 3- and 4-set units. Resistors, capacitors and tap positions vary for 2-, 3- and 4-set couplers.

Fig. 5—An elevator-coil type coupler. Coils must be one-quarter-wave long electrically.

Fig. 6—Improved version of Fig. 5 setup shown with 150-ohm ribbon-line sections, but may use elevator coils.

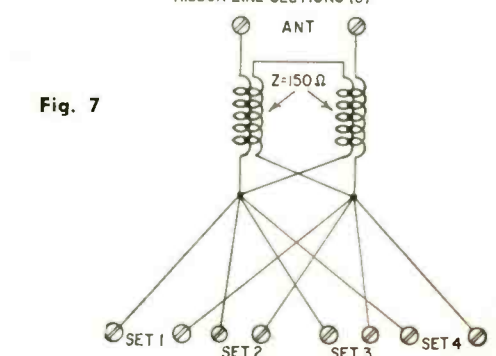
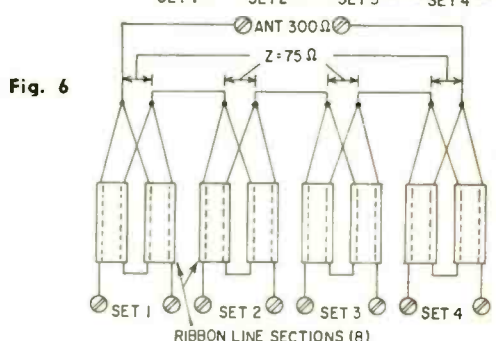
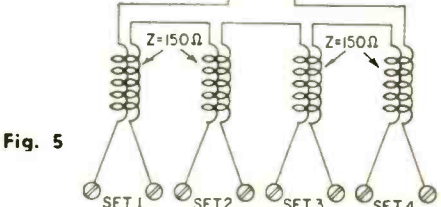

Fig. 5

Fig. 6

Fig. 3

Fig. 4

Fig. 7

a laboratory for learning

As a Field Engineer at Hughes, through training and assignment, you become familiar with advanced electronics weapons systems, including the most advanced analog and digital computers. With this knowledge you will be ideally suited to broaden your experience and learning for future application in either the military or commercial fields.

The Hughes Field Engineering activity is a highly trained organization of professional engineers, giving support to the armed forces and air-frame manufacturers using Hughes equipment. Assignments are in Southern California, the continental U.S., or overseas.

Other field engineering advantages include: 1) Training at full salary before assignment. 2) Generous moving and travel allowance between present location and Southern California. 3) Additional compensation plus complete moving and travel expenses on assignments away from the Culver City plant. 4) Reimbursement for after-hours courses at universities in area of assignment.

E. E. or Physics graduates: Your inquiry is invited. Please apply directly to Dr. Allen Puckett, Associate Director, Systems Development Laboratories.

The West's leader in advanced electronics

HUGHES

Hughes Aircraft Co., Culver City 18, Calif.

FIELD ENGINEER GIVES PILOT PRE-FLIGHT BRIEFING



SUPERIOR'S NEW MODEL TW-11

STANDARD
PROFESSIONAL

TUBE TESTER



- EXTRAORDINARY FEATURE**
- ★ **SEPARATE SCALE FOR LOW-CURRENT TUBES**—Previously, an emission type tube tester, it has been standard practice to use one scale for all tubes. As a result, the calibration for low-current types has been restricted to a small portion of the scale. The extra scale used here greatly simplifies testing of low-current types.

- ★ Tests all tubes, including 4, 5, 6, 7, Octal, Lock-in, Hearing Aid, Thyatron, Miniatures, Sub-miniatures, Novals, Subminars, Proximity fuse types, etc.
- ★ Uses the new self-cleaning Lever Action Switches for individual element testing. Because all elements are numbered according to pin-number in the RMA base numbering system, the user can instantly identify which element is under test. Tubes having tapped filaments and tubes with filaments terminating in more than one pin are truly tested with the Model TW-11 as any of the pins may be placed in the neutral position when necessary.
- ★ The Model TW-11 does not use any combination type sockets. Instead individual sockets are used for each type of tube. Thus it is impossible to damage a tube by inserting it in the wrong socket.
- ★ Free-moving built-in roll chart provides complete data for all tubes. All tube listings printed in large easy-to-read type.
- ★ **NOISE TEST:** Phono-jack on front panel for plugging in either phones or external amplifier will detect microphonic tubes or noise due to faulty elements and loose internal connections.
- ★ The Model TW-11 operates on 105-130 Volt 60 Cycles A.C. Comes housed in a beautiful hand-rubbed oak cabinet complete with portable cover.

\$47⁵⁰
NET

Superiors New Model 82

A truly do-it-yourself type

TUBE TESTER

TEST ANY TUBE IN 10 SECONDS FLAT!



- 1 Turn the filament selector switch to position specified.
- 2 Insert tube into a numbered socket as designated on our chart (over 600 types included).
- 3 Press down the quality button —

THAT'S ALL! Read emission quality direct on bad-good meter scale.

Primarily, the difference between the conventional tube tester and the multi-socket type is that in the latter, the use of an added number of specific sockets (for example, in Model 82 the noval is duplicated eight times) permits elimination of element switches thus reducing testing time and possibility of incorrect switch readings.

To test any tube, you simply insert it into a numbered socket as designated, turn the filament switch and press down the quality switch — **THAT'S ALL!** Read quality on meter. Inter-element leakage, if any indicates automatically.

Production of this Model was delayed a full year pending careful study by Superior's engineering staff of this new method of testing tubes. Don't let the low price mislead you! We claim Model 82 will outperform similar looking units which sell for much more — and as proof, we offer to ship it on our examine before you buy policy.

- Tests over 600 tube types.
- Tests OZ4 and other gas-filled tubes.
- Employs new 4" meter with sealed air-dampening chamber resulting in accurate vibrationless readings.
- Use of 22 sockets permits testing all popular tube types and prevents possible obsolescence.
- Dual Scale meter permits testing of low current tubes.
- 7 and 9 pin straighteners mounted on panel.
- All sections of multi-element tubes tested simultaneously.
- Ultra-sensitive leakage test circuit will indicate leakage up to 5 megohms.

\$36⁵⁰
NET

Model 82 comes complete, housed in portable, hand-rubbed oak cabinet with removable cover. Only

SHIPPED ON APPROVAL
NO MONEY WITH ORDER — NO C.O.D.

Try for 10 days before you buy! If completely satisfied, send down payment after trial and pay balance at indicated monthly rate — **NO INTEREST OR FINANCE CHARGES ADDED.** If not completely satisfied, return to us, no explanation necessary.

SEE PAGE 89 FOR COMPLETE DETAILS

MOSS ELECTRONIC DIST. CO., INC. 3849 TENTH AVE., NEW YORK 34, N. Y.

Superior's New
MODEL

77 VACUUM TUBE VOLTMETER

WITH NEW 6" FULL-VIEW METER

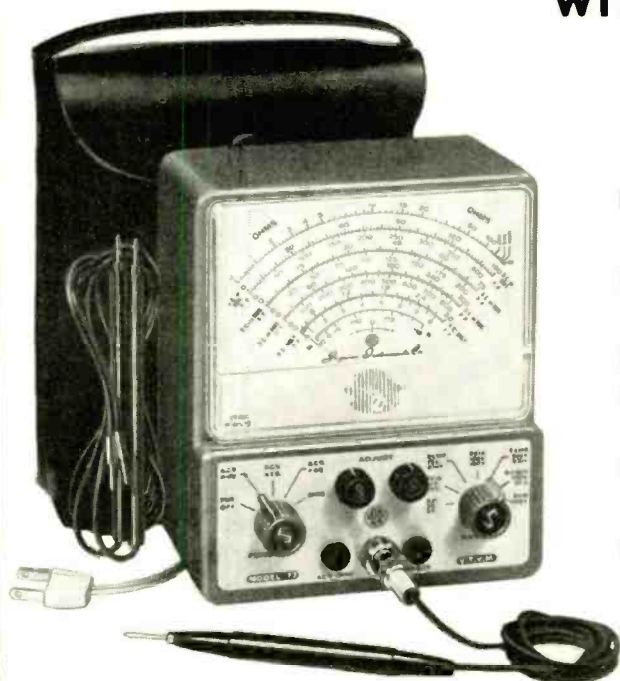

Compare it to any peak-to-peak V.T.V.M. made by any other manufacturer at any price!

- ✓ Model 77 completely wired and calibrated with accessories (including probe, test leads and portable carrying case) sells for only \$42.50.
- ✓ Model 77 employs a sensitive six inch meter. Extra large meter scale enables us to print all calibrations in large easy-to-read type.
- ✓ Model 77 uses new improved SICO printed circuitry.
- ✓ Model 77 employs a 12AU7 as D.C. amplifier and two 9006's as peak-to-peak voltage rectifiers to assure maximum stability.
- ✓ Model 77 uses a selenium-rectified power supply resulting in less heat and thus reducing possibility of damage or value changes of delicate components.
- ✓ Model 77 meter is virtually burn-out proof. The sensitive 400 microampere meter is isolated from the measuring circuit by a balanced push-pull amplifier.
- ✓ Model 77 uses selected 1% zero temperature coefficient resistors as multipliers. This assures unchanging accurate readings on all ranges.

Traditionally, the V.T.V.M. has been the one instrument used for voltage measurements where low-drain or wide frequency response is essential. And now, the Model 77 V.T.V.M. by taking advantage of new developments including modern balanced push-pull circuit design, etched circuitry, an extra large meter and other improvements provides such measurements quicker, with a higher degree of accuracy and with better readability.

The Model 77 will measure DC with negligible loading and AC of ANY WAVE FORM; whether sine wave, pulse wave, spike wave, square wave or other complex wave forms. It will measure all AC from 30 cycles to over 5 megacycles and will do so without additional accessories or cables.

AS A DC VOLTMETER: The Model 77 will measure any voltage up to 1500 volts with negligible loading. It is indispensable in receiver and Hi-Fi Amplifier servicing and a must for Black and White and color TV servicing where circuit loading cannot be tolerated. A special feature permits accurate zero center measurements necessary for the true alignment of Foster-Seely (Armstrong) FM detectors, Ratio Detectors and the newer Gated Beam Detectors.

AS AN AC VOLTMETER: The old-fashioned laboratory AC V.T.V.M. was cumbersome, erratic, and required several dial manipulations to arrive at a reading. The Model 77 when connected to a circuit will quickly and simply measure its RMS value if sine wave, and its peak-to-peak value if complex wave. Pedestal voltages that determine the "black" level in TV receivers, sync pulses and saw tooth voltages are easily read with the Model 77.

S P E C I F I C A T I O N S

- DC VOLTS — 0 to 3/15/75/150/300/750/1500 volts at 11 megohms input resistance.
- AC VOLTS (RMS) — 0 to 3/15/75/150/300/750/1500 volts.
- AC VOLTS (Peak to Peak) — 0 to 8/40/200/400/800/2000 volts.
- ELECTRONIC OHMMETER — 0 to 1000 ohms/10,000 ohms/100,000 ohms/1 megohm/10 megohms/100 megohms/1,000 megohms.
- DECIBELS — -10 db to +18 db, +10 db to +38 db, +30 db to +58 db. All based on 0 db = .006 watts (6 mw) into a 500 ohm line (1.73v).
- ZERO CENTER METER — For discriminator alignment with full scale range of 0 to 1.5/7.5/37.5/75/150/375/750 volts at 11 megohms input resistance.

AS AN ELECTRONIC OHMMETER: Because of its wide coverage of measurement in the resistance range (from .2 ohms to 1,000 megohms) the Model 77 will be your most frequently used resistance meter. Leaky capacitors which may not show up on other resistance meters, show up glaringly when tested with the new Model 77. Because of its sensitivity and low loading, intermittents are more easily found, isolated and repaired.

Model 77 comes complete with operating instructions, probe and test leads. Use it on the bench — use it on calls. A streamlined carrying case, included at no extra charge, accommodates the tester, instruction book, probe and leads. Operates on 110-120 volt 60 cycle. Only

\$42⁵⁰
NET

SHIPPED ON APPROVAL
NO MONEY WITH ORDER — NO C.O.D.

Try for 10 days before you buy! If completely satisfied, send down payments after trial and pay balance at indicated monthly rate — **NO INTEREST OR FINANCE CHARGES ADDED.** If not completely satisfied, return to us, no explanation necessary.

SEE PAGE 89 FOR COMPLETE DETAILS

MOSS ELECTRONIC DIST. CO., INC. 3849 TENTH AVE., NEW YORK 34, N. Y.

SUPERIOR'S NEW MODEL 79

The Most Versatile All-Purpose Multi-Range Tester Ever Designed!

SUPER-METER

WITH NEW 6" FULL-VIEW METER



Model 79 comes complete with operating instructions and test leads. Use it on the bench—use it on calls. A streamlined carrying case included at no extra charge accommodates the tester, instruction book and test leads. Only

\$38⁵⁰
NET

A Combination VOLT-OHM MILLIAMMETER.
Plus CAPACITY, REACTANCE, INDUCTANCE AND DECIBEL MEASUREMENTS.
Also Tests SELENIUM AND SILICON RECTIFIERS, SILICON AND GERMANIUM DIODES

The Model 79 represents 20 years of continuous experience in the design and production of SUPER-METERS, an exclusive SICO development. In 1938 Superior Instruments Co. designed its first SUPER-METER—Model 1150. In 1940 it followed with Model 1250 and in succeeding years with others including Models 670 and 670-A. All were basically V.O.M.'s with extra services provided to meet changing requirements.

Now, Model 79, the latest SUPER-METER includes not only every circuit improvement perfected in 20 years of specialization, but in addition includes those services which are "musts" for properly servicing the ever increasing number of new components used in all phases of today's electronic production. For example with the Model 79 SUPER-METER you can measure the quality of selenium and silicon rectifiers and all types of diodes—components which have come into common use only within the past five years, and because this latest SUPER-METER necessarily required extra meter scale, SICO used its new full-view 6-inch meter.

Specifications

D.C. VOLTS: 0 to 7.5/15/75/150/750/1,500.
A.C. VOLTS: 0 to 15/30/150/300/1,500/3,000.
D.C. CURRENT: 0 to 1.5/15/150 Ma. 0 to 1.5/15 Amperes.
RESISTANCE: 0 to 1,000/100,000 Ohms. 0 to 10 Megohms.
CAPACITY: 001 to 1 Mfd. 1 to 50 Mfd.
REACTANCE: 50 to 2,500 Ohms, 2,500 Ohms to 2.5 Megohms.
INDUCTANCE: .15 to 7 Henries, 7 to 7,000 Henries.
DECIBELS: -6 to +18, +14 to +38, +34 to +58.

The following components are all tested for QUALITY at appropriate test potentials. Two separate BAD-GOOD scales on the meter are used for direct readings.

All Electrolytic Condensers from 1 MFD to 1000 MFD.
All Selenium Rectifiers. All Germanium Diodes.
All Silicon Rectifiers. All Silicon Diodes.

For the first time ever: ONE TESTER PROVIDES ALL THE SERVICES LISTED BELOW!

Superior's New Model **76**



IT'S A **CONDENSER BRIDGE**
with a range of .00001 Microfarad to 1000 Microfarads (Measures power factor and leakage too.)

IT'S A **RESISTANCE BRIDGE**
with a range of 100 ohms to 5 megohms

IT'S A **SIGNAL TRACER**

which will enable you to trace the signal from antenna to speaker of all receivers and to finally pinpoint the exact cause of trouble whether it be a part or circuit defect.

IT'S A **TV ANTENNA TESTER**

The TV Antenna Tester section is used first to determine if a "break" exists in the TV antenna and if a break does exist the specific point (in feet from set) where it is.

SPECIFICATIONS:

CAPACITY BRIDGE SECTION

4 Ranges: .00001 Microfarad to 1000 Microfarads. Will also locate shorts, and leakages up to 20 megohms. Measures the power factor of all condensers from .1 to 1000 Microfarads. (Power factor is the ability of a condenser to retain a charge and thereby filter efficiently.)

SIGNAL TRACER SECTION

With the use of the R.F. and A.F. Probes included with the Model 76, you can make stage gain measurements, locate signal loss in R.F. and Audio stages, localize faulty stages, locate distortion and hum, etc. Provision has been made for use of phones and meter if desired.

RESISTANCE BRIDGE SECTION

2 Ranges: 100 ohms to 5 megohms. Resistance can be measured without disconnecting capacitor connected across it. (Except, of course, when the R C combination is part of an R C bank.)

TV ANTENNA TESTER SECTION

Loss of sync., snow and instability are only a few of the faults which may be due to a break in the antenna, so why not check the TV antenna first? 2 Ranges: 2' to 200' for 72 ohm coax and 2' to 250' for 300 ohm ribbon.

Model 76 comes complete with all accessories including R.F. and A.F. Probes; Test Leads and operating instructions. Nothing else to buy. Only

\$26⁹⁵
NET

SHIPPED ON APPROVAL
NO MONEY WITH ORDER—NO C.O.D.

Try for 10 days before you buy! If completely satisfied, send down payment after trial and pay balance at indicated monthly rate — **NO INTEREST OR FINANCE CHARGES ADDED.** If not completely satisfied, return to us, no explanation necessary.

See following page for complete details

MOSS ELECTRONIC DIST. CO., INC. 3849 TENTH AVE., NEW YORK 34, N. Y.

Superior's New
Model TV-50A

GENOMETER

7 Signal Generators in One!

- ✓ R.F. Signal Generator for A.M.
- ✓ R.F. Signal Generator for F.M.
- ✓ Audio Frequency Generator
- ✓ Bar Generator
- ✓ Cross Hatch Generator
- ✓ Color Dot Pattern Generator
- ✓ Marker Generator



This versatile All-Inclusive
GENERATOR Provides **ALL**
the Outputs for Servicing:

- A.M. RADIO • F.M. RADIO
- AMPLIFIERS
- BLACK AND WHITE TV
- COLOR TV

Specifications

R. F. SIGNAL GENERATOR:

The Model TV-50A Genometer provides complete coverage for A.M. and F.M. alignment. Generates Radio Frequencies from 100 Kilocycles to 60 Megacycles on fundamentals and from 60 Megacycles to 180 Megacycles on powerful harmonics. Accuracy and stability are assured by use of permeability trimmed Hi-Q coils. R.F. is available separately, modulated by the fixed 400 cycle sine-wave audio or modulated by the variable 300 cycle to 20,000 cycle variable audio. Provision has also been made for injection of any external modulating source.

VARIABLE AUDIO FREQUENCY GENERATOR:

In addition to a fixed 400 cycle sine-wave audio, the Model TV-50A Genometer provides a variable 300 cycle to 20,000 cycle peaked wave audio signal. This service is used for checking distortion in amplifiers, measuring amplifier gain, trouble shooting hearing aids, etc.

BAR GENERATOR:

This feature of the Model TV-50A Genometer will permit you to throw an actual Bar Pattern on any TV Receiver Screen. Pattern will consist of 4 to 16 horizontal bars or 7 to 20 vertical bars. A Bar Generator is acknowledged to provide the quickest and most efficient way of adjusting TV linearity controls. The Model TV-50A employs a recently improved Bar Generator circuit which assures stable never-shifting vertical and horizontal bars.

CROSS HATCH GENERATOR:

The Model TV-50A Genometer will project a cross-hatch pattern on any TV picture tube. The pattern will consist of non-shifting, hori-

zontal and vertical lines *interlaced* to provide a stable cross-hatch effect. This service is used primarily for correct ion trap positioning and for adjustment of linearity.

DOT PATTERN GENERATOR (For Color TV)

Although you will be able to use most of your regular standard equipment for servicing Color TV, the one addition which is a "must" is a Dot Pattern Generator. The Dot Pattern projected on any color TV Receiver tube by the Model TV-50A will enable you to adjust for proper color convergence. When all controls and circuits are in proper alignment, the resulting pattern will consist of a sharp white dot pattern on a black background. One or more circuit or control deviations will result in a dot pattern out of convergence, with the blue, red and green dots in overlapping dot patterns.

MARKER GENERATOR:

The Model TV-50A includes all the most frequently needed marker points. Because of the ever-changing and ever-increasing number of such points required, we decided against using crystal holders. We instead adjust each marker point against precise laboratory standards. The following markers are provided: 189 Kc., 262.5 Kc., 456 Kc., 600 Kc., 1000 Kc., 1400 Kc., 1600 Kc., 2000 Kc., 2500 Kc., 3579 Kc., 4.5 Mc., 5 Mc., 10.7 Mc. (3579 Kc. is the color burst frequency.)

The Model TV-50A comes absolutely complete with shielded leads and operating instructions. Only

\$47⁵⁰
NET

SHIPPED ON APPROVAL

NO MONEY WITH ORDER — NO C. O. D.

MOSS ELECTRONIC DISTRIBUTING CO., INC.

Dept. D-526 3849 Tenth Ave., New York 34, N. Y.

Please send me the units checked on approval. If completely satisfied I will pay on the terms specified with no interest or finance charges added. Otherwise, I will return after a 10 day trial positively cancelling all further obligation.

Name

Address

City Zone State

All prices net. F.O.B., N. Y. C.

- Model 79 Total Price \$38.50
\$8.50 within 10 days. Balance \$6.00 monthly for 5 months.
- Model TW-11 Total Price \$47.50
\$11.50 within 10 days. Balance \$6.00 monthly for 6 months.
- Model 77 Total Price \$42.50
\$12.50 within 10 days. Balance \$6.00 monthly for 5 months.
- Model TV-50A Total Price \$47.50
\$11.50 within 10 days. Balance \$6.00 monthly for 6 months.
- Model 82 Total Price \$36.50
\$6.50 within 10 days. Balance \$6.00 monthly for 5 months.
- Model 76 Total Price \$26.95
\$6.95 within 10 days. Balance \$5.00 monthly for 4 months.

First the fabulous TD-124



TD-124 \$99.75 net

NOW

two new "TD" Stereo-Monaural turntables



TD-134 \$60.00 net

Here's good news for budget-minded hi-fi aficionados. These two new Thorens turntables (with integral tone arm) give you the same basic drive mechanism you get in the ultra-precise TD-124 transcription turntable, but they're streamlined for economy. See the new TD-184 and TD-134 at your authorized Thorens hi-fi dealer's today.

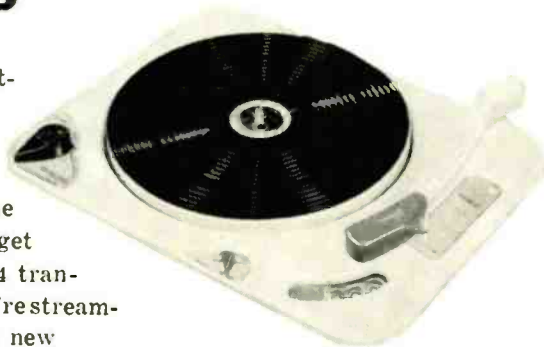

TD-184 \$75.00 net

TD-134 Manual Player. 4 speeds. It has the same precision-machined, adjustable-speed drive as the Thorens TD-124 transcription turntable for minimum wow, flutter and rumble. Turntable floats on nylon bearings. Integral tone arm equals tracking performance of separate arms costing as much as half the price of this entire unit. Plug in adapter for standard stereo or monaural cartridges. 15" x 12", extends 2½" below panel, 3" above.

TD-184. Same as TD-134 with semi-automatic operation: One dialing motion selects 7", 10" or 12" record size, starts motor. Arm literally floats down into first record groove on air; adjustable piston controls lowering speed. Absolutely no connection between arm and table during playing. Featherweight position trip shuts off player at end of record, idler disengages and arm lifts. Manual reject control permits shut-off, interruption or manual operation.



Thorens celebrates 75 years of progress in music reproduction

THORENS

SWISS MADE PRODUCTS
HI-FI COMPONENTS • LIGHTERS
SPRING-POWERED SHAVERS
MUSIC BOXES
NEW HYDE PARK, NEW YORK

TELEVISION

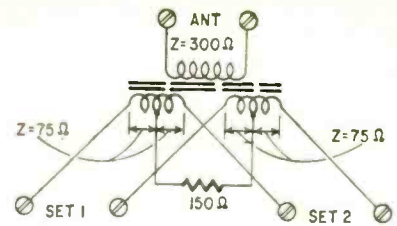

Fig. 8—Hybrid transformer type coupler for minimum loss, maximum isolation. Inductive coupling must be high, capacitive coupling low and all coupling symmetrical.

(Continued from page 84)

formance in well-installed systems, is shown in Fig. 8. The output match derives equally from the input and from the resistor, while isolation is obtained from a bridge balance achieved by meticulous symmetry in the windings. Loss is about 3.5 db, isolation about 13 db. There are other hybrid circuits with the same features, as well as some of the virtues and vices already discussed. Among them are ring hybrids, some of which use or misuse elevator coils, and resistance-bridge hybrids.

Good impedance matching in any of the couplers shown in Figs. 1 to 8 requires that both capacitance between terminal lugs and stray lead inductance be kept to a minimum and well controlled.

Recommendations

In an extreme fringe area where snow is already a problem, do not cut

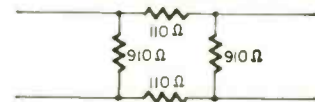

Fig. 9—A simple 6-db pad.

a multiset coupler into an existing installation without adding a booster ahead of the coupler to lift the signal well out of the snow. Dividing the signal *always* weakens it.

Use only a type of coupler with matched input and output impedances. Do not use very-low-loss couplers unless you are prepared to make an excellent installation, keeping all lines clear of pipes, ducts, flashings, all other metal or damp materials, and avoiding sharp bends and corners. The lower the loss of the coupler, the less it will do to minimize standing waves due to impedance irregularities in the line.

Do not throw away signal needlessly by using a three-set coupler for two sets or a four-set coupler for three sets, unless you are in a strong-signal area. If you do, be sure to terminate each of the unused outlets with a 300-ohm resistor to keep your impedance match.

If you have plenty of signal strength, insert a 6-db pad at the terminals of each set to minimize off-channel reflections. Such a pad is easily made from four resistors and is shown in Fig. 9.

Remember that buying a multiset coupler is like buying anything else. You get what you pay for. Rarely more, sometimes less. Get a reputable make, from a reputable dealer. END

HARMONICS WORK FOR YOU

in **CONVERGENCE** new **CONVERGENCE** CIRCUIT

A system of color-dot convergence said to give better results than earlier systems is appearing in modern color TV receivers. Here's how it works and how it's adjusted

By **ROBERT G. MIDDLETON**
TELEVISION CONSULTANT

MORE and more technicians are moving into color TV servicing, and interest in the practical aspects of new circuits, controls and adjustments is growing. If you have not run across second-harmonic convergence controls, for example, you surely will before long. This is a Motorola innovation which makes closer convergence possible. Here's how it works:

The color dots on the picture-tube screen are converged with the static and dynamic convergence controls. Center-screen convergence is made with the static controls; edge-screen convergence with the dynamic controls.

A typical static control is shown in Fig. 1. Three beam (PM) magnets are used in most receivers. A few receivers have electromagnetic beam magnets, but from a practical standpoint they work just like the PM type.

All color receivers also have another static control—the blue lateral corrector, shown in Fig. 2. This is another PM unit. It is pushed up and down in its mounting strap to obtain center-screen convergence. The actions of the beam magnets and blue lateral corrector are shown in Fig. 3. Thus, we have four static controls, which are adjusted

to obtain center-screen convergence.

Dynamic convergence

After the preliminary static adjustments are made and the color dots are converged at center screen, we find the situation depicted in Fig. 4. That is, the color dots at the screen edges are *overconverged*. This results from the fact that the radius of the phosphor-dot screen is greater than the radius of the electron beams in the picture tube.

This misconvergence is corrected by dynamic convergence controls. In theory, a parabolic current would be passed through the dynamic convergence coils (coil beneath beam magnet in Fig. 1) to correct overconvergence. In practice, a parabolic current is not used (a parabola has the shape of an auto headlight reflector).

Instead of using a parabolic current, a section of a sine wave is used to obtain horizontal dynamic convergence. The reason—a parabola and a suitable sine-wave section have approximately equivalent shapes and sine waves are much easier and more economical to generate at the horizontal scanning frequency.

However, the problem of dynamic convergence does not end here. We know that there are tolerances on all manufactured components. That is why one color receiver can be converged very accurately, while another set of the same make cannot be converged as closely as we might wish. All yokes and picture tubes cannot be made exactly the same. Most convergence variations

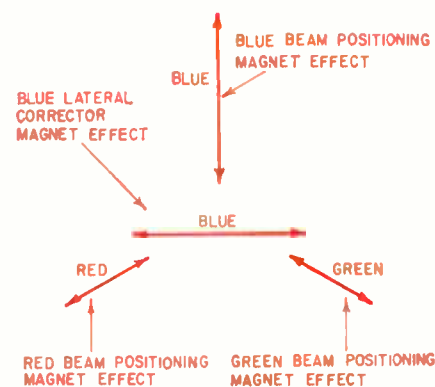

Fig. 3—Motions of color dots controlled by adjusting beam magnets and blue lateral corrector.

arise from yoke tolerances.

Second-harmonic correction

By adding a small amount of second-harmonic voltage to a sine-wave voltage we can change the shape of the sine wave. It can be made closer to a parabola. Hence, we obtain a waveform which is better from the theoretical standpoint.

Moreover, by varying the voltage and phase of this second harmonic, we can make the waveform more peaked or flatter or lean it slightly to one side or the other. This is how we make up for yoke and picture-tube tolerances.

From the practical point of view, this second harmonic puts "waves" in (Continued on page 94)

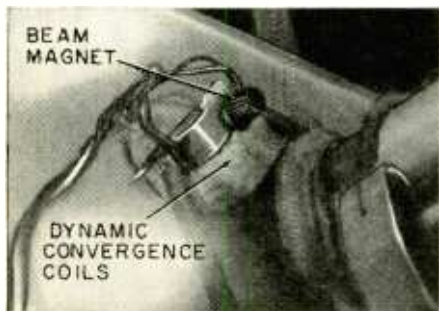

Fig. 1—A typical beam magnet is a PM unit with a control knob. It is rotated to obtain center-screen convergence. Note the dynamic convergence coils below the magnet.



Fig. 2 (right)—A typical blue lateral corrector, mounted over the blue gun.

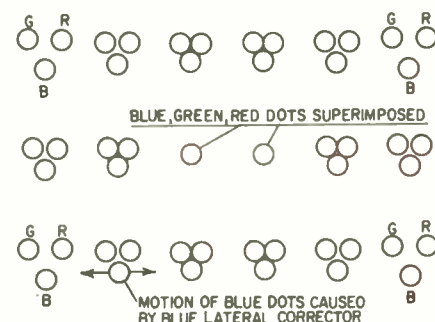

Fig. 4—Center screen is converged, but edges are overconverged.

Mr. Service Dealer
PHILCO offers you
 a program of
COMPLETENESS!

Here is a program of completeness designed to increase your volume and profit. In products and services, Philco and Philco Distributors are

doing everything possible to help you in the successful and profitable operation of your business. See your Philco Distributor today!



Complete Parts Catalogs

Over 60,000 items are cataloged in 3 separate books . . . one for each product line: electronics, appliances and laundry equipment. Here is complete information, up-to-date and put together in a way that's designed to save you time and effort.

Universal Service Parts

Your Philco Distributor has available for you a complete new line of electronic universal parts that not only fit all Philco receivers but many competitive make and model as well. All Philco Universal parts are precision engineered and quality tested to insure superior operation and longer life.



Universal Full Fidelity Needles

Now, one complete line of precision engineered and custom designed needles to fit every make and model phonograph and High Fidelity receiver. Also available . . . the most accurate, up-to-date, cross-reference catalog in the industry. Ask your Philco distributor how you can get the beautiful needle counter dispenser free!



SEE YOUR PHILCO DISTRIBUTOR TODAY!

Don't Gamble with your Reputation!

FOR DEPENDABILITY, FOR QUALITY INSIST ON
GENUINE **PHILCO-Bendix** WASHER PARTS

Your Philco Distributor maintains a complete stock of parts and accessories designed especially for Philco-Bendix

washer products. As a qualified Serviceman you may obtain these genuine parts at any time from your local Philco Distributor.

Now, Factory-Remanufactured



Washer Micro-Transmissions

The only genuine Micro-Transmissions factory remanufactured to the latest and most exacting quality engineering specifications. Six months' warranty from the date of installation.

PHILCO • PHILCO-BENDIX • CROSLEY
Washer and Dryer Parts

Your Philco Distributor carries a complete stock of these various parts to enable you to offer quick and efficient service in this big, profitable business.



INSIST ON GENUINE PHILCO APPLIANCE PARTS

Don't gamble with cheap imitations. See your Philco Distributor for a complete line of quality-built, quality-tested appliance parts. He has everything you might need from a door hinge to a liner, from a gasket to a compressor. Don't settle for less.



See Your Philco Distributor Today!

PHILCO
Accessory Division

World-Wide Distribution

Service Parts • Power-Packed Batteries • Universal Components • Long-Life Tubes • Heavy-Duty Rotors • Star Bright 20/20 Picture Tubes • Long Distance Antennas • Appliance Parts • Laundry Parts • Universal Parts and Accessories

These men are getting practical training in...

Electronics

ELECTRICITY ELECTRONICS

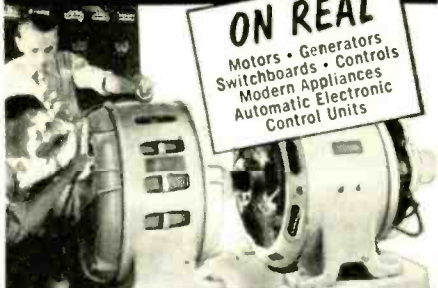

ON REAL

Motors • Generators
Switchboards • Controls
Modern Appliances
Automatic Electronic
Control Units

TELEVISION RADIO ELECTRONICS



ON REAL

TV Receivers
Black & White and Color
AM-FM and Auto Radios
Transistors • Printed
Circuits • Test Equipment

Train in NEW Shop-Labs of COYNE

in Chicago — Electronic Center of the World. Prepare for a better job and a successful future in TOP OPPORTUNITY FIELD. Train on real full size equipment at COYNE where thousands of successful men have trained for 60 years—largest, oldest, best equipped school of its kind. Professional and experienced instructors show you how, then do practical jobs yourself on more than a quarter of a million dollars worth of equipment. No previous experience or advanced education needed. Employment Service to Graduates.

Start Now—Pay Later—Liberal Finance and Payment Plans. Pay most of tuition after graduation. Part-time employment help for students. Choose from nine yearly Starting Dates.

Mail Coupon For Free Book—"Guide to Careers." Whether you prefer ELECTRICITY-ELECTRONICS, TELEVISION-RADIO ELECTRONICS or COMBINED ELECTRONICS TRAINING, this book describes all training offered and gives all the facts to Vets and Non-Vets.

Information comes by mail. No obligation and NO SALESMAN WILL CALL.

B. W. Cooke, Jr., Pres. Founded 1899

COYNE ELECTRICAL SCHOOL

Chartered Not For Profit

1501 W. Congress Pkwy., Chicago 7, Ill., Dept. 78-5A

MAIL COUPON FOR BOOK

Coyne Electrical School, Dept. 78-5A
1501 W. Congress Pkwy.
Chicago 7, Ill.

Send FREE book. "Guide to Careers" and details of all training you offer.

Name

Address

City State

(I understand no Salesman will call)

TELEVISION

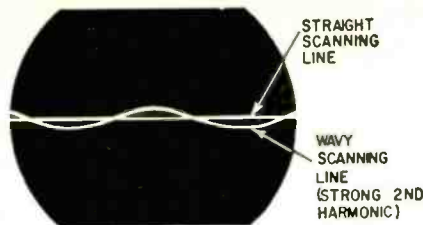

Fig. 5—Correct amounts of fundamental and second-harmonic current produce a straight scanning line.

the horizontal scanning line, as illustrated in Fig. 5. Dynamic convergence is obtained by using enough sine-wave and second-harmonic current to obtain a straight scanning line. That is, the curved lines of blue dots, seen in Fig. 4, are made straight.

As in Fig. 5, too much second-harmonic current causes "waves" in the scanning line and it is no longer straight. Hence, the convergence controls must be adjusted accurately.

A diagram of a control panel for a second-harmonic convergence system is shown in Fig. 6. Note, first, that combined red-green controls are used. These affect motions of both red and green color dots. This too, is new in color receiver design.

At this point we are concerned chiefly with adjusting the controls which cause a flow of fundamental and second-harmonic sine-wave current through the convergence coils. With reference to Fig. 5, preliminary straightening of the blue scanning line is made with the blue horizontal phase 1 control (B HOR PHASE 1) control seen in Fig. 6.

The effect of adjusting the blue horizontal phase 1 control is seen in Fig. 7. This control determines the phase or timing of the fundamental sine-wave current. Adjust the blue horizontal phase 1 control to peak the blue line at center screen, as shown by the "correct" pattern in Fig. 7.

This brings us to the second-harmonic adjustment. The phase of the second-harmonic voltage (or current) is set by turning the blue horizontal phase 2 control (B HOR PHASE 2) control seen in Fig. 6. Adjust this control to obtain second-harmonic symmetry along the blue scanning line, as shown in Fig. 8. Of course, we have an over-correction at this point. The next step is to reduce the amount (amplitudes) of the fundamental and second-har-

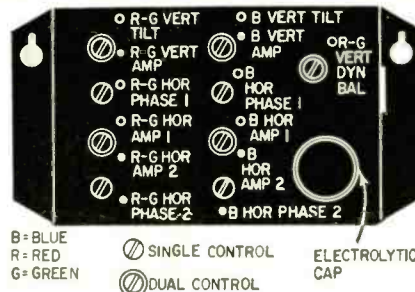

Fig. 6—A control panel for a second-harmonic convergence system. Note: Controls (1) are for fundamental sine waveforms. Controls (2) are for second-harmonic sine waveforms.

1 Antenna

4 Sets

MOSLEY 4-Set Coupler

LOW LOSS
EFFECTIVE ISOLATION
EFFICIENT SIGNAL DISTRIBUTION

Owners of Duplex or 4-unit Apartment Buildings will want you to install Mosley 4-Set Couplers!
Here's a Big profit-maker in a Big market!
Mosley 904, 4-Set Coupler \$6.25 List
Another Mosley Premium Quality TV Accessory!

Mosley Electronics, Inc.

8622 ST. CHARLES ROCK ROAD
ST. LOUIS 14, MISSOURI



LOOK GOV'T SURPLUS

BUY DIRECT from U.S. Government. Jeeps, trucks, fork-lifts, tents, tools, machinery, compressors, gear reducers, motors, typewriters, hydraulics, tires, camping equipment and 1000's of other high-quality useful items that sell as low as 1, 2 or 3% of the original low Gov't cost! Send \$1.00 today for complete instructions and list of depots to:

AVIATION SURPLUS CENTER

Dept. RE

Box 789, York, Pa.

RADIO-ELECTRONICS

TELEVISION



INCORRECT

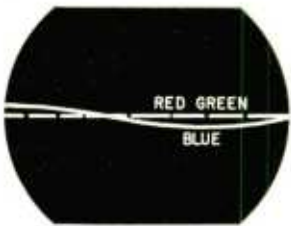

INCORRECT



CORRECT

Fig. 7—Fundamental sine wave is adjusted in phase to peak blue line at center screen.

monic currents to get a straight scanning line.

Straighten the blue line shown in Fig. 8 first, by adjusting the blue horizontal amplitude control 1. This is the (B HOR AMP 1) control seen in Fig. 6. This adjusts the amount of fundamental sine-wave current through the blue convergence coil. Usually, this adjustment alone is insufficient to obtain a perfectly straight blue line.

To get a very straight blue line, now adjust the blue horizontal amplitude control 2. This is the (B HOR AMP 2) control in Fig. 6. It sets the amount of second-harmonic sine-wave current through the blue convergence coil. This permits a straighter blue line than possible without second-harmonic correction. We get better convergence.

This explanation has been limited to the blue controls. You will observe from Fig. 6 that second-harmonic controls are also used for the red-green lines. The same general principles apply here, and will not be discussed in detail.

Second-harmonic voltages

Both the fundamental and the second-harmonic waveforms are obtained very simply by ringing tuned circuits from the flyback pulse, as illustrated in Fig. 9. The BLUE HOR PHASE 1 coil resonates at 15,750 cycles. The BLUE HOR PHASE 2 coil resonates at 31,500 cycles. The flyback pulse not only has a fundamental component, but also strong harmonic components. Hence, it "rings" both tuned circuits strongly. The tuned circuits have a high Q and deliver sine waveforms to the blue convergence coil.

When we turn the slugs in the phasing coils, we cause the current to lag

NEW!



TWO-SET COUPLER

delivers

MAXIMUM INTER-SET ISOLATION (12_{db}-20_{db})

with

MINIMUM SIGNAL LOSS (3_{db})

New Model A-102 Two-Set Coupler delivers more signal to each VHF TV or FM set, with greater inter-set isolation than any other coupler in the field. The reason — a new original B-T circuit with a phase cancellation feature which automatically defeats interfering signals. No ghosts, no smears... ideal for color TV and FM. Housed in a smartly styled, weatherproof, molded, non-breakable case. Mounts easily indoors or outdoors — with or without concealing terminals. List 2.95

THREE NEW B-T COUPLERS—4-SET HI-LO & UHF-VHF

Ideal for color, black and white, VHF, UHF and FM, these three new B-T couplers provide precise impedance match, lowest loss and maximum isolation. Housed in smartly styled, molded weatherproof cases.

A-104 FOUR SET COUPLER

Low loss 300 ohm directional coupler only 7 db insertion loss and 14-30 db inter-set isolation. Flat response 50 to 220 mc. Feeds 4 TV or FM sets from one antenna, or mixes 4 antennas into one line. List 3.95

A-105 HI-LO ANTENNA COUPLER

Combines low band and high band VHF antennas or provides separate low and high outputs from a common line or antenna. List 3.50

A-107 UHF-VHF ANTENNA COUPLER

Combines VHF and UHF antennas, or provides separate VHF and UHF outputs from a common line or antenna. List 3.50

A-100 OUTDOOR MOUNTING KIT

Bracket and strap assembly for fast, easy mast mounting of models A-102, A-104, A-105, A-107. List .90

These new B-T Couplers and a host of other quality engineered TV accessories are available at parts distributors. For further information write, Dept. RE-10.



BLONDER-TONGUE LABORATORIES, INC.

9 ALLING STREET

NEWARK 2, N. J.

UHF Converters • Amplifiers • TV Systems • Industrial TV Cameras

PENTRON STEREO

HIGH FIDELITY
TAPE RECORDERS

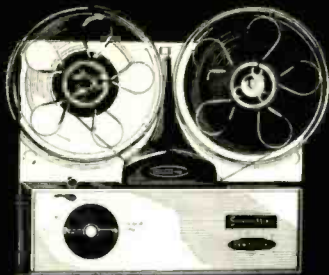

professional performance at popular prices
NOW YOU CAN RECORD STEREO, TOO!

Pentron's totally new TM-4 Stereo Tape Deck is the ideal addition to your custom high fidelity system: records and plays stereo... 4-track as well as 2-track tape, records and plays monaural and has all the exclusive Pentron stereo features which assure you matchless performance of a professional quality never before possible at popular prices.

Pentron tape mechanisms are precision engineered with full-range frequency response, Azmur-X head azimuth adjustment, single Finger-Flite rotary control, easy dual-speed control lever, four outputs plus two AC convenience outlets, self-energized braking, stereo or monaural erase, designed to operate at any mounting angle.

The Pentron TM-4 is priced at \$109.95 net and is available at professional high fidelity showrooms. For detailed information on Pentron high fidelity tape recorders, amplifiers, pre-amps, mike mixers, tape decks, and stereo conversion kits, write Dept. R-10 or see your yellow pages.

SEE THE NEW PENTRON EMPEROR II...



THE ONLY COMPLETE POPULAR-PRICED STEREO RECORDING SYSTEM

PENTRON CORPORATION 777 South Tripp Avenue, Chicago 24, Illinois
CANADA: Atlas Radio Ltd., Toronto EXPORT: Raytheon Manufacturing Company, Waltham, Massachusetts

NEW
Another Sencore Time-Saver

IMPROVED SENCORE LC3 Leakage Checker

Check these outstanding New Features
Now — For the first time...

- Checks 130 different tube types — more than any other "grid circuit" type checker. Includes UHF and latest type tubes.
- Checks picture tubes without removing tube from cabinet or chassis.
- New Roll Chart prevents obsolescence — just dial the tube type and save time. Chart is easily relocated at no extra cost.
- Dynamic Filament checks including heater to cathode leakage & shorts — no need for a second filament tester.
- Two spare preheating sockets to cut down testing time.
- Capacitor checks simplified.

\$28.95 DEALER NET
Really Whips Tough Dogs

The LC3 provides all these new improved features in addition to those employed in earlier leakage or "grid circuit" testers. A must for any TV service technician.

SERVICE INSTRUMENTS CORP. In stock at your local parts distributor
171 Official Rd • Addison, Ill.

Cut out this ad now for further information

CATALOG OF Professional Quality Kits "DIRECT FROM FACTORY"

FREE

TV KITS
INSTRUMENT KITS
HI-FI KITS, SPEAKERS
HI-FI CABINETS (Largest Selection)
Electronic PHOTOFLASH Kits

PAY AS YOU WIRE with Transvision "SPLIT-KITS." A few dollars gets you started. Each Kit is split into a few packages. You can order one at a time as you wire.

Also RECORDS at BIGGEST DISCOUNT!
RCA CBS All Labels

TRANSVISION, INC., New Rochelle, N.Y.

Rush FREE Catalog of KITS, HI-FI Equipment Cabinets, Records, etc

Name _____
Address _____
City _____ State _____

TELEVISION

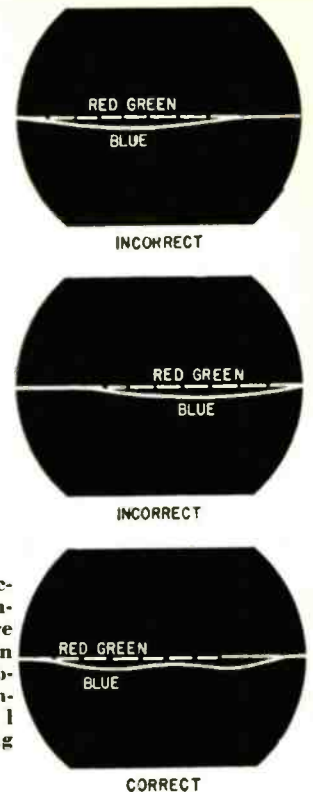

Fig. 8—Second-harmonic sine wave is adjusted in phase to obtain a symmetrical "wave" along blue line.

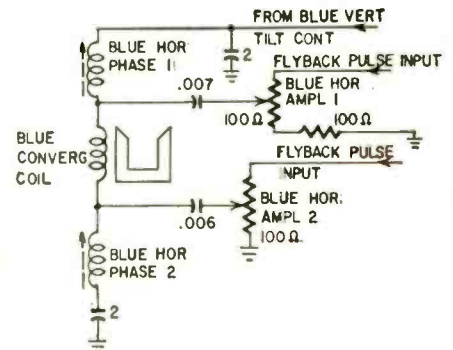

Fig. 9—Both fundamental and second-harmonic waveforms are obtained by "ringing" phasing coils with flyback pulses.

or lead the voltage, depending on whether we tune the coils slightly to the high or the low side of resonance. This produces the convergence effects shown in Figs. 7 and 8.

The 100-ohm potentiometers in Fig. 9 determine the amount of pulse voltage used to "ring" the coils. These are the amplitude controls. They determine how much of the corrective waveform current flows through the convergence coil.

Service technicians who are used to the dynamic convergence adjustments for earlier receivers will recognize that second-harmonic correction is unique. Other new adjustments, which cannot be covered in this article because of space limitations, are completely new to the color TV industry.

Hence, a new convergence procedure is necessary. You cannot generalize from previous design and tackle the new receivers successfully. Following articles will familiarize you with these innovations.

END

Send for FREE booklet and get the

BIG PAYOFF

in RADIO-TV-ELECTRONICS

"You might like to know that since I have started this course, my company has given me a \$32.00 a month raise. They seem to think anybody who has enough interest in their job to study at home is worth more money."

—Frank J. Mulvey, 910 124th St., S., Renton, Washington

What would a raise of just \$8 a week (\$416 per year) mean to You!

Think of it! Only one \$8-a-week raise (such as Frank Mulvey received) will repay your investment in CREI training, and leave you a substantial profit the very first year! Your increases in pay thereafter are all pure profit, and you'll be prepared for many more promotions and pay raises in the future years of your life!

Many of the men currently on the street are there for a reason. "As many as 8 out of 10 are dead-wood," estimates the chief engineer of a medium-sized Philadelphia firm; the problem is to find the live ones. —from *ELECTRONICS MAGAZINE*

If you're interested in an honest-to-goodness career in the vigorous young electronics industry, here's how you can step ahead of job-competition, move up to a better job, earn more money, AND BE SURE OF HOLDING YOUR TECHNICAL JOB, EVEN WHEN THE "DEADWOOD" IS BEING CLEANED OUT.

The "how" is advanced, professional home study training in Electronic Engineering Technology including SERVOMECHANISMS; COMPUTERS; RADAR; AUTOMATION; AERONAUTICAL ELECTRONICS; BROADCASTING; COMMUNICATIONS AND MANUFACTURING, and the ELECTRONIC PRINCIPLES ASSOCIATED WITH GUIDED MISSILES, TELEMETERING, ASTRONAUTICS and INSTRUMENTATION. You don't have to be a college graduate. You *do* have to be willing to study—at home. You can do it while holding down a full-time job. Thousands have. Since 1927 CREI has provided alert young men with the technical knowledge that leads to more responsibility, more job security, more money. And CREI has constantly kept pace with the rapid expansion and progress in electronic achievement.

Remember this: CREI starts with fundamentals and takes you along at your own speed. You are not held back by a class, not pushed to keep up with others. You set your own pace. CREI instructors guide you through the lesson material and *grade* your written work personally. You master the fundamentals, then get into more advanced phases of electronics engineering principles and practice. Finally you may elect training in highly specialized principles of electronic engineering technology as applied to guided missiles, servomechanisms, radar, computers, telemetering, automation, instrumentation and other applications.

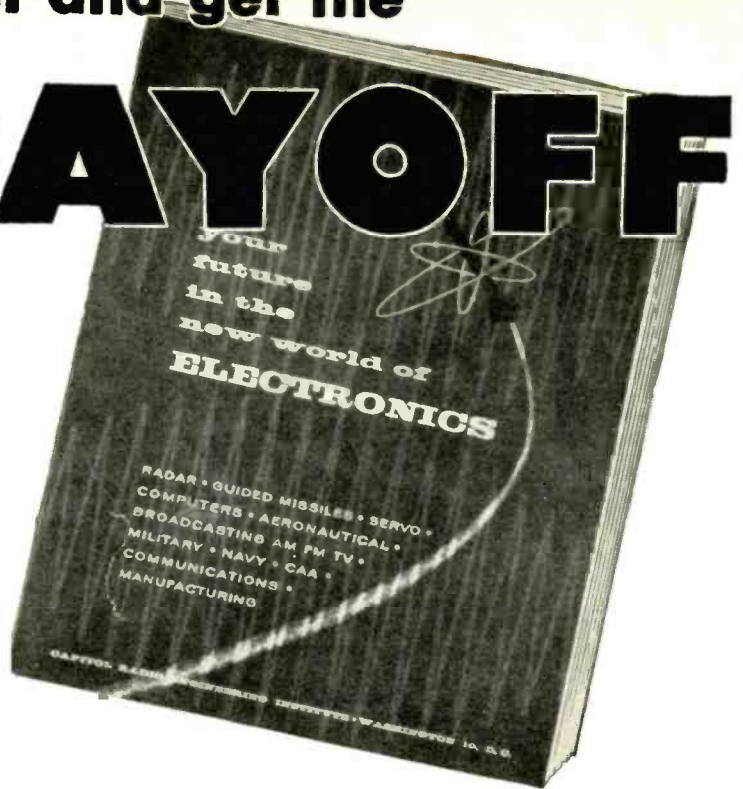

Look at this partial listing of organizations that recommend CREI training for their own personnel: United Air Lines, Canadian Broadcasting Corp., Trans-Canada Airlines, Douglas Aircraft Co., The Martin Co., Columbia Broadcasting System, All-American Cables and Radio, Inc., Gates Radio Co., Canadair Ltd., Federal Electric Corp., and U.S. Information Agency (Voice of America).

What's the next step? *Certainly get more information than we can cram into one page. Fill out and mail the coupon below today, or write Capitol Radio Engineering Institute, Dept. 1410-Y, 3224 16th St., N.W., Washington 10, D. C.*

CREI ALSO OFFERS RESIDENCE TRAINING at the same high technical level in Washington, D. C. Classes start at regular intervals. Qualified residence school graduates earn degree, "Associate in Applied Science." You can qualify for CREI home study training if you have had electronic education, or experience in electronics — and realize the need of a high level technical knowledge to make good in the better electronics jobs. (Electronics experience is not required for admission to CREI Residence School.)

VETERANS: If eligible for training under the new G.I. Bill of Rights, check the coupon for full information.

MAIL THIS COUPON FOR FREE BOOKLET!

CAPITOL RADIO ENGINEERING INSTITUTE

ECPD Accredited Technical Institute Curricula • Founded 1927
Dept. 1410-Y, 3224 Sixteenth St., N.W., Washington 10, D. C.

Please send me your course outline and FREE illustrated Booklet "Your Future in the New World of Electronics" describing opportunities and CREI home study courses in Practical Electronic Engineering Technology.

CHECK FIELD OF GREATEST INTEREST Radar, Servo and Computer Engineering Technology Electronic Engineering Technology Broadcast (AM, FM, TV) Engineering Technology Television Engineering Technology Aeronautical Electronic Engineering Technology

Name..... Age.....

Street.....

City..... Zone..... State.....

Check: Home Study Residence School Korean Veteran

To help us answer your request intelligently, please give the following information:

Employed By.....

Type of Present Work.....

Education: Yrs. High School.....

Other.....

Electronics Experience.....

TV Service CLINIC

conducted by
ROBERT G. MIDDLETON
TELEVISION CONSULTANT

BECAUSE many readers ask what receiver faults can be responsible for various types of picture distortion, we will point out some of the main causes at this time.

Fig. 1 shows that the fine detail in a picture or test pattern is contributed by the portion of the if response curve toward the sound-carrier end. When if response slumps off in this region, the narrow portions of the vertical wedges become blurred or invisible.

On the other hand, long horizontal lines or objects in the picture are maintained by the portion of the if response curve toward the picture-carrier end. This is also shown in Fig. 1.

When the local oscillator is tuned to run the picture carrier too far down on the curve, near the base line, low video frequencies are attenuated and the reproduction of long horizontal objects in the picture becomes faulty.

Beginners sometimes forget that good picture reproduction depends upon good frequency response of the entire signal section. For example, Fig. 2 shows how different regions of the rf response curve contributed to high and low video-

frequency reproduction. Poor tuner response can cause poor picture quality.

The same considerations apply to frequency response of the video amplifier. Defective or off-value peaking coils attenuate or eliminate reproduction of the high video frequencies. Off-value plate-load resistors will cause weak low-frequency reproduction when too low in value, or weak high-frequency reproduction when too high in value.

These considerations are of much greater importance in color reception. Fig. 3 shows how the chroma signal is transmitted in the higher video-frequency region of the signal channel, near the sound-carrier end. Poor response in the chroma-signal region weakens or kills the color signal.

Every modern service technician should own and use a good sweep and marker generator.

Not practical

I would like to replace a 12WP4 picture tube with a 12LP4. Is this practical?—W. H. R., Jr., Rockville, Md.

The 12WP4 has a thin neck requiring

a special yoke and associated components. A standard-sized tube does not fit into the 12WP4 assembly. Deflection power used and the B-boost voltage are also unsatisfactory for the 12WP4. Hence, we would advise against this particular conversion.

Tuner trouble

I am having difficulty with a Motorola tuner and would appreciate any hints on disassembly as I want to avoid throwing the circuits out of alignment.—J. S., Philadelphia, Pa.

Loss of alignment is unavoidable when circuit work is done on a tuner. A good rf sweep and marker generator, with scope, is essential for tuner work. Shops not equipped for rf sweep alignment work should replace such tuners

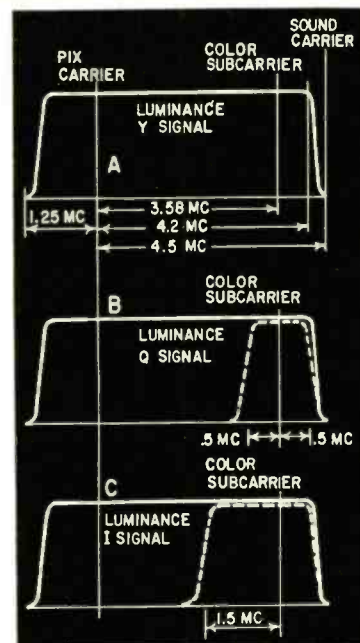

Fig. 3—The color signal occupies the high video-frequency end of the signal channel.

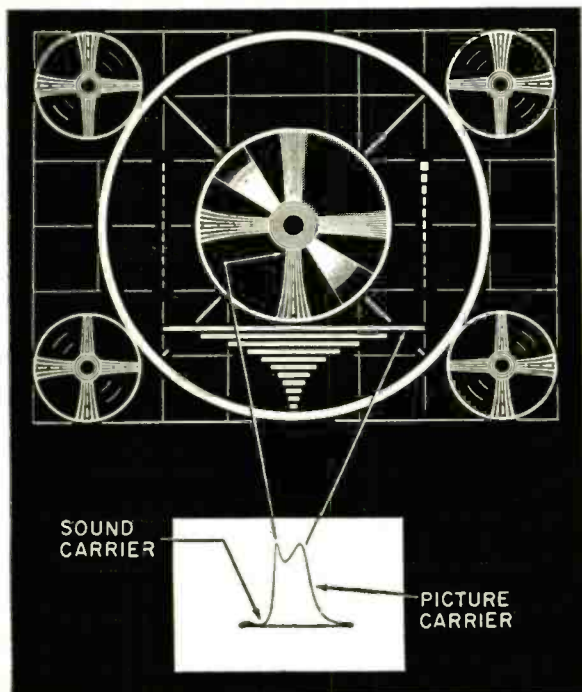

Fig. 1—Portions of a test pattern which indicate high- and low-frequency response of the if amplifier.

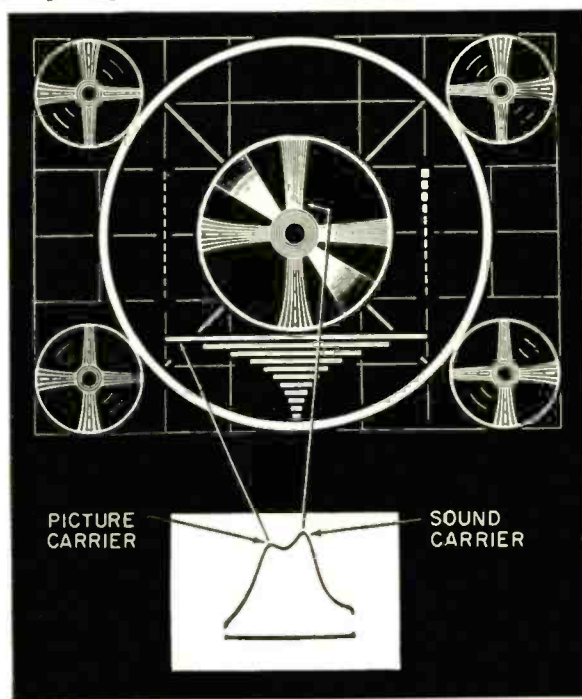

Fig. 2—Portions of a test pattern which indicate high- and low-frequency response of the rf amplifier.

CHOOSE FROM 3 TOP PERFORMING PAPER TUBULARS

DURAMIC CERAMIC-CASED TUBULARS . . .

Type P84CM paper capacitors are encased in dense steatite for performance above that of conventional paper tubulars. New thermo-setting end seals for exceptional humidity protection. Firmly imbedded leads will not work loose or pull out.



DURANITE MOLDED TUBULARS . . .

Type P88N units are molded in a blue permanent rock-hard casing that does not dry out or develop cracks or fissures. Moisture proof operation from sub-zero to 212°F.



VERTICAL MOUNTING TUBULARS . . .

Type P151N capacitors are specifically designed for use in printed-wiring chassis. Assembled in black molded phenolic casing, Aerolene impregnated, thermo-setting end fill, sturdy wire leads for firm mounting.

Ask your local Aerovox Distributor for your copy of the latest Aerovox Catalog.

AEROVOX CORPORATION

DISTRIBUTOR DIVISION

NEW BEDFORD MASSACHUSETTS

TELEVISION

or pass the job on to a shop that specializes in tuner work.

Picture pulling

A Zenith 17Z30Q operates OK on an antenna, but shows picture pulling on a signal from a cable system. Another receiver, however, operates satisfactorily on the cable signal. What do you suggest?—W. S., St. Johns, Ariz.

The first thing to try is a pair of 250- μ f capacitors in series with the receiver's antenna terminals. In case further attention is required, and if ample signal is present, also insert a 6-db H-pad at the receiver input terminals (see RADIO-ELECTRONICS, June, 1958, page 90). Also, don't forget to check the age control.

Going overseas

We are moving to Australia and have a DuMont RA-170 that we would like to use. How can this receiver be suitably converted?—B. J. N., St. Thomas, Ontario

The Australian sound frequency is 5.5 mc above the picture carrier and deviates ± 50 kc. Since 625 lines and 50 fields are used, and the channels are 7 mc wide, we would advise against this conversion. The power transformer may heat objectionably on 50 cycles, and the tuner would probably have to be reworked. You will have difficulty in obtaining satisfactory response for the 7-mc channels.

17 to 21-inch

What would you advise for converting a 17BP4 to a 21-inch tube in a Tele-King 174?—W. D. W., Brooklyn, N. Y.

The 21EP4 is the most practical conversion type in this case. No electrical changes will be required, although the second-anode voltage will be a little low. This makes ion-trap adjustment somewhat critical.

Excessive height

We have a problem of excessive height and width on a Magnavox CT358. A metal sleeve under the yoke does not give the required reduction. What would you suggest?—B. H., Hughson, Calif.

You are on the right track in placing a metal sleeve under the yoke. Try using a longer and thicker sleeve, and the desired picture size will surely be obtained. You can roll up a sheet of aluminum foil, as required.

More width needed

A tube layout for a Minerva code 92, serial 134949 chassis (stamped Regal) is enclosed. The schematic seems to be unavailable. The problem is to get more picture width. The 5U4-GT has been replaced, but width is still a bit short.—E. T. R. Co., Wallington, N. J.

You can sometimes bring the width out satisfactorily by selecting "hot" tubes for the horizontal circuit. However, this is a typical situation in which replacing the 5U4 with a pair of silicon rectifiers will give the needed picture

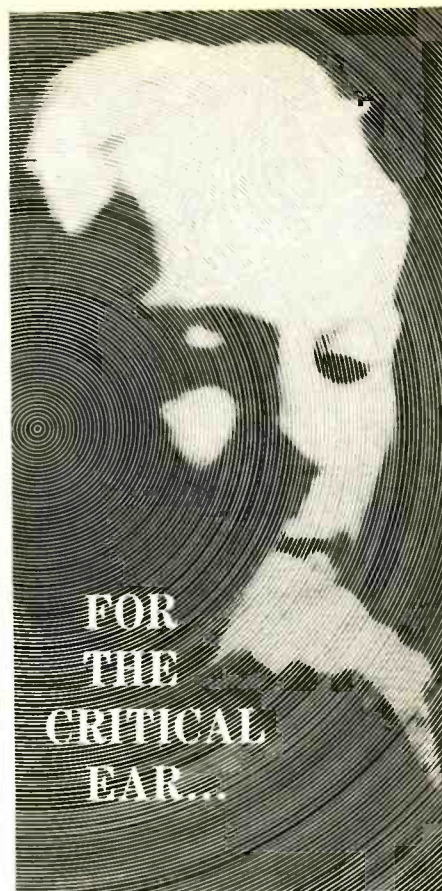

FOR
THE
CRITICAL
EAR...

the incomparable

SHURE
PROFESSIONAL

Stereo Dynamic
CARTRIDGE

The Shure Stereo Dynamic Moving-Magnet Cartridge is designed and made specifically for the listener who appreciates accuracy and honesty of sound. It separates disc stereo sound channels with incisive clarity. It is singularly smooth throughout the normally audible spectrum...and is without equal in the re-creation of clean lows, brilliant highs, and true-to-performance mid-range.



MODEL M3D

Fits 3 and 4-lead transcription type and record changer stereo arms. Completely compatible, plays monaural or stereo. 10-second stylus replacement.

Individually tested to meet or exceed these specifications: Frequency response, 20 to 15,000 cps. Output level, 5 mv at 1,000 cps. Compliance, 4.0 x 10⁻⁶cm per dyne. Channel separation, more than 20db throughout the critical stereo frequency range. Recommended tracking, 3 to 6 grams.

Note to Service Technicians: Shure Stereo-Dynamic Cartridges are made with the care and precision of fine, shockproof watches. Resist damage from impact. Sealed case prevents tampering, ends service call-backs.

Literature available: Department 12-J
SHURE BROTHERS, INC.
222 Hartrey Avenue, Evanston, Illinois

JERROLD

announces *The First* **AMPLIFIED**

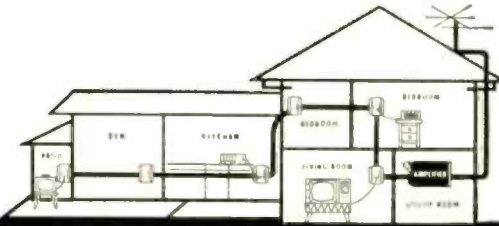

Plug-In TV-FM HOME SYSTEM



Now in Complete, Easy-To-Install Kit!

Now the world's first fully amplified home system comes in a lightweight kit that's a handsome selling tool with everything you need to bring hi fidelity TV and FM reception to every room of a home!

Each kit contains a broadband VHF (TV & FM) amplifier, sufficient 300 ohm Twin-Lead, and 5 outlets for surface or flush mounting, creating a complete system for any new or existing home.



HOME SYSTEM COMPONENTS AVAILABLE SEPARATELY. FOR COMPLETE DETAILS SEE YOUR JERROLD DISTRIBUTOR OR WRITE DEPT. PD87

JERROLD

ELECTRONICS CORPORATION

The Jerrold Building, Philadelphia 32, Pa.

Jerrold Electronics Corp., Ltd., Toronto, Canada

Export Representatives, CBS International, New York 22, N.Y.

LOOK TO JERROLD FOR AIDS TO BETTER TELEVIEWING

TELEVISION

width without tube selection. The internal resistance of a silicon rectifier is low and gives more B-plus than a 5U4.

630 conversion

Can a 24-inch picture tube be used in an RCA 630-TS?—F. Y., Miami, Fla.

We assume that the chassis now has a 10-inch tube. Conversion to a 24-inch tube such as a 24AP4 is expensive and extensive mechanical and electrical changes are required. However, the job can be done.

A more practical conversion would be to a 21-inch tube such as the 21EP4.

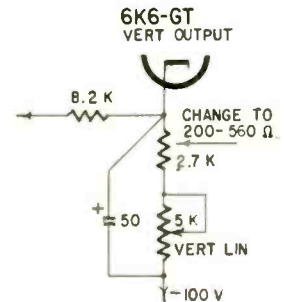

Fig. 4—Cathode resistor of the vertical output tube is reduced in value to increase picture height.

For this tube the second-anode voltage must be raised to 15,000, using a standard flyback and yoke for the 21EP4. To obtain satisfactory vertical sweep, the 2,700-ohm 6K6-GT cathode resistor must be reduced to a value between 200 and 560 ohms, determined by experiment. Some of these chassis have less than 50- μ f cathode bypass capacitance. If your chassis has less than 50 μ f, it must be increased (see Fig. 4).

Parts hard to get

We have come up against the problem of replacement parts for the high-voltage system of an Emerson 6L9A, chassis 12094A. Would it be advisable to convert to a direct-view picture tube?—W. M. I., Albuquerque, N. Y.

This is an old-type power supply of special design. Conversion is possible, but would be a losing proposition because of the extensive changes required. This is one of the occasional situations in which the customer should be frankly advised that he trade in the receiver on an up-to-date model.

Line fuse blows

An RCA 17S6022 occasionally blows the line fuse when turned on. This can be stopped by using fuse resistors, but then a buzz appears in the sound. How can the buzz be eliminated?—J. B. McD., Dallas, Tex.

The buzz occurs because the fuse resistor adds 11.2 ohms to the line, bringing the B-plus voltage down to a marginal value. The present-day trend is to install a Surgistor and use a conventional fuse. If the fuse blows after installing the Surgistor, there is an intermittent short in the power-supply system which needs localizing. The fil-

TELEVISION

ter capacitors always make a good starting point.

Wants less width

I am enclosing a schematic for an Addison TV set, no longer in production. Various circuit changes have been made. I installed a width coil, but although this reduced the width as required, the picture became nonlinear. Any assistance will be appreciated.—G. L., Quebec, Canada

Instead of adding a width coil, a simpler means of reducing width and keeping linearity is to slide an aluminum-foil sleeve under the yoke.

Loses horizontal sync

I have a Freed-Eisemann 1916-19 that loses horizontal sync for a few seconds every 10-15 minutes. The picture snaps back by itself. What would you suggest?—W. H., Astoria, N. Y.

Lack of voltage data in your report makes specific suggestions difficult. However, drift in horizontal sync can be corrected in some cases by shunting the .015- μ f capacitor in the cathode circuit of the 6AC7 horizontal oscillator control tube with a .001- μ f ceramic unit. The Gernsback Library TV *Techniques* book (No. 46) advises that the 5,000-ohm plate-load resistor in the 6K6-GT horizontal-oscillator circuit can be increased to 10,000 ohms to improve sync lock.

Hot flyback

A Crosley 380 has me stumped. Its flyback was replaced with a Thordarson 85. The flyback went out again and was replaced as before. Too much current is being drawn. Disconnecting the yoke is the only thing that brings the current back to normal. The yoke is OK. The transformer gets too hot.—H. R. W., Mendenhall, Miss.

You will probably find incorrect voltages at the horizontal output tube. You should have 138 volts dc and 9 volts peak-to-peak ac on the screen grid. If incorrect, check the screen circuit. The control grid should have -41 volts dc and 60 volts peak-to-peak ac. If not, check the adjustment of the drive control and test the coupling capacitor. It is possible, but less likely, that the high-voltage filter capacitor is leaky.

Slow warmup

The complaint is slow warmup and low brightness, with noticeable retrace lines in a Craftsman RC-101. I suspect that a new picture tube is needed. Can an aluminized tube be used for higher contrast?—D. G. H., Owatonna, Minn.

A new picture tube will undoubtedly correct this trouble, but whether an aluminized tube can be used depends upon the second-anode voltage available. Check the rated voltage for the aluminized tube you select, and make sure that this rated voltage is available. If so, you will get a definite advantage in contrast. END

NO OTHER TUBE TESTER MADE- AT ANY PRICE—can MATCH the VALUE of the CENTURY FAST-CHECK



SIZE:
H: 11 1/4"
W: 14 5/8"
D: 4 3/8"

Model FC-2—housed in rugged oak carrying case complete with CRT adapter . . . only

Guaranteed for
One Full Year
\$69.50
Net

20,000 SERVICEMEN CAN'T BE WRONG!

See for yourself—AT NO RISK—why over 20,000 servicemen selected the FAST-CHECK above all other tube testers—regardless of price. With the FAST-CHECK you will make every call pay extra dividends by merely showing your customer the actual condition and life expectancy of the tube. The extra tubes you will sell each day will pay for the FAST-CHECK in a very short time.

Special compartment accommodates line cord and Picture Tube Test Adapter

PICTURE TUBE TEST ADAPTER INCLUDED WITH FAST-CHECK

Enables you to check all picture tubes (including the new short-neck 110 degree type) for cathode emission, shorts and life expectancy . . . also to rejuvenate weak picture tubes. This feature eliminates the need of carrying extra instruments and makes the FC-2 truly an all-around tube tester.

FAST-CHECK'S low price is made possible because you are buying direct from the manufacturer.

Just 2 settings on the FAST-CHECK TUBE TESTER tests over 650 tube types completely, accurately — AND IN SECONDS!

- **POSITIVELY CANNOT BECOME OBSOLETE**
Circuitry is engineered to accommodate all future tube types as they come out. New tube listings are furnished periodically at no cost.
- **NO TIME CONSUMING MULTIPLE SWITCHING**
Only two settings are required instead of banks of switches on conventional testers.
- **NO ANNOYING ROLL CHART CHECKING**
Tube chart listing over 650 tube types is conveniently located inside FAST-CHECK cover. New tube listings are easily added without costly roll chart replacement.

COMPARE FAST-CHECK WITH OTHER TESTERS RANGING FROM \$40 TO \$200

RANGE OF OPERATION

- ✓ Checks quality of over 650 tube types, which cover more than 99% of all tubes in use today, including the newest series-string TV tubes, auto 12 plate-volt tubes, OZ4s, magic eye tubes, gas regulators, special purpose hi-fi tubes and even foreign tubes.
- ✓ Checks for inter-element shorts and leakage.
- ✓ Checks for gas content.
- ✓ Checks for life-expectancy.

IMPORTANT FEATURES

- Checks each section of multi-section tubes and if only one section is defective the tube will read "Bad" on the meter scale
- Less than 10 seconds required to test any tube
- 41 long lasting phosphor-bronze tube sockets accommodate all present and future tube types . . . cannot become obsolete
- 7-pin and 9-pin straighteners mounted on panel
- Large D'Arsonval type meter is extremely sensitive yet rugged—fully protected against accidental burn-out
- Special scale on meter for low current tubes
- New tube listings furnished periodically at no cost
- Compensation for line voltage variation.

Other testers may have some of the above features . . . but only the FAST-CHECK has them all!

SHIPPED ON APPROVAL FOR 10 DAY FREE TRIAL

Try the FC-2 before you buy it! No obligation to buy.

PAY IN SMALL MONTHLY PAYMENTS

Easy to buy if you're satisfied. Pay at net cash price . . . no financing charges.

**NO MONEY REQUIRED
WITH ORDER . . .**

CENTURY ELECTRONICS CO., INC.

Dept. 110, 111 Roosevelt Ave., Mineola, N. Y.

Rush the FAST-CHECK for a 10 day trial period. If not completely satisfied I will return the instrument within 10 days without further obligation. If fully satisfied I agree to pay the down payment within 10 days and the monthly installments as shown. No financing charges are to be added.

Model FC-2 . . . \$69.50 — Pay \$14.50 within 10 days. Balance \$11.00 monthly for 5 months.

Name

Address

City

State

F.O.B., Mineola, N.Y.

The NE-77 is about the same size as the common NE-2. Note the red dot on the anode side of its stem.

Miniature neon triode for sensitive relay circuits

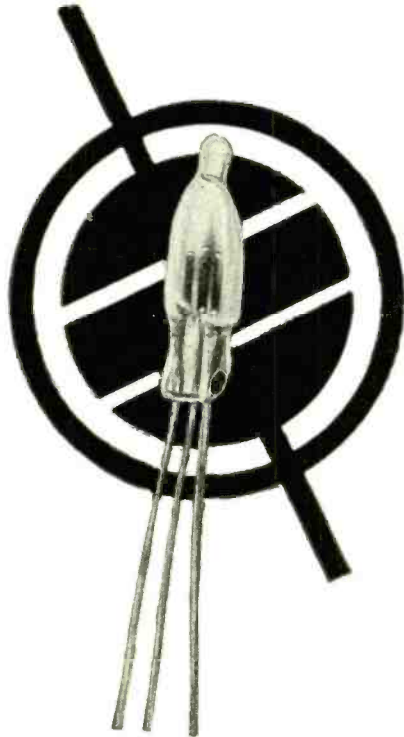

new neon bulb... acts like a THYRATRON

By TOMMY N. TYLER

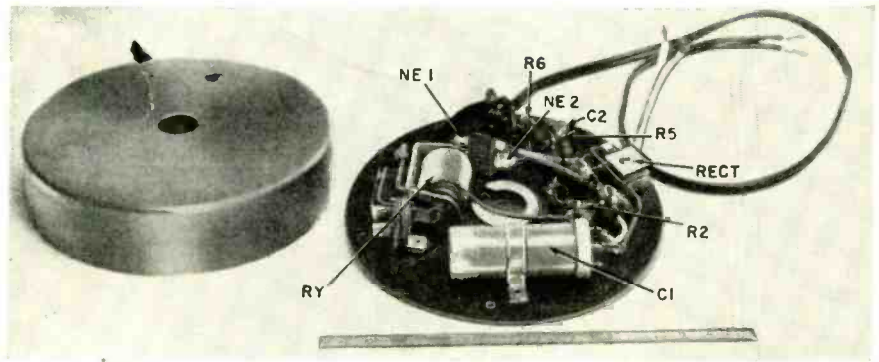

A commercial unit using the circuit shown in Fig. 6.

If you have ever wanted a simple and inexpensive circuit for actuating a relay by closing a high-impedance circuit, you will find the NE-77 miniature glow lamp worth knowing. Developed by General Electric for triggering and switching circuits, it will perform such tasks as switching appliances on and off at the touch of a hand, indicating when liquid in a tank reaches a predetermined level, and many others. Its operation is similar to that of cold-cathode thyratrons, such as the OA4 and the 5823, yet it costs only a fifth as much and takes up less room.

The NE-77 is about the same size and shape as the familiar NE-2 neon lamp, but it has *three* electrodes instead of two. Although the bulb is designed for a continuous current of 0.5 ma, short pulses as great as 100 ma or more can easily be handled. This feature makes the lamp ideal for use in circuits where a capacitor discharge actuates an im-

pulse, latching or stepping relay. When used within its ratings, the bulb will last for many thousands of operations.

The characteristics of the NE-77 are such that 140-180 volts dc, applied across the outer electrodes, is not sufficient to fire the lamp. However, if this voltage is maintained across the outer electrodes while a triggering voltage of 140 to 180 dc is applied to the center electrode, the lamp fires and continues to conduct until the circuit is broken or a reverse pulse is applied to the center electrode. A reverse pulse on the center electrode will not stop conduction. Triggering current is extremely small (80 μ a or less), which lets you use a high-impedance trigger circuit. Although the lamp gives off a bright flash when triggered in a capacitor-discharge circuit, its steady-state illumination is too feeble to serve as a good indicator lamp.

Fig. 1 is the basic circuit for using the NE-77. Note the polarity of the lamp in the circuit. Its anode lead is identified by a red dot on the side of the glass envelope. [Actually either outside electrode can be used as the anode. But once in a circuit, do not reverse the outside leads—whichever lead you use as the anode, continue to use it as the anode. Reversing these leads after using the unit will change its characteristics.—*Editor*] Applying the triggering voltage to the center electrode causes the lamp to conduct, energizing relay RY. The relay must be a sensitive type which will pull in

at 0.5 ma, and the combined resistance of R and RY must be about 170,000 ohms to limit the current to this value. This circuit is so sensitive that it can usually be triggered by merely touching the center electrode with the hand, or the triggering voltage can be tapped off the anode supply voltage and applied through switch S, as in Fig. 2. Resistor R2 in the triggering circuit can be several megohms.

Capacitor-discharge circuit

Fig. 3 shows the basic capacitor-discharge type of circuit. With this circuit a relatively insensitive relay with a coil resistance as low as 200 ohms may be used. When the lamp is not conducting, capacitor C charges to the value of the dc voltage applied across the outer electrodes. When triggered, the lamp dumps the charge on C through relay RY. Resistor R limits the continuous current through the lamp when conducting, to prevent it from being overloaded. This type of circuit does

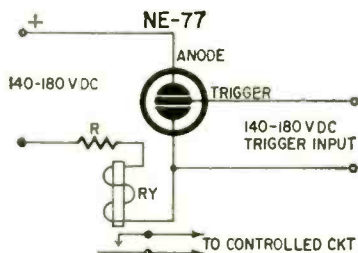

Fig. 1—Basic circuit using a NE-77. Trigger input is positive.

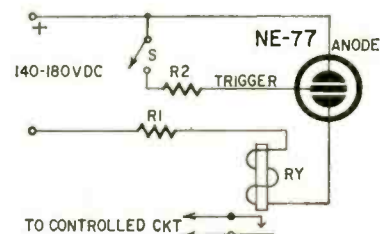

Fig. 2—Triggering pulse can be tapped off neon lamp's anode circuit.



STEREO THAT MEETS THE REAL TEST

SOUND REALISM at REALISTIC PRICES!



SPA-55 STEREO AMP

Priced for everyone's budget, here at last is a STEREO amp which is almost a must for every STEREO fan! Housing two identical 27½ watt distortion-free amplifiers the SPA-55 is unsurpassed in quality and performance. The SPA-55 may be used as a STEREO amp, a bi-amp, and as a 55 watt Monaural unit.

Wired and tested \$79.95 Easy-to-build-kit \$64.95
SPA-35 35 watt \$62.95 Easy-to-build-kit \$49.95



SP-6 STEREO CONTROL CENTER

The SP-6 is a completely self powered sensitive dual pre-amp with dual inputs and outputs. Engineered to fit your requirements today, as well as tomorrow, the SP-6 provides unparalleled flexibility. Output of both amps is individually adjusted by one control, reverse position, hi lo filters, etc.

Prices less cover— Wired and tested \$62.95
for panel mounting SAVE! Easy-to-build-kit \$39.95

ST-11 AM-FM STEREO TUNER



Here, for the first time, is an AM-FM STEREO Tuner within the reach of every audiophile. Unmatched by units costing twice the price, the ST-11 is two distinct receivers in one, featuring 4 µV. for 20 db quieting. Variable AFC. Single front panel switch controls AM, FM or STEREO selection.

Wired and tested \$74.50
SAVE! Easy-to-build-kit \$49.95



SA-25 STEREO PRE-AMP PLUS ONE 25 WATT AMP

Here is the finest dual channel pre-amp and amp on one precisely engineered and designed chassis. When the SA-25 is attached to your present power amplifier it reproduces two separate channels of sound for STEREO from tape, records, and AM-FM. One easy, inexpensive step brings you the realistic, breathtaking magic of STEREO—with Arkay's SA-25.

Wired and tested \$89.95
SAVE! Easy-to-build-kit \$59.95

HFT-7 AM-FM TUNER

World renowned as a standard of excellence, the HFT-7 is a compact self-powered AM-FM tuner of superb engineering and performance. Temperature compensated FM RF circuits and Automatic Frequency Control assures excellent stability and no drift. Foster-Seeley discriminator, Grounded Grid RF amp, Rat type construction, AFC with provisions for AFC erase.

Wired and Tested \$49.95
SAVE! Easy-to-build-kit \$32.00

All prices 5% higher west of Mississippi.

FREE!

Now at your local dealer!



FL-30 AMP AND PRE-AMP

Reasonably priced . . . superlative in quality, the FL-30 now brings to you an amp/pre-amp with fully transistorized front end designed to provide hum & distortion-free reproductions. Freq. response ± db. 10-40,000 cps @ 30 watt peak. Inputs for magnetic pickup, tuner, tape and 2 aux.

Wired and tested \$74.50
SAVE! Easy-to-build-kit \$49.95

16 page illustrated catalogue giving complete details and specifications of Radio, Hi-Fi & Stereo equipment. Write today for your free copy.

ELECTRONICS

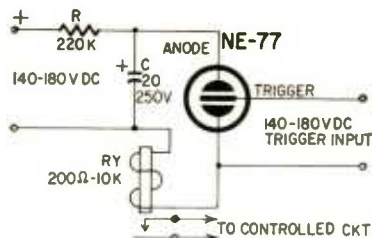

Fig. 3—Basic capacitor-discharge trigger circuit requires a 140-180-volt dc pulse to key the circuit.

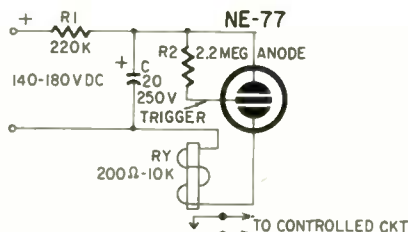

Fig. 4—Using the NE-77 as a relaxation oscillator.

have one limitation—the relay will not remain energized, restricting it to applications involving impulse type relays. If a latching or stepping relay is not available, a junkbox 28-volt dc relay can be wired to energize another slave relay which has a pair of self-holding contacts.

This circuit can also be triggered from the anode supply voltage, as described before. If the center electrode is permanently connected to the anode through a suitable resistance, as in Fig. 4, the lamp becomes a relaxation oscillator. When the lamp is not lit capacitor C charges slowly through resistor R1. When the ionization voltage is reached, the lamp fires and sends the charge on C through the relay coil. This in turn drops the anode voltage and the lamp goes out, starting another cycle. With the values shown, the relay will pulse once every 2 or 3 seconds. This circuit can be used to flash warning lights, animate displays, etc.

Fig. 5 shows a way to use the lamp for ac operation. Closing the circuit through resistor R2 applies a triggering voltage to the lamp during positive half-cycles of the ac line, energizing the relay. In this circuit the lamp performs the dual role of trigger tube and half-wave rectifier. Capacitor C1 keeps the relay from chattering. Since the lamp conducts only on positive half-cycles, opening the triggering circuit lets the lamp de-ionize on the next negative half-cycle of the ac line. This circuit also requires a sensitive relay, since the average current should be kept around 0.5 ma.

If resistor R2 is replaced by a thermistor, photocell or some other device which changes resistance appreciably with changes in pressure, temperature, humidity or other conditions, the lamp can be used to energize or de-energize the relay, depending on whether the resistance increases or decreases. The lowest value of R2 which may be inserted without triggering the lamp should be determined by experiment for

now **PHOTOFACT** makes
“duck soup” of tough
Printed Board Servicing

with

CIRCUITRACE*

*TRADE MARK

exclusive new SAMS feature eliminates costly hunting for test points . . . no more maze to trace . . . no need to flip-flop board . . . makes printed board servicing fast and easy!

here's how CircuitTrace works:

- 1 All test points are clearly shown on the schematic and each is plainly coded . . .

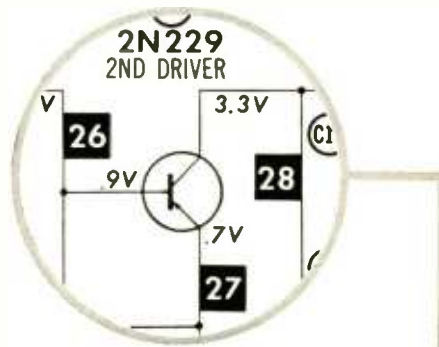

- 2 The test points are similarly coded on the printed board photo so you instantly know where to apply the test!

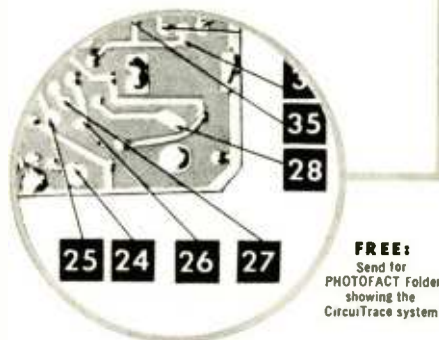

FREE:
Send for PHOTOFACT Folder showing the CircuitTrace system

Now, more than ever, you need PHOTOFACT! It's the best way to keep up with servicing trends, to maintain your leadership, to build your earning power. Be a regular monthly subscriber to PHOTOFACT. Sign up with your Distributor.

subscribe to **PHOTOFACT** today!

HOWARD W. SAMS & CO., INC.
2205 E. 46th St., Indianapolis 6, Ind.

- Send FREE Folder showing CircuitTrace
 I am interested in subscribing to PHOTOFACT

My Distributor is _____

Name _____

Address _____

City _____ Zone _____ State _____



James Melton makes his tape recordings on

irish
BRAND
ferro-sheen
recording
tape

That's not the reason why you should use

irish
BRAND
ferro-sheen
recording
tape

Here's why you should use

irish
BRAND
ferro-sheen
recording
tape:

It's the best-engineered tape in the world...

...gives you better highs... better lows... better sound all around! Saves your tape recorder, too—because the **irish** FERRO-SHEEN process results in smoother tape... tape that can't sand down your magnetic heads or shed oxide powder into your machine. Price? Same as ordinary tape!



Available wherever quality tape is sold.

ORRadio Industries, Inc., Opelika, Alabama
Export: Morhan Exporting Corp., New York, N. Y.
Canada: Atlas Radio Corp., Ltd., Toronto, Ontario

ELECTRONICS

each individual lamp, but will generally be greater than 2 megohms.

Contact relay trigger

Fig. 6 is a trigger circuit designed to go off when conductors P1 and P2 are bridged with the hand or other part of the body. In this circuit, the selenium rectifier provides half-wave rectification for charging capacitor C1. Resistors R5 and R6 are a voltage-dividing network holding the dc voltage on the triggering electrode slightly below that necessary to fire the lamp. Bridging P1 and P2 with the hand, or other high-impedance circuit, presents a triggering pulse to the lamp on the next positive half-cycle. The lamp ionizes, dumping the charge on C1 through the relay. The NE-2 lamp in series with resistor R1 provides enough voltage regulation to prevent spurious operation of the device from sudden ac line transients and to

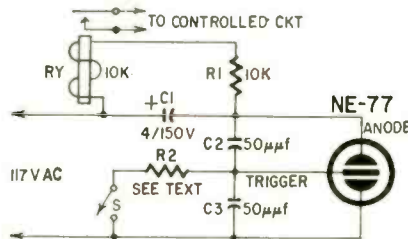

Fig. 5—This relay trigger circuit is powered by the ac line.

permit operation over a wide range of line voltages. A few seconds must be allowed between successive operations so C1 may charge to full voltage.

This circuit is independent of ac ground polarity, and contacts P1 and P2 are well isolated from the ac line by resistors R2 and R4 to eliminate shock hazard. The circuit works best with leads to P1 and P2 kept less than 4 feet long. With longer leads, some difficulty may be experienced with capacitance-to-ground effects which may cause spontaneous triggering, depending on the spacing of the leads, their configuration, etc. Reversing the line plug may help in such cases.

The circuit shown in Fig. 6 may be adapted to indicate liquid level by at-

taching contact P1 to any metallic tank and by making P2 an insulated metal contact placed at the level to be indicated. When the liquid surface touches P2, the lamp fires, closing the relay and actuating an alarm, solenoid valve, etc. Even liquids which are very poor conductors will trigger the circuit, since the contact resistance between P1 and P2 may be as high as 10 megohms or more. This is also an excellent system for highly inflammable or explosive liquids, since the current through the contacts is so small it precludes sparking.

Probably the most beneficial use of this circuit is to provide a way for persons afflicted with arthritis, paralysis or other physical disability to turn lights and appliances on and off by bringing some part of their body in contact with the two closely spaced metal plates.

A wired unit, like that shown in Fig. 6, is manufactured by the General Electric Co. (Accessory Equipment Dept., Bridgeport, Conn.), as Catalog No. ASL-211-01. This device, known as the Touchtron, was developed specifically for installation in the bases of table lamps to permit turning the lamp on and off by touching two insulated metal "touch" areas provided in the design of the lamp. The complete unit, shown in the photo, is 3/4 inches in diameter by 1 1/4 inches thick, and includes an ingenious impulse latching relay capable of switching loads up to 5 amperes at 120 volts ac. As purchased, the unit has five external leads: Two are for attaching to an ac line cord and plug. Two leads are for attaching to a lamp socket. The fifth lead and the case of the unit are the touch leads. Since the relay is wired to deliver ac line voltage when energized, the relay contacts must be rewired before the device can perform some other control function. To do so, cut away the two tubular brass rivets holding the cover on the unit. I have modified several of these units to silence TV commercials, stop tape recorders at the end of a reel and do many other odd jobs. END

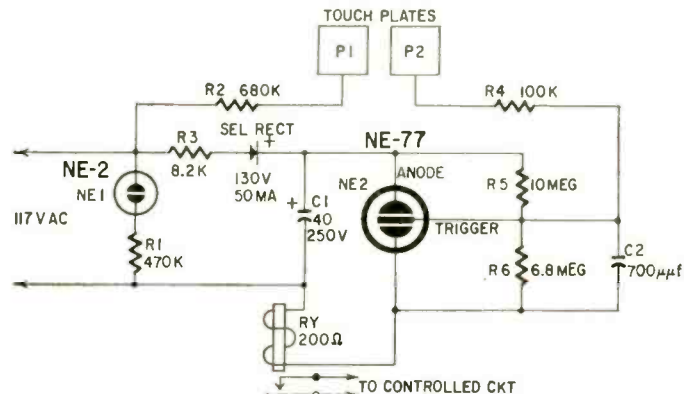

R1—470,000 ohms
R2—680,000 ohms
R3—8,200 ohms
R4—100,000 ohms
R5—10 megohms
R6—6.8 megohms

All resistors 1/2 watt, 10%

C1—40 µf, 250 volts, electrolytic
C2—700 µf
NE1—NE-2 neon lamp
NE2—NE-77 neon lamp
P1, P2—small metal touch plates
RECT—selenium, 50 ma, 130 volts
RY—200-ohm coil
Miscellaneous hardware

Fig. 6—Bridging touch plates in this circuit with hand keys the relay.

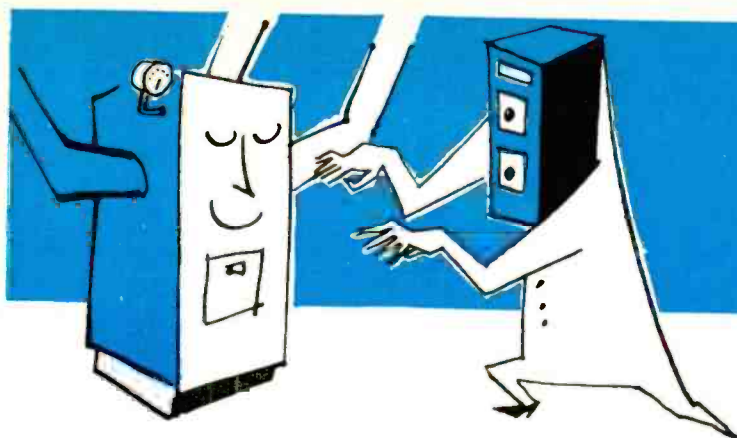

MIND READING FURNACE CONTROL

One-transistor unit anticipates the need for extra heat when outdoor temperatures start dropping, and your house stays warm

By JAMES A. McROBERTS

EVER come home with cold feet to a cold house just after dark on a winter evening? Sure, the thermostat is OK. It's working fine, as far as it goes. But it cannot anticipate a sudden change in outside temperature. The control described here does just that—it expects a demand for more heat ahead of time.

Once the two controls are set, your house will stay at a constant temperature despite changes in the weather.

And it's simple and easy to construct and operate. One knob (IN) controls inside temperature while the other (OUT) sets the differential between inner and outer temperature. The differential is the key to a warm house ahead of time! If the outer temperature goes down, the differential increases and the electronic brain tells the furnace to supply more heat.

Basic action depends on two thermistors. A thermistor is a resistor whose value changes with temperature. As a thermistor is heated, its resistance decreases; as it cools, its resistance increases. For the two units, R4 and R5, used in this device the change is roughly 2.5% per degree F, related to the nominal value at 77°.

How to use this variable resistance as an anticipator for your furnace is shown by the partial circuit in Fig. 1 and the complete schematic in Fig. 2. Essentially we control the base current of a p-n-p transistor with two thermistors—R4 outside the house and R5 inside.

Under its metal skin are the electronic mind-reading components.

As the transistor's base current, in proportion to the base voltage, increases so does its collector current. This collector current operates the sensitive relay. When the relay closes, it turns on the heat. Until base current drops and collector current along with it, the furnace stays on.

Now consider Fig. 1. An adjustment to set base current close to the normal operating point is provided by R1. With the transistor's internal resistance, paths are provided to bleed the voltage at its base to ground, the positive bus, through thermistors R4 and R5. Pot R2 is a fine adjustment for turn-on and turn-off points. In effect, it sets the inside temperature.

Continuing along the bleeder path

The outside sensor is mounted in a plastic box for protection against wind and rain.

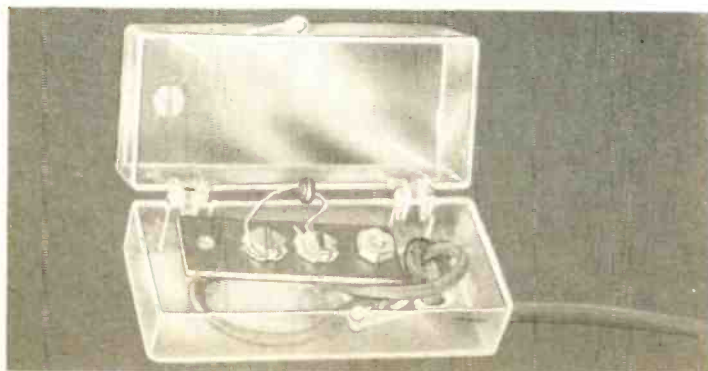
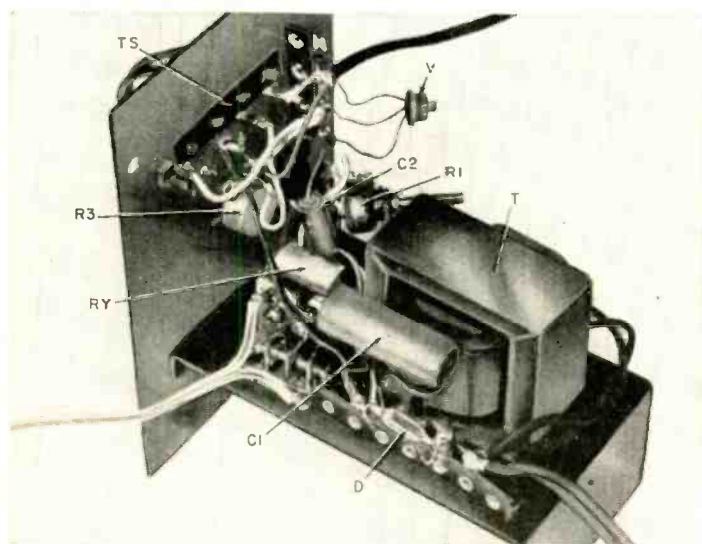
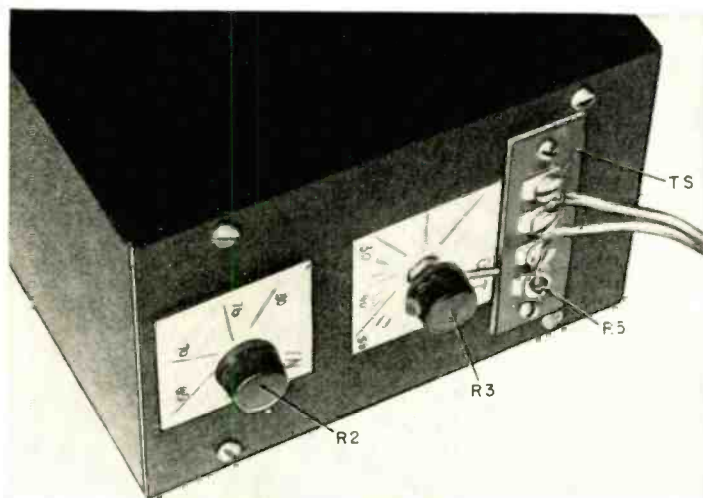

SPEED REPAIRWORK FIELD-TESTED TV SERVICE

Time saved is money saved when repairing television sets. Because of this, General Electric has developed a whole series of original tools and devices to cut your servicing time and costs. They've been exhaustively field-tested, field-proved. They add profit hours to the work week of the television technician.

Read about these ingenious aids below! See them on your next visit to your G-E tube distributor's! Only General Electric makes available this group of special service devices—each and every one a time and trouble saver. They're easy to use . . . and easy to obtain. Ask your G-E distributor how to get them! *Distributor Sales, Electronic Components Division, General Electric Company, Owensboro, Kentucky.*



TWIN-X WRENCH SET (ETR-752)—designed and built expressly for TV-radio repairwork. Replaces eight hex-head socket wrenches $\frac{3}{8}$ " to $\frac{1}{2}$ ". Sizes are clearly marked for quick selection. Hollow shafts permit wrench to grip the nut over protruding end of bolt. Chrome-plated case-hardened steel—will stand up in long, hard service.

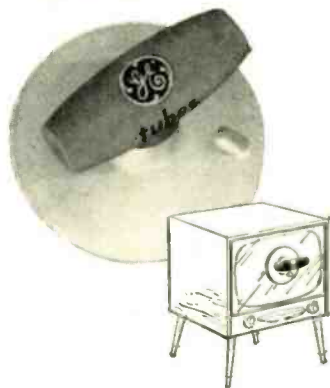

SAFETY-GLASS PULLER (ETR-1592). Now you can remove the television safety glass easily, without risk of cracking or chipping. Handle of this device controls a three-inch rubber suction cup with vacuum-release tip.



NEW TUBE-FUSE-LAMP CHECKER (ETR-981A). Only $3\frac{1}{2}$ " by $2\frac{3}{4}$ " by $1\frac{7}{8}$ ". Can easily be carried in pocket. Powered by 3 "C" flashlight batteries. Will check 7- and 9-pin miniature tubes, also lock-in and octal-base types . . . picture-tube heaters . . . all TV and radio fuses . . . all filament-type pilot lamps. A "must" for technicians.

PLUS...

New G-E Chassis-Jack (ETR-1470)

Picture-Tube Nek-Rest (ETR-1169)

Picture-Tube Pillow (ETR-1469)

All-Type Tube Puller (ETR-1094)

Service Drop Cloth (ETR-1021)

Adjustable Bench Mirror (ETR-1275)

WITH G-E AIDS!

SEE THEM ON THIS PEG-BOARD COUNTER DISPLAY!

Your G-E tube distributor features this large peg-board display of TV-service aids. Inspect them in detail! All are safety-packaged in heavy transparent plastic, which keeps them clean, protects them from scratches or other injury. Be sure to look for this display at your distributor's—be sure to study the useful service aids. You'll want them all!

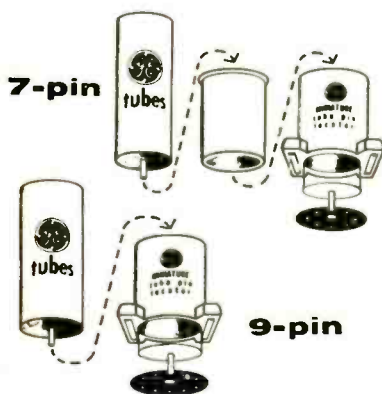

PIN-LOCATOR FOR MINIATURE TUBES (ETR-1540). Use it to place miniatures in hard-to-reach sockets. Centering plug positions the locator above pin holes. Magnets then hold locator while tube is turned till pins drop into socket.

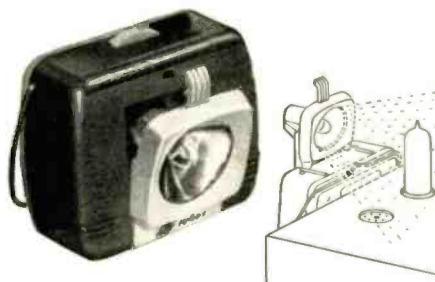

MAGNETIC SWING-BEAM SERVICE LIGHT (ETR-1593). Magnet holds the light securely to chassis of set, so that both your hands are free for work. Swing-beam design puts illumination just where you need it. A time-saving aid you'll want on every job. Small, fits easily in your service case. Strongly made, durable . . . uses standard flashlight bulb and batteries.



TRI-PLEX EXTENSION LEAD (ETR-1527). New in design. Compact for your service case, with only one lead plus adapter. Practical and easy to use. Like other G-E service aids, the Tri-Plex Extension Lead comes in a protective, reusable polyethylene container.

Progress Is Our Most Important Product

GENERAL  ELECTRIC



Now! SOLVE CIRCUIT PROBLEMS FAST!

Goodbye to trial-and-error methods. Every circuit calculation you need can now be done accurately with **THE ALGEBRA OF ELECTRONICS**



YOU'LL BE AMAZED at how easy it is to figure resistances, load inductances, impedances, etc. for ANY part of ANY electronic circuit. With this new book, **THE ALGEBRA OF ELECTRONICS**, you will quickly gain the tools, techniques and shortcuts needed.

Three Great Books in One!

First, it's a textbook. All practical mathematical techniques explained clearly step-by-step: easy to follow by those with no more math training than high-school algebra and simple differential calculus.

Second, it's a handbook. Graphs and tables answer common electronic problems for those not wishing to work out complex derivations themselves.

Third, it's a review. Every equation is discussed, along with its practical on-the-job applications. 100 problems are shown with methods and answers provided.

THE ALGEBRA OF ELECTRONICS was written by Chester H. Page, Consultant to the Director of the National Bureau of Standards. Dr. Page discusses basic laws and fundamental principles, practical methods of solving simultaneous equations. He develops elementary Fourier waveform analysis, shows effects of frequency selectivity, modulation, and analyzes tubes, transistors and power supplies.

Try It FREE for 10 Days

Whether you're a repairman, technician, or engineer, you'll find **THE ALGEBRA OF ELECTRONICS** both profitable and interesting. Send coupon for a **FREE 10-DAY EXAMINATION**. No obligation — unless you want to keep the book. Mail coupon today to

D. VAN NOSTRAND CO., INC.
Dept. 1810,
Princeton, N.J.
(Established 1848)

**127
TOPICS**

**340 Pages
252 Illustrations**

Nonlinear Resistances
Network Topology
Mesh Currents
Kirchoff's Law
Voltage Variables
Triangularization
Simultaneous Equations
Kramer's Rule
Thevenin's Theorem
Wheatstone Bridge
Conjugacy
Black-Box Variables
Image Impedances
Attenuators
Capacitance
Dielectrics
Sinusoidal Voltage
Energy Storage
Series-Tuned Circuits
Series Resonance
Complex Phasors
Mutual Inductance
Transformers
Critical Coupling
F-M Discriminator
Impedance Matching
Hyperbolic Functions
Diodes
Amplifiers
Transistors
Thermal Noise
Demodulation
—many more

**D. VAN NOSTRAND CO., Dept. 1810
PRINCETON, N.J.**

(In Canada: 25 Hollinger Rd., Toronto 16)

Send for free examination—**THE ALGEBRA OF ELECTRONICS**. If I don't feel it can make electronic calculations clearer, easier, and faster, I may return it within 10 days; owe nothing. Otherwise, I will pay \$2.75 down, plus small delivery cost, and \$3 per month for 2 months.

Name..... (Please Print Plainly)

Address.....

City..... Zone..... State.....

SAVE! Enclose \$8.75 WITH coupon and we will pay all shipping costs. Same ten-day money-back privilege.

ELECTRONICS

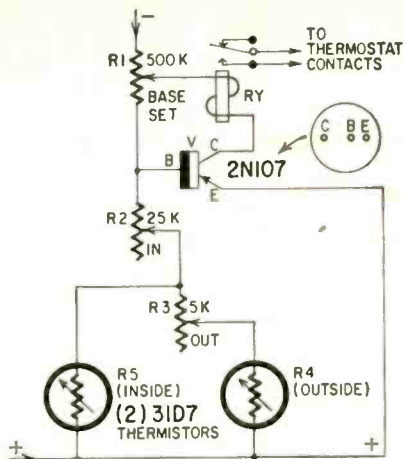

Fig. 1—Partial circuit showing the business end of the anticipator.

from the transistor base to the positive ground, the current splits into two parallel branches. One is through R4 and the outside control R3. R3 is marked OUT in the photos and diagrams. The other path is through thermistor R5.

Consider R5 first. If it gets cold, its resistance increases and both base and collector current rise due to increased voltage at the transistor's base. If it gets cold enough, collector current becomes large enough to close the relay, turning on the heat. As the furnace warms up the house and R5, just the opposite occurs, and the heat is turned off.

This part of the circuit provides simple thermostatic action. As the time the relay is closed is also dependent on the relay's pull-in and drop-out current values, the time the furnace is on is longer than the actual time resulting from thermistor action in the circuit.

A second bleeder path may be traced through R4, mounted outside the house. Decreasing outside temperature raises R4's resistance, which in turn raises the voltage at the transistor base and therefore the collector current. The relative effect of R4 on the simple thermostatic action of R5 is controlled by series resistance inserted by R3. For example, if equal resistance is added in series with R4 and thermistor R4, then changes by 10%, the series circuit changes by about 5%. With more series resistance, the effect is still less. So we have added an anticipator circuit to the thermostat.

Put one together

After mounting terminal strip TS check for possible shorts to the panel. Insulate the relay frame from the chassis. The transistor is soldered in place. Use a heat sink on its leads to prevent damage. Solder it and diode D quickly with a hot iron. Use the same thermal precautions with the leads of capacitors C1 and C2.

The outside thermistor is mounted in a plastic box. If mounted on a wood window sill, a hole through the bottom of the case allows for holding it in place with a woodscrew. A knot in the

SUPERB FOR STEREO



... and better than ever
for monaural records

new

GLASER- STEERS GS-77

the modern record changer

When it comes to the selection of a record changer to meet the exacting requirements of both modern stereo and modern high fidelity monaural records — there is only one choice, the GS-77.

From the day this modern record changer was born, strict adherence to rigid precision standards and advanced engineering made it the ideal high fidelity record changer. Now, new features have been added to make it the ideal stereo changer. An easily accessible stereo-monaural switch directs the stereo signal to the proper speaker. On monaural records, it provides a signal to both speakers adding extra depth. A double channel muting switch assures complete silence at all times except when the stereo record is being played. New GS-77 quick-change cartridge holder makes it easy to change from stereo to monaural cartridge with the turn of a knob.

Other GS-77 features assure the finest reproduction, stereo or monaural. The tone arm exhibits no resonance in the audible spectrum, and virtually eliminates tracking error. The arm counterbalance is so designed that stylus pressure between the first and tenth record in the stack does not vary beyond 0.9 gram. These characteristics virtually eliminate vertical rumble — to which stereo is sensitive. Turntable pause eliminates the grinding action which takes place where records are dropped on a moving turntable or disc — protecting the delicate stereo record grooves.

The GS-77 is the perfect record changer for stereo as it is for monaural high fidelity. \$59.50 less cartridge and base. At hi-fi dealers, or write: Glaser-Steers Corp., 20 Main St., Belleville 9, N.J., Dept. RE-10. In Canada: Alex L. Clark, Ltd., Toronto, Ontario. Export: M. Simons & Sons Co., Inc., N.Y.C.

ELECTRONICS

power-line type cable prevents strain on the leads. After mounting, close the box. This prevents sudden drafts and rain from unduly influencing R4's action. Drill a small hole in the lowermost part of the plastic case to vent any condensed moisture. About 1/8 inch is large enough.

Ground the positive side of the power supply. This prevents undue static charges from building up. Lead length to the outside thermistor may be as much as 1,000 feet since this is a low-impedance line.

Operation and calibration

After the unit has been assembled and wired, give it a bench check. Final installation and operation will be similar. Connect the outside thermistor to terminals 1 and 2 of TS and the inside thermistor to terminals 3 and 4. Turn the BASE SET control so all its resistance is in the circuit. Plug in the power supply and measure voltage. About 18 to 20 volts is OK—it will vary slightly due to tolerances of C1 and D.

Now, measure the voltage across RY's coil. Very little should be read. About 2 volts is right for a maximum.

Leaving the meter across the relay coil, reduce the resistance of R1. Watch the voltmeter. It should rise to nearly the supply voltage (17-19 now). Do not go beyond the point where the voltage stops rising or base current will be drawn and the transistor will be damaged or destroyed. If you wish, add a 47,000-ohm safety resistor in series with R1.

During this collector current variation test the relay should click in at about 10 or 11 volts. As the BASE SET pot is turned back again the relay should click out at about 6 or 7 volts.

Set the outside temperature control R3 for zero resistance. Adjust the BASE SET for a meter reading of about 5.5 volts. Touch the inside thermistor (R5) with your fingers. The meter should show a decrease in voltage. Allow meter indication to return to near normal again. Touch the outside thermistor. A similar action should be observed—a meter reading decrease.

Now set R3 so about half its resist-

ance is cut into the circuit. Touch R5 again. The change should be far less pronounced than when pot R3 was set for zero resistance.

The foregoing tests indicate correct circuit operation. Now adjust the relay. The factory adjustment provides too great a range. Screw in the normally closed contact until there is little mechanical play between opening and closing. Make a BASE SET check again. The relay should now pull in at about 7 volts and drop out at around 6 or 6.5 volts. A difference of about 1 volt between drop-out and pull-in points (voltage across coil points) is what we want. The relay spring tension may have to be adjusted to secure this range.

Installation

Place the outside thermistor, mounted in its case where it will not be affected by the sun. If necessary use a shade. A piece of sheet aluminum, iron or plastic on a bracket will serve quite well.

The control unit should be calibrated in turn-off values for the inside unit (setting of R2). Outside control R3 should be calibrated for a range of outside temperatures. Here one need not be exact, but just make a setting for some desired comfortable differential that you want maintained. It will function automatically thereafter. The differential setting is adjusted so that R5's action (inside thermistor) is normal during the afternoon. (Devote a Sunday afternoon to this.) Then the device will function well at night.

For night duty during sleeping hours a lower temperature may be wanted. If so, just set R2, INSIDE, to a lower turn-on and turn-off point. There is no need to reset outside control R3 for this service. If desired, a fixed resistor may be used in series with R2. Shunt this resistor with a switch. This gives you a night and a day position—the day position with the switch shorting out the added resistor. Value of the resistor is determined by measuring the amount of resistance cut in by R2 for a change from day to night service.

Now just relax and let your mind reading furnace control do the job! END

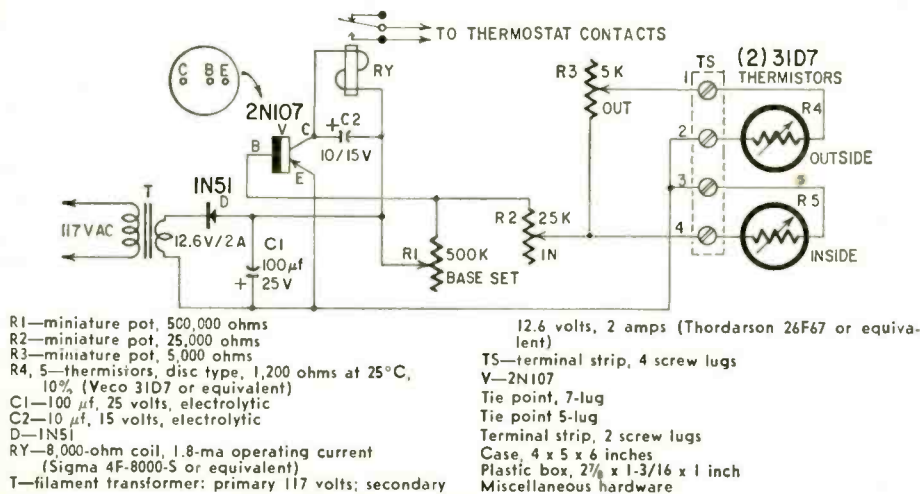
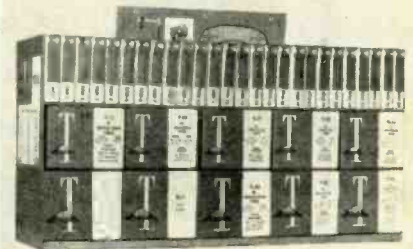

Fig. 2—The complete control circuit.



Solve majority of deflection problems



- 8 POPULAR YOKES
- 25 NETWORK KITS
- 2 ACCESSORIES
- PACKAGED IN ALL STEEL CABINET

Most of your deflection problems as well as your yoke stocking problems are solved with the new Triad Yoke Pack. With this equipment, the solutions to more than 4000 yoke testing and replacement problems will be available to the professional service man. The Yoke Pack comes attractively arranged in a handsome steel cabinet—and attractively priced, too. For further information on Triad's Yoke Pack as well as the latest information on yoke servicing, request a copy of the Professional Television Man's Service Aid #3 from your distributor or write direct to:

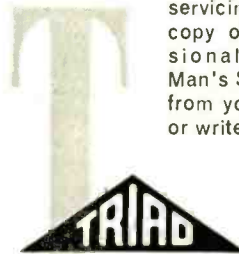

TRIAD TRANSFORMER CORPORATION
 4055 REDWOOD AVE. | 812 E. STATE STREET
 VENICE, CALIFORNIA | HUNTINGTON, INDIANA
 A SUBSIDIARY OF LITTON INDUSTRIES

"Silver runs in veins,
GOLD is where you find it."

THE GOLD RUSH

to PYRAMID'S new "Gold Standard"
Capacitor, $\pm 10\%$ Tolerance, is on!

For the first time in the radio and TV replacement market, Pyramid offers the Service Technician for his everyday use, a new high reliability capacitor with a critical tolerance factor of ± 10 , featuring non-hygroscopic Mylar[®] dielectric. This construction additionally, provides extreme high resistance to moisture plus high insulation resistance.

The Pyramid "Gold Standard" Mylar capacitor absolutely guarantees the reliability that makes other types of by-pass and coupling capacitors obsolete.

Now at a price competitive with paper capacitors currently in use, Pyramid's new "Gold Standard" Mylar capacitor is available in (1) standard capacity values (2) standard voltage ratings (3) standard capacity tolerance of $\pm 10\%$, formerly available only on special orders at premium prices.

PYRAMID



The Gold Rush is on at your
Pyramid distributor or for information,
write to "Gold Standard" Assayers Office,
Pyramid Electric Company, North Bergen, N. J.

The Old-Timer Diversifies

He finds that industrial types of electronic equipment can pack a wallop, both in high voltage and income

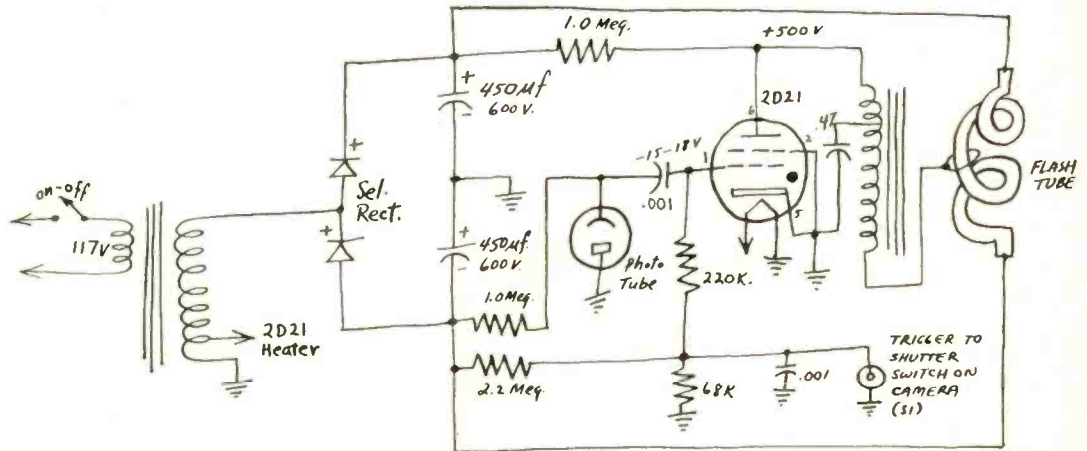

This photoflash unit almost had a mileage charge added to its repair bill.

By JACK DARR

THERE was a peculiar sound from the shop. It seemed to be composed of equal parts of a very loud "oof!", a crash, a thump, a clatter and a tinkle of breaking glass. Added to this was an overtone like the vicious snap of a large arc. The Young Ham raced up the hall from the Ham Club to see what had happened. He yanked open the shop door and gasped. The Old-Timer sat on the floor at the far side of the shop, his long legs entangled in the bench stool. His cap was over his eyes and the stand mirror used for watching TV sets was wrapped around his neck. Fragments of the broken mirror covered the floor, accounting for the tinkling sound.

"Hey! Are you hurt?" asked the Young Ham anxiously.

The Old-Timer pushed his cap up over his forehead, took a deep breath and opened his eyes. His lips tightened and he shook his head sadly from side to side. He heaved a deep sigh.

"No, Junior, I ain't hurt," he said wearily. "Permanently, that is. Shocked, yes. Stupid, yes. Careless, yes. Mortified, yes. But, thanks to the kind Providence that takes care of drunks and danged fools, I ain't hurt!" His voice rose to a roar and the Young Ham jumped back in pretended alarm.

"You can't be or you wouldn't be able to beller like that," he agreed. "What in the world happened?"

The Old-Timer got to his feet painfully, shaking off the remains of the mirror and disentangling himself from the stool. He righted it and sat down, wincing as it contacted an evidently somewhat tender portion of his anatomy. "Well," he answered, "I was diversifyin'."

"Hah?" said the young Ham. "I'm not reading you, Dad."

"Diversifyin'," repeated the Old-

Timer, picking another piece of glass from his shirt front. "You hear about it all the time; these wise guys in th' magazines tellin' us that we oughta diversify—branch out into other kinds of electronics work besides radio and TV. That's what I was doin'. See this?" and he indicated a medium-sized gray box on the bench, with some obviously electronic apparatus inside. "This is an electronic photoflash unit, from Miss Golden's studio. See these cute little capacitors here," pointing at two very large electrolytics, bolted to the sides of the case, "450 mikes at 600 volts? Lemme tell you this, one of them is sure good! I oughta know—it just diversified me all the way across the shop just now! I know *one* thing about this dang machine. Whatever else may be wrong with it, it ain't that capacitor! That one's good, for sure!"

"Yes, it seemed to get pretty good distance," agreed the Young Ham, grinning now that the crisis seemed to have passed. "It must be good, to throw that much lead that far!" and he ducked.

Coffee time

"One more crack like that and you'll pay for your own coffee!" growled the Old-Timer, seizing the boy by the back of his crew-cut neck and leading him out the door. "Let's go gitta cup while my arm and shoulder quits tingling." The two made their familiar dash out the back door, through the drugstore and across to the coffee shop which they referred to as the Main Office, claiming that they did more business there than at the shop. Settled at a table, with the inevitable rude remarks about the strength of the coffee and thickness of the "cream" disposed of, the Young Ham asked, "How does that thing work? I mean, what's it good for,

besides knocking you across the shop?"

"Would make a good burglar alarm or electric fence or something like that, wouldn't it?" agreed the Old-Timer. "Main purpose, though, is to make flashes for takin' pictures. D'ja see that little curly tube in the reflector, there?"

"Yes," answered the Young Ham. "The one with the frosted glass over it?"

"That's a gas tube, just like a neon sign," explained the Old-Timer. "Frosted glass over it kinda diffuses the light. Gas in there makes it flash a bright white, instead of red, blue and so forth. Flash only lasts for a few milliseconds or maybe it's microseconds, but it's awful bright while it does last. Thing's good for lots of shots. Heard somewhere that the tube's good for 10,000 flashes or something like that."

"How's it fired?" asked the Young Ham.

"Well, it's flashed by a momentary pulse of current," answered the Old-Timer, reaching for the inevitable paper napkin and his ballpoint pen. "See here?" and he drew a sketch of the circuit (see diagram). "This transformer here feeds a center-tapped rectifier. Hot lead from the transformer goes to the center tap on the rectifier. Rectifier's got a flock of plates to enable it to stand the high voltage. Something like 400 volts, I think."

"You ought to know," grinned the Young Ham.

"I do, I do!" said the Old-Timer, rubbing his arm. "Anyhow, the center point of these capacitors is grounded. Now, the flash tube is connected across the two capacitors *in series*. So if they're charged up to about 400 volts apiece, you've got 800 volts across the two of 'em . . . and shut up. I know what you were goin' to say. So the capacitors charge up, fire the tube and

It pays to SPECIALIZE!

Let these Rinehart how-to-do-it books train you for good pay in specialized fields

These famous Rinehart books are complete, easy to understand, fully authentic. Start your training with them at home today for more interesting work and bigger pay.

HOW TO GET THE MOST OUT OF HIGH FIDELITY



1

HIGH FIDELITY TECHNIQUES by John H. Newitt is a 494-page guide for hobbyists, servicemen and custom builders. Shows how to get better hi-fi results at less cost; how to service hi-fi; compares different techniques and methods and is crammed full of construction tips and ideas. 203 illustrations. Price \$7.50.

Get top notch hi-fi results . . . at minimum cost!

BE AN EXPERT ON MAGNETIC RECORDING



2

MAGNETIC RECORDING by S. J. Begun covers every phase of wire and tape recording equipment, components, measurements and application—from high fidelity work to broadcasting, from movies to industrial installations, secret communications and all the rest. 146 illustrations help make every step absolutely clear. Price \$5.00.

REPAIR ANY HOME ELECTRICAL APPLIANCE



3

This 370-page Rinehart **ELECTRICAL APPLIANCE SERVICE MANUAL** brings you complete, easy repair instructions for practically every appliance used in modern homes. Even includes appliance refinishing methods. Gives you the "know how" to add a profitable sideline to your radio-TV service . . . or to build a full-time appliance repair business. Price \$5.00.

LEARN TO FIX OR REWIND ANY ELECTRIC MOTOR



4

Train for something really different! This giant 560-page **ELECTRIC MOTOR REPAIR** guide opens a fascinating big pay field, even to beginners. Covers all repairs PLUS complete rewinding of practically every AC or DC motor or generator . . . also motor controls. Approved by instructors, repair specialists and unions. Price \$6.95.

Over 100,000 copies in use!

LEARN TO USE INSTRUMENTS BETTER AND FASTER!



5

BASIC ELECTRONIC TEST INSTRUMENTS helps you work better and faster on service jobs. Shows how to put old instruments to new uses; teaches you to interpret readings, etc. A complete, fully understandable instrument training course. Explains over 60 instruments including the latest types . . . outlines work-saving shortcuts. 254 pages. Price \$4.95.

STUDY 10 DAYS FREE!

Dept. RE-108, RINEHART & CO., Inc., 232 Madison Ave., New York 16, N. Y.

Send following book or books for 10-DAY FREE EXAMINATION. (Circle the books you want):

1 2 3 4 5

In 10 days, I will either remit price indicated above for each book (plus postage) or return book to you and owe nothing. (SAVE! Send cash with order and we pay postage. Same 10 day return privilege with money refunded.)

Name.....

Address.....

City, Zone, State.....

OUTSIDE U.S.A.—Add \$06 for each book to cover handling. Cash with order. Money refunded if you return books in 10 days.

ELECTRONICS

then recharge again. This is controlled by this thyatron, the 2D21 here. There's an autotransformer in its plate circuit. The 0.47-mike capacitor here keeps it from shortin' out the voltage.

"When the grid voltage is lowered by shorting the trigger switch in the camera, the thyatron fires, and the pulse set up in the autotransformer fires the tube through this control-element hootenanny I've got looped around the middle of the flash tube. To tell the truth, I'm just a wee bit hazy about how those tubes work, but this dingus here seems to put an electrostatic field around the tube that makes it fire when the thyatron sends a pulse through it. I've gotta look that up one of these days, to see just how it does work."

About the photocell

"Didn't I see a phototube sticking up out of the top of that thing?" asked the Young Ham.

"Yep," replied the Old - Timer. "You're very observant. That's also connected into the thyatron grid circuit" and he added it to the diagram. You can fire the tube by closing switch S1, which is the shutter switch in the camera itself, or by getting enough light on the photocell. That way, you can use two or more of these units at once. When you trigger one of 'em, the rest go off, too. That way, it's a 'slave' unit and—"

"I know what a slave is," said the Young Ham. "It's like you do me and—"

"Never mind!" growled the Old-Timer. "No snotty remarks about your salary! I'd pay you what you were worth, but I'd hate to see you starve! Anyhow, as I was sayin' before I was so rudely interrupted, any number of slave units can be fired at once by just firin' one of 'em from the camera itself. That way, the photographer can set up two or three lights to cover all sides of the subject and have them all go off at once."

"I see," said the Young Ham, thoughtfully sipping his coffee as he studied the sketch. "So, to fix these things, all you've gotta do is check up on the voltages and stuff. Actually, they're fairly simple, aren't they?"

"Why, sure," agreed the Old-Timer. "Most of this kind of stuff is, after you've got it figured out. T'ain't near as

complicated as the sync-clipper section of a TV set! All you need to do is set down, figure out what the thing is supposed to do, then check it to see just how they went about doin' it and there you are! Just like this here. What's he doin' there? Generatin' a high-voltage pulse. How? Discharging a pair of capacitors through a stepup transformer. How is it controlled? By a thyatron. What fires the thyatron? Either an ordinary switch or the photocell. There you is. Simple, ain't it?"

"Yeah, simple," agreed the Young Ham. "What was the trouble with that one?"

"Fired all the time," replied the Old-Timer. "Soon as the voltage built up, bingo, away she went. Wouldn't stop. Tough job. Had a leaky coupling capacitor in the thyatron grid. Wouldn't let it build up enough grid voltage to shut the tube off. Soon as the capacitors charged, the leakage voltage fired the thyatron again."

"That sounds pretty simple at that," said the Young Ham. "Have we got any diagrams of this kind of stuff?"

"You're joking, of course," said the Old-Timer. "Only way to get a diagram of this kind of material is to draw 'em up yourself as you go along. Best thing to do when you run into a strange piece of apparatus is take the time to draw up a schematic of it. Trace the circuits out and draw 'em up. Then, you can see what you're doin'."

"Looks like they'd send the schematics out with these things," observed the Young Ham. "Sure would make 'em easier to service."

"Boy, wouldn't it!" agreed the Old-Timer, getting up and fumbling for change. "I sometimes think that people don't care whether we fix the stuff they make or not! It's awful hard to get any information about 'em." He paid for the coffee and they ambled back across the street to the shop. Once back there, the Old-Timer reassembled the photo-flash unit while the Young Ham unwillingly swept up the fragments of glass, grumbling under his breath as he did so. The Old-Timer ignored him, as usual, while tightening the screws in the case. Plugging it in, he tested it for flash action. Wrapping up the line cord, he gathered it up. While making out the job ticket, he laughed. "Oughta charge her mileage on this job, by golly."



"Our Magic Armchair Control turns off 4B's set, too!"

Adapted from

**NEW
COMPLETE**

**DIRECT
VIEWING**







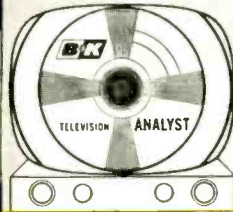
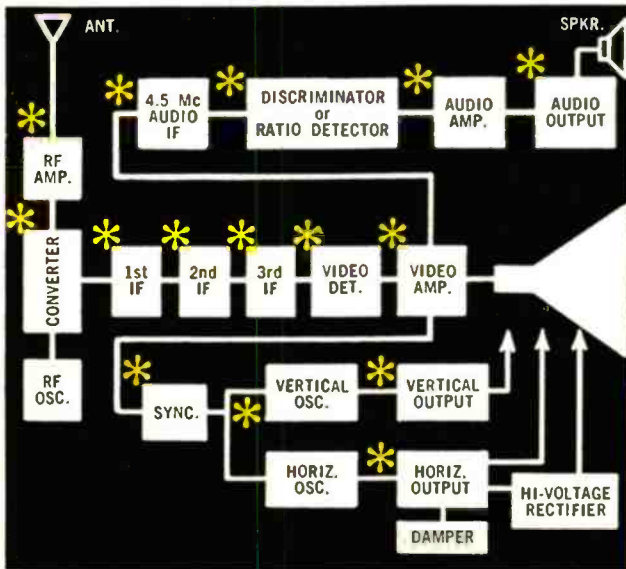

TELEVISION ANALYST

**test each stage
SEPARATELY**

and watch the
← result on the
TV set itself



**UNIQUE NEW SIGNAL-INJECTION TECHNIQUE
Saves TV Trouble-Shooting Time and Work**

-  **R.F.** Supplies complete r.f. and i.f. signals with video and audio modulation to quickly trouble-shoot each stage in each of the sections of the TV receiver. Enables you to check the r.f. sensitivity and AGC settings of TV receivers.
-  **I.F.** Reproduces a complete test pattern on the screen of the TV picture tube and injects signals into each video stage of the TV receiver for fast, visual trouble-shooting and correction—anywhere, anytime. Makes it easy to check bandwidth, resolution, shading and contrast capabilities of the TV set.
-  **VIDEO** Provides composite signal, sync positive and negative.
-  **SYNC** Provides separate vertical and horizontal driving pulses for trouble-shooting deflection circuits.
-  **SWEEP CIRCUIT DRIVING PULSES** Test signal injection also aids in locating intermittent troubles.
-  **INTERMITTENTS** Provides a 4.5 mc sound channel, FM modulated with approximately 25 kc deviation. (This audio carrier is modulated either from a built-in 400 cycle tone generator, or from your own external audio source.) Injection of the 400 cycle tone signal simplifies trouble-shooting of the audio section.
-  **AUDIO** Enables you to trouble-shoot and signal trace color circuits in color TV sets. Generates white dot and crosshatch patterns on the TV screen for color TV convergence adjustments. Generates full color rainbow pattern of orange, red, magenta, blue, cyan, green to test color sync circuits, check range of hue control, align color demodulators, etc.
-  **COLOR** Enables you to check and adjust the vertical and horizontal linearity, size and aspect ratio of television receivers.
-  **SET ADJUSTMENT**



**MODEL
1075**



QUICK, DIRECT, COMPLETE TV TROUBLE-SHOOTING

Now, by point-to-point signal injection and test pattern reproduction, you can easily trouble-shoot and signal trace *any stage throughout the video, audio and sweep sections of black & white and color TV receivers.* With the remarkable new Model 1075 B&K TELEVISION ANALYST, you can quickly isolate and diagnose TV troubles (including intermittents). By use of the generated test pattern, you can *actually see* the condition directly on the picture tube of the television set itself. No external scope is needed. The TELEVISION ANALYST is practically a *complete TV service shop in one instrument!* Net, \$259⁹⁵



See your B&K Distributor or write for Bulletin AP12-E

B & K MANUFACTURING CO.
3726 N. Southport Ave. • Chicago 13, Illinois

Canada: Atlas Radio Corp., 50 Wingold, Toronto 10, Ont.

Export: Empire Exporters, 458 Broadway, New York 13, U.S.A.

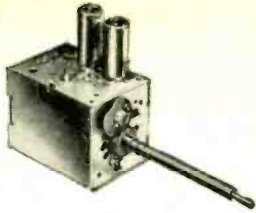

**Now YOU can get
TUNERS
repaired, or replaced,
in a hurry!
Send them to TARZIAN!**

● Sarkes Tarzian, Inc., announces a new tuner repair service and factory replacement program for Tarzian-manufactured tuners. Distributors, dealers and servicemen will welcome this direct factory service program which is designed to take delay and confusion out of the tuner repair business.

We're set up to offer a 48 hour service from the date of receipt to shipment to you.

Cost is reasonable, too. Only \$7.50 per unit (\$15 for UV combinations) and that includes ALL replacement parts! Both repaired—or exchange units if available from stock—carry a 90 day warranty against defective workmanship and part failure.

Replacements will be offered at these current prices* on units not repairable:

- VHF 12 position tuner... \$17.50
- VHF 13 or 16 position tuner..... 19.50
- VHF/UHF combination. 25.00
- UHF only..... 15.50

*Subject to change

When inquiring about tuner service, always refer to tuner by part number. When inquiring about direct replacements for tuners other than Sarkes Tarzian-manufactured, please indicate tube complement, shaft length, filament voltage, series or shunt heater. Use this address for quickest service:

SARKES TARZIAN, Inc.

Attn: Service Mgr., Tuner Division
East Hillside Drive
Bloomington, Indiana



TARZIAN Electronic Product and Services include TELEVISION TUNERS . . . SELENIUM AND SILICON RECTIFIERS . . . BROADCAST EQUIPMENT . . . AIR TRIMMERS . . . TV STATIONS WTTV and WPTA, and RADIO STATION WTTs.

ELECTRONICS

Took me quite a while to git back from where it knocked me!" Filing the card, he put on his cap. "Junior, there's a couple of little radios out there on the counter. Clean 'em up while I'm gone, willya?" and he lugged the flash out to the truck.

Off to Doc Wood

When he returned, the Young Ham met him at the back door. "Don't even get out of the truck!" he yelled. "Doc Wood's nurse just called, all in a flap. Wants you down there, right away!"

"All right already," said the Old-Timer, starting the engine again, as the Young Ham scrambled in. "What's the big panic?"

"I don't know," said the Young Ham. "She just said get down there as quick as you could."

The Old-Timer backed out again and drove down the street to the doctor's office, a small brick building on the lower end of the main street. As he went in, a plump, starched nurse met him, grabbed him by the arm and marched him down the hall to a small treatment room. "There!" she said, pointing to a white enameled cabinet, with a long arm atop it, ending in a bowl-shaped reflector. "It just popped and blew a fuse and there was a terrible smell, and now it won't come on. It won't heat up at all."

The Old-Timer examined the machine. Plugging it in, he turned it on. A green light lit up on the panel. "You have to wait 3 minutes for some reason or other, for the rest of it to come on," explained the nurse. "That red light will light when it's ready to go."

"Yes, ma'am," said the Old-Timer, patiently. "This has a time-delay relay in it. Won't let the power come on until the main tube has a chance to warm up. You say it smelled? Like burned varnish or something? Did you replace the fuse?"

"Yes," said the nurse. "Then it would light up, but it wouldn't work. I never could get the meter to read afterward."

"Well, let's see," said the Old-Timer, opening a door in the front of the cabinet and sticking his head inside. He sniffed. "Phew! Smells like you've blown something!" He crawled out. The red light had come on and he turned the timer up a few notches, flipping the remaining switch on. The meter remained stationary. He held his hand under the bowl-shaped unit. "Hmm. No heat. Well," and he grinned at the nurse, "looks like we'll have to operate. Patient'll have to be taken to the hospital!" He crawled back inside the cabinet and removed the mounting bolts. Lifting the heavy machine up from the cabinet, he lugged it out to the truck, where he placed it carefully on a folded pad in the back. He said to the worried nurse, who had followed them out, "We'll get it back just as soon as we can. I'll check it soon's I get to the shop and let you know if it's anything serious."

Reaching the shop, he lugged it in

DYNAKIT
STEREO or MONOPHONIC
Provides Complete Flexibility
and Control at Lowest Cost

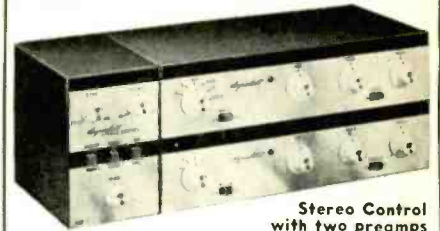

Stereo Control with two preamps

The Dynakit
PREAMPLIFIER KIT

- ★ Finest Quality Available
- ★ Lowest Distortion and Noise
- ★ Easiest Assembly Using Pre-Assembled Printed Circuit
- ★ Handsome Styling — Selected For Display at Brussels World's Fair
- ★ Only \$34.95* net

The Dynakit
STEREO CONTROL KIT

- ★ Adds Complete Stereo Control To Two Preamps Without Noise or Distortion
- ★ Unique Blend Control Fills In "Hole In Middle"
- ★ Level, Balance, Loudness, Channel Reverse, and Dual Tape Monitor Controls
- ★ Only \$12.95* Net

Power Supply available for 2 Preamplifiers
PS-1 Kit \$8.95* net price



*Slightly higher in the West

Literature available on request

DYNACO INC.

Dept. RE 617 N. 41st St., Phila. 4, Pa.
Export Division: 25 Warren St., New York, N.Y.

ELECTRONICS

and set it up on the bench. Inside the unit were several large transformers, two large capacitors, two medium-sized tubes with top caps, and a peculiar-looking object from which a large metal pipe led into the end of the jointed arm, terminating in the bowl.

The Young Ham could contain his curiosity no longer. "All right," he burst out, "now tell me what that is?"

The Old-Timer grinned. "Why anybody should recognize this," he said, with a twinkle in his eye. "It's a super-electronic radar type hootenanny, with a thermal overtone filter and a parabolic reflector."

The Young Ham snarled at him, and the Old-Timer relented.

"All right, this is a diathermy machine. See the bowl-shaped dingus? That's the radiating element."

"Oh, it lights up in there, just like a heat lamp?"

That's an antenna

"Well, not exactly," and the Old-Timer laughed. "I'll admit I waited around for a while for it to light up first time I worked on it, but it didn't. No, sir, sonny, that's an antenna, believe it or not. Told you it was a radar type hootenanny, didn't I?"

"Hello, antenna!" said the Young Ham. "You're kidding me!"

"Nary a bit," denied the Old-Timer. "Here, look." He slipped the frosted plastic cover from the bowl. Inside was a very small inverted cone, about an inch in diameter, at the "bottom" of the bowl. "There's the radiator itself and the bowl's a parabolic reflector. This big fat cable here going up to it is just a plain old coax. In fact, I thought it was a waveguide, but I think it's a solid-dielectric coax. This gizmo here," indicating the lumpy object connected to the end of the coaxial cable inside the apparatus, "is a magnetron. This thing is just like the old diathermy machines, but instead of working on the 24-mc band or so, where it fouled up all the TV sets for miles around, it works up somewhere in the kilomegacycle region. Don't know exactly where, but she's away up there. Maybe that's why they call it a Microtherm. Way it heats, it beams an rf field at the affected part. Gets hot way down inside because of your body's rf resistance." He hooked up the unit and turned it on, watching the wattmeter carefully. It read about 60 watts and he relaxed while the timer ran up.

"Well, Hooty-tooty!" marveled the Young Ham. "A microwave transmitter! If we only had another one, we could really set up a keen microwave link to somewhere!"

"Yep," laughed the Old-Timer. "That's just exactly what this town needs, a good ham microwave link to somewhere! There, the dang timer's finally run down. Now we can see what's going on. Let's see what she says." Picking up a pair of test leads, he hooked up a vtvm, choosing the 5,000-

when your reputation depends on

PUBLIC ADDRESS QUALITY

install these fine

American MICROPHONES

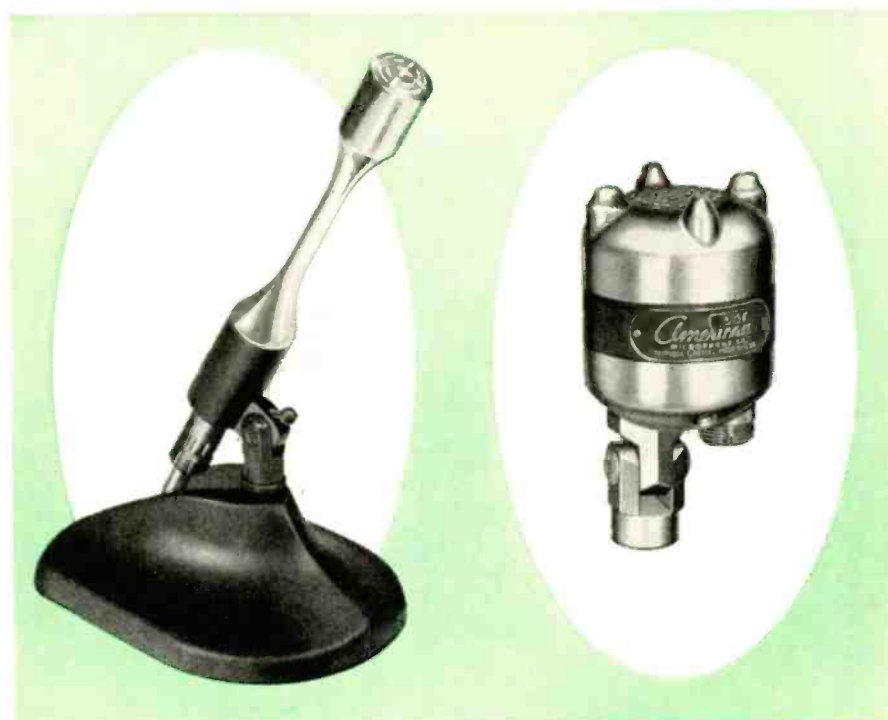

D22 *The Perfect Choice* D4 *Series Microphones*

FOR PRESTIGE INSTALLATIONS

CAN TAKE LOTS OF PUNISHMENT!

This fine public address and general purpose microphone provides studio quality performance and great versatility. Its smooth peak-free response (from 40 to 13,000 c.p.s.) means you virtually eliminate feedback problems and get excellent performance. "Slide-Lock" permits easy removal from the stand for hand or suspension use. Simple linkage bar adjustment quickly varies impedance from 50 to 40,000 ohms.

This slender, graceful black-and-gold microphone is a real stand-out in performance and appearance. If you want to take pride in a sound installation—if you want to assure your good reputation—choose the rugged, dependable, efficient American D22. List Price \$99.50.

These omni-directional dynamic mikes are extra rugged! they're shock resistant, with guarded grill and swivel head. That's why they are so widely used in public address, paging, and communications where a microphone takes a lot of abuse. Another reason for their popularity: their smooth response from 45 to 8,500 c.p.s., approaching studio requirements.

The versatile D4 Series Microphones are available in both low and high impedance models. Their low price makes them your best microphone choice where budget is as important as quality and durability. The D4 (low impedance) model has a list price of \$28.00. List price of the D4T (high impedance) is \$31.00.



Write for your free copy of the AMERICAN MICROPHONE catalog—a complete line of microphones, cartridges, and handsets, for every application.

American Microphone MANUFACTURING COMPANY
a division of GC-Textron Inc.

West Coast Plant: Los Angeles 18, California
MAIN PLANT: 420 SOUTH WYMAN STREET, ROCKFORD, ILLINOIS, U.S.A.
Export and Canada: Telesco International Corporation, 36 W. 40th St., New York, N.Y.

ELECTRONICS

volt range. He carefully clipped one lead to the base of the tubes and the other to the chassis. "These are little mercury-vapor rectifiers. 816's," he explained, flipping the power switch on. He snapped it off immediately as the meter promptly backed off scale. "Dangit all, I forget that every time!" he growled, reversing the meter leads. "What happen?" asked the Young Ham. "Oh, I hooked it up backward," said the Old-Timer. "See here?" pointing to the base of the magnetron, where a pair of rf chokes fed filament current to the tube and another lead obviously connected the high voltage. "This part up here's the plate, and as even you can see, it's very firmly grounded to the chassis. Well, where does that leave your plate voltage?"

"Why, it would be . . . I think . . . Oh, yes! I remember. That's just like an oscilloscope, isn't it? To get a positive voltage on the plate, which is grounded, they just put a high negative voltage on the cathode!" said the Young Ham.

"Y'know, sometimes I think there's hope fer you at that," grinned the Old-Timer, turning the switch on again. "Let's see now, 1,400 volts at 'Start'. That's pretty good. Now," and he turned the "Advance" knob on the panel. "Oh, that's just dandy. Voltage goes down instead of up. That'll help a lot! Let's see what's busted up in here." He turned the plate switch off and turned the chassis so he could see inside it. "Hey, look here. Here's the burned smell," he said, pointing at a Variac in the center of the chassis. "Look at the end of that mess." Several turns at the end were badly charred and one wire was broken. Pulling the line cord from the socket, the Old-Timer said, "Well, we'll have to fix that before we can go any farther."

Good color coding

He removed the knob and carefully disconnected the Variac. "Oh, fine! That's what I like, good color coding!" He snarled.

"Huh?" asked the Young Ham, from the far end of the bench.

"They're color-coded very nicely—all blue!" snapped the Old-Timer. "Toss me that bottle of nail polish, willya?" The Young Ham complied and the Old-Timer carefully marked one of the wires and its associated terminal with a red dot, then marked another with a blue dot, using a handy bottle of blue corona dope, leaving the third wire unmarked. "That's what I like about some of this apparatus," he grumbled, disconnecting the wires and taking the Variac out of the case. "They're so dang thoughtful of the repairman. Hmm, here's the trouble. Looks like this slider scored the wires, then she arced over and burned a turn in two. This thing's as open as an old maid's heart."

Heating up a very small soldering iron, he carefully patched the broken ends of the broken turn, bridging the gap with solder. Giving the damaged part a thick coating of corona dope, he



**TIME-
SAVING
HANKS**

**FOR EASY
Fall Replacements**

AMPHENOL job-size Twin Lead Hanks are just right for the big Fall replacement market! Pre-assembled with lugs on one end and packaged in convenient 25, 50, 75 and 100 ft. lengths, AMPHENOL Hanks are a natural for time-saving replacements.

Boost your Fall profits with AMPHENOL job size Twin Lead Hanks!

Remember: For finest quality, virgin polyethylene is used in all AMPHENOL Twin Leads.

**PREASSEMBLED
with lugs
on one end!**

Part No.	Description	Available in Hanks of			
		25 ft.	50 ft.	75 ft.	100 ft.
214-318	Indoor—60 mil, 7/28 pure copper cond.	✓	✓	✓	✓
214-056	Standard—60 mil, 7/28 pure copper cond.	✓	✓	✓	✓
214-559	Steelcore—72 mil, 7/28 copperweld cond.		✓	✓	✓
214-298	Rotator—4 conductor—7/28 pure copper cond.		✓	✓	✓
214-100	Century—100 mil, 7/28 pure copper cond.		✓	✓	✓
Now Available in Coils					
214-271	Air-Core—U.S.Pat. 2543696 7/28 pure copper cond.		✓	✓	✓



chicago 50
AMPHENOL ELECTRONICS CORPORATION
illinois

RADIO-ELECTRONICS

ELECTRONICS

set it aside to dry. He leaned back, hooking his feet into the rungs of the stool. "Y'know" he reminisced, "I nearly scared poor old Doc to death last time I had this thing up here! You were in school, that's why you haven't seen it before. Had something like this and before I found out where the trouble actually was, I very cleverly diagnosed it as a bad magnetron! They only cost about \$150! Told Doc what I thought and dang near ordered one. Just got to lookin' around in it, and discovered an open wire that I hadn't thought of. Why, I thought Doc was goin' to bean me with a 5-iron when I told him! Y'know, I haven't dared question any of his diagnoses since then!" He chuckled reminiscently and picked up the Variac. Finding the quick-drying dope had set sufficiently, he cleaned and adjusted the sliding contact, polished the turns of wire over which it moved, applied a thin film of lubricant with the tip of one horny finger, and replaced it in the machine. "Now, what'd I do with the line cord. Oh, there it is, on the floor again." Picking up the line cord he connected the unit, turned it on and waited for the timer to run down.

When the timer had clicked down, he turned the plate switch on and re-measured the voltage. He clucked in satisfaction as the needle moved up-scale with rotation of the Variac. Now the panel meter showed a reading, and the little mercury-vapor tubes showed a higher glow. "There you is," he announced, leaning back. "Try that and see if you can feel the heat." The Young Ham gingerly stuck his hand before the bowl. "Yeah!" he said. "I sure can. Say, that's quite a deal!"

"Yep," agreed the Old-Timer. "Makes it mighty handy. You can put the heat right where you want it. We could sure use one of these here every once in a while. I could use it to preheat my head in the morning!"

"That's true," said the Young Ham. "I've seen the time you didn't look so hot, when you came in!"

"None of yer lip," said the Old-Timer. "Well, let's go gitta cuppa cawfee while this thing cooks for a while" and he reached for his cap.

"Can you leave it like that?" asked the Young Ham.

"Sure. It's plugged into that watt-meter outlet and, if you recollect, that's protected by a very handy little 3-amp fuse. Also, there's a fuse in this gizmo. Say, remind me to check that when we get back. I don't want to turn it off now. If I do, I'll have to wait another 3 minutes for the timer to run down, but I'd bet a cookie that she put at least a 20-amp car-radio fuse in it!" The two went out the back door and over to the coffee shop. When they returned, the Old-Timer checked the output of the Microtherm. Finding no change, he disconnected it. "Did you check that fuse?" asked the Young Ham.

"Not yet, but I'm going to," replied the Old-Timer. He unscrewed the fuse-

The Tube-Tester that's always up-to- date!

- fast...
- fully automatic...
- pays for itself

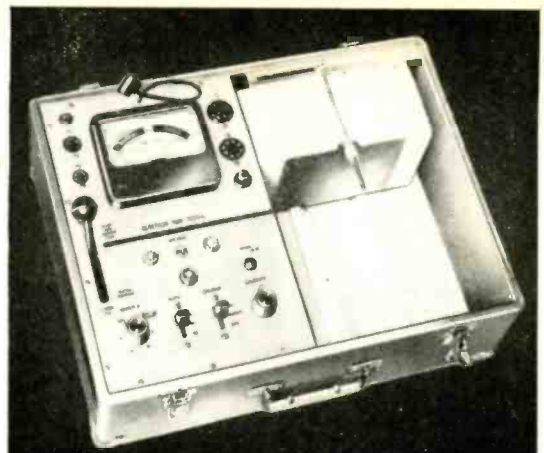

RCA WT-110A Automatic Electron Tube Tester

\$199⁵⁰* includes 239 punched cards locked in sequence—covers 95% of active TV types...
USER PRICE (Optional) *Prices higher in Hawaii and Alaska

Plus—at no extra cost...



These bonus accessories... 24 additional punched cards, 24 unpunched cards, and sturdy new card punch!

With RCA's exclusive accessory punch and card kit, your WT-110A tester is always up-to-date as fast as new tube type punching information is announced. When you use the RCA WT-110A—the ultra-modern way to test tubes—you gain speed and accuracy for extra service income, and improved efficiency which pays for the tester in a very short time!

Remember, when you choose RCA's WT-110A Automatic Electron-Tube Tester, you also choose a brighter profit picture—now and in the future.

- Fully automatic! Sets up all socket connections and all operating voltages for heater, control grid, plate, screen grid, and bias.
- Checks for shorts and leakage between each element and all others consecutively—plate, screen, control grid, cathode. Multiunit tube sections checked individually.
- Checks amplifier tubes for transconductance—green scale indicates normal range of tube's transconductance.
- File capacity for 700 cards.
- High- and low-sensitivity ranges for gas and leakage tests.
- Automatically selects correct test conditions from 220 different heater voltages (from 0.1 volt to 120 volts) at currents up to 4 amps., 10 bias voltage, and 11 values of cathode resistance.
- Rectifier-type tubes tested for emission under heavy load currents (up to 140 ma per plate).
- 12-volt plate-and-screen supply for testing new auto-radio tubes.

See Your Authorized RCA Test Equipment Distributor!



RADIO CORPORATION OF AMERICA
Electron Tube Division
Harrison, N. J.

COYNE offers
LOW COST
TELEVISION
 Training in
 Spare Time **AT HOME**

The future is **YOURS** in
TELEVISION—RADIO
COLOR TV!

A fabulous field—good pay—fascinating work—a prosperous future! Good jobs, or independence in your own business!



Coyne brings you **MODERN—QUALITY** Television Home Training; training designed to meet Coyne standards. Includes **RADIO, UHF and COLOR TV**. No previous experience needed. Practical Job Guides to show you how to do actual servicing jobs—make money early in course. You pay only for your training, no costly “put together kits.”

SEND COUPON FOR FREE BOOK

and full details including easy Payment Plan. No obligation, no salesman will call.



B. W. Cooke, Jr., President

Coyne—the Institution behind this training... the largest, oldest, best equipped residential school of its kind. Founded 1899.

COYNE ELECTRICAL SCHOOL

500 S. Paulina, Chicago, Dept. 78-H5
 A Technical Trade Institute
 Chartered Not For Profit

COYNE Television, Home Training Division
 500 S. Paulina St., Chicago 12, Ill.
 Dept. 78-H5
 Send Free Book and details on how I can get Coyne Quality Television Home Training at low cost and easy terms.

Name

Address

City State

(It is understood no salesman will call)

ELECTRONICS

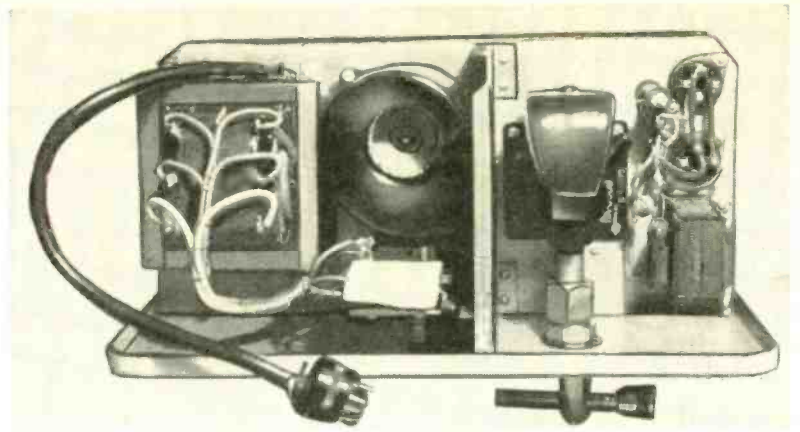

Top view of the Microtherm. Power transformer is on the left, time-delay relay at the bottom, near the plug. The magnetron is the object at right center.

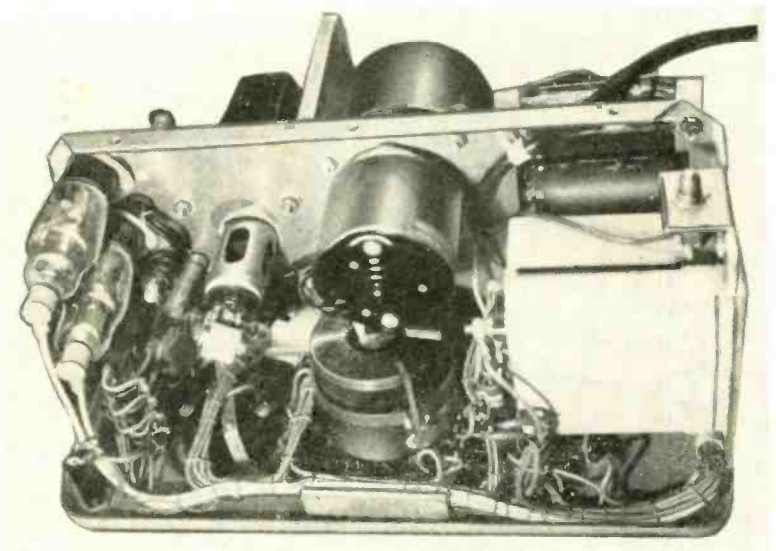

The other side of the Microtherm. The Variac which had to be repaired is in middle of the front panel.

post and looked at its contents. “Yep,” he grinned, “Just what I thought. Where’s that box of 3-amp fuses? Here they are.” He replaced the fuse with a more appropriate size and taped the rest of the box to the panel. “That’ll last ‘em for a while, I hope,” and he packed the machine out to the truck.

There’s a lot of that stuff

When he came back into the shop from making the delivery, the Young Ham said thoughtfully, “You know, there’s a whole lot more of that stuff around town than I ever thought of. Why, there’s almost enough oddball stuff like that to keep a man busy full time!”

“Well, not quite, in this size town,” said the Old-Timer with a grin. “There’s enough to make a darn nice addition to a shop’s income though, if you’ll just go after it. If we had a little bit bigger town now, feller might specialize in that kind of stuff and make a livin’. Here, there just wouldn’t be enough volume. But! It makes a heck of a profitable sideline though, and you can save the folks a lot of waitin’ time, while they’re gettin’ a ‘specialist’ from a city or somethin’. Now just look, here’s these

two things, although it’s a mite unusual to get two of ‘em in a single day, and there’s a lot of stuff up at the hospital. EKG’s, another diathermy just like that one, an electronic control system on the gas-fired boilers an’ . . .”

“Whoa!” interrupted the Young Ham. “What’s an EKG?”

“That’s what doctors say when they don’t have time to say electrocardiograph,” explained the Old-Timer. “Gadget that makes recordings of heart sounds and so on. Simple. Then there’s moisture meters out at the sawmills. They ain’t a thing but plain old ohmmeters to us. Hammond Organs and other kinds of electronic musical instruments, which are just plain PA amplifiers where we can work on ‘em, hi-fi sets, Watchmasters—”

“Whoa again,” said the Young Ham. “No dig Watchmaster.”

“Electronic gadget for testing watches. Amplifier, electrically driven tuning fork, which generates accurate current to drive a motor that turns a recording drum. Got a microphone on the amplifier. Y’ put a watch in a little clamp on this mike, and the watch ticks are amplified to drive a recording pen. Th’ tuning fork holds the drum speed

ELECTRONICS

absolutely constant, and the ticks make a line of little dots. If the line of dots is straight across, the watch is in good shape. If they slant up, it's fast. Down, it's slow. Diggez vous?"

"Oui, j'ai diggons," agreed the Young Ham. "Sounds very simple, to hear you tell it."

"It is," said the Old-Timer. "It's just an amplifier. Even you can fix *them*. Tuning-fork drive's just an amplifier too. Takes the waveform generated by the tuning fork and amplifies it up to enough voltage to drive the motor. Uses a pair of 6L6's. Y'want to check the thing to see if it's absolutely on the money? No sweat there either."

"How?" asked the Young Ham.

"What do you do when you want to check your receiver?" asked the Old-Timer.

Use WWV

"Tune in WWV on 10 mc," replied the Young Ham.

"Same here," said the Old-Timer. "Tune in WWV on any of their frequencies. Take the loudest one. Y' know that tick, tick you hear in their signals? That's a slightly accurate 1-second tick! Just put an earphone in the watch-holder clamp, fire that ticking into it and run a test sheet on the drum. That'll give you a pretty fair idea of what the thing's doing!"

"Never thought of that," said the Young Ham.

"Next time we get Garmon's Watchmaster in, I'll show you. There's lots of other things you can use WWV for, too. Remember those two big black boxes we had in a couple of months ago? They were parts of a piano-tuning apparatus. Used the same basic circuit—a tuning-fork drive. Only this time it drove a whole bunch of small stroboscope discs, behind a lot of little windows. Had a long neon-tube lamp mounted above 'em so it lighted up the strobes. Amplifier and a mike, with the output hooked to the neon light. Neon light had sharp pulses of whatever frequency was being picked up by the microphone. Each window was labeled for a different musical note. You hit a middle A on the piano, and the bars on the window marked A stood still, if the note was right on frequency, or as the musicians say 'on pitch'."

"That's the same thing we do when we use a strobe disc to check the speed of a phonograph turntable, isn't it?" asked the Young Ham.

"Right you are," said the Old-Timer. "When you get the bars to stand still, then the turntable's right at the proper speed. Of course, those are calibrated for 60-cycle line frequency, while the discs on the tuner gizmo are calibrated for all different frequencies. You know, musicians use one octave or eight notes as a basis for their computations. By a strange coincidence, that's what us old electronic type geniuses would call a harmonic relation—a note one octave higher in pitch is the second harmonic or twice the frequency of the lower tone.

YOU CAN'T HEAR A 'SPEC' SHEET!

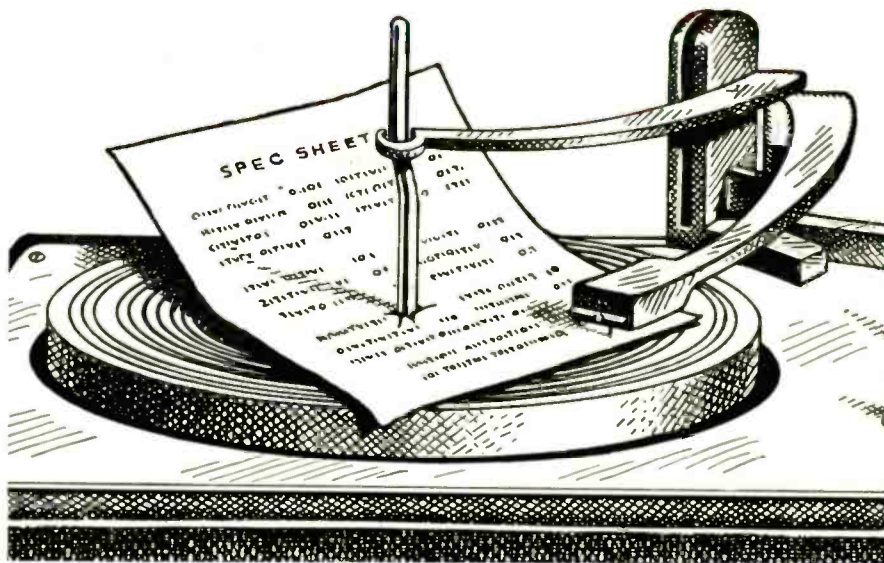

Sonotone's stereo cartridge has more than just good specs... it gives brilliant performance! More phono makers specify Sonotone for the top of their line—here's why:

Only Sonotone gives true sound *without* distortion...high frequency response *without* record cutting! Sonotone stereo gives a performance so superior you can truly *hear* the difference. The secret? Sonotone's four exclusive *operating* features:

1. Extremely high compliance.
2. Amazingly clean wide range frequency response.
3. Wide channel separation, due to Sonotone's pantagraph yoke.
4. Rumble filter to screen out vertical turntable noise.

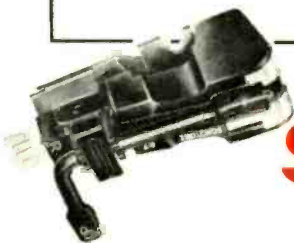

SPECIFY...STOCK...SELL...

Sonotone

Electronic Applications Division, Dept. CE-108

ELMSFORD, NEW YORK

PRO-C

Customers Impatient?

It's full speed ahead



with
Centralab
Hi-Kap*
Ceramic
Capacitor
Kits

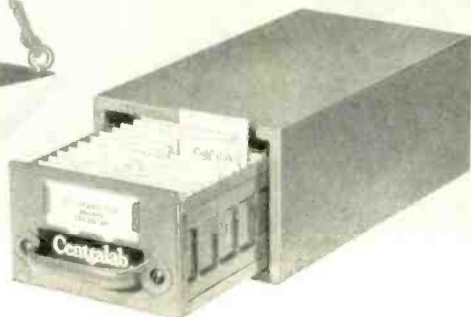

No delays! It's always smooth sailing when you use Centralab ceramic capacitor kits. No extra trips to your distributor, no wasted time. The units you need are on hand when you need them.

To keep you on an even keel, these heavy gauge steel kits contain balanced inventories of the most frequently used values. Individual values are prominently and clearly labeled, so you can locate the Hi-Kap you need, instantly. The new rigid plastic package permanently separates and protects the units—yet is easily opened to remove a single capacitor.

So don't be left at sea. Ask your distributor about these four time-saving kits—and while you're at it, be sure to get your free copy of Catalog 30, listing the full line of Centralab capacitors and other quality components.

FREE: \$4.75 cabinet (4"x7"x11") with each kit.

- D6K-200 Kit—200 Tubular Ceramic BC Hi-Kaps (27 values)
- DDK-200 Kit—200 Standard Ceramic Disc Hi-Kaps (31 values)
- TCK-80 Kit—80 TC (Temp. Compensating) Hi-Kaps (40 values)
- HVK-150 Kit—150 High Voltage Disc Hi-Kaps (19 values)

Centralab products are listed in COUNTERFACTS, PHOTOFACTS, and THE RADIO-ELECTRONIC MASTER.



*Trademark

D-5829

A DIVISION OF GLOBE-UNION, INC.
922K E. KEEFE AVE. • MILWAUKEE 1, WIS.
In Canada: 804 MI. Pleasant Rd. • Toronto, Ontario

SWITCHES • PACKAGED ELECTRONIC CIRCUITS • CERAMIC CAPACITORS
CONTROLS • ENGINEERED CERAMICS • SEMI-CONDUCTOR PRODUCTS

ELECTRONICS

So, they got several rows of bars on these discs, so that they can use them for several different tone scales and so forth."

"How would you check a thing like that with a 1-second tick?" asked the Young Ham, puzzled.

"Didn't say I was going to use the tick, silly," said the Old-Timer. "Didn't you ever hear that beep tone in there, too?"

"Yes, but I thought that was just for tuning in the signal," said the Young Ham. "About 400 cycles, isn't it?"

A very precise 440-cycle tone

"Not about," answered the Old-Timer. "That beep's a very danged precise 440-cycle tone and by a very strange coincidence that happens to be the same frequency as the middle A or what musician's call concert pitch. So, we warm up a communications receiver, pick up WWV, put the microphone by the speaker and see if our middle A disc is standing still. If it ain't, we adjust the machine until it is. Then, because all of the discs are driven by the same shaft and motor, the rest of 'em are all correct, too."

"Gosh, you can do lots more things with those WWV signals than I ever thought of," said the Young Ham. "All I ever thought they were good for was frequency checks and time signals."

"That, too," agreed the Old-Timer. "You can check photographic timers with 'em, using the 1-second ticks. Set the timer for 5 seconds, say, and count off 5 ticks, and so forth. Nothin' to it."

"You make it sound so simple," complained the Young Ham.

"I've said it before and I'll say it again," said the Old-Timer, "it is. It's just like anything else in this business. Just set down and glare at it until you figure out what it's supposed to do and how it does it. Then start checking it to see why it ain't doin' it!"

"You're right there," agreed the Young Ham. "Speaking of checking things for absolute accuracy, have you checked your watch against WWV lately?"

"No," replied the Old-Timer, puzzled. "Why?"

"Because it's 10 minutes after quittin' time, and we've got a big hop over at the hall tonight!" said the Young Ham. "I've been on overtime for the last 10 minutes!"

"Great Gosh, I can't afford that!" cried the Old-Timer. Let's git outa here!" They shut off the bench and made a mad dash for the back door.

END

CREDIT MEMO

By Phyllis Barlow

Concerning the bill
Of the guy who says,
"Charge it!"
I'm often inclined
To just slightly
Enlarge it!

RADIO-ELECTRONICS

ELECTRONICS

TRANSISTOR QUIZ

THE following quiz is designed to test your knowledge of transistor fundamentals and terminology. Check your answers against those given at the bottom of this column. A score of 4 correct is excellent; 3, good; 2, fair, and 1 is poor.

1. In reference to transistors, a hole is:
 - (a) an opening drilled through the transistor to accommodate a mounting bracket.
 - (b) a slight depression in the surface of the germanium to accommodate the catwhisker.
 - (c) a place in the crystalline structure of the germanium which could be, but is not, occupied by an electron.
 - (d) an opening or window in the transistor envelope to permit adjustment of the catwhisker.
2. N-type germanium:
 - (a) is a slab of germanium cut in the shape of the letter N to increase the length of the conducting path.
 - (b) is a type of germanium which has no chemical impurities.
 - (c) has a surplus of electrons.
 - (d) has a deficiency of electrons.
3. A donor substance added to germanium will:
 - (a) absorb internal gas bubbles and therefore serves a purpose similar to the getter of a vacuum tube.
 - (b) neutralize chemical impurities and give the transistor the same efficiency as one made of pure germanium.
 - (c) produce n-type germanium.
 - (d) prevent arc-over between the two catwhiskers.
- 4 Which of the following statements is true:
 - (a) Transistors are not affected by moisture and temperature changes and are therefore never enclosed in an evacuated envelope like the elements of a vacuum tube.
 - (b) The transistor will operate as a voltage amplifier but its current gain must always be less than unity.
 - (c) Although transistors do not require filaments as do thermionic tubes, a heating element is always enclosed in the transistor envelope to raise the temperature to a value at which the germanium becomes a good conductor.
 - (d) None of the above statements are correct.—Ed Bukstein*

*Northwestern Vocational Institute, Minneapolis, Minn.

1. C
2. C
3. C
4. D

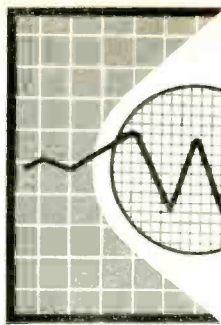

**TIME SAVING
MULTIPLE USE
also
STICKLEBACK TOOLS**

FOR HUNDREDS OF JOBS IN THE SHOP—AT HOME—IN INDUSTRY

Cut any size or shape hole in wood, plaster, plywood, plastic, masonite, etc., twice as fast as any conventional tool. Can be used for drilling, sawing or routing. Try one at your parts distributor.

DRILL ROUTERS



**DRILL
OR
SAW**

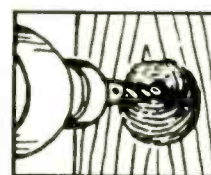
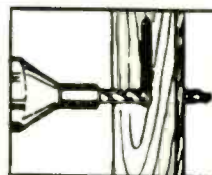

ROUT

For power tools, fit any 1/4" chuck. Six sizes from 2 3/8" long, 1/8" diam. (No. 588-01, \$2.35 List) to 7" long, 1/2" diam. (No. 588-06, \$5.40 List)

DRILL SAWS

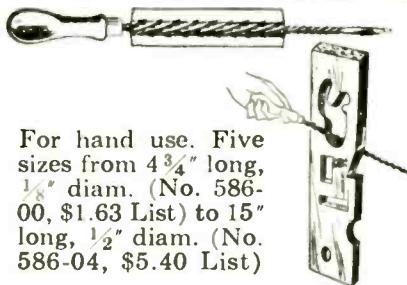

For hand use. Five sizes from 4 3/4" long, 1/8" diam. (No. 586-00, \$1.63 List) to 15" long, 1/2" diam. (No. 586-04, \$5.40 List)

FILE RASP



Three times as fast as an ordinary file. Can be used as a plane. Has coarse side for rough work, fine side for finishing. Part No. 587, List Price \$3.25.



STRIP-ER-CLIP WIRE STRIPPER



Compact, efficient unit that is perfect for your tool case. Gets into tight places and does a clean, fast job without damaging the wire strands. Special 7-stop gauge quickly adjusts to any wire size from 14 to 26 gauge. Has heavy insulated grips. Part No. 595, List Price \$2.30.

TEKNI-LABELS

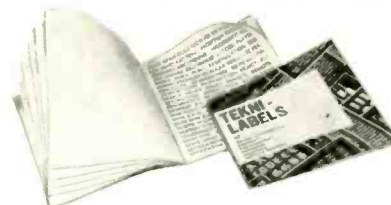

Handy decals that give your electronic equipment a professional appearance. Sets in black or white (each with hundreds of titles) for receivers, transmitters, television, dial marking, audio-hi-fi, panel markings (gold only), receiving tubes, etc. Only \$1.35 net per set.

FREE: Walsco's new 64 page catalog with thousands of tools, chemicals and items for hi-fi, radio and TV servicing. Ask your distributor or write Walsco for your copy.

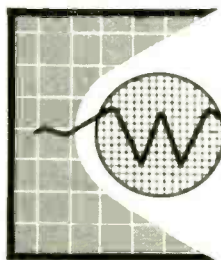

Walsco—ELECTRONICS MFG. CO.
A Division of Textron Inc.
West Coast Plant: Los Angeles 18, California
MAIN PLANT: 110 W. GREEN ST., ROCKFORD, ILL., U.S.A.
In Canada: Atlas Radio Corporation, Toronto 10, Ontario

True
High-
Fidelity

in the
most
dramatic
setting...

See your local radio-
television service dealer.



OXFORD
Components, Inc.

Subsidiary of Oxford Electric Corp.
556 West Monroe Street
Chicago 6, Illinois

Illustrated literature
available upon request.

OXFORD 3-WAY SPEAKER SYSTEMS and BASS REFLEX CABINETS

Enhance the beauty and comfort of your room while you enhance the sound of your high fidelity. Every room will sparkle with these OXFORD cabinets whether for stereo or in a setting with just one cabinet. Here is double-duty design... cabinets can be used for horizontal or vertical positioning... with use of tapered legs or runners which are both supplied. Available with or without OXFORD 3W20 3-way speaker systems, to give you the best sound reproduction.

Cabinet Model No.	Audiophile Net
BR-7M Red Mahogany	\$111.00
BR-1C Cherry	117.00
BR-1B Blande Oak	117.00
Complete 3 way speaker system for above cabinets Model 3W20	\$ 39.00

F.O.B. Factory

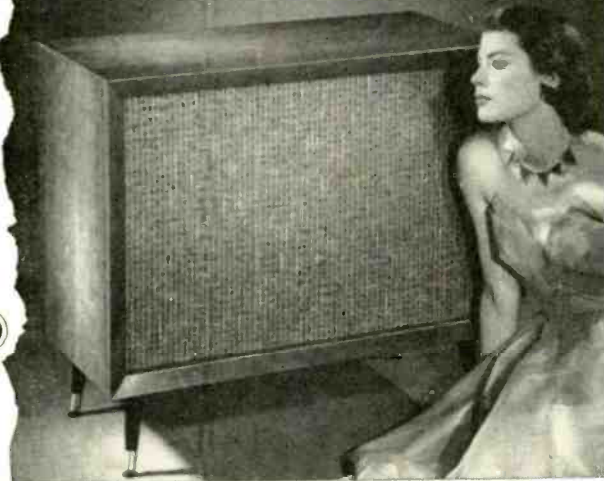

Technotes



EMERSON 654D

The set came in with a continuous vertical roll that could not be stopped at any setting of the vertical hold control. After replacing or testing all components in the vertical oscillator and output circuits, we found a high resistance short in the 12BH7 (vertical osc and output) tube socket between pins 1 and 7 (the oscillator's grid and the output's plate). Rather than replace the socket, a difficult job at best, we used the set's high-voltage supply to burn it out, and it's been OK since.—
H. Muller

TRAV-LER 317-67

The top of the picture will fold over if the retrace time is too long. In the vertical oscillator stage of this set, capacitor C73 (470 μf) effectively shunts the secondary of the vertical

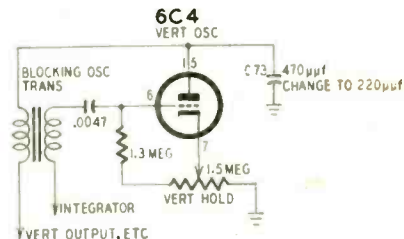

blocking oscillator transformer. Replacing this capacitor with a 220-μf unit eliminated the foldover in this case. A different 6C4 may do the same thing, but you'll have to have a number of them around to try. A slight reduction in capacitance was the better choice.—
E. A. Chung

OPEN VOICE COIL

A shorted capacitor across the output transformer's primary killed the receiver's audio. Replacing it with one of the 1,500-volt variety restored operation and the set was returned to the customer—a simple job.

Two days later, the set was back. This time, a short in the output transformer, primary to secondary (one side of secondary grounded).

A few days later the set was back again, the customer complaining of a horrible crackling noise which was traced to sparking on the partly charred socket of the output tube, between plate and screen pins. The voltages normally encountered here could not account for this and, besides, noise was present only with a signal tuned in.

As I thought I was hearing a noise caused by a loose or rubbing voice coil, I lightly touched the cone. A shower of sparks between the plate and screen pins was my reward, and the meter

NEW SPEED TV SERVICING SYSTEM

FIND TUBE—CURE TROUBLE
with TROUBLE INDICATING
TUBE LOCATION GUIDES

Each guide shows location and type of all tubes. Also by copyrighted method indicates exact location of tubes needing replacement.

Following Books are Available:

- TV TUBE LOCATOR, Vol. 1—Guides for over 3000—'47 to '54 models—\$1 postpaid.
- TV TUBE LOCATOR, Vol. 2—Guides for over 5000—'55, '56, '57 models—\$1.50 postpaid.
- RCA TV GUIDES—Complete compilation of RCA tube guides—'47-'56 models—\$1 postpaid.
- ADMIRAL TV GUIDES—1500 Admiral models, '47-'56—\$1 postpaid.

TV TROUBLE TRACERS

Seven volumes, different guides in ea. Hundreds of TV models. Over 70 illustr. in ea. vol. 40 most common TV Tube troubles Illustr.—50c ea.

- Vol. 1—Older sets
- Vol. 2—'52-'53 sets
- Vol. 3—'53-'54 sets
- Vol. 4—'54-'55 sets
- Vol. 5—'55-'56 sets
- Vol. 6—'56-'57 sets
- Vol. 7—JUST OFF PRESS! NEW 1958 Models

Regular price of all books listed above is \$8. If all are ordered same time price is Only \$7. Check desired books—Clip ad—Print name and address clearly—enclose with remittance.

MAIL NOW TO:

H. G. CISIN, CONSULTING ENGINEER
Amagansett, L.I., N.Y. Dept. E-48

Enclosed find \$..... Rush Books
checked above to:

Name.....

Address.....

City..... Zone..... State.....



SIGNAL TRACER

Checks all stages from Antenna to Speaker or Picture Tube. Tests microphones, appliances, pickups, transformers, speakers, resistors, condensers, etc.

- Model 202 (with AF Probe) Net \$37.50
- Model A Probe (RF Demodulator) Net 4.50
- Model B Probe (RF Demodulator, Amplifier) Net 7.50



TV CLARIFIER

Removes annoying signals that cause picture distortion in TV sets due to FM, amateurs, shortwave, diathermy, ignition and adjacent channels. Ghosts, lines, herringbone patterns, tears and wavy effects are eliminated or reduced simply by turning the two control knobs on this new type interference eliminator \$7.50

PRECISION ELECTRONICS, INC.

Dept. RE-10, 9101 King St., Franklin Park, Illinois

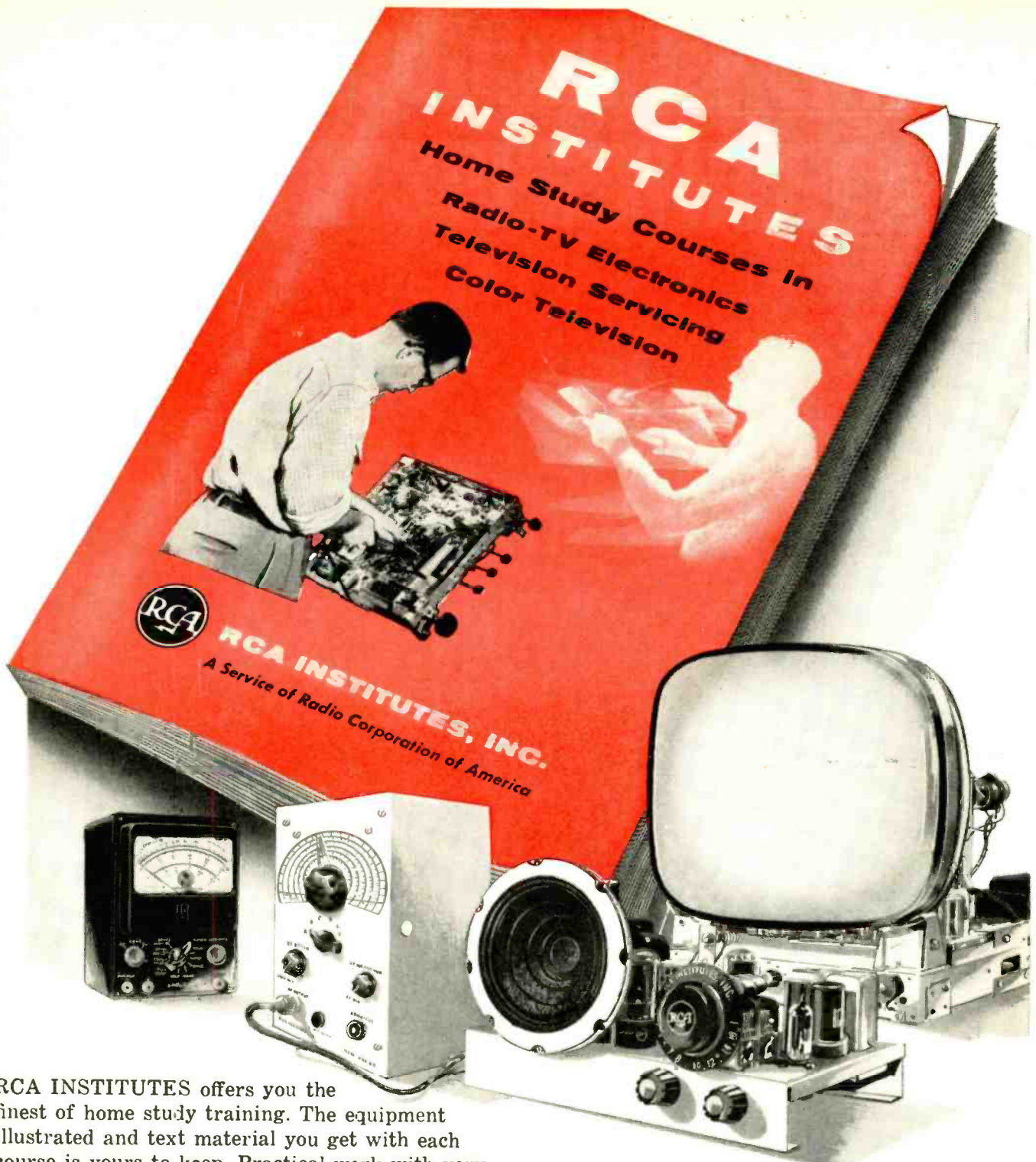

RCA INSTITUTES offers you the finest of home study training. The equipment illustrated and text material you get with each course is yours to keep. Practical work with very first lesson. Courses for the beginner and the advanced student. Pay-as-you-learn. You need pay for only one study group at a time.

**Send for this
FREE Book Now** ▶

RESIDENT SCHOOL courses in New York City offer comprehensive training in Television and Electronics. Day and evening classes start four times each year.
Detailed information on request

RCA INSTITUTES, Inc. Home Study Dept. RE-108

A Service of Radio Corporation of America

350 West Fourth Street, New York 14, N. Y.

Without obligation, send me FREE 52 page CATALOG on Home Study Courses in Radio, Television and Color TV. No salesman will call.

Name..... please print

Address.....

City..... Zone..... State.....

Korean Vets! Enter discharge date.....

CANADIANS — Take advantage of these same RCA courses at no additional cost. No postage, no customs, no delay. Send coupon to: RCA Victor Company, Ltd., 5001 Cote de Liesse Rd., Montreal 9, Quebec
To save time, paste coupon on postcard.

... another
P. R. MALLORY & CO. Inc.
MALLORY
 service-engineered
 product

Solve Hot Filter Problems with Mallory FP Capacitors



TV circuits, hi-fi amplifiers, and other electronic equipment are being squeezed into some pretty small cabinets these days. That means higher working temperatures in the cabinet, and—quite often—filters being mounted next to hot rectifiers and output tubes.

Ordinary replacement filters wilt under this heat . . . but not Mallory FP capacitors. FP's are the original capacitors for temperatures up to 85°C (that's 185°F). The combination of fabricated plate construction and etched cathodes, available without premium price only in Mallory FP capacitors, assures long life and hum-free performance.

Protect your service reputation *and* put a stop to "call-backs"—by insisting on Mallory FP capacitors. See your Mallory Distributor—today.



- Capacitors • Vibrators • Resistors • Controls • Switches • Filters
- Rectifiers • Power Supplies • Mercury and Zinc-Carbon Batteries

TECHNOTES (Continued)

connected to the plate circuit went violently off its 1,000-volt scale. And here it was! An intermittently open voice coil was inducing tremendous surges in the transformer's primary. These caused the original 300-volt capacitor across the primary to break down.

The next victim was the output transformer, shorting primary to secondary. Before a complete breakdown in the transformer occurred, the numerous surges nibbled away at the dielectric strength of the wafer in the 6AQ5 socket.

When the transformer was replaced, the weakest link was the socket. Replacing the socket and voice coil cured all troubles. This time, the repair was on the house, with "just a loose connection" as far as the customer was concerned. This time the set didn't come back.—*Capt. Daniel Nof*

HALLICRAFTERS 17TT701M

The chassis was pulled for distorted sound with high-frequency background hash and troublesome intercarrier buzz. A scope showed a high-frequency signal at the grid of the 3BN6 detector. Part of this signal was obviously 4.5-mc

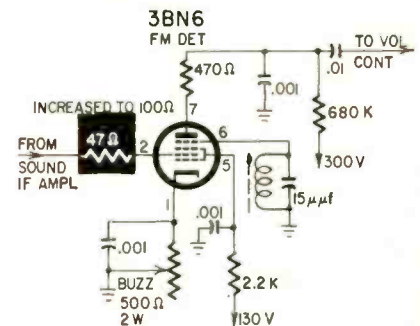

sound and was removed by grounding the grid of the 4.5-mc amplifier. But, even with the audio signal removed, the high-frequency signal at the grid of the 3BN6 remained.

The 47-ohm resistor in series with the 3BN6 grid was increased to 100 ohms and the trouble disappeared. Apparently it was caused by parasitic oscillation which overloaded the detector tube, causing distortion as well as hash.—*Alfred Roberts*

COLOR SERVICING HINT

If you want to make signal-substitution tests in the video or chroma channels of a color TV receiver using vestigial color-sideband if response, you need a bar signal in which the chroma is attenuated 6 db.

If your generator does not have a 6-db switch, an extremely simple method of obtaining the desired signal attenuation is to shunt a 650-μμf capacitor across the 75-ohm termination of the generator's output cable. If other cable impedances are used, the reactance of the capacitor must be equal to the cable impedance at 3.58 mc. For example, a 50-ohm termination requires a 900-μμf capacitor.—*Robert G. Middleton*

END

Technicians' News



20% TEST OWN TUBES

Some 20% of television owners have attempted to repair their own sets by testing the tubes. This was indicated in a survey of more than 600 Dayton, Ohio, consumers by president Paul Bales of the Television Electronic Service Association (TESA) of Dayton. Of the amateur tube testers, 61% used do-it-yourself testers, 31% went to full-time service shops for the tests and about 8% went to part-time shops. Of those who used do-it-yourself testers, 92% replied "yes" when asked if they planned to do it again.

Other survey results: In case of TV trouble, 80% said they call a technician right away. Of these, 72% said they call a full-time man, 23% call a part-time man and 5% call a friend. Some 10% replied affirmatively when asked if they had ever heard of TESA or the TV Service Guild. Asked to name a fair price for a TV service call, the set owners' gave figures averaging \$4.17.

WAR ON "FREE SERVICE"

The announcement of "free service" warranties by leading TV-radio-hi-fi manufacturers may be "the shot heard 'round the world" for independent technicians. Their immediate reaction was to unite in a nationwide offensive against this "threat to the very existence of independent service."

The new warranty plans provide for 90-day parts and labor and, in some cases, free parts for a full year, generally handled by the distributor's service department (see RADIO-ELECTRONICS, September, 1958, page 110).

The National Alliance of Television & Electronics Service Associations (NATESA) called the warranty move "basically wrong" and announced a program of "unremitting war on this evil."

As one step, NATESA began purchasing a small number of shares of stock in large set manufacturing companies, so that the voice of independent service may be heard at stockholders' meetings.

Meanwhile, local and regional technician organizations held special meetings to map strategy. The Television Service Association (TSA) of Delaware Valley (Philadelphia area) told its members that they will begin to feel the pinch this fall with a 25% loss of service revenue.

At a mass meeting of all technicians' groups in the New Jersey-Pennsylvania area, resolutions were adopted condemning the new warranty practices and pointing out that technicians are

Leading Choice
for Performance and Profit...

MALLORY MERCURY BATTERIES

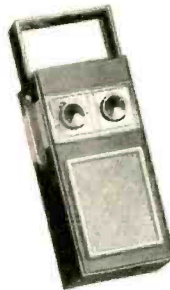

Powerful, miniature mercury batteries, pioneered by Mallory, have rocketed into popularity with transistor radios. Your customers will like their long, fade-free performance. You'll like the high profit per sale they give you. And you can

stock Mallory Mercury Batteries without worry about deterioration, because they stay at full strength for months on the shelf.

Where zinc-carbon batteries are required... for powering vacuum-tube portables or transistor types... you can depend on Mallory for quality and economy. Make sure you have a complete stock of both mercury and zinc-carbon types—order the Mallory "twin-line" from your distributor today.

- Capacitors • Vibrators • Resistors • Controls • Switches • Filters
- Rectifiers • Power Supplies • Mercury and Zinc-Carbon Batteries



In Canada, Mallory Battery Company of Canada Limited, Toronto 4, Ontario.

P. R. MALLORY & CO. Inc., INDIANAPOLIS 6, INDIANA

you learn **MORE**
from a **SAMS BOOK**

OVER 1,000,000
SAMS BOOKS
bought to date

JUST OUT!



"Handbook of Electronic Circuits"

valuable reference book on important circuits, authored by RCA Service Company, Inc.

This practical handbook discusses the following circuits: 4 power supply circuits; 14 circuits used in radio stages; 8 circuits used in transmitter stages; 32 circuits used in TV receiver stages; 7 additional circuits having special applications. An analysis of the operation of each circuit is given; a schematic for each is included; a component failure analysis describes various troubles which could occur if particular components in the circuit should fail. Of real value to engineers, technicians, students. 80 pages; 8½ x 11".

Handbook of Electronic Circuits Only\$2.00

SAMS "BEST-SELLERS"

- Servicing TV Sync Systems.** Covers theory function and variation of all types. Speeds sync system servicing. 320 pages, 5½ x 8½". Only\$3.95
- TV Servicing Guide.** Picture tube screen photos show trouble symptoms; describes proper repair procedures. 132 pages, 8½ x 11". Only\$2.00
- Television Tube Location Guide.** Vol. 7 in this invaluable series. Covers 1956-57 sets. Only\$2.00
- Tape Recorder Manual.** Vol. 1; covers recorders produced in 1956-57. Only\$2.95
- Auto Radio Service Manual.** Vol. 7; covers auto radios produced in 1956-57. Only\$3.75
- How To Understand and Use TV Test Instruments.** Revised to include data on Color TV Servicing. Only\$3.50
- Recording & Reproduction of Sound.** Oliver Read's best-selling volume on all aspects of audio. 810 pages. Only\$7.95
- Color TV Training Manual.** Trains you practically for Color servicing; 260 pages; includes many color illustrations. Only\$6.95
- Hi-Fi Handbook.** Invaluable data on hi-fi theory, design, selection, installation, components. Only\$3.00
- Servicing Transistor Radios.** Complete analysis of 70 popular transistor radio models, including basic pointers on servicing transistorized sets. 152 pages. Only\$2.95

HOWARD W. SAMS & CO., INC.

Order from your Parts Jobber, or mail to Howard W. Sams & Co., Inc., Dept. 2-K8 2201 E. 46th St., Indianapolis 6, Ind.

Send books checked above. My (check) (money order) for \$..... is enclosed.

Name _____
Address _____
City _____ Zone _____ State _____
(outside U.S.A. priced slightly higher)

TECHNICIANS' NEWS (Continued)

not obligated to honor any manufacturers' parts warranties beyond the standard 90-day period. Another resolution stated that the rates charged for the manufacturers' warranties (sometimes as low as \$1 for 90 days) are "unrealistic and not competitive to existing present rates."

Copies of the resolutions were sent to every service association in the country with the request that all groups transmit their own protests to TV-radio manufacturers and distributors.

The meeting, held in Philadelphia under the auspices of TSA of Delaware Valley, was attended by members of Allied TV Technicians of New Jersey, the Federation of Radio & Television Service Associations of Pennsylvania (FRTSAP), Television Service Dealers Association (TSDA) of Delaware County, TSDA of Lower Bucks County (Pa.) and TSDA of Wilmington, Del. FRTSAP previously had held an emergency meeting on the subject.

AMETA NAMES OFFICERS

The Alliance of Michigan Electronics Television Associations (AMETA) elected John Stefanski, of Pontiac, its 1958-59 president at a meeting in Lansing. Other new officers are Clifford Bennett, Kalamazoo, first vice president; C. Geer, Grand Rapids, second vice president; Mike Moser, Birmingham, secretary; John Hawkins, Lansing, treasurer.

TV "SWINDLERS" NABBED

Four technicians were arrested in Los Angeles on petty theft charges as police, in cooperation with the Better Business Bureau, began a crackdown on 14 suspected dishonest firms. Using gimmicked sets with defective tubes, the police said they received bills for \$40, \$60 and \$80. Bunco squad agents estimated dishonest TV repairing is a \$2,000,000-a-year racket in Los Angeles.

For the *Los Angeles Mirror-News*, the arrests were well timed, coming just before the launching of a three-part exposé of crooked technicians. The arrests were given top front-page play under a two-line banner head (see illustration below).

The TV service industry fared better than usual in the *Mirror-News* exposé which followed. The stories took extreme pains to repeat, several times, that "only 1% of TV repairmen are racketeers, cheats or frauds." Unlike recent national magazine articles, this

one did stress that the technician is entitled to be paid for his labor (as well as parts) and that in 40% of the cases the set must be taken into the shop for repairs.

TEXAS FAIR SETS RECORD

A new attendance record of 690 was established at the Texas Electronics Association's Clinic and Fair in Dallas, hailed by TEA members as the most successful in the event's 6-year history.

Among the highlights of the 3-day meeting and show: Gail S. Carter, executive officer of the National Electronics Distributors Association (NEDA), called for technician-distributor cooperation to wipe out disagreements and misunderstandings. Westinghouse headquarters service manager K. H. Brown pledged his company to deal only through independent service technicians. Executive vice president A. W. Bernsohn of National Appliance & Radio-TV Dealers Association (NARDA) urged all technicians to increase their collective strength by joining associations such as TEA. Zenith public relations director Ted Leitzell said pay TV would benefit the independent service dealer.

Tilman Babb was clinic chairman. Next year's Clinic and Fair will be held in San Antonio.

LICENSE BILL DRAFTED

A proposed technician licensing ordinance has been drafted by a special committee of the Associated Radio-Television Service Dealers (ARTSD) of Columbus, Ohio, and presented to city officials, who reportedly are strongly in favor of a licensing law. The committee has met twice with municipal authorities and received the support of seven parts jobbers.

At a recent meeting, ARTSD passed out "deadbeat" credit lists to 44 cooperating members who had supplied their lists of nonpaying customers who owe a total of more than \$13,000. Each member was urged to consult the list before responding to calls.

STATE LICENSING DRIVE

Satisfied with the value of technician licensing after a year of city-wide licensing in Detroit, the Television Service Association (TSA) of Michigan has embarked on a fund drive to promote a state TV license law. Appealing to all state technicians to contribute, TSA of Michigan started the ball rolling with its own \$500 contribution and



POLICE DECLARE WAR ON TV REPAIR CHEATS

Four Arrested Here After Bunco Officers Plant Marked Sets

TSA News with \$200. TSA activities chairman Isa Katuah heads the drive.

In another move, TSA president Karl Heinzman announced a concerted effort to organize all Michigan technicians into the group. To date, TSA's main strength has been in Detroit.

KENTUCKY GROUP ELECTS

C. T. Simmons (left), of Leatherman Electronics, Louisville, was elected president of Kentuckiana Television & Radio Technicians Association (KTRTA). Other new officers, all from



Louisville, are (standing) Art Johnson, Commercial Radio & TV, treasurer; Lou Wilkes, Mercury TV Service, secretary, and (seated) Jim Hall, Electronic Repair Service, vice president.

NEW TECHNICIANS' GROUP

Verne La Plante, of Toledo, has been chosen as president of the new Midwest Electronic Alliance. Howard Wolfson, Mercury Radio Service, Chicago, is secretary; Robert Sickles, Indianapolis, is vice president.

MEA officials say the group was formed as the result of more than a year's organization work by the Electronic Technicians Associations of Toledo, the Indianapolis Television Technicians Association, the Indiana Electronic Servicemen's Association, Associated Radio & Television Servicemen (Chicago) and The Electronic Association of Missouri (TEAM).

MARTS SPONSORS CONTEST

A prize contest, open only to non-member technicians, is being sponsored by the Milwaukee Association of Radio & Television Services (MARTS), with a year's paid-up membership (value \$65) as the prize. The winner will be the contestant who does the best job of completing the statement: "I believe in the collective security of a television servicemen's association because . . ."

Ralph Ehlers of Ehlers Radio & TV is the new MARTS vice president, succeeding Al Nelson, resigned.

SERVICE'S 8 PROBLEMS

The eight major problems confronting the independent service industry, as enumerated by Frank J. Moch, executive director of the National Alliance of Television & Electronic Service Associations: (1) Captive service; (2) "night crawlers" (part-time technicians); (3) bad publicity; (4) cut-rate service ads; (5) retail dealing by wholesalers; (6) phony service schools; (7) do-it-yourself tube testers; (8) the need for licensing. **END**

A must
for TV and
radio
service
technicians



with built-in MAGNASTAT
temperature control

... automatically maintains correct soldering temperature



MODEL TC-40—40 watts.
Controlled lower temperature for
printed circuits, etc.

\$800
list price



MODEL TC-60—60 watts.
Controlled temperature for light
to medium electrical soldering.

\$900
list price



MODEL TC-120—120 watts.
Controlled temperature for me-
dium to heavy electrical soldering.

\$1050
list price

Here's another "first" from Weller, long time leader in the soldering field. New soldering irons with built-in MAGNASTAT temperature control for more reliable soldered connections. Never any overheating. Proper soldering temperature automatically remains constant. Plus these other exclusive features:

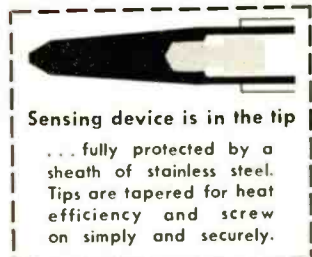

Sensing device is in the tip

... fully protected by a sheath of stainless steel. Tips are tapered for heat efficiency and screw on simply and securely.

- Saves current when idling
- Reaches full heat quickly
- Approximately 1/2 the weight of uncontrolled irons
- Delicate balance—cool handle
- All structural parts are stainless steel
- Cord plugs into handle
- Guaranteed against defects in material and workmanship

Order NOW from your Electronic Parts Distributor
or write direct for catalog bulletin

WELLER ELECTRIC CORP.

601 Stone's Crossing Rd.
Easton, Pa.



build what it takes
to get the best

high fidelity SOUND REPRODUCTION

IT TAKES THE FINEST OF COMPONENTS
—PRECISION JBL SIGNATURE LOUD SPEAKER UNITS—

THE D130 EXTENDED RANGE SPEAKER THE 175DLH HIGH FREQUENCY ASSEMBLY OR THE 075 HIGH FREQUENCY UNIT

— to get the best in high fidelity sound. And to get all of the rich, crisp, accurate, deep down bass generated by your D130, you must mount it in a carefully constructed, engineered acoustical enclosure. One of the most popular enclosures ever made, because of its compact dimensions and smooth, clean response, is the JBL Harkness Model C40—a back-loaded folded horn. Sound below 150 cps is radiated from the back of your D130 through the horn. Above 150 cps the speaker acts as a direct radiator. The six foot long, exponentially-flared horn path is ingeniously folded within sleek, low enclosure measuring only 38" wide. The horn is completely contained within the enclosure and is independent of room walls.

BUILD YOUR C40 FROM PRODUCTION PRINTS

Prove your woodworking skill and get the greatest thrill high fidelity can give you. Here is a project that will make use of your finest craftsmanship for the enjoyment of yourself and your family—a project you can show off to others with pride. Detailed production prints, complete with a list of parts, and step-by-step instructions have now been released by the factory. The set is yours for only three dollars.



USE THIS FORM TO ORDER YOUR PLANS™

JAMES B. LANSING SOUND, INC.
3249 Casitas Ave., Los Angeles 39, Calif.

Gentlemen: Enclosed find \$3.00 for one set of Model C40 Production Prints. Please print clearly or type your name and complete address:

Name _____

Address _____

New Tubes & Semi-conductors



THIS month brings a couple of vertical-deflection amplifiers for 110° TV sets, a high-frequency amplifier transistor, some stud-mounting silicon rectifiers and a germanium audio-driver transistor.

6EM5, 8EM5

These pentodes are high-perveance beam power tubes of the 9-pin miniature type and are intended for use as vertical-deflection amplifiers in TV receivers using 110° picture tubes. In vertical-amplifier service they are rated to withstand a maximum peak positive-pulse plate voltage of 2,200, a maximum

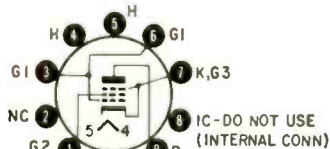

6EM5, 8EM5

grid 2 voltage of 285 and a maximum peak cathode current of 210 ma. Maximum plate dissipation is 10 watts and maximum grid 1 input is 1.5 watts.

The 6EM5 and 8EM5 differ only in heater ratings. The 6EM5 has a 6.3-volt 800-ma heater while the 8EM5 has a 8.4-volt 600-ma heater with controlled warmup for use in series heater strings.

Characteristics of these RCA tubes in class-A1 amplifier service are:

V_p	250
V_{G2}	250
V_{G1}	—18
gm (μ mhos)	5,100
I_p (ma)	35
I_{G2} ma	3
V_{G1} for $I_p = 1$ ma	—37

2N414

A p-n-p alloy-junction transistor designed and tested for use in high-frequency amplifier applications up to



2N414

APPROX ACTUAL SIZE

8 mc. The case features a welded hermetic seal.

Maximum ratings of this Tung-Sol transistor at 25°C are:

V_{CB}	30
V_{EB}	20
V_{CE}	15
V_{CE} ($V_{BE} = 0.1$)	20
I_C (dc ma)	200
I_C (peak ma)	400

From any Point of View, more Experts choose ACROSOUND ULTRA-LINEAR II 60 watt amplifier

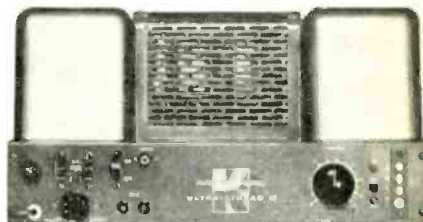

DESIGN The combination of patented ULTRA-LINEAR circuitry—plus new HYBRID FEEDBACK principle—VARIABLE DAMPING CONTROL, and ULTRA STABILITY, represents a new high in the art of amplifier design... an example of ACROSOUND'S latest achievement in AMERICAN Know-How. This superiority of design now enables anyone with or without any previous knowledge of electronics to assemble for himself or herself... (yes! it's that easy!)... the finest of amplifiers and at a most reasonable cost, in only two hours!

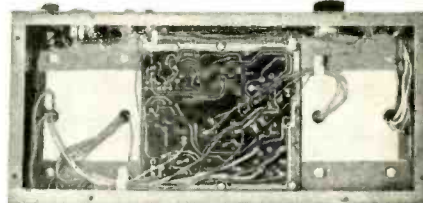

PERFORMANCE By listening test, or by instruments... second to none in clarity and frequency response. Normal level distortion is virtually unmeasurable—IM 1% or less at 60 watts, 120 watts peak. Completely stable... unaffected by loads, perfect square waves.

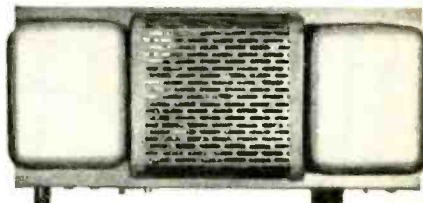

QUALITY Every part going into the assembly of critical and even non-critical circuitry is tested and checked to allow no more than $\pm 1/2\%$ variation from ACROSOUND'S standards. Specialized test equipment unavailable commercially was designed in ACROSOUND'S laboratories to achieve this result. Every printed circuit board is placed in trial operation on a laboratory amplifier. Output tubes are matched by trial and double checked.



COMPONENTS ACRO'S newest T0-600 output transformer with special hybrid winding—separates functions of output circuit and feedback circuit. Heavy duty, completely assembled, and thoroughly tested, printed circuit board assures uniformity of performance. Low distortion EL34 output tubes are operated well within their ratings ensuring long tube life and optimum performance.

PRICE In preassembled kit form so that you may save money, learn while doing, and have the proud satisfaction you built the best for only \$79.50 net... or if you feel you would prefer it laboratory assembled it still represents a bargain at \$109.50 net.

HEAR IT AT YOUR DEALER NOW!

BE READY FOR ACROSOUND DISTORTIONLESS PRE-AMP DESIGNED FOR THE STEREO-PHILE

Experts know why ACRO is best!
Others... Learn why! Write to

ACRO PRODUCTS
369 SHURS LANE
PHILA. 28, PA.

Design center characteristics at 25°C are:

h_{ib} (ohms)	25	($V_{CB}=6, I_E=1 \text{ ma}, f=1 \text{ kc}$)
h_{fe}	60	($V_{CE}=6$)
f_{ab} (mc)	7	($V_{CB}=6, I_E=1 \text{ ma}, f=1 \text{ kc}$)
NF (db)	6	($V_{CE}=6, f=1.5 \text{ mc}$)
G_p (db)	16	($V_{CE}=6, f=1.5 \text{ mc}$)

2N497, 2N498

Two medium power n-p-n silicon transistors designed for switching and amplifying applications that feature low collector saturation voltage, high current gain and fast switching time at 200 ma. These applications include

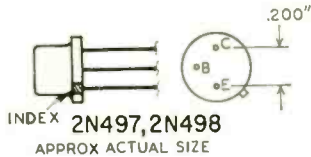

output stages, servo-motor control, magnetic core switching, solenoid operation, dc-to-dc converters and medium-power oscillators. The collector in these units is connected to the transistor's case. Insulate over positive chassis.

Maximum ratings of these Transistor transistors are:

	2N497	2N498
V_{CE} ($I_C=250 \mu\text{a}$)	60	100
V_{CB} ($I_C=100 \mu\text{a}$)	60	100
V_{EB} ($I_E=250 \mu\text{a}$)	8	8
P_{total} (watts)		
25°C	4	4
150°C	1	1

Typical characteristics at 25°C are:

h_{FE}	20	($I_C=200 \text{ ma}, V_{CE}=10$)
h_{iE} (ohms)	625	($I_B=8 \text{ ma}, V_{CE}=10$)
	(max)	
R_{CS} (ohms)	20	($I_C=200 \text{ ma}, I_B=40 \text{ ma}$)
I_{CO} (μa)	0.2	($V_{CB}=30$)
I_{EO} (μa)	0.1	($V_{EB}=5$)

INI575, INI576, INI577, INI578

These stud-mounted diffused-junction silicon rectifiers are intended for industrial usage. All will handle 3.5 amps of half-wave rectified forward current at their rated voltages at 25°C case temperature. At 125°C case temperature this current rating is derated to 1 ampere. Peak 1/2 cycle forward current (60 cycles, 25°C case) is 70 amps. Peak recurrent forward current for these diodes (60 cycles, 25°C case) is 10 amperes.

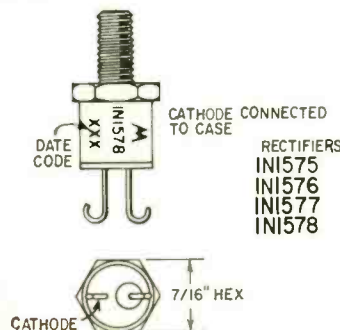

Whatever you want to do in Radio-Electronics . .

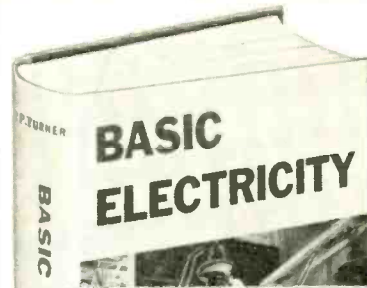

LEARN BASIC ELECTRICITY FIRST!

"The most important training of all!"

A well-known leader in electronics says: "No radio-TV men ever knew too much basic electricity—and a lot of them only think they know it. A good, solid background in these so-called fundamentals is the most important training they'll ever get."

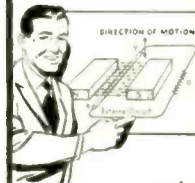

Learn your basic electricity NOW! Learn it thoroughly! Then everything else in electronics, radio, TV, communications, hi-fi, etc. comes 10 times as easy

—because they're all based on the same fundamental electrical principles!

That's why this big, new, 396-page BASIC ELECTRICITY manual brings you the most important training of all. It is a complete course in basic electrical subjects, including basic electronics. For the beginner, it is as necessary as oars are to rowing a boat. For the more experienced serviceman, amateur, experimenter or hi-fi enthusiast it paves the way to new and better understanding of almost any problem, circuit, component or piece of equipment.

COMPLETE ELECTRICAL "KNOW HOW" (Including Basic Electronics) in one big, easily understood home training guide

BASIC ELECTRICITY'S down to earth treatment of the all-important fundamentals can quickly clear up misunderstandings and problems that may be puzzling you now.

No involved mathematics—just plain, common technical sense!

From basic circuits and currents to electro-magnetism . . . from capacitance to resistance . . . from polyphase systems to 'phone principles . . . from instruments to the whys and wherefores of electrical tests . . . from amplifiers to oscillators . . . from vacuum tubes to transistors and dozens of other subjects, this big book explains things from the beginning.

Essential elements such as motors, generators, batteries, rectifiers, transformers and subjects like polyphase and power factor often neglected by ordi-

nary books are fully, and clearly taught in a way you can hardly fail to understand.

More than 300 pictures, charts and diagrams SHOW you the how and why of things. Dozens of basic electrical problem solutions make details doubly clear. Each chapter ends with a self test review so you'll be sure not to miss out on matters it's important for you to know. A top notch instructor standing by your side could hardly do better!

Best of all, the price of this new training book is only \$6.50. If sent to you in lesson form as a correspondence course, you'd say it was a bargain at \$100!

Use coupon today! Read BASIC ELECTRICITY for 10 days. If not more than satisfied, send back the book and don't owe us a cent!

Here's what it contains!

Following is a partial list of subjects:

- Circuits and Currents**
- Magnetism and Electromagnetism
 - Controls • Capacitance
 - Inductance • Resistance
- Phase Relations • Generators
- Motors • Rectifiers • Transformers
 - Wiring • Illumination
- Instruments • Measurements
- Tubes • Transistors • Amplifiers
 - Oscillators • X-Rays
 - Power Factor • Servos
 - Industrial Electronics
- Automation . . . and many others.

10-DAY FREE EXAMINATION

Dept. RE-108, RINEHART & CO., INC.
232 Madison Ave., New York 16, N.Y.

Send 396-page BASIC ELECTRICITY home training manual for 10-day FREE EXAMINATION. If I like book, I will then send \$6.50 (plus postage) promptly in full payment. If not, I will return book in 10 days and owe nothing. (SAVE! Send \$6.50 with order and we pay postage. Same 10-day return privilege with money refunded.)

Name _____

Address _____

City, Zone, State _____

OUTSIDE U. S. A. - \$7.00 cash. Money back if you return book in 10 days.

now a DC TO 5 Mc



OSCILLOSCOPE KIT

by

P A C O

Model S-55 \$87⁵⁰
5" Wide-Band Oscilloscope

Model S-55 is an outstanding addition to the only line of kits engineered and produced under the auspices of a major test equipment manufacturer. PACO kits are backed by over 26 years of **PRECISION** experience in the development of a world-renowned line of quality electronic instruments. This new, high-sensitivity, extra-wide band, DC oscilloscope has been especially engineered for ultra-low-frequency analysis as well as for high-frequency color TV applications.

PACO KITS ARE DISPLAYED AND SOLD BY YOUR FAVORITE LOCAL ELECTRONIC PARTS DISTRIBUTOR. YOU CAN ALSO BUY THEM FACTORY-WIRED, TESTED AND CALIBRATED.

SPECIFICATIONS

VERTICAL CHANNEL—3 stage push-pull
SENSITIVITY: DC—70 mv/in.
AC—25 mv RMS/in.

FREQ. RESPONSE:
DC—Within 3 db to 4.5 Mc.
Within 5 db at 5 Mc.
AC—Within 3 db from 1 cps to 4.5 Mc.
Within 5 db at 5 Mc.

RISE TIME: Better than .06 microseconds
INPUT IMPEDANCE: 1.5 megohms shunted by 33 mmfd

VERTICAL-INPUT STEP ATTENUATOR
VERTICAL POLARITY REVERSAL SWITCH

HORIZONTAL CHANNEL—push-pull output
SENSITIVITY: 0.6 v RMS/in.

FREQ. RESPONSE: Within 3 db from 1 cps to 400 Kc
INPUT IMPEDANCE: 5 megohms shunted by 23 mmfd

CATHODE-FOLLOWER HORIZONTAL INPUT CIRCUIT
LINEAR TIME BASE: 10 cps to 100 Kc, TV-V and TV-H, plus provisions for external capacitor sweep to 1 cps. Automatic "positive" and "negative" synchronization.

BUILT-IN VOLTAGE CALIBRATOR
ILLUMINATED SCREEN GRATICULE AND CAMERA-MOUNT BEZEL

MODEL S-55: Complete with all tubes including CRT, PACO-detailed assembly-operating manual. In louvred steel cabinet with two-color, easy-reading panel. Size: 13³/₄" x 8³/₄" x 17¹/₄".
Kit Net Price: \$87.50

MODEL AS-1: OSCILLOSCOPE PROBE SET
Factory Wired Net Price: \$14.95

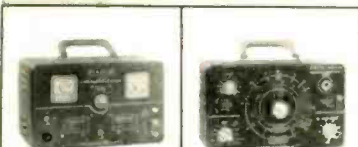

Model B-10
Battery Eliminator
Kit, Net Price: \$41.95

Model C-20
Resistance-Capacity-
Ratio Bridge
Kit, Net Price: \$20.95



Model G-30
RF Signal Generator
Kit, Net Price: \$28.50

Model M-40
High-Sensitivity
V-O-M
Kit, Net Price: \$31.50

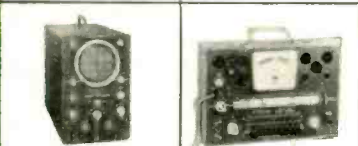

Model S-50
5" Cathode Ray
Oscilloscope
Kit, Net Price: \$49.50

Model T-60
Tube Checker
Kit, Net Price: \$38.75



Model T-65
Transistor and
Crystal Diode Tester
Kit, Net Price: \$39.95

Model V-70
Vacuum Tube Voltmeter
Kit, Net Price: \$31.50

Model Z-80
RF-AF Signal Tracer
Kit, Net Price: \$29.50

P A C O ELECTRONICS CO., INC.

70-31 84th Street, Glendale 27, Long Island, New York

A DIVISION OF **PRECISION Apparatus Company, Inc.**

Export: 458 B'way, N. Y. 13, U.S.A., Canada: Atlas Radio Corp., Ltd., 50 Wingold Ave., Toronto 19.

NEW TUBES & SEMICONDUCTORS (Cont'd)

Voltage ratings of these Motorola units are:

	1N1575	=76	=77	=78
Max contin dc inverse volts	100	200	300	400
Max peak inverse volts	100	200	300	400
Max sine-wave rms input volts	71	141	212	283

2N591

A germanium alloy-junction transistor of the p-n-p type, this unit is especially useful in high-gain large-signal

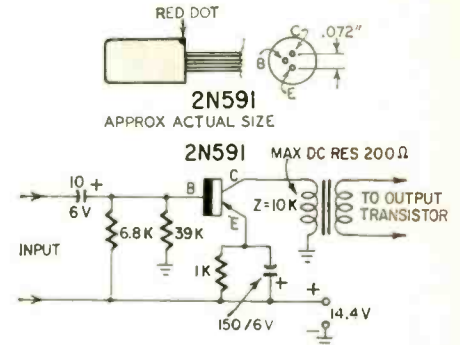

class-A audio-driver stages of automobile radio receivers.

In a common-emitter circuit the 2N591 features a typical small-signal current transfer ratio of 70.

Characteristics of the RCA 2N591 in the driver-amplifier circuit shown in the diagram are:

V _{dc} supply	14.4
V _{CE}	12
V _{BE}	0.13
I _C (ma)	2
h _{FE} (ohms)	1,000
G _P (db)	41
(at primary of driver transformer)	
P _{total} (mw)	25

END

50 Years Ago

In Gernsback Publications

HUGO GERNSBACK, Founder

Modern Electrics	1908
Wireless Association of America	1908
Electrical Experimenter	1913
Radio News	1919
Science & Invention	1920
Television	1927
Radio-Graft	1929
Short-Wave Craft	1930
Television News	1931

Some larger libraries still have copies of Modern Electrics on file for interested readers.

In October, 1908, Modern Electrics
Collins Long Distance Wireless Telephone, by A. Frederick Collins.
A Novel (Flame) Telegraph, by Caleb Brokaw.

Aerials, by A. C. Austin, Jr.
Aerophone Tower.

The Audion, by John L. Hogan, Jr.
The Aerophone Station at Lyngby (Denmark), by the Berlin Correspondent.

The Construction of a Small Transformer, by Garrett B. Linderman, Jr.
Selective Tuning, by A. M. Curtis.
Magnetic Telegraph Key for Wireless, by G. B. Medearis.
Tantalum Detector.

new Devices



DX COMPUTER. Large slide-rule chart gives world-wide amateur radio information. All call-letter prefixes, Great Circle bearings for beam headings, time differentials, international postage rates, continent, zone



and country. Addresses of all QSL bureaus of world. — **Radio Manufacturing Engineers Inc.,** Div. of Electro-Voice Inc., Buchanan, Mich.

CW TRANSMITTER KIT, EICO model 720. 90 watts. 80-10 meters in 5 bands. 6146 final amplifier, 6AQ5 clamper, 6CL6 oscillator, 6AQ5 buffer multiplier, GZ34 rectifier. One-knob bandswitching. One-knob power, tune and operate switch. Final amplifier grid drive control with-

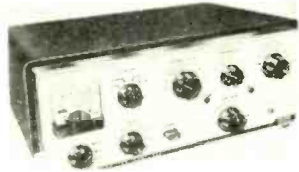

out detuning oscillator. Oscillator keying for break-in operation. Also available wired. — **Electronic Instrument Co.,** 33-00 Northern Blvd., Long Island City 1, N. Y.

4-BAND RADIO KIT, Explorer KT-135. 3-tube regenerative receiver. Wooden case. All controls on front face. Has broadcast and 1.7-5-, 5-14- and 14-30-mc bands. — **Lafayette Radio,**



165-08 Liberty Ave., Jamaica 33, N. Y.

TRANSISTOR POWER SUPPLIES. Direct replacements for vibrator type power supplies for battery and mobile receivers. Rectified and filtered units in wide variety of current ratings from 6- or 12-volt dc of input. *Model 250/12/130* (shown) produces 250 volts dc



at 130 ma from 12-volt dc input, weighs 12 ounces. — **Universal Transistor Products Corp.,** 17 Brooklyn Ave., Westbury, N. Y.

TRANSISTOR SILICONE COMPOUND, Z-5. Greaselike com-



ponent applied between transistor and chassis dissipates heat and prevents burnouts. — **General Cement Mfg. Co.,** 400 S. Wyman St., Rockford, Ill.

SPRAY-CAN HANDLE. Con-



verts any spray can into pistol-grip type spray gun. Trigger action. — **Walco Electronics Manufacturing Co.,** 100 W. Green St., Rockford, Ill.

STEREO CONVERSION KITS, SCK-1 and SCK-2. For all recent *Garrard* record players. Contains female connector wired with 3 leads for pickup arm, audio cable with plug for second amplifier, stereo shell for car-

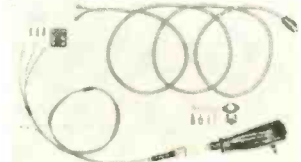

tridge, hardware, instruction sheet. No soldering. — **British Industries Corp.,** 80 Shore Rd., Port Washington, N. Y.

STEREO CONTROL CONSOLE, Madison Fielding series 340. 12 inputs, 5 outputs. Left and right channels may be blended in any proportion to feed third channel.

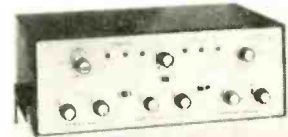

Get This Valuable Book

FREE



Just For Examining COYNE'S New Set
"Applied Practical Radio-Television"
on 7 DAY FREE TRIAL!

Yes, you get this big, brand new book, "150 Radio-Television Picture Patterns and Diagrams Explained", absolutely FREE! Complete 11x22" Schematic Diagrams on leading models Radio and TV Sets help cut your servicing time. Easy-to-read, large 8½x11" pages, with full instructions on how to use the diagrams. A "must" in every repair kit. You get this book as a FREE Gift for asking to see Coyne's new 7-book set, "Applied Practical Radio-Television"!

At Last! Money-Making "Know-How" On Transistors, Color TV and Servicing

Coyne's great 7-volume set gives you all the answers to servicing problems—quickly! For basic "know-how" that's easy to understand you'll find everything you want in Volumes 1 to 5 on over 5000 practical facts and data. Every step from fundamentals to installing, servicing and trouble-shooting all types of radio and TV sets. So up-to-date it includes the latest on COLOR TV and UHF. All this plus Volume 7—TRANSISTOR CIRCUITS—the most complete book ever published on the applications of transistors in electronics. *New!* Set has colorful design, washable covers.

EXTRA! 868-Page TV Cyclopaedia Included!

For speedy on-the-job use, you also get Vol. 6—famous Coyne's TV CYCLOPAEDIA. Answers problems on servicing, alignment, installation, etc. in easy ABC order. Use this 7-volume TV-RADIO LIBRARY FREE for 7 days; get the Servicing Book FREE!

FREE!

5 Years
Of Valuable
Supplements



With your set you also get Coyne's annual Supplement Service FREE for 5 years. Keeps your set up-to-date on everything that will be new in radio, television, electronics and electricity.

NOW!
7 BIG BOOKS
IN ONE GREAT SET!



SEND NO MONEY! Just mail coupon for 7-volume set on 7 days free trial. We'll include book of 150 TV-Radio Patterns & Diagrams. If you keep the set, pay \$3 in 7 days and \$3 per month until \$26.50 plus postage is paid. (Cash price, only \$24.95). Or you can return the library at our expense in 7 days and owe nothing. **YOU BE THE JUDGE.** *Either way, the book of TV-Radio Patterns is yours FREE to keep!* Offer is limited. Act NOW!

FREE BOOK—FREE TRIAL COUPON!

Educational Book Publishing Division
COYNE ELECTRICAL SCHOOL, Dept. A8-T1
500 S. Paulina St., Chicago 12, Ill.

YES! Send 7-Volume "Applied Practical Radio-Television" for 7 days FREE TRIAL per your offer. Include TV-Radio Patterns & Diagram Book FREE.

Name Age

Address

City Zone State

Where Employed

Check here if you want library sent C.O.D. You pay postman \$24.95 plus C.O.D. postage on delivery. 7-day money-back guarantee.

Educational Book Publishing Division

COYNE ELECTRICAL SCHOOL

500 S. Paulina St., Dept. A8-T1, Chicago 12, Ill.

Mixing switch for selectively feeding 2 channels simultaneously into monaural system. Rumble and noise filters. Response 30-20,000 cycles within 3 db. Gain 15 db on high-level channels, 50 on low-level. Six 7025/ECC83 dual triodes. Cathode-follower main output. 4 ac outlets controlled by main power switch.—**Brand Products Inc.**, 11 Lorimer St., Brooklyn, N. Y.

STEREO RECORD CHANGER, GS 77. Stereophonic version has same features as monophonic



changer plus quick-change cartridge holder for switch from stereo to monophonic, double-channel muting switch, service receptacle for automatic amplifier shutoff, improved 4-pole motor with dynamically balanced rotor.—**Glaser-Steers Corp.**, 20 Main St., Belleville, N. J.

GROOVE SELECTOR, Feather-Lift FL-1. Guards against damage to needle and record. Clipped to pickup arm, spring



permits needle to be dropped into any groove of record without scratching record.—**Duotone Co.**, Keyport, N. J.

TURNOVER CARTRIDGE, 4T. Ceramic cartridge available with 2 LP needles for twice the wear,



or in combinations of 1- and 3-mil diamond and sapphire needles. Held in pickup arm by snap-in bracket requiring no tools. Needles coupled directly to transducer without shaft. Response flat from 20-12,000 with gradual rolloff up to 20,000 cycles.—**Sonotone Corp.**, Elmsford, N. Y.

STEREO CARTRIDGE, model 371D Stanton Stereo Fluxvalve. Contains 2 magnetic systems



with discriminator to attenuate interchannel interference by more than 20 db. Response flat 10-30,000 cycles within 2 db. Hum-rejection circuit. *T-Guard* stylus assembly contains all moving parts.—**Pickering & Co.**, Sunnyside Blvd., Plainview, N. Y.

STEREO HI-FI LINE, Custom series. All-new models 24PG



and 214 stereo preamps, 101GT FM and 102GT FM-AM tuners. 4 other new and redesigned amplifiers and one preamp complete the *Custom* series.—**Grommes, Div. of Precision Electronics Inc.**, 9101 King St., Franklin Park, Ill.

STEREO DIAMOND NEEDLE for cartridges of 3 major manufacturers. Measures slightly less than 0.7 mil.—**Fidelitone Inc.**, 6415 Ravenswood Ave., Chicago.

TAPE-DECK MODIFICATIONS. Improved FF75 deck



with belt shift speed changer and improved control knob. Available with head designed to play 4-track stereo tape. New models 89 and 95 also available.—**Viking of Minneapolis Inc.**, 9600 Aldrich Ave., S., Minneapolis 20, Minn.

CARTRIDGE TAPE RECORDER plays RCA type 3 1/2-



ips 4-track stereo cartridge tapes; plays and records at 7 1/2 ips. 5 pushbutton tape transit controls, 2 preamps, 5-watt amplifier. VU meter. Automatic shutoff. Response 40-15,000 cycles. Same company also has announced *Emperor II (model NL-4)*: open-reel stereo tape recorder with 2 input channels.—**Pentron Corp.**, 777 S. Tripp Ave., Chicago 24, Ill.

TAPE RECORDER KIT, Heathkit model TR-1A. Monaural record-playback with fast forward and rewind. Belt drive, 7 1/2 and 3 3/4 ips. Flutter and wow less than 0.35%. Response at 7 1/2 ips 50-5,000 cycles ±2 db. Single control lever selects all functions. Use in vertical or horizontal position. Model TE-1 record-playback preamp, supplied with mechanical assembly, provides standard NARTB equalization. Record interlock



Stromberg-Carlson Audiophile Turntable



ASR-433 Stereo Amplifier—Selected for display at the Vienna International Fall Fair.



AP-437 Power Amplifier

THE NEW STROMBERG-CARLSON COMPONENTS

integrity in music

Integrity in Music, as applied to high fidelity components, means reproduction which adds nothing to, or takes nothing from, the original performance.

Our choice of this slogan is no accident. Just as your purchase of a component system is not a casual investment, our attitude toward the manufacture of components is very serious. Each piece of gear must reflect the highest possible achievement of engineering, production, and musical skill. Yes, musical skill—because the guiding minds of the Stromberg-Carlson component group are those of electronic and acoustic engineers with extensive musical training.

The musical sound of our new components was the final critical test before they were made available to you.

We will be glad to submit our specifications to your critical judgment.

See your dealer or write to us for full data on our complete new line of Amplifiers, Speakers, Speaker Systems, Enclosures and Program Sources.

"There is nothing finer than a Stromberg-Carlson"

STROMBERG-CARLSON SC GD

A DIVISION OF GENERAL DYNAMICS CORPORATION

1478C N. Goodman St. • Rochester 3, N. Y.

Electronic and communications products for home, industry and defense.

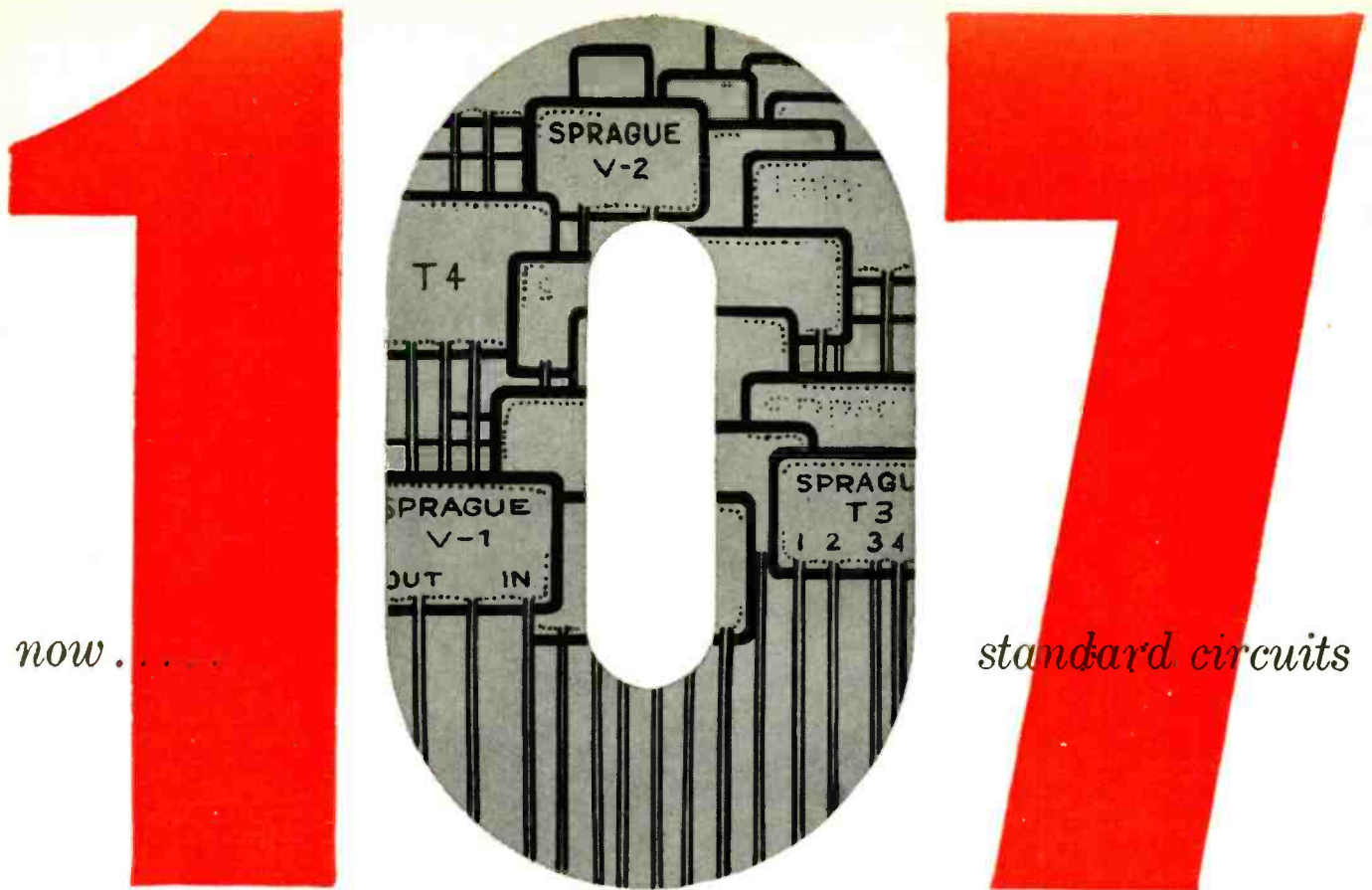

BULPLATE® Printed Circuits

for all your printed circuit replacements

Sprague's new BULPLATE Printed Circuit line now includes *the most comprehensive listing of printed circuits available anywhere*. By standardizing on the Sprague BULPLATE line, you'll be able to replace practically every printed circuit found in original equipment, including . . .

antenna-chassis isolation networks
 detector-triode coupling networks
 retrace-suppression networks
 vertical feedback networks
 triode coupling networks
 detector-pentode coupling networks
 automatic gain control networks
 horizontal deflection networks
 sound i-f networks

vertical integrators
 decoupling filters
 audio output networks
 phase comparators
 parallel resistor-capacitor networks
 tone compensation networks
 diode filters
 pentode coupling networks
 sync take-off networks

Get your copy of Sprague's new BULPLATE Replacement Manual K-351 now. Original set manufacturers' part numbers are cross-referenced to



Sprague replacement part numbers . . . making Sprague BULPLATES extra-easy-to-use. Ask your distributor for a free copy, or send 10c (to cover handling and mailing costs) to Sprague Products Co., 81 Marshall St., North Adams, Massachusetts.

don't be vague . . . insist on

SPRAGUE®

the mark of reliability

SPRAGUE RESEARCH IS CONSTANTLY PRODUCING NEW AND BETTER COMPONENTS FOR YOU

RADIO and ELECTRONICS TRAINING AT HOME

BUILD 16 RADIO

**CIRCUITS with DELUXE
1959 Progressive
RADIO "EDU-KIT"®**

Reg. U.S.
Pat. Off.

**PRACTICAL only
HOME RADIO COURSE \$22.95**



NOW INCLUDES

- ★ 12 RECEIVERS
- ★ TRANSMITTER
- ★ SIGNAL TRACER
- ★ SIGNAL INJECTOR
- ★ CODE OSCILLATOR

- ★ No Knowledge of Radio Necessary
- ★ No Additional Parts or Tools needed
- ★ Excellent Background for TV
- ★ School Inquiries Invited
- ★ Attractively Gift Packed

FREE EXTRAS

- SET OF TOOLS ● RADIO & ELECTRONICS TESTER ● ELECTRIC SOLDERING IRON ● TESTER INSTRUCTION MANUAL ● MEMBERSHIP IN RADIO-TV CLUB ● CONSULTATION SERVICE ● HI-FI GUIDE ● QUIZZES ● TV BOOK ● FCC AMATEUR LICENSE TRAINING ● RADIO BOOK ● PRINTED CIRCUITRY ● PLIERS-CUTTERS ● ALIGNMENT TOOL ● WRENCH SET ● CERTIFICATE OF MERIT ● VALUABLE DISCOUNT CARD

WHAT THE "EDU-KIT" OFFERS YOU

The "Edu-Kit" offers you an outstanding PRACTICAL HOME RADIO COURSE at a rock-bottom price. Our kit is designed to train Radio & Electronics Technicians, making use of the most modern methods of home training. You will learn radio theory, construction, servicing, basic Hi-Fi and TV repairs, code, FCC amateur license requirements.

You will learn how to identify radio symbols, how to read and interpret schematics, how to mount and layout radio parts, how to wire and solder, how to operate electronic equipment, how to build radios. Today it is no longer necessary to spend hundreds of dollars for a radio course. You will receive a basic education in radio, worth many times the small price you pay, only \$22.95 complete.

THE KIT FOR EVERYONE

The Progressive Radio "Edu-Kit" was specifically prepared for any person who has a desire to learn radio. The "Edu-Kit" has been used successfully by young and old in all parts of the world, by many Radio Schools and Clubs in this country and abroad. It is used for training and rehabilitation of Armed Forces Personnel and Veterans throughout the world.

The Progressive Radio "Edu-Kit" requires no instructor. All instructions are included. Every step is carefully explained. You cannot make a mistake.

PROGRESSIVE TEACHING METHOD

The Progressive Radio "Edu-Kit" is the foremost educational radio kit in the world, and is universally accepted as the standard in the field of electronics training. The "Edu-Kit" uses the modern educational principle of "Learn by Doing." Therefore, you will construct radio circuits, perform jobs and conduct experiments to illustrate the principles which you learn.

You begin by examining the various radio parts included in the "Edu-Kit." You then learn the function, theory and wiring of these parts. Then you build a simple radio. With this first set, you will enjoy listening to regular broadcast stations, learn theory, practice testing and troubleshooting. Then you build a more advanced radio, learn more advanced theory and techniques. Gradually, in a progressive manner, and at your own rate, you will find yourself constructing more advanced multi-tube radio circuits, and doing work like a professional Radio Technician.

Included in the "Edu-Kit" course are sixteen Receiver, Transmitter, Code Oscillator, Signal Tracer and Signal Injector circuits. These are not unprofessional "breadboard" experiments, but genuine radio circuits, constructed by means of professional wiring and soldering on metal chassis, plus the new method of radio construction known as "Printed Circuitry." These circuits operate on your regular AC or DC house current.

In order to provide a thorough, well-integrated and easily-learned radio course, the "Edu-Kit" includes practical work as well as theory; troubleshooting in addition to construction; training for all, whether your purpose in learning radio be for hobby, business or job; progressively-arranged material, ranging from simple circuits to well-advanced topics in Hi-Fi and TV. Your studies will be further aided by Quiz materials and our well-known FREE Consultation Service.

THE "EDU-KIT" IS COMPLETE

You will receive all parts and instructions necessary to build 16 different radio and electronics circuits, each guaranteed to operate. Our Kits contain tubes, tube sockets, variable, electrolytic, mica, ceramic and paper dielectric condensers, resistors, tie strips, coils, hardware, tubing, bunched metal chassis, Instruction Manuals, hookup wire, solder, etc.

In addition, you receive Printed Circuit materials, including Printed Circuit chassis, special tube sockets, hardware and instructions. You also receive a useful set of tools, a professional electric soldering iron, and a self-powered Dynamic Radio & Electronics Tester. The "Edu-Kit" also includes Code Instructions and the Progressive Code Oscillator, in addition to the F.C.C.-type Questions and Answers for Radio Amateur License training. You will also receive lessons for servicing with the Progressive Signal Tracer and the Progressive Signal Injector, and a High Fidelity Guide and Quiz Book. Everything is yours to keep.

J. Statistis, of 25 Poplar Pl., Waterbury, Conn., writes: "I have repaired several sets for my friends, and made money. The "Edu-Kit" paid for itself. I was ready to spend \$240 for a course, but I found your ad and sent for your Kit."

UNCONDITIONAL MONEY-BACK GUARANTEE

The Progressive Radio "Edu-Kit" has been sold to many thousands of individuals, schools and organizations, public and private, throughout the world. It is recognized internationally as the ideal radio course.

By popular demand the progressive Radio "Edu-Kit" is now available in Spanish as well as English. It is understood and agreed that should the Progressive Radio "Edu-Kit" be returned to Progressive "Edu-Kits" Inc., for any reason whatever, the purchase price will be refunded in full, without quibble or question, and without delay.

The high recognition which Progressive "Edu-Kits" Inc. has earned through its many years of service to the public is due to its unconditional insistence upon the maintenance of perfect engineering, the highest instructional standards, and 100% adherence to its Unconditional Money-Back Guarantee. As a result, we do not have a single dissatisfied customer throughout the entire world.

ORDER FROM AD—RECEIVE FREE BONUS RESISTOR AND CONDENSER KITS WORTH \$7.00

- Send "Edu-Kit" Postpaid. I enclose full payment of \$22.95.
- Send "Edu-Kit" C.O.D. I will pay \$22.95 plus postage.
- Send me FREE additional information describing "Edu-Kit."

Name.....
Address.....

Progressive "EDU-KITS" Inc. 1186 Broadway, Dept. 145G
Hewlett, N. Y.

NEW DEVICES (Continued)

prevents accidental erasure. 6E5 tube indicates recording level. Bias-erase frequency provided by 60-ke push-pull oscillator. Cathode-follower output from playback channel.—Heath Co., Benton Harbor, Mich.

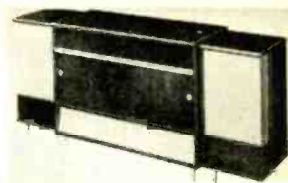

STEREO TAPE RECORDER, Crown Stereo-X. Professional portable. Tape speeds 15, 7½, 3½ ips (others available on request). Split- or full-track erase. Micro-sync timing. Response 20–30,000 cycles ±2 db at 15 ips,

fier. Gold and black panels and grill cloth. Grained ¼-inch Philippine mahogany or select birch plywood. Sliding top panel and front doors. Speaker and center cabinets may be purchased separately. Precut panels for Heathkit components, blank panels for other equipment.—Heath Co., Benton Harbor, Mich.

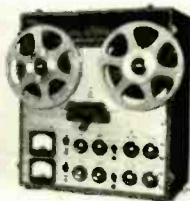

HI-FI TURNTABLES, TD-184 (shown) has semi-automatic action. Dial selects record size, starts motor, actuates arm which

20–20,000 ±2 db at 7½, 20–10,000 ±3 db at 3½. Flutter and wow .07% at 15 ips, .09% at 7½, 0.2% at 3½. Accommodates 5- to 10½-inch NAB reels, and 14-inch reels on long-play model. Fast forward or rewind time 55 seconds for 2,400 feet. Aluminum construction. — International Radio & Electronics Corp., S. 17th St. & Mishawaka Rd., Elkhart, Ind.



TAPE DEMAGNETIZER. Professional equipment now offered to hobbyists. Handles reels up to 10 inches, any width

lowers automatically into first groove. Automatic shutoff. TD-184 is similar, for manual operation. Both have integral arm, nylon bearings, 4 speeds. — Thorens Co., New Hyde Park, N. Y.



STEREO AMPLIFIERS, RA-100 recording amplifier (shown) supplies audio, bias and erase power for conversion of monophonic tape recorder to stereo. NARTB equalization, VU-meter, audio monitor jack. PL-100 playback amplifier has equalization

tape.—Aerovox Corp., Distributor Div., 740 Belleville Ave., New Bedford, Mass.

REPLACEMENT SPEAKERS, series 05. Sintered-iron-cup pot construction. Miniature cup pot permits placement of components around back of speaker.



control allowing frequency response to be varied 15 db at 10 kc.—The Nortronics Co., 1015 S. 6 St., Minneapolis 4, Minn.



Included are models 2A05, 4A05 (shown) and 5A05 with pin-cushion basket.—Quam Nichols Co., Marquette Rd. & Prairie Ave., Chicago 37, Ill.

STEREO AMPLIFIER, model 299. Two 20-watt channels. Quick-set "dot controls" for optimum balancing. Phase reverse switch changes phase of one channel 180° with respect to

COMPACT SPEAKER, WR-8, 8-inch unit designed for stereo and shelf-sized cabinets. Response 15–15,000 cycles. Curvilinear cone and rigidizing processing method prevent cone decoupling. Special 1- and 2-speaker enclosures available from Q-Sonics Inc., Skyline Bldg., Syracuse 3, N. Y.—Sonotone Corp., Elmsford, N. Y.



other. 2 low-, 3 high-level stereo inputs. Preamp tube heaters de-operated. Self-balancing phase inverter compensates for variation in output tubes due to aging. May be used as electronic crossover. — H. H. Scott Inc., Dept. P., 111 Powdermill Rd., Maynard, Mass.



STEREO CABINET KIT, model SE-1. Holds complete hi-fi stereo system. AM-FM tuner, tape deck, preamp, power ampli-

STEREO TUNER, model 1157. AM-FM. AM sensitivity more than 30 μv. FM sensitivity 2.5



μ v with 20-db quieting. Afc. 2 amplifier outlets. 9 tubes and selenium rectifier. FM response 20-20,000 cycles, AM 20-6,000. Also available: model 457 FM tuner, model 357 AF FM-AM tuner.—Eric Engineering, 8270 Santa Monica Blvd., Los Angeles 46, Calif.

PICTURE-SOUND GENERATOR, model 1150. Transmits pictures from 35-mm slides with simultaneous sound to any number of TV receivers (closed-circuit). Automatic magazine slide changer. May be



remotely controlled. 2 audio inputs. Response 80-13,000 cycles. Channel selector provides choice of any channel from 2 through 6.—B & K Mfg. Co., 3726 N. Southport Ave., Chicago 13, Ill.

TV CHASSIS, Gold Medal Custom model 2430 N. Uses 630-type circuit. Designed for self-contained 12-inch speaker or play-

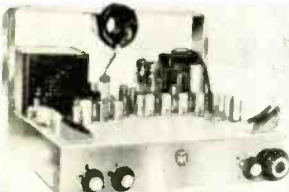

ing through hi-fi system. Cascade turret tuner. Keyed age circuit. Hi-sweep autotransformer circuit. Sensitivity 5 μ v. Local-distance area control switch. Picture-expander control for low line voltage. Nickel-plated. Phono input. Accommodates 21-27-inch 90° picture tube.—Tech-Master Corp., 75 Front St., Brooklyn 1, N. Y.

UHF CONVERTERS, Ultracon Deluxe model FTC (shown) has



high-gain amplifier, low-loss circuit, built-in uhf amplifier, sealed coaxial tuner, preselection stage, 6AF4-A oscillator, low-noise mixer diode. Ultracon TCU similar but designed for primary signal areas.—Jerrold Electronics Corp., 15 St. & Lehigh Ave., Philadelphia 32, Pa.

INFRA-RED TELESCOPE. Military Sniperscope M-2. Contains 1P25-A image tube, semitransparent photocathode sensitive to



infra-red radiation, electron lens, fluorescent screen, power pack, infra-red light source.—Edmund Scientific Co., Barrington, N. J.

PRECISION POTENTIOMETERS, series 55. Cast epoxy



resin shell. Minimum breakdown voltage 4,000. Rated at 3 watts. Center-tapped. Servo or bushing mounting. Gold-plated terminals. Exceeds MIL specs. Stocked in values of 500, 5,000, 20K, 50K, 100K ohms.—Clarostat Mfg. Co., Dover, N. H.

ELECTROLYTIC KITS, Stack-a-Lytic. For TV-radio replacements. 8 most popular AFH



twist-prong capacitors housed in metal cabinet.—Aerovox Corp., 740 Belleville Ave., Distributor Div., New Bedford, Mass.

MINIATURE MULTITESTER, AR-660. Weighs 10 ounces. Precision 38-microamp D'Arsonval movement, jeweled bearings. Resistance 20,000 ohms per volt on dc, 10,000 on ac. Ranges: 0-5, 25, 100, 500, 1,000 volts dc; 0-5, 25,



100, 500, 1,000 volts ac; 0-6,000 and 600,000 ohms, 6 and 60 megs; 0-.05, 5, 50, 500 amperes; -20 to +16, -6 to +30, +8 to +44, +20 to +56, +28 to +64 db.—Argonne Electronics Mfg. Corp., 165-11 South Rd., Jamaica 33, N. Y.

MINIATURE FUSE POST, no. 342012. Accepts 3AG fuse 1 1/4



inches long and 1/4 inch in diameter. Rated at 15 amps at 250 volts dc.—Littelfuse Inc., Des Plaines, Ill.

TRANSISTOR RADIO TESTER, model 810. 200-575-kc tuned receiver for checking



**ORDER by MAIL and SAVE!
TV PICTURE TUBES**

10BP4 ...\$ 7.95	17BP4 ...\$10.95	21AMP4 \$19.95
12LP4 ... 8.95	17CP4 ...17.00	21ATP4 ...20.95
14B/CP4 ... 9.95	17GP4 ...17.60	21AUP4 ...20.95
16DP4 ...14.95	17HP4 ...13.60	21EP4 ...14.95
16EP4 ...15.90	17LP4 ...13.60	21FP4 ...15.95
16GP1 ...15.90	17QP4 ...11.95	21WP4 ...17.30
16KP4 ...10.95	17TP4 ...19.30	21YP4 ...15.95
16LP4 ...10.95	19AP4 ...19.30	21ZP4 ...14.95
16RP4 ...10.95	20CP4 ...13.90	24CP4 ...23.95
16WP4 ...15.20	20HP4 ...17.95	24DP4 ...26.95
16TP4 ...10.95	21AP4 ...22.10	27EP4 ...39.95
17AVP4 ...15.20	21ALP4 ...20.95	27RP4 ...39.95

27"—6 month guarantee—all others 1 year. Aluminized Tubes, \$5.00 more than above prices. These prices are determined to include the return of an acceptable similar tube under vacuum.

ALL PRICES FOB CHICAGO, ILLINOIS. Deposit required, when old tube is not returned, refundable at time of return. 25% required on C.O.D. shipments. Old tubes must be returned prepaid. We ship anywhere.

WRITE FOR COMPLETE LIST.

—PICTURE TUBE OUTLET—
3032 Milwaukee Ave., Chicago 18, Ill.
Dickens 2-2048

GET YOUR COMMERCIAL TICKET EASIER WITH...

Kaufman's
RADIO OPERATOR'S LICENSE Q AND A MANUAL

now available
6th EDITION
on to the minute

The BEST book for
FCC License Preparation
Covers elements 1 thru 8.

The only book with complete discussion of answers to every technical question in the FCC Study Guide. Makes it very easy to answer multiple choice questions. Used by leading schools and industry. Only \$6.60 at jobbers, bookstores or direct from: RE-10

JOHN F. RIDER PUBLISHER, INC.
116 West 14th Street, New York 11, N. Y.

New

ERIE

ELECTRONIC COMPONENTS CATALOG D-58

ERIE RESISTOR CORPORATION, ERIE, PA.

Free!

ERIE



D-58 CATALOG
at your
Authorized
ERIE DISTRIBUTOR

The new ERIE D-58 Catalog, including the complete and enlarged line of ERIE Electronic Components is ready. Your authorized ERIE Distributor has a copy for you. If he can't supply you, write us, giving his name.

Make the ERIE Catalog
Your Catalog

ERIE Electronics Distributor
DIVISION
ERIE RESISTOR CORPORATION
ERIE, PA.

The specs are the proof...now your best buy in ham equipment is

EICO



New

90-WATT CW TRANSMITTER #720
KIT \$79.95 WIRED \$119.95

Conservative, highly efficient design plus stability, safety, and excellent parts quality. Covers 80 thru 40, 20, 15, 11, 10 meters (popular operating bands) with one knob band-switching. 6146 final amplifier for full "clean" 90W input, protected by clamper tube circuit. 6CL6 Colpitts oscillator, 6AQ5 clamper, 6AQ5 buffer-multiplier, GZ34 rectifier. "Novice limit" calibration on meter keeps novice inside the FCC-required 75W limit. No shock hazard at key. Wide range, hi-efficiency pi-network matches antennas 50 to 1000 ohms, minimizes harmonics. EXT plate modulation terminals for AM phone modulation with 65W input. Excellent as basic exciter to drive a power amplifier stage to maximum allowable input of 1KW. Very effective TVI suppression. Ingenious new "low silhouette" design for complete shielding and "living room" attractiveness. Finest quality, conservatively rated parts, copper-plated chassis, ceramic switch insulation. 5" H, 15" W, 9 1/2" D.



NEW UNIVERSAL MODULATOR-DRIVER #730
KIT \$49.95 WIRED \$79.95 Cover E-5 \$4.50

Superb, truly versatile modulator at low cost. Can deliver 50 watts of undistorted audio signal for phone operation, more than sufficient to modulate 100% the EICO #720 CW Transmitter or any xmitter whose RF amplifier has a plate input power of up to 100W. Multi-match output xfr matches most loads between 500-10,000 ohms. Unique over-modulation indicator permits easy monitoring, precludes need for plate meter. Low level speech clipping and filtering with peak speech frequency range circuitry. Low distortion feedback circuit, premium quality audio power pentodes, indirectly heated rectifier filament. Balance & bias adjust controls. Inputs for crystal or dynamic mikes, phone patch, etc. Excellent deluxe driver for high-power class B modulation. ECC83/12AX7 speech amplifier, 6AL5 speech clipper, 6AN8 amplifier driver, 2-EL34/6CA7 power output, EM84 over-modulation indicator, GZ34 rectifier. Finest quality, conservatively rated parts, copper-plated chassis. 6" H, 14" W, 8" D.

NEW GRID DIP METER #710
KIT \$29.95 WIRED \$49.95 including complete set of coils for full band coverage.

Exceptionally versatile. Basically a VFO with micro-ammeter in grid; determines freq. of other osc. or tuned circuits; sens. control & phone jack facilitate "zero beat" listening. Excellent absorption wave meter. Ham uses: pre-tuning & neutralizing xmitters, power indication, locating parasitic osc., antenna adj., correcting TVI, de-bugging with xmitter power off, determining C,L,Q. Servicing uses: alignment of filters, IF's; as sig. or marker gen. Easy to hold & thumb-tune with 1 hand. Continuous 400 kc - 250 mc coverage in 7 ranges, pre-wound 0.5% accurate coils. 500 ua meter movement. 6AF4(A) or 6T4 Colpitts osc. Xmfr-operated set, rect. 2 1/4" H, 2 3/4" W, 6 1/4" L. Satin deep-etched aluminum panel; grey wrinkle steel case.

IN STOCK! Compare & take them home - right "off the shelf" - from 1900 neighborhood EICO dealers. For free catalog mail coupon. Over 1 MILLION EICO instruments in use throughout the world. Add 5% in the West

Send for FREE CATALOG now C-10
EICO, 33-00 Northern Blvd., L.I.C. 1, N. Y.
Show me HOW TO SAVE 50% on 60 models of top-quality equipment (in box I have checked here: HAM GEAR HI-FI TEST INSTRUMENTS. Send FREE literature and name of EICO dealer.

NAME.....
ADDRESS.....
CITY..... STATE.....

See EICO's Hi-Fi and Test Equipment ads on Pages 33 and 34.



EICO

NEW DEVICES (Continued)

if stages, 550-1600-ke receiver for rf, audio amplifier for troubleshooting audio stages, 400-cycle audio output, 200-1600-ke AM signal generator, transistor test circuit (leakage and gain), loudspeaker.—Hickok Electrical Instrument Co., 10531 Dupont Ave., Cleveland 8, Ohio.

WIDE-BAND SCOPE KIT, model S-55, 5-inch. For ultra-low-frequency analysis and high-frequency applications. Vertical-channel 3-stage push-pull; sensitivity 70 mv/inch on

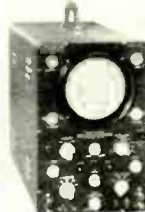

dc, 25 mv rms/in on ac. Horizontal channel, push-pull output; sensitivity 0.6 volt rms/inch. Available factory-wired and calibrated.—PACO Electronics Co., 70-31 84 St., Glendale 27, N. Y.

BATTERY TESTER, Sencore Tru-Load model BT-101. Checks all dry and mercury types under optimum load specified by man-



ufacturers. Chart lists over 1,000 types of batteries.—Service Instruments Corp., 121 Official Rd., Addison, Ill.

FIELD-STRENGTH METER, model 498-A. Calibrated for simple and accurate readings. Designed for location of maximum



signal areas, comparing antenna systems, adjusting boosters, antenna orientation and tuner substitution checks. Portable.—Simpson Electric Co., 5200 W. Kinzie St., Chicago 44, Ill.

STEREO BALANCE METER, model TM-40. Two independent damped ac meter movements with scales calibrated in VU



and percent. Separate continuously variable attenuator for up to 20 db of attenuation in each channel. Input impedance 10,000 ohms per channel. Sensitivity 1.4 volts for 0 VU.—Lafayette Radio, 165-08 Liberty Ave., Jamaica 33, N. Y.

MINIATURE EDGEWISE

METER, model 120. For panels where space is at a premium. Weight 4 ounces. Fits hole 9/16

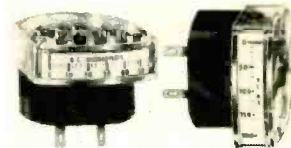

x 1 11/16 inches. Shelf-shielded bar-wing magnet, not affected by magnetic panels. High-torque rugged movement.—Triplett Electrical Instrument Co., Bluffton, Ohio.

SINE-SQUARE-WAVE GENERATOR, model E-310. Range 5 cycles to 600 kc, 5 bands, ±1% direct-reading accuracy. Output within 1 db over each band and band-to-band. Distortion less



than 1% at 10 volts into 600 ohms. Output level, sine wave 10 volts rms into 600 ohms, square wave 10 volts p-p, 0.15-microsecond rise time.—Precision Apparatus Co., 70-31 84 St., Glendale 27, N. Y.

AM-RF GENERATOR, model 7200. Range 100 kc-280 mc. Used for alignment of TV oscillator coils on all channels and as



marker at rf or if frequencies in all TV receivers. Large vernier scale. High rf output.—Philco Corp., Accessory Div., C & Westmoreland Sts., Philadelphia 34, Pa.

VTVM, model 208. Sloping panel, 4 1/2-inch 200-microamp meter; 7 dc, 7 ac, 7 ohm ranges, plus EIA ohm scale to check color-coded resistance values and tolerance limits. Accuracy



within 3%. "Shift-lever" type function switch, automatically connects proper probe, isolating probe not in use.—Seco Manufacturing Co., 5015 Penn Ave. S., Minneapolis, Minn.

CABINET REPAIR KIT, for technicians. 13 jars of stains, solvents and pigments for use in combination to duplicate any finish. Touchup brushes, steel wool and instructions.—Motorola Inc., Field Service Dept., 4545 W. Augusta Blvd., Chicago 51, Ill.

NEW DEVICES (Continued)

ANTENNA BASES, for amateurs. *Model M-14* (shown): swivel base, coaxial connector, pads and steel backup plate. *Model M-13*: swivel base with



Brite cadmium-plated die-cast aluminum swivel ball, 3 layers of base insulator, 2 rubber pads. *Model M-15*: coaxial adapter permits use of coaxial plug, eliminating splitting of cable.—**Antenna Specialists Co.**, 12435 Euclid Ave., Cleveland 6, Ohio.

TRANSISTOR BATTERIES, Nos. 2731, 2761, 2752 and 2713. Cathodic-envelope flat-cell con-



struction gives longer life in heavy-drain applications.—**National Carbon Co.**, 30 E. 42 St., New York 17, N. Y.

SPEAKER SYSTEM, JansZen



Z-300. *Model 65* 2-element electrostatic tweeter and *model 350* 11-inch cone woofer in Fiberglass-filled enclosure — **Neshaminy Electronic Corp.**, Easton Rd., Neshaminy, Pa.

SMALL ENCLOSURE, *model TSE-1*. Accommodates 8-inch woofer and tweeter. 2 ducted



ports. "Forward-front" design. May be used horizontally or vertically.—**Argos Products Co.**, Genoa, Ill.

SPEAKER FUSE BOX, *Gramercy Speaker-Saver*. Protects speakers from failure due to overloads, faulty wiring, switching transients or amplifier failure. For speakers with voice-coil impedance of 4, 8 or 16



ohms. Mounted on phenolic board with clear plastic door.—**Pro-Sound Corp.**, 175 Fifth Ave., New York 10, N. Y.

All specifications on these pages are from manufacturers' data.

SAVE TIME . . .

SAVE MONEY . . .

HELP MORE PEOPLE . . .

SAVE MORE LIVES . . .

GIVE THE UNITED WAY

SENCORE

Handy "36"

R-C Substitution Unit

Another Sencore Time-Saver

"36"

Most Often Needed Components At YOUR Fingertips!

3 pole, 12 position switch individually selects one of the "36" components for direct substitution.

Contains:

- ★ 12—1 watt 10% resistors from 10 ohms to 5600 ohms
- ★ 12—1/2 watt 10% resistors from 10K ohms to 5.6 megohms
- ★ 10—600 volt capacitors Completely isolated from 100-mmf. to .5mf.
- ★ 1—10mf., 450V Electrolytic
- ★ 1—40mf., 450V Electrolytic

★ For Shop, Lab, or outside service

AVAILABLE AT ALL PARTS DISTRIBUTORS!

SERVICE

INSTRUMENTS CORP.
171 OFFICIAL RD., ADDISON, ILL.

ONLY \$1275 DEALER NET

POPULAR SENCORE PRODUCTS

- Transistor Tester
- Leakage Checker
- Filament Tester
- Voltage Regulator
- Bias Supply

Cut out this ad now for further information.

Just Out

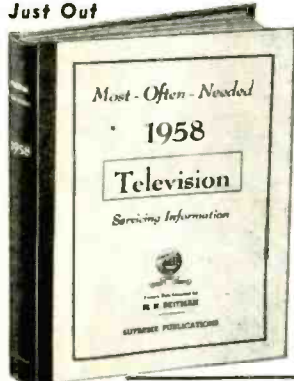

New SUPREME 1958 TV Manual

AMAZING BARGAIN

The new 1958 TV manual is the scoop of the year. Covers all important sets of every make in one giant volume. Your price for this mammoth manual is only \$3. This super-value defies all competition. Other annual volumes at only \$3 each. Factory service material simplifies repairs. Includes all data needed for quicker TV servicing. Practically tells you how to find each fault and make the repair. More pages, more diagrams, more service data per dollar of cost.

TELEVISION SERVICING COURSE

Let this new course help you in TV servicing. Amazing bargain, complete, only \$3. full price for all lessons. Giant in size, mammoth in scope, topics just like a \$200.00 correspondence course. Lessons on picture faults, circuits, adjustments, short-cuts, UHF, alignment facts, hints, antenna problems, trouble-shooting, test equipment, picture analysis. Special, only **\$3**

Companion RADIO COURSE, Introduction to TV

Here is your complete radio training in 21 easy-to-follow lessons. Covers fundamentals, fault finding, use of test equipment. Everything in radio. Introduction to TV. Self-test questions. New edition. Special, only **\$2.50**

18 RADIO VOLUMES

RADIO DIAGRAMS

Here is your complete source of all needed RADIO diagrams and service data. Covers everything from the most recent 1958 radios to pre-war old-timers: home radios, auto sets, combinations, changers, III-FI, FM, and portables. Sensational values. Only \$2 for most volumes. Every manual has extra large schematics, all needed alignment facts, parts lists, voltage values, trimmers, dial stringing, and helpful hints. Volumes are large in size, 8 1/2 x 11 inches, about 190 pages. See coupon at right for a complete list of these radio manuals.



COVERS ALL POPULAR SETS

Here is your service data for faster, easier TV repairs. Lowest priced. Best by comparison. **Supreme TV** manuals have all needed service material on every popular TV set. Helpful, practical, factory-prepared data that will really make TV servicing and adjustment easy for you. Benefit and save with these amazing values in service manuals. Only \$3 per large volume. The choice of wise servicemen.

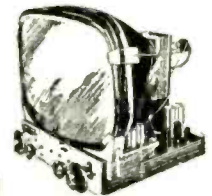

SIMPLIFIES TV REPAIRS

These giant TV manuals have complete circuits, needed alignment facts, curves, service hints, all factory production changes, voltage charts, waveforms, and double-page schematics. Here are your authentic service instructions to help you do expert work quicker; and priced at only \$3 per large yearly manual. Repair any TV model ever made by having in your shop all 13 volumes as listed in coupon. Your special price for all, only \$36. Or try the new 1958 TV manual to see what an amazing bargain you get for \$3. Send no-risk trial coupon today.

The repair of any television set is really simple with **Supreme TV** service manuals. Every set is covered in a practical manner that will simplify trouble-shooting and repair. This is the help you need to find toughest faults in a jiffy. Each \$3 TV volume covers a whole year of service material. New Television Servicing Course will aid you in learning TV. Be wise, buy **Supreme Manuals** only once each year. Instead of spending dollars every week.

NO-RISK TRIAL ORDER COUPON

SUPREME PUBLICATIONS, 1760 Balsam Rd., Highland Park, ILL.

- 1958 Radio Diagrams, \$2.50
- Radio Servicing Course, 2.50
- 1957 Radio Manual, \$2.50
- 1956 Radio Diagrams, \$2.50
- 1955 Radio Manual, only \$2
- 1954) These annual
- 1953) RADIO volumes
- 1952) specially priced
- 1951) at only
- 1950) each... **\$2.50**
- 1949)
- 1948)
- 1947)
- 1946)
- 1942)
- 1941)
- 1940)
- 1939)
- 1926-1938 Manual, \$2.50
- Radio & TV Master Index, 25c

THIS GROUP ONLY \$2 EACH

Rush today TV manuals checked below and Radio manuals at left. Satisfaction guaranteed.

- New 1958 Television Servicing Manual, only \$3.
- Additional 1957 TV, \$3.
- Early 1957 TV, \$3.
- 1956 Television Manual, \$3.
- Early 1955 TV, \$3.
- Additional 1955 TV, \$3.
- 1954 TV Manual, \$3.
- 1953 Television Manual, \$3.
- 1952 TV, \$3.
- 1951 Television Manual, \$3.
- 1950 TV, \$3.
- 1949 TV Manual, \$3.
- 1948 TV Manual, \$3.
- New Television Servicing Course, complete... \$3.

I am enclosing \$..... Send postpaid.

Send C.O.D. I am enclosing \$..... deposit.

Name:

Address:

**SAVE \$\$\$ DURING
LEKTRON'S BIG
DO-IT-YOURSELF
BUCK-A-THON!**



**UP TO \$35 SAVINGS ON EACH
\$1 POLY-PAK®**

**SPECIAL BUCK-A-THON OFFER
BUY 8 POLY-PAKS,
PICK 9TH FREE!**

OFFER GOOD UNTIL NOVEMBER 1st

- 70 MICA CONDENSERS
00025 to .01 to 1200
V. Silver, too! 25 \$1
values. Reg. \$28.
- 10-RADIO-TV
ELECTROLYTICS
10-500 mf. to 450 VDC.
Wt. 3 lbs. \$1
Reg. \$12
- 50 KNOBS, RADIO & TV
Ass'd. colors, insula-
tion. Some worth \$1 ea.
Wt. 2 lbs. \$1
Reg. \$17
- WORLD'S SMALLEST
RADIO
2x1 1/2". KIT incl. loop-
stick, jacks, diode, etc.
w/instructions. Reg. \$1
\$3. Wt. 1 lb.
- 6 SYLVANIA
SILICON DIODES
1N22, 1N29. \$1
Reg. \$36
- \$25 SURPRISE PACK!
Large & varied ass't. Ra-
dio & TV parts. \$1
Wt. 3 lbs.
- 0-60 MINUTE TIMER
W/dial & knob. Sounds
clear alarm. Wt. 2 \$1
lbs. Reg. \$5
- 40 PRINTED
CIRCUIT PARTS
Diodes, chokes, resis-
tors, cond., boards. \$1
Wt. 1 lb. Reg. \$7
- 60 SUB-MINI
RESISTORS
1/4" lonk. 20 values;
1/2 w. to 10 meg. \$1
Reg. \$6
- 40 SUB-MINI
CONDENSERS
for transistor, printed
circuit work. Wt. \$1
1 lb. Reg. \$7
- 2 "MICRO"
VARIABLES
10 to 365 mf. 1 1/2"
sq. w/haft. \$1
Wt. 1 lb.
- 100 CERAMIC
CONDENSERS
Hi-Q discs, tubular; to
.01 mf. Wt. 2 lbs. \$1
Reg. \$11
- 60-PC.
CONDENSER SPECIAL!
Molded, paper, ceramic,
oil, mica, discs,
variables. Wt. 2 lbs. \$1
- 75-PC.
RESISTOR SPECIAL!
WW, precision, carbon,
variable, mini types. \$1
Worth \$15. 3 lbs.
- 15-PC.
TWIST DRILL KIT
1/16 thru 1/4" by 64ths,
w/calibrated case. \$1
Reg. \$3
- 70 TUBULAR
CONDENSERS
Paper, molded, oil,
porc., .0002 to .5mf to
1,000V. Wt. 2 lbs. \$1
Reg. \$14
- MINI-METER
1 1/4" dia. 0-6 Amps.
AC. Wt. 1 lb. \$1
Reg. \$3
- 4 OUTPUT
TRANSFORMERS
50L., etc. Wt. 3 \$1
lbs. Reg. \$8
- 12 POLY BOXES
Clear plastic, hinged,
w/snap locks. Ass'd. \$1
sizes. Wt. 1 lb.
- "SUN" BATTERY
Similar to famed B2M.
1" long. \$1
Reg. \$2.50
- 30 DISC
CONDENSERS
Wafer-thin. To .01
mf. Reg. \$5 \$1
- 60 HI-Q CARBON
RESISTORS
IRC. Ohmite, 10% too!
1/2, 2W, 10 ohms to 10
megs. Wt. 2 lbs. \$1
Reg. \$13
- 35 PRECISION
RESISTORS
1 1/2, 1/2 & 1 W. Carbo-
loy & WW. 100 \$1
ohms to 1 meg. Reg. \$17
- 15 ROTARY SWITCHES
Ass'd. gangs. Wt. \$1
3 lbs. Reg. \$12
- 300 FT.
HOOKUP WIRE
Tinned, ass'd. colors,
sizes. 2 lbs. \$1
Reg. \$5
- 8-PC.
NUTDRIVER KIT
\$3 value. Plastic han-
dle. 3/16, 7/32, 1/4,
5/16, 11/32, 3/8, 7/16
steel socket wrenches in
plastic case. 1 lb. \$1
Reg. \$3
- 70 COILS, CHOKES
1F, RF, ant. Stuk-tuned,
too. 3 lbs. \$1
Reg. \$13
- 8 GERMANIUM
DIODES
w/long leads. Glass \$1
sealed. Reg. \$5
- 15 VOLUME CONTROLS
incl. duals. To 1 meg.
some w/switch. 2 \$1
lbs. Reg. \$12
- 2 PNP TRANSISTORS
Pop. make; for hun-
dreds projects. \$1
8.5 value.
- 35 POWER RESISTORS
WW. 50 to 50W. to
10,000 ohms; incl. vit.
resup. 3 lbs. \$1
Reg. \$15
- 1500 PCS. HARDWARE
Nuts, screws, washers,
etc. 2 lbs. \$1
Reg. \$4
- 40 HI-Q CONDENSERS
Finest porcelain; NPO's
too! 1 lb. \$1
Reg. \$6
- 35 TUBE SOCKETS
4 to 9-pin, ceramic,
mica; shield-based. \$1
too. 2 lbs. Reg. \$9
- 150 CARBON
RESISTORS
1/2 to 2 W. 15 ohms to
1 meg. incl. insu-
lated types. 2 lbs. \$1
- 8 TRANSISTOR
SOCKETS
Mica-filled; for sub-
mini tubes, too. \$1
- 20 PRINTED CIRCUITS
Built-in IC circuits,
incl. integrals. 1 \$1
lb. Reg. \$7
- POSTAGE STAMP
MIKE
Crystal, 100 to 8,000
cps. 1 lb. \$1
Reg. \$7
- 30 MOLDED
CONDENSERS
Black beauties, etc.
Best made! \$1
Wt. 2 lbs.
- 60 TERMINAL STRIPS
Solder lug & binding-
to 20 terminals. \$1
2 lbs.

HOW TO ORDER Check items wanted. Return entire
client postage; excess ad w/check or M.O., including suffi-
cient postage; returned. C.O.D. orders 25% down;
rated, net 30 days. Print name, address WITH POSTAL
ZONE NO., amount money enclosed, in margin. (Canada
postage, 48¢ 1st lb.; 28¢ ea. addl. lb.) EXPORT OR-
DERS INVITED.

LEKTRON 131 Everett Ave.
CHELSEA 50, MASS.

Patents

STROBOSCOPIC GOLF TRAINER Patent No. 2,825,569

Luis W. Alvarez, Berkeley, Calif. (Assigned to Gaither & Co., San Francisco, Calif.)

Correct swing, speed and stance are important
to a golfer who is trying for low scores. This
training device may be used outdoors or indoors
(with a simulated ball). A series of five lamps

Fig. 2 is a block diagram of one of the control
circuits: five are needed. When the club blocks a
particular beam, point P goes positive when cur-
rent through the phototube is interrupted. V1 is

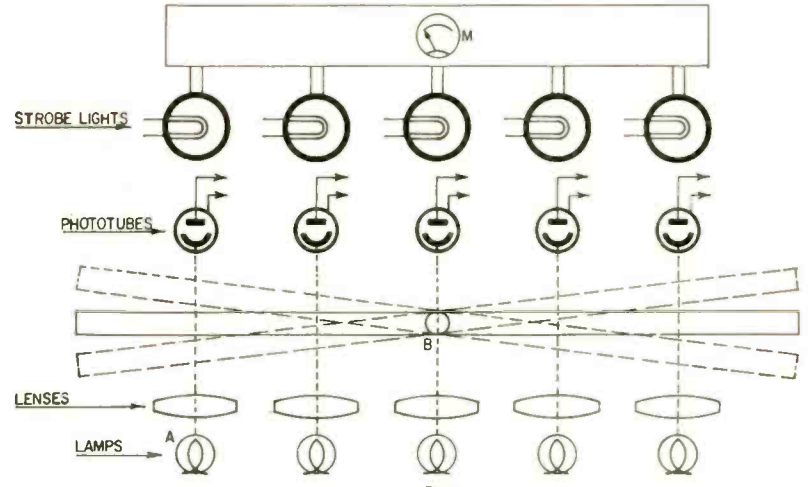

Fig. 1

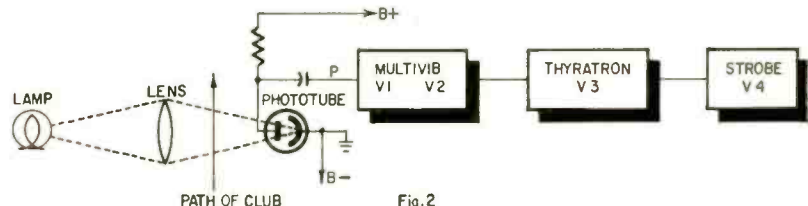

Fig. 2



Fig. 3

is spaced from corresponding photocells and
strobe lights (Fig. 1). B is the ball, and the
solid rectangle indicates the optimum swing.

driven to conduction. V2 blocks and V3 triggers
the strobe V4.

Each strobe is triggered by an electronic cir-
cuit when the corresponding light beam is inter-
rupted by the golf club. Thus, with his eye on the
ball, the golfer sees a series of "stopped-motion"
images and can actually watch and judge the
direction of swing, angle of club face, etc.

To measure club speed, meter M (Fig. 1)
measures the voltage on a charging capacitor
(not shown). The capacitor is allowed to charge
during the time the club is moving between the
first and third light beams. Fig. 3 shows how a
fast swing leaves less time for charging so M
reads low.

TRANSISTOR CLOCK DRIVE French Patent No. 1,147,598

C. Hunter McShan, Great Neck, N. Y.

A novel use for transistors is disclosed here.
A very-low-power transistor is used to drive and

control the timing mechanism of clocks and
watches. It maintains timing precision, provides

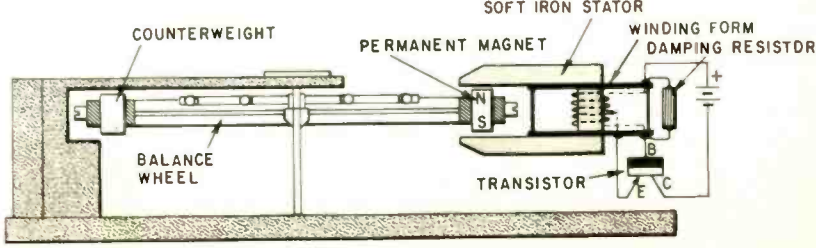

TRUE HI-FI for PUBLIC ADDRESS VOICE and MUSIC

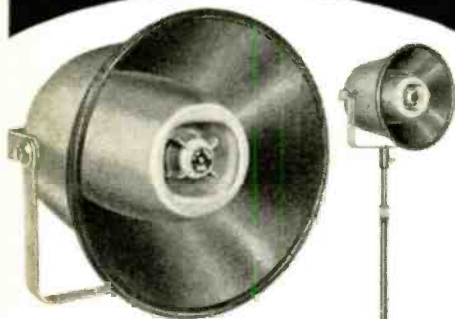

WT-6 NET \$34.50

support stand only,
SS-4 NET \$12.60

new ATLAS COAX-PROJECTOR WT-6

for wherever HI-FI is a MUST, indoors or out . . .
entertainment places: theatres, auditoria . . .
industrial music & paging systems . . .
outdoors: carnivals, pools, boat clubs . . .
home patios, gardens . . . permanent or
portable installations.

ALL-WEATHER

— install it, forget it! —

HIGH-EFFICIENCY . . . COMPACT . . .

True HIGH FIDELITY TWO-WAY system — not just a "compromise" of two horns coupled to a single diaphragm. The WT-6 comprises a weather-proof cone type driver (with 6-inch throat) coupled to its individual woofer horn; a separate pressure-type driver loaded to its separate tweeter horn. The built-in crossover electronic filter supplements the electro-mechanical frequency-limiting characteristics of the 2 individual reproducers — providing for smooth frequency division as each speaker functions within its engineered range of frequencies.

Universally adjustable "U"-type rugged steel mounting . . . finished in high temperature baked modern beige enamel.

Power Rating 15 watts continuous
Freq. Resp. 140-15,000 cps
Impedance 8 ohms
Dispersion 120°
Dimensions Bell opening 15",
overall depth 12"

See the WT-6 at your local distributor.
Send for complete catalog R-10.



ATLAS SOUND CORP.

1443-39 St., Brooklyn 18, N. Y.
Atlas Radio Ltd., Toronto, Canada

PATENTS (Continued)

high efficiency and occupies little space.

A transistor oscillator drives the balance wheel and hairspring assembly as shown in the diagram. At one point along the rim of the wheel a tiny but powerful magnet is fixed. It is counter-balanced by a weight. As the wheel rotates, its magnet approaches the iron stator and is accelerated. Upon leaving the pole pieces, the magnet generates a voltage across the tapped winding. Phase of emitter voltage is correct to trigger the transistor to full conduction. Collector current now flows through the coil. It energizes the poles to repel the magnet. The pull and subsequent push constitute total drive for the system. Only 8 mw is required.

This ingenious principle is suitable for use in wrist watches, portable clocks, etc.

RADIOACTIVITY INDICATOR

Patent No. 2,818,509

Joseph M. Johnston, Bradley Beach, N.J. (Assigned to USA as represented by Secretary of Army)

This is an "inverted" amplifier in which the control and collecting elements are transposed. The control grid acts as an anode and is biased positive. The plate and screen are connected and given a slightly negative bias by the electrons which pass through the screen. This bias level is set by the position of the radioactive source in the ionization chamber, which determines the amount of ionization in the

RADIOACTIVE SOURCE

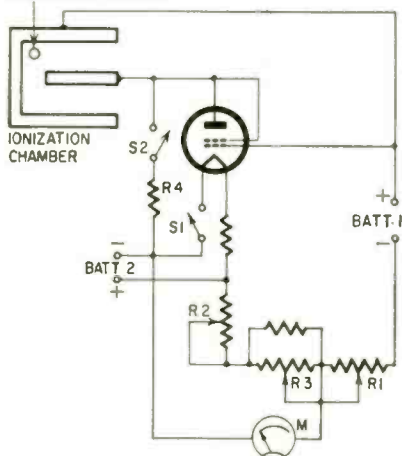

chamber and therefore the amount of current flow through it. R2 and R3 are adjusted for a zero meter reading.

Now the unit is ready for use as a radioactivity indicator. As the ionization chamber is brought near a source of radioactivity, the ionization of gas in the chamber is increased and the bias on the plate becomes more positive, increasing the current drawn by the grid from the cathode. This current increase is read on the meter which may be calibrated in roentgens per hour. R1 is the sensitivity control.

Resistor R4 provides means for checking the operating condition of the circuit and establishes a reference point for meter calibration. This high-megohm unit, when switched into the circuit by S2, places a fixed voltage on the plate, which corresponds to a particular radiation rate.

The advantages of this circuit are a very high input resistance of about 10¹¹ ohms and increased range of measurement which tends to be logarithmic; both highly desirable qualities to have in radiation counters. END



"I'm the TV repairman."

NEW FM & AM STEREO TUNER with built-in STEREO PREAMPLIFIER by

Pilot

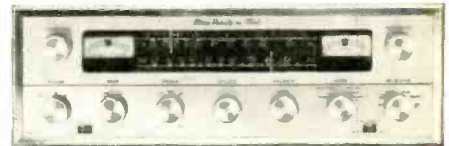

MODEL FA-690

\$269⁵⁰

complete with cabinet (as illustrated)

Tuner features include:

- 1 microvolt FM sensitivity with cascade front end
- independent FM and AM operation for FM-AM stereo
- independent FM and AM tuning meters
- broad/narrow AM bandwidth selector
- FM interstation muting with defeat switch
- multiplex jacks for FM-FM stereo

Preamp features include:

- stereo volume, tone and balance controls
- inputs with equalization for stereo records, tape heads, recorder and dual microphones
- output for stereo and monaural tape recordings

also PILOT MODEL FA-680
FM AND AM STEREO TUNER
\$199.50 COMPLETE

identical to model FA-690,
less preamp section.

prices slightly higher in West

PILOT RADIO CORP.

37-12 36th Street
Long Island City 1, New York

Please send complete details of
FA-690, FA-680 and other PILOT
Tuners.

Name _____

Address _____

City _____ Zone _____ State _____

Electronics manufacturer for over 39 years.

t-m KITS

Master-Engineered — Master-Crafted!

Transistor Stereo Preamplifier Equalizer Kit



Clean, hum-free control and amplification. Straight DC operation—no microphonics or tube noises. Separate bass and treble controls for each channel plus common and balancing controls. Six hi-impedance inputs: four equalized lo-impedance inputs; two levels on "magnetic" for both low and high output cartridges without using external transformer. Four output jacks for amplifier and tape. AC control switch. Power drain so low that battery lasts almost full "shelf-life." Size, 3"x9"x5 1/2"; weight, 1 lbs. Model 41K, less battery, with cabinet, \$59.50. Model 41, factory-wired.

Preamplifier Equalizer Transistor Kit



Deluxe hi-fi control kit that assembles simply and quickly with new easy-to-follow instructions. Sub-assembly building method facilitates construction. Magnetic (RIAA) plus 3 hi-impedance inputs. Amplifier and tape outputs. Exceptionally wide-range bass and treble adjustments. Linear gain control. Operates from single battery. Noiseless and hum-free amplification. Top quality parts and selected transistors used. Will work indefinitely without replacing parts. Size, 3"x9"x5 1/2"; weight, 3 lbs. Model 24K, complete with cabinet, less battery, \$24.50.

60-Watt High Fidelity Amplifier-Preamplifier Kit



The highest achievement to date in integrated high-power amplifier design... now in kit form! 60-watts undistorted power at any frequency from 20 to 20,000 cps. Frequency response flat from 10 to 50,000 cps. Ultra-linear type output stage; direct interstage coupling; 4-8-16 ohm speaker outputs. Variable calibrated pickup load control for all magnetic cartridges. RIAA, AES, NAB, LP and 78 equalizer positions. Input selector switch for piezo cartridge, tuner, TV sound and tape. Cathode follower tape take-off. 2 AC outlets. Low-distortion, feedback-type tone controls with concentric control knobs. Size 14 1/4"x10 3/4"x5 1/2"; weight, 28 lbs. Model 19K, \$79.95. Cabinet, \$7.50. Model 19, factory wired, with cabinet, \$129.95.

25-Watt High Fidelity Amplifier-Preamplifier Kit



Top quality integrated amplifier-preamplifier on a single chassis in kit form at an exceptionally low price. RIAA equalizer; treble control has exclusive calibrating feature for accurate compensation of old AES, NAB, LP and 78. Circuitry, components and features similar to Model 19K, except for lower power rating of output tubes and transformer; performance identical up to rated power. Size, 14 1/4"x9"x5 1/2"; weight, 21 lbs. Model 21K, \$59.95. \$7.50 Cabinet.

Deluxe Williamson-Type 20-Watt Amplifier Kit

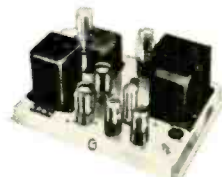

Uses famous Williamson circuit with unique modifications for true hi-fidelity reproduction at increased power output. Ultra-linear operation; screen tapped primary output transformer. Frequency response flat and smooth thru entire audible range, with distortion less than .0025 at normal listening levels, and excellent transient characteristics. 20-watt, undistorted output; 4-8-16 ohm output impedances. The perfect basic amplifier for stereo systems. Size, 9"x12"x6 1/2"; weight, 27 lbs. Model 15A, \$49.95. Model 15W, factory-wired, \$59.95.

Ask your dealer or write direct to:



TECH-MASTER CORPORATION
75 Front St., B'klyn 1, New York

radio-electronic Circuits

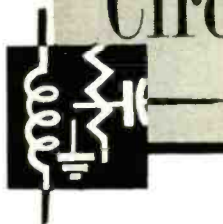

ECONOMICAL AUDIO AMPLIFIER

The accompanying diagram shows a miniature audio amplifier produced in France by BTH. It is economical, but nevertheless can qualify as high-fidelity at low power. It employs the pentode part of a 6U8 in a rarely used, starved-circuit arrangement. The plate

The high-gain input stage is stabilized by the screen dc feedback and the 1.2- μf capacitor between input grid and cathode of the triode, to neutralize the parasitic capacitance inside the tube. The power supply uses a full-bridge dry rectifier to provide a B-plus

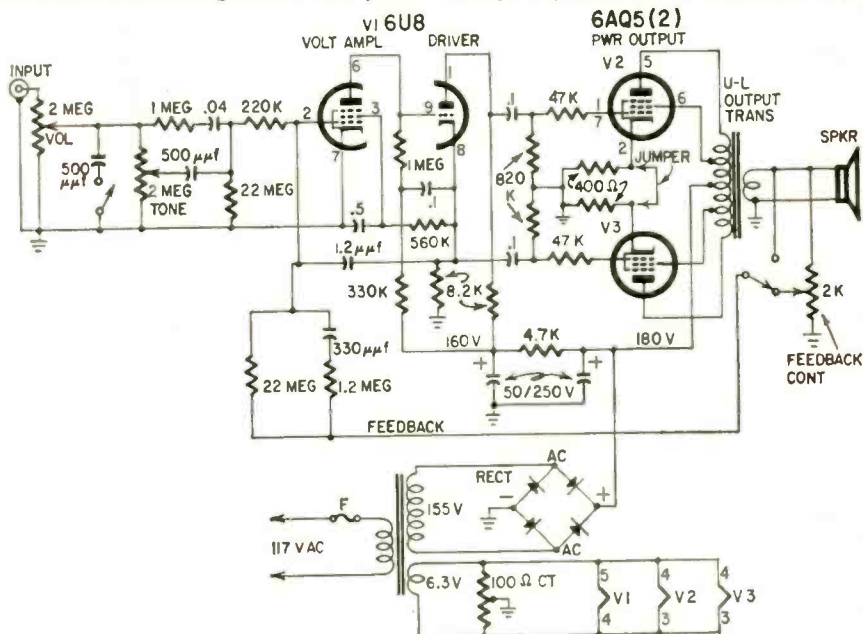

receives a low voltage, and the screen is fed by the cathode voltage of the following stage. The gain of such a stage can reach the incredible value of 1,400. The triode section of the same tube is used as a direct-coupled split-load driver. It is followed by a pair of output pentodes in an Ultra-Linear circuit arrangement, using an economical small-size output transformer with grain-oriented laminations. Overall feedback and a tone control are provided.

of only 180 volts. An artificial center tap, on the heater winding, is grounded. This amplifier passes signals from 10 to more than 200,000 cycles, with distortion less than 0.5% from 20 to 15,000 cycles at 0.5 watt output.

Intermodulation distortion is 0.25% for a 0.2-volt input signal, using 50 and 6,000 cycles in a 4-to-1 ratio. The maximum feedback is 44 db. The rated output power of 4 watts is obtained with a 0.5-volt input.—A. V. J. Martin

HANDY POWER SUPPLY

The diagram shows a versatile power supply that does many jobs around the

shop. It is built with junkbox parts. Four outputs are provided: variable

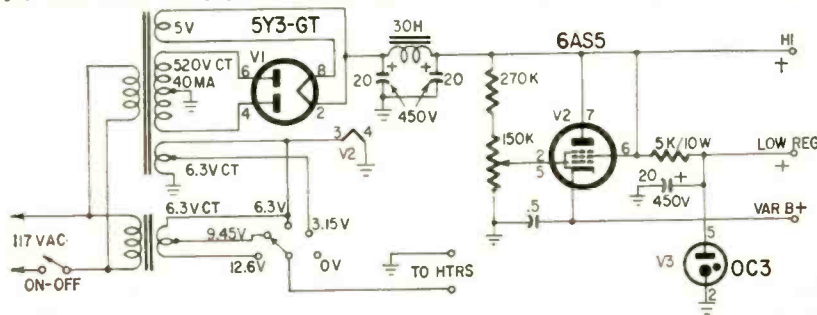

heater voltage: 12.6, 9.45, 6.3, and 3.15; B-plus of about 275; regulated B-plus of 105, and variable B-plus.

I use the regular and regulated B-plus coupled with the heater voltage when repairing tuners. The variable B-plus takes care of portable (battery-operated) radios.—*W. G. Eslick*

ELECTRONIC FLASHER

This simple electronic device will turn electric lights on and off in a flashing-recycling manner.

The unit can be assembled in a few hours with a minimum of parts. It is housed in a 3 x 4 x 5-inch case. *Caution: Wiring in this unit is connected to the ac line. Be sure that the unit is completely enclosed and that all wiring is isolated from the chassis and case.* Two chassis-mounted female outlets are attached to the cabinet. As shown by the diagram, they are wired so that power is supplied to them alternately in 4-second bursts.

The 4-second interval is an arbitrary value selected as the most pleasing to the eye. It can be shortened or lengthened by changing the values of R1 and C2. To lengthen the lights-on period, both R1 and C2 must be increased. Conversely, reducing these values reduces the on period. R1 should be increased by 0.5-megohm steps and C2 by 20- μ f steps.

When power is first applied to the flasher, the relay is not energized. Since the grid and cathode are connected to

the same side of the line, grid capacitor C1 does not charge. Therefore, plate current flows as soon as the tube is warmed up. The relay is energized and the relay arm is pulled down to the lower contact. This disconnects the cathode from the grid side of the line and now, through R2, the cathode is connected to the other side of the line.

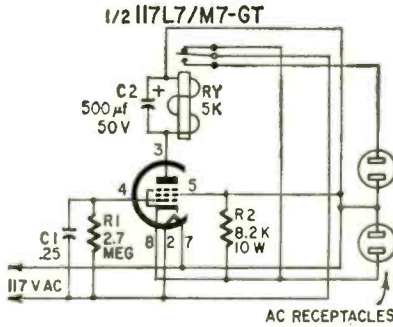

Immediately C1 begins to charge, placing a negative voltage on the tube's grid. When the grid is sufficiently negative, plate current is cut off. At this point the relay is de-energized and returns to the up position. However, the relay does not immediately de-energize due to capacitor C2, which charged while the tube was conducting. With the tube cut off, this capacitor slowly discharges through the relay's coil, holding it closed for several seconds. When the relay does open, the entire process starts again.—*Dominic Ripani* END

CENTER ELECTRONICS
ALWAYS ON THE SPOT WITH SPECIALS

STEPHENS 206 AXA
15" 2-Voice Coil Coaxial Speaker
Freq. response 20-20,000 cps—BRAND NEW

Audiophile Net PRICE \$162.50
CENTER PRICE \$99.50

Mail Orders 25% deposit, Balance COD
GET OUR SPECIAL PRICES ON YOUR HI-FI REQUIREMENTS

CENTER ELECTRONICS CO., INC.
Dept. N-1, 74 Cortlandt St., New York 7

CONVERT TO COLOR TV

COLORDAPTOR—A simple 10-tube circuit and rotating color wheel converts any-size black-and-white TV, direct view or projection, to receive compatible color TV. **COLORDAPTOR** is simply attached to TV set, does not affect normal operation and can be built from parts experimenters have on hand.

Complete specifications including theory of operation, complete simplified construction plans, schematic and sample color filters \$1.95

Essential parts kit containing all special parts—coils, delay line, crystal, color filters—
Up to 16" sets— \$19.95 17" and larger— \$20.95

All other COLORDAPTOR parts, kits, motors, etc. available.
COLORDAPTOR, 1798 Santa Cruz, Menlo Park, Calif.

all new edition
VOL. III, NO. 1

+ up-to-date component prices
+ the quick easy way to figure service charges

Pure Rice's

OFFICIAL PRICING DIGEST

Flat rate and hourly service charges, based on and showing regional and national averages, plus up-to-date list or resale prices on over 63,000 components. Arranged alphabetically by manufacturers and products, numerically by part number. Compact, convenient size fits in tube caddy, toolbox or pocket. \$2.50 per copy from your distributor.

ELECTRONIC PUBLISHING COMPANY, INC.
180 N. WACKER DRIVE, CHICAGO 6, ILL.

"ONE DOLLAR" buys

As much as \$15 worth — Everything Brand New and sold to you with a money back guarantee.

DEDUCT 10% ON ANY ORDER OF \$10 OR OVER
Plus a FREE SURPRISE PACKAGE

- 515 — "JACKPOT" TELEVISION PARTS.....\$1
- 40 — ASSORTED PRECISION RESISTORS.....\$1
- 4 — ELECTROLYTIC COND. 10/10-450V.....\$1
- 20 — TUBULAR CONDENSERS 25-600V, 85°.....\$1
- 100 — ASSORTED FUSES popular sizes.....\$1
- 100 — ASST. 1/2 WATT RESISTORS some 5%.....\$1
- 70 — ASSORTED 1 WATT RESISTORS.....\$1
- 35 — ASSORTED 2 WATT RESISTORS.....\$1
- 50 — ASST. TUBULAR CONDENSERS.....\$1
- 10 — 6' ELECTRIC LINE CORDS with plugs.....\$1
- 5 — TV CHEATER CORDS with both plugs.....\$1
- 4 — 50' SPOOLS HOOK-UP WIRE 4 colors.....\$1
- 50 — STRIPS ASST. SPAGHETTI best sizes.....\$1
- 100 — ASST. RUBBER GROMMETS best sizes.....\$1
- 100' — TWIN LEAD-IN WIRE 300# heavy duty.....\$1
- 50' — FLAT 4-CONDUCT. WIRE many purposes.....\$1
- 25' — INSULATED SHIELDED WIRE.....\$1
- 1 — S7 INDOOR TV ANTENNA hi-gain 3 section.....\$1
- 20 — ASST. TV KNOBS, ESCUTCHEONS, etc.....\$1
- 3 — ASST. TOGGLE SWITCHES spst, dpdt, etc.....\$1
- 6 — ASST. SLIDE SWITCHES spst, dpdt, etc.....\$1
- 4 — BAKELITE KNIFE SWITCHES dpdt.....\$1
- 15 — ASST. ROTARY SWITCHES \$15 worth.....\$1
- 100' — FINEST NYLON DIAL CORD best size.....\$1
- 200 — SELF TAPPING SCREWS #8 x 1/2".....\$1
- 35 — ASST. RADIO KNOBS screw and push-on.....\$1
- 100 — KNOB SPRINGS standard size 3/8" x 1/2".....\$1
- 100 — ASSORTED KNOB SET-SCREWS.....\$1
- 25 — ASSORTED CLOCK RADIO KNOBS.....\$1
- 400 — ASST. H'DWARE screws, nuts, rivets, etc.....\$1
- 50 — ASST. SOCKETS octal, novel and miniature.....\$1
- 20 — ASSORTED TUBE SHIELDS best sizes.....\$1
- 50 — ASST. MICA CONDENSERS some in 5%.....\$1
- 50 — ASST. CERAMIC CONDENSERS.....\$1
- 10 — ASST. VOLUME CONTROLS less switch.....\$1
- 5 — ASST. VOLUME CONTROLS with switch.....\$1
- 100 — VOLUME CONTROL HEX NUTS.....\$1
- 20 — ASST. PILOT LIGHTS popular types.....\$1
- 10 — PILOT LIGHT SKTS. bayonet type, wired.....\$1
- 50 — ASST. TERMINAL STRIPS 1, 2, 3, 4 lug.....\$1
- 10 — ASST. RADIO ELECTRO. CONDENSERS.....\$1
- 5 — ASST. TV ELECTROLYTIC CONDENSERS.....\$1
- 15 — ASST. TV COILS sync, peaking, width, etc.....\$1
- 25 — ASST. MICA TRIMMER CONDENSERS.....\$1
- 50 — TUBULAR CONDENSERS .001-600V.....\$1
- 50 — TUBULAR CONDENSERS .01-400V.....\$1
- 2 — ELECTROLYTIC COND. 40/40-450V.....\$1
- 2 — ELECTROLYTIC COND. 40/10/10-450V.....\$1
- 30 — FP CONDENSER MOUNTING WAFERS.....\$1
- 3 — ELECTROLYTIC COND. 80-450V.....\$1
- 3 — ELECTROLYTIC COND. 50/30-150V.....\$1
- 10 — HV TUBULAR CONDENSERS .005-1000V.....\$1
- 10 — HV TUBULAR CONDENSERS .001-6000V.....\$1
- 10 — HV TUBULAR CONDENSERS .005-6000V.....\$1
- 35 — MICA COND. 20-100 mmf & 15-270 mmf.....\$1
- 35 — MICA COND. 20-470 mmf & 15-680 mmf.....\$1
- 35 — MICA COND. 20-820 mmf & 15-1000 mmf.....\$1
- 35 — CERAMIC COND. 20-5 mmf & 15-10 mmf.....\$1
- 35 — CERAMIC COND. 20-25 mmf & 15-47 mmf.....\$1
- 35 — CERAMIC COND. 20-56 mmf & 15-82 mmf.....\$1
- 35 — CERAMIC COND. 20-100 mmf & 15-150 mmf.....\$1
- 35 — CERAMIC COND. 20-270 mmf & 15-470 mmf.....\$1
- 35 — CERAMIC COND. 20-1000 mmf & 15-1500 mmf.....\$1
- 35 — CERAMIC COND. 20-2000 mmf & 15-5000 mmf.....\$1
- 50 — 100Ω 1/2 WATT RESISTORS 5%.....\$1
- 75 — 470KΩ 1/2 WATT RESISTORS 10%.....\$1
- 50 — 470KΩ 1 WATT RESISTORS 10%.....\$1
- 10 — ASST. WIRE'ND RES. 5, 10, 20 watts.....\$1
- 3 — AUDIO OUTPUT TRANS. 50L8 type.....\$1
- 3 — AUDIO OUTPUT TRANS. 6X6 or 6V6 type.....\$1
- 3 — I.F. COIL TRANSFORMERS 456 kc.....\$1
- 3 — I.F. COIL TRANSFORMERS 10.7 mc FM.....\$1
- 4 — OVAL LOOP ANTENNAS ass't hi-gain types.....\$1
- 3 — LOOPSTICK ANT. new ferrite adjustable.....\$1
- 12 — RADIO OSCILLATOR COILS 456 kc.....\$1
- 3 — 1/2 MEG VOLUME CONTROLS with switch.....\$1
- 10 — SURE GRIP ALLIGATOR CLIPS.....\$1
- 1 — GOLD GRILLE CLOTH 14"x14" or 12"x18".....\$1
- 1 — 5" PM SPEAKER alnico #5 magnet.....\$1
- 5 — SETS SPEAKER PLUGS wired.....\$1
- 10 — SETS PHONO PLUGS and PIN JACKS.....\$1
- 2 — \$2.50 SAPPHIRE NEEDLES 4000 playings.....\$1
- 5 — DIODE CRYSTALS 2-IN21 2-IN23 1-IN64.....\$1
- 2 — SELENIUM RECTIFIERS 1-65 ma & 1-150 ma.....\$1
- 5 — TV CRT. SOCKETS with 18" leads.....\$1
- 5 — HI-VOLT. ANODE LEADS with 18" leads.....\$1
- 1 — LB SPOOL ROSIN CORE SOLDER 40/60.....\$1
- 6 — SPIN TIGHT SOCKET SET 3/16" to 7/16".....\$1
- 3 — TV ALIGNMENT TOOLS 5", 7", 12".....\$1

HANDY WAY TO ORDER—Simply tear out advertisement and pencil mark items wanted (X in square is sufficient); enclose with money order or check. You will receive a new copy of this ad for re-orders.

ON SMALL ORDERS—include stamps for postage, excess will be refunded. Larger orders shipped express collect.

COMPLETE TECHMASTER LINE AT ATTRACTIVE PRICES. FREE CATALOG ON REQUEST.

BROOKS RADIO & TV CORP.
84 Vesey St. Dept. A, New York 7 N.Y.

COSMOTRON*

- MINIATURE ATOM SMASHER
- PRODUCES 75,000 VOLTS
- ABSOLUTELY SAFE



In no sense of the word a toy or a gadget. The COSMOTRON* is a scientific instrument capable of producing 75,000 volts—makes sparks up to 2" long—yet is absolutely safe because the current is infinitesimal. The science teacher—science lover—or hobbyist can perform experiments to astound students—friends—family. Makes smoke disappear—defy gravity—turns propellers at a distance—transforms atomic energy into light—makes artificial lightning—demonstrates ionic space ship drive—and many other experiments. Constructed of the finest materials. Will do exactly—for instruction purposes—what generators that cost 3 to 10 times more will do. The perfect device to teach the secrets of atomic physics and electricity. Will hold an audience spellbound as it performs trick after amazing trick. Includes an experiment kit and illustrated experiment manual. Manual explains the "how" and "why." You will invent many new experiments of your own. A fine research tool that will give years of beneficial service to the institution or individual who owns one. In kit form or assembled.

*TM Pending

Kit form \$14.95
Assembled \$19.95

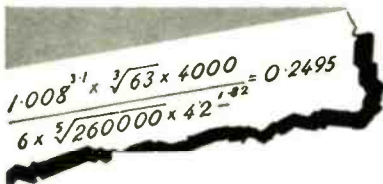

A 66-inch Slide-rule for your pocket



Slide Rule Open

The GENIAC® Calculator carries 66-inch spiral scales yet measures only ten inches fully extended and six inches when closed. Four to five figure accuracy can be relied on. It is indispensable to the scientist, research worker and student. Administrative staff and business men will find it of tremendous value for a host of estimating and checking calculations.

The GENIAC® Slide Rule solves multiplication, division, percentage calculation and gives 5 place logarithms.

You may use it for 30 days and if you are not satisfied repack and mail it back.

What our users say:

"It does all you claim—four or five figure accuracy without eyestrain or magnifiers. Half an hour's study is ample for its use." A. E. B. . . .

"I use the GENIAC Calculator for all my slide rule work and need the extra digit which normal slide rules cannot give. I had to get one of my customers a GENIAC Slide Rule last month, after using mine in his office." E. & G. H. Textile Manufacturers.



Slide Rule Closed

Send for yours now—Only \$19.95

MAIL THIS COUPON

(Please be sure to include your name & address)
OLIVER GARFIELD CO., Inc., Dept. RE-108
108 E. 16th St., New York 3, N.Y.

Please send me:

- 1 COSMOTRON Atom Smasher and Manual. \$19.95 (Complete assembled)
- \$14.95 (In kit form)

Add 80¢ for postage and handling in U.S.; \$1.00 abroad.

1 GENIAC® Pocket Calculator

Add 44¢ for postage in U.S. \$1.00 abroad.

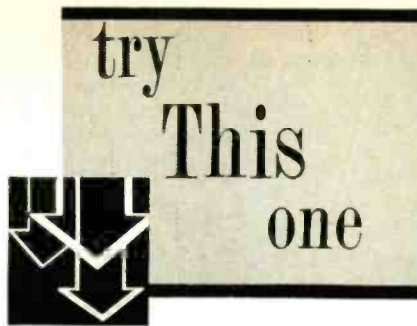

CLEANING PLASTIC SAFETY GLASS

A little penetrating oil applied with a soft cloth does an effective job of cleaning fogged plastic safety glass on TV sets. Be sure to wipe it off thoroughly afterwards.—E. Mayover

RECORDER CLEANING KINK

Tape recording enthusiasts who take pride in keeping their recorder in tip-top running condition will be interested to know that an empty plastic squeeze bottle makes a handy addition to a



"BUCK STRETCHER" HI-FI VALUES!



Expand the buying power of your Hi-Fi dollar at Sun Radio with substantial savings on new and fully guaranteed name brand Hi-Fi components!

Send for our special price quotations and our Hi-Fi package specials! Dept. L8

SUN Radio & Electronics Co., Inc.
650 6th Ave., New York 11, N.Y.
Phone: ORegon 5-8600

DIGITAL COMPUTER KIT



Build 100 transistor computer circuits and work with them! Basic units can be built within hours. Assemble them into computers and operate. The language of computers is explained and projects included. You will receive 22 transistors and 200 electrical parts. \$59.50 plus postage. Twelve other kits available.

Partial list of courses:

- C1 Elementary relay brains \$12.50
- C2 Elementary digital computers \$24.50
- C3 Elementary analog computers \$19.50
- C14 Computer Master 50 lessons and projects (digital voltmeter, digital ohmmeter)
- C15 Electronics, 40 lessons and 3 text books. \$22.50 down and \$10 for 5 months.
- Complete catalog.

EBE Inc., 1015 Atkin Ave.
Salt Lake City 6, Utah

Send one transistor computer kit

- Enroll me in course
- Enclosed \$

Name and address attached

tape recordist's cleaning and lubricating kit. It makes a handy miniature air gun for blowing metallic dust particles from a recorder's mechanism. To make the air gun work more efficiently, pry out the neck plug and remove the inside spray tube. Then replace the plug.—John A. Comstock

MORE ROOM IN AUTO RADIOS

Many radio amateurs use their car radios with converters as mobile short-wave receivers. When so used, it is sometimes desirable to add noise limiters or extra if amplifiers to the receiver. This is usually difficult as space inside these radios is limited. However, with some sets, there is a way out. Some auto radios have the speaker mounted in the same case with the chassis and often have a large cutout in the chassis to accommodate the speaker frame. If the speaker is removed from the radio's case and mounted elsewhere in the car, a small subchassis can be mounted in this cutout, allowing room for any desired additional circuits.—Charles E. Cohn

SPLICING TV LEAD-IN

Although it's not generally recommended practice to splice a TV lead-in, sometimes it is necessary (especially on extra-long runs). If you have to splice a joint on a windy day and don't have a torch along, soldering on a rooftop can be difficult. The wind, together with the voltage drop in a long elec-

2 WAY PORTABLE RADIO SET

Sends—Receives up to 10 miles as shown or hundreds of miles with outside antenna! 40 and 10 meter amateur radio bands (included) also Aircraft and overseas broadcasts (3 to 8 mc.). POWERFUL WITH SELF-CONTAINED PORTABLE RADIO BATTERIES. NO AC PLUG-INS NEEDED! Take it with you everywhere you go—



Keep in contact with home-friends. Has 3 watt crystal controlled transmitter—Sensitive, Regenerative Receiver. Send-receive switch. We only 3 lbs. Size, only 6"x4"x4". TESTED—PROVEN—SIMPLIFIED—PRACTICAL—Full information given on quick easy to get license.

SEND ONLY \$3.00 (bill, etc. mo) and pay postman \$12.95 COD postage on arrival or send \$15.95 for postpaid delivery. Complete kit includes all parts, tubes, coils, plastoid cabinet, easy instructions. (Set of batteries—\$3.49; crystal \$1.49). COMPLETELY WIRED AND TESTED POSTPAID \$19.95. A regular \$49.95 value—Order now before price goes up! GUARANTEED—AVAILABLE ONLY FROM:

WESTERN RADIO, Dept. BNR-10, KEARNEY, NEBR.

Everbody benefits when everbody gives The UNITED WAY



And they have the finest features and specs. Fully illustrated step-by-step 28-page manual makes assembly a snap! WRITE FOR FREE CATALOG! *Add 10¢ for Federal Tax. QUALITY ELECTRONICS 319 Church Street Dept. RE-10 New York 13, N.Y.

TRY THIS ONE (Continued)

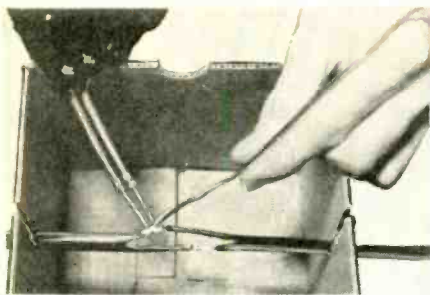

tric cord, robs the soldering iron of its heat.

When I was recently caught with torch out of fuel and faced this problem, I solved it by using a cardboard box as a wind shield. The slits cut in the side of the box hold the lead firmly for easy soldering.—*Scott Mack*

TWIST DRILL COVERS

I slip lengths of spaghetti insulation over the cutting edges of the twist drills I carry in my tool kit. This protects the cutting edges against nicks and helps keep the set of drills sharp longer. And that's not all—the drills used to roll around in the metal tray and make a racket, but the spaghetti drill covers take care of this too.—*John A. Comstock*

SOLDERING TIP

Some of the tips used with the Ungar soldering pencil are small copper rods screwed into the main copper body. The performance of these tips depends on heat conduction into the tip. A simple way to improve this is to flow a little solder into the joint between tip and body, making a much better conductor than the mere physical contact normally obtained. — *Charles Erwin Cohn*

EASY CONNECTIONS FOR TIP JACKS

This simple adapter comes in handy in experimental work when various components must be temporarily connected to tip jacks. To make this adapter, simply push the lug end of a No. 30 Mueller alligator clip into the sleeve of a phone tip and run a little

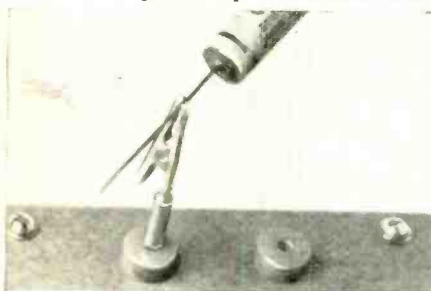

solder in to make a solid connection. The photo shows how wire leads, capacitors, resistors, diodes, banana plugs, etc. may be quickly connected to tip jacks.

If you prefer to use a larger alligator clip, simply force the sleeve of the phone tip into the sleeve of the clip and run a little solder around the joint.—*Art Trauffer*

FREE

GIANT ALL NEW 1959 B-A CATALOG

WITH THE BIGGEST SAVINGS ANYWHERE

A COMPLETE BUYING GUIDE FOR EVERYTHING IN

RADIO TV ELECTRONICS

BA 1959

ANNUAL CATALOG 591

SINCE 1927

180 KING-SIZED PAGES

EVERYTHING IN RADIO TV AND ELECTRONICS

100'S OF NEW ITEMS LISTED HERE FOR 1ST TIME

21 PAGES OF BARGAINS NOT IN ANY OTHER CATALOG

Guarantee
We guarantee everything in our Catalog to be of the quality and value represented. To our regret, we are unable to return items in the original condition and give the money back for such quantities.

RUSH COUPON TODAY!

BURSTEIN-APPLEBEE CO. Dept. S,
1012-14 McGee St., Kansas City 6, Mo.

Send Free 1959 B-A Catalog No. 591.

NAME _____
ADDRESS _____
CITY _____ STATE _____

SUPER POWERED SINGLE CHANNEL AMPLIFIER

Minimum 20 V—5 Watts on All Channels

This all new super powered unit has the highest output of any TV channel amplifier with sufficient power to cover large communities with ample signal voltage and deliver a strong signal thru many miles of cable. The unit was designed specifically for community television and is the only unit of its kind that does not produce power in fractions of a watt. For full rated output a high-powered commercial transmitting tube is used.

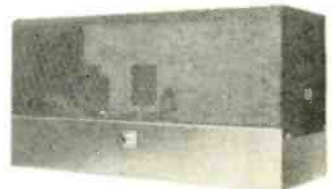

- C. C. S. Service
- 26 db min. gain
- 6-8 mcs. band width
- Channels 2-13 as specified
- Requires only 1 V input
- Co-axial input and output connectors for 75 OHM Line
- Linear class A operation
- Low Power Drain (1 Amp.)

MODEL SPA
\$350

Write for details today

SEG Electronics • 1778 Flatbush Ave., Brooklyn 10, New York



One of our BEST Values!

2.9 AMP. HEAVY DUTY 1/4" RAM DRILL

with Jacobs Geared Chuck & Key

Reg. \$39.95—Our Price \$14.95

Ask any expert and he'll always say "RAM for take years of rough-tough use. Newer, more rugged motor gives 1/2" capacity in hardwood and 3/4" capacity in steel with a full load speed of 1200 R.P.M. Durable Heavy Duty Work." Not just an ordinary 2, 2 1/4 or 2 1/2 amp. unit, but a powerful full 2.9 AMP. drill to do every heavy duty job in home, shop or industry. Built to mirror finished, lightweight aluminum housing. Features Universal, series wound AC-DC motor; heavy duty multiple thrust ball bearings; automatic release trigger switch with locking pin; 6 ft. 2 conductor, UL approved cord and plug. Standard 1 1/2 V. AC-DC. This powerhouse measures 9" in length yet weighs only 3 1/2 lbs.

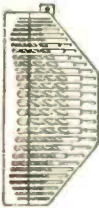

29-PC. CHROME VANADIUM DRILL SET

Specially made for speed drilling. In sturdy plastic tool roll. Finest alloy steel drills hardened and precision ground to the sharpest, longest lasting cutting edge obtainable; will easily and cleanly bite through hardwoods, plastics, aluminum, iron and the toughest steels. Unconditionally guaranteed for thousands of drillings. Full jobber length. Sizes by 64ths from 1/16" to 1/2". There are only a limited quantity of these imported German sets available at this low price. So hurry!

Now... ppd. \$6.49

Also available with Turned Down Shanks to fit all 1/4" drills. In individual pocket roll. ppd. \$8.95

Send check or money order. If C.O.D., fees extra.
Money-Back Guarantee.

ONLY 75c EACH

for the FINEST QUALITY Imported
PRECISION PLIERS

Flat Nose • Combination • Diagonal
Cutter • End Cutting Nippers • Round
Nose • One Side Flat—One Side Round •
Snipe

FOR JEWELERS, OPTICAL WORKERS,
HOBBISTS, CRAFTSMEN. ALL
KINDS! These superb European instru-
ments are of deep-forged, heat-treated high
quality tool steel, fabricated to most exact-
ing specifications. All-over ground and
polished to smooth hard surfaces. Smooth
working joints with just the right tension.
Jaws meet perfectly to safely and securely
hold even the most delicate objects in the hard-to-reach
corners and angles. Each plier is 4" long and a ver-
itable gem of precision and strength.

75c each all 7 for \$5.00



60 Pc. Set Wire Gauge CHROME VANADIUM DRILLS

Top quality German import, high test
Chrome Vanadium Drills designed for
speed drilling through toughest steels,
woods, plastic, iron and aluminum. Pre-
cision-ground long-lasting cutting edges. Guaranteed to
give years of satisfaction. A full 60 pc. set.
Nos. 1 thru 60. A \$14.95 Value. Now Only
plus 35c pp. and hdg. \$5.40
Same set above available with Huet Metal Index
container. Only plus 35c pp. and hdg. \$6.65

Also Available—20-PC. SET
NOS. 61-80 WIRE GAUGE DRILLS
Finest steel! Tops for precision work in woods, plastic,
iron, aluminum, etc. Includes plastic kit with
marked pocket for each drill. Only... ppd. \$2.50

SCOTT-MITCHELL HOUSE, Inc., Dept. P-10 415 So. Broadway, Yonkers, N. Y.

TRY THIS ONE (Continued)

LOW-COST TRANSISTOR BATTERIES

A number of transistor circuits use a 22.5-volt battery. This type of battery costs about \$1.50. However, if you buy a 67.5-volt XX45 battery for \$2.95 and

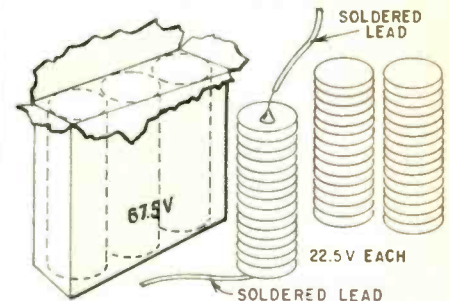

cut it open you will find three individual 22.5-volt batteries. Each one may be used separately by simply soldering leads to the batteries as in the diagram. They are small and easy to purchase as they are a common replacement for tube type portable radios.—Frank J. Lutz, Jr.

COIL PICKER

Save that ballpoint pen when it runs dry. Open it up and remove the ball from the cartridge with pressure from pliers on the cartridge tip. Force a sewing needle into the tip, eye end first, and leave about 1/4—3/8 inch of the tip exposed. Now, replace the cartridge in the pen.

This device is a very useful prod for picking out fine wires from coils being repaired when a replacement coil is not available.—William Porter

PROTECT YOUR MIKE

To keep from damaging a small hand-held crystal mike, such as the type used with home tape recorders, when it isn't

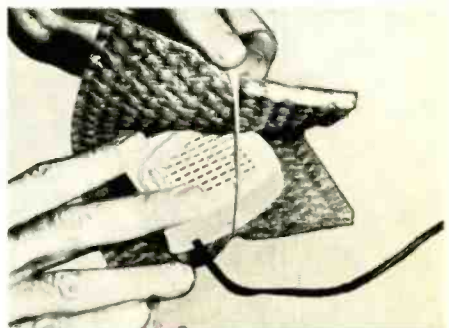

in use, wrap it in a piece of sponge rubber and place a rubber band around the works to hold it in place. Now, should the mike be dropped accidentally, the sponge will cushion its fall and protect the delicate crystal element.—John A. Comstock

FRONT-END ALIGNMENT

When aligning the front end of a TV receiver, the signal is fed into a shield placed over the oscillator mixer tube. This shield must not be grounded to the chassis. To avoid accidentally grounding the shield, I fold a piece of plastic tape over the bottom edge.—Wm. M. Atkinson

NOW!

Step ahead faster
as an

INDUSTRIAL ELECTRONICS TECHNICIAN



Turn your experience into a big, new better-paying career!

Day by day industrial plants are adding more electronic devices — for sorting, counting, checking almost any control job you can name. Cash in on industry's great need for men who can keep these devices in top working order. Make more money, feel more secure, doing work that is second nature to you. With what you already know about electronics you have a long head start in a field just beginning to boom. GET INTO IT RIGHT NOW with the help of

PRACTICAL INDUSTRIAL ELECTRONICS LIBRARY

No long sessions on math or theory! These 4 practical volumes show you how to keep the plant's electronic equipment working... how to locate and correct tube and circuit troubles... how to install, service, and maintain even brand new equipment without being stumped by new circuits!

4 volumes (1369 pp., 102 illus.).
Chute's Electron-
ics in Industry

Miller's Maintenance Manual of Electronic Control

Markus & Zeluff's Handbook of Industrial Electronics Circuits

Henny & Fahnestock's Electron Tubes in Industry

FREE TRIAL—EASY TERMS

McGraw-Hill Book Co., Dept. RE-10,
321 W. 41st St., N.Y.C. 36

Send me the Practical Industrial Electronics Library for 10 days' examination on approval. In 10 days I will send \$3.00, then \$3.00 a month until \$29.50 is paid. (A saving of \$5.00 under the regular price of \$28.50.) Otherwise I will return books postpaid. (Print)

Name.....

Address.....

City..... Zone..... State.....

Company.....

Position..... RE-10

For price and terms outside U.S. write McGraw-Hill Int'l., N.Y.C.

CATHODE RAY TUBE SPECIALS ONE YEAR GUARANTEE

Type	STAN BURN	Type	STAN BURN	Type	STAN BURN
10BP4	\$10.00	16LP4A	16.25	21EP4B	23.25
12LP4	13.95	17BP4	15.75	21FP4	21.15
12QP4	11.50	17BP4B	18.75	21MP4	26.25
12DP4	11.50	17CP4	15.00	21CP4	22.00
14CP4	13.75	17GP4	21.50	21YP4A	25.00
13DP4	14.50	17LP4	18.00	21ZP4	21.00
16AP4	18.50	18AP4A	24.00	21ZP4B	24.00
16DP4A	15.25	20CP4A	18.95	24AP4	56.00
16GP4	18.75	20CP4B	21.95	(6 mos. guar.)	
16KP4	15.75	21AP4	25.00	24CP4A	38.00
16KP4A	18.75	21EP4A	20.15	24FP4A	39.00

*Aluminized, Stan-Burn CRT tubes RCA Licensed, mfd. by Lincoln. FOB New York warehouse.

HI-FI DIAMOND NEEDLES—1 Yr. Guar.

SINGLE DIAMOND needle..... \$4.95
DIAMOND SAPH dual needle..... 5.95
(plus 25c postage—specify cartridge make)

\$20 WORTH OF ELECTRONIC PARTS IN GRAB-BAG consisting of: porcelain sockets, coils, speaker transistors, condens. ONLY..... \$1.98 (plus 50c postage)

COLLARO TC 340 RECORD CHANGER with SONOTONE DIAMOND-SAPH. STEREO cart. \$34.95.

NOBODY BUT NOBODY BEATS OUR HI-FI PRICES! Send us your requirements for STAN-BURN'S LOWEST QUOTATIONS on systems, kits, and individual components.

STAN-BURN RADIO and
ELECTRONICS CO.
558 CONEY ISLAND AVE. • B'KLYN 18, N. Y.

November
Radio Electronics
On Sale October 28th.

ENGINEERING B. S. DEGREE IN 27 MONTHS

Prepare for unlimited opportunities of the Electronic Age! Earn your B.S. DEGREE IN 27 MONTHS in Aeronautical, Chemical, Civil, Electrical or Mechanical Engineering; in 36 MONTHS in Mathematics, Chemistry, Physics. Intensive, specialized courses. Comprehensive training in electronics, television, advanced radio theory and design, math, nuclear physics and elec. eng. Engineering Science preparatory courses. Low rate. Graduates in demand. Spacious campus; 20 bldgs., dorms, gym, playing field. Earn part of your expenses in Fort Wayne, G.I. approved. Enter Dec., March, June, Sept. Catalog.

INDIANA TECHNICAL COLLEGE
1710 E. Washington Blvd., Fort Wayne 2, Indiana
Please send me free information on B.S. ENGINEERING DEGREE IN 27 MONTHS as checked.
 Electronics Chemical Aeronautical
 Civil Mechanical Electrical
B.S. DEGREE IN 36 MO. in: Math. Chem. Physics

Name.....
Address.....

Business and People

RCA Electron Tube Division, Harrison, N. J., is merchandising its transis-



tor batteries in a new all-metal counter merchandiser.

Centralab Div., Globe Union, Milwaukee, Wis., introduced a new packaged-circuit kit. It contains 40 units divided among the 14 most used types.

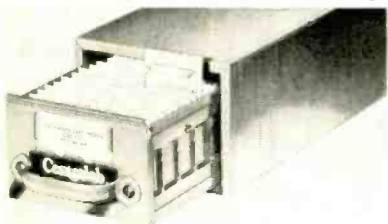

The kit will cover 80% of all packaged-circuit replacement needs. The units are packed in a plastic container arranged for identification in a metal cabinet.

CBS-Hytron, Danvers, Mass., is providing service technicians with a full-



color picture-tube display card advising customers how to check their own picture tubes.

Jensen Industries, Forest Park, Ill., is getting its phonograph-needle promo-



DX-16 Super Deluxe TV KIT

70° or 90°—operating all 17", 21", 24" and 27" PICTURE TUBES
NEW IN DESIGN

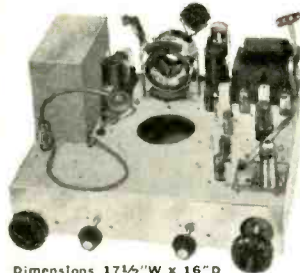

Dimensions 17 1/2" W x 16" D
Shipping weight 40 lbs.

Mounts Horizontally, Vertically or Sideways

- ★ Produces a 16-Tube Chassis with 30-Tube performance.
- ★ Latest Intercarrier Circuitry and Multi-section Tubes.
- ★ Standard Neutrode Tuner for Selectivity & Fine Definition.
- ★ 5 Microvolts Sensitivity (20V peak to peak at CRT grid).
- ★ Fast Action AGC for Drift Free, Steady and Clear Pictures.
- ★ 3 Hi-gain Video I.F. Stages for fine Contrast and Details.
- ★ AGC Level Control, for adjusting reception to signal area.
- ★ All Video and I.F. Coils factory pre-aligned and tuned.
- ★ Large 250ma Power Transformer for dependable service.
- ★ 12" Speaker or Twin-cone 6" x 9" Speaker.

COMPLETE with LIFE-SIZE step-by-step Building Instructions
Most up-to-date and practical Course in Television.

Sold on the Easy-Payment-Plan—\$2.49 starts you off. You receive LIFE-SIZE step-by-step Building Instructions . . . just buy a few dollars worth of parts at a time as you build . . . or buy it complete at the low price shown below.

COMPLETE with SET of WESTINGHOUSE TUBES **\$79.97**
4-6CB6 and 6U8, 6T8, 6C4, 12BH7, 6SN7, 6XQ6, 6V4, 6K6, 1X2B, 5U4, 6UN4 and 6CG8 included in the Tuner. (less CRT)

Westinghouse ALUMINIZED PICTURE TUBES

BRAND NEW in Factory Sealed Cartons—With a Full Year Guarantee

17" 17 AVP4A	21" 21 ALP4A	24" 24 AHP4	27" 27 EP4A
17 BP4B	21 AMP4A	24 ALP4	27 LP4
17 CDP4	21 AUP4A	24 CP4A	27 RP4
17 HP4B	21 EP4B	24 DP4A	
17 LP4A	21 YP4A	24 VP4A	
17 QP4A	21 ZP4B	24 YP4	

\$22.66 | \$32.21 | \$48.99 | \$74.31

BUILD YOUR OWN TV CABINET FOR ANY TV CHASSIS

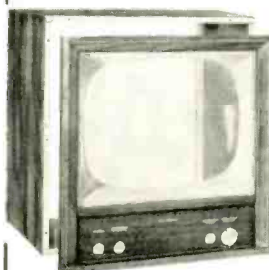

Comparable to the type that Top Mfrs. use on high priced TV sets.

CABINET KIT with 90% of the job done, includes—

FRONT SECTION in Solid Mahogany, Walnut or Blond Korina, TOP, SIDES, BACK, MASK, SAFETY GLASS, ETC.

And Easy-to-follow Instructions

Front, Top and Sides supplied in a beautiful Piano Finish • Knob panel undrilled. • For matching Mask specify type or number of CRT used. Same price—Mahogany, Walnut or Blond.

21" CABINET KIT 26"H., 25"W., 22"D. **\$24.95**

(Shipping weight 36 lbs.)

17" CABINET KIT 24 1/2"H., 22"W. \$24.95 24" or 27" CABINET KIT 30"H., 28 1/2"W. \$36.47

FRONT SECTION for WALL INSTALLATIONS includes Mask, 21" \$17.45 | 24" or 27" \$22.97 only

Same price—Mahogany, Walnut, Blond or Natural unfinished for your own color application

BROOKS RADIO & TV CORP. 84 Vesey St. Dept. A, New York 7, N.Y.

SUPER MAGNET SUPER SAVING!

Buy this Little Giant Magnet, most powerful made, a sensational bargain! The low price of \$1.50 is less than 50% of what you'd pay for this magnet. Experimenters, hobbyists will find hundreds of uses for this powerful 4 oz. Alnico permanent magnet. LIFTS 5 lbs. EASILY. Limited quantity. Order several today. Measures 1 3/4 x 1 1/2". **\$1.50**
Special Bargain (Shp. Chgs. 10c)



250 POWER TELESCOPE LENS KIT

Make your own high powered 6 ft. telescope! Kit contains 2" diam., 75" focal length, ground and polished objective lens and necessary eye pieces. Magnifies 50x to 250x. Full instructions.

ITEM NO. 123
\$2.95
(Shp. Chgs. 10c)



AMAZING BLACK LIGHT

250-watt ultra-violet light source. Makes fluorescent articles glow in the dark. Fits any lamp socket. For experimenting, entertaining, unusual lighting effects.

Ship. wt. 2 lbs. **\$2.95**
ITEM NO. 87
(P. P. & Mdg. Chgs. 35c)



HUDSON SPECIALTIES CO., 160 W. 14th St. Dept. RE-10-58, New York 7, N.Y.
I am enclosing full remittance for items circled below. (Be sure to include shipping charges.)
87 33 86 123

Name _____ Please Print Clearly
Address _____
City _____ Zone _____ State _____



WATHOUR METER

Leading makes—reconditioned. Ideal for trailer parks, 100-110 volts, 60 cycles, 2-wire A.C. 5 amp. Heavy metal case 8 1/2" x 6 1/4" x 5". Easy to install. Ship. wt. 14 lbs.

ITEM NO. 33
NOW ONLY \$4.50
(P. P. & Mdg. Chgs. \$1.25)

VACO HAS "TWINS"

**TWIN DRIVERS!
TWIN USES!**

Two combination tools that make your servicing work easier . . . faster!

No. 1 . . . 5/32" insulated blade screw driver with 1/4" nut driver. Pocket clip handle.

No. 2 . . . genuine Phillips No. 1 point driver with 1/4" nut driver. Pocket clip handle.

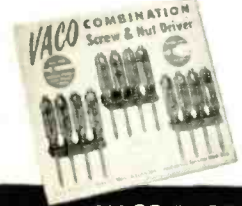

Look for them on this handsome VACO Display Card at your favorite Parts Jobber.



Only **79¢** each dealer's net.

VACO PRODUCTS CO. 317 E. Ontario St., Chicago 11, Ill.
In Canada: Atlas Radio Corp., Toronto 19, Ontario

Service stations wanted

Additional authorized exclusive service and repair stations required by America's first mass producer of dependable low-cost ultrasonic systems. Thousands of units already installed throughout the United States and Canada. Excellent opportunity for established radio, TV, industrial electronics or appliances service firms. Write Robert Markel, Service Manager, or phone EDgewood 3-3400.

the narda ultrasonics corporation
625 Main Street, Westbury, L.I., N.Y.

**FIRST DUOTONE
FIRST DUOTONE
FIRST DUOTONE
FIRST DUOTONE
FIRST DUOTONE
FIRST DUOTONE**

- IN PROFIT
- IN DEALS
- IN ACCESSORY PRODUCTS
- IN GUARANTEES
- IN NEW ITEMS

DUOTONE CO., INC.
Keyport, New Jersey
In Canada, Charles W. Pointon, Ltd.

TAPE RECORDERS

HI-FI COMPONENTS
Tapes • Accessories

MERITAPE
Low cost, high quality recording tape. In boxes or cans.

UNUSUAL VALUES
Send for Free Catalog

DRESSNER, 69-02RE 174 St., Flushing 65, N.Y.

CRYSTALS, Inc.
Accuracy, Dependability,
Quality and ONE DAY SERVICE

AMATEUR BAND CRYSTALS
Not surplus! New quartz ground and etched to your exact specified frequency. Checked on HP cycle counters.

1500 KC to 2000 KC . . . \$2.00 ea. postpaid
2001 KC to 8995 KC . . . \$1.50 ea. postpaid
8996 KC to 11000 KC . . . \$2.50 ea. postpaid

SSB FILTER CRYSTALS
Plated type in FT-241A holders. All channels 370 to 534 KC (Except 500 KC) \$1.00 ea. postpaid. 500 KC . . . \$1.75 ea. postpaid. Channel groups accurately matched. No extra charge.

MARINE FREQUENCIES
All channels. Guaranteed accuracy. Supplied in MC7 or FT243 holders (Specify which type) \$3.75 ea. postpaid.

VERY THIN CRYSTALS
Supplied in very thin FT243 holders. Order by fundamental frequency. \$2.00 ea. postpaid.

MINIMUM ORDER \$2.00 NO CODs

Satisfaction guaranteed or your money back! Illinois orders . . . please include sales tax.

CRYSTALS, Inc.
ODELL, ILLINOIS

BUSINESS AND PEOPLE (Continued)

tion in orbit with a sputnik-shaped plastic and cardboard rocket display holding 16 needles of the most popular types for retail store counters.

Cornell-Dubilier Electric Corp., South Plainfield, N. J., and Radiart Corp., Indianapolis, Ind., announced that Frederick Diehl of Traynor Dean, Tampa, Fla., was the winner in their nationwide contest for service technicians for choosing the best name for the TR



15/16 CDR antenna rotor marketed by both firms. Diehl beat out over 15,000 other contestants to win first prize, a 1958 Plymouth station wagon, and an all-expense-paid trip to Indianapolis. He is shown receiving keys to the car from Kay Thompson, Miss Indianapolis of 1959, as Bill Schoneberger (left), Radiart sales manager, and Ray Leary, Cornell Dubilier sales manager, look on. The winning name was not revealed.

Paco Electronics Co., Glendale, N. Y., designed a four-color display board



which mounts front panels of eight of its most popular test equipment kits.

ORRadio Industries, Opelika, Ala., is



offering its Irish brand recording tape dealers an identification decal.

EIA Unit Sales Record
First Six Months

	1958	1957
Transistors	18,452,324	11,199,300
TV Sets	2,177,652	2,810,403
Radios (excluding auto sets)	2,964,338	3,638,969
TV picture tubes	3,689,587	4,814,659
Receiving tubes	190,406,000	221,175,000

Production

	1958	1957
TV sets	2,167,930	2,722,139
Radios	4,961,293	7,187,294

Robert Erickson, former president and director of the Heath Co., Benton Harbor, Mich., a subsidiary of Daystrom Inc., was appointed executive vice president of Beckman Instruments Inc., Fullerton, Calif., where he will be chief operating executive.



Daniel J. Webster joined Tung-Sol Electric Inc., Newark, N. J., as general sales manager. He comes to the company from Raytheon Manufacturing Co. where he was assistant division manager of the Commercial Equipment Div.



Ira M. (Duke) Slater (left), sales manager the Vibrator Div. of P. R. Mallory & Co., Du Quoin, Ill., was promoted



to manager-sales engineering of the division. Fred H. Larrabee, Jr., former manufacturers representative, becomes sales manager of the division.

C. R. (Russ) Robertson, regional sales manager of Weller Electric Corp., Easton, Pa., was advanced to the post of sales manager.



Frank A. Sullivan (left) is now semiconductor general sales manager for CBS-Hytron, Danvers, Mass. He comes from the Wheeler Reflector Div. of



Franklin Research Corp. David A. Sokolov takes over the new post of manager-field engineering, government and industrial products, for CBS-Hytron. He had been supervisor of receiving tube developments.

Joe Ramer, engineering adviser of Heath Co., Benton Harbor, Mich., assumes new duties as chief engineer of the Engineering Dept.



John H. Cashman, founder and former president of Radio Craftsman Inc. and a pioneer in the industry, died at his home in Chicago at the age of 58. END

TELEVISION

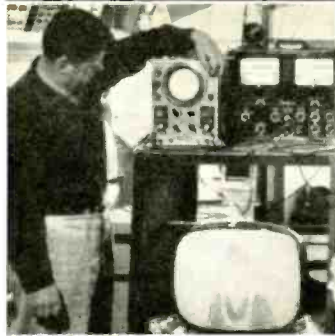

Never before in American history has the need been so great for Trained Engineers and Technicians. No other type of training can compare with actual shop practice you get at Healds under expert instructors.

Bachelor of Science Degree, 27 Months

- Radio-TV Technician including Color TV (12 Months)
- Electronics Technician (12 Months)
- Industrial Electronics Technician (12 Months)
- Electronics Engineering (B.S. Degree)
- Electrical Engineering (B.S. Degree)
- Mechanical Engineering (B.S. Degree)
- Civil Engineering (B.S. Degree)
- Architecture (B.S. Degree)

Heald College ranks FIRST West of the Mississippi in "Who's Who in America"

Approved for Veterans
DAY AND EVENING CLASSES

Write for Catalog and Registration Application.
New Term Starting Soon.

AT HEALDS YOU LEARN
BY DOING IN MODERN
ELECTRONICS LABORATORIES

HEALD

ENGINEERING COLLEGE

Established 1863

Van Ness at Post, RE
San Francisco, Calif.

Your Name _____
Address _____
City _____
State _____

BOOK MANUSCRIPTS

CONSIDERED

by cooperative publisher who offers authors early publication, higher royalty, national distribution, and beautifully designed books. All subjects welcomed. Write or send your MS directly.

GREENWICH BOOK PUBLISHERS, INC.
Attn. MR. JAMES 489 FIFTH AVE.
NEW YORK 17, N. Y.

MAIL ORDER HI-FI

You can now purchase all your Hi-Fi from one reliable source and be assured of perfect delivery. Carston makes delivery from NY stock on most Hi-Fi, Recorders and Tape within 24 hours. SEND US A LIST OF YOUR HI-FI REQUIREMENTS FOR OUR QUOTATION.

CARSTON STUDIOS 215-RD E. 88 St.
New York 28, N. Y.

"You'd get even better results with a JENSEN NEEDLE, old man."

THIS CAN BE YOU

earning up to \$25,000 a year

here is an amazing new BUSINESS OPPORTUNITY for you

Self-service tube testers do all the work for you . . . just collect your profits once a week

A basic principle for making money is to have something work for you, rather than you yourself do the work. As an operator of a FAST-CHECK SELF SERVICE TUBE TESTER route you can be the proud owner of a solid fast-growing business . . . earning money for you while you take life easy. Business can be operated from home and during spare time. All you do is make calls once a week to restock testers and collect profits.

No selling required

Century's self-service tube testers check and sell TV and radio tubes automatically 12 hours a day - 7 days a week. Consumers do their own testing and defective tubes are replaced on the spot for highly profitable sales. You place testers and tube stock in stores on consignment . . . and each one can net up to \$1000 a year.

Retail stores welcome self-service testers

Drug stores, luncheonettes, supermarkets, candy stores, hobby stores, etc. welcome having a tube tester placed in their store because of the extra traffic it attracts and the commission they earn.

FREE booklet tells all about this booming business

If you are interested in starting a lifetime business, then ACT NOW and send for FREE booklet to convince yourself that this is today's greatest business opportunity.

DON'T DELAY . . . MAIL COUPON TODAY

CENTURY ELECTRONICS CO., INC.
Dept. E-10, 111 Roosevelt Ave., Mineola, N. Y.

Please send me FREE booklet and particulars about setting-up a self-service tube tester route.

Name _____
Address _____
City _____ State _____



... Superbly made and designed for Radio, T.V. and Electronic Technicians. See your Distributor ... only one quality ... the finest — whether you choose individual items or the handy kits ...

Use the Tools the Professionals use!



XCELITE, INCORPORATED
ORCHARD PARK, NEW YORK
Canada: Charles W. Pointon, Ltd., Toronto

XCELITE
Quality Hand Tools
PREFERRED BY THE EXPERTS

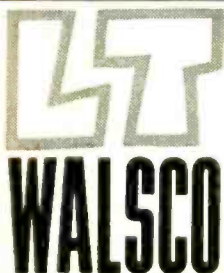

FIRST NEW
PUNCH
DEVELOPMENT
IN 20 YEARS ...
OBSOLETES
EVERY OTHER
PUNCH NOW
ON THE MARKET

**"L.T." LOW TORQUE
CHASSIS PUNCH**

**CUTS a cleaner hole
with 50% less effort!**

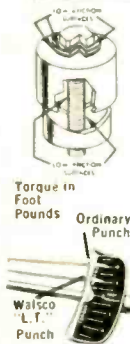

A brand-new electro-coating process (which can't wear off) reduces friction, thus lowers torque. You get a much cleaner hole with much less effort. The Walsco "L.T." Chassis Punch requires no lubrication of any kind and will give perfect service almost indefinitely. Available in a wide variety of sizes, round, square, key and D shapes.

Full information on these extra-easy to use "L.T." punches is available from your Walsco distributor or by writing direct to Walsco.

WALSCO ELECTRONICS MFG. CO.
A Division of Textron Inc.
West Coast Plant: Los Angeles 18, California
Main Plant: 110 WEST GREEN STREET
ROCKFORD, ILLINOIS, U.S.A.



**SUITS NEED PRESSING—
MERIT DEFLECTION YOKES
DO NOT!**

Merit deflection yokes are cosine wound TO FORM, not pressed. Pressing can lead to distortion and poor focusing. Pressing after winding frequently causes breakdown.

**MERIT COILS AND TRANSFORMERS
HAVE "BUILT-IN" ADVANTAGES.**



Each Merit yoke is
100% LIVE TESTED

**COMPARE IT WITH
MERIT**
MERIT COIL AND TRANSFORMER CORP.
MERIT PLAZA • HOLLYWOOD, FLORIDA

technical Literature



Any or all of these catalogs, bulletins, or periodicals are available to you on request direct to the manufacturers, whose addresses are listed at the end of each item. Use your letter-head—do not use postcards. To facilitate identification, mention the issue and page of RADIO-ELECTRONICS on which the item appears. UNLESS OTHERWISE STATED, ALL ITEMS ARE GRATIS. ALL LITERATURE OFFERS ARE VOID AFTER SIX MONTHS.

SPEAKERS AND ENCLOSURES are featured in two new catalogs. The speaker catalog pictures and describes the complete line of Tempo hi-fi speakers and speaker systems. The enclosure catalog shows bass-reflex cabinets and complete systems.—Oxford Components Inc., 556 W. Monroe St., Chicago 6, Ill.

HOW TO "SEE" SOUND on magnetic tape using Magna-See developing solution is the subject of illustrated *Bulletin RS 57-10*. The solution makes magnetic sound track visible for quick checks on recorder-head alignment, track uniformity, balance and head wear.—Reeves Soundcraft Corp., 10 E. 52 St., New York 22, N. Y.

METER KITS, using a single basic meter movement with interchangeable dial-component units giving a wide variety of meter ranges, are illustrated and described in 4-page *Unimeter* brochure.—Triplett Electrical Instrument Co., Bluffton, Ohio.

PISTON CAPACITORS. *Bulletin 207A* gives specifications of panel and printed-circuit board type Sealcap precision variable capacitors. *Bulletin 210* lists miniature quartz trimmers. A separate catalog sheet announces the availability of L-C tuners, combining a variable inductance and a capacitor in a glass cylinder.—JFD Electronics Corp., 1462 62 St., Brooklyn, N. Y.

TANTALUM SLUG CAPACITORS are discussed and described, with a table of standard capacitance and voltage values, in *Bulletin 159*.—Ohmite Mfg. Co., 3694 Howard St., Skokie, Ill.

LOUDSPEAKER HANDBOOK for technicians, sound engineers and architects, *The University Technilog on Loudspeakers* is a 64-page guide to sound planning containing technical and product information. Among topics covered are application of driver-unit specs, overload protection, line matching, phasing, adjusting power capacity and cutoff, types of speakers, etc.—University Loudspeakers Inc., 80 S. Kensico Ave., White Plains, N. Y. \$1.

TRANSISTOR CHARACTERISTICS and Interchangeability Guide lists more than 600 types currently being manufactured and gives ratings and characteristics

TECHNICAL LITERATURE (Continued)

of nearly 100 made by Sylvania.—Sylvania Electric Products Inc., 1100 Main St., Buffalo 9, N. Y.

PHONO NEEDLES, how they wear and when to replace them is the subject of a non technical leaflet, *A Stitch in Time*.—Jensen Industries Inc., 7333 W. Harrison St., Forest Park, Ill.

VIDICON CAMERA TK-15 for education, military and broadcast use, adaptable to both live and film operation, is described in a 24-page brochure—RCA Broadcast & Television Dept., Camden, N. J.

PRECISION COMPONENTS, hardware, terminal boards, insulated terminals and coil forms are shown in diagrams and photographs with detailed specifications in *Catalog No. 600*.—Cambridge Thermionic Corp., 445 Concord Ave., Cambridge 38, Mass.

KIT CATALOG. A 23-page illustrated booklet showing and describing the entire line of *Heathkit* servicing, hi-fi, lab and special-service equipment kits.—Heath Co., Benton Harbor, Mich.

COMPARATIVE RF MEASUREMENTS using a coaxial switcher are discussed in *Vol. 1, No. 1* of the *Jerrold Technical Newsletter*. This technical paper explains the use of the switcher, which provides simultaneous display of two channels or voltages on one oscilloscope.—Jerrold Electronics Corp., Measurement & Test Div., 15th St. & Lehigh Ave., Philadelphia 32, Pa.

SILICON UNIUNCTION TRANSISTOR, a voltage-sensing and triggering device, is the subject of two brochures (*GP-176*) of specification and application information.—General Electric Co., Semiconductor Products Dept., Electronics Park, Syracuse 1, N. Y.

SNAP-AROUND VOLT-AMMETERS and volt-ammeter-ohmmeters are illustrated in *Catalog No. A-583*.—Pyramid Instrument Corp., Amprobe Div., 630 Merrick Rd., Lynbrook, N. Y.

RELIABLE TUBES of new Frame Grid design, for military and industrial requirements, are described in detail and specific applications given in a brochure entitled *Amperex PQ Reliable Frame Grid Tubes*.—Amperex Electronic Corp., Advertising Dept., 230 Duffy Ave., Hicksville, N. Y.

FULL LINE OF SEMICONDUCTORS is covered in a new folder giving electrical and physical characteristics of silicon junction diodes, Zener diodes and power voltage regulators, silicon solar cells and diffused junction rectifiers.—Hoffman Electronics Corp., Semiconductor Div., 930 Pitner Ave., Evanston, Ill.

SWITCHES AND HARDWARE are featured in a complete 23-page catalog. Included are rotary and miniature push-button switches, binding posts, test clips and miscellaneous components. Every part is illustrated.—Grayhill Inc., 561 Hillgrove Ave., La Grange, Ill.

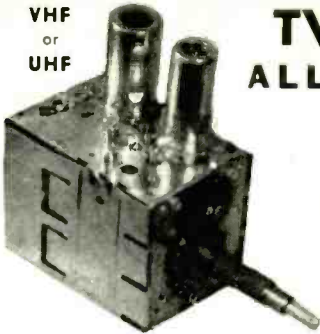

VHF
or
UHF

TV TUNERS REBUILT

ALL MAKES & MODELS

THOUSANDS OF TUNERS IN STOCK

EXCHANGED OR OVERHAULED

\$9.95

NET Price includes WORN parts only. Replacement tubes and smashed or missing parts are charged extra.

COMBINATION UHF/VHF UNITS \$19.90

90 DAYS WARRANTY

ALIGNED TO ORIGINAL STANDARDS USING THE FINEST EQUIPMENT. ALL WORK PERFORMED BY TUNER EXPERTS WITH YEARS OF EXPERIENCE IN THE TUNER FIELD.

SAME DAY SERVICE

EXCHANGE TUNER SHIPPED SAME DAY
(OTHERWISE DEFECTIVE TUNER OVERHAULED AND RETURNED WITHIN 48 HOURS IN MOST CASES.)

Forward Tuner with All Smashed Parts: Quote Make and Model F.O.B. Chicago or Toronto We will ship C.O.D.

Castle Television Tuner Service

1723 W. LUNT AVE.,
CHICAGO 26, ILL.

U.S.A.

152 MAIN ST.,
TORONTO 13, ONT.

CANADA

Suppliers of rebuilt TV Tuners to leading manufacturers, technicians & service dealers, coast to coast. Original and Only Complete TV Tuner Service covering the North American Continent.

GIVE THE UNITED WAY to: UNITED FUNDS COMMUNITY CHESTS

The Most Highly
Recommended Enclosure
in Hi-Fi

Karlson

PATENTED* ENCLOSURE

The Karlson Enclosure is not just a box, but a thoroughly engineered and patented musical instrument, used to perfect the bass response, high frequency dispersion, tonal definition and efficiency of all full range Hi-Fi speakers.

As Featured in *Popular Mechanics*, July '58

Outstanding High Fidelity Experts Say—
Joseph Marshall, Radio Electronics "It can put out an amazing bass, completely out of proportion to its size and far beyond the design capacity of the speaker used."
Donald Hoefler, Hi-Fi Manual "A truly beautiful piece of scientific reasoning, with an ultimate solution which should please even the most highly critical." "A new standard of performance."
Lothar Stern, Electronics Made Easy "Offers the utmost in versatility, outstanding bass response and unusual styling."

Kit, Unfinished and Finished Models
from \$18.60 to \$174.00

*Pat. No. 2,816,619

Write for name of nearest dealer

KARLSON ASSOCIATES, INC.

Dept. RE8, 433 Hempstead Ave., Hempstead, N. Y.

NEW! IMPROVED!

SENCORE

TRC4
TRANSISTOR
CHECKER

Another
Sencore
Time-
Saver



Only tester that checks car radio power transistors

NOW CHECKS:

- ★ Transistors for opens, shorts, leakage and current gain. Includes new gain test on power transistors.
- ★ Crystal Diodes checks forward to reverse current ratio on all diodes.
- ★ Selenium Rectifiers checks forward and reverse currents.

Controls are accurately set for each transistor by referring to replaceable set-up chart on rear. Test leads or socket provides for fast hook-up. See your parts distributor.

SIMPLE TO OPERATE

ONLY \$17.95

Dealer Net
Cannot become obsolete.
Approved by leading manufacturers



Mfg. by

SERVICE INSTRUMENTS CORP.

171 OFFICIAL RD., ADDISON, ILL.

Cut out this ad now for further information

Looking
for
the
lowdown
ON
HI-
FI?

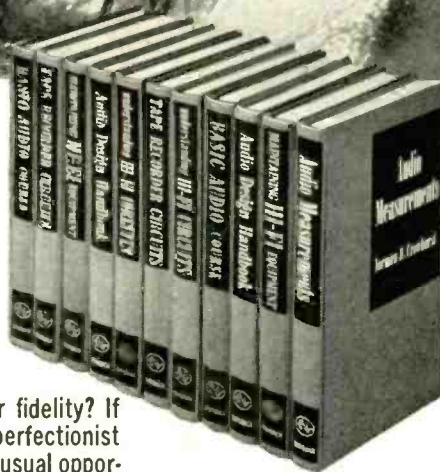
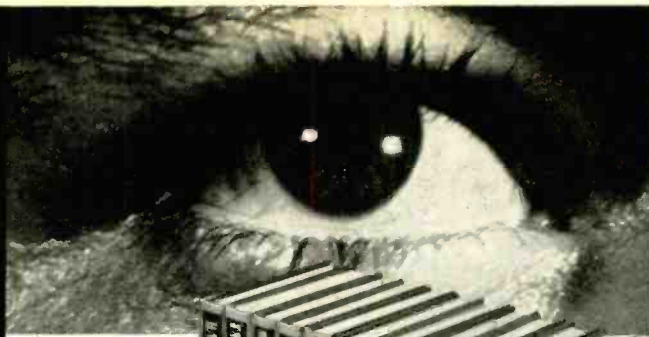

Are you an audio-hi fi man who's constantly looking for ways to improve your system? Do you want to know more about how to modify circuits, service and maintain hi-fi, switch, test, experiment, and build in your never-ending quest for truer fidelity? If the spirit of the experimenter and perfectionist burns bright within you, here's an unusual opportunity for you to approach your goal.

Now through the **G/L AUDIO-HI FI BOOK CLUB** you can acquire a complete set of beautifully bound books on all the phases of high fidelity you've always yearned to know more about. Look over the titles—and authors—titans like Crowhurst, Hartley, Marshall, Hoefler (see his article elsewhere in this magazine)! These books sell for \$5 each—but members get them for only \$3.75. A saving of 25%—\$1.25 on each book! And you risk nothing. You examine each book before you buy—return it if you don't want it.

THESE BOOKS ALREADY PUBLISHED — select one only

H. A. HARTLEY'S AUDIO DESIGN HANDBOOK —Latest addition to the club. This British expert explains design principles so that the non-engineering hi-fi fan can actually design his own equipment.

ELEMENTS OF TAPE RECORDER CIRCUITS — By Herman Burstein and Henry C. Pollak. Here's a book that answers all your questions about the electronic aspects of a tape recorder. Tells what to look for when you buy—what various types will and will not do.

MAINTAINING HI-FI EQUIPMENT — By Joseph Marshall. Covers the specialized techniques necessary to repair hi-fi

equipment. Includes acoustical and mechanical as well as electronic faults.

UNDERSTANDING HI-FI CIRCUITS — By Norman H. Crowhurst. Now you can have the hi-fi system best suited to your tastes—and budget. Crowhurst tells you which phase inverter is best, weighs fixed vs. self bias, triode vs. pentode, answers the questions you ask when looking for hi-fi perfection.

BASIC AUDIO COURSE — By Donald C. Hoefler. Explains everything about audio from the theory of sound to disc and tape recording techniques.

HOW TO JOIN THE G/L AUDIO-HI FI BOOK CLUB

- Select one book from those listed on the coupon.
- **SEND NO MONEY**—we will send you the book on approval. If you like it send your remittance for the special club price of \$3.75.
- New books are released about every four months. You receive these automatically on the same no-risk plan.
- You may cancel any time after you have accepted four books—no time limit.

MAIL THIS COUPON NOW

Gernsback Library, Inc., Dept. 108
154 West 14th Street, New York 11, N. Y.



Enroll me in the G/L
AUDIO-HI FI BOOK CLUB.

(Please check one only)

- Audio Design Handbook
- Elements of Tape Recorder Circuits
- Maintaining Hi-Fi Equipment
- Understanding Hi-Fi Circuits
- Basic Audio Course

Send me the book checked on approval.

Name.....
Street.....
City..... Zone..... State.....

please print

Books



ELECTRONIC SEMICONDUCTORS, by Eberhard Spenke. McGraw-Hill Book Co., Inc., 330 W. 42nd St., New York 36, N. Y. 6 x 9 inches, 402 pages. \$11.

This is a translation of a German second edition. It is a text for physicists, scientists and engineers. Part 1 comprises five chapters which introduce semiconductor theory to the beginner in the field. Part 2 is strictly for advanced students and scientists. It deals with quantum mechanics, Fermi statistics and higher math. Problems appear at the end of each chapter.—IQ

TELEVISION IN SCIENCE AND INDUSTRY, by V. K. Zworykin, E. G. Ramberg and L. E. Flory. John Wiley & Sons, Inc., 440 Fourth Ave., New York 16, N.Y. 6 x 9 inches, 300 pages. \$10.

If you have any doubt of the value of gaining an intimate knowledge of closed-circuit television equipment and techniques, it would be well to read the last chapter of this book first. Entitled "Forecast", it predicts a world in which personal contacts are substantially reduced by television; stores and banks as we know them disappearing; medicine, industry and education undergoing a revolution; the TV camera becoming the most valued servant in the home—as well as the "pioneer observer in interplanetary travel."

Written by a top RCA research team, this volume is both technical and non-technical, describing the applications, basic circuits and available equipment. There are also descriptions of closed-circuit color TV systems—both NTSC and field sequential—as well as stereo television and TV microscopy.

This is a valuable introduction to a vast new field which is now in its infancy. Everyone connected with electronics, industry or education will have to explore this field sooner or later.—DL

ELSEVIER'S DICTIONARY OF ELECTRONICS AND WAVEGUIDES, in six languages. Compiled and arranged on an English alphabetical base by W. E. Clason. Elsevier Publishing Co., Amsterdam, Holland. Distributed in US by D. Van Nostrand Co., Inc., 120 Alexander St., Princeton, N. J. 6 x 9 inches. 628 pages. \$17.50.

This ambitious work is basically an English electronics dictionary. Over 2,000 technical words and terms are listed and defined on the left-hand pages. On the opposite pages are the terms in French, Spanish, Italian, Holland and German. Terms from "electronic tube"

SCHOOL DIRECTORY

Your choice of school is highly important to your career in



INDUSTRIAL ELECTRONICS



RADIO-TELEVISION



ELECTRONICS COMMUNICATIONS

Become an **ELECTRICAL ENGINEER**

or an **ENGINEERING TECHNICIAN**

at **MSOE in Milwaukee**

Choose from courses in:

ELECTRICAL ENGINEERING
Bachelor of Science degree in 36 months—
Communications or Electrical Power.

ENGINEERING TECHNOLOGY
Associate in Applied Science degree in 18 months—
Electronics Communications, Electrical Power, or Computers.

MSOE — located in Milwaukee, one of America's largest industrial centers—is a national leader in electronics instruction—with complete facilities, including the latest laboratory equipment, visual aid theater, amateur radio transmitter—offers 93 subjects in electrical engineering, electronics, radio, television, electrical power, and electricity.

Advisory committee of leading industrialists. Courses approved for veterans. Over 50,000 former students. Excellent placement record. Previous educational, military, and practical experience is evaluated for advanced credit.

QUARTERS BEGIN SEPTEMBER, JANUARY, MARCH, JULY

Choose wisely—your future may depend on it. Mail coupon today!



MILWAUKEE SCHOOL OF ENGINEERING

Dept. RE-1058, 1057 N. Milwaukee St. Milwaukee, Wis.

Please send free illustrated career booklet (please print)

I'm interested in..... (Course)
Name..... Age.....
Address.....
City..... State.....
 I am I am not eligible for veterans benefits
(discharge date)

SENDING SPEED
CODE RECEIVING

Be a "key" man. Learn how to send and receive messages in International Morse code. Communicate with operators around the globe. Learn at home quickly through famous Candler System. Used by best operators. Qualify for Amateur or Commercial License. Write for FREE BOOK.

CANDLER SYSTEM CO.
Dpt. 3-L, Box B226, Denver 20, Colo. USA

ELECTRONICS ENGINEERING DEGREE IN 27 MONTHS

Prepare for unlimited opportunities in electronics! B.S. degree in 27 months, mathematics, electrical engineering, TV, advanced radio theory and design. Modern labs. Low tuition. Earn board. Also Aero., Chemical, Civil, Electrical, Mech., Engineering. B.S. degree in 36 mo. in Math., Chem., Physics. Also prep courses. G.I. appr. 20 bldgs., dorms., gym, Enter Dec., March, June, Sept. Catalog: Keeping Pace With Progress.

INDIANA TECHNICAL COLLEGE
1510 E. Washington Boulevard, Fort Wayne 2, Indiana

GET INTO ELECTRONICS

V.T.I. training leads to success as technicians, field engineers, specialists in communications, guided missiles, computers, radar and automation. Basic and advanced courses in theory and laboratory. Assoc. degree in electronics in 20 mos. B.S. in electronic engineering obtainable. ECFE accredited. G.I. approved. Graduates in all branches of electronics with major companies. Start September, February. Dorms, campus. High School graduate or equivalent. Catalog.

VALPARAISO TECHNICAL INSTITUTE
Dept. C Valparaiso, Indiana

ENGINEERING DEGREES
E.E. Option Electronics or Power

Earned through **HOME STUDY**
Residence Classes Also Available

PACIFIC INTERNATIONAL UNIVERSITY
College of Engineering, Physics, and Business Administration
5719-M, Santa Monica Blvd., Hollywood 38, Calif.

college grads get ahead faster!

... have higher incomes ... advance more rapidly. Grasp your chance for a better life. Share rewards awaiting college men. Important firms visit campus regularly to employ Tri-State College graduates. Start any quarter. Approved for Vets.

Bachelor of Science Degree in 27 months

Electrical Engineering with either an Electronics or Power major. Also Mechanical, Civil, Chemical, Aeronautical Engineering. In 36 months a B.S. in Business Administration (General Business, Accounting, Motor Transport Management Majors). Superior students faster. More professional class hours. Small classes. Enrollment limited. Beautiful campus. Well-equipped labs. Prep courses. Enter Jan., March, June, Sept. Earnest, capable students (whose time and budget require accelerated courses and modest costs) are invited to write Jean McCarthy, Director of Admissions, for Catalog and "Your Career in Engineering and Commerce."

TRI-STATE COLLEGE
24108 College Avenue, Angola, Indiana

FINISH HIGH SCHOOL AT HOME!

No classes to attend. Easy spare-time training covers big choice of subjects. Friendly instructors; standard texts. Full credit for previous schooling. Diploma awarded. Write now for FREE catalog!

WAYNE SCHOOL Catalog HKE-17
2527 Sheffield Ave., Chicago 14, Illinois

ELECTRONICS

PREPARE FOR A GOOD JOB!
BROADCAST ENGINEER
RADIO SERVICING AUTOMATION

TELEVISION SERVICING
BLACK & WHITE—COLOR

APPROVED FOR VETERANS AND SURVIVORS OF VETERANS
BUILDING AIR CONDITIONED
SEND FOR FREE LITERATURE

BALTIMORE TECHNICAL INSTITUTE
1425 EUTAW PLACE, BALTIMORE 17, MD.

YOUR CAREER IN AVIONICS!

AVIATION - ELECTRONICS
JETS - ROCKETS - MISSILES
SPACE TECHNOLOGY

Jet Airliners; Guidance Systems; Space Studies; Moon Landings—All this means just one thing to a Northrop educated man — **OPPORTUNITY!**

Graduate in two short years

Thousands of successful Northrop Institute graduates are now employed by leading companies in the fields named above. They hold important, responsible, highly-paid positions, and their Engineering Technology training at Northrop required only 24 months to complete.

EARN A BACHELOR OF SCIENCE DEGREE

If you elect, you may continue your study an additional year and earn a B.S. degree in the fields of Aeronautical Engineering, Electronics Engineering, or Aircraft Maintenance Engineering.

GET COMPLETE FREE INFORMATION

Fill out this coupon and mail today. Check the training which most interests you.

APPROVED FOR VETERANS

NORTHROP AERONAUTICAL INSTITUTE
1181 W. Arbor Vitae Street, Inglewood 1, Calif.

Please send me immediately the Northrop catalog, employment data, and schedule of class starting dates. I am interested in:

Electronic Engineering Technology
 Aeronautical Engineering Technology
 Aircraft Maintenance Engineering Technology
 Master Aircraft and Engine Mechanic
 Jet Engine Overhaul and Maintenance

Name..... Age.....
Address.....
City..... Zone... State.....
Veterans: Check here for Special Veteran Training Information.

ADVERTISING INDEX

Radio-Electronics does not assume responsibility for any errors appearing in the index below.

Aero Products Co.	128	Moss Electronic Distributing Co. Inc.	86-89
Aerovox Corp.	99	Narda Ultrasonics Corp.	146
Allied Radio Corp.	22-23, 29	National Radio Institute	3, 19-20
American Microphone Manufacturing Co.	115	National Schools	5
Amphenol Electronics Corp.	116	Opportunity Adlets	152
Arkay Inc.	103	ORRadio Industries Inc.	104
Atlas Sound Corp.	139	Oxford Components Inc.	122
Aviation Surplus Center	94	Paco Electronics Co., Inc.	130
B & K Manufacturing Co.	14, 113	Pentron Corp.	96
Barry Electronics Corp.	153	Philco Accessory Division	92-93
Bell Telephone Labs.	32	Picture Tube Outlet	135
Blonder-Tongue Labs.	95	Pilot Radio Corp.	139
Brooks Radio & Television Corp.	141, 145	Precision Electronics	122
Burstein-Applebee Co.	143	Progressive Edu-Kits Inc.	134
CBS-Hytron	83	Pyramid Electric Co.	110
Capitol Radio Engineering Institute	9, 97	Quality Electronics	142
Carston Studios	147	RCA Electron Tube Division	Back Cover
Castle Television Tuner Service	149	RCA Institutes	123
Center Electronics Co.	141	RCA (Test Equipment)	117
Centralab Div. of Globe Union	120	Radio Shack Corp.	21
Century Electronics Co., Inc.	101, 147	Raytheon Manufacturing Co.	8
Cisind (H. G.)	122	Rider (John F.) Inc.	135
Cleveland Institute of Radio Electronics	10-11	Rinehart & Co., Inc.	112, 129
Coloraptor	141	Sams (Howard W.) & Co., Inc.	13, 103, 126
Coyne Electrical School	94, 118, 131	Scott (H. H.) Inc.	18
Crystals Inc.	146	Scott-Mitchell House, Inc.	144
DeVry Technical Institute	7	Seg Electronics	143
Dressner	146	Service Instruments Corp.	96, 137, 149
Duotone Co., Inc.	146	Shure Brothers, Inc.	99
Dynaco Inc.	114	Sonotone Corp.	119
Ebe Inc.	142	Sprague Products Co.	133
Electro-Sonic Labs.	28	Sprayberry Academy of Radio Television	25
Electro-Voice Inc.	Inside Back Cover	Stan-Burn Radio & Electronics	144
Electronic Instrument Co. (EICO)	33, 34, 136	Stromberg-Carlson	132
Electronic Publishing Co., Inc.	141	Sun Radio & Electronics	142
Erie Resistor Corp.	135	Supreme Publications	137
Garfield (Oliver) Co.	142	Sylvania Electric Products, Inc.	24
General Electric Co.	106-107	"TAB"	152
Gernsback Library Inc.	150	Tarzian (Sarkes) Inc.	114
Glaser-Steers Corp.	108	Techmaster Corp.	140
Grantham School of Electronics	15	Thorns Co.	90
Greenwich Book Publishers	147	Transvision Inc.	96
Heald Engineering College	147	Triad Transformer Corp.	109
Heath Co.	66-81	Trio Manufacturing Co.	12
Hudson Specialties Co.	145	Triplett Electrical Instrument Co.	Inside Front Cover
Hughes Aircraft & Development Labs.	85	Tung-Sol Electric Co.	6
Indiana Technical College	144	University Loudspeakers, Inc.	16-17
JFD Electronics	30-31	Vaco Products Co.	146
Jensen Industries	147	Van Nostrand (D.) Co., Inc.	108
Jerrold Electronics Corp.	100	Walsco Electronics Manufacturing Co.	121, 148
Karlson Associates Inc.	149	Weller Electric Corp.	127
Key Electronics Co.	142	Western Radio	142
Lafayette Radio	154-156	Winegard Co.	26-27
Lansing (James B.) Sound Inc.	128	Xcelite, Inc.	148
Lektron Inc.	138		
Mallory (P. R.) & Co., Inc.	124-125		
McGraw-Hill Book Co., Inc.	144		
Merit Coil & Transformer Corp.	148		
Michigan Magnetics, Inc.	17		
Mosley Electronics Inc.	94		

SCHOOL DIRECTORY PAGE 151

Baltimore Technical Institute
Candler System Co.
Indiana Technical College
Milwaukee School of Engineering
Northrop Aeronautical Institute
Pacific International University
Tri-State College
Valparaiso Technical Institute
Wayne School

BRANCH ADVERTISING OFFICES: Chicago: 600 Waukegan Road, Glenview, Ill., Glenview 4-6900. Los Angeles: Ralph W. Harker and Associates, 600 South New Hampshire, Tel. DUNkirk 7-2228. San Francisco: Ralph W. Harker and Associates, 444 Market St. Tel. GARfield 1-2481.

FOREIGN AGENTS: Great Britain: Atlas Publishing and Distributing Co., Ltd., 18 Bride Lane, London E.C. 4. Australia: McGill's Agency, Melbourne. France: Brenano's, Paris 2e. Belgium: Agence et Messageries de la Presse, Brussels. Holland: Trilectron, Heenvoede. Greece: International Book & News Agency, Athens. So. Africa: Central News Agency, Ltd., Johannesburg. Capetown. Driban. Natal: Universal Book Agency, Johannesburg. India: Broadway News Centre, Dadar, Bombay #14. Pakistan: Paradise Book Stall, Karachi 3.
Printed in the United States of America

EQUIPMENT & COMPONENT SPECIALS

- **JENNINGS VACUUM-VARIABLE CAPACITORS:** Type UCSX—Range Approx. 20 to 700 MMFD @ 10 Kv. Complete w/ MTG—Brkts mounting and Gear Drive and motor \$36.95
- **Cornell-Dubilier Heavy-Duty 12-Volt Power Supply.** C.D. Model No. 3414 Heavy-Duty 300 Volts D.C. Output at 335 MA. Vibrator Supply Units are made with the finest of components and best construction for long trouble-free use. All units are brand new, packed in original Cartons. Units come complete with two CK-1006 Rectifier Tubes and C.D. Vibrator Type 12VF10. Input: 12.6 VDGS. Output: 300 Volts D.C. at 335 Milliamperes. Size: 8 1/2" High x 13 1/4" Wide x 7 1/4" Deep. Weight: 28 lbs. Sale Price...\$19.50
- **RCA No. 77413 FILAMENT XMFR (Auto-XMFR Type) Primary:** 117 volts AC—60 cycles. Secondary: 38 volts @ 150 Ma. Cat. No. FS-101...Special \$1.00
- **GENERAL-RADIO VARIAC TYPE 200 CUH—The Original Continuously Adjustable Autotransformer—Input Voltage:** 115 volts at output voltage of 0 to 270 volts @ 2 amps. Also will operate from 230 volts and deliver from 0 to 270 volts at 2 amps. Brand new—sealed in original cartons—only...\$11.95
Model 200 CUH with knob and dial—only...less knob and dial—\$12.95
- **PHILCO HI-VOLTAGE XMFR.** 115v-60 cycle input Primary Secondary: 1,100 volts @ 5 Ma. with tap at 700 volts. Entire secondary insulated for 7,000 volts. Cat. No. FS-103...Price \$3.00
- **15" DYNAMIC SPEAKER BRAND NEW.** 8 OHM voice coil. 3500 OHM field coil \$10.00
- **MILLEN 2" MAGNETIC SHIELD** with 2 1/2" x 2 3/4" Bezel with green tinted face. Made of Nicoloi. Brand new—Millen No. 80042...\$2.50
- **MARION 2 1/2" Round Hermetically-Sealed 36 Volt D.C. Voltmeter.** Has expanded 10 to 36 volt scale in half-volt steps. Clean; removed from equipment...\$2.95
- **RAYTHEON VOLTAGE STABILIZER.** Model VR-6114—250 watts input; 95 to 130 volts—output: 115 volts ± 1/2%...\$29.50
- **Scintillation Counter Gammascint Model 1002**
Self-contained portable Scintillation type Gamma-Ray Detector designed for prospecting, radiation monitoring, etc. Contains a nine stage photo multiplier tube coupled to Gamma sensitive plastic phosphor which makes this instrument a real buy. Regular Price \$245.00 complete with headphones, leather strap, batteries, ready-to-operate. Sale Price \$49.95.

WRITE FOR LATEST TUBE CATALOG FREE! Receiving, transmitting, special purpose tubes, diodes, transistors, etc. We have a large, diversified stock at sensible prices.

2-COLOR TUBE CARTONS

Keeps your tube stock neat. New safety partition prevents tube breakage. Distinctively graphed in glossy red and black. The most distinctive tube carton available today. Minimum quantity: 100 of any one size. Write for case lot prices. Packed 1000 to case. F.O.B. N.Y.C. No C.O.D.'s on cartons—send full remittance including postage—excess refunded.

Size	For Tube	Per 100
Miniature	6AU6, etc.	\$1.00
GT	6SN7, etc.	1.25
Large GT	1B3, etc.	1.50
Large C	5U4G, etc.	2.00

WHITE GLOSSY BOXES

Completely blank. No printing or color. Otherwise same as above. Same high quality, same low prices. Specify "WHITE" when ordering. When color is not stated, 2 color cartons will be shipped.

HOW TO ORDER: Send full remittance and save C.O.D. collection fee—include sufficient money for postage—We refund unused amount.—If you desire shipment C.O.D., include 25% deposit.—Send cash by registered mail. Subject to price variation and stock depletion. No C.O.D.'s on tube cartons. All prices FOB N.Y.C.

Specify Exact Method of Shipment You Desire. (Give name of truckline.)

Open Monday to Saturday—Come In and Browse—We are near Prince St. BMT Station—Spring St./IRT Sta. 1 Night up—10,000 sq. feet of values.

BARRY ELECTRONICS CORP.

512 Broadway, Dept. RE-10, N.Y. 12, N.Y.
Phone: Walker 5-7000

KT-500
IN KIT
FORM
74.50

New! Years Ahead!

LAFAYETTE STEREO TUNER KIT

**ONLY
\$7.45
DOWN
7.00 MONTHLY**



Use it as a Binaural-Stereophonic
FM-AM tuner

Use it as a Dual-Monaural
FM-AM tuner

Use it as a straight Monaural
FM or AM tuner

THE MOST FLEXIBLE TUNER EVER DESIGNED

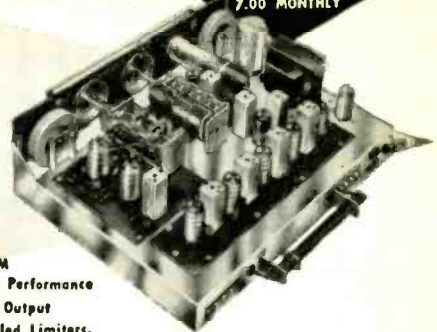

- Multiflex Output for New Stereo FM
- 10KC Whistle Filter
- Pre-aligned IF's
- Tuned Cascode FM
- 11 Tubes (including 4 dual-purpose) + Tuning Eye + Selenium rectifier Provide 17 Tube Performance
- Separately Tuned FM and AM Sections
- 12 Tuned Circuits
- Dual Cathode Follower Output
- Armstrong Circuit with FM/AFC and AFC Defeat
- Dual Double-Tuned Transformer Coupled Limiters.

More than a year of research, planning and engineering went into the making of the Lafayette Stereo Tuner. Its unique flexibility permits the reception of binaural broadcasting (simultaneous transmission on both FM and AM), the independent operation of both the FM and AM sections at the same time, and the ordinary reception of either FM or AM. The AM and FM sections are separately tuned, each with a separate 3-gang tuning condenser, separate flywheel tuning and separate volume control for proper balancing when used for binaural programs. Simplified accurate knife-edge tuning is provided by magic eye which operates independently on FM and AM. Automatic frequency control "locks in" FM signal permanently. Aside from its unique flexibility, this is, above all else, a quality high-fidelity tuner incorporating features found exclusively in the highest priced tuners.

FM specifications include grounded-grid triode low noise front end with triode mixer, double-tuned dual limiters with Foster-Seeley discriminator, less than 1% harmonic distortion, frequency response 20-20,000 cps \pm 1/2 db, full 200 kc bandwidth and sensitivity of 2 microvolts for 30 db quieting with full limiting at one microvolt. AM specifications include 3 stages of AVC, 10 kc whistle filter,

built-in ferrite loop antenna, less than 1% harmonic distortion, sensitivity of 5 microvolts, 8-kc bandwidth and frequency response 20-5000 cps \pm 3 db.

The 5 controls of the KT-500 are FM Volume, AM Volume, FM Tuning, AM Tuning and 5-position Function Selector Switch. Tastefully styled with gold-brass escutcheon having dark maroon background plus matching maroon knobs with gold inserts. The Lafayette Stereo Tuner was designed with the builder in mind. Two separate printed circuit boards make construction and wiring simple, even for such a complex unit. Complete kit includes all parts and metal cover, a step-by-step instruction manual, schematic and pictorial diagrams. Size is 13 3/4" W x 10 3/4" D x 4 1/2" H. Shpg. wt., .22 lbs.

The new Lafayette Model KT-500 Stereo FM-AM Tuner is a companion piece to the Models KT-300 Audio Control Center Kit and KT-400 70-watt Basic Amplifier Kit and the "Triumphator" of these 3 units form the heart of a top quality stereo hi-fi system.

KT-500 Net **74.50**
LT-50 Same as above, completely factory wired and tested.....Net **124.50**

NEW! LAFAYETTE PROFESSIONAL STEREO MASTER AUDIO CONTROL CENTER



KT-600
79.50
IN KIT
FORM

**ONLY 7.95 DOWN —
8.00 MONTHLY**

The Lafayette KT-600 Solves Every Stereo/Monaural Control Problem!

- UNIQUE STEREO & MONAURAL CONTROL CENTER FACILITIES!
- OUTSTANDING PERFORMANCE SUPERIORITY!
- AMAZING NEW BRIDGE CIRCUITRY & CONTROL FOR 3d CHANNEL OUTPUT FOR 3-SPEAKER STEREO SYSTEMS!
- VARIABLE CROSS-CHANNEL SIGNAL FEED ELIMINATES "PING-PONG" EFFECTS!
- PRECISE "NULL" BALANCING & CALIBRATING SYSTEM — BETTER THAN METERS!
- 24 EQUALIZATION POSITIONS PER CHANNEL!
- CLUTCH-TYPE DUAL VOLUME-BALANCE CONTROLS!

- RESPONSE 10-25,000 CPS \pm 0.5 DB
- TAPE HEAD PLAYBACK EQUALIZATION FOR NEW 4-TRACK STEREO
- 1.78 MILLIVOLTS SENSITIVITY FOR 1 VOLT OUT
- LESS THAN .03% IM DISTORTION
- 6 CONCENTRIC FRONT PANEL CONTROLS
- 4 CONCENTRIC REAR PANEL INPUT LEVEL CONTROLS
- 180° ELECTRONIC PHASE REVERSAL

A REVOLUTIONARY DEVELOPMENT IN STEREO HIGH FIDELITY. Provides such unusual features as a Bridge Control, for variable cross-channel feed for elimination of "ping-pong" (exaggerated channel separation) effects and for control of a 3d-channel output for 3-speaker stereo systems; the 3d-channel output also serves for converting stereo program material to high quality monaural for recording or to play a stereo program monaurally through a separate amplifier and speaker system. The KT-600 also has full input mixing of monaural program sources (such as tape recorder and phonograph, etc.), a special "null" stereo balancing and calibrating system (better than meters), 24 equalization positions per channel, 12 db per octave rumble and scratch filters, and a loudness on-off switch. Has clutch-type dual concentric volume controls which operate independently for balancing or simultaneously as the Master Level Control. Other features include channel reverse, 180° phase reversal, input level controls at all inputs. Sensitivity is 1.78 millivolts for 1 volt out. Dual low impedance outputs ("plate followers," 1300 ohms) are provided. Frequency response is 10-25,000 cps \pm 0.5 db; less than .03% IM distortion. Uses 7 new 7025 low-noise dual triodes. Size 14" x 4 1/2" x 10 1/2". Shpg. wt., 16 lbs. Complete with printed circuit board, modern-styling metal chassis and cage, profusely illustrated instructions, all necessary parts.

LAFAYETTE KT-600 Stereo Preamp Kit Net **79.50**

NEW! LAFAYETTE STEREO/MONAURAL BASIC POWER AMPLIFIER KIT



KT-310

**ONLY 4.75 DOWN
5.00 MONTHLY**

47.50

- 36-WATT STEREO AMPLIFIER - 18-WATTS EACH CHANNEL
- FOR OPTIONAL USE AS 36-WATT MONAURAL AMPLIFIER
- EMPLOYS 4 NEW PREMIUM-TYPE 7189 OUTPUT TUBES

- 2 PRINTED CIRCUIT BOARDS FOR NEAT, SIMPLIFIED WIRING
- RESPONSE BETTER THAN 35-30,000 CPS \pm 1/2 DB AT 18 WATTS
- LESS THAN 1% HARMONIC OR INTERMODULATION DISTORTION

A superbly-performing basic stereo amplifier, in easy-to-build kit form to save you lots of money and let you get into stereo now at minimum expense! Dual inputs are provided, each with individual volume control, and the unit may be used with a stereo preamplifier, for 2-18 watt stereo channels or, at the flick of a switch, as a fine 36-watt monaural amplifier — or, if desired, it may be used as 2 separate monaural 18-watt amplifiers! **CONTROLS** include 2 input volume controls, channel Reverse switch (AB-BA), Monaural-Stereo switch. **DUAL OUTPUT IMPEDANCES** are: 4, 8, 16 and 32 ohms (permitting parallel (monaural) operation of 2 speaker systems of up to 16 ohms. **INPUT SENSITIVITY** is 0.45 volts per channel for full output. **TUBES** are 2-6AN8, 4-7189; G2-34 rectifier. **SIZE** 9-3/16" d (10-9/16" with controls) x 5 1/4" h x 13 1/4" w. Supplied complete with perforated metal cage, all necessary parts and detailed instructions. Shpg. wt., 22 lbs.

KT-310 Stereo Power Amplifier Kit Net **47.50**

LAFAYETTE RADIO DEPT JJ
165-08 Liberty Ave. JAMAICA 33; N. Y. Write for FREE Bargain Packed Catalog!
PLEASE INCLUDE POSTAGE WITH ORDER

100 SIXTH AVE., NEW YORK, N. Y.
BOSTON, MASS., 110 Federal St.
PLAINFIELD, N. J., 139 West 2nd St.
NEWARK, N. J., 24 Central Ave.
BRONX, N. Y., 542 E. Fordham Rd.

NEW! LAFAYETTE "STEREO" HI-FI PHONO MUSIC SYSTEM

AN IDEAL QUALITY SYSTEM FOR LISTENING

TO THE NEW HIGH-REALISM STEREO SOUND!

For Stereo & Monaural Reproduction



LA-90

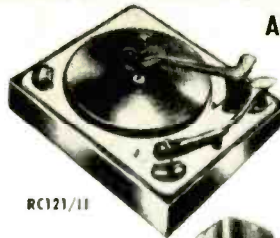

RC121/11

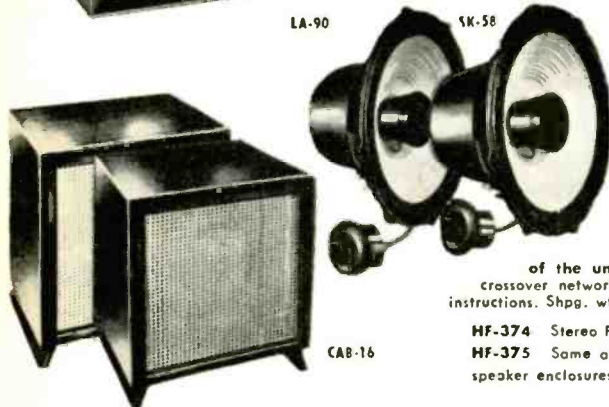

CAB-16



of the unbeatable, for performance-value, Lafayette SK-58 12" coaxial speakers with built-in crossover network and brilliance level control. Supplied complete with cables, connectors, and easy-to-install instructions. Shpg. wt., 66 lbs.

NEW GE GC-7 STEREO COMPATIBLE CARTRIDGE WITH DIAMOND STYLUS

COMPONENTS	
Lafayette LA-90 28-Watt Stereo Amplifier	72.50
Garrard RC121/11 Changer	41.65
Lafayette PK-111 Wood Base	3.95
GE GC-7 Stereo Magnetic Cartridge	23.47
2-Lafayette SK-58 Coaxial 12" Speakers	59.00
Total Reg. Price	200.57

YOU PAY ONLY 167.50 SAVE 33.07!

A complete superb stereo hi-fi phono music system brought to you by Lafayette to bring out the thrilling capabilities of the new stereo recordings. Heart of the system is the new Lafayette LA-90 with 28 watts per channel and with all the inputs necessary for a complete stereo control center. Other fine components are the famous new Garrard RC121/11 4-speed automatic record changer ready to accept stereo cartridges, the Lafayette PK-111 wood base for changer, of fine selected woods; the new GE GC-7 stereo/monaural variable reluctance cartridge with 0.7 mil genuine GE diamond stylus; and 2

HF-374 Stereo Phono System, with mahogany or blonde wood changer base (please specify) Net 167.50

HF-375 Same as HF-374 but with 2-Lafayette CAB-16 mahogany or walnut or CAB-17 blonde Resonator-type speaker enclosures (specify which) Net 222.50

LAFAYETTE STEREO FM/AM-PHONO MUSIC SYSTEM

Same as HF-374 above but with new Lafayette stereo Model LT-99 FM/AM Tuner.

HF-376 Stereo FM/AM-Phono System Net 237.00

HF-377 Same as HF-376 but with 2-Lafayette CAB-16 mahogany or walnut or CAB-17 blonde speaker enclosures Net 292.00

ONLY 16.75 DOWN—12.00 MONTHLY

LAFAYETTE MASTER AUDIO CONTROL CENTER with BINAURAL CHANNEL AND DUAL VOLUME CONTROL.

- Self-Powered • DC On All Filaments • 24 Positions of Equalization
- Tape Head Input, High Impedance • Dual Cathode Follower Output Stages

This is not only the finest hi-fi preamp characterized by unmatched features, but it has been functionally designed to keep pace with the conversion of your present hi-fi system to binaural (Stereo) sound. Incorporates an extra channel and dual volume control for binaural reproduction. Features include DC on all tube filaments, negative feedback in every stage, dual cathode follower output stages and latest printed circuit construction. Less than 0.09% 1M distortion and less than 0.07 harmonic distortion at 1V. Hum and noise level better than 80 db below 3V. Uniformly flat frequency response over entire audible spectrum. 7 inputs for every type of phono, tuner or tape. Tasteful styling, brilliantly executed. Size 12 1/2" x 9 1/2" x 3 1/4". Shpg. wt., 10 1/2 lbs.

KT-300—Lafayette Master Audio Control Kit Complete with cage and detailed assembly instructions. Net 39.50

LT-30—Same as above completely wired and tested with cage and instruction manual. Net 59.50

Net 39.50

DELUXE 70 WATT BASIC AMPLIFIER

- Conservatively Rated At 70 Watts • Inverse Feedback • Variable Damping
 - Metered Balance And Bias Adjust Controls • Available In Kit and Wired Form
- Here's ultra-stability in a 70 watt basic power amplifier employing highest quality components conservatively rated to insure performance and long life. Features matched pair KT 88's and wire range linear Chicago output transformer, variable damping control, meter for bias and balance and gold finish chassis. Frequency response 10-100,000 cps \pm 1db. Hum and noise 90 db below full output. 1M distortion less than 1 1/2% at 70 watts, less than 0.3% below 30 watts. Harmonic distortion less than 2% at 70 watts from 20 to 20,000 cps \pm 1 db. Output impedance 4, 8 and 16 ohms. Handsome decorative cage perforated for proper ventilation. Size 14 1/2" x 10" x 7 1/8" including cage and knobs. Shpg. wt., 40 lbs.

KT-400—Lafayette 70 watt Deluxe Basic Amplifier Kit complete with cage and detailed assembly instructions. Net 69.50

LA-70—Same as above completely wired and tested with cage and instruction manual. Net 94.50

Net 69.50

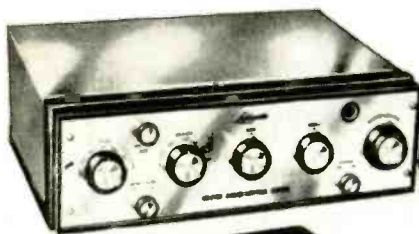

KT-300
1N KIT
FORM
39.50



KT-400
1N KIT
FORM
69.50

ONLY 6.95
DOWN
7.00 MONTHLY

NEW! LAFAYETTE STEREO AMPLIFIER KIT

- 4 WATTS STEREO OUTPUT
- COMPLETE STEREO CONTROLS

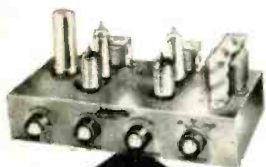

Brand new stereo amplifier kit for that extra small stereo hi-fi set, featuring separate volume controls; ganged tone control; stereo, reverse and monaural switch. 40 millivolt sensitivity! Complete kit with tubes, rectifier, all parts and instructions. Only 9 1/2" x 5" x 4 1/2". For 110-120 60 cycle AC. Shpg. wt., 7 lbs.

KT-126 — Complete Kit Net 18.95

COMBINATION MONEY SAVER

The KT-126 Stereo Amplifier kit and the new Ronette OV Stereo Turnover Cartridge with dual sapphire styli.

KT-136 Net 24.90

Only
18.95

ILLUMINATED SCALE VU METER

- 3 1/4" SQUARE
- JEWELLED BEARINGS
- 25-16,000 \pm 1/2 db
- D'ARSONVAL MOVEMENT

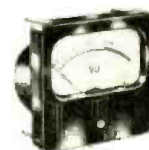

Standard 7500 ohm (with 3600 ohm external resistor supplied) "B" scale volume indicator calibrated in 0-100% and -20 to +3 VU. Accurate to \pm 0.2 VU from 35 to 10,000 cps, \pm 0.5 VU from 25 to 16,000 cps (0 VU corresponds to 100%). Soft, non-glare illumination supplied by two built-in 6-8 volt bulbs. Dynamic and damping characteristics conform to standard VU meter practice—99% of final reading reached in 0.3 second with suddenly applied sine wave, overshoot of 1 to 1 1/2%. 3/4" square, 1-11/16" depth, 2-9/16" dia. mtg. hole. Shpg. wt., 1 lb.

TM-80 Volume Unit Meter Net 7.50

Lafayette Radio

165-08 LIBERTY AVE.
JAMAICA 33, N. Y.

Dept. JJ

NEW YORK, N. Y.
100 6th Ave.
WOrth 6-5300

BOSTON, MASS.
110 Federal St.
HUBbard 2-7850

BRONX, N. Y.
542 E. Fordham Rd.
FORDham 7-8813

NEWARK, N. J.
24 Central Ave.
MARket 2-1661

PLAINFIELD, N. J.
139 W. 2nd St.
PLAINfield 6-4718

PLEASE INCLUDE POSTAGE WITH ORDER



LAFAYETTE'S 1959 CATALOG

"Everything in Electronics"

260 GIANT-SIZED PAGES

Our 38th Year

The Complete Catalog Featuring
"The Best Buys In The Business"

FOR THE NEWEST AND FINEST IN

STEREOPHONIC HI-FI EQUIPMENT AND SYSTEMS

- TAPE RECORDERS ● PUBLIC ADDRESS SYSTEMS
- AMATEUR EQUIPMENT ● INDUSTRIAL SUPPLIES
- MINIATURE COMPONENTS ● RADIO & TV TUBES AND PARTS
- EXCLUSIVE LAFAYETTE TRANSISTOR & HI-FI KITS

Send for Lafayette's 1959 Catalog — the most complete, up-to-the-minute electronic supply catalog crammed full of everything in electronics at our customary down-to-earth money-saving prices.

CONTAINS HUNDREDS OF EXCLUSIVE LAFAYETTE ITEMS NOT AVAILABLE IN ANY OTHER CATALOG OR FROM ANY OTHER SOURCE — SEND FOR YOUR COPY NOW!

A "must" for the economy-minded hi-fi enthusiast, experimenter, hobbyist, engineer, technician, student, serviceman and dealer.

Leaders in Hi-Fi

The most complete selection and largest stocks of hi-fi components and systems—available for immediate delivery at the lowest possible prices. Save even more on Lafayette endorsed "best-buy" complete systems.

EASY PAY TERMS Available on orders over \$45—
Only 10% down—Up to 18 months to pay

NEW!

LAFAYETTE-GOODMANS 12" 3-WAY SPEAKER

- 30 WATTS
- FREQUENCY RESPONSE
30-20,000 CPS
- PLUG-IN 12 DB/OCTAVE
CROSSOVER NETWORK
WITH LEVEL CONTROL

Custom-built by Goodmans of England with 1 3/4 lb. Alcomax 3 Magnet. Features axially mounted, free-edged wide range woofer, stiff-coned mid-range radiator and compression-driver tweeter.

SK-110 Net 47.50
Two for Stereo Net 89.00



NEW!



Lafayette

TRANSCRIPTION PLAYER WITH 3 LB. 12"

ALUMINUM TURNTABLE

Professional 4-speed player ideally suited for stereo. Has magnetic eddy-current brake permitting ± 10% speed variation. Amazingly low priced! Shpg. wt., 14 lbs.

PK-240 Net 37.50

NEW!

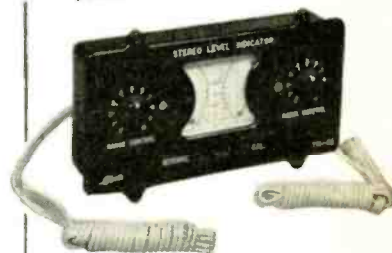

STEREO BALANCE VU METER

Dual audio output level indicator with two meters, for comparing audio levels. Ideal for balancing hi-fi stereo systems.

TM-40 Net 8.95

NATIONALLY ADVERTISED 4-SPEED AUTOMATIC RECORD CHANGER



NEW GE GC-7
STEREO
CARTRIDGE
WITH
DIAMOND
STYLUS

Famous brand latest model with new GE GC-7 Magnetic Compatible Stereo Cartridge with diamond stylus. Guaranteed to please or money refunded! Regular 69.50 Value! Shpg. wt., 21 lbs.

PK-251—(less Wood base)
Net 39.50

NEW MINIATURE HIGH SENSITIVITY MULTITESTER

20,000 OHMS PER VOLT DC —
10,000 OHMS PER VOLT AC



20,000 ohms per volt DC and 10,000 ohms per volt AC instrument. Hand-held, weighs only 10 oz! Clear plastic face cover. Has 23 most used ranges selected by single switch. With batteries and leads. Shpg. wt., 1 lb.

AR-660 Net 22.50

FREE

CUT
OUT
AND
PASTE
ON
POST
CARD

LAFAYETTE RADIO, Dept. JJ
P.O. Box 511, Jamaica 31, N.Y.

SEND FOR THE WORLD'S LEADING ELECTRONICS,
RADIO, T.V., INDUSTRIAL, AND HI-FI GUIDE

Send FREE LAFAYETTE Catalog 598

Name

Address

City..... Zone.... State.....

JAMAICA, N. Y. 165-08 Liberty Ave. AXtel 1-7000	NEW YORK, N. Y. 100 6th Ave. WOrth 6-5300	BOSTON, MASS. 110 Federal St. HUBbard 2-7850
BRONX, N. Y. 542 E. Fordham Rd. FORDham 7-8913	NEWARK, N. J. 24 Central Ave. MARket 2-1661	PLAINFIELD, N. J. 139 W. 2nd St. PLAINfield 6-4718

STEP-UP TO THE FINEST ELECTRO-VOICE STEREO'S STANDARD



if this is your present or proposed speaker system

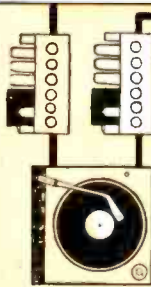

step one

you need the totally compatible E-V STEREO CARTRIDGE

Thousands already in use prove it plays all records better; unexcelled for stereo; superior even to your present cartridge for monaural. Highest vertical and horizontal compliance. Best channel separation: over 20 db between channels. Flattest responses: flat beyond audibility to RIAA curve. Hum and rumble are far below any magnetic cartridge. Two ceramic elements deliver precise RIAA curve with no hum! Exclusive E-V Built-in Rumble Suppressor allows record changer use for stereo. 7 mil replaceable (diamond or sapphire) stylus is ideal size... gives better reproduction, longer record wear.

The E-V Totally Compatible Stereo Cartridge is the industry's standard. Choose the model to fit your needs: MODEL 21D—Stereo with .7 mil Diamond Stylus.....Net \$19.50 MODEL 26 DS1—Dual Stylus Turnover from .7 mil Diamond Stereo to 3 mil Sapphire Monaural.....Net \$22.50 or the E-V Velocity Stereo Cartridge MODEL 21MD—Stereo with .7 mil Diamond Stylus.....Net \$19.50 MODEL 26MDST—Dual Stylus Turnover from .7 mil Diamond Stereo to 3 mil Sapphire Monaural.....Net \$22.50 Then choose a second amplifier and pre-amplifier. If this is your initial high fidelity system, start with any stereo-phonographic dual amplifier-preamplifier. Play manually until you add a second speaker for stereo.

Electro-Voice

ELECTRO-VOICE, INC., BUCHANAN, MICHIGAN
 Forward in Electro-Acoustic-Microphones, Phono-Cartridges, High-Fidelity Loudspeakers and Enclosures, Public Address Speakers, Marine Instruments, EMI Professional Electronic Instruments and Military Material.

4-way 12-inch speaker system costing between \$200 and \$300 such as the E-V Duchess IVE (Net \$292)

step two

you need the finest E-V mid-bass, treble and high frequency components.



4-way 15-inch speaker system costing between \$325 and \$375 such as the E-V Carlton IV (Net \$359)

4-way 12 inch speaker system costing between \$325 and \$375 such as the E-V Centurian IVE (Net \$365)

3-way 15-inch speaker system costing between \$375 and \$400 such as the new E-V Regency III (Net \$393)

4-way corner 15-inch speaker system costing between \$400 and \$480 such as the E-V Cardinal IV (Net \$425)

4-way corner 18-inch speaker system costing over \$600 such as the incomparable E-V Patricia (Patricia IV Traditional, \$970; Patricia 600 Contemporary, \$819 Net)

4-way corner 15-inch speaker system costing between \$480 and \$600 such as the E-V Georgian 600 (Net \$490)

4-way corner 18-inch speaker system costing over \$600 such as the incomparable E-V Patricia (Patricia IV in traditional styling. Net \$970)

Special models available to custom-finish specifications... at higher price. Net \$819

Patricia 600 in Faldner-designed contemporary housing. Net \$490

Utilizes same horn construction and driver complement of Cardinal IV enclosed by beautiful contemporary housing functionally styled by Robert W. Faldner. Net \$490

Authentic E-V Klipsch "K" horn mated for deep fundamental bass range; complemented by diffraction principle in coaxial mid-bass and treble driver assembly. Very high frequencies insure realism over broadest living room areas. Net \$425

The versatile Regency III deluxe separate 3-way system allows operation in the corner for full bass efficiency or along the wall for convenience. Powerful 15-inch bass driver crosses over at 800 cycles per second to diffraction-type treble and very high frequency components to give maximum dispersion and full stereo effect. Net \$393

New complete 4-way system incorporating all design features of the magnificent E-V Georgian, but on a smaller scale. Uses Klipsch "K" folded horn with E-V deluxe 12-inch indirect-radiator speaker system, 30 coaxial mid-bass and treble assembly, T35 VHF driver and \$336 crossover). Response from 30 cps to beyond audibility. Net \$365

Deluxe version of the Duchess IVE in smart, handsome low-boy design; harmonizes gracefully with many modern furnishing modes. A complete Phase-Loaded System, affording unusual bass response with smooth, resonance-free characteristics. Includes deluxe 15-inch indirect bass driver 4-way components. Net \$359

Compact, deluxe Klipsch-licensed separate 3-way loudspeaker system for smooth, efficient wide-range reproduction. Uses folded horn throat in compact furniture piece of pleasing proportions. The walls of the living room and the corner form the large horn mouth required for lowest range response. Diffraction horns in treble and very high range insure best stereo over widest listening area. Net \$303

Companion piece, matches Aristocrat III. Uses same driver system. Designed to operate optimally in along-the-wall position where a corner is not available. Net \$303

Compact, deluxe Klipsch-licensed separate 3-way loudspeaker system for smooth, efficient wide-range reproduction. Uses folded horn throat in compact furniture piece of pleasing proportions. The walls of the living room and the corner form the large horn mouth required for lowest range response. Diffraction horns in treble and very high range insure best stereo over widest listening area. Net \$312

Unexcelled for purity of tone and range through highly developed 4-way driver system. Super-efficient, smooth response through use of diffraction horns to give wide stereo listening area; bass is especially extended in range through E-V Phase Loading principle with 12" driver mounted low and at rear of enclosure. Compares in performance to corner horns. Net \$292

ADD-ON E-V STEREO III or alternate step two or alternate step two

Stereo have the finest E-V mid-bass, treble and high frequency components. (Frequency response: 300 to 19,000 cps).
 STEREO III for high efficiency systems.....Net \$129.50
 XX3 STEREO CONTROL.....Net \$40.00

NOTE: All E-V Systems also available in lined oak or walnut finishes.

The all-new Electro-Voice speaker system that solves your space problem—saves you money. Where space doesn't permit you to add a second full-range speaker, Electro-Voice is the answer. It's compact, because the Stereo reproduces only those frequencies NEEDED for stereo (bass below 300 cps does not contribute to the stereo effect... so bass from both is handled by your PRESENT full range speaker through the accessory XX3 Stereo Control Filter).



Hurry! Hurry! Hurry!

FREE GIFTS

...with your purchases of
RCA TUBES!

Right now RCA is offering for the first time anywhere, one of the greatest bargains ever presented on this or any other midway! With this exclusive RCA offer, you receive these valuable premiums absolutely free with your purchases of RCA Receiving Tubes!



for only
250 RCA
TUBES!

FREE—a \$19.95 value—the exclusive RCA TV-TOTER! Saves your time, your energy. Safely handles chassis and sets, upstairs, downstairs, in the shop. Rugged. Lightweight. Absolutely free with your purchase of 250 RCA Receiving Tubes.



for only
750 RCA
TUBES!

FREE—a \$59.50 value—your choice of a Bulova watch! Choose either the handsome "Pacemaker" for yourself, or the lovely "Nanette" for your lady. Absolutely free with your purchase of 750 RCA Receiving Tubes.

See your authorized
RCA tube distributor
...today! This
offer is good for
a limited time only!



RADIO CORPORATION OF AMERICA
Electron Tube Division
Harrison, N. J.