

Build a Low-Distortion 12-Watt Amplifier

AUGUST 1958

Radio-Electronics

TELEVISION • SERVICING • HIGH FIDELITY

HUGO GERNSBACK, Editor

Less Oscillator Drift
With New TV Tuners



New Developments
In Stereo



Humidity Meter
Uses Thermistors



New Transistor
Shortwave Radios



New High-
Temperature
Tubes Are
Smaller Than
Transistors ▶

(See page 50)

35c

U.S. and Canada



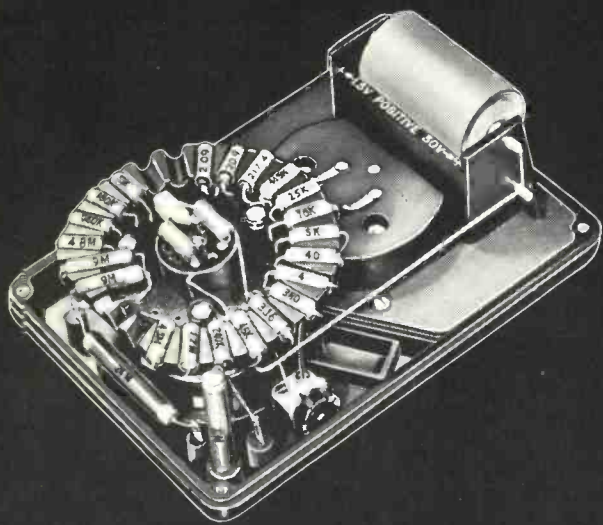

NEW TRIPLETT MODEL 630-PL | \$44.50 net

new... most easy to read



- Clear, unbreakable, shadowless front for instant wide vision.
- 5 to 500,000 cps on A.C.
- Continuous resistance reading from 0.1 ohms to 100 megohms.
- Polarity reversing switch.
- *Only one* (king-sized) switch selects both circuit and range —minimizes wrong settings, burnouts.

Only Triplett affords you such a wide choice of VOMs. Whatever your application—broad or limited—there is a Triplett VOM particularly suited for it.

the mighty nine + two

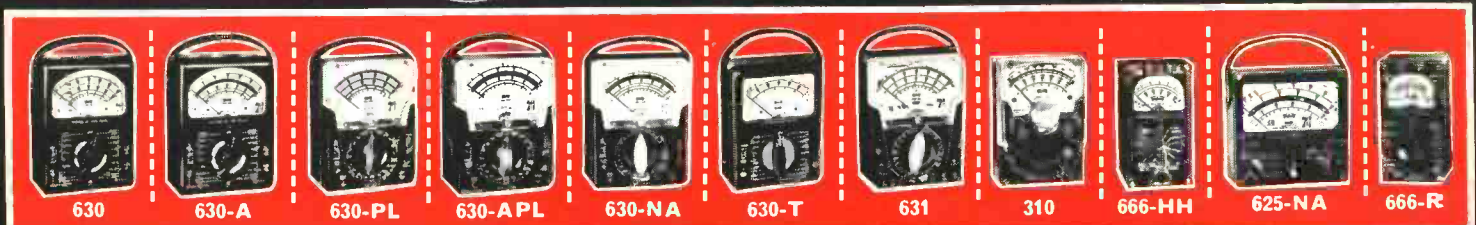

TRIPLETT ELECTRICAL INSTRUMENT COMPANY • BLUFFTON, OHIO

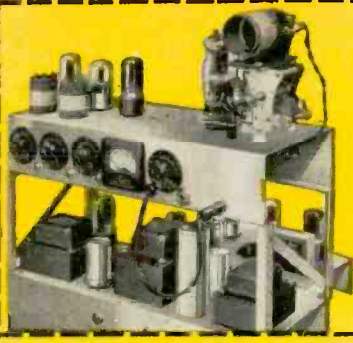

YOU BUILD Broadcasting Transmitter

As part of N.R.I. Communications Course you build this low power Transmitter; use it to learn methods required of commercial broadcasting operators, train for FCC license.

YOU BUILD Signal Generator

N.R.I. sends kits of parts to build this Signal Generator. You get practical experience, conduct tests to compensate Radio frequency amplifiers, practice aligning a typical I.F. video amplifier in TV circuit, many other experiments.

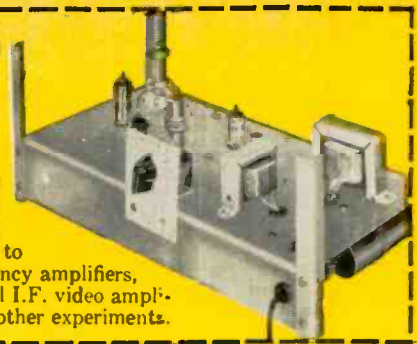

YOU BUILD Vacuum Tube Voltmeter

Use it to get practical experience, earn extra cash fixing neighbors' sets in spare time, gain knowledge to help you work in Radio, Television Color TV. With N.R.I. training you work on circuits common to both Radio and TV. Equipment you build "brings to life" things you learn in N.R.I.'s easy-to-understand lessons. 64 page Catalog FREE, shows all equipment you get.



YOU BUILD AC-DC Superhet Receiver

N.R.I. servicing training supplies all parts, everything is yours to keep. Nothing takes the place of practical experience. You get actual servicing experience by practicing with this modern receiver; you learn-by-doing.



Learn RADIO TELEVISION by Practicing at Home

WHAT GRADUATES DO AND SAY NEED FOR TECHNICIANS INCREASING

Fast Growing Field Offers Good Pay, Bright Future

Chief Engineer
"I am Chief Engineer of Station KGCU in Mandan, N. D. I also have my own spare time business servicing high frequency two-way communications systems." R. BARNETT, Bismarck, North Dakota.



Paid for Instruments
"I am doing very well in spare time TV and Radio. Sometimes have three TV jobs waiting and also fix car Radios for garages. I paid for instruments out of earnings." G. F. SEAMAN, New York, N. Y.



Has Own TV Business
"We have an appliance store with our Radio and TV servicing, and get TV repairs. During my Army service, N.R.I. training helped get me a top rated job." W. M. WEIDNER, Fairfax, South Dakota.



Today's OPPORTUNITY field is Radio-Television. Over 125 million home Radios plus 30 million sets in cars and 40,000,000 Television sets mean big money for trained Radio-TV Technicians. More than 4,000 Radio and TV Broadcasting stations offer interesting and important positions for technicians, operators. Color television, portable TV sets, Hi-Fi, other developments assure future growth.

It's the trained man who gets ahead. The fellow who uses his spare time to develop knowledge and skill gets the better job, drives a better car, lives in a better home, is respected for what he knows

and can do. So plan now to get into Radio-TV. Keep your job while training with N.R.I. You learn at home in your spare time. N.R.I. is oldest and largest home study Radio-TV School. Our methods have proved successful for more than 40 years, provide practical experience.

Soon after enrolling, many N.R.I. students start to earn \$10, \$15 a week extra in spare time fixing sets. Many open their own full time Radio-TV shops after getting N.R.I. Diploma. Find out more. Mail Coupon. Cost is low, terms easy; includes all equipment. Address: **National Radio Institute, Dept. 8HF, Washington 16, D.C.**

Send for
LESSON
and **CATALOG**
FREE

VETERANS
Available under
G.I. Bills



MAIL COUPON NOW

NATIONAL RADIO INSTITUTE
Dept. 8HF, Washington 16, D. C.

Mail me Sample Lesson and 64-Page Catalog, FREE. (No Salesman will call. Please write plainly.)

Name _____ Age _____

Address _____

City _____ Zone _____ State _____

ACCREDITED MEMBER, NATIONAL HOME STUDY COUNCIL



AUGUST, 1958

Radio-Electronics

Formerly RADIO-CRAFT ■ Incorporating SHORT WAVE CRAFT ■ TELEVISION NEWS ■ RADIO & TELEVISION

EDITORIAL

25 Our Growing Industry—Hugo Gernsback

ELECTRONICS

- 26 Wet-Thermistor Relative-Humidity Meter—James A. McRoberts
- ✓ 28 Gating with Diodes—Harold B. McKay
- 31 Dynamic Brake Stops Power Tools—Frank J. DiElsi
- 32 Tiny Tube Steals Transistor's Thunder (Cover Feature)

AUDIO—HIGH FIDELITY

- ✓ 33 Designing a Low-Distortion 12-Watt Amplifier—Robert M. Voss
- 35 Compatibility and the Stereo Disc—Norman H. Crowhurst
- 38 New Discs and Stereo Tapes—Reviewed by Chester Santon
- 40 Special Amplifier Circuits—Herbert Ravenswood

TELEVISION

- ✓ 43 New Circuits in TV Tuners, Part I—E. D. Lucas, Jr.
- 46 Troubleshooting Color TV Receivers—Walter J. Cerveny
- 47 New Tubes Made Easy Job a Dog—John M. Ford
- 48 TV Service Clinic—Conducted by Robert G. Middleton

RADIO

- 50 Transistor All-Wave Radios—Robert F. Scott
- 54 Servicing the Motorola Auto Transistor Radio
- 55 What's Old? What's New?
- 72 Three-Way Portables, Tips and Techniques, Part II—Jack Darr

WHAT'S NEW

- 77 Pictorial Report of New Developments

TEST INSTRUMENTS

- ✓ 80 An RCL Bridge, It's Easy to Build—David Stone
- 86 Servicing Fuse-Resistor Circuits—Herb Bowden
- 88 A Tape Recorder Test Adapter—L. B. Hoffman

- | | |
|---------------------------------|-------------------------------|
| 117 Books | 107 Patents |
| 112 Business and People | 109 Radio-Electronic Circuits |
| 108 Corrections | 115 Technical Literature |
| 14 Correspondence | 95 Technicians' News |
| 100 New Devices | 111 Technotes |
| 90 New Tubes and Semiconductors | 105 Try This One |
| 6 News Briefs | 110 50 Years Ago |

ON THE COVER

(Story on page 32)

Developmental ceramic triode amplifier tube, designed to operate at 900–1,500°F., now being evaluated at General Electric Research Laboratory, is smaller than transistor (right).

Color original by Habershaw Studios

- Hugo Gernsback Editor and Publisher
- M. Harvey Gernsback Editorial Director
- Fred Shunaman Managing Editor
- Robert F. Scott W2PWG, Technical Editor
- Larry Steckler Associate Editor
- I. Queen Editorial Associate
- Robert G. Middleton Television Consultant
- Elizabeth Stalcup Production Manager
- Cathy Coccozza Advertising Production
- Wm. Lyon McLaughlin Tech. Illustration Director
- Sol Ehrlich Art Director
- Fred Meinast Staff Artist
- Lee Robinson General Manager
- John J. Lamson Sales Manager
- G. Aliquo Circulation Manager
- Adam J. Smith Director, Newsstand Sales
- Robert Fallath Promotion Manager



Average Paid Circulation Over 195,000



RADIO-ELECTRONICS is indexed in *Applied Science & Technology Index* (Formerly *Industrial Arts Index*)

RADIO-ELECTRONICS, August, 1958, Vol. XXIX, No. 8. Published monthly at Mt. Morris, Ill., by Gernsback Publications, Inc. Second-class mail privileges authorized at Mt. Morris, Ill. Copyright 1958 by Gernsback Publications, Inc. All rights reserved under Universal, International and Pan-American Copyright Conventions.

SUBSCRIPTION RATES: U. S., U. S. possessions and Canada, \$4.00 for one year; \$7.00 for two years; \$9.00 for three years; single copies 35c. Pan-American countries \$4.50 for one year; \$8.00 for two years; \$10.50 for three years. All other countries \$5.00 a year; \$9.00 for two years; \$12.00 for three years.

SUBSCRIPTIONS: Address correspondence to Radio-Electronics, Subscription Dept., 404 N. Wesley Ave., Mt. Morris, Ill., or 154 West 14th St., New York 11, N. Y. When requesting a change of address, please furnish an address label from a recent issue. Allow one month for change of address.

GERNSBACK PUBLICATIONS, INC. Executive, Editorial and Advertising Offices, 154 West 14th St., New York 11, N. Y. Telephone ALgonquin 5-7755. Hugo Gernsback, Chairman of the Board; M. Harvey Gernsback, President; G. Aliquo, Secretary.

BRANCH ADVERTISING OFFICES and FOREIGN AGENTS listed on page 122.

POSTMASTER: If undeliverable, send Form 3579 to: RADIO-ELECTRONICS, 154 West 14th St., New York 11, N. Y.

*Trademark registered U. S. Pat. Office.

RADIO-ELECTRONICS

**GREATEST
ADVANCE IN
SHOP-METHOD
HOME TRAINING**

EARN MORE MONEY...GET INTO TELEVISION ELECTRONICS - RADIO

Learn ALL 8 PHASES in ONE MODERN HOME-STUDY COURSE
At Home - In Spare Time

YOU GET ALL THIS NEWEST PRACTICAL EQUIPMENT

- Parts to build a modern TV set, including all tubes plus a large screen Picture Tube
- Parts to build a powerful Superhet Receiver, standard broadcast and short wave
- Parts to conduct many experiments and build Continuity Checker, RF Oscillator, TV Circuits, Audio Oscillator, TRF Receiver, Signal Generator
- A Valuable Professional Multitester



**19 BIG KITS
YOURS TO KEEP**

YOUR NATIONAL SCHOOLS TELERAMA COURSE COVERS ALL 8 PHASES

- | | |
|------------------------------------|--------------------------------|
| 1. TELEVISION, INCLUDING COLOR TV | 5. PREPARATION FOR FCC LICENSE |
| 2. RADIO, FM AND AM | 6. AUTOMATION |
| 3. INDUSTRIAL ELECTRONICS | 7. RADAR AND MICRO WAVES |
| 4. SOUND RECORDING AND HI FIDELITY | 8. COMMUNICATIONS |

YOU ARE NEEDED IN THE TELEVISION-ELECTRONICS-RADIO INDUSTRY!

You can build a secure future for yourself if you get into Electronics NOW! Today's shortage of trained technicians creates tremendous opportunities. National Schools Shop-Method trained technicians are in constant and growing demand for high-pay jobs in Broadcasting and Communications, Electronic Research, Servicing and Repair, and many other branches.

Let National Schools, a Resident Technical School for over 50 years train you for today's unlimited opportunities in electronics! Our Shop Method trains you to be a MASTER-TECHNICIAN. Completely up to date, developed by experienced instructors and engineers, your Telerama Course will teach you all phases of the industry quickly, clearly and correctly. You can master the most modern projects, such as Color TV, printed circuits - even prepare for FCC License without taking a special

course. You can handle sales, servicing, manufacturing, or make good money in your own business. SEND FOR FACTS TODAY!

EARN AS YOU LEARN. Many of our students earn their entire tuition and more in Spare Time jobs we show them how to do while learning.

YOU GET EVERYTHING YOU NEED - Clear, profusely illustrated lessons, shop-tested manuals, modern circuit diagrams, practical job projects - all the valuable equipment shown above

- many other materials and services
- consultation privilege with our qualified staff, and Graduate Employment Service. **EVERYTHING YOU NEED** for outstanding success in Electronics

RESIDENT TRAINING AT LOS ANGELES

If you wish to take your training in our Resident School at Los Angeles, the world's TV capital, start NOW in our big, modern Shops, Labs and Radio-TV Studios. Here you work with latest Electronic equipment - professionally installed - finest, most complete facilities offered by any school. Expert, friendly instructors. Personal attention. Graduate Employment Service. Help in finding home near school - and part time job while you learn. Check box on coupon for full information.



FREE! Fully illustrated "Career" Book in TV-Radio-Electronics. PLUS actual sample lesson - yours at no cost, no obligation. **CLIP COUPON NOW... MAIL IT TODAY!**



MEMBER



APPROVED FOR G.I. TRAINING

NATIONAL SCHOOLS

4000 S. FIGUEROA ST., LOS ANGELES 37, CALIF.

NATIONAL SCHOOLS

TECHNICAL TRADE TRAINING SINCE 1905
LOS ANGELES 37, CALIFORNIA

GET FAST SERVICE - MAIL NOW TO

NATIONAL SCHOOLS, DEPT. RG-88
4000 S. FIGUEROA ST.
LOS ANGELES 37, CALIF.

Rush free TV-Radio "Opportunity" Book and sample lesson. No salesman will call.

NAME _____ AGE _____

ADDRESS _____

CITY _____ ZONE _____ STATE _____

Check if interested ONLY in Resident School training at Los Angeles.
VETERANS: Give date of Discharge _____

Leading Set Makers
Specify Tung-Sol

High

IN PERFORMANCE

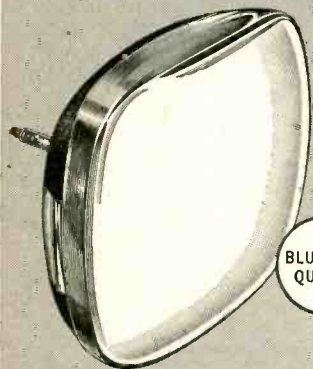

BLUE CHIP
QUALITY

Leading Independent
Service Dealers
Choose Tung-Sol

LOW

IN CALLBACKS

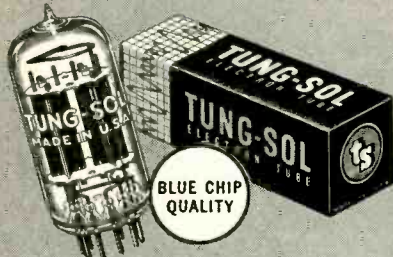

BLUE CHIP
QUALITY

TUNG-SOL®

Magic Mirror Aluminized
PICTURE TUBES
RECEIVING TUBES

ELECTRON TUBE DIVISION
TUNG-SOL ELECTRIC INC., NEWARK 4, N. J.

News Briefs



USE OF GRAVITATIONAL WAVES for a wireless communication substitute for radio is being explored by Joseph L. Ryerson, chief of the Advanced Development Laboratory, Rome, Air Development Center, Griffiss Air Force Base, Rome, N.Y.

The proposal is still in the theory stage, no equipment having been built. Key to the system would be gravitational coupling between oscillating masses. Ryerson gave the example of a lead ball vibrating at a given rate in a frictionless bearing. Its gravitational field should cause a "receiver" ball of the same mass to vibrate at the same rate.

TV VIEWERS KNOW how to get the best pictures from their receivers—contrary to some widely held beliefs of technicians and engineers—according to a recent survey.

William L. Hughes, of Iowa State College, who heads a panel of the Television Allocations Study Organization (TASO), formed to gather data for presentation to the FCC, said his group's study of set owners' tuning capabilities in their own homes showed that "the ability of the receiver owner to get optimum performance from his receiver was much higher than most of the survey participants expected."

In a paper presented to a joint IRE-AIEE meeting in Washington, he also revealed these survey results: The average viewer knows when he's receiving a poor picture; his ratings of picture quality rarely differed significantly from those of broadcast engineers. Aging of receivers is a more important factor than aging of antennas in degradation of picture. Weather conditions cause greater variation in picture quality than do seasonal variations. More variation in receiver performance in a given area was due to misalignment than to improper antenna installation.

WHEN VIOLINISTS PLAY together in a symphony orchestra, how far apart are they in pitch and timing? That's the subject of a study just begun by acoustical scientists at the Massachusetts Institute of Technology under an \$80,000 grant from the National Association of Music Merchants. As explained by nuclear engineer Dr. Melville Clark, Jr., who heads the program, if all violins in an orchestra played exactly the same way, they would sound like a single instrument amplified.

The study, which is expected to have implications in the field of reproduction of music, will seek to determine the optimum differences between instru-

ments playing in unison.

THE POLICE CALL BOX may soon be a thing of the past, as foot patrolmen join their motorized colleagues in utilizing the benefits of two-way FM-radio. Patrolmen in major New York City parks are currently using the



transistor receivers (right) and will soon be equipped with transmitters like the one shown at left. The transmitter weighs 28 ounces, the receiver 10 ounces. They have an effective range of about ¾-mile. Both are made by RCA.

"MOON DXING" is being encouraged by the Army Signal Corps, which sends the QSL card shown here to listeners who report picking up radar signals bounced from the moon.

The signals, beamed from Fort Monmouth, N. J., by the Signal Corps and the US Naval Research Laboratories, are on the US satellite frequency of 108 mc and are transmitted for the purpose of calibrating far-flung Mini-track receiving stations. The Fort Monmouth transmitter aims 1.2 megawatts of radiated power at the moon from a 50-foot parabolic antenna.

The 108-mc transmissions start 2 hours before the moon reaches its highest point, and last for 6 hours—but not on a daily schedule, because of the possibility of interference with transmissions from satellites on the same frequency. Diana signals are usually CW, but are occasionally frequency-modulated with an identification message in International Code. Pulse-modulated and CW signals are also transmitted at 151.11 mc in connection with other moon-bounce research.

The 108-mc Jersey bounce has been received in Germany and South America. An extremely sensitive receiver and directional antenna are required. Amateurs who pick up this ½-million mile dx should send a listener's card to

NOW
JENSEN
INDUSTRIES
MAKES
CARTRIDGES
TOO



discover the *"Superb"* sound
with a cartridge by jensen

It was as inevitable as coffee and doughnuts, ham and eggs, bagels and lox . . .
these Cartridges by Jensen to go with Needles by Jensen!

Ask your dealer to show you these new Jensen Cartridges. You only get
ultra rate Jensen quality pick-up when you replace with a cartridge by Jensen.

Jensen **PHONO NEEDLES AND CARTRIDGES**
by the oldest name in sound engineering

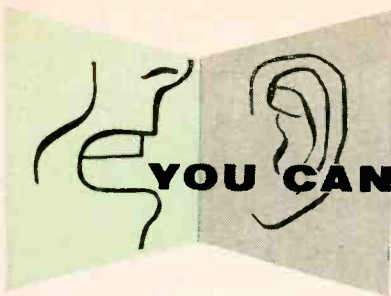

YOU CAN EDIT THE SOUND
as you record

WITH THIS VERSATILE

NEW American Microphone

Selective recording is easy with AMERICAN's new TRC microphone. You can hold the push button to talk, or "lock it on" for extended use. A handy clip-on stand is supplied for resting the microphone on conference tables... lavalier cord is also supplied. With the sleek, modern TRC, you can take full advantage of your tape recorder's range... at low cost. Choose from dynamic, ceramic, or crystal models. Wide frequency response (from 70 to 10,500 c.p.s. in the crystal model), omni-directional pickup, and faithful audio reproduction are yours for as little as \$16.00 list price.

TRC 204 Series
Microphones
List Prices
\$16.00 to \$24.30

for professional quality
public address and sound
recording

AMERICAN's D22 Omni-directional Dynamic Microphone (with variable impedance)

This slender, graceful black-and-gold microphone sounds as good as it looks. Its smooth peak-free response (from 40 to 13,000 c.p.s.) means you virtually eliminate feedback problems and get wonderful performance. If you want quality, efficiency, and dependability—if you want a versatile microphone to use in hand or stand—if you want a microphone that's a stand-out in appearance—you want the D22.

D22 List Price \$99.50,
shipped in
Jewel-Box Case

D33 Broadcast model, with
smooth flat response
from 35 to 15,000 c.p.s. Jewel-
Box Case. List Price \$130.00

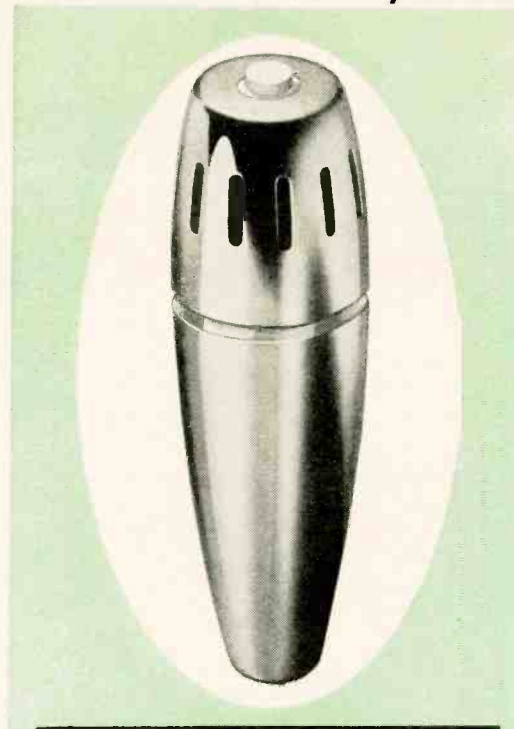

Write for your free copy of the new AMERICAN MICROPHONE catalog, giving complete specifications on these and other fine AMERICAN microphones, handsets, cartridges, and tone-arms.



American Microphone MANUFACTURING COMPANY
a division of GC-Textron Inc.

West Coast Plant: Los Angeles 18, California
MAIN PLANT: 412 SOUTH WYMAN STREET, ROCKFORD, ILLINOIS, U.S.A.
Export and Canada: Telesco International Corporation, 36 W. 40th St., New York, N.Y.

NEWS BRIEFS (Continued)

Diana, c/o RADIO-ELECTRONICS, 154 W. 14th St., New York 11, N. Y. The information will be forwarded to the Signal Corps moon radar project and will be acknowledged with a QSL card.



THE UNITED STATES ARMY SIGNAL ENGINEERING LABORATORIES
1301 MONMOUTH NEW JERSEY U.S.A.

Voice-modulated signals have been bounced from the moon and received halfway around the earth "without appreciable loss of quality" by University of Michigan researchers working under an Air Force contract. This marked improvement over previous transmissions, according to preliminary reports, was due to use of very short wavelengths (about 1 inch). Success of these experiments has led to predictions that commercial use of the moon for inter-continental communications is only a few years away.

GERNSBACK SCHOLARSHIP for the academic year 1958-59 has been awarded to William G. Fawcett. Established by Hugo Gernsback, the scholarship is presented annually to an outstanding student through New York University's Department of Electrical Engineering.

Pittsburgh-born William G. Fawcett, 26 years old, was graduated from high school in Bucyrus, Ohio, and served in



the Air Force for 4 years, largely as an instructor in operation and maintenance of bomb-navigation computers used in jet bombers. He worked as an electronic inspector for North American Philips Co. before entering NYU in September, 1955. He's a member of Eta Kappa Nu and Tau Beta Pi honorary societies and is chairman of the NYU student Chapter of IRE.

THE PAY-TV TEST in Bartlesville, Okla., was suspended as the Telemovie system turned off the switch 8 months after it began sending first-run movies to local homes by closed circuit.

Video Independent Theatres, the local theatre chain which operated the system, claimed 800 subscribers at the time service was discontinued. The company blamed lack of an acceptable

SEE FOR YOURSELF WHY...

Communications Officers of the

French Line **Recommend Good Training For a Career in**

ELECTRONICS



The French Line's Majestic S.S. LIBERTE

**NO
PREVIOUS
TECHNICAL
EXPERIENCE
REQUIRED**

Chief Wireless Operators aboard luxury liners of the French Line's transatlantic fleet, often called France afloat, know the value of good Electronics training. And when YOU learn of the many Electronics opportunities at sea, on land, in the air — or dealing with outer space — you will discover the real worth of DeVry Tech's practical training.



**JACK DEMPSEY,
FORMER HEAVYWEIGHT
BOXING CHAMPION,
ALSO RECOMMENDS**

DeVRY TECH

"Take Jack Dempsey's word for it . . . if I didn't think DeVry Tech was the finest, I wouldn't be associated with it.

"After being part of DeVry Tech for the last eight years, I can recommend it to any man 17 to 55 who wants to get ready for a better job or business of his own in Electronics."

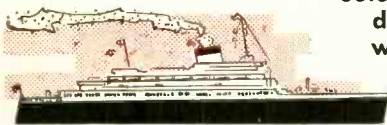

The New S.S. FLANDRE

NO ADVANCED EDUCATION NEEDED

Find out why so many DeVry-trained men 17 to 55 are now in interesting and profitable jobs in Radar, Guided Missile Control, Automation Electronics, Communications, Television, etc. . . . or in operating their own Electronic Service Shops. See why DeVry Tech's training, which includes texts, home movies, and practical equipment, is the very help needed for a better future in Electronics. Send coupon today for information on how you may train for outstanding opportunities at home in your spare time, or in our Chicago or Toronto Laboratories.

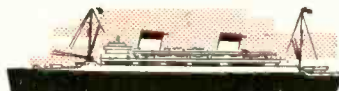

The Beautiful S.S. ILE DE FRANCE

LIVE-WIRE EMPLOYMENT SERVICE

When you complete your DeVry Tech training, our effective employment service immediately goes to work to help you get started.

DRAFT AGE?

We have valuable information for all men of draft age. Check coupon below.

Free BOOKLET!

Our booklet, "Electronics and YOU," tells how you may prepare to get into the fast growing, profitable field of Electronics. Send for it today!



DeVRY TECHNICAL INSTITUTE

CHICAGO 41, ILLINOIS • Formerly DeFOREST'S TRAINING, INC.

Accredited Member of National Home Study Council

"One of North America's
Foremost Electronics
Training Centers"



MAIL COUPON TODAY!

DeVry Technical Institute
4141 Belmont Ave., Chicago 41, Ill., Dept. RE-8-0
Please give me your FREE booklet, "Electronics and YOU," and tell me how I may prepare to enter one or more branches of Electronics.

Name _____ Age _____
(PLEASE PRINT)

Street _____ Apt. _____

City _____ Zone _____ State _____

Check here if subject to Military Training.
Canadian residents address DeVry Tech of Canada, Ltd.
2041 626 Roselawn Avenue, Toronto 12, Ontario

MR. INDEPENDENT SERVICE DEALER:

how many of
your tube dollars
are helping
your "competitors"?



Not a single one of them, if you standardize on Raytheon TV and Radio Tubes because Raytheon does not make TV and Radio sets — does not have a factory controlled TV and Radio Service organization — does not compete with you for profitable service business.

On the contrary, Raytheon's sole aim is serving you, the Independent Service Dealer — by making available to you the finest quality TV and Radio Tubes money can buy — tubes that are perfect for replacement work because they are designed to

provide quality performance in all makes and models of sets.

Independent Raytheon Tube Distributors from coast to coast are as near as your phone — ready to fill your tube needs — eager to supply you with the hundreds of shop and sales aids Raytheon makes available to you to help make your job easier, more efficient and more profitable.

You win all ways when you ask your Raytheon Tube Distributor for Raytheon TV and Radio Tubes — the tubes that are Right . . . for Sound and Sight!



RAYTHEON MANUFACTURING COMPANY

Receiving and Cathode Ray Tube Operations

NEWTON 58, MASS.
55 Chapel Street

CHICAGO, ILL.
9501 Grand Ave. (Franklin Park)

ATLANTA 6, GA.
1150 Zonclite Rd. N.E.

LOS ANGELES 7, CALIF.
2419 So. Grand Ave.

Raytheon makes
all these

Receiving and Picture Tubes, Reliable Subminiature and Miniature Tubes,
Semiconductor Diodes and Transistors, Nucleonic Tubes, Microwave Tubes.



HOW TO PASS Your FCC Commercial LICENSE EXAMS*

We guarantee
to train you until you receive
Your FCC license
—or your money back

The Master Course in Electronics will provide you with the mental tools of the electronics technician and prepare you for a First Class FCC License (Commercial) with a radar endorsement. When you successfully complete the Master Course, if you fail to pass the FCC examination, you will receive a full refund of all tuition payments.

"License and Good Job . . . Thanks"

"After finishing your Master Course, I passed the FCC exam for the 1st class license. I had my ticket for only one week and I got a job at WOC-TV, AM-FM. Incidentally, WOC is the oldest radio station west of the Mississippi. I sincerely feel that if it weren't for taking your Master Course, I would not have received my 1st class ticket. So I want to take this occasion to again thank you for such a fine, complete and composite study for electronics work."

Francis J. McManus
Davenport, Iowa

Cleveland Institute training results in job offers like these:

Service Technician:

Man needed in Cleveland, Ohio to service and maintain electronic medical instruments and equipment. Must have a solid knowledge of electronic fundamentals. A car is required. Company benefits include retirement plan.

West Coast Manufacturer:

"We are currently in need of men with electronics training or experience in radar maintenance. We would appreciate your referral of interested persons to us."

CLEVELAND INSTITUTE OF RADIO ELECTRONICS
Desk RE-20 4900 Euclid Avenue Cleveland 3, Ohio



We can train you to pass your License Exams if you've had any practical experience—amateur, military, radio servicing, or other. Our proven plan can help put you on the road to success.

• Your FCC ticket will be recognized by employers as proof of your technical ability.

Mail Coupon Now
and get both **FREE**
good training doesn't cost
... it pays!

Accredited by the National Home Study Council

Cleveland Institute of Radio Electronics

Desk RE-20, 4900 Euclid Ave. Cleveland 3, Ohio

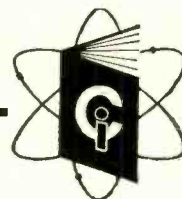

Please send Free Booklets prepared to help me get ahead in Electronics. I have had training or experience in Electronics as indicated below.

- | | |
|---|---|
| <input type="checkbox"/> Military | <input type="checkbox"/> Broadcasting |
| <input type="checkbox"/> Radio-TV Servicing | <input type="checkbox"/> Home Experimenting |
| <input type="checkbox"/> Manufacturing | <input type="checkbox"/> Telephone Company |
| <input type="checkbox"/> Amateur Radio | <input type="checkbox"/> Other _____ |

In what kind of work are you now engaged?

In what branch of Electronics are you interested?

Name _____ Age _____

Address _____

City _____ Zone _____ State _____

RE-20

TRANSFORMER NEWS FROM TRIAD

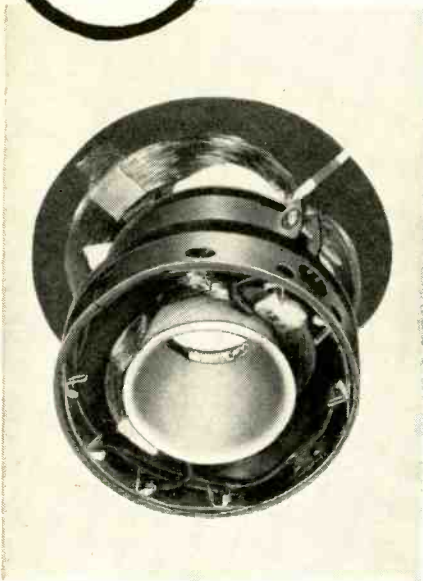

SAF-T-LINER® PROTECTS YOU IN NEW, BETTER YOKE

A special insulating sleeve is now permanently positioned on the inside of most Triad yokes. This Saf-T-Liner® protects the service man against shock when a metal width sleeve is used on the neck of the tube, and also protects the yoke from damage when being installed. This is still another advanced feature that guarantees Triad's unsurpassed excellence in the TV replacement field.

NEW YOKE PACK

Solve the majority of your deflection problems and yoke stocking problems with TRIAD'S new yoke pack.

This steel cabinet contains 8 of the most popular yokes, 25 network kits and 2 accessories. Write today for folder YP-8 New Triad Yoke Pack.

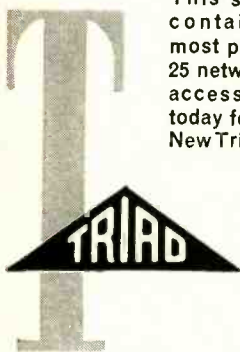

TRIAD TRANSFORMER CORPORATION
4055 REDWOOD AVE. | 812 E. STATE STREET
VENICE, CALIFORNIA | HUNTINGTON, INDIANA

A SUBSIDIARY OF LITTON INDUSTRIES

NEWS BRIEFS (Continued)

metering device to charge customers on a per-movie basis, and promise to resume service when a reliable meter is available. Viewers were charged a flat fee of \$4.95 a month—the rate established last February after six months of operation at \$9.50 a month.

Other subscription-TV proponents said they will go ahead with closed-circuit plans, using their own scrambled-picture metering-decoding devices, despite the failure of this first experiment.

TWO NEW TV STATIONS, one in the United States and another in Canada, started programming since our July report:

- KRTV, Great Falls, Mont.....3
- CKOS-TV, Yorkton, Sask.....3

With these additions, the United States now has 542 operating stations (447 vhf and 95 uhf) with 31 of these noncommercial. Canada's new total is 52.

Calendar of Events

Texas Electronic Association Clinic and Fair Aug. 1-3, Statler-Hilton Hotel, Dallas, Tex.

Technical Conference on Nonlinear Magnetics and Magnetic Amplifiers, Aug. 6-8, Hotel Statler, Los Angeles, Calif.

Conference on Electronic Standards and Measurements, Aug 13-15, Radio Standards Laboratory, Bureau of Standards, Boulder, Colo.

West Coast Electronic Show and Convention, (WESCON) Aug. 19-21, Ambassador Hotel and Pan Pacific Auditorium, Los Angeles, Calif.

Radio-TV-Electronics Service Industry Convention (NATESA) Aug. 21-24, Congress Hotel, Chicago.

Instrument-Automation Conference and Exhibit, Sept. 15-19, Convention Hall, Philadelphia, Pa.

High Fidelity Show and Music Festival, Sept. 19-21, Palmer House, Chicago, Ill. (RADIO-ELECTRONICS and the Gernsback Library will exhibit in Room 746.)

National Symposium of Telemetry, Sept. 22-24, Americana Hotel, Miami Beach, Fla.

Industrial Electronics Conference, Sept. 24-25, Rackham Memorial Bldg., Detroit, Mich.

High Fidelity Show, Sept. 30-Oct. 4, Trade Show Bldg., New York, N. Y. (RADIO-ELECTRONICS and the Gernsback Library will exhibit in Room 525.)

WORLD'S FASTEST MESSAGE PRINTER

and code puncher has been developed for the Signal Corps by Kleinschmidt Laboratories Inc. The first in a family of super-speed teletypewriter units, it pounds out messages at 750 words per minute—fast enough to receive and print every word on a standard size newspaper page in less than 8 minutes.

Designed for transmitting military messages five times faster than voice communications, it could also be used to feed battle information into a new mobile combat computer now under development. The printer's electronic control uses 36 printed-circuit modules with 140 transistors. It employs a five-channel code, typing out messages on 3/8-inch paper tape, at the same time punching out coded holes for feeding to other teletypewriter machines or for printing in page form by automatic typewriters.

END

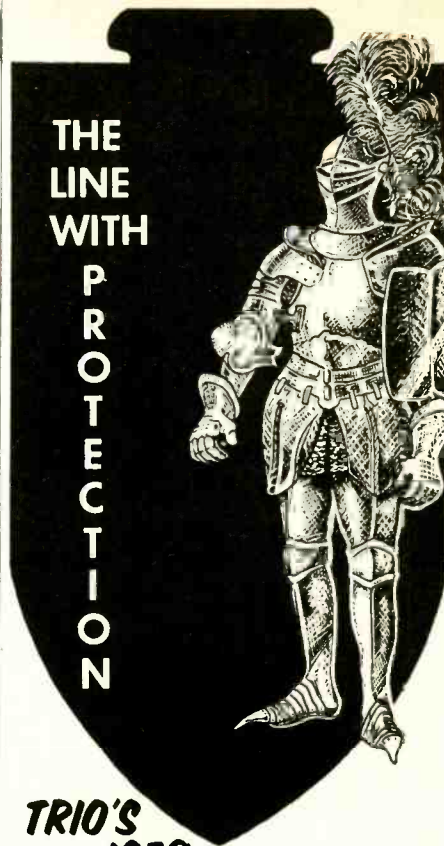

TRIO'S 1958 ZEPHYR FAMILY OF ANTENNAS

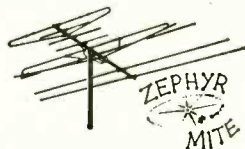

FOR DISTANCE

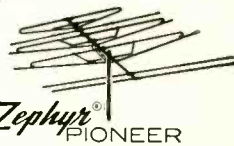

FOR EXTREME DISTANCE

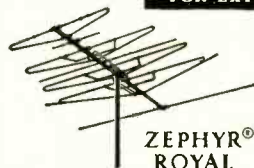

FOR THE MAXIMUM

U.S. PATENT No. 2,772,413
CANADIAN PATENT No. 541,670

EXTENDED "WING" DIPOLE
"WING" DIRECTOR
COLLINEAR DIRECTOR
STAGGER - TUNED

TRIO® Manufacturing Company
GRIGGSVILLE, ILLINOIS

Export Sales Div.,
Scheel International Inc.,
5909 N. Lincoln Ave., Chicago, U.S.A.
Cable Address: HARSHEEL

RADIO-ELECTRONICS

ALLIED HI-FI CLEARANCE SALE

BIG SAVINGS ON QUALITY COMPONENTS AND COMPLETE SYSTEMS

SAVE \$39.55



REG. \$139.50 **SALE PRICE \$99.95**
KNIGHT KN-200 TUNER-PREAMP

Precision-designed deluxe preamplifier combined with a highly sensitive FM-AM tuner—complete control unit and tuner in one case! Just add a good basic amplifier and speaker for an outstanding music system. Features: preamp control of tuner volume and tone; scratch and rumble filters; loudness controls; bass and treble controls; full equalization for all records; tuner filament switch off during phono use; FM dipole. Handsome case, 4 1/8 x 13 1/8 x 9 3/4. Shpg. wt., 15 lbs.

91SZ985. Reg. \$139.50. **SALE \$99.95**

SAVE \$24.05



REG. \$124.00 **SALE PRICE \$99.95**
KNIGHT KN-315 TUNER-AMPLIFIER

The famous "Uni-Fi"—combining 15-watt amplifier, sensitive FM-AM tuner and versatile preamp in a single quality unit. Add only speaker and record changer for a complete system. Features: full 15 watt output, special switch for converting from volume to loudness control; bass, treble controls; 3-position speaker selector switch; rumble and scratch filters; AFC on FM with defeat position for tuning weak stations; two EL 84 power tubes; built-in antennas. 4 1/4 x 15 x 10 1/2". Handsome case, 22 lbs.

91SZ986. Reg. \$124.00. **SALE \$99.95**

SAVE \$15.00



REG. \$49.50
SALE PRICE \$34.50
KNIGHT KN-1300

KLIPSCH-DESIGNED ENCLOSURE KIT

Precision-designed Knight-Klipsch prefinished corner speaker enclosure for 12" speaker. Efficient folded-horn uses walls of room to greatly improve and extend bass range. Requires only a screwdriver for assembly into a beautiful furniture-finished enclosure. Lock-miter joints securely seal horn chamber without glue. Adapter board supplied accommodates tweeter or extra speaker. Available in Mahogany, Walnut or Blonde. SPECIFY FINISH WHEN ORDERING. 10x21x32" deep. Shpg. wt., 43 lbs.

79DZ263-C. Reg. \$49.50. **SALE \$34.50**

SAVE \$65.00

Reg. \$264.14

SALE PRICE

\$199.14

EASY TERMS AVAILABLE

SAVE ON SYSTEMS!

SAVE \$110.00

Reg. \$377.86

SALE PRICE

\$267.86

knight RADIO-PHONO SYSTEM

Ready-To-Play... With G.E. Cartridge and Diamond LP Needle

KNIGHT KN-315 "Uni-Fi" Tuner-Amp-Preamp..... Reg. \$124.00
 UNIVERSITY Enclosure with UXC-122 12" Speaker.... Reg. 75.07
 GARRARD RC 121-11 4-Speed Changer with base... Reg. 65.07

Specify choice of Mahogany, Walnut or Blonde for speaker enclosure and changer base.

REGULAR PRICE..... \$264.14
SALE PRICE..... 199.14
YOU SAVE \$65.00

ORDER SYSTEM NO. 79PA927 (Shpg. wt. 72 lbs.)



knight RADIO-PHONO SYSTEM

Ready-To-Play... With G.E. Cartridge and Diamond LP Needle

KNIGHT KN-200 FM-AM Tuner-Preamp..... Reg. \$139.50
 KNIGHT KN-1515 30-Watt Basic Amplifier..... Reg. 74.50
 COLLARO RC-440 4-Speed Changer with base..... Reg. 64.86
 KNIGHT KN-1300 Klipsch Kit Prefinished Enclosure... Reg. 49.50
 KNIGHT KN-800 12" Three-Way Hi-Fi Speaker..... Reg. 49.50

Specify choice of Mahogany, Walnut or Blonde for speaker enclosure and changer base.

REGULAR PRICE..... \$377.86
SALE PRICE..... 267.86
YOU SAVE \$110.00

ORDER SYSTEM No. 79PA928 (Shpg. wt. 112 lbs.)



ORDER FROM ALLIED RADIO

• ALLIED RADIO, Dept. 2-H8
 • 100 N. Western Ave., Chicago 80, Ill.

• Ship the following: 91SZ985. 79DZ263-C. 79PA928.
 • 91SZ986. 79PA927. \$.....enclosed.
 • Send FREE Supplement No. 175. Send FREE Stereo Tape Catalog

• Name _____

• Address _____

• City _____ Zone _____ State _____



FREE ALLIED'S

LATEST BARGAIN SUPPLEMENT! STEREO TAPE CATALOG!

Send for both! See our latest Big Value Supplement for the best buys in Hi-Fi systems and components, stereo, recorders, Public Address—bargains in everything in Electronics. Write also for our complete catalog of latest Hi-Fi Stereo Tapes. FREE—use coupon!

The only stereo arm:

the
new
ESL
GYRO BALANCE



► From the laboratories which achieved the world-famed ESL C-60 Series cartridge and the triumphant new ESL GYRO/JEWEL stereo cartridge comes the first and only arm designed for all stereophonic and monophonic pickups.

► The striking new shape of the GYRO/BALANCE arm results from its unique rotationally balanced design. Turntable leveling is unnecessary; the GYRO/BALANCE arm plays records at any angle up to 90 degrees!

► Stereo discs may be easily ruined by vertical stylus forces which are satisfactory for standard records. With a high quality cartridge, such as the ESL GYRO/JEWEL, the GYRO/BALANCE arm will track properly at two grams.

► No other make of arm uses ball bearings throughout for all vertical and horizontal motions. This assures smoother operation, increased record life, and longer, trouble-free arm performance. Only \$34.95, complete with shell; write for details.

PS: Magnificent for standard records, too!



For Listening At Its Best
Electro-Sonic
Laboratories, Inc.

Dept. E • 35-54 36th St., Long Island City 6, N.Y.

Correspondence



IT'S OLDER THAN YOU THINK

Dear Editor:

From your excellent editorial in the May issue, the inexperienced reader may easily draw the conclusion that only in the transistor era did the honorable Drs. Folkman and Watkins conceive the idea of stimulating a weak or defective heart electronically. As with many "new" ideas, the fundamental principle is described as far back as 20 years ago in the German magazine *Journal of Technical Physics*, Vol. 19, 1938, under the title "Electrical Stimulation of the Human Heart in Its Own Rhythm." At that early date, of course, the negative resistance which supplies electrical stimulating energy was built with a tube type multivibrator instead of its transistor version of today.

DR. H. E. HOLLMANN

Northridge, Calif.

GROWTH OF TRANSLATORS

Dear Editor:

Robert Cooper's excellent article ("Translators—Television's Last Frontier," July, 1958) should convince the few remaining doubters that translators are the *only* economical and legal solution to the TV rebroadcast problem.

More and more communities, TV stations and military installations are turning to low-cost, dependable translators to bring TV programs to previously unserved and "shadowed" areas. Progressive dealers and technicians—by encouraging the development of these movements—can build for themselves continuing sources of revenue from the sale of TV receivers, antennas, associated equipment and servicing.

A recent survey conducted by Adler Electronics of almost 100 translator stations produced the following information on overall translator economy:

Cost of installation per translator (including equipment, roads, power, shelter and engineering, if any)—average, \$6,000; minimum, \$3,800; maximum, \$10,000. Yearly operating costs—average, \$1,000; minimum, \$500; maximum, \$2,500. Estimated total US population served by translators—625,000.

The rapidly increasing number of translator installations, however, is the best indication of the outstanding job being performed by these economical, rugged and reliable rebroadcast equipments.

EMANUEL STRUNIN

Adler Electronics, Inc.
New Rochelle, N. Y.

(Continued on Page 18)

Before you buy
any capacitor
checker see
and try the

ALL-NEW

**MODEL 97
AEROVOX
LC-CHECKER**



\$69.95

The all-new Model 97 LC-Checker represents the ultimate in r-f circuit and component testing. In a single instrument it covers the widest range of checking functions. It's the only instrument that will test for capacitance without disconnecting capacitors from the circuit. Incorporates latest printed-circuit techniques.

THE ALL-NEW MODEL 97 LC-CHECKER CAN DO ALL THESE JOBS...

- 1—Measure capacitance and relative "Q" of capacitors.
- 2—Measure capacitor insulation resistance.
- 3—Align r-f and i-f circuits.
- 4—Check super-het oscillator tracking with set "hot-or-cold."
- 5—Align i-f channels in FM receivers and independent alignment of i-f transformers.
- 6—Determine resonant absorption points.
- 7—Locate resonant points in unused portions of coil assemblies in multi-range oscillators.
- 8—Align video and sound i-f systems in TV sets.
- 9—Precise alignment of 4.5 mc intercarrier sound i-f channels.
- 10—Determine natural resonant points of r-f chokes.
- 11—Determine natural period of antennas and transmission lines.
- 12—Measure fundamental crystal frequencies and operation at harmonic levels.
- 13—Measure transmitter buffer, amplifier and tank circuits for parasitic current loops with power off.
- 14—Measure correct wave-trap and filter tuning.
- 15—With a standard plug-in crystal, can be used as an accurate signal generator for signal substitution and precise signal sources.

Write for Name of Nearest Distributor

AEROVOX CORPORATION

DISTRIBUTOR DIVISION

NEW BEDFORD, MASS.

RADIO-ELECTRONICS

FREE from HOWARD W. SAMS!...valuable all-steel file cabinets with your purchase of **PHOTOFACT**—
the world's finest TV-Radio Service Data



FREE! FOR REGULAR PHOTOFACT SUBSCRIBERS

You get your File Cabinets FREE if you are a regular subscriber to PHOTOFACT Folders and buy all new Sets as issued each month. Your Folders come to you in special envelopes, each including a "Bonus Certificate." Sixty (60) of these entitle you to a single-drawer File Cabinet ABSOLUTELY FREE...



FREE! FOR PHOTOFACT LIBRARY PURCHASERS

Get FREE File Cabinets as you complete your profit-building PHOTOFACT Library... here's how:



FREE!
Single-Drawer File Cabinet with your purchase of 60 Sets of PHOTOFACT Folders.
Cabinet Worth... \$895



FREE!
Two single-drawer File Cabinets with your purchase of 120 Sets of PHOTOFACT Folders.
Cabinets Worth... \$1790



FREE!
Three single-drawer File Cabinets with your purchase of 180 Sets of PHOTOFACT Folders.
Cabinets Worth... \$2685



FREE!
Four single-drawer File Cabinets with your purchase of 240 Sets of PHOTOFACT Folders.
Cabinets Worth... \$3580

NEW EASY-BUY PLAN

It's easy to complete your present PHOTOFACT Library or start a PHOTOFACT Library. Use the EASY-BUY PURCHASE PLAN:

- NO INTEREST
- NO CARRYING CHARGE
- AS LITTLE AS \$10 DOWN
- UP TO 24 MONTHS TO PAY

Get the world's finest TV-Radio Service Data... get FREE File Cabinets with your PHOTOFACT purchases... take advantage of the Easy-Buy Plan. See your Sams Distributor today, or write to Howard W. Sams for full details.

get the full details of the HOWARD W. SAMS money-saving way to build your complete profit-making PHOTOFACT Library!

HOWARD W. SAMS & CO., INC.
2205 E. 46th St., Indianapolis 5, Indiana



Send details on your FREE File Cabinet offer and EASY-BUY Plan.

I'm a Service Technician: full time; part time

My Distributor is: _____

Shop Name: _____

Attn.: _____

Address: _____

City _____ Zone _____ State _____

Sylvania comparisons point out—

The big difference in Picture Tubes!

Here's the inside story on why local "off-brands" don't measure up to Silver Screen 85® standards

If you're like most dealers, you know off-brand tubes don't have the same quality standards as first-line tubes. To help you see how big the difference is, Sylvania purchased a nationwide sample of sixty 21YP4A's made by 19 different local tube makers. These tubes were put through the same production tests that all Sylvania tubes must pass.

Not a single local off-brand passed all 54 mechanical and electrical tests! Many of these were minor defects making little or no difference in whether or not the tube "lit up." But look how loose manufacturing controls can affect the important features of light output, focus, and life!

LIGHT OUTPUT

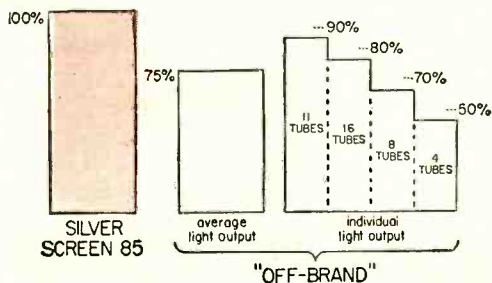

So far, 39 off-brand tubes have been compared with the *minimum* light output of Silver Screen 85. Five additional tubes couldn't even be tested. Eleven tubes were less than 90% as bright as the minimum for Silver Screen 85; 16 were less than 80%; 8 were less than 70%; and 4 were *less than 50%* as bright. Since most Silver Screen 85 tubes average as much as 125% of minimum standards, the difference becomes even greater. Small wonder that Silver Screen 85 is the easy way to more satisfied customers.

FOCUS

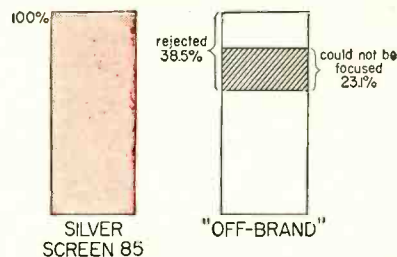
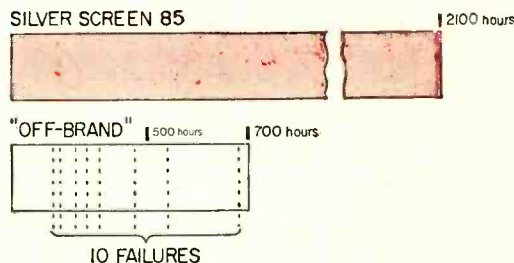

Chart 2 shows how these same 39 tubes stacked up to registered limits on focus voltage. 38.5% were rejected under these limits. Over half of all those rejected could not be focused in a TV receiver. Small wonder then that "Silver Screen 85" pictures are sharper, brighter, clearer.

LIFE TEST



Nineteen off-brand tubes were placed on Sylvania's standard 2000-hour life test. Chart 3 tells you how fast these tubes developed slow-heating cathodes. Over half, or ten units, failed to go beyond the 700-hour mark. Small wonder then that Silver Screen 85 gives you less troublesome callbacks.

Of all the off-brand tubes tested, Sylvania engineers estimate that 43% probably would not have operated properly in a TV set. Why gamble your reputation, customer satisfaction, and success. It's just *good business* to sell up to "first line" picture tubes; Silver Screen 85 picture tubes.



SYLVANIA

SYLVANIA ELECTRIC PRODUCTS INC.
1740 Broadway, New York 19, N. Y.
In Canada: Sylvania Electric (Canada) Ltd.
University Tower Bldg., Montreal

LIGHTING • TELEVISION • RADIO • ELECTRONICS • PHOTOGRAPHY • ATOMIC ENERGY • CHEMISTRY-METALLURGY

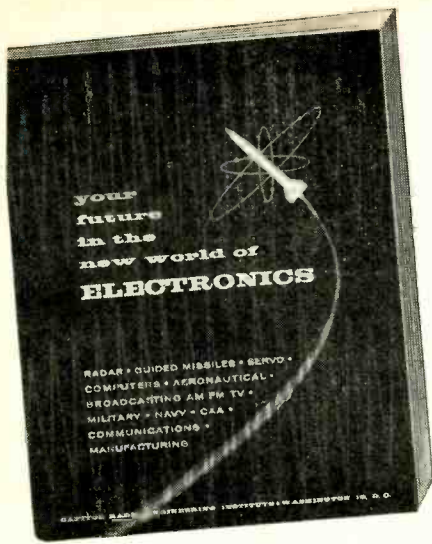

The data that launched thousands
of careers is yours FREE

► TELLS how you can be successful in
ELECTRONICS . . . including:

Servomechanisms . . . Computers . . . Radar . . . Automation . . .
Aeronautical Electronics . . . Broadcasting . . . Communications
and Manufacturing, and the Electronic Principles Associated with
Guided Missiles, Telemetry, Astronautics, and Instrumentation.

Send for your Free Copy today!

This is a brand new edition of the book which has launched thousands of men on good-paying careers in radio-TV-electronics.

It brings you completely up to date—answers important questions on newest career developments in electronics, including Radar, Guided Missiles, Servomechanisms, Computers, as well as Aeronautical Electronics, Broadcasting (AM, FM, TV), Military, Navy and CAA Electronics, Communications and Electronics Manufacturing.

This book, "Your Future in the New World of Electronics," also shows you how CREI Home Study leads the way to greater earnings in the booming electronics world.

However, CREI does not promise you a "snap." With accredited technical school curricula such as CREI offers, you must study to convert your ambition into technical knowledge which you can sell in the fabulous field of Electronics. Since its founding in 1927, CREI has provided thousands of professional electronics men with technical education. During World War II, CREI trained thousands for the Armed Services. Leading firms recommend CREI training for their own personnel. Among them: United Air Lines, Canadian Broadcasting Corporation, Trans-Canada Airlines, Douglas Aircraft Co., The Martin Co., Columbia Broadcasting System, All-American Cables and Radio, Inc., Gates Radio Co., Canair, Ltd., Federal Electric Corp., and U.S. Information Agency (Voice of America).

CREI courses are prepared by recognized experts, in a practical, easily understood manner, and constantly revised to meet the new electronic challenges of our time. You get the benefit of time-tested study assignments under the personal supervision of a CREI staff instructor. Your studies are accomplished on your own time, during hours selected by you, and controlled by your own will-power. This complete training is the reason that graduates find their CREI diplomas keys-to-success in even the most advanced of electronic applications. CREI alumni hold top positions in America's leading firms. At your

service is the CREI Placement Bureau, which maintains constant contact with electronic industry, and cooperates with employers and graduates in making satisfactory placements. This free service is available to students, as well as graduates. Fill out the coupon below completely and mail it now. We'll promptly send you your free copy of "Your Future in the New World of Electronics." The rest—your future—is up to you!

CREI ALSO OFFERS residence training in Washington, D. C. . . . at the same high technical level. Day and evening classes start at regular intervals. Qualified residence school graduates earn degree as "Associate in Applied Science." Check coupon if you prefer residence or home study information . . . or write Capitol Radio Engineering Institute, Dept. 148-E, 3224 — 16th St., N.W., Wash. 10, D. C.

ELECTRONIC TECHNICIANS

Growing Peninsula Co. has openings for 1st class electronic technicians to work directly with engineering in development of new products. Only those with CREI or equal training and 3 years minimum commercial experience will be considered. Top salaries for qualified applicants. Call Mr. McQueeney, DA. 4-4733 for appointment. ALTO SCIENTIFIC Co., Inc. 855 COMMERCIAL ST. PALO ALTO

ENGINEERING AIDES AND TECHNICIANS

Immediate Positions Available

C.R.E.I. or other formal electronic training desirable.

Experienced in reading schematics, breadboard construction of electronic circuits and chassis preparation.

EMERSON RESEARCH LABORATORIES

INDUSTRY CALLS FOR CREI TRAINING BY NAME . . . SO SHOULD YOU!

Here you see actual help wanted ads—one from a San Francisco newspaper, another seen in Washington. They are just two of many which specify "CREI or equal" education. This shows that industry approves CREI training, even insists on it. Experience has taught many, many companies that CREI students are taught what industry needs and wants them to know. Let this be your cue when you choose your educational program.

MAIL TODAY FOR YOUR FREE BOOKLET

CAPITOL RADIO ENGINEERING INSTITUTE
ECPD Accredited Technical Institute Curricula—Founded 1927
Dept. 148-E, 3224 Sixteenth St., N.W., Washington 10, D. C.

Please send me your course outline and FREE illustrated Booklet, "Your Future in the New World of Electronics" . . . describing opportunities and CREI Home Study courses in Practical Electronic Engineering Technology.

CHECK FIELD OF GREATEST INTEREST

Radar, Servo and Computer Engineering Technology
 Electronic Engineering Technology
 Broadcast (AM, FM, TV) Engineering Technology
 Television Engineering Technology
 Aeronautical Electronic Engineering Technology

Name..... Age.....
 Street

City..... Zone..... State.....

Check: Home Study Residence School Korean Veteran

If you have had a high school education, and experience in electronics—and realize the need of a high-level technical knowledge to make good in the better electronic jobs—you can qualify for CREI home study training. (Electronics experience is not required for admission to CREI Residence School.) Please fill in the following information.

Employed By _____
 Type of Present Work _____
 Education:
 Yrs. High School _____
 Yrs. College _____
 Electronics Experience _____

Focus on Profits

with
Centralab[®]
Model B
Controls



Enlarge your income and develop a long list of satisfied customers. It's easy with Centralab Model B Radiohms in the picture.

This is a replacement carbon control that adapts readily to virtually any application. Universal, fluted, knurled-type shaft fits all knobs—split knurl, shallow flat, deep flat, half-round, round, etc.

AC Line switches snap on, to convert control to switch-type unit.

There's nothing negative about Model B's . . . and you'll get a double exposure of profits. Order today from your Centralab distributor.

Centralab products are listed in COUNTERFACTS and PHOTOFACTS.

Centralab[®]
B-5806

A DIVISION OF GLOBE-UNION, INC.
922H E. KEEFE AVE. • MILWAUKEE 1, WIS.
In Canada: 804 Mt. Pleasant Rd. • Toronto, Ontario

**CONTROLS • SWITCHES • PACKAGED ELECTRONIC CIRCUITS
CERAMIC CAPACITORS • SEMI-CONDUCTOR PRODUCTS**

APPRENTICE SYSTEM

Dear Editor:

For several years I have been attending resident servicing schools and conversing with students of other institutions. In nearly all of them the emphasis was on factory type production of graduates.

How can a pupil learn to adjust a color set if four or five students are assigned to the same receiver at the same time, each going a different way? How can he learn troubleshooting techniques with the defective instruments usually supplied? What kind of progress can be made when a pair of greenies are given an alignment job while experienced technicians wait around for advanced work? Why not have the advanced student help the inexperienced?

Grades are good for records only. Who asks to see them? Never the employer.

In the old days, craftsmen served long apprentice periods. Yet today we become engineers without mathematics, and television servicemen simply by changing bottles. Tubeless valves (transistors) and printed circuits don't decrease the necessity for education; they increase it. Semiconductors are only in their advent now, and electronic applications in the home will triple in another decade. The demand for full-fledged TV mechanics will be far more pressing in 1968.

We must train others without the fear of their leaving their employment upon graduation. A modified form of the old-time apprentice system appears to be the answer here. Quality was the keynote, and when you completed your course of instruction you were ready to assume any job and perform it well and completely.

It can be done, and the time has arrived when our method of learning must be reorganized if we wish to have master craftsmen tomorrow.

CLYDE D. KIEBACH

Alexandria, Va.

WIND-IT-YOURSELF ADVOCATE

Dear Editor:

I have just finished reading the May issue of RADIO-ELECTRONICS, and I notice that one of your readers has an aversion to coil winding ("Why Wind Coils?" page 14). He says that he passes up projects that require the winding of coils.

In my opinion, this is not the general case. I myself, and several of my friends, do not have pockets bulging with greenbacks to buy every coil that is needed for a project. Most of us have junkboxes where we can dig up all the necessary wire.

In the past I have had to pass up projects because too many expensive parts were required. Keep up the good work and let's have more projects giving the specifications for coil winding.

ORVIN WAGNER

College Place, Wash.

F. C. C. LICENSE — THE KEY TO BETTER JOBS

An F. C. C. *commercial* (not amateur) license is your ticket to higher pay and more interesting employment. This license is Federal Government evidence of your qualifications in electronics. Employers are eager to hire *licensed* technicians.

WHICH LICENSE FOR WHICH JOB?

The **THIRD CLASS** radiotelephone license is of value primarily in that it qualifies you to take the second class examination. The scope of authorized work covered by a third class license is extremely limited.

The **SECOND CLASS** radiotelephone license qualifies you to install, maintain and operate most all radiotelephone equipment except commercial broadcast station equipment.

The **FIRST CLASS** radiotelephone license qualifies you to install, maintain and operate every type of radiotelephone equipment (except amateur). It also authorizes you to operate radio and television stations in the United States, its possessions and territories. This is the highest class of license available.

GRANTHAM TRAINING PREPARES YOU

The Grantham School of Electronics Course prepares you for a **FIRST CLASS** license, and it does this by **TEACHING** you electronics. The subject is covered simply and in detail, with emphasis on the practical. The subject is easy to understand. The organization of the course is such that your progress, step-by-step, leads directly to your special goal — a first class F. C. C. license.

CORRESPONDENCE OR RESIDENCE CLASSES

Grantham training is available by correspondence or in resident classes. Either way (residence or correspondence), we train you quickly and well — **NO** previous training required. A beginner may qualify for his first class license in as little as 12 weeks.

HERE'S PROOF...

that Grantham students prepare for F. C. C. examinations in a minimum of time. Here is a list of a few of our recent graduates, the class of license they got, and how long it took them:

	License Weeks	
Henry M. Best, 1003 Vermont St., Fremont, N.C.	1st	11
Harold V. Jones, P. O. Box 705, Alamogordo, N. Mex.	1st	13
Michael F. Aperio, 916 Townsend St., Chester, Pa.	1st	12
Norman R. Cook, 130 Olive St., Neodeska, Kan.	1st	12
Antone Mello, 68 Union Street, Nantucket, Mass.	1st	10
John Ward, 407 E. Cowden Ave., Midland, Texas	1st	10
F. T. Verga, 538-7th Street, Buffalo, N.Y.	1st	12
Philip J. Hooks, 4825 N. Capitol, N.W., Washington, D.C.	1st	12

THREE COMPLETE SCHOOLS: To better serve our many students throughout the entire country, Grantham School of Electronics maintains three complete schools — one in Washington, D.C., one in Hollywood, Calif., and one in Seattle, Wash. All schools offer the same rapid courses in F. C. C. license preparation, either home study or resident classes.

Get your First Class Commercial F. C. C. License in 12 weeks by training at



GRANTHAM SCHOOL OF ELECTRONICS

Hollywood Division
1505 N. Western Ave.
Hollywood 27, Calif.

Washington Division
821-19th Street, N.W.
Washington 6, D.C.

Seattle Division
408 Marion Street
Seattle 4, Wash.

GET YOUR First Class Commercial F. C. C. LICENSE IN 12 WEEKS!

Our **FREE** booklet, *Careers in Electronics*, gives complete details of our training — either home study or resident classes. This booklet tells how we prepare *you*, quickly, to pass F. C. C. examinations. For your free copy of this booklet, clip the coupon below and mail it to the Grantham School nearest you.

WASHINGTON D.C. Grantham School of Electronics
821-19th Street, N.W.
Washington 6, D.C.

HOLLYWOOD CALIF. Grantham School of Electronics
1505 N. Western Avenue
Hollywood 27, California

SEATTLE WASH. Grantham School of Electronics
408 Marion Street
Seattle 4, Washington

MAIL TO SCHOOL NEAREST YOU

(Mail in envelope or paste on postal card)

To: **GRANTHAM SCHOOL OF ELECTRONICS**
Desk 84-M • Washington • Hollywood • Seattle

Gentlemen:

Please send me your free booklet telling how I can get my commercial F. C. C. license quickly. I understand there is no obligation and no salesman will call.

Name _____ Age _____

Address _____

City _____ State _____

I am interested in: Home Study, Resident Classes

First

from

PACO

Manufacturers of quality electronic equipment in kit form.



TRANSISTOR and Crystal Diode TESTER in kit form

Model T-65 only \$39.95

60% of all 1958 electronic equipment will include transistors and diodes.

PACO, the only test instrument kit line produced under the auspices of a major test equipment manufacturer, is the first to bring you a comprehensive transistor tester in kit form—available at your local distributor. This is the instrument you *must* have to maintain modern electronic equipment!

Produced in accordance with the recommendations of leading transistor manufacturers, PACO's T-65 provides comprehensive tests for I_{cbo} , gain, leakage, shorts, etc., on low, medium and high-power transistors of both the p-n-p and n-p-n types, as well as tetrode transistors.

25 YEARS OF PRECISION KNOW-HOW IS YOURS IN PACO KITS

MODEL V-70 VACUUM TUBE VOLTMETER KIT

• wide-range • peak-to-peak NET PRICE: \$31.50

MODEL B-10 BATTERY ELIMINATOR KIT

• less than 0.3% ripple • no external filters required NET PRICE: \$41.95

MODEL G-30 RF SIGNAL GENERATOR KIT

• 160 Kc to 240 Mc in 8 bands • 120 Mc fundamental NET PRICE: \$28.50

MODEL G-30-PC Same as Model G-30 but with pre-wired and precalibrated front end. NET PRICE: \$35.50

MODEL S-50 5" CATHODE RAY OSCILLOSCOPE KIT

• push-pull vertical and horizontal amplifiers. NET PRICE: \$49.50

MODEL C-20 RESISTANCE-CAPACITY-RATIO BRIDGE KIT

• 10 mmfd to 2000 mfd • ½ ohm to 200 megs NET PRICE: \$20.95

MODEL T-60 TUBE CHECKER KIT

• full free-point lever selector system NET PRICE: \$38.75

MODEL Z-80 RF-AF SIGNAL TRACER KIT

• High gain RF & AF amplifier • Visual-audible indicator NET PRICE: \$29.50

MODEL M-40 HIGH-SENSITIVITY V-O-M KIT

• 20,000 ohms/volt DC • 10,000 ohms/volt AC NET PRICE: \$31.50

► Available and on display at leading electronic parts distributors. Write for free descriptive bulletin.

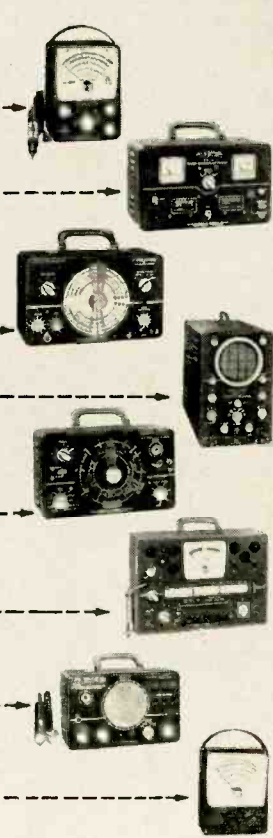

PACO ELECTRONICS CO., INC.

70-31 84th Street, Glendale 27, Long Island, New York

A DIVISION OF **PRECISION Apparatus Company, Inc.**

Export: 458 B'way, N. Y. 13, U.S.A., Canada: Atlas Radio Corp., Ltd., 50 Wingold Ave., Toronto 19.

CORRESPONDENCE (Continued)

"TO COMPLETE DAD'S DREAM"

Dear Editor:

I am writing you in the hope that you or your readers can help me. I have a collection of many wireless publications which once belonged to my father (W3AGD). I am now 16 and have been a general ticket holder since I was 14.

I am the owner of various issues of *The Electrical Experimenter*, but I need eight issues of 1913 and the full year of 1914 to complete my file of this publication. And can you be instrumental in helping me locate a copy of Vol. I, No. 1 (April, 1908) of *Modern Electrics*? I could use a few other issues of *Modern Electrics* either as replacements for worn copies or to fill in issues I do not have.

I have advertised in trying to complete Dad's dream and writing to you is one of my last hopes. Can you help me in any way, or do you know of any old-timer that I might contact?

R. E. (BOB) JONES, W3GQQ
713 Front St., Catasauqua, Pa.

(Our files of these early issues are depleted. Can any reader help Mr. Jones?—Editor)

ENTHUSIASTIC FM DXER

Dear Editor:

Notification has been received from Mr. Robert B. Cooper, Jr., TV-FM dx editor for your publication, concerning a possible bimonthly FM dx column, alternating with the present TV dx column.

I think this is a splendid idea. Not only will the vhf dx picture be brought into a clearer focus with the addition of the 100-channel FM band to your pages, but I feel that your publication and the FM medium itself will enjoy a mutual benefit. The increasing interest in FM, in general, I have found as editor of an FM dx column has been reflected by an upturn in the listening for dx FM. One cannot, of course, predict the degree of short- or long-term acceptance such an endeavor will realize; however, judging from the circulation of RADIO-ELECTRONICS, I would predict a high degree of success.

As a fairly successful FM dxer myself, I believe that I can perceive some of the intangible reward values, unique to FM dx, which will one day make FM just about the leading form of long-distance radio exploration by the public. This is coming about in part through the sales of high-gain FM antennas.

Not only do I expect a successful FM column in RADIO-ELECTRONICS, but I expect that such a column will lead many to discover in FM dx the vital means of entertainment, information and education that is FM.

BRUCE ELVING

FM Editor, Newark News Radio Club
Iowa City, Iowa

END

**WE'RE MAKING IT EASIER THAN EVER TO BECOME A WELL PAID
RADIO-TELEVISION SERVICE TECHNICIAN**

**NOW - Just \$6 Starts You Training in
RADIO-TELEVISION
the SPRAYBERRY "Learn-by-Doing" Way . . .**

**25 BIG, COMPLETE KITS
of PARTS & EQUIPMENT**

To help you learn *fast* the practical side of Radio-Television, we send you expertly engineered training kits to test and assemble for interesting, valuable shop-bench practice!

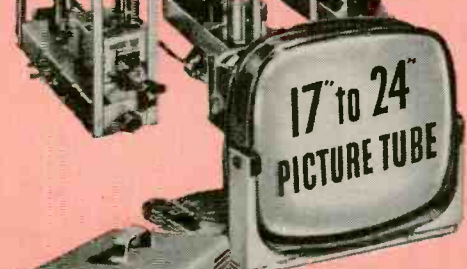

- The new Sprayberry Training Television Receiver, built and tested in 5 sections.
- Now offered . . . this fine modern oscilloscope.
- You build this powerful two-band superheterodyne radio receiver.

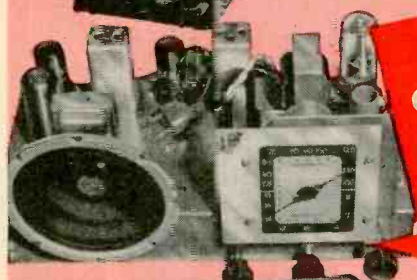

**Big New
CATALOG
AND
Sample Lesson
FREE!**

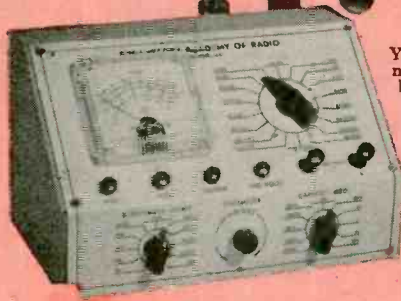

You build the new Sprayberry tester—a complete 18-range Volt-Ohm-Milliammeter test meter.



★ ★ ★ ★ This great industry is begging for trained men . . . to step into good paying jobs or a profitable business of their own! Our new plan opens the doors of Radio-Television wide to every ambitious man who is ready to act at once!

Men by the thousands . . . trained Radio-Television Service Technicians . . . are needed at once! Perhaps you've thought about entering this interesting, top paying field, but lack of ready money held you back. Now—just \$6 enrolls you for America's finest, most up to date home study training in Radio-Television. Unbelievable? No, the explanation is simple! We believe Radio-Television *must* have the additional men it needs as quickly as possible. We are willing to do our part by making Sprayberry Training available for less money down and on easier terms than ever before. This is your big opportunity to get the training you need . . . to step into a fine job or your own Radio-Television Service Business.

Complete Facts Free—Act Now; Offer Limited

Only a limited number of students may be accepted on this liberal and unusual basis. We urge you to act at once . . . mail the coupon below and get complete details plus our big new catalog and an actual sample lesson—all free. No obligation . . . no salesman will bother you.

HOME STUDY TRAINING IN SPARE TIME

Under world-famous 27-year old Sprayberry Plan, you learn entirely at home in spare time. You keep on with your present job and income. You train as fast or as slowly as you wish. You get valuable kits of parts and equipment for priceless shop-bench practice. And everything you receive, lessons and equipment alike, is all yours to keep.

LET US PROVE HOW EASILY YOU CAN LEARN!

Radio-Television needs YOU! And Sprayberry is ready to train you on better, easier terms, that any ambitious man can afford. *Just \$6 starts you!* Mail coupon today . . . let the facts speak for themselves. You have everything to gain. Let us prove the kind of opportunity that's in store for you!

SPRAYBERRY Academy of Radio-Television
1512 Jarvis Avenue, Dept. 20-K, Chicago 26, Illinois

Mail This Coupon Now—No Salesman Will Call

Sprayberry Academy of Radio-Television
Dept. 20-K, 1512 W. Jarvis Ave., Chicago 26, Ill.

Please rush all information on your ALL-NEW Radio-Television Training Plan. I understand this does not obligate me and that no salesman will call upon me. Include New Catalog and Sample Lesson FREE.

NAME..... Age.....

ADDRESS.....

CITY..... ZONE..... STATE.....

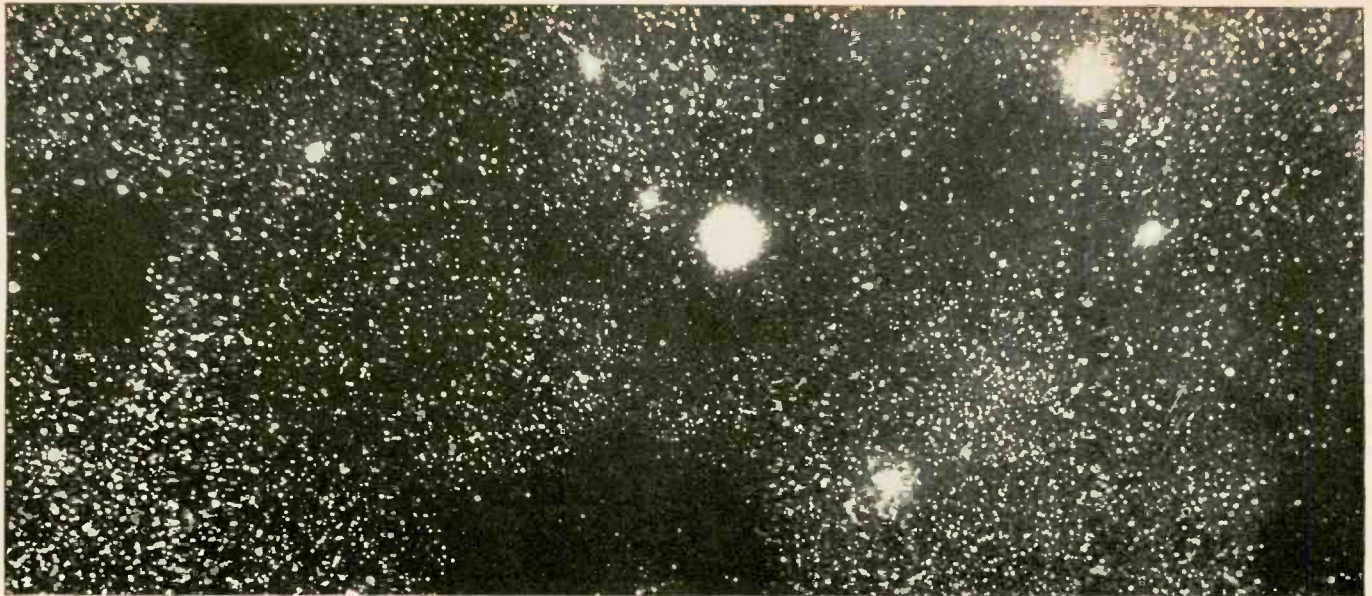

Courtesy Mount Wilson Observatory

FROM BEYOND THE SKY TO BENEATH THE SEAS

In the field of communications, two extraordinary events have occurred within a short span of time. One was the linking of Europe to America by the submarine telephone cable. The other was the sending of radio signals from U. S. satellites in outer space.

Both achievements depended on developments from Bell Telephone Laboratories. The cable was made possible

by development of long-life electron tube amplifiers able to withstand crushing pressure on the ocean floor. The satellites derive their radio voices from transistors—products of basic research in semiconductor physics.

The deep sea amplifier and the transistor illustrate the wide range of work at Bell Telephone Laboratories. Here, over 3000 professional scientists and

engineers explore and develop in physics, mathematics, electronics, chemistry, mechanical engineering, even biology—in every art and science which can help improve electrical communications.

Through this work, Bell Telephone Laboratories has helped make your telephone service the world's finest—and will keep it so.



BELL TELEPHONE LABORATORIES

WORLD CENTER OF COMMUNICATIONS RESEARCH AND DEVELOPMENT

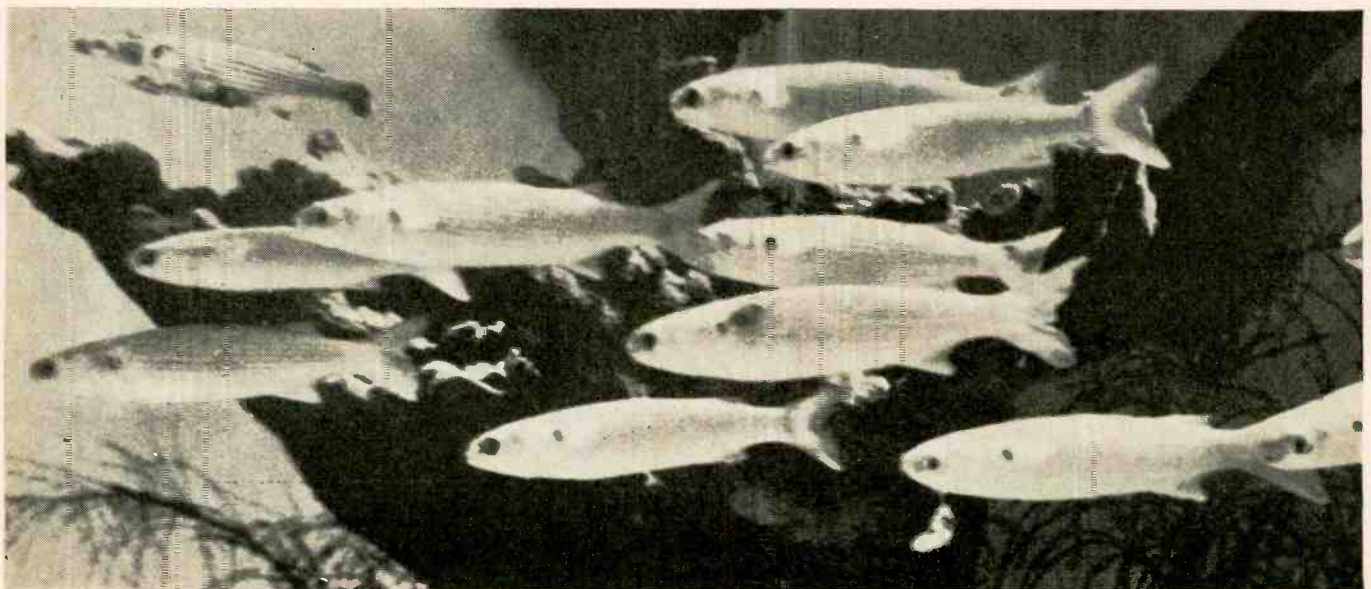

STEREO STEREO AND MONAURAL

the
experts
say...
in HI-FI
the best buys are



World-famous
EICO advantages
guarantee your complete satisfaction:

- Advanced engineering • Finest quality components
- "Beginner-Tested," easy step-by-step instructions
- LIFETIME service & calibration guarantee
- IN STOCK — Compare, then take home any EICO equipment—right "off the shelf"—from 1900 neighborhood EICO dealers. No mail delays, no high penalty freight costs.



Stereo Preamplifier HF85



FM Tuner HFT90



Stereo
Amplifier-Preamplifier
HF81



Monaural Integrated Amplifiers:
50, 30, 20, and 12-Watt
(use 2 for Stereo)



Bookshelf
Speaker System
HFS1



Speaker System HFS2
36" H x 15 1/4" W x 11 1/2" D



Monaural Power Amplifiers:
60, 50, 35, 30, 22 and 14-Watt
(use 2 for Stereo)



Monaural Preamplifiers:
HF65, HF61
(stack 2 for Stereo)



Over 1 MILLION EICO instruments in use throughout the world.

STEREOPHONIC EQUIPMENT

HF85: Stereo Dual Preamplifier selects, preamplifies & controls any stereo source — tape, discs, broadcasts. Distortion borders on unmeasurable. Self-powered. Works with any 2 high-quality power amplifiers such as EICO HF14, HF22, HF30, HF35, HF50, HF60. Available shortly.

HF81: Stereo Dual Amplifier-Preamplifier selects, amplifies & controls any stereo source — tape, discs, broadcasts — & feeds it thru self-contained dual 14W amplifiers to a pair of speakers. Monophonically: 28 watts for your speakers; complete stereo preamp. Ganged level controls, separate focus (balance) control, independent full-range bass & treble controls for each channel. Identical Williamson-type, push-pull EL84 power amplifiers, excellent output transformers. "Low silhouette" construction. Kit \$69.95. Wired \$109.95, incl. cover.

MONAURAL PREAMPLIFIERS (stack 2 for Stereo)
HF65: superb new design. Inputs for tape head, microphone, mag-phono cartridge & hi-level sources. IM distortion 0.04% @ 2V out. Attractive "low silhouette" design. HF65A Kit \$29.95, Wired \$44.95. HF65 (with power supply) Kit \$33.95, Wired \$49.95.

HF61: "Rivals the most expensive preamps" — Marshall, AUDIOCRAFT. HF61A Kit \$24.95, Wired \$37.95, HF61 (with power supply) Kit \$29.95, Wired \$44.95.

MONAURAL POWER AMPLIFIERS (use 2 for STEREO)

HF60: 60-Watt Ultra Linear Power Amplifier with Acro T0-330 Output Transformer; wide band-width, virtually absolute stability & flawless transient response. "One of the best-performing amplifiers extant; an excellent buy." AUDIOCRAFT Kit Report. Kit \$72.95. Wired \$99.95. Matching Cover E-2 \$4.50.

HF50: 50-Watt Ultra Linear Power Amplifier with extremely high quality Chicago Standard Output Transformer. Identical in every other respect to HF60, same specifications at 50 watts. Kit \$57.95. Wired \$87.95. Matching Cover E-2 \$4.50.

HF35: 35-Watt Ultra-Linear Power Amplifier version of the HF60 above. Kit \$47.95. Wired \$72.95.

HF30: 30-Watt Power Amplifier employs 4-EL84 high power sensitivity output tubes in push-pull parallel, Williamson circuit, 20 db feedback, & high stability margin. 2-EZ81 full-wave rectifiers for highly reliable power supply. Unmatched value in medium-power amplifiers. Kit \$39.95. Wired \$62.95. Matching Cover E-3 \$3.95.

HF22: 22-Watt Power Amplifier version of the HF60 above. Kit \$38.95. Wired \$61.95.

HF14: 14-Watt Power Amplifier of the HF81 above. Kit \$23.50. Wired \$41.50.

MONAURAL INTEGRATED AMPLIFIERS (use 2 for STEREO)

HF52: 50-Watt Integrated Amplifier with complete "front end" facilities & Chicago Standard Output Transformer. Ultra-Linear power amplifier essentially identical to HF50. "Excellent value" — Hirsch-Houck Labs. Kit \$69.95. Wired \$109.95. Matching Cover E-1 \$4.50.

HF32: 30-Watt Integrated Amplifier combines excellent HF30 power amplifier above with versatile preamplifier featuring tape head & microphone inputs, scratch & rumble filters, all amplifier facilities. Kit \$57.95. Wired \$89.95. Both include cover.

HF20: 20-Watt Integrated Amplifier complete with finest preamp-control facilities, excellent output transformer that handles 34W peak power, plus a full Ultra-Linear Williamson power amplifier circuit. "Well-engineered" — Stocklin, RADIO TV NEWS. Kit \$49.95. Wired \$79.95. Matching Cover E-1 \$4.50.

HF12: 12-Watt Integrated Amplifier provides complete "front end" facilities & excellent performance for any medium-power application. "Packs a wallop" — POPULAR ELECTRONICS. Kit \$34.95. Wired \$57.95.

SPEAKER SYSTEMS (use 2 for STEREO)

HFS2: Natural bass 30-200 cps via slot-loaded 12-ft. split conical bass horn. Middles & lower highs: front radiation from 8 1/2" edge-damped cone. Distortionless spike-shaped super-tweeter radiates omni-directionally. Flat 45-20,000 cps, useful 30-40,000 cps. 16 ohms. HWD 36", 15 1/4", 11 1/2". "Remarkable realism; eminently musical; unusual suitability for stereo." — Holt, HIGH FIDELITY. Completely factory-built: Walnut or Mahogany. \$139.95; Blonde, \$144.95.

HFS1: Bookshelf Speaker System, complete with factory-built cabinet. Jensen 8" woofer, matching Jensen compression-driver exponential horn tweeter. Smooth clean bass; crisp extended highs. 70-12,000 cps range. Capacity 25 w. 8 ohms. HWD: 11" x 23" x 9". Wiring time 15 min. Price \$39.95.

FM TUNER

HFT90: surpasses wired tuners up to 3X its cost. Pre-wired, pre-aligned, temperature-compensated "front end" — drift-free. Precision "eye-tronic" tuning. Sensitivity, 1.5 uv for 20 db quieting — 6X that of other kit tuners. Response 20-20,000 cps ±1 db. K-follower & multiplex outputs. "Drift absolutely absent; audio quality excellent; novel tuning quite effective." — ELECTRONICS ILLUSTRATED. Kit \$39.95*. Wired \$65.95*. Cover \$3.95. *LESS COVER, F. E. T. INCL.

EICO, 33-00 Northern Blvd., L. I. C. 1, N. Y. C-8

SHOW ME HOW TO SAVE 50% on 60 models of top-quality equipment as checked below. Hi-Fi Test Instruments Ham Gear. Send FREE literature & name of neighborhood EICO dealer.

NAME.....
ADDRESS.....
CITY..... STATE.....

Copyright 1958 by Electronic Instr. Co., Inc. 33-00 N. Blvd., L. I. C. 1, N. Y.

Add 5% in the West

the specs prove it . . .
your BEST BUY is

EICO®

for COLOR & Monochrome TV servicing

FREE CATALOG

shows you HOW TO SAVE 50%
on 50 models of top quality
professional test equipment.
MAIL COUPON NOW!



NEW!
TV-FM SWEEP
GENERATOR &
MARKER #368

KIT \$69⁹⁵ WIRED \$119⁹⁵

Entirely electronic sweep circuit (no mechanical devices) with accurately-biased inductor for excellent linearity. Extremely flat RF output; new AGC circuit automatically adjusts osc. for max. output on each band with min. ampl. variations. Exceptional tuning accuracy; edge-lit hairlines eliminate parallax. Sweep Osc. Range 3-216 mc in 5 fund. bands. Variable Marker Range 2-75 mc in 3 fund. bands; 60-225 mc on harmonic band. 4.5 mc Xtal Marker Osc., xtal supplied. Ext. Marker provision. Sweep Width 0-3 mc lowest max. deviation to 0-30 mc highest max. dev. 2-way blanking. Narrow range phasing. Attenuators: Marker Size, RF Fine, RF Coarse (4-step decade). Cables: out-pull, 'scope horiz., 'scope vertical. Deep-etched satin aluminum panel; rugged grey wrinkle steel cabinet.

**NEW! RF
SIGNAL GENERATOR
#324**

KIT \$26⁹⁵ WIRED \$39⁹⁵



150 kc to 435 mc with ONE generator! Better value than generators selling at 2 or 3 times its cost! Ideal for IF-RF alignment, signal tracing & trouble-shooting of TV, FM, AM sets; marker gen.; 400 cps audio testing; lab. work. 6 fund. ranges: 150-400 kc, 400-1200 kc, 1.2-3.5 mc, 3.5-11 mc, 11-37 mc, 37-145 mc; 1 harmonic band 111-435 mc. Freq. accurate to ±1.5%; 6:1 vernier tuning & excellent spread at most important alignment freqs. Etched tuning dial, plexiglass windows, edge-lit hairlines. Colpitts RF osc. directly plate-modulated by K-follower for improved mod. Variable depth of int. mod. 0-50% by 400 cps Colpitts osc. Variable gain ext. amplifier: only 3.0 v needed for 30% mod. Turret-mounted coils slug-tuned for max. accuracy. Fine & Coarse (3-step) RF attenuators. RF output 100,000 uv; AF sine wave output to 10 v. 50-ohm output Z. 5-way jack-top binding posts for AF in/out; coaxial connector & shielded cable for RF out. 12AU7, 12AV7, selenium rectifier; xmfr-operated. Deep-etched satin aluminum panel; rugged grey wrinkle steel cabinet.

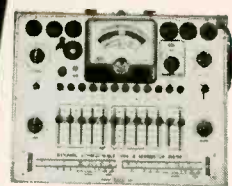

**NEW! DYNAMIC
CONDUCTANCE
TUBE & TRANSISTOR
TESTER #666**
KIT \$69⁹⁵ WIRED \$109⁹⁵

COMPLETE with steel cover and handle.

SPEED, ease, unexcelled accuracy & thoroughness. Tests all receiving tubes (and picture tubes with adapter). Composite indication of Gm, Gp & peak emission. Simultaneous sel of any 1 of 4 combinations of 3 plate voltages, 3 screen voltages, 3 ranges of continuously variable grid voltage (with 5% accurate pot). New series-string voltages: for 600, 450, 300 ma types. Sensitive 200 ua meter. 5 ranges meter sensitivity (1% shunts & 5% pot). 10 SIX-position lever switches: freepoint connection of each tube pin, 10 pushbuttons: rapid insert of any tube element in leakage test circuit & speedy sel. of individual sections of multi-section tubes in merit tests. Direct-sealing of inter-element leakage in ohms. New gear-driven rollechart. Checks n-p-n & p-n-p transistors: separate meter readings of collector leakage current & Beta using internal dc power supply. Deep-etched satin aluminum panel; rugged grey wrinkle steel cabinet. CRA Adapter \$4.50



**COLOR
and Monochrome
DC to 5 MC LAB & TV
5" OSCILLOSCOPE
#460**

KIT \$79⁹⁵ WIRED \$129⁹⁵
• Features DC Amplifiers!

Flat from DC-4.5 mc, usable to 10 mc. VERT. AMPL.: sens. 25 rms mv/in; input Z 3 megs; direct-coupled & push-pull thruout; K-follower coupling bet. stages; 4-step freq-compensated attenuator up to 1000:1. SWEEP: perfectly linear 10 cps-100 kc (ext. cap. for range to 1 cps); pre-set TV V & H positions; auto. sync. ampl. & lim. PLUS: direct or cap. coupling; bal. or unbal. inputs; edge-lit engraved lucite screen; dimmer; filter; bezel fits std photo equip. High intensity trace CRT. 0.06 usec rise time. Push-pull hor. ampl., flat to 400 kc, sens. 0.6 rms mv/in. Built-in volt. calib. Z-axis mod. Sawtooth & 60 cps outputs. Astig. control. Retrace blanking. Phasing control. 5" PUSH-PULL Oscilloscope #425: Kit \$44.95, Wired \$79.95. 7" PUSH-PULL Oscilloscope #470: Kit \$79.95, Wired \$129.50.



**NEW! PEAK-to-PEAK
VTVM #232 & UNI-
PROBE (pat. pend.)**
KIT \$29⁹⁵ WIRED \$49⁹⁵

Half-turn of probe tip selects DC or AC-Ohms. Uni-Probe - exclusive with EICO - only 1 probe performs all functions!

Latent circuitry, high sensitivity & precision, wide ranges & versatility. Calibration without removing from cabinet. New balanced bridge circuit. High Z input for negligible loading. 4 1/2" meter, can't burn-out circuit. 7 non-skip ranges on every function. 4 functions: +DC Volts, -DC Volts, AC Volts, Ohms. Uniform 3 to 1 scale ratio for extreme wide-range accuracy. Zero center. One zero-adj. for all functions & ranges. 1% precision ceramic multiplier resistors. Measure directly peak-to-peak voltage of complex & sine waves: 0-4, 14, 42, 140, 420, 1400, 4200. DC/RMS sine volts: 0-1.5, 5, 15, 50, 150, 500, 1500 (up to 30,000 v. with HVP probe & 250 mc with PRF probe). Ohms: 0.2 ohms to 1000 meg. 12AU7, 6AL5, selenium rectifier; xmfr-operated. Deep-etched satin aluminum panel; rugged grey wrinkle steel cabinet.



New!
Series/Parallel
R-C COMBINATION
BOX #1140
KIT \$13.95
WIRED \$19.95



**TUBE TESTER
#625**
KIT \$34.95
WIRED \$49.95
• tests 600 mil series string type tubes
• illuminated roll-chart

Pix Tube Test Adapter\$4.50



**6V & 12V BATTERY
ELIMINATOR
& CHARGER #1050**
KIT \$29.95
WIRED \$38.95
Extra-filtered for transistor equip.
#1060 KIT \$38.95
WIRED \$47.95



New!
Miniaturized
MULTI-SIGNAL
TRACER #145A
KIT \$19.95
WIRED \$28.95



**20,000 Ohms/Volt
V-O-M #565**
KIT \$24.95
Wired \$29.95



**1000 Ohms/Volt
V-O-M
#536**
KIT \$12.90
Wired \$14.90



Reads 0.5 ohms -500 megs, 10 mmdf-5000 mfd, power factor.

**R-C BRIDGE & R-C-L COMPARATOR
#950B**



VTVM PROBES	KIT	Wired
Peak-to-Peak	\$4.95	\$6.95
RF	\$3.75	\$4.95
High Voltage Probe-1		\$6.95
High Voltage Probe-2		\$4.95

SCOPE PROBES	KIT	Wired
Demodulator	\$3.75	\$5.75
Direct	\$2.75	\$3.95
Low Capacity	\$3.75	\$5.75

EICO, 33-00 Northern Blvd.
Long Island City 1, N. Y.

C-8

Show me HOW TO SAVE 50% on Test Equipment and Hi-Fi. Send me FREE Catalog and name of neighborhood distributor.

Name.....
Address.....
City.....Zone.....State.....

TURN PAGE
FOR MORE
EICO VALUES

EICO®

Send for
FREE CATALOG
now

Prices 5% higher on West Coast.

33-00 Northern Blvd., Long Island City 1, N. Y.

OUR GROWING INDUSTRY

... Radioelectronics Leaps into the Space Age ...

SEVEN years ago, in our November, 1951, editorial "Radioelectronic Giant," we made the then-considered-rash forecast that by 1960 the radioelectronic industry would reach a fabulous \$10 billion. That figure was based on a total dollar volume *exclusive* of military electronics.

This highly optimistic forecast proved to be very tame and far too conservative. Long before 1960, in 1957, to be exact, the industry, increasing by leaps and bounds, had grown to a healthy total of \$9.78 billion, *exclusive* of military electronics — and still had three years to go!

If we add the military orders to this, we come to the astonishing total of close to \$13.7 billion in 1957.

There are those who feel that the industry will experience a severe setback in 1958. We do not share this pessimistic view. Indeed, a compilation of authoritative figures, made at the time this was written (late in May) indicates that the total effective recession the first quarter of 1958 for the industry was not more than 5% to 8%. This comparatively small decline may be wiped out entirely by the end of 1958, and it is quite possible that 1958 may exceed the 1957 total.

Let us review here only the last three years to obtain a better perspective of our industry. All figures are factory values, except phono records, which are retail (see table).

How does the immediate future appear from these figures—let us say up to the end of 1960? We have projected here a forecast which, in view of the past record of the industry, seems conservative. We feel certain that our figures again, as in the

past, will prove low. Why? There are a number of excellent reasons why the industry **MUST** move forward, if we leave out of this forecast such imponderables as a world war.

Natural growth. Even without the factors listed below, the industry must speed up due to its own growth momentum.

Population growth. At present, the total US population is 173.8 millions. By the end of 1960, we will number 180 millions. More people mean an increased demand for everything — electronics included.

New Inventions and Discoveries. If you look back only 10 years you will find that there were thousands of now familiar radio-electronic items not then in existence, from transistors to sputniks. Now, under the healthy and salutary pressure of Russian competition, we are really flexing our muscles and moving fast. The next three years will tell the story.

Space electronics. No branch of the industry is moving faster than missiles, rockets and space vehicles. *Electronics is the key to all of them.* Here it is that radio-electronics really will dazzle the past. And when it comes to the highly sophisticated electronic instrumentation of the future, we really have not scratched the surface. Great break-throughs are on the horizon, pointing to planet-wide radar, foolproof missile and space-vehicle guidance, collisionproof aircraft and automobiles, positive electronic missile interceptors, and a host of others.

All in all, there seems to be no limit in sight to future electronic expansion.

—H. G.

Category	1955 Total	1956 Total	1957 Total
Radio Receivers	\$ 291,157,000	\$ 298,372,000	\$ 373,975,000
TV Receivers	1,071,020,000	938,596,000	832,747,000
Phonos & Hi Fi	138,000,000	163,000,000	300,000,000
Industrial & Commercial Electronics	750,000,000	950,000,000	1,300,000,000
Distribution Value Added to Above Items	1,100,000,000	1,400,000,000	1,500,000,000
Repair Parts (including tubes, transistors)	750,000,000	850,000,000	900,000,000
Servicing & Installation (excluding parts)	900,000,000	1,150,000,000	1,700,000,000
Military Electronics Sales to Government	2,400,000,000	2,700,000,000	3,900,000,000
Phono Records	235,200,000	312,622,000	360,000,000
Electricity to Operate TV-Radio	401,000,000	541,000,000	555,000,000
Radio-TV Broadcasting Revenues	1,570,200,000	1,776,900,000	1,963,000,000
ELECTRONICS INDUSTRY TOTAL	\$9,606,577,000	\$11,080,490,000	\$13,684,722,000

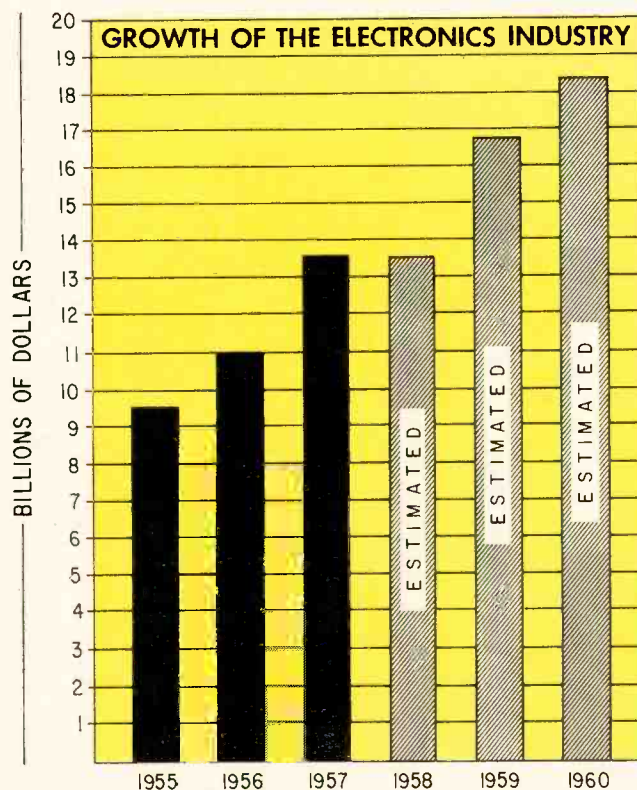

Thermistors replace thermometers in a simple instrument for measuring humidity

Wet-Thermistor Relative-Humidity Meter

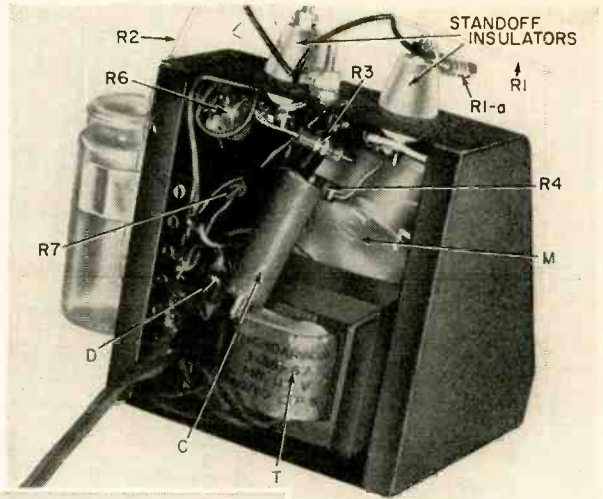

With the back removed, parts placement is revealed.

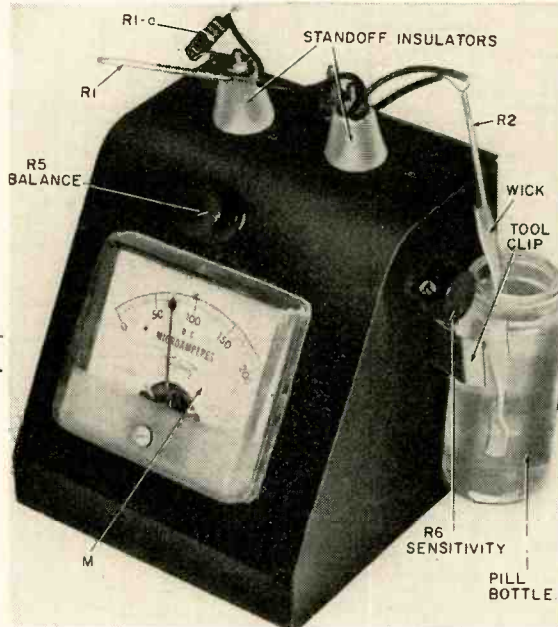

Here the instrument is indicating about 80% humidity.

By JAMES A. McROBERTS

THIS easy-to-build instrument may be used as an ornament for the home or office or may be calibrated for precise reading of relative humidity. It is remarkably simple and nearly self-compensating as to temperature changes and variations in power-line voltage.

How it works

Measuring relative humidity entails reading two thermometers, one of which is wet with a wick from a water well or fountain. Evaporation of water from the wet wick cools one thermometer. The amount of cooling is determined by the rate of evaporation, which in turn depends on the humidity to a great extent but is also temperature-dependent. The lower the humidity, the greater the cooling effect on the wet-bulb thermometer and the greater the temperature differential with respect to the dry-bulb thermometer. To illustrate this, the chart excerpts the percentage relative humidity for three temperatures from a standard table.

Glancing at the chart, one notes that humidity changes by a fixed percentage for different temperatures. For all practical purposes this computation is avoided by the wet-thermistor relative-humidity meter since the two thermistors change their resistance with

- R1, 2—Bead thermistors 3,500 ohms at 25°C 30%, (Veco 34A3)
- R3, 4—10,000 ohms
- R5—pot, 5,000 ohms, miniature
- R6—pot, 10,000 ohms, miniature
- R7—680-1,000 ohms
- All resistors 1/2-watt 10% unless noted
- C—100 μf, 20 volts, electrolytic
- D—1N51
- M—200-μa dc meter

- T—filament transformer: primary 117 volts; secondary 12.6 volts, 2 amps (Thordarson 26F67 or equivalent)
- Meter case with insulators, 4 1/4 x 4 x 4 inches punched for 2-inch meter (Bud CM-1241B or equivalent)
- Tool clip
- Glass pill bottle, 1-inch diameter, 2 1/2 inches long
- Terminal strip, 5 lugs
- Miscellaneous hardware

temperature. The change is fortunately correct as to direction so the temperature factor may be neglected except for extremely precise measurement. In this event, separate calibration charts would be used for three or more rather separated temperatures.

The circuit proper is simple as shown in the diagram. Only a few milliwatts are needed to power the unit so

a 1N51 diode is used as the rectifier. The 100-μf capacitor (C) effectively suppresses short power-line surges since it is larger than required for adequate filtering. The thermal time constant of the two thermistors (R1 and R2) further eliminates many short surges.

The two thermistors are in a bridge arrangement which can be balanced by the BALANCE pot, a front-panel control.

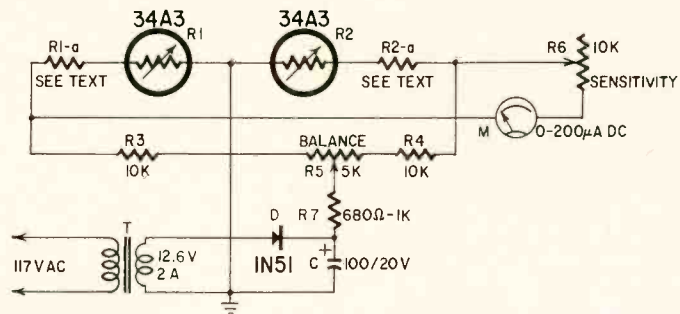

Circuit of the humidity meter.

In practice, balance is set (with the wick removed from the normally wet thermistor) for a zero reading of the meter, which also corresponds to 100% relative humidity.

The bridge with meter connections is polarized so that any decrease from 100% relative humidity causes the meter to read upscale. Amount of reading is controlled by the SENSITIVITY pot on the side of the meter case. I used about 1,500 ohms resistance with my model to enable the meter to read 25% humidity at full scale on a 200- μ a meter. More resistance can be inserted to permit lower humidity to be read. (By reversing the wet and dry thermistors it might be possible to let a full-scale reading represent 100% humidity. However, keep the maximum current rating of the thermistors in mind.)

A 680-ohm safety and compensating resistor (R7) is in the power supply line to the bridge. This seems to be a little low for my unit. About 820 ohms is suggested. This resistor provides a fixed drop so that different humidity readings at different temperatures will be minimized. It works in conjunction with the other fixed components to provide this compensation and places some resistance in series with the power supply to protect against accidental shorts.

Construction kinks

The meter case already has the meter hole cut out and comes with the stand-off insulators. The meter is packed with a template for its mounting holes so no problems arise here. A single hole is drilled for the 6/32 ground lug about halfway between the two standoffs and toward the rear of the case top. Holes for the two pots are drilled, using the pots themselves as templates after the meter mounting holes have been drilled but, obviously, before permanently mounting the meter.

Similarly, use the transformer to lay out its mounting holes. The upper terminal-strip mounting screw secures the tool clip used to hold the pill-bottle water fountain (see photos). When laying out these holes check for adequate clearance of the strip's lugs from the side of the transformer case.

The lowermost two lugs of the terminal strip are power-line and transformer primary tie points. Next two, going up, support the crystal rectifier and form the positive power supply points. The last lug is the negative (grounded at the top of case). Filter capacitor C is swung across the last two lugs and its leads are insulated with spaghetti. Solder leads to the diode quickly, using a thermal sink to avoid damage.

Lugs under the nuts on the standoff insulators provide easy soldering. Also use lugs under the ground on both the inside and outside of the case cover.

The wick is part of a cotton hem from the tail of a man's shirt. Simply cut out about 3 inches of the hem from an old shirt for the wick and, while you're at it, make a second one. The wick is

RELATIVE HUMIDITY TABLE*

Dry-Bulb Temperature (°F)	Difference between readings of wet and dry bulbs (°F)															
	1	2	3	4	5	6	7	8	9	10	11	12	13	14	15	16
60	94	89	83	78	73	68	63	58	53	48	43	39	34
70	95	90	86	81	77	72	68	64	59	55	51	48	44	40	36	33
80	96	91	87	83	79	75	72	68	64	61	57	54	50	47	44	41

*From *Basic Physics*, Vols. I and II, by Alexander Efron, page 675 (Copyright 1957 by John F. Rider, Publisher).

inserted over the bead of the wet thermistor after the bridge is balanced.

100% humidity calibration

When a wet and a dry temperature indicator (either thermistor or thermometer) give the same reading, humidity is 100%. The atmosphere has all the moisture it will hold and hence will not evaporate any water from the wick on the thermometer or thermistor. We use a more practical method for 100% calibration. Simply remove the wick and allow the thermistor to dry (or don't wet it to start with).

With both thermistors dry and with some mean temperature (about 70°F), turn on the power with the BALANCE control previously set at about its midpoint. Try to get a zero meter reading by adjusting the BALANCE as quickly as possible. You may find it impossible to balance the bridge. If so, check resistors R3 and R4 to see if either one departs too radically from the nominal 10,000-ohm value.

The most likely cause of imbalance is excessive tolerance of either or both thermistors (R1 and R2). Manufacturing tolerance of these units runs high— $\pm 30\%$. A total of 60% can be obtained as a consequence. Doctoring resistance is added in series with the lower thermistor so that the BALANCE control can balance the bridge near its midpoint with both thermistors dry.

Add this resistance (R1-a or R2-a) in series with only one of the thermistors. (The dry one in my model. The doctoring resistor is the one connected at the standoff insulator.) If a 1,000-ohm pot is handy, insert it in series with each thermistor (successively) to determine the amount of resistance required for proper operation of the BALANCE control. After normal operation is secured, simply remove the pot and measure its resistance with an ohmmeter. Then insert the nearest commercial fixed-resistor value.

Allow about a minute after each attempt to adjust the BALANCE control, due the thermal time constants of the two thermistors. (They will be heated a trifle by their internal current.)

Less time may be allowed during preliminary adjustments to get the meter reading near zero. It is a good idea to cut in all the resistance of the SENSITIVITY control to protect the meter. After the bridge is balanced near zero, a final balance may be obtained with all resistance cut out of the meter circuit—re-

sistance of the SENSITIVITY control zero. Now fill the pill bottle with water and insert wick. Wet the wick up to the thermistor bead. Allow about 15 minutes for the water to reach evaporative equilibrium with the surrounding air, and for the temperature of the water to reach the surrounding temperature.

The instrument should stand outside a window exposed to the open air when a calibration reading is taken. Avoid any wind or draft. Take the reading of the meter and plot it against radio reports of the humidity. Several such points are enough for most purposes. The SENSITIVITY control may be adjusted to bring some desired value of humidity to a particular point on the scale, for example, 200 μ a = 30% humidity. Use a chart or mark the readings on adhesive tape affixed to the meter face.

Scale expansion

A 100- or a 50- μ a meter may supplant the 200- μ a unit to give greater sensitivity. This permits expanding the scale in the neighborhood of the 100% point. With a more sensitive meter, use at least 10,000 ohms (you should use more) resistance in series with the meter during the BALANCE calibration. This may save a meter!

R7 may be doctored if there seems to be too wide a swing of humidity with temperature. More resistance for R7 will lessen the change while less resistance will cause the change to be more pronounced. For ordinary observation, the values quoted will be OK for 100% to 40% humidity and for temperatures of the ordinary room (50–80°F).

For more precise work, make a series of observations at high and low temperatures by checking against weather reports. Allow for local variation to a slight extent. Use the final chart prepared from these checked points. As an alternative, you can use a standard wet-bulb hygrometer as the standard for all calibrations.

The experimenter can compensate for ambient temperature with thermistors in the meter circuit. Including a series thermistor will cause a greater meter reading when hot. The shunting of the meter will cause a decrease in the meter reading of the combined meter-thermistor circuit when the thermistor heats. Variation of series and shunt resistance associated with the thermistor will permit precise control of its action.

END

GATING with DIODES

By HAROLD B. McKAY

Switches and relays do not have to be mechanical—semiconductor diodes and transistors are taking over these jobs and may give us all-electronic telephone switchboards

THE semiconductor diode, once the detector used in all radio receivers, seems headed for a new career as an electronic switch.

Although present solid-state rectifiers are a great improvement over the old cat's-whisker detector, they work on similar principles. Many of the units are made in an identical fashion—they consist of a crystal of silicon touched by a whisker of tungsten wire. Like the galena detector of old, these are adjusted during the manufacturing process for the most sensitive spot.

Many substances are unilaterally conductive—they can rectify alternating current. They include germanium, silicon, selenium, copper oxide and magnesium sulphide. Some, like copper oxide, also have a nonlinear characteristic which can impart a sort of negative-resistance effect to a circuit.

Electrical switching devices, such as those in automatic telephone exchanges, have traditionally used relays and rotary mechanical units for setting up different circuit combinations. These same devices have been adapted into many allied systems—everything from burglar alarms to train signal systems.

The latest development for these applications is electronic switching. Complete telephone systems, without any moving parts, have been designed. A shipboard installation for the French Navy, designed by International Telephone & Telegraph, uses the versatile diode as a gate for alternating current. Fig. 1 is an example of the kind of circuit used for switching.

With no direct current applied to this

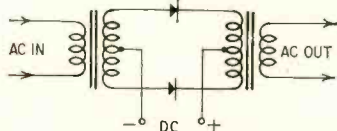

Fig. 1—A basic electronic switch. Two diodes are used in this circuit.

circuit, it is impossible for alternating current to flow through from the input to the output. This is because the two rectifiers are poled so that they both "point" the same way. For instance, when the upper conductor is negative, current would tend to flow through the crystal. But at this time the bottom wire would be positive, and the lower crystal would not pass current.

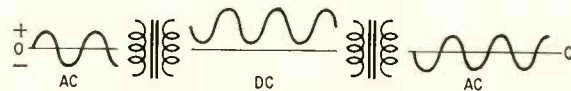

Fig. 2—Waveforms at various points of Fig. 1: a—the input transformer; b—ac superimposed on the dc; c—ac output.

Thus, regardless of the polarity, current would not flow. However, if dc is applied to the leads shown, in a polarity which will flow through both crystals, it will close the circuit by causing both diodes to conduct.

It might be said that the ac would then "ride through" on top of the dc which was passing through the crystals. Actually, the crystals conduct only in one direction and the ac which flows through them on the dc is really fluctuating direct current.

Fig. 2 explains this. Alternating current exists up to the first transformer. The superimposed dc raises this above the zero line so it becomes a fluctuating direct current. Going through the second transformer, the dc is lost and the output is again alternating current. Suppose for example, that the circuit of Fig. 1 is biased to such a potential that 2 ma dc flows through the diodes and transformer windings. Now the ac of Fig. 2 will alternately aid and oppose that current. Let us say that the transformers have a 1-1 ratio and the ac at the left is 1 ma. In one direction it will add to the dc—in the other subtract from it. Thus the pulsating dc in the center is varying between 1 and 3 ma, and the output at right is 1 ma ac.

Thus, the diode rectifiers act as a switch. The dc acts as the winding of a relay and the diodes as the contacts.

Switching devices of this sort have the advantage of no contacts and no moving parts. The latter permits extremely rapid action—much faster than possible with mechanical switches. This feature is used in modulators for carrier systems, such as those used by

railroads, telephone and pipeline companies.

Diode modulators

These carriers, unlike radio, operate over wire lines and need very little power to reach their destination. This permits the use of a simple modulator like that shown in Fig. 3. It is a bridge arrangement made up of four copper-oxide rectifiers.

Notice that, regardless of the momentary polarity of the audio frequency, no current travels through the rectifier bridge. The positions of the elements are such that they block any polarity applied to top and bottom terminals.

On the other hand, if a radio frequency is applied to the side terminals of the bridge, the rectifiers conduct when the right-hand terminal is positive. The combination of these two effects produces modulation:

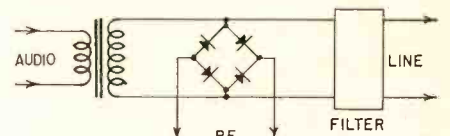

Fig. 3—A diode-bridge rf switch used as a modulator in carrier communications systems.

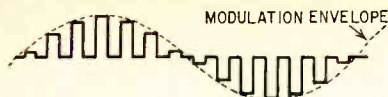

Fig. 4—Waveform produced by the circuit of Fig. 3.

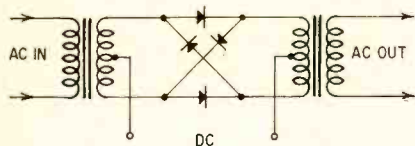

Fig. 5—Lattice network used for demodulation in carrier systems.

When the rf presents its negative pole to the right-hand side, the rectifiers do not conduct, and the audio frequency passes into the filter. When the rf carrier presents its positive pole to the right-hand side, the rectifiers conduct. While they are passing this rf current, they short-circuit the audio-frequency lines.

Thus, as the rf reverses, it causes a switching or chopping effect to interrupt the voice frequency, just as if a switch were being opened and closed at carrier frequency. This results in a waveform like that shown in Fig. 4.

Another effect is carrier suppression. Analysis of the modulator circuit shows that no path exists for connecting the radio frequency to the line. Both sidebands would be transmitted, as would the audio frequency, but the filter stops this results in single-sideband suppressed-carrier operation with a minimum of equipment.

Another configuration often used for demodulation in carrier systems is the lattice network of Fig. 5. This device has the interesting feature of being a reversing switch. Fig. 6 shows why this is so. In this drawing, only the crystals which conduct at any one time are shown and the nonconducting ones are omitted.

When the dc polarity is changed, it is equivalent to reversing the leads between the transformers. As a modulator, the carrier frequency is used in place of dc. It has the effect of operating a reversing switch at the carrier frequency. This circuit design is used in wide-band modulators which handle several carrier frequencies. It suppresses the original signal frequency as well as the carrier and delivers sidebands, which have twice the power of the bridge arrangement.

Nonlinear effects

Copper-oxide rectifiers are not perfect in their action—they are not a complete short to one polarity and a perfect open to the opposite one. Actually, these units have resistance in both directions, but this resistance is much higher in one direction than in the other. Furthermore, the resistance varies with the applied voltage—as the voltage increases, the resistance decreases. This lets you use materials of this sort in another type of switching action—a controlled variable resistance.

One application of this principle is in communication circuits which use headphones. Rectifying action is not required here, so two rectifiers are connected in parallel, facing in opposite directions, as in Fig. 7. Here the two rectifiers are called a varistor—its varying resistance is its principal function in this application.

In normal use, the phones receive only a fraction of a volt. At this low voltage the varistor has a very high resistance and consumes very little of the applied power. If a sudden burst of noise occurs, the resulting rise in voltage lowers the resistance of the varistor. It then acts as a short across the earphones and prevents an acoustic shock to the listener's ears. This is widely used in telephone installations where the listener has a receiver held to the ear with a headband. Similar

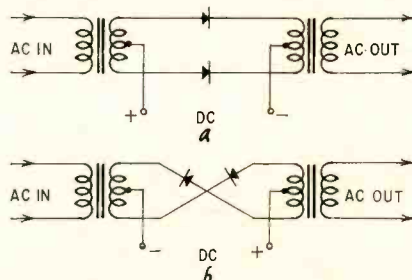

Fig. 6—Reversed dc polarity electronically reverses leads between transformers.

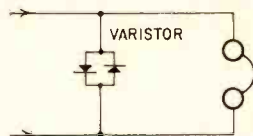

Fig. 7—Typical varistor application.

circuits are used to protect sensitive meters.

Computer readout

Electronic computers often require a memory or storage circuit of some kind where a number of bits—binary digits of information—can be kept for a short time. These circuits must accept and hold an impulse and later deliver it as a readout.

One method of doing this is shown in Fig. 8. Here the impulse is recorded by impressing a voltage between the appropriate A wire and a common C wire. This charges one of the capacitors. The charge is held and constitutes a recorded bit of information.

To read out the information, a connection is made to the common and the appropriate B wire. The capacitor discharges into the external circuit, thus delivering its bit of information. The diodes in this application switch the charge and discharge circuits onto the required paths.

Transistor switching

Some semiconductor devices which are classed as transistors rather than diodes are also used for switching purposes. In fact, just as a vacuum tube can work as a switch, a transistor can be made to perform this function. Fig.

9 shows how a transistor will relay the action of switch S. If a power transistor is used, a large load may be handled.

The power tetrode transistor has been used experimentally in the switching field and shows some promise. A device which operates in a similar manner is the Unijunction transistor. It is called a transistor because it meets this definition by having three connecting leads. However, it is actually a different article, and its original name of "double-base diode" was perhaps more descriptive.

The Unijunction (see "Using the Unijunction," RADIO-ELECTRONICS, July, 1957) consists of an n-type silicon-crystal bar, with an ohmic contact at each end and an aluminum wire attached to the bar between them. A number of circuit arrangements are possible which can make any of the three terminals serve as a signal input or a load output.

In switching service, the silicon bar will have a resistance of perhaps 5,000 to 10,000 ohms between its base connections. The aluminum wire forms a p-n junction and is called the emitter. The conductivity of the bar is dependent upon the emitter's forward bias.

In the cutoff condition, the emitter and interbase power supplies provide potentials which back-bias the emitter. If the emitter potential is raised enough to overcome this bias, holes are injected into the bar. These holes are carried toward one of the base connections by the internal field of the bar. This increased charge concentration decreases the resistance and also the internal voltage drop from the emitter to the base connection.

This becomes a regenerative effect and the emitter current increases to the limit allowed by the emitter power supply. Thus the conductivity is controlled by the emitter, and this also appears as a modulation of the current between the two base connections. Fig. 10 shows a Unijunction which is

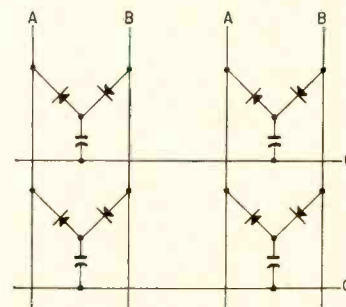

Fig. 8—Diode arrangement in a computer readout circuit.

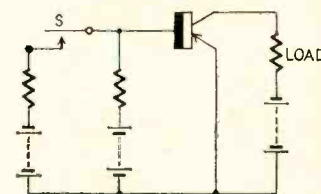

Fig. 9—In this circuit the transistor is used as a relay.

connected as a one-shot multivibrator.

Four-layer diode

Another new development in switching semiconductors is the Shockley four-layer diode. (See "New Tubes," RADIO-ELECTRONICS, February, 1958, pages 131-132 and "More Jobs for Semiconductors," RADIO-ELECTRONICS, May, 1958.) This is a two-terminal unit consisting of an n-p-n-p combination. It presents an open or high-impedance state, which may run from 1 to 100 megohms, and a closed or low-impedance state of less than 20 ohms.

It can be switched from one state to the other by the voltage and current applied to its terminals. As the voltage is raised, a breakdown point is approached at which the diode changes to the low-impedance condition. It will hold in this condition until the current drops below a critical value, at which time it will return to the high-impedance condition.

The four-layer diode will switch 100-ma currents in less than 1/2 micro-second. Its circuit designation is the figure 4 in a circle. The 4 signifies the number of layers and the slant line on the numeral indicates the forward direction. Fig. 11 shows a typical circuit using the diode.

Here the voltage is high enough to cause the diode to break down, but the resistor limits the current to a value below the sustaining value.

Sometimes crystal diodes are used with electromechanical relays. An interesting application is one which affects the release time of the mechanical relay. Traditionally, magnetic relays have been made "sluggish" or slow to operate by placing a copper sleeve around the core or over the winding. This sleeve became the equivalent of a single turn of wire.

The relay in effect then becomes a transformer, with the regular winding

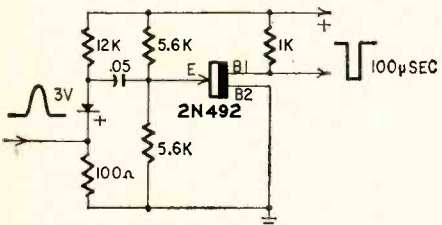

Fig. 10—One-shot multivibrator using a Unijunction transistor.

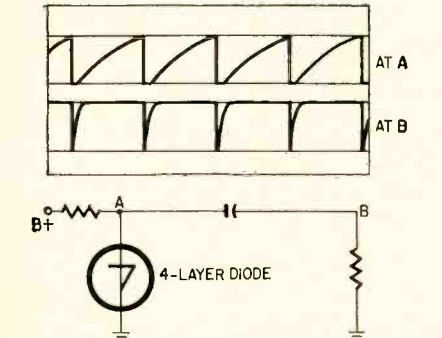

Fig. 11—Four-layer diode in a sawtooth-oscillator circuit.

for the primary and the copper sleeve as a shorted secondary. Magnetic flux is established in the relay core when current is applied to the winding. This flux, as it changes, sets up a current in the copper sleeve. In turn, this current tends to build up the flux.

Thus the sleeve has a flux-preserving action which retards the action of the relay.

The same effect is obtained by using a second short-circuited winding. Using a crystal diode to short circuit the relay, the shorting action becomes effective for one direction of current only. This permits a relay in a telephone switchboard trunk, for example, to ignore pulses of one direction, such as switching or dialing transients. An alternating ringing current would operate the relay on the half-cycle when the crystals are not conducting and when there is no flux-delaying action.

Isolating circuits

For a crystal diode to be useful in a switching circuit, the circuit must be arranged to take advantage of the diode's properties. The one-way conductivity is now widely used for isolation of circuits which use common

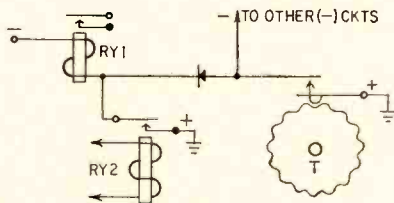

Fig. 12—This type of relay circuit is found in communications and computer applications.

pieces of equipment. One example of this, shown in Fig. 12, is a relay circuit of a type used in communications or computer applications.

The problem is to operate relay 1 under two different circumstances, either solidly from the contracts of relay 2 or on an interrupted basis from timer T.

But timer T is also used to pulse other circuits. Without the diode in the circuit, the ground from relay 2 would project itself backward to the timing contacts. This would ground the other circuits and nullify the effect of the interrupter. The diode, while it will permit positive ground from the timer to flow forward to the left and actuate relay 1, will not let the effect of the solid ground flow back into the other circuits above.

An extension of this idea is shown in the cross-wire array in Fig. 13. Matrices of this sort are used in memory circuits. When a positive voltage is applied to any lettered wire to which it is connected by diodes. But it cannot flow backward, out on another numbered wire.

In practical applications, such a matrix can be a printed or etched circuit, and the diode used to connect the vertical plating on one side of the board to the horizontal on the other

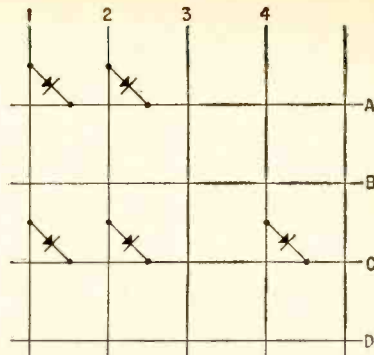

Fig. 13—How diodes are used in a cross-wire matrix of a memory circuit.

side. In some equipment this is readily done by hand. The pigtail leads of a regular radio type diode are pushed through the board or the diode is a tiny wafer, no bigger than an aspirin tablet, which is inserted in a clip that looks like a bobbypin.

A typical use for this kind of circuit is locating lines in a telephone office. With this type of a matrix, telephone numbers do not have to be located in the building in numerical order. Instead, the numbers can be assigned to any switch in any place that is convenient to handle the traffic load.

The incoming trunk equipment, which is searching for the line, will do so on a numerical basis and can be connected to the numbered wires of a matrix like that in Fig. 13. Depending on the location of the diodes, the matrix will tell the routing equipment whether the line is a good one or a disconnect, and will also tell it what floor, bay or frame the number is located on.

This permits relieving overloaded equipment of some traffic by merely connecting the subscriber lines to less used equipment and changing the diode routing matrix accordingly. In older systems, changing the location of the subscriber's line meant changing the telephone number.

A matrix of this sort then becomes the equivalent of a card or similar index, which can be kept up to date by merely slipping diodes in or out of clips.

Contact protection

All electrical circuits having inductive components have a tendency to spark at points where the circuit may be broken. Devices with magnetically actuated components frequently draw heavy current, and severe arcing occurs at switch or relay contacts when these circuits are interrupted.

In the past, damage to contacts has been minimized by contact-protection networks made of capacitor and resistor assemblies. The diode has changed all of this. It is now possible, using diodes which will withstand the high voltage often present in inductive discharges, to shunt out the kickback currents harmlessly.

This is done by placing the diode where the discharge current from the coil will be of the correct polarity to be shorted out. END

Dynamic Brake Stops Power Tools

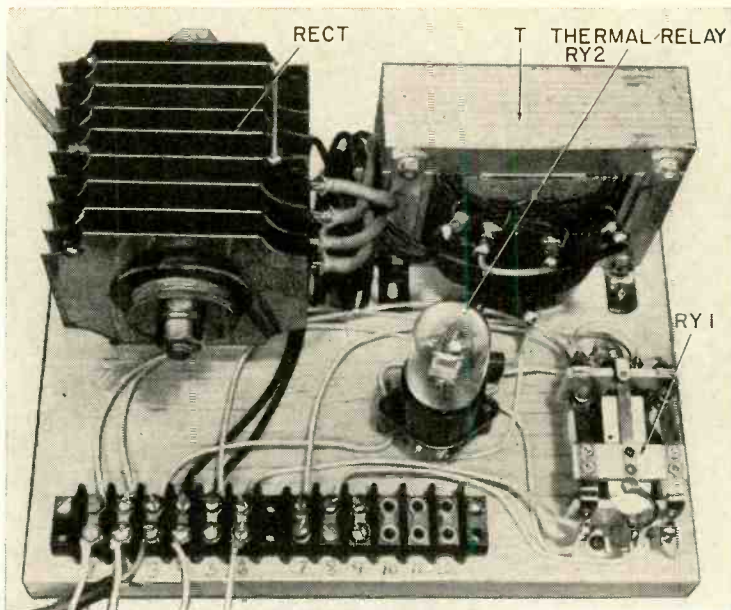

*Don't wait a minute—
this electronic brake
stops that saw blade in
2 seconds!*

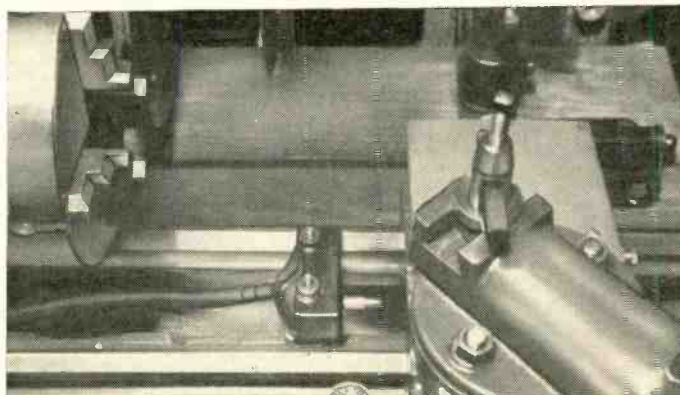

The author built his unit on a piece of 3/4-inch board.

Fig. 1—When used as a carriage stop on a lathe, this is way to mount stop switch.

By FRANK J. DI ELSI

Fig. 2—Circuit of the electronic brake.

ALTHOUGH this unit was built for a small metal lathe with a 1/2-hp motor, it can be used with any motor-driven tool where instant stopping, without coasting, is desired. It will operate with any split-phase or capacitor type motor up to 1 1/2 hp and is entirely electronic, so there isn't any mechanical brake or clutch to wear out or require adjustment. Only five external connections are necessary and they may be permanent since they do not interfere with normal operation of the motor.

This brake is especially valuable with radial and swing saws which normally would continue to spin for approximately 1 minute after power is turned off, making it necessary to wait before setting up for the next cut.

When used as a carriage stop on a lathe, the stop switch can be clamped to the bed so the carriage will actuate the switch when the preset position is reached (Fig. 1). If the operator moves the carriage away from the stop switch after the brake has been applied, a holding circuit on relay RY1 (Fig. 2)

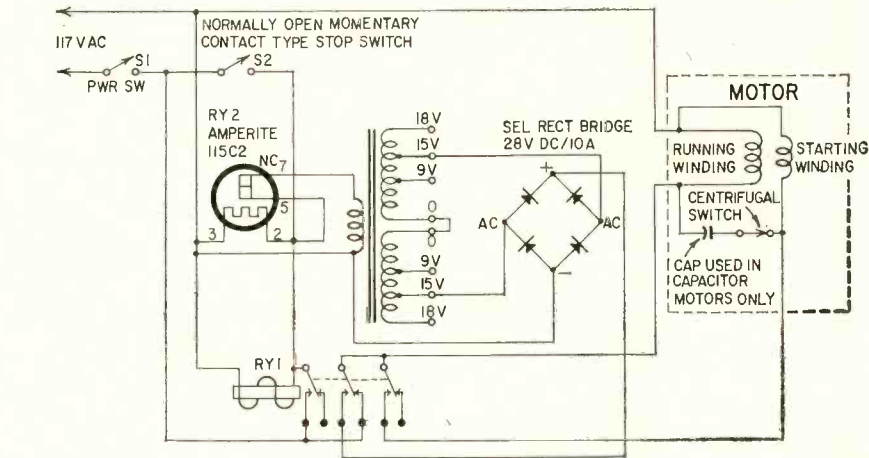

RECT—selenium full-wave bridge, 28 volts, 10 amps (TAB BK-36 or equivalent)
RY1—117-volt ac relay, 3-pole double-throw (Advance GHB/3C/115VA or equivalent)
RY2—2-second thermostatic delay relay (Amperite 115C2)

S1—sps toggle
S2—sps momentary-contact push button
T—power transformer: primary, 117 volts; secondary dual windings 18-15-9-0 volts each section, 12 amps (TAB TR5002 or equivalent)
Miscellaneous hardware

prevents the motor from restarting unless power switch S1 is first turned off and then on. This is a very important safety feature.

A push button switch can be mounted

at some convenient place for manual operation when instant stopping is desired. A momentary-contact foot switch can also be used as the stop switch, leaving the hands free.

The circuit in Fig. 2 shows how the unit operates. When stop switch S2 is closed, relay RY1 is energized, removing ac power from the motor and instantly applying 20 volts dc to it. This brings it to a complete stop in a very few seconds. If a shorter stopping time is desired, increase the dc brake voltage by changing transformer T and rectifier RECT for the higher voltage and current. Since a motor-starting capacitor blocks dc and the centrifugal switch will not close until the motor has already lost considerable speed, a third set of contacts on relay RY1 shorts out the starting capacitor and centrifugal switch when the brake is applied. In a split-phase motor, the same contacts just short out the centrifugal switch. This puts the brake voltage immediately across the starting winding as well as the running winding, bringing the motor to a quicker stop. Two seconds after the brake voltage is applied, it is automatically removed by the thermostatic time-delay relay (RY2), thus preventing any possible overheating of the transformer, rectifier or motor.

(A point to remember for safety's sake is that many motor shafts, arbors, chucks and direct-drive attachments have threaded fittings. The direction of the thread is such that the fitting is self-tightening. When the driving motor is stopped too quickly, the nut or fitting unscrews and the saw blade, shaper head or other attachment can become a deadly missile. *Do not use these types of tools without decreasing the braking voltage to lengthen the time required for stopping.*

(The safe stopping speed depends on the speed of rotation, the rim speed of the pulley, saw blade, and their weight. For example, when using a dynamic brake with their $\frac{3}{4}$ -hp 3,450-rpm radial saw, DeWalt states that the stopping speed should be not less than 5 seconds with 9-inch saw blades and not less than 12 seconds with heavy shaper heads, molding cutters, grindstones, etc. To increase the time required for stopping, decrease the dc braking voltage and, if necessary, use a thermal relay with a delay of a few seconds longer.—*Editor*)

The rectifier and transformer used in the brake are surplus units similar to those listed in the parts list. The current drawn by the $\frac{1}{2}$ -hp motor at 20 volts dc is approximately 14 amperes, or about twice the motor's normal running current. The manufacturers' current ratings of the transformer and rectifier may be exceeded by as much as 40% without overheating since the duty cycle is only 2 seconds out of 30 under the severest conditions.

The unit measures 7 x 10 x 6 inches. Its construction is not critical except that the rectifier fins should be in a vertical position and wire used should be No. 14 or larger.

The added safety and convenience in using this brake are well worth the expense and work involved in building it. END

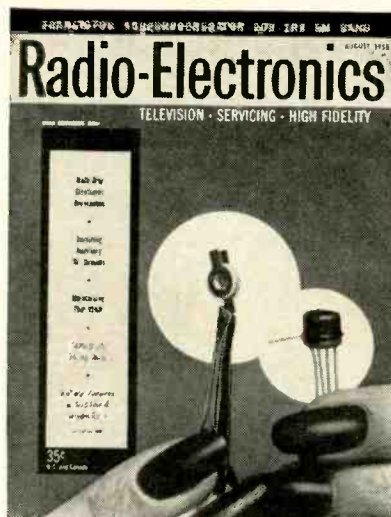

Tiny Tube Steals Transistor's Thunder

THE development of the transistor hasn't stopped research into new frontiers for the electron tube.

One of the fruits of 15 years of research and development of high-temperature ceramic tubes is the tiny triode pictured on the cover alongside a tetrode transistor. Not much larger than a shirt button— $\frac{1}{4}$ inch in diameter and $\frac{1}{8}$ inch thick—this experimental high-frequency tube is now being evaluated in the General Electric Research Laboratory.

Among the advantages of the transistor-sized tube is its capability of operating at temperatures of 900–1500°F, something that no transistor can do. The little triode has only three leads, its extremely small size being due partly to the fact that it contains no heater; heat is provided by the temperature of its surroundings.

Like its predecessors in G-E's high-temperature miniature-tube program,

the new type is constructed of layers of titanium as the elements and a special ceramic (designed to match the expansion characteristics of the titanium) as the "envelope." Designed for applications at microwave frequencies, the tube's miniaturization results in improved signal-to-noise ratio due to reduced transit time between cathode and grid.

Two laboratory models now being tested operate at 600°F. One of the tubes has an amplification factor of 100, mutual conductance of 6,000 micromhos, 5 milliamps of plate current at a plate voltage of 100. The other's amplification factor is 10, with 250 micromhos mutual conductance, plate current of 0.5 milliamp at 50 volts. Both operate at zero grid voltage.

The high-temperature miniaturization program at G-E is headed by electron tube research manager E. D. McArthur and James E. Beggs.

NEXT MONTH.....

Five European Hi-Fi Amplifiers

A. V. J. Martin selects from the overseas technical press the most interesting examples of high-quality amplifiers. Published with full schematics.

Looking in on London

How to modify your TV receiver to pick up international TV dx successfully.

Electronic Wind Speed Indicator

We have described simple electronic thermometers and humidity meters. Now you can construct an anemometer that registers wind speed on a meter in your living room.

For low-power applications, 6V6's in an Ultra-Linear circuit can give good results—here is one such amplifier

Designing

A LOW-DISTORTION 12-WATT AMPLIFIER

By ROBERT M. VOSS

FEW and far between are 10- or 12-watt amplifiers which deliver clean undistorted power at the levels required for filling a small room. Current commercial design trends point toward units with power ratings in three-digit figures, on mammoth chassis. I am not taking sides in the apparently never-ending battle between the high-power and low-power factions among the audiophiles. Few people, however, will argue that 150 square feet of floor space need more than 10 or 12 watts (over the complete audio range) for adequate reproduction of music, the 7th Avenue Express coming into Times Square or whatever else the listener may care to subject himself to.

Recently, I was asked to design a power amplifier to be used with an 8-inch shelf type speaker system in a room measuring 10 x 15 feet. The unit had to satisfy the following requirements:

1. Inaudible distortion at all feasible sound levels (in the 10 x 15-foot room).
2. Low source impedance.
3. High efficiency.
4. Best possible stability characteristics.
5. Hum and noise below audibility (with input shorted or when driven by moderately low impedance, such as cathode follower).

In designing the amplifier, these considerations, except for the last item, were taken as a group. The first four all apply to the output stage and the application of feedback around it. Item 5 is, of course, dependent upon the amount of feedback used, but I decided to aim for as low a hum and noise figure as possible *without* feedback. With inherently low extraneous noise, the minimum amount of feedback used can depend upon the ratio of distortion and internal resistance reduction necessary, rather than noise considerations (10 db of feedback will reduce distortion by a factor of 3.1; 20 db by a factor of 10). This often results in a more stable arrangement.

To satisfy requirement 1, a power output of 10 to 12 watts (undistorted) was considered adequate. Requirement 2 narrowed the choice to two possibilities

—triode-connected tubes of the 6L6 variety, as used in the original Williamson circuit, or Ultra-Linear connection of the 6V6 family. The Ultra-Linear (also known as "tapped-screen" or "gilded lily") mode of operation first achieved popularity as a replacement for the triode output stage in the Williamson circuit. It combines the advantages of the high efficiency characteristic of tetrodes with the inherently low distortion of triodes (or triode-connected tetrodes). Today, it is probably the most commonly used type of audio output circuit. In addition, its low distortion characteristics make a minimum amount of feedback necessary, thus satisfying requirement 4. Because of the high efficiency (requirement 3) of

Ultra-Linear operation, I used this type of output stage.

I feel it is wiser to design an amplifier along conventional lines, aiming at simplicity, than to incorporate revolutionary circuitry, extremely critical components or very heavy feedback loops. The unit described here sounds clean, well damped and noiseless *with the feedback loop removed*.

Ultra-Linear operation of 6V6's requires a tap at 25% of the primary impedance on each side of the output transformer's center tap. In addition, this component must be able to handle 10 watts over the complete audio range and have excellent frequency response at all levels. To satisfy these requirements, an Acrosound TO-310 is used.

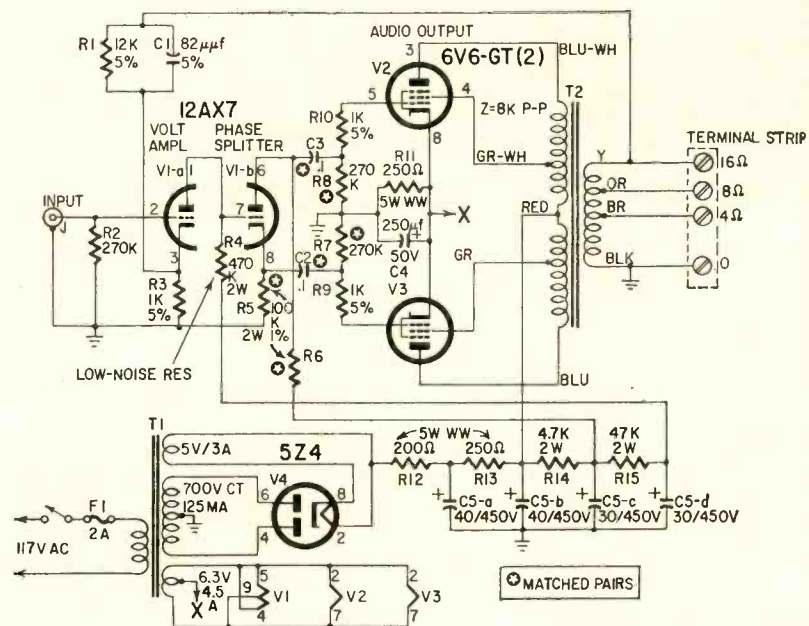

- R1—12,000 ohms, 5%
- R2—270,000 ohms
- R3, 9, 10—1,000 ohms, 5%
- R4—470,000 ohms, 2 watts, low-noise type
- R5, 6—100,000 ohms, 2 watts, 1%
- R7, 8—270,000 ohms, 5%
- R11, 13—250 ohms, 5 watts, wirewound
- R12—200 ohms, 5 watts, wirewound
- R14—4,700 ohms, 2 watts
- R15—47,000 ohms, 2 watts
- All resistors 1/2-watt 10% unless noted
- C1—82 μ f, 5%
- C2, 3—0.1 μ f

- C4—250 μ f, 50 volts, electrolytic
- C5—40-40-30-30 μ f, 450 volts, can type electrolytic, with insulated mounting
- F—2 amp, 3AG fuse and holder
- J—phono jack
- T1—power transformer: primary, 117 volts; secondary, 700 volts ct, 125 ma; 5 volts, 3 amps; 6.3 volts ct, 4.5 amps (Triad R-14A or equivalent)
- T2—output transformer: primary, 8,000 ohms, plate-to-plate, 25% screen taps; secondary, 4, 8 and 16 ohms (Acrosound TO-310)
- Chassis, 5 x 9 1/2 x 1 1/2 inches
- Miscellaneous hardware

The 12-watt amplifier uses only 4 tubes.

AUDIO—HIGH FIDELITY

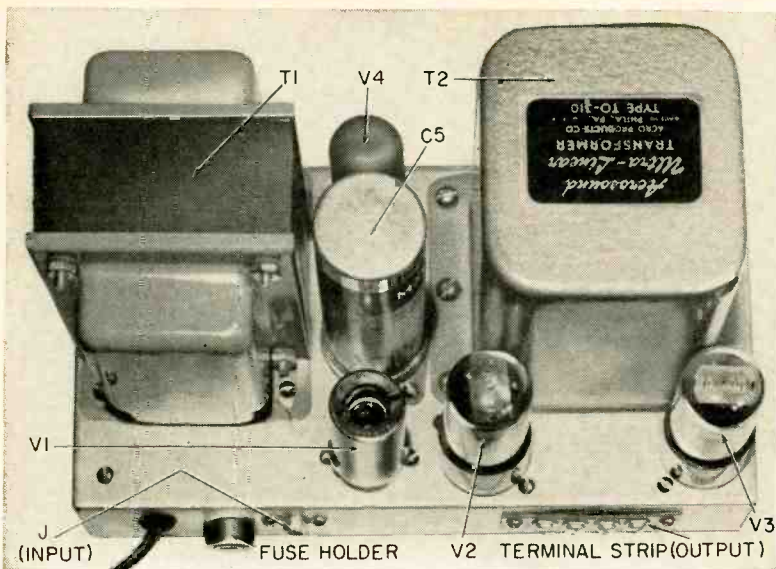

Space on the chassis is tight, so proper parts placement is important.

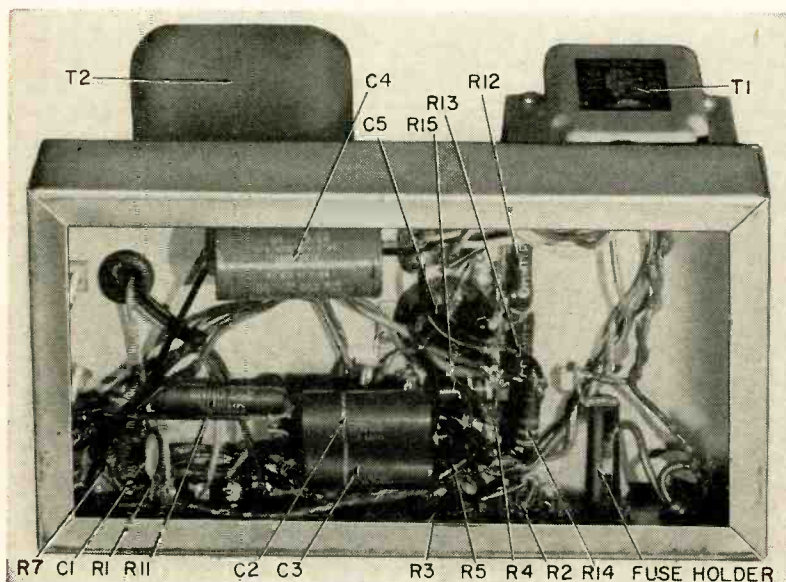

As few components are used, there is plenty of room under the chassis.

It is an outstanding performer, delivering 10 watts from 20 to 30,000 cycles and 20 watts from 30 to 20,000 cycles per second. It has enough primary inductance to provide adequate low-frequency response.

Amplifier circuit

For the voltage-amplifier and phase-splitter stages, I decided to use a direct-coupled split-load phase inverter. This arrangement has many subtle, frequently overlooked advantages. The dc coupling means one less capacitor-coupled stage, resulting in greater feedback stability. Putting the phase inverter directly before the output stage (6V6's do not require much grid drive) eliminates the hum frequently associated with the large potential difference between the heater and unbypassed cathode. The plate load of the voltage amplifier also functions as the grid

resistor of the phase splitter; hence the voltage amplifier works into an extremely high impedance, and high gain and low-distortion signal voltage at high levels are available from the first stage. The phase splitter has excellent distortion characteristics because of the large amount of degeneration inherent in the circuit. The output at either side of the phase splitter is approximately equal to the input.

Great pains were taken to keep hum and noise to a minimum. An isolated ground system is used, connected to the chassis only at the input jack. A deposited-carbon resistor is used for the plate load of the first stage. The power supply has more than the normal amount of filtering. A 5Z4 is used as the rectifier because its long warmup time protects the filter capacitors and it has a lower internal voltage drop than the more common 5Y3, allowing for more

filtering. The center tap of the heater winding is connected to the output tube cathodes. This puts a bias of about 24 volts on the heaters, which prevents any hum from being generated at the cathode of the voltage amplifier.

When building the amplifier, match R5 and R6 within 1% to assure equal voltages from each side of the phase splitter. C2 and C3 should, if equipment is available, be matched and it may also be desirable to match R7 and R8. Standard 10% tolerances are used elsewhere, with the exception of R1, R3, R9, R10 and C1, which should have no more than 5% tolerance. The power supply is conventional, except that—as mentioned before—more than the usual amount of filtering is used before the push-pull output stage. With this arrangement, the strongest noise component should be the hiss originating in the voltage amplifier.

With the input open, noise produced by a very efficient speaker is inaudible more than 1 foot from the cone. Shorting the input brings noise down to the point at which the listener must press his ear against the cone to hear it.

No balancing circuit was used in the output stage, but you can easily add one in the cathode circuit of the 6V6's.

Actually, from a fresh carton of six 6V6's, the two farthest apart differed less than 5% in the amount of plate current they drew. G_m matched tubes may further reduce distortion. An ECC83 or 5751 may be used in place of the 12AX7, and EL84's may be used as power amplifiers (replacing R11 with a 130-ohm unit). The output transformer should, in any case, be a TO-310; feedback components are based on the characteristics of this unit. (R1-C1's time constant determines ultrasonic roll-off and transient response.)

The amplifier was built on a 5 x 9½ x 1½-inch chassis, which is just about as small as is possible since the transformers are rather on the large side. If the layout shown is used, the 6V6 farthest from the 12AX7 should be driven by the cathode of the phase inverter. This tends to compensate for the difference in output impedances of the cathode-follower and plate-loaded outputs. Connect the leads from the output transformer with the tracers (gr-wh, blu-wh) to the output tube which is connected to the plate of the phase splitter. (Blu and blu-wh to plates, gr and gr-wh to screens.) If leads are reversed, feedback will be in a positive phase. The amplifier will kick off, possibly damaging the output transformer and tubes.

The finished amplifier fulfills all the requirements. Sound is clean and not colored by the amplifier. The improvement in damping characteristics is very noticeable when compared with a typical commercial 10 or 12 watter. The simplicity of design and the straightforward circuitry lead some to believe that the amplifier will continue to deliver clean audio for years without servicing.

END

COMPATIBILITY

and

the STEREO DISC

AUDIO—HIGH FIDELITY

Are stereo recording and playback systems compatible with each other? Comparison of European techniques and the American methods answers this question and shows to what extent these processes are interchangeable

By NORMAN H. CROWHURST

STEREO on discs—using the Westrex system—now seems to be a *fait accompli*. Where a few months ago the question was “Where can I get a stereo disc—and if I get one, where can I get the cartridge to play it with?” now the problem is: “Which pickup shall I choose?” Disc manufacturers have gone over to stereo *en masse*, and everything seems to have settled down. From the commercial point of view this may well be true. On the technical side, much more may be forthcoming. This magazine has already described the Minter system. And we still remember the surprise announcement at the spring IRE convention of Dr. Peter Goldmark’s (now temporarily withdrawn from circulation) Columbia compatible stereophonic system.

The stir this created is still settling down. I do not propose to try assessing the politics involved. The technical aspects are quite enough. Many engineers at the session went away very confused as to what it was, or is, all about. So let’s try and unravel the mystery. Of course, there’s one big piece of the mystery that we cannot unravel—“What is the ASRA?” but more of that when we come to it.

First let’s run over the compatibility picture before the “Columbia Compatible” entered the scene. Apart from the questions of whether a stereo pickup will play an older LP and whether monaural pickups designed to play LP’s will play stereo recordings, the RIAA (Record Industry Association of America) was anxious to ensure that the American system is compatible with at least those European records that are likely to be subject to mutual exchange.

European stereo disc systems

The three systems that developed over there all used what was basically vertical-lateral recording. So at first sight it might seem that European recordings could never be compatible with a 45/45 system. London Records gave a very good demonstration of

experimental records using vertical for one channel and lateral for the other, but they are releasing 45/45’s now.

A closer look at the other two systems shows they were more compatible than appeared at first sight. This is because different microphone techniques were used, as well as a different cut.

In the MS system (MS stands for the German words for front-on and sideways), one microphone, the M unit, faces the orchestra or program source. This one is a cardioid. The other microphone picks up a positioning element, by being sideways-on to the orchestra and using a ribbon element (see Fig. 1-a). Thus instruments at center front get picked up only by the M microphone. Instruments to one side get picked up by the M microphone and also by the S microphone, but the phasing of the S pickup, relative to the M pickup, depends on whether the instrument is left or right of center.

For playback (Fig. 1-b), the M component, recorded laterally, is fed to a front-facing speaker, while the S component, recorded vertically, is fed to a sideways-on loudspeaker.

In the Stereosonic system, originated by the British E.M.I. (Electric and Musical Industries) ribbon microphones at right angles are used (see Fig. 2) and the orchestra or program source is located in one quadrant of the angle they make. The output from the two microphone elements can then be combined in two ways. Sound coming from the 45° angle in the center of the quadrant used will be equally received by both mikes. This is the in-phase connection. So an in-phase combination from these mikes gives the equivalent of an M signal from the MS system. An out-of-phase combination similarly gives the counterpart of an S signal.

The Stereosonic system can be recorded in two ways. Either each microphone is fed directly to one of the recording cutters, or the M and S signals are fed to lateral and vertical, respectively. This method makes the system at least partially compatible with LP’s, because the lateral compo-

nent then includes sound from the entire pickup area while the vertical component contains the S signal which gives an indication of position. To play this back as stereo requires a recombination (assuming a vertical-lateral pickup is used) before feeding the usual spaced speakers.

Are they compatible?

As both systems (using the second variety of Stereosonic) record the main frontal signal laterally and the spatial or difference signal vertically, they are compatible. Either playback system will play the other’s records satisfactorily, with minor differences in effect. And the 45/45 system is compatible with both of them too.

This is because in-phase signals in the two mike channels of the 45/45 system are arranged to give a pure lateral cut, while exactly out-of-phase signals give a pure vertical cut (see Fig. 3). Intermediate locations in pickup source will give corresponding angles of cut or ellipses. The latter motion represents a time as well as an intensity difference between the program content of the two channels. In the MS and Stereosonic systems the cut is never elliptical and its *angle* indicates the position of the original sound source.

So, apart from the difference in recording technique, the fact that the MS and Stereosonic use unspaced mikes and an intensity but not a time difference, while the techniques more commonly employed use spaced mikes with differences between channels that are predominantly time or phase components, *the playback systems are electronically interchangeable.*

The original reason for matrixing the output from the Stereosonic mikes apparently was not to make the system compatible, but to make the recording technique more flexible. By this method the difference component can be enlarged or contracted, relative to the sum part, so the final presentation sounds broader or narrower. This ad-

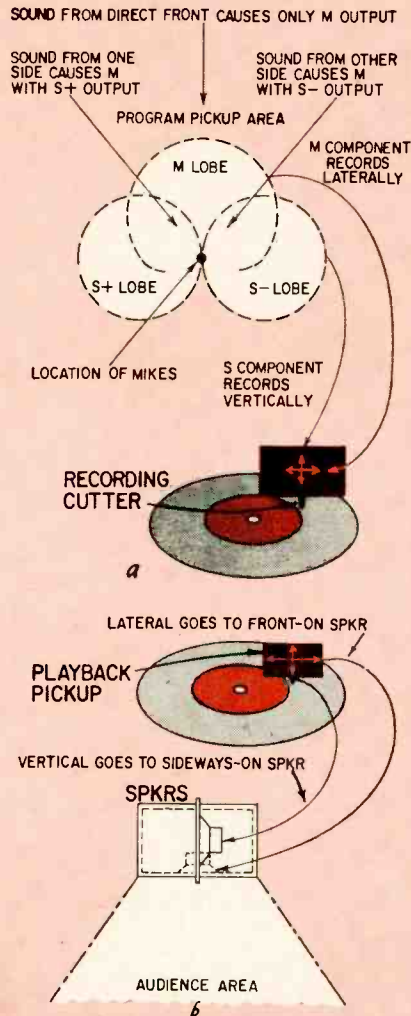

Fig. 1—Basic recording and playback methods of the MS system: a—recording; b—playback.

vantage to such a method has already been pointed out relative to the compatible multiplex system developed here by Jerry Minter, which has the additional advantage of giving the listener this control.

The problems of 45/45

That about gets us up to date and gives the picture of stereo disc possibilities so far. Now for the *really* compatible stereophonic record! First, what is wrong with 45/45? The answer to this depends on whom you listen to. One criticism I had already pointed up—the fact that combining a basically low-distortion way of cutting (lateral) with a high-distortion process (vertical) for each channel results in more distortion than existing LP's whatever you do. The way the 45/45 people get around this is to record at much lower level than for LP's. But this deteriorates dynamic range and may make it incompatible with existing systems because they may not have enough gain, or, if they do have, hum is likely to be a problem.

At the same IRE convention, one of the papers was an exhaustive analysis of possible distortions between

channels and came up with the conclusion that 45/45, in theory, must produce the same distortion caused by a simple vertical cut of corresponding amplitude, due to contour and pinch effects. As some questioners discovered, this analysis was somewhat theoretical because it assumed a spherical playback stylus that never dents the groove, and a perfectly sharp cutter. Neither of these conditions is fully realized, so the theory may not present a true picture.

However, one failure to meet compatibility was verified by both calculation and experiment. To play an LP, a good pickup must have a vertical compliance that will allow it to move up and down about .0002 inch at all frequencies to follow the groove bottom or allow for pinch effect. This has been a tough requirement, but many modern pickups come close to meeting it.

But when the same pickup is called on to play 45/45's, its vertical motion must be much greater than this or it will jump off the bottom of the groove, which is called, rather graphically, tobogganing. Whether or not this damages the record, which may depend on the quality of the vinyl (at the present

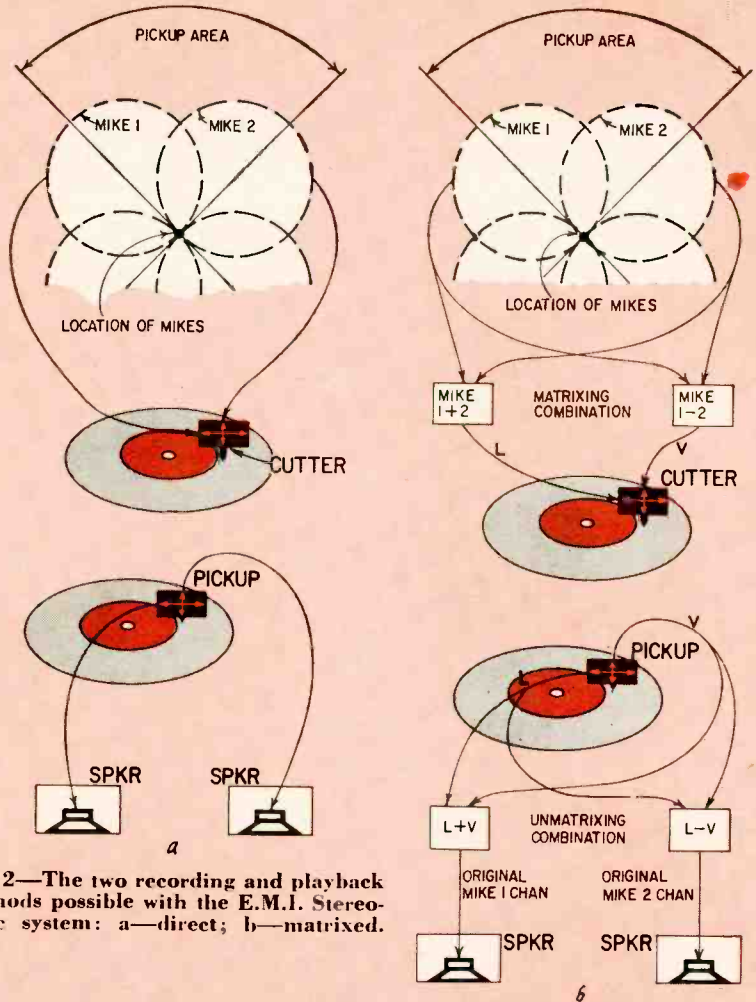

Fig. 2—The two recording and playback methods possible with the E.M.I. Stereonic system: a—direct; b—matrixed.

there are two sides to the argument about this possibility), it means a conventional hi-fi pickup cannot possibly play a stereo disc and give high-fidelity monaural reproduction.

Hence, according to the camp Columbia represented, the need for a *compatible* stereo record. The other camp took the view that the compatibility discussed in an earlier article ("Single-Groove Stereo Discs," RADIO-ELECTRONICS, January, 1958, page 54)—the ability of a stereo cartridge to play older LP's and give high fidelity, as well as playing its own variety of stereo—is enough or at least as much as will ever be done. According to this viewpoint, it is not feasible to expect an

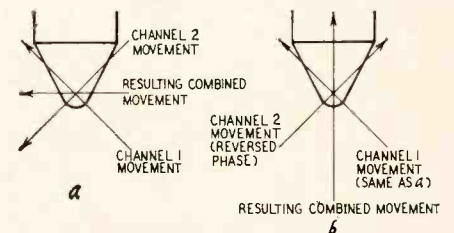

Fig. 3—Two ways of phasing stereo program in a 45/45 system: a—dominantly lateral; b—dominantly vertical.

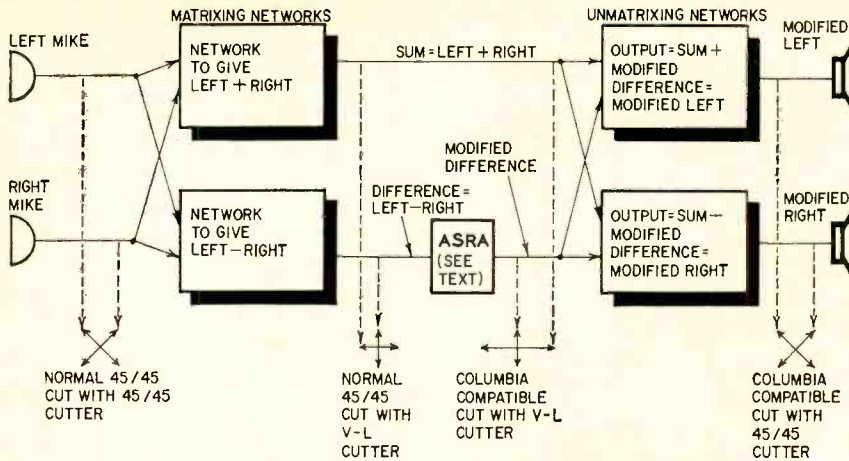

Fig. 4—Possibilities in cutting regular 45/45 or Columbia compatible discs, shown on block diagram of the CBS system.

earlier type LP cartridge to play stereo records at all.

While this is a nice ideal, it puts the record maker on the spot. If he cannot make a disc that will play on both systems, he has no alternative but to issue two kinds of pressing of his complete catalog! And dealers will have to carry a double inventory. So there is considerable pressure toward producing a system compatible both ways.

The CBS system

Well, what does Columbia do? According to its claims, it would be the only completely compatible record. Fig. 4 shows the basic recording setup. The two channels are combined, or matrixed, into sum and difference channels. If these are then directly recorded by a vertical-lateral cutter, the result would be identical—in theory at least—to a 45/45 disc cut directly from the input channels with a 45/45 cutter. But the difference channel is operated on by the box marked ASRA (Automatic Stereophonic Recording Amplifier).

Many engineers present at the convention were anxious to know (and likely many readers will be too) what the black box marked ASRA contained, or at least just what it does. But it remains a black box. The Columbia boys are not talking; they have a patent situation. According to the paper, CBS labs had done exhaustive work on recorded stereophonic program material to ascertain the necessary ingredients of the matrixed channels to give a satisfactory stereophonic illusion.

The sum channel, of course, carries the combined audio in both channels and is like the luminance signal in color TV that will give good black-and-white without the chrominance signal. Similarly, the sum channel will give good high-fidelity single-channel if it can be played without interference from the difference channel.

The difference channel, on the other hand, is entirely responsible for spatial or placement effects, just as the chrominance signal in TV produces color from black-and-white. According to the CBS paper, it carries much less energy

than the sum channel, but there are occasions when the peaks on the difference channel are as big as the peaks on the sum channel although these seldom if ever occur at the same time. Other workers in this field report different results.

So how can an ASRA operate on the difference signal to avoid these short-duration peaks? One way would be by using a compressor or limiter, so the difference channel remains at a prescribed maximum amplitude. This would retain the full dynamic range of the system, because the sum component would take care of that. But it is fairly obvious that the breadth or stereo effect would be good at low levels, but would tend to disappear on crescendos. So the orchestra would seem big at low levels and small at high levels!

Cutting off the extreme high frequencies would not help too much, because these frequencies have relatively small amplitude and removing them would be disastrous to the stereo effect on percussion. Cutting off the lower frequencies would conceivably help, if the program content of the two original channels were completely unrelated. But in all genuine stereo recordings, using multiple mikes in the same studio, the low frequencies progressively disappear from the difference matrix anyway, so it would not help much to remove them.

All that CBS would say about what ASRA does is that it works like an electronic brain and operates on the basis of the frequency content and level at every instant.

Its effect on the resulting groove excursions is like that of a limiter. At low levels, up to about 20 db below maximum output of the system, the difference matrix is unchanged and the record remains exactly the same as a 45/45. But, for the top 20 db of dynamic range, the ASRA gets busy and changes the difference matrix so the vertical excursion never exceeds the desired figure of .0002 inch. But it makes this change to the content of the difference matrix in such a way that the final recombined channels will

give very close to the correct illusion.

The boys from CBS maintained it was impossible to hear the difference between such a recording played back and the tape from which it was cut. But they did not demonstrate this lack of audible difference. What they did demonstrate was a record cut from a demonstration tape that said, "This is an orchestra playing out of the loudspeaker on your left . . . this is it playing out the right loudspeaker . . . and this is the orchestra playing stereophonically. . . ."

Demonstration results

Sitting in the press room listening to this demonstration—which came fairly close to a living-room test—the illusion that only one speaker was playing on the first two takes was remarkable, considering that, on peaks, both loudspeakers were receiving almost equal energy. But on careful listening this could be heard. By concentrating on the speaker that was off, one could hear a kind of breakthrough effect. If this one-side presentation happened all the time, one would become aware of a definite distortion-like effect. However, when both channels were used, as they normally are in any stereo recording, the breakthrough seemed to vanish.

Of course the condition was drastically changed then, because, when the system tried to make all the sound appear to come from one speaker, one speaker produced good sound while the other gave all the distortion. But when both speakers were producing, the distortion tended to get lost, at least by direct comparison. However, continued listening might well lead the discerning audiophile to a very different conclusion.

What was demonstrated—and this is worth something—was that the Columbia stereo record was recorded at a level compatible with an LP. So a direct comparison of quality between the Columbia compatible and a Westrex-cut 45/45 is not a fair one, because the 45/45 is cut at a much lower level.

The only difference between using a Columbia compatible and the "regular" 45/45, apart from a probable difference in recorded level, is in the recording. The same playback equipment can be

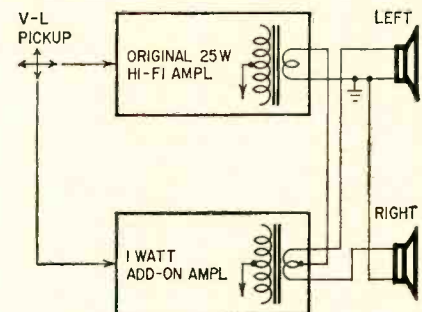

Fig. 5—A second possibility with the Columbia compatible resulting in lower cost when changing a monaural hi-fi system to handle stereo—if you have a vertical-lateral pickup.



Reviewed by
CHESTER SANTON
Station WQXR, New York City

MANY developments in stereo these days are accompanied by a decrease in compatibility, that technical "togetherness" that made possible the easy linkage of audio components in former days. A new low in stereo tape compatibility has been reached in the 3.75-ips four-track RCA system described in RADIO-ELECTRONICS last month. This appears to be a good time to mention a two-channel idea that is tops in compatibility. In recent months I have been playing monaural records with a monaural pickup through both channels of my stereo system. The resultant sound appears to cover the area between the loudspeakers yet it fills the room evenly. Using two amplifiers, less gain is required to match any given single-channel volume setting. Distortion is reduced and dynamic range is improved. At low-level listening, I feel less need of any loudness control. Among the monaural records reviewed this month, the Epic disc of the Merrill Station Choir exhibited the best illusion of depth on two channels. The effect obtained is not true stereo but you can't beat it for compatibility.

RCA Victor's release of fifty-five stereo records in June signaled the formal launching of the stereo disc. Pre release copies of records LSC-2100 and LSP-1554 (*Hi-Fi Fidler and the*

Boston Pops and Abbe Lane with Tito Puente and His Orchestra, respectively) show traits found in earlier stereo discs. The Abbe Lane record has clean sound but is lacking in bass. The Boston Pops-Fiedler disc exhibits distortion, particularly in the low end. Among other items recently sampled, the Electro-Voice 10-inch demonstration stereo record offers quiet surfaces and sound adequate by stereo-disc standards. The Cook stereo record 1150 (*The King of Organs*) has good bass but poor surfaces. The best sample of things to come—the London ffr demonstration record (PS-100) is the first stereo disc with examples of classical music to measure up to present monaural disc standards in terms of frequency range and freedom from distortion.

Stereophonic Concert
Ralph Marterie and His Orchestra
Mercury Stereo Tape MVS2-27
(7-inch; playing time, 20 min. \$7.95)

In an attempt to gain stereo presence on loudspeakers deficient in that desirable attribute, Mercury is experimenting with added microphones at its Chicago sessions. The David Carroll tape reviewed last month (MVS2-19) involved the use of five mikes. This Marterie release is the product of nine microphones of six

types. On low-price equipment, a chorus, large orchestra, the Marterie trumpet and lavish arrangements of light classics create an impressive ballroom concert effect. Unfortunately, an expensive sound system brings out the heavy use of echo and the clutter of mikes.

Band of the Coldstream Guards
RCA Victor Stereo Tape BPS-112
(7-inch; playing time, 18 min. \$8.95)

The exciting sound of one of England's crack military bands will take you outdoors at the first note. Crisp, natural highs and that unique sonority found in the lower winds and brasses of the top British bands make this one of the outstanding tape releases of the month. Some of the better known marches are included in the album—*Anchors Aweigh*, *Entry of the Gladiators*, *Radetzky March* and *National Emblem*.

CHAUSSON: Symphony in B Flat
Paul Paray conducting Detroit Symphony Orchestra
Mercury Stereo Tape MDS5-26
(7-inch; playing time, 31 min. \$12.95)

DEBUSSY: La Mer
RAVEL: Daphnis and Chloe Suite No. 2
Erich Leinsdorf conducting Los Angeles Philharmonic Orchestra
Capitol Stereo Tape ZF-25
(7-inch; playing time, 38 min. \$14.95)

Under home listening conditions, most French composers have in stereo a particularly useful ally. Their music needs at least two channels in order to breathe with complete freedom. Chausson's mellow symphony, in Paray's treatment, finally attains in the living room the depth and spaciousness planned by the composer. The Leinsdorf tape offers top-notch performance of two masterpieces of French impressionism. The subtle tone colors of Debussy and Ravel are handled with great skill by Capitol's engineers. A fabulous demonstration item.

ROMBERG: Selections from the Desert Song
RCA Victor Stereo Tape CPS-141
(7-inch; playing time, 26 min. \$10.95)

A larger canvas for the unfading Romberg panorama of desert romance. The chorus is on the pale side with full stereo stress placed on

COMPATIBILITY and the STEREO DISC (continued)

used for either. This means it is entirely compatible with both the LP (because the level is about the same) and the 45/45 (because it can be played with identical equipment).

A 45/45 disc can be played with a vertical-lateral pickup (if you can find one anywhere!) by using sum-and-difference matrixing (or unmatrixing). With 45/45 this has no specific advantage. But with the Columbia compatible there is a prospective advantage.

The vertical signal is very small and can be handled by an amplifier with only a fraction of the power needed for the lateral. For example, if a 25-watt amplifier were previously used for hi-fi monaural, a 1-watt amplifier could handle the difference matrix from the vertical. Unmatrixing can then be done quite simply in the amplifier output circuits (Fig. 5). One of the output transformers is center-tapped and the rest is easy.

Now, how does the technical situation stack up? The original vertical-lateral is out of the running. We are left with 45/45, compatible multiplex, the Columbia compatible or some future adaptation.

Regular 45/45 promises good stereo, provided some concession is made on

level. For this reason it will never be compatible with LP's from the record makers' viewpoint.

Compatible multiplex (the Minter system) would be compatible with LP's from the record makers' viewpoint, but is rather a late entry to contend with 45/45 seriously because the two are not compatible with one another. I believe, however, that this may well be a medium for the hard-core audiophiles who gave hi fi its start while the other system(s) suit the mass market better.

And the Columbia compatible really is, but it is still questionable whether this compatibility does not enforce either some loss in quality or some loss in stereo illusion. If it does, then this will make it unacceptable, possibly even to the Columbia executive. (For the present, Columbia has shelved its system.) But maybe they went too far (could be they did so advisedly) in going after complete compatibility with LP's. Possibly a compromise between the present ASRA and the full 45/45 or a modification in level between the two or further improvements in operation of the ASRA may at some time in the future give us what will prove to be acceptable stereo on discs.

Stereo discs have had a difficult time

getting born. The standard in LP's has gone so high that even the people who make them for the mass market are relative perfectionists. They do not want to let stereo loose if it represents—or even appears to represent a retrogressive step in any way. This sets a tough problem. But I believe the Columbia development was significant in that it showed the matrix concept is adaptable for this field. Although other manufacturers do not feel prepared to accept the standard of quality it gives right now, it has convinced them there is enough potential for improvement to allow them to get started making almost-perfect stereo discs, one way or another.

END

Bibliography*

W. S. Bachman, "RIAA Engineering Committee Activities with Respect to Stereophonic Disc Records."

C. C. Davis and J. G. Frayne, "The Westrex Stereodisk System."

M. S. Corrington and T. Murakami, "Tracing Distortion in Stereophonic Disc Recording."

B. B. Bauer and R. Stepvankers, "Compatibility Problems in Stereophonic Disc Reproduction."

W. S. Bachman and B. B. Bauer, "Phonograph Pickups for Stereophonic Record Reproduction."

P. C. Goldmark, B. B. Bauer and W. S. Bachman, "The Columbia Compatible Stereophonic Record."

* All papers listed were presented at the 1958 IRE convention in New York City.

the starring voices of Giorgio Tozzi and Kathy Barr. Rich sound and mature treatment of the music make this an ideal tape for the listener with memories.

Dancing Through Space
RCA Victor Stereo Tape CPS-143
 (7-inch; playing time, 25 min. \$10.95)

This tape is a sonic showcase for 10 RCA pop stereo albums. The complete selections represent the current work of 9 of their name bands and the Three Suns. Sauter-Finegan's *Surrey With the Fringe on Top*, Frankie Carle's *Arabian Nights* and the Three Suns' *Music, Music, Music* are standout items, the latter enlisting the aid of a honky-tonk piano and the thunderous New York Paramount Wurlitzer organ. Also included are Ray McKinley and the New Glenn Miller orchestra, Mitchell Ayres, George Melachrino, Eddie Heywood, Bob Scobey, Tito Puente and Skitch Henderson. With the entire sampler given over to dance music, it is very interesting to compare the techniques used in picking up each band. Uniformly good sound.

Jazz Impressions of Pal Joey
Kenny Drew Trio
Riverside Stereo Tape RT-21F
 (7-inch; playing time, 30 min. \$11.95)

Jazz versions of stage and screen musicals have found a wide audience in recent months. Improvisations based on familiar songs seem easier to follow. Here the trend is advanced by the piano, bass and drums of the Kenny Drew Trio in easy playing of six tunes from *Pal Joey*. They are heard in cohesive, natural depth and very clean, wide-range sound.

Silk Stockings
Pajama Game
New World Theatre Orchestra
Bel Canto Stereo Tape STB-40
 (7-inch; playing time, 25 min. \$9.95)

Hit tunes from two other fine shows handled with finesse by a pit-size orchestra. The arrangements are effectively designed for stereo—melody mainly from the strings on the left, ornamentation and rhythm on the right. Like other tapes intended for the average home machine, it sounds best on my system at moderate level and filtered at 7 kc.

Voices of the Satellites
Taben Recordings
 (5-inch; playing time, 29 min. \$3.95)

This monaural tape offers a variety of satellite signals picked up by Prof. Thomas Benham of the Physics Dept. of Haverford College. The celestial cast includes Sputniks I and II, Vanguard I, and Explorer I, II and III. Commentary on a popular level by Professor Benham covers each signal and provides background information on the satellites. The Doppler effect in the signal of a satellite as it passes the monitoring point is illustrated and explained. Fully adequate amplification and reproduction of the signals. Also available on 10-inch LP disc.

Note: Records below are 12-inch LP and play back with RIAA curve unless otherwise indicated.

BIZET: *Orchestral Suite from Carmen L'Arlesienne Suite No. 1*
Mario Rossi conducting Vienna State Opera Orchestra
Vanguard SRV-107

The sixth release in the specially priced series of Vanguard High-Fidelity Demonstration records. At \$1.98, the complete performances on these discs are a good buy for a beginner's basic library. While less sweet in the highs than the full-priced Vanguards, this series stands heads and shoulders above other complete recordings in its price range. Good performances and a resonant hall add up to a can't-go-wrong item.

The Strauss Dynasty: *Vienna Dances*
Anton Paulik conducting Vienna State Opera Orchestra
Vanguard VRS 1019/22

This omnibus four-record album, wrapped in silken sound, gives you everything you would ever want to own in the dance music of the Strauss family. Waltzes, polkas, galops and marches of all four members of the Strauss

empire are played in true Viennese style. In addition to the smooth, wide-range sound, there is further inducement in the special price, \$11.90.

Brass in Hi-Fi
Jean-Francois Paillard conducting Jean-Marie Leclair Instrumental Ensemble
Westminster XWN 18664

The album title is sure to attract many who would otherwise overlook this interesting collection of 18th-century music for brasses and strings. Three of the four composers are unknown today. Trumpets, trombones and organ are used in bold, masculine style to embellish the strings in this well-engineered European recording.

STRAVINSKY: *Petrushka (Complete Ballet)*
Ernest Ansermet conducting L'Orchestre de la Suisse Romande
London ffr LL-3018

The best-known demonstration record of early LP days (Ansermet's *Petrushka* on London LL-130) has been replaced by this brand-new disc. The sound is now much cleaner, the orchestral balance has been greatly improved and the men in the orchestra are no longer noisy at their music stands in the quiet passages. Exceptional sound systems again have a test record to set them apart.

WAGNER: *Siegfried Idyll*
MAHLER: *Adagio*
SCHOENBERG: *Verklaerte Nacht*
Arthur Winograd conducting M-G-M Orchestra
M-G-M E 3630

Except for an early batch of performances recorded in England, M-G-M was offered sound on their records that has been downright parched. Recording director Edward Cole, with a severity unique in the industry, suppressed any suggestion of acoustics in his recording studios. I have not been alone in wondering how some of his otherwise excellent recordings would sound under more reverberant conditions. This record provides the answer. The sound now ranks with that of the finer discs on the market. First rate musicianship in the loveliest of Wagner's works and two compositions influenced by Wagner.

The Fabulous Dorseys in Hi-Fi
Columbia C2L-8

An unusual legacy in sound, this album contains 24 of the last selections recorded by the Tommy Dorsey orchestra, featuring Jimmy Dorsey. A few months before his death in November, 1956, Tommy Dorsey arranged this recording session at his own expense in order to play, without regard to commercial considerations, his favorite sweet ballads, swinging spirituals and original swing tunes. The sound is the finest of the orchestra's career on records.

Movin' West
Merrill Staton Choir
Epic LN 3472

Two unique factors explain the popularity of the Merrill Staton Male Choir, an ability to identify themselves with the subject matter of their albums and the sonority and spaciousness found therein. These songs of the American frontier include *Home on the Range*, *Strawberry Roan* and *Red River Valley* with harmonica, banjo and guitar accompaniment.

BEETHOVEN: *Violin Concerto in D Major*
Fritz Kreisler, violinist
Sir John Barbiroli conducting London Philharmonic Orchestra
Angel COLH-11

Angel's eagerly awaited series "Great Recordings of the Century" raises to a fine art the work of engineers dubbing from old master discs. The transfer to LP was made without recourse to any tricks. The sound of this Kreisler performance, a classic of Viennese warmth, does not extend much beyond 7 kc but the serious collector will find within that range a great era in music.

Spotlight on Winds
Vox DL-312
 The fifth release in the Vox Spotlight series

examines, in auditory closeup, the family tree of the wind instruments. As in the case of previous Spotlight albums, the crude instruments forming the roots of the tree reveal the more interesting sounds. In this two-record set, about 50 wind instruments, some of them distant relatives borrowed from museums in Boston and New York, are put through their sonic paces on the empty stage of Symphony Hall, Boston.

Juerga Flamenca
Audio Fidelity AFLP-1852

A clever idea has been used to good advantage in this realistic recording of the impromptu singing and dancing that characterize the flamenco of Spain. The normally empty grooves between bands are filled on this record with the crowd noise of spectators and the chatter of performers as they prepare for the selection on the next band. This simple device adds further interest to the challenging thud of heel beats, the brightness of castanets and guitars.

Alexander Kipnis in Russian Opera
Camden CAL-415

Vocal artistry such as this can be found on few records made today. At \$1.98 this 12-inch Camden reissue is an excellent buy. On first-rate equipment, the rich bass voice of Alexander Kipnis is available in surprising clarity in Russian arias that accounted for much of his fame. During the past 10 years, many of the great recordings in the vaults of the older record companies were rerecorded onto LP. Most of these transfers are already out of date because the early LP cutting heads introduced more distortion than do those in use today. The future should reveal the full value of great recordings of the past.

RAVEL: *Quartet in F Major*
DEBUSSY: *Quartet in G Minor*
Budapest String Quartet
Columbia ML-5245

Record collectors familiar with the earlier Budapest versions of these intriguing chamber works will welcome the cleaner sound of this new release. A good investment because it offers a definitive performance of music that retains its freshness. Ideally miked.

GASPARD LE ROUX: *Pieces de Clavecin*
Albert Fuller, Harpsichordist
Overtone 15

Overtone stubbornly specializes in discs of music off the beaten path. In this release seven suites of dances by an unknown French composer of the 17th and early 18th century are played with elegance by Albert Fuller, a pupil of Ralph Kirkpatrick. The instrument used is a metal-frame modern harpsichord built by the American designer, John Challis. The unusually sweet sound prompted me to inquire about the choice of microphone. Overtone's director and recording engineer, Richard Burns, disclosed that he used a single RCA 44 BX ribbon mike. The logic of his choice is audible on first-grade equipment.

VIVALDI: *Four Violin Concertos*
I Musici String Ensemble
Epic LC-3443

On of the richest formulas for recording of strings I have encountered to date. Other all-string groups playing Vivaldi on records sound almost cold by comparison. Felix Ayo, soloist and an ensemble consisting of first and second violins, violas, cellos and continuo perform in beautiful balance Concertos 9 through 12. A most welcome import from Italy.

RIMSKY-KORSAKOV: *Scheherazade*
Sir Thomas Beecham conducting Royal Philharmonic Orchestra
Angel 35505

There's always room for another good performance of *Scheherazade* if the sound is better than that of previous recordings. Such is the case here. On a sound system of top design, Beecham sets forth the full value of the rich tonal colors in this oriental tapestry. One of the great records of the year. **END**

Name and address of any manufacturer of records mentioned in this column may be obtained by writing Records, RADIO-ELECTRONICS, 154 West 14th St., New York 11, N.Y.

SPECIAL AMPLIFIER CIRCUITS

By HERBERT RAVENSWOOD

Modern hi-fi amplifiers have some not-always-understood features. Two of these, cross-coupled phase inverters and positive feedback in the driver stage, are described here

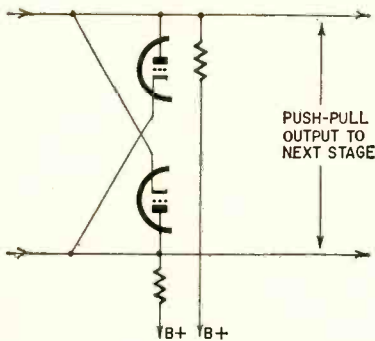

Fig. 1—Basic circuit of the cross-coupled phase inverter.

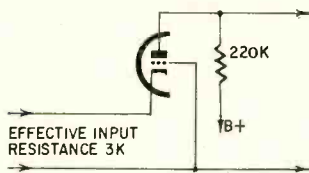

Fig. 2—Grounded-grid stage shows derivation of impedance at cathode.

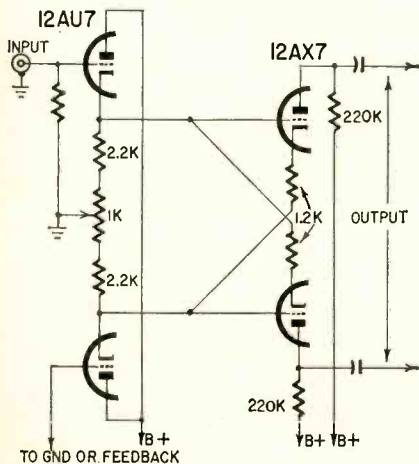

Fig. 3—One form of cross-coupled inverter as used in audio circuits. The values shown are discussed in the text.

TWO features found in modern hi-fi amplifiers are cross-coupled phase inverters and the use of positive feedback to get more swing from a driver circuit. As a number of amplifiers incorporate these features in their design, let's see what the merits of these circuits are.

Cross-coupled inverters

In an amplifier, the natural position for the cross-coupled inverter is as the input stage of a push-pull amplifier, where it provides phase inversion from a single-ended input. Fig. 1 is the circuit of a basic cross-coupled stage. It consists of two identical triodes with their inputs cross-coupled so that a signal from grid to cathode of one tube is applied from cathode to grid of the other. Actually, this circuit can seldom be used by itself. Because the load impedance of a cathode in a grounded-grid circuit (the upper tube is grounded-cathode, while the lower is grounded-grid) is low and that of grid high, this circuit must be fed from a low-resistance source to prevent undue loading and possible distortion. For this reason the cross-coupled inverter is inseparably connected at the output of a push-pull cathode-follower arrangement.

The load impedance presented by the cross-coupled stage can be derived from the grounded-grid circuit shown in Fig. 2. As the grid circuit normally passes no current, because the tube remains negatively biased, current in the plate and cathode must be the same, so current swing must be the same. Therefore, the relation between the cathode and the plate voltage swings is determined by the working gain of the tube, with the plate load resistor used.

For example, assume the tube is a 12AX7, with a 220,000-ohm plate load resistor direct-coupled to the following stage. Assuming a plate resistance of 80,000 ohms and amplification factor of 100, the tube will give a working gain of about 73.

$$\begin{aligned} \text{Triode amplifier gain} &= \frac{\mu R_L}{R_p + R_L} \\ &= \frac{100 \times 220,000}{80,000 + 220,000} = \frac{22,000,000}{300,000} \\ &= 73 \end{aligned}$$

So the voltage swing at the plate, with the same current swing as that at the cathode, will be 73 times. This means that the effective load resistance presented by the cathode is 220,000 ohms divided by 73, which works out to 3,000 ohms.

Therefore, the cross-coupled circuit, using a 12AX7 in this manner, presents a load to the preceding stage of 3,000 ohms each side—a total of 6,000 ohms, center-tapped to ground. This is why the conventional cathode-follower input is used, as shown in Fig. 3.

Cathode coupling values

To maintain symmetry in the cross-coupled inverter's performance, the halves of the 12AX7 must be, as nearly as possible, at identical operating points. So bias resistors are inserted in series with each cathode to provide the necessary bias, and low-value resistors are used from cathode to ground in the preceding stage to insure that the operating points of these cathodes are reasonably close. This provides a low source resistance which is quite satisfactory for working into the load resistance of approximately 6,000 ohms.

Typical circuits, using a 12AU7 for the input stage, have 2,700 ohms between each cathode and ground, consisting of 2,200 ohms from each cathode with a 1,000-ohm variable resistor for balance trimming. Then 1,200-ohm resistors are used between the 12AX7 and 12AU7 cathodes, to provide the additional bias for the 12AX7.

The snag with this arrangement is that the 12AU7 is operating into a very low load. Each half "sees" a 2,700-ohm resistor directly from cathode to ground, together with 1,200 and 3,000 ohms in series, as an ac resistance pro-

vided by the input to the cross-coupled stage, a resultant of about 1,650 ohms. This is all right if the input level is very small; with larger inputs, it results in considerable curvature in the 12AU7.

This, it is true, introduces *second-harmonic* distortion, which will ultimately cancel in the output stage. However, as each side of the push-pull sequence amplifies independently, further second harmonic introduced by later stages will produce second harmonics of second harmonics, which is fourth, so that higher-order components are introduced which can be cancelled only by overall feedback.

From this standpoint, a circuit improvement could be arranged by raising the load resistance of the first stage. This would also avoid the necessity of using a low- μ tube such as the 12AU7, which is needed in this circuit only to achieve reasonable linearity.

Using a higher resistance in the cathode circuit, with the input circuit still returned to ground, tends to strangle the tube and does not improve matters very much. The more satisfactory method is to let the input circuit float at a dc potential above ground. To do this, a separate bias resistor, as shown at Fig. 4, is required. If each side of the cathode-follower front-end stage had separate returns in this way, the potential of the separate cathodes could differ considerably, due to slight differences in the tube characteristics. But, if grid potentials are kept the same, the cathode potential will also follow and the two will remain almost the same although resistance values and tube characteristics in each circuit may vary a little.

To insure this, both grids receive their bias from the same tapping point on one of the cathode resistors as in Fig. 5. If the second grid is used as a return point for overall feedback instead of being capacitance-coupled to ground, a further point that needs attention is the effective impedance due to the resistor between grids, from the viewpoint of the input and the feedback network.

From the input, as the signal on the second grid will be 9 times that on the first grid (for 20-db overall feedback), the voltage appearing across this resistor will be 10 times the input voltage and thus the effective resistance presented to the input will be 1/10th of the actual resistance value because it will pass 10 times the current. Correspondingly, the effective resistance presented at the grid for calculation of feedback effect is 9/10ths of the actual resistance value because the voltage across the whole resistor is 10/9 times that at the feedback grid (Fig. 5).

If the second grid is ac-coupled to ground through a capacitor as shown by Fig. 6, the resistor acts in the normal manner and doesn't require this adjustment in effective value.

An advantage of using the cross-coupled inverter is that inherent stabil-

ity criteria for feedback design are considerably improved. The cathode-follower drive for the cross-coupled stage is directly coupled to this cross-coupled stage. Further, the cross-coupled stage can be directly coupled to the driver stage. This then is R-C-coupled to the output stage, as shown in Fig. 7. Thus, many of the low-frequency parameters normally present in an amplifier of this type are avoided by this degree of direct coupling.

High-frequency parameters can be improved by neutralizing the intermediate stage, or by connecting small neutralizing capacitors from each plate to the opposite grid, balancing out the tube's internal plate-to-grid capacitance. This eliminates the Miller effect in this stage and extends its high-frequency response, improving the stability criteria at the high-frequency end.

Using this improved version of the cross-coupled front end, a larger signal can be provided which enables better types of output circuit to be used—unity coupling or some similar variant, which requires a bigger grid swing.

Feedback for driver circuits

Where this does not give enough swing there is another way of improving grid swing of these types of circuit. This is by the use of a form of *positive feedback* between the output stage and the driver, which is exemplified in the circuit used in the Circlotron amplifier. It is not, however, uniquely applicable to the Circlotron circuit and can be applied to any circuit where the cathode and plate swing by approximately equal amounts, such as the unity-coupled circuit used by McIntosh or some of the partially cathode-coupled Ultra-Linear varieties.

The interesting feature of this circuit is the way it improves the available

Fig. 6—The same circuit as Fig. 5 with-out provision for negative feedback.

Fig. 7—Complete amplifier circuit, with driver stage, using cross-coupled inverter direct-coupled to following driver stage. Neutralizing capacitors C1, C2 extend high end almost indefinitely, for feedback stability, when overall feedback is applied. X indicates points for local short-loop feedback from output-tube plates.

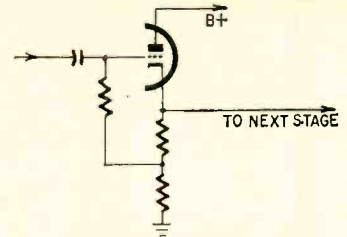

Fig. 4—This basic cathode-follower connection gives less distortion and better source impedance than the direct-coupled arrangement used in Fig. 3.

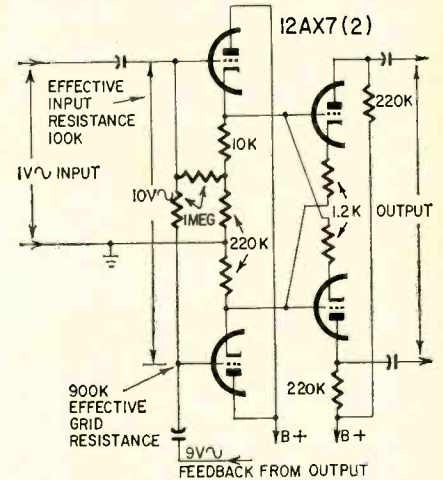
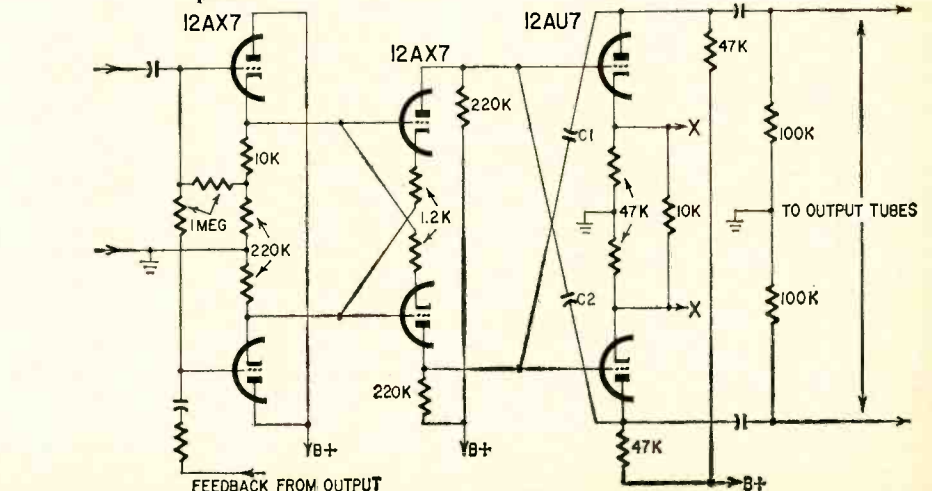
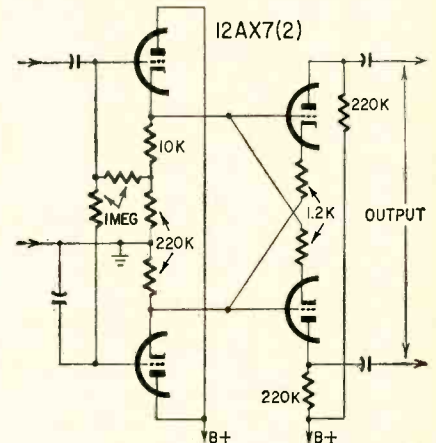

Fig. 5—One practical application of the improved cathode follower to the complete cross-coupled inverter, with provision for overall feedback.



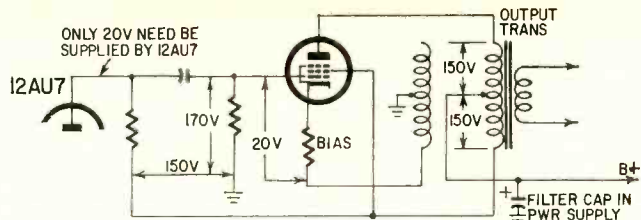

Fig. 8—Basic relations of push-pull driver and output stage using positive feedback. Voltages shown are ac swings.

swing given by the driver stage. Normally, R-C coupling of a driver stage suffers from the disadvantage that the dc drop in the plate coupling resistor reduces the swing available from the driver stage. An old method of overcoming this was to use a direct-coupled transformer. This lets the plates operate at a voltage not much below the B-plus and yet use a load line of quite high resistance, so that overall swing could extend above the B-plus voltage.

The overall swing can also be extended above the B-plus voltage by using positive feedback. Fig. 8 will illustrate this. It shows part of the unity-coupled McIntosh circuit. The output transformer has two primaries. The center tap of one goes to ground, while the center tap of the other goes to B-plus which is coupled to ground by a smoothing capacitor in the supply circuit. The screen of each tube (for greater clarity only one is shown) is connected to the end of the B-plus primary corresponding to the end of the other winding that is connected to its cathode. Because of transformer action and phasing, both screen and cathode receive the same ac swing.

Also the plate is connected to the opposite end of the high-voltage primary. So each tube is acting as a pentode (because the voltage between screen and cathode stays constant) and the voltage swings at cathode and plate must be equal, but in opposite phase, again because of transformer action. Thus, if each tube requires a grid swing of 20 volts to produce a swing of 300 volts in the chosen value of "plate" load, this 300 volts will be equally divided between plate and cathode, to give 150 volts swing at each.

As the cathode is swinging by 150 volts relative to ground, with a grid-to-cathode swing of 20 volts driving it, the total grid drive voltage (grid to ground) must be 170. This is a big swing for the previous driver stage to produce for each tube. But this is where positive feedback helps. Connecting the top end of the plate resistor of the 12AU7 driver stage to the same end as the output tube screen will cause that point to swing by 150 volts, while its bottom (plate) end swings by 170 volts. The ac drop across the plate coupling resistor is only the 20 volts required to drive the output stage grid—but the 20 volts is riding the 150.

So the ac voltage swing across the plate coupling resistor is only 20/170 times the actual plate swing. This means that the effective coupling resistor seen by the 12AU7 plate is 17/2 times this

actual resistor. Now let's put some values into a load-line diagram.

Assume the B-plus supply is 360 volts and the tube used is a 12AU7, which permits 300 volts on the plate at 2.75 watts dissipation. As shown at Fig. 9, a 9-ma plate current will come just within this rating. With 60 volts drop, from 360 to the allowed 300, at 9-ma, the coupling resistor can be 6,800 ohms. This, with a suitable bias resistor in the cathode to achieve the operating point of 9 ma at 300 volts, will set the operating point for the tube.

But now the dynamic load line will be at a slope representing 17/2 times 6,800 ohms, or about 58,000 ohms. The operating bias for 300 volts at 9 ma is about 12.5 volts. A swing from 0 to -25 grid volts gives a plate swing

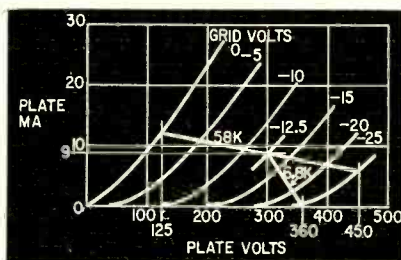

Fig. 9—Tube characteristics, showing how positive feedback lets the plate swing of the driver stage go above the 360-volt supply voltage.

from about 125 to 450 volts, which is 325 volts swing—ample margin for the 170 specified. Thus, by using positive feedback to steepen the active load line, we obtain voltage swings extremely difficult with conventional R-C coupling.

Fig. 10 shows the complete (simplified) circuit of the Circlotron amplifier which uses the same principle. The positive feedback actually only boosts the swing above B-plus because it uses the inductive coupling of the output transformer. In this sense the method proves similar to the use of a direct-coupled interstage transformer. The feedback may be regarded as a method of achieving this with only one transformer.

The arrangement can also be regarded as making the triode driver stage provide only the swing required from grid to cathode of each output stage. This means that the distortion-reducing effect of the degenerative feedback in the cathode of the output stage itself is neutralized. Only the overall feedback (or if Ultra-Linear connection is used, the screen feedback as well) serves toward distortion reduction. But the influence of output cathode degeneration on output source resistance is almost as effective as

without the positive feedback, because the drive of the 12AU7 is inserted, as it were, in the grid-to-cathode circuit of each output stage as an entity.

Thus this arrangement is suited for use with a straight pentode operating condition, such as the Circlotron uses, and provides a source resistance (or effective plate resistance of the output tubes) somewhere about (and possibly less than) the nominal load resistance.

One further fact needs attention. The slope of the load line provided for the driver stage is somewhat dependent upon the output loading. For example, if the output goes open-circuit, the maximum swing may change from 150 volts at plate and cathode to 200, but to get this swing, without the load, the grid-to-cathode swing may need to be only say, 15 volts, in place of the previous 20. This means that the grid-to-ground swing required by the output stage will be about 215, instead of 170.

On the other hand, the factor by which the plate resistor in the driver stage gets multiplied is changed from 170/20 or 8.5 to 215/15 or 14.3. Thus the dynamic load line for the driver stage will step up from about 58,000 ohms to the region of 98,000 ohms because of open-circuiting the output stage load. This will not materially increase the effective gain or available swing.

When you take into account the possibilities of reactive loads on the output stage producing out-of-phase fluctuations at the top end of the plate resistor, it becomes evident that the dynamic load line for the driver stage can become elliptical under these circumstances, which may considerably reduce the available swing from the driver stage. This adds up to the fact that the available swing, calculated as 345 volts, is probably none too much to allow for the possible deviations in practice, although at first sight it seems to be a very liberal allowance for an output stage that only requires just about half of this—170 volts swing.

Thus we have two very useful circuits to improve audio performance. Unfortunately they cannot be combined too readily. The big swings made available by positive feedback will be sacrificed to some extent if direct coupling is used, because the cathode of the driver stage will have to be considerably above ground. END

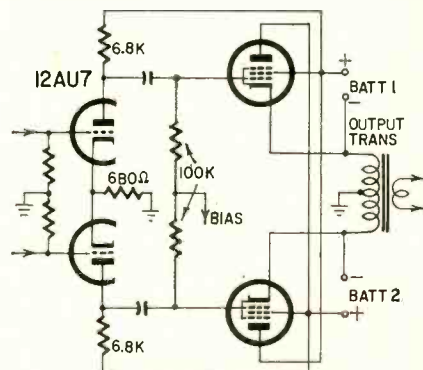

Fig. 10—Simplified version of Circlotron circuit, using positive feedback.

NEW CIRCUITS in TV TUNERS

Part I—Two vhf tuners, representing the latest developments in the electronic and mechanical art of tuner design

By E. D. LUCAS, JR.

PROBABLY the most outstanding advances in television tuners, both vhf and uhf, have been made in improved local oscillator design. The new circuits insure less drift, greater long-term stability and no need for repeated fine tuning when changing channels or after warmup. Typical examples of such improvements are found in the Standard Coil Neutrode D or ND vhf tuner; a uhf tuner designed by the same firm and intended to fit piggy-back alongside the larger ND unit, and an even smaller one, the General Instruments model 204 uhf tuner.

Other than circuit improvements, the engineers have made several changes in mechanical design which benefit the TV receiver manufacturer in terms of lower cost and smaller size as well as easier tuning for the customer.

Before discussing the new Standard Coil and General Instrument tuners, I would like to point out that "Automatic Fine Tuning Is Here," by Sol Libes in *RADIO-ELECTRONICS*, February, 1958, is an excellent analysis of a parallel approach to the problem of how to eliminate repeated manual fine tuning. This development uses a tuner in which the fine-tuning circuit is replaced by the aft (automatic fine tuning) control circuit. This tuner is essentially a Standard Coil ND, except that the fine tuning circuit is replaced by the aft control circuit.

The Neutrode circuit

Before going into circuit details, let's briefly review the advantages of the neutralized triode or Neutrode rf amplifier for a vhf tuner compared with a cascode amplifier, or a pentode rf stage. All else being equal, a triode contributes less electrical noise than a tube with more elements. One drawback, however, is that capacitance between the grid and plate of a triode severely limits gain at television frequencies, unless this capacitance can be neutralized.

The cascode rf amplifier is one answer to this problem. In typical circuits the input triode of a cascode amplifier serves as a grounded-cathode amplifier feeding the second triode, which is used as a grounded-grid amplifier. As there is minimum signal voltage at the plate of the input triode, there is little signal-

current flow through the grid-to-plate capacitance. Since the signal is fed to the cathode of the second triode, its grounded grid isolates the input and output of the rf amplifier.

While the cascode amplifier has proved itself in many vhf tuner designs, it has some disadvantages. In the simplest form of cascode, direct coupling is used between the two triode stages. This circuit generally requires a high B-plus voltage, usually 180 or more. Other variations of the cascode tuner operate on lower supply voltages, but these circuits demand more components and thus the tuner becomes more complex and costly. Also it is generally difficult to achieve effective age in tuners using cascode rf amplifiers without either increasing the noise figure at low signal levels or encountering receiver overload or cross-modulation at high signal levels.

The single-triode neutralized rf amplifier or Neutrode circuit overcomes these disadvantages, still retaining the benefits of low noise factor consistent with ample gain. For example, the Neutrode amplifier in the ND tuner requires only a 135-volt supply, and the total power dissipation is low in comparison with a dual-triode cascode. Increased reliability is one result of this lower power dissipation. Because of the relatively low B-plus needed, the ND tuner is well suited for use in transformerless receivers. Then, too, the Neutrode is appreciably less costly

to manufacture than dual-triode cascode circuits.

Progress in mechanical design

The ND tuner has some mechanical advances worth noting. One major improvement is a new method of mounting the drum type turret (see Fig. 1). J-shaped slots rather than the previous straight slots are used to hold the turret shaft. In earlier tuners with the straight slots, a spring wire was the principal means of holding the drum in position. Now a detent holds the turret shaft in the notch of the J for more positive retention and decreased bearing friction. As a result the channel selector turns easier. Also, improved retention of the turret assures greater uniformity of contact pressure. Both factors make the ND tuner easier to use in manual tuning and help simplify remote-control drive units for armchair tuning.

Another model of the ND tuner, known as the Fireball, is shown in Fig. 2. Here the turret is flattened into a disc instead of a drum to minimize size, but again turning torque is minimized and positive contact maintained. While the drum-turret ND is 4.83 inches long (not including shafts), 3.34 inches wide and 5.57 inches high, the Fireball is only 1.99 inches long (again omitting shaft lengths, which vary to meet the receiver's design requirements), 3.29 inches wide and about 4 inches high. Obviously this tuner has become popu-

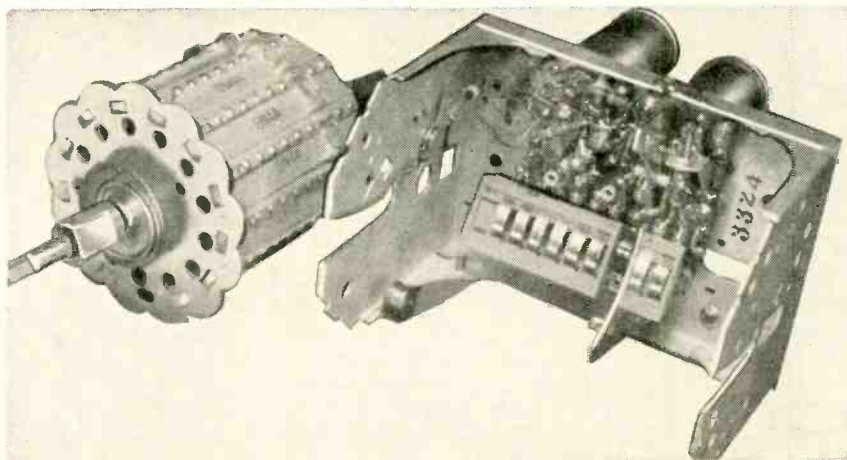

Fig. 1—Standard Coil Neutrode D tuner with the drum removed.

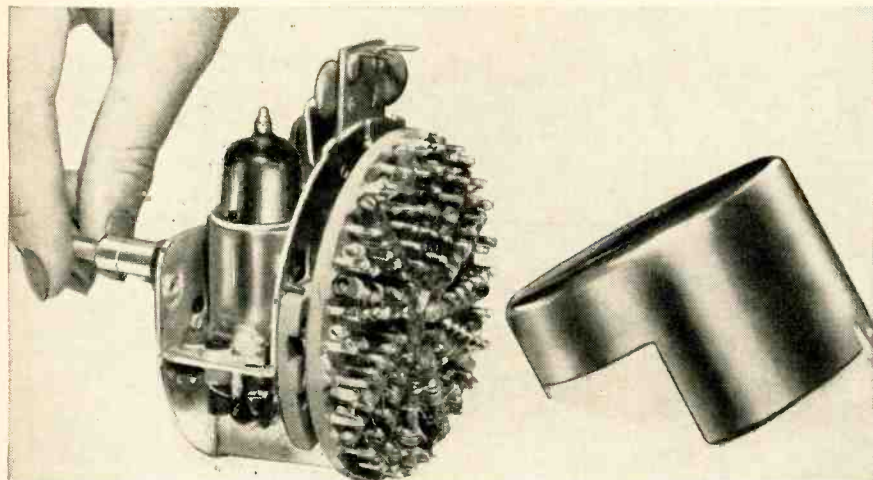

Fig. 2—Fireball Neutrode tuner has disc-type turret.

lar with set manufacturers designing compact and flattened-out receivers.

A design improvement common to both ND models is placing the fine-tuning vernier shaft on a sleeve. This sleeve is kept from turning by the J notch in the slot design of the drum-turret model and by a stop on the Fireball. Therefore, turning the turret from channel to channel does not turn the fine-tuning shaft.

The fine-tuning mechanism has been changed from a variable capacitor to a variable inductor in the drum-turret. The fine-tuning control moves the powdered iron slug of L9, shown in the schematic (Fig. 3). This coil has a low thermal coefficient and aids in assuring minimum oscillator drift.

Circuit of ND tuner

Let's turn now to a detailed study of the ND drum-turret tuner (see Fig. 3) and begin at the antenna terminals. Here we find a ferrite-core balun used as the matching transformer (T1) which couples the balanced 300-ohm antenna line to the nominally 75-ohm rf amplifier input. This ferrite balun performs well over the entire vhf range.

To provide more than 54-db if rejection for all frequencies between 41 and 46 mc, there is a band-rejection filter consisting of L1 and C1 in parallel and L2 and C3 in a series-tuned circuit, with the two traps stagger-tuned. For increased rejection of a particular frequency, we adjust L2. The manufacturer *does not recommend adjusting L1* because the L1-C1 parallel-resonant circuit tunes rather broadly and, if adjusted to a higher frequency, may cause some distortion of the channel-2 rf response curve. If you *must* adjust L1, spread or compress the turns of the coil.

Feedthrough capacitor C2 (30 $\mu\mu\text{f}$), located between the parallel- and series-tuned traps, has a number of functions. It provides the low-side capacitive coupling for the pi type resonant input circuit of the Neutrode rf amplifier. Also, with the inductance of rf grid coil L3, it forms a low-pass filter which attenuates any local oscillator signal feedback through the rf amplifier and

thus minimizes oscillator radiation. C2's value depends on considerations of optimum impedance match from the standpoint of tuner gain, antenna impedance match and tuner noise factor.

C4, the 12- $\mu\mu\text{f}$ capacitor in series with rf grid coil L3, is a dc blocking capacitor to isolate the agc bias voltage. Because of C4's relatively low capacitance, the total capacitance in the resonant pi rf input circuit is effectively reduced and the L/C ratio of the tuned circuit increased, resulting in a higher circuit Q. Since C4 is in series with the signal, its relatively high reactance at lower frequencies further increases rejection of possible interference.

Rf grid coil L3 is series resonant with capacitors C2, C4 and the input capacitance of the rf amplifier triode. As the tube's input capacitance is small compared to C2 and C4, the greater amount of signal voltage drop appears between the grid and cathode of the tube. Thus there is an effective signal-voltage gain, just as though a transformer type of input coupling had been used.

The antenna circuit is tuned to ap-

proximately the mid-frequency of the desired channel—adjusting rf grid coil L3 by spreading or compressing turns will "rock" the rf response curve. This antenna coil is adjusted by the manufacturer for maximum gain consistent with minimum tilt of the response curve. Resistor R1 and feedthrough capacitor C5 decouple the rf amplifier's control grid from the agc bias bus.

We find that the triode used in the ND tuner is either a 6BN4, where parallel heater connections are required, or one of the series heater equivalents such as the 2BN4 or 3BN4. Reasons for selection—actually development—of this tube type are explained a little further along.

The rf amplifier plate coil (L4) is parallel resonant with the output capacitance of the amplifier triode as well as trimmer capacitor C8. This trimmer is adjusted on only one channel—usually channel 10. All other rf amplifier plate coils are designed and adjusted to tune properly with this established capacitance.

Resistor R2 is the rf amplifier plate decoupling resistor. Because feedthrough C7 is relatively low in value, however, it does not bypass the signal voltage completely. Hence a small portion of the amplified signal appears at the junction of C7 and R2. This small signal is 180° out of phase with the signal appearing on the grid of the triode and caused by the grid-to-plate capacitance.

Here we have the essential feature of Neutrode design — neutralization carried out by feeding back from the plate to the grid a signal equal in amplitude and 180° out of phase to that flowing through the grid-to-plate capacitance. In the ND circuit we are considering, the small opposing signal appearing at the junction of C7 and R2 is coupled back to the grid through neutralizing trimmer C12, which is adjusted to make the amplitude of the neutralizing signal equal to the internal signal from grid to plate.

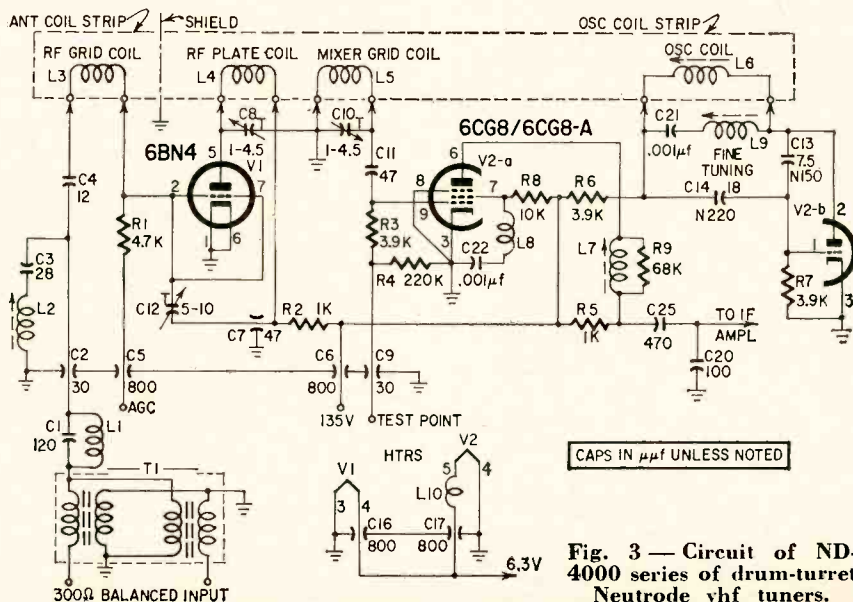

Fig. 3—Circuit of ND-4000 series of drum-turret Neutrode vhf tuners.

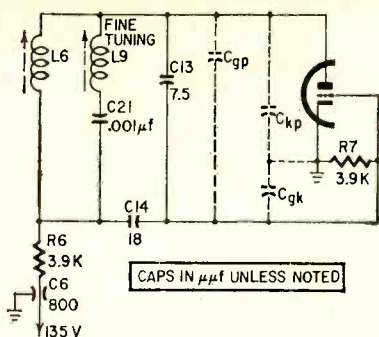

Fig. 4—ND tuner oscillator circuit.

We might also consider this Neutrode circuit as a capacitance bridge. With the proper setting of the neutralizing trimmer, a null can be obtained between the signal flowing through the grid-to-plate capacitance (one arm of the bridge) and the signal fed back through the neutralizing circuit (the other arm of the bridge). Neutralizing the tube's internal capacitance between grid and plate permits using a single triode amplifier to achieve high gain with low noise.

In practice, the neutralizing trimmer is adjusted by connecting an rf sweep generator to the antenna terminals and observing the tuner's response curve on an oscilloscope screen. The rf amplifier triode is then cut off by applying a negative bias of 9 volts or more. Now that the triode is no longer conducting, any signal visible on the scope must be the signal flowing through the grid-plate capacitance. Hence we can adjust the neutralizing trimmer by using it to minimize the response curve seen on the scope while the amplifier tube is not conducting.

Not all triodes can be neutralized in this manner for all vhf channels. Actually the 'BN4 series of tubes owes its development to this tuner application. These relatively new triodes are conspicuously low in grid-to-plate capacitance. In addition, lead inductances are minimized by using two connections to both grid and cathode. Either excessive lead inductance or high grid-plate capacitance would make it difficult to neutralize the rf amplifier correctly. The result would be a loss in gain.

Another circuit feature is the use of a feedthrough capacitor for C7. This is essential to avoid inductance which might be common to grid and plate circuits of the amplifier. Such a common inductance would prevent neutralization over the required vhf range.

In the mixer stage, we find that the signal developed across the rf amplifier plate coil (L4) is inductively coupled to the mixer grid coil (L5), which is tuned by the input capacitance of the mixer tube (pentode section of a 6CG8) and trimmer capacitor C11. As with the rf plate trimmer, this mixer grid trimmer is adjusted on one channel and all other channel coils are adjusted to tune with this known capacitance.

Bandwidth of the rf response curve

is controlled by varying the amount of coupling between coils L4 and L5. Since this coupling can be adjusted independently for each channel, bandwidth for all channels may be made highly uniform.

Oscillator features

One new feature of the oscillator, which uses a modified grounded-cathode Colpitts circuit including the triode section of a 6CG8 or one of its series-heater equivalents such as the 6CG8A or 5CG8, is the use of a variable inductor instead of a variable capacitor for fine tuning. This inductive fine-tuning control helps improve the stability of the oscillator circuit. With fine-tuning inductance L9 in parallel with oscillator coil L6, the total inductance is reduced. This makes it possible to increase circuit capacitance without reducing the range of oscillator adjustment—the greater capacitance helps to swamp out changes in oscillator frequency caused by variations in tube characteristics.

Now let's look at Fig. 4, a schematic of the oscillator drawn to emphasize the effect of tube interelectrode capacitance. L6 and fine-tuning coil L9 form a combined inductance which is in parallel resonance with capacitors C13 and C14—effectively in series—and the interelectrode capacitances of the tube. C13 and C14 are large in value compared with these interelectrode capacitances and since C13 is in parallel with Cgp, effects of tube capacitance variations are minimized. Another stabilizing factor is the selection of capacitors C13 and C14, as well as tuning inductance L9, with temperature coefficients that keep change in frequency with changes in temperature at a minimum.

An additional advantage of the ND tuner's oscillator circuit is that difference in the fine-tuning range from high to low vhf channels is greatly reduced. In some earlier tuners, the fine-tuning range on channel 13 was often 250% greater than the tuning range on channel 2.

Capacitor C21 is a dc blocking capacitor used to disable the oscillator circuit between channels and when an rf input strip is used in receivers containing a uhf tuner. As in previous Standard Coil turret tuners, the ND oscillator coils may be individually adjusted for each channel without interaction with other channels. Oscillator coil L6 is inductively coupled to the mixer grid coil L5. The separate coil strips for each channel permit adjusting oscillator injection to an optimum level, channel by channel.

The pentode section of the 6CG8 is a grid-leak biased mixer. A convenient test point is provided by feedthrough capacitor C9 connected to the junction of grid resistors R3 and R4. Although most of the dc bias developed across the grid resistors is a result of the oscillator signal, part of the total voltage is developed by the received TV signal. Thus the mixer's grid circuit

acts as a detector. By connecting an rf sweep generator to the antenna terminals, the response curve of the tuner rf circuits can be observed with a scope at this point in the mixer grid circuit.

Coil L8 is in series with the mixer screen bypass capacitor C22 and introduces a slight amount of regeneration in the mixer at higher frequencies. This makes the tuner's gain more nearly constant for all channels.

The if coil L7 is part of a tuned circuit consisting of its own distributed capacitance, the output capacitance of the mixer pentode, and capacitor C25. Part of the total if signal developed across L7 appears across C25 and this capacitor is also in the tuned input circuit of the receiver's first if amplifier stage. Thus, the tuner's if output is coupled to the if amplifier in the receiver through a mutual or common capacitor, C25. By varying the value of this capacitor, the amount of coupling and thus the bandwidth of the if response may be varied.

Specifications of the ND drum-turret tuner call for an oscillator drift of less than 150 kc for a rise of 30° C. during warmup. This is a remarkable improvement over earlier designs.

The circuit for the Fireball neutrode tuner is similar to that just described for the drum-turret model, except that fine tuning is handled by a variable capacitance rather than a variable inductance. Gain of this much smaller vhf tuner is about 3 db less than the drum-turret type. Oscillator drift is slightly greater, but it compares well in overall performance including VSWR, image rejection, if rejection and noise factor.

We have taken a close look at two Neutrode tuners, one a standard size unit, the other a compact model. Both are vhf models. Next month a piggyback uhf model designed to work with the Neutrode and the General Instrument model 204 uhf tuner will be described.

TO BE CONTINUED

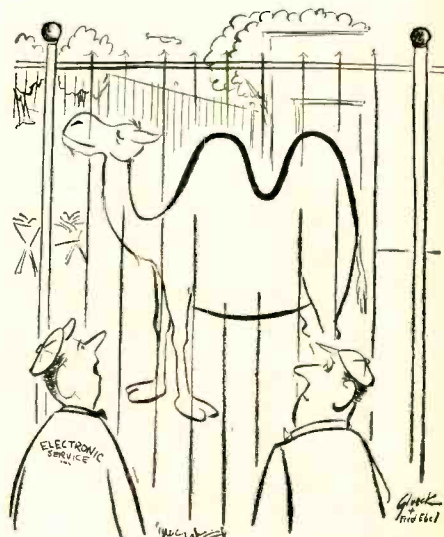

"That reminds me, I've got an FM alignment on the bench."

TROUBLESHOOTING

COLOR TV

RECEIVERS

By WALTER J. CERVENY*

THE video output of a color bar generator is very valuable for troubleshooting color TV receivers.

With its aid, we immediately divide the receiver into main sections. We can find out with a simple quick test whether trouble is present in rf, if or picture detector sections, or in the chroma section.

To use the video frequency output from a color bar generator effectively, pull the receiver's last if tube. While not absolutely necessary, this step eliminates interfering distortions which might lead to false conclusions. Pulling the last if tube insures that no signal or noise from the high-frequency channels is applied to the picture detector.

The video signal is normally developed across the picture detector charging capacitor (C in Fig. 1-a). Hence, we apply the video output from the color bar generator across C, as in Fig. 1-b. Often, we find a dc voltage from the bias system of the receiver on both sides of capacitor C. For example, in the Sylvania 1-534-1 chassis, there is about 5 volts at this point. Hence, the chassis of the color bar generator must be floating, so this bias is not disturbed.

From Fig. 1-a you can see that the picture detector's output has a certain polarity. The arrow of the diode is the anode, or we can say that the electron

flow is opposite to the direction in which the arrow points.

If you connect the color bar generator as in Fig. 1-b, use the "-video" output from the generator. However, note that it is also possible to connect the color bar generator as in Fig. 2. Here, we will use the generator's "+video" output. In fact, the shunt capacitances to ground imposed by the generator, for this example, make the Fig. 2 setup a bit more stable sync-wise than the setup shown in Fig. 1-a when testing an arrangement which operates above ground. Keep this point in mind.

Don't use wrong signal polarity

In either event, don't use the wrong signal polarity from the color bar generator or you will get a screen pattern that is out of this world. Fig. 3 shows the result of a polarity error in the signal. The pattern locks with a large phasing error in horizontal sync, and the color sync is "on the ragged edge." All hues are incorrect, as shown. Fig. 4 shows the meaning of signal polarity.

Bar widths are incorrect when signal polarity is wrong, and the exact geometry of the false pattern depends upon the settings of the various operating controls. So don't forget to check the picture detector polarity, and set the generator accordingly.

The picture detector usually delivers about 1 volt peak to peak. A video signal level of 1 volt peak to peak should provide a normal color bar pattern on the screen of the picture tube. The value of the applied signal is not highly critical since color intensity and contrast controls can be used to compensate for different signal levels, within their normal operating ranges. However, excessively high signal levels overload the chroma circuits and cause loss of color sync, which cannot be corrected by adjusting the color intensity control.

Quite a few present-day color TV re-

Use the video output of your color bar generator to do a faster servicing job

* Chief engineer, television equipment, Hickok Electrical Instrument Co.

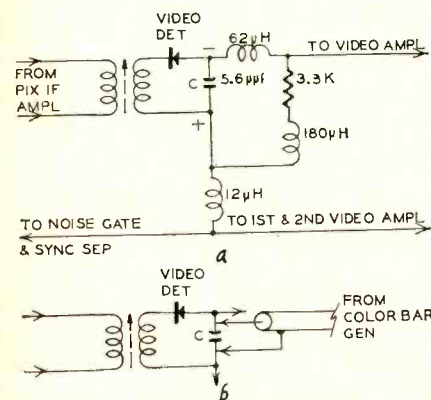

Fig. 1-a—Typical picture detector output circuit in color TV receiver. Detector output is negative going. b—How to connect video output of color bar generator to picture detector circuit. Scope used has upward-positive polarity.

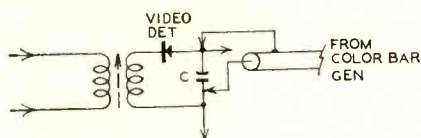

Fig. 2—Video output cable from color bar generator can be connected to capacitor as shown here.

ceivers use the vestigial color sideband system of if operation. In this design, the color subcarrier falls halfway down on the if response curve (on the opposite side from the picture carrier). This attenuates the chroma signal 50%, as shown in Fig. 5.

If the receiver uses vestigial color sideband reception, it is necessary to use the corresponding signal for video frequency tests. Otherwise, the response obtained from the receiver may not be indicative of normal operation. Generators which have an overall chroma control, such as the Hickok 655XC, can be adjusted as required with the aid of a wide-band scope.

Other generators, such as the Hickok 656XC, also have a -6-db chroma switch incorporated with the modulation on-off switch, so that vestigial color sideband output can be obtained without the use of a scope. Generators which have no service control for chroma level can be modified for vestigial color sideband output by shunting a suitable value of fixed capacitance across the cable termination. The value of the capacitor is determined by the cable impedance, and

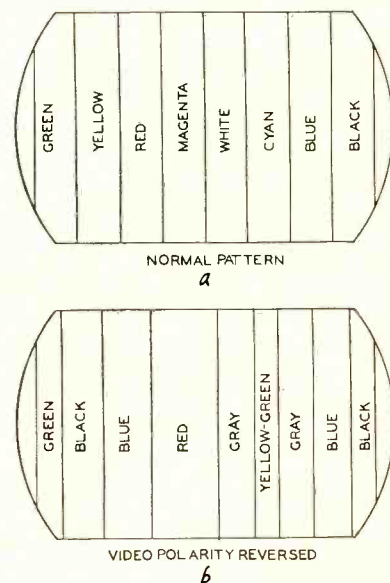

Fig. 3—Comparison between a normal color bar pattern and a typical wrong-polarity pattern: a—normal color bar pattern; b—color bar pattern with reversed video polarity.

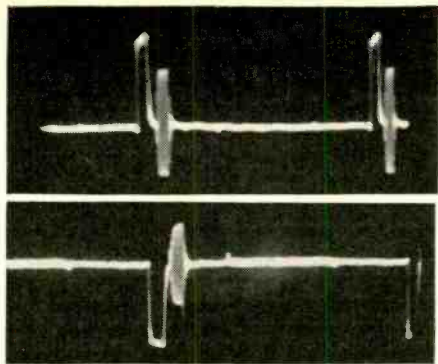

Fig. 4—Color burst always follows horizontal sync; (top) positive signal polarity; (bottom) negative signal polarity.

by its termination at both input and output ends. The exact value for the shunt capacitor is best determined with the aid of a wide-band scope.

The capacitor has a much lower reactance at 3.58 mc than at 100 kc, and hence several hundred μf will attenuate the chroma signal 50% without noticeably affecting the Y signal.

Using signal injection

Applying a suitable video signal at the output of the picture detector im-

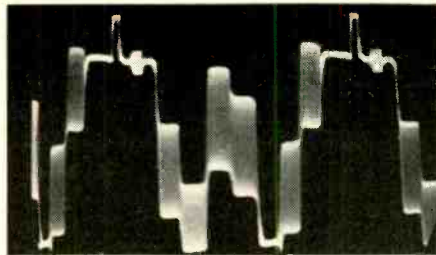

Fig. 5—Color receiver with vestigial sideband system attenuates chroma signal 6 db at the picture detector.

mediately shows whether trouble is present in the chroma circuits. However, don't be misled into thinking that similar tests could be made at subsequent points in the receiver circuits, such as at the grid of the bandpass amplifier. Such tests are impractical for two reasons. First, the output from service color bar generators is insufficient to drive the bandpass amplifier, which operates at a fairly high level. Second, applying a video signal to the grid of the bandpass amplifier results in loss of drive to the sync separator, and horizontal sync cannot be maintained. In many receivers, the burst amplifier branches off the signal chan-

nel prior to the bandpass amplifier, and in these sets color sync cannot be maintained.

It is not essential to use an NTSC color bar generator in video tests of chroma circuits. Either a rainbow generator or a keyed rainbow-generator signal can be used. However, the checks made with an NTSC generator are more conclusive and much easier to interpret. If a rainbow generator is used, the output must be approximately 1 volt peak to peak and must be applied with correct polarity in the case of a keyed rainbow signal.

A simple rainbow signal consists of a 3.56-mc sine wave, and so polarity is not a matter for consideration. However, a keyed rainbow signal is provided with horizontal sync pulses, and the horizontal sync system of the receiver is upset and erratic when the wrong-polarity sync pulses are applied.

Either type of signal shows whether trouble in color reproduction is located in the high-frequency signal circuits or in the chroma channels. Because of the practical utility of video-frequency chroma tests, every technician concerned with color TV service should familiarize himself in this type of test work. END

NEW TUBES MADE EASY JOB A DOG

COMPLAINT was no sound or picture. The 1.25-amp fuse in the B-supply had blown. A resistance check showed the rectifiers and filter capacitors to be OK and there was no short in the B-plus circuits. The fuse was replaced, but blew within seconds after the set warmed up. When the second one blew in the same manner, we gave the set a thorough going-over, paying particular attention to the filter and coupling capacitors and the 10- μf cathode bypass on the 12AT7 video output stage. Everything checked perfect.

With the chassis on the bench, we then turned on the set and momentarily shorted the fuse block. It was then that we noticed the tube heaters glowed abnormally bright. They returned to normal brightness when the short was removed from the fuse block. It looked like higher-than-normal voltage was reaching the heater strings through a heater-to-cathode short.

The diagram showed the cathodes of the video output and damper tubes at 75 and 450 volts above ground, respectively. Although both tubes checked good, they were replaced with new ones from stock. The fuse still blew as soon as the set warmed up. We could not leave the set turned on long enough to measure dc voltages for fear of burning out one or more tubes in the series heater strings. Most heaters were nearly white-hot in less than 10 seconds after B plus was applied.

Disconnecting first one B-plus line and then the other, we found that the trouble was on the 245-volt line. Resistance checks and tube substitutions failed to pinpoint the source of the

trouble. With the 245-volt line reconnected, we shorted the fuse post to apply B plus to the set, and then yanked the 12AT7 video amplifier. Pulling the tube extinguished the heaters in all other tubes in series with it. In the other string, the limiter and ratio detector heaters flared brightly and the 6AK5 rf amplifier burned out. Heaters on the line side of the damper tube glowed normally. This definitely established the trouble as a heater-to-cathode short in the damper circuit. The only question was why did the trouble occur with all of the four 25W4's that we had tried?

The 6AK5 was replaced and we borrowed the 25W4 damper from another set. The set's performance re-

turned to normal. A new 25W4 of a different brand was installed and the set returned to service after a continuous run of around 8 hours.

Later we tested the four 25W4's that we had in stock in a half-wave rectifier circuit fed from a variable-voltage supply. With one side of the heater grounded, three tubes developed hot heater-cathode shorts with around 280 volts on the plate. The other broke down at 135 volts.

The distributor replaced these tubes with four of the same brand. We checked these with up to 450 volts between heater and cathode without having one short out. Evidently, the tubes that shorted all came from the same bad run.—John M. Ford

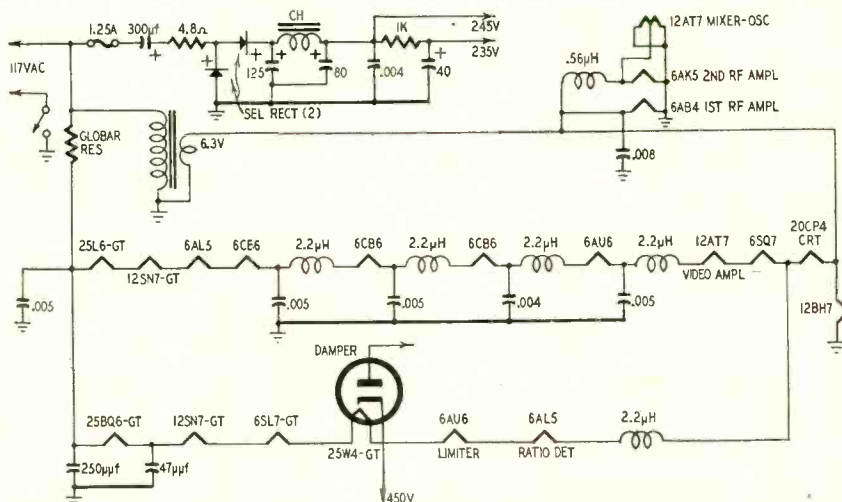

Power supply and heater strings of G-E model 21C105 discussed.



**TV Service
CLINIC**
conducted by
ROBERT G. MIDDLETON
TELEVISION CONSULTANT

If you have joined the society of "pink trees and purple people," you may be interested in the following compilation.

Many factors can cause improper coloration of color TV program material. Some are almost self-evident, while others are real sneaky.

Here are the main points to check:

1. Is the fine-tuning control set correctly? A little sound in the picture causes ragged edges, "blue noise" and incorrect picture hues.

2. Is the picture tube tracking correctly? When screen and background controls are not adjusted right, the raster becomes tinted at low or high light levels, or both. This causes improper rendition of picture hues. (It also causes tinting in highlights or low-lights of a black-and-white picture.)

3. Are the brightness and contrast controls set within normal operating range? Although a picture tube is tracking properly, picture hues will be incorrect if the tube is operated at an excessively high level.

4. Technical difficulties at the TV transmitter occur at rare intervals. In case of doubt, try another channel, or call the studio.

5. After a color receiver has been in operation for several years, it is advisable to check the electrolytic decoupling capacitors. Just as failing electrolytics cause cross-talk between circuits in black-and-white receivers, they can permit spurious voltages to enter the chroma channels and give false hues.

We sometimes find that an object which appears red at the left-hand side of the screen becomes greenish or bluish as it moves to the right-hand side of the screen. An actress' dress is a common example of such changing color. This is caused by a sawtooth ac ripple on the dc bias voltage of the bandpass amplifier or other chroma tube (assuming that normal setup adjustments, such as purity, have been completed satisfactorily).

The sawtooth ac ripple usually arises because of capacitor failure. Some receivers, for example, obtain grid bias by pulsing the grid of the bandpass amplifier into grid current during fly-

back. If the time constant of the circuit decreases because of capacitor failure, this bias does not hold constant during forward scan. Instead, the bias decays appreciably and results in coloration changes from left to right across the screen.

A scope and low-capacitance probe are the best detectives for running down the culprit.

Poor interlace

I have been working on a receiver troubled with poor interlace. Usual tests of the integrator and vertical oscillator circuits have not revealed the difficulty.—S. H. J., Knoxville, Tenn.

Poor interlace is always caused by a defective waveform at the output of the integrator. A scope and low-capacitance probe should be used to make this check. You will find that horizontal pulses are present, along with the vertical trigger pulse. The horizontal pulses may be picked up by stray coupling, fed into the oscillator circuit by insufficient decoupling, or the integrator may not provide sufficient filtering. When the horizontal pulses are reduced to a very low level, interlacing will be normal (see Fig. 1).

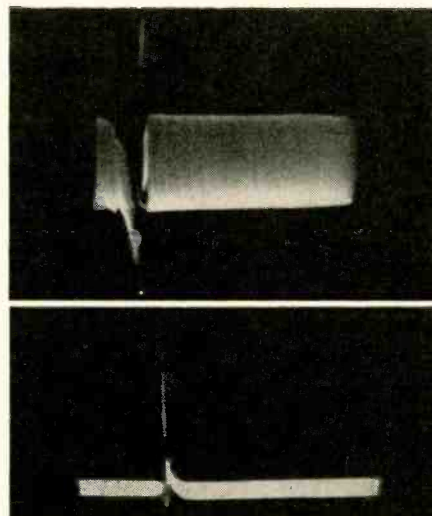

Fig. 1—(Top) Vertical pulse, with high-level horizontal pulses; (bottom) horizontal pulses reduced to comparatively low level.

12-to-17-inch conversion

I am repairing a Trans-Vue model 1951 and want to convert the 12LP4 to a 17-inch tube. Can a 17LP4 be used without making circuit changes?—F. G. F., Sta Cruz, Manila, P. I.

We would advise against this conversion. The 12LP4 is a 52° tube, and extensive circuit changes will be required for a 17LP4. The 17BP4 is a better choice, but you will require a conversion kit. As you wish to use the present circuit, we cannot recommend the conversion.

24-inch 90° conversion

A Radio Craftsman model 202 is to be converted to a 90° tube such as the 27EP4 or 27RP4. I have a focusing magnet on hand, but would prefer to use a focus coil. Is this conversion practical?—C. E. S., Denver, Colo.

This is a practical conversion. You can use either a 27EP4 or a 27RP4. A Focalizer is preferable to a focus coil, to avoid a B-plus drop. The 16 kv which is available is sufficient for the 27-inch tube.

Tuner disassembly

The TV Clinic has helped many beginners and veterans, including myself. Now I have a Motorola 21K1 tuner which is not operating properly. I would like to know if the tuner can be disassembled without putting it out of alignment.—J. S., Philadelphia, Pa.

Tuners are almost always thrown out of alignment when circuit work is done. It is something that cannot be avoided. Quite possibly, lack of proper operation is already caused by incorrect alignment. It is impractical to work on tuners, unless the shop is equipped with a good rf sweep and marker generator and scope. (See Fig. 2.) I would advise that one man in the shop study up on sweep alignment, so that this type of work can be handled profitably.

Poor high-frequency response

In a Philco 22C4011X, small objects are very blurred and indistinct. Is this an indication of poor high-frequency response?—W. S., Saco, Me.

There is poor high-frequency response in the rf, if or video-frequency circuits. Adjustment of the signal-circuit coils must be checked throughout, using a good sweep and marker generator and scope.

Add agc

What is the simplest way to add agc to an old-style receiver having a manual control for grid bias?—(Name withheld by request)

A generally applicable method is shown in Fig. 3. Couple a crystal diode (D) through a 27- μ f capacitor to the picture-detector input lead. The agc level is determined by the value of R. Select a value that gives best operation for your area. About 2 megohms is typical. Be sure that rectifier D is polarized to deliver negative output voltage and has a high front-to-back

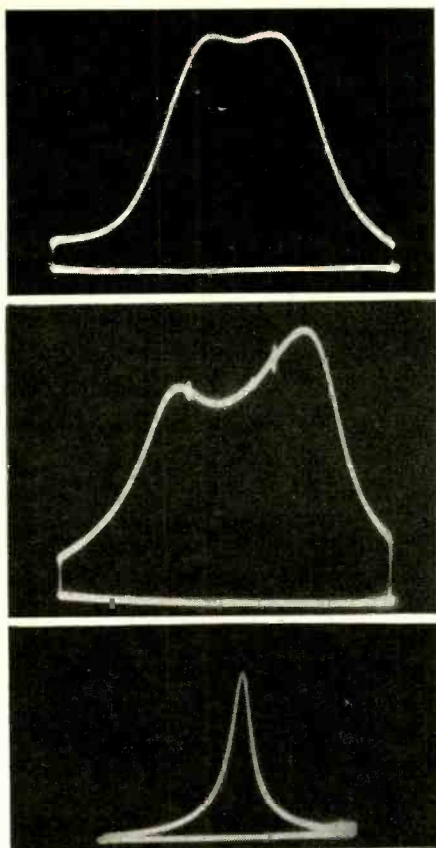

Fig. 2—Typical rf tuner response curves: (top) normal response; (center) average response; (bottom) poor response.

ratio. Remove the bias-control lead from the arm of the old contrast control, and return it to point A in the diagram.

For a contrast control, use a potentiometer in the cathode circuit of the video amplifier. It should have a value about five times as high as the fixed resistor usually found in this circuit. After making these changes, be sure to realign the if amplifier, using a good sweep and marker generator.

Tunable buzz

There is difficulty in eliminating buzz from the sound of a Zenith 24H21 unless the fine-tuning control is critically adjusted. Would aging of the contacts in the tuner cause this?—W. G., Bronx, N. Y. C.

It is unlikely that the buzz is caused by tuner contact trouble. A check of rf and if alignment with a sweep and marker generator will probably show that the sound carrier is riding too high on the overall response curve. Another possibility is that one of the signal circuits carrying both sound and picture is on the verge of overload. Check plate, screen, grid and agc bias voltages.

Pincushion magnets

Will you please advise where magnets to correct pincushioning can be obtained?—J. P. B., Oelwein, Iowa

These magnets are made by several firms. General Cement Manufacturing Co. lists three types in their catalog. If your local jobber does not stock these

magnets, you can use the magnets from a double-field ion-trap magnet. Disassemble the trap and mount the magnets on brass strips. In some sets, the magnets can be taped to the side of the picture tube, in a location which clears up the pincushioning. In others the magnets have to be spaced a bit from the sides of the tube.

21-inch to 24-inch screen

How can I convert a 1956 DuMont RA-340 using a 21-inch 21ALP4A picture tube for a 24DP4A?—L. D., Martin, S. D.

Some circuit changes will be necessary. There will likely be insufficient width. Local shops often shunt a 6-kv ceramic capacitor of 10 to 50 μf from the plate of the horizontal output tube to ground. This dims the picture slightly, but gives the necessary width. To avoid dimming the picture, the flyback and yoke can be replaced. Vertical height will probably be OK.

Metal to glass

I would appreciate data concerning conversion of a 21T227 RCA set from a metal picture tube to a 21-inch glass tube.—W. A. J., Mt. Prospect, Ill.

The 21EP4 is a suitable tube for conversion. No circuit changes are anticipated.

Improving reception

One of my customers recently purchased a 1958 color receiver and gets all the Philadelphia programs. Neither the black-and-white nor the color signals are very good. What would you suggest?—H. E., Irvington, N. J.

Use an 8- or 10-element Yagi, broadbanded to give flat response over the desired color channel. A single antenna will probably do the job, but you can stack two or more for more signal strength. In stacking, be sure to use correct matching bars, on the channel the antenna is cut for.

If oscillation

A Motorola TS-114A has noisy or no sound and picture since mounting the chassis on its side and putting in a new 6W6-GT vertical output tube. Taking off one of the lead-in wires, I get normal picture and sound. Any hints will be appreciated.—S. S., Blackduck, Minn.

This is a typical case of if oscillation. It has been caused by some mechanical disturbance of the components when the chassis was mounted on its side. Since you are in a fringe area, the if coils

are probably peaked too close to the same frequency. The trouble can undoubtedly be corrected by using a good sweep and marker generator and by aligning the if amplifier for stable response at low bias.

Conversion has low brightness

A yoke and flyback transformer from a 16-inch Trav-Ler were used to convert a 10-inch Olympic receiver. The picture is good, but there is not enough brightness. The picture blooms when the brightness control is advanced. The high voltage measures 8 kv. Thanks for any help.—E. L. H., Cleveland, Ohio.

You need more high voltage and about the easiest way to get it is to add a simple voltage-doubler circuit. The only difficulty may be that with higher voltage, you may not be able to fill the screen. However, it is worth trying. You will need a heater supply for the doubler tube, which can be obtained by adding a one- or two-turn loop of heavily insulated wire around the flyback core. Make it the same as the present filament winding. If you find that the doubler gives you too much voltage, add 1, 2 or 3 megohms in series with the lead to the picture tube.

Agc trouble?

An RCA KCS88K chassis seems to have agc trouble and sensitive sync. With no antenna, I get channel 3 OK. With the lead-in connected I cannot get 3, but 2 and 4 come in OK. What do you suggest?—V. L. L., Pensacola, Fla.

First make sure that the agc system is actually faulty. This can be done by connecting a bias box to the agc line. The unusual response obtained when the lead-in connected and disconnected indicates that you have regeneration in circuits—most likely in the if amplifier. Use a good sweep and marker generator, and make certain that the response curve is stable at low values of grid bias. Incorrect peaking frequencies in the if amplifier are the most common cause of regeneration.

Color problem

In reception of color programs, why does a dancer appear with a red dress in the background, and with a green dress as she enters the foreground? I believe that the color picture tube is properly tracked.—J. H. C., Willowdale, Ont.

Technical difficulties at the studio are less common nowadays, but I might mention the problem of lighting with respect to gamma correction. Because of gamma correction at the color transmitter, studio lighting is a more complex problem than in black-and-white TV transmission. A technician's error in lighting control could cause the situation you report. Try reducing the setting of the brightness control somewhat, to see if you may be operating on the ragged edge of picture-tube output. Also, be sure that the fine-tuning control is correctly adjusted to keep sound interference out of the picture. END

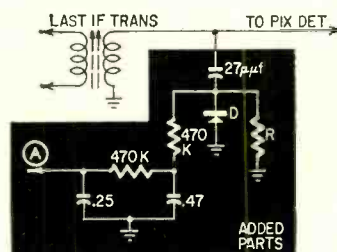

Fig. 3—Simple circuit for adding age to old receivers.

TRANSISTOR

ALL-WAVE RADIOS

The vacuum-tube radio is going the way of the dodo—these two all-transistor receivers show why

By ROBERT F. SCOTT
TECHNICAL EDITOR

ONE of the surest signs that transistors will completely replace vacuum tubes in all radios of the future is that several leading receiver manufacturers have recently introduced or announced fully transistorized all-wave receivers, some tuning up through the 13-meter shortwave broadcast band. The new Magnavox Intercontinental model AW100 and Zenith Trans-Oceanic Royal 1000 are two such receivers and are discussed in this article.

These new sets have many advantages over earlier vacuum-tube all-wave models. The use of transistors and subminiature components has greatly reduced weight and overall dimensions. Batteries for tube portables are bulky, heavy, expensive and often unavailable except through mail-order supply houses or the set manufacturers' outlet. Most of the new transistor portables use standard 1.5-volt flashlight cells that are small, inexpensive and available anywhere flashlights are used.

The light weight, small size and wide frequency range of these sets make them ideal for travelers and tourists in foreign countries. They enable the owner to keep abreast of events and happenings in his homeland via short-wave radio broadcasts on the 31-, 25-, 19-, 16- and 13-meter bands.

Fishermen and operators of private pleasure boats can use these receivers for WWV time signals, weather reports and navigation information. Hams and SWL's can keep up with the goings-on on the most popular vhf amateur phone bands.

These all-wave transistor portables are generally equipped with telescopic whip antennas for shortwave reception, phone jacks, dial lights with momentary pushbutton switches for battery economy and either electrical or mechanical bandspread for easy tuning on the shortwave bands.

The Magnavox and Zenith sets use tuners with the RCA 2N370, 2N371

Due to last-minute changes, the cover story "Tiny Tube Steals Transistor's Thunder" appears on page 32.



One of the smallest all-wave portables made, the Magnavox AW100 is designed with the traveler in mind.

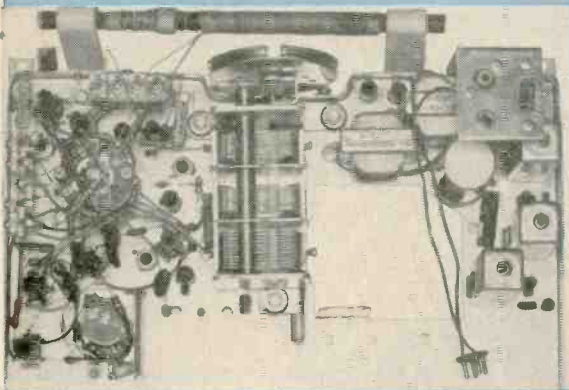

The old-timer may get a surprise when he looks for tubes inside the Intercontinental.

Trans-Oceanic weighs only 13 pounds and has three antennas.

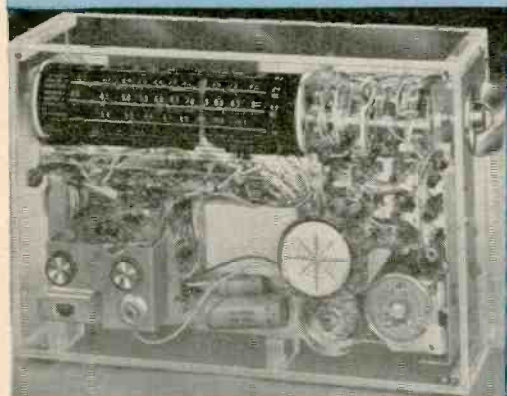

A look at the nine-transistor circuit of Zenith's Royal 1000 in clear plastic display cabinet.



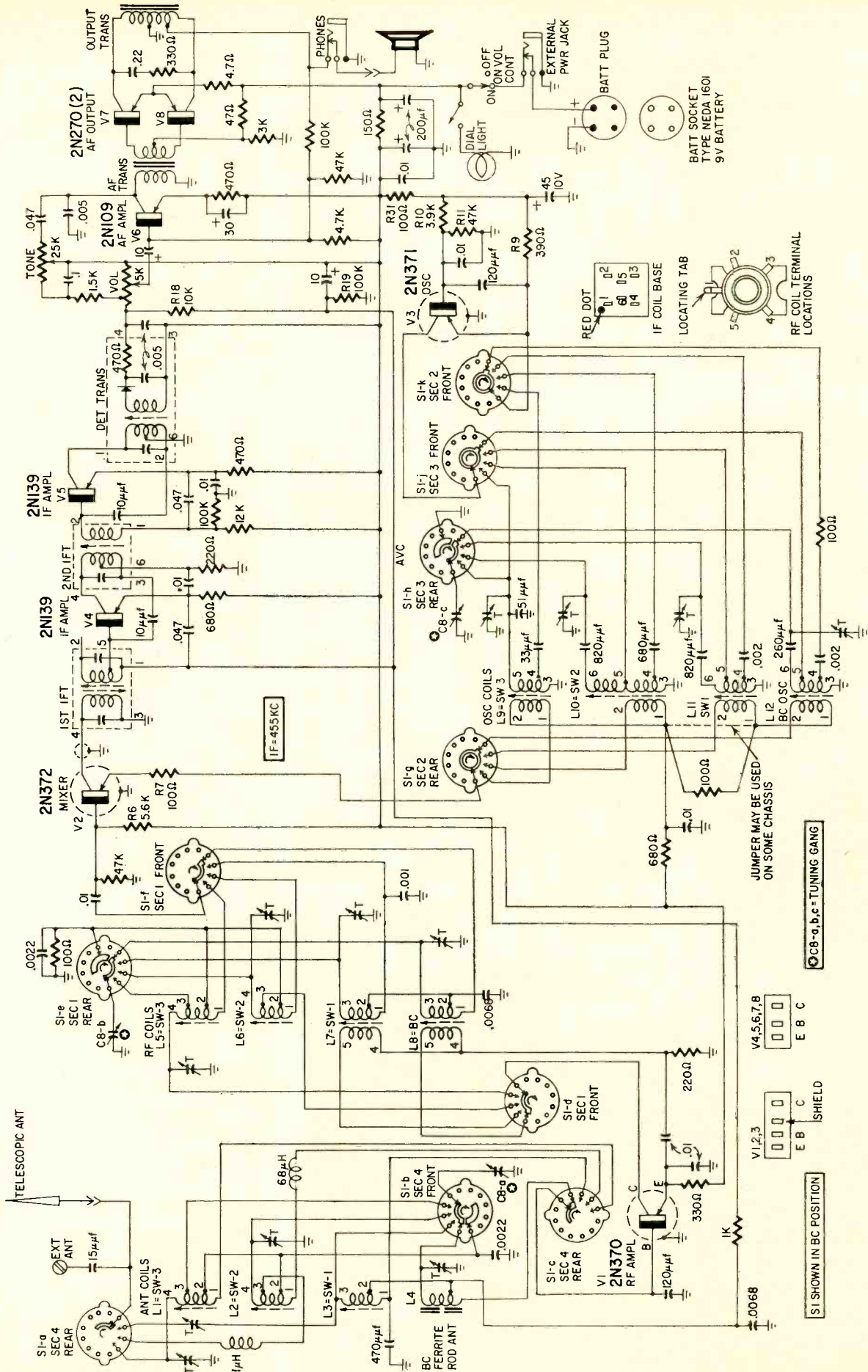

Fig. 1—The Magnavox Intercontinental uses eight transistors in its four-band circuit.

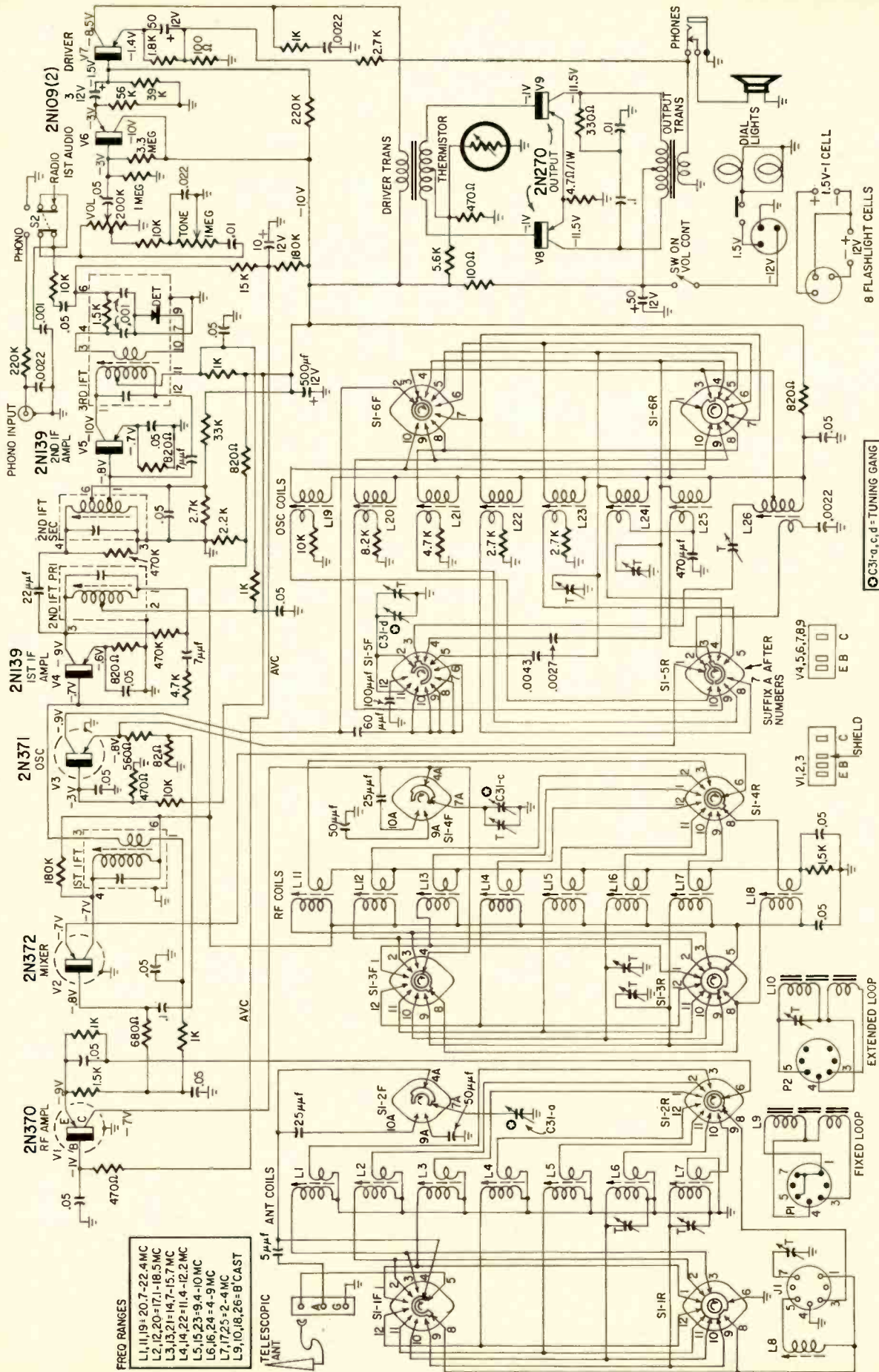

Fig. 2—Circuit of the Zenith Royal 1000. It has a 455-ke if.

FREQ RANGES

L1, 11, 19	= 20.7-22.4 MC
L2, 12, 20	= 17.1-18.5 MC
L3, 13, 21	= 14.7-15.7 MC
L4, 14, 22	= 11.4-12.2 MC
L5, 15, 23	= 9.4-10 MC
L6, 16, 24	= 4-9 MC
L7, 17, 25	= 2-4 MC
L9, 10, 18, 26	= B'CAST

ⓈC31-a, c, d = TUNING GANG

SHIELD

FIXED LOOP

EXTENDED LOOP

SUFFIX A AFTER NUMBERS

V4, 5, 6, 7, 8, 9 E B C

and 2N372 germanium p-n-p drift transistors designed for rf amplifier, oscillator and mixer service, respectively, at frequencies up to 23 mc. Drift transistors are germanium alloy-junction types with a base region in which controlled impurities develop an accelerating (drift) field that enhances the flow of holes from emitter to collector. This results in transistors whose high-frequency performance is superior to conventional designs because of the reduction in base resistance and collector transition capacitance. These transistors use shielding to minimize stray coupling and capacitance between adjacent leads. This shield consists of a fourth lead connected to the transistor case and situated between the base and collector leads.

Magnavox Intercontinental

This is an eight-transistor model providing full coverage from 540 kc to 22.5 mc in four bands (BC, 540-650 kc; SW-1, 1.65-4.75 mc; SW-2, 4.75-12.5 mc and SW-3, 12.5-22.5 mc). Individually tuned rf amplifier and mixer and two 455-kc if amplifiers provide adequate sensitivity and selectivity. Tuning on the shortwave bands is simplified by a vernier fine-tuning knob.

The circuit of the AW100 Intercontinental is shown in Fig. 1. Band-switch S1 is shown in the broadcast position. The ferrite rod antenna (L4) is connected to tuning capacitor (C8-a) through one section of S1-b and the signal is fed to the base of rf amplifier V1 through S1-c. The rf amplifier is connected in a common-emitter circuit. When S1 is set to one of the shortwave bands, S1-b shorts out the coils for the lower bands to eliminate "suckout" and other effects of stray resonances. S1-a connects the 52-inch telescopic whip antenna and the external antenna post to the antenna coil being used.

The amplified signal appears in V1's collector circuit and is developed across the primary or a tapped portion of the rf coil (L5 through L8) that is in the circuit. S1-d, S1-e and S1-f select the correct rf coil. The rf coils are tuned by C8-b and the signal is fed through S1-f to the base of mixer V2.

The mixer is operated close to zero bias to insure proper conversion through rectification and amplification. V2's emitter is returned to its base through R7, S1-g, the secondary of the oscillator coil (L9 through L12) and R6. The oscillator signal is fed to V2's emitter through the winding on the oscillator coil.

The oscillator is a form of tapped-coil Hartley with a section of the coil between base and collector. The oscillator is stabilized by R9 and R31 in the emitter return and by the base bias provided by the voltage divider consisting of R10 and R11. Sections S1-h, S1-j and S1-k of the bandswitch select the oscillator tuning circuits for each band. A section of S1-h shorts and grounds the unused coils as the set is tuned to progressively higher bands.

The two-stage if amplifier uses 2N139 p-n-p germanium alloy-junction transistors designed especially for 455-kc if amplifier service. They are connected in common-emitter circuits neutralized by 10- μ f capacitors between the bases and one end of the if transformer primaries.

The second detector is a germanium diode. The af signal appears across load resistor R18 and is fed to the base of the af amplifier through the volume control. The dc component of the detector output appears across R19 and is used as avc for the rf and first if amplifiers.

The audio system is conventional, using a 2N109 driving a pair of class-B 2N270's. The tone control is an R-C feedback network between V6's collector and the tap on the volume control. The speaker is fed from a tap on the output autotransformer. The 2N270 collectors return to ground through the transformer's center tap.

Negative feedback taken from the voice-coil tap on the output transformer is fed to the emitter of the amplifier. Inserting the phone plug automatically disconnects the speaker.

The AW100 is powered by a 9-volt battery pack (Eveready 26-06 or equivalent) which provides approximately 500 hours of operation. An external power receptacle is provided for connecting an external 9-volt supply.

Zenith Trans-Oceanic

This set is a nine-transistor model tuning from 540 kc to 10.1 mc in four ranges, unbroken except for a 400-kc gap between 1.6 and 2.0 mc. Electrical bandspread is used on the 31-meter (9.4-10.1-mc), 25-meter (11.4-12.3-mc), 19-meter (14.6-15.8-mc), 16-meter (17.1-18.5-mc) and 13-meter (20.7-22.5-mc) bands. It has two broadcast-band antennas. One is a fixed ferrite-rod antenna coil inside the cabinet and the other is the *Wavemagnet*, a detachable ferrite-rod antenna with an extension cable for use on windows in steel buildings, trains, planes and automobiles or busses. Two suction cups hold the *Wavemagnet* in place on the window. The shortwave antenna—called the *Waverod*—is a 36-inch telescopic rod that slips down into the handle when not in use.

The Trans-Oceanic weighs only 13 pounds with batteries and is 10 $\frac{1}{4}$ inches high, 12 $\frac{1}{2}$ inches wide and 4 $\frac{7}{8}$ inches deep. It uses nine standard flashlight cells—good for up to 300 hours' use at normal volume. Eight of the batteries are for the transistor circuits and one for the dial lamps. A phono jack permits connecting a record player with a high-output cartridge (crystal or ceramic) to the set and playing it through the receiver's audio system.

Features of interest to the SWL include a rotary slide-rule type tuning dial ganged to the bandswitch so only the scale in use is visible, a calibrated logging scale just above the

dial face to insure accuracy in logging and retuning to a given shortwave station, a time-zone dial and a world time-zone map for use when listening for foreign broadcast stations.

Fig. 2 shows the circuit of the Trans-Oceanic Royal 1000. The transistor lineup is the same as in the Intercontinental except for the pair of 2N-109's in the first audio and driver stages.

The 2N370 rf amplifier is connected in a common-base circuit that corresponds to a grounded-grid vacuum-tube amplifier. This connection insures high stability in the (triode) amplifier without neutralizing it. The base is grounded for rf through a .05- μ f capacitor and is biased through the avc line. The input signal from the tuned antenna circuit is fed to the emitter and the output is developed across the primary of the rf coil (L11 through L18) for the band in use.

The amplified rf signal is fed to the mixer emitter through a low-impedance winding on the rf coil. The oscillator injection signal is fed to the mixer base. The mixer is operated close to zero bias for optimum conversion.

The oscillator is a tuned-plate arrangement with tickler feedback to the emitter. The base is biased and stabilized by a voltage-divider network. Oscillator output voltage is tapped off the emitter-return resistor network and fed to the mixer base through a 0.1- μ f capacitor.

The two-stage 455-kc if amplifier uses common-emitter circuitry. Each stage is neutralized by a 7- μ f capacitor between the base and one end of the tapped primary of the following if transformer. The second detector is a germanium diode. Its dc output is filtered and fed to the base of the rf amplifier. The first if amplifier is controlled by returning its base to the rf amplifier's emitter circuit.

The audio circuit is straightforward. The tone control consists of a variable R-C network across the tapped volume control. Treble cut is provided when the tone control is set so its arm connects the .01- μ f capacitor directly across the 200,000-ohm volume control.

The first af amplifier is a common-collector (cathode-follower) circuit. It feeds the 2N109 driver in a common-emitter arrangement. The driver is transformer-coupled to the 500-mw push-pull class-B stage. The power output stage is stabilized against thermal drift by a thermistor used as a part of the voltage divider supplying base bias.

The output transistors (Zenith part number 121-47) are used in matched pairs and are coded with red, white, yellow or green dots. If one fails, replace it with one having the same color code. Negative feedback is taken from the secondary of the output transformer and fed to the driver emitter. A 15-ohm phone is available as an accessory for private listening. Plugging in the phone automatically breaks the circuit to the speaker voice coil. END

Servicing the MOTOROLA AUTO TRANSISTOR RADIO

Servicing hints to keep in mind when working on the Motorola model GV-800 universal all-transistor auto radio

THE two main sources of trouble in transistor radios are the bias networks and the signal paths." This quote comes from the service manual on the Motorola model GV-800 all-transistor universal auto radio. The receiver, which is starting to appear in auto radios throughout the country, represents one of the first standard models intended for use in the ordinary automobile—it will fit almost any car with a 12-volt battery. It also shows the state of the Transistor Age, for here is a set that is not a luxury item for use in prestige type cars, but in those of the ordinary working man.

The model GV-800, whose circuit is shown in Fig. 1, is an AM receiver covering 540-1610 kc. It uses eight

transistors and operates from a 12-volt storage battery — **NEGATIVE GROUND.**

Servicing techniques

On the bench for repairs, use a storage battery to power the set, or a *well filtered and regulated supply*. The ripple in many battery eliminators will damage the transistors in this receiver.

Transistor receivers present new types of troubles and require new servicing methods. As in tube sets, when the receiver is defective the first step is to find the defective stage. But, here is where the process changes. In the transistor receiver two types of checks must be made. First is the usual process of signal injection to locate faults

in signal circuits. (Be sure that the generator's output is set so low that it can't possibly damage the transistors.) Now for the next step. *Measure the voltage drop across the emitter resistors*. This pinpoints troubles in the bias circuits. As a sign of how important this is, take a close look at Fig. 1. Here, as in the service manual, voltages that should be present across the emitter resistor resistances are on the schematic.

These voltage drops indicate the amount of current flowing through the stage when it is properly biased. Any defective component in the bias circuit, including the transistor, will change the bias voltages, changing the current and therefore changing the emitter resistor voltage drop. Any voltage drop

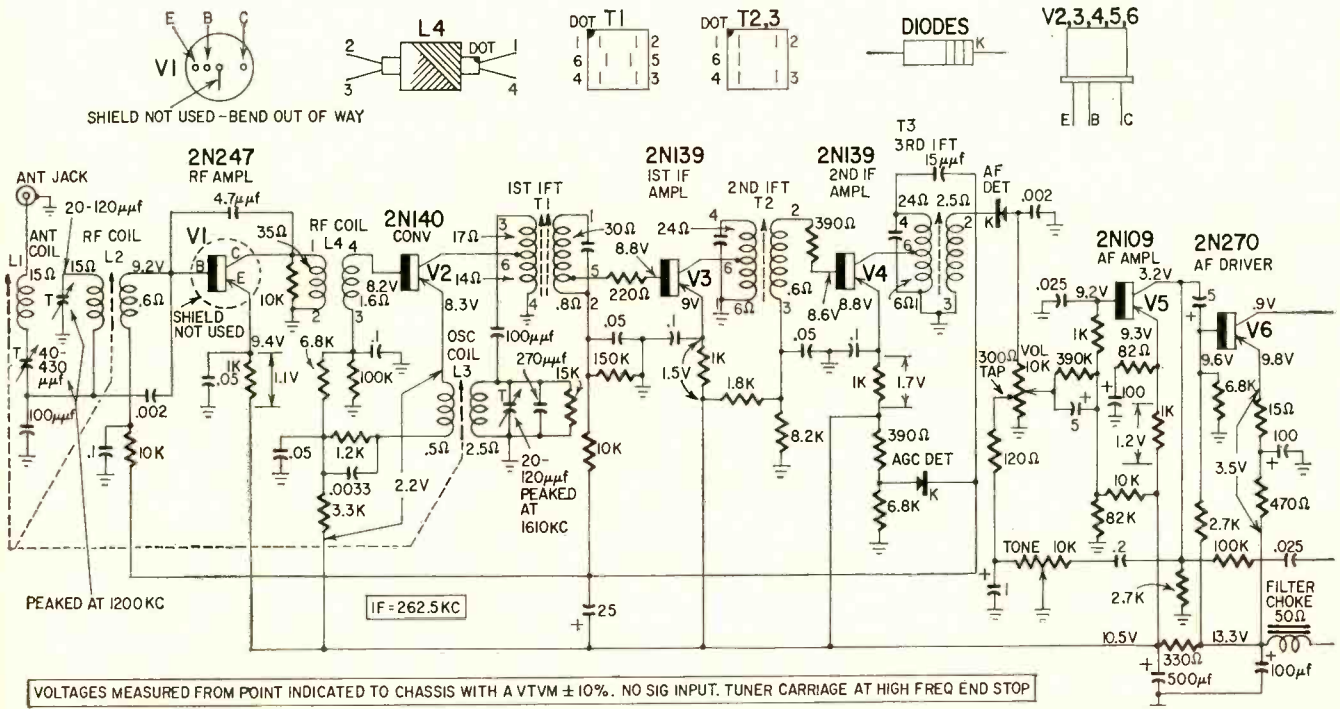

Fig. 1—Circuit of the 8-transistor broadcast receiver.



The GV-800 with its separate speaker.

that varies very much from those shown in the schematic indicates a defective stage.

The next step is to determine whether the transistor or the bias network is at fault. This is done by substituting a known good transistor in the stage. If the emitter resistance voltage drop remains the same, the original transistor is good; if it returns to normal, the transistor was bad. If this test shows the fault to be in the bias network, resistance checks will locate the defective part.

Weak reception is often caused by open bypass capacitors. To speed the checking of these units, use a capacitor subber (see Fig. 2). To use this aid, attach the alligator clip to the chassis and touch the probe to the ungrounded

end of the bypass capacitors. If a bypass is open, volume will increase when it is shunted. When checking the audio section there may be no increase in gain, but the pitch of the sound will change when an open bypass is shunted.

A few precautions

Do not short any part of the circuit to ground while testing, even though this may be a common practice in tube-set servicing.

For example, if a transistor base is grounded, bias is removed and excessive current can flow through the transistor, causing permanent damage.

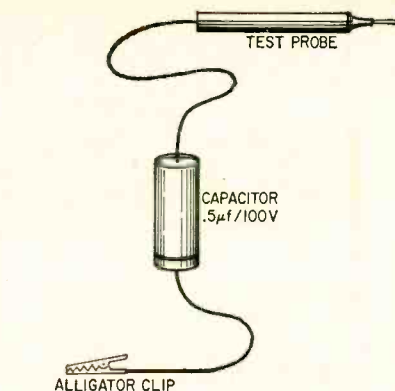

Fig. 2—Capacitor subber helps check bypasses fast.

When replacing power transistors, use a replacement with the same color type stamping. If the one you take out has the type number in white, replace it with another white one.

When installing the replacement, be sure the insulator is in place and that mounting screws are tight. If the insulator is left off, the transistor is shorted. If mounting screws are not tightened, there is not enough heat dissipation.

Whenever a power transistor is changed, collector current must be adjusted. See the service manual for the proper method to use on the set you are repairing. Following these simple steps will make repairing transistor auto receivers easier, faster and more profitable.

END
(The Radio Department continues on page 72)

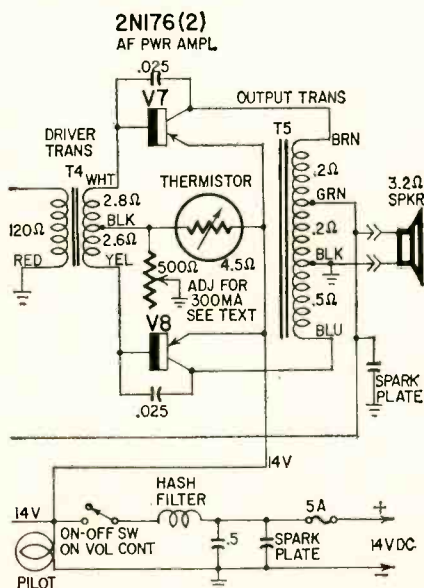
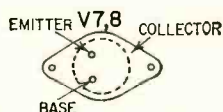

What's New? What's Old?

THE photo at the left shows a laboratory model fountain-pen-sized radio recently unveiled by RCA. The photo at the right was taken 12 years earlier to illustrate an article in the April, 1946, issue of this magazine in which

teries and antenna contained in the pen case. Gernsback's "radio pen" circuit, also based on military-developed components, was described as a four-tube superheterodyne receiver with self-contained battery and earphone,



Hugo Gernsback predicted the "radio pen," even preparing a mockup which was, of course, nonoperative. RCA's 2-ounce pen radio uses micromodular components developed for military use, has a five-transistor circuit with bat-

telescoping antenna. It measured 6 inches long, 3/4 inch in diameter. Shown a mockup of Gernsback's "radio pen" in 1946, RCA chairman (then president) David Sarnoff quipped: "It's too big!" RCA's "pen" is 5 1/2 x 1/2 inch!

"HEATHKITS[®]

gave me my start and I'm still sold!"

"... they are my lowest cost way to real quality and dependability in electronic equipment of any kind . . .

. . . The clean, modern styling of HEATHKITS make me proud to own them. They make a handsome and useful addition to my workshop.

. . . Rigid quality standards of components used in HEATHKITS assure me of performance equal to or surpassing instruments costing many times more.

. . . after assembling a HEATHKIT myself, I know what "makes it tick". . . I know that the thoughtful circuitry design and name-brand components used throughout guarantee me years of trouble-free service.

. . . HEATHKITS cost me half as much as ordinary equipment . . . and I get so much more. In assembling my own instruments I am sure of the quality that goes into them. Plus the complete assembly and operating instructions as well as detailed schematics that are at my fingertips for future reference."



NEW: Stereophonic Sound for your home with the new HEATHKIT STEREO CENTER. This, and other exciting new high fidelity developments are now available from the world's largest maker of "do-it-yourself" electronic kits.

NEW: For the Ham Radio fans—an all new Ham Transmitter and companion Receiver—featuring all the latest developments in Ham communication—including single-sideband operation.

NEW: A completely up-to-date Oscilloscope answering the long felt needs of electronic engineers and servicemen everywhere.

NEW: A host of newly developed marine instruments for the safety and convenience of the boat owner.

HEATH COMPANY Benton Harbor 20, Michigan

 a subsidiary of Daystrom, Inc.

The HEATH TIME PAYMENT PLAN allows you to outfit your whole workshop at one time with needed test instruments while you pay in easy monthly installments.



PROFESSIONAL OSCILLOSCOPE KIT

An exciting development in the Heathkit test instrument line is the introduction of the Heathkit model OP-1 Professional Oscilloscope. Emphasizing complete flexibility in any application, the OP-1 features DC coupled amplifiers and also DC coupled CRT tube un-blanking. The triggered sweep circuit will operate on either internal or external signals and may be either AC or DC coupled. The polarity of the triggering signal may also be selected, and any point on the wave form may be selected for the start of the sweep by using the "triggering level" control. An automatic position is also provided, in which the sweep recurs at a 50 cycle rate, but can be driven over a wide range of frequencies with no additional adjustments. The sweep frequencies are provided by switch-selected base rates of 2 and .2 milliseconds/CM, and 20, 2, and 1 microseconds/CM, in conjunction with a continuously variable 10 to 1 multiplier. Sweep frequencies are calibrated to within 10% at all control settings, and the sweep frequency may be reduced by adding capacity to the "ext. cap" binding post on the front panel. A 5ADP2 flat face CR tube is used for accurate readings on an edge lighted grid screen. A high quality conetic-fernetic CR tube shield prevents stray AC fields from distorting trace. A 12-position vertical attenuator is calibrated in volts-per-CM and the horizontal sweep is calibrated in time-per-CM. Prewired terminal boards are used for rapid, easy assembly of all critical circuits. Simply install and connect the color coded leads. Power supply is transformer operated utilizing silicon diode rectifiers and is fused for protection. Under development for over a year the OP-1 promises outstanding results in any application requiring the use of an oscilloscope.

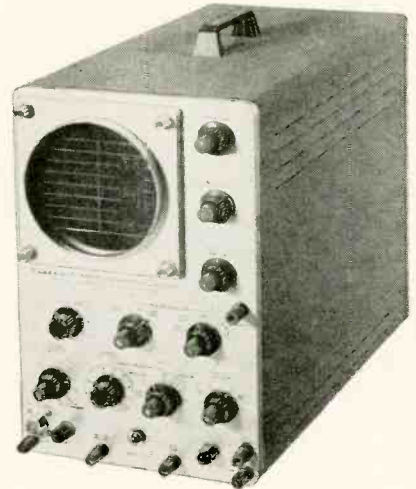

HEATHKIT
OP-1
\$179⁹⁵

*Here's the scope you've
been waiting for!*

AVAILABLE AFTER JUNE 15



**Laboratory
Performance At Less
Than Utility Scope
Price**

HEATHKIT
O-12
\$64⁹⁵



**A Scope You Will Be
Proud To Own**

HEATHKIT
OM-3
\$39⁹⁵

"EXTRA DUTY" 5" OSCILLOSCOPE KIT

Top quality features at half the cost of ordinary equipment sum up the advantages of this popular kit. Critical observations in your laboratory or shop are handled easily, with clear, sharp pattern displays in every application. Vertical frequency response extends from 3 CPS to 5 mc ± 1.5 db -5 db without extra switching. Response is down only 2.2 db at 3.58 mc. The Heath patented sweep circuit functions effectively from 10 CPS to better than 500 kc in five steps, giving you 5 times the usual sweep obtained in other scopes. An automatic sync circuit with self-limiting cathode follower provides excellent linearity and lock-in characteristics. Extremely short retrace time and efficient blanking action. Both vertical and horizontal output amplifiers are push-pull and the scope incorporates a 1 V peak-to-peak calibrating source, step attenuated and frequency compensated vertical input, plastic molded capacitors and top quality parts throughout. The 11-tube circuit features a 5U1 cathode ray tube, and provision is made for Z-axis input for intensity modulation of the beam. Frequency response of the horizontal amplifier is within ± 1 db from 1 CPS to 200 kc. Horizontal sensitivity is 0.3 volts RMS per inch. Construction is simplified through the use of two metal circuit boards and pre-cut, cable wiring harness. Shpg. Wt. 22 lbs.

GENERAL PURPOSE 5" OSCILLOSCOPE KIT

For servicing and routine laboratory work this fine kit is a favorite with technicians throughout the country. It incorporates many extras not expected at this low price. Features wide vertical amplifier frequency response, extended sweep generator operation, and improved stability. Frequency response of the vertical amplifier is within ± 3 db from 4 CPS to 1.2 mc. Vertical sensitivity is .09 volts RMS per inch at 1 kc. Sweep generator functions reliably from 20 CPS to over 150 kc. A modern etched circuit board is featured for high stability and reduces assembly time considerably. Standard components are mounted on this board with each position clearly marked preventing wiring errors. Both vertical and horizontal amplifiers are push-pull types. Uses a 5BP1 CRT. Provision for external or internal sweep or sync, built in 1 V peak-to-peak reference voltage and calibrated grid screen. An adjustable "spot shape" control is provided to insure a sharp trace. Input to the vertical amplifiers is through a step attenuated, frequency compensated circuit. The OM-3 is an extremely versatile instrument and has a multitude of practical uses in electronic testing fields. Particularly useful in alignment of television receivers, for testing audio amplifiers and circuits, and checking the quality of modulated RF signals in Ham Radio transmitters. Shpg. Wt. 22 lbs.

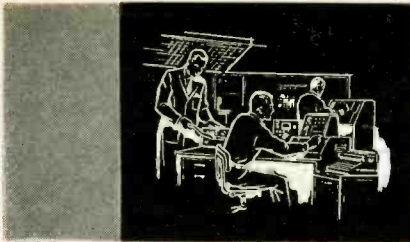

Equip Your Service Bench...



HEATHKIT
CD-1 **\$59⁹⁵**

Cash In Now On Color TV

- ★ 10 VERTICAL COLOR BARS
- ★ CRYSTAL CONTROLLED ACCURACY
- ★ CHOICE OF 6 DIFFERENT PATTERNS

COLOR BAR AND DOT GENERATOR KIT

Colored television is now a reality and as the number of these sets increase the need for a reliable service instrument is apparent. Nothing on the market... in this type of generator has as many features as the CD-1 at such a tremendous price saving. This unit combines two basic color service instruments, a color bar generator, and white dot generator in one versatile portable unit which has crystal controlled accuracy and stability for steady locked-in patterns (requires no external sync leads). Color receivers converged with the CD-1 will still be converged properly on a television program from the station. The 13-tube circuit has been carefully laid out for ease of assembly and provides choice of six different patterns. Produces white-dots, cross hatch, horizontal and vertical bars, ten vertical color bars, and a new shading bar pattern for screen and background adjustments. Variable RF output on any channel from 2 to 6. Positive or negative video output, variable from 0 to 10 volts peak-to-peak. Crystal controlled sound carrier with off-on switch. Voltage regulated power supply uses long-life silicon rectifiers. Kit includes three crystals and test lead, plus an information packed instruction manual covering convergence, and screen and background adjustments of a color TV set. Compare with other generators on the market and you will see that this instrument is loaded with extras and top quality all the way through. Shpg. Wt. 13 lbs.



HEATHKIT
TS-4A **\$49⁵⁰**

*For fast,
easy alignment
of TV sets*



HEATHKIT
AG-10 **\$49⁹⁵**

*Sine and
square waves for
countless uses*



HEATHKIT
MM-1 **\$29⁹⁵**

*High accuracy
in a
portable meter*



HEATHKIT
M-1 **\$17⁹⁵**

*An all-round
meter of
many uses*

TV ALIGNMENT GENERATOR KIT

This generator has many special design features for flexible, easy operation and reliability. The all-electronic sweep circuit insures stability and covers 3.6 mc to 220 mc in four bands. Sweep deviation is controllable from 0 to 42 mc. Crystal and variable marker oscillators are built in. Crystal (included with kit) provides output at 4.5 mc and multiples thereof. Variable marker provides output from 19 to 60 mc on fundamentals and from 57 to 180 mc on harmonics. Effective two-way blanking and phasing control also provided. A truly outstanding number of features at a tremendous price saving. Shpg. Wt. 16 lbs.

SINE-SQUARE GENERATOR KIT

High quality sine and square waves are produced by this generator over a wide range. Frequency response is ± 1.5 db from 20 CPS to 1 mc on both sine and square waves, with less than .25% sine wave distortion, 20 to 20,000 CPS. Output impedance is 600 ohms on sine wave and 50 ohms on square wave (except on 10 volt range). Square wave rise time less than .15 microseconds. Five-position bandswitch—continuously variable tuning—shielded oscillator circuit—separate step and variable output attenuators in ranges of 10, 1 and .1 volts with extra range of .01 volt on sine wave. Shpg. Wt. 12 lbs.

20,000 OHMS/VOLT VOM KIT

This meter is ideal for use in field applications where accuracy is important. Employs a 50 ua $4\frac{1}{2}$ " meter, and features 1% precision multiplier resistors for high accuracy. Requires no external power for operation (batteries supplied). Sensitivity is 20,000 ohms-per-volt DC and 5,000 ohms-per-volt AC. Measuring ranges are 0-1.5, 5, 50, 150, 500, 1500 and 5,000 volts AC and DC. Measures direct current in ranges of 0-150 ua, 15 ma, 150 ma, 500 ma and 15 a. Resistance multipliers are x 1, x 100 and x 10,000. Covers -10 db to +65 db. Batteries and test leads are also included with this kit. Shpg. Wt. 6 lbs.

HANDITESTER KIT

Small enough to carry with you wherever you go, this fine handitester is ideal for use in portable applications when making tests away from the work bench or as an "extra" meter in the service shop, when the main instruments are occupied. The combination function-range switch simplifies operation. Measures AC or DC voltage from 0-10, 30, 300, 1000 and 5000 volts. Direct current ranges are 0-10 ma and 0-100 ma. Ohmmeter ranges are 0-3000 and 0-300,000. Top quality precision components employed throughout. Very popular with home experimenters and electricians. Shpg. Wt. 3 lbs.

with Low-Cost Dependable Heathkits



ETCHED CIRCUIT VTVM KIT

The fact that this instrument is outselling all other VTVM's says a great deal about its accuracy, reliability, and overall quality. The precision and quality of the components used in this VTVM cannot be duplicated at this price through any other source. Its attractive appearance as well as its performance will make you proud to own it. A large 4½" panel meter is used for indication, with clear, sharp calibrations for all ranges. Front panel controls consist of a rotary function switch and a rotary range selector switch, zero-adjust and ohms-adjust controls. Precision 1% resistors are used in the voltage divider circuit. An etched circuit board is employed for most of the circuitry, cutting assembly time and eliminating the possibility of wiring errors. It also assures duplication of laboratory instrument performance. This multi-function VTVM will measure AC voltage (RMS), AC voltage (peak-to-peak), DC voltage and resistance. There are 7 AC (RMS) and DC voltage ranges of 1.5, 5, 15, 50, 150, 500 and 1500. In addition there are 7 peak-to-peak AC ranges of 0-4, 14, 40, 140, 400, 1400 and 4,000. Seven ohmmeter ranges providing multiplying factors of x 1, x 10, x 100, x 1000, x 10 k, x 100 k and x 1 megohm. Center scale resistance readings are 10, 100, 1000, 10 k, 100 k ohms, 1 megohm and 10 megohms. A zero-center scale db range is also provided. Battery and test leads included with kit. Shpg. Wt. 7 lbs.



HEATHKIT
V-7A
\$24.50

**World's largest selling
VTVM kit**

- ★ LARGE EASY-TO-READ 4½" 200 UA METER
- ★ 1% PRECISION RESISTORS EMPLOYED FOR HIGH ACCURACY



HEATHKIT
C-3
\$19.50

**Checks all types of
condensers accurately**



HEATHKIT
T-4
\$19.95

**Locate faults quickly
by tracing signals**



HEATHKIT
SG-8
\$19.50

**Easy-to-build—prewound
and calibrated coils**

CONDENSER CHECKER KIT

Check unknown condenser and resistor values quickly and accurately. Capacity measurements are made in four ranges of .00001 mfd-.005 mfd; .001 mfd-.5 mfd; .1 mfd-50 mfd; 20 mfd-1,000 mfd. Checks paper, mica, ceramic, and electrolytic condensers. Leakage test provides switch selection of five polarizing voltages, 25 volts to 450 volts DC to indicate condenser operating quality under actual load conditions. Electron beam "eye" tube indicates balance and leakage. A spring return test switch automatically discharges condenser under test and eliminates shock hazard to the operator. Measures resistance from 100 ohms to 5 megohms in two ranges. Shpg. Wt. 7 lbs.

VISUAL-AURAL SIGNAL TRACER KIT

Here is a brand new signal tracer completely redesigned with compact dimensions and new circuit layout. Features built-in speaker and electron beam "eye" tube for signal indication and a unique noise locator circuit. Ideal for use in AM, FM and TV circuit investigation. RF and audio inputs are provided in one convenient probe with switch on probe to select either input. Useful for checking microphones, phono cartridges, record changers, tuners, etc. Makes a handy substitution speaker for servicing TV sets at the shop. Transformer operated for safety and high efficiency. Complete with test leads and informative construction manual. Shpg. Wt. 6 lbs.

RF SIGNAL GENERATOR KIT

Save valuable time in aligning RF tuned circuits of all kinds with this easy-to-use kit. Also a quick way to trace signals in faulty RF, IF and audio circuits. Designed for general service applications—the SG-8 covers 160 kc to 110 mc on fundamentals in five bands, and from 110 mc to 220 mc on calibrated harmonics. The entire oscillator circuit is built on a special sub-chassis, using prewound and calibrated coils. No further calibration is required so it is ready to use as soon as construction is completed. RF output is in excess of 100,000 microvolts, controlled by both step and continuously variable controls. Complete with output cable and instructions. Shpg. Wt. 8 lbs.

HEATH COMPANY • a subsidiary of Daystrom, Inc. • **Benton Harbor 20, Mich.**

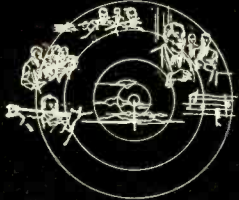

Enjoy Rich 3 Dimension Sound...

Beautifully Styled with Plenty of Room for the Most Complete Stereo System

AVAILABLE IN THE FOLLOWING MODELS:
 Model SE-1B—Stereo Equipment Cabinet (birch)
 Model SE-1M—Stereo Equipment Cabinet (mahogany)

\$149⁹⁵ ea.

Model SC-1BR—Stereo Wing Speaker Enclosure (birch—right end)
 Model SC-1BL—Stereo Wing Speaker Enclosure (birch—left end)
 Model SC-1MR—Stereo Wing Speaker Enclosure (mahogany—right end)
 Model SC-1ML—Stereo Wing Speaker Enclosure (mahogany—left end)

\$39⁹⁵ ea.

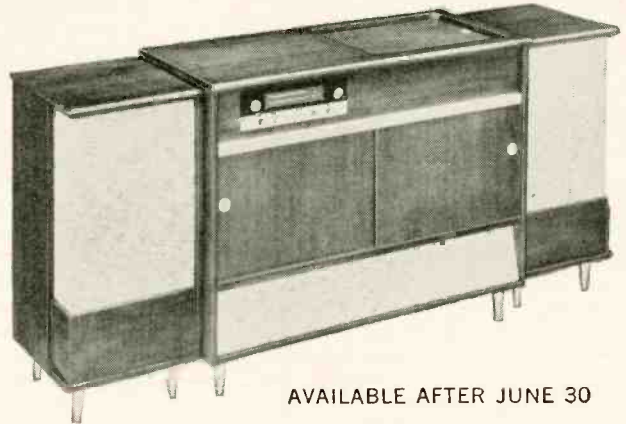

AVAILABLE AFTER JUNE 30

STEREO EQUIPMENT CABINET KIT

Imagine!... Stereophonic sound in your own home. This superbly designed cabinet holds all of your hi-fi stereo equipment and lends striking elegance to your living room. The attractive gold and black panels, trim and hardware brilliantly highlight the overall effect. Rich toned grille cloth, flecked in gold and black, complement the cabinet. The unit has ample room provided for an AM-FM tuner, tape deck, stereo pre-amplifier, amplifiers, record changer, record storage and speakers. Beautifully grained 3/4" solid core Philippine mahogany or select birch plywood is used for construction. The top features a shaped edge and sliding top panel for easy access to the stereo tape deck and stereo preamplifier. Sliding doors are employed for convenient front access to the

changer and record storage compartment. All parts of the cabinet are precut and predrilled for simple assembly. The speaker wings and center cabinet may be purchased separately if desired. Note: the kit is delivered equipped with panels precut to accommodate Heathkit components and also blank panels to cut out for your own equipment. Measurements of the individual component areas follow: tape deck and preamplifier area 20 3/4" L. x 17 3/4" W. x 10" D., record changer area 21" W. x 16" D. x 9 5/8" H., record storage area 22 5/8" W. x 14 1/2" H. x 12 1/2" D., speaker wing area (inside) 14" W. x 29 1/2" H. x 15 3/4" D., AM-FM Tuner area 20 1/2" W. x 5 1/4" H. x 14" D., amplifier (2 areas) 15 1/4" W. x 10 3/4" H. x 13 1/4" D.

Model HH-1B Birch
 Model HH-1M Mahogany
 Now only **\$299⁹⁵** each



The Same Superior Performance At a New Low Price



HEATHKIT SS-2 **\$39⁹⁵**

OPTIONAL LEGS EXTRA

Economical Hi-Fi For Your Home

"LEGATO" HI-FI SPEAKER SYSTEM KIT

The increasing sales of the Legato has made more economical quantity production possible so we are passing the savings on to you by offering you this magnificent speaker system at a reduced price. Truly a "queen" among hi-fi speaker systems, the Legato was specially designed to meet and surpass the most stringent requirements of high fidelity sound reproduction. Two 15" Altec Lansing low frequency drivers cover frequencies of 25 to 500 CPS while a specially designed exponential horn with high frequency driver covers 500 to 20,000 CPS. A unique crossover network is built in making electronic crossovers unnecessary. Internal reflections are absorbed by splayed back panel and a 3" fiber glass lining. The Legato emphasizes simplicity of line and form to blend with modern or traditional furnishings. Cabinet construction is 3/4" veneer surface plywood in either African mahogany or white birch and measures 41" L. x 22 1/4" D. x 34" H. All parts are precut and predrilled for easy assembly, Shpg. Wt. 195 lbs.

"BASIC RANGE" HI-FI SPEAKER SYSTEM KIT

True high fidelity performance at modest cost make this basic speaker system a spectacular buy for any hi-fi enthusiast. The amazing performance of this popular kit is made possible by the use of high quality speakers in an enclosure specially designed to receive them. The cabinet is a ducted port bass reflex type enclosure 11 1/2" H. x 23" W. x 11 3/4" D. It features an 8" mid range woofer to cover 50 to 1600 CPS and a compression-type tweeter with flared horn covering 1600 to 12,000 CPS. Both speakers are by Jensen. The adjustable flared tweeter horn allows speaker to be used in either upright or horizontal position. The cabinet is constructed of 1/2" veneer surfaced plywood suitable for light or dark finish of your choice. All wood parts are precut and predrilled for easy assembly. Shpg. Wt. 25 lbs.

Attractive brass tip accessory legs convert SS-2 into attractive console. Legs screw into brackets provided. All hardware included. Shpg. Wt. 3 lbs. No. 91-26 \$4.95

with a Heathkit Stereo System

HEATHKIT

HIGH FIDELITY STEREO TAPE DECK KIT

For your unparalleled enjoyment in the world of stereophonic sound Heathkit brings you an all new stereo tape deck. This tape deck is a precision engineered instrument providing monaural record/playback, and stereo playback of prerecorded tapes. Incorporates three separate heads, erase-record-stereo playback (stacked). The mechanical tape deck assembly is supplied complete. You build only the record and playback circuit employing two etched circuit boards for ease of wiring. Low noise EF-86 tubes in input stages and efficient push-pull bias-erase oscillator insures complete freedom from hum and noise in recording and playback. Provision made for $3\frac{3}{4}$ and $7\frac{1}{2}$ IPS tape speed selected by a push button. Deck handles up to 7" reels of tape. Other features are: provision for monitoring tape while recording, built in VU meter for proper recording level, pause control for editing tape, "fast forward" and "rewind" control. Frequency response at $7\frac{1}{2}$ IPS tape speed is ± 2 db from 40 to 12,000 CPS, at $3\frac{3}{4}$ IPS speed 40 to 6,000 CPS. Signal-to-noise ratio is 55 decibels with less than 1% total harmonic distortion. NARTB tape playback equalization. A safety interlock button prevents accidentally switching to record position causing erasure of recorded tapes. Shpg. Wt. 33 lbs.

Model TR-1C monaural tape deck incorporates all of the features described for the model TR-1D with the exception of stereo playback. \$131.95.

No. C-TR-1C conversion kit converts model TR-1C to include stereo function of model TR-1D. \$15.95.



HEATHKIT
TR-1D

\$143⁹⁵

**Preassembled Tape Mechanism . . .
You Build Only Electronic Circuit**

AVAILABLE AFTER JUNE 30

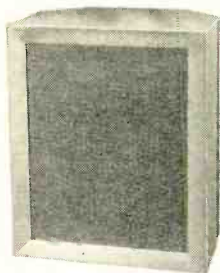

HEATHKIT
SS-1B

\$99⁹⁵

**Fill out the Hi-Fi Range
of Your SS-2 Speaker**

"RANGE EXTENDING" HI-FI SPEAKER SYSTEM KIT

This is not a complete speaker system in itself, but is designed to extend the range of the SS-2. The SS-1B uses a 15" woofer and a small super tweeter to supply the very high and very low frequencies to fill out the response of the basic SS-2. The SS-2 and SS-1B when used together, form an integrated four speaker system. The SS-2 and SS-1B combination provide an overall response of ± 5 db from 35 to 16,000 CPS. The kit includes circuit for crossover at 600, 1600 and 4,000 CPS. Impedance is 16 ohms and power rating is 35 watts. A control is also provided to limit output of super tweeter. The handsome cabinet measures 29" H. x 23" W. x 17 $\frac{1}{2}$ " D. Constructed of beautiful $\frac{3}{4}$ " veneer surface plywood. Complete step-by-step instructions make this kit easy to build. No wood-working experience required. Shpg. Wt. 80 lbs.

AVAILABLE AFTER JUNE 30



HEATHKIT
SW-1

PRICE TO BE
ANNOUNCED

Save Time Rewinding Tape

"SPEEDWINDER" KIT

This handy device leaves your tape recorder free for operation while it rewinds tape at the rate of 1200' in 40 seconds. Prevents unnecessary wear to the tape and recorder by eliminating wear against guides and heads. It will handle up to 10 $\frac{1}{2}$ " tape reels as well as 800' reels of 8 and 16 millimeter film. A very useful aid to operators of movie projection equipment. The Heathkit Speedwinder features an automatic shutoff which prevents whipping of tape when it has rewound. A manual shutoff is also provided. An automatic braking device is built in for protection against power failure. Driven by a heavy duty four pole motor. Handsome cabinet is constructed of furniture grade plywood. Step-by-step instructions are provided to make this kit easy to assemble even by one with no experience.

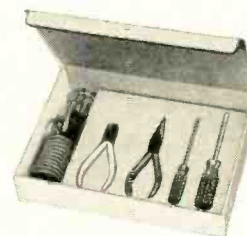

HEATHKIT
TK-1

\$9⁹⁵

**All The Tools You Need For
Building Heathkits**

COMPLETE TOOL SET

A clear illustration of just how easy Heathkit building is. The pliers, diagonal sidecutters, two screw drivers and soldering iron are all the basic tools you need for building practically any Heathkit. Pliers and sidecutters are equipped with insulated rubber handles. The American Beauty soldering iron has a replaceable tip to facilitate cleaning. All the tools are of top quality case hardened steel for rugged duty and long life. With these simple, inexpensive tools in your hand you need not be afraid to tackle the most elaborate kit. The manual included with this handy kit provides you with many useful tips on the use and care of your tools. It shows the all important step of making proper solder connections. A truly worthwhile investment for the beginner in electronic kit building. Shpg. Wt. 3 lbs.

HEATH COMPANY • a subsidiary of Daystrom, Inc. • Benton Harbor 20, Mich.

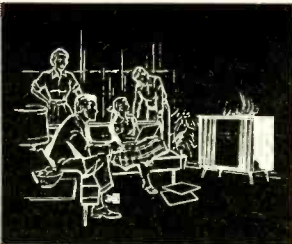

Plan Your Hi-Fi System...

AVAILABLE AFTER JUNE 30



HEATHKIT
SP-2 **\$56⁹⁵**

Model SP-1 (monaural)
\$37.95

Model C-SP-1 (converts SP-1 to SP-2)
\$21.95

**Control both stereo
channels simply
and conveniently**

MONAURAL-STEREO PREAMPLIFIER KIT

This expertly designed preamplifier provides all the controls required for either standard monaural (single channel) or stereo (dual channel) sound reproduction. Features building block design... you can start with a basic preamplifier and add a second channel for stereo later on, without rewiring. Second channel plugs in for fast conversion. The complete model SP-2 (stereo) features twelve separate inputs, six on each channel with input level controls. Six dual-concentric controls consist of: two 8-position selector switches, two bass, two treble, two volume level and two loudness controls, a scratch filter switch and a 4-position function switch (separate on-off switch). The function switch provides settings for stereo, two-channel mix, channel A or B for monaural use. Inputs consist of tape, mike, mag phono and three high-level inputs. Tape input has NARTB equalization and input selector provides for RIAA, LP, 78 record compensation. EF86 tubes are used in the input stages along with hum balance controls to assure low hum and noise. Two cathode follower outputs with level controls provided in addition to two separate tape outputs for stereo recording. A remote balance control with twenty feet of cable allows balancing the stereo system from listening position. Construction is greatly simplified through the use of two printed circuit boards (one in each channel) and encapsulated printed circuits. The beautiful vinyl clad steel cover has leather texture in black with inlaid gold design. Built-in power supply.



HEATHKIT
WA-P2
\$19⁷⁵

**Finger-tip controls for
your operating convenience**



HEATHKIT
UA-1
\$21⁹⁵

**A low cost
versatile performer**

"MASTER CONTROL" PREAMPLIFIER KIT

Designed as a control center for basic amplifiers the WA-P2 provides you with true high fidelity performance for the finest audio systems. Five switch-selected inputs accommodate a record changer, tape recorder, AM-FM tuner, TV receiver, microphone, etc., each with level control. Provision is also made for a tape recorder output. Ideal for "remote" installations, the WA-P2 features a low impedance cathode-follower output circuit allowing greater length of output lead. Full frequency response is obtained within $\pm 1\frac{1}{2}$ db from 15 to 35,000 CPS and will do full justice to the finest available program sources. Equalization is provided for records through separate turnover and rolloff switches for LP, RIAA, AES, and early 78's. A special hum balance control allows setting for minimum hum level. Power for operation is required from basic amplifier or external source. Shpg. Wt. 7 lbs.

"UNIVERSAL" 12-WATT AMPLIFIER KIT

A true high fidelity performer in every sense of the word, the UA-1 makes an ideal basic amplifier for any hi-fi system and is a perfect addition to gear your present hi-fi system for stereo sound. Uses 6BQ5/EL84 push-pull output tubes for less than 2% harmonic distortion throughout the entire audio range (20 to 20,000 CPS) at full 12 watt output. The on-off switch is located right on the chassis and an octal socket is provided for connecting a preamplifier for remote control operation. The specially designed output transformer provides excellent stability and frequency-response. Taps for 4, 8 and 16 ohm speakers, with switched damping for "unity" or "maximum" on the 16-ohm tap. An input level control is provided for use in wired music systems where a preamplifier is not required. This versatile unit is the latest addition to the fine line of Heathkit basic amplifiers. Shpg. Wt. 13 lbs.

With Flexible Heathkit Components



DELUXE AM-FM TUNER KIT

Outstanding features in both styling and circuitry are combined in this 16-tube deluxe AM-FM combination tuner to bring you the very finest in program sources, for your listening enjoyment. Features include three circuit boards for easy construction and high stability—prewired, prealigned FM front end—built-in AM rod antenna—tuning meter—AFC (automatic frequency control) with on-off switch and flywheel tuning. AM and FM circuits are separate and individually tuned making it ideal for stereo applications. Cathode follower outputs with individual controls are provided for both AM and FM. Other features include variable AM bandwidth, 10 kc whistle filter, tuned-cascode FM front end, FM AGC and amplified AVC for AM. The unique IF limiter design automatically provides the number of limiting and IF stages required for smooth non-flutter reception. The silicon diode power supply is extremely conservatively rated and is fuse protected assuring long service life. A tuning meter shows when the station is tuned-in for clearest reception on AM or FM. Use of three circuit boards greatly simplifies construction of circuit, you do only a minimum of wiring. All IF transformers and coils are prealigned so it will be ready to operate as soon as construction is completed. Appearance of this top-quality unit is further enhanced by the vinyl-clad steel cover in black with inlaid gold design. A multiplex jack is provided for addition of converter unit to receive multiplex stereo broadcasts on FM. A top dollar value.

AVAILABLE AFTER JUNE 30



HEATHKIT
PT-1

\$89⁹⁵

**A deluxe AM-FM
tuner combination
loaded with extras!**

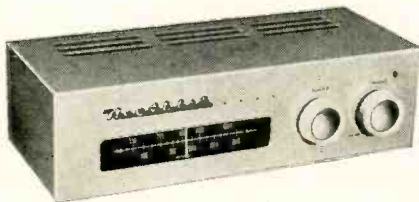

HEATHKIT
BC-1A

\$25⁹⁵

Wide range broadcast reception



HEATHKIT
FM-3A

\$25⁹⁵

Enjoy static-free FM entertainment

HIGH FIDELITY AM TUNER KIT

This AM tuner was designed especially for high fidelity applications. It incorporates a special detector using crystal diodes, and the IF circuit features broad bandwidth to assure low signal distortion. Audio response is ± 1 db from 20 CPS to 9 kc, with 5 db of pre-emphasis at 10 kc to compensate for station rolloff. Sensitivity and selectivity are excellent and the tuner covers the entire broadcast band from 550 to 1600 kc. Quiet performance is assured by a 6 db signal-to-noise ratio at 2.5 uv. Prealigned RF and IF coils eliminate the need for special alignment equipment. Incorporates AVC, two outputs, two antenna inputs, and built-in power supply. Edge-lighted glass slide rule dial for easy tuning. Your "best buy" in an AM tuner. Shpg. Wt. 9 lbs.

HIGH FIDELITY FM TUNER KIT

FM programming, your least expensive source of high fidelity will provide you with years of real enjoyment. This beautifully styled FM tuner features broad-banded circuits for full fidelity and better than 10 uv sensitivity for 20 db of quieting to pull in stations with clarity and full volume. Covers the complete FM band from 88 to 108 mc. Stabilized, temperature-compensated oscillator assures negligible drift after initial warmup. A ratio detector provides high-efficiency demodulation without sacrificing hi-fi performance. IF and ratio transformers are prealigned, as is the front end tuning unit, making special alignment equipment unnecessary. Edge-lighted glass slide rule dial for easy tuning. You need not wait to have FM in your home at this low price. Shpg. Wt. 8 lbs.

HEATH COMPANY • a subsidiary of Daystrom, Inc. • **Benton Harbor 20, Mich.**

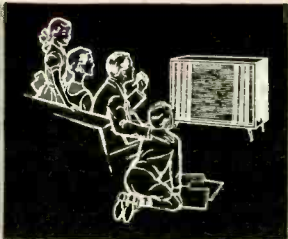

You can be sure you're buying High Fidelity

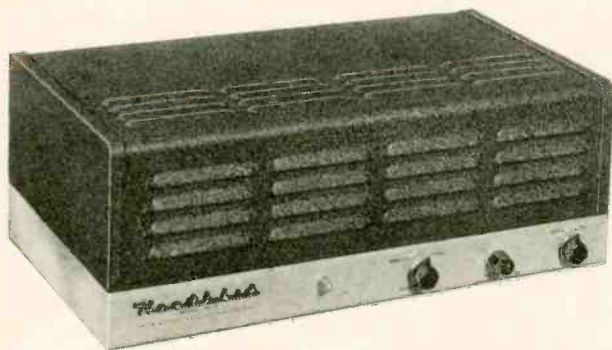

HEATHKIT
W-7M

\$54⁹⁵

**55 watts of hi-fi power at
only \$1 per watt**

- ★ BEAUTIFULLY STYLED IN BLACK AND GOLD
- ★ UNITY OR MAXIMUM DAMPING

**"EXTRA PERFORMANCE"
55 WATT HI-FI AMPLIFIER KIT**

Another Heathkit first! An honestly rated high power amplifier with many top quality features at less than a dollar per watt. Full audio output is conservatively rated at 55 watts from 20 CPS to 20 kc with less than 2% total harmonic distortion throughout the entire range. Unique paired output connections permit instant switch selection of "unity" or "maximum" damping factors for all 4, 8 or 16 ohm speakers. Each output has an optimized current feedback circuit for unity damping so that there will be no compromise in performance when any of the impedances is used. This current feedback circuitry is entirely shorted out when not in use to obtain the highest possible damping factor. Features include level control and "on-off" switch right on the chassis plus provision for remote control from preamp, etc. Famous "bas-bal" circuit conveniently balances EL-34 output tubes. These heavy duty push-pull tubes operate into a high quality tapped-screen transformer designed especially for this unit. A 70-volt output on the transformer provides for P.A. or large music systems. The silicon diode power supply features a protection device that controls current until tubes have warmed up, greatly increasing service life of all components. The stylish black and gold case measures 6" H. x 8½" D. x 15" W. Convenient pilot light on the chassis. Thoughtful circuit layout makes this kit easy to build. Dollar for watt you can't beat this buy. Shipped express only. Shpg. Wt. 28 lbs.

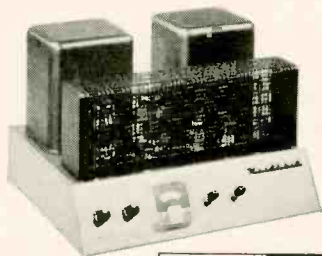

HEATHKIT
W-6M

\$109⁹⁵

**Plenty of Reserve Power
Without Distortion**

"HEAVY DUTY" 70-WATT HI-FI AMPLIFIER KIT

Here is an amplifier that will provide the extra "push" needed to drive any of the fine speaker systems available today, for truly fine performance at any power level. Silicon-diode rectifiers are used to assure long life and a heavy duty transformer gives you extremely good power supply regulation. Variable damping control provides optimum performance with any speaker system. Quick change plug selects 4, 8 and 16 ohms or 70 volt output and the correct feedback resistance. Frequency response at 1 watt is from 5 CPS to 80 kc with controlled HF rolloff above 100 kc. At 70 watts output harmonic distortion is below 2%, 20 to 20,000 CPS and 1M distortion is below 1%, 60 and 6,000 CPS. Hum and noise 88 db below full output. Metered balance circuit. Designed especially for easy assembly and years of dependable service. Shipped express only. Shpg. Wt. 52 lbs.



HEATHKIT
W-5M

\$59⁷⁵

**Top-Flight Performance
for the Critical Listener**

25-WATT HI-FI AMPLIFIER KIT

Considered top value in its power class by leading independent research organizations, the W-5M incorporates all the design features required by the super critical listener. Features include a specially designed Peerless output transformer and KT66 tubes. The circuit is rated at 25 watts and will follow instantaneous power peaks of a full orchestra up to 42 watts. A "tweeter saver" suppresses high frequency oscillation and a new type balancing circuit facilitates adjustment of the "dynamic" balance between output tubes. Frequency response is ±1 db from 5 CPS to 160,000 CPS at 1 watt and within 2 db from 20 to 20,000 CPS at full 25 watts output. Harmonic distortion is less than 1% at 25 watts and 1M distortion is 1% at 20 watts (60 and 3,000 CPS, 4:1). Hum and noise are 99 db below 25 watts for truly quiet performance. Rich black and gold colored styling. Shipped express only. Shpg. Wt. 31 lbs.



HEATHKIT
W4-AM

\$39⁷⁵

**Faithful Sound Reproduction
with Minimum Investment**

20-WATT HI-FI AMPLIFIER KIT

This fine amplifier will amaze you with its outstanding performance. It features a true Williamson circuit with extended frequency response, low distortion, and low hum levels. Enjoy true hi-fi with only a minimum investment compared to other units on the market. 5881 tubes and a special Chicago-Standard output transformer are employed to give you full fidelity at minimum cost. Frequency response extends from 10 CPS to 100 kc within ±1 db at 1 watt assuring you of full coverage of the audio range. Clean, clear sound amplification takes place in circuits that hold harmonic distortion at 1.5% and 1M distortion below 2.7% at full 20 watt output. Hum and noise are 95 db below full output. Taps on the output transformer are at 4, 8 or 16 ohms to match the speaker system of your choice. An outstanding performer, this investment will bring you years of listening enjoyment. Shipped express only. Shpg. Wt. 28 lbs.

All basic amplifiers recommended for use with model WA-P2, SP-1 or SP-2 preamplifiers

...When You Buy Heathkits

HEATHKIT

"BOOKSHELF" 12-WATT AMPLIFIER KIT

The model EA-2 combines eye-pleasing style and color with many extra features for high quality sound reproduction. This fine amplifier provides full range frequency response from 20 to 20,000 CPS within ± 1 db. Harmonic distortion is less than 1% at full 12 watt output over the entire range (20-20,000 CPS). IM distortion is less than 1.5% at 12 watts with low hum and noise. Miniature tubes are used throughout the advanced circuitry, including EL84 output tubes in a push-pull tapped-screen output circuit using a special designed output transformer. Transformer has taps at 4, 8 and 16 ohms. The model EA-2 has its own built-in preamplifier with provision for three separate inputs, mag phono, crystal phono and tuner. The mag phono input features RIAA equalization. Separate bass and treble controls are provided with boost and cut action. A special hum-balance control assures quiet operation. The luxury styled cabinet has a smooth simulated leather texture in black with inlaid gold design and is constructed of vinyl plastic bonded to steel. It resists scuffing, wear, abrasion, and chemicals. The front panel features brushed-gold trim and buff knobs with gold inserts for a very pleasing appearance. An amber neon pilot lamp indicates when the amplifier is on. Cabinet measures 12½" W. x 3¾" D. x 4¾" H. making it suitable for use on a bookshelf, end table, etc. High quality is emphasized throughout for performance matching amplifiers costing many times more. Shpg. Wt. 15 lbs.



HEATHKIT
EA-2

\$27⁹⁵

**Combines beauty, style
and quality**

- ★ LESS THAN 1% DISTORTION AT FULL OUTPUT OVER ENTIRE AUDIO RANGE.
- ★ BUILT-IN PREAMPLIFIER

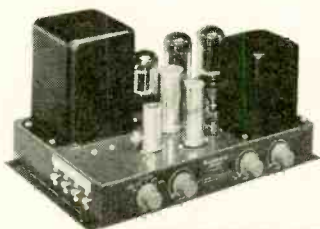

HEATHKIT
A9-C

\$35⁵⁰

**A Bargain Package of
Power and Performance**



HEATHKIT
AV-3

\$29⁹⁵

**Invaluable for
Hi-Fi Testing**



HEATHKIT
AW-1

\$29⁵⁰

**Measure Exact
Power Output**

GENERAL-PURPOSE 20-WATT AMPLIFIER KIT

The A9-C combines a preamplifier, main amplifier and power supply all on one chassis providing a compact unit to fill the need for a good high fidelity amplifier with a moderate cash investment. Designed primarily for home installations, it is also capable of fulfilling P.A. requirements. The preamplifier section features four separate switch selected inputs. Separate bass and treble tone controls offer 15 db boost and cut. A true high fidelity performer, the A9-C covers 20 to 20,000 CPS within ± 1 db. Front panel is detachable, and can be installed on the outside of a cabinet where the chassis comes through, for custom installations. A fine unit with which to start your hi-fi system. Shpg. Wt. 23 lbs.

AUDIO VTVM KIT

Critical AC voltage measurements are made easy with this high quality vacuum tube voltmeter which emphasizes stability, broad frequency response and sensitivity. Features large 4½" 200 microampere meter, with increased damping in the meter circuit for stability in low frequency tests. Extremely high voltage range handles measurements from a low value of 1 millivolt to a maximum of 300 volts. AC (RMS) voltage ranges are: 0-.01, .03, .1, .3, 1, 3, 10, 30, 100 and 300 volts. Db ranges cover -52 to +52 db. Employs 1% precision multiplier resistors for maximum accuracy. High input impedance (1 megohm at 1,000 CPS). Frequency response is essentially flat from 10 CPS to 200 kc. Shpg. Wt. 6 lbs.

AUDIO WATTMETER KIT

Here is a fine meter to accurately measure output wattage. Five power ranges cover 0-5 mw, 50 mw, 500 mw, 5 w and 50 w full scale. Five switch selected db ranges cover -10 db to +30 db. All indications are read directly on the large 4½" 200 ua meter. Frequency response is ± 1 db from 10 CPS to 250 kc. External or internal load resistors are selected with convenient front panel switch. Non-inductive load resistors are built in for 4, 8, 16 or 600 ohms impedance. Precision multiplier resistors are used for high accuracy and incorporates a crystal diode bridge for wide-range frequency response. Modern styling and convenient front panel design. Cabinet is ventilated to allow efficient cooling of load resistors. Shpg. Wt. 7 lbs.

HEATH COMPANY • a subsidiary of Daystrom, Inc. • Benton Harbor 20, Mich.

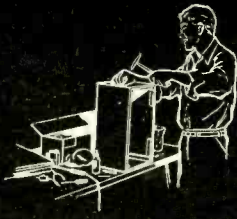

Easy to Buy - Easy to Build - Easy to Use...



CONTEMPORARY
Model CE-1B Birch
Model CE-1M Mahogany



TRADITIONAL
Model CE-1T Mahogany

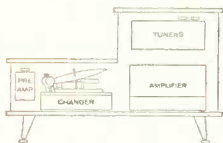

HEATHKIT
CE-1
\$4395
each

CHAIRSIDE ENCLOSURE KIT

This Chairside Enclosure lets you combine all of your hi-fi equipment into one compact control center and, at the same time add a beautiful piece of furniture to your home. The CE-1 is designed to house the AM and FM tuners (BC-1A and FM-3A) and the WA-P2 preamplifier along with the majority of record changers which will fit into the space provided. Adequate room is available in the rear of the unit to house any of the Heathkit amplifiers designed to operate with the WA-P2. The enclosure is flexible enough to give you a large choice in component installation. If only one tuner and the preamplifier are used, the two units can be installed in the tilt-out drawer, or if more convenient, either unit can be placed in the space provided in front of the changer compartment. The tilt-out shelf can be installed on either right or left side and the lift-top lid is similarly designed to lift from either side depending on your choice during construction! Good ventilation is achieved through appropriately placed slots in the bottom and back of the enclosure. Overall dimensions are 18" W. x 24" H. x 35½" D. The changer compartment measures 17¾" L. x 16" W. x 9⅝" D. All parts are precut and predrilled for easy assembly and attractive hardware is supplied to match each style. The contemporary cabinet is available in either mahogany or birch and the traditional cabinet is available in mahogany only. Furniture grade plywood can be finished to your taste. Shpg. Wt. 46 lbs.

Combine all your Hi-Fi equipment
in this attractive cabinet



HEATHKIT
AG-9A **\$34⁵⁰**

Your own source of
Hi-Fi audio signals



HEATHKIT
AA-1 **\$49⁹⁵**

3 Audio test instruments
in one compact unit



HEATHKIT
HD-1 **\$49⁵⁰**

Check amplifier
distortion quickly

AUDIO SIGNAL GENERATOR KIT

The model AG-9A is "made to order" for high fidelity applications, and provides quick and accurate selection of low-distortion signals from 10 CPS to 100 kc. Three rotary switches select two significant figures and a multiplier to determine audio frequency. Incorporates step-type and a continuously variable output attenuator. Output indicated on large 4½" panel meter, calibrated in volts and db. Attenuator system operates in 10 db steps, corresponding to meter calibration, in ranges of 0-.003, .01, .03, .1, .3, 1, 3 and 10 volts RMS. "Load" switch permits use of built-in 600-ohm load, or external load of different impedance. Output and frequency indicators accurate to within ±5%. Distortion less than .1 of 1% between 20 and 20,000 CPS. Shpg. Wt. 8 lbs.

AUDIO ANALYZER KIT

Complete high fidelity testing facilities are yours in the AA-1. It combines the functions of three separate instruments; an AC VTVM, audio wattmeter and a complete IM analyzer with filters and high and low frequency oscillators built in. VTVM ranges are: 0-.01, .03, .1, .3, 1, 3, 10, 30, 100 and 300 volts (RMS). Db scale reads from -65 to +52 dbm. Wattmeter ranges are: .15 mw, 1.5 mw, 15 mw, 150 mw, 1.5 w, 15 w and 150 w. IM scales are 1%, 3%, 10%, 30% and 100% full scale. Provides internal load resistors of 4, 8, 16 or 600 ohms. Combining and consolidating functions reduces the number of test leads and controls required for the same test. Complete instructions are provided for easy assembly, also valuable information on use of instrument. Shpg. Wt. 13 lbs.

HARMONIC DISTORTION METER KIT

Valuable in both designing and servicing of audio circuits, the HD-1 used with an audio signal generator, will accurately measure harmonic distortion at any or all frequencies between 20 and 20,000 CPS. Distortion is read on panel meter in ranges of 0-1, 3, 10, 30 and 100% full scale. Full scale voltage ranges of 0-1, 3, 10 and 30 volts are provided for the initial reference settings. Signal-to-noise ratio is measured on a separate meter scale calibrated in db. Features high input impedance (300,000 ohms) and 1% precision resistors in the VTVM voltage divider circuit for excellent sensitivity and accuracy. High quality components insure years of dependable service. Complete instructions provided for easy assembly and operation. Shpg. Wt. 13 lbs.

Heathkits are Your Best Dollar Value



TRANSISTOR PORTABLE RADIO KIT

The overwhelming sales of this outstanding transistor portable have made a substantial price reduction possible... in addition, an all new plastic molded case adds the finishing touch to the exceptional circuitry. Six name-brand (Texas Instrument) transistors are used for extra good sensitivity and selectivity. The 4" x 6" PM speaker with heavy magnet provides excellent tone quality. Use of this large speaker and roomy chassis make it unnecessary to crowd components adding greatly to the ease of construction. Transformers are prealigned so it is ready for service as soon as construction is completed. A touchup in alignment is easily accomplished on a station by following simple instructions in manual. Alignment tool furnished. Has built-in rod-type antenna for reception in all locations. Six standard size "D" flashlight cells are used for extremely long battery life (between 500 and 1000 hours) and they can be purchased almost anywhere. Cabinet is two-tone blue molded plastic with pull-out carrying handle. Dimensions are 9½" L. x 7¼" H. x 4" D. Shpg. Wt. 6 lbs.

Model XR-1-L: Identical to XR-1-P except in genuine leather case. Rich, warm sun-tan tone. Leather carrying strap included. Shpg. Wt. 7 lbs.

Leather Case: can be purchased separately if desired. Fits all XR-1P's and XR-1's. No. 93-1. Shpg. Wt. 3 lbs. \$6.95.



MODEL XR-1-L
\$34⁹⁵

HEATHKIT
XR-1-P **\$29⁹⁵**

Newly designed plastic case . . . new low price!

- ★ 4" X 6" SPEAKER FOR "BIG SET" TONE
- ★ LONG BATTERY LIFE (500 to 1000 Hours)



HEATHKIT
CT-1
\$7⁹⁵

Test condensers right in the circuit



HEATHKIT
DF-1 **\$54⁹⁵**

Pin-point your exact location

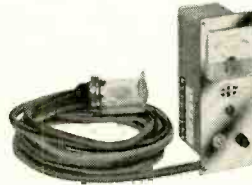

HEATHKIT
FD-1 **\$35⁹⁵ each**
(6 volt model FD-1-6)
(12 volt model FD-1-12)

Detects gas fumes



HEATHKIT
MC-1
\$42⁹⁵

Save your boat batteries

IN-CIRCUIT CAPACI-TESTER KIT

Check most capacitors for "open" or "short" right in the circuit with this handy kit. Detects open capacitors from about 50 mmf up, not shunted by an excessively low resistance value. Checks shorted capacitors up to 20 mfd (not shunted by less than 10 ohms). (Does not detect leakage nor check electrolytic condensers.) Employs a 60-cycle frequency for the short test and a 19 megacycle frequency for the open test. Uses electron beam "eye" tube for quick indication. Test leads included. Shpg. Wt. 5 lbs.

TRANSISTOR RADIO DIRECTION FINDER KIT

This transistor radio compass will double as a portable radio. Covers the standard broadcast band from 540 to 1600 kc. Ideal for use aboard boats and also on land by hunters, hikers, etc. A directional high-Q ferrite antenna rotates from the front panel to obtain a fix on a station. A 1 ma meter serves as null and tuning indicator. Prealigned IF transformers—six transistor circuit. Powered by tiny 9-volt battery with spare included. Dimensions 7½" W. x 5¼" H. x 5¼" D. Shpg. Wt. 5 lbs.

FUEL VAPOR DETECTOR KIT

Protect your boat and passengers against fire and explosion with one of these fuel vapor detector kits. Indicates the presence of fumes on a three-color "safe-dangerous" meter scale and immediately shows if it is safe to start the engine. A pilot lamp shows when the detector is operating. Easy to build and install, even by one not having previous experience. Operates from your boat battery. The kit is complete with heavy-duty neoprene insulated cable and includes spare detector unit. Shpg. Wt. 4 lbs.

MARINE CONVERTER KIT

Charge 6 or 12 volt batteries with this marine converter and battery charger. A panel mounted 25 ampere meter continuously monitors the charging current. Moisture and fungus proofed for rugged marine use. Convection cooling prevents unsafe temperature rise. The MC-1 has no moving parts, tubes nor blowers wear out or break. Mounting brackets are supplied for easy installation on any boat. Ideal for keeping batteries fully charged or to supply extra current for appliances, Shpg. Wt. 16 lbs.

HEATH COMPANY • a subsidiary of Daystrom, Inc. • Benton Harbor 20, Mich.



New Styling - New Features...



HEATHKIT TX-1 \$229.50

Complete Versatility for Top-Notch Amateur Communications

- ★ NEWLY DESIGNED VFO—ROTATING SLIDE RULE DIAL
- ★ MODERN STYLING—PROVISION FOR SSB ADAPTER

"APACHE" HAM TRANSMITTER KIT

Fresh out of the Heath Company laboratories, the brand-new "Apache" model TX-1 ham transmitter features modern styling and the latest in circuitry for extra fine performance. The "Apache" is a high quality transmitter operating with a 150 watt phone input and 180 watt CW input. In addition to CW and phone operation, built-in switch selected circuitry provides for single-sideband transmission through the use of a plug-in external adapter. These SSB adapters will be available in the near future. A compact, stable and completely redesigned VFO provides low drift frequency control necessary for SSB transmission. A slide rule type illuminated rotating VFO dial with vernier tuning provides ample bandspread and precise frequency settings. The bandswitch allows quick selection of the amateur bands on 80, 40, 20, 15 and 10 meters. (11M with crystal control). This unit also has adjustable low level speech clipping and a low distortion modulator stage employing two of the new 6CA7/EL-34 tubes in push-pull class AB operation. Time sequence keying is provided for "chirpless" break-in CW operation. The final amplifier is completely shielded for greater TVI protection and transmitter stability. Die-cast aluminum knobs and front panel escutcheons add to the attractive styling of the transmitter. Pi network output coupling matches antenna impedances between 50 and 72 ohms. Shpg. Wt. 115 lbs.

\$50.00 deposit required on C.O.D. orders. Shipped motor freight unless otherwise specified.



HEATHKIT DX-20 \$35.95

An Ideal Code Transmitter



HEATHKIT DX-100 \$189.50

You'll be Proud to Own This Outstanding Performer



HEATHKIT DX-40 \$64.95

Phone & CW Facilities at Low Cost

DX-20 CW TRANSMITTER KIT

Designed especially for CW work, the DX-20 features high efficiency at low cost. An ideal rig for the novice or advanced-class CW operator. Plate power input is 50 watts, and covers 80, 40, 20, 15, 11 and 10 meters with single knob bandswitching. Features a single 6DQ6A tube in the final amplifier stage and a 6CL6 as a crystal oscillator. Pi network output circuit matches various antenna impedances between 50 and 1000 ohms and reduces harmonic output. Top-quality parts are featured throughout, including "potted" transformers, etc., for long service life. Complete shielding to minimize TVI. Removable metal pull-out plug on left end of cabinet provides access for crystal changing. Very easy to build with complete instructions supplied. Shpg. Wt. 19 lbs.

DX-100 PHONE AND CW TRANSMITTER KIT

Well known for its high quality and fine performance the DX-100 features a built-in VFO, modulator, and power supply, complete shielding to minimize TVI, and a pi network coupling to match impedances from 50 to 600 ohms. RF output is in excess of 100 watts on phone and 120 watts on CW, for clean strong signals on all ham bands from 10 to 160 meters. Single knob bandswitching and illuminated VFO dial and meter face add real operating convenience. RF output stage uses a pair of 6146 tubes in parallel, modulated by a pair of 12Z5's. High quality components are used throughout, such as potted transformers, silver-plated or solid coin silver switch terminals, aluminum-heat dissipating caps on the final tubes, copper plated chassis, etc. Shpg. Wt. 107 lbs.

\$50.00 deposit required on C.O.D. orders. Shipped motor freight unless otherwise specified.

DX-40 PHONE AND CW TRANSMITTER KIT

An outstanding buy in its power class the DX-40 provides both phone and CW operation on 80, 40, 20, 15, 11 and 10 meters. A single 6146 tube is used in the final amplifier stage to provide full 75 watt plate power input on CW, or controlled carrier modulation peaks up to 60 watts for phone operation. Modulator and power supplies are built in and single-knob bandswitching is combined with the pi network output circuit for complete operating convenience. Complete shielding to minimize TVI. Provision is made for three crystals. A four-position switch selects any of the three crystals or a jack for external VFO. Crystal sockets are reached through access door in rear of cabinet. High quality D'Arsonval movement panel meter. Shpg. Wt. 25 lbs.

For Real Ham Enjoyment

HEATHKIT

"MOHAWK" HAM RECEIVER KIT

Here is a ham receiver that any radio operator would be proud to own. The "Mohawk" has all the functions required for high quality communications with clear, rock-steady reception on all bands. This 15-tube receiver features double conversion with IF's at 1682 kc and 50 kc and covers all of the amateur frequencies from 160 through 10 meters on seven bands with an extra band calibrated to cover 6 and 2 meters using a converter. Receiver accommodations are provided for these converters which will be available in Heathkits soon. The "Mohawk" is specially designed for single-sideband reception with crystal controlled oscillators for upper and lower sideband selection. A completely preassembled, wired and aligned front end coil assembly assures ease of construction and top performance of the finished unit. Other features include five selectivity positions from 5 kc to 500 CPS, bridged T-notch filter for maximum heterodyne rejection, and a built-in 100 kc crystal calibrator. The set provides a 10 db signal-to-noise ratio at less than 1 microvolt input. Front panel features S meter, separate RF, IF and AF gain controls, T-notch tuning, T-notch depth, ANL, AVC, BFO, bandswitch, tuning, antenna trimmer, calibrate set, calibrate on, CW-SSB-AM, receive-standby, upper-lower sideband, selectivity, phone jack and a wide band rotating slide rule type vernier tuning dial with easy to read calibrations. Shpg. Wt. 90 lbs.

\$50.00 required on C.O.D. orders. Shipped motor freight unless otherwise specified.



HEATHKIT RX-1 \$274⁹⁵

Now in Kit Form a Top Quality Ham Band Receiver

- ★ PREWIRED AND ALIGNED FRONT END COIL ASSEMBLY.
- ★ CRYSTAL CONTROLLED OSCILLATORS FOR DRIFT-FREE RECEPTION.



HEATHKIT B-1 \$8⁹⁵

Get Proper Match Between Transmitter and Antenna

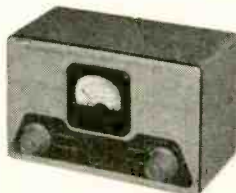

HEATHKIT AM-2 \$15⁹⁵

Measure Standing Wave Ratio



HEATHKIT VX-1 \$23⁹⁵

Eliminates Hand Switching

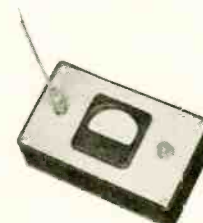

HEATHKIT PM-1 \$14⁹⁵

Quick Check of Transmitter Operation

BALUN COIL KIT

Unbalanced coax lines used on the most modern transmitters can be matched to balance lines of either 75 or 300 ohms impedance by using the model B-1 Balun Coil Kit. Can be used with transmitters and receivers without adjustment over the frequency range of 80 through 10 meters, and will handle power inputs up to 200 watts. Cabinet size is 10" square by 5" D. and may be located any distance from the transmitter or antenna. A protective cover is supplied to prevent damage in outdoor installations. Shpg. Wt. 4 lbs.

REFLECTED POWER METER KIT

The match of your antenna transmission system can be checked by measuring the forward and reflected power or standing wave ratio from 1:1 to 6:1 with this fine unit. Designed to handle a peak power of well over 1 kilowatt of energy the AM-2 may be left in the antenna system feed line at all times. Band coverage is 160 meters through 2 meters. Input and output impedances for 50 or 75 ohm lines. No external power required for operation. Cabinet size is 7 3/4" x 4 1/4" x 4 3/8". Shpg. Wt. 3 lbs.

ELECTRONIC VOICE CONTROL KIT

This unique device allows you to switch from receiver to transmitter merely by talking into your microphone... you get the advantage of "telephone-type conversation" as in single sideband but with regular AM transmission. The unit is adjustable to all conditions by sensitivity controls provided. A variable time delay control changes the "hold" time. Provision is made for receiver and speaker connections and also for a 117 volt antenna relay. Built-in power supply. Complete instructions provided. Shpg. Wt. 5 lbs.

RF POWER METER KIT

This self contained unit requires no power for operation. You simply place it close to the transmitter antenna to sample the RF field which is then indicated on the panel meter. Operates with any transmitter having an output frequency between 100 kc and 250 mc, regardless of power. Sensitivity is 0.3 volts RMS full scale, and a special control on the panel allows for further adjustment of the sensitivity. Measures 3 3/4" W. x 6 1/4" L. x 2" D. An easy way to put your mind at ease concerning transmitter operation. Shpg. Wt. 2 lbs.

HEATH COMPANY • a subsidiary of Daystrom, Inc. • **Benton Harbor 20, Mich.**

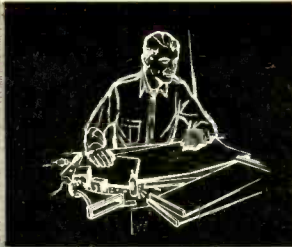

Choose from a wide variety of Heathkits

DUAL-CHASSIS 20 WATT HI-FI AMPLIFIER KIT

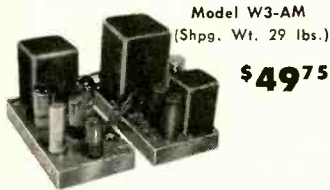

Model W3-AM
(Shpg. Wt. 29 lbs.)

\$49⁷⁵

12" UTILITY SPEAKER



Model 401-6
(Shpg. Wt. 7 lbs.)

\$7⁵⁰

ALL-BAND RADIO KIT



Model AR-3
(Shpg. Wt. 12 lbs.)

\$29⁹⁵
(less cabinet)

CRYSTAL RADIO KIT



Model CR-1
(Shpg. Wt. 3 lbs.)

\$7⁹⁵

BROADCAST BAND RADIO KIT



Model BR-2
(Shpg. Wt. 10 lbs.)

\$18⁹⁵
(less cabinet)

ELECTRONIC CROSSOVER KIT



Model KO-1
(Shpg. Wt. 6 lbs.)

\$18⁹⁵

"Q" MULTIPLIER KIT



Model QF-1
(Shpg. Wt. 3 lbs.)

\$9⁹⁵

"AUTOMATIC" CONELRAD ALARM KIT



Model CA-1
(Shpg. Wt. 4 lbs.)

\$13⁹⁵

GRID DIP METER KIT



Model GD-1B
(Shpg. Wt. 4 lbs.)

\$21⁹⁵

VIBRATOR POWER SUPPLY KIT



6 volt Model VP-1-6
12 volt Model VP-1-12
(Shpg. Wt. 4 lbs.)

\$7⁹⁵
ea.

VARIABLE FREQUENCY OSCILLATOR KIT



Model VF-1
(Shpg. Wt. 7 lbs.)

\$19⁵⁰

PROFESSIONAL RADIATION COUNTER KIT



Model RC-1
(Shpg. Wt. 8 lbs.)

\$79⁹⁵

ISOLATION TRANSFORMER KIT



Model IT-1
(Shpg. Wt. 9 lbs.)

\$16⁵⁰

ELECTRONIC SWITCH KIT



Model S-3
(Shpg. Wt. 8 lbs.)

\$21⁹⁵

REGULATED POWER SUPPLY KIT



Model PS-3
(Shpg. Wt. 17 lbs.)

\$35⁵⁰

VOLTAGE CALIBRATOR KIT



Model VC-3
(Shpg. Wt. 4 lbs.)

\$12⁵⁰

DIRECT-READING CAPACITY METER KIT



Model CM-1
(Shpg. Wt. 7 lbs.)

\$29⁵⁰

TUBE CHECKER KIT

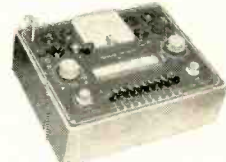

Model TC-2
(Shpg. Wt. 12 lbs.)

\$29⁵⁰

EASY TIME PAYMENTS AVAILABLE FOR YOUR CONVENIENCE...

Any order totaling \$90 or more can be paid for in small monthly payments (send for complete details).

RESISTANCE SUBSTITUTION BOX KIT



Model RS-1
(Shpg. Wt. 2 lbs.)

\$5⁰⁰

CONDENSER SUBSTITUTION BOX KIT

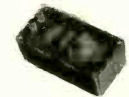

Model CS-1
(Shpg. Wt. 2 lbs.)

\$5⁰⁰

CATHODE RAY TUBE CHECKER KIT



Model CC-1
(Shpg. Wt. 10 lbs.)

\$24⁹⁵

LABORATORY RF GENERATOR KIT



Model LG-1
(Shpg. Wt. 16 lbs.)

\$48⁹⁵

"Q" METER KIT



Model QM-1
(Shpg. Wt. 14 lbs.)

\$44⁵⁰

DECADE CONDENSER KIT

Model DC-1
(Shpg. Wt. 3 lbs.)

\$16⁵⁰



DECADE RESISTANCE KIT

Model DR-1
(Shpg. Wt. 4 lbs.)

\$19⁵⁰

...to Fill Your Exact Needs



PORTABLE TUBE CHECKER KIT



Model TC-2P
(Shpg. Wt. 15 lbs.)

\$34.50

**TV PICTURE TUBE TEST ADAPTER*
FOR TC-2 AND TC-2P**



Model 355
(Shpg. Wt. 1 lb.)

\$4.50

BINDING POST KIT

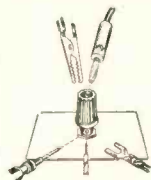

Model 362
(Shpg. Wt. 1 lb.)

\$4.00

BATTERY TESTER KIT



Model BT-1
(Shpg. Wt. 2 lbs.)

\$8.50

**ELECTRONIC IGNITION
ANALYZER KIT**



MODEL IA-1
(Shpg. Wt. 20 lbs.)

\$59.95

SCOPE PROBES

Scope Demodulator Probe Kit



Model 337-C
(Shpg. Wt. 1 lb.)

\$3.50

Low Capacity Probe Kit

Model 342

(Shpg. Wt. 1 lb.)

\$3.50



VTVM PROBES



30,000 Volt DC HV
Probe Kit No. 336
Shpg. Wt. 2 lbs. \$4.50



Etched Circuit RF
Probe Kit No. 309-C
Shpg. Wt. 1 lb. \$3.50



Peak-to-peak Voltage
Probe Kit No. 338-C
Shpg. Wt. 2 lbs. \$5.50

ENLARGER TIMER KIT



Model ET-1
(Shpg. Wt. 3 lbs.)

\$11.50

IMPEDANCE BRIDGE KIT

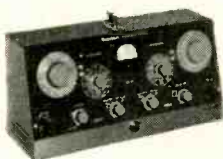

Model IB-2A
(Shpg. Wt. 12 lbs.)

\$59.50

**"LOW RIPPLE" BATTERY
ELIMINATOR KIT**



Model BE-5
(Shpg. Wt. 21 lbs.)

\$39.95

**ELECTRONIC ANALOG
COMPUTER KIT**

Full Computer Group C
\$945.00

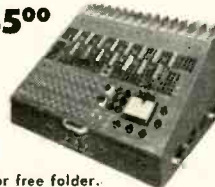

Write for free folder.

*Free
Catalog*



Send for this
informa-
tive booklet
describing these and many other
do-it-yourself kits.

**ORDER DIRECT BY MAIL . . . from the
WORLD'S LARGEST MANUFACTURER
OF ELECTRONIC INSTRUMENTS IN KIT FORM**

Save 1/2 or more over equivalent ready-made products by buying direct and assembling them yourself. You gain priceless knowledge through complete and informative construction manuals.



HEATH COMPANY A Subsidiary of  **DAYSTROM, INC. BENTON HARBOR 20, MICH.**

**ORDER
BLANK**

NOTE: All prices and specifications subject to change without notice.

Enclosed find () check () money order for. Please ship C.O.D. () postage enclosed for _____ pounds.

On Express orders do not include transportation charges—they will be collected by the express agency at time of delivery.

On Parcel Post Orders include postage for weight shown. All prices are NET F.O.B. Benton Harbor, Michigan, and apply to Continental U.S. and Possessions only.

Name _____

Address _____

City & Zone _____ State _____

(PLEASE PRINT)

SHIP VIA

- Parcel Post
- Express
- Freight
- Best Way

QUANTITY	ITEM	MODEL NO.	PRICE
<input type="checkbox"/> SEND FREE Heathkit Catalog		POSTAGE	
		TOTAL	

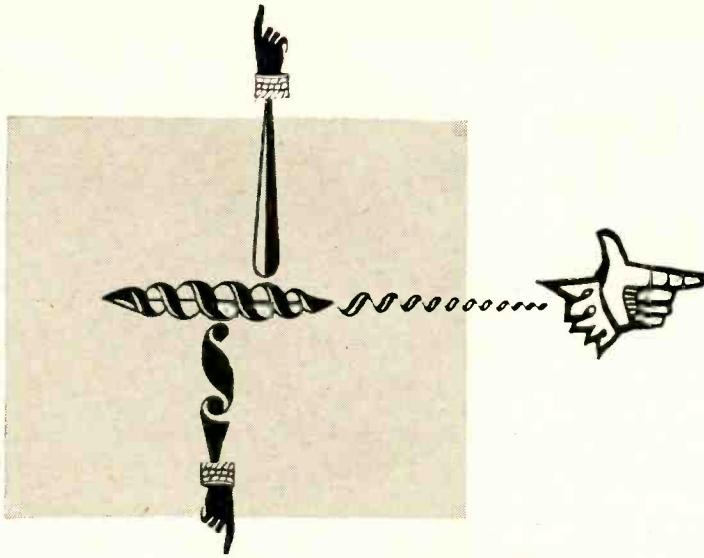

3-WAY PORTABLES

Tips and Techniques

Part II—Some final pointers on repairing these tricky receivers and instructions on how to build an important service aid—a variable autotransformer for boosting and lowering line voltage

By JACK DARR

LAST month we took a careful look at the three-way portables which inundate the service shops every summer. We discussed initial servicing tests and paid particular attention to the power supply. This month we continue with more hints.

Battery life

The portable is basically a straight battery-powered receiver. The ac power supply is actually tacked on and controlled by the power selector switch. Due to the high cost of battery packs, battery life is very important. The small packs used are expensive, when compared with the large ones used in home battery radios. The cost of manufacture accounts for most of this, as the materials are inexpensive—it costs as much to make a 200-hour portable pack as it does to make a 1,000-hour farm pack. By the way, if the set is used as a home radio, as in a hunting cabin, larger batteries may be provided by connecting them to the radio through an extension battery cable.

Battery drain should always be checked when servicing. Fortunately, this is easy. The audio output tube consumes practically all the current drawn by the set—over 90% of it. Therefore, we need check only this one stage—the remaining ones seldom have this trouble. The easiest way is to check the grid bias on the audio output tube. The grid resistor returns to the filament circuit and is usually around 1 megohm. Voltage readings are taken with a vtvm at the grid and the bottom end of the resistor, referred back to B-minus. There should be practically no voltage drop at all across the resistor. If there is, the operating point

of the audio tube is upset and the set will consume far more than its normal current. This bias voltage is easily determined from tube manuals if it is not given in the service information. Look up the tube type used. For instance, a 3Q5-GT requires -4.5 volts. Unless grid voltage reads very close to this figure, it should be checked.

The most common source of trouble is leakage in the coupling capacitor to the first audio amplifier plate. Positive voltage leaking through can upset the bias. A drop of only 1 or 2 volts is enough to cause serious trouble. Disconnect the grid end of this capacitor and measure the grid voltage. If it returns to normal, but drops (goes toward positive) when the free end of the capacitor is touched to the grid, the capacitor should be replaced. *Always use 600-volt types for replacements in this spot.* Gassy output tubes can cause a similar symptom. If the grid voltage remains off normal with the capacitor disconnected, replace the tube and remeasure the grid voltage. Now and then a grid resistor will be open or up in value. It should be within at least 15% of the rated ohmage.

Severe audio distortion usually accompanies any of these troubles, making the sound very mushy. However, if the set has a pentode first audio amplifier tube such as the 1U5 and the screen resistor, usually a 3.3-megohm unit, is open, the symptoms may be similar. The plate load resistor (average 1.0 megohm) also causes similar distortion if it goes up in value to the point where it reduces the plate voltage too much. Both these resistors should be viewed with suspicion if they are of the matchstick type, as quite a bit of

trouble has been found with them.

Alignment problems

Possibly the most common customer complaints on these sets are low sensitivity or loss of volume. This can be due to many things: weak tubes, low batteries, misalignment or attempting to use the radio at locations far out of its normal range. The bitter truth is that these sets should be used only within range of several strong stations! The technician must be able to determine from experience whether the volume and pickup of a portable are normal for his own area.

Alignment is extremely critical. With low-gain antennas and low battery drain, *alignment must be very precise if performance is to be satisfactory.* Consult service data for correct alignment frequencies and procedures and follow them to the letter. This problem is much worse in older sets. Later models using iron-cored high-gain if transformers and ferrite loop antennas are much better at this and natural drifting of alignment has almost disappeared. Nowadays, "screwdriver drift" resulting from the customer's efforts at aligning the set himself is the major cause of actual misalignment.

Tracking of the loop antenna is very important, especially on the older sets. The performance of some of these may be improved amazingly by replacing the old loop with a new ferrite antenna, properly adjusted. This is not a complicated procedure. The new antenna is firmly mounted, preferably on the chassis itself. On most sets, the frame of the tuning capacitor is a handy place. Be sure that it is firmly mounted as it must withstand a lot of jarring



It's Fantabulous!*

SATELLITE-HELIX

TV ANTENNA SUMMER SPECIAL

HERE'S your made-to-order opportunity to get the spectacular Satellite-Helix — today's "hottest" TV antenna — in orbit in *your* area!

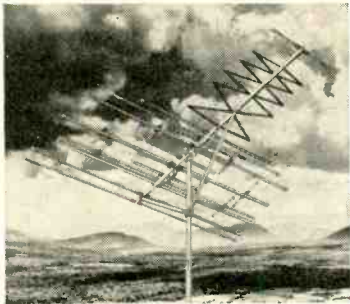

Model VXIII

List \$47.50

The news of its fabulous performance is sweeping the trade. But the only way you can start profiting from its fantastic gain is to try the Satellite-Helix in your toughest, roughest fringe installations. And you'll never have a better chance than now — while our fantabulous chaise lounge offer lasts.

Time is short. See your JFD Distributor today for the Satellite-Helix the "hottest" TV antenna with the "hottest" deal in the industry.

Take home a chaise right then and there!

FREE! . . . THIS DELUXE
ALUMINUM INNERSPRING
CHAISE WITH UPHOLSTERED
ARMS (\$49.95 RETAIL)
WITH EACH 10 NEW
SATELLITE-HELIX ANTENNAS!



* Combination of fantastic and fabulous.

JFD INTERNATIONAL
15 Moore Street
New York, N.Y.

JFD CANADA LTD.
51 McCormack Street
Toronto, Ontario, Canada



Pioneers in electronics since 1929

ELECTRONICS CORPORATION

6101 Sixteenth Avenue
Brooklyn 4, New York

PHONE DEWey 1-1000

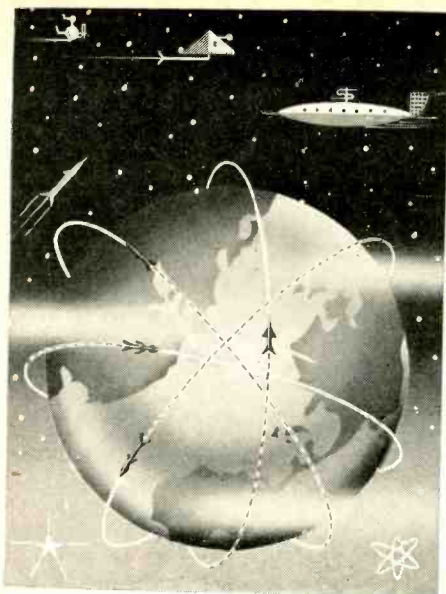

HOW TO PREPARE FOR YOUR GREATEST FUTURE in the SPACE AGE!

ELECTRONICS—AERONAUTICS... If you have been reading the papers—or watching television—or listening to the radio, you are well aware that the greatest need in the world's history for trained engineering minds is NOW!

You can fill this need—prepare for an IMPORTANT POSITION—an UNLIMITED FUTURE—in a world of Satellites, Rockets, Jet Airliners and Space Projects, all dependent upon the sciences of Electronics and Aeronautics... IF YOU WILL TAKE THE PROPER TRAINING NOW... at Northrop Institute!

Here at Northrop, in just TWO SHORT YEARS, you can graduate into a fine position with a leading company in the Aviation-Electronics Fields. Northrop has trained thousands of young men—ambitious, intelligent, just like yourself—who are now employed in many of the important Avionics Companies of the country.

Your first step is easy. Just fill out the coupon below. We will send you our 32-page, fully illustrated, FREE CATALOG. It will supply you with the answers to all the questions about your future, and Northrop training, which you want to know. DO IT NOW!



Northrop
Aeronautical Institute
An Accredited Technical Institute
1189 W. Arbor Vitae Street
Inglewood 1, California

APPROVED FOR VETERANS

NORTHROP AERONAUTICAL INSTITUTE
1189 W. Arbor Vitae Street, Inglewood 1, Calif.

Please send me immediately the Northrop catalog, employment data, and schedule of class starting dates. I am interested in:

- Electronic Engineering Technology
- Aeronautical Engineering Technology
- Aircraft Maintenance Engineering Technology
- Master Aircraft and Engine Mechanic
- Jet Engine Overhaul and Maintenance

Name..... Age....

Address

City..... Zone.. State.....

Veterans: Check here for Special Veteran Training Information.

RADIO

and jolting in the course of normal operation.

Set up a signal generator and vtvm. Connect the vtvm to the avc line and couple the signal generator loosely to the antenna. This assumes that all other preliminary servicing and alignment adjustments have been finished. Tune in a station near the upper end of the band, 1300-1400 kc, and adjust the trimmer on the antenna-tuning (largest) section of the tuning capacitor. Incidentally, on many sets a handy place to read the avc voltage is on the frame of the tuning capacitor. Otherwise, use the antenna return connection, as shown in Fig. 6. Now, tune to the lower end of the band, around 600 kc, and adjust the core of the ferrite antenna for maximum reading.

There are two types of these ferrite loops. The older type has a loose core, adjusted by sliding it back and forth with an insulated tool. Later models have a screw adjustment on the core. Return to the high end and adjust the trimmer, then back to the low end for another core adjustment. This process will have to be repeated until no further improvement is noted. The loop is

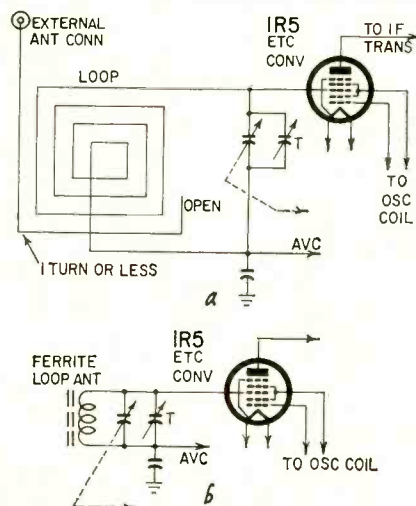

Fig. 6—Typical loop antenna systems used in almost all portables.

now tracking, and maximum results will be obtained. With loose-cored loops, the core must be fastened securely in place with a dab of cement and allowed to dry before returning it to the owner. (The rubber-to-metal cement used in service shops is very good for this purpose as it will hold the core tightly yet permit future adjustment if necessary.)

Unusual troubles

In portables as in all other electronic gear, the unusual trouble will crop up occasionally. In one set tested, everything checked perfectly normal. Tubes, voltages, etc., were all right on the button. Only one minor fault was observed—it wouldn't play! After much head scratching, the avc voltage was measured. It was 10-12 volts, negative! This had a tendency to reduce the gain of the if and rf stages somewhat! The trouble was in the oscillator coil itself, as shown in Fig. 7. The



Columbia
Model SC-1...
\$36.25 list



New COLUMBIA Constant Displacement STEREO CARTRIDGE features...

Constant displacement . . . unique moving lever system provides balanced output voltages constant for given stylus displacement regardless of frequency.

Complete compatibility . . . plays stereo and existing monaural record libraries.

4 speeds . . . 33 $\frac{1}{3}$, 45, 78 and 16 $\frac{2}{3}$ (home entertainment) r.p.m. with single diamond stylus.

Standardization . . . conforms with RIAA standards.

Frequency response . . . 30 to 20,000 cycles; flat within ± 1.5 db in fundamental stereo range of 30 to 7,000 cycles.

Channel separation . . . in excess of 20 db.

Uniformly high compliance . . . superior tracking throughout frequency range.

SPECIFICATIONS

Diamond stylus.....0.0008 inch radius
Recommended needle force.....5 to 7 grams
Compliance, lateral and vertical. 2×10^{-6} cm/dyne
Open-circuit output voltage.....0.4 volts \pm 3 db
Extended stereo range at \pm 2.5 db 30 to 16,000 cps

Start enjoying stereo now.

Demand the ceramic cartridge with the most features, the Columbia Constant Displacement Stereo Cartridge designed by Columbia Records and made by CBS-Hytron.

CBS-HYTRON, Danvers, Massachusetts
A Division of Columbia Broadcasting System, Inc.

RADIO

small gimmick used as an oscillator grid capacitor had shorted to the main tank winding which returned to the ave bus. This put the highly negative oscillator grid voltage into the ave circuit, cutting the gain. The cure was simple. The winding was disconnected and a 250- μf mica capacitor substituted, connected from the oscillator grid to the top of the coil.

In another, still older set, with erratic performance, a decided variation was noted in the filament voltages of the tubes. One if amplifier tube had only 0.7 volt, while the oscillator had 1.6 and the second detector 1.7. The cause of this was the if amplifier tube itself. Although it tested fairly good in a tube tester, it was slightly weak. Evidently the filament resistance was very low, causing it to assume less than its normal voltage in a series circuit.

Probably the prize item was the old Sentinel portable which came into the shop with the 3Q5 audio output tube dead, open-circuited. A new tube was installed and the set played perfectly. Next day, the customer was back, saying indignantly, "When I got home, it was dead!" The new 3Q5 was burned out. The set was removed from the cabinet, and the filament circuit carefully checked. Everthing was normal. Another 3Q5 was installed and the set was gingerly turned on. Sure enough, it played perfectly. All voltages were normal. The set was turned off and replaced in its cabinet. Before delivering it to the customer, I turned it on again to be sure that it was all right. It wasn't. The 3Q5 filament had burned out again.

To shorten a long sad story, two days and three 3Q5's later, I discovered that, when the set was turned off, due to the peculiar hookup on the battery-ac/dc switch, which went from off through battery to ac/dc, the 90-volt B-plus voltage was being discharged, through cross-leakage into the filament string. The filament filter capacitor, a 100- μf electrolytic, was in the same can with the two high-voltage filters. This high-voltage surge snapped the fragile filament of the 3Q5 immediately upon application (which *did* prevent damage to the remaining tubes, at that). It was cured by replacing the capacitor.

Although most cases of audio oscillation are caused by weak or open B-plus filter capacitors, do not overlook any

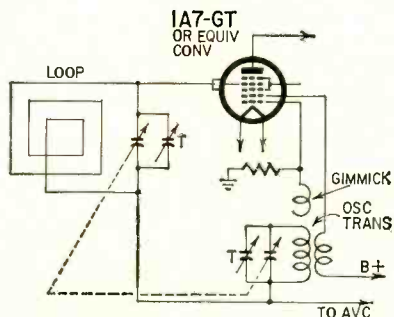

Fig. 7 — Oscillator coil which caused trouble by shorting small gimmick winding used as oscillator grid capacitor.

possibilities. A recent case brought this point firmly home. A small portable had a severe audio oscillation—motorboating. Testing all components, including bridging the main filters, had absolutely no effect. I finally discovered that the filament filter, a 200- μf unit at 20 volts, was open!

Under normal circumstances, open filament filters cause only a slight increase in the hum level. This time, the designer was evidently driving the few tubes so hard that a high feedback level existed in the return circuits, including the filaments. This resulted in enough feedback to cause severe motorboating when the filter capacitor opened. This set was also rather unusual in that it employed a separate filament filter, in addition to the unit in the can with the B-plus filters.

Cabinet repairs

Many portables are housed in plastic cabinets. A number of these are built of plastic too thin to withstand the shocks of normal usage and the result is cracks and breakage. These may be repaired without trouble if the proper techniques are used. Most plastics used in cabinets are acrylate or acetate types, with a few being the thermoplastic type (softening with heat, resetting upon cooling) while most are of the thermosetting type. The proper cement must be used for each type. To determine the type of plastic used, apply a small drop of cement to the inside of the cabinet. If the cement roughs the plastic when wiped away, it has "cut" the material and is the right kind. If the cement can be wiped off without any effect, it is not the proper type.

Most of the trouble seems to center about breaks and cracks in the bottom of the cabinet, possibly due to the weight of the battery pack. To make a strong repair, coat the edges of the crack with cement, working from the inside. Press the edges together and quickly wipe off the surplus cement squeezed out on the outside, to make the job look as neat as possible. Apply more cement to the inside, spreading it to about a 2-inch width. Now, tear off a strip of stout cloth (about the same general type as a good handkerchief, some closely woven material) about 2 inches wide and a bit longer than the crack. Place this over the crack, pressing it firmly in place until the cement has worked up through the mesh of the material. Apply more cement if needed, working it well over both edges and the ends. Allow to dry at least two days and the cabinet will be stronger than new.

If small pieces have been broken off entirely, cement the crack together, apply the cloth and then replace the loose pieces, coating them well with cement. Several large flat rubber bands snapped around the cabinet in each direction will hold it together until the cement has set. Do not use short bands or the excessive tension may distort



build what it takes
to get the best

high fidelity SOUND REPRODUCTION

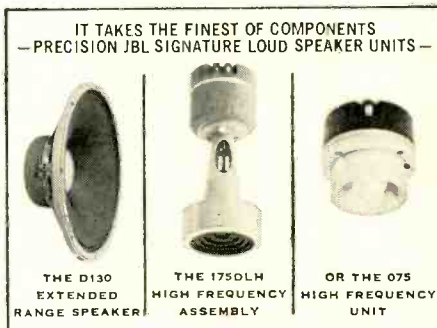

—to get the best in high fidelity sound. And to get all of the rich, crisp, accurate, deep down bass generated by your D130, you must mount it in a carefully constructed, engineered acoustical enclosure. One of the most popular enclosures ever made, because of its compact dimensions and smooth, clean response, is the JBL Harkness Model C40—a back-loaded folded horn. Sound below 150 cps is radiated from the back of your D130 through the horn. Above 150 cps the speaker acts as a direct radiator. The six foot long, exponentially-flared horn path is ingeniously folded within sleek, low enclosure measuring only 38" wide. The horn is completely contained within the enclosure and is independent of room walls.

BUILD YOUR C40 FROM PRODUCTION PRINTS

Prove your woodworking skill and get the greatest thrill high fidelity can give you. Here is a project that will make use of your finest craftsmanship for the enjoyment of yourself and your family—a project you can show off to others with pride. Detailed production prints, complete with a list of parts, and step-by-step instructions have now been released by the factory. The set is yours for only three dollars.



USE THIS FORM TO ORDER YOUR PLANS

JAMES B. LANSING SOUND, INC.
3249 Casitas Ave., Los Angeles 39, Calif.

Gentlemen: Enclosed find \$3.00 for one set of Model C40 Production Prints.

Please print clearly or type your name and complete address:

Name _____

Address _____

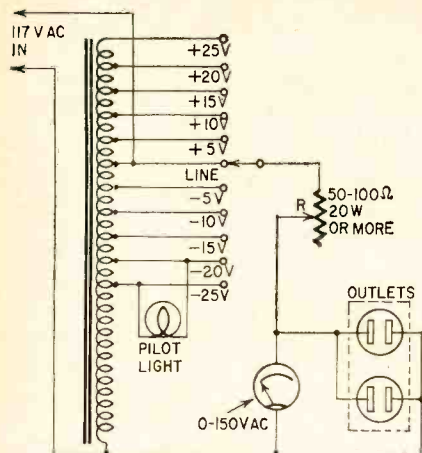

Fig. 8 — Autotransformer circuit. Unit provides five taps above and five taps below applied line voltage. Rheostat R is used for fine control of voltage.

the cabinet. High pressure is not necessary with this type of cement, only enough to hold the cabinet together.

Some thermoplastic materials may be welded back together by applying a soldering iron tip to the inside of the cabinet. Philco used several cabinets of this type some years ago. Run a broad tip up and down the inside of the cabinet along the crack until the plastic has softened. Then press the edges together and smooth down. Cement may also be used on this type. Small extrusions, such as the round studs used to hold the loop in place on the cabinet back, may be replaced this way.

Broken catches and hinges are a common problem. These are also repairable, unless the damage is too heavy. Flat spring catches may be replaced or new ones made from flat brass shim stock (available at auto-supply stores) of the proper thickness. A few pieces of spring wire are useful. They may be bent into various shapes for hinge and catch replacement and cemented in place.

Test equipment

Standard test equipment is suitable for servicing these sets, if it includes a voltmeter that can make accurate measurements on a 3-volt dc scale, for reading those critical filament voltages.

A very useful—in fact, almost indispensable—piece of equipment for this type of work is an autotransformer. It is used to vary the line voltage applied to the set, to check its performance under varying conditions. This is about the quickest single test which can be applied and will yield more information in less time than any other test possible. A satisfactory unit may be made in a short time, using the iron from a burned-out TV power transformer or other piece of heavy equipment. A tap switch selects the desired voltage, while an accurate ac voltmeter, 0-150 volts ac, indicates the voltage applied (see Fig. 8).

Fig. 8 shows the circuit I use. This is a combination setup. The switch selects the tap on the transformer while the rheostat, a heavy-duty low-

resistance type obtained from surplus, serves as a fine control. A 6-volt pilot light is connected across any pair of taps on the transformer.

Building an autotransformer

A heavy transformer, burned out, is disassembled and the turns ratio checked. This is done by locating the 5-volt rectifier filament winding, unwinding it and counting the turns. Of course any winding will do, but a filament winding makes it simpler. This gives the turns ratio of the original transformer, a figure proportional to the amount and size of iron used and other factors. Admittedly somewhat rough, but this is accurate enough for our purposes.

If still usable, the form is saved. If the original is badly burned, make a new one of two layers of medium heavy fish-paper (electrical fiber—try the local electrician). Be sure to get the inside dimensions right so the iron may be replaced without damaging the winding. Best way is to make a wooden core about $\frac{1}{8}$ inch larger than the core cross-section (and about $\frac{1}{8}$ inch shorter than the window opening). Put your form on it to wind. If you drill the block through the center, put a bolt with a nut and two washers on it, and chuck it in a lathe or horizontal drill (a stout breast drill clamped in a vise will do), you have a fair coil winder. If the original transformer had 20 turns on a 5-volt winding, the turns ratio was 4 turns per volt (t/v). Therefore, wind enough turns on your transformer to make up the line voltage plus whatever taps above line voltage are needed.

Using 4 t/v as a base, a total of 380 turns must be wound before we reach the first tap (in the circuit shown, this is 25 volts below line voltage). Multiplying the voltage by the turns ratio, we get $95 \times 4 = 380$ turns. Of course, if fewer taps are needed, then the actual figures would be different. However, the ratio shown above and below the applied line voltage has proven very useful in actual work. For ease in figuring, 120 is used as the applied line voltage. This is not exactly accurate, but accurate enough for all practical purposes.

At 4 t/v, each individual tap requires 20 turns at 5 volts per tap. Therefore, after the initial 380 turns are wound on the form, a loop of wire is pulled up and doubled on itself to make the tap. A piece of cambric spaghetti (no plastic!) is slipped over the loop and slid snugly down to the winding to prevent shorting. Use as thin-walled a spaghetti as possible, consistent with the necessary strength. This may be labelled -25 V or 95 V with a scrap of paper, or a small tag. When twenty more turns are wound, repeat the process, until all of the taps decided upon are wound. The finish wire of the winding is covered with a piece of spaghetti brought out and marked +25 V or 145 V.

The winding may be random-wound as long as enough care is taken to pre-

vent piling up the wire at one side. It must be tight enough to allow the iron to be slipped back into place without touching the windings. To finish up, coat the winding well with insulating varnish and allow to dry. When dry, wrap a turn or two of fish-paper or insulating cambric (Empire cloth) around the outside and fasten with plastic tape, coating this with varnish. Carefully replace the iron, being certain that the sharp edges do not cut the windings and that the iron is bolted together tightly to prevent buzzing. After assembly, connect the taps to the appropriate terminals of the tap switch.

If desired, the completed unit may be mounted in a separate metal box or in the panel of the service bench. Wire size should be whatever is necessary to carry, without undue heating or voltage drop, the loads which will be imposed upon it. If the wire is too small, a severe voltage drop will be noted. A second unit built for TV work and designed to carry 175-250 watts used No. 20 enameled wire. The original, as shown here, was built for low-drain work, portable radios, etc., and used No. 30 wire. Consequently, it will not carry over 40 or 50 watts in normal service.

A lot of trouble can be saved if you pick an old transformer whose primary is in good condition. Take off the other windings (the primary is wound next to the core in most transformers) and unwind (carefully) just enough turns to make your -25V tap. Then wind them back, tapping each 5 volts as you go along, and wind on the additional 25 volts with wire the same size as that of the original transformer primary.

The magnet wire can be obtained from any mail order house—your local electrician may also be a source. Try him also for fish-paper, spaghetti, varnished cambric (Empire) cloth and paper, tape and the other sundries, which are otherwise hard to get. (Some of these may be obtained from an electronic sundries house, such as General Cement.)

A less expensive unit, though not nearly as flexible, may be made up using only the heavy-duty rheostat connected in series with an ac outlet. This is then adjusted to drop the line voltage as desired. The disadvantage of this lies in the inability of this arrangement to raise the line voltage.

A final word of caution: when making any repairs or measurements on these small sets, be very careful not to let test leads slip causing a short circuit. Never probe in them with a metal screwdriver. If probing is necessary, always use a well-insulated tool. Watch out for accidental shorts caused by un-insulated wiring, as this usually results in the burnout of one or more tubes.

(After 20 years of servicing portables I burned out two tubes the day before this was written! Motto: Be careful!)
END

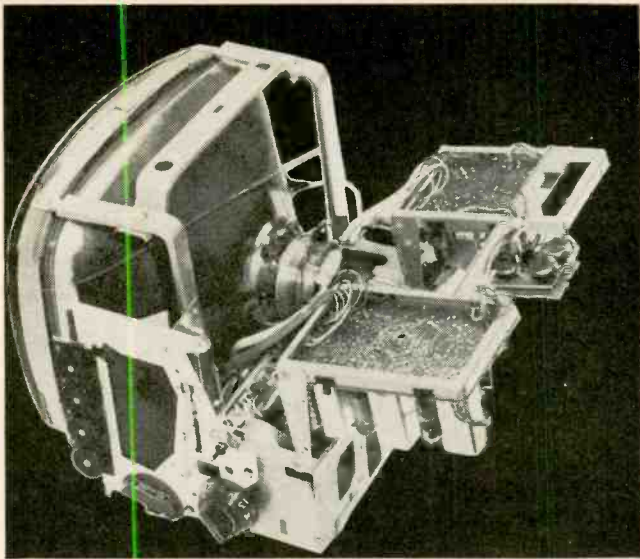

HINGED VERTICAL CHASSIS of this British television receiver swings down for easy access to all components without the the necessity of removing it from the cabinet. Plated circuits are used. Like many other British TV set models, this Sobell tunes the FM radio band in addition to the 13 channels allocated in England.

SHAPE OF TV TO COME? TV design engineers and stylists on both sides of the Atlantic have simultaneously come up with the idea of separating the picture tube from the chassis. At left is the Rocket, made by F.L.M.I. of Italy, and at right the Philco Predicta console. Both of them—plus the similarly designed Satellite by Teleavia of Paris—are now in production. The plastic-encased picture-tube assembly of the Philco TV pivots for best viewing position. The picture-tube assembly of another Philco Predicta model, the Tandem, is connected to the chassis only by a flat cable, permitting the viewing screen to be placed as far as 25 feet from the receiver.

ELECTRONICS SPEEDS HAND ASSEMBLY—It's not automation, but a new tape device developed by Westinghouse and Dictaphone is claimed to increase production by 20% to 100%. Known as Audibly Instructed Manufacturing Operations (AIMO), the method substitutes aural instructions for work drawings and written instruction sheets. Production workers get their instructions from a tiny transistor amplifier and earphone. The wireless system uses inductive pickup to receive instructions from the tape playback unit (lower right).

what's

new
?

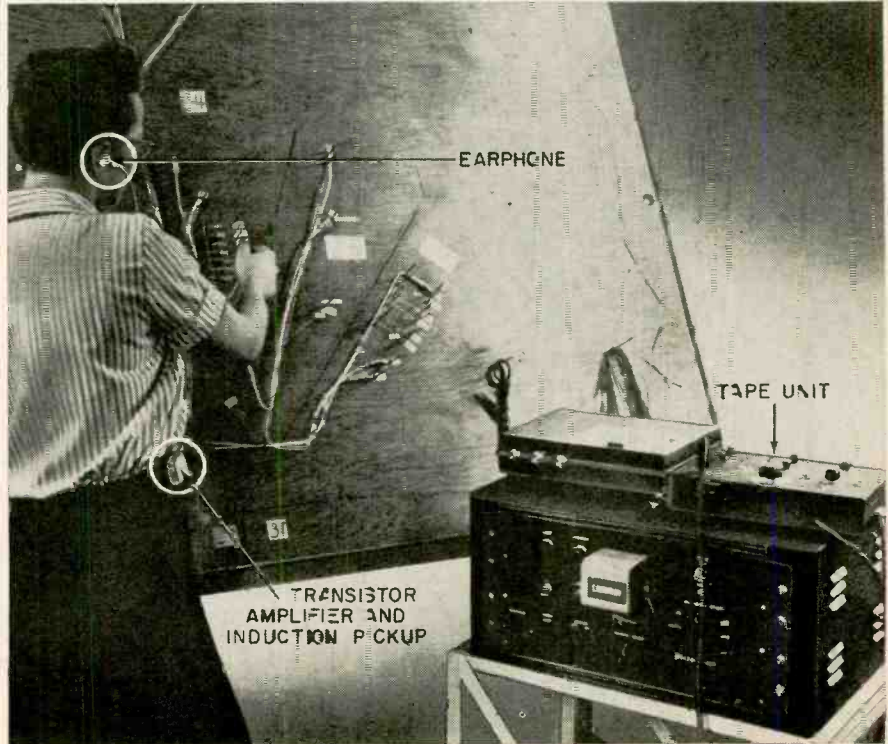
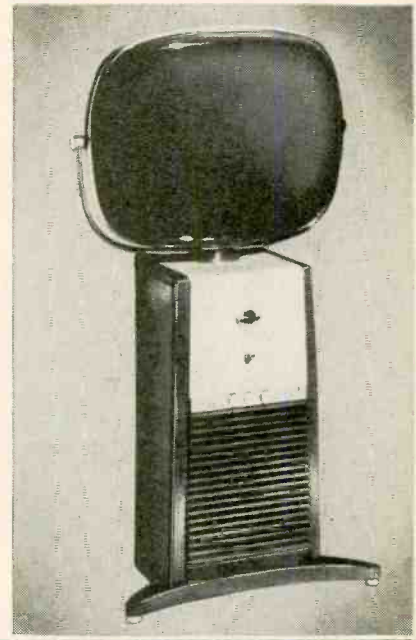
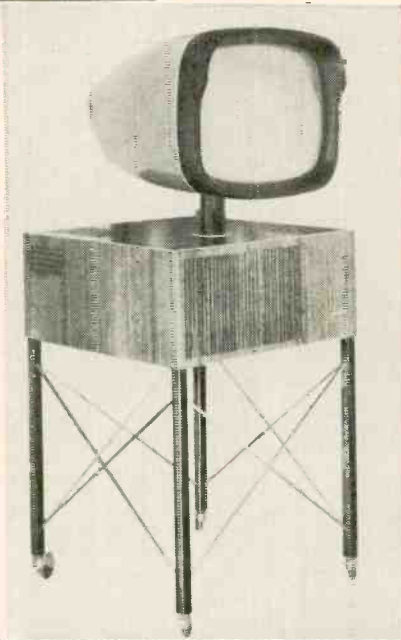



Superior's New Model TD-55
EMISSION TYPE

TUBE TESTER

For the Experimenter or Part-time Serviceman, who has delayed purchasing a higher priced Tube Tester.
For the Professional Serviceman, who needs an extra Tube Tester for outside calls.
For the busy TV Service Organization, which needs extra Tube Testers for its field men.

Speedy, yet efficient operation is accomplished by:

1. Simplification of all switching and controls.
2. Elimination of old style sockets used for testing obsolete tubes (26, 27, 57, 59, etc.) and providing sockets and circuits for efficiently testing the new Noval and Sub-Minar types.

"Free-point" element switching system

The Model TD-55 incorporates a newly designed element selector switch system which reduces the possibility of obsolescence to an absolute minimum. Any pin may be used as a filament pin and the voltage applied between that pin and any other pin or even the "top-cap."

Checks for shorts and leakages between all elements

The Model TD-55 provides a super sensitive method of checking for shorts and leakages up to 5 Megohms between any and all of the terminals. Continuity between various sections is individually indicated. This is important, especially in the case of an element terminating at more than one pin. In such cases the

element or internal connection often completes a circuit.

Elemental switches are numbered in strict accordance with R.M.A. specification

One of the most important improvements, we believe, is the fact that the 4 position fast action snap switches are all numbered in exact accordance with the standard R.M.A. numbering system. Thus, if the element terminating in pin No. 7 of a tube is under test, button No. 7 is used for that test.

The Model TD-55 comes complete with operating instructions and charts. Housed in rugged steel cabinet. Use it on the bench—use it for field calls. A streamlined carrying case, included at no extra charge, accommodates the tester and book of instructions.

\$26⁹⁵
NET

You can't insert a tube in wrong socket

It is impossible to insert the tube in the wrong socket when using the new Model TD-55. Separate sockets are used, one for each type of tube base. If the tube fits in the socket it can be tested.

Superior's New Model TW-11



STANDARD PROFESSIONAL

TUBE TESTER

- Tests all tubes, including 4, 5, 6, 7, Octal, Lockin, Hearing Aid, Thyatron, Miniatures, Sub-miniatures, Novals, Sub-minars, Proximity fuse types, etc.

- Uses the new self-cleaning Lever Action Switches for individual element testing. Because all elements are numbered according to pin-number in the RMA base numbering system, the user can instantly identify which element is under test. Tubes having tapped filaments and tubes with filaments terminating in more than one pin are truly tested with the Model TW-11 as any of the pins may be placed in the neutral position when necessary.

- The Model TW-11 does not use any combination type sockets. Instead individual sockets are used for each type of tube. Thus it is impossible to damage a tube by inserting it in the wrong socket.

- Free-moving built-in roll chart provides complete data for all tubes. All tube listings printed in large easy-to-read type.

NOISE TEST: Phono-jack on front panel for plugging in either phones or external amplifier will detect microphonic tubes or noise due to faulty elements and loose internal connections.

EXTRAORDINARY FEATURE

SEPARATE SCALE FOR LOW-CURRENT TUBES—Previously, on emission-type tube testers, it has been standard practice to use one scale for all tubes. As a result, the calibration for low-current types has been restricted to a small portion of the scale. The extra scale used here greatly simplifies testing of low-current types.

The Model TW-11 operates on 105-130 Volt 60 Cycles A.C. Comes housed in a beautiful hand-rubbed oak cabinet complete with portable cover.

\$47⁵⁰
NET

Superior's New Model 82

RAPID TESTER

The Very Best Value In Multi-Socket Tube Testers!



Production of this Model was delayed a full year pending careful study by Superior's engineering staff of this new method of testing tubes. We don't expect it to completely replace conventional testers but if you want to try this new type of tester, you can do no better than mail the coupon on facing page. *Don't let the low price mislead you!* We claim Model 82 will outperform similar looking units which sell for much more—and as proof, we offer to ship it on our examine before you buy policy.

Primarily, the difference between the conven-

tional tube tester and the multi-socket type is that in the latter, the use of an added number of specific sockets (for example, in Model 82 the noval is duplicated eight times) permits elimination of element switches thus reducing testing time and possibility of incorrect switch readings.

To test any tube, you simply insert it into a numbered socket as designated, turn the filament switch and press down the quality switch—THAT'S ALL! Read quality on meter. Inter-element leakage, if any, indicates automatically.

FEATURES:

- ★ Dual Scale meter permits testing of low current tubes.
- ★ 7 and 9 pin straighteners mounted on panel.
- ★ All sections of multi-element tubes tested simultaneously.

- ★ Use of 22 sockets permits testing all popular tube types and prevents possible obsolescence.
- ★ Ultra-sensitive leakage test circuit will indicate leakage up to 5 megohms.

\$36⁵⁰
NET

EXAMINE BEFORE YOU BUY!
USE APPROVAL FORM ON NEXT PAGE

Superior's New Model 77

VACUUM TUBE VOLTMETER

WITH NEW 6" FULL-VIEW METER



AS A DC VOLTMETER

The Model 77 is indispensable in H-F-I Amplifier servicing and a must for Black and White and color TV Receiver servicing where circuit loadings cannot be tolerated.

AS AN ELECTRONIC OHMMETER

Because of its wide range of measurement leaky capacitors show up glaringly. Because of its sensitivity and low loadings, intermittents are easily found, isolated and repaired.

- Compare it to any peak-to-peak V. T. V. M. made by any other manufacturer at any price!
- ✓ Model 77 completely wired and calibrated with accessories (including probe, test leads and portable carrying case) sells for only \$42.50.
- ✓ Model 77 employs a sensitive six inch meter. Extra large meter scale enables us to print all calibrations in large easy-to-read type.
- ✓ Model 77 uses new improved SICO printed circuitry.
- ✓ Model 77 employs a 12AU7 as D.C. amplifier and two 9006's as peak-to-peak voltage rectifiers to assure maximum stability.
- ✓ Model 77 uses a selenium-rectified power supply resulting in less heat and thus reducing possibility of damage or value changes of delicate components.
- ✓ Model 77 meter is virtually burn-out proof. The sensitive 400 microampere meter is isolated from the measuring circuit by a balanced push-pull amplifier.
- ✓ Model 77 uses selected 1% zero temperature coefficient resistors as multipliers. This assures unchanging accurate readings on all ranges.

Specifications

• DC VOLTS—0 to 3/15/75/150/300/750/1,500 volts at 11 megohms input resistance • AC VOLTS (RMS)—0 to 3/15/75/150/300/750/1,500 volts • AC VOLTS (Peak to Peak)—0 to 8/40/200/400/800/2,000 volts • ELECTRONIC OHMMETER—0 to 1,000 ohms/10,000 ohms/100,000 ohms/1 megohm/10 megohms/100 megohms 1,000 megohms • DECIBELS—-10 db to +18 db, +10 db to +38 db, +30 db to +58 db. All based on 0 db = .006 watts (6 mw) into a 500 ohm line (1.73v). • ZERO CENTER METER—For discriminator alignment with full scale range of 0 to 1.5/7.5/37.5/75/375/750 volts at 11 megohms input resistance.

AS AN AC VOLTMETER

Measures RMS values if sine wave, and peak-to-peak value if complex wave. Pedestal voltages that determine the "black" level in TV receivers are easily read.

Model 77 comes complete with operating instructions, probe and test leads. Use it on the bench—use it on calls. A streamlined carrying case, included at no extra charge, accommodates the tester, instruction book, probe and leads. Operates on 110-120 volt 60 cycle. Only.....

\$42.50
NET

The Most Versatile All-Purpose Multi-Range Tester Ever Designed!

Superior's New Model 79

SUPER-METER

WITH NEW 6" FULL-VIEW METER

A Combination VOLT-OHM MILLIAMMETER.

Plus CAPACITY, REACTANCE, INDUCTANCE AND DECIBEL MEASUREMENTS.

Also Tests SELENIUM AND SILICON RECTIFIERS, SILICON AND GERMANIUM DIODES.



Model 79 completely wired and calibrated with test leads and portable carrying case sells for only \$38.50. Positively no extras to buy.

The Model 79 represents 20 years of continuous experience in the design and production of SUPER-METERS, an exclusive SICO development. In 1938 Superior Instruments Co. designed its first SUPER-METER, Model 1150. In 1940 it followed with Model 1250 and in succeeding years with others including Models 670 and 670-A. All were basically V.O.M.'s with extra services provided to meet changing requirements. New Model 79, the latest SUPER-METER includes not only every circuit improvement perfected in 20 years of specialization, but in addition includes those services which are "musts" for properly servicing the ever increasing number of new components used in all phases of today's electronic production. For example with the Model 79 SUPER-METER you can measure the quality of selenium and silicon rectifiers and all types of diodes—components which have come into common use only within the past five years, and because this latest SUPER-METER necessarily required extra meter scale, SICO used its new full-view 6-inch meter.

Specifications

- ✓ D.C. VOLTS: 0 to 7.5/15/75/150/750/1,500.
 - ✓ A.C. VOLTS: 0 to 15/30/150/300/1,500/3,000.
 - ✓ D.C. CURRENT: 0 to 1.5/15/150 Ma. 0 to 1.5/15 Amperes.
 - ✓ RESISTANCE: 0 to 1,000/100,000 Ohms. 0 to 10 Megohms.
 - ✓ CAPACITY: .001 to 1 Mfd. 1 to 50 Mfd.
 - ✓ REACTANCE: 50 to 2,500 Ohms. 2,500 Ohms to 2.5 Megohms.
 - ✓ INDUCTANCE: .15 to 7 Henries. 7 to 7,000 H-mhos.
 - ✓ DECIBELS: -6 to +18, +14 to +38, +34 to +58.
- The following components are all tested for QUALITY at appropriate test potentials. Two separate BAD-GOOD scales on the meter are used for direct readings.
- ✓ All Electrolytic Condensers from 1 MFD to 1000 MFD.
 - ✓ All Selenium Rectifiers. ✓ All Germanium Diodes.
 - ✓ All Silicon Rectifiers. ✓ All Silicon Diodes.

Model 79 comes complete with operating instructions and test leads. Use it on the bench—use it on calls. A streamlined carrying case included at no extra charge accommodates the tester, instruction book and test leads.....Only

\$38.50
NET

SHIPPED ON APPROVAL NO MONEY WITH ORDER—NO C.O.D.

Try any of the instruments on this or the facing page for 10 days before you buy. If completely satisfied then send down payment and pay balance as indicated on coupon. No Interest or Finance Charges Added! If not completely satisfied return unit to us, no explanation necessary.

MOSS ELECTRONIC DISTRIBUTING CO., Inc.
Dept. D-492, 3849 Tenth Ave., New York 34, N. Y.

Please send me the units checked on approval. If completely satisfied I will pay on the terms specified with no interest or finance charges added. Otherwise, I will return after a 10 day trial positively cancelling all further obligation.

- | | | |
|---|--|--|
| <input type="checkbox"/> Model TD-55..... Total Price \$26.95
\$6.95 within 10 days. Balance \$5.00
monthly for 4 months. | <input type="checkbox"/> Model TW-11..... Total Price \$47.50
\$11.50 within 10 days. Balance \$6.00
monthly for 6 months. | <input type="checkbox"/> Model 79..... Total Price \$38.50
\$8.50 within 10 days. Balance \$6.00
monthly for 5 months. |
| <input type="checkbox"/> Model 77..... Total Price \$42.50
\$12.50 within 10 days. Balance \$6.00
monthly for 5 months. | <input type="checkbox"/> Model 82..... Total Price \$36.50
\$6.50 within 10 days. Balance \$6.00
monthly for 5 months. | |

Name

Address

City..... Zone..... State.....

All prices net, F.O.B., N. Y. C.

an RCL BRIDGE

...it's easy to build...

Multipurpose instrument measures resistance, capacitance and inductance. Built-in vtvm used as null indicator has dc ranges from 1.5 to 1,000 volts

By DAVID STONE

THE RCL bridge is an instrument capable of directly measuring most values of resistance, capacitance and inductance. It is built with standard, easily obtained parts and assembled in a few hours. It is sufficiently accurate for general servicing and experimenting and aids in determining the values of a great many parts found in the average junkbox.

The test set (see Fig. 1) is a combination of four bridges—a Wheatstone resistance, Schering capacitance, a Maxwell and a Hay inductance bridge. Two inductance bridges are used to cover the large range of values from air-core coil to iron-core choke inductors.

The resistance bridge compares an unknown resistance against a known standard resistor of 1% tolerance and the capacitance bridge compares an unknown capacitor to a known standard capacitor of 5% tolerance. The inductance bridges compare an unknown coil or choke inductance against a known standard capacitance of 5% tolerance. The basic difference between the Hay and Maxwell bridges is in the placement of a balance potentiometer in the standard capacitance arm of the bridge.

The signal source is obtained from a 1-to-3 audio interstage transformer (impedance ratio) with the lower impedance winding connected to the 117-volt 60-cycle ac line. It operates as a stepup transformer and provides about 200 volts of 60-cycle signal to the bridge. If desired, an audio signal generator can be used as a signal source by wiring the bridge's signal input leads to some convenient jack for connection to the signal generator. Not as much signal voltage will be needed at higher frequencies.

The detector can be a standard ac vtvm, oscilloscope or dc vtvm with a pair of germanium diodes connected across the input to rectify the signal. I needed a dc vtvm and built one into the same cabinet with the RCL bridge. It uses two 1N64 diodes for rectification. The voltmeter is on the right-hand side. Fig. 2 shows the voltmeter's circuit.

What will it measure?

The ranges measured by the RCL bridge are: resistance, 1 ohm to 10 megohms; capacitance, 10 μf to 1 μf ; inductance, 10 μh to 10 henrys.

The VERNIER control (R8) selects values from 1 to 10 and the MULTIPLY BY switch (S1) provides a multiplying

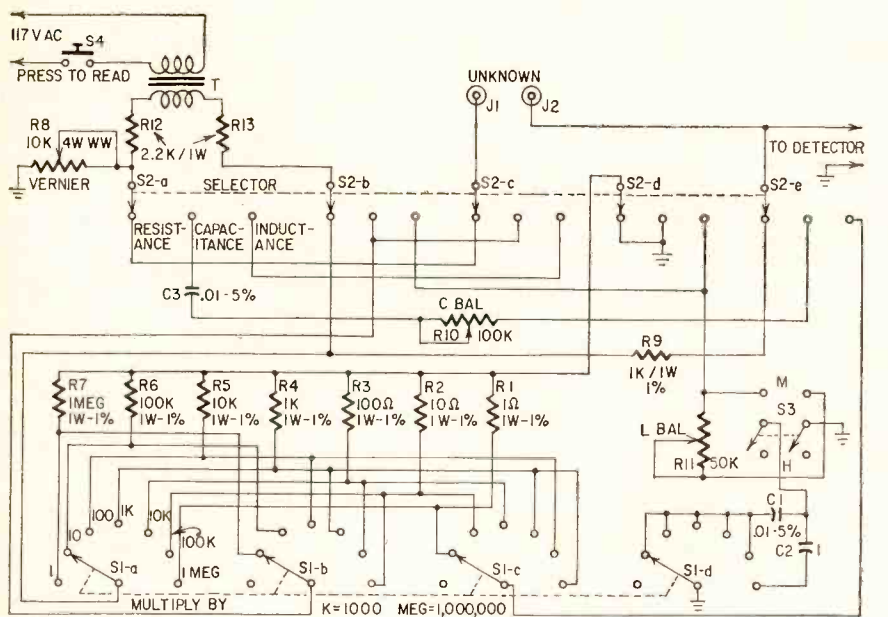

- R1—1 ohm, 1 watt, 1%
 - R2—10 ohms, 1 watt, 1%
 - R3—100 ohms, 1 watt, 1%
 - R4—1,000 ohms, 1 watt, 1%
 - R5—10,000 ohms, 1 watt, 1%
 - R6—100,000 ohms, 1 watt, 1%
 - R7—1 megohm, 1 watt, 1%
 - R8—pot, 10,000 ohms, 4 watts, linear taper, wirewound
 - R10—pot, 100,000 ohms
 - R11—pot, 50,000 ohms
 - R12, R13—2,200 ohms, 1 watt, 10%
 - C1, C2—0.01 μf , mica, 5%
 - J1, J2—binding posts
 - S1—4 poles, 4 gangs, 7 positions, rotary
 - S2—5 poles, 5 gangs, 3 positions, rotary
 - S3—dpdt toggle
 - S4—spst, momentary contact, pushbutton, normally open
 - T—interstage transformer, 1:3 (Stancor A-73-C or equivalent)
- Case, 15 x 8 x 3 inches

Fig. 1—RCL bridge incorporates four bridge circuits—Wheatstone resistance, Schering capacitance, Maxwell inductance and Hay inductance.

(Below) Here's how the finished unit looks. The vtvm in this model has seven ranges extending to 1,500 volts.

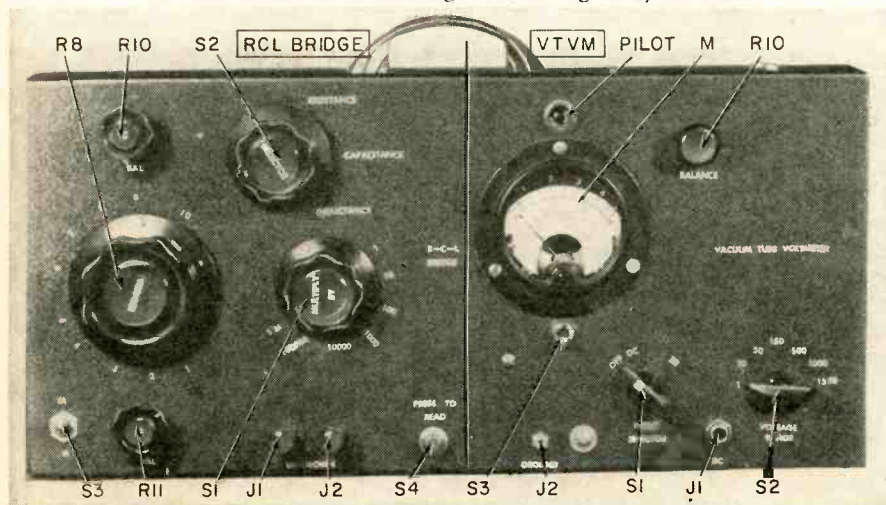



RCA INSTITUTES offers you the finest of home study training. The equipment illustrated and text material you get with each course is yours to keep. Practical work with very first lesson. Courses for the beginner and the advanced student. Pay-as-you-learn. You need pay for only one study group at a time.

**Send for this
FREE Book Now** ▶

[RESIDENT SCHOOL courses in New York City offer comprehensive training in Television and Electronics. Day and evening classes start four times each year.
Detailed information on request]

RCA INSTITUTES, Inc. Home Study Dept. RE-88

A Service of Radio Corporation of America
350 West Fourth Street, New York 14, N. Y.

Without obligation, send me FREE 52 page CATALOG on Home Study Courses in Radio, Television and Color TV. No salesman will call.

Name.....
please print

Address.....

City.....Zone.....State.....

Korean Vets! Enter discharge date.....

CANADIANS — Take advantage of these same RCA courses at no additional cost. No postage, no customs, no delay. Send coupon to:
RCA Victor Company, Ltd., 5001 Cote de Liesse Rd., Montreal 9, Quebec
To save time, paste coupon on postcard.

TEST INSTRUMENTS

factor. These two readings, when multiplied together, indicate the value of the unknown part. The values are read directly in ohms, micromicrofarads and microhenries, and these values can be easily converted to larger values if necessary. For example, when checking an unknown capacitor, the VERNIER dial is rotated to obtain a null reading on the detector while switch S1 is rotated to some setting which will place the null within range of R8. If the null is obtained at 5 on the VERNIER scale with the MULTIPLY BY switch set at 10,000, the value of the unknown is $5 \times 10,000$ or 50,000 μf . This is easily converted, mentally, to .05 μf . If the same settings are obtained on the inductance bridges, the unknown coil value is 50,000 μh , or 50 mh. The BALANCE controls L BAL (R11) and C BAL (R10) are used to sharpen the null for an accurate reading with the inductance and capacitance bridges, respectively.

Construction and calibration

The RCL bridge circuit is shown in Fig. 1. There is nothing critical about the parts layout except for the size and placement of the hookup wire. Use No. 14 or heavier wire to minimize resistance and dress leads away from each other where possible, to minimize stray capacitance. Good solder connections are important.

The close tolerance values of the range resistors R1 through R7 can be made up by paralleling resistances with the help of a very good ohmmeter or resistance bridge, or by obtaining 1% tolerance units. My bridge was built with paralleled resistors as I had a good supply of 10% units.

The scale accuracy of the combination bridge depends mainly upon the careful calibration of R8, a 10,000-ohm wire-wound linear-taper unit. Use an accurate ohmmeter or resistance bridge to calibrate R8 in 1,000-ohm steps.

Mount this control on the panel and fasten the indicator knob before calibrating. The 1,000-ohm steps can now be permanently inscribed on the panel. View the control from the rear and ground the left-hand terminal to the

panel. The center and right-hand terminals are connected. The calibrating ohmmeter or resistance bridge can then be hooked to the grounded terminal and the connected terminals. The resistance will rise as the VERNIER knob is rotated in a clockwise direction. At 1,000 ohms, inscribe the numeral 1 on the panel, at 2,000 ohms the numeral 2 and so on until 10,000 ohms is reached and the number 10 is inscribed. When this is completed, wire the VERNIER control into the circuit.

A momentary-contact normally open pushbutton PRESS TO READ switch (S4), is installed in series with one ac line connection to the primary of transformer T. It cuts off the 60-cycle signal voltage to the UNKNOWN terminals and removes

the possibility of shock when an unknown part is placed across the testing terminals.

A known close-tolerance 1,000- and 10,000-ohm resistor can be placed across the UNKNOWN terminals to test the accuracy of the bridge when construction and calibration is completed. A null reading should be obtained at VERNIER setting 1 and MULTIPLY BY settings 1,000 and 10,000, respectively. This procedure can be repeated with the capacitance and inductance bridges, using known capacitors and inductors.

Using the bridge

To find the value of an unknown resistance, rotate the SELECTOR switch (S2) to RESISTANCE. Connect the resis-

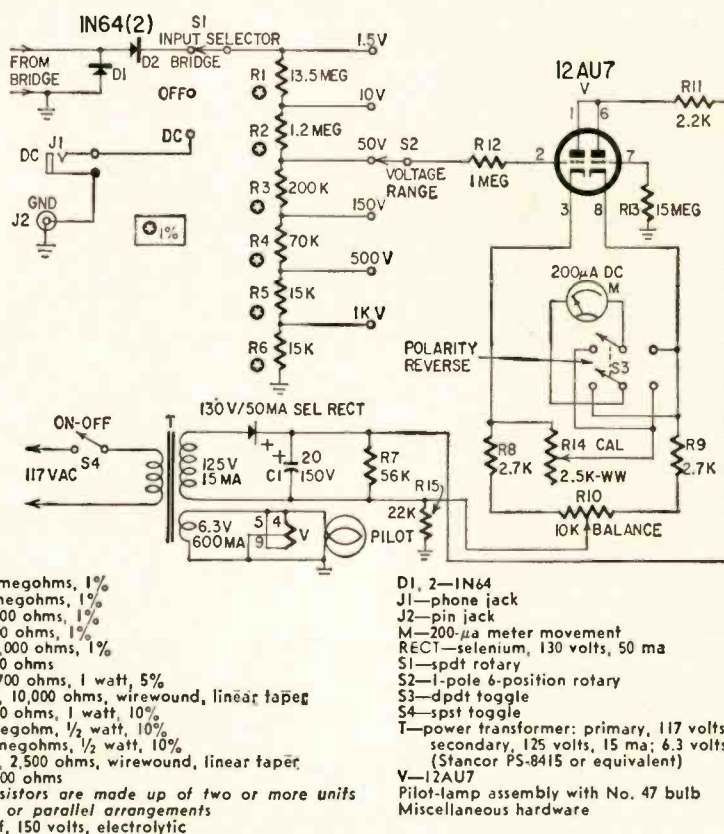
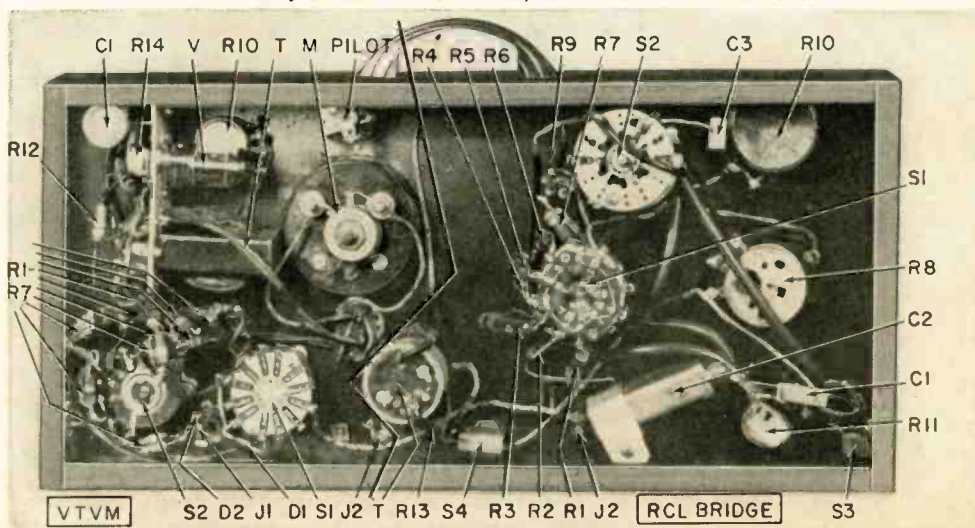

Fig. 2 (above)—Circuit of vtvm (detector) section. If you have a dc vtvm, this unit is not needed.



A large case provides plenty of room for all components. Note that the author used a multiple section rotary switch which he had on hand for S1 in the vtvm.

TEST INSTRUMENTS

tor to the UNKNOWN terminals or use short, heavy leads to connect the part to the bridge. Connect an external detector, if used. Set VERNIER to mid-range and rotate the MULTIPLY BY switch while holding down the PRESS TO READ pushbutton. The detector reading will approach a minimum at one setting of the MULTIPLY BY switch. Leave the MULTIPLY BY control at this setting and rotate the VERNIER knob for a null reading of the detector. This is characterized by a dip of the detector meter needle, with a rise on each side of the dip as the VERNIER is rocked slowly back and forth through a small range. If this dip is not obtained within the VERNIER'S range, set the MULTIPLY BY switch to the next higher or lower setting and repeat the process. It takes only a few seconds to cover each range. When the null is obtained, multiply the VERNIER reading by the MULTIPLY BY reading to determine the resistance value in ohms.

When checking an unknown capacitor, set SELECTOR switch S2 on CAPACITANCE. Connect the capacitor to the UNKNOWN terminals or use short, heavy leads to connect the part to the bridge. Set VERNIER to mid-range, push PRESS TO READ switch and rotate MULTIPLY BY switch for minimum reading. Rotate VERNIER after minimum is obtained, to find null reading. When a null is reached, rotate C BAL control to sharpen the null. The dip will become sharper as the C BAL is rotated and the VERNIER is rocked slowly through each side of the null point. When the null is at its

sharpest, multiply the value of the VERNIER dial by the MULTIPLY BY setting to obtain the capacitance in μf .

To test for the value of an unknown inductance, rotate SELECTOR switch S2 to INDUCTANCE. Connect coil or choke to UNKNOWN terminals. Throw M-H switch S3 to M position. If a sharp null cannot be obtained with the following procedure, throw M-H switch to H and repeat the process. As a rule of thumb, use the M position for checking all coils except large iron-core chokes. The H position will work best for the larger inductances. Rotate VERNIER and MULTIPLY BY switch to obtain null. When the null is reached, rotate L BAL control to sharpen the null. The action of this control is critical, so turn the knob slowly. A sharp null will be obtained, with care. The value of the unknown inductance is read directly from the VERNIER dial reading multiplied by the MULTIPLY BY setting, in microhenries.

If an external detector is used with this instrument, it should be very sensitive. The signal voltage output at the detector terminals is quite low when a null is being approached. It is also low on the higher ranges of the MULTIPLY BY settings. To avoid overloading, start with the detector's higher ranges and lower them when approaching the null.

With careful use, the readings are fairly accurate. The RCL bridge is easy to use and will pay dividends by determining the values of unmarked parts. It is also useful for finding components that have changed value. END

Relax... you can when you buy tubes from mail order advertisers in RADIO-ELECTRONICS. Since January 1956 we have insisted that if the tubes being offered for sale are new and unused, advertisers say so. If they aren't, they have to tell you that too. So when you buy tubes by mail from RADIO-ELECTRONICS advertisers—relax—you get just what you ask for.



TRANSISTOR RADIO REPAIRS NOW EASY!



with this

NEW *Howard W. Sams* BOOK

"SERVICING TRANSISTOR RADIOS"

COMPLETE ANALYSIS OF 70 POPULAR TRANSISTOR RADIO MODELS

includes new General Motors (Delco) Transistorized Auto-Portable Radio

Also Valuable Section— "BASIC POINTERS ON SERVICING TRANSISTORIZED RADIOS"...

COVERS LATEST MAKES AND MODELS

This book helps you earn big profits on Transistor Radio repairs—gives you complete, time-saving information—helps you become an expert on transistorized radios! Complete data on 70 latest models is based on actual lab analysis of each set. You get the famous Sams Standard Notation schematics—accurate, big, legible; full photo views of each chassis, with all components identified; complete alignment instructions; complete parts lists with full replacement data—everything you need to be successful in fast-growing transistorized radio servicing. Here's a "must" book for your bench. Order it now!

152 pages; 8½ x 11" **\$295**
PRICE ONLY.....

SEE THIS BOOK AT YOUR SAMS DISTRIBUTOR OR MAIL COUPON

FREE TRIAL COUPON

Howard W. Sams & Co., Inc., Dept. 2-HH3
2201 E. 46th St., Indianapolis 5, Ind.

Send me Sams "Servicing Transistor Radios" for 10 days FREE examination. In 10 days I will pay for the book, plus few cents delivery cost, or return postpaid.

We pay delivery costs if you remit with this coupon; same return privilege.

Name _____

Address _____

City _____ Zone _____ State _____

(Outside U.S.A. priced slightly higher)

How far can you go in electronics without a degree?

A few years ago, Lincoln E. Kitchin had no formal degree and knew nothing about electronic computers.

He still doesn't have a degree, yet today, he is a Field Engineer on one of America's biggest electronics projects. He helps maintain one of the largest computers in the world. He's doing work ordinarily done by engineers—an opportunity usually denied to men without a degree. This is a story of unusual significance to every technician who feels himself handicapped by lack of a formal degree.

"It all started back at the Base," Link recalls, "about two years ago. We were having lunch. One of my fellow Aircrewmembers described an interview he had just had—with IBM.

"It sounded good to me—particularly the field engineering aspects. I wasn't anxious to start my civilian electronics career stuck in a corner of some plant. Here was a chance to work in the field—with all the advantages of a permanent location. I made a note to add IBM to the companies I was considering for civilian work."

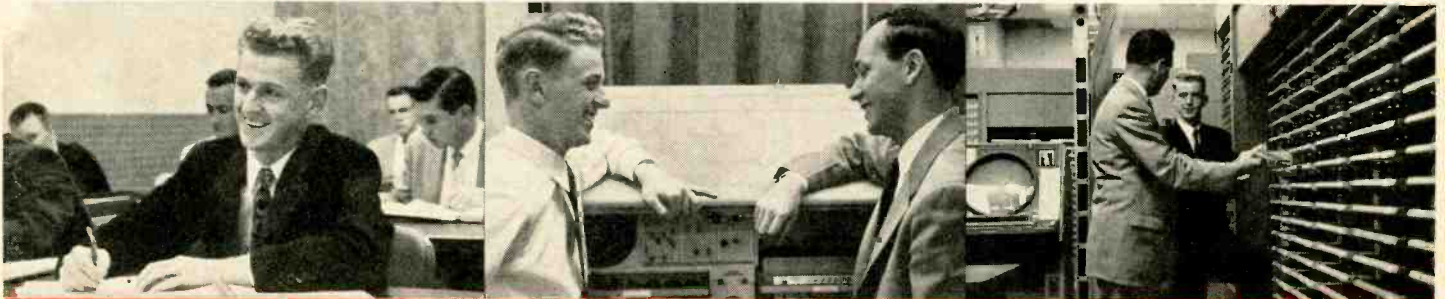

Taking notes in IBM Field Engineering class

Discussing a SAGE display console

Front view of computer frame

Interviewed by IBM

A month later, Link sat across the desk from an IBM interviewer. "Frankly," confesses Link, "I was scared at the thought of this interview. I didn't know the difference between an analog and a digital computer. I didn't expect to get the job."

The interviewer put Link quickly at his ease. A check of his background revealed Link's Service training—28 weeks of Class "A" aviation electronics plus Class "C" schooling in LORAN, RADAR and SONAR. He took a test, which indicated excellent aptitude for computer work.

Then Link learned how IBM would train him in electronics—for five months at full salary—to become a Field Engineer on the SAGE Program. He learned about SAGE, part of our nation's radar defense net, which is built around giant IBM computers—each containing 50,000 vacuum tubes plus 170,000 diodes. He heard about IBM's excellent company benefits, especially interesting to Link who had a wife and child. By the time the interview was over, Link had decided that IBM and the SAGE Program were what he was looking for. He decided then and there that he wanted to come with IBM.

Receives 20 weeks' training

Link reported to Kingston, N. Y., for training. In the IBM "school," he studied basic computer circuits, com-

puter logic and programming, card punch machines—all part of the twenty-week course a Computer Units Field Engineer takes. "The instruction was excellent," he recalls. "Our teachers, experienced field men, often made points not in the textbooks." Formal classroom lectures accounted for half his time, the other half being spent in the laboratories, where he worked on actual computer equipment for SAGE. During his training period, Link received a living allowance in addition to his salary.

Assigned to site in home state

His twenty weeks' training completed, Link was assigned to the SAGE site at Topsham, Maine. "IBM makes every effort to assign you to a location of your choice wherever possible," Link, who is a native State-o'-Mainer, points out.

At Topsham, Link has completed the installation phase of the computer. Now, his work consists of preventive maintenance and "keeping the customer happy"—the customer, in this case, being the Air Force personnel who man and operate the computer. "Installing this giant computer was a significant engineering feat," Link recalls. "First we ran 2,509 cables from 4 to 300 feet long. Then we bolted the computer sections together and hooked up the cables. Next came the testing phase in anticipation of Air Force acceptance tests.

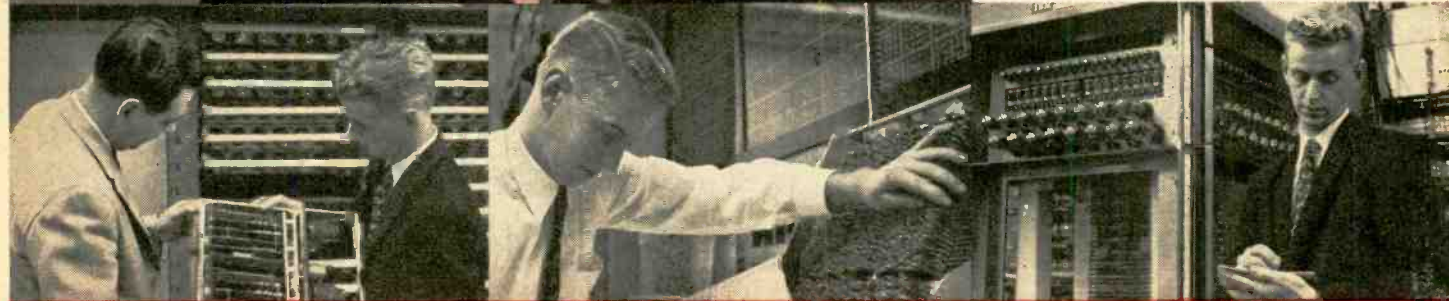

A problem in pluggable units

Working on manual input board of SAGE computer

Recording data on main core memory unit

"I'm in the Display Group," Link continues, "which has responsibility for over one hundred display consoles. Each of these has a 19-inch and a 5-inch cathode ray tube (similar to a TV tube) plus associated circuits. The knowledge of complex circuitry which we learned in the IBM school is essential for this work. We also maintain our own test equipment—oscilloscopes, meters, signal generators and specially designed pluggable unit test equipment."

What does the future hold?

Link looks forward to a rewarding career as a Computer Units Field Engineer. Promotion-wise, he could become, with further training, a Computer Systems Field Engineer, a Group Supervisor or Group Manager. Most important, however, he believes, is the excellent electronics background he's acquiring for the years ahead. "I've had a new engineering dimension added to my career—thanks to IBM's willingness to spend time and money training technicians to assume engineering responsibilities."

A career for you with IBM?

Since Link Kitchin joined IBM and the SAGE Program, opportunities are more promising than ever. This long-range program is destined for increasing national importance and IBM will invest thousands of dollars in the right men to insure its success.

If you have a minimum of three years' education or experience in electronics—gained through technical schooling or military service—you may qualify to become a member of this important, permanent, expanding program as a Computer Units Field Engineer.

You'll receive twenty weeks' advanced computer training at Kingston, N. Y., with full pay, plus living allowance, before assignment to a permanent location. Current openings are in the Great Lakes area and in the Pacific Northwest—and will be filled in the fall, 1958. You'll receive salary, not wages. And, of course, you'll receive IBM's famous company-paid benefits.

Mr. N. H. Heyer, Room 649-T

WRITE TODAY TO: Military Products Division
IBM Corp., Kingston, N. Y.

A prompt reply will be sent to you. Personal interviews arranged in all areas of the U. S. if your résumé of experience and education indicates you have the qualifications.

IBM

**MILITARY
PRODUCTS**

DATA PROCESSING • ELECTRIC TYPEWRITERS • MILITARY PRODUCTS
SPECIAL ENGINEERING PRODUCTS • SUPPLIES • TIME EQUIPMENT

TEST INSTRUMENTS

unit has a wattage scale for measuring up to 1,100 watts. A 5-ohm 10-watt resistor protects the circuit tested and is automatically switched in when the test leads are used (see Fig. 3).

When a fuse resistor opens, merely connect the meter in place of the fuse resistor and turn the receiver on. Set the switches to TEST LEADS and the 2 AMP range. Separate scales have been computed for each fuse resistor (see Fig. 4). If the total current, ac or dc, is more than specified for that particular fuse resistor, the meter will indicate in the red area. The meter can

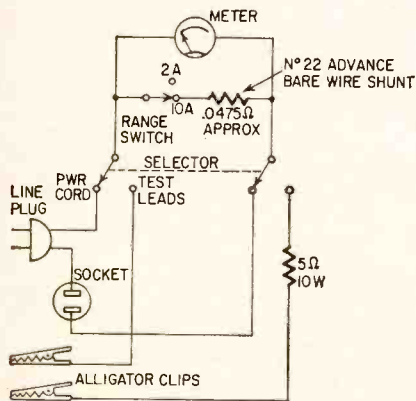

Fig. 3—Circuit of Fuse Safe checker. be left in the circuit to monitor the current while troubleshooting.

Do not leave the receiver on too long if the meter reads high in the red area; it is possible to burn out the resistor used for circuit protection. If the meter reads in the green area, it is safe to replace the fuse resistor. To check fused circuits, such as the horizontal output or B-plus, use the

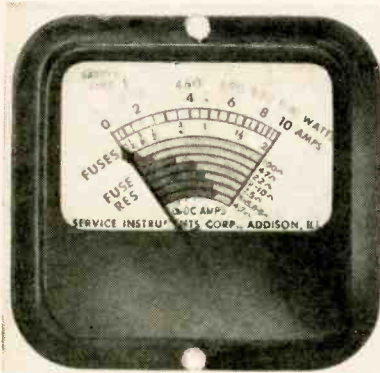

Fig. 4—Closeup of meter in the Sencore FS-3 Fuse-Safe circuit tester. Red area is light shading on scale's right-hand side. same procedure, reading the current on the 2 AMP scale. The meter is a moving-iron type that reads either ac or dc.

To check line fuses or power, set the switches to PWR CORD and 10 AMP range. Merely plug the receiver into the receptacle on the instrument and the meter line cord into the power receptacle. Short out the line fuse when making this test. Proper servicing of fuse-resistor circuits will result in fewer callbacks and more satisfied customers. It isn't the cost of the fuse resistors or fuse that counts, it's fixing a set the second time free. **END**

A Tape Recorder Test Adapter

By L. B. HOFFMAN

Here's a magnetic-induction type probe that lets you quickly check record and playback amplifiers of a tape recorder with the tape transport removed

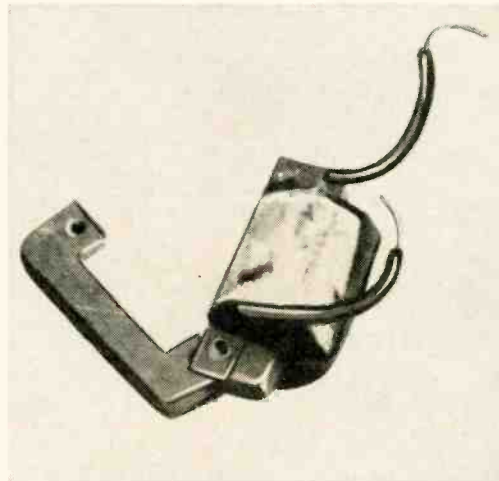

A

Obtain a midget transformer, similar to the type found in dynamic microphones and headphones. Remove the core-return laminations (shown partially removed) and snip off the low-impedance leads.

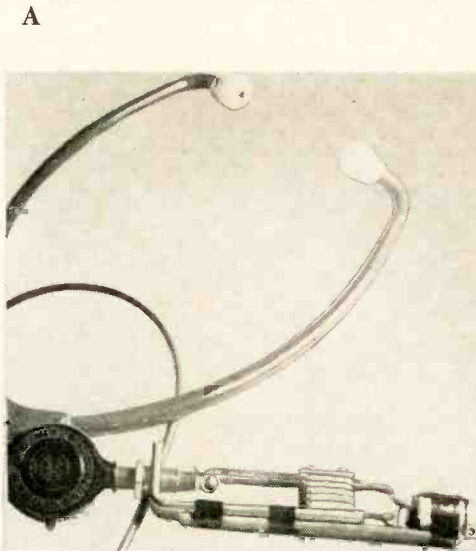

A

B

Connect the transformer to a long phono jack and mount the two parts on a popsicle stick to complete the probe. With headphones or a signal tracer plugged into the jack, you can check the record section of a tape recorder. Feed a signal to the recorder and place the probe transformer against the record head. You should hear a clear, sharp signal.

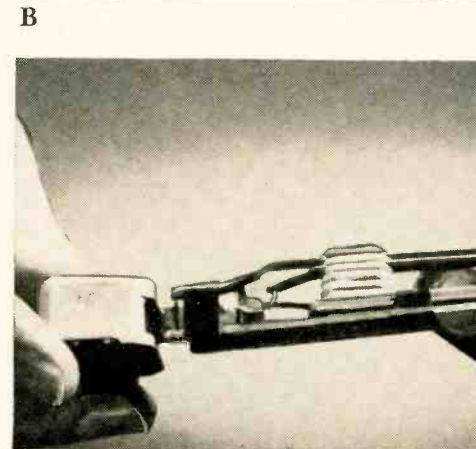

B

C

To check a playback amplifier, place the transformer against the playback head and plug a phonograph into the probe. The recorder should operate just as though you were playing back a tape.

C



CBS-Hytron
offers you
over 400
industrial
types



You will find CBS-Hytron's expanded industrial tube line the most comprehensive and the most dependable. See it at your distributor's. Ask him or write us for the CBS-Hytron catalogs you need: Power Tubes, E-290T... Military and Special-purpose Tubes, E-290S... Gas Tubes and Power Rectifiers, E-290C... Phototubes and Photocells, E-290P. *More reliable products through Advanced-Engineering*

CBS-HYTRON, Danvers, Massachusetts • A Division of Columbia Broadcasting System, Inc.

SUMMER vi-fi SPECIAL!

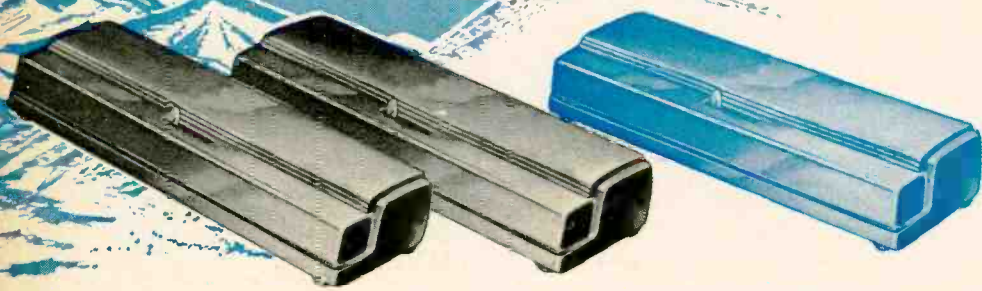

-3 for cost of 2

Or buy 4 and receive 2 free with an extra "special" discount! Under either plan, you can't afford to miss the extra profits of this "Summer Vi-Fi Special"!

Vi-Fi is the *only* indoor antenna that has the modern, slim lines of the new tv sets. Vi-Fi is the *only* indoor antenna with transformer coupling and variable inductors for sharp pictures. Vi-Fi is always a good buy; this "Summer Special" makes it the biggest antenna bargain ever!

Your Authorized AMPHENOL Distributor has all the details. See him right now!

THE BIGGEST
ANTENNA
BARGAIN
EVER!

SEE YOUR

AUTHORIZED
DISTRIBUTOR

AMPHENOL



New Tubes & Semi- conductors

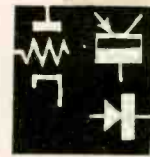

A MULTITUDE of types were announced this month. They range from a new concept in indicator tubes to audio output transistors for auto radios and a 110° test picture tube. One group of transistors can be used in de-dc power supplies capable of delivering 130 watts.

EM84/6FG6

A new type of tuning indicator tube that has a rectangular indication pattern for use in broadcast receivers and tape recorders. This type of indicator is becoming especially popular in FM receivers. The blue-white pattern changes in length with signal strength.

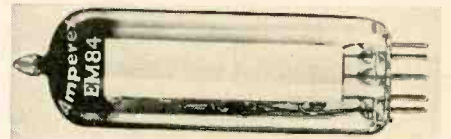

The pattern of the EM84 is not displayed on a specially shaped electrode, but on the inner side of the tube bulb to which a fluorescent layer is applied. The tube can be used vertically or horizontally.

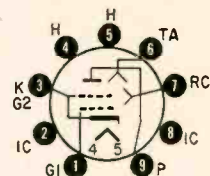

EM84/6FG6

TA = TARGET
RC = RAY-CONTROL ELECTRODE
IC = INTERNAL CONNECTION

Typical operating characteristics of this Amperex tube are:

V _H	6.3
I _H (ma)	270
V _{supply}	250
V _{target}	250
V _{gi}	0-22
I _P and ray-control electrode (ma)	0.45-0.06
I _{target} (ma)	1.1-1.6

2N373

Here is a p-n-p germanium alloy type drift transistor designed for 455-kc if amplifier service in portable radio receivers. The 2N373 features exceptional stability, excellent uniformity of characteristics and low feedback capac-

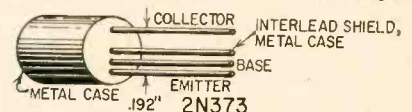

itance. It can provide 34 db of useful power gain in a common-emitter circuit

RADIO-ELECTRONICS

**NEW
COMPLETE**

**DIRECT
VIEWING**

TELEVISION ANALYST



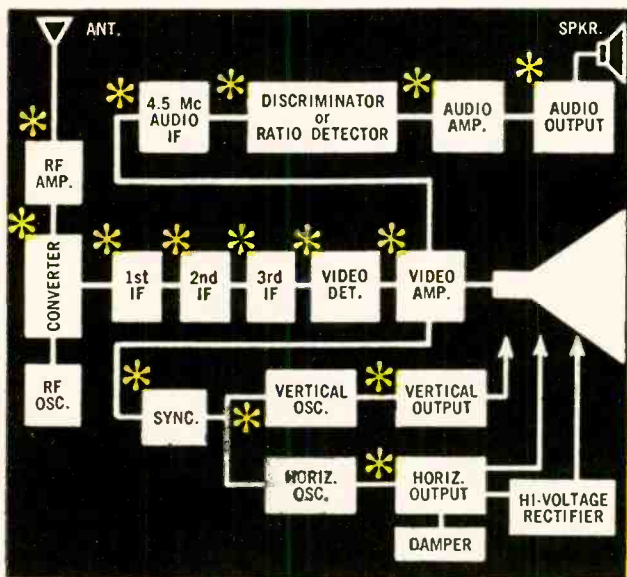

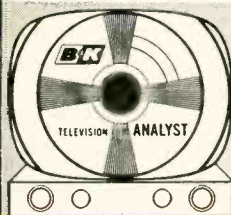

test each stage
SEPARATELY



and watch the
← result on the
TV set itself



UNIQUE NEW SIGNAL-INJECTION TECHNIQUE
Saves TV Trouble-Shooting Time and Work

-  **R.F.** Supplies complete r.f. and i.f. signals with video and audio modulation to quickly trouble-shoot each stage in each of the sections of the TV receiver. Enables you to check the r.f. sensitivity and AGC settings of TV receivers.
-  **VIDEO** Reproduces a complete test pattern on the screen of the TV picture tube and injects signals into each video stage of the TV receiver for fast, visual trouble-shooting and correction—anywhere, anytime. Makes it easy to check bandwidth, resolution, shading and contrast capabilities of the TV set.
-  **SYNC** Provides composite signal, sync positive and negative.
- SWEEP CIRCUIT DRIVING PULSES** Provides separate vertical and horizontal driving pulses for trouble-shooting deflection circuits.
- INTERMITTENTS** Test signal injection also aids in locating intermittent troubles.
-  **AUDIO** Provides a 4.5 mc sound channel, FM modulated with approximately 25 kc deviation. (This audio carrier is modulated either from a built-in 400 cycle tone generator, or from your own external audio source.) Injection of the 400 cycle tone signal simplifies trouble-shooting of the audio section.
-  **COLOR** Enables you to trouble-shoot and signal trace color circuits in color TV sets.
Generates white dot and crosshatch patterns on the TV screen for color TV convergence adjustments.
Generates full color rainbow pattern of orange, red, magenta, blue, cyan, green to test color sync circuits, check range of hue control, align color demodulators, etc.
-  **SET ADJUSTMENT** Enables you to check and adjust the vertical and horizontal linearity, size and aspect ratio of television receivers.



NEW



**MODEL
1075**



QUICK, DIRECT, COMPLETE TV TROUBLE-SHOOTING

Now, by point-to-point signal injection and test pattern reproduction, you can easily trouble-shoot and signal trace *any stage throughout the video, audio and sweep sections* of black & white and color TV receivers. With the remarkable new Model 1075 B&K TELEVISION ANALYST, you can quickly isolate and diagnose TV troubles (including intermittents). By use of the generated test pattern, you can *actually see* the condition directly on the picture tube of the television set itself. No external scope is needed. The TELEVISION ANALYST is practically a *complete TV service shop in one instrument!* Net, \$259⁹⁵

See your B&K Distributor or write for Bulletin AP12-E



B & K MANUFACTURING CO.
3726 N. Southport Ave. • Chicago 13, Illinois

Canada: Atlas Radio Corp., 50 Wingold, Toronto 10, Ont. Export: Empire Exporters, 458 Broadway, New York 13, U.S.A.

The March is on for Lektron's Fabulous

88¢ POLY-PAKS

FREE! BUY 10 PAKS — PICK 11th FREE!

POLY-PAKS ARE EXCLUSIVE WITH LEKTRON
PROVED BIGGEST BUYS IN ELECTRONICS PARTS
KIT FIELD BY VOLUME OF "PAK" SALES!
SAVE \$3 TO \$30 ON EACH POLY-PAK!

- 50 KNBS. Radio & TV. Asstd. colors, ins. Some worth \$1 ea. Wt. 2 lbs. Reg. \$17. **88¢**
- 100-PART SURPRISE PAK. Asstd. radio & TV parts. Wt. 2 lbs. Reg. \$10. **88¢**
- 50-PC. CONDENSER SPECIAL. Molded, paper, ceramic, oil, mica, variable discs. Wt. 2 lbs. **88¢**
- 65-PC. RESISTOR SPECIAL. WW, precision, carbon, variable, mini. Worth \$15. Wt. 3 lbs. **88¢**
- 13-PC. TWIST DRILL KIT. 1/16" thru 1/4" by 64ths. w/calibrated case. Reg. \$9. **88¢**
- 10 ELECTROLYTICS. Tubular and FP. Trip. too! To 1000mf & 500V. Wt. 3 lbs. **88¢**
- 12 "POLY" BOXES. Clear plastic hinged, w/snap locks. Asstd. sizes. Wt. 1 lb. **88¢**
- 7 SCREWDRIVERS & RACK. Plastic handles. 7 Different drivers w/screw rack. Wt. 2 lbs. **88¢**
- 4 OUTPUT TRANSFORMERS. 50L6, etc. Wt. 3 lbs. **88¢**
- "SUN" BATTERY. Sim. 1/2" to 1" famed B2M. 1" long; for hundreds of "lite" projects. Reg. \$2.50. **88¢**
- 15 ROTARY SWITCHES. Asstd. gangs. Wt. 3 lbs. Reg. \$12. **88¢**
- 60 TUBULAR CONDENSERS. Paper, molded, oil, poro. .0002 to .5mf to 1,000V. Wt. 2 lbs. Reg. \$12. **88¢**
- MINI-METER. 1 1/2" dia. 0 to 6 Amps AC. Reg. \$9. **88¢**
- 75 CERAMIC CONDENSERS. Hi-Q. discs tubular to .01 mf. Wt. 2 lbs. **88¢**
- 30 DISC CONDENSERS. Water-thin! Mini builders note! To .01 mf. **88¢**
- 30 PRECISION RESISTORS. 1/2, 1/4 & 1 W. Carbonyl & WW. Wt. 1 lb. Reg. \$15. **88¢**
- 60 HI-Q CARBON RESISTORS. 1/2, 1/4, 1 W. 10 ohms to 10 meg. Wt. 2 lbs. Reg. \$15. **88¢**
- 300-FT. HOOKUP WIRE. Tinned, asstd. colors, sizes. Wt. 2 lbs. **88¢**
- 0000-9999 COUNTER. Vender - Root. Double shafts. Reg. \$5. **88¢**
- 60 COILS. CHOKES. IF. RF. ANT. Slug-tuned, too. Wt. 3 lbs. **88¢**
- 15 VOLUME CONTROLS. Duals, too. To 1 meg. some w/switch. Wt. 2 lbs. Reg. \$12. **88¢**
- WARE. Nuts, screws, washers, etc. Wt. 2 lbs. Reg. \$8. **88¢**
- 8 GERMANIUM DIODES. Long leads, glass sealed. Reg. \$5. **88¢**
- 20 INSTRUMENT KNBS. Raytheon, Bakelite, w/brass insert & set screws. Skirted, too! Wt. 2 lbs. Reg. \$12. **88¢**
- 20 PRINTED CIRCUITS. Built-in R/C circuits. Integrals incl. Wt. 1 lb. Reg. \$7. **88¢**
- WORLD'S SMALLEST RADIO KIT. 2 1/2 x 2 x 1" All parts, instructions. Wt. 1 lb. **88¢**
- 0-60 MINUTE TIMER. For home, photo lab. Sounds alarm. Wt. 2 lbs. Reg. \$6. **88¢**
- SYLVANIA TV MIRROR. 8 x 12" stainless steel. Hundreds uses! Wt. 2 lbs. Reg. \$4. **88¢**
- 40 HI-Q CONDENSERS. Finest porcelain, NPO's too! Wt. 1 lb. **88¢**
- 60 TERMINAL STRIPS. Solder-lug & binding; to 20 terms. Wt. 2 lbs. **88¢**
- 30 POWER RESISTORS. 1/2, 1 W. 5 to 50 W; to 10,000 ohms. Vitreous, too. Wt. 3 lbs. **88¢**
- 6 FERRI-LOOPSTICK CORES. To 7". flat incl. Wt. 2 lbs. **88¢**
- EMERSON RADIO TUNER. 540 to 1600 KCS. Reg. \$7. **88¢**
- 50 PLUGS. RECEP. CLES. Audio, power, speaker, etc. Wt. 2 lbs. **88¢**
- 30 MOLDED CONDENSERS. Black Beauties, etc. Finest made! Wt. 2 lbs. **88¢**
- 35 TUBE SOCKETS. 4 to 9-pin; ceramic, mica, shield-based, too. Wt. 2 lbs. Reg. \$9. **88¢**
- 125 CARBON RESISTORS. 1/2 to 2 W; 15 ohms to 1 meg. Insulated types incl. Wt. 2 lbs. **88¢**
- POSTAGE-STAMP MIKE. Crystal. 100 to 8,000 cps. Wt. 1 lb. **88¢**
- 6 DIODES. Crystal & silicon. Some worth \$10. Reg. \$17. **88¢**
- 6 TRANSISTOR SOCKETS. Mica-filled; for sub-mini tubes, too! **80¢**
- 10 PANEL SWITCHES. 115 VAC. SPST. SPDT, etc. Wt. 1 lb. **88¢**
- 40 SUB-MINI RESISTORS. 1/2, 1 W; long; 1/5 values; 1/5 W. Reg. \$6. **88¢**
- TEN 3-SECOND TIMER MECHANISMS. Precision geared. Wt. 2 lbs. **88¢**
- 4-IN-1 DRILL BIT. Copies, saws, drills; reams all shape holes. **88¢**
- 5 HORSESHOE MAGNETS. Powerful, pocket types. Hundreds of uses. **88¢**

AUGUST VOLUME BONUS!
SPECIAL \$5.00 ASSORTMENT OF RADIO PARTS FREE WITH ANY \$15 ORDER!

NEW TUBES & SEMICONDUCTORS (Cont'd)

without a neutralizing network. In circuits where maximum power gain is desired, it can provide a useful power gain of 39 db.

Maximum ratings of the RCA 2N373 in if amplifier service are:

V _{CB}	10
V _{EB}	—25
I _C (ma)	—0.5
I _E (ma)	—10
P _{total} (mw)	(at 25°C) 80
	(at 55°C) 50
	(at 71°C) 35

8JP4

A new aluminized test picture tube for servicing 110° television receivers with picture tubes of any size and any type base. Features electrostatic self-focus, no ion trap and no external conductive coating. Its carton serves as a

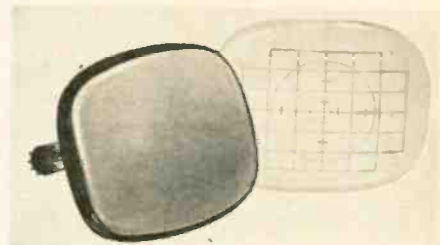

carrier that can be adapted to use as a test mount for the tube. A plastic mask fits over the face of the tube and has various grid lines to help speed servicing. The 8JP4 is made by CBS-Hytron.

2N650, -51, -52, -53, -54, -55

These germanium p-n-p alloy-junction transistors are intended for general-purpose use in the audio-frequency range, including both amplifier and

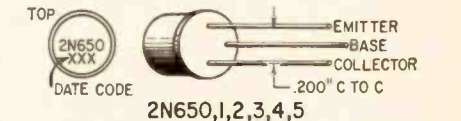

switching service. Their high maximum junction temperature of 100°C permits using these units where germanium transistors were not previously considered.

The maximum ratings of these Motorola units are:

	2N650	2N653
	2N651	2N654
	2N652	2N655
V _{CB}	45	30
V _{CE}	25	15
V _{EB}	25	25
I _C (ma)	250	250
P _c (mw)	200	200

2N456, -57, -58

A group of germanium p-n-p alloy-junction power transistors designed for high-power high-voltage applications.

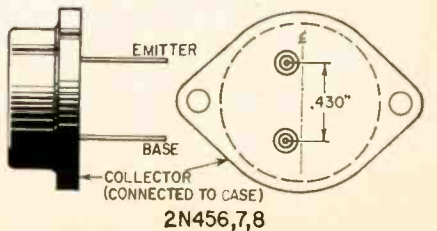

BIG BUYS IN 'MINI' TYPE

- TURNER MIKE. Crystal, 100-8,000 cps. Hand, desk. **\$2.99**
- 12-HR. CLOCK. Needs only 1 1/2 v. penlite cell for power. **\$1.99**
- HI-FI 12" PM SPKR. 6-8 ohms. 50-10K cps. **\$3.99**
- 3-TUBE AC-DC AMP. Wired, w/vol., tone, controls. **\$2.99**
- Tubes, \$1.91 extra
- 3-SPEED PICKUP. Flip-over cart. sapphire needles. **\$2.99**
- P-N-P TRANSISTORS. Reg. \$5 ea. Famous make. **2 for \$1**
- TRANSISTOR IF'S. 456 kc. only 1/2" square. **2 for \$1**
- 10K ohm SIGMA RELAY. w/R-C assembly. Reg. \$8. **\$1.00**
- 3 VARI-LOOPSTICKS. 540 to 1500 kc. Adj. **3 for \$1**
- 8-PC. NUTDRIVER SET. Steel socket driver, 3/16 thru 7/16" in 7 sizes, plastic handle, case. **\$1.00**
- HEARING AID PHONE. Crystal, w/cord & plug. **\$1.19**
- HEARING AID PHONE. 5,000-ohm, w/cord, plug. **\$1.69**

- 12" COAX SPEAKER**
- 12" woofer w/6 oz. magnet; 3 tweeter; built-in crossover network. Famous U.S. maker. 40,15,000 cps. 6-8 ohm v.c. Wt. 5 lbs. only **\$8.88**
- POCKET MULTI-TESTER**
- 3 1/2 x 2 x 1 1/2" bakelite case; 100 ohms/volt. Zero adj. 0.15/150/1000 AC & DC V; 0-150 mA; 0/100,000 ohms. w/test leads & battery. In orig. pack. **\$6.99**

FAMOUS Regency

Vest Pocket TRANSISTOR RADIO only \$14.95

Including Phone and Batteries!

Lektron scoops the field with the "hottest" pocket transistor radio since the advent of the transistor! Designed and built by Regency, one of America's great names in Radio. Uses an exclusive circuit with RF, DET and AMP stages. SMALLER THAN A PACK OF CIGARETTES! — only 3x2x1". NO EXTERNAL ANTENNA OR GROUND—no hanging wires! Amazing sensitivity, volume and selectivity. Attractively designed two-tone styrene case. Variable tuning covers 540 to 1500 kc. READY TO PLAY when you receive it! 1000-hour batteries and ultra-sensitive phone included in this fabulously low price! Gift packed. Wt. 1 oz.

HOW TO ORDER: Check items wanted. Return entire ad w/check or M.O. including sufficient postage, excess returned. C.O.D. orders, 25% down; rated, net 30 days. Print name, address, amount money enclosed, in margin. (Canada postage, 45c 1st lb., 28c ea. addl. lb.) EXPORT ORDERS INVITED.



ENGINEERING

Prepare for unlimited opportunities of the Electronic Age!
B.S. DEGREE IN 27 MONTHS
Earn your B.S. DEGREE IN 27 MONTHS in Aeronautical, Chemical, Civil, Electrical or Mechanical Engineering; in 36 MONTHS in Mathematics, Chemistry, Physics. Intensive, specialized courses. Comprehensive training in electronics, television, advanced radio theory and design, math, nuclear physics and elec. eng. Engineering Science preparatory courses. Low rate. Graduates in demand. Spacious campus; 20 bldgs., dorms, gym, playing field. Earn part of your expenses in Fort Wayne. G.I. approved. Enter Sept., Dec., March, June. Catalog.

INDIANA TECHNICAL COLLEGE
1788 E. Washington Blvd., Fort Wayne 2, Indiana
Please send me free information on B.S. ENGINEERING DEGREE IN 27 MONTHS as checked.
 Electronics Chemical Aeronautical
 Civil Mechanical Electrical
B.S. DEGREE IN 36 MO. in: Math. Chem. Physics

Name.....
Address.....

GET YOUR COMMERCIAL TICKET EASIER WITH...

now available 6th EDITION up to the minute

Kaufman's RADIO OPERATOR'S LICENSE Q AND A MANUAL

The BEST book for FCC License Preparation
Covers elements 1 thru 8.

The only book with complete discussion of answers to every technical question in the FCC Study Guide. Makes it very easy to answer multiple choice questions. Used by leading schools and industry.
Only \$6.60 at jobbers, bookstores or direct from: RE-8

JOHN F. RIDER PUBLISHER, INC.
116 West 14th Street, New York 11, N. Y.

JUST OFF THE PRESS!



WHERE
Would You
be Today
in Radio-TV
Electronics
IF...

you had sent for
this FREE Valuable Booklet 12 Months Ago?

NEWLY REVISED AND UP-TO-DATE

TAKE A MINUTE TO MAIL THIS COUPON FOR FREE BOOKLET!

Thousands of men *did* send for it. They *read* it. And now they are a full year ahead in their march toward:

- a better job
- better pay
- promotion
- greater security
- greater confidence
- better living for self and family

All these benefits can be yours . . . if you act now to see what the rapidly expanding field of Electronics offers you. Take that first big step this minute. No obligation whatsoever. Mail coupon today, or write: Capitol Radio Engineering Institute, Dept. 148-Y, 3224 16th St., N.W., Washington 10, D. C.

CAPITOL RADIO ENGINEERING INSTITUTE
ECPD Accredited Technical Institute Curricula—Founded 1927
Dept. 148-Y, 3224 Sixteenth St., N.W., Washington 10, D. C.

Please send me your course outline and FREE illustrated Booklet, "Your Future in the New World of Electronics" . . . describing opportunities and CREI Home Study courses in Practical Electronic Engineering Technology.

- CHECK FIELD OF GREATEST INTEREST
- Radar, Servo and Computer Engineering Technology
 - Electronic Engineering Technology
 - Broadcast (AM, FM, TV) Engineering Technology
 - Television Engineering Technology
 - Aeronautical Electronic Engineering Technology

Name..... Age.....

Street

City..... Zone..... State.....

Check: Home Study Residence School Korean Veteran

If you have had a high school education, and experience in electronics—and realize the need of a high-level technical knowledge to make good in the better electronic jobs—you can qualify for CREI home study training. (Electronics experience is not required for admission to CREI Residence School.) Please fill in the following information.

Employed By.....

Type of Present Work.....

Education:

Yrs. High School.....

Yrs. College.....

Electronics Experience.....



Whatever the choice may be — tape, record, or good old fashioned AM/FM radio, straight or multiplexed — Madison Fielding is the design center of any stereo system. Complete control and amplifier facilities for both monaural and stereophonic sound are built into the perfectly matched Series 330 AM/FM Stereophonic Tuner and Series 320 40-watt Stereophonic Amplifier.

Series 330 Tuner:

Two complete ultra-sensitive tuners on one compact chassis for either AM or FM reception individually, or, with a turn of a switch, both signals can be made available simultaneously. Multiplexed output is provided for by use of one adapter.

Series 320 40-watt Amplifier:

In addition to individual controls for each channel, the unit features a Master Volume Control, which controls both levels simultaneously for stereo. When used monaurally, it will serve as a complete electronic crossover system to feed separate woofer and tweeter.

For further information, write to:

BRAND PRODUCTS, INC.

11 Lorimer Street, Brooklyn, New York

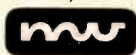

Marketing Organization for Madison Fielding Corp.

NEW TUBES & SEMICONDUCTORS (Cont'd)

One important use is in dc-dc power converters with outputs up to 130 watts.

Maximum ratings of these Texas Instruments power transistors are:

	2N456	2N457	2N458
V _{CBO}	-40	-60	-80
*V _{CEX}	-40	-60	-80
V _{EBO}	-20	-20	-20
I _C (amps)	5	5	5
I _B (amps)	3	3	3
P total (at 25°C) (watts)	50	50	50

*Base not open, resistor in base circuit

3BZ6, 4BZ6

A semi-remote-cutoff pentode in a 7-pin miniature envelope intended for use in gain-controlled video if stages of television receivers. The 3BZ6 has a 3.15-volt 600-ma heater and the 4BZ6

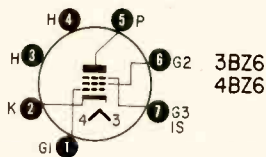

has a 4.2-volt 450-ma heater with controlled warmup for use in series heater circuits. All other ratings of these RCA tubes are identical to the 6BZ6.

2N623

A p-n-p diffused-base germanium transistor designed for high-frequency



amplification and high-speed switching. In a 43-mc if amplifier this transistor provides 15-db power gain. Switching times as low as 0.5 μsec are also possible.

Tentative maximum specifications of this Texas Instruments unit are:

V _{CBO}	-30
V _{CEO}	-15
V _{EBO}	-1
P _{total} (mw)	40

6-, 12-, 25-, 50EH5

These power pentodes are 7-pin miniature types for use in the audio output stage of radio and television receivers. All four are alike except for heater ratings. The 6EH5 has a heater rated at 6.3 volts, 1.2 amps. The 12EH5's is 12.6 volts at 600 ma with an 11-second controlled warmup time. The 25EH5 has a 25-volt 300-ma heater and the 50EH5 heater is rated at 50 volts, 150 ma.

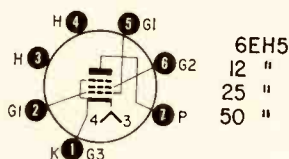

Typical operating characteristics of these RCA tubes are:

V _P	110
V _{g2}	115
R _K (ohms)	62
V _{g1} (peak audio)	3

I _P (0 signal) (ma)	42
(max signal) (ma)	42
I _{g2} (0 signal) (ma)	11.5
(max signal) (ma)	14.5
R _P (approx ohms)	11,000
gm (μmhos)	14,600
R _L (ohms)	8,000
Total harmonic distortion (%)	7
Max signal power output (watts)	1.4

2N176, 2N351, 2N376

All three are alloy-junction germanium p-n-p power transistors intended for use in class-A audio power output stages, particularly in automobile radio receivers. The case of these units acts as the collector connection and must be

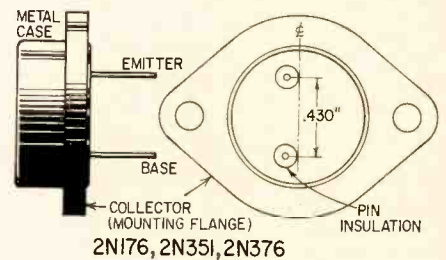

fastened to a heat sink. If the heat sink is at a positive potential, it must be insulated from the transistor.

Tentative specifications for these RCA transistors in class-A power amplifier service are:

	2N176	2N351	2N376
V _{dc} supply	-14.4	-14.4	-14.4
V _{CE}	-13.7	-13.2	-13.2
V _{BE}	-0.24	-0.3	-0.3
I _C (peak) (amps)	-1	-1.4	-1.4
(0 signal) (amps)	-0.5	-0.7	-0.3
Signal-source impedance (ohms)	10	10	10
Load impedance (ohms)	25	15	15
Power gain (db)	35.5	33.5	35
Max power output (watts)	2	4	4
P _c (watts*)	6.83	9.25	9.25

* P_z equals collector dissipation

END

ALBERTA HAM FEST

All hams have been welcomed to the 1958 Alberta Ham Fest Aug. 23-24, sponsored by the Northern Alberta Radio Club, Box 163, Edmonton, Alberta, Canada.

SERVICE TECHNICIANS

want reprints of our July editorial Service Technician and Client?

We've already received requests for thousands of reprints of this editorial. We are therefore offering service technicians reprints suitable for imprinting, at cost:

- 100—\$1.00
- 500—\$3.75
- 1000—\$6.50

Additional thousands—\$5.00 postpaid

RADIO-ELECTRONICS Reprints
154 West 14th Street
New York 11, N.Y.

Technicians' News

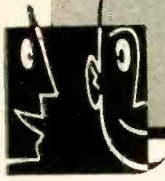

AD CLAIMS PROTESTED

A formal objection to advertising claims that "fading has been eliminated" in new portable radios was sent to Westinghouse Electric Corp. by the Federation of Radio-Television Service Associations of Pennsylvania, Inc. (FRTSAP) after a discussion of portable-radio advertising at the group's meeting in Harrisburg.

FRTSAP delegates approved the affiliation of the new Harrisburg Mid-State Service Dealers Association, headed by Charles Ross. Federation president Bert Bregenzer reported on the NATSEA directors' meeting in Springfield, Mo. Harrisburg attorney Robert E. Horner was retained as federation counsel. Dan Halter of Bellefonte resumed his post as corresponding secretary after a 2-month leave of absence.

STANEK HEADS CONN. GROUP

William Stanek was elected president of the Television Service Association (TSA) of Connecticut, Inc. at the group's convention. Joseph Francis of Groton was named vice president; Deane Gould, Waterbury, secretary; Anthony Lacapo, Meriden, treasurer; Peter Lucas, Willimantic, financial secretary. Robert Steer of Stratford continues as business agent.

TECHNICIANS SELL HI FI

Some 65% of the nation's electronic service dealers also sell high-fidelity components, reports the Institute of High Fidelity Manufacturers, on the basis of a survey of technicians. Analyzing 472 replies to a questionnaire, the manufacturers' group discloses: (1) Of those technicians who sell hi-fi gear, 45.9% do \$2,000 or more a year in audio component sales. (2) Of this over-\$2,000 group, more than 50% gross \$5,000 a year or more from hi-fi sales. (3) About 85% of those responding state that they install and repair high-fidelity components.

HEINZMAN RE-ELECTED BY TSA OF MICHIGAN

The Television Service Association (TSA) of Michigan unanimously re-elected president Karl Heinzman and overwhelmingly approved new bylaws which provide for regional vice presidents representing each of the five sections of metropolitan Detroit.

These other officers were elected: Charles March, Vutronic Television, central vice president; Thomas W.

Just 2 settings on the NEW

Model FC-2

FAST-CHECK TUBE TESTER

tests over 600 tube types completely, accurately... **AND IN SECONDS!**

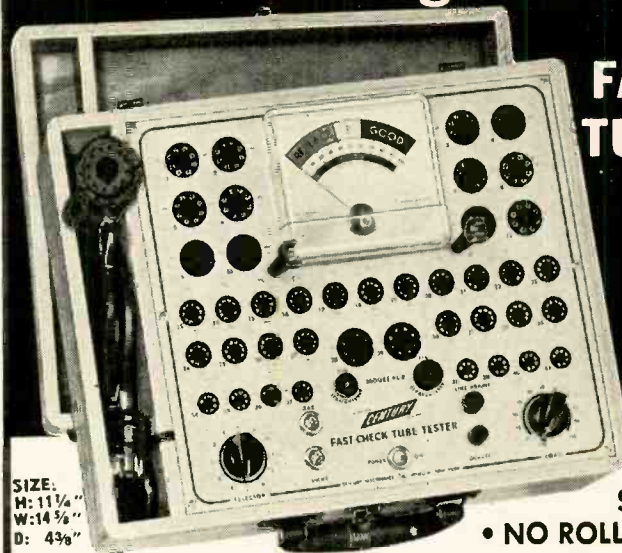

SIZE:
H: 11 1/4"
W: 14 3/8"
D: 4 3/8"

NEW Special compartment to accommodate line cord and CRT Test Adapter cable

CANNOT BECOME OBSOLETE

Engineered to accommodate all future tube types... new tube listings furnished periodically.

TRY THE FC-2 BEFORE YOU BUY IT!

Shipped on approval for **FREE 10 day trial... No obligation to buy**

EASY TO BUY IF YOU'RE SATISFIED!

Pay in small monthly payments at net cash prices... **no financing charges**

MODEL FC-2—housed in rugged oak carrying case complete with CRT adapter, tube listings... only **\$69.50** Net

GUARANTEED FOR 1 FULL YEAR

This extremely low price is made possible only because **YOU ARE BUYING DIRECT FROM THE MANUFACTURER**

- NO MULTIPLE SWITCHING
- NO ROLL CHART CHECKING

The FAST-CHECK enables you to save valuable time and eliminate unprofitable call backs. You earn extra money and win confidence by showing your customer the actual condition and life expectancy of the tube on the large meter scale of the FC-2. The extra tubes you will sell each day will pay for the FAST-CHECK in a very short time.

WIDE RANGE OF OPERATION

- Checks quality of over 600 tube types... more than 99% of all TV and radio tubes, including the newest series-string TV tubes, auto 12 plate-volt tubes, OZ4s, magic eye tubes and gas regulators.
- Checks inter-element shorts and leakage.
- Checks for gas content.
- Checks for life expectancy.

IMPORTANT FEATURES

- ✓ Checks each section of multi-section tubes and even if only one section is defective the tube will read "Bad"
- ✓ 41 long lasting phosphor-bronze tube sockets accommodate all present and future tube types—cannot become obsolete
- ✓ Less than 10 seconds required to test any tube
- ✓ Large D'Arsonval type meter is extremely sensitive yet rugged—is fully protected against accidental burn-out
- ✓ Line isolated
- ✓ 7-pin and 9-pin straighteners conveniently mounted on panel
- ✓ Quick reference tube chart lists over 600 tube types
- ✓ Line voltage compensation

NEW A specially designed PICTURE TUBE ADAPTER cable is now part of the FC-2... making it a highly efficient CRT Tester-Revjuvenator. This feature eliminates the need of carrying extra instruments and makes the FC-2 truly an all-around tube tester. The adapter enables you to check all picture tubes (including the new short-neck 110 degree picture tubes) for cathode emission, shorts and life expectancy... also to rejuvenate and restore cathode emission of weak picture tubes.

"You've really made tube testing a snap"... "I've almost got the cost of the Fast-Check paid off with the extra money I've made, and it's only 2 weeks since I received it"... "It's easier to use than you said"... "I wouldn't ever want to be without it"... "I use it in the shop and take it along on every call".

WHAT SERVICEMEN* ARE SAYING ABOUT THE FC-2

*Names on request

MAIL COUPON NOW—NO MONEY REQUIRED WITH ORDER

CENTURY ELECTRONICS CO., INC. 111 Roosevelt Avenue Dept. 108, Mineola, N. Y.

Please rush the new Model FC-2 FAST-CHECK TUBE TESTER for a 10 day trial period. If I am not completely satisfied I will return the instrument within 10 days without further obligation. If fully satisfied I agree to pay the down payment within 10 days and the monthly installments as shown. No financing charges are to be added. Should I fail to make payment when due, the unpaid balance shall become due and payable at once.

- BUDGET TERMS:** Pay \$14.50 within 10 days after receipt of instrument. Balance \$11.00 monthly for 5 months, plus shipping charges.
- PREPAID TERMS:** Enclose \$69.50 with coupon as payment in full and Century will pay all shipping costs. 10 day money-back guarantee.

Name.....
Address.....
City..... State.....

ABSOLUTELY NO RISK ON YOUR PART

True
High-
Fidelity

*in the
most
dramatic
setting...*

See your local radio-
television service dealer.



OXFORD
Components, Inc.

Subsidiary of Oxford Electric Corp.
556 West Monroe Street
Chicago 6, Illinois

Illustrated literature
available upon request.

OXFORD 3-WAY SPEAKER SYSTEMS and BASS REFLEX CABINETS

Enhance the beauty and comfort of your room while you enhance the sound of your high fidelity. Every room will sparkle with these OXFORD cabinets whether for stereo or in a setting with just one cabinet. Here is double-duty design... cabinets can be used for horizontal or vertical positioning... with use of tapered legs or runners which are both supplied. Available with or without OXFORD 3W20 3-way speaker systems, to give you the best sound reproduction.

Cabinet Model No.	Audiophile Net
BR-1M Red Mahogany	\$111.00
BR-1C Cherry	117.00
BR-1B Blonde Oak	117.00

Complete 3 way speaker system
for above cabinets
Model 3W20..... \$ 39.00
F.O.B. Factory



TECHNICIANS' NEWS (Continued)

Taber, Jr., Taber Radio & TV Service, north vice president; Charles Judd, Judd Electronics, northwest vice president; Edward J. Brown, Visual Electronics, east vice president; Stephen Raboczkay, Southwest Radio & TV Lab, southwest vice president; Samuel J. Mooney, General Television Lab, secretary; Mike Dallen, Dallen Television Inc., treasurer.

SANDUSKY TECHNICIANS' GROUP

William Fultz has been elected chairman of a five-man organizational board of directors of the new Television Electronic Technicians Association of Sandusky, Ohio.

OCEA OFFICERS NAMED

The Oakland County Electronics Association (OCEA) Inc., with headquarters in Pontiac, Mich., elected Bernard Seiber, Hods Radio & TV, president; John Stefanski, Stefanski TV, vice president; Thomas E. Johnson, Johnson's Radio & TV, secretary; Bill Holcomb, Obel's TV, treasurer.

OCEA reports the successful completion of a special project to mark National Servicemen's Week. With the aid of the Pontiac Chamber of Commerce and the local newspaper, the group reconditioned more than 40 TV sets donated by the public and installed them in local institutions. OCEA's next project is a campaign to assure that distributors sell only to those holding state sales tax licenses.

OCEA's new mailing address is in care of President Seiber, 770 Orchard Lake Ave., Pontiac, Mich.

SAN FRANCISCO OFFICERS

San Francisco Television Service Guild (SFTSG) elected Edward R. Harkins president. Other new officers: J. Jerrold Strauss, vice president; Bill Finnerty, secretary; Mrs. Gibson Bories, treasurer. New directors are Andy Cerisier, Earl Crocker, Ned Gramlich, Walt Kolbuss, Bryant McGrath, Jim Miller and Roy Norton. L. B. Gross was reappointed executive secretary.

ANOTHER LICENSING LAW

A TV technicians' licensing ordinance, identical to the Detroit law, has been adopted by the suburban community of Lincoln Park, Mich. Other Detroit suburbs are expected to follow suit. The Downriver Television Association (DTA) held a special meeting to explain the new law to technicians. Speakers included president Karl Heinzman of the Television Service Association (TSA) of Michigan, Lincoln Park city attorney Jim Mueller and electrical inspector W. Ezell. About 40 technicians attended. DTA is headed by Ross Porter of Porter TV.

TEAM RENAMES PRESIDENT

John V. Glass, ABC Radio & Electric Co., was re-elected president of the Electronic Association of Missouri

NEW
IMPROVED
SENCORE
LC3
Leakage Checker

Another Sencore Time-Saver

Check these outstanding New Features

Now — For the first time...

Checks 130 different tube types — more than any other "grid circuit" type checker. Includes UHF and latest type tubes.

Checks picture tubes without removing tube from cabinet or chassis.

New Roll Chart prevents obsolescence — just dial the tube type and save time. Chart is easily replaced at no extra cost.

Dynamic Filament checks including heater to cathode leakage & shorts — no need for a second filament tester.

Two spare preheating sockets to cut down testing time.

Capacitor checks simplified.

The LC3 provides all these new improved features in addition to those employed in earlier leakage or "grid circuit" testers. A must for any TV service technician.

SERVICE INSTRUMENTS CORP.
171 Official Rd. • Addison, Ill.

In stock at your local parts distributor

Cut out this ad now for further information.

\$28.95
DUAL-BINET
Really
Whips
Tough
Dogs

NORELCO® presents

the world's
second finest*
pickup cartridge



a new
MAGNETO-DYNAMIC
design by
Philips of the Netherlands

*to find out which pickup cartridge is the world's finest and why the NORELCO is the world's
second finest
write to

NORTH AMERICAN PHILIPS CO., INC.
High Fidelity Products Division, Dept. 2E8
230 Duffy Avenue, Hicksville, L. I., N. Y.

MINIATURE ELECTROLYTICS FOR MINIATURE SETS

designed for transistorized radios, hearing aids, wireless microphones, miniature tape recorders, auto receivers, and similar miniature electronic products.

FOR POINT-TO-POINT WIRING AND FLAT MOUNTING ON PRINTED WIRING BOARDS

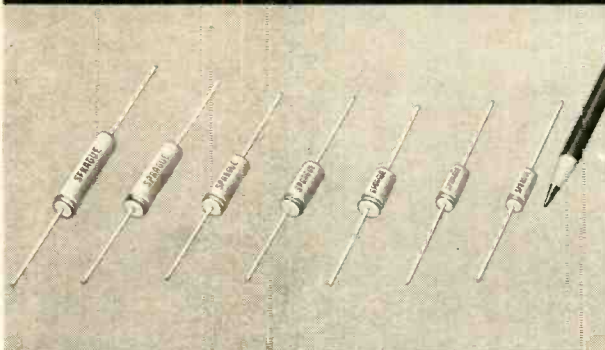

Sprague's new and improved 85°C Littl-lytic* Capacitors are the *tinest* reliable electrolytic capacitors made to date . . . and their performance is better than ever. Their remarkable dependability is the result of a new manufacturing technique in which *all the terminal connections are welded. No pressure joints . . . no "open circuits" with the passage of time.* Littl-lytics are hermetically-sealed and aluminum-encased. And check this for low leakage current: for a 2 μ f, 6 volt capacitor . . . only 1.0 μ a max.; for a 300 μ f, 6 volt capacitor . . . 3.5 μ a max.! There are no transistor burn-out troubles when you use Littl-lytics. Available in the largest list of ratings in the industry! Request Bulletin M-753.

FOR UPRIGHT MOUNTING ON PRINTED WIRING BOARDS



Space-saving Verti-lytic* Capacitors are designed for easy manual upright mounting on printed wiring boards. Keyed terminals assure fast mounting and correct polarity. Their low leakage current and high purity aluminum foil construction provide top performance and excellent protection against expensive transistor burn-outs. Sturdy premolded phenolic shell with resin end-fill gives excellent protection against drying-out of the electrolyte or the entry of external moisture. The phenolic case eliminates the necessity for any additional insulation. Request Bulletin M-757.

Be sure to see these new and improved 'lytic capacitors at your distributors. Check Sprague's other transistor capacitors while you're at it. You'll find that Sprague has the most complete ratings in the industry. Ask your

distributor for your copy of Sprague's Bulletins M-753 and M-757, or write Sprague Products Co., Distributors' Division of Sprague Electric Company, 81 Marshall Street, North Adams, Massachusetts.

*Trademark

don't be vague . . . insist on

SPRAGUE®

world's largest capacitor manufacturer

SPRAGUE RESEARCH IS CONSTANTLY PRODUCING NEW AND BETTER CAPACITORS FOR YOU

3
new
STEREO-
FIDELITY
components
by



SP-210 • Stereo Preamplifier
\$89.50 less power supply
P-10 Power Supply ... \$19.50

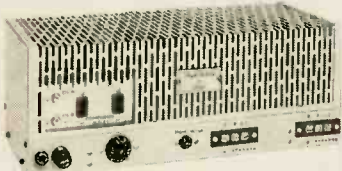

SA-232 • Basic Stereo Amplifier
Total Power Output:
64 watts peak
Has power tap-off for SP-210
\$89.50

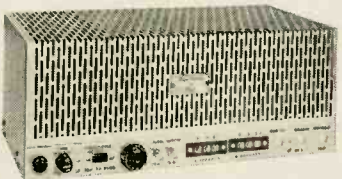

SA-260 • Basic Stereo Amplifier
Total Power Output:
120 watts peak
Has power tap-off for SP-210
\$129.50
prices slightly higher in West

Pilot Radio Corporation

37-12 36th St., L. I. C. 1, New York

Please send literature covering
Pilot Stereo Components.

NAME _____

ADDRESS _____

CITY _____ ZONE _____ STATE _____

Electronics manufacturer
for over 39 years.

TECHNICIANS' NEWS (Continued)

(TEAM). Other officers elected were: Richard L. Richter, vice president; Arthur A. Mayer, secretary-treasurer; Robert Lucas, recording secretary; Joseph McMillan, sergeant-at-arms. Edward Haines, Stanley Siegel and McMillan were named directors.

STATE GROUP FORMED

A permanent Washington State Conference of radio and TV service associations was formed by representatives of local groups meeting in Yakima, with Cliffold Wold of Everett named as temporary chairman. Each local association will name one delegate and one alternate for meetings to be held at least twice yearly.

RTASCV OPENS OFFICE

The Radio & Television Association of the Santa Clara Valley (RTASCV) has opened a headquarters office in Room 467A, Porter Building, Santa Clara and Second Sts., San Jose, Calif. Chet Spink, editor of *RTA Magazine*, is the group's new executive secretary, succeeding Howard Thunen of San Jose.

GLAMORIZING TV SERVICE

"Technicians should dress for a service call as though they were taking the lady customer out for dinner and a Broadway premiere. Suppose he does get a little dirty, poking around in the TV. She will think of Sir Walter Raleigh flinging his beautiful cape into

the mud to provide a clean place for the feet of a queen. And who would quibble over a few dollars with so gallant a man? If her husband is there and asks why you make service calls in your best clothes, tell him your washing machine broke down and you took all the parts to a drug store to have them checked. . . . He'll understand."—From "Sparks' Remarks," *Team News*, Electronic Association of Missouri.

PORTLAND OFFICERS NAMED

Tom Torgler, Walker-Torgler TV, was chosen as new president of the TV-Appliance Association, service technicians' organization in Portland, Ore. Bill Boggs, Sylvan Electronics, was elected vice president; Les Armstrong, Armstrong TV, treasurer, and Roscoe E. Watts, secretary.

CANADIAN GROUP ELECTS

R. V. Mielen was elected president of the Radio Electronic Technicians Association (RETA) of British Columbia at their annual meeting. S. B. Spencer is the new secretary and E. Wheeler is treasurer. All are from Victoria.

MARTS OFFICIAL DIES

Joe Bates, vice president of the Milwaukee Association of Radio & Television Services (MARTS) and operator of Bates Radio & Television Service, West Allis, Wis., died of cancer at the age of 47. END

ATOMOTRON

- MINIATURE ATOM SMASHER
- PRODUCES 75,000 VOLTS
- ABSOLUTELY SAFE



In no sense of the word a toy or a gadget. The ATOMOTRON is a scientific instrument capable of producing 75,000 volts—makes sparks up to 2" long—yet is absolutely safe because the current is infinitesimal. The science teacher—science lover—or hobbyist can perform experiments to astound students—friends—family. Makes smoke disappear—defy gravity—turns propellers at a distance—transforms atomic energy into light—makes artificial lightning—demonstrates ionic space ship drive—and many other experiments. Constructed of the finest materials. Will do exactly—for instruction purposes—what generators that cost 3 to 10 times more will do. The perfect device to teach the secrets of atomic physics and electricity. Will hold an audience spellbound as it performs trick after amazing trick. Includes an experiment kit and illustrated experiment manual. Manual explains the "how" and "why." You will invent many new experiments of your own. A fine research tool that will give years of beneficial service to the institution or individual who owns one. In kit form or assembled.

Kit form \$14.95
Assembled \$19.95

MAIL THIS COUPON

(Please be sure to include your name & address)
OLIVER GARFIELD CO., Inc., Dept. RE-88
108 E. 16th St., New York 3, N.Y.

Please send me:
1 ATOMOTRON Atom Smasher and Manual.
\$19.95 (Complete assembled)
\$14.95 (In kit form)
Add 80¢ for postage and handling
in U. S.; \$1.00 abroad.

The September Issue of
RADIO-ELECTRONICS

will be on sale August 26th. Order
your copy now.

DIGITAL COMPUTER KIT



Build 100 transistor computer circuits and work with them! Basic units can be built within hours. Assemble them into computers and operate. The language of computers is explained and projects included. You will receive 22 transistors and 200 electrical parts. \$59.50 plus postage. Twelve other kits available.

Partial list of courses:

- C1 Elementary relay brains \$12.50
- C2 Elementary digital computers \$24.50
- C3 Elementary analog computers \$19.50
- C14 Computer Master 50 lessons and projects (digital voltmeter, digital ohmmeter)
- C15 Electronics, 40 lessons and 3 text books. \$22.50 down and \$10 for 5 months.
- Complete catalog.

EBE Inc., 1015 Atkin Ave.

Salt Lake City 6, Utah

- Send one transistor computer kit
- Enroll me in course.....
- Enclosed \$.....

Name and address attached

NEW CATALOG

from the

NEW RADIO SHACK

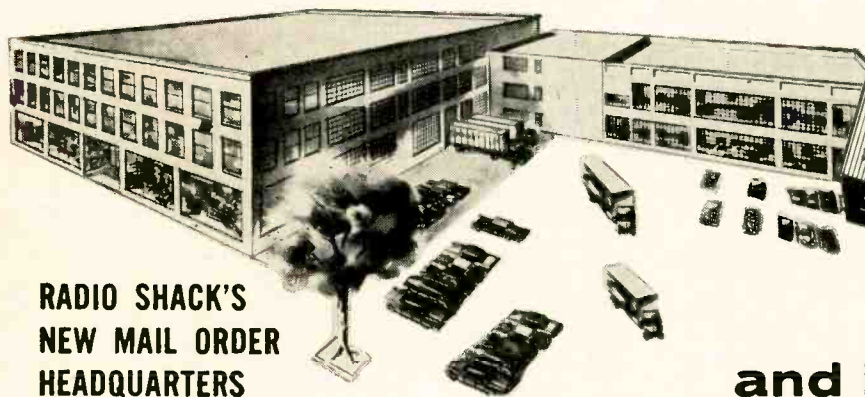

**RADIO SHACK'S
NEW MAIL ORDER
HEADQUARTERS**

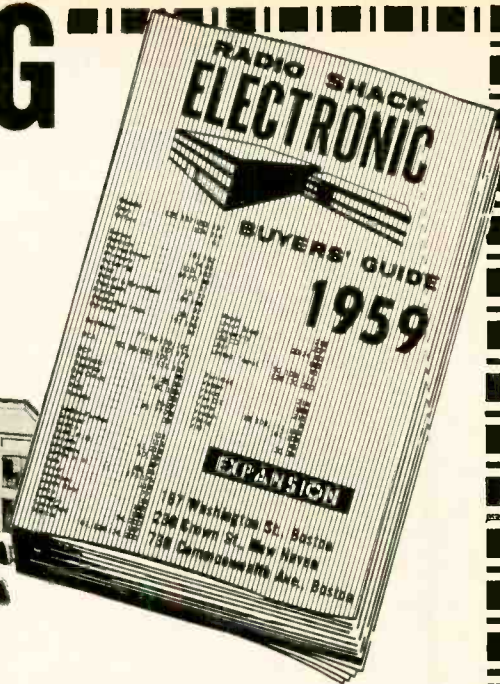

and it's absolutely

FREE!

**232 Pages FULL of
Vital Listings for:**

- High Fidelity
- Schools — Labs • Experimenters
- Hobbyists • Servicemen
- Amateurs • Industrials

EASY TO USE!

- Comprehensive Product Index
- Complete Manufacturers Index
- Handy Thumb Index

THIS JULY we move seven warehouses, our executive and mail-order and industrial sales forces to this vast building at 730 Commonwealth Avenue in Boston, adding — in addition — a second big Boston store! No expense has been spared to give us and you the most accurate and FASTEST SERVICE in the entire country!

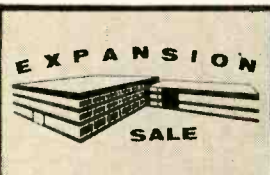

REALISTIC FM TUNER



Worth \$90.00

Our Regular Price

~~\$47.50~~

- ★ 3 Microvolt Sensitivity GUARANTEED!
- ★ Tuned RF Stage! Automatic Frequency Control
- ★ Complete with Gold-Tone Metal Cabinet!

Professionally wired and aligned,
yet at or below "kit price"

NEW MODEL of the FM tuner that received rave reviews in top audio magazine and reports! Attach to any amplifier, console or TV set. Compact 9³/₈ x 4³/₈ x 6¹/₈" size. 20-20,000 cps response, Armstrong-type FM

\$39⁵⁰

\$5 Down,
\$5 Monthly

RADIO SHACK CORP.
Stores: 167 Washington St., Boston, Mass.
230 Crown St., New Haven, Conn.

MAIL } **RADIO SHACK** Dept. 8F
ORDERS } 730 COMMONWEALTH AVENUE, BOSTON 16
TO:

- Please Send FREE 232 pg. 1959 Catalog
- FM Tuner 36-888-2F @ \$39.50
- \$..... Check or M.O. Enc.

Name

Address

City Zone State

new Devices



TRANSISTOR KIT, KT-134. Pegboard layout for hobbyists and experimenters. Complete components to build 15 devices,

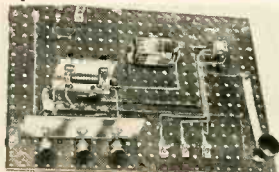

including electronic timer, burglar alarm, 2-stage audio amplifier, broadcast receiver. Instruction manual.—Lafayette Radio, 165-08 Liberty Ave., Jamaica, N.Y.

TANTALUM CAPACITORS, type WT. Subminiature wire units for low-voltage devices such as transistor radios, hearing aids, etc. Polarized types only. High-purity tantalum an-



ode, silver cathode. Available in 0.1-65 μf at standard voltage ratings from 1 to 80 dc.—Aerovox Corp., New Bedford, Mass.

FILAMENT TRANSFORMER, Stancor No. P-6463. For use with Eimac 4CX1000A transmitting tube. Center-tapped second-



aries of 6, 6.5 or 7 volts at 13 amps. Designed to withstand 2,000 volts rms.—Chicago Standard Transformer Corp., 3501 Addison St., Chicago, Ill.

BYPASS CAPACITORS, type V84C. Mylar dielectric, ceramic-



cased. Rated at 200, 400 and 600 volts dc .001-0.5 μf . Small size, high operating temperatures, low dielectric absorption and power factor.—Aerovox Corp., New Bedford, Mass.

REPLACEMENT YOKES, 110°. Part No. 322-7775 replaces Admiral 94D147-1, 94D147-3; RCA



104482, 105053; Packard Bell 29645C, 29696; Ram Y-110; Stancor DY27A. No. 322-7776 replaces RCA 104078, 104408, 105632; Ram Y-111; Stancor DY26A. — Philco Accessory Div., A St. and Allegheny Ave., Philadelphia, Pa.

MAGNETIZER-DEMAGNETIZER, Magneformer model F-100. Magnetizes or demagnetizes small tools in less than 10 seconds. Powered by 117 volts ac.—



Perma-Power Co., 3100 N. Elston Ave., Chicago, Ill.

TRANSISTOR INTERCOM, Communicator. Compact, streamlined loudspeaker system. Basic master unit (illustrated) has

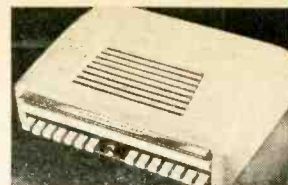

channels for up to 12 master or remote stations. Compatible bases permit expansion in blocks of 14 stations. Remote stations provide 2-way communication with either of 2 master stations.—Stromberg Carlson, Div. of General Dynamics Corp., Rochester 3, N. Y.

HEARING AID, model F-300. Miniature low-cost 4-transistor unit. Weighs 5 oz., measures 2 3/16 x 2 13/16 x 3/4 inches.

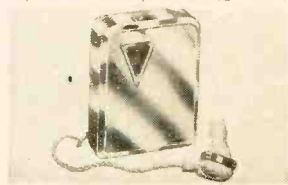

Molded dynamic earphone, 3-foot cord, zipper leather case included. Powered by 2 penlight cells.—Lafayette Radio, 165-08 Liberty Ave., Jamaica 33, N. Y.

DYNAMIC MICROPHONE, 77 series. Cardioid type. Output —52 db. Range 30-15,000 cycles. Front-to-back cancellation 18 db (8 to 1). Available with on-off switch, mounted on G-Stand or as head alone.—Astatic Corp., Conneaut, Ohio.

STEREO AMPLIFIER, Trio

STEREO or MONAURAL



The Dynakit PREAMPLIFIER

- ★ Lowest Distortion and Noise
- ★ Easiest Assembly Using Pre-Assembled Printed Circuit
- ★ Handsome Styling — Selected For Display at Brussels World's Fair
- ★ Only \$34.95 net.

DYNAKIT

PROVIDES COMPLETE
FLEXIBILITY AND
CONTROL AT LOWEST COST

The Dynakit STEREO CONTROL

- ★ Adds Complete Stereo Control To Two Preamps Without Noise or Distortion
- ★ Unique Blend Control Fills In "Hole In Middle"
- ★ Level, Balance, Loudness, Channel Reverse, and Dual Tape Monitor Controls
- ★ Only \$12.95 Net

Descriptive literature available on request

DYNACO, INC., 617 No. 41st St., Phila. 4, Pa. Export Division 25 Warren St., New York, N. Y.

ANOTHER FIRST
FROM

Almo
WORLD FAMOUS

Regency

TRANSISTOR RADIO

SUB-MINIATURE
PRIVATE EAR
VEST-POCKET
ALL-TRANSISTOR



PORTABLE

Now only!

\$14.95
COMPLETE
WITH
BATTERIES

MODEL XR-2A

The smallest real transistor radio—not as large as a cigarette pack—listen any time, anywhere without disturbing anyone. Weighs less than a hearing aid—perfect for spectators at sports, night owls, students in libraries, etc.—featherweight earphone plays for you alone. Mandarin Red. Operates hundreds of hours on 2 fresh Penlight Batteries.

CALL, WRITE OR COME INTO THE
Almo **RADIO CO.**
913 ARCH ST., PHILA., PENNA.

RADIO-ELECTRONICS



model A-224. Contains 2 separate 12-watt power amplifiers (24 watts peak each). Can be used as 24-watt monaural amplifier or 24-watt monaural with stereo preamp to convert existing monaural amplifier to stereo. Separate ganged treble and bass controls, balance control, mode switch, speaker-selector switch (local and remote), contour control, rumble filter.—Harmon-Kardon Inc., 520 Main St., Westbury, N. Y.

STEREO CONVERSION KIT for mass-market phonos. Contains 4-watt push-pull amplifier for stereo channel, 2 tone con-



trols, auxiliary loudspeaker in baffled cabinet, ceramic stereo pickup cartridge.—Walco Products Inc., 60 Franklin St., East Orange, N. J.

STEREO CONVERSION, model CSK-2. Designed for all record changers in Stromberg-Carlson high-fidelity line. Includes ceramic turnover stereo cartridge, cable, hardware and instruction booklet. Also available from same manufacturer: auxiliary second-channel amplifier, remote speaker and en-



closure. — Stromberg-Carlson, Div. of General Dynamics Corp., Rochester 3, N. Y.

STEREO SPEAKER, Stereon. Compact, furniture-finished speaker for stereo, producing second-channel sounds above 300



cycles only. Bass is directed to single full-range speaker system. Contains mid-bass, treble and high-frequency drivers.—Electro-Voice Inc., Buchanan, Mich.

SPEAKER BAFFLES, Forward Front design. New line of console, wall and corner cabinets

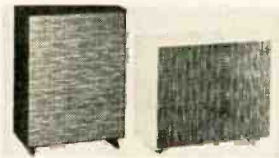

features protruding front panel, providing up to 22% more air volume without increase in external dimensions. Model DBR-2 shown.—Argos Products Co., 310 Main St., Genoa, Ill.

SPEAKER ENCLOSURES, Norelco FRS. Removable bases permit horizontal or vertical placement. Decorator-styled, ducted-port type. Model FRS I

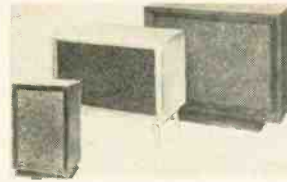

for 12-inch speakers, FRS II for 12- and 8-inch, FRS III for model 9770M and AD3800M speakers.—North American Philips Co. Inc., High-Fidelity Products Div., 230 Duffy Ave., Hicksville, N. Y.

SPEAKER ENCLOSURE, Troubadour EN-15LH. For 12- or 15-inch wide-range speaker or multiple system. Lowboy style,



rear-loaded folded horn with angled baffle board. Offered as complete system (Troubadour S-12) using University Master speaker system.—University Loudspeakers Inc., 80 S. Ken-sico Ave., White Plains, N. Y.

CLIP-IN STYLUS, Duoclip line. Can be snapped off and on new Duoclip phono cartridges without tools.—Ronette Acoustical Corp., 190 Earle Ave., Lynbrook, N. Y.

DRIVES AND BELTS for phonos and recorders. 19 new units for Webcor, Revere, Viking, Crestwood recorders and Admiral, Garrard, RCA, Webcor, Philco, Monarch phonos.—Walco Electronics Mfg. Co., 100 W. Green St., Rockford, Ill.

4-TRACK TAPE DECK, Universal A, series 900. Plays 4-track 3 3/4-ips and 2-track 7 1/2-ips stereo tapes; records and plays monaural tapes. Automatic

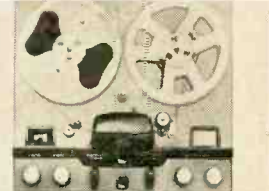

shutoff. Conversion kit also available for all A series recorders.—Amplex Audio Inc., 1020 Kifer Rd., Sunnyvale, Calif.

TAPE DEVELOPER, Magna-See



Get This Valuable Book

FREE



Just For Examining COYNE'S New Set

"Applied Practical Radio-Television"

on 7 DAY FREE TRIAL!

Yes, you get this big, brand new book, "150 Radio-Television Picture Patterns and Diagrams Explained", absolutely FREE! Just off the press. Gives complete 11 x 22" Schematic Diagrams on leading models Radio and TV Sets. Easy-to-read, large 8 1/2 x 11" pages, with full instructions on how to use the diagrams. A "must" in every repair kit. You get this book as a FREE Gift for asking to see Coyne's new 7-book set, "Applied Practical Radio-Television"!

At Last! Money-Making "Know-How" on Transistors, Color TV and Servicing

Coyne's great 7-volume set gives you all the answers to servicing problems—quickly! For basic "know-how" that's easy to understand you'll find everything you want in Volumes 1 to 5 on over 5000 practical facts and data. Every step from fundamentals to installing, servicing and trouble-shooting all types of radio and TV sets. So up-to-date it covers COLOR TV, UHF and the latest on TRANSISTORS. All this plus Volume 7—NEW Coyne TECHNICAL DICTIONARY with over 4000 definitions of the latest terms, symbols and abbreviations in radio-TV, electronics and electricity.

EXTRA! 868 Page TV Cyclopeda Included! For speedy on-the-job use, you also get Vol. 6—famous Coyne CYCLOPEDIA. Answers problems on servicing, alignment, installation, etc. in easy ABC order. Use this 7-volume TV-RADIO LIBRARY FREE for 7 days; get the Servicing Book FREE!

FREE! Valuable Supplements With your set you also get Coyne's annual Supplement Service FREE for 5 years. Keeps your set up-to-date on everything that will be new in radio, television, electricity and electronics for the next 5 years.

NOW!
7 BIG BOOKS
IN ONE GREAT SET!



SEND NO MONEY! Just mail coupon for 7-volume set on 7 days free trial. We'll include book of 150 TV-Radio Patterns & Diagrams. If you keep the set, pay \$3 in 7 days and \$3 per month until \$24.50 plus postage is paid. (Cash price, only \$22.95). Or you can return the library at our expense in 7 days and owe nothing. **YOU BE THE JUDGE.** Either way, the book of TV-Radio Patterns is yours FREE to keep! Offer is limited. Act NOW!

FREE BOOK—FREE TRIAL COUPON!

Educational Book Publishing Division
COYNE ELECTRICAL SCHOOL, Dept. 88-T1
500 S. Paulina St., Chicago 12, Ill.

YES! Send 7-Volume "Applied Practical Radio-Television" for 7 days FREE TRIAL per your offer. Include TV-Radio Patterns & Diagram Book FREE.

Name..... Age.....
Address.....
City..... Zone..... State.....

Where Employed.....
 Check here if you want library sent C.O.D. You pay postman \$22.95 plus C.O.D. postage on delivery. 7-day money-back guarantee.

Educational Book Publishing Division
COYNE ELECTRICAL SCHOOL
500 S. Paulina St., Dept. 88-T1, Chicago 12, Ill.

type 50. Makes recorded sound visible on magnetic tape for editing and checking recorder performance. Kit contains 1/2 pint of solution, plastic bath, magnifier, pressure-sensitive tape, 5 glass slides for permanent mounting.—Reeves Soundcraft Corp., 10 E. 52 St., New York 22, N. Y.

INTERCOM SYSTEMS, Ektacom K series. Moderately priced units feature Auto-Mute which silences system during no-conversation



periods. No power transformer. Steel cabinets. 2-station system or 5-station master units.—Fisher Berkeley Corp., 4224 Holden St., Emeryville, Calif.

HI-FI SYSTEM ANALYZER, Win-Tronix model 800. Combines functions of vtvm, audio signal generator, audio output watt-



meter with speaker loads, IM and harmonic distortion meters and db and noise meters in one portable instrument.—Winston Electronics Inc., 4312 Main St., Philadelphia 27, Pa.

COUNTER-TIMER, model 400. Compact, 5-decade electronic counter. Response from 1 cycle to beyond 100 kc. Measures frequency, period, time interval and 10-period average using crystal-stabilized clock source with maximum error of .001%.—Erie Resistor Corp., 644 W. 12 St., Erie, Pa.

HIGH-IMPEDANCE VTVM, model 311. Input impedance 22 megohms. Seven ranges of ac and dc, from 1.5 to 1,500 volts; 7 ohmmeter ranges. Peak-to-peak readings of complex ac voltages, as well as sine waves. New type probe can be hung on lead wire for continuous readings or used for positive pressure contacts in point-to-point measurements.



Accuracy of $\pm 3\%$ on low dc voltage scale. Rf probe available as accessory.—Simpson Electric Co., 5200 W. Kinzie St., Chicago.

SELF-SERVICE TESTER. Checks over 600 types with only 6 sockets. Occupies 15 x 15-inch floor space. Available as floor unit (model VII) or counter model (V12). Four egg-crate drawers hold up to 200 tubes. Revisions of tube chart provided by company.—Vis-U-All Prod-

ucts Co., 303 Fuller Ave. NE, Grand Rapids, Mich.

TUBE TESTER, Fast-Check model SS-1. Self-service tester—dispenser checks quality, shorts,



leakage, gas content of more than 600 types with only 2 settings. Circuitry has provision for accommodation of all new tube types as introduced. Lock cabinet holds more than 400 tubes.—Century Electronics Co. Inc., 111 Roosevelt Ave., Mineola, N. Y.

BATTERY ELIMINATOR, model PS-2. For servicing portable radios and low-power transistor equipment. Supplies filtered dc, 0-15 volts, adequate for checking receivers of up to 22.5 volts. Can be used to check batteries by substitution. Internal im-

pedance less than 2 ohms. Plug-in jacks for external voltmeter,



40-inch leads, insulated clips.—Seco Mfg. Co., 5015 Penn Ave. S., Minneapolis, Minn.

TUBE-TRANSISTOR TESTER, model 10-60 Electronamic. Tests tubes, transistors, crystal diodes, TV picture tubes. Features picture-tube beam-current test,

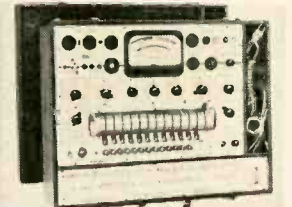

ultra-sensitive gas test, functional testing of voltage regulator tubes.—Precision Apparatus Co. Inc., 70-31 84 St., Glendale, N. Y.

TUBE TESTER, Philips Cartomatic III. Dutch-made punched-card instrument tests all popular U. S. and European types. With 50 prepunched cards, 16 adapter sockets, 50 blank cards, equipment for preparing cards for

When Converting Your Phono to Stereo... Use

The ERIE AUDIO-AMPLIFIER KIT featuring "PAC" and an ERIE Printed Wiring Board

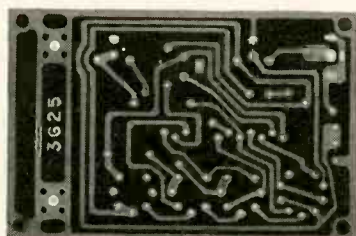

MODEL PAC-AMP-1

With these Plug-in Components:

- ERIE "PAC" (Pre-Assembled Components)
- ERIE PRINTED BOARD
- OUTPUT TRANSFORMER
- FILTER CAPACITOR
- VOLUME CONTROL and SWITCH
- TUBE SOCKETS
- CAPACITORS
- TONE CONTROL
- TUBES

SPECIFICATIONS FOR ERIE STANDARD AUDIO-AMPLIFIER

- Frequency Response: 30 cycles to 12,000 cycles ± 0 , -3.5 db.
- Sensitivity: 0.56 volt RMS (input at 1 KC) for 2 watt output.
- Power Output: 2 watts • Input Impedance: 2 megohms.
- Output Impedance: 4 ohms • AC Power Consumption: 17 watts.
- Overall Dimensions: 6 1/2" L x 4 1/2" W x 3 1/2" H • Shipping Weight: 2 lbs.

See and hear it at your local distributor or Write for nearest source.



ORDER by MAIL and SAVE! TV PICTURE TUBES

10BP4	...\$ 7.95	17BP4	...\$10.95	21AMP4	\$19.95
12LP4	... 8.95	17CP4	... 17.00	21ATP4	20.95
14B/CP4	... 9.95	17GP4	... 17.60	21AUP4	20.95
16DP4	... 14.95	17HP4	... 13.60	21EP4	14.95
16EP4	... 15.90	17LP4	... 13.60	21FP4	15.95
16GP4	... 15.90	17QP4	... 11.95	21WP4	17.30
16KP4	... 10.95	17TP4	... 19.30	21YP4	15.95
16LP4	... 10.95	19AP4	... 19.30	21ZP4	14.95
16RP4	... 10.95	20CP4	... 13.90	21CP4	23.95
16WP4	... 15.20	20HP4	... 17.95	21DP4	26.95
16TP4	... 10.95	21AP4	... 22.10	27EP4	39.95
17AVP4	... 15.20	21ALP4	... 20.95	27RP4	39.95

27"—6 month guarantee—all others 1 year. Aluminized Tubes \$3.00 more than above prices. These prices are determined to include the return of an acceptable similar tube under vacuum.

ALL PRICES FOB CHICAGO, ILLINOIS. Deposit required, when old tube is not returned, refundable at time of return. 25% required on COD shipments. Old tubes must be returned prepaid. We ship anywhere.

WRITE FOR COMPLETE LIST.

—PICTURE TUBE OUTLET—
3032 Milwaukee Ave., Chicago 18, Ill.
Dickens 2-2048

LEARN WHILE YOU SLEEP

100 page fact-filled illustrated instruction book tells all. How to do it... what it costs... results obtained... plus hundreds of time-saving hints. Price \$2.00. Satisfaction guaranteed. Sleep-Learning Research Ass'n. Box 24-15, Olympia, Washington.



And they have the finest features and specs. Fully illustrated step-by-step 28-page manual makes assembly a snap! WRITE FOR FREE CATALOG *Add 10% for Federal Tax. QUALITY ELECTRONICS 319 Church Street Dept. RE-8 New York 13, N. Y.

RADIO-ELECTRONICS

BUILD 16 RADIO

CIRCUITS AT HOME

with the New Deluxe 1958

PROGRESSIVE RADIO "EDU-KIT"

A COMPLETE RADIO COURSE

only

\$22⁹⁵

Reg. U.S.
Pat. Off.



Now Also Includes

- ★ TRANSMITTER
- ★ SIGNAL TRACER
- ★ SIGNAL INJECTOR
- ★ CODE OSCILLATOR

- ★ No Knowledge of Radio Necessary
- ★ No Additional Parts or Tools Needed
- ★ EXCELLENT BACKGROUND FOR TV
- ★ School Inquiries Invited
- ★ Attractively Gift Packed

NO NEED TO SPEND HUNDREDS OF DOLLARS FOR A RADIO COURSE

The "Edu-Kit" offers you an outstanding PRACTICAL HOME RADIO COURSE at a rock-bottom price. Our Kit is designed to train Radio & Electronics Technicians, making use of the most modern methods of home training. You will learn radio theory, construction practice and servicing.

You will learn how to build radios, using regular schematics; how to wire and solder in a professional manner; how to service radios. You will work with the standard type of punched metal chassis as well as the latest development of Printed Circuit chassis.

You will learn the basic principles of radio. You will construct, study and work with RF and AF amplifiers and oscillators, detectors, rectifiers, test equipment. You will learn and practice code, using the Progressive Code Oscillator. You will learn and practice trouble-shooting, using the Progressive Signal Tracer, Progressive Signal Injector, Progressive Dynamic Radio & Electronics Tester and the accompanying instructional material.

You will receive training for the Novice, Technician and General Classes of F.C.C. Radio Amateur Licenses. You will build 16 Receiver, Transmitter, Code Oscillator, Signal Tracer and Signal Injector circuits, and learn how to operate them. You will receive an excellent background for Television.

Absolutely no previous knowledge of radio or science is required. The "Edu-Kit" is the product of many years of teaching and engineering experience. The "Edu-Kit" will provide you with a basic education in Electronics and Radio, worth many times the complete price of \$22.95. The Signal Tracer alone is worth more than the price of the entire Kit.

THE KIT FOR EVERYONE

You do not need the slightest background in radio or science. Whether you are interested in Radio & Electronics because you want an interesting hobby, a well paying business or a job with a future, you will find the "Edu-Kit" a worth-while investment.

Many thousands of individuals of all ages and backgrounds have successfully used the "Edu-Kit" in more than 79 countries of the world. The "Edu-Kit" has been carefully designed, step by step, so that you cannot make a mistake. The "Edu-Kit" allows you to teach yourself at your own rate. No instructor is necessary.

PROGRESSIVE TEACHING METHOD

The Progressive Radio "Edu-Kit" is the foremost educational radio kit in the world, and is universally accepted as the standard in the field of electronics training. The "Edu-Kit" uses the modern educational principle of "Learn by Doing." Therefore you construct, learn schematics, study theory, practice trouble-shooting—all in a closely integrated program designed to provide an easily-learned, thorough and interesting background in radio.

You begin by examining the various radio parts of the "Edu-Kit." You then learn the function, theory and wiring of these parts. Then you build a simple radio. With this first set you will enjoy listening to regular broadcast stations, learn theory, practice testing and trouble-shooting. Then you build a more advanced radio, learn more advanced theory and techniques. Gradually, in a progressive manner, and at your own rate, you will find yourself constructing more advanced multi-tube radio circuits, and doing work like a professional Radio Technician.

Included in the "Edu-Kit" course are sixteen Receiver, Transmitter, Code Oscillator, Signal Tracer, and Signal Injector circuits. These are not unprofessional "breadboard" experiments, but genuine radio circuits, constructed by means of professional wiring and soldering on metal chassis, plus the new method of radio construction known as "Printed Circuitry." These circuits operate on your regular AC or DC house current.

A COMPLETE RADIO COURSE—NOTHING ELSE TO BUY

You will receive all parts and instructions necessary to build 16 different radio and electronics circuits, each guaranteed to operate. Our Kits contain tubes, tube sockets, variable, electrolytic, mica, ceramic and paper dielectric condensers, resistors, tie strips, coils, hardware, tubing, punched metal chassis, Instruction Manuals, wire, solder, etc.

In addition, you receive Printed Circuit materials, including Printed Circuit chassis, special tube sockets, hardware and instructions. You also receive a useful set of tools, a professional electric soldering iron, and a self-powered Dynamic Radio & Electronics Tester. The "Edu-Kit" also includes Code Instructions and the Progressive Code Oscillator, in addition to F.C.C.-type Questions and Answers for Radio Amateur License training. You will also receive lessons for servicing with the Progressive Signal Tracer and the Progressive Signal Injector, a High Fidelity Guide and a Quiz Book. You receive all parts, tools, instructions, etc. There is nothing else to buy. Everything is yours to keep.

FREE EXTRAS

- SET OF TOOLS
- SOLDERING IRON
- ELECTRONICS TESTER
- TESTER INSTRUCTION MANUAL
- HIGH FIDELITY GUIDE
- QUIZZES
- TELEVISION BOOK
- RADIO TROUBLE-SHOOTING BOOK
- MEMBERSHIP IN RADIO-TV CLUB
- CONSULTATION SERVICE
- FCC AMATEUR LICENSE TRAINING
- PRINTED CIRCUITRY
- PLIERS-CUTTERS
- ALIGNMENT TOOL
- CERTIFICATE OF MERIT
- VALUABLE DISCOUNT CARD
- WRENCH SET

SERVICING LESSONS

You will learn trouble-shooting and servicing in a progressive manner. You will practice repairs on the sets that you construct. You will learn symptoms and causes of troubles in home, portable and car radios. You will learn how to use the professional Signal Tracer, the unique Signal Injector and the dynamic Radio & Electronics Tester. While you are learning in this practical way, you will be able to do many a repair job for your friends and neighbors, and charge fees which will far exceed the price of the "Edu-Kit." Our Consultation Service will help you with any technical problems you may have.

J. Stataitis, of 25 Poplar Pl., Waterbury, Conn., writes: "I have repaired several sets for my friends, and made money. The "Edu-Kit" paid for itself. I was ready to spend \$240 for a Course, but I found your ad and sent for your Kit."

FROM OUR MAIL BAG

Ben Valerio, P. O. Box 21, Magna, Utah: "The Edu-Kits are wonderful. Here I am sending you the questions and also the answers for them. I have been in Radio for the last seven years, but like to work with Radio Kits, and like to build Radio Testing Equipment. I enjoyed every minute I worked with the different kits: the Signal Tracer works fine. Also like to let you know that I feel proud of becoming a member of your Radio-TV Club."

Robert L. Shuff, 1534 Monroe Ave., Huntington, W. Va.: "Thought I would drop you a few lines to say that I received my Edu-Kit, and was really amazed that such a bargain can be had at such a low price. I have already started repairing radios and phonographs. My friends were really surprised to see me get into the swing of it so quickly. The Troubleshooting Tester that comes with the Kit is really swell, and finds the trouble, if there is any to be found."

Unconditional Money-Back Guarantee

The Progressive Radio "Edu-Kit" has been sold to many thousands of individuals, schools and organizations, public and private, throughout the world. It is recognized internationally as the ideal radio course.

By popular demand, the Progressive Radio "Edu-Kit" is now available in Spanish as well as English.

It is understood and agreed that should the Progressive Radio "Edu-Kit" be returned to Progressive "Edu-Kit" Inc. for any reason whatever, the purchase price will be refunded in full, without quibble or question, and without delay.

The high recognition which Progressive "Edu-Kits" Inc. has earned through its many years of service to the public is due to its unconditional insistence upon the maintenance of perfect engineering, the highest instructional standards, and 100% adherence to its Unconditional Money-Back Guarantee. As a result, we do not have a single dissatisfied customer throughout the entire world.

- Send "Edu-Kit" Postpaid. I enclose full payment of \$22.95.
- Send "Edu-Kit" C.O.D. I will pay \$22.95 plus postage.
- Send me FREE additional information describing "Edu-Kit."

Name _____

Address _____

PROGRESSIVE "EDU-KITS" INC.

1186 Broadway, Dept. 143G, Hewlett, N.Y.



new tubes.—**Amperex Electronic Corp.**, 230 Duffy Ave., Hicksville, N. Y.

TRANSISTOR POWER SUPPLIES. Line of miniature units for transistor, plate and filament voltage and ac-to-dc. Avail-

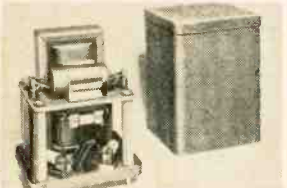

able with or without regulation. Operate from 105-125 volts ac, 60 or 400 cycles single-phase, or 400-cycle 3-phase inputs. Outputs 5-28 volts dc rated up to 5 amps, 100-300 volts up to 400 ma.—**Universal Transistor Products Corp.**, 17 Brooklyn Ave., Westbury, N. Y.

CIRCUIT COOLER, Zero-Mist GC-8667. Sprayed on circuit



components, it immediately locates trouble resulting from temperature changes in resistors, capacitors, transistors, cold solder and oxidized junctions. Instantly reduces temperature of components sprayed.—**General Cement Mfg. Co.**, 400 S. Wyman St., Rockford, Ill.

ADAPTER LEAD, Tri-Plex. For TV servicing. Connects 50°, 70° or 110° picture tubes to tester



or chassis. Eliminates need for 110° "test tube."—**General Electric Co.**, Receiving Tube Dept., Owensboro, Ky.

SINGLE-SIDEBAND ADAPTER, model DX-10SB. Plug-in adapter unit for **TX-1 Apache** transmit-



ter. May be used with other transmitters with simple circuit modifications. SSB signal generated by phasing method. Single-knob bandswitching for 5 bands. Relative power output meter. Output 10 watts peak

envelope power.—**Heath Co.**, Benton Harbor, Mich.

VOM KIT, Paco model M-40. Sensitivity 20,000 ohms/volt dc, 10,000 ohms/volt ac. Has 4 1/2-inch 50-microamp Pace meter,



2% accuracy. Has 7 ac and 7 dc voltage ranges over 3-12,000 and 1.5-6,000 volts respectively; 3 widespread resistance ranges, 0-20 megohms. Self-contained batteries for ohmmeter. High-voltage safety probe available as accessory.—**Precision Apparatus Co. Inc.**, 70-31 84 St., Glendale, N. Y.

TRANSISTOR OHMMETER, model EMT 321. Designed for all



transistor circuitry. Direct reading. Loading under 30 mv to 300 ohms. Measures 10 milliohms to 10 megohms in 8 ranges. Single scale.—**Electronic Applications**, 194 Richmond Hill Ave., Stamford, Conn. END

TOWERS. Sectionals in 10- and 20-foot lengths can be combined



to height of 150 feet. Regular 30-, 40- and 50-foot models now contain mounting post for rotor (shown).—**Tele-Vue Towers**, St. Petersburg, Fla.

TRANSISTOR RADIO KIT, Knight. Uses 5 transistors, 3 1/2-inch speaker, class-B push-pull audio output. Printed-circuit

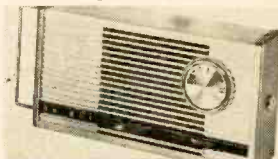

board phone jack. Single 9-volt battery.—**Allied Radio Corp.**, 100 N. Western Ave. Chicago 80.

COMMUNICATIONS RECEIVER, model HQ-170. Designed for optimum single-sideband reception. Continuous tuning of 6-, 10-, 15-, 20-, 40-, 80-, and 160-meter bands. Triple conversion on 7-54 mc, dual on 1.8-2 and 3.5-4 mc. 17-tube superheterodyne. Electrical bandspread. Telechyon timer optional.—**Hammarlund Mfg. Co.**, 460 W. 34, New York. END

All specifications on these pages are from manufacturers' data.

DX-16 Super Deluxe TV KIT ^{ONLY} \$2.49 Starts you off . . . on the EASY-PAYMENT-PLAN

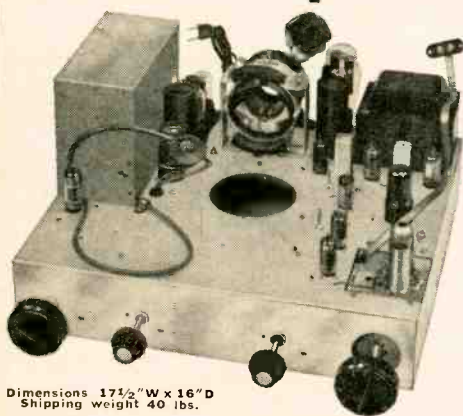

Dimensions 17 1/2" W x 16" D
Shipping weight 40 lbs.

70° or 90°—operating all 17", 21", 24" and 27" PICTURE TUBES
NEW IN DESIGN—Mounts Horizontally, Vertically or Sideways.

- ★ Produces a Superior 16-Tube Chassis with 30-Tube performance.
- ★ Latest advanced Intercarrier Circuitry and Multi-section Tubes.
- ★ Standard Neutrode Tuner for Selectivity and Fine Definition.
- ★ 5 Microvolts Video Sensitivity (20 volts peak to peak at CRT grid).
- ★ Fast Action AGC for Drift Free, Steady and Clear Pictures.
- ★ 3 Hi-gain Video I.F. Stages for excellent Contrast and Details.
- ★ AGC Level and Area Control, for adjusting reception to signal area.
- ★ All Video and I.F. Coils factory pre-aligned and tuned.
- ★ Horizontal Sweep Circuit is the famous RCA Synchronuide Network.
- ★ Large 250 ma Power Transformer ★ Large 12" Concert-tone Speaker.

Sold on the Easy-Payment-Plan—\$2.49 starts you off. You receive LIFE-SIZE step-by-step Building Instructions . . . just buy a few dollars worth of parts at a time as you build . . . or buy it complete at the low price shown below.

COMPLETE KIT WITH SET OF

Westinghouse TUBES 4-6C16 and 6U8, 6T8, 6C4, 12BH7, 6SN7, 6RQ6, 6W4, 6K6, 1X2E, 5U4, 6J6 and 6BQ7 included in the Tuner. (less CRT) . . . **\$79.97**

BUILD YOUR OWN TV CABINET FOR ANY TV CHASSIS

Comparable to the type that Top Mfrs. use on their higher priced TV sets.

FRONT SECTION complete as pictured in Solid Mahogany, Walnut or Blond Korina. **CABINET KIT** with 90% of the job done, includes—
TOP, SIDES, BACK, MASK, SAFETY GLASS, ETC. and Easy-to-follow Instructions.

Front, Top and Sides supplied in a beautiful Piano Finish . . . Knob panel undrilled (or drilled on receipt of your template) . . . For matching Mask specify type of CRT used. Same price for Mahogany, Walnut or Blond.

Worth \$60 when completed, only takes a few hours to assemble

21" CABINET KIT 26"H, 25"W, 22"D	\$24.95	17" CABINET KIT 24 1/2"H, 22"W, 22"D	\$24.95
(Shipping weight 36 lbs.)		24" or 27" CABINET KIT 30"H, 28 1/2"W, 22"D	\$36.47

FRONT SECTION for WALL INSTALLATIONS Includes Mask, Safety Glass, Decals and Illustrated Instructions. (Shipping wgt. 21 lbs.)

21" .. \$17.45	24" or 27" .. \$22.97
-----------------------	------------------------------

(only) Same price on Mahogany, Walnut or Blond or in Natural (unfinished) for your own color application.

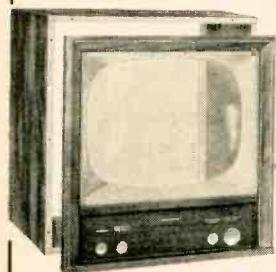

BROOKS RADIO & TV CORP., 84 Vesey St., Dept. A, New York 7, N.Y.

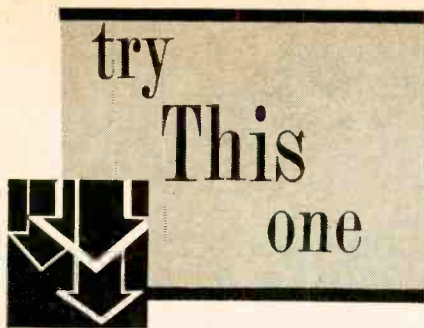

SOLDERING PHONE TIPS

The method Hugh Lineback describes for soldering wires to phone tips (RADIO-ELECTRONICS, December, 1957, page 116) works ideally, but I would like to add that an inverted steam iron can be used for the same purpose without drilling holes. Most steam irons have 1/8-inch vent holes in the soleplate that phone tips fit perfectly. All you have to do is invert iron, turn the thermostat to its highest level and rest the tips in the vent holes.—*Scott Mack*

HANDY CONNECTING STAND

With this simple device, fixed capacitors, fixed resistors, germanium diodes, etc. can be quickly connected or disconnected in experimental circuits without damaging their leads. Germanium diodes may be easily and rapidly reversed by simply turning the diode around in the clips.

As shown in the photo, drill two 3/16-inch holes about 2 1/2 inches apart

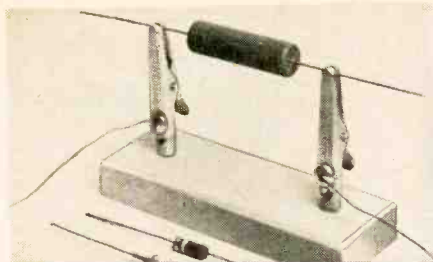

in a block of wood or plastic and force the sleeve of a "60 series" Mueller alligator clip into each hole. It's a good idea to put a little all-purpose cement into each hole before mounting the clips. Wire leads connected to the screw terminals on the clips go to the experimental circuit.—*Art Trauffer*

ENLARGING HOLES IN PLASTIC

If a hole in plastic has to be made larger (such as plastic bosses) to hold a larger self-tapping screw, try this simple method. Start the larger screw in the original hole—just a few turns are sufficient. Then apply heat from a soldering gun to the screw. Before the screw cools, turn it into the soft plastic. Apply more heat and continue until the hole reaches the desired size. Leave the screw in the plastic till it has cooled. When cool, slowly and carefully remove the screw. Now you have a fresh hole large enough to hold the larger self-tapping screw.—*A. von Zook*



ready for STEREOPHONIC records GLASER-STEERS GS-77

With the availability of stereophonic records, the requirements for turntable and record changer quality become more critical than ever before. Yesterday's 'bests' may no longer be good enough. All previously acceptable units must now be re-examined in the light of the new quality demands imposed by stereo.

That the Glaser-Steers GS-77 should be ideally suited for stereo is no mystery. It is simply the result of strict adherence to rigid precision standards, and permitting no compromise in quality. This is evident in every feature of the GS-77.

The Tone Arm, by reason of optimum mass distribution and free pivot suspensions, exhibits no resonance in the audible spectrum. And tracking error is virtually eliminated. In addition, the arm counterbalance is so designed that the stylus pressure between the first and tenth record in a stack does not vary beyond 0.9 gram. These characteristics virtually eliminate vertical rumble (to which stereo is sensitive).

Turntable Pause is an ingenious GS-77 innovation designed for added record protection. During the record-change cycle, the GS-77 turntable comes to a complete halt, and doesn't resume motion until the stylus has come to rest in the lead-groove of the next record. This completely eliminates the grinding action which takes place where records are dropped onto a moving turntable or disc—more important than ever because of the delicate grooves of stereo records.

The GS-77 is the perfect record changer for stereo as it is for conventional monaural high fidelity. Only \$59.50 less cartridge & base.



SELECT-O-SWITCH
4-WAY SELECTOR SWITCH
Use as antenna switch or as a hi-fi speaker switch. Permits channeling one input to any one of 4 outputs.
model SS4 LIST \$3.25



Switch-in-Base
DUO-JUVENATOR
Parallel and Series TV tube booster. Cures 95% of all CRT failures. One-piece construction.
model RPS2 LIST \$2.95

TELE-LINK
2-SET TV & FM COUPLER

Matched transformers for peak performance on 2 TV or FM sets from one antenna.
model TL2 LIST \$2.95



Only from famous COYNE do you get this modern up-to-the minute TV Home Training. Easy to follow instructions—fully illustrated with 2150 photos and diagrams. Not an old Radio Course with Television tacked on. Includes UHF and COLOR TV. Personal guidance by Coyne Staff. *Practical Job Guides* to help you EARN MONEY QUICKLY IN A TV-RADIO SALES AND SERVICE BUSINESS—part time or full time. COSTS MUCH LESS—pay only for training—no costly "put together kits."

SEND COUPON FOR FREE BOOK
SEND COUPON BELOW for Free Book and full details including EASY PAYMENT PLAN. NO COST OR OBLIGATION—NO SALESMAN WILL CALL.

B. W. COOKE, Jr., Pres. **COYNE ELECTRICAL SCHOOL** FOUNDED 1899
A TECHNICAL TRADE INSTITUTE OPERATED NOT FOR PROFIT
500 S. Paulina, Dept. C8-H5, Chicago 12, Illinois

COYNE ELECTRICAL SCHOOL
Television Home Training Div.
500 S. Paulina St., Chicago 12, Ill., Dept. C8-H5
Send FREE BOOK and details of your Television Home Training offer.

Name _____
Address _____
City _____ State _____

RE-8
GLASER-STEERS CORP.
20 Main Street, Belleville 9, N. J.

Please send me complete information on the GS-77.

NAME _____
ADDRESS _____
CITY _____ ZONE _____ STATE _____

performance
proven in more
than 500,000
homes



**UHF
CONVERTERS**

No matter where you are — primary or fringe area — there's a B-T UHF converter that makes any TV set a modern, powerful 82-channel receiver.

New FCC tuner standards* are met by these B-T Converters.

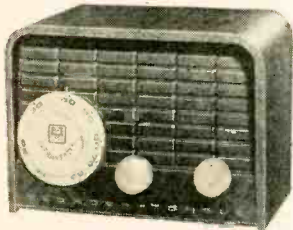

for superior reception
in fringe areas the

BTU-2_R

precise 300-ohm impedance match; high gain—high stability; low noise factor; double tuned input; dual speed channel selector for easy, accurate tuning only 39.95



for primary areas — top
performance at low cost

MODEL 99_R

precise 300 ohm impedance match; double tuned RF section; one knob tuning; drift-free performance only 22.95

B-T converters are UL approved, CSA approved and approved by actual performance in more than 500,000 American homes.

Sold by Electronic Parts Distributors

For further information write: Dept. RE-8

Blonder-Tongue Laboratories, Inc.

9 Alling Street Newark 2, N. J.

*Models 99r and BTU-2r comply with tuner limits of FCC rules, Part 15, of 1000 UV/M — Hazeltine Research Corp. — report #57041.

PATENTS (Continued)

The circuit in Fig. 2 eliminates the need to measure and calculate. Here we wish to determine the phase difference between input and output voltages of an apparatus under test. With S2 as shown, the input connects to the horizontal amplifier or plates and the output to the vertical. For convenience, the scope's vertical gain is adjusted for a maximum amplitude of 10 small squares to make B equal 10 (Fig. 1). In its other position, S2 shorts the horizontal input to ground and feeds the output from potentiometer P to the vertical input. The

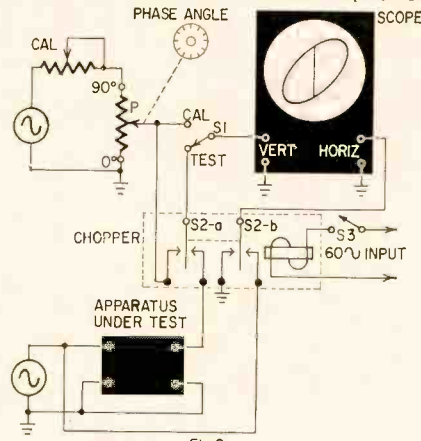

Fig. 2

pattern becomes a vertical line whose length is controlled by P to lie within the ellipse (line A). Then the phase angle is read directly from the dial of P, which has been previously calibrated.

Calibration is not difficult. With S1 on CAL, various positions of the P dial correspond to different lengths of A. When A is 10, the angle is 90°, since $\sin 90^\circ$ is 1. When A is 5, the angle is 30°, and so on. S3 controls a chopper, causing S2 to vibrate between its two positions. When operating the ellipse and vertical line seem to appear simultaneously, and P can then be set as required.

Broadcast Superregenerator

Patent No. 2,821,625

Harry L. Price, Astoria, N. Y.

This inventor claims excellent results from his superregenerator. A special feature is the

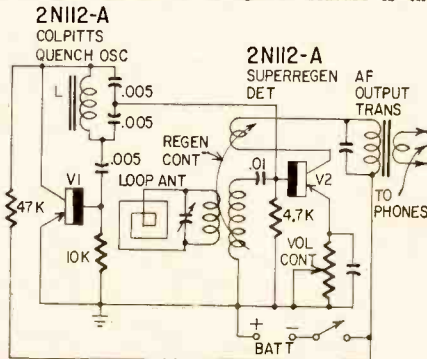

way he couples the quench oscillator V1 to the superregenerator detector V2.

Values are shown for the critical components. L (approximately 0.1 henry) is designed to oscillate at 10 kc with its 2 series-connected tuning capacitors. END

Corrections

Credit for the color photograph on the June cover was inadvertently given to Mr. Pugh whose electronic compass was illustrated. The credit should have gone to Paul Ihde for his excellent work.

In the article "Square-Wave Generator" on page 92 of the June issue, blocking capacitor C6 should be inserted between R3 and R7, with R3 connected between B plus (200 volts) and pin 1 of V1, otherwise the circuit is inoperative. In this circuit R5 is the frequency control. R1 affects waveform (as to some extent does R7).

OPPORTUNITY ADLETS

Rates—50c per word (including name, address and initials). Minimum ad 10 words. Cash must accompany all ads except those placed by accredited agencies. Discount, 10% for 12 consecutive issues. Misleading or objectionable ads not accepted. Copy for October issue must reach us before August 15, 1958.

RADIO-ELECTRONICS,
154 West 14 St., New York 11, N. Y.

HIGH-FIDELITY SPEAKERS REPAIRED. AMPRITE Speaker Service, 70 Vesey St., New York 7, N.Y. BA 7-2580.

CASH PAID! Sell your surplus electronic tubes. Want unused, clean transmitting, special purpose, receiving, TV types, magnetrons, klystrons, broadcast, etc. Also want military & commercial lab test and communications gear. We swap too, for tubes or choice equipment. Send specific details in first letter. For a fair deal write, wire or telephone: BARRY, 512 Broadway, New York 12, N.Y. Walker 5-7000.

RECORDERS, Hi-Fi, Tapes. Free Wholesale Catalogue. CARSTON, 215-T East 88th St., New York 28, N.Y.

STEREO TAPE RENTALS. For the very best at lowest prices. Write CALIFORNIA TAPED MUSIC ASSN., 1971 Cordilleras Road, Redwood City, Calif.

DISCOUNTS UP TO 50% on Hi-Fi amplifiers, tuners, speakers, tape recorders, individual quotations only, no catalogs. CLASSIFIED HI-FI EXCHANGE, 2057 Coney Island Ave., Brooklyn, N. Y.

LABORATORY QUALITY equipment and Military Surplus Electronics bought, sold. ENGINEERING ASSOCIATES, 434 Patterson Road, Dayton 9, Ohio.

DIAGRAMS FOR REPAIRING RADIOS \$1. Television \$2. Give make, Model. DIAGRAM SERVICE, Box 672-RE, Hartford 1, Conn.

"HYPNOTIZE... One word... One fingersnap..." on stage. Satisfaction—or refund. \$2. HYPNOMASTER, 846-S5 Sunnyside, Chicago 40, Ill.

ALL MAKES OF ELECTRICAL INSTRUMENTS AND TESTING equipment repaired. HAZELTON INSTRUMENT Co., 128 Liberty Street, New York, N. Y.

TELEVISION Tuner Repairs. DAN'S TELEVISION LABORATORY, 619A Sunrise Highway, Babylon, N.Y.

REPRINTS available of any article in RADIO-ELECTRONICS. Reasonable rates. High quality. PASSANTINO PRINTING CO., 250 West 49th St., New York, N. Y.

"15 TESTED One-tube Circuits." Transistor experiments and catalog—25¢. LABORATORIES, 1131-B Valera, Redwood City, California.

DISCOUNTS TO 50%, recorders, tapes, hi-fi components, consoles, photograph equipment. Request specific prices only. LONG ISLAND AUDIO & CAMERA EXCHANGE, 3 Bay 26th St., Brooklyn 14-R, N. Y.

DIAGRAMS! Repair Information! Radios—Amplifiers—Recorders \$1 Televisions \$1.50. Give make, model, chassis. TV MILTIE, Box 101EA, Hicksville, N.Y.

HIGH-PAYING JOBS, opportunities; foreign, USA. All Trades. Companies pay fare. For information, write Dept. 57U. NATIONAL EMPLOYMENT INFORMATION, 1020 Broad, Newark, N.J.

PROFESSIONAL Electronic Projects—Organs, Timers, Intercoms, Counter, etc. \$1 each. List Free. PARKS, Box 1665, Lake City Station, Seattle 55, Wash.

COLOR PRINTS
25¢
from your positive transparencies 2 1/2 x 3 1/2

Direct from laboratory to you—by mail
Custom quality—money back guarantee

COLOR FILM PROCESSING	COLOR PRINTS & DUPLS
Ansochrome, Ektachrome, 3 1/2 x 5 \$.45	
or Super Ansochrome— 8 x 10 2.00	
35mm 20 exp. 2 1/4, mtd \$1.25	35mm duplicates25
Kodachrome-20 exp. 1.50	Sorry we do not ship COD

Write today for free mailer and complete price list!

Colorflex Authorized Anso Color Laboratory
laboratories • inc
1160-F Bonifant Street • Silver Spring, Maryland

radio-electronic Circuits

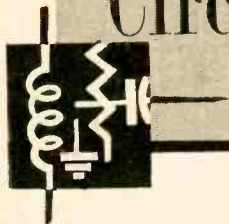

SUBSTITUTION CHECKER FOR RECTIFIERS AND FILTER CAPACITORS

When checking ac-dc radio and TV receivers for low B-plus or low high voltage, the selenium or silicon rectifiers are common suspects. The usual procedure is to parallel known good rectifiers across the rectifiers in the chassis with jumpers and check the results with a meter. This takes time and results in leads all over the place as well as a few exposed and hot (117 volts ac) ones on the bench.

The checker shown in the diagram ends these problems. It has but three leads and a built-in meter. It also lets you check, with just a flick of a switch, the difference between silicon and selenium rectifiers. With switch in off (center) position, meter can be used alone.

Including a capacitor in the circuit makes it possible to check another com-

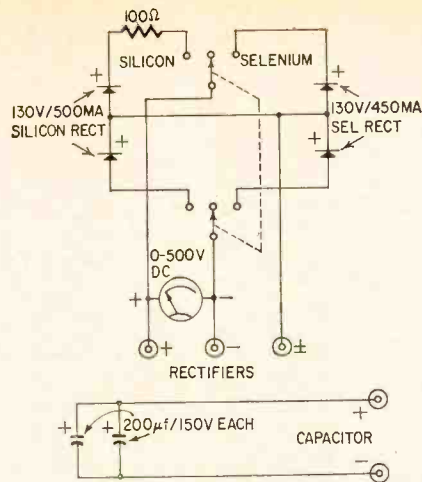

mon troublemaker in voltage-doubler supplies. Of course, other electrolytics in the receiver can be checked as well.

While tip jacks and test leads can be used with the checker, I have wired test leads into the unit's circuitry. I never have to go looking for leads.—
Bert Carroll

R-C TUNED TRANSISTOR OSCILLATOR

Low-power audio oscillators are used in many types of equipment. Recently, there has been much interest in using transistor oscillators in these circuits. One such oscillator obtains the necessary feedback through a transformer tuned by a capacitor. An alternative is to use a circuit with one or two tran-

better reception on
1, 2 or 3 tv sets...
with one antenna

NEW **B-T LABS.** B-23

TWO-SET BOOSTER



only \$23.95

From B-T comes the most important advance in better TV reception for 1958—a broadband TV amplifier that boosts signal strength on all VHF channels and operates 1, 2 or 3 TV sets with one antenna—no tuning required.

Combines two functions in one—

- BOOSTS signal strength on 1 or 2 TV sets—up to 6 db gain operating two TV sets from one antenna.
- COUPLES 2 or 3 TV sets—using the present antenna. Outperforms non-powered couplers in any reception area by more than 2 to 1.

Check these B-23 features:

- Ideal for color—add a color TV set and keep present black-and-white set, use the same antenna—the result, sharper, clearer pictures on both sets
- Low noise figure—designed to work with new VHF sets
- Reduces interference
- Easily installed at antenna terminals of set
- Automatically amplifies channels 2-13
- Ideal small TV system

For operating 3 to 8 TV sets, use the B-T Labs DA8-B—more than 10 db gain on all VHF channels.

The DA8-B Distribution Amplifier is a broadband, all-channel unit that requires no tuning, impedance matching devices, pre-amps or other special fittings. Ideal for all small TV systems (garden apartments, motels, TV showrooms). Approved for color. Only \$94.50

The B-23, the DA8-B, and other B-T quality engineered products, are available at electronic parts distributors.

For further information, use coupon.



self-service
tube testers offer a
lucrative **BUSINESS**
OPPORTUNITY for you

Start a big income producing tube tester route without giving up your present job or business. If you ever planned some day of starting a solid growing business, this is the time to do so. Place Century's money-making self-service tube testers with tubes on consignment in drug stores, luncheonettes, super-markets and other retail outlets. Consumers test their own radio and TV tubes automatically 12 hours a day—7 days a week. Defective tubes are replaced on the spot for highly profitable sales. Each Century tube tester you place can net up to \$1000 a year... and there is no limit to how many you can handle spare or full time. No selling required... Century backs you up with a proven plan of operation, sales literature, window streamers, etc.

Learn how you can start to build a good business of your own in this unlimited market, without giving up your present source of revenue. Write today for FREE booklet that tells all about this booming business.

MAIL THIS
COUPON
TODAY FOR
FREE
BOOKLET!

CENTURY ELECTRONICS CO., INC.

Dept. E-8, 111 Roosevelt Avenue, Mineola, N. Y.

Please send me without obligation, FREE booklet and particulars about setting-up a self-service tube tester route. I understand no salesman will call.

Name Please print clearly
Address
City State

B-T LABS. BLONDER-TONGUE LABS., INC. RE-8
9 Alling Street, Newark 2, New Jersey

Please send me literature covering:

B-T B-23 B-T TV Accessories

Name _____

Address _____

City _____ Zone _____ State _____

"ONE DOLLAR" buys

As much as \$15 worth — Everything Brand New and sold to you with a money back guarantee.

DEDUCT 10% ON ANY ORDER OF \$10 OR OVER
Plus a **FREE SURPRISE PACKAGE**

- 5 - ELECTROLYTIC CONDENSERS 30-450v. . \$1
- 25 - TUBULAR CONDENSERS .047-400v. 85¢ . \$1
- 100 - ASSORTED FUSES popular sizes. . . . \$1
- 100 - ASST. 1/2 WATT RESISTORS some 5% . . \$1
- 70 - ASSORTED 1 WATT RESISTORS \$1
- 35 - ASSORTED 2 WATT RESISTORS \$1
- 50 - ASST. TUBULAR CONDENSERS \$1
- 10 - 6' ELECTRIC LINE CORDS with plugs . . \$1
- 5 - TV CHEATER CORDS with both plugs . . \$1
- 4 - 50' SPOOLS HOOK-UP WIRE 4 colors . . \$1
- 50 - STRIPS ASST. SPAGHETTI best sizes . . \$1
- 100 - ASST. RUBBER GROMMETS best sizes . \$1
- 100' - TWIN LEAD-IN WIRE 300Ω heavy duty . \$1
- 50' - FLAT 4-CONDUCT. WIRE many purposes . \$1
- 25' - INSULATED SHIELDED WIRE \$1
- 5 - RCA RESISTANCE CORDS 550 ohms . . . \$1
- 1 - \$7 INDOOR TV ANTENNA hi-gain 3 section . \$1
- 20 - ASST. TV KNOBS, ESCUTCHEONS, Etc. . \$1
- 3 - ASST. TOGGLE SWITCHES spst, dpdt, etc. . \$1
- 6 - ASST. SLIDE SWITCHES spst, dpdt, etc. . \$1
- 4 - BAKELITE KNIFE SWITCHES dpdt \$1
- 15 - ASST. ROTARY SWITCHES \$15 worth . . . \$1
- 100' - FINEST NYLON DIAL CORD best size . . \$1
- 200 - SELF TAPPING SCREWS #8 x 1/2" . . . \$1
- 35 - ASST. RADIO KNOBS screw and push-on . \$1
- 100 - KNOB SPRINGS standard size 3/8" x 1/2" . \$1
- 100 - ASSORTED KNOB SET-SCREWS \$1
- 25 - ASSORTED CLOCK RADIO KNOBS . . . \$1
- 400 - ASST. H'DWARE screws, nuts, rivets, etc. \$1
- 50 - ASST. SOCKETS octal, noval and miniature . \$1
- 20 - ASSORTED TUBE SHIELDS best sizes . . \$1
- 50 - ASST. MICA CONDENSERS some in 5% . . \$1
- 50 - ASST. CERAMIC CONDENSERS \$1
- 10 - ASST. VOLUME CONTROLS less switch . . \$1
- 5 - ASST. VOLUME CONTROLS with switch . . \$1
- 100 - VOLUME CONTROL HEX NUTS \$1
- 20 - ASST. PILOT LIGHTS popular types . . \$1
- 10 - PILOT LIGHT SKTS, bayonet type, wired . \$1
- 50 - ASST. TERMINAL STRIPS 1, 2, 3, 4 lug . . \$1
- 10 - ASST. RADIO ELECTRO. CONDENSERS . . \$1
- 5 - ASST. TV ELECTROLYTIC CONDENSERS . . \$1
- 15 - ASST. TV COILS sync. peaking, width, etc. \$1
- 10 - RCA COIL FORMS 7/8" x 3" many purposes . \$1
- 25 - ASST. MICA TRIMMER CONDENSERS . . \$1
- 50 - TUBULAR CONDENSERS .001-600v. . . . \$1
- 50 - TUBULAR CONDENSERS .01-400v. . . . \$1
- 2 - ELECTROLYTIC COND. 40/40-450v. . . . \$1
- 2 - ELECTROLYTIC COND. 40/10/10-450v. . . \$1
- 30 - FP CONDENSER MOUNTING WAFERS . . . \$1
- 3 - ELECTROLYTIC COND. 80-450v. . . . \$1
- 3 - ELECTROLYTIC COND. 50/30-150v. . . . \$1
- 15 - TUBULAR CONDENSERS .015-1600v. . . \$1
- 10 - HV TUBULAR CONDENSERS .008-1600v. . \$1
- 10 - HV TUBULAR CONDENSERS .001-8000v. . \$1
- 10 - HV TUBULAR CONDENSERS .005-8000v. . \$1
- 35 - MICA COND. 20-100 mmf & 15-270 mmf . . \$1
- 35 - MICA COND. 20-470 mmf & 15-680 mmf . . \$1
- 35 - MICA COND. 20-820 mmf & 15-1000 mmf . \$1
- 35 - CERAMIC COND. 20-5 mmf & 15-10 mmf . . \$1
- 35 - CERAMIC COND. 20-25 mmf & 15-47 mmf . \$1
- 35 - CERAMIC COND. 20-56 mmf & 15-82 mmf . \$1
- 35 - CERAMIC COND. 20-100 mmf & 15-150 mmf . \$1
- 35 - CERAMIC COND. 20-270 mmf & 15-470 mmf . \$1
- 35 - CERAMIC COND. 20-1000 mmf & 15-1500 mmf . \$1
- 35 - CERAMIC COND. 20-2000 mmf & 15-5000 mmf . \$1
- 50 - 100Ω 1/2 WATT RESISTORS 5% \$1
- 50 - 470KΩ 1 WATT RESISTORS 10% \$1
- 25 - 100KΩ 2 WATT RESISTORS 10% \$1
- 10 - ASST. WIREW'ND RES. 5, 10, 20 watts . . \$1
- 3 - AUDIO OUTPUT TRANS. 50L8 type \$1
- 3 - AUDIO OUTPUT TRANS. 6K8 or 8V8 type . . \$1
- 3 - I.F. COIL TRANSFORMERS 456 kc \$1
- 3 - I.F. COIL TRANSFORMERS 10.7 mc FM . . . \$1
- 4 - OVAL LOOP ANTENNAS ass't hi-gain types . \$1
- 3 - LOOPSTICK ANT, new ferrite adjustable . . \$1
- 12 - RADIO OSCILLATOR COILS 456 kc \$1
- 3 - 1/2 MEG VOLUME CONTROLS with switch . \$1
- 5 - 50K VOLUME CONTROLS less switch . . . \$1
- 10 - SURE GRIP ALLIGATOR CLIPS \$1
- 1 - GOLD GRILLE CLOTH 14" x 14" or 12" x 18" . \$1
- 1 - 5" PM SPEAKER alnico #5 magnet \$1
- 5 - SETS SPEAKER PLUGS wired \$1
- 10 - SETS PHONO PLUGS and PIN JACKS . . \$1
- 2 - \$2.50 SAPPHIRE NEEDLES 4000 playings . \$1
- 5 - DIODE CRYSTALS 2-IN21 2-IN23 1-IN64 . \$1
- 2 - SELENIUM RECTIFIERS 1-65 ma & 1-150 ma . \$1
- 1 - TV VERT. OUTPUT TRANS. 10 to 1 ratio . . \$1
- 5 - TV CRT. SOCKETS with 18" leads \$1
- 5 - HI-VOLT. ANODE LEADS with 18" leads . . \$1
- 1 - TV RATIO DETECTOR TRANS. 4.5 mc . . . \$1
- 1 - SET TV KNOBS standard type incl. decals . \$1
- 1 - LB SPOOL ROSIN CORE SOLDER 40/60 . . \$1
- 6 - SPIN TIGHT SOCKET SET 3/16" to 7/16" . . \$1
- 3 - TV ALIGNMENT TOOLS 5", 7", 12" . . . \$1
- \$15 - "JACKPOT" TELEVISION PARTS \$1

HANDY WAY TO ORDER—Simply tear out advertisement and pencil mark items wanted (X in square is sufficient); enclose with money order or check. You will receive a new copy of this ad for re-orders.

ON SMALL ORDERS—Include stamps for postage, excess will be refunded. Larger orders shipped express collect.

BROOKS RADIO & TV CORP.
84 Vesey St. Dept. A, New York 7 N.Y.

RADIO-ELECTRONIC CIRCUITS (Continued)

sisters in which feedback is through an R-C network.

A hybrid arrangement is also possible. Here, a transformer used with one transistor provides the feedback, but an R-C network determines the frequency of oscillation. If, for example, you wish to use a transformer anyway, say with a third winding for the output, R-C tuning may be better than tuning the transformer and may give a better waveform.

The diagram shows the circuit of such an oscillator. The transformer (which must be connected with proper phasing) provides feedback and the R-C network determines the frequency. Ideally, frequency f is equal to $\frac{1}{2\pi CR}$. If, however, the transformer has any

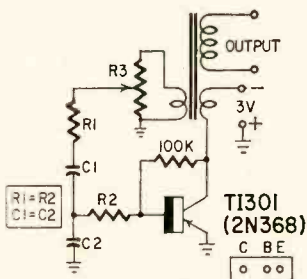

phase shift, the operating frequency will change somewhat. In the circuit I built, R1 and R2 are 10,000 ohms each and C1 and C2 were chosen as needed. Potentiometer R3 controls the amount of feedback. For the best waveform, this should be the minimum needed to maintain oscillation. The transformer has a voltage stepup of about 3 to 1. A large range of ratios could be used, however, with a change in the value of resistors R1 and R2 if needed. The 100,000-ohm resistor provides base-bias current.

With the values mentioned, the oscillator gives a good waveform when properly adjusted—no noticeable distortion. Battery drain is about 0.5 ma. —H. L. Armstrong END

50 Years Ago

In Gernsback Publications

HUGO GERNSBACK, Founder

Modern Electrics	1908
Wireless Association of America	1908
Electrical Experimenter	1913
Radio News	1919
Science & Invention	1920
Television	1927
Radio-Craft	1929
Short-Wave Craft	1930
Television News	1931

Some larger libraries still have copies of Modern Electrics on file for interested readers.

In August, 1908, Modern Electrics

The Collins Wireless Telephone, by William Dubilier.

Wireless 'Phone New York to Newark. Loud Speaking Telephone.

Wireless Telephone, by Victor H. Laughter.

The Construction of a Potentiometer, by M. A. Deviny.

The Aurophone.

High Frequency Spark Gap.

A Novel Tuning Device, by Newell A. Thompson.

IMPROVE

your amplifier 5 ways

with the **Amperex® GZ34/5AR4 RECTIFIER**

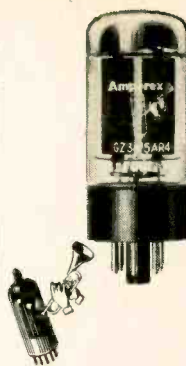

A LOW-IMPEDANCE, INDIRECTLY HEATED, FULL-WAVE RECTIFIER WITH 250 MA OUTPUT CAPACITY

The unique AMPEREX GZ34 replaces without circuit changes, in the majority of amplifier circuits, an entire line of popular, heavy-duty 5-volt rectifiers — 5U4G, 5V4G, 5T4, etc. — with the following benefits:

- Better voltage regulation due to lowered power supply impedance;
- Higher power supply output voltage for more power;
- Added filter condenser protection due to reduced surge;
- Cooler operation due to lower voltage drop;
- Protection of costly power output tubes through delayed warm-up.

Ask your Amperex distributor about Amperex voltage amplifier, rectifier and output tubes for hi-fi circuits



Amperex ELECTRONIC CORP.
230 Duffy Avenue
Hicksville, L. I., N. Y.



SUITS NEED PRESSING— MERIT DEFLECTION YOKES DO NOT!

Merit deflection yokes are cosine wound TO FORM, not pressed. Pressing can lead to distortion and poor focusing. Pressing after winding frequently causes breakdown.

MERIT COILS AND TRANSFORMERS HAVE "BUILT-IN" ADVANTAGES.



Each Merit yoke is 100% LIVE TESTED

COMPARE IT WITH **MERIT**
MERIT COIL AND TRANSFORMER CORP.
MERIT PLAZA • HOLLYWOOD, FLORIDA

Technotes



VERTICAL HOLD TROUBLES

We have found the RCA CTC5N color capacitor. It goes up in value to .0022 μ f. The other fault is seen as a complete

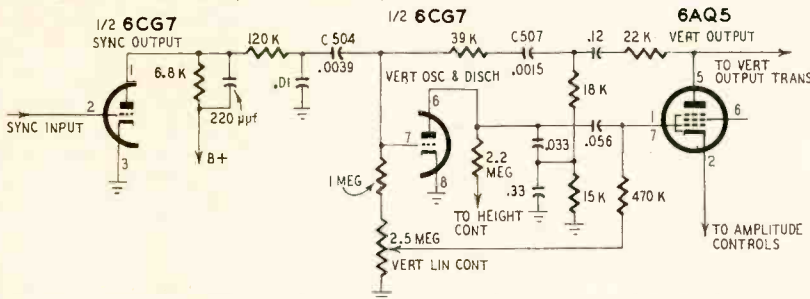

the picture holding only with the vertical hold control at the extreme end of its range, is caused by C504, a .0015- μ f

loss of vertical hold. This too, is caused by a capacitor—the C507, a .0015- μ f

HALLICRAFTERS 760

This set came in with retrace lines that the customer didn't want. To get rid of them I installed a cathode blank-

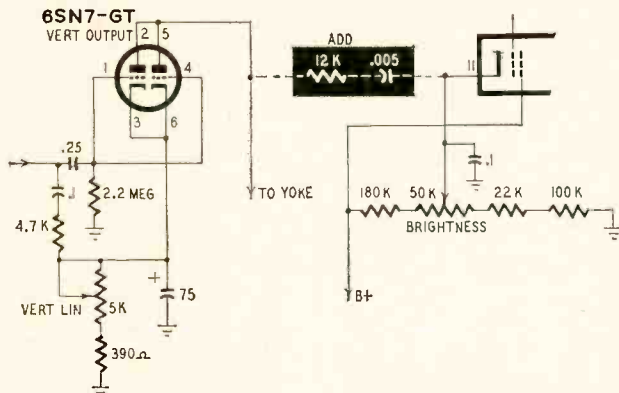

ing circuit. It consists of a 12,000-ohm resistor in series with a .005- μ f capacitor connected between the vertical output tube's plate and the picture-

tube's cathode. (Circuitry in block in diagram). These particular values seem to work best for this model, but may

have to be juggled for others. In operation the vertical-blanking pulses bias the picture tube to cutoff during vertical retrace.—*John B. Ledbetter*

PHILCO 51-T-1634

The set came into the shop with a B-plus short. A filter capacitor, two resistors and both 5U4-G's were replaced, and the set left to cook. Within a short time spasmodic vertical jitter appeared. Several lines in the lower half of the picture were affected most, but at times the bottom of the picture would rise and fall sharply $\frac{1}{2}$ inch or so.

Vertical tubes were changed. There was no improvement. Voltage and resistance checks showed nothing. A scope used in an effort to locate the source of the trouble showed all waveforms crisp and clear with no interruption.

Capacitors were changed, resistors

replaced and even a new vertical blocking transformer and output transformer installed, but nevertheless the trouble persisted.

With all components in the vertical circuit checked, the one item remaining was the yoke. Since replacing the yoke meant disassembling it and focus-coil assembly, we decided to try one more move. The yoke cable plug was pulled out of its socket and both the plug and socket thoroughly cleaned. The plug pins were reheated and the socket pins squeezed slightly to insure a tighter contact. With the yoke reconnected, the trouble—caused by a high-resistance dirt short or poor connection—was gone.—*Frank A. Salerno* END

MULTIPLE TV INSTALLATIONS MADE EASY!

PROFITABLE BUSINESS

- Hotels
- Motels
- Apartments
- Institutions
- Stores, etc.

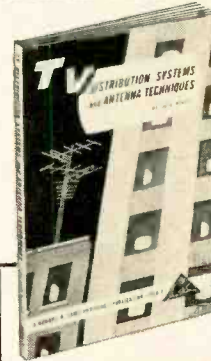

GET ALL THE KNOW-HOW IN THIS VALUABLE SAMS BOOK

"TV DISTRIBUTION SYSTEMS and ANTENNA TECHNIQUES"

by Jack Beever

MAKES YOU AN EXPERT ON MULTIPLE TV INSTALLATION

Here's complete information on how to feed TV signals to multiple TV sets from a single antenna system. Describes equipment required to solve signal distribution problems; shows how to use equipment properly. Covers every type of multiple-set system from simple two-receiver service to large commercial installations. Full information on how to solve difficult "local" reception problems and how to get good fringe area results. Describes community antenna systems—planning, equipment, installation, legal problems, costs, maintenance, service charges—all the facts.

17 FACT-PACKED CHAPTERS:

You get detailed practical information on: selection, location and orientation of the antenna—recommended signal distribution systems and how to install them—requirements for coaxial cable, set outlets or tap-offs—available equipment for amplifying and filtering signals—modernizing or converting a system for UHF—how to maintain the system, what to charge—even how to prepare bids and estimates and make the sale! It's complete—it's practical—tells you everything you need to know to build a profitable business in multiple TV installations. Order today!

176 pages, $5\frac{1}{2} \times 8\frac{1}{2}$ " PRICE ONLY \$295

SEE THIS BOOK AT YOUR SAMS DISTRIBUTOR OR MAIL COUPON

FREE TRIAL COUPON

Howard W. Sams & Co., Inc., Dept. 2-H8
2201 E. 46th St., Indianapolis 5, Ind.

Send me Sams "TV Distribution Systems and Antenna Techniques" for 10 days FREE examination. In 10 days, I will pay for the book, plus few cents delivery cost, or return postpaid.

We pay delivery cost if you remit with this coupon; same return privilege.

Name

Address

City..... Zone..... State.....

(Outside U.S.A. priced slightly higher)



Triad Transformer Corp., Venice, Calif., worked out a new yoke replacement kit which makes it possible for the TV service technician to service thousands of makes of TV sets with a very small yoke inventory. The new yoke pack consists of 8 yokes and 25 network

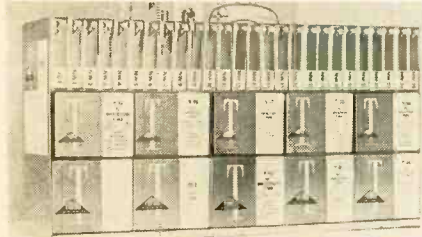

kits, offering an almost unlimited number of network combinations.

P. R. Mallory & Co., Indianapolis, Ind., is promoting its Gem tubular ca-



pacitors packaged five in a clear plastic box and displayed on a handy new self-service rack.

Walsco Manufacturing Co., Rockford, Ill., is offering service technicians a

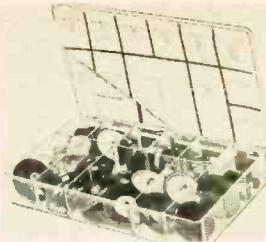

plastic inventory case for its phono and recorder drives and belts, with orders of \$10 or more.

Pyramid Electric Co., North Bergen, N. J., designed a new combination self-

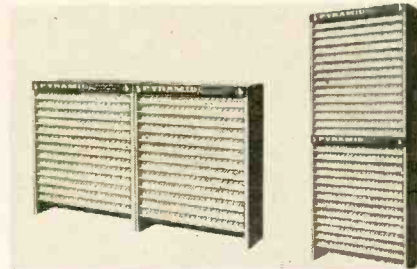

service and self-stocking sales fixture for its capacitors and selenium rectifiers.

P. R. Mallory & Co., Indianapolis, Ind., inaugurated a helicopter service to provide fast delivery on rush orders of disc ceramic capacitors made in the Chicago plant of Radio Materials Co., a

UNEXCELLED PERFORMANCE IN LESS THAN 2 HOURS



NEW Ultra-Linear II AMPLIFIER

World-famous circuit in an easy-to-assemble kit

ENTIRE CIRCUIT including all tubes, filter capacitors, and resistors pre-assembled on an extra heavy printed circuit board . . . built and pretested by Acro.

COMPLETE AMPLIFIER assembled in less than two hours.

OUTPUT and POWER TRANSFORMERS specially designed and built by Acro for the Ultra-Linear II circuit.

NEW HYBRID FEEDBACK provides realistic amplification that insures unequalled stability and excellent square wave response on all types of output loads.

PRICE \$79.50 complete with all components. \$109.50 wired and assembled (slightly higher in West).

60 WATTS continuous output, instantaneous peak power of 120 watts.

EFFECTIVE DAMPING CONTROL variable between 0.5 and 10 for optimum speaker match . . . does not change volume, may be switched out for fixed damping factor of 15.

IM DISTORTION less than 1% at 60 watts.

HARMONIC DISTORTION less than 1% between 20 CPS and 20 KC at power output within 1 DB of 60 watts.

OUTPUT TUBES EL-34 or 6CA7. Simple bias adjustment permits use of 6550 or KT88's.

Stereo-Philes! Two for the price of one. Assemble a pair of high quality Ultra-Linear II kits for less than the cost of a comparable factory-built amplifier.

Please send literature on

- Ultra-Linear II amplifier
- Complete Acro line of high quality output transformers.

Name

Address

City State

ACRO PRODUCTS COMPANY
369 SHURS LANE, PHILADELPHIA 28, PA.

HAVE A HOBBY HOLIDAY!

It's Summer—relax and enjoy it. Four Gernsback Library books show you how to ease tension, forget phobias, calm your nerves—and have a heck of a lot of fun with electronic doodling. Shuffle—don't run to your nearest distributor and start on the road to hobbiness now!

ELECTRONIC HOBBYISTS' HANDBOOK -- Rufus P. Turner

93 different circuits to have fun with (many transistorized). Amplifiers—oscillators—power supplies—communications equipment—control and photo electronic devices—you can make them all. They've all been tested—and they all work. Honest! No. 69. 160 pages. \$2.50.

RADIO-CONTROL HANDBOOK Howard G. McEntee

This radio pioneer and hobby expert lays out a step-by-step guide to making radio controlled planes, boats, trains. Touches all the bases—transmitters, receivers, motors, etc. Emphasizes the how rather than the why. No. 53—192 pages. \$2.25.

SEE YOUR DISTRIBUTOR OR USE THIS COUPON

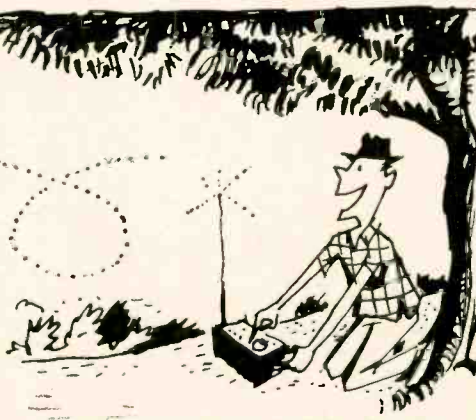

ELECTRONIC PUZZLES AND GAMES

This new book is more fun than a circus! Shows you how to make 20 games—from a simple knife switch puzzle to a complex horse race game. Use only simple tools and materials. Ideal for a beginner. Fun for the expert. No. 70. 128 pages. \$1.95.

MODEL CONTROL BY RADIO

Edward L. Safford, Jr.

The author's a guided missile expert and winner of many R/C model meets. He teaches you practice—and theory. Coders, decoders, control systems, troubleshooting—everything. And what a bargain! No. 43. 112 pages, \$1.00.

PAPER COVER EDITIONS

Gernsback Library, Inc., Dept. 88
154 West 14th St.
New York, N.Y.

Please send me the books checked below postpaid. My remittance of _____ is enclosed.

Name 70 69 53 43
Street _____ please print
City _____ Zone _____ State _____

STAN-BURN

CATHODE RAY TUBE SPECIALS ONE YEAR GUARANTEE

G.E.	Type	STAN-BURN	G.E.	Type	STAN-BURN
\$15.80	10BP4	\$10.00	24.75	17LP4	\$18.00
19.10	12LP4A	13.95	37.00	19AP4A	24.00
11.50	12QP4	11.50	28.35	12CP4A	18.95
20.35	12UP4	15.00	33.60	20CP4B	21.95
20.75	14CP4	13.75	36.00	21AP4	25.00
15.00	15DP4	14.50	29.75	21EP4	20.15
33.75	16AP4	18.50	34.85	21EP4B	23.15
32.20	16DP4A	15.25	30.90	21FP4	21.15
33.75	16GP4	18.75	37.00	21MP4	26.25
23.50	16KP4	15.75	29.75	21YP4	22.00
28.40	16KP4A	18.75	34.85	21YP4A	25.00
31.50	16LP4A	16.25	28.30	21ZP4	21.00
31.50	16WP4	16.25	33.60	21ZP4B	24.00
23.50	17BP4	15.75	100.00	24AP4	56.00
28.40	17BP4B	16.75			
30.75	17CP4	20.50	48.40	24CP4A	38.00
33.90	17GP4	21.50	50.00	24DP4A	39.00

*ALUMINIZED—INQUIRE FOR ANY TUBE TYPE NOT LISTED. STAN-BURN CRT TUBES RCA LICENSED—MFD. BY LINCOLN. All orders of 6 or more STAN-BURN CRT are subject to additional 10% discount. TERMS: REMITTANCE IN FULL.

WHY PAY MORE?

HI-FI COMPONENTS • KITS
RECORD PLAYERS • TAPE RECORDERS • TUNERS
AMPLIFIERS • SPEAKERS
ELECTRONIC PARTS & TUBES • Etc.

Top brand nationally adv. merchandise in plastic and other Radio & TV mags. 14 years at low, low cost. Send us your list. Give Mfr's name and Model No. of item. Write for '58 catalogs to Dept. RE-8 today.



SETCHELL-CARLSON PORTABLE TELEVISION

WITH 17" ALUMINIZED PICTURE TUBE. POWER TRANSFORMER OPERATED. UNITIZED CHASSIS. TOP TUNING. RAZOR SHARP PICTURES. Has light

weight aluminum chassis covered with colorful plastic coated fabric, styled and designed for the finest, modern indoor and outdoor viewing. Write for dealer price sheet and literature.

HI-FI DIAMOND NEEDLES—1 Yr. Guar.
Diamond needles reduce record wear and needle noise thus retaining full frequency response and tonal qualities of your records for a longer period of time.
SINGLE DIAMOND needle . . . \$4.95
DIAMOND SAPP dual needle . . . \$5.95
Shipment PPD. (specify cartridge make)

RECORD CHANGERS

- MONARCH Model UABU 4 SPEED \$19.95
- INTERMIX CHANGER less cartridge . . .
- VM 4 SPEED HI-FI CHANGER—Model 1210 with Ronette or Astatic flip-over cartridge . . . \$22.95
- WBCOR 4 SPEED CHANGER with turn-over cartridge . . . \$23.95
- RONETTE (phono fluid) cartridge flip-over type . . . \$2.98
- SONOTONE cartridge, flip-over . . . \$2.98
- 45 RPM SPINDLE for V.M. or Monarch . . . \$1.98
- WOOD MOUNTING BASE for V.M. or Monarch . . . \$3.95
- MOUNTING BOARD unfinished for V.M. or Monarch . . . \$1.50
- NEW GENERAL ELECTRIC HI-FI VARIABLE RELUCTANCE CARTRIDGE. Replaces discontinued RPX050 type. Full range reproduction 20-20,000 cycles. Four gram tracking force for minimum record and stylus wear.
- 4G050—Dual Sapphire needles . . . \$8.77
- 4G052—Diamond, Sapphire needles . . . \$18.99
- COLLARO TC-340 4 speed changer . . . \$36.75
- COLLARO RC-440 4 speed changer . . . 40.67
- COLLARO TC-540 4 speed changer . . . 45.57
- GARRARD RC-88 4 speed changer . . . 53.41
- GARRARD RC-98 4 speed changer . . . 66.15

FREE wood mounting base, record wiping cloth and 45 RPM spindle with all orders for Collaro and Garrard changers, with this ad.

KITS!

We stock the following manufacturers complete line of Kits—see reference pages.
EICO see pages 23-24
QUALITY see page 102
PRECISE
BOGEN
ACRO see page 113
All domestic orders will be shipped prepaid. Send us your list. Order by Mfr. and Model No. of item.

\$20 WORTH OF ELECTRONIC PARTS IN GRAB-BAG consisting of: Porcelain sockets, coils, speaker, transistors, resist. cond. ONLY . . . \$1.98 (plus 50c postage)

YOU NAME IT—WE HAVE IT

Complete line of T.V. & Radio receiving tubes, coils, controls, antennas & accessories—No Minimum Order—DEALER DISCOUNTS! Thousands of satisfied Hi-Fi enthusiasts and dealers will attest that STAN-BURN GIVES THE BEST DEAL POSSIBLE!
EXPORT INQUIRIES AND OFFERS INVITED.
Terms: 20% with order. Balance C.O.D. All prices F.O.B. NEW YORK Warehouse.
Write for our latest price list and Hi-Fi Catalog RE-8. All Prices Subject to Change Without Notice.

STAN-BURN RADIO and ELECTRONICS CO.
558 CONEY ISLAND AVE. • B'KLYN 18, N. Y.

BUSINESS AND PEOPLE (Continued)



division. In the photo J. Earl Templeton (left), manager of the Mallory Distributor Div., accepts the first shipment from Robert Merritt, sales manager of RMC. Pilot George Snyder looks on. The helicopter was pressed into service for the local telecast of the 500-mile auto race at the Indianapolis Speedway on Memorial Day. Highlights of the race were filmed and presented over WLW-I, Indianapolis, minutes after they happened.

ORRadio Industries president, J. Herbert Orr, is shown presenting sales awards to Preston Mack (right) of Kaelber & Mack and to John T. Stinson,



WALSCO
FIRST NEW PUNCH DEVELOPMENT IN 20 YEARS... OBSOLETES EVERY OTHER PUNCH NOW ON THE MARKET

"L.T." LOW TORQUE CHASSIS PUNCH

CUTS a cleaner hole with 50% less effort!

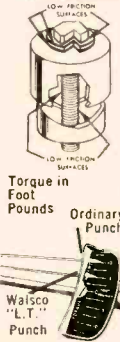

A brand-new electro-coating process (which can't wear off) reduces friction, thus lowers torque. You get a much cleaner hole with much less effort. The WalSCO "L.T." Chassis Punch requires no lubrication of any kind and will give perfect service almost indefinitely. Available in a wide variety of sizes, round, square, key and D shapes.

Full information on these extra-easy to use "L.T." punches is available from your WalSCO distributor or by writing direct to WalSCO.

WALSCO ELECTRONICS MFG. CO.
A Division of Textron Inc.

West Coast Plant: Los Angeles 18, California
Main Plant: 110 WEST GREEN STREET
ROCKFORD, ILLINOIS, U.S.A.

top ranking sales reps. for Irish Brand tape. Kaelber & Mack won top honors and Stinson was third. Second award went to Nickerson-Grey & Assocs. ORRadio also announced the offer of sales aids to its dealers tying in with an advertising campaign in *Life Magazine*.

Sarkes Tarzian Rectifier Div., Bloomington, Ind., developed a new

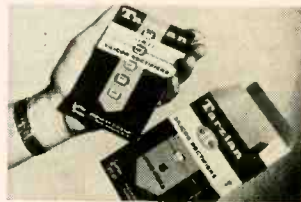

packaging program for its Series K silicon rectifiers. The pocket-size match-book style container holds five replacement rectifiers.

R-Columbia Products Co., Inc., Highwood, Ill., is promoting its Humi-Kup



weatherproof two-set TV coupler with a self-merchandising package and display stand. END

CRYSTAL CONTROLLED CONVERTERS

POLICE • FIRE • COMMERCIAL



- ✓ Precision—Stability
- ✓ Sensitivity
- ✓ Easy Installation

\$32.50

• A compact converter supplied with commercial tolerance crystals, self contained automatic noise limiter. Also models with squeelch. Ideal for mobile or home use.

TUNERS

Enjoy FM Programs While You Drive.

- FM BROADCAST
- 30-50 MC
- 108-176 MC

from \$22.50



WRITE FOR LITERATURE

KUHN ELECTRONICS
20 GLENWOOD CINCINNATI 17, OHIO

BOOK MANUSCRIPTS CONSIDERED

by cooperative publisher who offers authors early publication, higher royalty, national distribution, and beautifully designed books. All subjects welcomed. Write, or send your MS directly.

GREENWICH BOOK PUBLISHERS, INC.
Attn. MR. IMMS 489 FIFTH AVE.
NEW YORK 17, N. Y.

TAPE RECORDERS

HI FI COMPONENTS
Tapes—Accessories
UNUSUAL VALUES
Send for Free Catalog
DRESSNER
69-02 RE; 174 St.
Flushing 65, N.Y.

MERITAPE
Low Cost. High Quality Record-
ing Tape—in boxes or cans.

technical Literature



Any or all of these catalogs, bulletins, or periodicals are available to you on request direct to the manufacturers, whose addresses are listed at the end of each item. Use your letter-head—do not use postcards. To facilitate identification, mention the issue and page of RADIO-ELECTRONICS on which the item appears. UNLESS OTHERWISE STATED, ALL ITEMS ARE GRATIS. ALL LITERATURE OFFERS ARE VOID AFTER SIX MONTHS.

TRANSISTOR CIRCUITS, complete with schematics and parts lists, are supplied on a single handy sheet. Included are 4- and 6-transistor superheterodyne radio receivers, a 3-transistor solar battery reflex receiver, and many circuits.—Lafayette Radio, Dept. ST-93, 165-08 Liberty Ave., Jamaica 33, N. Y.

COMMUNICATION EQUIPMENT details and characteristics are presented in a new 56-page 1958 *General Catalog*. Among the wide variety of products listed are airborne communication, control, instrumentation and navigation gear; ground VOR; amateur, broadcast, single-sideband, microwave and

trans-horizon scatter equipment.—Collins Radio Co., Cedar Rapids, Iowa.

ELECTRONIC COMPONENTS CATALOG No. 59 contains 36 pages of descriptions of rf chokes, line filters, AM coil kits, if transformers, line filter chokes, industrial coils, etc., with table of exact replacements by manufacturer's part number.—J. W. Miller Co., 5917 S. Main St., Los Angeles 3, Calif.

RECORD THE SATELLITES. A 12-page booklet, *You Can Record the Satellites*, tells with text, graphs and schematics how to receive, record and interpret the radio signals from US satellites, and how your recordings may provide valuable assistance in IGY space research.—Audio Devices, Inc., 444 Madison Ave., New York 22, N. Y. 10c. Free from Audiotape dealers.

DYNAMOTOR POWER SUPPLIES for dc-to-dc applications are contained in a colorful 28-page booklet. Detailed specifications for many types of units are presented. 1958 *catalog 158*.—Carter Motor Co., 2711 W. George St., Chicago.

INSIDE HIGH FIDELITY is an attractively illustrated 16-page booklet telling, in layman's language, just what hi fi is all about. It's *Form No. AD-1063*.—Sylvania Electric Products, Inc., Home Electronics Div., 700 Ellicott St., Batavia, N. Y.

SILICON RECTIFIER HANDBOOK. *Catalog No. 67* deals with this manufacturer's line of silicon rectifiers. Theory

It pays to SPECIALIZE!

Let these Rinehart how-to-do-it books train you for good pay in specialized fields

These famous Rinehart books are complete, easy to understand, fully authentic. Start your training with them at home today for more interesting work and bigger pay.

HOW TO GET THE MOST OUT OF HIGH FIDELITY



1 **HIGH FIDELITY TECHNIQUES** by John H. Newitt is a 494-page guide for hobbyists, servicemen and custom builders. Shows how to get better hi-fi results at less cost; how to service hi-fi; compares different techniques and methods and is crammed full of construction tips and ideas. 203 illustrations. Price \$7.50.

Get top notch hi-fi results at minimum cost!

BE AN EXPERT ON MAGNETIC RECORDING



2 **MAGNETIC RECORDING** by S. J. Regun covers every phase of wire and tape recording equipment, components, measurements and application—from high fidelity work to broadcasting, from movies to industrial installations, secret communications and all the rest. 146 illustrations help make every step absolutely clear. Price \$5.00.

REPAIR ANY HOME ELECTRICAL APPLIANCE



3 This 370-page Rinehart **ELECTRICAL APPLIANCE SERVICE MANUAL** brings you complete, easy repair instructions for practically every appliance used in modern homes. Even includes appliance refinishing methods. Gives you the "know how" to add a profitable sideline to your radio-TV service . . . or to build a full-time appliance repair business. Price \$5.00.

LEARN TO FIX OR REWIND ANY ELECTRIC MOTOR



4 Train for something really different! This giant 560-page **ELECTRIC MOTOR REPAIR** guide opens a fascinating big pay field, even to beginners. Covers all repairs PLUS complete rewinding of practically every AC or DC motor or generator . . . also motor controls. Approved by instructors, repair specialists and unions. Price \$6.95.

Over 100,000 copies in use!

LEARN TO USE INSTRUMENTS BETTER AND FASTER!



5 **BASIC ELECTRONIC TEST INSTRUMENTS** helps you work better and faster on service jobs. Shows how to put old instruments to new uses; teaches you to interpret readings, etc. A complete, fully understandable instrument training course. Explains over 60 instruments including the latest types . . . outlines work-saving shortcuts. 254 pages. Price \$4.95.

STUDY 10 DAYS FREE!

Dept. RE-88, RINEHART & CO., Inc., 232 Madison Ave., New York 16, N. Y.

Send following book or books for 10-DAY FREE EXAMINATION. (Circle the books you want):

1 2 3 4 5
In 10 days, I will either remit price indicated above for each book (plus postage) or return book to you and owe nothing. (SAVE! Send cash with order and we pay postage. Same 10 day return privilege with money refunded.)

Name.....
Address.....
City, Zone, State.....
OUTSIDE U.S.A.—Add 50c for each book to cover handling. Cash with order. Money refunded if you return books in 10 days.

LOOKING FOR VALUE?

...in high fidelity



LOOK FOR

University

UNIVERSITY LOUDSPEAKERS, INC., WHITE PLAINS, N. Y.

GET INTO ONE OF THESE TOP OPPORTUNITY FIELDS

ELECTRICITY - Electronics or TELEVISION - Radio-Color TV

TRAIN IN THE GREAT SHOPS OF

COYNE

OLDEST, BEST EQUIPPED SCHOOL OF ITS KIND IN U. S.

Veterans and Non-Veterans—Prepare for a better job NOW that offers a real future, too! Get practical training in TELEVISION—RADIO—ELECTRICITY—ELECTRONICS—(Refrigeration & Electric Appliance Repair can be included). Learn on real equipment—no advanced education or previous experience needed. Lifetime employment service to graduates.

Finance Plan—enroll now, pay most of tuition later. Part time employment help to students.

FREE BOOK Clip coupon for Big Free Illustrated Book. No salesman will call. Act NOW.

B. W. COOKE, JR., FOUNDED 1899
President

COYNE ELECTRICAL SCHOOL
A TECHNICAL TRADE INSTITUTE OPERATED NOT FOR PROFIT
500 S. PAULINA ST., CHICAGO, Dept. CE-5C
ELECTRICITY • TELEVISION • RADIO • REFRIGERATION • ELECTRONICS

B. W. COOKE, JR., Pres., COYNE ELECTRICAL School
500 S. Paulina St., Chicago 12, Ill., Dept. CE-5C

Send FREE BOOK and details on:
 TELEVISION-RADIO
 ELECTRICITY-ELECTRONICS

NAME.....
ADDRESS.....
CITY.....STATE.....

"TAB" Tubes Tested, Inspected, Boxed
New and used Gov't & Mfrs.

Surplus! 6 Mos. Guarantee No Rejects

Orders \$10 or more. Receive only types only ypd, 48 states

0A2	.80	6B16	.72	12A7E	.59	11723	.69
0B2	.72	6B17	.99	12A77	.89	11726	1.10
0C3	.84	6B17L	1.95	12AUG	.63	2C51	2.65
0D3	.80	6B18	1.08	12AU7	.69	2D21	.68
0Z4	.50	6BQ6	.19	12AX7	.77	3D23	5.00
1A7	1.00	6BZ7	1.25	12BA6	.65	717A	5.51
1B3	.78	6C4	.49	12BA7	.99	4-125	29.00
1B5	.78	6C5	.69	12BE6	.59	4-225	19.00
154	.78	6CB6	.80	12BE7	.59	4E27	7.00
174	.78	6CDB	1.49	12BF6	.59	4PR60	29.50
1U4	.59	6H6	.59	12BH7	1.00	4X15	35.00
1U5	.89	6J5	.59	12BY7	1.00	4X250	35.00
1X2A	.68	6J6	.59	12C7	.99	4X500	38.00
304	.99	6K6	.59	12CU6	1.45	5BP1	3.99
3Q5	.86	6K7	.79	12DA7	.69	5B4	1.98
354	.68	6L6	1.19	12EG7	.89	35T	4.00
3V4	.99	6L7	.59	12G7	.79	100T	7.00
5R4	1.25	6S8	.99	12SH7	.89	100T	7.00
5V4	.59	6SA7	.69	12SK7	.75	388A	1.00
5V5	.89	6SB7	1.19	12SQ7	.69	418A	14.00
5Y4	.59	6SC7	.59	12SW7	2.15	450T	43.00
6AB4	.59	6SG7	.79	19T8	1.16	807	1.10
6AC7	.79	6SH7	.69	25B06	1.39	808	1.00
6AG7	.89	6S17	.69	25L7	1.29	810	1.00
6AH6	.99	6SK7	.72	25W4	.77	810	10.00
6AK5	.69	6SL7	.89	25Z5	.72	811	3.00
6AL5	.59	6SN7	2.15	EL34	3.49	812	3.00
6AQ5	.66	6SQ7	.74	EL37	2.49	813	9.00
6AS7	3.00	6SR7	.79	EL37	2.49	814	2.45
6AT6	.49	6TB	.98	35L6	.59	815	2.50
6AU4	1.29	6U8	.98	35W4	.52	829B	8.00
6AU5	1.19	6V6	1.39	35Y4	.69	832A	7.00
6AU6	.79	6V4	.79	35Z5	.89	866A	1.60
6AX4	.89	6V5	.89	35Z5	.69	866B	4.00
6BA6	.59	6X4	.39	50B5	.69	5879	1.20
6BA7	1.00	6X5	.49	50C5	.69	5881	2.70
6BD6	.69	6V6	.89	6V6	.69	6550	3.90
6BE6	.59	7N7	.89	KT66	3.99	842	1.25
6BG6	1.50	12AL5	.59	75	.89	564	1.00
6BH6	.79	2A05	.75	80	.59	5894	14.00

Write for Complete Tube List! Discounts to Qty. Buyers
TUBES WANTED! WE BUY! SELL & TRADE!

NEW "TEKSEL" SELENIUM FULL WAVE BRIDGE RECTIFIERS, ONE YEAR GTD!

CURR.	18VAC	36VAC	72VAC	144VAC
CONT.	14VDC	28VDC	56VDC	118VDC
1AMP	\$ 1.30	\$ 2.00	\$ 4.00	\$ 9.45
2AMP	2.15	3.00	6.25	12.30
3AMP	2.90	4.00	8.50	16.75
6AMP	4.15	8.00	16.75	32.00
10AMP	6.10	12.15	26.30	48.80
15AMP	8.10	19.00	40.00	66.60
24AMP	13.00	25.45	57.50	108.45

NEW GTD: RADIO & T.V. RECTIFIERS

35MA 40¢ @ 6 for \$2; 65MA 45¢ @ 6 for \$2;
75MA 49¢ @ 5 for \$2; 100MA 59¢ @ 6 for \$3;
150MA 70¢ @ 5 for \$3; 200MA 79¢ @ 5 for \$3;
300MA 88¢ @ 5 for \$4; 350MA \$1.00 @ 8 for \$7;
400MA \$1.10 @ 5 for \$5; 500MA \$1.35 @ 4 for \$5;
65MA/260V \$1.10 @ 5 for \$5; 100MA \$1.25 @ 5 for \$5;
@ 9 \$10; 100MA/156V 95¢ @ 300MA/156V
\$1.75, 3/55. Order \$10, Postpaid 48 States!

NEW SILICON 500MA/100°C/280VAC/400p.i.v. Rectifier Kit \$1.50

5 for \$6.50, 40 for \$46, 100 for \$100.00.
Order \$10 postpaid 48 states.

HAMS NEW TRANSISTORIZED "TABPAK" D.C. to D.C. Power Supply!!!

Kit or assembled. Filtered. Small in size! Quiet! Light Wgt.! Input 12 to 14VDC. (Low Idle Current.) Output 450 & tap @ 250 VDC at up to 150 ma/65 watts.

"TABPAK" Assembled TR39CB.....\$35
"TABPAK" Kit TR39CK.....\$30

NEW TPSK2 DC POWER for TRANSISTORS!

Transistors! Filtered Power Supply Kit used to power transistor circuits, amplifiers etc. Delivers 12VDC at 2AMPS filtered less than 0.5% ripple or 28VDC at 1A. TPSK2 Kit \$18. TPS2W assembled & wired \$24. 115VAC Inpt Transformer & Full Wave Bridge Rectifier for 12VDC @ 2AMPS. RETRAN KIT RT11.....\$4.50
RT1W Assembled & Wired.....\$8.50
RT2K Kit 12 or 18VDC at 6 AMPS.....\$9.00
RT2W Assembled & Wired.....\$17.75
BCK1 Battery charger kit 1 to 4 amps charges 2-4-6 & 12 volt batteries.....\$9.95

TOROID COMPUTER LOGIC TRANSFORMER

Toroid—Use as gate or counting circuit or logic drive memory device. 3 windings @ 200ma/2 microsecond switching time wound core. "IBM" design, fits 9 pin miniature socket. \$1.50 each. 5 for \$5 postpaid.

DIAMOND PHONO-NEEDLES! Postpaid 48 States! REGISTERED ONE YR. GUARANTEED BY THE MFR!

ALL MAKES 1478 ONE DIAMOND \$6; TWO DIAMONDS \$14; DIAMOND & SAPPHIRE \$18. PLEASE SEND CARTRIDGE NAME & NUMBER

FINEST HI-FI RECORDING TAPE

7200 Ft.—7" Reel **\$1.45** Lots of 3
Money Back Gtd.

Highest quality controlled plastic base tape made by new "Erin" process. Precision coated & slit. Gd. Constant output. Splice Free. Freq. 7 1/2 IPS
40-15KC Oxide Wnd In.
New 1st Quality "Mylar" 2400 Ft.—7" Reel Ferro "Erin" Gloss Process Recording tape—\$4.49, 3/\$12.

KITS! "TAB" THE BEST KITS!

All Kits Contain Most Popular Values & Sizes
Kit 35 Precision Resistors Kit 75 Mica Cond's
Kit 18 Switches Kit 6 Crystal Diodes
Kit 3 Transistor Transf. Kit 8x25 Ft. Hookup Wire
Kit 150 Carbon Resistors Kit 100 Fuses
Kit 42 Panel Lamps Kit 100 Ceramic Cond
Kit 15 Volume Controls Kit 18 Rotary Switches
Kit 36 Tube Sockets Kit 6 Crystals & Holders
Kit 50 Tubular Cond's Kit 65 Inductors & Coils
Kit 500 Lugs & Eyelets Kit 5 Microswitches
Kit 10 Kmit Mica Cond's Kit 40 Insulators
Kit 5 Lbs. Suprise Kit Kit 85 Insulated Resist.
Kit Encapsulation Fluid Kit Kit Twp Knobs
Kit Volume Control Fluid Kit Kit Glycol Cement & Varnish
Kit 35 Power Resistors

BUY 10 KITS GET ONE FREE! EACH KIT 99c

"TAB" TERMS: Money Back Guarantee! Our 14th year. \$2 min order F.O.B. N.Y.C. Add ship charges or for C.O.D. 25¢ Dep. Prices shown subject to change.

111KG LIBERTY ST., N. Y. 6, N. Y. Catalog
Write for PHONE: RECTOR 2-6245

TECHNICAL LITERATURE (Continued)

of operation, manufacturing processes, characteristics and uses are shown.—Sarkes Tarzian Inc., Rectifier Div., 415 N. College Ave., Bloomington, Ind. \$1. Free to Radio-Electronics readers.

TRANSISTOR POWER SUPPLY building and operating instructions are contained in *Bulletin E-279*. The 40-watt unit employs two 2N256 power transistors, operates from a 12-volt battery and is small enough to be held in the palm. It provides two output voltages simultaneously, 450 and 225 volts, has a peak load of 90 watts.—CBS-Hytron Advertising Service, Parker St., Newburyport, Mass.

MINIATURE COMPONENTS. Catalog M-202 has 8 pages of miniature and sub-miniature items, including pushbutton switches, binding posts, test clips and rotary tap switches.—Grayhill Inc., 561 Hillgrove Ave., LaGrange, Ill.

MICROPHONE CATALOG No. 58, 16 pages, describes a complete line of microphones for tape recording, broadcast, public-address and general purposes. American Microphone Mfg. Co., 412 S. Wyman, Rockford, Ill.

CONTINUOUS-LOOP RECORDERS in the *Magne-loop* series are listed in a 4-page folder. Features of 21 basic models—available in single- or dual-speeds as well as 1, 2 and 3 channels—are described. Technical specifications and direct factory prices are furnished.—Amplifier Corp. of America, 398 Broadway, New York 13, N. Y.

OUTPUT TRANSFORMERS. An 8-page brochure features schematics of amplifier and preamp circuits using new *Super-Fidelity* output transformers. Included are suggested modifications of existing amplifiers, as well as circuits of new Dynakit amplifiers.—Dynaco Inc., 617 N. 41 St., Philadelphia 4, Pa.

SUBMINIATURE ELECTROLYTICS in the *Illini SMT* tubular and *SMTU* upright capacitor lines are illustrated and described in a 4-page catalog folder.—Illinois Condenser Co., 1616 N. Throop St., Chicago 22, Ill.

RELIABLE TUBE interchangeability chart, *Publication No. ETI-1572*, lists the essential characteristics of the full line of 34 high-reliability *Five-Star* tubes and the standard miniature prototypes which they can directly replace.—General Electric Receiving Tube Dept., Owensboro, Ky., or G-E tube distributors.

SILICON RECTIFIERS. New line of diffused-junction rectifiers is featured in a 4-page folder. Also described are selenium and copper oxide rectifiers.—Bradley Laboratories Inc., New Haven 11, Conn.

PILOT LIGHTS. The 16-page *Digest of Pilot Lights (Form L-161)* contains data and life-sized illustrations of a wide range of units.—Dialight Corp., 60 Stewart Ave., Brooklyn 37, N. Y.

END

NEW! IMPROVED!
SENCORE
TRC4
TRANSISTOR CHECKER

Another Sencore Time-Saver

America's newest, most popular test instruments

NOW CHECKS:
★ Transistors for opens, shorts, leakage and current gain. Includes new gain test on power transistors.
★ Crystal Diodes checks forward to reverse current ratio on all diodes.
★ Selenium Rectifiers checks forward and reverse currents.

Controls are accurately set for each transistor by referring to replaceable set-up chart on rear. Test leads or socket provides for fast hook-up. See your parts distributor.

ONLY \$17.95
Dealer Net
Cannot become obsolete. Approved by leading manufacturers.

SIMPLE TO OPERATE

by SERVICE INSTRUMENTS CORP.
171 OFFICIAL RD., ADDISON, ILL.

Cut out this ad now for further information

Pure Riee's
OFFICIAL ORDER BOOK
for every TV-Radio service call

CONVENIENT! EASY TO USE!

Simplify your record-keeping with these convenient triplicate forms. They serve as order form, invoice and office record, with spaces for complete information on every job. Separate listings for receiving tubes, picture tubes, parts, serial numbers, labor and tax charges, etc. 75c a book, \$6.50 for money-saving dust-proof box of 10.

In stock at your distributor

ELECTRONIC PUBLISHING CO. INC.
180 North Wacker Drive Chicago 6, Illinois

TV-RADIO SERVICE

Official Order Book

Books



LOW-COST HIGH-QUALITY AMPLIFIER, by P. J. Baxandall. Hiffe & Sons, Ltd., Dorset House, Stamford St., London SE 1, England, 7 1/4 x 10 1/4 inches, 29 pages. 4 shillings postpaid.

This booklet tells how to construct and test a 5-watt hi-fi amplifier. Details include parts layout, schematics, voltages and performance curves. The author even shows how to make the output transformer if desired. Equalization, tone control, preamps and test procedures are also described.

To some, 5 watts may seem too low for good listening. The author cites extensive tests which prove that loud hi-fi listening requires less than 1 watt, while average listening is generally done at 0.1 watt or less.—*IQ*

SOLID STATE PHYSICS, by A. J. Decker. Prentice-Hall, Inc., 70 Fifth Ave., New York 11, N.Y. 6 x 9 inches, 540 pages. \$12.

This is an introductory text progressing from the relatively simple to the complex, requiring an elementary knowledge of atomic physics and some acquaintance with quantum mathematics. Among the aspects of the solid state treated are properties of crystal structures, the electron theory of solids, conductivity of metals and the magnetic properties of solids. Of particular interest are three chapters on semiconductors, including rectifiers and transistors, with special emphasis on silicon and germanium.—*DL*

TUBE TIPS, Vol. I (Nos. 1-12), by Bud Tomer, CBS-Hytron, Danvers, Mass. 6 1/2 x 9 1/4 inches. 50c.

For a long time to come, tubes will remain an important factor in radios and TV receivers. This booklet contains 12 articles on various tube topics, previously issued separately.

Among the subjects are: how to test properly, causes of failure in service, replacement and substitution, avoiding damage during testing, problem tube types, characteristics of a good tube, tube tester characteristics.

Much of the above information is not available elsewhere. All of it is important to electronic technicians.—*IQ*

FUNDAMENTAL PRINCIPLES OF TRANSISTORS, by J. Evans. D. Van Nostrand Co. Inc. 120 Alexander St., Princeton, N. J. 5 1/2 x 8 3/4 inches, 255 pages. \$6.75.

Transistors have become a vital part of the electronics industry and to keep up with the times electronic technicians and engineers must learn how transis-

TELEVISION

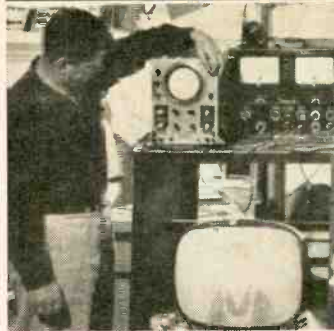

Never before in American history has the need been so great for Trained Engineers and Technicians. No other type of training can compare with actual shop practice you get at Healds under expert instructors.

Bachelor of Science Degree, 27 Months

- Radio-TV Technician including Color TV (12 Months)
- Electronics Technician (12 Months)
- Industrial Electronics Technician (12 Months)
- Electronics Engineering (B.S. Degree)
- Electrical Engineering (B.S. Degree)
- Mechanical Engineering (B.S. Degree)
- Civil Engineering (B.S. Degree)
- Architecture (B.S. Degree)

Heald College ranks **FIRST** West of the Mississippi in "Who's Who in America"

Approved for Veterans
DAY AND EVENING CLASSES

Write for Catalog and Registration Application.
New Term Starting Soon.

**AT HEALDS YOU LEARN
BY DOING IN MODERN
ELECTRONICS LABORATORIES**

**HEALD
ENGINEERING COLLEGE**

Established 1863

Van Ness at Post, RE
San Francisco, Calif.

Your Name

Address

City

State

TAPE RECORDERS
WHOLESALE PRICES
HI-FI COMPONENTS
NATIONAL BRANDS
WRITE FOR FREE CATALOGUE
CARSTON 215-TD E. 88 ST.
NEW YORK 28, N. Y.

LOOK
no further . . . if you're searching for hi-fi savings. Write us your requirements now.
Key Electronics Company
120-A Liberty St., N.Y. 6, N.Y.
TEV 4-6071

For my Money
XCELITE Tools are
the Finest!

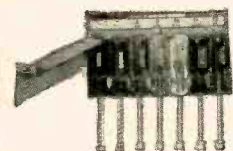

. . . Superbly made and designed for Radio, T.V. and Electronic Technicians. See your Distributor . . . only one quality . . . the finest — whether you choose individual items or the handy kits . . .

Use the Tools the Professionals use!

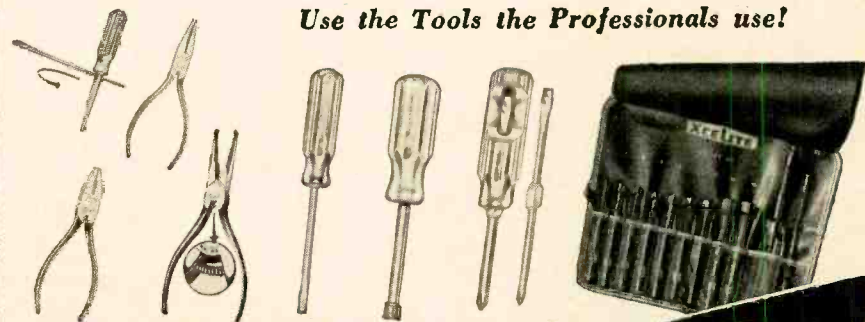

XCELITE, INCORPORATED
ORCHARD PARK, NEW YORK
Canada: Charles W. Pointon, Ltd., Toronto

XCELITE
Quality Hand Tools
PREFERRED BY THE EXPERTS

NOW

H. A. Hartley offers
you a complete practical guide to
audio design. . .



H. A. Hartley
Popular author of articles
in RADIO-ELECTRONICS
and RADIO & TV NEWS.
Hailed on both sides of
the Atlantic as a brilliant
audio engineer.

H. A. Hartley's new book -- AUDIO DESIGN HANDBOOK

saves you the time of wading through masses of technical data to ferret out the core of practical design information you're searching for. He steers you away from the shoals of tricky common mistakes and misconceptions. Hartley shows you how audio design can be done easily and simply! He tells you how to avoid blind alleys by first determining WHAT YOU WANT—and then building within the limits of your own goal. The book covers amplifiers, feedback, power supplies, speakers and enclosures, dividing networks, measurements and testing, plus a few salty personal observations on the wrong directions hi-fi has taken. Easily the most stimulating and helpful book on audio designing ever written!

You can get this deluxe, beautifully-bound \$5 book—the latest addition to the G/L Audio Hi-Fi Book Club—for only \$3.75! Read how you can join the club, get this book and save money.

HOW THE G/L AUDIO HI-FI BOOK CLUB CAN HELP YOU



- Shows you the way to more pleasure in hi-fi if it's your hobby—more profits if it's your profession.
- Offers you the benefits of the knowledge and experience of top writers like Crowhurst, Hartley, Dorf, Marshall and others.
- You can build a complete hi-fi library in easy stages—on the NO-RISK INSPECTION PLAN.
- You SAVE \$1.25–25%—ON EACH BOOK YOU BUY!

HOW TO ENROLL

- Select the book you want on the coupon below.
- SEND NO MONEY NOW—we send you the book on a NO-RISK inspection plan.
- If you like the book you keep it and pay—not the \$5.00 retail price—but the SPECIAL MEMBER'S RATE OF ONLY \$3.75—and we pay postage.
- If you don't want the book, simply send it back—no fuss, no obligation, no high pressure—AND NO SALESMAN WILL CALL.
- You receive a new book on the same NO-RISK INSPECTION PLAN every four months.
- You need take a minimum of only four books during the whole membership period. No time limit—no long term contract. You may cancel anytime after that.

Each book handsomely bound with a deluxe gold-leaf stamped cloth cover.

OTHER BOOKS ALREADY PUBLISHED

Order Audio Design Handbook or any other book.

ELEMENTS OF TAPE RECORDER CIRCUITS

By Herman Burstein and Henry C. Pollak
Answers all the questions a hi-fi fan would ask about tape recorder circuits. Includes a chapter on design for modifying your own equipment.

UNDERSTANDING HI-FI CIRCUITS

By Norman H. Crowhurst
Mr. Hi-Fi himself tells you how to get hi-fi tailored to your own needs. Tells you which type of components to choose for the system you want and can afford.

BASIC AUDIO COURSE — By Donald Carl Hoefler.
Complete coverage of theory and fundamentals from the physics of sound to advanced techniques, including amplifiers, feedback, power supplies, distortion, attenuators, speaker systems, and so much more it is impossible to list all here.

MAINTAINING HI-FI EQUIPMENT — By Joseph Marshall. Now for the first time—learn the techniques necessary to recognize and repair hi-fi troubles. Covers acoustic as well as electronic, electrical and mechanical faults. A must for the professional hi-fi man—or any audiophile who really cares about his hi-fi system.

Other books are in preparation

NO-RISK COUPON

GERNSBACK LIBRARY, Inc., Dept. 88C
154 West 14th St., New York 11, N.Y.

Enroll me in the G/L Audio Hi-Fi Book Club. Begin my membership with the book checked below.

- AUDIO DESIGN HANDBOOK
- UNDERSTANDING HI-FI CIRCUITS
- BASIC AUDIO COURSE
- MAINTAINING HI-FI EQUIPMENT
- ELEMENTS OF TAPE RECORDER CIRCUITS

Name _____
Street _____
City _____ Zone _____ State _____

MAIL THIS
COUPON
TODAY
SEND NO MONEY



BOOKS (Continued)

tors work and how they can be used. This text keeps these problems in mind as it presents a detailed introduction to transistor theory.

Starting with the basic theory of semiconductors—showing the nature of a single crystal, concept of the positive hole and diffusion of minority carriers—the text continues through topics such as the p-n junction, point-contact transistors, the manufacture of transistors, and special types of transistors. In the closing chapter silicon and other materials suited for use in transistors are discussed.—LS

BASIC TELEVISION, Vols. 1-5, by A. Schure. John F. Rider Publisher Inc., 116 W. 14 St., New York 11, N.Y. 6 x 9 inches, 688 pages. \$10.

The technique of "visualization"—at least one illustration for each idea or concept—is heavily relied upon in this course. The first volume deals with the transmitter, the other four with receiver organization and circuitry. The course was developed in 3 years of experimentation in teaching methods and presentation at the New York Technical Institute.—DL

1958 TEST EQUIPMENT ANNUAL Howard W. Sams & Co., Inc., 2201 E. 46 St., Indianapolis 5, Ind. 8½ x 11 inches, 116 pages. \$1.

A new annual publication, this manual has sections dealing with test equipment for color TV, special applications, maintenance, test-equipment methods, measurement analysis, troubleshooting, questions and answers and a product listing section containing specifications of 375 instruments and accessories of 44 major manufacturers.

CALCULUS FOR ELECTRONICS, by A. E. Richmond. McGraw-Hill Book Co., Inc., 330 W. 42 St., New York 36, N.Y. 6 x 9 inches, 407 pages. \$8.25.

Primarily a college text, this book also will prove valuable to technicians, engineers and others with a basic knowledge of algebra and trigonometry. Throughout the volume, each subject is closely related to electronic and electrical applications. An appendix contains all tables needed to work any calculus problem, eliminating any necessity for additional books or tables.—DL

PRINCIPLES OF ELECTRICAL MEASUREMENTS, by H. Buckingham and E. M. Price. Philosophical Library, Inc., 15 E. 40 St., New York 16, N.Y. 5½ x 8½ inches, 600 pages. \$15.

A book for lab technicians, engineers and students of electrical engineering. Treatment is mathematical. This British text describes the construction, operation and utilization of all kinds of meters, bridges, oscilloscopes, vtvm's, etc.

Among measurements discussed are frequency, waveform, peak voltage, core loss, Q, temperature, etc., together with possible errors and corrections. Other topics include instrument transformers, integrating meters, power systems, resonance, magnetic measurements, units and standards.—IQ

END

SCHOOL DIRECTORY

Your choice of school is highly important to your career in



INDUSTRIAL ELECTRONICS



RADIO-TELEVISION



ELECTRONICS COMMUNICATIONS

Become an **ELECTRICAL ENGINEER** or an **ENGINEERING TECHNICIAN** at **MSOE in Milwaukee**

Choose from courses in:

ELECTRICAL ENGINEERING
Bachelor of Science degree in 36 months—
Communications or Electrical Power.

ENGINEERING TECHNOLOGY
Associate in Applied Science degree in 18 months—
Electronics Communications, Electrical Power, or Computers.

MSOE — located in Milwaukee, one of America's largest industrial centers—is a national leader in electronics instruction—with complete facilities, including the latest laboratory equipment, visual aid theater, amateur radio transmitter — offers 93 subjects in electrical engineering, electronics, radio, television, electrical power, and electricity.

Advisory committee of leading industrialists. Courses approved for veterans. Over 50,000 former students. Excellent placement record. Previous educational, military, and practical experience is evaluated for advanced credit.



QUARTERS BEGIN SEPTEMBER, JANUARY, MARCH, JULY

Choose wisely — your future may depend on it. Mail coupon today!

MILWAUKEE SCHOOL OF ENGINEERING

Dept. RE-858, 1057 N. Milwaukee St. Milwaukee, Wis.

Please send free illustrated career booklet (please print)

I'm interested in _____ (Course)

Name _____ Age _____

Address _____

City _____ State _____

I am I am not eligible for veterans benefits

(discharge date)

1 + 2 x 3 does NOT = 9
Don't be held back by lack of math. Learn math from arithmetic through college-level differential and integral calculus by one correspondence course. No previous college or high school math necessary. Above-average intelligence not needed to master the easy to understand lessons on arithmetic, college algebra, trigonometry, analytic geometry, differential, and integral calculus. All that is needed is willingness to work. This course is an excellent review for those who took these subjects long ago. Complete course \$25.00 (no other texts needed) plus few cents postage for mailing lessons to and from school. Start immediately! Work at your rate of speed. Mail check or money order to
MATH A to C 112 No. Fayette St. Alexandria, Va.

CODE SENDING SPEED
RECEIVING SPEED
Be a "key" man. Learn how to send and receive messages in International Morse code. Communicate with operators around the globe. Learn at home quickly through famous Candler System. Used by best operators. Qualify for Amateur or Commercial License. Write for FREE BOOK.
CANDLER SYSTEM CO.
Dpt. 3-J, Box 9226, Denver 20, Colo. USA

ELECTRONICS ENGINEERING DEGREE IN 27 MONTHS
Prepare for unlimited opportunities in electronics!
B.S. degree in 27 months, mathematics, electrical engineering, TV, advanced radio theory and design. Modern labs. Low tuition, earn board. Also Aero., Chemical, Civil, Electrical, Mech., Engineering. B.S. degree in 36 mo. in Math., Chem., Physics. Also prep courses. G.I. appr. 20 bldgs., dorms, gym. Enter Sept., Dec., March, June. Catalog: **INDIANA TECHNICAL COLLEGE**
1588 E. Washington Boulevard, Fort Wayne 2, Indiana

ELECTRONICS
PREPARE FOR A GOOD JOB!
BROADCAST ENGINEER
RADIO SERVICING AUTOMATION
TELEVISION SERVICING
BLACK & WHITE—COLOR
APPROVED FOR VETERANS AND SURVIVORS OF VETERANS
BUILDING AIR CONDITIONED
SEND FOR FREE LITERATURE
BALTIMORE TECHNICAL INSTITUTE
1425 EUTAW PLACE, BALTIMORE 17, MD.

ENGINEERING DEGREES
E.E. Option Electronics or Power
Earned through **HOME STUDY**
Residence Classes Also Available
PACIFIC INTERNATIONAL UNIVERSITY
(Operating as a College of Engineering only at present)
5719-M, Santa Monica Blvd., Hollywood 38, Calif.

ENGINEERING Home Study Courses

COURSES written by world authorities in all branches of engineering. Step-by-step instructions using methods proved successful by thousands of our graduates. One hour each day in your spare time will start you off to higher pay, security, prestige. Check the course you are interested in and we will send you a complete outline of the course with a booklet describing the Institute and our advanced methods of teaching. Send to: Canadian Institute of Science and Technology Ltd., 683 Century Bldg., 412, 5th St. N.W., Wash., D.C.

- | | |
|------------------------------|-------------------|
| Civil Eng. | Electrical Eng. |
| Surveying | Radio |
| Architecture | Electronics |
| Forestry | Television |
| Mining | Aeronautical Eng. |
| Structural | Navigation |
| Mechanical Eng. | General Education |
| Industrial Eng. & Management | Chemical |
| Refrigeration | Mathematics |
| Heating | Journalism |
| Drafting | Accounting |
| Plastics | |

GET INTO ELECTRONICS
V.T.I. training leads to success as technicians, field engineers, specialists in communications, guided missiles, computers, radar and automation. Basic and advanced courses in theory and laboratory. Assoc. degree in electronics in 24 mos. B.S. in electronic engineering obtainable. ECPD accredited. G.I. approved. Graduates in all branches of electronics with major companies. Start September, February. Dorms, campus. High School graduate or equivalent. Catalog: **VALPARAISO TECHNICAL INSTITUTE**
Dept. C Valparaiso, Indiana

college grads get ahead faster!
... have higher incomes ... advance more rapidly. Grasp your chance for a better life. Share rewards awaiting college men. Important firms visit campus regularly to employ Tri-State College graduates. Start any quarter. Approved for Vets.

Bachelor of Science Degree in 27 months
Complete Radio Engineering courses (TV, UHF, FM, Electronics). Also Mechanical, Civil, Electrical, Chemical, Aeronautical Engineering in 36 months a B.S. in Business Administration (General Business, Accounting, Motor Transport Management Majors). Superior students faster. More professional class hours. Small classes. Enrollment limited. Beautiful campus. Well-equipped labs. Prep courses. Enter Sept., Jan., Mar., June. Earnest, capable students (whose time and budget require accelerated courses and modest costs) are invited to write Jean McCarthy, Director of Admissions, for Catalog and "Your Career in Engineering and Commerce."

TRI-STATE COLLEGE
2488 College Avenue, Angola, Indiana

NAME _____
ADDRESS _____
CITY _____ STATE _____
Course Interested In _____
Canadians: Send to Canadian Institute of Science & Technology Limited, 683 Garden Bldg., 263 Adelaide St. West, Toronto, Ont.

KT-500
IN KIT
FORM
74.50

New! Years Ahead!

LAFAYETTE STEREO TUNER KIT

ONLY
\$7.45
DOWN
7.00 MONTHLY



- Use it as a Binaural-Stereophonic FM-AM tuner
- Use it as a Dual-Monaural FM-AM tuner
- Use it as a straight Monaural FM or AM tuner

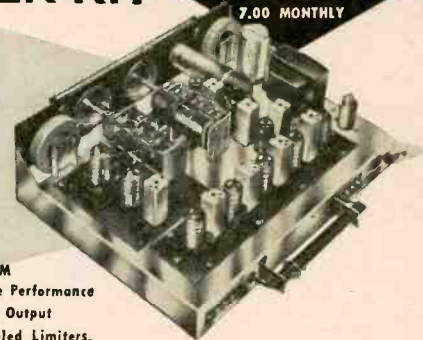

THE MOST FLEXIBLE TUNER EVER DESIGNED

- Multiflex Output for New Stereo FM
- 10KC Whistle Filter
- Pre-aligned IF's
- Tuned Cascode FM
- 11 Tubes (including 4 dual-purpose) + Tuning Eye + Selenium rectifier Provide 17 Tube Performance
- Separately Tuned FM and AM Sections
- 12 Tuned Circuits
- Dual Cathode Follower Output
- Armstrong Circuit with FM/AFC and AFC Defeat
- Dual Double-Tuned Transformer Coupled Limiters.

More than a year of research, planning and engineering went into the making of the Lafayette Stereo Tuner. Its unique flexibility permits the reception of binaural broadcasting (simultaneous transmission on both FM and AM), the independent operation of both the FM and AM sections at the same time, and the ordinary reception of either FM or AM. The AM and FM sections are separately tuned, each with a separate 3-gang tuning condenser, separate flywheel tuning and separate volume control for proper balancing when used for binaural programs. Simplified accurate knife-edge tuning is provided by magic eye which operates independently on FM and AM. Automatic frequency control "locks in" FM signal permanently. Aside from its unique flexibility, this is, above all else, a quality high-fidelity tuner incorporating features found exclusively in the highest priced tuners.

FM specifications include grounded-grid triode low noise front end with triode mixer, double-tuned dual limiters with Foster-Seeley discriminator, less than 1% harmonic distortion, frequency response 20-20,000 cps $\pm 1/2$ db, full 200 kc bandwidth and sensitivity of 2 microvolts for 30 db quieting with full limiting at one microvolt. AM specifications include 3 stages of AVC, 10 kc whistle filter,

built-in ferrite loop antenna, less than 1% harmonic distortion, sensitivity of 5 microvolts, 8-kc bandwidth and frequency response 20-5000 cps ± 3 db.

The 5 controls of the KT-500 are FM Volume, AM Volume, FM Tuning, AM Tuning and 5-position Function Selector Switch. Tastefully styled with gold-brass escutcheon having dark maroon background plus matching maroon knobs with gold inserts. The Lafayette Stereo Tuner was designed with the builder in mind. Two separate printed circuit boards make construction and wiring simple, even for such a complex unit. Complete kit includes all parts and metal cover, a step-by-step instruction manual, schematic and pictorial diagrams. Size is 13 3/4" W x 10 3/8" D x 4 1/2" H. Shpg. wt., 22 lbs.

The new Lafayette Model KT-500 Stereo FM-AM Tuner is a companion piece to the Models KT-300 Audio Control Center Kit and KT-400 70-watt Basic Amplifier Kit and the "Triumvirate" of these 3 units form the heart of a top quality stereo hi-fi system.

KT-500 Net **74.50**
LT-50 Same as above, completely factory wired and tested. Net **124.50**

NEW! LAFAYETTE STEREO/MONAUROAL BASIC POWER AMPLIFIER KIT



- 36-WATT STEREO AMPLIFIER - 18-WATTS EACH CHANNEL
- FOR OPTIONAL USE AS 36-WATT MONAUROAL AMPLIFIER
- EMPLOYS 4 NEW PREMIUM-TYPE 7189 OUTPUT TUBES
- 2 PRINTED CIRCUIT BOARDS FOR NEAT, SIMPLIFIED WIRING
- RESPONSE BETTER THAN 35-30,000 CPS $\pm 1/2$ DB AT 18 WATTS
- LESS THAN 1% HARMONIC OR INTERMODULATION DISTORTION

A superbly-performing basic stereo amplifier, in easy-to-build kit form to save you lots of money and let you get into stereo now at minimum expensel Dual inputs are provided, each with individual volume control, and the unit may be used with a stereo preamplifier, for 2-18 watt stereo channels or, at the flick of a switch, as a fine 36-watt monaural amplifier — or, if desired, it may be used as 2 separate monaural 18-watt amplifiers! CONTROLS include 2 input volume controls, channel Reverse switch (AB-BA), Monaural-Stereo switch. DUAL OUTPUT IMPEDANCES are: 4, 8, 16 and 32 ohms (permitting parallel [monaural] operation of 2 speaker systems of up to 16 ohms. INPUT SENSITIVITY is 0.45 volts per channel for full output. TUBES are 2-6AN8, 4-7189; GZ-34 rectifier. SIZE 9-3/16" d (10-9/16" with controls) x 5 1/4" h x 13 1/4" w. Supplied complete with perforated metal cage, all necessary parts and detailed instructions. Shpg. wt., 22 lbs.

KT-310 Stereo Power Amplifier Kit Net **47.50**

ONLY 4.75 DOWN
5.00 MONTHLY

KT-310

47.50

LAFAYETTE MASTER AUDIO CONTROL CENTER with BINAURAL CHANNEL AND DUAL VOLUME CONTROL.

- Self-Powered
- DC On All Filaments
- 24 Positions of Equalization
- Tape Head Input, High Impedance
- Dual Cathode Follower Output Stages

This is not only the finest hi-fi preamp characterized by unmatched features, but it has been functionally designed to keep pace with the conversion of your present hi-fi system to binaural (stereophonic) sound. Incorporates an extra channel and dual volume control for binaural reproduction. Features include DC on all tube filaments, negative feedback in every stage, dual cathode follower output stages and latest printed circuit construction. Less than 0.09% IM distortion and less than 0.07 harmonic distortion at 1V. Hum and noise level better than 80 db below 3V. Uniformly flat frequency response over entire audible spectrum. 7 inputs for every type of phono, tuner or tape. Tasteful styling, brilliantly executed. Size 12 3/4 x 9 1/2 x 3 3/4". Shpg. wt., 10 1/2 lbs.

KT-300—Lafayette Master Audio Control Kit Complete with cage and detailed assembly instructions. Net **39.50**

LT-30—Same as above completely wired and tested with cage and instruction manual. Net **59.50**

DELUXE 70 WATT BASIC AMPLIFIER

- Conservatively Rated At 70 Watts
 - Inverse Feedback
 - Variable Damping
 - Metered Balance And Bias Adjust Controls
 - Available In Kit and Wired Form
- Here's ultra-stability in a 70 watt basic power amplifier employing highest quality components conservatively rated to insure performance and long life. Features matched pair KT 88's and wire range linear Chicago output transformer, variable damping control, meter for bias and balance and gold finish chassis. Frequency response 10-100,000 cps ± 1 db. Hum and noise 90 db below full output. IM distortion less than 1 1/2% at 70 watts, less than 0.3% below 30 watts. Harmonic distortion less than 2% at 70 watts from 20 to 20,000 cps ± 1 db. Output impedance 4, 8 and 16 ohms. Handsome decorative cage perforated for proper ventilation. Size 14 1/2 x 10 x 7 3/8" including cage and knobs. Shpg. wt., 40 lbs.

KT-400—Lafayette 70 watt Deluxe Basic Amplifier Kit complete with cage and detailed assembly instructions. Net **69.50**

LA-70—Same as above completely wired and tested with cage and instruction manual. Net **94.50**

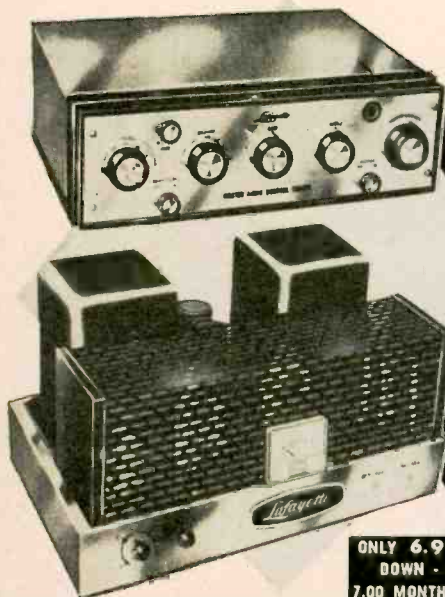

KT-300
IN KIT
FORM
39.50

KT-400
IN KIT
FORM
69.50

ONLY 6.95
DOWN -
7.00 MONTHLY

LAFAYETTE RADIO

DEPT. JH

165-08 Liberty Ave. JAMAICA 33; N. Y.

Write for FREE Bargain Packed Catalog!
PLEASE INCLUDE POSTAGE WITH ORDER

100 SIXTH AVE., NEW YORK, N. Y.
BOSTON, MASS., 110 Federal St.
PLAINFIELD, N. J., 139 West 2nd St.
NEWARK, N. J., 24 Central Ave.
BRONX, N. Y., 542 E. Fordham Rd.

New! LAFAYETTE STEREO FM-AM TUNER

Its Flexibility of Design & Low Budget Price Allow You to Install Stereo Now!



LT-99
72.50
ONLY 7.25 DOWN—
8.00 MONTHLY

For FM-AM Stereo Reception.
For FM or AM Monaural Reception.
For FM Multiplex Reception (Requires Decoder).
For Separate FM & AM Simultaneous Listening
In Different Rooms.

- Separate AM AND FM SECTIONS • INDIVIDUAL PRECISION FLYWHEEL TUNING • 4 FM IF STAGES WITH DISCRIMINATOR • ARMSTRONG FM CIRCUIT • FM RESPONSE 20-20,000 CPS \pm 1 DB • FM SENSITIVITY 3 MICROVOLTS • DRIFT-FREE FM WITH AFC & AFC DEFEAT • OUTPUTS FOR AM/FM MONAURAL, AM & FM STEREO, STEREO OR MONAURAL TAPE RECORDING, FM MULTIPLEX • HANDSOME, MODERN HI-FI STYLING

LAFAYETTE is happy to be able to announce this excellent stereo tuner with its many outstanding features; its low cost and high degree of flexibility combine to make it practicable to enjoy stereo FM/AM broadcasts NOW without fear of obsolescence. **SPECIFICATIONS:** Sensitivity — FM 3 microvolts for 20 db quieting; AM 75 microvolts loop sensitivity. Selectivity — FM 200 kc. bandwidth at 6 db down; AM 7 kc. at 6 db down. Frequency Response — FM 20-20,000 cps \pm 1 db; AM 20-5,000 cps \pm 2 db. Output Voltages — FM 2 1/2 volts for 100% modulation; AM 1 volt average. Hum — 70 db below 1 volt. Output Jacks — AM/FM Monaural, AM Stereo, AM Tape Recording, FM Tape/Multiplex. Controls

— Stereo-Monaural Switch, Selector Switch (AM, FM-AFC, FM, Off), AM Tuning, FM Tuning, Multiplex-Tape Switch (rear panel). Built-in FM and AM Antennas: with provision for connecting external antennas. Tubes — 6BE6, 2-6BA6, 6U8, 12AT7, 6AU6, 6AL5; diode AM detector, selenium rectifier. Auxiliary AC Outlet. For 105-120 volts, 50/60 cps AC. Size — 8 1/2" d. (10 1/2" including knobs and ferrite loop) x 13-5/16" w x 4 1/4" h (add 3/8" for rubber feet). Shipping Weight — 16 1/2 lbs.

LAFAYETTE LT-99 Stereo Tuner Net 72.50

NEW! VOLUME UNIT (VU) METER

- MINIATURE PANEL METER, ONLY 1 1/2" SQUARE • 2% ACCURACY
- INDICATES OUTPUT LEVEL WITH COMPLEX AUDIO WAVEFORMS
- STANDARD VU METER DAMPING

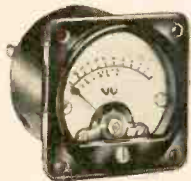

3.95

Volume level indicator, calibrated in standard -20 to +3VU and 0-100% ranges. Uses precision carbon film multiplier resistor and full-wave rectifier. Damped in accordance with standard VU meter requirements for faithful indications of actual sound levels. 0-100% scale used to indicate percent use of amplifier output or percentage of correct tape recorder recording level without referring to VU scale. 1 1/4" dial face, silvered dial, black numerals and pointer. Requires only 1 1/2" diam. panel hole for mounting. Clear optical glass front. Shpg. wt., 8 oz.

TM-10 Net 3.95

NEW! PROFESSIONAL-TYPE VU METER WITH ILLUMINATED SCALE

- JEWELLED BEARINGS • 2% ACCURACY
- MEETS ACCEPTED VU METER SPECIFICATIONS

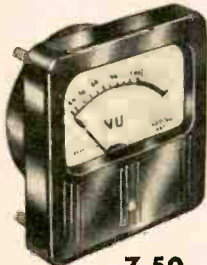

7.50

A high-quality precision built unit, only 3 1/8" square, 2-5/16" x 1 3/8" silvered dial face, 1-11/16" overall depth. Black pointer, highly legible black calibrations. Clear optical glass front. "B" scale, has 0-100% on upper scale, -20 to +3 VU on lower scale. Reads 99% of applied VU in 0.3 secs., with overshoot between 1-1 1/2%. Calibrated for 0 VU when 1.228 volts sine wave AC applied through external 3600 ohm series resistor from a 600 ohm source with 600 ohm load. 6-8 volt scale illuminating lamp. Shpg. wt., 1 lb.

TM-80 Net 7.50

Nationally Advertised

4-SPEED AUTOMATIC RECORD CHANGER

39.50 Reg. 50.50

with NEW G.E. TURNOVER CARTRIDGE VRII and GENUINE G.E. DIAMOND SAPPHIRE SYTLI



NOT A CLOSEOUT—NOT A DISCONTINUED Model. This is a nationally advertised, latest model record changer, with new GE VRII Series Triple Play Cartridge with G. E. Genuine diamond and sapphire stylus and is priced so low that we DARE NOT mention the manufacturer's name. This fully automatic record changer has exclusive and deluxe features for the finest hi-fi systems, such as automatic intermix, muling switch, click filter and automatic shut-off after last record. Heavy duty 4-pole shaded pole motor with heavy rim-weighted turntable. 4 speeds, 78, 45, 33 1/3, 16-2/3 RPM. Negligible wow and flutter. We are so confident that you will be happy with this purchase, that if for any reason you do not feel you have received an exceptional value, we shall cheerfully refund your purchase price. Size 12 1/4" x 13 3/4", requiring 1 1/16" clearance above and 2-11/16" below motorboard. Shpg. wt., 21 lbs.

PK-250 RECORD CHANGER (less woodbase) with NEW GE 4G-052 Diamond Sapphire Cartridge Net 39.50

MAHOGANY OR BLONDE WOODBASE CUT TO FIT ABOVE

PK-111—Specify Finish, Shpg. wt., 5 lbs. Net 3.95

NEW MINIATURE HIGH SENSITIVITY MULTITESTER

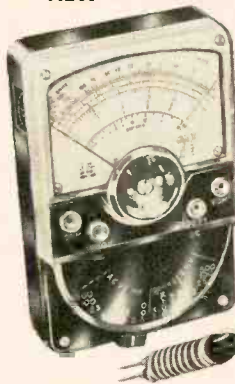

22.50

- 20,000 OHMS PER VOLT DC
- 10,000 OHMS PER VOLT AC
- CLEAR PLASTIC FACE COVER
- WEIGHS ONLY 10 OZ.
- 23 MOST-USED RANGES
- SELECTOR SWITCH WITH POSITIVE, FAST RANGE SETTINGS

A terrific buy in a hand-held, compact, light, accurate, completely wired instrument. Has a 38 μ A movement, 1% precision resistors and simple selector switch with calibration markings protected against wear. Scales: Volts DC and AC; 0-5, 25, 100, 500, 1000; Ohms: 0-6K-600K — 6 Meg — 60 Meg. DC Current: 0-50 μ A — 5-50-500 MA; Decibels — -20 to +64 in 5 ranges. Size 4 1/2" x 2 7/8" x 1 1/4". Shpg. wt., 1 lb. Complete with batteries and test leads. Imported to save you money.

AR-660 Miniature Meter Net 22.50

New! Lafayette 4-SPEED PROFESSIONAL TRANSCRIPTION PLAYER WITH 3 LB. 12" ALUMINUM TURNTABLE



PK-240
ONLY
37.50

- IDEALLY SUITED FOR STEREO! • BETTER THAN -50 DB RUMBLE & NOISE
- VIBRATIONLESS MOTOR SUSPENSION
- BELOW 0.2% WOW & FLUTTER • MAGNETIC EDDY-CURRENT BRAKE • 3 LB. 12" BALANCED & MACHINED ALUMINUM TURNTABLE • SPEED CONTROL FOR \pm 10% VARIATION OF EACH SPEED

An amazingly low price for the superior quality embodied in this fine instrument. Features include heavy, rim-weighted, 3 lb. machined-aluminum 12" turntable, magnetic brake with speed control for \pm 10% variation of each speed; the extremely low noise and rumble figure of -50 db below average recorded level; wow and flutter (speed variations) of less than 0.2%; new-type oversize precision-ground idler with special lubrication features; positive-locking detents on 4-speed single-knob speed selector; ("off" positions between all speed positions; free-floating shock-mounted motor; automatic idler disengagement in "off" positions; precision spindle turns on single ball bearing; heavy duty 4-pole induction motor. Heavy rubber turntable mat. For 105-120 volts, 60 spc AC; draws 0.13 amperes. Size of motor plate 11" x 10" x 1 1/2"; requires 4" below motor board, 1 1/2" above. Complete with stroboscope disc, 45 rpm adapter, AC line cord. Shpg. wt., 14 lbs.

PK-240 12" TRANSCRIPTION TURNTABLE Net 37.50

LAFAYETTES SPECIAL-VALUE COMBINATION

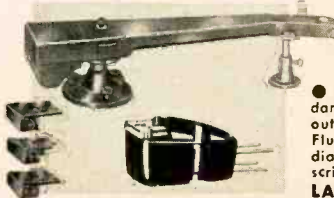

- Lafayette Model PK-170 "16" viscous-damped transcription arm, equipped with the outstanding new Pickering Model 371D Stereo Fluxvalve magnetic cartridge with 0.7 mil diamond stylus, and the Model PK-240 transcription turntable.

LAFAYETTE SPECIAL! Net 79.95

LAFAYETTE RADIO

DEPT JH

JAMAICA 33; N. Y. 165-08 Liberty Ave. Write for FREE Bargain Packed Catalog!

100 SIXTH AVE., NEW YORK, N. Y.
BOSTON, MASS., 110 Federal St.
PLAINFIELD, N. J., 139 West 2nd St.
NEWARK, N. J., 24 Central Ave.
BRONX, N. Y., 542 E. Fordham Rd.

HQ for the 5 TOP NAMES in
TV & RECEIVING TYPE

TUBES

AT SENSIBLE PRICES!

WRITE FOR LATEST TUBE CATALOG FREE!

Receiving, transmitting, special purpose tubes, diodes, transistors, etc.

2-COLOR TUBE CARTONS

Keeps your tube stock neat. New safety partition tube breakage. Distinctively lithographed in glossy red and black. The most distinctive tube carton available today. Minimum quantity: 100 of any one size. Write for case lot prices. Packed 1000 to case. F.O.B. N.Y.C.



Size	For Tube	Per 100
Miniature	6AUG, etc.	\$1.00
GT	6SN7, etc.	1.25
Large GT	1B3, etc.	1.50
Large G	5U4G, etc.	2.00

WHITE GLOSSY BOXES

Completely blank. No printing or color. Otherwise same as above. Same high quality, same low prices. Specify "WHITE" when ordering. When color is not stated, 2 color cartons will be shipped.

EQUIPMENT & COMPONENT SPECIALS

- **Cornell-Dubilier Heavy-Duty 12 Volt Power Supply**. C.D. Model No. 3414 Heavy-Duty 300 Volts D.C. Output at 335 MA. Vibrator Supply Units are made with the finest of components and best construction for long trouble-free use. All units are brand new, packed in original Cartons. Units come complete with two CK-1006 Rectifier Tubes and C.D. Vibrator Type 12VF10. Input: 12.6 VD.CS. Output: 300 Volts D.C. at 335 Milliamperes. Size: 8-1/2" High x 13-1/4" Wide x 7-1/2" Deep. Weight: 28 lbs. Sale Price \$19.50.
- **Bud 77" Panel Space Relay Racks**. Standard 19" amateur width—17" deep. Deluxe grey-crackle finish—louvered side panels—top and bottom—back door with double lock—brand new in original wrappings—complete with hardware—shipped knocked-down—F.O.B. N.Y.C. An excellent buy at \$35.00.
- **University Labs 10 Watt Outdoor Loudspeaker**. 8 OHMS—300 to 5000 CPS—Brand New Boxed—with Mounting Bracket and 10 Foot rubber cord and amphenol connector made for Navy—Black Finish—finest construction—Excellent for portable Metaphone Amplifier. \$12.95
- **Portable Microphone, Sound-Powered** (Requires no Batteries) with chest plate and strap. Brand New. Black Finish with On-Off Switch Button—Complete w/25 Foot Rubber Cord & Connector—Finest Navy Construction. New. \$4.75
- **6 Henry—500 MA. Chokes—26 OHMS D.C. Resistance**. New—Open Frame. \$3.95 (3 for \$9) Grey-Commercial Finish.
- **Glas-Line Non Metallic Guy Line**. (Eliminates need for glass "break-up" insulators) Strong, weather resistant, plastic coated spun glass fibers formed a high tensile strength guy cable ideally suited for the heaviest amateur antennas in use today. Extensively used in commercial service too. Guaranteed not to rot, rust, or deteriorate for five years or more. Packed in 600 ft. reels, but sold in any multiple of 100 ft. Glas-Line (Green Only). Per 100 Ft. \$2.30. 600 Ft. Reel \$17.34.
- **B & W Model No. L-1001A Linear Amplifier**. Brand New in Sealed B&W Original Carton. \$240.00.
- **28 Volt—10 Amp. Xmfr-Pri**; 115 vac/60 CPS \$4.50.
- **TS 13 Hand Set Battery Powered**. Type: Made by American Microphone Co. (Original Cost \$17.50) Receiver: 3500 ohms impedance. Transmitter: 50 ohms impedance (200 to 3500 CPS) Both single phenolic housing with switch 68" long cord with 4 conductor rubber-covered cable. Special \$4.50—2 for \$7.00.
- **Prop Pitch Motor**. Desirable medium-size prop-pitch motors approx. 55 lbs. Like new condition. Will handle any size beam, any weight, a brute for force. Cost Uncle Sam \$354.00 ea. Gear Ratio 10,000 to 1. Works on 20 to 30 v AC or DC. Comes with reversible motor attached complete in one unit. Weatherproof—55 lbs. uncrated. Like new, a real buy! Only \$34.50 F.O.B. New York or Atlanta.
- **BC-645 Xmtr Receiver**, 15 Tubes 435 to 500 MC. Can be modified for 2-way communication, voice or code, on ham band 420-450 mc. fixed and mobile 450-460 mc. television experimental 470-500 mc. 15 tubes. 4-7F7, 4-7H7, 2-6F6, 2-2-955 and 1-WE216A. Now covers 460 to 490 mc. Brand new BC-645 with tubes, less power supply in factory carton. Shipping weight 25 lbs. \$29.50. Pe-101C Dynamotor for BC 645, has 12-24V input, sold only with BC-645 (easy to convert for 6V Battery operation) \$7.95. UHF Antenna Assembly, for BC-645 \$5.50; \$2.25; Complete set of 10 Plugs for BC-645 \$5.50; Control Box for above \$2.25. Shock Mount for above \$1.25. Conversion Booklet. Instructions for most useful surplus rigs \$2.50.

Write for New 1958 Green Sheet 25c, listing hundreds of equipment and component specials. All shipments F.O.B. Our Warehouse. Rated firms (Dun & Brad. current F 3 or better) Net 10 Days. 10 day guar. price of midsr. only. All merchandise guaranteed.

HOW TO ORDER: Send full remittance and save C.O.D. collection fee—include sufficient money for postage.—We refund unused amount.—If you desire shipment C.O.D., include 25% deposit.—Send cash by registered mail. Subject to price variation and stock depletion. No C.O.D.'s on tube cartons.

Open Monday to Saturday—Come In and Browse—We are near Prince St./BMT Station—Spring St./IRT Sta.

BARRY ELECTRONICS CORP.

512 Broadway, Dept. RE-4, N.Y. 12, N.Y.
Phone: WAlker 5-7000

ADVERTISING INDEX

Radio-Electronics does not assume responsibility for any errors appearing in the index below.

Acro Products Co.....	113	Lektron Inc.	92
Aerovox Corp.....	14	Madison Fielding	94
Allied Radio Corp.....	13, 87	Mallory (P. R.) & Co., Inc.....	106-107
Almo Radio Co.....	100	Merit Coil & Transformer Corp.....	110
American Microphone Manufacturing Co.....	8	Miss Electronic Distributing Co., Inc.	78-79
Ampex Electronic Corp.....	110	National Radio Institute.....	3
Amphenol Electronics Corp.....	90	National Schools	5
Arkay Inc.....	112	North American Philips Co., Inc. (Norelco)	96
B & K Manufacturing Co.....	91	Northrop Aeronautical Institute	74
Barry Electronics Corp.....	122	Opportunity Adlets	108
Bell Telephone Labs.....	22	Oxford Components Inc.....	96
Blonder-Tongue Labs.....	108-109	Paco Electronics Co., Inc.....	20
Brooks Radio & Television Corp.....	104, 110	Picture Tube Outlet.....	102
CBS-Hytron	74, 89	Pilot Radio Corp.....	98
Capitol Radio Engineering Institute	17, 93	Progressive Edu-Kits Inc.....	103
Carston Studios	117	Quality Electronics	102
Centralab Div. of Globe Union.....	18	RCA Electron Tube Division	Back Cover
Century Electronics Co., Inc.	95, 109	RCA Institutes	81
Cleveland Institute of Radio Electronics	11	Radio Shack Corp.....	99
Colorfax Laboratories, Inc.....	108	Raytheon Manufacturing Co.....	10
Coyne Electrical School 101, 105, 115		Rider (John F.) Inc.....	92
DeRO Electronics	105	Rinehart & Co., Inc.....	115
DeVry Technical Institute.....	9	Sams (Howard W.) & Co., Inc.	15, 83, 111
Dressner	114	Service Instruments Corp.....	96, 112, 116
Dynaco Inc.....	100	Sleep-Learning Research Ass'n	102
Ebe Inc.....	98	Sprague Products Co.....	97
Edmund Scientific Co.....	112	Sprayberry Academy of Radio-Television	21
Electro-Sonic Labs.....	14	Stan-Burn Radio & Electronics	114
Electro-Voice Inc.	Inside Back Cover	Sylvania Electric Products, Inc.	16
Electronic Instrument Co. (EICO)	23, 24	Tab	116
Electronic Publishing Co., Inc.....	116	Triad Transformer Corp.....	12
Erie Resistor Corp.....	102	Trio Manufacturing Co.....	12
Garfield (Oliver) Co.....	98	Triplet Electrical Instrument Co.....	Inside Front Cover
Gernsback Library Inc.....	113, 118	Tung-Sol Electric Co.....	6
Glaser-Steers Corp.....	105	University Loudspeakers, Inc.....	115
Grantham School of Electronics	19	Walsco Electronics Manufacturing Co.	114
Greenwich Book Publishers.....	114	Xcelite, Inc.....	117
Heald Engineering College.....	117	SCHOOL DIRECTORY PAGE 119	
Heath Co.	56-71	Baltimore Technical Institute	
IBM	84-85	Canadian Institute of Science & Technology	
Indiana Technical College.....	92	Candler System Co.	
JFD Electronics	73	Indiana Technical College Math A to C	
Jensen Industries	7	Milwaukee School of Engineering	
Key Electronics Co.....	117	Pacific International University	
Kuhn Electronics	114	Tri-State College	
Lafayette Radio	120-121	Valparaiso Technical Institute	
Lansing (James B.) Sound, Inc.	75		

BRANCH ADVERTISING OFFICES: Chicago: 600 Waukegan Road, Glenview, Ill., GLenview 4-6900. Los Angeles: Ralph W. Harker and Associates, 600 South New Hampshire. Tel. DUnkirk 7-2328. San Francisco: Ralph W. Harker and Associates, 444 Market St. Tel. GArdfield 1-2481.
FOREIGN AGENTS: Great Britain: Atlas Publishing and Distributing Co., Ltd., 18 Bride Lane, London E.C. 4. Australia: McGill's Agency, Melbourne. France: Brentano's, Paris 2e. Belgium: Agence et Messageries de la Presse, Brussels. Holland: Trilectron, Heemstede. Greece: International Book & News Agency, Athens. So. Africa: Central News Agency, Ltd., Johannesburg. Capetown, Durban, Natal: Universal Book Agency, Johannesburg. India: Broadway News Centre, Dadar, Bombay #14. Pakistan: Paradise Book Stall, Karachi 3.
Printed in the United States of America

NOW... AN *Electro-Voice*[®] PUBLIC ADDRESS SPEAKER FOR ANY APPLICATION

For SUPERIOR SOUND • • • CONTROLLED COVERAGE

See Electro-Voice public address projectors. They offer perfect voice penetration and full-range "musicasting." They're weatherproof, splashproof and blastproof.

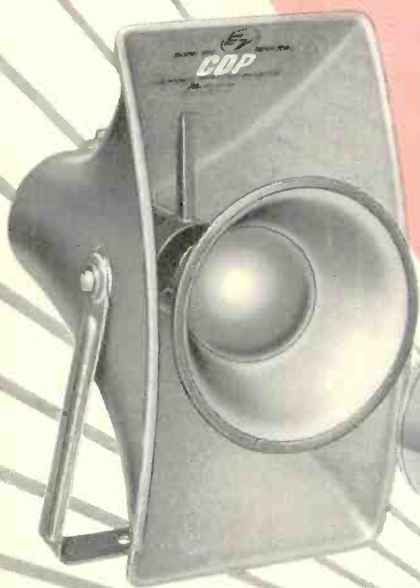

\$75.00
LIST

Model 848 30-Watt CDP* (With 1000-cycle concentrating horn). For projecting intelligible, extended-range sound over great distances.

Model 844 30-Watt Paging Unit. Compact, economical unit for quality, high-efficiency voice reproduction.

\$34.50
LIST

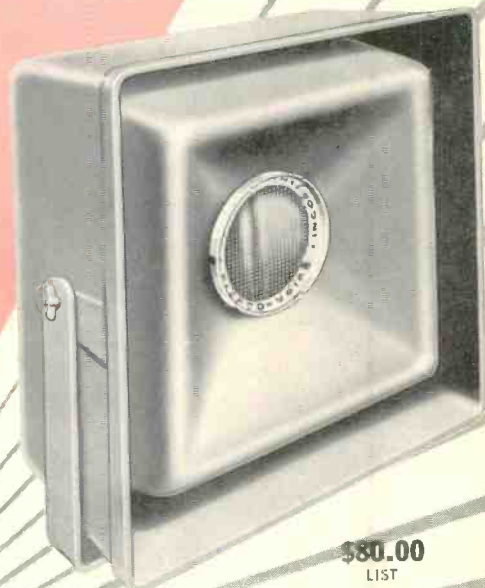

\$80.00
LIST

The New Electro-Voice Musicaster. Rugged, weatherproof high-fidelity speaker system for high-quality music reproduction.

*CDP (Compound Diffraction Projection) Design Patent 169,704. Additional Patent Pending.



Model 848 30-Watt CDP. For wide-angle coverage and extended range. Standard of the industry.

\$75.00
LIST



Model 847 25-Watt CDP. Smaller version of Model 848.

\$46.33
LIST



Model LS-12. For interior installations requiring full-range response.

\$32.50
LIST



Model LS-8. Smaller version of Model LS-12.

\$30.00
LIST

THESE ELECTRO-VOICE MICROPHONES ARE
ESPECIALLY OUTSTANDING FOR PUBLIC ADDRESS



\$85.00
LIST

Model 664 Cardioid Dynamic. Broadcast-quality for every public address installation.



\$49.50
LIST

Model 951 Cardioid Crystal. Excellent, wide-range, all-purpose microphone.

The Sound of Electro-Voice... Assures Superior Installations, Customer Satisfaction, Your Reputation!

Electro-Voice[®]

ELECTRO-VOICE, INC.
BUCHANAN, MICH.

In Canada: E-V of Canada Ltd., 73 Crookford Blvd., Scarborough, Ontario
Cables: ARLAB

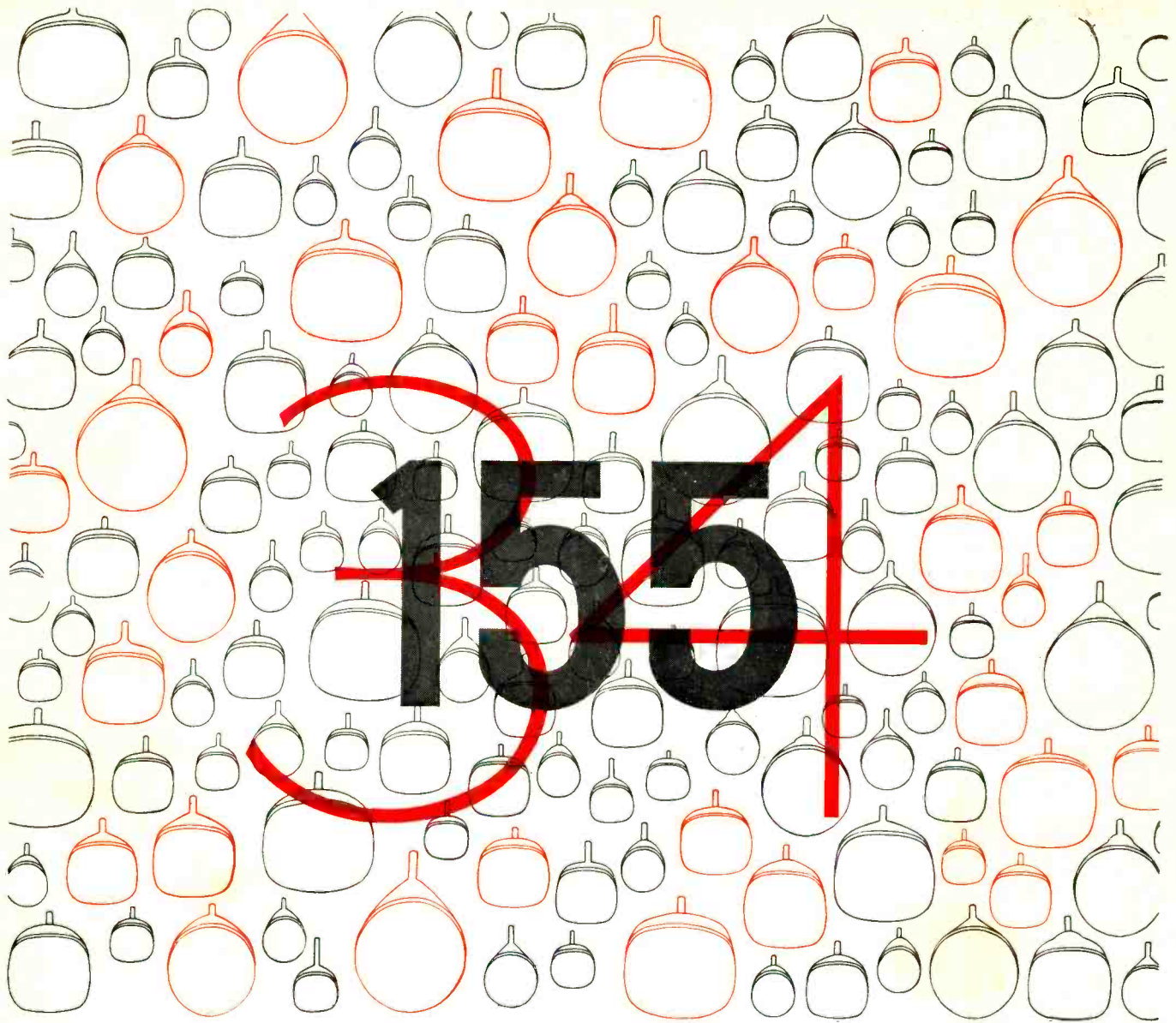

Just 34 RCA Silverama Picture Tubes now replace 155 types!

RCA cuts Picture Tube inventory and complex replacement problems, by nearly 80%. Simplification—that's like money in the bank—as every TV service technician knows.

Best of all, your customer is satisfied, too. He gets a brand name he knows and trusts... that gives his old set a picture that's often clearer and brighter than when the set was new... and that carries a full year's warranty, backed by RCA.

See your local Authorized
RCA Distributor for your
copy of the Silverama
Replacement Chart

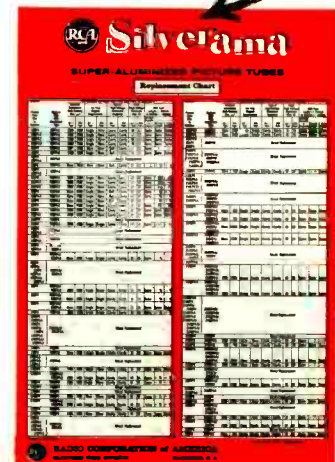

RADIO CORPORATION OF AMERICA

Electron Tube Division

Harrison, N. J.

Silverama®