

THE STRANGE WORLD OF COLOR VISION

JANUARY 1958

# Radio-Electronics

HUGO GERNSBACK, Editor

TELEVISION • SERVICING • HIGH FIDELITY

Complete TV  
Station List

Stereophonic  
Phono Discs

New Amplifier  
With KT88's

108-Mc Converter  
for US Satellites

35c

U.S. and Canada

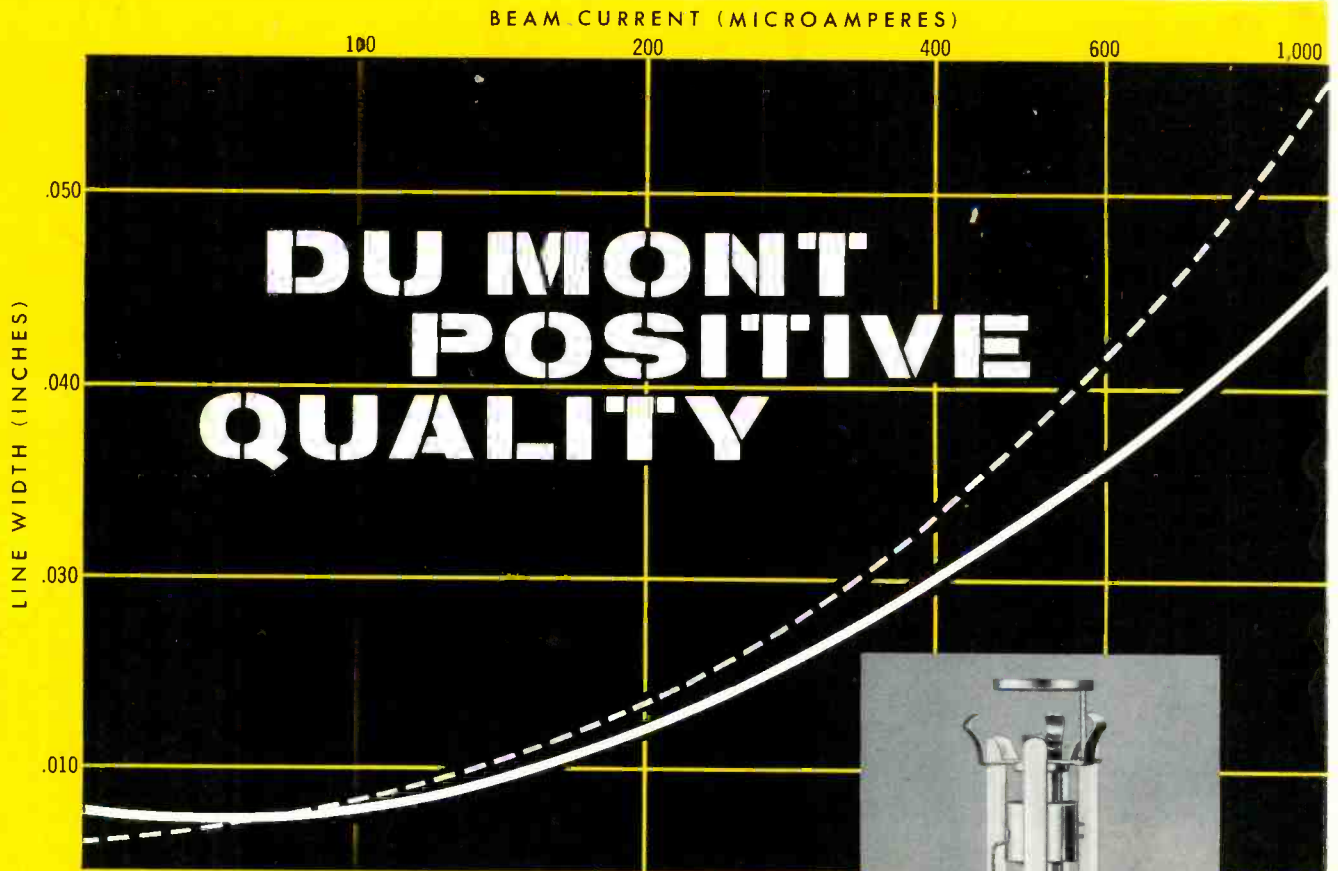

# 38% SHARPER PICTURES

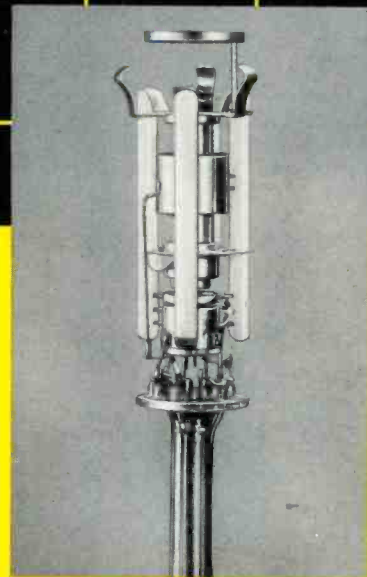

Du Mont "Stubby" electron guns showed the industry the way to short neck tubes, and are recognized as the industry's best. The gun is the heart of the picture tube — the determining factor in picture sharpness.

Another positive fact about Du Mont Positive Quality . . .  
 You get not only sharper pictures with a Du Mont picture tube — "blossoming" in picture highlights is minimized — line width is retained, resulting in sharper, clearer pictures that make and keep customers happy. Always use Du Mont Positive Quality picture tubes and receiving tubes . . .

\*Send for your free copy of the  
 Du Mont Picture Tube Data Chart.



# DU MONT®

TELEVISION TUBE DIVISION, ALLEN B. DU MONT LABORATORIES, INC., 750 BLOOMFIELD AVE., CLIFTON, N. J.

# Learn to be a PROFESSIONAL TV Technician AT HOME

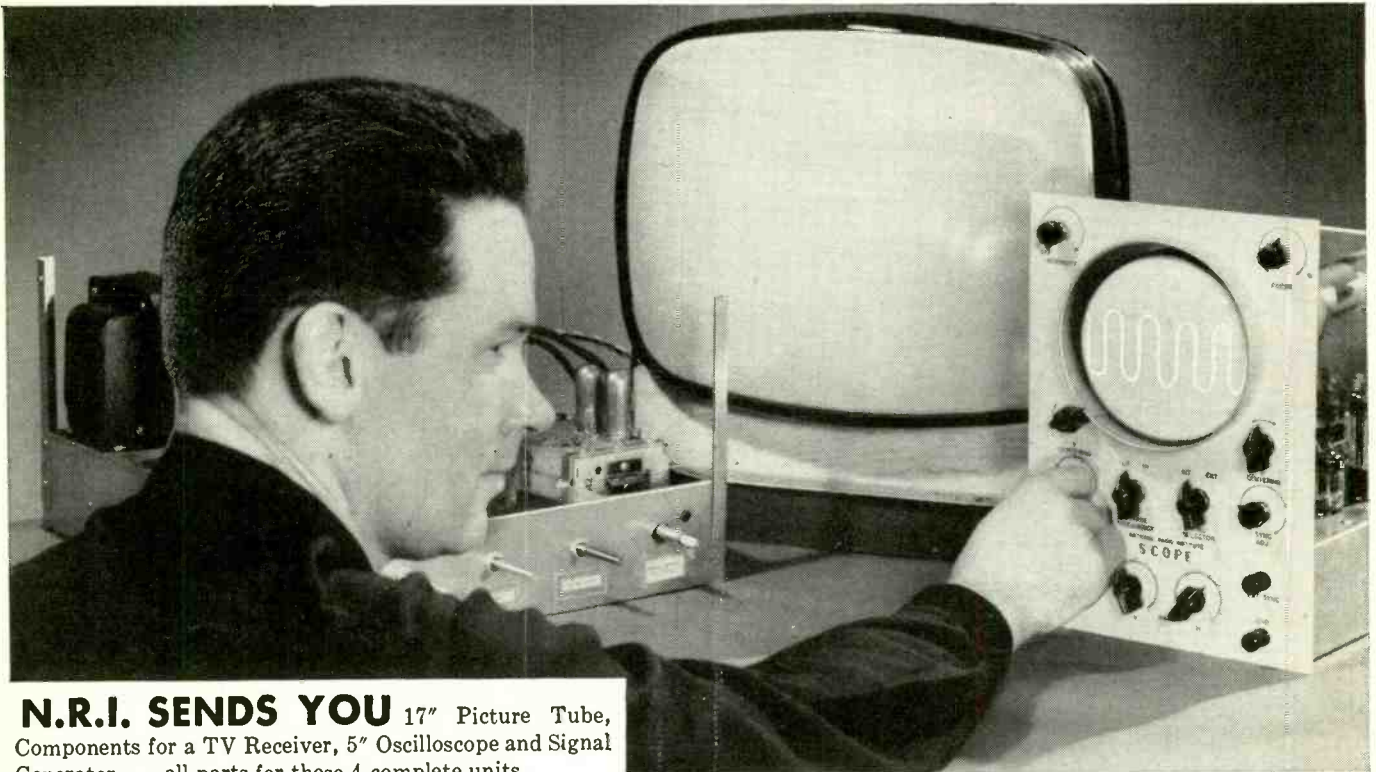

**N.R.I. SENDS YOU** 17" Picture Tube, Components for a TV Receiver, 5" Oscilloscope and Signal Generator . . . all parts for these 4 complete units.

## N.R.I. All-Practice Method Trains You in Spare Time to Fix TV Sets Quickly, Correctly, with Confidence

How many times have you day-dreamed of being your own boss? Or thought about what you could do if you were the man who made the decisions. The man who knows the answers—the well trained Technician—enjoys the prestige, gets the better jobs, higher pay. It's time to stop dreaming. Here is the learn-by-practice training that shows you the way to be the boss, to earn top pay. Television Servicing needs well trained men. Yes, if you have a basic knowledge of radio and electronics you can make some Television repairs some of the time. You can make some simply by trial and error. But sooner or later you will face Television Service problems you cannot solve. All the diagrams in the world won't help you then. And you can't get the training you need while customers wait.

### NRI Is Oldest and Largest Home Study Radio-TV School

Forty years experience, and the record and reputation of NRI, back up this learn-by-doing Professional TV Servicing course. Instead of reading about TV problems, you build and conduct experiments on circuits in a TV receiver. Because you learn methods, "tricks of the trade" used and proved

by top TV Servicemen, you recognize and repair defects quickly and accurately. Learn to fix any set . . . any make, any model . . . with confidence. Earn a Diploma that certifies to your training.

### Television is Forging Ahead with More Sets, More Color, Hi-Fi

TV Servicing has only started to grow in importance. New sets, portables, color TV, constant changes, improvements make this a genuine "gold rush" for the man who is trained and ready. Know . . . so you can get ahead. Learning how to build and use a professional-type 5" Oscilloscope is part

of the practice you get in this NRI All-Practice Training. Installing front-end channel selector strips, distinguishing between faulty blocking oscillator or a defect in the sync circuit, etc., are just a few of the important TV Servicing facts you learn through practice.

### Not for beginners

Here is a course for men who know basic theory, either from Radio or TV Servicing experience or planned training, but realize the need for more knowledge to be able to forge ahead. Get details of this course now. Mail coupon today. Address: National Radio Institute, Dept. 8AFT, Washington 16, D.C.



**Send for FREE BOOK** →

### NATIONAL RADIO INSTITUTE

Dept. 8AFT, Washington 16, D. C.

Please send FREE copy of "How to Reach the Top in TV Servicing." I understand no salesman will call.

Name.....Age.....

Address.....

City.....Zone.....State.....

ACCREDITED MEMBER NATIONAL HOME STUDY COUNCIL

# Radio-Electronics

Formerly RADIO-CRAFT ■ Incorporating SHORT WAVE CRAFT ■ TELEVISION NEWS ■ RADIO & TELEVISION

## EDITORIAL

- 31 Electronics in Space—Hugo Gernsback

## TELEVISION

- 32 The Strange World of Color Vision—Robert G. Middleton
- 35 New Slant on Moscow TV
- 36 More About Auxiliary Circuits—Charles J. Garrett
- ✓ 38 Red and Fuzzball on Convergence—Robert G. Middleton
- 40 Television Station List—Muriel Schiller
- 41 TV Dx for 1957—Robert B. Cooper, Jr.
- 43 TV Service Clinic

## WHAT'S NEW

- 45 Pictorial Report of New Developments

## TEST INSTRUMENTS

- 46 Wien-Bridge Analyzer—L. B. Hedge
- ✓ 49 Fix That Rotator—Homer L. Davidson
- 51 All-Transistor Direct-Reading Af Meter—David Stone
- 53 Simple Signal Generator

## AUDIO—HIGH FIDELITY

- 54 Single-Groove Stereo Discs—Norman H. Crowhurst
- 58 New Amplifier With KT88's—David Hafler
- 60 Hi-Fi Pickup Arms, Part II—Julian D. Hirsch
- ✓ 80 Is the Output Transformer Out?—Herbert Ravenswood
- 120 New Records—Monitor

## RADIO

- 93 Servicing Transistor Auto Radios—Jack Darr
- ✓ 98 Rediscovery of FM Broadcasting—David Lauchenbruch
- 100 Faster Radio Repairs—John B. Ledbetter
- ✓ 101 Vanguard 108—Richard Graham
- 106 Tiny-Tran Pocket Radio—Forrest H. Frantz, Sr.

## ELECTRONICS

- 112 Transistors Sensitize Relay Circuits—Edwin Bohr
- 116 Power Failure Alarm—George P. Pearce
- 118 Sensitive Photocell—I. Queen
- 150 Books
- 147 Business and People
- 141 Corrections
- 16 Correspondence
- 141 Miscellany
- 133 New Devices
- 123 New Tubes and Semiconductors
- 6 News Briefs
- 128 Patents
- 142 Radio-Electronic Circuits
- 144 Technical Literature
- 126 Technicians' News
- 139 Technotes
- 130 Try This One
- 132 35 Years Ago

NEXT MONTH: MEDIUM-POWER AMPLIFIER WITH HIGH-POWER PERFORMANCE •  
 AUTOMATIC FINE TUNING FOR TV • ALL-TRANSISTOR SOUND SURVEY METER

## ON THE COVER

(For details see page 32)

An abstraction by our art director, Sol Ehrlich, from an original design by Robert G. Middleton, illustrating "The Strange World of Color Vision."

Hugo Gernsback	.....Editor and Publisher
M. Harvey Gernsback	.....Editorial Director
Fred Shunaman	.....Managing Editor
Robert F. Scott	.....WZPWG, Technical Editor
Larry Steckler	.....Assistant Editor
I. Queen	.....Editorial Associate
Robert G. Middleton	.....Television Consultant
Elizabeth Stalcup	.....Production Manager
Cathy Coccozza	.....Advertising Production
Wm. Lyon McLaughlin	.....Tech. Illustration Director
Sol Ehrlich	.....Art Director
Fred Neinast	.....Staff Artist
Lee Robinson	.....General Manager
John J. Lamson	.....Sales Manager
G. Aliquo	.....Circulation Manager
Adam J. Smith	.....Director, Newsstand Sales
Robert Fallath	.....Promotion Manager



Average Paid Circulation  
Over 195,000

RADIO-ELECTRONICS is Indexed in *Applied Science & Technology Index* (Formerly *Industrial Arts Index*) Associate Member Institute of High Fidelity Mfrs., Inc.

RADIO-ELECTRONICS, January, 1958, Vol. XXIX, No. 1. Published monthly at Mt. Morris, Ill., by Gernsback Publications, Inc. Second-class mail privileges authorized at Mt. Morris, Ill. Copyright 1957 by Gernsback Publications, Inc. All rights reserved under Universal, International and Pan-American Copyright Conventions.  
**SUBSCRIPTION RATES:** U. S., U. S. possessions and Canada, \$4.00 for one year; \$7.00 for two years; \$9.00 for three years; single copies 35c. Pan-American countries \$4.50 for one year; \$8.00 for two years; \$10.50 for three years. All other countries \$5.00 a year; \$9.00 for two years; \$12.00 for three years.  
**SUBSCRIPTIONS:** Address correspondence to Radio-Electronics, Subscription Dept., 404 N. Wesley Ave., Mt. Morris, Ill., or 154 West 14th St., New York 11, N. Y. When requesting a change of address, please furnish an address label from a recent issue. Allow one month for change of address.  
**GERNSBACK PUBLICATIONS, INC.** Executive Editorial and Advertising Offices, 154 West 14th St., New York 11, N. Y. Telephone ALgonquin 5-7755. Hugo Gernsback, Chairman of the Board; M. Harvey Gernsback, President; G. Aliquo, Secretary.  
**BRANCH ADVERTISING OFFICES and FOREIGN AGENTS** listed on page 155.  
**POSTMASTER:** If undeliverable, send Form 3578 to: RADIO-ELECTRONICS, 154 West 14th St., New York 11, N. Y.

\*Trademark registered U. S. Pat. Office.

Get into

# TELEVISION RADIO-ELECTRONICS



**LEARN ALL 8 PHASES OF THE INDUSTRY BY SHOP METHOD**

1. Television . . . including Color TV
2. Radio . . . AM, FM
3. Industrial Electronics
4. Communications

**HOME TRAINING**

5. Sound Recording & Hi-Fidelity
6. Automation
7. FCC License Preparation
8. Radar & Micro Waves

Let National Schools of Los Angeles, a Practical Resident Technical School for over 50 years, train you at home by Shop-Method for unlimited opportunities in All phases of TV, Electronics, Radio.

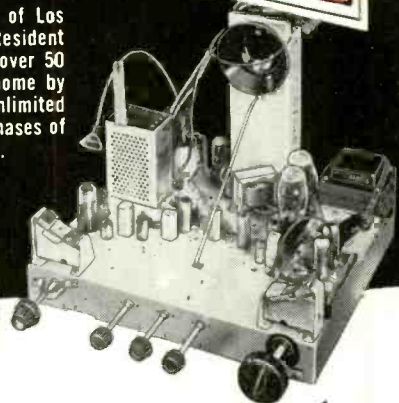

**You get 19 big kits of equipment!**

**GOOD JOBS . . . MORE MONEY SECURITY . . . ALL CAN BE YOURS**

YOU are needed in the great modern Television-Electronics industry. Trained technicians are in growing demand, at excellent pay, in sales and service, manufacturing, broadcasting, telecasting, communications, research, and many other important branches of the field. National Schools Master Shop-Method Training, with newly added lessons and equipment prepares you in your spare time right in your own home for these fascinating opportunities. **OUR OUTSTANDING METHOD IS PROVED BY THE SUCCESS OF GRADUATES ALL OVER THE WORLD!**

**YOUR TRAINING IS ALL INCLUSIVE**

We prepare you for a long list of job opportunities. Thousands of TV and Radio receivers are being sold every day—more than ever before. And, now, Color TV is here. Applications of Electronics in industry—**AUTOMATION**—are growing in tremendous strides. The whole field is alive—opening up new, important jobs rapidly. National Schools complete training program qualifies you in all phases of the industry.

**YOU EARN WHILE YOU LEARN**

Many students pay for their entire training—and more—with spare time earning. We'll show you how you can, too! Early in your course you receive material that shows you how to earn extra money servicing TV and Radio receivers, appliances, etc., for friends and acquaintances.

**YOU GET EVERYTHING YOU NEED**

Clear, profusely illustrated lessons, shop-tested manuals, modern circuit diagrams, practical job projects—all the valuable equipment shown above—many other materials and services—consultation privilege with our qualified staff, and Graduate Employment Service. **EVERYTHING YOU NEED** for outstanding success in Electronics.

**INDUSTRY NEEDS YOU. NATIONAL SCHOOLS WILL TRAIN YOU. SEND FOR FACTS TODAY NO OBLIGATION.**

**YOU LEARN BY SHOP METHOD . . .** you do servicing, circuit analysis, and do over 100 down-to-earth experiments. You build a Superhet Receiver and a modern TV Receiver, from the ground up, including a new, big screen picture tube. You also receive a professional, factory-made **MULTI-TESTER**. All of this standard equipment is yours to keep . . . at just one low tuition.

**RESIDENT TRAINING AT LOS ANGELES**

If you wish to take your training in our Resident School at Los Angeles, the world's TV capital, start NOW in our big, modern Shops, Labs and Radio-TV Studios. Here you work with latest Electronic equipment—professionally installed—finest, most complete facilities offered by any school. Expert, friendly instructors. Personal attention. Graduate Employment Service. Help in finding home near school—and part time job while you learn. Check box in coupon for full information.

Approved for GI Training



**NATIONAL SCHOOLS**

LOS ANGELES 37, CALIF.

**FREE! VALUABLE BOOK & SAMPLE LESSON—Just Send Coupon!**



**NATIONAL SCHOOLS**

TECHNICAL TRADE TRAINING SINCE 1905  
LOS ANGELES 37, CALIFORNIA

**GET FAST SERVICE—MAIL NOW TO**

NATIONAL SCHOOLS, DEPT. RG-18  
4000 S. FIGUEROA ST.  
LOS ANGELES 37, CALIF.

Rush free TV-Radio "Opportunity" Book and sample lesson. No salesman will call.

NAME \_\_\_\_\_ AGE \_\_\_\_\_  
ADDRESS \_\_\_\_\_  
CITY \_\_\_\_\_ ZONE \_\_\_\_\_ STATE \_\_\_\_\_

Check if interested ONLY in Resident School training at Los Angeles  
VETERANS: Give date of Discharge \_\_\_\_\_

FOR A brighter TV picture

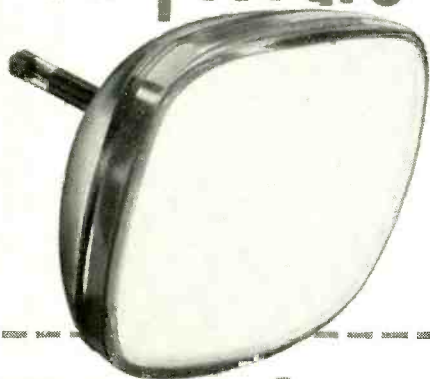

FOR A brighter profit picture



Keep your customers sold on you! Use the exact same tubes leading independent set makers specify. Tell your supplier you'd rather have Tung-Sol Tubes.

Tung-Sol Electric Inc., Newark 4, N. J.

**TUNG-SOL**  
MAGIC MIRROR ALUMINIZED  
PICTURE TUBES  
RECEIVING TUBES

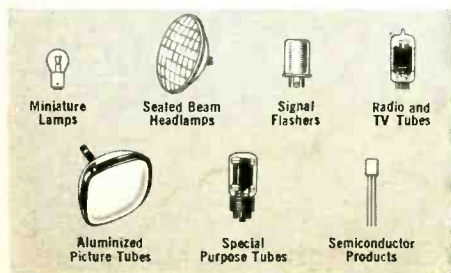

# News Briefs



**"SEEING AIDS" FOR THE BLIND** may be possible as a result of experiments on direct stimulation of the brain with voltages from photocells. A New Jersey volunteer, Miss Betty Corstorphine of Newark, reported seeing flashes of light as she turned a photocell towards windows and other light sources. The photocell currents were conducted to the optic centers of the brain by fine wires, which were inserted through tiny holes drilled in the skull. Three-way cooperation made the test possible. Dr. John C. Button of East Orange, N. J., an osteopath devoted to nerve study, originated the idea. A team of physicians at Rochester (Minn.) State Hospital mapped the brain areas concerned and Dr. Tracy Putnam of Los Angeles performed the actual operation.

**RADAR CONVICTION** in Westchester County (N. Y.) of an alleged speeding offender was reversed by Judge Hugh S. Coyle after hearing an electrical consulting engineer, J. Kelly Johnson, testify that "even the rustling of leaves on a tree" or the "jangling of a radar patrolman's car keys" could cause inaccuracies in the radar equipment used to determine the speed of a passing vehicle.

In further testimony Mr. Johnson said that the transfer of a patrolman's revolver to another pocket, the metal on his gun belt, the patrol car's short-wave transmitter, a loose license plate on the car being timed or even vibration from the car itself could upset the radar receiver's accuracy.

In reversing an earlier decision, Judge Coyle said that evidence showed that the device in question "is accurate to the extent that it tells the existence of a moving target in proximity to the instrument but that its use for any additional purpose, such as measurement of speed of the vehicle, is subject to grave possibility or probability of error."

**RADAR PATENTS** are now coming out of hiding. Following close on the granting of the fundamental radar patent to Col. Wm. R. Blair (RADIO-ELECTRONICS, November, 1957) comes news that a patent has been granted to P. F. M. Gloess, a French scientist who developed the plan position indicator (PPI) radar while working in the Paris laboratories of the International Telegraph & Telephone Corp., now assignees of the patent.

The original patent application was filed in France in 1937 and in the United States a year later. PPI is the

type of radar that, using a radial sweep, "paints" a rough map on the C-R tube screen, making it possible to see the distance and direction of individual objects directly. For that reason it is now the common type of radar used in surface and aerial navigation applications.

**COLOR TV TAPE RECORDER** was demonstrated by RCA recently at a closed-circuit demonstration. The new system uses tape 2-inches wide, which moves at 15 inches a second, on which the signal is impressed nearly crosswise by rapidly rotating heads. In this respect it is like the black-and-white system used by Ampex with which RCA has cross-licensing agreements. Ampex has not so far announced a tape recorder for color, although they have stated they will market a conversion kit for their black-and-white recorder. Both the RCA unit and Ampex adapter are expected to be available to broadcast stations sometime in 1958.

The head mechanism consists of four separate recording (or reproducing) elements. The disc carrying the heads rotates at 14,400 rpm, so that each head crosses the tape 240 times per second. During each traverse a single head records information corresponding to slightly more than 16 lines of a color TV picture. A 1-hour program can be recorded on a 12½-inch reel.

## Calendar of Events

**Fourth National Symposium on Reliability and Quality Control**, Jan. 6-8, Statler Hotel, Washington, D. C.

**High-Fidelity Music Show**, Jan. 10-12, Dykmann Hotel, Minneapolis, Minn.

**High-Fidelity Music Show**, Jan. 17-19, Hotel Antlers, Indianapolis, Ind.

**Second EIA Conference on Automation**, Jan. 22-24, Arizona State College, Tempe, Ariz.

**Hi-Fi Music Show**, Jan. 24-26, Hotel Statler, Buffalo, N. Y.

**High-Fidelity Music Show**, Feb. 7-9, Hotel Cosmopolitan, Denver, Colo.

**TSA Midwest Electronic Forum**, Feb. 8-11, Hotel Statler, Detroit, Mich.

**High-Fidelity Show**, Feb. 14-16, Hotel Whitcomb, San Francisco, Calif.

**Transistor and Solid State Circuits Conference**, Feb. 20-21, University of Pennsylvania and Sheraton Hotel, Philadelphia, Pa.

**Institute of High Fidelity Manufacturers Show**, Feb. 26-Mar. 2, Hotel Biltmore, Los Angeles, Calif.

**DR. ELMER ENGSTROM**, color TV pioneer was granted the 1958 medal of the Industrial Research Institute. It will be presented to him at the institute's annual meeting in May.

The medal is awarded for "outstanding accomplishment in leadership in or

(Continued on page 10)

# Get Full Facts FREE!

Prepare in Spare Time for Good-Paying Jobs in

# Electronics

AS USED IN GUIDED MISSILES • RADAR • TELEVISION • MICRO-WAVES • INDUSTRIAL ELECTRONICS • RADIO • COMMUNICATIONS, Etc.

## No Advanced Education or Previous Technical Experience Needed!

When you hear of outstanding developments like "SPUTNIK" —or the others shown above—do you know the important part **ELECTRONICS** plays in making them realities? And do you also know of the great future that Electronics offers trained men between the ages of 17 and 55?

Even though YOU have no previous technical experience or advanced education, you may prepare to enter this fast-expanding field that today has much of the world talking. Regardless of the job you now have, see how you may get ready for a part in this great industry. Send the coupon for **FREE** facts now. This may be a turning point in your life!

### CHICAGO OR TORONTO LABORATORIES

You may train day or evening in our well-equipped Electronics laboratories in either Chicago or Toronto. However, if you would rather continue with your present job, we will thoroughly prepare you in your spare time at home, using training movies, clearly-written lessons and actual Electronic equipment. Mail coupon now!

### Can You Do It?

Salesmen, farmers, laborers, clerks, men of nearly every calling have taken the DeVry Tech program and today have better jobs or Electronic service shops of their own — **REAL PROOF** of the effective training offered by DeVry Tech.

Accredited Member of National Home Study Council

### Draft Age?

We have valuable information for every man subject to military service. Check coupon for details.

### 27 Years' Experience!

For over 27 years we have trained many men for better careers. This first-hand experience brings a great advantage to men like you — practical training **KNOW-HOW** designed for **RESULTS!**

"One of North America's Foremost Electronics Training Centers"

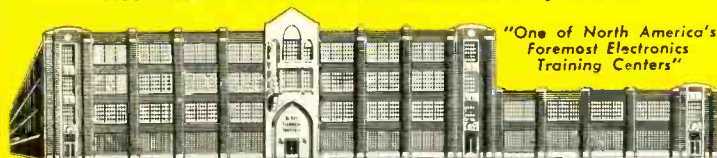

## DEVRY TECHNICAL INSTITUTE

CHICAGO 41, ILLINOIS

Formerly DeFOREST'S TRAINING, INC.



### Employment Service

DeVry Tech's Placement Department is in contact with some of the best-known employers in the Electronics field. The service is free to all graduates — and DeVry Tech's record in helping to place men has been outstanding.



## FREE Sample Booklet!

We'll give you a free copy of an interesting booklet, "Electronics and YOU." See how you may take advantage of the opportunities in this fast-growing field.

### MAIL TODAY FOR FREE FACTS!

DeVry Technical Institute  
4141 Belmont Ave., Chicago 41, Ill., Dept. RE-1-O

Please give me your **FREE** booklet, "Electronics and YOU," and tell me how I may prepare to enter one or more branches of Electronics as listed above.

Name \_\_\_\_\_ Age \_\_\_\_\_  
PLEASE PRINT

Street \_\_\_\_\_ Apt. \_\_\_\_\_

City \_\_\_\_\_ Zone \_\_\_\_\_ State \_\_\_\_\_

Check here if subject to Military Training.

DeVry Tech's Canadian Training Center is located at:  
2030 626 Roselawn Avenue, Toronto 12, Ontario

*another first*

*for*

**RAYTHEON  
BONDED  
ELECTRONIC  
TECHNICIANS**



*Now eligible for*

**GROUP LIFE INSURANCE**

*from* **RAYTHEON**

**SPONSORING BONDED PROGRAM DISTRIBUTORS**

*at no added cost.....*

Registered Bonded Dealers who by preference use Raytheon Receiving Tubes are now eligible for valuable life insurance coverage through their sponsoring distributors. It is obtainable without the necessity of a physical examination.

This Group Life Insurance Plan for Raytheon Bonded Electronic Technicians is underwritten by one of America's leading insurance companies for the exclusive use of sponsoring distributors of the Bonded Dealer Program.

Any Sponsoring Bonded Distributor who meets the necessary requirements for setting up a Group Life

Insurance Plan for Bonded Dealers may help them obtain this important protection.

Check with your Raytheon Sponsoring Distributor and see if he has available to you this automatic way to gain personal security for you and your family. If you're not already a Raytheon Bonded Dealer, here's another wonderful reason why you should call your distributor and see if you can qualify. Being a Raytheon Bonded Dealer makes you stand out from the crowd. And using finest quality Raytheon Receiving Tubes for replacement work makes you the fair-haired boy with your customers, too.



**RAYTHEON MANUFACTURING COMPANY**  
 Receiving and Cathode Ray Tube Operations

<b>NEWTON 58, MASS.</b> 55 Chapel Street	<b>CHICAGO, ILL.</b> 9501 Grand Ave. (Franklin Park)	<b>ATLANTA 6, GA.</b> 1150 Zonolite Rd. N.E.	<b>LOS ANGELES 7, CALIF.</b> 2419 So. Grand Ave.
---	---	---	---

Raytheon makes all these } Receiving and Picture Tubes, Reliable Subminiature and Miniature Tubes, Semiconductor Diodes and Transistors, Nucleonic Tubes, Microwave Tube.



# FREE... ANY 3

of these superb High-Fidelity

## 12" COLUMBIA LP RECORDS

if you join the Columbia Record Club now—and agree to purchase 4 selections during the coming 12 months



Two delightful and romantic ballet scores by Offenbach and Chopin



Definitive performances of three best-loved Beethoven sonatas

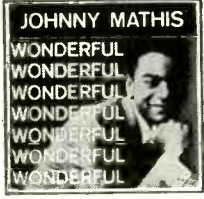

Johnny Mathis sings 12 favorites—Day In Day Out, Old Black Magic, etc.

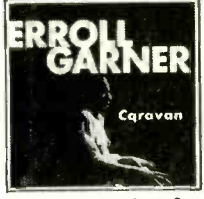

Erroll Garner plays Caravan, No Greater Love, Memories of You, etc.

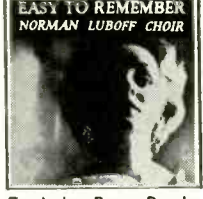

Tenderly, Deep Purple, Soon, Laura, September In The Rain, 7 others



Complete score! I Could Have Danced All Night, The Rain In Spain, etc.

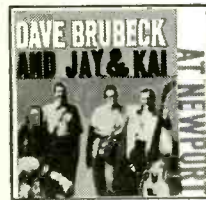

7 exciting new jazz improvisations by two great modern combos



Duchin plays The Man I Love, April Showers, Am I Blue?, Brazil—11 more



Suave arrangements of Embraceable You, Somebody Loves Me—12 more

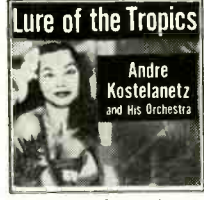

The Moon of Manakora, Lotus Land, Poinciana, Jamaican Rhumba, etc.



Armstrong and his All-Stars. 10 numbers from triumphant tour abroad



Stunning hi-fi performances of the "Firebird" and "Romeo and Juliet"



Doris Day sings The Song Is You, But Not For Me, Autumn Leaves—9 more

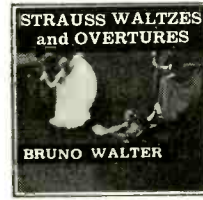

Emperor Waltz, Blue Danube, Vienna Life, Gypsy Baron Overture—2 more



12 Sinatra favorites—Mad About You, Love Me, Nevertheless, etc.

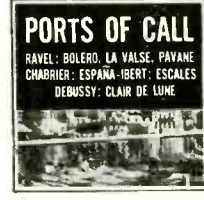

A romantic musical tour—Ormandy and The Philadelphia Orchestra

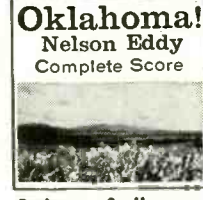

Rodgers & Hammerstein's fabulous hit, with Nelson Eddy as Curly



3 Gershwin works—Concerto in F, Rhapsody in Blue, American in Paris



12 inimitable Elgart arrangements—ideal for listening or dancing



Eight of the best-loved melodies of all time—magnificently performed

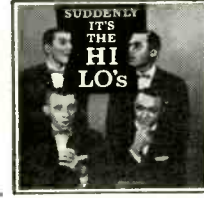

America's favorite quartet sings Love Walked In and 11 others



Benny Goodman and his Original Orchestra, Trio and Quartet. 11 numbers



6 works: Symphony No. 3, Academic Festival Overture, 4 Hungarian Dances



The complete score of Lehar's operetta—Vilja, Maxim's, Women, etc.

- ★ You receive, at once, any 3 of these records—FREE. One is your gift for joining, and the other two are your Bonus records "in advance"
- ★ After you have purchased only four records, you receive a 12" Columbia Bonus record of your choice FREE for every two additional selections you purchase from the Club
- ★ You enroll in any one of the four Club Divisions: Classical; Jazz; Listening and Dancing; Broadway, Movies, Television and Musical Comedies
- ★ Every month you receive, FREE, a new issue of the Columbia Record Club Magazine—which describes all forthcoming selections
- ★ You may accept or reject the selection for your Division, take records from other Divisions or take NO records in any particular month
- ★ Your only membership obligation is to buy four selections from the more than 100 to be offered in the coming 12 months. You may cancel membership any time thereafter
- ★ The records you want are mailed and billed to you at only \$3.98 (Original cast Musical Shows somewhat higher), plus small mailing charge
- ★ You must be delighted with membership or you may cancel it by returning the free records within 10 days

**COLUMBIA LP RECORD CLUB**  
TERRE HAUTE, INDIANA

**FREE—ANY 3—VALUE UP TO \$12.94—MAIL ENTIRE COUPON NOW!**

COLUMBIA LP RECORD CLUB, Dept. 521  
TERRE HAUTE, INDIANA

Please send me as my FREE gift the 3 records whose numbers I have circled at the right—and enroll me in the following Division of the Club:

(check one box only)

- Classical     Listening and Dancing     Jazz  
 Broadway, Movies, Television and Musical Comedies

I agree to purchase four selections from the more than 100 to be offered during the coming 12 months... at regular list price, plus small mailing charge. For every two additional selections I accept, I am to receive a 12" Columbia Bonus record of my choice FREE.

Name.....  
(Please Print)

Address.....

City..... Zone..... State.....

CANADA: Prices slightly higher, address 11-13 Soho St., Toronto 2B  
If you wish to have this membership credited to an established Columbia Records dealer, authorized to accept subscriptions, please fill in the following information:

Dealer's Name.....

Dealer's Address..... .85-1

© Columbia Records Sales Corp., 1967

**CIRCLE 3 NUMBERS BELOW:**

1. Eddy Duchin Story
2. Beethoven: 3 piano sonatas
3. Erroll Garner ("Caravan")
4. Gaité Parisienne; Les Sylphides
5. Easy To Remember—Luboff Choir
6. My Fair Lady—Orig. Broadway Cast
7. Brubeck and Jay & Kai
8. Gershwin Hits—Percy Faith
9. Sinatra—Adventures of the Heart
10. Ambassador Satch
11. Firebird; Romeo and Juliet
12. Day By Day—Doris Day
13. Johann Strauss—Waltzes
14. Lure of the Tropics—Kostelanetz
15. Ports Of Call
16. Oklahoma!
17. Levant Plays Gershwin
18. The Elgart Touch
19. The Great Melodies of Tchaikovsky
20. Suddenly It's the Hi-Lo's
21. King of Swing—Benny Goodman
22. Brahms: Symphony No. 3
23. The Merry Widow
24. Wonderful, Wonderful—Mathis PE-1



management of industrial research which contributes broadly to the development of industry or in the public welfare."

Dr. Engstrom is senior executive vice president of the Radio Corporation of America, which he joined in 1930. He has been active throughout his period of service in the development and improvement of color television transmission and reception techniques.

**JUMP IN FM** receiver sales and an upswing in the number of FM stations on the air has focused the attention of FM broadcasters on protecting the 88-108-mc band. (See also p. 98) High-fidelity manufacturers are also concerned about the possibility of a cut-back on the FM band to allow for more TV stations and industrial facilities.

One FM receiver manufacturer, Granco Products Corp., states that it has increased its 1957 production of FM receivers by 30% over the previous year.

**FACSIMILE SIGNALS BOUNCED** off meteor trails cover a distance of almost 1,000 miles without relays.

Announced by RCA, preliminary tests between the National Bureau of Standards in Havana, Ill., and RCA Labs in Riverhead, L. I., New York, have been completed. These points are 910 miles apart.

For the experiments the material to be transmitted was recorded on 35-mm film and was scanned to produce a signal similar to that used in transmitting television films.

The signals were projected by a highly directional antenna into the earth's atmosphere where they hit ionized meteor trails and are reflected back to earth to be picked up by another directional antenna.

The system was developed for the Cambridge Research Center of the Air Research and Development Command. The three principal scientists on the job were Warren H. Bliss, R. J. Wagner, Jr., and G. B. Wickizer. All are employees of RCA.

**ALUMINUM SOLDERING** is made easy by a new technique which uses an inexpensive and stable zinc alloy as a preferred solder. The solder does not flow, but must be rubbed on with the solder stick. No vigorous abrasion is necessary, and no flux is needed. Joints are stronger

# How to Pass

An FCC License can be

## Get Your FCC License

We Guarantee  
to train you until you receive  
Your FCC License

Completion of the Master Course (both Sections) will prepare you for a First Class Commercial FCC License with a radar endorsement. Completion of Section I only of the Master Course will prepare you for a Second Class Commercial FCC License. We guarantee to train and coach you, without any additional cost, until you receive the FCC License as indicated above. This guarantee is valid for the entire period of your enrollment agreement.

Cleveland Institute Training Results in success with commercial FCC examinations . . . easily . . . and quickly.

every month our trainees get jobs like these:



**Boyd Daugherty:**

"I recently secured a position as Test Engineer with Melpar, Inc. A substantial salary increase was involved. My Cleveland Institute training played a major role in qualifying me for this position."

*Boyd Daugherty  
105 Goodwin Ct., Apt. C  
Falls Church, Va.*

### Top Grade Employers Like These Look

**Bendix Radio:** "We shall look forward to receiving completed applications from your students."

**Philco:** "We have employed a great number of well qualified electronics personnel who were graduates of Cleveland Institute."

**Westinghouse:** "We would appreciate your listing our current openings in your monthly Job Opportunities."

(Commercial)

# FCC License Exams

## your Guarantee of Success in Electronics

## in a Minimum of Time

mail  
coupon  
**NOW!**

here's proof . . .

Name and Address	License	Time
Walter Eggers, Pacific Grove	1st	12 weeks
Paul Reichert, West Salem, Ohio	2nd	10 weeks
Harold Phipps, La Porte, Indiana	1st	28 weeks
John H. Johnson, Boise City, Okla.	2nd	12 weeks
James Faint, Johnstown, Pa.	1st	26 weeks

## Get Both FREE



Accredited by National Home Study Council

### Cleveland Institute of Radio Electronics

Desk RE-1, 4900 Euclid Ave., Cleveland 3, Ohio



Please send Free Booklets prepared to help me get ahead in Electronics. I have had training or experience in Electronics as indicated below:

- |   |   |
|---|---|
| <input type="checkbox"/> Military           | <input type="checkbox"/> Broadcasting       |
| <input type="checkbox"/> Radio-TV Servicing | <input type="checkbox"/> Home Experimenting |
| <input type="checkbox"/> Manufacturing      | <input type="checkbox"/> Telephone Company  |
| <input type="checkbox"/> Amateur Radio      | <input type="checkbox"/> Other .....        |

In what kind of work are you now engaged? .....

In what branch of Electronics are you interested? .....

Name ..... Age.....

Address .....

City ..... Zone..... State.....

Special Tuition Rates to Members of Armed Forces Desk RE-1,

#### James Glen:



When Jim enrolled, he was a temporary employee of the City of Tacoma, Washington. In the space of 14 months, he completed the Master Course and received his first class license. He is now installing and maintaining mobile and microwave equipment.

*James S. Glen, Jr.  
2920 Knob Hill Road  
Tacoma, Washington*

#### To Cleveland Institute

Aerojet-General  
American Airlines  
American Telephone & Telegraph Co.  
Bendix Radio  
Braniff Airways  
Burroughs Corp.  
Capital Airlines  
Continental  
Air Lines, Inc.  
Convair  
General Electric  
Glenn L. Martin Co.

Goodyear Atomic Corp.  
IBM  
International Telephone & Telegraph Co.  
Mohawk Airlines  
Motorola  
North American Aviation, Inc.  
Northwest Airlines  
Philco  
RCA  
Ryan Aeronautical Co.  
\*Plus many others

## It's no trick to save time replacing dual controls



### with Centralab Fastatch® FR-22A Control Kit

Why waste time with special trips to jobbers every time you need a dual-concentric, when — at a fraction of the cost — you can stock a complete line within arm's reach?

The handy Fastatch® FR-22A kit puts 570 dual-control variations at your fingertips — gives you the replacement you need for 85% of your TV, radio, and auto-set service calls . . . and all this for only \$28.51!

Make it a point to pick up a Fastatch® FR22A dual-control kit at your Centralab distributor the next time you need supplies.



Each Fastatch® FR-22A kit contains 22 control units, 4 Fastatch® switches, and 2 auto-adaptor bushings that you can combine to get 570 of the most popular dual controls. Each control is factory-assembled, tested, and guaranteed by Centralab.



# Centralab

B-3258

A DIVISION OF GLOBE-UNION INC.  
922A EAST KEEFE AVENUE • MILWAUKEE 1, WISCONSIN  
IN CANADA: 804 MT. PLEASANT ROAD • TORONTO, ONTARIO

### NEWS BRIEFS (Continued)

than the commercial aluminum itself. It is not even necessary to remove rolling-mill oils or the surface oxide from the surface to be soldered.

The new technique, which was developed by G. M. Houton and P. R. White of the Bell Telephone Laboratories, uses an already available alloy sold under the trade name of *Zamak 3* for making zinc castings. It contains aluminum, copper, and magnesium as well as zinc. The soldering technique is equally effective for joining galvanized surfaces without a flux.

**TV LIBRARY** at the University of Virginia now permits students to read books by remote control, without even entering the main buildings where the stacks are kept. Students may phone their requests from either of the two library branches and have the book of their choice placed in view of the TV camera. After having finished a page at the remote viewer, they can turn pages with a remote control device. A considerable saving in time and energy may result, since the books can be made available to students on the other side of the 510-acre campus without any delay.

**HI-FI TRAPS WILDLIFE.** Sportsman have discovered that recordings of geese and ducks while feeding makes an effective lure to draw game within range of the hunter. Recorded with high-fidelity equipment, the sounds are played back by portable tape recorders or record players and are amplified and beamed in the proper direction with directional speakers. One such device helped bring down 1,285 geese during the last hunting season.

The Interior Department's Fish & Wildlife service (FWS), worried over the effectiveness of this equipment, plans to ban these devices. Canada has already put such a ban into effect. When the United States ban goes into effect, it is expected to apply only to the use of recordings to attract game birds.

**RADIO STREET-LAMP CONTROL** was declared a success under New York City traffic conditions after a Fire Department test of the new equipment. Temporary radio-controlled portable signal lights were mounted at three intersections. The lights were controlled by FM transistor radio units in the cabs of two fire trucks. At the approach of a fire truck the flashing signal came on. The light continued to operate until the truck had passed. The system is adaptable to use by all emergency vehicles.

**TV IN JAPAN** has shown a tremendous growth in the 4½ years since the first station went on the air transmitting to 366 registered receivers. Today there are 68 stations on the air and 629,595 licensed receivers. This number is increasing by 40,000 a month. All programs are monochrome, but color is expected. Present price of a TV receiver is about \$200 for a 14-inch screen, high for the average Japanese, but only half of its cost a year ago. END

RADIO-ELECTRONICS

# FREE!

# ALLIED'S 1958 CATALOG

404 value-packed PAGES

the only COMPLETE catalog for everything in electronics

Get ALLIED'S 1958 Catalog—it's complete, up-to-date—404 pages packed with the world's largest selection of quality electronic equipment at lowest, money-saving prices. Get every buying advantage at ALLIED: fastest shipment, expert personal help, lowest prices, guaranteed satisfaction...

## WORLD'S LARGEST STOCKS

- Latest Hi-Fi Systems and Components
- Money-Saving, Build-Your-Own KNIGHT-KITS
- Recorders and Supplies
- Public Address Systems and Accessories
- TV Tubes, Antennas and Accessories
- Amateur Receivers, Transmitters, Station Gear
- Test & Lab Instruments
- Specialized Industrial Electronic Equipment
- Huge Listings of Parts, Tubes, Transistors, Tools, Books

### EASY-PAY TERMS:

Only 10% down, up to 18 months to pay. Available on orders over \$45. Fast handling—no red tape.

featuring:

### ALLIED'S money-saving knight-kits:

Finest electronic equipment in money-saving kit form. Over 50 quality kits available—Hi-Fi amplifier, tuner and speaker kits, Hobby kits, Test Instruments, Ham kits (see our KNIGHT-KIT values elsewhere in this publication). ALLIED KNIGHT-KITS are easiest to build and they SAVE YOU MORE.

### EVERYTHING IN HI-FI

World's largest selection of quality Hi-Fi components and complete music systems—available for immediate shipment from stock. Save on exclusive ALLIED-Recommended complete systems. Own the best in Hi-Fi for less!

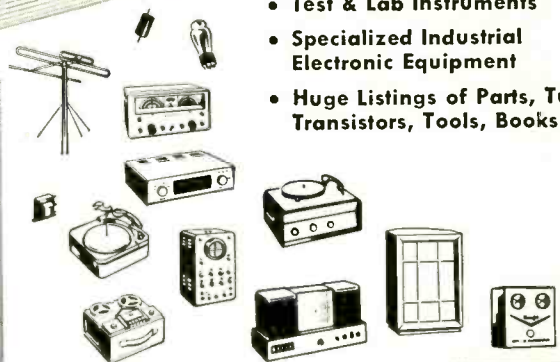

send for the leading electronic supply guide

# FREE!

ALLIED RADIO CORP., Dept. 2-A8  
100 N. Western Ave., Chicago 80, Ill.

Send FREE 404-Page 1958 ALLIED Catalog

Name \_\_\_\_\_

Address \_\_\_\_\_

City \_\_\_\_\_ Zone \_\_\_\_\_ State \_\_\_\_\_



*Our 37th Year*

# ALLIED RADIO

World's Largest Electronic Supply House

JANUARY, 1958

# LET'S TAKE WHISKERS\*

*\*Whiskers are an old disguise to cover up the facts!*

## **IMITATOR NO. 1 SAYS**

*in an advertisement in the SATURDAY EVENING POST*

**that its sets do not have to be fine tuned!**

*Big headlines say: "Stop fiddling with fine tuning—now—brings you Electronic Self-Tuner." The ad continues: "You just touch a button and the next channel comes on with a sharp-tuned picture . . . It's automatic—for you pre-tune each channel individually the day you get your set."*

## **LET'S TAKE THE WHISKERS OFF!**

The fact is that Zenith has had pre-tuning—called BULL'S EYE TUNING—since the first Zenith Television Set ever marketed in 1948! Now, it appears to be new because someone else thinks he has discovered it and starts using it.

## **IMITATOR NO. 1** further says in the same ad

*"Now remote control is truly practical."*

*And also says that its consoles "include remote control—at no extra cost."*

## **LET'S TAKE THE WHISKERS OFF!**

The fact is that what they are talking about is a "one-half" imitation of Zenith's "Lazy Bones" remote control which Zenith put on the market in 1950, and which changes stations in either direction. The one being advertised currently by our imitator is merely a wired contraption that changes stations in one direction—it is as obsolete as the covered wagon, because now, Zenith's Space Command Remote TV Tuning Control turns the set on and off, changes stations in either direction, and cuts off long, annoying commercials while the picture remains on the screen. And, Space Command Tuning uses no wires, no flashlights, no batteries.



QUALITY BY

# Zenith

# THE OFF!

At Zenith we are growing weary of inventing and introducing new, novel and different television improvements—only to see them imitated years later by competitors who boast that they brought them to you or by competition disguising their imitations in new terminology and then claiming them in advertising as new—as exclusive—as their inventions.

**IMITATOR NO. 2** says in an advertisement in LIFE magazine

*"One touch changes channels and fine-tunes picture and sound electronically!"*  
It says . . . "EVEN BLINDFOLDED, YOU GET PERFECT TUNING."

## LET'S TAKE THE WHISKERS OFF!

The whiskers on this one have a nine-year growth dating back to 1948, when Zenith first introduced one-knob automatic station selection. New Zenith sets then, and now, are pre-tuned!

**IMITATOR NO. 2** also claims discovery of remote TV control

*This same ad in LIFE magazine also claims: "FIRST TRUE REMOTE CONTROL!" "... lets you change channels and soften sound . . ." "No wire stretching to set!" "No batteries!"*

*What they don't tell is that this gadget has to have wires running to the electric light line, and even then it will not turn the set "on" and "off" and will not completely mute the sound of long, annoying commercials while the picture remains on the screen as does Zenith Space Command Tuning.*

## LET'S TAKE THE WHISKERS OFF!

These whiskers sprouted seven years ago! In 1950 Zenith introduced, as mentioned above, "Lazy Bones" remote control . . . and since that time Zenith researchers and engineers have worked to develop and introduce the one remote TV control that obsoleted all others. This is Zenith Space Command Television, introduced to the public in 1956. With Space Command Tuning you can tune TV from anywhere in the room by "silent sound" . . . without wires, cords, batteries, transistors or flashlights!

ZENITH RADIO CORPORATION • CHICAGO 39, ILLINOIS

**THEY SAY** "imitation is the best form of flattery," but, do you blame us for getting weary of having competitors boast of, or claim as new, improvements which we invented and introduced, and have been supplying to the public for years?

The Royalty of  
RADIO, TELEVISION, HIGH FIDELITY AND HEARING AIDS

Backed by 38 years of leadership in Radionics exclusively



# NEW STANDARD OF PERFORMANCE



**SHURE  
STUDIO**

*Dynetic*

PHONO REPRODUCER

**IT TRACKS AT ONE GRAM!  
ITS FREQUENCY RESPONSE IS  
20 TO 20,000 CPS ( $\pm 2$ db)!**

## ONLY WITH THE STUDIO DYNETIC

- Record and needle wear are drastically reduced!
- You can completely avoid record scratches!
- You never have to level your turntable!
- You don't have to worry about groove-jumping!
- You can get superb fidelity, even from warped records!

You get the excellent response, low distortion and high compliance of dynamic cartridge construction, plus high output, minimum hum pick-up and the elimination of tone arm resonance and needle talk. There are also the additional benefits of the elimination of the pickup of low frequency rumble and motor noise. This superb unit sells for \$79.50 net. Your hi-fi dealer will be happy to arrange a demonstration.

**Write to Sales Department for  
reprints of informative,  
published articles.**

**SHURE**

*The Mark of Quality*

IN ELECTRONICS SINCE 1925

SHURE BROTHERS, INC., 212 HARTREY AVENUE, EVANSTON, ILL.

## Correspondence



### THE RIGID-CONE SPEAKER

Dear Editor:

Mr. Klipsch pays me a handsome compliment in his October article, but is rather unkind in calling me an elder statesman (Bernard Baruch or Winston Churchill type?). Damn it all, I'm not that old and I still feel full of energy and ideas. I cannot reply at length to his article at this moment. I had promised you a new analysis of speaker performance and this is being prepared; but perhaps I may suggest, with a sly grin, that Mr. Klipsch hasn't completed his course in hermeneutics. He is still being fooled by those carefully checked figures. He hasn't appreciated that they do apply only to speakers with paper cones.

My data, referred to in my first letter, was taken with Bakelite cones; hence the disagreement. The letter from Mr. Harold Luth (September) was, in my opinion, of great importance; what he wrote was what I believed. I have just returned from seeing what he is doing and all he has found confirms what I found—the paper cone is a dead dog.

It requires no great technical knowledge to understand that for a given size a rigid piston will push more air than a flexible one. A paper cone is a flexible piston, and when driven hard by the voice coil it folds up to some extent and so its air-pushing efficiency is lowered—some of the applied energy is dissipated in bending the cone instead of pushing the air. My prewar Bakelite cones were more rigid than paper, but had certain undesirable properties and that led me to revert to paper, but treated in various ways to make it a better piston material. This approach was demonstrated by the Hartley 215 speaker.

That speaker is well liked by a lot of people but it never satisfied me. Some said it had insufficient bass because it was too small. I believed it had insufficient bass because the cone wasn't stiff enough. The 217 speaker has a cone in which the paper is converted into something quite different, much more rigid, and without any other change in the speaker the undistorted output at very low frequencies went up more than 100%.

Luth revealed to me the fundamental principles of the work he has been doing. He proved to my satisfaction that, if one wholly rejects conventional notions of cone design, it is possible to achieve the most striking results. If a cone, a piston, does not distort in

# IMPROVE your AMPLIFIER in 5 ways

with the  
**Amperex®  
GZ34/5AR4**  
RECTIFIER

A LOW-IMPEDANCE, INDIRECTLY HEATED, FULL-WAVE RECTIFIER WITH 250 MA OUTPUT CAPACITY

The unique AMPEREX GZ34 replaces without circuit changes, in the majority of amplifier circuits, an entire line of popular, heavy-duty 5-volt rectifiers—5U4G, 5V4G, 5T4, etc. — with the following benefits:

- Better voltage regulation due to lowered power supply impedance;
- Higher power supply output voltage for more power;
- Added filter condenser protection due to reduced surge;
- Cooler operation due to lower voltage drop;
- Protection of costly power output tubes through delayed warm-up.

---

OTHER **Amperex TUBES** FOR HIGH-FIDELITY AUDIO APPLICATIONS:

EL84/6BQ5	9-pin power pentode; 17 W PP
6CA7/EL34	High-power pentode; 100 W PP
EF86/6Z67	Low-noise high- $\mu$ pentode
ECC81/12AT7	Low-noise medium- $\mu$ dual triode
ECC82/12AU7	Low-noise low- $\mu$ dual triode
ECC83/12AX7	Low-noise high- $\mu$ dual triode
ECC85/6AQ8	High- $\mu$ dual triode for FM tuners
EZ80/6V4	9-pin rectifier; cathode; 90 ma.
EZ81/6CA4	9-pin rectifier; cathode; 150 ma.

At All Leading Electronic Parts Distributors

**Amperex  
ELECTRONIC CORP.**  
230 Duffy Ave., Hicksville, Long Island, N.Y.



I chose **COYNE TELEVISION**  
**RADIO-COLOR TV**  
 home training because  
 Coyne has been training  
 men for good jobs OR  
 their **OWN BUSINESS** for  
**NEARLY 60 YEARS**

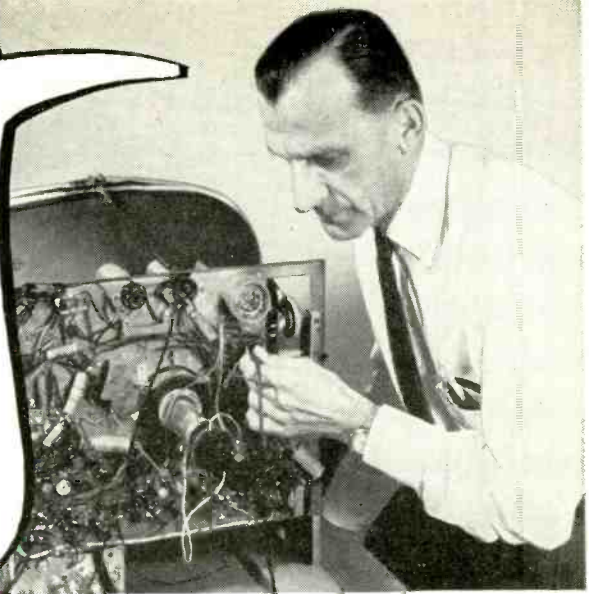

Giant opportunity field! Join the thousands Coyne Home Training is preparing for a successful future in TV—open the door to better pay jobs, or your own business! COYNE—a leading residential, practical school—oldest of its kind—established 1899—is the institution behind this training.

Here is **MODERN—QUALITY TELEVISION** Home Training designed to meet the rigid standards that have made Coyne famous. You get personal supervision of Coyne Staff who know TV and know how to teach. **Learn quickly and easily in spare time.** No previous experience or advanced education necessary.

I chose **COYNE** because  
 their new method costs less  
 than half what most others do!



**SEND COUPON FOR FREE BOOK**

Send coupon below for all-new fully-illustrated book and full details including **EASY PAYMENT PLAN. NO COST OR OBLIGATION—NO SALESMAN WILL CALL**

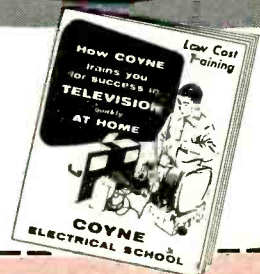

Modern, up-to-the-minute. Easy to follow, step-by-step instructions—fully illustrated with 2150 photos and diagrams. **UHF and COLOR-TV included.** So practical you can quickly earn extra money in TV-Radio Sales and Service. Not only Coyne Quality training, but costs *half* what you'd expect to pay because you pay only for training—no costly extras. Free life-time employment service.

B. W. Cooke, Jr.  
 President

**COYNE** Founded 1899  
**ELECTRICAL SCHOOL**

A TECHNICAL TRADE INSTITUTE OPERATED NOT FOR PROFIT  
 500 S. Paulina Dept. 18-H5 Chicago 12, Illinois

**COYNE TELEVISION  
 HOME TRAINING DIVISION  
 500 S. Paulina St., Chicago 12, Ill.  
 Dept. 18-H5**

Send **FREE** Book and details of your Television - Radio - Color TV Home Training offer.

Name \_\_\_\_\_  
 Address \_\_\_\_\_  
 City \_\_\_\_\_ State \_\_\_\_\_

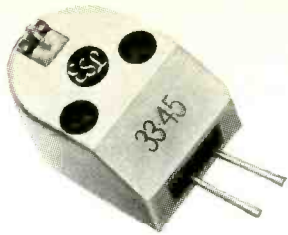

*fabulous!*

Would you like the greatest possible improvement in your hi-fi system at the lowest possible cost? Would you like to hear all the music on your records, the instruments and sounds you've been missing? Would you like to prolong the life of your valuable records and styli?

All this can be yours with the fabulous new ESL C-60 electrodynamic cartridge, as advanced as tomorrow's jet airliner and musical as a rare Stradivarius. Yet, the C-60 will easily drive all modern preamplifiers, and is ruggedly suitable for any record changer or arm. Only the C-60 has all these advantages:

- ▶ Frequency response flat within 1 db 18 cps to 20,000 cps (Elektra 35 test record)
- ▶ Response extends beyond 30,000 cps
- ▶ Minimum output 10 mv at 10 cm/sec
- ▶ Minimum compliance  $6.8 \times 10^{-6}$  cm/dyne
- ▶ Dynamic mass 1 mg
- ▶ IM distortion almost immeasurably small
- ▶ Vertical stylus force 2-6 gms
- ▶ Output impedance 40 ohms at all audio frequencies
- ▶ No transformer nor transistor amplifier ordinarily required
- ▶ Performance unaffected by load resistance
- ▶ Only \$39.50 net at your audio dealer's

After a single hearing, no other make of pickup can ever again satisfy. Be among the first to own the ESL C-60—the cartridge of tomorrow.

*magnificent!*

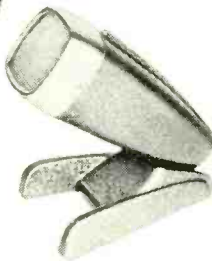

Microphone users are spreading the good news about ESL's new line of magnificent moving coil microphones at sensible prices. For every application, ESL has a low impedance microphone specifically designed to provide the highest quality of performance.

An example is the ESL MC-1 pictured above. This superb omnidirectional microphone will easily meet the most exacting professional requirements for music and speech, yet it lists for only \$80 complete with base.

- ▶ Frequency range 50 cps to 15,000 cps  $\pm 3$  db
- ▶ Internal impedance 200 ohms
- ▶ Output level -47 db re 1 mw/10 dynes/cm<sup>2</sup>
- ▶ Size  $4\frac{3}{4}$ " x  $1\frac{13}{16}$ " x  $1\frac{13}{16}$ "
- ▶ Weight 8 oz.

A catalog of the entire line of ESL moving coil microphones and accessories may be obtained free upon request.



FOR LISTENING AT ITS BEST

**Electro-Sonic Laboratories, Inc.**

Dept. E • 35-54 Thirty-sixth Street • Long Island City 6, N.Y.

CORRESPONDENCE (Continued)

shape when driven by the voice coil, there will be no distortion in the sound created by the moving air. This was an endorsement of the sort of thinking that has been in my mind for a long time, yet I did not allow myself to be fooled. I had to be convinced before I would go along with him. I was convinced.

Even so, Mr. Klipsch is right in his first statement: "Much air must be moved to radiate appreciable power at low frequencies." What he has not appreciated is that we are not bound to accept a paper cone as the only device to move the air. We might as well criticize the performance of an automobile after running it on kerosene. Adopt a rigid cone and the size of the speaker is not important, so long as enough air is moved. The Hartley-Luth 220 speaker introduced at the New York High Fidelity Show is a demonstration of the thought processes of its designers. The public can judge if we are crazy or not.

H. A. HARTLEY

"On tour"  
New York City

**WHOSE SATELLITE MODEL?**

Dear Editor:

Attached is an article which appeared in the *Chicago Sun-Times* on Saturday Oct. 12, 1957.

This article states that the Soviet journal *Young Technique* showed a cutaway diagram of an alleged Russian

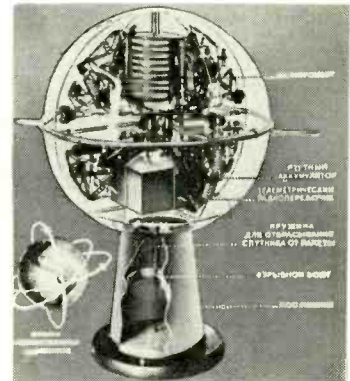

Wide World Photos

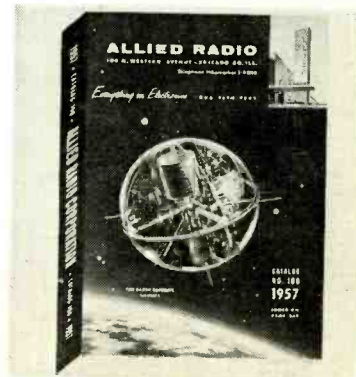

satellite, and reveals that the picture originally appeared in the January, 1956, issue of *Popular Science* and on the four-color cover of *Allied Radio's 1957 Catalog*. Many Chicago residents saw the plastic model in December,

# Learn TELEVISION-RADIO

## Servicing or Communications by Practicing at Home in Spare Time

WITHOUT EXTRA CHARGE you get special NRI kits developed to give actual experience with TV-Radio equipment. You build, test, experiment with receiver or broadcasting circuits. All equipment yours to keep.

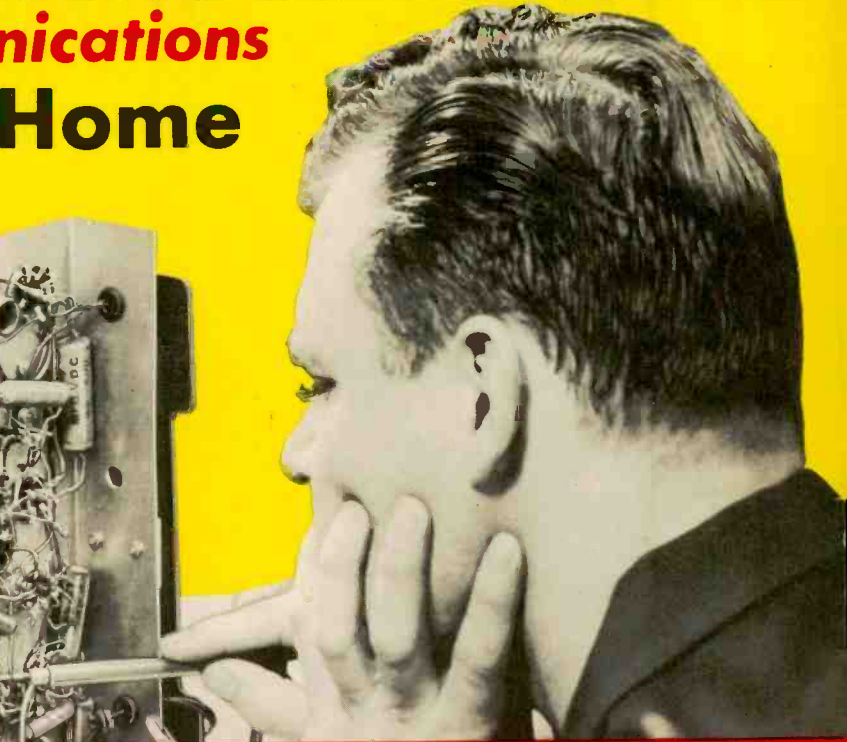

**NRI Has Trained Thousands for Successful Careers in TV-Radio**



**Studio Engr., Station KATV**  
"I am now Studio Engineer at Television Station KATV. Before enrolling for the NRI Course, I was held back by limitation of a sixth grade education." **BILLY SANCHEZ**, Pine Bluff, Ark.

**Has All the Work He Can Do**  
"Since finishing NRI Course I have repaired more than 2,000 TV and Radio sets a year. NRI training certainly proved to be a good foundation." **H. R. GORDON**, Milledgeville, Ga.

**Has Good Part Time Business**  
"Quite early in my training I started servicing sets. Now have completely equipped shop. My NRI training is the backbone of my progress." **E. A. BREDA**, Tacoma, Wash.

### Have the High Pay, Prestige, Good Future of a Skilled TV-Radio Technician

People look up to and depend on the Technician, more than ever before. Offices, plants, homes everywhere are obliged to buy his knowledge and services. His opportunities are great and are increasing. Become a TV-Radio Technician. At home, and in your spare time, you can learn to do this interesting, satisfying work—qualify for important pay. To ambitious men everywhere here in the fast growing Television-Radio field is rich promise of fascinating jobs, satisfaction and prestige as well as increasing personal prosperity.

### Increased Opportunities in Growing Field

A steady stream of new Electronic products is increasing the job and promotion opportunities for Television-Radio Technicians. Right now, a solid, proven field of opportunity for good pay is servicing the tens of millions of Television and Radio sets now in use. The hundreds of TV and Radio Stations on the air offer interesting jobs for Operators and Technicians.

### More Money Soon—Make \$10 to \$15 a Week Extra Fixing Sets in Spare Time

NRI students find it easy and profitable to start fixing sets for friends and neighbors a few months after enrolling. Picking up \$10, \$15 and more a week gives substantial extra spending money. Many who start in spare time soon build full time TV-Radio sales and service businesses.

**Act Now—See What NRI Can Do for You**

NRI has devoted over 40 years to developing simplified practical training methods. You train at home. Get practical experience, learn-by-doing. Address: NATIONAL RADIO INSTITUTE, Washington 16, D. C.

**The Tested Way To Better Pay** **See Other Side** **CUT OUT AND MAIL CARD NOW**

**SAMPLE LESSON AND CATALOG BOTH FREE** NO STAMP NEEDED!  
WE PAY POSTAGE

This card entitles you to Actual Lesson on Servicing, shows how you learn Television-Radio at home. You'll also receive 64-Page Catalog.  
**NATIONAL RADIO INSTITUTE, Dept. A Washington 16, D. C.**  
Please mail me the FREE sample lesson and 64-Page Catalog. (No Salesman will call.)  
Name..... Age.....  
Address.....  
City..... Zone..... State.....  
ACCREDITED MEMBER, NATIONAL HOME STUDY COUNCIL



**Technical "KNOW-HOW" Can Give You Interesting, Important Work  
LEARN-BY-DOING with Kits NRI Sends at No Extra Charge**



**YOU BUILD AC-DC Superhet Receiver**

NRI Servicing Course includes all needed parts. By introducing defects you get actual servicing experience practicing with this modern receiver. Learn-by-doing.



**YOU BUILD Signal Generator**

You build this Signal Generator. Learn how to compensate high frequency amplifiers, practice aligning typical I.F. amplifiers in receiver circuits. Make tests, conduct experiments.

**YOU BUILD Broadcasting Transmitter**

As part of NRI Communications Course you build this low power Transmitter, learn commercial broadcasting operators' methods, procedures. Train for your FCC Commercial Operator's License.

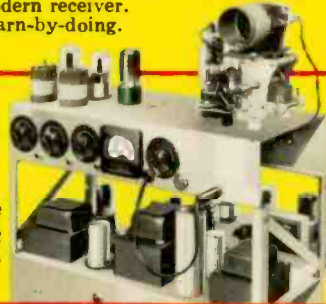

**YOU BUILD Vacuum Tube Voltmeter**

Use it to earn extra cash fixing neighbors' sets; bring to life theory you learn from NRI's easy-to-understand texts.



# For Higher Pay, Better Jobs Be a Television-Radio Technician



**Servicing Needs More Trained Men**

Portable TV, Hi-Fi, Transistor Radios, Color TV are making new demands for trained Technicians. Good opportunities for spare time earnings or a business of your own.

**Broadcasting Offers Satisfying Careers**

4000 TV and Radio stations offer interesting positions. Govt. Radio, Aviation, Police, Two-Way Communications are growing fields. Trained Radio-TV Operators have a bright future.



J. E. Smith, Founder

**Train at Home the NRI Way Famous for Over 40 Years**

NRI is America's oldest and largest home study Television-Radio school. The more than 40 years' experience training men for success, the outstanding record and reputation of this school—benefits you in many ways. NRI methods are tested, proven. Successful graduates are everywhere, from coast to coast, in small towns and big cities. You train in your own home, keep your present job while learning. Many successful NRI men did not finish high school. Let us send you an actual lesson, judge for yourself how easy it is to learn.

**No Experience Necessary—NRI Sends Many Kits for Practical Experience**

You don't have to know anything about electricity or Radio to understand and succeed with NRI Courses. Clearly written, well-illustrated NRI lessons teach TV-Radio-Electronic principles. You get NRI kits for actual experience. All equipment is yours to keep. You learn-by-doing. Mailing the postage-free card may be one of the most important acts of your life. Do it now. Reasonable tuition. Low monthly payments available. Address: NATIONAL RADIO INSTITUTE, Washington 16, D. C.

**NRI Graduates Do Important Work**



**Now Quality Control Chief**  
"Had no other training in Radio before enrolling, obtained job working on TV amplifiers before finishing course. Now Quality Control Chief." T. R. FAVAROLO, Norwich, N. Y.

**NRI Course Easy to Understand**  
"I opened my own shop before receiving my diploma. I have had to hire extra help. I am independent in my own business." D. P. CRESSEY, Stockton, Cal.

**Works on Color-TV**  
"NRI changed my whole life. If I had not taken the course, probably would still be a fireman, struggling along. Now Control Supervisor at WRCA-TV." J. F. MELINE, New York, N. Y.

FIRST CLASS  
Permit No. 20-R  
(Sec. 34.9, P. L. & R.)  
Washington, D.C.

**BUSINESS REPLY CARD**

No Postage Stamp Necessary if Mailed in the United States

POSTAGE WILL BE PAID BY

NATIONAL RADIO INSTITUTE

Washington 16, D. C.

**SAMPLE LESSON  
64-page CATALOG  
both FREE**

**See Other Side  
for more  
information on  
the Tested Way  
to Better Pay**

# NEWS

## CORRESPONDENCE (Continued)

1955, when it was on display at the Chicago Museum of Science and Industry.

The photographs show the Soviet version and the Allied Radio Catalog cover, which was photographed from the displayed model.

J. W. RUBIN

Allied Radio Corp.

(The original model which was displayed in Chicago, weighed 25 pounds. It was built at a cost of \$150 by Herbert R. Pfister, associate editor of *Popular Science*.—Editor)

## DOPPLER DISTORTION

Dear Editor:

The latest round shows the complete state of superstition existing in some minds. Mr. Luth ("More About Speakers", page 18, September, 1957) implies a different cone material will eliminate doppler distortion. It must be pointed out, repeated and emphasized that doppler distortion is a function of a moving sheet of air, not a fault of a speaker. Regardless of how the air is moved, with a plutonium diaphragm or just some more air, the fact that it is in motion produces the frequency modulation. Thus the solution lies in reducing the amplitude and velocity of motion by increase in area. Obviously — or is it obvious when everybody seems to want to belabor the point — if the distortion is due to air in motion, the diaphragm material cannot affect this form of distortion, be it either paper, glass, lead or Styro-foam.

To reiterate, doppler frequency distortion is a function of the air in motion, regardless of how it is caused to move.

For the late readers, this is about the frequency modulation of one frequency by another. A sheet of air, as moved by a cone speaker, for example, or by any other means, carrying simultaneously some low frequency (like 50 cycles) and some higher frequency (like 500 cycles) will produce a frequency shift of a higher frequency in the form of a flutter at the lower frequency. A motion of .06 inch of the sheet of air at 50 cycles will produce about 1% peak-to-peak frequency shift or flutter, an amount which is plainly audible.

The obvious remedy is to increase the area so a given amount of energy can be radiated at a lower energy density per unit area. The pressure-velocity transforming function of a horn is useful in accomplishing this. In well designed horns the diaphragm needs to move through only a slight excursion; and the virtual diaphragm at the horn mouth (simply a sheet of air) can be several square feet in area and transmit up to an acoustic watt or more with negligible distortion, even at very low frequencies.

Hope, Ark.

PAUL W. KLIPSCH  
END

JANUARY, 1958

21

## New AM-FM Tuner puts wide band FM, wide range AM within your budget!

Completely new in styling . . . in engineering . . . in performance . . . the H. H. Scott model 300 AM-FM tuner embodies many new engineering features found nowhere else.

- Selectivity is superior to conventionally designed tuners because of the wide-band detector.
- Circuitry is completely drift-free . . . without the need for troublesome AFC.
- Cross-modulation is minimized so strong local stations do not appear at several points on the dial.
- AM section features wide-range circuitry. Reception is so good on fine AM stations you'll think you are listening to FM.

When you tune the H. H. Scott 300 to a weak FM station next to a strong one, it stays in tune perfectly. Ordinary tuners using AFC rather than Wide-Band, wander from the weak station to the strong, making it impossible to tune to weak stations. Smooth acting slide-rule dial is extra-long giving better band spread, so stations are easy to separate.



Precision-ray tuning eye makes it simple to tune precisely on both AM and FM.

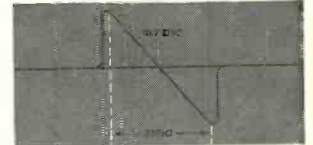

Wide-band FM circuitry eliminates co-channel and adjacent channel interference — makes tuning drift-free.



Famous musicians like Metropolitan Opera singer Jerome Hines choose H. H. Scott components for their own homes.

### Additional Technical Information — Model 300

FM sensitivity 3 microvolts for 20 db of quieting; 2 megacycle wide-band detector; 10 kc sharp-tuned whistle filter; outputs — main, multiplex, tape; tuned RF stage insures high sensitivity and selectivity on both AM and FM; two position AM bandwidth for Normal and High Fidelity programs; size in mahogany accessory case 15½ w x 5 h x 12½ d. \$159.95. Choice of handsome accessory cases at \$9.95 and \$19.95.



The new 300 is a perfect match to H. H. Scott's Best Buy Amplifier . . . the famous "99". This 22 watt complete amplifier is only \$109.95. This means that for only \$269.90 you can have a complete H. H. Scott system.



H. H. Scott, 111 Powdermill Road, Maynard, Mass.

Export Dept: E-1 Telesco International Corp.,  
36 West 40th Street, New York City

NAME.....  
ADDRESS.....  
CITY.....STATE.....



www.americanradiohistory.com

# BELL TELEPHONE LABORATORIES DEVELOPS NEW COMPACT COMPUTER FOR U. S. AIR FORCE

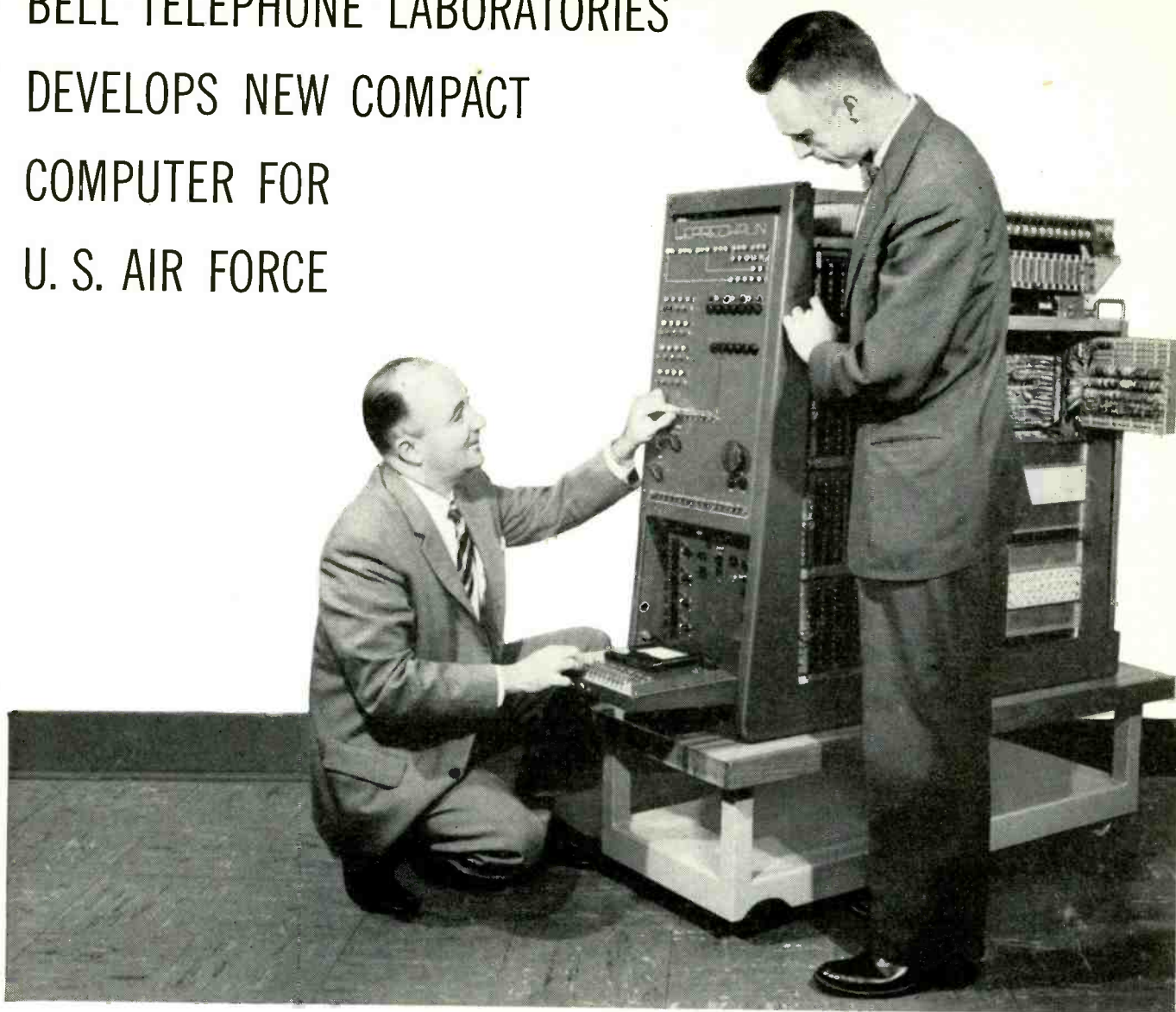

J. A. Githens, B.S. in E.E., Drexel Institute of Technology, and J. A. Baird, Ph.D. in E.E., Texas A. & M., check the control panel of Leprechaun, a new high-speed computer which solves extremely complex problems in one-tenth of a second. Small size and low power are made possible by new design principles and Bell Laboratories' invention of the transistor.

The United States Air Force assigned Bell Labs an interesting assignment: develop a new kind of electronic computer. The major requirement was greater simplicity. Of course, no computer is simple, but this one (known as "Leprechaun" to its designers) is much smaller and simpler than most of the computers currently in use.

It has only some 9000 electrical components; 5000 of them are transistors. As a result, Lepre-

chaun has less than one-third the components of conventional computers. This facilitates testing, experimentation, assembly and service.

Even in its experimental state, Leprechaun is a stimulating example of great strides in the simplification and miniaturization of circuitry . . . a problem of profound interest to all Bell Laboratories researchers as they develop radically new equipment for your future telephone service.

**BELL TELEPHONE LABORATORIES**



WORLD CENTER OF COMMUNICATIONS RESEARCH AND DEVELOPMENT

Learn **PRACTICAL RADIO-TV**  
with **25 BIG KITS**

of equipment I send you while  
you train with me . . . for valuable  
shop bench experience . . .

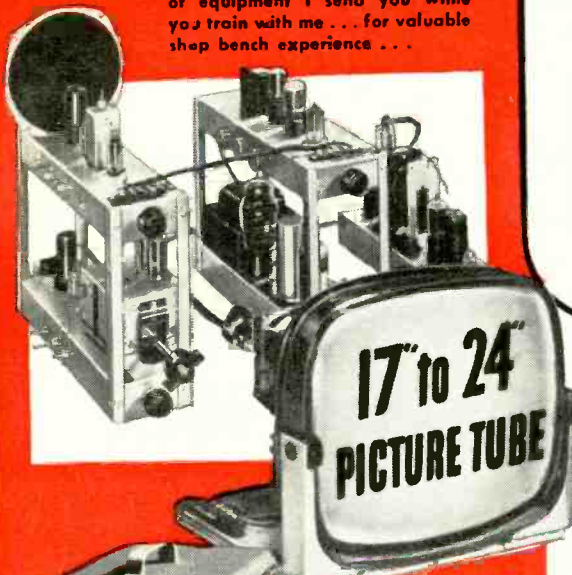

This is the new Sprayberry Training Television receiver, built and tested in sections for greatest instruction value.

I now offer this fine modern oscilloscope to help you learn practical Television servicing.

You will build this powerful short wave and broadcast superhet radio receiver for valuable shop instruction practice.

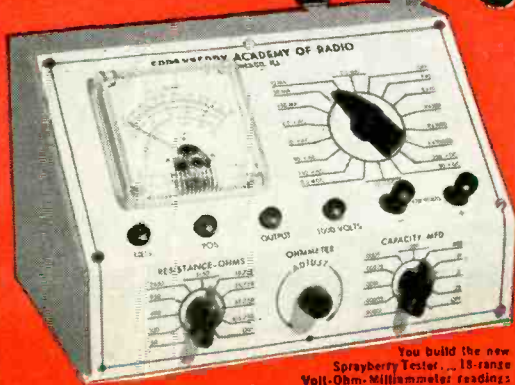
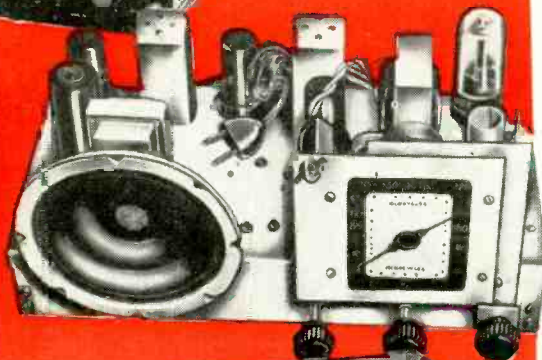

You build the new Sprayberry Tester . . . 18-range Volt-Ohm-Milliammeter readings plus output meter and condenser and resistor substitution selector.

Average cost per lesson  
**ONLY \$3.42**  
Including Kits and Equipment

**Clip and Mail the Coupon Below—Now!**

**Train in Spare Hours at Home  
for the Best Jobs and Big Pay in**

# Radio-Television

**—my new, faster way!**

**Want Proof? Send for my  
big FREE CATALOG and  
Sample Lesson. Let the facts  
speak for themselves!**



Frank L. Sprayberry  
Educational Director

Why wait—get into Radio-Television fast! I will train you in as little as 10 months to step into the top paying Radio-Television field as a much-needed Service Technician! You will train entirely at home in your spare time . . . which means you can train as fast or as slowly as you like. You have a choice of **THREE** Sprayberry Training Plans . . . one *exactly* suited to your needs. My easier-than-ever payment terms make it possible for you to get set for the good jobs in Radio-Television without the slightest strain on your budget! Get the true facts . . . just mail the coupon for my big new 56 page fact-filled catalog plus actual sample lesson—both **FREE**.

**REALLY PRACTICAL TRAINING—NO PREVIOUS EXPERIENCE NEEDED**

My students do better because I train both the mind and the hands. Sprayberry Training is offered in 25 individual training units, each includes a practice giving kit of parts and equipment . . . all yours to keep. You will gain priceless practical experience building the specially engineered Sprayberry Television Training Receiver, Two-Band Radio Set, Signal Generator, Audio Tester and the new Sprayberry 18 range Multi-Tester, plus other test units. You will have a complete set of Radio-TV test equipment to start your own shop. My lessons are regularly revised and every important new development is covered. My graduates are completely trained Radio-Television Service Technicians.

**NEWEST DEVELOPMENTS**

Your training covers U H F, Color Television, F M, Oscilloscope Servicing, High Fidelity Sound and Transistors.

**MAIL THE COUPON—See what's ahead in Radio-TV . . . No Salesman Will Call On You!**

The coupon below brings you my big new catalog plus an actual sample Sprayberry Lesson. I invite you to read the facts . . . to see that I actually illustrate every item in my training. With the facts in your hands, you will be able to decide. No salesman will call on you. The coupon places you under no obligation. Mail it now, today, and get ready for your place in Radio-Television.

**SPRAYBERRY ACADEMY OF RADIO-TELEVISION**

1512 Jarvis Avenue, Dept. 20-C, Chicago 26, Illinois

**Mail This Coupon For Free Facts and Sample Lesson**

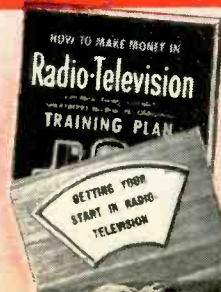

SPRAYBERRY ACADEMY OF RADIO-TELEVISION  
1512 Jarvis Ave., Dept. 20-C, Chicago 26, Ill.

Please rush all information on your **ALL-NEW** Radio-Television Training Plan. I understand this does not obligate me and that no salesman will call upon me. Include New Catalog and Sample Lesson **FREE**.

Name \_\_\_\_\_ Age \_\_\_\_\_  
Address \_\_\_\_\_  
City \_\_\_\_\_ Zone \_\_\_\_\_ State \_\_\_\_\_

# how long would it take you to solve this service problem?

**SYMPTOM:** Smearing Picture  
(showing black streaks trailing  
from blacks)

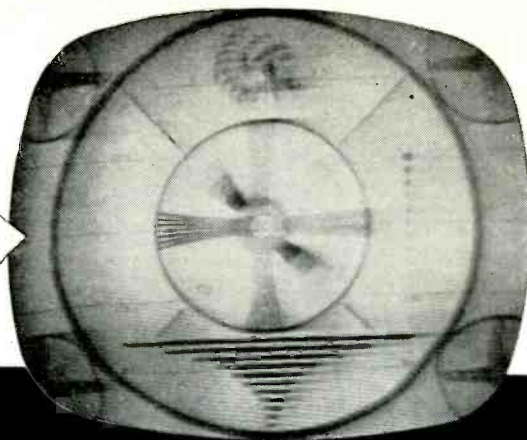

**PHOTOFACT** helps you lick problems like this  
in just minutes for only  
*\* 2½¢* per model!

Let's take a look at this problem: A smeared picture such as illustrated above is caused by excessive low-frequency response coupled with poor high-frequency response. Look for the following possible causes:

1. Defective video amplifier, video output, or Picture tube
2. Low value of coupling capacitor C51 or C53
3. Low value of grid resistor R46 or R52
4. Open cathode bypass capacitor C50 or C52
5. Open series-peaking coil L23 or L21
6. High value of plate resistor R44, R48 or R49

With the applicable PHOTOFACT Folder at your fingertips, you trouble-shoot and solve this problem in just seconds. Here's how:

Check the Video Detector (V7) and the Video Amplifier (V8). Just refer to the Tube Placement Chart (you'll find it in every PHOTOFACT TV Folder) for quick location of these tubes.

Use the servicing method you prefer—checking of waveform, voltage or resistance—you'll find all the information you need at your finger-tips in PHOTOFACT. For only \*2½¢ per model, PHOTOFACT helps you solve your service problems in just minutes—helps you service more sets and earn more daily!

\*Based on the average number of models covered in a single set of PHOTOFACT Folders.

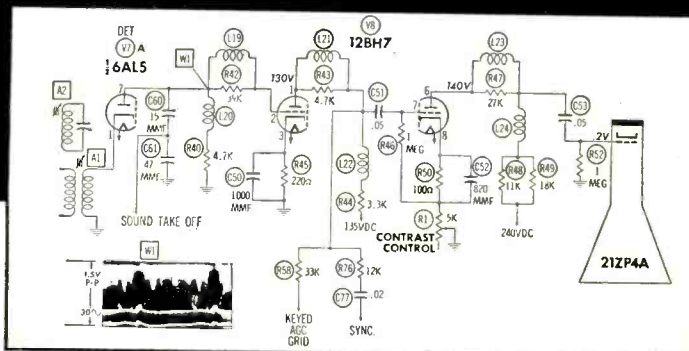

(Based on an actual case history taken from the Howard W. Sams book "TV Servicing Guide")

Tubes okay?—then: Check the waveform at pin 7 of V7. The correct waveform is shown right on the PHOTOFACT Standard Notation Schematic. Waveform correct?—then: Check the voltages in the Video amplifier and Video output stages to determine which part is defective. The correct voltages appear right on the exclusive Standard Notation Schematic, along with resistances (shown in easy-to-read chart form). Exclusive PHOTOFACT chassis photos with "call-outs" keyed to the schematic help you locate the faulty parts in just minutes.

Whatever the trouble, you'll locate it faster and easier with a PHOTOFACT Folder by your side. Be sure to use the complete Replacement Parts List to select the proper replacement for the repair.



**MONEY BACK  
GUARANTEE!**

Got a tough repair? Try this—at Howard W. Sams' own risk: see your Parts Distributor and buy the proper PHOTOFACT Folder Set covering the receiver. Then use it on the actual repair. If PHOTOFACT doesn't save you time, doesn't make the job easier and more profitable for you, Howard W. Sams wants you to return the complete Folder Set direct to him and he'll refund your purchase price promptly. GET THE PROOF FOR YOURSELF—TRY PHOTOFACT NOW!

**FREE**



**FOR SERVICE  
TECHNICIANS ONLY**

Fill out and mail coupon today for Free subscription to the Sams Photofact Index—your up-to-date guide to virtually any receiver model ever to come into your shop. Send coupon now.

**HOWARD W. SAMs & CO., INC.**

Howard W. Sams & Co., Inc.  
2205 E. 46th St., Indianapolis 5, Ind.

Put me on your mailing list to receive the Sams Photofact Index and Supplements. My (letterhead) (business card) is attached.

I'm a Service Technician:  full time;  part time

My Distributor is: \_\_\_\_\_

Shop Name \_\_\_\_\_

Attn: \_\_\_\_\_

Address: \_\_\_\_\_

City \_\_\_\_\_ Zone \_\_\_\_\_ State \_\_\_\_\_



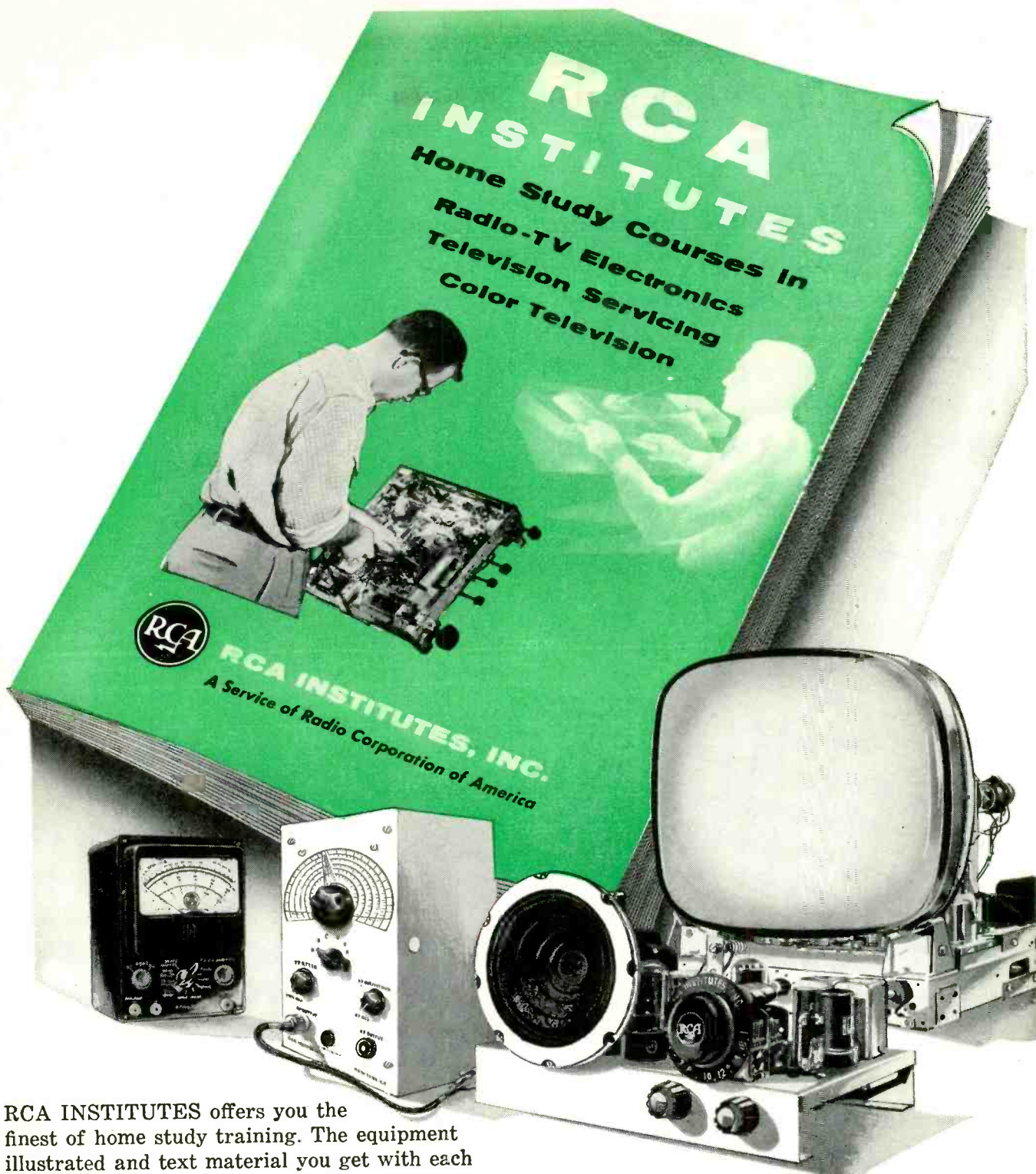

RCA INSTITUTES offers you the finest of home study training. The equipment illustrated and text material you get with each course is yours to keep. Practical work with very first lesson. Courses for the beginner and the advanced student. Pay-as-you-learn. You need pay for only one study group at a time.

**Send for this  
FREE Book Now** 

[ RESIDENT SCHOOL courses in New York City offer comprehensive training in Television and Electronics. Day and evening classes start four times each year. Detailed information on request ]

**RCA INSTITUTES, Inc. Home Study Dept. RE-18**

350 West Fourth Street, New York 14, N. Y.

Without obligation, send me FREE 52 page CATALOG on Home Study Courses in Radio, Television and Color TV. No salesman will call.

Name ..... please print

Address .....

City ..... Zone ..... State .....

Korean Vets! Enter discharge date .....

In Canada — RCA Victor Co., Ltd.  
5001 Cote de Liesse Rd., Montreal 9, Que.

To save time, paste coupon on postcard.

# ROHN TOWERS cover 3 fields

*Bigger Profits for You!*



Rohn Manufacturing Company is the largest *exclusive* manufacturer of home television towers! Thousands of distributors, dealers and servicemen have handled, sold and installed Rohn Towers for years! They've proved to themselves that *there's more money in Rohn Towers and accessories than any other line!* Rohn Towers now *dominate the field* and profits for those handling this line are better than ever. Why? Because Rohn offers profits in all 3 major tower fields:

# 1

## HOME TV

By far the biggest usage of Rohn products has been and still is for home TV installations. In addition to finest of self-supporting towers, the Rohn line includes telescoping masts, tubing, roof towers and all other types of accessories for installations of all kinds. Wise dealers and servicemen rely *entirely* on the Rohn line for *all* installation requirements. This means **BIGGER PROFITS.**

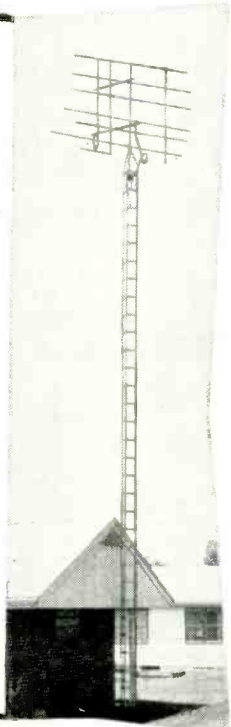

# 2

## COMMUNICATIONS

Many distributors, dealers and servicemen are making **EXTRA PROFITS** by stocking or handling the heavier type Rohn Towers that are suitable for communications purposes. There is a demand in *every area* for radio communications towers, micro-wave towers, radio telephone towers and industrial towers. You can supply this need in your area. Special new literature is available for your use.



# 3

## AMATEUR USE

Another major field of usage for Rohn Towers is in the field of amateurs and experimenters. The especially designed "fold-over" tower is the *best in the field* for the amateur because it allows working on the antenna *on the ground*. Thousands of amateurs use Rohn Towers with a tremendous demand still to be sold. You can supply this demand in your area and capture **BIG PROFITS** for yourself.

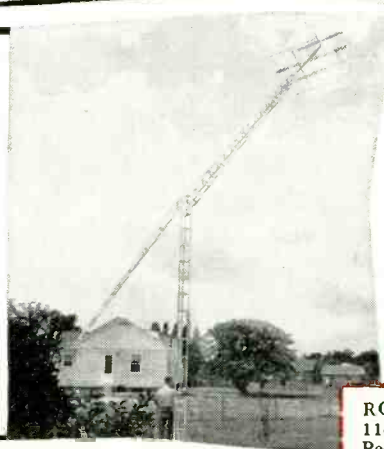

## look at these ROHN exclusives

- **HOT DIPPED GALVANIZED**

The finest, most durable finish is available for ROHN Towers and accessories . . . all done entirely on the ROHN premises under careful ROHN supervision.

- **UNEQUALLED DESIGN AND ENGINEERING**

ROHN is the only design that has stood up over the years. ROHN has been first and foremost . . . and always the *leader* in new products to meet the changing demands.

- **MASS PRODUCTION FOR LOW COSTS**

ROHN was the first to utilize mass production techniques to build a superior tower at the most competitive prices. This means no sacrifice in quality yet far greater profits for you.

- **UNIVERSAL CUSTOMER ACCEPTANCE**

Thousands and thousands of installations prove the ROHN line first in customer satisfaction.

- **PIONEER MANUFACTURERS**

Pioneers in tower manufacturing—and today one of the world's largest manufacturers of this type equipment. The ROHN Company was built on satisfaction on the part of distributor, dealer and customer alike.

- **COMPLETE LINE**

Only ROHN offers a full line—*one* dependable one-stop source for all TV installation equipment. Save headaches, save shipping costs, save time . . . use ROHN unequalled service *exclusively*.

Send the coupon or write or phone today for the field that you are neglecting or those that interest you the most. ▶

## ROHN Manufacturing Company

116 LIMESTONE, BELLEVUE  
PEORIA, ILLINOIS Phone 4-9156

ROHN MANUFACTURING COMPANY  
116 Limestone, Bellevue  
Peoria, Illinois

GENTLEMEN: Please send me the catalog and information on the following:

TV Towers  Amateur Towers  
 Communications Towers  Full line  
of Rohn products

NAME \_\_\_\_\_

FIRM \_\_\_\_\_

ADDRESS \_\_\_\_\_

CITY \_\_\_\_\_ STATE \_\_\_\_\_

# MAKE MORE MONEY in ELECTRONICS COMMUNICATIONS with an F.C.C. LICENSE

## The Key to Better Jobs

An F.C.C. commercial (not amateur) license is your ticket to higher pay and more interesting employment. This license is Federal Government evidence of your qualifications in electronics. Employers are eager to hire licensed technicians.

## Learn by Mail or in Resident Classes

Grantham School of Electronics specializes in preparing students to pass F.C.C. examinations. Correspondence training is conducted from Washington and Hollywood; resident DAY and EVENING classes are held in both cities. Either way, we train you quickly and well — NO previous training required. A beginner may qualify for his first class F.C.C. license in as little as 12 weeks.

This booklet  
**FREE!**

This free booklet gives details of our training and explains what an F.C.C. license can do for your future. Send for your copy today.



## Here's Proof...

that Grantham Students prepare for F.C.C. examinations in a minimum of time. Here is a list of a few of our recent graduates, the class of license they got, and how long it took them:

	License	Wks.
Douglas Moore, 5102 Flambeau Rd., Madison, Wisc.	1st	11
Bernard Kirschner, 504 E. 5th, New York, N.Y.	1st	12
Albert D. Meeleib, Box 136, Elrama, Pa.	1st	12
Dan Breece, Station KOVE, Lander, Wyo.	1st	12
Richard Meelan, 166 Jerome St., Brooklyn, N.Y.	1st	10
Leo Bishop, 37 Calle Contenta, Flagstaff, Ariz.	1st	12
Carl Deare, Jr., P.O. Box 467, Jeanerette, La.	1st	11
Jackson York, 1029 N. Quincy St., Arlington, Va.	1st	15

# Grantham School OF ELECTRONICS

Hollywood  
Division

1505 N. Western Ave.  
Hollywood 27, Calif.  
Phone: HO 2-1411

Washington D.C.  
Division

821 - 19th Street, N.W.  
Washington 6, D.C.  
Phone: ST 3-3614

for **FREE** Booklet **CLIP COUPON** and  
mail in envelope or paste on postal card.

## MAIL COUPON TO SCHOOL NEAREST YOU

Grantham Schools, Desk 84-A

821 - 19th Street N.W.  
Washington 6, D.C.

OR

1505 N. Western Ave.  
Hollywood 27, Calif.

Please send me your free booklet telling how I can get my commercial F.C.C. license quickly. I understand there is no obligation and no salesman will call.

Name \_\_\_\_\_ Age \_\_\_\_\_

Address \_\_\_\_\_

City \_\_\_\_\_ State \_\_\_\_\_

I am interested in:  Home Study,  Resident Classes

# UNIVERSITY ANNOUNCES THE VERSATILE MODEL CLH WIDE-ANGLE PROJECTOR

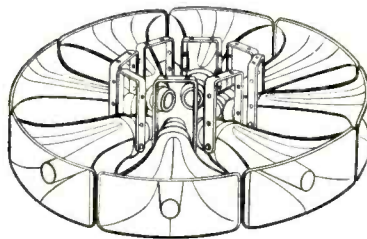

PATENTS  
PENDING

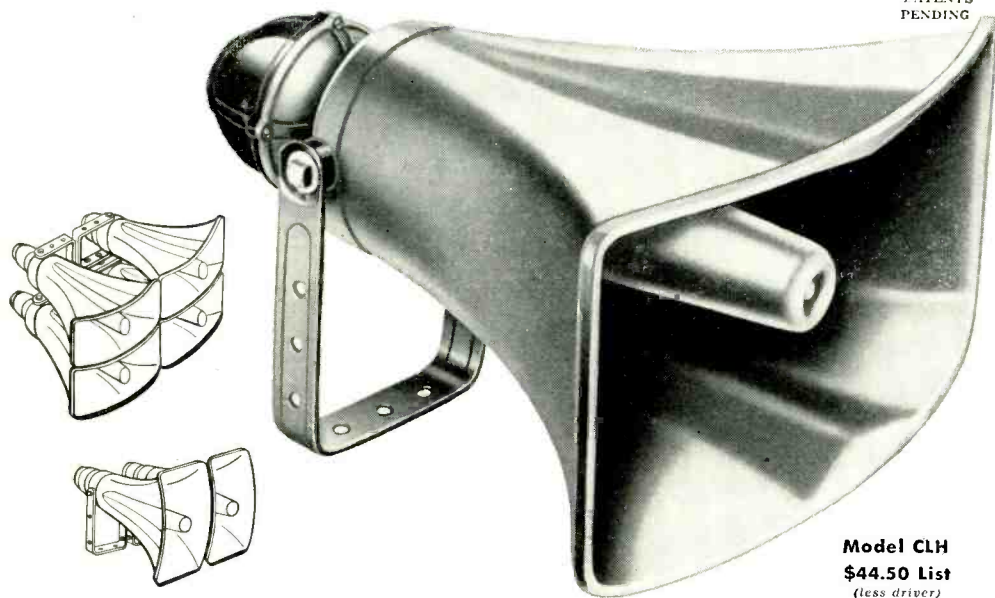

**Model CLH**  
\$44.50 List  
(less driver)

## EXCLUSIVE OMNI-DIRECTIONAL MOUNTING

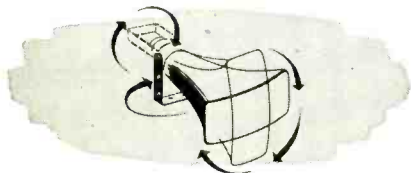

Horn bell rotates full 360° on its axis, while the 'U' mtg. bracket provides better than 180° vertical and 360° horizontal adjustment of projector positioning. Thus, sound can be distributed in any direction regardless of projector location.

## "TUNE OUT" ECHO & REVERBERATION

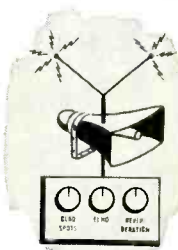

The unique *pin-point adjustment* possible with the CLH at last provides the long-awaited answer to coverage of "dead spots" and control over troublesome echo and reverberation—regardless of structural or physical placement limitations!

## USE SINGLY OR STACKED

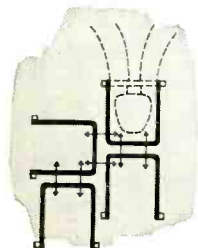

The 'U' mounting bracket of the Model CLH is specially designed to link two or more projectors into any configuration, achieving *exactly* the sound distribution pattern required. Even diagonal or alternating projections are just as easy to achieve as "standard" patterns.

**SPECIFICATIONS:** Air Column, 4 1/2 ft.; Horn Cut-off, 120 cps; Dispersion, 120° x 60°; Bell Mouth, 21 1/2" x 11 1/2"; Depth (less driver), 20"; \$44.50 List.

## VERSATILITY & ADAPTABILITY UNLIMITED



Meets every soundcasting requirement. Use the CLH wide-angle projector with any University driver to get exactly the frequency response, efficiency and power handling capacity you need. Here is dependable performance and *real economy*—for actual dollar savings you can count on year after year.

DELIVERY NOW  
FROM STOCK

THE MOST COMPLETE SELECTION  
OF DRIVERS IN THE INDUSTRY NOW  
AVAILABLE FOR USE WITH THE CLH



**Model PA-50.** Features extended high and low frequency range, highest continuous duty power capacity, greatest conversion efficiency, husky built-in multi-match transformer with terminals conveniently located at base of unit. The answer to the toughest sound problem. Nothing finer!

Response: 70 to 10,000 cps. Power Capacity: Full Range 30 watts; Adjusted Range\* 100 watts; List Price: \$57.50.



**Model PA-HF.** For applications requiring the greatest power handling capacity, maximum sensitivity, widest range frequency response, plus rugged lifetime construction. Completely die-cast aluminum housing. Increased sound output cuts amplifier requirements in half!

Response: 70 to 10,000 cps. Power Capacity: Full Range 50 watts; Adjusted Range\* 100 watts; List Price: \$47.50.



**Model SA-30.** "Battleship" construction for maximum durability against abuse or in hazardous environments. Completely die-cast aluminum housing and built-in matching transformer for connection to high impedance lines or "constant voltage" systems.

Response: 80 to 10,000 cps; Power Capacity: Full Range 30 watts; Adjusted Range\* 60 watts; List Price: \$47.50.



**Model SA-HF.** Will deliver that extra punch needed to cut through heavy noise. Use for speech or high quality music.

Response: 80 to 10,000 cps.; Power Capacity: Full Range 25 watts; Adjusted Range\* 60 watts; List Price: \$36.00.



**Model MA-25.** Low in cost, high in quality, featuring high efficiency magnet, tropicalized 2" voice coil, "rim-centered" breakdown-proof bakelite diaphragm.

Response: 85 to 6500 cps.; Power Capacity: Full Range 25 watts; Adjusted Range\* 50 watts; List Price: \$27.50.

\*Program response adjusted to horn cut-off.

## ACCESSORIES



**2YC Connector** enables two driver units to be used with one CLH trumpet for up to 200 watts output. Now you can get the Super-Power you want...when you want it, using standard stock drivers.

**PMA Adapter** fits standard 1/2" dia. threaded pipe to the CLH 'U' mounting bracket. Takes the headache out of mounting on pipe!

RADIO-ELECTRONICS

LISTEN

University sounds better



UNIVERSITY LOUDSPEAKERS, INC., 80 SOUTH KENSICO AVENUE, WHITE PLAINS, N. Y.

**NEW! 12-WATT Williamson-type HIGH FIDELITY INTEGRATED AMPLIFIER HF12**



with Preamplifier, Equalizer & Control Section

**KIT \$34<sup>95</sup> WIRED \$57<sup>95</sup>**

Compact, beautifully packaged & styled. Provides complete "front-end" facilities and true high fidelity performance. Direct tape head & magnetic phono inputs with NARTB (tape) & RIAA (phono) feedback equalizations. 6-tube circuit, dual triode for variable turnover bass & treble feedback-type tone controls. **Output Power:** 12 w cont., 25 w pk. **IM Dist.** (60 & 6000 cps @ 4:1): 1.5% @ 12 w; 0.55% @ 6 w; 0.3% @ 4 w. **Freq. Resp.:** 1 w;  $\pm 0.5$  db 25 cps - 20 kc. **Harmonic Dist:** 20 cps: 2% @ 4.2 w; 1/2% @ 2.5 w; 30 cps: 2% @ 11 w; 1/2% @ 6.3 w; 40 cps: 1% @ 12 w; 1/2% @ 9.3 w; 2000 cps: 1/2% @ 12 w; 10 kc: 1% @ 10 w; 1/2% @ 6 w. **Transient Resp:** excellent square wave reproduction (4 usec rise-time); negligible ringing, rapid settling on 10 kc square wave. **Inverse Feedback:** 20 db. **Stability Margin:** 12 db. **Damping Factor:** above 8, 20 cps - 15 kc. **Speaker Connections:** 4, 8, 16 ohms. **Tone Control Range:** @ 10 kc,  $\pm 13$  db; @ 50 cps,  $\pm 16$  db. **Tubes:** 2-EC83/12AX7, 1-EC82/12AU7, 2-EL84, 1-EZ81. **Size:** HWD: 3 3/4" x 12" x 8 1/4". 13 lbs. Mounts in or out of cabinet.

**NEW! 50-WATT Ultra-Linear HIGH FIDELITY POWER AMPLIFIER**

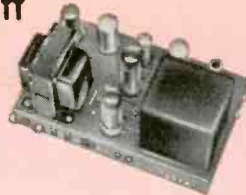

**HF50 KIT \$57<sup>95</sup> WIRED \$87<sup>95</sup>**

Like the HF60 shown below, the HF50 features virtually absolute stability, flawless transient response under either resistive or reactive (speaker) load, & no bounce or flutter under pulsed conditions. Extremely high quality output transformer with extensively interleaved windings, 4, 8, & 16 ohm speaker connections, grain-oriented steel, & fully potted in seamless steel case. Otherwise identical to HF60. **Output Power:** 50 w cont., 100 w pk. **IM Distortion** (60 & 6000 cps @ 4:1): below 1% at 50 w; 0.5% @ 45 w. **Harmonic Dist.:** below 0.5% between 20 cps & 20 kc within 1 db of rated power. **Freq. Resp.** at 1 w:  $\pm 0.5$  db 6 cps - 60 kc;  $\pm 0.1$  db 15 cps - 30 kc at any level from 1 mw to rated power; no peaking or raggedness outside audio range. All other specs identical to HF60 below. Matching cover Model E-2, \$4.50.



**NEW! 50-WATT Ultra-Linear HIGH-FIDELITY**

**INTEGRATED POWER AMPLIFIER HF52 with Preamplifier, Equalizer & Control Section**

**KIT \$69<sup>95</sup> WIRED \$109<sup>95</sup>**  
Combines a power amplifier section essentially identical to the HF50 power amplifier with a preamp-equalizer control section similar to HF20 below. Provision for use with electronic crossover network & additional amplifier(s). See HF50 for response & distortion specs; HF60 for square wave response, rise-time, inverse feedback, stability margin, damping factor, speaker connections; HF20 for preamplifier, equalizer & control section description. Hum & noise 60 db below rated output on magnetic phono input (8 mv input for rated output), & 75 db below rated output on high level inputs (0.6 v input for rated output). Matching cover Model E-1, \$4.50.

**The specs are the proof... 7 NEW BEST BUYS by**



**NEW HIGH FIDELITY PREAMPLIFIER**

#HF61A KIT \$24<sup>95</sup>, WIRED \$37<sup>95</sup>

With Power Supply: #HF61 KIT \$29<sup>95</sup>, WIRED \$44<sup>95</sup>

Will not add distortion or detract from the wide-band or transient response of the finest power amplifiers at any control settings. High quality feedback circuitry throughout plus the most complete control & switching facilities. Heavy-gauge solid brushed brass panel, concentric controls, one-piece brown enamel steel cabinet for lasting attractive appearance. Feedback-type, sharp cut-off (12 db/octave) scratch & rumble filters. Low-distortion feedback equalization: 5 most common recording curves for LPs & 78s including RIAA. Low-distortion feedback tone controls: provide large boost or cut in bass or treble with mid-freqs & volume unaffected. Centralab printed-circuit Senior "Compenrol" loudness control with concentric level control. 4 hi-level switched inputs (tuner, tv, tape, aux.) & 3 low-level inputs (separate front panel low-level input selector permits concurrent use of changer & turntable). Proper pick-up loading & attenuation provided for all quality cartridges. Hum bal. control. DC superimposed on filament supply. 4 convenience outlets. Extremely flat wideband freq. resp.:  $\pm 1$  db 8-100,000 cps;  $\pm 0.3$  db 12-50,000 cps. Extremely sensitive. Negligible hum, noise, harmonic or IM distortion. Size: 4-7/8" x 12-5/16" x 4-7/8". 8 lbs.

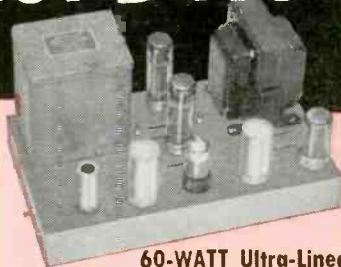

**NEW 60-WATT Ultra-Linear**

**HIGH FIDELITY POWER AMPLIFIER #HF60 with ACRO TO-330 OUTPUT TRANSFORMER**

**KIT \$72<sup>95</sup> WIRED \$99<sup>95</sup>**

Superlative performance, obtained through finest components & circuitry. EF86 low-noise voltage amplifier direct-coupled to 6SN7GTB cathode coupled phase inverter driving a pair of Ultra-Linear connected push-pull EL34 output tubes operated with fixed bias. **Rated power output:** 60 w (130 w peak). **IM Distortion** (60 & 6000 cps at 4:1): less than 1% at 60 w; less than 0.5% at 50 w. **Harmonic Distortion:** less than 0.5% at any freq. between 20 cps & 20 kc within 1 db of 60 w. **Sinusoidal Freq. Resp.:** at 1 w: 35 kc at any level from 1 mw to rated power; no peaking or raggedness outside audio range. **Square Wave Resp.:** excellent from 20 cps to 25 kc, 3 usec rise-time. **Sensitivity:** 0.55 v for 60 w. **Damping Factor:** 17. **Inverse Feedback:** 21 db. **Stability Margin:** 10 db. **Hum:** 90 db below rated output. **ACRO TO-330 Output Transformer** (fully potted). **Speaker Taps:** 4, 8, 16 ohms. **GZ34 extra-rugged rectifier** (indirectly-heated cathode eliminates high starting voltage on electrolytics & delays B+ until amplifier tubes warm up). **Input level control.** Panel mount fuse holder. Both bias and DC - balance adjustments. Std. octal socket provided for pre-amplifier power take-off. Size: 7" x 14" x 8". 30 lbs. Matching cover Model E-2 \$4.50.



**NEW COMPLETE with Preamplifier, Equalizer & Control Section 20-WATT Ultra-Linear Williamson-Type HIGH FIDELITY AMPLIFIER #HF-20**

**KIT \$49<sup>95</sup> WIRED \$79<sup>95</sup>**

A low-cost, complete-facility amplifier of the highest quality that sets a new standard of performance at the price, kit or wired. **Rated Power Output:** 20 w (34 w peak). **IM Distortion** (60 & 6000 cps/4:1) at rated power: 1.3%. **Max. Harmonic Distortion** between 20 & 20,000 cps at 1 db under rated power: approx. 1%. **Mid-band Harmonic Distortion** at rated power: 0.3%. **Power Response** (20 w):  $\pm 0.5$  db 20-20,000 cps;  $\pm 1.5$  db 10-40,000 cps. **Freq. Resp.** (1/4 w):  $\pm 0.5$  db 13-35,000 cps;  $\pm 1.5$  db 7-50,000 cps. 5 feedback equalizations for LPs & 78s. **Low-distortion feedback tone controls:** large boosts or cuts in bass or treble with mid-freqs. & volume unaffected. **Loudness control** & separate level set control on front panel. **Low Z** output to tape recorder. 4 hi-level switched inputs: tuner, tv, tape, aux; 2 low-level inputs for proper loading with all cartridges. **Hum bal. control.** DC superimposed on filament supply. **Extremely fine output transformer:** interleaved windings, tight coupling, careful balancing, grain-oriented steel. 8 1/2" x 15" x 10". 24 lbs. Matching cover Model E-1, \$4.50.

**NEW COMPLETE with FACTORY-BUILT CABINET - 2-WAY HI-FI SPEAKER SYSTEM #HFS1 \$39<sup>95</sup>**

See the "BEST BUYS" NOW IN STOCK at your nearest distributor. Fill out coupon on other side for FREE CATALOG.

Prices 5% higher on West Coast.



Genuine 2-way book-shelf size speaker system. Jensen heavy duty 8" woofer (6.8 oz. magnet) & matching Jensen compression-driver exponential horn tweeter with level control. Smooth clean bass & crisp extended highs free of coloration or artificial brilliance. **Factory-built** tuned bass reflex birch hardwood cabinet (not a kit) constructed to high quality standards. Neutral acoustical grille cloth framed by a smooth-randed solid birch molding. **Freq. Resp.** measured 2 ft. away on principal axis in anechoic chamber with 1 watt input - **Woofer:**  $\pm 4$  db 80-1800 cps; **Tweeter:**  $\pm 2$  db 2800-10,000 cps; **Crossover Region:** 1800-2800 cps, shift in level over this region depends on tweeter level control setting. **Power-handling capacity:** 25 watts. **Size:** 23"x11"x9". 25 lbs. **Wiring Time:** 15 min.

33-00 Northern Blvd., L.I.C. I, N.Y.



Turn page for other EICO ad.

the specs prove it . . .  
your **BEST BUY** is

**EICO**®

for COLOR & Monochrome TV servicing

**FREE CATALOG**

shows you **HOW TO SAVE 50%**  
on 50 models of top quality  
professional test equipment.  
**MAIL COUPON NOW!**



**NEW!**  
TV-FM SWEEP  
GENERATOR &  
MARKER #368

KIT \$69<sup>95</sup> WIRED \$119<sup>95</sup>

Entirely electronic sweep circuit (no mechanical devices) with accurately-biased inductor for excellent linearity. Extremely flat RF output; new AGC circuit automatically adjusts osc. for max. output on each band with min. ampl. variations. Exceptional tuning accuracy; edge-lit hairlines eliminate parallax. Swept Osc. Range 3-216 mc in 5 fund. bands. Variable Marker Range 2-75 mc in 3 fund. bands 60-225 mc on harmonic band. 4.5 mc Xtal Marker Osc., xtal supplied. Ext. Marker provision. Sweep Width 0-3 mc lowest max. deviation to 0-30 mc highest max. dev. 2-way blanking. Narrow range phasing. Attenuators: Marker Size, RF Fine, RF Coarse (4-step decade). Cables: output, "scope horiz.", "scope vertical. Deep-etched satin aluminum panel; rugged grey wrinkle steel cabinet.

**NEW! RF  
SIGNAL GENERATOR  
#324**

KIT \$26<sup>95</sup> WIRED \$39<sup>95</sup>



150 kc to 435 mc with ONE generator! Better value than generators selling at 2 or 3 times its cost! Ideal for IF-RF alignment, signal tracing & trouble-shooting of TV, FM, AM sets; marker gen.; 400 cps audio testing; lab. work. 6 fund. ranges: 150-400 kc, 400-1200 kc, 1.2-3.5 mc, 3.5-11 mc, 11-37 mc, 37-145 mc; 1 harmonic band 111-435 mc. Freq. accurate to ±1.5%; 6:1 vernier tuning & excellent spread at most important alignment freqs. Etched tuning dial, plexiglass windows, edge-lit hairlines. Colpitts RF osc. directly plate-modulated by K-follower for improved mod. Variable depth of int. mod. 0-50% by 400 cps Colpitts osc. Variable gain ext. amplifier: only 3.0 v needed for 30% mod. Turret-mounted coils slug-tuned for max. accuracy. Fine & Coarse (3-step) RF attenuators. RF output 100,000 uv; AF sine wave output to 10 v. 50-ohm output Z. 5-way jack-top binding posts for AF in/out; coaxial connector & shielded cable for RF out. 12AU7, 12AV7, selenium rectifier; xfr-operated. Deep-etched satin aluminum panel; rugged grey wrinkle steel cabinet.

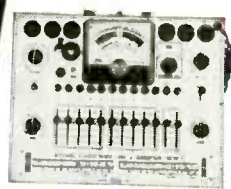

**NEW! DYNAMIC  
CONDUCTANCE  
TUBE & TRANSISTOR  
TESTER #666**  
KIT \$69<sup>95</sup> WIRED \$109<sup>95</sup>

**COMPLETE with steel cover and handle.**

SPEED, ease, unexcelled accuracy & thoroughness. Tests all receiving tubes (and picture tubes with adapter). Composite indication of Gm, Gp & peak emission. Simultaneous sel of any 1 of 4 combinations of 3 plate voltages, 3 screen voltages, 3 ranges of continuously variable grid voltage (with 5% accurate pot). New series-string voltages: for 600, 450, 300 ma types. Sensitive 200 ua meter, 5 ranges meter sensitivity (1% slunts & 5% pot). 10 SIX-position lever switches: (freepoint connection of each tube pin, 10 pushbuttons: rapid insert of any tube element in leakage test circuit & speedy sel. of individual sections of multi-section tubes in merit tests. Direct-reading of inter-element leakage in ohms. New gear-driven rollechart. Checks n-p-n & p-n-p transistors: separate meter readings of collector leakage current & Beta using internal dc power supply. Deep-etched satin aluminum panel; rugged grey wrinkle steel cabinet. CRA Adapter \$4.50



**NEW!**  
**COLOR**  
and Monochrome  
DC to 5 MC LAB & TV  
5" OSCILLOSCOPE  
#460

KIT \$79<sup>95</sup> WIRED \$129<sup>50</sup>

• Features DC Amplifiers!

Flat from DC-4.5 mc, usable to 10 mc. VERT. AMPL.: sens. 25 rms mv/in; input Z 3 megs; direct-coupled & push-pull thruout; K-follower coupling bet. stages; 4-step freq-compensated attenuator up to 1000:1. SWEEP: perfectly linear 10 cps-100 kc (ext. cap. for range to 1 cps); pre-set TV V & H positions; auto. sync. ampl. & lim. PLUS: direct or cap. coupling; bal. or unbal. inputs; edge-lit engraved lucite graph screen; dimmer; filter; bezel fits std photo equip. High intensity trace CRT. 0.06 usec rise time. Push-pull hor. ampl., flat to 400 kc, sens. 0.6 rms mv/in. Built-in volt. calib. Z-axis mod. Sawtooth & 60 cps outputs. Astig. control. Retrace blanking. Phasing control.



**NEW! PEAK-to-PEAK  
VTVM #232 & UNI-  
PROBE (pat. pend.)**

KIT \$29<sup>95</sup> WIRED \$49<sup>95</sup>

Half-turn of probe tip selects DC or AC-Ohms.

Uni-Probe - exclusive with EICO - only 1 probe performs all functions!

Latest circuitry, high sensitivity & precision, wide ranges & versatility. Calibration without removing from cabinet. New balanced bridge circuit. High Z input for negligible loading. 4 1/2" meter, can't burn-out circuit. 7 non-skip ranges on every function. 4 functions: +DC Volts, -DC Volts, AC Volts, Ohms. Uniform 3 to 1 scale ratio for extreme wide-range accuracy. Zero center. One zero-adj. for all functions & ranges. 1% precision ceramic multiplier resistors. Measure directly peak-to-peak voltage of complex & sine waves: 0-4, 14, 42, 140, 420, 1400, 4200. DC/RMS sine volts: 0-1.5, 5, 15, 50, 150, 500, 1500 (up to 30,000 v. with HVP probe & 250 mc with PRF probe). Ohms: 0.2 ohms to 1000 megs. 12AU7, 6AL5, selenium rectifier; xfr-operated. Deep-etched satin aluminum panel, rugged grey wrinkle steel cabinet.

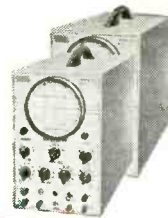

5" PUSH-PULL  
OSCILLOSCOPE  
#425  
KIT \$44.95  
Wired \$79.95



7" PUSH-PULL  
OSCILLOSCOPE  
#470  
KIT \$79.95  
Wired \$129.50



6V & 12V  
Battery Elim  
& Charger  
#1050:  
KIT \$29.95  
Wired \$38.95  
or transistorized eqpt, #1060:  
KIT \$38.95, Wired \$47.95



Sep. hi-gain RF  
& lo-gain audio  
inputs.  
Special noise  
locator. Calibra-  
ted wattmeter.  
KIT \$24.95  
Wired \$39.95



20,000 Ohms/Volt  
MULTIMETER #565  
KIT \$24.95  
Wired \$29.95



1000 Ohms/Volt  
MULTIMETER  
#536  
KIT \$12.90  
Wired \$14.90



Reads 0.5 ohms  
-500 megs, 10  
mmfd-5000 mfd,  
power factor.

R-C BRIDGE & R-C-L COMPARATOR  
#950B

VTVM PROBES	KIT	Wired
Peak-to-Peak	\$4.95	\$6.95
RF	\$3.75	\$4.95
High Voltage Probe-1		\$6.95
High Voltage Probe-2		\$4.95
SCOPE PROBES		
Demodulator	\$3.75	\$5.75
Direct	\$2.75	\$3.95
Low Capacity	\$3.75	\$5.75

TURN PAGE  
FOR MORE  
EICO VALUES

**EICO**®

Send for  
**FREE CATALOG**  
now

Prices 5% higher on West Coast.

33-00 Northern Blvd., Long Island City 1, N.Y.

EICO, 33-00 Northern Blvd.,  
Long Island City 1, N. Y. C-1  
Show me **HOW TO SAVE 50%** on Test Equip-  
ment and Hi-Fi. Send me **FREE Catalog** and  
name of neighborhood distributor.

Name.....  
Address.....  
City..... Zone..... State.....

# ELECTRONICS IN SPACE

. . . *The Space Age Will Bring Many Electronic Changes* . . .

**T**he Space Age, ushered in on Oct. 4, 1957, by the first man-made satellite, served a sharp and poignant notice on all technologists that henceforth their thinking must embrace a new viewpoint—outer space.

Since the dawn of humanity, man has been confined to the very bottom of a vast protective ocean—the atmosphere. Now he is venturing forth into airless space and into a vacuum far more perfect than any vacuum tube he has ever produced on earth. At the same time, he will be exposed to the fierce interstellar cold, not far from absolute zero (when screened from the sun), and, as if this were not sufficient, to an array of dangerous radiations ranging from cosmic to X-rays. Man's leap into space is certain to be far more exciting and have far greater consequences than Columbus' discovery of the New World.

A whole new and vastly complex space technology is now in the making. It affects every technician, whether he is a chemist, a metallurgist, a mechanical, electrical or electronics technician. All must revise their thinking if they do not wish to be left hopelessly behind.

Take such a comparatively simple space object as the Russian sputniks. Consider the electronic gear, the transmitter and receiver. Then reflect that while they are in the sun for 45 minutes, they become fiercely hot from solar radiation. Then for 45 minutes they travel in the earth's shadow, when if they remained there they would cool to below  $-200^{\circ}$  Fahrenheit! Fortunately, the satellite traveling at 18,000 miles an hour will acquire a mean temperature after a few revolutions around the earth. To further this, the Russians pumped an inert gas into their sputnik to keep the inside temperature from fluctuating too violently. Nevertheless, the transmitter's and receiver's components often undergo greater temperature stresses than on earth and must be engineered accordingly.

Much of this changes once we leave the warming rays of the sun. Suppose that—as will soon happen—a technical crew is working on the dark side of the moon. Here the night lasts for about 14 (earth) days. The temperature goes down to around  $-400^{\circ}$  F. soon after sundown. What will then happen to an exposed radio transmitter and receiver? You wouldn't, for instance, install electrolytic capacitors; they would cease operating long before the  $-400^{\circ}$  freeze. One must also consider the fact that at extreme low temperatures various electronic components become extremely brittle and have a tendency to fall apart. Batteries? The Leclanché carbon-manganese-zinc type is probably the most efficient in cold weather. At  $70^{\circ}$  we have a 100% capacity (output); at  $20^{\circ}$ , 48%; at  $0^{\circ}$ , 27%; at  $-20^{\circ}$ , 6%; at  $-400^{\circ}$ ? Long before that point is reached, they would have burst open. Hence, in the dark of interplanetary space we would have to use a different means of current supply, such as hand- or foot-operated generators or, more likely, in the near future, atomic batteries.

Curiously, too, as the temperature falls, our electronic circuits improve vastly—the colder it gets the lower the electrical resistance of a conductor. Finally, a few degrees above absolute zero ( $-459.72^{\circ}$  F.), many conductors lose all resistance—they become *superconductors*. On earth we al-

ready have superconductive circuits in which an induced electric current has been kept going without stopping for many months without any outside current supply!

If you ponder this statement—space-wise—you will appreciate what electronic revolutions are coming in the future. This does not mean that we will get electrical energy for nothing, but rather that we will get energy for less effort, at incredible efficiency.

In outer—or even nearby—space, the electronic technician will find other surprises. You do not need a *vacuum* tube in space—it will be far more efficient *without* the glass envelope. This holds true only if the tube is out in open space; it is not true within a pressurized spaceship.

Transistors, too, work efficiently at lower temperatures. They have been operated routinely by scientists down to  $-40^{\circ}$  F. where they perform quite well. What about transistors at near-absolute zero in the superconductivity region? We suspect that at such temperatures there will be some more electronic surprises—but right now this is strictly hush-hush information.

What about the comparatively new semiconductor, the solid-state solar cells? These cells are now being used increasingly in space rockets and will be used in most man-made satellites, replacing the old type dry-cell batteries. We talked about this with Bell Laboratories' Dr. D. M. Chapin, one of the inventors of the solar cell. On earth on a clear day, the average output of the cell is about 10 milliwatts per square centimeter. Above the atmosphere in airless space, there is 30% to 35% more radiation and at least part of this increase is in useful frequencies. *Also the voltage of the solar cells increases as the temperature decreases.* Thus, in space, the solar cell's output will be up considerably, generally speaking. This, then, means that future spaceships equipped with a bank of efficient solar-cell batteries will obtain much of their electrical energy directly from the sun.

At this point we should qualify some of the above statements regarding solar radiation. They hold true only in the vicinity of the earth's orbit. Near Mars, the solar energy from the sun is only 0.44 (earth is 1.00), while near Venus it is up to 2.04. Near Saturn's orbit, it is only .011. Finally, in the orbit of the outermost planet, Pluto, solar cells would be almost completely useless.

Nor would it be simple to communicate with a spaceship in the vicinity of Pluto. It would take an average of 6 hours and 25 minutes for a radio message to bridge the distance between Pluto and earth, or 12 hours and 50 minutes for a short two-way conversation.

Weightlessness in space, as far as humans are concerned, has never been explored except for short periods up to 30 seconds at a time. The first manned satellite will have at least one human completely wired with all sorts of electronic gear, from electroencephalic to cardiac, to study human physical and psychic behavior during extended states of weightlessness. From what we already know, zero gravity will probably benefit most individuals. Extended periods of the weightless state may even cure or ameliorate certain ailments and diseases. —H.G.

# The strange world of

# color vision

By **ROBERT G. MIDDLETON**

TELEVISION CONSULTANT

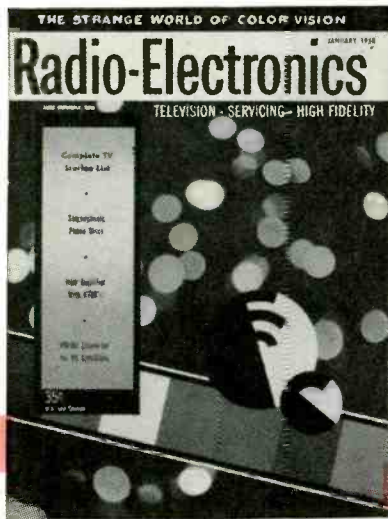

### THE COVER

Our cover this month is an abstraction based on a suggestion by Mr. Middleton to illustrate this article. The two odd-looking discs are used to produce sensations of color from black and white elements only. (See Fig. 6.) The bar slanting across the bottom is, of course, the color spectrum as most of us know it, and the upright panel is the color spectrum of a color-anomalous or "color-blind" person, whose world of color is based on stimuli from two instead of three primaries. The floating colored dots or bubbles, chosen to produce a random display of color, are actually a nighttime color photograph of colored lights on a Ferris Wheel deliberately shot out of focus. The picture was taken by Jay Maisel.

*Color is by no means simple—it is often incomprehensible and always tricky; but its apparent inconsistencies make compatible color television possible*

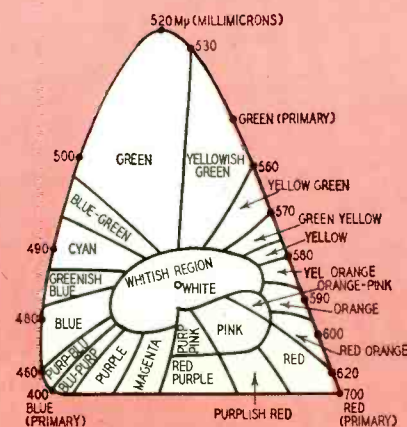
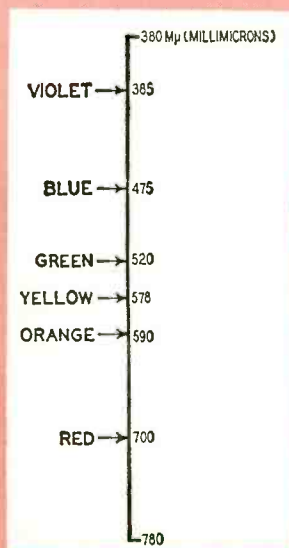

Fig. 2—The standard color map or chromaticity diagram. All colors are arranged around white as an optical center.

Fig. 1 — As wavelength of electromagnetic waves is raised from 380 to 780 millimicrons, we see in succession all the colors of the rainbow.

**C**HILDREN and simple folk suppose that the colors they see really exist in nature and scoff at the idea that colors exist only in the mind.

Physicists explain that the colors we see correspond to waves of electromagnetic energy from  $4$  to  $8 \times 10^{14}$  cycles per second. Electromagnetic waves used in radio and television transmission have longer wavelengths.

Of course, light waves are not *color*, any more than radio waves are color. Physicists do not attempt to explain further and physiologists cannot. Psychologists are baffled and philosophers offer various theories which cannot be proved or disproved.

In spite of the unsatisfactory state of our knowledge concerning color vision, many interesting laws have been discovered, upon which the technology of color television rests. Some of these laws are well known while others are familiar only to specialists.

### Trichromatic vision

Of all our body's organs, the eye is most remarkable. Loss of hearing is a personal tragedy but loss of sight is a calamity—our eyes provide us with more information concerning the external world than any other organ.



It was once supposed that the eye is a frequency-sensitive organ because we see various colors when electromagnetic waves of various frequencies enter the eye. As shown in Fig. 1, a wavelength of 475  $m\mu$  (millimicrons) causes us to see blue, 520  $m\mu$  green, 578  $m\mu$  yellow and 700  $m\mu$  to see red.

Fig. 1 shows in a limited manner the information given in Fig. 2. The chromaticity diagram (Fig. 2) shows around its border the wavelengths of light corresponding to the common colors. Note that there are colors along the base of the diagram to which no single wavelength of light corresponds. This is a rather unexpected fact which is discussed later in the article.

In view of such experimental data, it is reasonable to conclude that each color we see has a corresponding frequency or wavelength. However, there are difficulties which make this conclusion unacceptable.

When we mix red light with green light, we do not see either of these two colors. Instead we see a new color: yellow. On this basis, we must abandon the definition that yellow corresponds to a wavelength of 578  $m\mu$ , since yellow is also produced by a combination of two other wavelengths.

In fact, investigation has shown that the many thousands of colors which we see can be obtained by mixing only three colored lights—red, green and blue—in various proportions. Color television operates upon this law, the law of trichromatic vision. Fig. 3 illustrates how the primary colors of red, green and blue combine by pairs to form the complementary colors of yellow, cyan and magenta. Fig. 4 shows how the three primary colors combine to form white.

To obtain compatible operation of black-and-white and color TV receivers, wavelengths of light are transmitted as various phase angles of a color sub-carrier. This is shown in Fig. 5. Burst is taken as the reference frequency. Red, which has a wavelength of 700  $m\mu$ , is transmitted as a phase angle of 76.5°. Magenta, which is a combination of 700  $m\mu$  and 475  $m\mu$ , is transmitted as a phase angle of 119°.

The colors seen in the spectrum of a prism are 100% saturated. They are pure colors. Saturated colors are vivid. Desaturated colors are pale—they have a pastel shade. The wavelength of a desaturated color is the same as the wavelength of the same saturated color. However, white light is mixed with a saturated color to make a desaturated color. In Fig. 5, the relative voltages of the saturated colors are shown by the lengths of the vectors. Now, if we shorten the length of the red vector to half that shown in Fig. 5, we transmit pink—a desaturated red.

It is no mystery that hues are transmitted in terms of phase, and that saturations are transmitted in terms of voltage. These values are easily calculated throughout. We encounter the unknown only when we attempt to

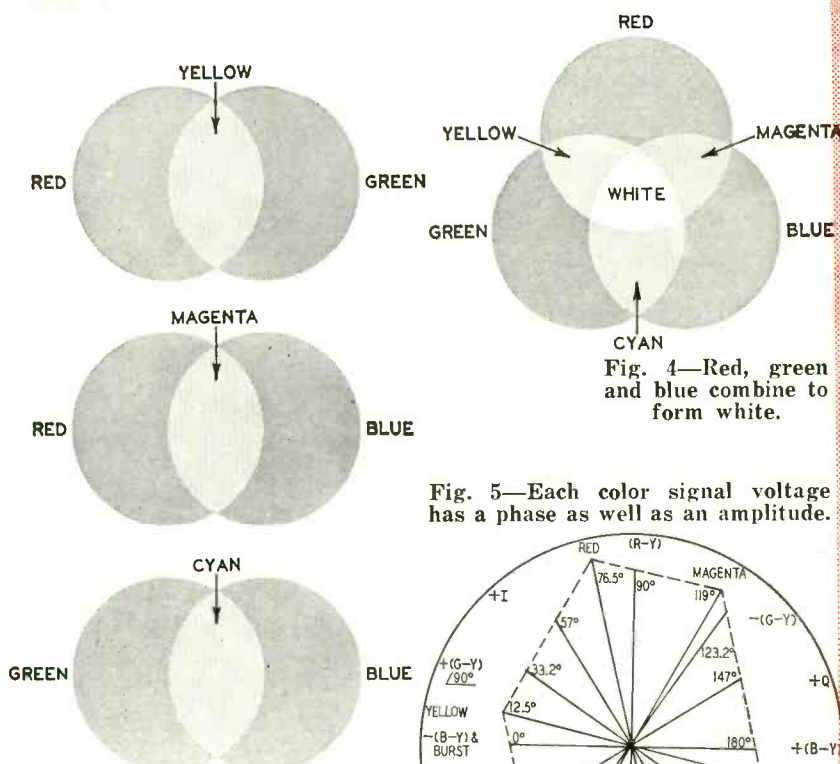

Fig. 3—Red and green combine to form yellow; red and blue combine to form magenta; green and blue combine to form cyan.

Fig. 4—Red, green and blue combine to form white.

Fig. 5—Each color signal voltage has a phase as well as an amplitude.

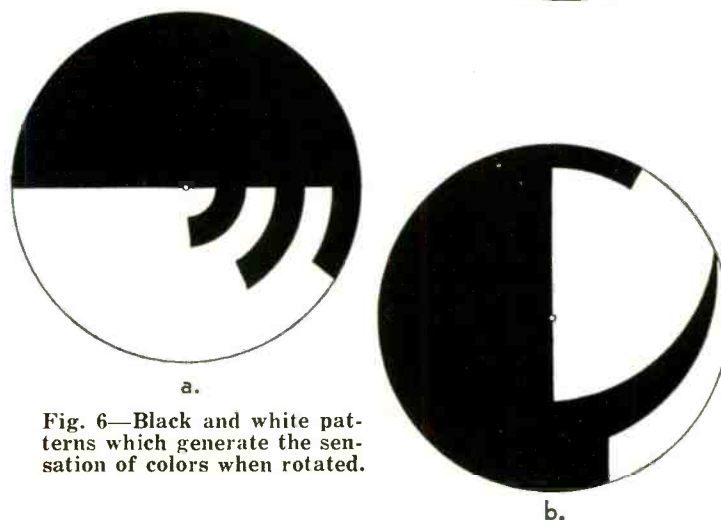
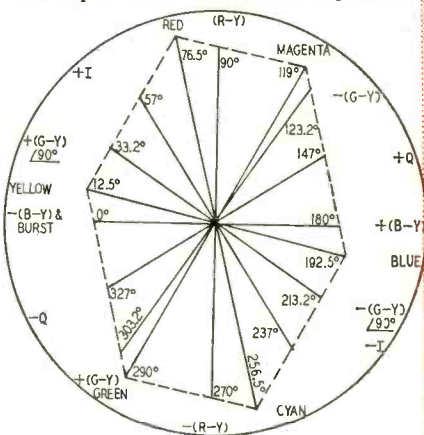

Fig. 6—Black and white patterns which generate the sensation of colors when rotated.

understand how a color such as yellow is seen when the eye is viewing a mixture of red and green lights. Perhaps we shall never know.

**Producing color**

White is a mixture of red, green and blue. Black is the absence of visible electromagnetic wave energy. As white can be produced from colors, conversely, colors can be produced by suit-

able arrangements of black and white. For example, when we mount the disk shown in Fig. 6-a on the shaft of a variable-speed motor, we see an arc of color in the rotating pattern. As the speed of the motor is varied, the hue of the color changes accordingly. A disk which produces red and yellow is shown in Fig. 6-b.

It is thought that there may be three types of color receptors in the retina

# TELEVISION

of the eye, with peak responses to wavelengths in the regions of red, green and blue. These color receptors are not sharply tuned but have overlapping responses or considerable bandwidth. Furthermore, when these color receptors are simultaneously energized by white light which is then suddenly stopped, the response of the color receptors does not fall to zero at once, but requires a small time interval to decay to zero.

Because the color receptors have differing decay times, a residual unbalance of response occurs from the receptors during the decay time so that we see color in the black-and-white whirling pattern, which attacks the eye with sudden changes from black to white and vice versa. The disk should be rotated counterclockwise at a speed on the borderline of persistence of vision, and the level of daylight or artificial light adjusted to produce the maximum intensity of color in the whirling pattern. Thin, fairly intense red rings, blue tails and yellow fields will appear under suitable conditions.

The known facts of "color blindness" also support the theory of three color receptors in the retina, responding in the regions of red, green and blue.

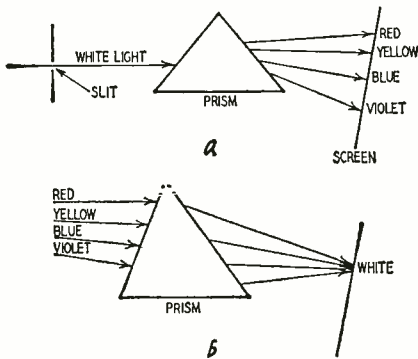

Fig. 7-a—Splitting white light into a color spectrum; b—recombination of color spectrum produces white light.

Test charts are available, which reveal the presence of various types of color blindness in afflicted persons. Some persons are completely color-blind, but still get about quite handily, since black-and-white vision remains (provided by the rods in the retina) although the color receptors (cones) are incapable of response.

All of us are color-blind in dim light. If you walk out of a lighted room into a dimly lit hall and look at a color chart, you will find that all the colors appear to be in shades of gray.

We are also color-blind to very small patches of color and semi-color-blind to somewhat larger patches. All colors seem to drift into orange or cyan hues as a patch of the color is reduced in size. This is the I axis of color television and is the basis of wide-band color transmission.

## Development of the eye

In an embryonic infant, the retina develops as an outgrowth of the fore-brain. However, the function of vision

is located in the hind-brain and persons who suffer injury to the hind-brain are as blind as if their eyes had been put out.

If a person has the hind-brain intact, but his eyes have been injured, he may still see flashes of light and colors as a result of mechanical stimulation of the exposed ends of the optic nerves. A somewhat similar response is observed by normal persons. If the eyelids are closed and pressure is applied to the edge of the eyeball, rings of yellowish light are seen.

How the sensation of light is produced in the mind when the optic nerves are energized is not known. As far as color television is concerned, it is essential only that we know the laws of

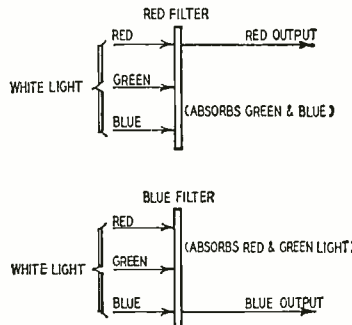

Fig. 8—Optical filters use resonant electrical circuits which are provided by nature in the electronic orbits of the atoms comprising the filter glass.

color mixture whereby any desired color can be synthesized by a suitable mixture of the three primary colors.

Fig. 7-a shows how a prism can decompose white light into a spectrum of its color components. Fig. 7-b shows how the color spectrum can be recombined into white light again. This is not a very striking demonstration. However, we find that we can remove

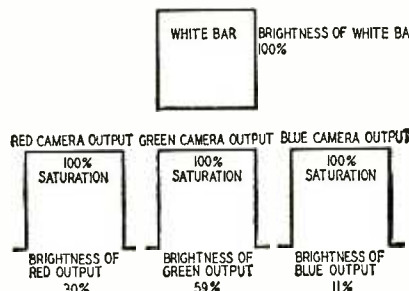

Fig. 9—The brightness of a white bar, like that of a color bar, is equal to the sum of the brightness of its components.

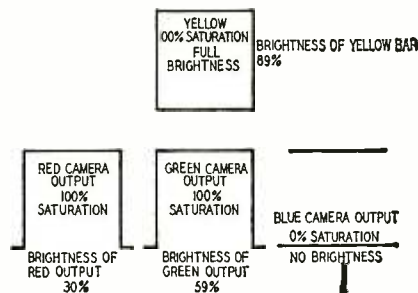

Fig. 10—The brightness of a color is equal to the sum of the brightness of its components.

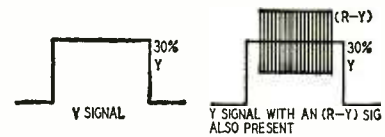

Fig. 11—Color is characterized by three quantities: brightness, hue and saturation. Color brightness is determined only by Y-voltage value and is not affected by chrominance voltage.

large regions of the spectrum, leaving only the colors at the extreme ends and a color at the middle, and still obtain white on recombination. This robbed white is quite undistinguishable by the human eye from the first white.

If we were unable to rob the spectrum in this manner, color television as we know it today would be impossible. It is hard enough to transmit three primary-color signals in a 6-mc channel containing a black-and-white signal and sound signal without contending with individual signals for tens of thousands of particular hues.

## Robbing the color spectrum

A rainbow spectrum of light is conveniently robbed by use of filters, as depicted in Fig. 8. Optical filters operate like electric or electronic filters,

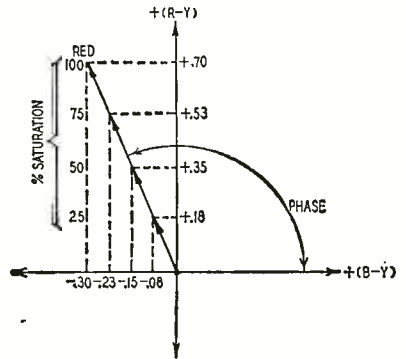

Fig. 12—The chrominance voltages produced by scanning 25%, 50%, 75% and 100% saturated red. Length of chrominance vector is directly proportional to color saturation. Its phase does not change with change in saturation.



Fig. 13—Compatibility of color-TV and black-and-white TV requires that the Y signal as used in black-and-white transmission be unaltered.

except that the resonant circuits utilized are contained in the electronic orbits of the atoms in the filter.

All matter is an arrangement of electrical forces or fields. The electrons comprising a substance have a certain frequency of rotation about the nucleus of the atom and are coupled to external space just as an antenna is coupled to space. Incident electromagnetic energy can be absorbed by electrons in certain orbits, just as a tuned circuit absorbs electromagnetic energy from an antenna.

Thus, an optical filter is an electronic wavetrap, of atomic dimensions, which is tuned to the frequency of the electro-

magnetic energy recognized by us as a given color. There is no basic difference between an optical filter and a wave trap except that the wave-lengths used in the optical filter are shorter.

Color can be specified on a technical basis in terms of brightness, hue and saturation. Fig. 9 shows that the brightness of a white bar is equal to the sum of the brightnesses of its components (red, green and blue). The brightness of red, as seen on a black-and-white picture tube, is 30%; the brightness of green is 59%; the brightness of blue is 11%—hence, the brightness of white is 100%.

Fig. 10 shows that the brightness of a color is equal to the sum of the brightnesses of its components. Yellow has a brightness, as seen on a black-and-white picture tube, of 89%. Yellow is comprised of green which has a brightness of 59% and of red which has a brightness of 30%—hence, the brightness of yellow is the sum of these brightnesses, or 89%.

The brightness of a color, as transmitted from a color TV station, is given by the level of the Y (black-and-white) signal component, as shown in Fig. 11. To this brightness signal level is added a 3.58-mc chroma signal. The chroma signal specifies hue and saturation. Fig. 12 shows how the voltage of the chroma signal specifies the saturation (vividness) of the color. We have already seen how the *phase* of the chroma signal specifies color (hue).

This particular (NTSC) signal arrangement has been established to provide compatibility in black-and-white and color TV reception. Fig. 13 shows how a succession of red, green and blue bars is transmitted as a series of video levels at 30%, 59% and 11%. This is the only part of the complete color signal which is seen by a black-and-white TV receiver.

The chroma signal has a relatively high frequency (3.579545 mc) which is largely filtered out in the if and video amplifier of a black-and-white TV receiver. In a color TV receiver, however, the chroma signal component is not rejected, but is processed through the chroma circuits of the color receiver.

The color receiver responds to the phase of the chroma signal by displaying a corresponding hue; it responds to the voltage of the chroma signal by displaying a corresponding color saturation. This is how we get compatibility. END

### DEFINITIONS

A **translator** picks up vhf or uhf signals, both audio and video, amplifies both and then retransmits them on one of the upper vhf channels.

A **booster** (or reflector) is simply a rf amplifier.

A **satellite** is, according to some sources, a booster or translator operated by a TV station itself to reach a "shadowed" area. Others refer to satellites as any amplifier that rebroadcasts a signal that it does not originate itself.

## NEXT MONTH

### Medium-Power Amplifier With High-Power Performance

Three-tube-plus-rectifier Ultra-Linear job delivers 20 watts with excellent quality from a 1.8-volt signal input.

### Automatic Fine Tuning for TV

The how and why of the new Westinghouse AFT circuit.

### All-Transistor Sound Survey Meter

Want to check on the noise level in home, factory or office? This highly portable instrument will do the job.

## New Slant on Moscow TV

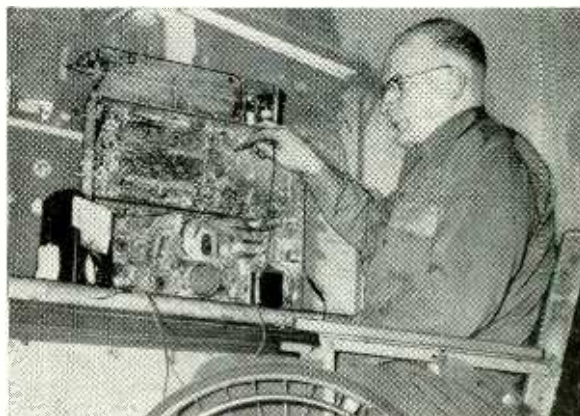

Albert Johnson, Moscow, Idaho, radio-TV repair man at work on modern TV receiver.

**R**EPAIRING complex modern electronic circuits is a long step from keeping crystal radios in good repair, but that is the span of work covered by Albert Johnson of Moscow, Idaho, during his 24 years as an electronic technician.

Injured in an automobile accident and confined to a wheelchair, Johnson gives Milo T. Means of the State Vocational Training Department the credit

for starting him on the road to success.

In 1934, after a period of training, Johnson rented a store and began to repair radios. He has had a store in several different locations before settling at his present place of business.

Now, there are five full-time employees working for him, servicing and selling radio and TV sets. Johnson's comment on his success, "I've been awfully lucky."

An illustrated discussion of retrace blanking, vertical peaking and yoke-damping defects

By CHARLES J. GARRETT

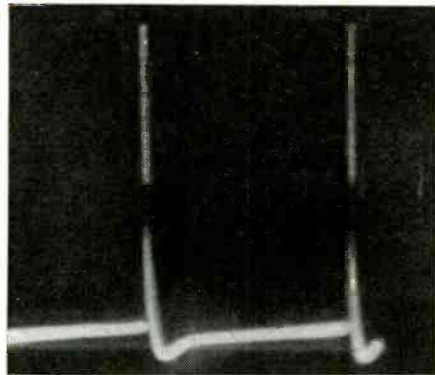

B

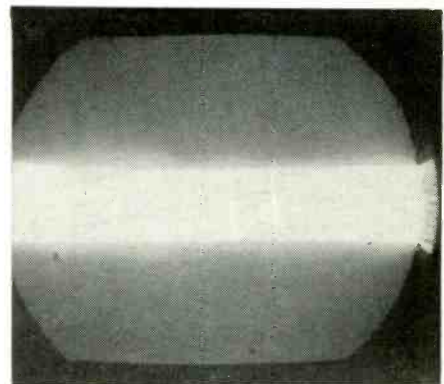

C

# more about auxiliary circuits

THE last time we got together we talked about those deep dark corners of a television receiver's horizontal circuits. This time, let's take a look into a few more ignored spots in the receiver's circuitry. The vertical output stage should be a good place to begin.

## Retrace blanking defects

The vertical output circuit contains a simple network that in its many forms has been used more and more in the last year or two. This network for retrace blanking is shown in Fig. 1-a. In normal operation it supplies a vertical retrace pulse of the proper polarity and spike shape to the picture tube to cut it off during the vertical retrace period. Photo A shows the scope pattern of the blanking pulse applied to the picture tube. It is during this interval that slanting horizontal lines (retrace lines) can form on the screen. Photo B shows retrace lines caused by reversed polarity of the blanking pulse.

The values of the circuit components are chosen and arranged to pass only the quicker retrace pulse and very little of the actual vertical sweep voltage which would harmfully affect screen brightness.

Troubles in retrace-blanking circuits are usually caused by one or both of the capacitors developing leakage or a direct short. A short or leakage in capacitor C1 (circuit 1-a) can reduce vertical size as well as allowing retrace lines to form. A shorted or leaky C2 can black out the screen because it injects practically the full vertical

sweep voltage into the picture tube. An open component in this circuit will be indicated by the presence of retrace lines and the absence or distortion of the retrace-blanking pulse.

## Vertical peaking

When the sawtooth capacitor in a vertical blocking oscillator opens (Fig. 2-a), the condition shown in Photo C develops. If the resistor shorts or loses resistance, vertical interlace is destroyed and double the number of retrace lines form. Photo D shows a normal number of retrace lines. Photo E shows the result of a shorted resistor in the sawtooth-forming network.

The sawtooth capacitor in a combination vertical-multivibrator-vertical-output circuit (circuit 2-b) can produce vertical-sweep distortion, like that shown in Photo F, when it opens. When the resistor in this network goes down in value, severe nonlinearity, like that seen in the spacing of the cross-hatch pattern in Photo G, occurs. Waveforms at the input plate in this circuit are similar to those in vertical-blocking oscillators except that a sharper square wave is formed when the sawtooth capacitor opens as in Photo H.

## Yoke damping defects

The two 560-ohm resistors across the vertical yoke coils (circuit 1-b) have a purpose similar to that of the damper tube in the horizontal output transformer's secondary. The damper tube loads down the circuit, making it difficult for any transient oscillations to exist.

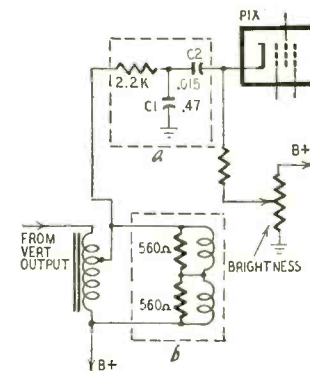

Fig. 1-a—Retrace-blanking network found in vertical output stages; b—the vertical yoke coils.

A similar condition exists in the vertical output transformer and yoke coils but, because vertical retrace is slower, transient oscillations are of much lower amplitude and duration and a damper tube is not needed. These two shunting resistors provide sufficient loading so that transient oscillations cannot exist. They also damp out any voltage peaks or spikes that might be picked up from the horizontal yoke coils.

Abnormal operation may not always be apparent—with these resistors disconnected, many older sets will still perform normally—it depends on the yoke efficiency or Q. On modern high-efficiency yokes, if these resistors are removed or open, ripples will form on the left edge of the screen that are

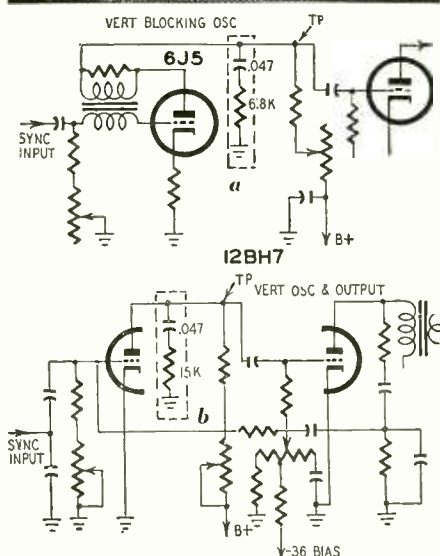
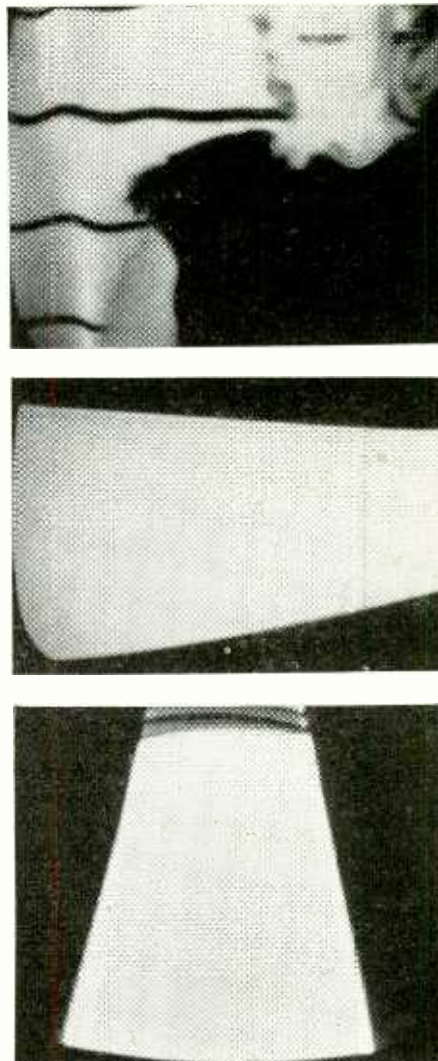
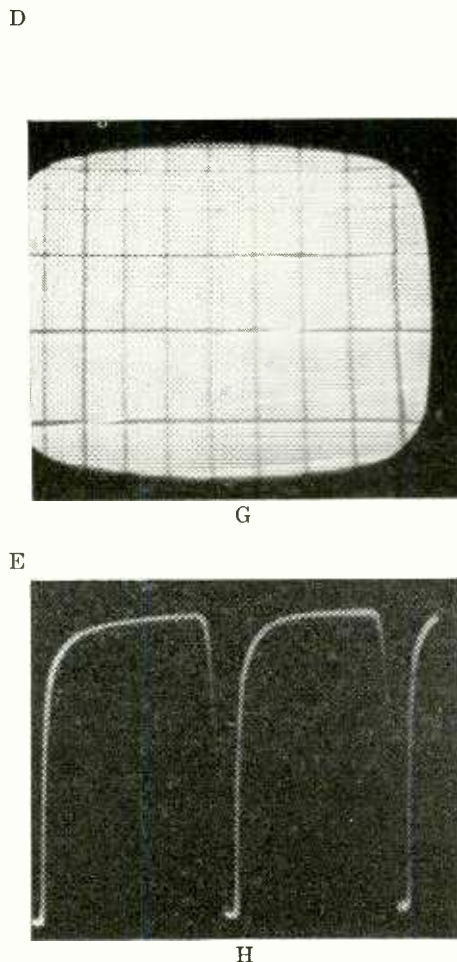
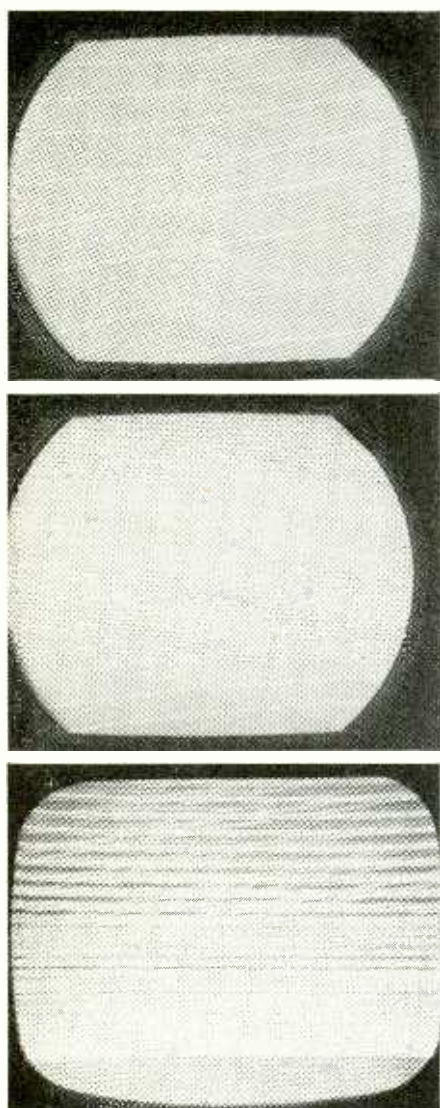

Fig. 2—*a*—Sawtooth capacitor in a vertical blocking oscillator; *b*—sawtooth capacitor in a vertical multivibrator — vertical output circuit.

indistinguishable from those caused by an improper-size horizontal yoke capacitor (see Photo I). Direct substitution is the best test in this case.

A shorted resistor can cause vertical

raster keystone like that produced by a shorted yoke coil (see Photo J). Therefore, an ohmmeter check of these vertical yoke-shunting resistors should be made before replacing a yoke for vertical keystone.

The small capacitor across the high side of the horizontal yoke coils (Fig. 3) has somewhat of a damping action, also. Ripples on the left side of the screen can also be due to interaction or crosstalk between the vertical and horizontal deflection coils.

The basic purpose of this capacitor across the top half of the horizontal deflection coils, the half farthest from B plus, is to balance the capacitance of both horizontal yoke coils (with respect to ground). Thus any coupling to the vertical deflection coils from the horizontal coils is equally out of phase. Interaction and crosstalk can thereby be nullified.

However, even on many new sets, some ripples are evident on the left edge of the screen. Assuming that the vertical yoke resistors are not defective in these sets, an adjustment of the value of the horizontal yoke capacitor can correct or improve this condition.

A mica trimmer adjustable from 10 to 100  $\mu\text{f}$  can be temporarily sub-

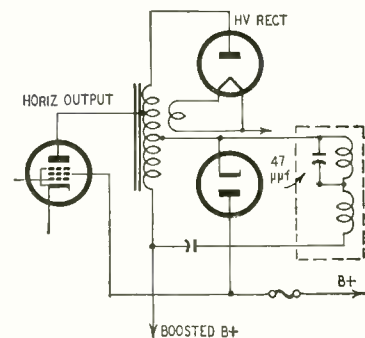

Fig. 3—A capacitor across the top half of the yoke coils has a damping action.

stituted for the original yoke capacitor and adjusted for best results. When the best setting is found, the capacitor can be carefully removed and measured. The indicated value will be correct for the horizontal yoke capacitor for that particular yoke and set.

Another common trouble that can be caused by this capacitor is horizontal keystone when it shorts out. This defect is shown in Photo K. Incidentally, a replacement horizontal yoke capacitor should be rated at 1,500 volts or more due to the high spike voltage present in yoke circuits. END

Fuzz is still learning about color TV—  
the hard way

# Red and Fuzzball on Convergence

By ROBERT G. MIDDLETON

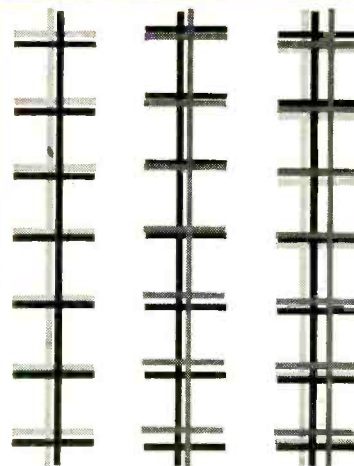
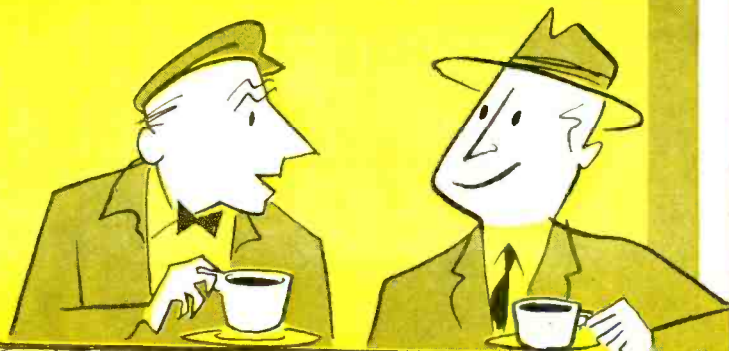

Fig. 1      Fig. 2      Fig. 3  
 ■ BLUE    ■ GREEN    ■ RED

Fig. 1—(left) Blue lateral corrector separates blue and green vertical lines for easier checking.  
 Fig. 2—(center) Make the red and blue lines parallel.  
 Fig. 3—(right) Red, green and blue vertical center lines must all be parallel.

**H**AVE I still got a job?" asked Fuzzball anxiously, as he sat down beside Red at the counter. "Take it easy," Red replied. "Old Fatpants is late himself this morning—he don't even know that you didn't show."

Fuzz' hand shook visibly as he reached for the cup of coffee. "So where you been, anyhow?" Bess asked curiously.

"It worked out to be sort of a lost weekend for me," Fuzzball explained. "I took one too many and . . ."

"There are times," Red chuckled, "when Fuzz lives in a world of his own."

"There *ain't* no such world," Bess snorted, and flounced off.

"There was a good reason for me falling off the wagon though," Fuzz said in self-defense.

"Always is," Red agreed. "What's yours?"

"It's that installation out on the South Side," said Fuzz. "Line voltage drifts up and down so much that I can't converge the picture tube for sour apples."

"That's easy," replied Red. "All you got to do is put in an automatic line-voltage regulating transformer."

"That's easy?" Fuzzball asked. "This guy won't even buy an outdoor antenna. I can't get him off my back."

"Lord have mercy," Red breathed. "The penny-pinching public again."

"What can I do?" Fuzzball asked helplessly.

"Ignore him," Red advised.

"Suppose he calls up Old Fatpants and complains?"

"Let him. I'll talk to Fatpants. I

been on these hey-rube runs before."

"Red."

"What now?"

"Can you cash me a check?"

"The answer is no. Here's a fin I'll give you. That way nobody ain't kidding nobody."

"Thanks, Red. I dunno what I'd do without a buddy like you."

"I know what you'd do—and so do you."

### A shortcut?

"Not to change the subject, but I got a new way to converge a picture tube that I like better."

"What's that?"

"When I start making the vertical dynamic, I kill the red gun and line up the green dots with the blue dots."

"Nothing wrong with doing it that way, if you want to."

"The way you started me out," explained Fuzzball, "I left the red gun on. It's less complicated to adjust the green by itself."

"At the beginning, yes," Red agreed. "But it's a sure bet that after you get some more experience, you'll be leaving the red gun on."

"I suppose you're right," Fuzzball remarked. "Right now, it seems easier to work with two colors at a time."

"After you get experience," Red explained, "you'll learn to pay no attention to the colors you're not working with. It will just be a bother to you, then, to be turning guns off and on."

"I see what you mean," Fuzzball replied.

"Tell me this," said Red, "do you keep the green and blue dots converged in the center?"

"I took your hint before, Red. I use

crosshatch to start the job and I found it's easier that way."

"Thought you would."

"But I don't keep the green and blue lines converged at the center unless I'm working in a real dark room."

"You're learning fast."

"Hope so," Fuzz replied. "I found that when there's light shining on the screen, it's easier to judge if the green and blue lines are straight with each other if I kept them separated a little bit." (See Fig. 1.)

"Most techs would agree with you on that one," Red assured him.

"One thing the set manufacturers have done that really helps on this convergence, though."

"Namely?"

"They are either mounting the dynamic controls on the front of the set or on a box that you can bring around to the front."

"You can say that again. It's cut convergence time just about in half."

"OK. I will say it again," Fuzzball grinned.

"You're a real character," Red replied disgustedly. "But what are you doing after you line up the green and blue vertically?"

"Well, then I kill the green gun and turn the red gun back on."

"That's OK."

"I adjust the red beam magnet or the blue lateral corrector to separate the red and blue lines a little bit."

"What next?"

"Just like the green. I adjust the red vertical amplitude and tilt controls to make the red and blue lines straight with each other up and down the

screen." (See Fig. 2.)

"I hope you mean you are watching just the vertical center column on these vertical adjustments," Red interjected.

"What do you think I am. Stupid?" Fuzzball asked.

"I'd rather not answer that question yet," Red observed. "Then what next?"

"That's when I turn the green gun back on and check to see whether the green light is still straight." (See Fig. 3.)

"A little green touchup might be in order," Red agreed.

### Finishing up

"Finally, I adjust the beam magnets and the lateral corrector to bring the three color lines together and make a white line."

"How's your luck running?"

"Sometimes there's a little tattle-tale color showing at the top or bottom," Fuzzball admitted.

"You'll never get it 100% perfect," Red reassured him. "We discussed that before."

"But you can't see it very far back from the set," Fuzz said.

"Better hadn't, at viewing distance anyhow."

"It's a funny thing," Fuzzball mused, "when there's a little color showing at the top of the white line, the dynamic adjustments will shift the color fringing to the bottom of the line, or to the middle. But you got to leave a little fringing somewhere."

"You're getting hep," Red remarked, "and just where do you leave the fringing?"

"Does it make a difference?" Fuzz asked innocently.

"Sure does. You'll have lots less complaints if you leave the final fringing at the bottom."

"But why should that be?" asked Fuzz.

"Simply because programming usually carries the action above center screen—that's where John Q. Public looks the most."

"I got to admit it makes sense," Fuzzball agreed.

"Now what next?"

"That's when I switch over to white dots and work on the blue amplitude and tilt controls."

"You can keep on with the cross-hatch if you want to," Red advised.

"How would you do that?"

"Well, the crossovers on the hatch give you the same use as dots."

"I guess they would, at that."

"So you can look up and down the vertical center line, and see how the crossovers are doing."

"It always looks OK at the center of the screen," Fuzzball reminded him.

"That's right. The static adjustments make it easy to bring the center in."

"But the crossovers are pretty cruddy at the top and bottom of the screen."

### Now the blue

"Right again. So you should open

up the blue vertical amplitude control wide and adjust the blue vertical tilt to get the *same* blue separation at both the top and bottom of the screen."

"You get away from the dot routine on this deal," Fuzz remarked.

"Naturally, because you're working with a different type of pattern."

"Well, after I get equal blue line spacing at the top and bottom, where do I go from there?"

"Next thing you do is turn down the blue amplitude to get equal blue line spacing all the way up and down the vertical center column."

"But I might have to touch up the blue tilt adjustment," Fuzzball suggested.

"Only a miracle could save you," Red agreed. "There's quite a bit of interaction."

"And, then, when the blue lines are spaced exactly the same amount from the yellow lines all the way up and down the center column, the static adjustments would give final vertical convergence."

"Fuzzball, there are times when you are so bright you dazzle me," Red said effusively. "Permit me to buy you another cup of coffee."

"That's coffee?" Fuzzball exclaimed, ducking agilely as Bess heaved a creamer at him.

"We can use crosshatch all the way on the horizontal dynamic convergence too, if we want to," Red added.

"How about giving me a rundown?" Fuzzball suggested.

"Well, you started off by telling me how you kill the red gun when you start the vertical. So you can start the horizontal the same way, killing the red gun."

"Makes it easier to remember that way," Fuzz observed.

"Then," continued Red, "turn the green horizontal amplitude and the green horizontal phase at the same time and get the green crossovers on the same side of the blue crossovers. Get the crossovers the same, all the way along the horizontal center line."

"Guess I might need to hit the beam magnets or lateral corrector a little to separate the green and blue," Fuzzball suggested.

"But definitely," Red agreed, "and positively if there is much light in the room."

"So after I get the green crossing all on the same side of the blue crossings, where do I go from there?" Fuzz asked.

"Then you get down to fine points," Red explained. "Look at the spacings between the green and blue crossings. You'll find it's dollars to doughnuts that the spacings aren't all exactly equal amounts."

"So I suppose I got to touch up the green amplitude and phase to make all the crossover spacings the same."

"Posilutely. Then, you do exactly the same thing for the red crossovers. Kill the green gun and turn on the red gun. Adjust the red amplitude and

phase to get equal crossover spacings, with all the red crossings on the same side of the blue crossings."

"That makes a pretty good routine for remembering," Fuzzball remarked. "What do I do next?"

"Turn the green gun back on. Both the red and green crossovers will be pretty near even from the blue crossovers. A little touchup on the red and green controls should do it about right."

"What about the blue horizontal dynamics?" Fuzz asked.

"I'm getting to that," Red replied. "But, first, you want to make sure you are satisfied with the job so far. Get on the static adjustments and make the pattern white in the center of the screen. Then, you might want to do just a little more touching up to get real good crossovers at the same points all along the horizontal center line."

"Then I go to the blue horizontal controls?" asked Fuzz.

"Absotively. Now we straighten up the blue line and bring it in with the yellow line."

"So far, I've always been resonating the blue phasing coil," Fuzz ventured.

"Saves time," Red agreed. "You should do it on this all-crosshatch routine also. Open up the blue horizontal amplitude and adjust the blue horizontal phasing coil for a peak, smack in the center of the screen."

"That's just like we were using dots."

"Right. Then, back off on the amplitude until the blue line is as near parallel with the yellow as possible."

"But I'll probably need to touch up the blue phasing here."

"You're reading my mind," Red stated. "The touchup will give the parallel spacing you're looking for between the blue and yellow lines."

"And the static controls will give me final overall convergence," Fuzz suggested.

"Just about," Red agreed. "But there are a couple of little points to keep in mind."

"Such as?"

"Look carefully at the vertical convergence. You might have knocked it out a trifle, and need to touch it up a wee bit."

"Anything else?" asked Fuzz.

"Yep. Check the corners of the screen. There's no adjustment here, but sometimes if you see a little fringing in the corners, you can compromise a little to improve it, without hurting other parts of the screen noticeably."

"Whoof!" exclaimed Fuzzball, blowing hard. "And I took up television for a living. I could of had a job in a putty-knife factory and nothing to worry about."

"Maybe you could get a job as a pilot on a rocket to the moon," Bess suggested.

Fuzzball rose to his feet. "Give the gal her money, Red, and let's get out of this booby trap."

Bess banged another creamer on the door behind the fast-moving Fuzzball's back. END







By ROBERT B. COOPER, JR.

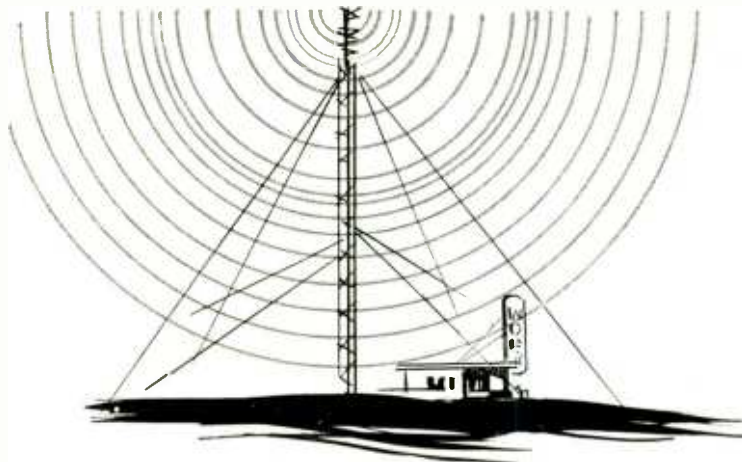

IN seven years of active television dxing, I have seen the coming and going of many dx-ers, not a few of whom had top-notch potential in their day. The average life of the red-hot dx-er seems to run to about three years, and then, suddenly, dxing takes a back seat to other interests.

With the number of television stations presently operating, a station total of 150 is not too much of a task for a diligent dx-er in a year's time, provided he lives east of the Mississippi River, where station concentration is high. In the Mountain States or along the West Coast, 100 stations may prove to be a formidable task when 80-90 of these must come via some form of skip reception. But, given time, even the Western dx-er can reach the 150-station mark.

The dyed-in-the-wool dx-er works hard at his hobby. Make no bones about it, dxing throughout a 4-hour session of fast-changing E-skip conditions can be tiring both physically and mentally. Yet, there must be a reason or reasons for a person perfectly sane in most other respects to spend a whole weekend at the dials of his (or her) television set, continually flipping the dials, rotating the antenna and keeping a written record of everything seen. Do you know what that reason is? If you do, you must be a dx-er. If you don't, then I suggest that you find out. Come on in, the water's fine!

'57—Good in spots

The year 1957 proved very interesting to all long-distance television fans. Generally speaking, the summer E-skip conditions over the North American continent left much to be desired. For the first year in many, very few existing records were broken, perhaps indicating that even the limits of TV dxing have almost been reached. However, some of the new records set this year may be only stepping stones to better things to come in 1958.

Riding the peak of the sunspot cycle, the world's record for television dxing was pushed out to 10,800 miles with the reception of England's BBC channel 1 in various parts of Australia. (See TV Dx Column, RADIO-ELECTRONICS, March, 1957.) Here in the Western Hemisphere, the high-band (channels 7-13) television dx record was extended to approximately 2,300 miles on Aug. 2,

<b>Oklahoma</b>		
KTEN	Ada	10
KVSO-TV	Ardmore	12
KGEO-TV	Enid	5
KSWO-TV	Lawton	7
KTVX	Muskogee-Tulsa	8
KETA	Oklahoma City	13
KWTV	Oklahoma City	9
WKY-TV	Oklahoma City	4
KOTV	Tulsa	6
KVOD-TV	Tulsa	2

<b>Oregon</b>		
KOAC-TV	Corvallis	7
KVAL-TV	Eugene	13
KOTI	Klamath Falls	2
KBES-TV	Medford	5
KGW-TV	Portland	8
KLOR	Portland	12
KOIN-TV	Portland	6
KPIC	Roseburg	4

<b>Pennsylvania</b>		
WFPG-TV	Altoona	10
WISU-TV	Eric	12
WSEE	Eric	35
WCMB-TV	Harrisburg	71
WHP-TV	Harrisburg	55
WTPA	Harrisburg	27
WARD-TV	Johnstown	56
WJAC-TV	Johnstown	6
WGAL-TV	Lancaster	8
WLBR-TV	Lebanon	15
WCAU-TV	Philadelphia	10
WFIL-TV	Philadelphia	6
WYBY-TV	Philadelphia	35
WRCV-TV	Philadelphia	3
KDKA-TV	Pittsburgh	2
WIIIC	Pittsburgh	11
WQED	Pittsburgh	13
WARM-TV	Scranton	16
WGBI-TV	Scranton	22
WBRE-TV	Wilkes-Barre	28
WILK-TV	Wilkes-Barre	34
WNGW-TV	York	49
WSBA-TV	York	43

<b>Puerto Rico</b>		
WORA-TV	Mayaguez	5
WAPA-TV	San Juan	4
WKAQ-TV	San Juan	2

<b>Rhode Island</b>		
WJAR-TV	Providence	10
WPRO-TV	Providence	12

<b>South Carolina</b>		
WAIM-TV	Anderson	40
WCSC-TV	Charleston	5
WUSN-TV	Charleston	2
WIS-TV	Columbia	10
WNOK-TV	Columbia	67
WBT	Florence	8
WFBC-TV	Greenville	4
WSPA-TV	Spartanburg	7

<b>South Dakota</b>		
KDLO-TV	Florence	3
KOTA-TV	Rapid City	3
KPLO-TV	Reliance	6
KELO-TV	Sioux Falls	11
KSOD-TV	Sioux Falls	13

<b>Tennessee</b>		
WDEF-TV	Chattanooga	12
WRGP-TV	Chattanooga	3
WDXI-TV	Jackson	7
WJHL-TV	Johnson City	11
WATE-TV	Knoxville	6
WBIR-TV	Knoxville	10
WTVK	Knoxville	26
WHBQ-TV	Memphis	13
WKNO-TV	Memphis	10
WNCT	Memphis	5
WREC-TV	Memphis	3
WLAC-TV	Nashville	5
WSIX-TV	Nashville	8
WSM-TV	Nashville	4

<b>Texas</b>		
KRBC-TV	Abilene	9
KFDA-TV	Amarillo	10

KGNC-TV	Amarillo	4
KTBC-TV	Austin	7
KFDM-TV	Beaumont	6
KEDY-TV	Big Spring	4
KBTX	Bryan	3
KRIS-TV	Corpus Christi	6
KSIX-TV	Corpus Christi	10
KRLD-TV	Dallas	4
WFAA-TV	Dallas	8
KELP-TV	El Paso	13
KROD-TV	El Paso	4
KTSM-TV	El Paso	9
KFJZ-TV	Fort Worth	11
WBAP-TV	Fort Worth	5
KGUL-TV	Galveston	11
KGFT-TV	Harlingen	4
KPRC-TV	Houston	2
KTRK-TV	Houston	13
KUHT	Houston	8
KHAD-TV	Laredo	8
KCBD-TV	Lubbock	11
KDUB-TV	Lubbock	9
KTRE-TV	Lufkin	9
KNID-TV	Midland	2
KOSA-TV	Odessa	7
KPAC-TV	Pt. Arthur-Beaumont	4
KCTV	San Angelo	8
KCOR-TV	San Antonio	41
KENS-TV	San Antonio	5
KONO-TV	San Antonio	12
WOAI-TV	San Antonio	4
KPAR-TV	Sweetwater-Abitene	12
KCEN-TV	Temple	6
KCMC-TV	Texarkana	6
KLTV	Tyler-Longview	7
KWTX-TV	Waco	10
KRGV-TV	Weslaco	5
KFDX-TV	Wichita Falls	3
KSYD-TV	Wichita Falls	6

<b>Utah</b>		
KSL-TV	Salt Lake City	5
KUTV	Salt Lake City	4
KUTV	Salt Lake City	2

<b>Vermont</b>		
WCAX-TV	Burlington	3

<b>Virginia</b>		
WCVB-TV	Bristol	5
WVEC-TV	Hampton-Norfolk	15
WSPA-TV	Harrisonburg	3
WLVA-TV	Lynchburg	13
WTRV-TV	Norfolk	3
WTOV-TV	Norfolk	27
WXEX-TV	Petersburg-Richmond	8
WAVY-TV	Portsmouth-Norfolk	10
WRVA-TV	Richmond	12
WTVR	Richmond	6
WDBJ-TV	Roanoke	7
WLSL-TV	Roanoke	10

<b>Washington</b>		
KVOS-TV	Bellingham	12
KBAS-TV	Ephrata	43
KPRP-TV	Pasco	19
KCTS	Seattle	9
KING-TV	Seattle	5
KOMO-TV	Seattle	4
KHQ-TV	Spokane	6
KREM-TV	Spokane	2
KXLY-TV	Spokane	4
KTNT-TV	Tacoma	11
KTVW	Tacoma	13
KRTV	Walla Walla	8
KIMA-TV	Yakima	29

<b>West Virginia</b>		
WHIS-TV	Bluefield	6
WCHS-TV	Charleston	8
WBOY-TV	Clarksburg	12
WHTN-TV	Huntington	13
WSAZ-TV	Huntington-Charleston	3
WOAY-TV	Oak Hill	4
WTAP	Parkersburg	15
WTRF-TV	Wheeling	7

<b>Wisconsin</b>		
WEAU-TV	Eau Claire	13
WBAY-TV	Green Bay	2
WFRV-TV	Green Bay	5
WKBT	La Crosse	8
WHA-TV	Madison	21
WISC-TV	Madison	3
WKOW-TV	Madison	27
WMTV	Madison	33
WMBV-TV	Marinette-Green Bay	11
WISN-TV	Milwaukee	12
WMVS-TV	Milwaukee	10
WTMJ-TV	Milwaukee	4
WXIX	Milwaukee	19
WSAU-TV	Wausau	7
WITI-TV	Whitefish Bay-Milwaukee	6

<b>Wyoming</b>		
KSPR-TV	Casper	7
KTWO-TV	Casper	2
KFBC-TV	Cheyenne	5

<b>Canada</b>		
CHCT-TV	Calgary, Alta.	2
CFRN-TV	Edmonton, Alta.	3
CJLH-TV	Lethbridge, Alta.	7
CHAT-TV	Medicine Hat, Alta.	6

CFCR	Kamloops, B. C.	4
CHBC-TV	Kelowna, B. C.	3
CBUT	Vancouver, B. C.	2
CHEK-TV	Victoria, B. C.	6
CFLA-TV	Goose Bay, Labrador	8
CKX-TV	Brandon, Man.	5
CBWT	Winnipeg, Man.	4
KCWC-TV	Moncton, N. B.	2
CHSJ-TV	St. John, N. B.	4
CJGX-TV	Argentina, Nfld.	10
CFSN-TV	Stephenville, Nfld.	8

CJON-TV	St. John's, Nfld.	6
CBHT	Hallifax, N. S.	3
CJCB-TV	Sydney, N. S.	4
CKVR-TV	Barrie, Ont.	3
CKSO-TV-I	Elliot Lake, Ont.	3
CHCH-TV	Hamilton, Ont.	11
CKWS-TV	Kingston, Ont.	11
CKCO-TV	Kingston, Ont.	13
CFPL-TV	London, Ont.	10
CKGN-TV	North Bay, Ont.	10
CBOT	Ottawa, Ont.	9
CBOT	Ottawa, Ont.	4
CHEX-TV	Peterborough, Ont.	12

CFPA-TV	Port Arthur, Ont.	2
CJIC-TV	Sault Ste. Marie, Ont.	2
CKSO-TV	Sudbury, Ont.	5
CFCL-TV	Timmins, Ont.	6
CBLT	Toronto, Ont.	6
CKLW-TV	Windsor, Ont.-Detroit (Mich.)	9
CKNX-TV	Wingham, Ont.	8
CFCY-TV	Charlottetown, Prince Edward Island	13
CKRS-TV	Jonquiere, Que.	12
CBFT	Montreal, Que.	2
CBMT	Montreal, Que.	6
CFCM-TV	Quebec City, Que.	4
CKMI-TV	Quebec City, Que.	5
CJBR-TV	Rimouski, Que.	3
CHLT-TV	Sherbrooke, Que.	7
CKCK-TV	Regina, Sask.	2
CFQC-TV	Saskatoon, Sask.	8

<b>Mexico</b>		
XEJ-TV	Juarez	5
XEM-TV	Mexicali-EI Centro Calif.	3
XEW-TV	Mexico City	2
XHGC-TV	Mexico City	5
XHTV-TV	Mexico City	4
XHNL-TV	Monterrey	2
XEQ-TV	Paso de Cortes	9
XEX-TV	Paso de Cortes (Altzomoni)	7
XEZ-TV	Queretaro	3
XETV	Tijuana	6
	Chihuahua	11

# TELEVISION



Robert Seybold displaying photos of some dx TV stations he has logged. In 1957, at 1900 CST, with the logging of the YVLV relay on channel 9 from Maricarbo, Venezuela, by dx-er Bobby Grimes in Little Rock, Ark. Two hours later, an old pro, Bedford Brown of Hot Springs, Ark., logged the channel-9 station, along with reception from Venezuela on channels 2, 4 and 5; Brazil on channel 2 and Argentina on channel 3.

A triple-hop channel-5 E-skip logging is noted in the report of Mrs. Doris Johnson of Longview, Wash. She reports a verification in writing for her reception of WORA, channel 5, Manaquez, Puerto Rico, at 1914 PST, on July 21 of last year—the distance, a neat 3,650 miles. Being a West Coast dx-er, I checked my log for this date and found a weird notation for 1720 hours on channel 3—a Japanese movie with Spanish subtitles! What you don't run into during a bang-up opening!

### Total champs

Hitting closer to home, we find that the magic number of 300 stations logged has been achieved by two dx-ers. 1956's feature dx-er, Bob Seybold of Dunkirk, N. Y., now rests at 312 stations logged, after 5 years of tireless efforts and fighting local stations on channels 2, 4, 6, and 12 plus many grade-B signals on all vhf channels in most every direction. Bob's location may be fine for watching any number of different programs, but all those locals don't do much for dxing!

Our second over-300 man is the fellow who has been pushing Bob Seybold the greater part of the way, Bedford Brown, of Hot Springs, Ark. Bedford has made history by logging up to 76 stations in a single 24-hour period. Last year, July 24, 1956, to be exact, Bedford broke all existing short-term dx records by logging 89 skip stations and a total of 116 stations in a mere 24-hour period! Bedford's new station total is 326 TV stations logged in 5 years of dxing from Hot Springs.

Perhaps nothing stands out more than the fairly constant number of members in the Over 50 TV Dx Club. You would think that, with television dxing always on the rise as a hobby of

wide acceptance, the number of dx-ers listed would increase by leaps and bounds each year. Unfortunately, dx-ers get a little careless and neglect to keep me informed on current totals. So, if you have a station total of over 50 and are actively engaged in dxing, why not get into the regular monthly reporting habit (using RADIO-ELECTRONICS report forms, of course) and join the RADIO-ELECTRONICS TV dx group.

In studying the dx reports for last spring, I noticed a tendency for long-distance east-west E-layer skip in northern latitudes during the heavy aurora sessions. The signals usually have violent fading rates, with multiple-path characteristics evident in the video. Dx-ers should be on the lookout for such E-skip openings during aurora displays this spring, reporting in detail any observations.

We are in the middle of the winter E-skip season. This season often pro-

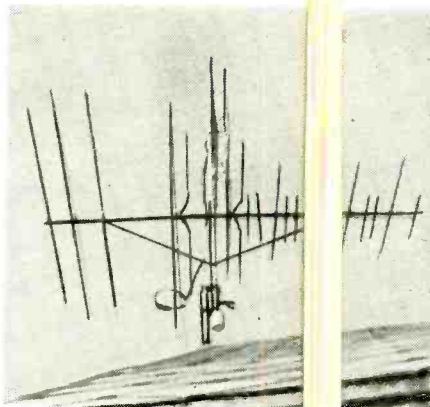

Bob Seybold's receiving antenna can be raised to about 60 feet above the ground.

vides several good openings occurring for the most part in the afternoon and early evening hours. In the past three years, the first two weeks of January and the first few days of February have been best for E-skip openings.

During October, E-skip appeared with three good openings over Western areas during the first three weeks of the month. This may indicate that the level of E-skip will be high throughout the winter period (October through March).

### Over 50 TV Dx Club

Observer	Location	Station Total
Bedford Brown	Hot Springs, Ark.	326
Bob Seybold	Dunkirk, N. Y.	312
Art Collins	Buffalo, N. Y.	260
B. H. Rauch	Peoria, Ill.	239
Ed Bourgeois	Norco, La.	230
Jerry Don Burch	Hot Springs, Ark.	219
Frank Hill	Gallipolis, Ohio	217
Ross Brown	Tupper Lake, Ont.	217
King Schafer	Kenmore, N. Y.	216
Carl Lupton	Shelbyville, Ill.	214
John K. Bettersworth	State College, Miss.	201
Ray Escoffier	New Orleans, La.	195
Don Roller	Fort Wayne, Ind.	193
Ed Rugel	Independence, Mo.	181
Clarence Rareshide	New Orleans, La.	180
Edwin Shorey	Derby, Conn.	173
David Janowiak	Milwaukee, Wis.	166
Paul Swartz	Gibsonburg, Ohio	164
Don Middleton	Sanford, N. C.	156
Bill Eckberg	Walnut, Cal.	156
Bob Cooper	Fresno, Cal.	155
B. J. Bingham	Festus, Mo.	153



Bedford Brown leads the TV dx list (326 stations).

Francis E. DeGroat	Salamanca, N. Y.	136
Norman Ernt	Kenmore, N. Y.	134
Al Caldwell	Brockton, Mass.	124
Larry Vehorn	Speedway, Ind.	119
W. J. Owen, Jr.	Springfield, Ohio	114
Bill Kraeb	Kewaunee, Wis.	112
Walker Ray	Baton Rouge, La.	112
Billy Meers	La Grange, Ky.	110
R. H. Gordon	Harrisburg, Pa.	110
Dibrell Ingram, Jr.	Cannay, Miss.	109
Percy Cox	Visalia, Calif.	105
Bobby Grimes	Little Rock, Ark.	104
Grant D. Ross	Marathon, Ont.	104
John Parillo	Girard, Ohio	101
J. W. Collier	Kilmarnock, Va.	100
Bob Martin	Girard, Pa.	95
Carlton Howington	Uniontown, Ohio	95
George Leach	Tampa, Fla.	89
Doris Johnson	Longview, Wash.	86
Dick Mason	Menasha, Wis.	86
Tom Ross	W. Liberty, W. Va.	80
John Comstock	Shelbyville, Ind.	79
Kenn Cooper	Fresno, Calif.	79
Dennis Smith	Wasco, Calif.	79
Morris Foote	Middleton, Idaho	77
James Howarth	Worcester, Mass.	76
Ed Hepp	Portland, Ore.	72
Eddie Albright	Medford, Ore.	69
Wayne Plunkett	Toronto, Ont.	66
John Black	Moffat, Ont.	65
Gary Ochenschlager	Sebeka, Minn.	65
Denny Cline	Eastport, Me.	64
Al Kopec	Himrod, N. Y.	64
Ray O'Rear	Zillah, Wash.	64
Benjamin Tobin	Mattapan, Mass.	63
Dan Samuels	Mt. Vernon, N. Y.	63
A. Reise	St. Louis, Mo.	62
Alan Livingston	Tulsa, Okla.	61
Jim Dillon	Regina, Sask.	60
Ronald Boyd	Truro, Nova Scotia	58
Ed Davis	Champaign, Ill.	54
Arthur Cordts	Norfolk, Va.	54
David Beal	Tucson, Ariz.	54
Carl-Richard Kassabian	Reedley, Calif.	53
Michael Holley	Geneseo, Ill.	53
Ghislain Girard	Arvida, Quebec	53
J. W. Collier	Arlington, Va.	51
Richard Gagnon	Royal Oak, Mich.	50
George S. Dunvant	Fancy Farm, Ky.	50

### TV dx report forms

Once again the TV Dx column of RADIO-ELECTRONICS offers free of any charge TV dx report forms for use in reporting TV dx loggings to the column. You may obtain your set of forms by merely sending your name and address to TV Dx Column, RADIO-ELECTRONICS, 154 W. 14 St., New York 11, N. Y. END

### COLOR BLIND?

By Jeanne DeGood

It's often been said  
(And I guess it is true)  
That roses are red  
And violets blue.

But roses are blue  
When they're seen on my screen,  
For my color TV  
Installer was green.

# TV Service CLINIC

HAVE received many inquires asking "Which color-bar generator should I buy?" This question cannot be answered with "Buy the new Super Chromonator, it does everything." So rather than tell you which to buy I will describe the features of four types of color bar generators and leave the selecting up to you.

1. The simplest color signal generator is a sidelock instrument operating at 3.570545 mc minus 15,750 cycles. In the simplest instruments, the sidelock oscillator and the picture-carrier oscillator are free-running. In spite of the simplicity and lack of accuracy of such instruments, certain color servicing jobs can be done quite well with them. Adjusting the quadrature transformer is one of these jobs. However, in numerous other tests, such a generator leaves much to be desired.

2. The next more elaborate and expensive type of color generator is a sidelock oscillator with crystal control. Horizontal sync pulses are provided. These features greatly improve the accuracy of the instrument and make additional practical applications possible. This type of instrument is often packaged with white-dot and cross-hatch facilities. Thus, the instrument is sufficiently complete for installation work, and is compact and portable. However, it leaves something to be desired for bench work. As in the case of 1, the color pattern is a color-difference spectrum, comprising hues which gradually merge from one tone to another. The display is dominated by reds, greens and blues. All the hues are dim and bluish with respect to true saturated colors. One color may possibly be made normal, in some cases, by careful adjustment of the brightness control.

This type of instrument is useful in some types of bench work, such as adjustment of quadrature, check of chroma-channel gains and adjustment of the afc balance control, etc.

3. Keyed sidelock generators are also color-difference generators, though usually referred to as color bar generators. They are similar to 2, except that a multivibrator is used to key up the rainbow pattern into a number of bars (usually 10). The instrument is often called a color simulator. The

signals are crystal-controlled, and accurate with respect to frequency. Each of the 10 bars is an approximation to an NTSC chroma phase, such as (R - Y), (B - Y), (G - Y), I, Q, etc. However, these are only practical approximations as the sidelock signal is changing from point to point. It is for this reason that such instruments are also referred to as linear phase sweeps. The keyed patterns make the instrument much more useful in bench work, because the chrominance axes can be identified with practical accuracy. Conclusive tests of synchronous detection and matrixing can be made with a keyed rainbow pattern. This type of generator often provides a sound sideband and an overload check, which makes it a runner up to the complete color generators.

4. The NTSC type of color bar generator—which provides 100% saturated true colors, with provision for saturation control and signal selection—is the most useful generator for general color service work. This type is expensive, but it also provides a large variety of basic color signals, either separately or in combination. A simultaneous display of the primary and complementary colors with white and black is useful in overall receiver checks as well as for checking delay lines, matrixing, color-subcarrier traps, cross-talk, burst gating and chroma detector operation (see Fig. 1). Individual color-difference signals with accurate phases are also provided, such as I, Q, (R - Y), (B - Y), and others. The (R - Y) and (B - Y) signals are usually available in combination, as well as separately. The bar widths are made unequal to provide identification during

signal-tracing procedures. However, you will find that while some of the elaborate generators provide signals which are within the NTSC specifications, lower-priced instruments in this category may provide individual color fields in which the brightness component is constant for all colors. This simplifies the generator's construction, but does not provide signals within the NTSC standards of hue or saturation.

Still more elaborate color bar generators are available for laboratory use, but their price is prohibitive for most service shops.

## Larger screen

*I have an Emerson 686B with a 17CP4 metal picture tube. I would like to replace the 17CP4 with a glass tube such as a 19EP4 or a 19JP4. High voltage measures approximately 12,500.*  
—C. B., Beckley, W. Va.

As your first step, make sure you have enough room for the larger tube in the cabinet. I would choose the 19JP4 as a better replacement for a 17CP4 than a 19EP4. The 19JP4 operates at a lower voltage, and your high-voltage value of 12,500 would be marginal for the 19EP4. The ion trap from the 17CP4 can be used on the 19JP4 and the flyback transformer will not have to be replaced. The 19JP4 is 2 inches longer than 17CP4, and the yoke will have to be moved back 2 inches. The same yoke can be used however. The mask, of course, will have to be replaced.

## Horizontal pulling

*I have a converted RCA 630TCS chassis in the shop that shows horizontal pulling whenever straight vertical lines are present in the background. If there is a closeup shot, the horizontal pulling straightens out and the lines are no longer wavy. Voltages and resistances check OK. I have replaced several coupling capacitors in the sync circuits. Do you have some suggestions?*  
—A. R. H., Salem, Mass.

The condition of the large electrolytic capacitors in this receiver should be checked. Measure the capacitance values and power factors to see if they are up to par. Don't forget also to check for leakage between sections of the multiple units. Replace any sub-standard capacitors, and the horizontal pulling will probably clear up. I

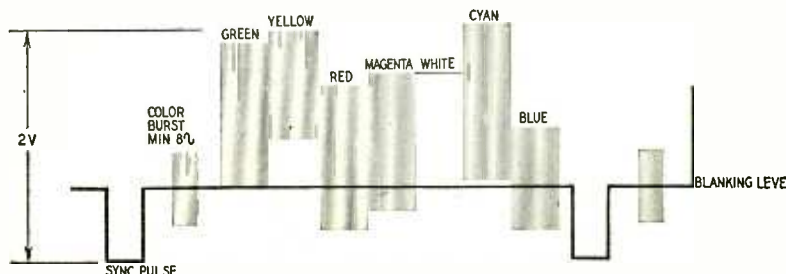

Fig. 1—Video waveform from an NTSC type of color bar generator which provides 100% saturated colors. This is the waveform of the simultaneous bar display.

## TELEVISION

suspect that you will also observe that interlace is poor and a vague and poorly defined tracery shifts through the background of the picture. It is caused by cross-talk among receiver sections, due to failing common electrolytics.

### Sync buzz

*I have been working on a Philco 22B4402, code 140, run 194, with sync buzz. Tubes, sound if alignment and video have been checked. By varying the volume control midway, the buzz can be heard very faintly. When the control is advanced, the buzz increases.*—J. S. T., Brooklyn, N. Y.

This trouble is evidently due to an overload in either the if or video amplifier. You may have a marginal age fault in the if system. This can be checked by operating the receiver from a battery and potentiometer dc bias source. If the receiver does not buzz when the if amplifier is operated from fixed bias, look for age trouble. This difficulty may also be due to a leaky coupling capacitor in an if stage. There is a lesser possibility that the charging capacitor in the sound detector circuit does not have sufficient capacitance.

### Burning flyback

*The high-voltage section of the flyback in a Sylvania 533-2 has burned out and, since a replacement could not easily be obtained, it was rewound. The resistance of the rewind portion is 500 ohms, as per the schematic. But 3 minutes after the set was turned on, this section began to overheat. I get a picture even though the flyback is smoking and have run the set 2 hours with an electric fan at the back. The picture is short 2 inches in width and the width control has no effect.*—A. L. G., Manila, P. I.

Rewinding the high-voltage section of a flyback transformer is a tricky job. The winding must be arranged to minimize the distributed capacitance of the coil and to avoid stray resonances. The smoking which you observed is probably caused by excessive circulating current in the winding due to stray resonance. Part of the winding is probably tuned by stray capacitance to 15,750 cycles and operates like a tuned secondary coupled to a primary coil—the circulating current is as many times greater than the line current as the Q of the section is greater than unity. The fact that the picture is short 2 inches means that the output voltage from the winding is excessive (which causes the electron beam in the picture tube to become "stiffer"), or it may mean that you have one or two shorted turns in the winding, which consume power. Resonant effects can result both in a resonant rise of voltage and excessive power consumption due to losses in the section with heavy circulating currents. Inasmuch as the width control has no effect on picture width, it would seem that the portion of the winding across which the control is

connected contributes little to the power output—this again could easily be caused by disturbed coupling and stray resonances in the rewinding job. It would be advisable to wait for a replacement transformer from the factory.

There is also the possibility that there is nothing wrong with the high-voltage winding and that whatever caused the original winding to burn out is affecting the one you have wound. If current through the flyback is excessive (over 100 ma, measured at the cathode of the horizontal output tube), even a new factory-built flyback may not fix the set and you should look for trouble elsewhere.

### Vertical-retrace blanking

*Please show a basic circuit for adding a vertical retrace blanking circuit that will be usable on most TV receivers?*—V. A. MacR., Franklin, N. Y.

A retrace blanking pulse can be obtained from the yoke, vertical output

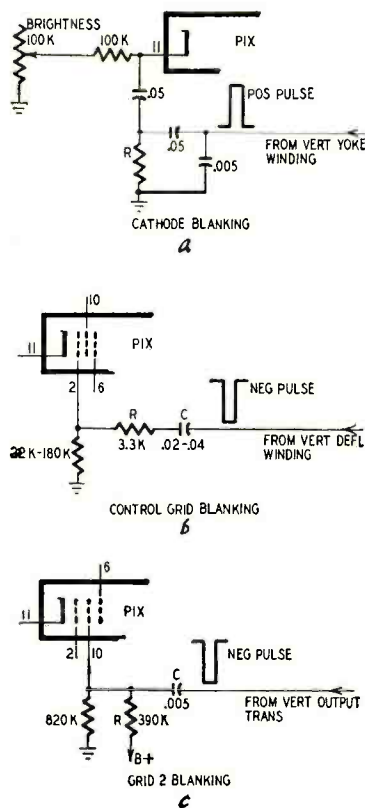

Fig. 2—Three methods of adding vertical-retrace blanking to a TV receiver: a—cathode blanked; b—control grid blanked; c—grid 2 blanked.

transformer or the vertical oscillator. A negative pulse is usually applied to the grid of the picture tube for blanking retrace. Suitable arrangements are shown in Fig. 2. Vary R and C for best blanking.

### Tube plate running red

*In some RCA, Admiral and Crosley receivers, I have found an occasional problem of overheating of the plate of the horizontal output tube. The 6BG6, 6CD6 or 6DQ6 will show a red-hot plate*

*and tube substitution will not correct the trouble.*

*The set owners did not wish to have the chassis pulled because they figured that, as long as the receivers are working, there is nothing to worry about. What do you suggest?*—J. T., East Chicago, Ill.

In response to your inquiry, the most likely cause of overheating of the plate in a horizontal output stage is too low bias on the grid of the tube. Low bias can result from a leaky coupling capacitor to the grid of the tubes, and it can also result from insufficient drive to the grid. Insufficient drive can result in overheating of the plate because most, if not all of the grid bias for the horizontal output tube is signal-developed bias. In other words, the sawtooth signal overdrives the grid into grid current and the drop of this current through the grid leak provides the necessary grid bias.

The service notes for the receiver will usually give the correct grid-bias voltage, and you can easily make a check with a vtvm to determine whether the grid bias is up to par.

### Correction

*The conversion described in the September issue of RADIO-ELECTRONICS is quite timely. I have an RCA T120 on my bench which has been converted to a pentode tuner. Two tuners have failed to give satisfactory operation, probably because the impedance matching was not observed. In regard to the instructions noted above, why do you add a third 27.25-mc trap? Was that a misprint, and did you intend to add a 19.75-mc series trap?*—W. L. J., Pasadena, Calif.

I congratulate reader W. L. J. on his 20-20 vision. The trap marked 27.25 mc in Fig. 1 should have been marked 19.75 mc. This is my error. The impedance of the plate output circuit of the tuner must be approximately the same as the input impedance to the grid of the first if amplifier, or energy transfer will be inefficient. An impedance match can be obtained with somewhat simpler conversions than shown. However, the if response will suffer more or less in bandwidth, which lowers the quality of picture reproduction. The RCA T120 is a wide-band receiver, which is capable of reproducing fine picture detail when the if response is properly maintained. In providing instructions to our readers, we always assume that the customer demands top performance from the receiver. END

**NEXT MONTH**  
**Sync Buzz**

# what's

# new

# ?

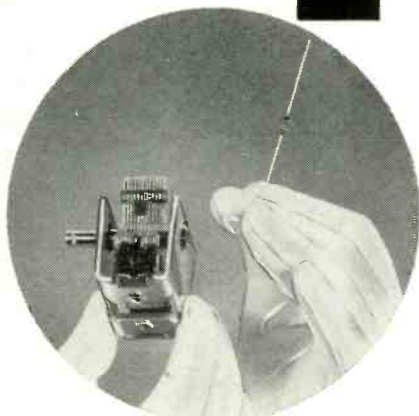

**VARICAP CAPACITOR**, a tiny electronic component, no larger than a teardrop, can automatically observe and maintain color fidelity in a color TV picture and perform many other functions. It is made by Pacific Semiconductors, Inc., Culver City, Calif.

The unit is a member of the solid-state device family, which includes transistors, semiconductor diodes and rectifiers. Its capacitance is varied by changing an applied bias voltage.

In one application the Varicap, a resistor and a mica capacitor replace 24 components. The photo shows a comparison between the Varicap and a standard variable capacitor which it might replace.

**TOROID TRANSISTOR POWER SUPPLY** simultaneously delivers 225 and 450 volts dc from a dc input of 12 or 24 volts. Its maximum output power is 90 watts (transmitter intermittent operation), 40 watts continuous. The compact unit fits into a 2 x 2 x 4-inch case and could move the amateur's power supply from the trunk to the glove compartment. The completely silent electronic operation is a boon to those irritated by the annoying whine of a dynamotor or hum of a vibrator.

The unit is designed around a special toroid transformer built by Sunair Electronics Inc., Ft. Lauderdale, Fla., (who also developed the circuit). The diagram shows the circuit, which uses two Delco power transistors and eight of the new Sarkes Tarzian cartridge rectifiers. The photos show the parts layout.

All rectifiers are mounted on one side of a bakelite board. On the opposite side are placed all other components. Transistors are mounted on brass heat dissipators. The Sunair model uses a printed-circuit board, but it is not a must.

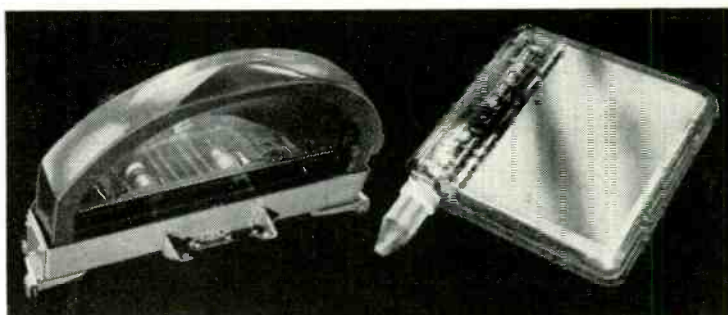

**FLAT TV TUBES** are foreshadowed by these transparent-screen types already in pilot production for experimental military use. Invented by William Ross Aiken, these follow the same fundamental principles as the flat tube described in this magazine, March, 1957. The electron beam, instead of starting at the back and curving up again behind the face, is injected at the bottom edge. It travels along the bottom, which is coated with a row of deflection plates. By controlling the voltage on these plates, it can be deflected up at any point. Another (transparent) set of plates on the back wall turn the rising beam ahead against the screen at the desired point. These two sets of plates sweep the beam as did the deflection plates in early TV receivers, or the coils in modern ones.

According to officials of the Kaiser Aircraft and Electronics Corp., which developed the tube, refinements in the glass envelope may be all that is needed to make picture-on-the-wall TV a reality, though they feel it is still



“a long way from commercial application.” One of the photos shows a standard rectangular tube and a transparent-phosphor model which fits into an airplane's windshield. The other is a pictorial prediction of the two-sided TV set of the future.

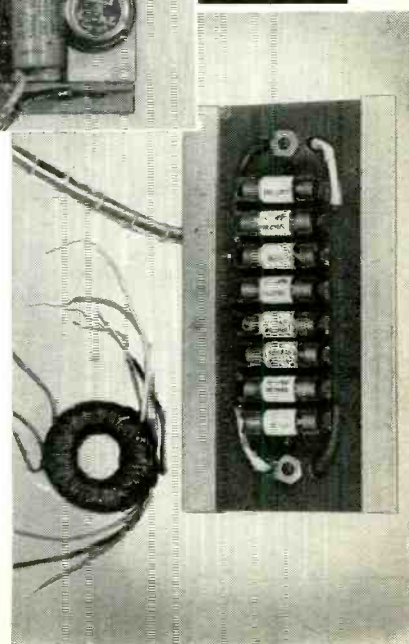
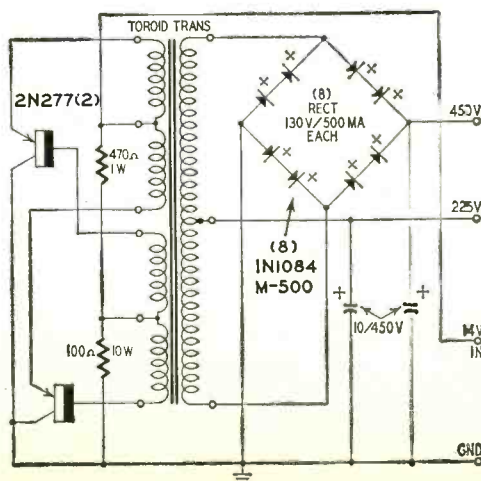
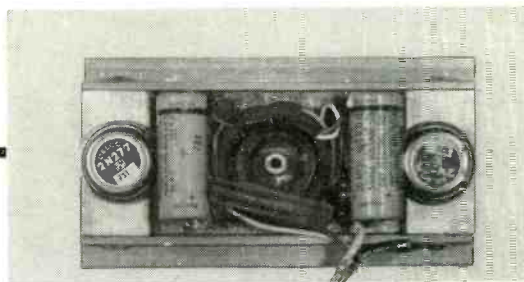

# WIEN-BRIDGE ANALYZER

This third article in a series on audio testing describes a distortion analyzer with a Wien-bridge filter for a heart

By L. B. HEDGE

TO measure harmonic distortion three instruments are needed. An audio oscillator (see "Extended Range Audio Oscillator," page 36, December, 1957), an audio vtvm (see "An Amplifier-Rectifier Vtvm for Audio Testing," page 53, October 1957), and a distortion analyzer. An oscilloscope will help, but is not absolutely necessary.

A single-frequency signal from the oscillator is fed to the amplifier under test. The analyzer is connected to the output of the amplifier (see Fig. 1). The signal from the generator is amplified and the amplified signal fed to the analyzer, along with any harmonics produced in the amplifier. In the analyzer the fundamental generator signal is removed. The remaining signal, consisting of harmonics of the input signal, passes through the analyzer and is measured with the ac vtvm (and oscilloscope if one is available).

The distortion analyzer is basically a tunable filter. While many tunable filters are easily built, they tend to attenuate the harmonics of the filtered frequency as well as the fundamental frequency, which is exactly what we don't want to do. However, the notch in the filter's frequency response can be sharpened by building the filter network into the feedback loop of a high-gain high-negative-feedback amplifier. Fig. 2 shows the relative response of the network used in the Wien-bridge analyzer described in this article. Curve *a* shows its response with a feedback amplifier and curve *b* shows response without a feedback amplifier. The difference is obvious.

The analyzer circuit is shown in Fig. 3. It consists of two high-gain amplifier circuits (V1-a, V2-a), a phase-inverter-driver (V1-b) for the Wien-bridge filter with a switch (S2) for selecting the FILTER or the (filter) FREE channel for the circuit, and a cathode-follower output and feedback coupling stage.

Fig. 4 is a simplified diagram of the Wien-bridge filter circuit used in this analyzer. It represents the filter circuit with S1 of Fig. 3 in the position shown. When the bridge is balanced for some particular frequency, say 100 cycles, only signals whose frequency is above or below 100 cycles will be passed by the filter network. When a Wien-bridge is at resonance, the output at the resonant frequency is zero.<sup>1</sup>

Precise balance of the filter requires that the ratio between E1 and E2 be accurately adjusted. (E1 is the output

<sup>1</sup> F. E. Terman, *Measurements in Radio Engineering*, first edition, McGraw-Hill, 1935; page 136.

The completed distortion analyzer.

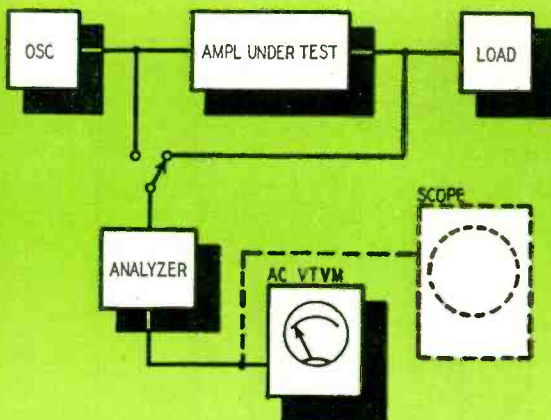

Fig. 1 — Block diagram of harmonic distortion test setup.

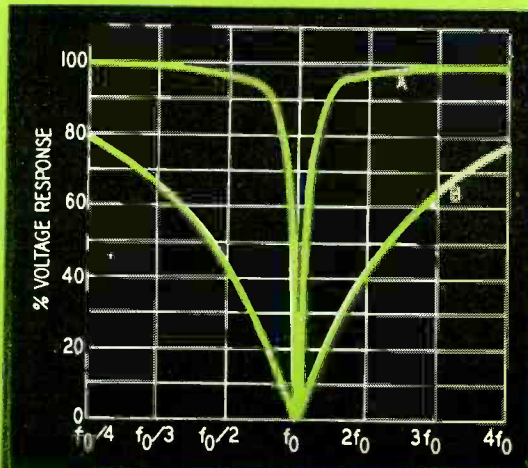

Fig. 2—Notched filter response; a—Wien-bridge with feedback amplifier; b—Wien-bridge without feedback amplifier.

from the plate of V1-b; E2 the output from its cathode.) As it is not practical to make this an automatic adjustment, COARSE (R10-R11) and FINE (R12), BALANCE controls are provided to control E1. The adjustment range is wide enough to correct for minor capacitor (C3, C4) tracking error and resistor (range-resistor) mismatch.

**Design demands**

Designing the analyzer to provide a satisfactory filter notch and a minimum of distortion within the analyzer, requires a high-gain amplifier loop and large negative feedback so that the product of the loop gain and the feedback factor will be much larger than 1.<sup>2</sup>

The triode-amplifier stages (V1-a, V2-a) provide a gain of approximately 200, and with the feedback factor

$$\frac{R17}{R17 + R3 + R4} = \frac{10,000}{10,000 + 8,590} = 0.55;$$

the analyzer's overall gain—when S2 is in the FREE position, or in the FILTER position with the input frequency an octave or more away from the filter's balance frequency—is approximately 1.8.

The one R-C coupling (R6-C2) in the feedback loop provides a minimum phase shift, which is further reduced by the secondary feedback loop, R7 between V1-a and V1-b. This combination makes the unit inherently stable and insures low distortion in the analyzer.

Since distortion above 20,000 cycles is of little importance in audio amplifiers, this unit is designed to operate between 15 and 10,000 cycles. (Harmonics of signals above 10,000 cycles are higher than 20,000 cycles, the extreme upper limit of human hearing.)

Values for the R13, R14, etc., range resistor series are selected to provide substantial tuning-range overlaps.

Mounting the twin capacitor on standoff insulators to keep it as far as practical from the chassis and cabinet—reduces tracking errors due to variable stray-capacitance effects.

Range resistors should be matched in pairs as accurately as possible. If a bridge or other resistance balancing equipment is not available, precision resistors (2% or better) should be used. The exact values of these resistors are significant only in determining the frequency ranges, but close matching of the corresponding pairs is a real factor in providing satisfactory performance. This may not be immediately obvious, in view of the balance adjustment included in the analyzer, but it should be noted that, if the E1/E2 ratio changes from say 2.0 to 2.4 between two values of  $f_0$ ,  $E_{out}$  will move in the direction of E1 rather than E2 as the unit is tuned from the first to the second frequency. Since E1 is 180° out of phase with E2, this will reverse the feedback phase, and oscillation will start! Close matching of resis-

Inside the case. Note the shield over the rectifier. In the original model, shown here, an 80 was used as the rectifier. A later version uses the 5Y3-GT indicated in the schematic.

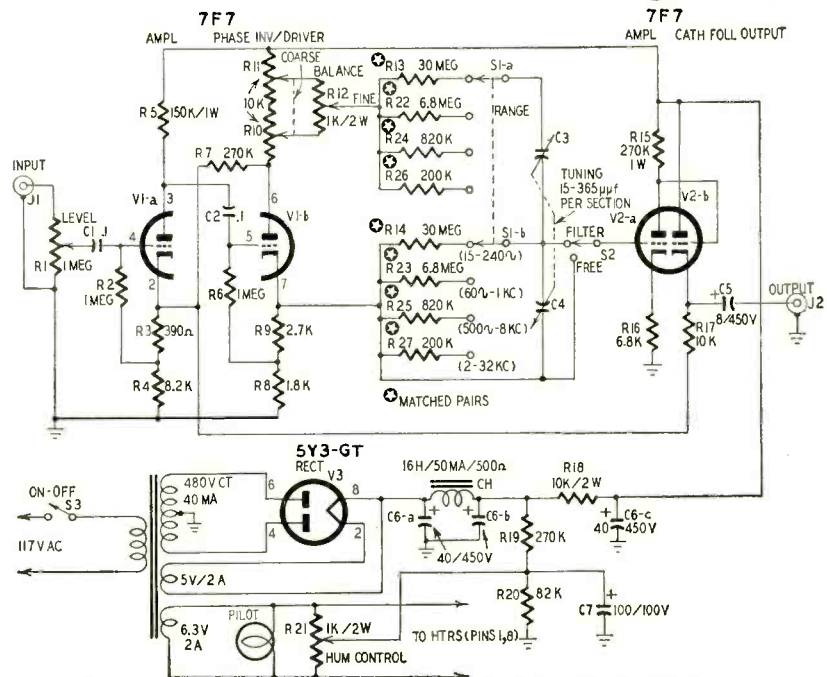
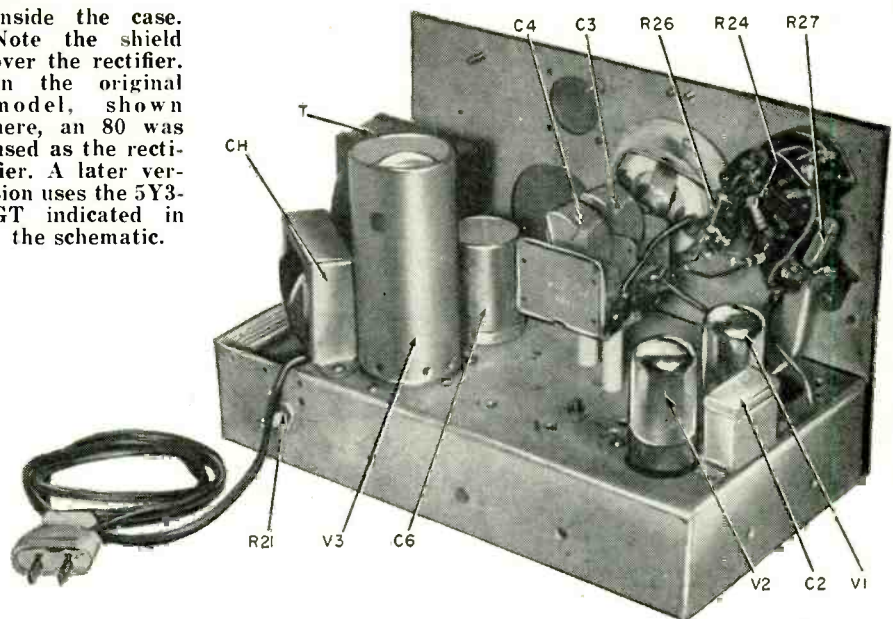

- R1—pot, 1 megohm
- R2, 6—1 megohm
- R3—390 ohms
- R4—8,200 ohms
- R5—150,000 ohms, 1 watt
- R7, 19—270,000 ohms
- R8—1,800 ohms
- R9—2,700 ohms
- R10, 11—twin pot, 10,000 ohms
- R12, 21—pot, 1,000 ohms, 2 watts
- \*R13, 14—30 megohms
- R15—270,000 ohms, 1 watt
- R16—6,800 ohms
- R17—10,000 ohms
- R18—10,000 ohms, 2 watts
- R20—82,000 ohms
- \*R22, 23—6.8 megohms
- \*R24, 25—820,000 ohms
- \*R26, 27—200,000 ohms
- All resistors 1/2 watt unless noted
- C1, 2—0.1 μf, 200 volts
- C3, 4—twin variable, 15-365 μf (Lafayette MS 142 or equivalent)
- C5—8 μf, 450 volts, electrolytic
- C6—40-40-40 μf, 450 volts, electrolytic, can type
- C7—100 μf, 100 volts, electrolytic
- CH—16 h, 50 ma, 550 ohms (Lafayette 105-03 or equivalent)
- J1, 2—coaxial connectors
- S1—2-pole 4-position rotary (shorting)
- S2—spdt toggle (shorting)
- S3—spst toggle
- T—power transformer: primary, 117 volts; secondary, 480 volts ct, 40 ma; 5 volts, 2 amps; 6.3 volts, 2 amps (Lafayette 100-01 or equivalent)
- V1, 2—7F7
- V3—5Y3-GT
- Chassis, 10 1/2 x 6 1/2 x 2 inches
- Case, 10 1/2 x 7 x 6 1/2 inches
- Pilot-light assembly
- Sockets, 8-pin octal (2)
- Socket, 8-pin octal (1)
- Knobs
- Miscellaneous hardware
- \*Matched pairs, within 2% or better

Fig. 3—Circuit of the three-tube distortion analyzer.

tors R13 and 14, R22 and 23, R24 and 25 and R26 and 27 and restriction of the C3, C4 range to its high-capacitance end will eliminate this effect, although oscillation can be started over most of the tuning range by incorrect setting of the balance controls.

Aside from these special elements of

design and construction, the only critical element in the construction and alignment of the distortion analyzer is the elimination of hum. A grounded metal shield is placed around the rectifier tube to avoid hum transfer to the tuning capacitor by the electrostatic field which surrounds the tube.

<sup>2</sup>G. E. Valley and H. Wallman, *Vacuum-Tube Amplifiers*, Vol. 18, MIT Radiation Lab Series, McGraw-Hill, 1948.

## TEST INSTRUMENTS

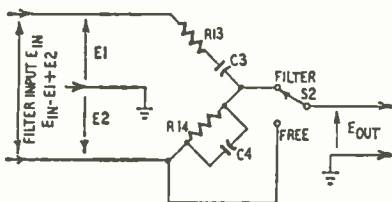

Fig. 4—Partial circuit shown Wien-Bridge analyzer filter.

Power-line leads must be kept away from the analyzer's amplifier loop circuit, and heater supply leads to the tubes should be twisted, laid close to the chassis and well spaced from the signal circuit elements. The bias network (R19-R20) places the heaters at higher potentials than the cathodes of the tubes, thus reducing heater-cathode hum leakage. R21 can be adjusted to minimize any hum which may get into the amplifier.

### Final adjustment

When the analyzer is completely assembled, its tuning scales can be calibrated and its performance checked by connecting the oscillator to its input and its output to a vtvm (Fig. 1, input connection, amplifier and load omitted). Set the oscillator at a frequency in one of the analyzer tuning ranges, set S2 on the FREE position and adjust the LEVEL control (R1) to give a 1-volt reading on the vtvm. Switch S2 to the FILTER position and adjust the tuning capacitor to give a minimum voltage reading. Next adjust the COARSE balance control for minimum voltage reading and then readjust the tuning capacitor for minimum voltage. Next adjust the FINE balance control for minimum voltage and then again adjust the tuning capacitor for minimum voltage.

As these adjustments progress, the voltmeter range switch should be set to keep the meter needle somewhere in mid-scale, permitting accurate adjustment of the tuning and balance controls. When settings of the tuning and balance controls are reached which provide a voltmeter reading which increases with any change in either tuning or balance, the voltage reading will be 1/100 the percentage of harmonic content of the oscillator output (.01 volt = 1% ; .006 volt = 0.6%), and the bridge will be tuned to the fundamental frequency ( $f_0$ ) of the oscillator output.

R21 can be accurately adjusted by setting the oscillator to a frequency a few cycles off 60 cycles, and adjusting the analyzer tuning and balance controls as indicated above. If any hum is present in the output, the vtvm will show a fluctuating reading and R21 should be adjusted to reduce this fluctuation to a minimum. If the fluctuation cannot be eliminated by this adjustment, the hum may be present in the oscillator output and this setup can be used to check the heater potentiometer of the oscillator if it has one.

The calibration procedure should be

repeated over a series of frequency values to provide calibration reference points on the tuning scales of the tuning capacitors.

A complete tuning-scale calibration is of little use since the scale is used only to provide an approximate initial setting of the tuning capacitors and final adjustment is made, as in the calibration procedure, to provide minimum voltage output reading with a given signal. On this analyzer I have five calibrated points on each range.

In application for checking harmonic distortion in an audio amplifier, connections are made as shown in Fig. 1. Provision should be made, as indicated, for connecting the analyzer input to the input and to the output of the amplifier. The harmonic content of the input and output signals should be checked without changes in the amplifier, amplifier load or oscillator adjustments between the two checks. The amplifier distortion is then determined, under the conditions and at the oscillator frequency of the test, as the difference between the percentage harmonic content of the output signal and the percentage harmonic content of the input signal.<sup>3</sup>

If an oscilloscope is available, it may be connected across the output of the analyzer—in parallel with the vtvm—where it will be of some help in reaching a quick balance and tuning adjustment of the analyzer. Specific applications of the oscilloscope to audio amplifier tests will be covered later in this series but, at any stage in

these tests, observation of waveforms involved will be worth while. An oscilloscope provides a kind of visual perspective which is always helpful in interpreting the measurements and effects involved in the various tests and test procedures.

With the analyzer, oscillator and vtvm available, the first three basic tests<sup>4</sup> of af amplifiers—amplification (voltage and power gain), frequency response (amplitude distortion) and harmonic distortion—can be made directly. The changes in connections among the various units involved are, however, somewhat complicated. The next article of this series will cover the design and construction of a master control unit which will provide all of the necessary interconnections of the vtvm, oscillator, distortion analyzer and the amplifier under test. It will also include connections and controls for additional test units—an oscilloscope and an electronic switch—which will complete the test set up. Construction of the electronic switch and modifications to simple oscilloscopes to provide improved response, will be covered in future articles, which will also include a detailed analysis of test procedures and performance standards and specifications applicable to audio amplifiers. END

<sup>3</sup> RETMA Standard on Amplifiers for Sound Equipment (SE-101A), RETMA, Washington, D. C., 1949.

<sup>4</sup> L. B. Hedge, An Amplifier-Rectifier Vtvm for Audio Testing, RADIO-ELECTRONICS, October, 1957.

## BLIND DATES don't always work out the way you hope!



Neither does buying tubes by mail — except when you buy through advertisements in RADIO-ELECTRONICS. Since January, 1956, the publishers of RADIO-ELECTRONICS have insisted that mail-order advertisers either state that their tubes are new and unused or say specifically that they are substandard. There's no "blind dating" in RADIO-ELECTRONICS. You always know just what to expect. It may not be fun—but it's safer!



# FIX THAT ROTATOR

By HOMER L. DAVIDSON

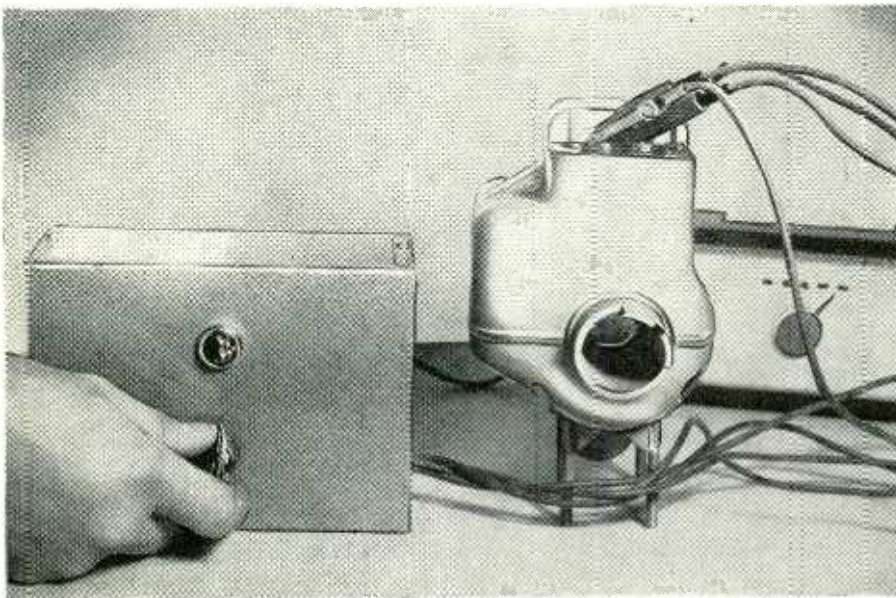

The rotator checker in use.

*This "trained control box" makes rotator checking easier*

**T**HE instrument described in this article may be built with parts from an old rotator control box and will check at least 90% of all rotator motors.

When a service call comes in for a rotator repair, the technician picks up his tool kit, several rotator control boxes (if he doesn't know just which type is needed) and takes off. The customer usually doesn't know what kind of rotator she has or if it is an automatic or manual type. The technician must localize the trouble. Is it in the motor or the control box?

The old way to check a rotator is with a continuity tester such as an ohmmeter. With this rotator checker you can check cable continuity and the motor, and you can even turn the motor. Provision for checking the meter rheostat in the motor while in operation is included. If the rotator is the automatic type, the pulse relay switch and return lead can also be checked.

In a regular rotator hookup (see Fig. 1) the control switch is turned in the desired direction. This places an ac voltage across the power transformer's primary and completes the secondary circuit through an ac capacitor and one winding of the rotator's motor, causing the motor to turn in one direction. When the switch is pushed in the other direction, the transformer's output is applied to another winding in the motor and the rotator turns in the other direction. To indicate the direction in which the rotator is turning, a rheostat is placed in the motor housing so that its resistance varies with the position of

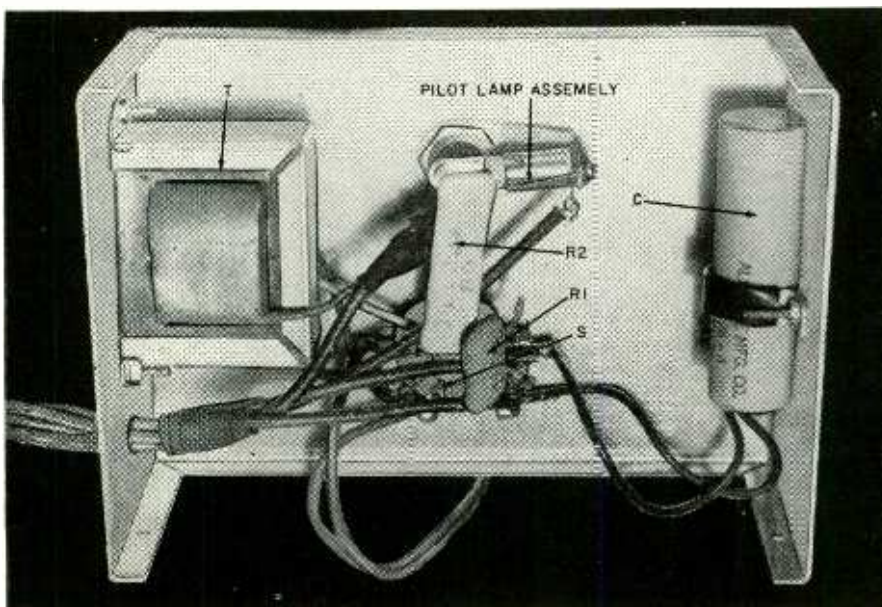

Inside the checker. Almost any kind of case can be used.

## TELEVISION

the antenna. A meter in the control box is wired into the circuit and provides a visual record of the direction in which the rotator and antenna are turning.

The rotator checker is essentially the same as the control box of an ordinary rotator. (See Fig. 2.) Since a meter is used in manual rotators and a relay assembly in automatic units, the tester employs a pilot light which serves as an indicator for both types. When checking we are not particularly interested in which direction the rotator is turning. We only want to know if it is turning. This job is handled best by the pilot lamp.

A No. 49 lamp is used. It is picked instead of the common No. 47 or 51 because it draws only 60 ma and will not cause the rheostat in the motor to run hot. Two 5-watt resistors, 200 and 75 ohms respectively, are connected in series to drop the voltage for the pilot lamp. By using the plain and black alligator clips on the checker, the pilot light becomes part of a continuity tester.

### Rotator tests

When testing a rotator either in the home or on the workbench, the checker is hooked up according to a chart fastened to its case. (See Table I.) For example, when testing a Cornell-Dubilier-Radiant (C-D-R) TR-11 motor, the red clip is connected to terminal 1, yellow clip to terminal 2, plain clip to terminal 3 and the black clip to terminal 4. Turn the switch in one direction and, if the motor turns, the trouble lies in the control box. If the motor does not turn in either direction, it is defective. If the motor turns and the pilot lamp doesn't light, the trouble is in the rheostat in the motor, or the return cable from the rheostat is broken.

If the motor being tested is an automatic type, the pilot light will click on and off, according to the pulse switch in the motor. In fast-pulsing motors (as in the C-D-R automatics) the light will not be as bright as in a slower-pulsing motor. This is due to the difference in switching-time duration.

The tester's construction is very simple. A complete unit can be built into almost any type of case. Alligator clips are used for connections to motor terminals. The clips should be insulated to avoid shock hazards and shorts. Indicated colors do not have to be followed as long as there is some distinction between clips. If you use different colors, be sure to make corresponding changes in Table I.

This little unit has been used, tried and tested in the field where it has successfully licked many rotator problems.

The most common failures in antenna rotators are a defective rheostat in the motor assembly, wind breakage and poor automatic timing. When the control-box indicator (meter) does not work, the fault is usually an open rheostat in the motor unit. Run a continuity test to make sure the unit is defective

	Alliance Tenna-Rotor	Brach, 54L, 54M	Channel-Master Golden Rotator	Cornell-Dubilier-Radiant TR-4, TR-11, TR-12	AR-1, AR-2, AR-3	Crown CAR6A	JFD RT100 RT400	La Pointe VEE-D-X VB	RMS M55
Red	1	1	1	1	1	1	1	1	1
Yellow	2	2	2	2	2	4	4	2	2
Plain	3	4	4	4	3	2	2	3	4
Black	4	3	3	3	4	3	1	4	3

before pulling the motor. Pulling a motor is usually a lot of work so when it is unnecessary it should be avoided.

After the motor has been pulled, another test should be made before taking the unit apart. Replacement rheostats can be obtained from most jobbers or directly from the factory.

The motor assembly doesn't cause much trouble unless damaged by wind or struck by lightning. These small

break a wire or the wires may become grounded when the unit is installed. When placing the cover over the motor unit's terminals, be sure the rotator wire is in its proper place. Otherwise, the cover will bite into the wire and eventually short the motor unit. Another point to remember is never place a strap standoff over the rotator cable to hold it in place. The strap will cut into the cable insulation and eventually

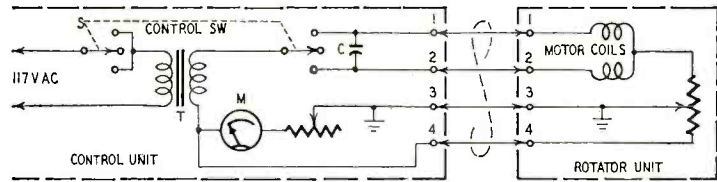
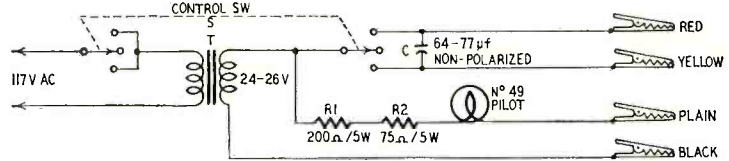

Fig. 1—Circuit of a typical rotator. Control and rotator units are shown.



R1—200 ohms, 5 watts  
R2—75 ohms, 5 watts  
C—64-77 uf, 60-cycle 45-volt ac type (Sprague AM-1108 or equivalent)  
S—2-pole 3-position rotary, nonshorting (Mallory 3223J or equivalent)

T—rotator transformer; primary, 117 volts; secondary, 24-26 volts  
Pilot-lamp assembly with No. 49 lamp  
Alligator clips, insulated (4)  
Case  
Knob  
Miscellaneous hardware

Fig. 2—The rotator checker can be made of parts from old rotator control boxes.

motors are practically trouble-free, though they can be burned out because of a defective control box. Whenever a motor is burned out, be sure that the control box has been checked.

### Wind, customers, lightning

Wind is the most common cause of damage to rotator motors, especially if the unit isn't properly installed. Too large an antenna with a lot of wind resistance will strip the rotator's gears in a wind storm. A thrust bearing should be used to help support the antenna's weight and to prevent damage from constant rocking.

Many troubles are caused by the customer. He will almost invariably get an automatic control head out of time, but with a little instruction (the service technician's job) he can learn how to lock the unit in step. If this instruction is given when the unit is installed, you may save an unnecessary service call.

Occasionally a roator will stick, bind or move slowly while turning. This is generally caused by a misaligned thrust bearing or a binding floating guy ring. It should be promptly repaired as the added strain may damage the rotator's motor. Simply place a ladder alongside the rotator and align the unit while someone operates the control box.

There are times when the rotator cable causes trouble. The wind may

ground out the rotator. Either tape the rotator wires to the mast or use an insulated standoff to hold the wire securely. Most four-lead rotator cable will be held securely by ribbon-line standoffs. Control boxes often get knocked down and broken. New cabinets are available from jobbers. Switch contacts tend to become dirty and bent. Then they must be cleaned and straightened to restore normal operation. When lightning strikes a rotator, the control box is often damaged. A lightning arrester placed on the rotator cable provides some protection but does not always save the rotator unit. END



"You're pulling in a strong station from Australia, mam."

**all-transistor**

Portable four-transistor unit gives direct readings on a 1-ma meter

**DIRECT-READING**

**AF METER**

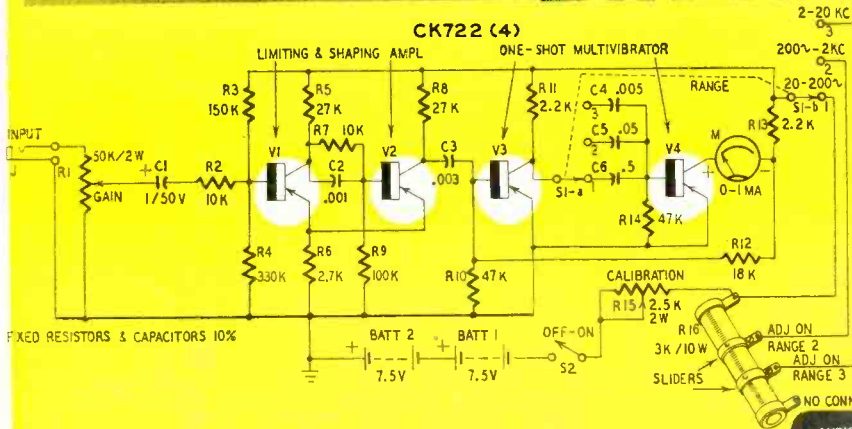

Fig. 1—Circuit of the all-transistor frequency meter.

by DAVID STONE

**A** DIRECT-READING audio-frequency meter is worth its weight in gold when you have to measure unknown audio frequencies, test or calibrate audio oscillators or measure audio beat notes. In addition, you can plug a microphone into the meter and check the frequencies of pitch pipes, tuning forks, piano strings, sirens or any other single-frequency sound-producing device. For greatest convenience, add portability and eliminate the need for supplying external power. The result is a valuable tool for audio-frequency testing, outdoors, in the shop or in the lab.

This all-transistor unit fills the requirements of portability, low battery drain, accuracy and sensitivity. It covers the entire audio spectrum in three ranges: 20 to 200, 200 to 2,000, and 2,000 to 20,000 cycles. It responds to 1 volt of audio signal, making it usable for most applications where low-level audio signals are measured. Nominally priced, noncritical compo-

**PARTS LIST FOR FIG. 1**

- R1—pot, 50,000 ohms, 2 watts
- R2, 7—10,000 ohms, 10%
- R3—150,000 ohms, 10%
- R4—330,000 ohms, 10%
- R5, 8—27,000 ohms, 10%
- R6—2,700 ohms, 10%
- R9—100,000 ohms, 10%
- R10, 14—47,000 ohms, 10%
- R11, 13—2,200 ohms, 10%
- R12—18,000 ohms, 10%
- R15—pot, 2,500 ohms, 2 watts
- R16—3,000 ohms, 10 watts, wirewound, adjustable with 2 sliders
- All resistors 1/2 watt unless noted
- C1—1 μf, 50 volts, 10%
- C2—.001 μf, 10%
- C3—.003 μf, 10%
- C4—.005 μf, 10%
- C5—.05 μf, 10%
- C6—0.5 μf, 10%
- BATT 1, 2—7.5 volts (Burgess C5 or equivalent)
- J—phone jack
- M—meter, 0-1 ma
- S1—2-pole 3-position rotary
- S2—sps toggle
- V1, 2, 3, 4—CK722
- Chassis
- Cabinet
- Miscellaneous hardware

ponents are used throughout. The entire instrument is self-contained and rugged enough for the roughest servicing use.

**Circuit description**

The circuit, shown in Fig. 1, uses four CK722 transistors operating in pairs. The first two, V1 and V2, are limiting and shaping amplifiers. They convert the incoming audio sine wave (Fig. 2-a) into sharply peaked trigger pulses (see Fig. 2-b). In addition, this transistor pair saturates and keeps the amplitude of the output pulses from V2's collector at a constant voltage level regardless of amplitude or frequency variations in the input sine wave. The net result, at the collector of V2, is an output which does not vary in amplitude, but whose frequency is identical with that of the input. A pulse is produced for each cycle of frequency. If the input frequency increases, the number of trigger pulses increases. If the incoming signal decreases in frequency, the number of pulses from V2 also decreases.

The second pair, V3 and V4, is arranged in a one-shot multivibrator circuit. This is a familiar resistance-

coupled amplifier with feedback from V4's collector to V3's base. V3 is normally biased to cutoff and does not conduct until a pulse arrives from V2 to trigger the circuit and overcome the bias. V3 then conducts heavily and the resulting pulse is amplified by V4. When the pulse ends, V3 goes sharply back into cutoff and V4 stops conducting. The circuit is ready for the next pulse from V2.

The output from this pair is a series of amplified current pulses (see Fig. 2-c). The number of pulses is propor-

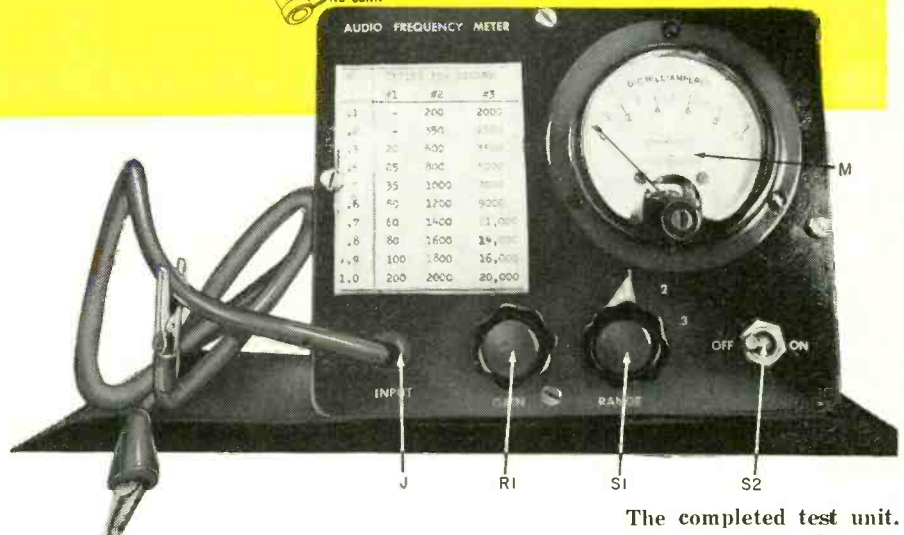

The completed test unit.

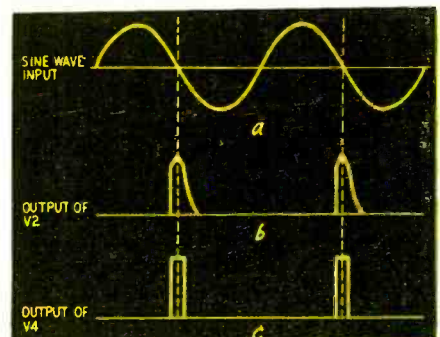

Fig. 2-a—Input waveforms; b—at output of V2; c—at output of V4.

## TEST INSTRUMENTS

tional to the frequency of the incoming audio sine wave at V1's input, and V4's collector current through the meter will deflect the meter needle higher for more pulses (a higher sine-wave frequency) and lower for fewer pulses (a lower sine-wave frequency). If you feed a known audio frequency into the unit and log the meter reading, you'll wind up with a standard by which unknown audio frequencies can be measured.

Since the circuit operates on a change of frequency, the coupling capacitor between V3 and V4 must be changed to allow the multivibrator circuit to operate over the 20–20,000-cycle frequency range. This is done with the RANGE switch. The unknown audio frequency's input level to V1 is controlled by the GAIN potentiometer.

Power requirements vary from 7 volts at 3 ma to 11 volts at 7 ma. The lowest range, 20 to 200 cycles, uses the higher voltage and current. A 15-volt battery pack, made from two series-connected 7.5-volt batteries, is used as the power supply and appropriate voltage-dropping resistors are selected by the RANGE switch to provide the correct voltage for each range.

A CALIBRATION potentiometer is inserted in series with the battery to compensate for battery voltage drop due to aging and use. This provides long service from a set of batteries, because the CALIBRATION potentiometer is adjusted to compensate for battery age. When battery voltage drops below 11, the pack must be discarded.

### Construction hints

There is nothing critical about building this test unit. The usual precautions must be observed if the transistors are soldered directly into the circuit. Keep soldering-iron heat away from the transistors by using long-nose pliers to hold the leads between the iron and the transistor body. Wire the GAIN potentiometer in the usual volume-control hookup, so its variable resistance decreases as the control shaft is turned counter-clockwise.

Any type of wood, metal or plastic chassis and case can be used. I used a Plexiglas block on which several terminal strips were mounted for the chassis. All resistors, capacitors and wires are soldered to the terminals before the transistors are wired into place. The panel is cut, drilled, painted and all parts mounted before the chassis is attached. The final hookup is completed and the batteries are fastened inside the wood cabinet with metal straps.

If you desire, a large milliammeter (square or round) can be used, as long as it has a basic 1-ma movement. Also, it will be necessary to get an extra slider for R16. Two sliders are needed because the wirewound unit is used to drop the voltage for two ranges.

After construction is completed, connect the batteries (*observe proper polarity!*) and throw the switch to ON.

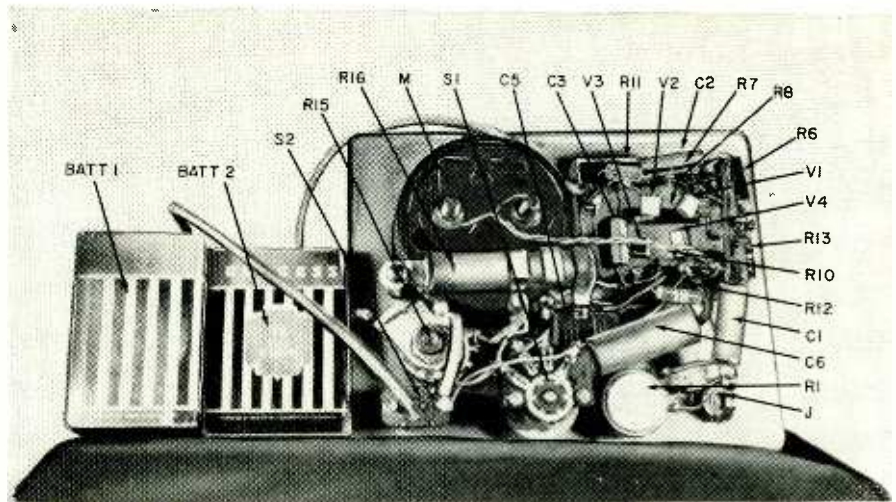

Parts layout inside the direct-reading meter. All transistors are CK722's. V4 is an older unit in a different style case.

The meter should indicate about 0.1 ma. If no reading is obtained or an appreciably higher reading is noted, something is wrong. Check the wiring, V3 and V4. The 0.1-ma reading is normal, static current. If everything seems to be in order, calibration can begin.

### Calibrating the meter

An accurate signal generator is needed to calibrate the transistorized test set. The final accuracy of the frequency meter depends upon *the accuracy of the calibrating audio generator*. Be sure it is a good one. They are not as hard to find as you may think for most well-equipped service shops or schools have them. Arrangements can be made to bring the test set in for calibration. If you're in an area where these facilities are not available, try the local telephone-system maintenance shop. The shop supervisors are friendly people and most of them have good audio generators on hand. My unit was calibrated in a telephone maintenance and repair section.

If all else fails, you can use a less accurate generator, a scope and Lissajous figures, but this method is extremely tedious and should be used only as a last resort. Normally, with a good audio oscillator, calibration takes from 15–30 minutes.

First switch the RANGE selector to range 1, 20 to 200 cycles. The GAIN control should be turned to its farthest counterclockwise position (toward the grounded end). Feed a 200-cycle 2–3-volt audio signal to the input jack and slowly rotate the GAIN control clockwise. The meter reading will slowly increase, then suddenly jump toward full scale. Further clockwise rotation of the GAIN control will not result in any further increase of the meter reading. Back the GAIN control down and reset it about a quarter turn *after* the needle has jumped toward full scale. Do this two or three times and you'll find it easy to reach this point. This procedure sets the best input level for proper operation of the test set.

Observe the meter reading. It will probably be a little above or below the full-scale 1-ma level. Adjust the 2,500-ohm CALIBRATION potentiometer for exactly 1 ma with a 200-cycle input. Calibrate the rest of the range by decreasing the calibrating generator's frequency until the meter needle drops to the 0.9-ma mark. Log the frequency on the audio oscillator dial.

Go down to the next mark (0.8 ma), log the frequency and continue this procedure until you hit 20 cycles. This frequency will probably produce a reading somewhere around 0.2 ma, so the 0.1 static-current reading will not be within the frequency range. Several of these test sets have been built and none of them read appreciably below 0.2 ma for the lowest frequency in each range.

When range 1 is calibrated, switch the RANGE selector to range 2, 200 to 2,000 cycles. Feed 2,000 cycles into the frequency meter and recheck the setting of the GAIN potentiometer. Move slider 1 (*nearest* the connected end) of R16 up or down the resistor for a full-scale reading of 1 ma at 2,000 cycles. When this reading is obtained, tighten the slider permanently and proceed with lowering the frequency and logging the meter readings all the way down to 200 cycles.

Finally, turn to range 3, 2,000 to 20,000 cycles, set the calibrating oscillator to 20,000 cycles and recheck the GAIN control setting. Adjust the slider *farthest* from the connected end of the R16 for a full-scale 1-ma reading at 20,000 cycles. After this, lower the frequency of the calibrating generator and log the readings versus frequency until 2,000 cycles is reached.

The chart on the test meter in the photograph shows the meter readings and frequencies. The readings will vary between one test set and another because transistor gains vary, even among the same type and manufacturer. However, the variation will not be large. Type the chart, cover with cellophane tape or plastic and fasten it to the instrument's panel. Calibration is com-

pleted and the unit is ready for use.

**Using the frequency meter**

Always start with the GAIN control turned fully counterclockwise when checking an unknown audio frequency. Rotate it a quarter more, after the jump point, and compare the meter reading against the chart to determine the frequency. It's very simple to use and the GAIN adjustment takes half a second to set the input to the best level.

Make sure the incoming level is 1 volt or better. The setting of the GAIN potentiometer quickly indicates whether the input level is high enough. If you cannot reach a point where rotating the GAIN control will not increase the meter reading, the input level is too low.

To check the frequency of an audio oscillator, simply hook the input test cable of the frequency meter to the output terminals of the oscillator. The input test cable is a shielded lead or a length of coaxial cable with clips and a phone plug, as shown in the photos.

Use a carbon microphone and microphone transformer to feed the input test jack to measure frequencies produced by tuning forks and other single-frequency sound-producing gear. A crystal microphone with a suitable pre-amplifier can be used for the same purpose.

Place the test cable across the speaker terminals of a receiver to test for beat frequencies between two stations interfering with each other. Be sure the volume is high enough to supply the minimum 1-volt level. Use it as an indicator instead of a speaker when signal tracing PA systems fed by an audio oscillator.

A high-output crystal phono cartridge with attached phono needle has been used for a relative vibration-frequency check of machinery. The phono needle is held lightly against the vibrating surface and the cartridge produces an output voltage that activates the frequency meter. All kinds of similar applications are possible with this test unit, limited only by the imagination and ingenuity of the experimenter.

Occasionally check to see whether the battery voltage has dropped. Feed a 200-cycle signal into the set and look for a full-scale reading on range 1. If the reading is low, indicating that the battery has aged, adjust the CALIBRATION potentiometer to bring the reading to full scale again. This adjustment automatically compensates for ranges 2 and 3.

This transistor test set is an extremely versatile piece of gear, with practically no limit to the life of its components. There are no complications in construction and it takes only a short time to build. It is a useful and welcome addition to the experimenter's and technician's stock of needed test equipment. END

**BIBLIOGRAPHY**

- "Multivibrator Circuits," *RCA Handbook of Electronic Circuits*, 1953, page 74.
- "Three New Transistor Circuits," by N. Hekimian, *Electronics Magazine*, November, 1956, page 178.

# Simple Signal Generator

Most experimenters and home constructors occasionally need an rf signal generator, but the need is seldom great enough to warrant purchasing one. Fig. 1 shows the circuit of a simple rf signal generator made from in-

quencies try TV linearity or width coils in various inductance ranges. For the broadcast and shortwave bands you can use the tuned windings of antenna, rf and oscillator coils designed for the desired frequencies. Above 18 mc or

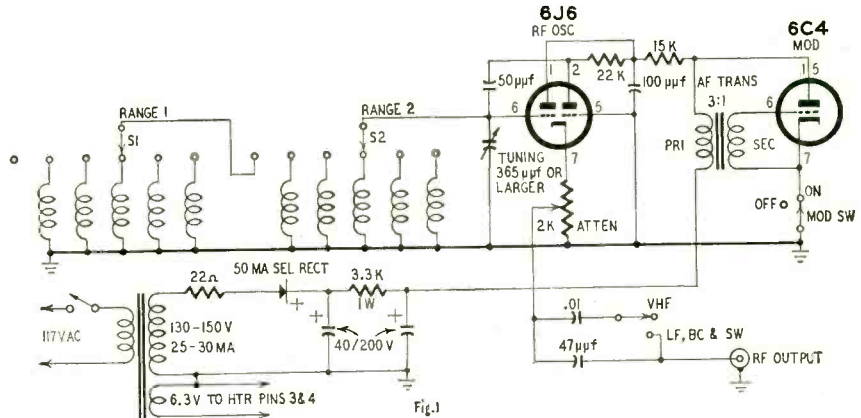

expensive or junkbox parts. The circuit originally appeared in *The Short Wave Magazine* (London, England).

The author used two banks of five coils selected by range switches S1 and S2 to cover from a few kc up to 250

mc so you can wind coils experimentally, cut sections of B & W Miniductors or use CTC (Cambridge Thermionic Corp.) 30- and 60-mc slug-tuned coils and check them with a grid-dip meter or on a receiver. Above 30 mc we sug-

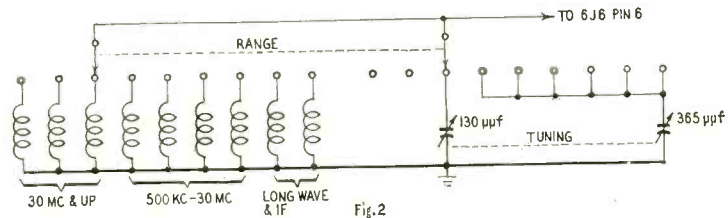

mc. You can select coils to fit your needs and may replace S1 and S2 with a single switch having one position for each tuning range.

Coil winding data was not given. It is recommended that coils be obtained from junked receivers and similar sources. Coils in the if range can be windings from 132-, 175-, 262- and 455-kc if transformers. For lower fre-

quency ranges, you can use a larger tuning capacitor—about 100 μf—as in Fig. 2. When using this arrangement, the tuning control may be a two-section superhet type tuning capacitor with a cut-plate style oscillator tuning section. A conventional unit with an rf tuning section or around 365 μf and an oscillator section of about 130 μf maximum should work nicely. END

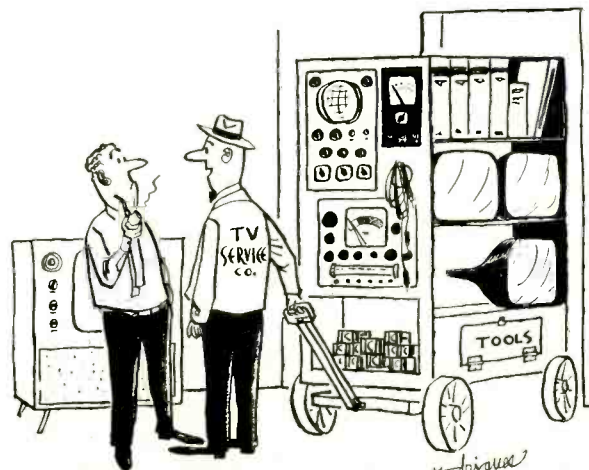

"You know our motto, sir. We fix the set in your home or no charge."

# Single-Groove

# STEREO DISCS

*Vertical and lateral recording techniques are combined in new processes that put two audio channels in one record groove*

By **NORMAN H. CROWHURST**

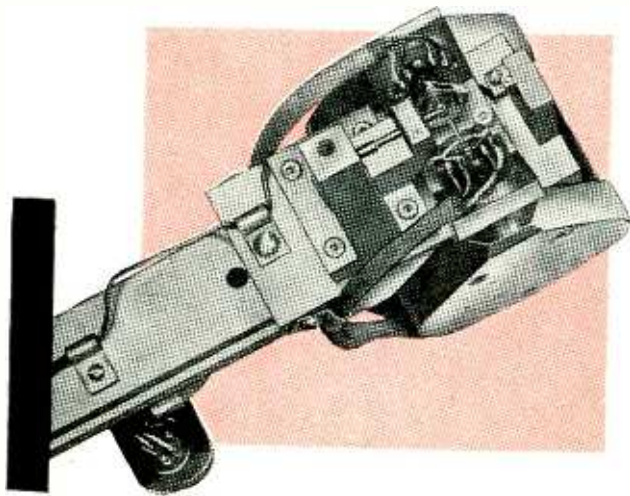

Closeup of the Westrex playback head.

THE question most often asked, when the possibility of a new stereophonic system of disc recording is mentioned, is "Does it use one or two styli?" Often surprise is expressed that it should be possible to use a system with only one stylus. Of course, the Cook "binaural" record has been available for some time. It uses two pickups spaced a certain distance apart, so each plays a separate section of the record. But many people seem to visualize two styli quite close together and probably in the same pickup, either playing adjacent grooves or following each other in the same groove.

This idea probably arises from the present systems of stereophonic tape which employ two tracks and consequently require two playback heads. Systems for stereo on tape have been suggested employing magnetization at different angles on only one track. Separate playback heads, mounted at the correct angle for the program information in each channel, could then play the same magnetic track (Fig. 1).

But disc is quite a different proposition. For one thing there would be the difficulty of making sure that each stylus is in the correct groove. If the arm and head of the pickup are mounted correctly so the styli are *theoretically* in line with the groove at all positions

across the record, the compliance of any modern pickup must be so large that the stylus can move a distance representing several grooves without appreciable opposition. Consequently it would still be very easy to lower the pickup in such a way that the two styli would settle in grooves two or three rotations apart instead of in the same groove. In fact it would become difficult to lower the pickup so that the two styli would rest in the *same* groove—and even more difficult to lower them so they rested correctly in adjacent grooves, if such a system should be used.

The great prospective advantage of stereophonic recording on disc is that it will be as easy to play as LP's are today. Consequently an arrangement that involves great precision in lowering the pickup to the record would invalidate its advantage. It would become no easier to handle than tape. So the only prospective system for stereophony on disc that represents an economic and utilitarian advantage is one where a single stylus is used.

### Vertical-lateral

The idea of using vertical-lateral recording is not new. It has been experimented with for a long time, and good pickups for the purpose were developed in the '30's. At the moment, two completely different systems, both using vertical and lateral movement of the stylus, are being proposed for high-fidelity reproduction of stereophonic sound.

One comes from England (the London Record Co.), employing vertical for one channel and lateral for the other channel of stereophonic sound. The second is a system recently developed by Westrex, which employs 45° movement one way for one channel and 45° movement at right angles to the first for the other channel. This new system claims several advantages over the vertical-lateral system. Whether these advantages are real or theoretical remains to be proved.

One question encountered with both should first be resolved. When any system of moving the stylus both vertically and laterally is discussed, someone invariably asks won't it be difficult to press recordings of this type. The implication seems to be that it must involve some undercutting in the groove

Stereophonic disc recording is a prospect for the immediate future. Not so long ago, during the Audio Engineering Society's convention in New York City, *two* systems of stereophonic disc recording — both using a single groove and single stylus — were demonstrated. Comments of manufacturers and engineers left little doubt that commercially practical disc stereo has arrived, and it is confidently expected that major record manufacturers on both sides of the Atlantic will start producing stereo discs this year.

walls. The argument usually begins, "If the stylus moves sideways when it is at the bottom of a vertical cut . . ."

In answer to this, note that both vertical and lateral recordings use a cutter and stylus whose disposition to the record is vertical (Fig. 2). When the same cutter is used to cut vertical and lateral, or the same stylus to play it back, it is still vertical. So there can be no undercutting at any point. In fact, London Records has pressed a quantity of these recordings in their standard machines used for LP's, and demonstrations were given with these pressings. We are assured that stereo discs need cost no more for the same playing time than LP's. This, surely, is the economic answer for stereo.

To explain the principle on which these systems work, Fig. 3 shows a simplified arrangement for a magnetic pickup (or cutter) for use on each. In the vertical-lateral (London) (Fig. 3-a) vertical motion of the armature attached to the stylus alters the magnetic field between the vertical pole pieces and produces vertical output from these coils. But the movement is parallel to the lateral pole pieces and thus produces no output. For lateral movement, the reverse is true.

The so-called 45/45 (Westrex) works in exactly the same way by rotating the pole-piece portion through 45° (Fig. 3-b). Each 45° motion is at 90° to the other so the same separation of outputs works just the same. Obviously the physical arrangement shown in Fig. 3 could not be used because the stylus could never touch the record in the position shown—the magnetic assembly would get in the way. These are simplified drawings to show how it works. Nor is the principle limited to magnetic pickups. The same separation can be achieved with moving-coil, crystal, capacitance, etc., or with combinations of them.

The first and biggest advantage claimed for the 45/45 is that vertical recording has always been accompanied by a greater amount of distortion than lateral recording. This is because depression of the cutter requires a greater force than lifting it. Because of the triangular shape of the cutter, depressing it by, say, 1 mil, increases the amount of record material removed by much more than lifting it by 1 mil *reduces* the quantity removed (Fig. 4). Force required is approximately proportional to material removed. Consequently, vertical recording (or hill-and-dale, as it was called in old days) is accompanied by second-harmonic and similar forms of distortion.

For a long while this has been the reason given for the preference for lateral recording where the cutter removes a constant amount of material from the master disc, and consequently there is no inherent distortion in the cutting operation. The argument for 45/45 is that both movements involve the same proportion of vertical and

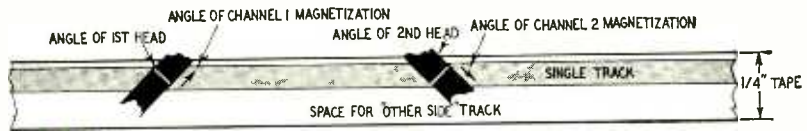

Fig. 1 — A method by which two-channel stereo might be put on a single tape track.

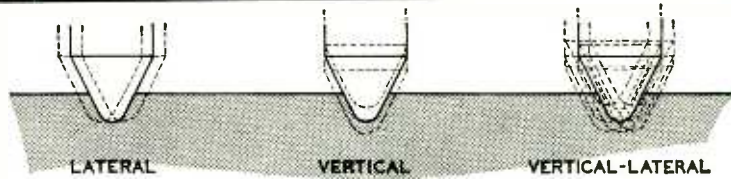

Fig. 2 — In lateral recording the stylus moves sideways; in vertical recording up and down. Vertical-lateral moves it in all directions.

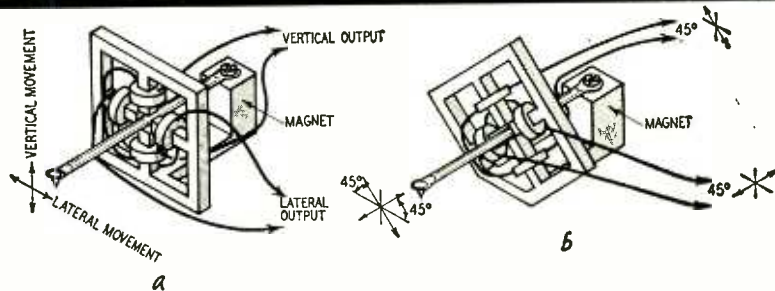

Fig. 3 — Simplified arrangement for stereo magnetic pickups: a — London method; b — Westrex method.

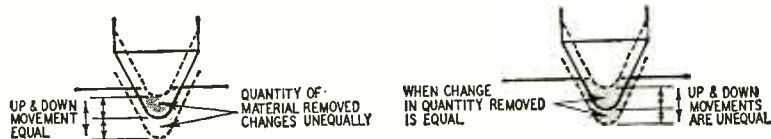

Fig. 4 — The reason for greater distortion problems with vertical recording.

lateral components (Fig. 5); consequently the quality is equal on both channels. The distortion contributed by the vertical component is not all on one channel but distributed equally between both channels.

**Compatibility**

The second claim for 45/45 is that it gives better compatibility both ways. Before going any further, let's define a little more precisely what we mean by compatibility. Complete compatibility would mean the system is capable of the following combinations:

1. A new type stereo pickup should be able to play and give satisfactory reproduction from an LP record recorded nonstereo, and
2. A nonstereo pickup and single-channel high-fidelity system should be able to play the new stereo disc with quality equivalent to reproduction from a good LP.

Compatibility in the first sense is achieved by either system. The second sense involves two further considerations. If it is possible to play the stereo disc with a nonstereo pickup and achieve high-fidelity reproduction, it would seem that the record manufacturer does not have to put out two types of discs for the same program. But there is another factor.

If the stereo disc is played with an LP type pickup, it may give satisfactory high-fidelity reproduction but still ruin the stereo disc for subsequent playing on a stereo pickup. The great majority of high-fidelity pickups today have much less vertical than horizontal compliance. In fact, one well known pickup, having a reputation among the best, has virtually zero vertical compliance. If such a pickup were used to play any stereo disc, it would completely wreck the vertical component of the stereo recording and the disc would then become useless for playing as anything but an LP.

While the hi-fi pickup would plow out most of the vertical material, it would not completely eliminate it. Consequently, whether vertical-lateral or 45/45 is used, if this disc were subsequently played on its appropriate stereo system, it would sound extremely distorted because of the damage to the vertical component. In a vertical-lateral recording one channel would get all the distortion, while the other would remain at its normal high fidelity. But with a 45/45 recording, both channels would be equally distorted.

Either way—and this is the vital factor about whether compatibility should be claimed by either system—the user is scarcely likely to blame

## AUDIO—HIGH FIDELITY

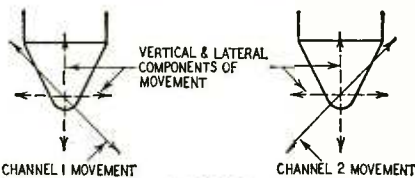

Fig. 5 — Use of 45/45, as shown here, makes each channel use a combination of vertical-lateral.

his trusted high-fidelity pickup for the damage. He is much more likely to conclude either that the record was no good in the first place or that his stereo pickup is no good, and thereby form a bad initial impression of the system.

For this reason, it would seem advantageous, whichever system is used, not to make any endeavor to claim the second form of compatibility. In their own interests, the record companies should continue to issue both types of recording, whichever system of stereo disc is ultimately chosen.

The man who goes for stereo disc will buy a stereo pickup and thereafter, because of its compatibility in the first sense, he will be able to play his monaural LP's with his stereo pickup. This is possible with both systems.

Further, it seems that with either system the user should be advised to keep his stereo disc to be played only with a stereo pickup and should be warned that any nonstereo high-fidelity pickup is likely to ruin the record. It's true that some hi-fi pickups may not ruin the record if they happen to have a high vertical compliance. But high vertical compliance is not inherently connected with the quality of an LP pickup. Consequently it would not seem advisable to differentiate between high-quality LP pickups with and without high vertical compliance. This will only be something that would confuse the consumer still further.

It would be best to play safe and recommend that stereo discs be played *only* with a stereo pickup, adding the warning that an ordinary pickup, which may give satisfactory high-fidelity reproduction, is likely to ruin the disc for playing over a stereo system.

Having settled (I hope) this question, let's investigate the comparative merits of vertical-lateral or 45/45, playing as a stereophonic system. First, let's look into this matter of distortion.

### Distortion

The implication has been made that the 45/45 distributes the distortion equally between both channels. This tacitly assumes the vertical distortion is inevitable. "So we have to live with it, let's make the best of it" by putting it equally in both channels instead of having it all in one.

This seems a rather unsatisfactory attitude in view of the fact that stereophonic reproduction is intended to be a step forward from high fidelity. In high fidelity we have worked hard to eliminate or minimize all possible causes of distortion. So it seems to be a retrogressive step to provide two-channel

recording at the cost of accepting a greater amount of distortion than we would tolerate with single-channel system.

The question arises "Do we really have to put up with all this distortion on vertical recording?" The idea that distortion is inherent to vertical recording dates from the days before feedback cutters were invented. Any attempt to produce vertical-lateral recording with a "straight" cutter, without the use of feedback, would undoubtedly involve considerably more distortion in the vertical than in the lateral cut.

If this were applied to a two-channel system, with the lateral for one channel and the vertical for the other, the vertical channel would have much more distortion than the lateral channel.

Whether such a cutter or one designed for the purpose were employed to produce the 45/45 system, *both* channels would have much more distortion than LP's using the simple lateral type of cut.

Fortunately, some very good feedback cutters have been developed, and

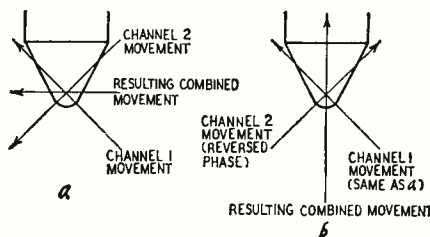

Fig. 6 — Two possible ways of phasing stereo program in 45/45 system; a — dominantly lateral; b — dominantly vertical.

a recent demonstration given by London Records for the benefit of the industry, using the vertical-lateral arrangement, proved that it is possible to record vertically with as high a quality as laterally. This particular recording made claims of going no higher than 12,000 cycles. But neither did the lateral.

The important thing here is that distortion in the vertical was no higher than distortion in the lateral, due to the excellent compensation by the feedback cutter.

This, then, eliminates the distortion comparison issue from the relative merits of the two systems. So we are left with three more factors to consider. One is the claim of compatibility already mentioned. The other two are the possible problems involved in achieving an adequate cross-talk ratio, and a space utilization factor of the record material itself, which will involve the relationship between playing length and dynamic range that can be achieved as compared with the regular LP.

There are two possibilities about the phasing of program material in the 45/45 system (Fig. 6). These principally affect the low frequencies which are responsible for the greater amplitude movement of the stylus in both directions. If the phasing is such that

a signal on both channels that would result in an ultimate push forward on both loudspeaker diaphragms moves the stylus to the left, one channel's signal moving it up and the other down at the same time, this combination will result in a lateral movement to the left, the next half-cycle moving it to the right. We can call this a *lateral-dominant* movement.

Changing the phase of one of the cutters will make the same in-phase combination from the microphones move the stylus up and down—in other words a vertical-dominant movement. A lateral movement in this case would correspond with pressure at one microphone and rarefaction at the other, or in playback would result in one speaker pushing when the other pulls. This phasing can result in certain economies in groove spacing but has disadvantages from the compatibility point of view. Playing an ordinary LP with a 45/45 stereo pickup so hooked up would result in the speakers being out of phase, which produces a rather unpleasant kind of reproduction.

If the vertical-dominant connection were selected for the 45/45 system as a standard, the system would be compatible for playing LP's only by arranging a phase changeover switch in one channel.

The vertical-lateral system is also compatible. If the stereo pickup is used to play an LP disc without changing connections in any way, the whole program will seem to come from one speaker. This is, of course, obvious to the user and it is a simple matter to provide this system with a paralleling switch to feed the output from the lateral coils of the pickup to the input of both channels. This would enable both speakers to get the same program in phase.

The question of possible cross-talk is one that ties in with two other factors: the way the recording is made—that is, the kind of microphone placement and combination used—and the results of future developments in cutters and pickups which, at the present stage, are difficult to predict.

It would seem at present that it would be simpler to provide precision isolation between two movements at 90° to one another when one of these is vertical and the other lateral than when both are at an angle. Deviation of either angle of movement from a perfect 45° will result in some breakthrough onto the other channel's sound

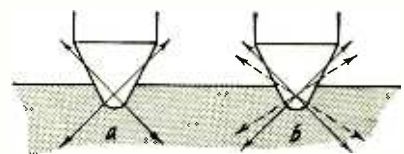

Fig. 7-a — Provided axes of movement are at precisely 45° in the cutter, cross-talk will be limited only by how well the cutter and pickup are made; — distortion of these axes (dashed lines) at some stage of the process will cause increased cross-talk.



because the two movements will no longer be at exactly 90° to one another.

Academically, of course, both methods are equally possible of as good separation. But mechanically it seems that the vertical-lateral arrangement would offer less problems in manufacture and also offer the greater potential for future development in cutter and pickup design. If anything at all should distort the vertical-lateral proportions of the recording during processing, this would produce deterioration as cross-talk (Fig. 7).

As against this, the claim for the 45/45 in this respect can be based on the use of symmetry—the fact that the two drives can be arranged in symmetrical manner, like a V-8 motor, which is not so readily possible with a vertical and lateral arrangement.

London Records demonstrated with a pickup whose cross-talk was reputed to be 25 db and they reported that a prototype has just been developed that gives a cross-talk ratio of 35 db, which is more than adequate and would seem to allow plenty for production deviation.

#### Price range?

In the initial development stage, the crystal transducer did not produce as good a cross-talk ratio as the other types but it was still adequate for use in a low-cost stereophonic disc system—a very important consideration for the mass market.

The tape people lay claim to the potential for highest possible quality because their playback heads have no moving parts. Of course they have magnetic circuits which can introduce their own troubles. But pickups have moving parts which make it more difficult to produce a uniform frequency characteristic. So, basically, it would seem that tape stereo offers the best *possibility* for those really interested in absolute top quality—a view that is underscored by the fact that, at present, all master recordings are made on tape, later to be dubbed on disc.

The obvious advantage of the stereo disc is its simplicity in use. It can be handled exactly the same as the present LP's. If a visitor steps in and you want to impress him with your latest recording, you can lower the stylus onto the particular passage you want to play and then, if he is further interested, play the whole disc. This is quite difficult with tapes because you cannot find the particular spot in a recording as quickly.

This and the ease of putting the stylus on the record and taking it off again will presumably result in greater popularity of stereo disc with the mass market. In fact, I would go for stereo disc in preference to tape myself, for the same reason. This being the case, we have to consider not only the possibility, but the very high probability, that stereo discs will be applied in the extremely low price range, comparable with present record players. At the

same time it should be possible to produce at an economical price a system having quality comparable with the best LP reproducers.

The final matter for comparison is the space factor. With both the London and Westrex systems, maximum groove width is greater than on standard LP's. This greater width is caused by the need for the cutter to go deeper into the record to record the vertical component properly. As the cutter is chisel-shaped, the deeper it goes the wider the groove.

In theory the modulation area for the 45/45 is the same square cross-section of possible movement as for the vertical-lateral, but it is turned up on its corner so that room has to be found in the material of the disc for a spiral modulation area of square section wound corner-on as it were. This results in less economical utilization of the record material than for a spiral wound so the flat surfaces of the modulation area lay one beside the other.

But there is another factor that brings up two possibilities. If the in-phase components result in lateral movement, the out-of-phase components, which will invariably be considerably smaller in amplitude, will result in less demand on the vertical excursion of the cutter and playback stylus. This enables the unwanted distortion we mentioned earlier—and which may well be only of academic interest at this stage—to be minimized.

On the other hand, if the in-phase operation produces a vertical resultant, the principal movement of the stylus with a 45/45 system now becomes vertical and the grooves can be cut much closer together, allowing a longer amount of program material to be squeezed into the same space but requiring much deeper vertical cut. This may either result in greater distortion or, by reducing the vertical excursion permitted, will considerably reduce dynamic range.

So, on the score of both compatibility and dynamic range, the 45/45 should be phased so in-phase program produces lateral-dominant movement. This is, in fact, the phasing standardized by Westrex in their system.

#### Recording techniques

A further factor that should be mentioned before we leave this subject is the effect of recording techniques. Systems developed in Europe independently, the *Stereosonic* and the German *MS* systems, both employ dominantly intensity differences in the program content of the two channels rather than time differences which are more dominant in most American stereophonic recordings.

A possible advantage of the intensity-dominant channel differences is that it makes cross-talk relatively unimportant as both channels contain exactly the same program information at the same time, but with different proportions of it in each channel for different sections

of the orchestra. Thus the only effect of possible breakthrough is that the directional effects intended will be slightly modified. There will be no undesirable echo or distortion products due to intermodulation from one channel to the other, such as can occur where there are time differences as well as intensity differences.

An adaptation of these recording techniques might utilize a vertical-lateral arrangement, with wide-range lateral and limited-fidelity vertical. This would offer additional possibilities for rumble reduction with low-quality turntables.

The London people, however, adopt the attitude that, in view of the improved quality in the vertical channel they have already succeeded in achieving on a production basis, this is an unnecessary limitation on the medium. Without such a limitation, it is possible to provide flexibility so that both channels can contain stereophonic information with either intensity or time differences equally well.

Sometimes stereophonic recordings deliberately contain out-of-phase components in the low and middle frequencies to get specific effects that are not obtainable with simple single-channel LP presentation. Use of a modified stereophonic or MS system would preclude this type of presentation and other possibilities of exploiting the new stereophonic medium to the utmost. Consequently, it is good to see that the vertical-lateral presentation has achieved a standard of recording and reproduction such that two high-quality channels can be provided.

The next question is shall we have both systems or only one, and, if so, which one. This is a matter for the record industry to decide. Obviously it is impractical to use both systems because, although each is compatible with single-channel LP's in its own way, neither is compatible with the other without a conversion switch to sum-and-difference combination to convert the output from the pickup from one form to the other. It would be impractical to use such a system as this because the user would never know which kind of disc he had and whether he was playing it correctly.

Consequently it would seem vital to select one system or the other and make this the standard for the industry. (Proponents of both systems agree that it is unthinkable that two incompatible systems should co-exist, and it is likely that they will agree on one of the systems before starting to make stereo discs.) From the foregoing discussion, it is evident that both systems have their possibilities and probably the decision will rest on the technique developed so far with each system and the quality it produces. This does not say the system with the inherent best possibilities will win. More likely it will be the one whose technological development at the time the decision is made has reached a higher order. END



to grid, enough for the KT88's, at an intermodulation figure of about 2%.

Distortion is reduced in the amplifier by negative feedback. With 20 db of feedback, the driver output stage combination delivers 60 watts at about 0.5% IM. The actual distortion figure varies slightly, depending on the tolerances in components and tubes. With matched resistors in the phase-inverter circuit, the tolerance of other components will cause distortion to range from about 0.2% to 1.0% at full output. At lower levels, distortion decreases and is well below 0.1% at the 1-watt level. Measurements below 0.1% are difficult to make because of limitations of measuring equipment and because noise levels obliterate the residual distortion.

#### Feedback circuit

Several circuit features are included to maintain stability under feedback conditions. The most important of these are the capacitive feedback loop from the screen of one output tube to the first cathode, and the relatively small screen bypass capacitor. The capacitive feedback loop improves high-frequency stability while the choice of screen bypass improves low-frequency stability. If this screen bypass is significantly increased or decreased in size, there will be a bump in the low-frequency response around 5 cycles, which is a symptom of incipient instability under transient conditions. The selected value gives critical damping of the low end. High-frequency stability is suitable for all types of speaker loads including the newer electrostatic types.

The feedback compensation reduces the total bandwidth slightly since it produces rolloff in response below 6 cycles and above 60 kc. However, within the 20–20,000-cycle range this is flat response at any power level up to a maximum of 60 watts. Even more important than flat response at high power is that total harmonic distortion is kept below 1% over the audio spectrum at powers up to 48 watts. The advantage of being able to handle large amounts of power cleanly at low frequencies shows up on speaker systems in which there is significant impedance variation below 100 cycles. These variations result in effective reduction of undistorted power output in the amplifier through the condition of mismatch (this type of mismatch is not corrected by variable damping circuits) brought about by a rising impedance characteristic. However, if there is a large amount of power available, the loss due to mismatch can be tolerated since sufficient undistorted reserve is retained to handle most operating conditions.

The power supply is conventional, using a GZ34 rectifier with capacitor input and choke filtering. A tap with a separate rectifier is used to obtain bias voltage. One feature of interest is the grounding of the heater center tap through a .02- $\mu$ f capacitor. The inherent heater-cathode leakage of the 6AN8 causes a small charge to build

Compact amplifier uses printed circuit for all wiring up to grids of the KT88's.

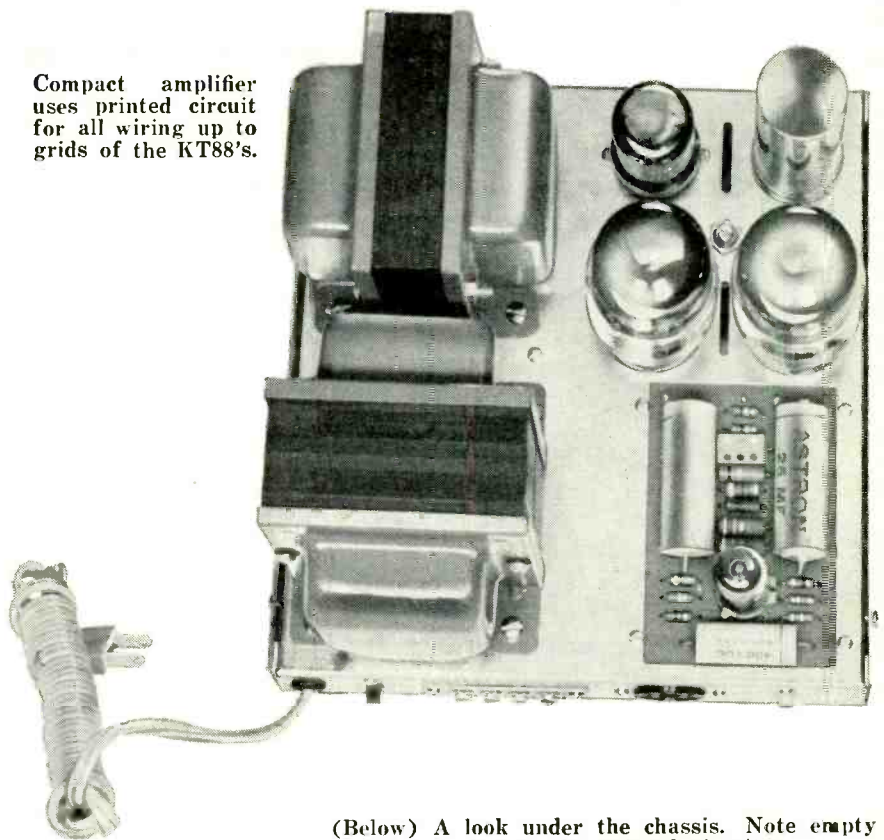

(Below) A look under the chassis. Note empty appearance due to the printed circuitry.

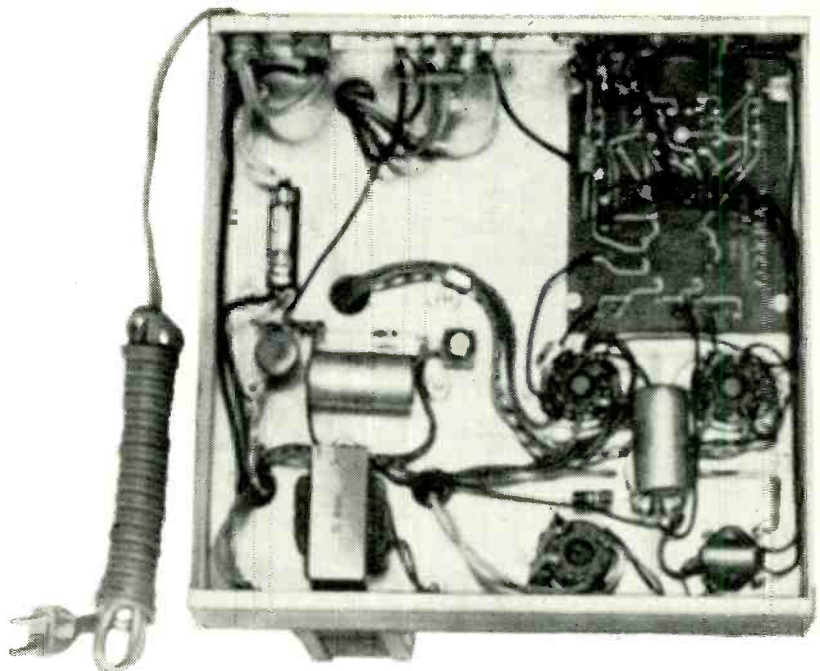

up across this capacitor, automatically biasing the heater string to the lowest noise condition. If a preamp is powered from the same heater supply, its heaters should not be grounded or the benefits of the amplifier arrangement will be destroyed. If the preamp has a hum pot or other device which requires grounding, it should be grounded through a capacitor to obtain an *ac ground* only so that the floating effect of the power amplifier arrangement is not removed.

This circuit has been constructed in several physical arrangements without any difficulty, provided normal good construction practice is followed. In the commercial kit, a printed-circuit board is used for all audio components up to the grids of the KT88's. This gives complete reproducibility of layout, but is not required to duplicate the circuit's characteristics. The photographs show the printed-circuit board and illustrate the essential simplicity of the entire amplifier. END

# HI-FI

# PICKUP ARMS

By JULIAN D. HIRSCH

*Part II: The Rek-O-Kut A-120, Pickering 194D, Leak Dynamic, Weathers, ESL 310 pickup arms. All have both pivots at essentially the same point*

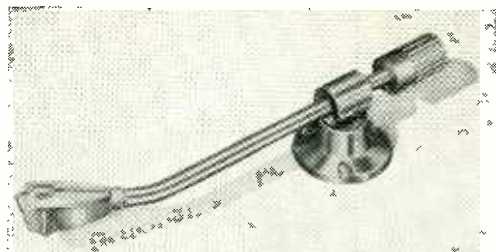

Rek-O-Kut A-120 pickup arm of tubular aluminum.



tated by a knob protruding from the front end. The pivot assembly may be moved vertically to adjust the height of the arm to the turntable.

### Pickering 194D

The Pickering 194D (Unipoise) pickup is shown in the photos. It is an integrated pickup design in which simplicity is the keynote. Indeed, it would be hard to imagine an arm simpler in construction or easier to install.

The entire arm is pivoted on a single needle point, just as a compass rose is supported. The needle is made of hard-



Fig. 2—Base, pivot and counterweight of the Weathers arm.

ened steel, and the cup into which it fits has a conical hole to receive the needle point. The needle passes through a slot in the arm and is contacted on both sides by a thin rubber membrane slitted to pass the pivot needle as the arm is raised or lowered. This membrane is intended to damp arm resonance somewhat.

Stylus tracking force is adjustable between 1 and 6 grams by sliding a knurled knob, located under the arm, toward the front of the arm to increase force or toward the rear to decrease the force. The white dots on the side of the arm correspond to the various settings of this knob. Each dot represents approximately a 1-gram change of stylus force from the adjacent dots. Most of the weight of the arm and cartridge is counterbalanced by the rear counterweight, which is designed so it also forms a part of the pivot assembly.

THE first article of this series discussed a number of pickup arms whose vertical and horizontal pivots are spaced appreciably apart. A second major category includes arms which have their vertical and horizontal pivots essentially at the same point. (As in the preceding article, we will consider the vertical pivot to be the one which lets the arm move vertically and the horizontal pivot the one which lets the arm move horizontally.)

This type of arm design is the most common and is familiar to most people since virtually all record-changer arms are so designed. Perhaps its major disadvantage is that its inertia is the same in both vertical and lateral planes. High lateral inertia (mass) is desirable, to keep arm resonance below the audible range, while low vertical mass tends to minimize record wear, particularly when playing warped records. In this type of arm design, a compromise is usually necessary between these conflicting requirements.

Most (though not all) arms of this type are not laterally balanced, which makes careful leveling a necessity. Even when they are laterally balanced, the high vertical mass makes the arm rather sensitive to groove jumping when it is jarred unless viscous damping is used on the vertical pivots.

### Rek-O-Kut A-120/A-160

The photos show the Rek-O-Kut A-120 arm. The A-160, designed for use with 16-inch records, is similar in appearance. This tubular aluminum arm has a removable die-cast cartridge

shell, and a die-cast counterweight threaded on the rear of the arm. The pivot structure is the gimbal type, with ball bearings in both vertical and horizontal pivots.

The stylus tracking-force adjustment is unique, simple and foolproof. No external gauge or scale is needed to set stylus force accurately. With the cartridge plugged into the arm, the counterweight is adjusted by screwing it on the rear arm extension until the arm is perfectly balanced. When the counterweight is then rotated clockwise, a net downward force is exerted at the stylus. On the A-120 arm, each 1¼ turns add 1 gram to the tracking force while on the A-160 arm each 2 turns add 1 gram. A self-locking thread is used so setscrews are not needed to keep the counterweight in position after adjustment.

Although the arm body appears to be a single tube, it is actually divided into two portions. The division is visible as a line around the tubular arm body, just behind the pivot gimbals. This line is a thin piece of acoustical damping plastic which joins the front and rear sections of the arm. Its purpose is to damp the arm resonance, which is usually between 13 and 16

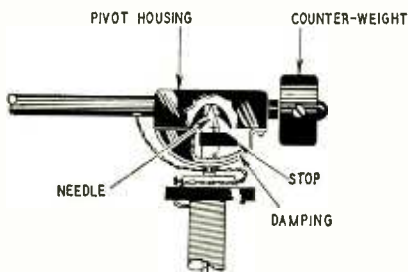

Fig. 1—Cutaway view of Leak Dynamic arm showing details of pivot.

cycles, depending on the cartridge employed.

The interchangeable cartridge shells are solidly constructed and are secured to the arm by a threaded locking ring. The front of the shell is open, permitting easy cuing of the stylus in the desired groove. This also permits the use of turnover cartridges which are ro-

*In next month's installment, Julian D. Hirsch will discuss the characteristics of the ESL/BJ Super-Go tangential arm, the Orthosonic V/4 radial arm and Audio Specialities AS-30 radial arm.*

The Leak dynamic pickup. Note the single-hole mounting.

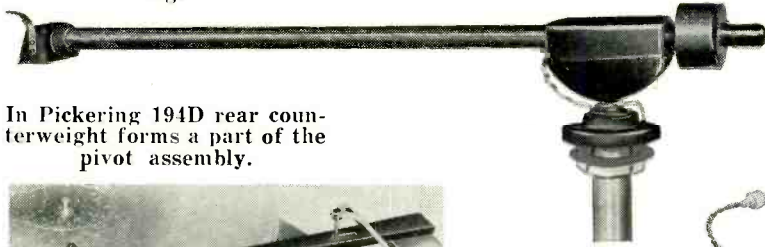

In Pickering 194D rear counterweight forms a part of the pivot assembly.

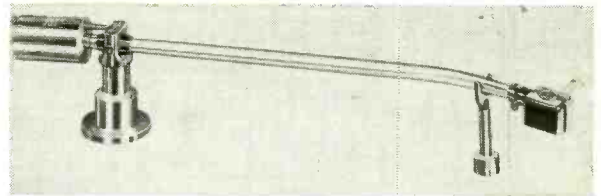
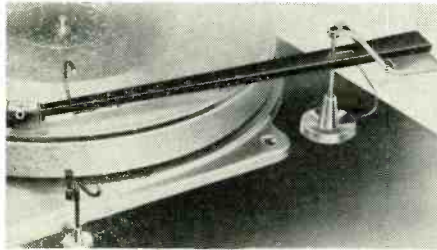

Tubular-aluminum construction and unusual counterweight are found on ESL type 310.



Weathers arm is made from lightweight wood.

Installation of the Pickering 194D is further simplified by the single-hole mounting of its base. A 11/16-inch hole is drilled in the motor board at any convenient point 8 inches from the turntable center. The pivot is fastened in this hole with a single wing nut which also holds, below the board, a bracket with a standard phono connector. Pickup height is adjusted by merely screwing the pivot needle up or down in the base. Since the pivot point is located well above the arm's center of gravity, it is self-leveling within a range of a few degrees. Therefore the only leveling operation necessary is to be sure that the turntable surface is truly horizontal.

The arm rest also mounts in a single hole. A small adjustable brush forms an integral part of the rest. This brush may be adjusted so the stylus is cleaned of lint each time the arm is returned to the rest. Although the rest merely supports the cartridge body, the magnet in the pickup is strongly attracted to it and there is no tendency for the arm to fall off the rest accidentally.

The Pickering 194D is noteworthy in that it goes one step beyond other integrated designs. The cartridge structure does not plug into the arm—it is a permanent part of the pickup. The styli are mounted in small T-shaped plastic bodies which may be slid in or out of the cartridge without difficulty. A small plastic box with a rack which holds up to eight stylus assemblies is furnished with the arm. Pickering manufactures styli in 0.5-, 1.0- and 2.7-mil radii (diamond), as well as a 2.7-mil sapphire stylus. Changing and storing these small stylus assemblies is certainly simpler than the usual practice of plugging in a different cartridge for each stylus size.

#### Leak dynamic pickup

The arm designed by H. J. Leak & Co. Ltd. (see photos) for their dynamic pickup is very similar in pivoting principle to the Pickering 194D. Fig. 1 is a cut away drawing of the Leak arm, showing the pivoting. The arm rotates

in both planes on the point of an upright needle, resting in an inverted conical depression. The arm base mounts in a single hole and the pivot needle is adjusted vertically by loosening a setscrew. Vertical rotation of the arm is limited by a slot in a curved metal cover surrounding the needle. The pivot makes contact with a damping material as it passes through this slot. Lateral rotation of the arm is restrained to an angle of less than 90° by a projection from the side of the needle which strikes the sides of the pivot housing at the limits of arm rotation.

The pickup's tracking force is adjusted by loosening a setscrew and sliding a counterweight along the projecting rear portion of the arm.

The arm is a straight tube which receives the plug-in Leak cartridge only. The required offset for minimum tracking-angle error is built into the cartridge.

As with any arm pivoted in this manner, the Leak arm is relatively insensitive to small leveling errors. Since it is not laterally balanced, accurate leveling of the turntable surface is important, however.

#### ESL type 310

The Electro-Sonic type 310 tone arm, shown in the photos, is designed solely for use with ESL Professional series cartridges. Like several other arms already described, it is of simple tubular-aluminum construction. The pivots are the gimbal type, using precision ball bearings in both vertical and horizontal pivots. The pivot assembly may be adjusted vertically to adapt the arm to turntables of different heights by loosening a single setscrew. No provision is made for leveling the arm, but its design is such that minor leveling errors should not cause trouble.

The ESL 310 is unique among the pickup arms discussed in this article since it is the only one which is balanced in the horizontal plane. The counterweight is factory-set to counterbalance exactly the mass of the arm and cartridge forward of the vertical

pivot. Because of this, exact leveling of the arm is not critical. To obtain a downward stylus force, a spring (which can be seen in the photo) is connected between the counterweight and the gimbal assembly. The tension of this spring may be adjusted by a knurled screw at the rear of the counterweight to set the stylus force. A calibrated scale is engraved on the counterweight, and the stylus force may be set between 0 and 30 grams.

Although the ESL 310 is carefully balanced and may operate with very low stylus forces, it has considerable vertical mass. In fact, the vertical and lateral masses are essentially the same. Because of this, the arm is quite sensitive to jarring effects and must be installed on a heavy well-mounted motor-board.

The front of the arm contains a socket into which the ESL Professional series cartridges are plugged. A knurled locking ring fastens the cartridge to the arm.

This arm does not have any damping provisions. However, its mass is considerable (it is a 16-inch arm) and this factor, combined with the high compliance of ESL cartridges, reduces the arm resonance to well below 10 cycles.

#### Weathers

The Weathers pickup arm is unique in several respects. It is made of a lightweight wood rather than the more usual metals used in other arms. It is designed for and may be used only with the Weathers FM capacitance pickup cartridge. The Weathers pickup arm is shown in the photos.

The base of the arm is made of a soft rubber and has small rubber feet extending above and below each of its mounting holes. When permanently installed, the mounting screws exert little or no pressure against these feet or the base, but serve merely to keep the pickup in its proper position on the motor board. The rubber feet and base isolate the arm from turntable and motor-board vibration.

The mass of the arm and cartridge is  
(Continued on page 78)



everybody's doing it!

**FRANK PERKINS**

Composer and arranger Frank Perkins listens attentively to his Decca hi-fi album "Music For My Lady" as its beautiful sounds are recreated with Heath high fidelity equipment. Music is a very important part of Frank's life, since his background includes composing and arranging musical scores for motion pictures, and for music publishers. Songs he has written include "Stars Fell on Alabama", "Emaline", "The Scat Song", "The Way I Feel Tonight", "After All These Years", and "Turn Back The Clock". Frank Perkins has discovered the beauty of Heath Hi-Fi sound . . . and the fun of "do-it-yourself" Heathkit construction. So, why don't you!

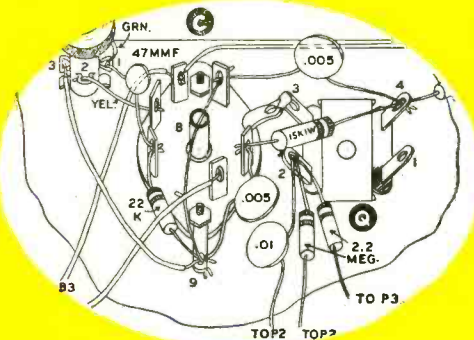

You'll get plenty of these detailed pictorial diagrams in your Heathkit construction manual to show where each and every wire and part is to be placed. Everything you do is spelled out in pictures so you can't go wrong.

That's what makes it such fun!

# Heathkits®

BY DAYSTROM

...fun to build  
and a thrill to own!

## and here's why...

1. You get higher quality at lower cost by dealing direct, and by doing your own assembly.
2. You receive personal, friendly, service (before and after sale) for complete satisfaction.
3. You benefit from the latest in engineering designs because of our concentration on kit-form equipment only.
4. You may depend on performance as advertised—backed by Heath's world-wide reputation for quality.
5. You can take a full year to pay with the **HEATH EASY TIME PAYMENT PLAN**.

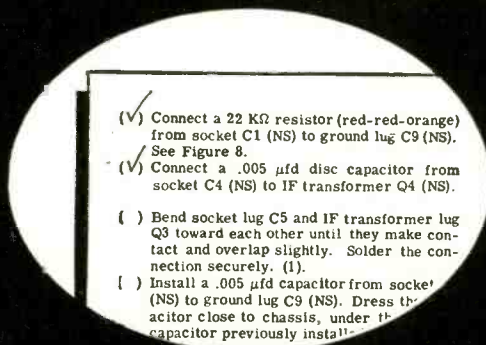

Read the step . . . perform the operation . . . and check it off—it's just that simple. These plain-worded, easy-to-follow, steps are combined with pictorial diagrams to take you through every phase of assembly. Let our experience be your teacher!

### TIME PAYMENTS . . .

The Heath Time Payment Plan was designed for your convenience. Now, you can order the kits of your choice, and pay for them in small monthly installments. Write for full details.

### HEATHKIT EXTRA PERFORMANCE 70-WATT AMPLIFIER KIT

For really high performance, with plenty of reserve power, the W-6M is a natural. The full 70-watts output will seldom, if ever, be required. However, this reserve insures distortion-less sound on power peaks. The W-6M will loaf along at normal listening levels and yet is always ready to extend itself when program material demands it, without the least amount of strain. The output circuit employs 6550 tubes with a special-design Peerless output transformer for maximum stability at all power levels. A quick-change plug selects 4, 8 and 16 ohms or 70-volt output and the correct feedback resistance. A variable damping control is also provided for optimum performance with any speaker system. Extremely good power supply regulation is possible through the use of a heavy-duty transformer along with silicon-diode rectifiers, which are noted for their very long life, and yet are smaller than a house fuse. Frequency response at 1 watt is  $\pm 1$  db from 5 cps to 80 kc with controlled hf rolloff above 100 kc. At 70 watts output harmonic distortion is below 2%, 20 to 20,000 cps and IM distortion below 1%, 60 and 6,000 cps. Hum and noise 88 db below full output. In addition to high performance, its fine appearance makes it a pleasure to display in your living room. Proper layout of chassis insures ease of assembly by eliminating those cramped and difficult places to get at. Clear instructions—and top-quality components. Get started now and make this amplifier the heart of your hi-fi system. Shipped express only. Shpg. Wt. 50 lbs.

MODEL W-6M

MODEL W-6: Consists of W-6M kit, plus WA-P2 preamplifier. Express only. Shpg. Wt. 59 lbs. \$129.70

**\$109<sup>95</sup>**

### HEATHKIT HIGH FIDELITY FM TUNER KIT

This tuner can bring you a rich store of FM programming, your least expensive source of high fidelity material. It covers the complete FM band from 88 to 108 mc. Stabilized, temperature-compensated oscillator assures negligible drift after initial warmup. Features broadbanded circuits for full fidelity, and better than 10 uv sensitivity for 20 db of quieting, to pull in stations with clarity and full volume. Employs a high gain, cascode RF amplifier, and has AGC. A ratio detector provides high-efficiency demodulation without sacrificing hi-fi performance. IF and ratio transformers are prealigned, as is the front end tuning unit. Special alignment equipment is not necessary. Edge-lighted glass dial for easy tuning. Here is FM for your home at a price you can afford. Shpg. Wt. 8 lbs.

MODEL FM-3A

**\$25<sup>95</sup>**

(with cabinet)

### HEATHKIT BROADBAND AM TUNER KIT

This AM tuner was designed especially for high fidelity applications. It incorporates a special detector using crystal diodes, and the IF circuits feature broad band-width, to insure low signal distortion. Audio response is  $\pm 1$  db from 20 cps to 9 kc, with 5 db of preemphasis at 10 kc to compensate for station rolloff. Sensitivity and selectivity are excellent, and tuner covers complete broadcast band from

550 to 1600 kc. Quiet performance is assured by 6 db signal-to-noise ratio at 2.5 UV. Prealigned RF and IF coils eliminate the need for special alignment equipment. Incorporates AVC, two outputs, two antenna inputs, and built-in power supply. Edge-lighted glass slide-rule dial for easy tuning. Your "best buy" in an AM tuner. Shpg. Wt. 8 lbs.

MODEL BC-1A

**\$25<sup>95</sup>**

(with cabinet)

### HEATHKIT MASTER CONTROL PREAMPLIFIER KIT

Designed for use with any of the Williamson-type amplifiers, the WA-P2 has five switch-selected inputs, each having its own level control to eliminate blasting or fading while switching through the various inputs, plus a tape recorder output. A hum control allows setting for minimum hum level. Frequency response is within  $\pm 1\frac{1}{2}$  db from 15 to 35,000 cps. Equalization provided for LP, RIAA, AES, and early 78's. Separate bass and treble controls. Low impedance cathode follower output circuit. All components were specially selected for their high quality. Includes many features which will eventually be desired. Shpg. Wt. 7 lbs.

MODEL WA-P2

**\$19<sup>75</sup>**

(with cabinet)

*An amplifier  
you will be  
proud to own*

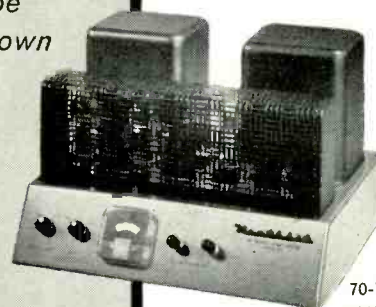

70-WATT  
AMPLIFIER

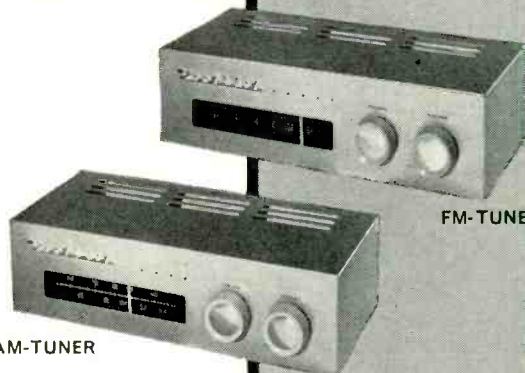

AM-TUNER

FM-TUNER

*Selects and  
controls sound  
to your taste*



PREAMPLIFIER



ADVANCED-DESIGN  
25-WATT AMPLIFIER

*Top performance  
in its  
power class!*

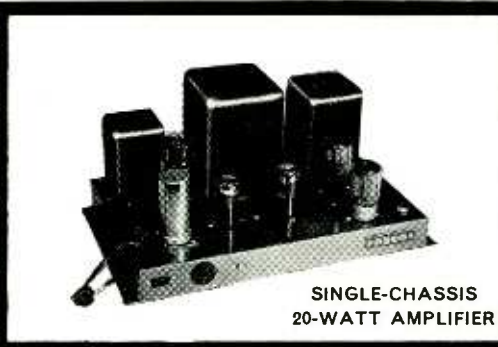

SINGLE-CHASSIS  
20-WATT AMPLIFIER

*Hi-Fi equipment  
for your listening  
pleasure!*

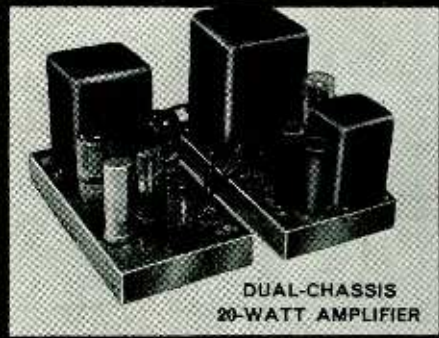

DUAL-CHASSIS  
20-WATT AMPLIFIER



GENERAL-PURPOSE  
20-WATT AMPLIFIER

#### HEATHKIT ADVANCED-DESIGN 25-WATT HIGH FIDELITY AMPLIFIER KIT

Designed especially to satisfy critical audio requirements, the W-5M incorporates the extra features needed to complement the finest in program sources and speaker systems. Faithful sound reproduction is assured with a frequency response of  $\pm 1$  db from 5 to 160,000 cps at 1 watt, and harmonic distortion is less than 1% at 25 watts, with IM distortion less than 1% at 20 watts. Hum and noise are a full 99 db below rated output, assuring quiet, hum-free operation. Output taps are 4, 8 and 16 ohms. Exclusive Heathkit features include the "tweeter saver", and the "bas-bal" balancing circuit, requiring only a voltmeter for indication. Years of reliable service are guaranteed through the use of conservatively rated, high quality components. KT66 tubes and Peerless output transformer are typical. Shipped express only. Shpg. Wt. 31 lbs.

**MODEL W-5:** Consists of W-5M kit above plus model WA-P2 preamplifier. Express only, Shpg. Wt. 38 lbs. \$79.50

**MODEL W-5M**  
**\$59<sup>75</sup>**

#### HEATHKIT DUAL-CHASSIS 20-WATT HIGH FIDELITY AMPLIFIER KIT

The model W3-AM is a Williamson-type amplifier built on two separate chassis. The power supply is on one chassis, and the amplifier stages are on the other chassis. Using two separate chassis provides additional flexibility in installation. Features include the famous acrosound model TO-300 "ultralinear" output transformer and 5881 tubes for broad frequency response, low distortion, and low hum level. The result is exceptionally fine overall tone quality. Frequency response is  $\pm 1$  db from 6 cps to 150 kc at 1 watt. Harmonic distortion is less than 1% and IM distortion is less than 1.3% at 20 watts. Hum and noise are 88 db below 20 watts. Designed to match the speaker system of your choice, with taps for 4, 8 or 16 ohms impedance. A very popular high fidelity unit employing top quality components throughout. Shipped express only. Shpg. Wt. 29 lbs.

**MODEL W-3A:** Consists of W-3AM kit above plus model WA-P2 preamplifier. Express only. Shpg. Wt. 37 lbs. \$69.50

**MODEL W-3AM**  
**\$49<sup>75</sup>**

#### HEATHKIT SINGLE-CHASSIS 20-WATT HIGH FIDELITY AMPLIFIER KIT

The model W4-AM Williamson-type amplifier will amaze you with its outstanding performance. A true Williamson circuit, featuring extended frequency response, low distortion, and low hum levels, this amplifier can provide you with many hours of listening enjoyment with only a minimum investment compared to other units on the market. 5881 tubes and a special Chicago-standard output transformer are employed to give you full fidelity at minimum cost. Frequency response extending from 10 cps to 100 kc within  $\pm 1$  db at 1 watt assures you of full coverage of the audio range, and clean clear sound amplification takes place in circuits that hold harmonic distortion at 1.5% and IM distortion below 2.7% at full 20 watt output. Hum and noise are 95 db below full output. Taps on the output transformer are at 4, 8 or 16 ohms. Shipped express only. Shpg. Wt. 28 lbs.

**MODEL W-4A:** Consists of W-4AM kit above, plus model WA-P2 preamplifier. Express only. Shpg. Wt. 35 lbs. \$59.50.

**MODEL W4-AM**  
**\$39<sup>75</sup>**

# Heathkits...

By DAYSTROM

*bring you the lasting satisfaction  
of personal accomplishment*

#### HEATHKIT GENERAL-PURPOSE 20-WATT HIGH FIDELITY AMPLIFIER KIT

The model A-9C will provide you with high quality sound at low cost. Features a built-in preamplifier with four separate inputs, and individual volume, bass and treble controls. Frequency response covers 20 to 20,000 cps within  $\pm 1$  db. Total harmonic distortion is less than 1% at 3 db below rated output. Push-pull 6L6 tubes are used, with output transformer tapped at 4, 8, 16 and 500 ohms. A true hi-fi unit using high-quality components throughout, including heavy-duty "potted" transformers. Shpg. Wt. 23 lbs.

**MODEL A-9C**  
**\$35<sup>50</sup>**



**HEATHKIT "BASIC RANGE"  
HI-FI SPEAKER SYSTEM KIT**

The extremely popular Heathkit model SS-1 Speaker System provides amazing high fidelity performance for its size. Features two high-quality Jensen speakers, an 8" mid-range woofer and compression-type tweeter with flared horn. Covers from 50 to 12,000 CPS within  $\pm 5$  db, in a special-design ducted-port, bass reflex enclosure. Impedance is 16 ohms. Cabinet measures 11½" H x 23" W x 11¼" D. Constructed of veneer-surfaced plywood, ½" thick, suitable for light or dark finish. All wood parts are pre-cut and pre-drilled for easy, quick assembly. Shpg. Wt. 30 lbs.

MODEL SS-1

**\$39.95**

**HEATHKIT "RANGE EXTENDING"  
HI-FI SPEAKER SYSTEM KIT**

Extends the range of the SS-1 to  $\pm 5$  db from 35 to 16,000 CPS. Uses 15" woofer and super-tweeter both by Jensen. Kit includes crossover circuit. Impedance is 16 ohms and power rating is 35 watts. Measures 29" H x 23" W x 17½" D. Constructed of veneer-surfaced plywood ¾" thick. Easy to build! Shpg. Wt. 80 lbs.

MODEL SS-1B

**\$99.95**

**HEATHKIT "LEGATO"  
HIGH FIDELITY SPEAKER SYSTEM KIT**

The quality of the Legato, in terms of the engineering that went into the initial design, and in terms of the materials used in its construction, is matched in only the most expensive speaker systems available today. The listening experience it provides approaches the ultimate in esthetic satisfaction. Two 15" theater-type Altec Lansing speakers cover 25 to 500 CPS, and an Altec Lansing high-frequency driver with sectoral horn covers 500 to 20,000 CPS. A precise amount of phase shift in the crossover network brings the high frequency channel into phase with the low frequency channel to eliminate peaks or valleys at the crossover point, by equalizing the acoustical centers of the speakers. The enclosure is a modified infinite baffle type, especially designed for these speakers. Cabinet is constructed of veneer-surfaced plywood, ¾" thick, pre-cut and pre-drilled for easy assembly. Frequency response 25 to 20,000 CPS. Power rating, 50 watts program material. Impedance is 16 ohms. Cabinet dimensions 41" L x 22¼" D x 34" H.

Choice of two beautiful cabinets. Model HH-1-C in imported white birch for light finishes, and HH-1-CM in African mahogany for dark finishes. Shpg. Wt. 195 lbs.

MODEL HH-1-C  
MODEL HH-1-CM

**\$325.00**

EACH

# Heathkits...

By DAYSTROM

*let you save up to ½  
or more on all types  
of electronic equipment.*

**HEATHKIT SINE-SQUARE GENERATOR**

The new AG-10 provides high quality, sine and square waves over a wide range, for countless applications. Some of these are; radio and TV repair work, checking scope performance, as a variable trigger source for telemetering and pulse work, and checking audio, video and hi-fi amplifier response. Frequency response is  $\pm 1.5$  db from 20 CPS to 1 MC on both sine and square waves, with less than .25% sine wave distortion, 20 to 20,000 CPS. Sine wave output impedance 600 ohms, square wave output impedance 50 ohms, (except on 10v ranges). Square wave rise time less than .15 usec. Five-position band switch—continuously variable tuning—shielded oscillator circuit—separate step and variable output attenuators in ranges of 10, 1, and .1 volts for both sine and square wave, with extra range of .01 volt on sine wave. Both sine and square wave can be used at the same time without affecting either wave form. Power supply uses silicon-diode rectifiers. Shpg. Wt. 12 lbs.

MODEL AG-10

**\$49.95**

**HEATHKIT AUDIO ANALYZER KIT**

The AA-1 is actually three instruments in one compact package. It combines the functions of an AC VTVM, an audio wattmeter, and an intermodulation analyzer. Input and output terminals are combined, and high and low frequency oscillators are built in. VTVM ranges are 0-.01, .03, .1, .3, 1, 3, 10, 30, 100 and 300 volts (RMS). Wattmeter ranges are .15 mw, 1.5 mw, 15 mw, 150 mw, 1.5 w, 15 w and 150 w. IM scales are 1%, 3%, 10%, 30% and 100%. Provides internal load resistors of 4, 8, 16 or 600 ohms. A tremendous dollar value. Shpg. Wt. 13 lbs.

MODEL AA-1

**\$49.95**

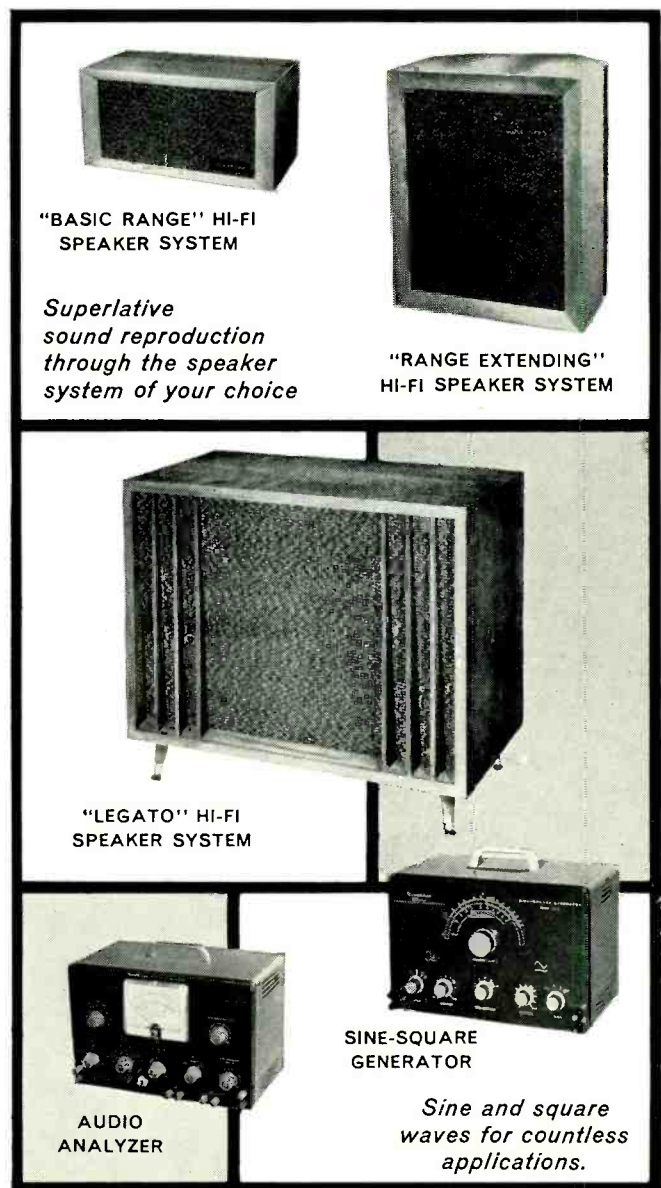

"BASIC RANGE" HI-FI  
SPEAKER SYSTEM

*Superlative  
sound reproduction  
through the speaker  
system of your choice*

"RANGE EXTENDING"  
HI-FI SPEAKER SYSTEM

"LEGATO" HI-FI  
SPEAKER SYSTEM

AUDIO  
ANALYZER

SINE-SQUARE  
GENERATOR

*Sine and square  
waves for countless  
applications.*



*Audio  
equipment  
for your  
hi-fi testing*

**GENERAL PURPOSE"  
SCOPE**



**AUDIO WATTMETER**



**AUDIO GENERATOR**



**HARMONIC  
DISTORTION METER**



**AUDIO VTVM**

**HEATHKIT "GENERAL PURPOSE" 5"  
OSCILLOSCOPE KIT**

The model OM-2 Oscilloscope is especially popular with part-time service technicians, students, and high fidelity enthusiasts. It features good vertical frequency response  $\pm 3$  db from 4 cps to over 1.2 mc. A full five-inch crt. and sweep generator operation from 20 cps to over 150 kc. Stability is excellent and calibrated grid screen allows precise signal observation. Extra features include external or internal sweep and sync, 1-volt peak-to-peak calibrating reference, 3-position step-attenuated input, adjustable spot shape control, push-pull horizontal and vertical amplifiers, and modern etched-metal circuits. Easy to build and a pleasure to use. Ideal for use with other audio equipment for checking amplifiers. Shpg. Wt. 21 lbs.

**MODEL OM-2**

**\$42<sup>50</sup>**

**HEATHKIT AUDIO WATTMETER KIT**

The AW-1 Audio Wattmeter can be used in any application where audio power output is to be measured. Non-inductive LOAD resistors are built in for 4, 8, 16 or 600 ohms impedance. Five power ranges cover 0-5 mw, 50 mw, 500 mw, 5 w, and 50 w full scale. Five switch-selected db ranges cover  $-10$  db to  $+30$  db. All indications are read directly on a large  $4\frac{1}{2}$ " 200 microampere meter. Frequency response is

$\pm 1$  db from 10 cps to 250 kc. Precision type multiplier resistors used for high accuracy, and crystal diode bridge for wide-range frequency response. This meter is used in many recording studios and broadcast stations as a monitor as well as servicing. A fine meter to help supply the answers to your audio operating or power output problems. Shpg. Wt. 6 lbs.

**MODEL AW-1**

**\$29<sup>50</sup>**

**HEATHKIT AUDIO SIGNAL GENERATOR KIT**

The model AG-9A is "made to order" for high fidelity applications, and provides quick and accurate selection of low-distortion signals throughout the audio range. Three rotary switches select two significant figures and a multiplier to determine audio frequency. Incorporates step-type and a continuously variable output attenuator. Output indicated on large  $4\frac{1}{2}$ " panel meter, calibrated in volts and db. Attenuator system operates in 10 db steps, corresponding to meter calibration, in ranges of 0-.003, .01, .03, .1, .3, 1, 3 and 10 volts RMS. "Load" switch permits use of built-in 600-ohm load, or external load of different impedance. Output and frequency indicators accurate to within  $\pm 5\%$ . Distortion less than .1 of 1% between 20 and 20,000 cps. Total range is 10 cps to 100 kc. Shpg. Wt. 8 lbs.

**MODEL AG-9A**

**\$34<sup>50</sup>**

**HEATHKIT HARMONIC DISTORTION METER KIT**

All sounds consist of dominant tones plus harmonics (over-tones). These harmonics enrich the quality and brightness of the music. However, additional harmonics which originate in the audio equipment, represent distortion. Used with an audio signal generator, the HD-1 will accurately measure this harmonic distortion at any or all frequencies between 20 and 20,000 cps. Distortion is read directly on the panel meter in ranges of 0-1, 3, 10, 30 and 100% full scale. Voltage ranges of 0-1, 3, 10 and 30 volts are provided for the initial reference settings. Signal-to-noise ratio measurements are also permitted through the use of a separate meter scale calibrated in db. High quality components insure years of outstanding performance. Full instructions are provided. Shpg. Wt. 13 lbs.

**MODEL HD-1**

**\$49<sup>50</sup>**

# Heathkits...

By DAYSTROM

*are well known for  
their high quality  
and reliability.*

**HEATHKIT AUDIO VTVM KIT**

This new and improved AC Vacuum Tube Voltmeter is designed especially for audio measurements and low-level AC measurements in power supply filters, etc. Employs an entirely new circuit featuring a cascode amplifier with cathode-follower isolation between the input and the amplifier, and between the output stage and the preceding stages. It emphasizes stability, broad frequency response, and sensitivity. Frequency response is essentially flat from 10 cps to 200 kc. Input impedance is 1 megohm at 1000 cps. AC (RMS) voltage ranges are 0-.01, .03, .1, .3, 1, 3, 10, 30, 100 and 300 volts. Db ranges cover  $-52$  db to  $+52$  db. Features large  $4\frac{1}{2}$ " 200 microampere meter, with increased damping in meter circuit for stability in low frequency tests. 1% precision resistors employed for maximum accuracy. Stable, reliable performance in all applications. Shpg. Wt. 5 lbs.

**MODEL AV-3**

**\$29<sup>50</sup>**

**RADIO-ELECTRONICS**

### HEATHKIT COLOR BAR AND DOT GENERATOR

The CD-1 combines the two basic color service instruments, a Color Bar Generator and White Dot Generator in one versatile portable unit, which has crystal-controlled accuracy and stability (no external sync lead required). Produces white-dots, cross hatch, horizontal and vertical bars, 10 vertical color bars, and a new shading bar pattern for screen and background adjustments. Variable RF output on any channel from 2 to 6. Positive or negative video output, variable from 0 to 10 volts peak-to-peak. Crystal controlled sound carrier with off-on switch. Voltage regulated power supply using long-life silicon rectifiers. Gain knowledge of a new and profitable field by constructing this kit. Shpg. Wt. 12 lbs.

MODEL CD-1  
\$59<sup>95</sup>

# Heathkits...

BY DAYSTROM

*are guaranteed to meet or exceed advertised specifications*

### HEATHKIT TV ALIGNMENT GENERATOR KIT

This fine TV alignment generator offers stability and flexibility difficult to obtain even in instruments costing several times this low Heathkit price. It covers 3.6 mc to 220 mc in four bands. Sweep deviation is controllable from 0 to 42 mc. The all-electronic sweep circuit insures stability. Crystal marker and variable marker oscillators are built in. Crystal (included with kit) provides output at 4.5 mc and multiples thereof. Variable marker provides output from 19 to 60 mc on fundamentals and from 57 to 180 mc on harmonics. Effective two-way blanking to eliminate return trace. Phasing control. Kit is complete, including three output cables. Shpg. Wt. 16 lbs.

MODEL TS-4A  
\$49<sup>50</sup>

### HEATHKIT "EXTRA DUTY" 5" OSCILLOSCOPE KIT

This fine oscilloscope compares favorably to other scopes costing twice its price. It contains the extra performance so necessary for monochrome and color-TV servicing. Features push-pull horizontal and vertical output amplifiers, a 5UPI CRT, built in peak-to-peak calibration source, a fully compensated 3-position step-type input attenuator, retrace blanking, phasing control, and provision for Z-axis modulation. Vertical amplifier frequency response is within +1.5 and -5 db from 3 CPS to 5 MC. Response at 3.58 MC down only 2.2 db. Sensitivity is 0.025 volts RMS/inch at 1 kc. Sweep generator covers 20 CPS to 500 kc in five steps, five times the usual sweep obtained in other scopes through the use of the patented Heath sweep circuit. Etched-metal circuit boards reduce assembly time and minimize errors in assembly, and more importantly, permit a level of circuit stability never before achieved in an oscilloscope of this type. Shpg. Wt. 21 lbs.

MODEL O-11  
\$69<sup>50</sup>

### HEATHKIT ELECTRONIC SWITCH KIT

A valuable accessory for any oscilloscope owner. It allows simultaneous oscilloscope observation of two signals by producing both signals, alternately, at its output. Four switching rates. Provides gain for input signals. Frequency response  $\pm 1$  db, 0 to 100 kc. A sync output is provided to control and stabilize scope sweep. Ideal for observing input and output of amplifiers simultaneously. Shpg. Wt. 8 lbs.

MODEL S-3  
\$21<sup>95</sup>

### HEATHKIT VOLTAGE CALIBRATOR KIT

This unit is an excellent companion for your oscilloscope. Used as a source of calibrating voltage, it produces near-perfect square wave signals of known amplitude. Precision 1% attenuator resistors insure accurate output amplitude, and multivibrator circuit guarantees good sharp square waves. Output frequency is approximately 1000 CPS. Fixed outputs selected by panel switches are: .03, 0.1, 0.3, 1.0, 3.0, 10, 30 and 100 volts peak-to-peak. Allows measurement of unknown signal amplitude by comparing it to the known output of the VC-3 on oscilloscope. Shpg. Wt. 4 lbs.

MODEL VC-3  
\$12<sup>50</sup>

*Functional styling with clean uncluttered look*



COLOR BAR AND DOT GENERATOR



"EXTRA DUTY" SCOPE

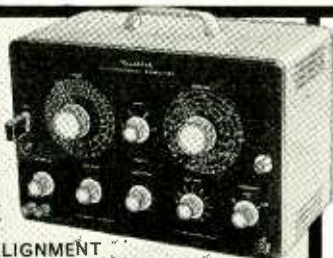

TV ALIGNMENT GENERATOR



ELECTRONIC SWITCH



VOLTAGE CALIBRATOR

HEATH COMPANY A Subsidiary of Daystrom, Inc. BENTON HARBOR 20, MICH.

JANUARY, 1958

67

### HEATHKIT TUBE CHECKER KIT

Eliminate guesswork, and save time in servicing or experimenting. The TC-2 tests tubes for shorted elements, open elements, filament continuity, and operating quality on the basis of total emission. It tests all tube types encountered in radio and TV service work. Sockets are provided for 4, 5, 6 and 7-pin, octal, and loctal tubes, 7 and 9 pin miniature tubes, 5 pin hytron miniatures, and pilot lamps. Tube condition indicated on 4½" meter with multi-color "good-bad" scale. Illuminated roll chart with all test data built in. Switch selection of 14 different filament voltages from .75 to 117 volts. Color-coded cable harness allows neat professional wiring and simplifies construction. Very easy to build, even for a beginner. Shpg. Wt. 12 lbs.

MODEL TC-2  
\$29.50

### HEATHKIT HANDITESTER KIT

The small size and rugged construction of this tester makes it perfect for any portable application. The combination function-range switch simplifies operations. Measures AC or DC voltage at 0-10, 30, 300, 1000 and 5000 volts. Direct current ranges are 0-10 ma and 0-100 ma. Ohmmeter ranges are 0-3000 (30 ohm center scale) and 0-300,000 (3000 ohm center scale). Very popular with home experimenters, electricians, and appliance repairmen. Slips easily into your tool box, glove compartment, coat pocket, or desk drawer. Shpg. Wt. 3 lbs.

MODEL M-1  
\$17.95

### HEATHKIT PICTURE TUBE CHECKER KIT

The CC-1 can be taken with you on service calls so that you can clearly demonstrate the quality of a customer's picture tube in his own home. Tubes can be tested without removing them from the receiver or cartons if desired. Checks cathode emission, beam current, shorted elements, and leakage between elements in electromagnetic picture tube types. Self-contained power supply, and large 4½" meter. CRT condition indicated on "good-bad" scale. Relative condition of tubes fluorescent coating is shown in "shadow-graph" test. Permanent test cable with CRT socket and anode connector. No tubes to burn out, designed to last a lifetime. Luggage-type portable case. Shpg. Wt. 10 lbs.

MODEL CC-1  
\$24.95

### HEATHKIT ETCHED-CIRCUIT VTVM KIT

This multi-purpose VTVM is the world's largest selling instrument of its type—and is especially popular in laboratories, service shops, home workshops and schools. It employs a large 4½" panel meter, precision 1% resistors, etched metal circuit board, and many other "extras" to insure top quality and top performance. It's easy to build, and you may rely on its accuracy and dependability. The V7-A will measure AC (RMS) and DC voltages in ranges of 0-1.5, 5, 15, 50, 150, 500 and 1500. It measures peak-to-peak AC voltage in ranges of 0-4, 14, 40, 140, 400, 1400 and 4000. Resistance ranges provide multiplying factors of X 1, X 10, X 100, X 1000, X 10k, X 100k, and X 1 megohm. Center-scale resistance readings are 10, 100, 1000, 10k, 100k, 1 megohm and 10 megohms. A db scale is also provided. The precision and quality of this VTVM cannot be duplicated at this price. Shpg. Wt. 7-lbs.

MODEL V7-A  
\$24.50

# Heathkits...

By DAYSTROM

*let you fill your exact needs  
from a wide variety  
of instruments*

### HEATHKIT 20,000 OHMS/VOLT VOM KIT

This fine instrument provides a total of 25 meter ranges on its two-color scale. It employs a 50 ua 4½" meter, and features 1% precision multiplier resistors. Requires no external power. Ideal for portable applications. Sensitivity is 20,000 ohms-per-volt DC and 5000 ohms-per-volt AC. Measuring ranges are 0-1.5, 5, 50, 150, 500, 1500 and 5000 volts, AC and DC. Measures direct current in ranges of 0-150 ua, 15 ma, 150 ma, 500 ma and 15 a. Resistance multipliers are X 1, X 100 and X 10,000, with center-scale readings of 15, 1500 and 150,000 ohms. Covers -10 db to +65 db. Easy to build and fun to use. Attractive bakelite case with plastic carrying handle. Shpg. Wt. 6 lbs.

MODEL MM-1  
\$29.95

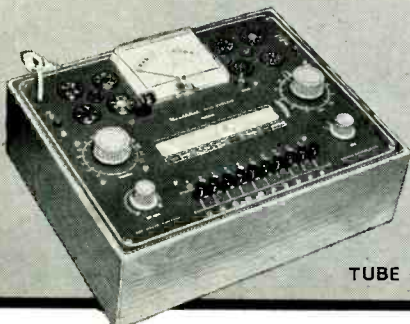

TUBE CHECKER

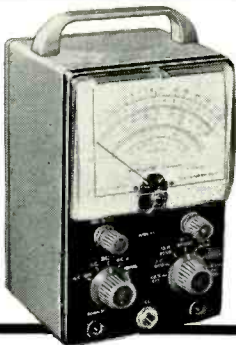

ETCHED  
CIRCUIT VTVM

*High quality  
test gear you  
will be  
proud to own*



HANDITESTER

*Priced low  
to fit your  
budget*



PICTURE TUBE  
CHECKER



20,000  
OHMS/VOLT VOM

### HEATHKIT RF SIGNAL GENERATOR KIT

Even a beginner can build this prealigned signal generator, designed especially for use in service work. Produces RF signals from 160 kc to 110 mc on fundamentals in five bands. Covers 110 mc to 220 mc on calibrated harmonics. Low impedance RF output in excess of 100,000 microvolts, is controllable with a step-type and continuously variable attenuator. Selection of unmodulated RF, modulated RF, or audio at 400 CPS. Ideal for fast and easy alignment of radio receivers, and finds application in FM and TV work as well. Thousands of these units are in use in service shops all over the country. Easy to build and a real time saver, even for the part-time service technician or hobbyist. Shpg. Wt. 8 lbs.

MODEL SG-8

**\$19<sup>50</sup>**

### HEATHKIT LABORATORY RF GENERATOR KIT

Tackle all kinds of laboratory alignment jobs with confidence by employing the LG-1. It features voltage-regulated B+, double shielding of oscillator circuits, copper-plated chassis, variable modulation level, metered output, and many other "extras" for critical alignment work. Generates RF signals from 100 kc to 30 mc on fundamentals in five bands. Meter reads RF output in microvolts or modulation level in percentage. RF output available up to 100,000 microvolts, controlled by a fixed-step and a variable attenuator. Provision for external modulation where necessary. Buy and use this high-quality RF signal generator that may be depended upon for stability and accuracy. Shpg. Wt. 16 lbs.

MODEL LG-1

**\$48<sup>95</sup>**

### HEATHKIT DIRECT-READING CAPACITY METER KIT

Here's a fast, simple capacity meter. A capacitor to be checked is merely connected to the terminals, the proper range selected, and the value read directly on the large 4½" panel meter calibrated in mmf and mfd. Ranges are 0 to 100 mmf, 1,000 mmf, .01 mfd, .1 mfd full scale. Not affected by hand capacity. Shpg. Wt. 7 lbs.

MODEL CM-1

**\$29<sup>50</sup>**

# Heathkits...

By DAYSTROM

*are educational  
as well as functional*

### HEATHKIT "IN-CIRCUIT" CAPACI-TESTER KIT

With the CT-1 it is no longer necessary to disconnect one capacitor lead to check the part, you can check most capacitors for "open" or "short" right in the circuit. Fast and easy—to save your valuable time in the service shop or lab. Detects open capacitors from about 50 mmf up, so long as the capacitor is not shunted by excessively low resistance value. Will detect shorted capacitors up to 20 mfd (not shunted by less than 10 ohms). (Does not detect leakage.) Employs 60 cycles and 19 megacycle test frequencies. Electron beam "eye" tube used as indicator. Compact, easy-to-build, and inexpensive. Test leads included. Shpg. Wt. 5 lbs.

MODEL CT-1

**\$7<sup>95</sup>**

*Use these  
kits for faster  
and more  
efficient testing*



RF SIGNAL GENERATOR



LABORATORY RF GENERATOR

DIRECT-READING CAPACITY METER



CONDENSER CHECKER



"IN CIRCUIT" CAPACI-TESTER



VISUAL-AURAL SIGNAL TRACER

### HEATHKIT CONDENSER CHECKER KIT

This handy instrument uses an electron beam "eye" tube as an indicator to measure capacity in ranges of .00001 to .005 mfd, .5 mfd, 50 mfd and 1000 mfd. Also measures resistance from 100 ohms to 5 megohms in two ranges. Checks paper, mica, ceramic and electrolytic capacitors. Selection of five polarizing voltages. Shpg. Wt. 7 lbs.

MODEL C-3

**\$19<sup>50</sup>**

### HEATHKIT VISUAL-AURAL SIGNAL TRACER KIT

Although designed originally for radio receiver work, the T-3 finds application in FM and TV servicing as well. Features high-gain channel with demodulator probe, and low-gain channel with audio probe. Traces signals in all sections of radio receivers and in many sections of FM and TV receivers. Built-in speaker and electron beam eye tube indicate relative gain, etc. Also features built-in noise locator circuit. Provision for patching speaker and/or output transformer to external set. Shpg. Wt. 9 lbs.

MODEL T-3

**\$23<sup>50</sup>**

HEATH COMPANY A Subsidiary of Daystrom, Inc. BENTON HARBOR 20, MICH.

### HEATHKIT IMPEDANCE BRIDGE KIT

The model IB-2A employs a Wheatstone Bridge, a Capacity Comparison Bridge, a Maxwell Bridge, and a Hay Bridge in one compact package. Measures resistance from 0.1 ohm to 10 megohms, capacitance from 100 mmf to 100 mfd, inductance from 0.1 mh to 100 h, dissipation factor (D) from 0.002 to 1, and storage factor (Q) from 0.1 to 1000. A 100-0-100 ua meter provides for null indications. The decade resistors employed are of 1% tolerance for maximum accuracy. Completely self-contained. Has built in power supply, 1000-cycle generator, and vacuum-tube detector. Special two-section CRL dial insures convenient operation. Instruction manual has entirely new schematic that clarifies circuit functions in various switch positions. A true laboratory instrument, that will provide you with many years of fine performance. Shpg. Wt. 12 lbs.

MODEL IB-2A

\$59<sup>50</sup>

### HEATHKIT "LOW RIPPLE" BATTERY ELIMINATOR KIT

This modern battery eliminator incorporates an extra low-ripple filter circuit so that it can be used to power all the newest transistor-type circuits requiring 0 to 12 volts DC,

and the new "hybrid" automobile radios using both transistors and vacuum tubes. Its DC output, at either 6 or 12 volts, contains less than .3% AC ripple. Separate output terminals are provided for low-ripple or normal filtering. Supplies up to 15 amps on 6 volt range or up to 7 amps on 12 volt range. Output is variable from 0 to 8 or 0 to 16 volts. Two meters constantly monitor output voltage and current. Will also double as a battery charger. Shpg. Wt. 23 lbs.

MODEL BE-5

\$39<sup>95</sup>

### HEATHKIT ISOLATION TRANSFORMER KIT

The model IT-1 is one of the handiest units for the service shop, home workshop or laboratory. Provides complete isolation from the power line. AC-DC sets may be plugged directly into the IT-1 without the chassis becoming "hot". Output voltage is variable from 90 volts to 130 volts allowing checks of equipment under adverse conditions such as low line voltage. Rated for 100 volt amperes continuously or 200 volt amperes intermittently. Panel meter monitors output voltage. Shpg. Wt. 9 lbs.

MODEL IT-1

\$16<sup>50</sup>

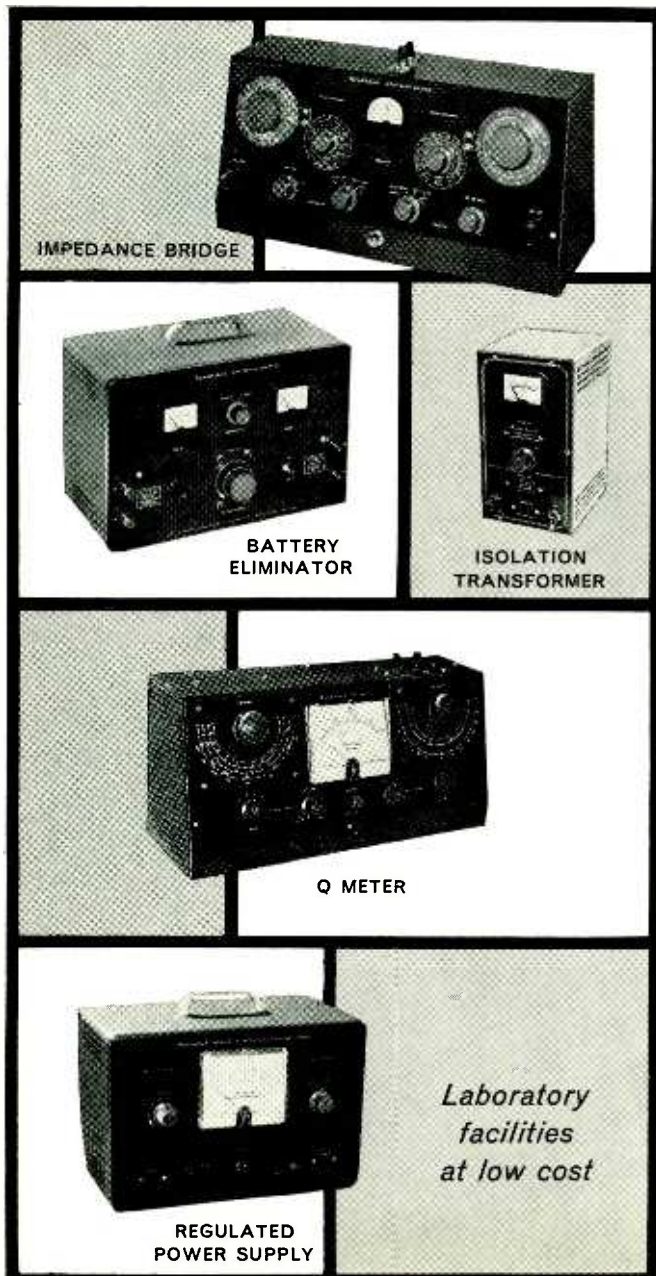

IMPEDANCE BRIDGE



BATTERY ELIMINATOR



ISOLATION TRANSFORMER



Q METER



REGULATED POWER SUPPLY

Laboratory facilities at low cost

# Heathkits...

By DAYSTROM

*are designed with high-quality, name-brand components to insure long service life*

### HEATHKIT "Q" METER KIT

At this price the laboratory facilities of a Q Meter may be had by the average service technician or home experimenter. The Q Meter permits measurement of inductance from 1 microhenry to 10 millihenry, "Q" on a scale calibrated up to 250 full scale, with multipliers of 1 or 2, and capacitance from 40 mmf to 450 mmf  $\pm$  3 mmf. Built in oscillator permits testing components from 150 kc to 18 mc. Large 4½" panel meter is featured. Very handy for checking peaking coils, chokes, etc. Use to determine values of unknown condensers, both variable and fixed, compile data for coil winding purposes, or measure RF resistance. Also checks distributed capacity and Q of coils. No special equipment is required for calibration. A special test coil is furnished, along with easy-to-follow instructions. Shpg. Wt. 14 lbs.

MODEL QM-1

\$44<sup>50</sup>

### HEATHKIT REGULATED POWER SUPPLY KIT

Here is a power supply that will provide DC plate voltage and AC filament voltage for all kinds of experimental circuits. The DC supply is regulated for stability, and yet the amount of DC output voltage available from the power supply can be controlled manually from 0 up to 500 volts. At 450 volts DC output, the power supply will provide up to 10 ma of current, and provide progressively higher current as the output voltage is lowered. Current rating is 130 ma at 200 volts output. In addition to furnishing B+ the power supply also provides 6.3 volts AC at up to 4 amperes for filaments. Both the B+ output and the filament output are isolated from ground. Ideal unit for use in laboratory, home workshop, ham shack, or service shop. A large 4½" meter on the front panel reads output voltage or output current, selectable with a panel switch. Shpg. Wt. 17 lbs.

MODEL PS-3

\$35<sup>50</sup>



*Terrific values  
in amateur  
equipment!*



DX-20 TRANSMITTER



DX-40 TRANSMITTER



DX-100 TRANSMITTER

#### HEATHKIT DX-20 CW TRANSMITTER KIT

The Heathkit model DX-20 "straight-CW" transmitter features high efficiency at low cost. It uses a single 6DQ6A tube in the final amplifier stage for plate power input of 50 watts. A 6CL6 serves as crystal oscillator, with a 5U4GB rectifier. It is an ideal transmitter for the novice, as well as the advanced-class CW operator. Single-knob band switching is featured to cover 80, 40, 20, 15, 11 and 10 meters. Pi network output circuit matches various antenna impedances between 50 and 1000 ohms and reduces harmonic output. Top-quality parts are featured throughout, including "potted" transformers, etc., for long life. It has been given full "TVI" treatment. Access into the cabinet for crystal changing is provided by a removable metal pull-out plug on the left end of the cabinet. Very easy to build from the complete step-by-step instructions supplied, even if you have never built electronic equipment before. If you appreciate a good, clean signal on the CW bands, this is the transmitter for you! Shpg. Wt. 18 lbs.

MODEL DX-20

**\$35<sup>95</sup>**

# Heathkits...

By DAYSTROM

*are designed by  
licensed ham-engineers,  
especially for you*

#### HEATHKIT DX-40 PHONE AND CW TRANSMITTER KIT

A most remarkable power package for the price, the new DX-40 provides both phone and CW facilities for operation on 80, 40, 20, 15, 11 and 10 meters. A single 6146 tube is used in the final amplifier stage to provide full 75 watt plate power input on CW, or control carrier modulation peaks up to 60 watts for phone operation. Modulator and power supplies are built right in and single knob bandswitching is combined with a pi network output circuit for complete operating convenience. The tight fitting cabinet presents

a most attractive appearance, and is designed for complete shielding to minimize TVI. A 4-position switch provides convenient selection of three different crystals or a jack for external VFO. The crystals are reached through access door at rear of cabinet. You can build this rig yourself and be proud to show it off to your fellow hams. Get your DX-40 now for many hours of operating enjoyment. Shpg. Wt. 25 lbs.

MODEL DX-40

**\$64<sup>95</sup>**

#### HEATHKIT DX-100 PHONE AND CW TRANSMITTER KIT

Listen to any ham band between 160 meters and 10 meters and note how many DX-100 transmitters you hear! The number of these fine rigs now on the air testifies to the enthusiasm with which it has been accepted by the amateur fraternity. No other transmitter in this power class combines high quality and real economy so effectively. The DX-100 features a built in VFO, modulator and power supplies, complete shielding to minimize TVI, and pi network output coupling to match impedances from approximately 50 to 600 ohms. Its RF output is in excess of 100 watts on phone and 120 watts on CW, for a clean strong signal on all the ham bands from 10 to 160 meters. Single-knob band switching and illuminated VFO dial and meter face add real operating convenience. RF output stage uses a pair of 6146 tubes in parallel, modulated by a pair of 1625's. High quality components are used throughout, such as "potted" transformers, silver-plated or solid coin silver switch terminals, aluminum heat-dissipating caps on the final tubes, copper plated chassis, etc. This transmitter was designed exclusively for easy step-by-step assembly. Shpg. Wt. 107 lbs.

MODEL DX-100

**\$189<sup>50</sup>**

#### FUNCTIONAL DESIGN . . .

The transmitters described on this page were designed for the ham, by hams who know what features are desirable and needed. This assures you of the best possible performance and convenience, and adds much to your enjoyment in the ham shack.

**HEATH COMPANY A Subsidiary of Daystrom, Inc. BENTON HARBOR 20, MICH.**

JANUARY, 1958

www.americanradiohistory.com

71

*Automatically turns off transmitter and gives visual signal*



"AUTOMATIC"  
CONELRAD ALARM



GRID DIP METER

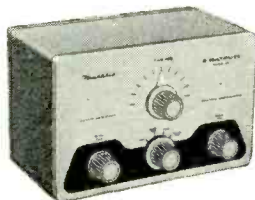

"Q" MULTIPLIER

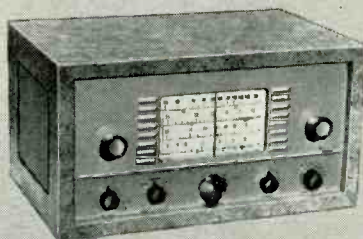

COMMUNICATIONS-TYPE  
RECEIVER

*An ideal receiver for the beginning ham or short wave listener*

#### HEATHKIT "AUTOMATIC" CONELRAD ALARM KIT

This conelrad alarm works with any radio receiver; AC-DC-transformer operated—or battery powered, so long as the receiver has AVC. Fully complies with FCC regulations for amateurs. When the monitored station goes off the air, the CA-1 automatically cuts the AC power to your transmitter, and lights a red indicator. A manual "reset" button reactivates the transmitter. Incorporates a heavy-duty six-ampere relay, a thyratron tube to activate the relay, and its own built-in power supply. A neon lamp shows that the alarm is working, by indicating the presence of B+ in the alarm circuit. Simple to install and connect. Your transmitter plugs into an AC receptacle on the CA-1, and a cable connects to the AVC circuit of a nearby receiver. A built-in sensitivity control allows adjustment to various AVC levels. Receiver volume control can be turned up or down, without affecting alarm operation. Build a Heathkit CA-1 in one evening and comply with FCC regulations now! Shpg. Wt. 4 lbs.

MODEL CA-1  
**\$13<sup>95</sup>**

#### HEATHKIT "Q" MULTIPLIER KIT

The Heathkit Q Multiplier functions with any AM receiver having an IF frequency between 450 and 460 KC, that is not "AC-DC" type. It derives its power from the receiver, and needs only 6.3 volts AC at 300 ma (or 12 VAC at 150 ma) and 150 to 250 volts DC at 2 ma. Simple to connect with cable and plugs supplied. Adds additional selectivity for separating signals, or will reject one signal and eliminate heterodyne. A tremendous help on crowded phone and CW bands. Effective Q of 4000 for sharp "peak" or "null". Tunes any signal within IF band pass without changing the main receiver tuning dial. A convenient tuning knob on the front panel with vernier reduction between the tuning knob and the tuning capacitor gives added flexibility in operation. Uses a 12AX7 tube, and special high-Q shielded coils. Instructions for connecting to the receiver and operation are provided in the construction manual. A worthwhile addition to any communications, or broadcast receiver. It may also be used with a receiver which already has a crystal filter to obtain two simultaneous functions, such as peaking the desired signal with the crystal filter and nulling an adjacent signal with the Q Multiplier. Shpg. Wt. 3 lbs.

MODEL QF-1  
**\$9<sup>95</sup>**

#### HEATHKIT GRID DIP METER KIT

A grid dip meter is basically an RF oscillator for determining the frequency of other oscillators, or of tuned circuits. Extremely useful in locating parasitics, neutralizing, identifying harmonics, coil winding, etc. Features continuous frequency coverage from 2 mc to 250 mc, with a complete set of prewound coils, and a 500 ua panel meter. Front panel has a sensitivity control for the meter, and a phone jack for listening to the "zero-beat." Will also double as an absorption-type wave meter. Shpg. Wt. 4 lbs.

**Low Frequency Coil Kit:** Two extra plug-in coils to extend frequency coverage down to 350 kc. Shpg. Wt. 1 lb. No. 341-A. \$3.00

MODEL GD-1B  
**\$21<sup>95</sup>**

#### HEATHKIT ALL-BAND COMMUNICATIONS-TYPE RECEIVER KIT

This communications-receiver covers 550 kc to 30 mc in four bands, and provides good sensitivity, selectivity, and fine image rejection. Ham bands are clearly marked on an illuminated dial scale. Features a transformer-type power supply—electrical band spread—antenna trimmer—head-phone jack—automatic gain control and beat frequency oscillator. Accessory sockets are provided on the rear of the chassis for using the Heathkit model QF-1, Q Multiplier. Accessory socket is handy, also, for operating other devices that require plate and filament potentials. Will supply +250 VDC at 15 ma and 12.6 VAC at 300 ma. Ideal for the beginning ham or short wave listener. Shpg. Wt. 12 lbs.

**Cabinet:** Fabric covered cabinet with aluminum panel as shown. Part no. 91-15A. Shpg. Wt. 5 lbs. \$4.95.

MODEL AR-3  
**\$29<sup>95</sup>**  
(Less cabinet)

# Heathkits...

BY DAYSTROM

*are outstanding in performance and dollar value*



### HEATHKIT REFLECTED POWER METER KIT

The Heathkit reflected power meter, model AM-2, makes an excellent instrument for checking the match of the antenna transmission system, by measuring the forward and reflected power or standing wave ratio. The AM-2 is designed to handle a peak power of well over 1 kilowatt of energy and may be left in the antenna system feed line at all times. Band coverage is 160 meters through 2 meters. Input and output impedances for 50 or 75 ohm lines. No external power required for operation. Meter indicates percentage forward and reflected power, and standing wave ratio from 1:1 to 6:1. Another application for the AM-2 is matching impedances between exciters or R.F. sources and grounded grid amplifiers. Power losses between transmitter output and antenna tuner may be very easily computed by inserting the AM-2 in the line connecting the two. No insertion loss is introduced into the feeder system, due to the fact that the AM-2 is a portion of coaxial line in series with the feeder system and no internal connections are actually made to the line. Complete circuit description and operation instructions are provided in the manual. Cabinet size is 7-3/8" x 4-1/16" x 4-5/8". Can be conveniently located at operating position. Shpg. Wt. 3 lbs.

MODEL AM-2

\$15<sup>95</sup>

### HEATHKIT VARIABLE FREQUENCY OSCILLATOR KIT

Enjoy the convenience and flexibility of VFO operation by obtaining the Heathkit model VF-1 Variable Frequency Oscillator. Covers 160-80-40-20-15-11 and 10 meters with three basic oscillator frequencies. Better than 10 volt average RF output on fundamentals. Plenty of output to drive most modern transmitters. It features voltage regulation for frequency stability. Dial is illuminated for easy reading. Vernier reduction is used between the main tuning knob and the tuning condenser. Requires a power source of only 250 volts DC at 15 to 20 milliamperes and 6.3 volts AC at 0.45 amperes. Extra features include copper-plated chassis, ceramic coil forms, extensive shielding, etc. High quality parts throughout. VFO operation allows you to move out from under interference and select a portion of the band you want to use without having to be tied down to only two or three frequencies through use of crystals. "Zero in" on the other fellow's signal and return his CQ on his own frequency! Crystals are not cheap, and it takes quite a number of them to give anything even approaching comprehensive coverage of all bands. Why hesitate? The model VF-1 with its low price and high quality will add more operating enjoyment to your ham activities. Shpg. Wt. 7 lbs.

MODEL VF-1

\$19<sup>50</sup>

# Heathkits...

By DAYSTROM

*are the answer for your electronics hobby.*

### HEATHKIT BALUN COIL KIT

The Heathkit Balun Coil Kit model B-1 is a convenient transmitter accessory, which has the capability of matching unbalanced coax lines, used on most modern transmitters, to balance lines of either 75 or 300 ohms impedance. Design of the bifilar wound balun coils will enable transmitters with unbalanced output to operate into balanced transmission line, such as used with dipoles, folded dipoles, or any balanced antenna system. The balun coil set can be used with transmitters and receivers without adjustment over the frequency range 160 through 10 meters, and will easily handle power inputs up to 250 watts. Cabinet size is 9" square by 5" deep and it may be located any distance from the transmitter or from the antenna. Completely enclosed for outdoor installation. Shpg. Wt. 4 lbs.

MODEL B-1

\$8<sup>95</sup>

### HEATHKIT 6 OR 12 VOLT VIBRATOR POWER SUPPLY KITS

These little power supply kits are ideal for all portable applications with 6 volt or 12 volt batteries, when you are operating electronic equipment away from power lines. By replacing the power supplies of receivers, small public address systems, or even miniature transmitters with these units, they can be used with conventional 6 or 12 volt batteries. Use in boats, automobiles, light aircraft, or any field application. Each unit provides 260 volts DC output at up to 60 milliamperes. More than one power supply of the same model may be connected in parallel for increased current capacity at the same output voltage. Everything is provided in the kit, including a vibrator transformer, a vibrator, 6X4 or 12X4 rectifier, and the necessary buffer capacitor, hash filter, and output filter capacitor. Shpg. Wt. 4 lbs.

6 VOLT  
MODEL VP-1-6  
12 VOLT  
MODEL VP-1-12

\$7<sup>95</sup> Each

REFLECTED POWER METER

*Insure your "on the air" performance with these fine accessories.*

VARIABLE FREQUENCY OSCILLATOR

VIBRATOR POWER SUPPLY

BALUN COIL SET

**HEATHKIT ELECTRONIC  
IGNITION ANALYZER KIT**

Previous electronic experience is not necessary to build this fine ignition analyzer. The construction manual supplied has complete step-by-step instructions plus large pictorial diagrams showing the exact placement and value of each component. All parts are clearly marked so that they are easily identified. The IA-1 is an ideal tool for engine mechanics, tune-up men, and auto hobbyists, since it traces the dynamic action of voltage in an ignition system on a cathode-ray tube screen. The wave form produced is affected by the condition of the coil, condenser, points, plugs, and ignition wiring, so it can be analyzed, and used as a "sign-post" to ignition system performance. This analyzer will detect inequality of spark intensity, a poor spark plug, defective plug wiring, breaker-point bounce, an open condenser, and allow setting of dwell-time percentage for the points. An important feature of this instrument is its ability to check dynamic performance, with the engine in operation (400 to 5000 RPM). It will show the complete engine cycle, or only one complete cylinder. Can be used on all types of internal combustion engines where breaker-points are accessible. Use it on automobiles, boats, aircraft engines, etc. Shpg. Wt. 18 lbs.

MODEL IA-1  
**\$59<sup>95</sup>**

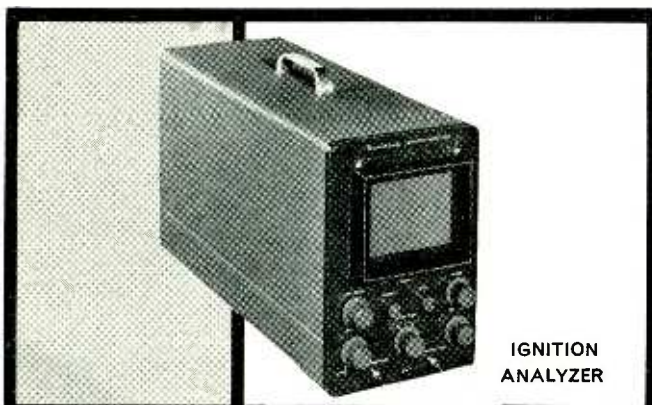

IGNITION  
ANALYZER

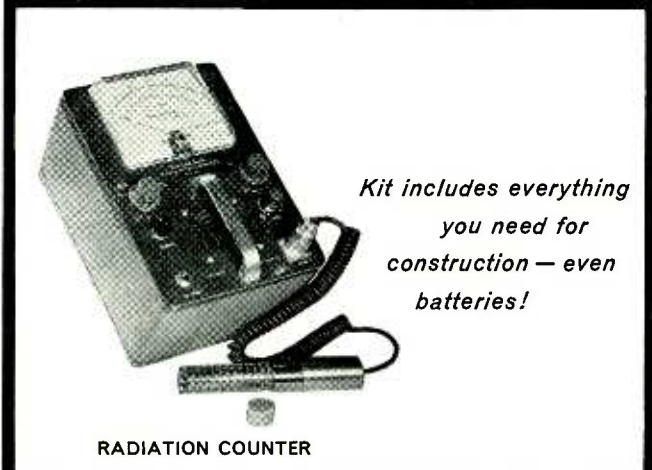

*Kit includes everything  
you need for  
construction — even  
batteries!*

RADIATION COUNTER



ENLARGER TIMER



BATTERY TESTER

**HEATHKIT PROFESSIONAL  
RADIATION COUNTER KIT**

This Heathkit professional-type radiation counter is simple to build successfully, even if you have never built a kit before. Complete step-by-step instructions are combined with giant-size pictorial diagrams for easy assembly. By "building it yourself" you can have a modern-design, professional radiation counter priced far below comparable units. Provides high sensitivity with ranges from 0-100, 600, 6000 and 60,000 counts-per-minute, and 0-.02, .1, 1 and 10 milliroentgens-per-hour. Employs 900-volt bismuth tube in beta/gamma sensitive probe. Probe and 8-foot expandable cable included in kit price, as is a radiation sample for calibration. Use it in medical laboratories, or as a prospecting tool, and for civil defense to detect radioactive fallout, or other unknown radiation levels. Features a selectable time constant. Meter calibrated in CPM or mR/hour in addition to "beep" or "click" from panel-mounted speaker. Prebuilt "packaged" high voltage power supply with reserve capacity above 900 volt level at which it is regulated. Merely changing regulator tube type would allow use of scintillation probe if desired. Employs five tubes (plus a transistor) to insure stable and reliable operation. Kit price includes batteries. Shpg. Wt. 8 lbs.

MODEL RC-1  
**\$79<sup>95</sup>**

# Heathkits...

BY DAYSTROM

*are supplied with comprehensive  
instructions that eliminate costly  
mistakes and save valuable time*

**HEATHKIT ENLARGER TIMER KIT**

The ET-1 is an easy-to-build electronic device to be used by amateur or professional photographers in timing enlarger operations. The calibrated dial on the timer covers 0 to 1 minute, calibrated in 5-second gradations. The continuously variable control allows setting of the "on" cycle of your enlarger, which is plugged into a receptacle on the front panel of the ET-1. A "safe light" can also be plugged in so that it is automatically turned "on" when the enlarger is turned "off." Handles up to 350 watts with built-in relay. All-electronic timing cycle insures maximum accuracy. Timer does not have to be reset after each cycle, merely flip lever switch to print, to repeat time cycle. A control is provided for initial calibration. Housed in a compact plastic case that will resist attack of photographic chemicals. A fine addition to any dark room. Shpg. Wt. 3 lbs.

MODEL ET-1  
**\$11<sup>50</sup>**

**HEATHKIT BATTERY TESTER KIT**

The BT-1 is a special battery testing device that actually "loads" the battery under test (draws current from it) while it is being tested. Weak batteries often test "good" with an ordinary voltmeter but the built-in load resistance of the BT-1 automatically draws enough current from the battery to reveal its true condition. Simple to operate with "good-weak-replace" scale. Tests all kinds of dry cell batteries within ranges of 0-15 volts and 0-180 volts. Slide switch provides for either 10 ma or 100 ma load, depending on whether you're testing an A or B battery. Not only determines when battery is completely exhausted, but makes it possible to anticipate failure by noting weak condition. Ideal for testing dry cell hearing aid, flashlight, portable radio, and model airplane batteries. Test batteries in a way your customers can understand and stimulate battery sales. Shpg. Wt. 2 lbs.

MODEL BT-1  
**\$8<sup>50</sup>**



CRYSTAL RADIO



Now you can have radio  
wherever you go —  
with the portable  
that plays anywhere!



BROADCAST BAND RADIO

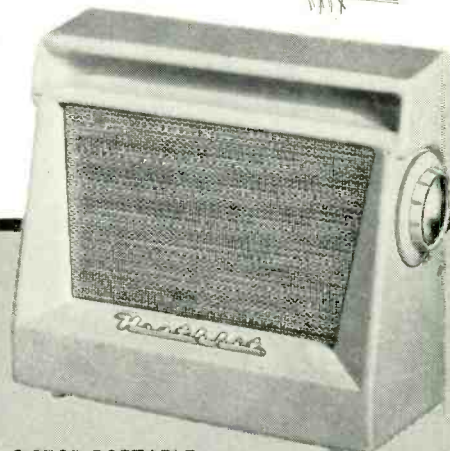

TRANSISTOR PORTABLE

### HEATHKIT CRYSTAL RADIO KIT

The Heathkit model CR-1 crystal radio is similar to the "crystal sets" of the early radio days except that it has been improved by the use of sealed germanium diodes and efficient "high-Q" coils. The sealed diodes eliminate the critical "cats whisker" adjustment, and the ferrite coils are much more efficient for greater signal strength. Housed in a compact plastic box, the CR-1 uses two tuned circuits, each with a variable tuning capacitor, to select the local station. It covers the broadcast band from 540 to 1600 kc. Requires no external power whatsoever. This receiver could prove valuable to emergency reception of civil defense signals should there be a power failure. The low kit price even includes headphones. Complete step-by-step instructions and large pictorial diagrams are supplied for easy assembly. The instruction manual also provides the builder with the basic fundamentals of signal reception so that he understands how the crystal receiver functions. An interesting and valuable "do-it-yourself" project for all ages. Shpg. Wt. 3 lbs.

MODEL CR-1  
\$7<sup>95</sup>

result of these efforts. Six name-brand (Texas Instrument) transistors were selected for extra good sensitivity and selectivity. A 4" by 6" PM speaker with heavy magnet was chosen to insure fine tone quality. The power supply was designed to use six standard size "D" flashlight cells because they are readily available, inexpensive, and because they afford extremely long battery life (between 500 and 1000 hours). Costs you no more to operate from batteries than what you pay for operating a small table-model radio from the power line. An unbreakable molded plastic was selected for cabinet material because of its durability and striking beauty. Circuit is compact and efficient, yet components are not excessively crowded. Transformers are prealigned so it is ready for service as soon as construction is completed. Has built in rod-type antenna for reception in all locations. Cabinet dimensions are 9" L x 8" H x 3<sup>3</sup>/<sub>4</sub>" D. Comes in holiday gray, with gold-anodized metal speaker grille. Compare this portable, feature by feature, to all others on the market, and you'll appreciate what a tremendous dollar value it represents! Shpg. Wt. 4 lbs.

MODEL XR-1  
\$34<sup>95</sup>  
(Less batteries)  
(With cabinet)

# Heathkits...

BY DAYSTROM

*are easy and fun to build,  
and they let you learn  
by "doing-it-yourself"*

### HEATHKIT TRANSISTOR PORTABLE RADIO KIT

Heath engineers set out to develop a "universal" AM radio, suitable for use anywhere. Their objective was a portable that would be as much "at home" inside as it is outside, and would feature top quality components for high performance and long service life. The model XR-1 is the

### HEATHKIT BROADCAST BAND RADIO KIT

This table-model broadcast radio is fun to build, and is a fine little receiver for your home. It covers the standard broadcast band from 550 to 1600 kc with good sensitivity and selectivity. The 5<sup>1</sup>/<sub>2</sub>" PM speaker provides surprisingly good tone quality. High-gain IF transformers, miniature tubes, and a rod-type built in antenna, assure good reception in all locations. The power supply is transformer operated, as opposed to many of the economy "AC-DC" types. It's easy to build from the step-by-step instructions, and the construction manual includes information on operational theory, for educational purposes. Your success is assured by completely detailed information which also explains resistor and capacitor color codes, soldering techniques, use of tools, etc. A signal generator is recommended for final alignment. Shpg. Wt. 10 lbs.

Cabinet: Fabric covered cabinet with aluminum panel as shown. Shpg. Wt. 5 lbs. Part no. 91-9A. \$4.95.

MODEL BR-2  
\$18<sup>95</sup>  
(Less cabinet)

*protects against possible explosion and fire from undetected fuel vapor*



**FUEL VAPOR DETECTOR**

*detects electrolysis currents which cause deterioration of underwater metal fittings on your boat*



**ELECTROLYSIS DETECTOR**

*indicates condition and charge of batteries for safe cruising*

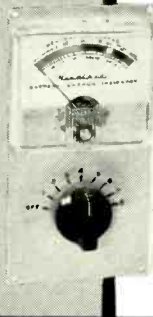

**BATTERY CHARGE INDICATOR**

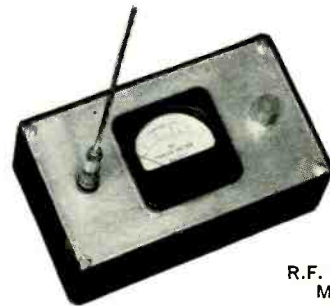

**R.F. POWER METER**

**HEATHKIT FUEL VAPOR DETECTOR KIT**

Protect your boat and its passengers against fire or explosion from undetected fuel vapor by building and using one of these fine units. The Heathkit Fuel Vapor Detector indicates the presence of fumes on a three-color "safe-dangerous" meter scale and immediately shows if it is safe to start the engine. A pilot light on the front panel shows when the detector is operating, and it can be left on continuously, or just used intermittently. A panel control enables initial calibration of the detector when installed. Features a hermetically-sealed meter with chrome bezel, and a chrome-plated brass panel. It is very simple to build and install, even by one not having previous experience. Models FD-1-6 (6 volts DC) and FD-1-12 (12 volts DC) operate from your boat batteries. The kit is complete in every detail, even to the inclusion of a spare detector unit. Shpg. Wt. 4 lbs.

6 volt  
MODEL FD-1-6  
12 volt  
MODEL FD-1-12

**\$35<sup>95</sup>**  
EACH

**HEATHKIT BATTERY CHARGE INDICATOR KIT**

The Heathkit model CI-1 Marine Battery Charge Indicator has been designed especially for the boat owner, although it has found use in service stations, power stations, and radio stations where banks of batteries are kept in reserve for emergency power. It is intended to replace the hydrometer method of checking storage batteries, and to eliminate the necessity for working with acid in small, below-decks enclosures. Now it is possible to check as few as one, or as many as eight storage batteries, merely by turning the switch and watching the meter. A glance at the meter tells you instantly whether your batteries are sufficiently charged for safe cruising. Dimensions are 2-7/8" W x 5-11/16" H x 2" D. Operates on either 6 or 12 volt systems using lead-acid batteries, regardless of size. Simple installation can be accomplished by the boat owner in fifteen minutes. Shpg. Wt. 3 lbs.

MODEL CI-1  
**\$16<sup>95</sup>**

**HEATHKIT ELECTROLYSIS DETECTOR KIT**

The Heathkit model ED-1 Electrolysis Detector indicates the extent of electrolysis currents between the boat's common ground and underwater fittings, except on boats having metal hulls. These currents, undetected, could

cause gradual corrosion and deterioration of the propeller or other metal fittings below the water line. It is particularly helpful when installing electrical equipment of any kind, or to determine proper polarity when power is obtained from a shore supply. Easy-to-build, the model ED-1 consists of a hermetically-sealed, waterproof meter, special sensing plate, and sufficient wire to install, including the necessary hardware. Mounts on instrument panel where it can be easily seen. Requires no power for operation, and gives instant warning to guard your boat for a lifetime. Shpg. Wt. 2 lbs.

MODEL ED-1  
**\$9<sup>95</sup>**

**HEATHKIT RF POWER METER KIT**

The Heathkit RF Power Meter Kit is designed to sample the RF field in the vicinity of your transmitter, whether it be marine, mobile, or fixed. Output meter is merely placed in some location close to the transmitter, to pick up RF radiation from the antenna. Requires no batteries, electricity, nor direct connection to the transmitter. It provides you with a continuing indication of transmitter operation. You can easily detect if power is dropping off by comparing present meter readings with past ones. Operates with any transmitter having output frequencies between 100 kc and 250 mc, regardless of power. Sensitivity is 0.3 volts RMS full scale, and a special control on the panel allows for further adjustment of the sensitivity. Meter is a 200 ua unit, mounted on a chrome-plated brass panel. The entire PM-1 measures only 3 3/4" W x 6 1/4" L x 2" D. An easy way to put your mind at ease concerning transmitter operation. Shpg. Wt. 2 lbs.

MODEL PM-1  
**\$14<sup>95</sup>**

**Heathkits...**

BY DAYSTROM

*now offer you completely modern marine equipment with outstanding design features*

**HEATHKIT TRANSISTOR RADIO DIRECTION FINDER KIT**

The Heathkit Transistor Radio Direction Finder model DF-1 is a self-contained, self-powered, 6-transistor super heterodyne broadcast radio receiver incorporating a directional loop antenna, indicating meter, and integral speaker. It is designed to serve primarily as an aid to navigation when out of sight of familiar landmarks. It can be used not only aboard yachts, fishing craft, tugs, and other vessels which navigate either out of sight of land or at night, but also for the hunter, hiker, camper, fisherman, aviator, etc. It is powered by a 9-volt battery. (A spare battery is also included with the kit). The frequency range covers the broadcast band from 540 to 1600 kc and will double as a portable radio. A directional high-Q ferrite antenna is incorporated which is rotated from the front panel to obtain a fix on a station and a 1 ma meter serves as the null and tuning indicator. The controls consist of: tuning, volume and power (on-off), sensitivity, heading indicator (compass rose) and bearing indicator (antenna index). Overall dimensions are 7½" W x 5⅝" H x 5⅜" D. Supplied with slip-in-place mounting brackets, which allow easy removal from ship bulkheads or other similar places. Shpg. Wt. 5 lbs.

MODEL DF-1  
**\$54.95**



*use it for a  
radio-compass or  
as a portable radio*

TRANSISTOR  
RADIO DIRECTION FINDER

# Heathkits...

By DAYSTROM

*are sold only by direct mail,  
passing middleman  
profits on to you*



Pioneer in  
"do-it-yourself"  
electronics

**HOW CAN YOU MISS?**

The Heath Company maintains a technical consultation service, should you experience some sort of difficulty in construction or operation. Although only a very small percentage of our customers ever have occasion to use this service (usually only beginners in electronics) it is still reassuring to know that technical help is available when needed. A service department is also available, should you wish a complete factory check of operation and alignment or repair. After you build your first Heathkit you'll realize how easy it is.

## Free Catalog

Send for this informative booklet listing more than 100 "do-it-yourself" kits.



**HEATH COMPANY** A Subsidiary of Daystrom, Inc. **BENTON HARBOR 20, MICH.**

## ORDER BLANK

**NOTE: All prices subject to change without notice.**  
Enclosed find ( ) check ( ) money order for  
Please ship C.O.D. ( ) postage enclosed for \_\_\_\_\_ pounds.  
**On Express orders do not include transportation charges—they will be collected by the express agency at time of delivery.**  
**ON PARCEL POST ORDERS include postage for weight shown. ORDERS FROM APO'S must include full remittance. All prices F.O.B. Benton Harbor, Mich.**

Name \_\_\_\_\_  
Address \_\_\_\_\_  
City & Zone \_\_\_\_\_ State \_\_\_\_\_  
(PLEASE PRINT)

**SHIP VIA**  
 Parcel Post  
 Express  
 Freight  
 Best Way

QUANTITY	ITEM	MODEL NO.	PRICE
			POSTAGE
			TOTAL

SEND FREE Heathkit Catalog

**AMPHENOL**

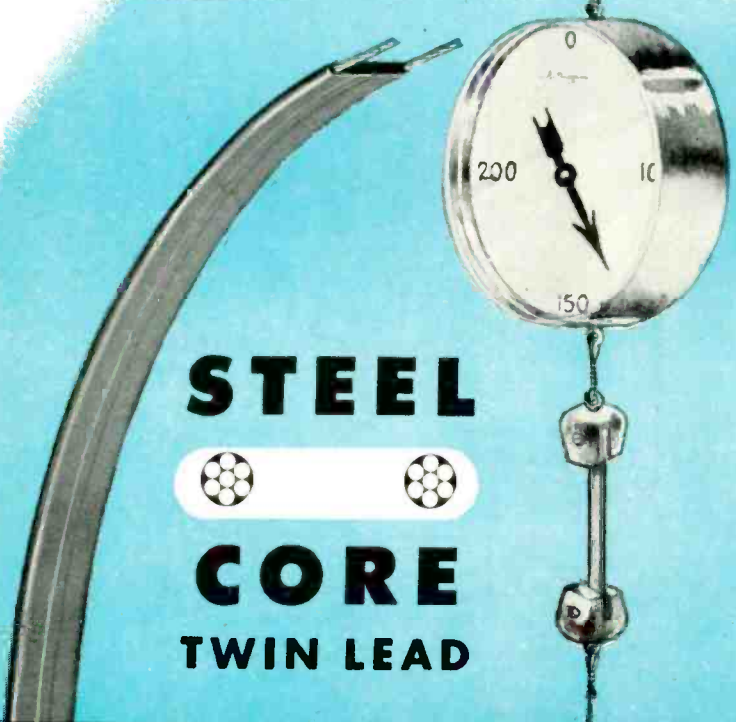

**STEEL  
CORE  
TWIN LEAD**

**TWICE AS TOUGH & FLEXIBLE**  
as stranded copper lead-in

Laboratory tests prove AMPHENOL's Steelcore Twin Lead to be twice as tough and flexible as conventional twin lead. And installers' reports from all over the country back these tests up: For long runs where adverse weather and high winds are encountered, AMPHENOL Steelcore is doing an outstanding job. Try Steelcore for your next tough installation—Steelcore can take it!

LABORATORY TEST RESULTS:		STEELCORE	Stranded Copper Lead-in
FLEXING TEST	Mechanical flexing of twin-leads in one direction through 90° from starting position, 5 pounds force at 90°—flexes before circuit interruption	7610 flexes	3175 flexes
TENSION TEST	Direct axial load applied to twin-lead—breaking points in pounds	138 lbs.	78 lbs.

**STEELCORE PUT-UPS & PRICES**

Part Number	Description	List Per 1000 Ft.
214-559-500	500 Foot Reel	\$38.00
214-559-1000	1000 Foot Reel	37.00
214-559-50	50 Foot Preassembled Hank	2.22 (each)
214-559-75	75 Foot Preassembled Hank	3.05 (each)
214-559-100	100 Foot Preassembled Hank	3.89 (each)

AMPHENOL ELECTRONICS CORPORATION  
chicago 50, illinois

**AMPHENOL**

**AUDIO—HIGH FIDELITY**

(Continued from page 61)  
counterbalanced by a weight in the rear portion of the hollowed-out wooden arm. See Fig. 2 for a detailed view of the base, pivot assembly and counterweight.

The Weathers arm uses viscous damping on both vertical and horizontal pivots. Fig. 2 clearly shows the vertical pivot which has two washers (appearing to be nylon or Teflon) between the rotating cylinder attached to the arm and the U-bracket attached to the horizontal pivot. The space between these washers and the rotating cylinder is filled with a silicone grease which provides viscous damping in the vertical plane. Enough damping is used so that the arm's descent is always gentle, even if it is dropped in handling.

The horizontal pivot employs a cylinder of the same plastic material used in the vertical pivot. It is surrounded by the damping grease and provides a viscous drag when the arm is moved laterally. Extended use of this arm has shown that there is no appreciable tendency for the grease to leak out or lose its damping properties.

The stylus force of the Weathers arm is set at the factory by adjusting the counterweight visible in Fig. 2. Since this arm is used only with the Weathers pickup, there is no need to adjust the tracking force from its normal setting of 3 grams.

Although the Weathers arm is not balanced laterally, it has little tendency to jump grooves and is stable even when considerably off level. This is due to the stabilizing and damping properties of the viscous material in the pivot bearings.

The only height adjustment on the Weathers arm is a rubber ring of the same diameter as the base and about 1/2 inch thick. If the turntable is unusually high, the ring may be installed under the arm base as a shim. Since the Weathers pickup is not unduly critical as to the angle the arm makes with the record surface, this rather crude method of height adjustment is adequate.

In the final article of this series, I will describe several arms of unconventional design, representing different approaches to the problem of reducing tracking-angle error. TO BE CONTINUED



TRANSMIT

# PICTURE and SOUND

AT ANY TIME—TO ANY TV SETS



Displays any pattern, picture, or message for TV servicing or for closed-circuit telecasting



Provides crystal-controlled, full color rainbow display for complete color TV testing



Provides FM sound carrier. Has built-in audio tone generator plus input for tape, tuner, mike

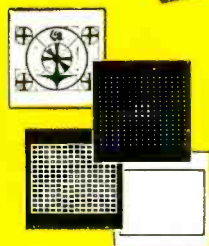
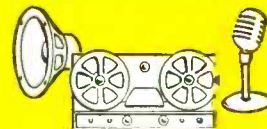

**3** Slide Transparencies and One Clear Acetate Supplied with Dyna-Scan Includes one Indian Head, one White Dot, and one White Line Crosshatch pattern, plus one clear acetate for messages

## **B&K** NEW MODEL 1050 **DYNA-SCAN** PORTABLE VIDEO and AUDIO GENERATOR

**THE FLYING SPOT SCANNER** produces a composite video and sync signal that operates any standard black & white or color TV receiver, at any VHF television frequency. Reproduces your own test pattern or picture on the TV screen with high definition, anytime, anywhere, from any slide transparency—or transmits messages typed or written on clear acetate. Can be used with one or more TV sets or fed into a master or community antenna system. Maximum resolution capability is well in excess of 450 lines at video.

**BUILT-IN COLOR-SCAN** provides crystal-controlled, full color rainbow display of orange, red, magenta, blue, cyan, green. Enables you to test color sync circuits—check range of hue control—align color demodulators, etc.

**BUILT-IN AUDIO-SCAN** provides FM sound transmission exactly like a TV station, 4.5 megacycles above video carrier, with modulation from any available audio source. Enables you to combine speech or music with the video display. Can be modulated with built-in 400 cycle tone generator for test signal or from external signal source such as microphone, tape recorder, FM-AM tuner, or from audio oscillator. Has built-in audio amplifier and volume control.

*Facilitates servicing, installation or demonstration of black & white and color TV receivers. Provides closed-circuit TV system with both video and audio for commercial, industrial, and educational applications. Allows convenient stand-by and break-in, or distribution line check, for community antenna system operation.*

**Model 1050 DYNA-SCAN** complete portable video and audio generator, with built-in Color-Scan and Audio-Scan. Includes 3 test pattern slide transparencies, one clear acetate and slide holder. Comes with 6 ft. r.f. cable. Size 16½ x 10¾ x 9½ in. Net, **\$259.95**

**Model 1000 DYNA-SCAN** picture and pattern video generator. Has all the features of the Model 1050 above, except without the Color-Scan and Audio-Scan sections. Net, **\$199.95**

**Color-Scan or Audio-Scan or both can easily be added to the Model 1000 at any time.**

**Model C15 COLOR-SCAN** for Model 1000. Net, \$19.95  
**Model S16 AUDIO-SCAN** for Model 1000. Net, \$29.95

Available from most Electronic Parts Distributors on easy time-pay plan.

See your B&K Distributor, or write for Bulletin 1050-E

**B & K MANUFACTURING CO.**  
3726 N. Southport Ave. • Chicdgo 13, Illinois

Canada: Atlas Radio Corp., 50 Wingold, Toronto 10, Ont. Export: Empire Exporters, 458 Broadway, New York 13, N.Y.



MODEL 1000



C15

S16

# Is the Output Transformer out?

*Merits of transformerless amplifiers are compared to those of conventional types. Distortion, power and circuitry are discussed*

By HERBERT RAVENSWOOD

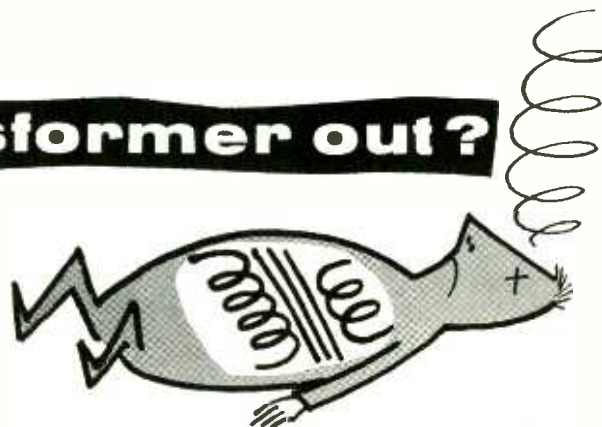

THESE seem to be two reasons for wanting to dispense with output transformers—they *cause* distortion and they are the principal obstacles to reducing distortion *due to other causes*. Both reasons are open to discussion.

To get a little perspective on the problem, let's examine the amounts of distortion involved and where they come from. The contention that the output transformer causes distortion is somewhat out of date. Modern high-quality output transformers *may* run into saturation at the low-frequency end of their response. But—provided the saturation region is not encroached upon—maximum distortion caused by the transformer at the lowest operating frequency falls between 2 and 5%. Very often it is considerably less. By using operating conditions that produce a high damping factor, the *effective* distortion produced by the output transformer can be reduced far below this.

But, anyway, this distortion figure (2-5%) is for a frequency between 20 and 60 cycles. At middle frequencies (600 to 1,000 cycles), distortion introduced by the transformer, *before feedback is employed to reduce it*, is down to less than 1/10 that figure. So the maximum basic distortion a transformer is likely to produce ranges from 0.25 to 0.5% over the greater part of the audio spectrum. Compared to this, output tubes have distortion figures, over the whole of the audio range, between 2 and 5% at maximum output.

Thus it is evident that the output tubes are a greater source of distortion than the output transformer. This brings us to the second objection to output transformers—they restrict the measures that can be taken to reduce distortion. This is true.

An output transformer introduces two extra stability criteria (or should it be *instability* criteria?) for feedback at the high-frequency end and seriously complicates design attempts to increase

feedback to reduce distortion due to output tubes. Overall feedback around an amplifier using an output transformer can seldom exceed 20 db. A few types raise the feedback to 26 db, while some employ no more than about 14 db. This means the reduction in distortion permitted in an amplifier with an output transformer is between 5 to 1 and 20 to 1. A distortion figure of 5% can be reduced to between 0.25 and 1%.

By contrast, some of the OTL's (Output TransformerLess amplifiers) use as much as 40-db feedback, which reduces distortion by a factor of 100 to 1. These are the facts; unfortunately this is not all there is to it. To get a true assessment of the relative merit of different circuits, we must consider several factors besides how much distortion the tubes give and how much feedback we can use to reduce it.

Another basic factor is cost. While some hi-fi addicts may be fortunate enough to pursue quality regardless of cost, economy has to be considered by most of us.

### Notch distortion

Where the need is to produce a higher power output economically, tubes must be operated more efficiently. First we step from triode to pentode and finally to class-B push-pull. These steps toward better tube utilization introduce further complications into transformer design. A good, fat, output transformer that would perform very well with simple class-A push-pull operation might be pushed into service for class-B triode operation and still give passable performance. But when we use pentodes

(or beam tetrodes) in class-B push-pull, or even class-AB push-pull, we run into such things as the well known notch distortion.

This should not be confused with crossover distortion, caused by over-biasing the output tubes. It sometimes occurs when maximum output is slightly exceeded, due to grid current on the positive excursion biasing the tubes further back and causing a short period during which both tubes are cut off. Waveforms of notch and crossover distortion are shown in Fig. 1.

Notch distortion is due to a reactance effect in the output transformer. Due to the high-impedance source on the primary—pentode plate resistance is many times the optimum load resistance—the combination of leakage inductance with primary capacitance causes a sort of resonance notch to occur in the transition from the plate current flowing in one tube to that in the other tube (Fig. 2). This effect characteristically becomes more noticeable as the test frequency is raised. Notch distortion does not usually show up below 1,000 cycles but becomes more excessive starting at about 3,000 cycles.

The discovery of notch distortion—and blaming it on the output transformer—has added more urgency to the call for eliminating output transformers and switching to OTL's: A variety of such circuits have appeared and it is pertinent to consider their relative merits in a little more detail.

Immediately upon trying to dispense with the output transformer, we are handed the problem of using a speaker that directly provides the necessary

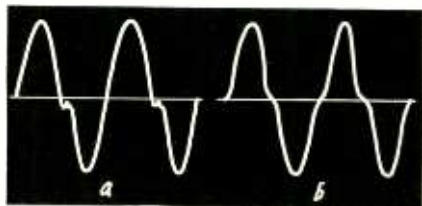

Fig. 1—*a*—Notch distortion; *b*—crossover distortion.

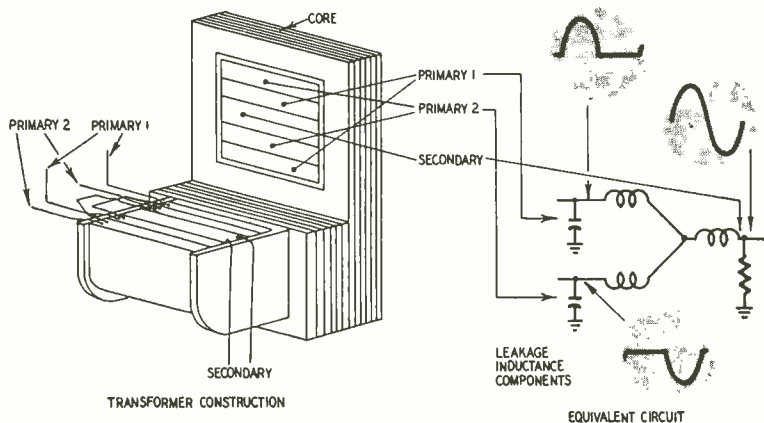

Fig. 2—The components in an output transformer responsible for notch distortion in class-B pentode operation.





# GOLDEN INVADER

## The Antenna That Beats Them All!

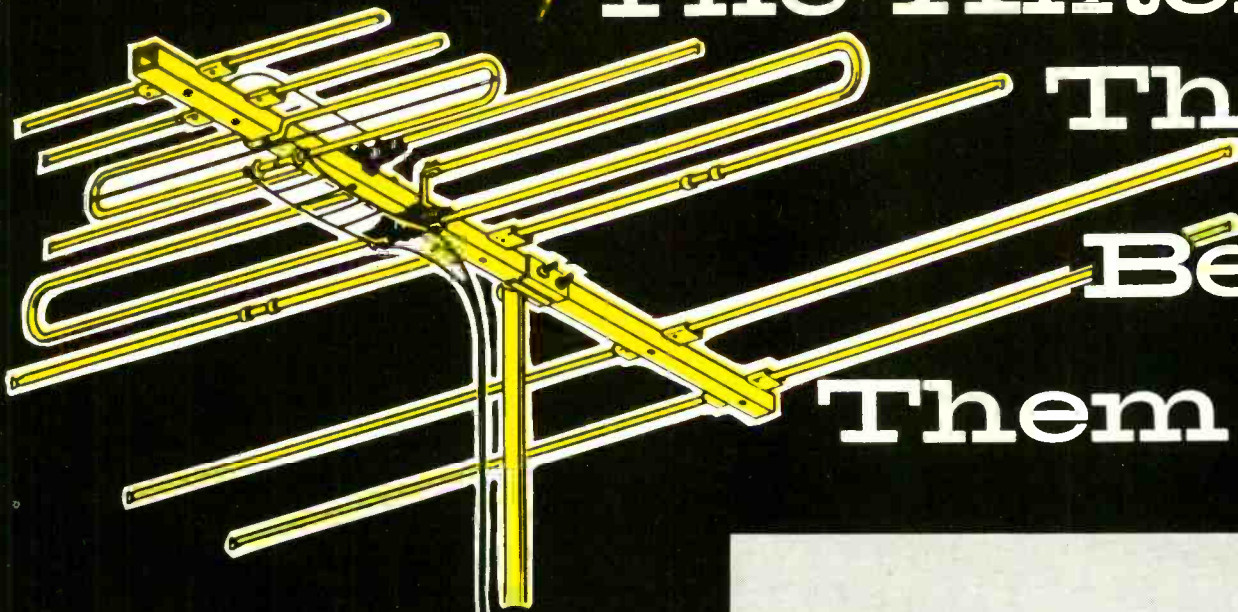

**TRY TELCO'S NEW GOLDEN INVADER,** the powerful antenna for VHF fringe areas and UHF primary areas. Extensive tests prove its uni-plane design can pull in stations from as far as 200 miles away. Ghosts and co-channel interference are eliminated. The GOLDEN INVADER, for color or black-and-white TV, comes pre-assembled with the new Snap-Lock construction that makes it easier to handle, easier to install. Available in single bay (illustrated), two-bay or four-bay models.

- SUPER SHARP DIRECTIVITY
- BEAUTIFUL GOLD ANODIZING
- NEW SNAP-LOCK DESIGN
- RECEPTION UP TO 200 MILES AWAY

No. A-8121 Single Bay..... List \$29.95  
 A-8122 Two-Bay..... 59.95

### VALUABLE BONUS FOR YOU!

Enclosed with each TELCO GOLDEN INVADER is a special Golden Bonus Certificate. Look for these Certificates . . . save them. They're valuable to you!

### UNCONDITIONAL GUARANTY...

A Telco Exclusive! TELCO guarantees the GOLDEN INVADER and all Telco Antennas to be free from defects in materials and workmanship. This guarantee on the Golden Invader is for *three* years. All other antennas are guaranteed for one year.



## TELCO ELECTRONICS MFG. CO.

Division of G-C - Textron Inc. • Los Angeles 18, Cal. • Rockford, Ill., U.S.A.

### THE COMPLETE LINE OF TELCO POWER PACKED ANTENNAS

CONICALS



YAGIS

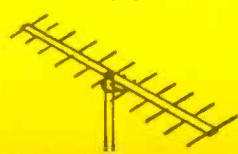

INLINES



BOW TIES

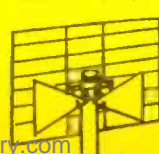

INDOORS

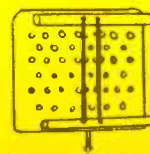

ANTENNA KITS

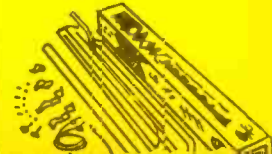

## AUDIO—HIGH FIDELITY

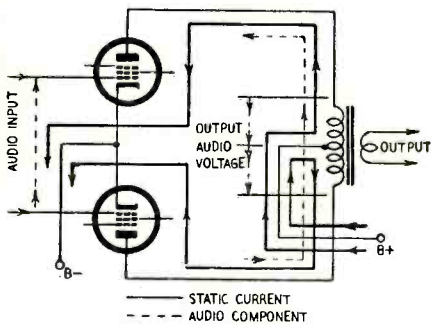

Fig. 3—In the conventional push-pull output circuit, the B-supply feed to the tubes is in parallel (solid lines with arrows) while the audio current and voltage are in series (dashed lines).

load impedance for the output tubes. It is relatively easy to wind speaker voice coils with impedances of 1 to 16 or even 40 to 50 ohms but complications arise if we try to exceed 400 to 600 ohms. The wire gauge becomes extremely fine, causing difficulties in assembly.

The alternative is to find some way to reduce the load needed for the output tubes. Push-pull operation using a transformer provides parallel feed from the supply circuit to the plate (Fig. 3) but operates the two tubes effectively in series. That is, the windings of the transformer primary are basically in series rather than in parallel—from the viewpoint of audio signal—because the two audio voltages are additive.

The so-called single-ended push-pull arrangement of operating tubes (Fig. 4) reverses this combination. Plate supply for the tubes is in series, but the audio signal action of the tubes may be regarded as in parallel. Suppose we use a couple of tubes that require a plate-to-plate load (in normal push-pull operation) of 8,000 ohms. Using the same tubes in single-ended push-pull reduces the required load to 2,000 ohms, which is a 4-to-1 improvement. If we use tubes with a plate-to-plate load requirement of 3,200 ohms, the single-ended push-pull arrangement reduces the required load to 800 ohms.

This is getting much nearer to what we really need. In the Philips amplifier (NG5200), two UL84's are used in both positions. In normal push-pull they have a plate-to-plate nominal load of 3,500 ohms. So this arrangement reduces the optimum load to 430 ohms—a considerable improvement. As two UL84's operated in push-pull are rated to supply 15 watts in class AB, we should expect the four-tube single-ended push-pull arrangement to deliver better than 25 watts into a speaker load of about 400 ohms. Actually this circuit has to be kept practically class A. So the Philips amplifier is rated to give only 12 watts for the four tubes.

This assumes we work the tubes as pentodes, so the supply circuit must be arranged so each tube works effectively as a pentode. Such a circuit, used by the Philips arrangement, is shown in Fig. 5. This circuit can be used with as much as 36-db feedback and Philips says that distortion is reduced to about 0.1%.

Working backward, if feedback is reducing distortion by a factor of 62 (36 db) and finishes up at 0.1%, the distortion provided by the output tubes must be about 6.2%.

The tube manual lists push-pull tubes of this type as delivering the same output with 3.5% distortion, so even operating the tubes into their correct plate load, the single-ended push-pull method of operation tends to cause about twice as much distortion as the normal push-pull method before feedback is applied.

### Unequal drive

At this point another fact should be linked in because it is closely related to the distortion-producing properties of the single-ended push-pull output circuit. Output tube grids require very unequal drive for single-ended push-pull. Assume that the voltage across each tube in quiescent condition is 200 (using a 400-volt supply) and that the

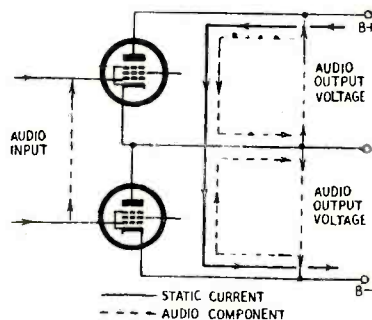

Fig. 4—In a single-ended push-pull circuit, B supply feeds tubes in series (solid line with arrow). Audio is handled in parallel (dashed line).

alternating voltage at maximum output is 150 (peak), which requires an output grid swing of 20 volts peak. On the lower tube the required grid swing is 20 volts each way, while on the upper tube it is 20 volts for the grid, plus a 150-volt plate-cathode swing at the output. So we require a phase-splitting arrangement that delivers 20 volts to the lower grid and 170 to the upper grid. This is not all. . .

We have considered ideal conditions where the output load is a pure resistance, so the voltage for a given grid swing comes out accurately according to calculations. Assume we use a speaker load. (Is this unusual in a hi-fi system?) Then the output voltage will not be the same as that with a resistance load, but will differ in two ways. There

will be a degree of phase shift in the drive to the two grids due to the reactance load and the voltages will be different. Suppose we continue to drive the upper tube with 170 and the lower tube with 20 volts on its grid. Now, when the output voltage is, say, 200 volts, at a phase angle considerably different from that on the grid of the upper tube, we may end up with the upper tube getting a total swing of 100 volts or more. Yet the lower tube is still getting the same 20 volts.

The lower tube will continue delivering its proportion of the power, relatively undistorted, while the upper tube will run into all kinds of distortion. Of course, the presence of overall feedback in bucket loads will cut down the input and minimize this distortion. The actual effect of loading on this type circuit depends on whether the output tubes are triodes, as in the Stephens amplifier and basic Peterson-Sinclair circuit (Fig. 6) (or pentodes operated as triodes) or whether they are pentodes, as in the modified Peterson-Sinclair circuit, as used in the National Horizon amplifier (Fig. 7).

With triode tubes, the difference in voltage output due to different loadings is not so large, but with pentodes the voltage change is almost in direct proportion to the load impedance and consequently the difference can be serious. A number of circuits, such as the Futterman (Fig. 8) and the Coulter (Fig. 9), use feedback arrangements to compensate the drives to the two tubes. Now, each one continues to deliver a corresponding proportion of the total load.

### Some single-ended circuits

The Futterman circuit can be understood by regarding the drive stage as the normal split-load phase inverter—equal halves—which feeds each output stage with a signal from plate to grid instead of the more normal cathode to grid. In the Coulter circuit the upper tube is fed directly while an inverter is used for the lower tube. The inverter has two inputs, one at the grid, adjusted for balance with normal output loading, and one in the cathode to compensate for different loading effects.

The Stephens circuit is quoted as having 0.4% distortion with 40-db feedback. This sounds very good until we realize the implication that without the feedback distortion would be 40%. If

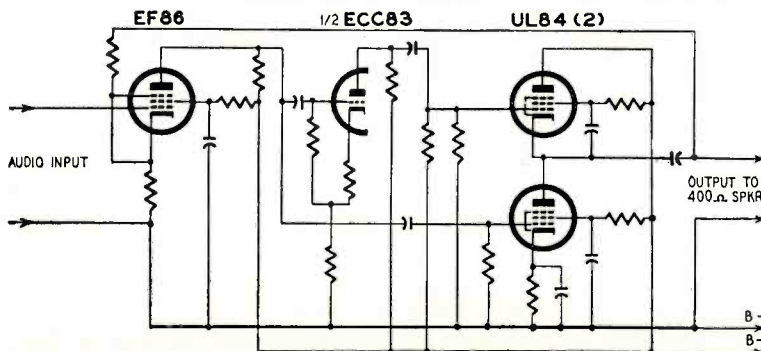

Fig. 5—Basic circuit of Philips NG5200, single-ended push-pull amplifier.

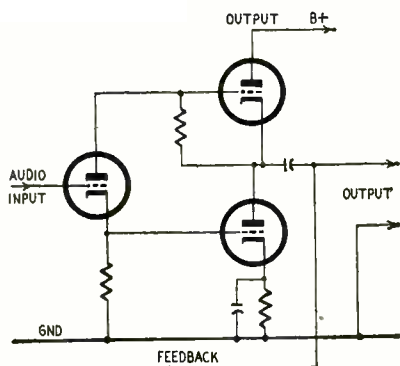

Fig. 6—Basic Peterson-Sinclair circuit using triodes.

the 40% was basically second and third harmonics, this means that the 0.4% contains a very large proportion of fourth, sixth and ninth harmonics, which makes the story a very different one. To put in some figures: If the amplifier, without feedback, gives 26.5% second and 26.5% third, with 40-db feedback, it will produce 0.265% second, 0.265% third, .07% fourth, 0.1% sixth and .07% ninth, which adds up (rms method) to 0.4% total.

Notice that some of the so-called single-ended push-pull circuits, although basically using an arrangement that does not need an output transformer, do use one. The National Horizon-20 does use an output transformer. Several other of these circuits also do, as a matter of convenience rather than necessity. This means the design of the output transformer is not so critical. It can be regarded as just a speaker-matching transformer rather than an amplifier output transformer because the push-pull action is not dependent on it.

How does this peculiarity of single-ended push-pull circuit compare with the more normal variety of push-pull? Doesn't the difference in loading upset the grid drive on normal push-pull circuits too? This certainly happens, but the eccentricity of the single-ended variety is that changing the load value unbalances the load distribution between the output tubes.

Modified adaptations of the Peterson-Sinclair circuit, such as the Futterman or Coulter, attempt to rectify this deficiency by using feedback. Such compensation is usually only a partial measure and cannot completely achieve

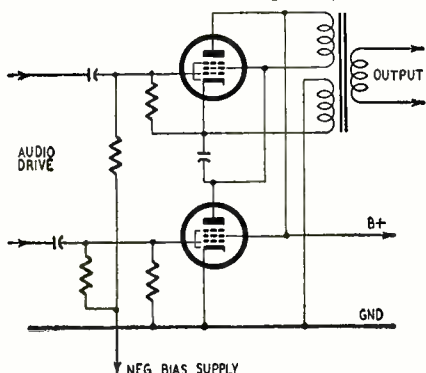

Fig. 7—An adaptation of Peterson-Sinclair circuit for pentodes, as used in National Horizon amplifier.

full correction over a wide range of different impedances. Consequently, the distortion obtained under practical conditions is still considerably larger than with the corresponding push-pull arrangement.

With push-pull operation the modification due to incorrect loading is *symmetrical* between the two tubes. Therefore, the tendency is not for one tube to provide all the output while the other one provides all the distortion. With a normal pentode type output using overall negative feedback, a higher-than-correct value of load impedance results in increased voltage feedback, which cuts down grid drive, so the output voltage is very little more than it would be into the correct load. True, the distortion does rise slightly since the tube is not operated under quite such linear conditions. But neither of the tubes operates into a saturation region and causes excessive distortion, which is what can easily happen with the single-

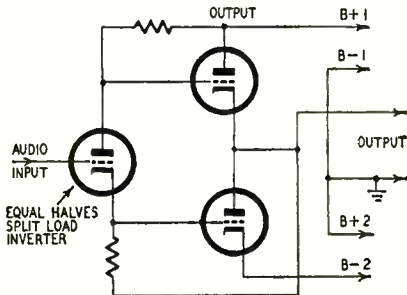

Fig. 8—Futterman circuit for equalizing the drive to output tubes requires two high-voltage supplies.

ended push-pull arrangement.

All this trouble to get rid of an output transformer seems to be due to the desire to use a large amount of feedback to minimize distortion, which we can more easily avoid by using a circuit that does not distort too readily in the first place.

Class-AB or class-B pentode operation produces notch distortion. Working the tubes as triodes avoids notch distortion, but drops the efficiency-power output for given tubes way down. Using an intermediate condition, like Ultra-Linear, has its problems, because it involves extremely tight coupling arrangements between each plate and the corresponding screen. Otherwise we get a much-amplified version of the notch-distortion problem, with little parasitic oscillations appearing at all kinds of odd points on the waveform. This means that Ultra-Linear operation requires extremely careful attention to the output transformer design.

#### Unity-coupled circuit

Another form of operation that takes full advantage of the pentode method of working with tubes is the unity-coupled circuit (Fig. 10). It puts half the load on each tube in its cathode circuit and the other half in the plate circuit. The tubes can be operated in class B and still maintain good output, provided coupling between the cathode and the screen section of the winding is ex-

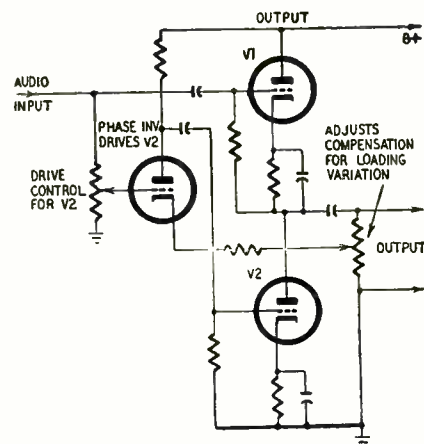

Fig. 9—Coulter circuit for separately adjusting basic drive to output tubes and then compensating for variation in loading.

tremely tight. Each tube then operates truly as a pentode and so full degeneration due to cathode coupling is achieved.

This eliminates the notch distortion of class-B-operated pentodes because the relative impedance of the respective windings in the tube circuit is divided by four and the cathode's degeneration reduces the effective source resistance presented by the tube to a fraction of the load resistance. Consequently, any tendency to produce notch distortion is reduced to a small fraction of triode-coupled output circuits, which never produce notches unless a very poor transformer is used. This circuit uses the output tubes as pentodes to make maximum power available.

The McIntosh method of achieving the necessary tightness of coupling consists of bifilar winding of the transformer's primaries. There is only one disadvantage to this and that is the increased cost of the transformer. McIntosh's solution is to make the transformers under the same roof as the amplifiers and in an integrated production line. As the company makes only bifilar-wound output transformers, they have the facilities for doing so at a lower cost than a regular transformer manufacturer could. They also eliminate the middle handling cost that occurs in most other types of transformer output amplifiers. Although this method of producing a transformer is normally not an economic proposition, their particular application produces a unit that is competitive with many other am-

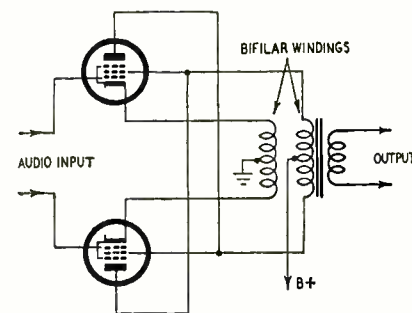

Fig. 10—Basic output circuit of unity-coupled amplifier requires special bifilar-wound output transformer.

*You get \**

# SR

(and a whole lot more)

## with this new mike!

**ACTUAL SIZE**

\* **Selective Recording**, (editing sound as you record), is easy with American's new TRC model. Push-button control at the mike can be locked "on" whenever wanted. You'd expect to pay much more for SR\* and other superb engineering features that let you take full advantage of your tape recorder range—wide frequency response, omnidirectional pickup, faithful audio reproduction. Note the sleek styling in polished chromeplate. Weighs a mere 9 oz.

Choose from three types: Dynamic—80-8500 c.p.s., low or high impedance, Ceramic—80-7500 c.p.s., high impedance, Crystal—80-9500 c.p.s., high impedance.

Use three ways—as a hand mike, table mike (stand included), or wear as a lavalier for p.a. use. You get a lot of microphone at low cost in American's TRC . . . complete specifications on request.

Choose the mike with SR\* Lists from \$11.50 to \$17.85



# American Microphone

**ELGIN**

A DEPARTMENT OF ELGIN NATIONAL WATCH COMPANY  
366 BLUFF CITY BOULEVARD, ELGIN, ILLINOIS

### AUDIO—HIGH FIDELITY

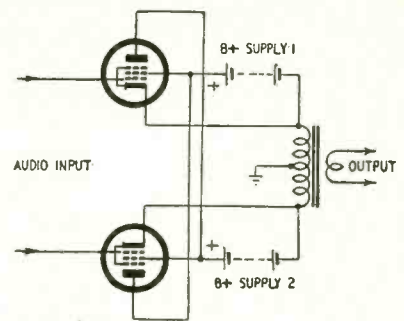

Fig. 11—Basic circuit of the Circotron amplifier requires two floating high-voltage supplies.

plifiers and performs better than most.

Another circuit that achieves the same mode of operation in the tubes is the Circotron (Fig. 11). It avoids a special output transformer by cross-connecting plates and screens, and coupling each screen to its own cathode through two separate B supplies. This adds the complication that components of the power supply circuit.

Still a third arrangement using the same tube operating conditions is the twin-coupled circuit described in the November, 1957, issue. This uses two output transformers of very low cost compared to that normally required for comparable quality, and relies on good capacitance coupling between cathode and screen for most of the frequency range. A side advantage is the provision of a pickoff point for feedback (push-pull) at low dc voltage, so no blocking capacitors are needed.

That is most of the story on OTL vs transformer outputs. *Maybe* the OTL, with special tube types, has an edge costwise (which is not the usual reason for the choice) but a good transformer output, of which we have several, still holds the lead for quality. But the last chapter has not yet been written. Transistors are slowly but surely creeping into the picture. Here too we meet the no-transformer advocates. Transistors are a natural for matching voice coil impedances without transformers. But a lot more work must be done, in developing both transistors and circuits, before such a clear picture emerges as we now have with tubes. END

#### BIBLIOGRAPHY

- A. Peterson and D. B. Sinclair, "A Single-Ended Push-Pull Audio Amplifier." *Proceedings of the IRE*, January, 1952.
- F. H. Gilbert, "Commercial OTL Amplifier of Unique Design." *Audio Engineering*, August, 1952.
- D. P. Dickie, Jr. and A. Macovski, "A Transformerless 25-Watt Amplifier for Conventional Loudspeakers." *Audio Engineering*, June, 1954.
- Monitor, "For Golden Ears Only." *RADIO-ELECTRONICS*, November, 1955.
- J. Futterman, "An Output-Transformerless Power Amplifier." *Journal AES*, October, 1954.
- W. H. Couter, "Amplifier Circuit Having Series-Connected Tubes." U.S. Pat. No. 2,659,775.
- F. H. McIntosh and G. J. Gow, "Description and Analysis of a New 50-Watt Amplifier Circuit." *Audio Engineering*, December, 1949.
- Sidney A. Corderman and Frank H. McIntosh, "A New 30-Watt Power Amplifier." *Journal AES*, October, 1953.
- D. J. Tomcik and A. M. Wiggins, "New Amplifier Has Bridge-Circuit Output." *Audio*, November, 1954.
- Norman H. Crowhurst, *Understanding Hi-Fi Circuits*. Gernsback Library, 1957.
- Norman H. Crowhurst, "High Fidelity at Low Cost With Twin-Coupled Amplifier", *RADIO-ELECTRONICS*, November, 1957.

# Build the Best— build ALLIED knight®-kits



the finest electronic equipment in money-saving kit form

### LOWEST COST

ALLIED'S giant buying power passes biggest savings on to you—you do the easy assembly and your finished instrument equals the performance and appearance of equipment selling for several times the low KNIGHT-KIT cost. Your savings are BIG.

### EASIEST TO BUILD

KNIGHT-KIT "Step-and-Check" instruction manuals with wall-sized picture diagrams are marvels of clarity—it's like having a good instructor at your side. No experience required—you can easily build any KNIGHT-KIT and get professional results.

### LATEST DESIGN

Each ALLIED KNIGHT-KIT incorporates the very latest circuitry for top-quality performance. Tried and proved professional design and the use of premium quality parts throughout help insure your building success to bring you quality results.

### COMPLETE KIT SELECTION:

- HI-FI
- HOBBY
- INSTRUMENT
- AMATEUR



**MONEYBACK GUARANTEE.** When properly assembled, KNIGHT-KITS fully meet published specifications or we refund your money in full.

**EASY TERMS.** If your KNIGHT-KIT order comes to \$45.00 or more, you can make your purchase on our attractive Easy Payment Plan.

## High Fidelity Everyone Can Afford

- World's Finest Hi-Fi Kits
- Custom-Styled
- Easiest to Build Hi-Fi
- Money-Saving

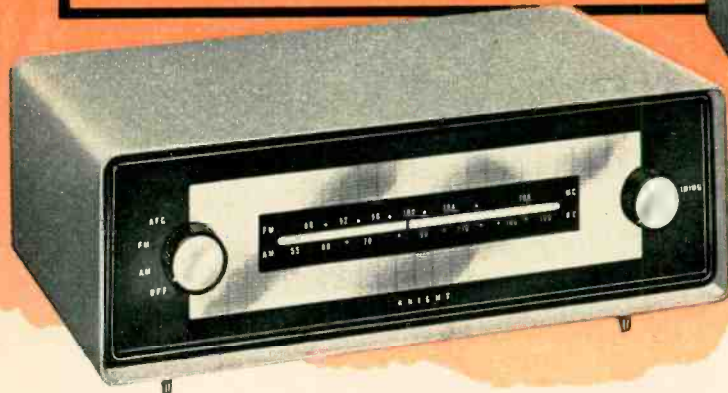

### knight-kit High Fidelity FM-AM Tuner Kit

Model Y-787

**\$49.95**

Only \$4.99 down

- Latest Time-Saving Printed Circuit Design
- Flywheel Tuning
- Automatic Frequency Control
- 2.5  $\mu$ v FM Sensitivity
- True High Fidelity Response
- Beautiful Custom-Styled "Space Saver" Case

The best-looking, best-performing FM-AM tuner kit your money can buy! Carefully designed for quick, easy construction—a tuner you'll enjoy assembling and be proud to own, both for its amazing musical performance and outstanding beauty. Covers the full AM broadcast band and 88 to 108 mc FM. On FM, *sensitivity is a remarkable 2.5 microvolts for 20 db of quieting*; hum and noise, -60 db; IF bandwidth, 200 kc at 50% down on curve; response,  $\pm 0.5$  db, 20-20,000 cps. On AM, *sensitivity is 3 microvolts for 10 db signal-to-noise ratio*; IF bandwidth, 8 kc at 50% down on curve; response, 20-8000 cps. Outstanding features include: Inertia Flywheel Tuning for effortless, accurate tuning; Automatic Frequency Control (plus AFC disabling) to "lock-in" FM stations; printed circuit board (with most of the kit wiring already done for you) assures time-saving, error-free assembly; pre-aligned RF and IF coils; tuned RF stage on FM; drift-compensated oscillator; neon glow tuning pointer; cathode follower output; two output jacks—one for recorder, one for amplifier; rotatable built-in ferrite antenna for AM. Includes beautiful French-gray case with chrome-finished tapered feet, 4 x 13 x 8". Ideal for use with 18, 20 or 30 watt KNIGHT-KIT amplifiers. Ready for easy assembly. Shpg. wt., 12 lbs.

Model Y-787. FM-AM Tuner Kit. Net only.....\$49.95



### knight-kit 18-Watt Complete Hi-Fi Amplifier Kit

Model Y-786

**\$39.95**

Only \$3.99 down

- The Last Word in Custom Hi-Fi Styling
- Full 18 Watts with Superb Hi-Fi Specifications
- 8 Inputs for Every Desired Signal Source
- Printed Circuit Switch and Printed Circuit Boards
- Full Equalization for All Record Types

Here is a custom-styled, easy-to-build complete Hi-Fi amplifier at a price that defies comparison. Delivers full 18 watts output with wide-range, flat frequency response for true hi-fi reproduction. Features 8 inputs for every possible signal source, including NARTB equalized tape head input. At full 18 watts output, distortion is only 0.5%; uses new RCA 6973 hi-fi output tubes. Frequency response is  $\pm 1$  db, 20-30,000 cps; tape head and magnetic cartridge sensitivity, 5 microvolts for 18 watts output; hum and noise level better than 60 db below 18 watts. Output taps for 4, 8 or 16 ohm speakers. Controls: Input and Record Equalization; Bass Boost and Attenuate; Treble Boost and Attenuate; Volume. Simplest assembly is made possible through the use of an exclusive printed circuit switch and two printed circuit boards—most of the kit wiring is already done for you. With custom-styled French-gray "space-saver" case on tapered feet finished in chrome, 4 x 13 x 8". Complete with case, tubes, all parts, and step-by-step instructions, for easy, error-free assembly. Shpg. wt., 15 lbs.

Model Y-786. 18-Watt Hi-Fi Amplifier Kit. Net only.....\$39.95

**EASY TERMS TO FIT YOUR BUDGET.** ALLIED KNIGHT-KITS may be purchased under our Easy Payment Plan. Your order need total only \$45.00 or more—only 10% down, small monthly payments thereafter. No red tape—fast handling assured.

*Our 37th Year*



® Registered Trade-Mark of Allied Radio Corporation

ORDER FROM **ALLIED RADIO** 100 N. WESTERN AVE. • CHICAGO 80, ILL.

www.americanradiohistory.com

# Now you can have Custom-Styled Hi-Fi in **ALLIED**



## knight-kit 30-Watt Complete Hi-Fi Amplifier Kit

Model Y-762

**\$76<sup>95</sup>**

Only \$7.69 down

- Full Equalization,  $\pm \frac{1}{2}$  db of Recommended Accuracy
- Printed Circuit Switches • Printed Circuit Boards
- 8 Inputs For Every Possible Signal Source
- Full 30 Watts Output • Custom-Styled Beauty

Comparable to the best in Hi-Fi—at far less cost! Deluxe features include: Linear-deluxe Williamson-type circuit for flawless response; equalization for all records within  $\frac{1}{2}$  db of recommended accuracy; 2 exclusive new printed circuit switches in preamp section (no complex wiring to do); 3 printed circuit boards for time-saving, error-free assembly; separate, continuously variable Level and Loudness controls; use of premium 12AY7 tube for low noise and hum; DC on all filaments of preamp tubes; exclusive A-AB-B speaker selector switch (use speakers of mixed impedances without mismatch). 8 inputs: Tape Head direct; G.E. and Pickering cartridges; Ceramic cartridge; Microphone; Auxiliary; Tape Preamp; Tuner (with separate Level Set control). Power amplifier response,  $\pm \frac{1}{2}$  db, 15-100,000 cps at full 30 watt level; distortion—harmonic, 0.55% at 30 watts—IM, 0.74% at 20 watts. Separate Bass and Treble controls; rumble filter switch; variable damping. Output, 8 and 16 ohms. With smart French-gray cabinet, 4 x 15 x 15". Ready for easy, money-saving assembly. Shpg. wt., 32 lbs.

Model Y-762. 30-Watt Hi-Fi Amplifier Kit. Net only ..... **\$76.95**

## knight-kit High Fidelity FM Tuner Kit

Model Y-751

**\$38<sup>95</sup>**

Only \$3.89 down

- Authentic High Fidelity FM Response
- Flywheel Tuning • Automatic Frequency Control
- Printed Circuit • Pre-Adjusted Coils and IF's
- 4 Microvolt Sensitivity Guaranteed

Here is top value in creative engineering, impressive hi-fi performance and distinctive design—a tuner you'll be proud to build and own. Covers the full FM band, 88 to 108 mc. Features Automatic Frequency Control (with disabling feature) to "lock-in" stations and prevent drift; Inertia Flywheel Tuning for velvet-smooth, accurate station selection; pre-adjusted RF coils; pre-aligned IF's; cascade broad-band RF amplifier; drift-compensated oscillator; neon bulb pointer. All critical wiring is already done for you in the form of a printed circuit board—assembly is simple. Sensitivity is 4 microvolts for 20 db of quieting across entire band; output, 2 volts at 1000 microvolts input; IF bandwidth, 200 kc; response, 20-20,000 cps. with only 0.6% distortion. Output jacks for amplifier and tape recorder; cathode follower output. Ideal for use with the KNIGHT-KIT amplifiers, or any amplifier with phono-tuner switch. Features custom-styled case in French-gray, with tapered chrome-finished feet, 4 x 13 x 8". Includes all parts, tubes and step-by-step instructions for easy assembly. Shpg. wt., 12 lbs.

Model Y-751. Hi-Fi FM Tuner Kit. Net only ..... **\$38.95**

## knight-kit Deluxe 3-Way Speaker System Kit

Model Y-937

**\$89<sup>50</sup>**

Only \$8.95 down

- Pre-Finished "Quik-Craft" Corner Enclosure
- Klipsch Designed and Licensed
- Famous Knight 12" 3-Way Speaker
- Easy to Assemble—Top Hi-Fi Quality
- Choice of Enclosure Finishes

Deluxe quality high fidelity speaker system at a money-saving low price. Easy to assemble—all you need is a screwdriver. System includes KNIGHT "Quik-Craft" corner-type folded-horn enclosure kit, and the famous-value KNIGHT 3-Way 12-inch speaker. Just assemble the enclosure—no finishing required—all surfaces are finished in hand-rubbed Korina blonde, mahogany or walnut. The speaker is the new 3-way type: 12" woofer cone for bass (full  $1\frac{3}{4}$  pound woofer magnet), conical radiator for mid-frequencies, built-in compression-type tweeter (with wired level control and calibrated dial) for highest frequencies. Unexcelled enclosure efficiency and superb speaker performance combine to cover the whole spectrum of audible sound for true hi-fi response from 35 to 15,000 cps,  $\pm 3$  db. Kit includes 12" 3-Way speaker, prefinished enclosure panels, grille cloth, hardware and instructions. Specify Korina blonde, mahogany or walnut when ordering. Shpg. wt., 44 lbs.

Model Y-937. 3-Way Speaker System Kit. Net only ..... **\$89.50**

3-Way Speaker

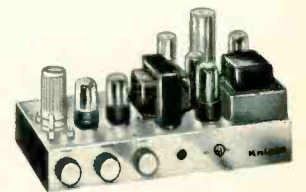
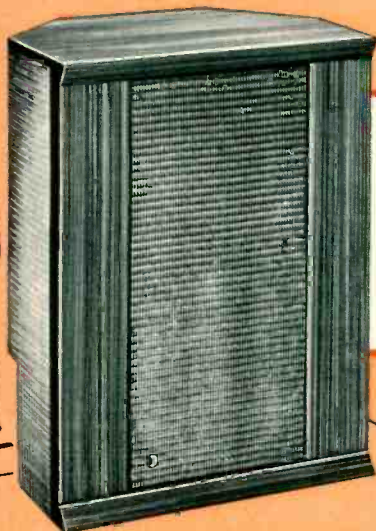

## knight-kit 10-Watt Hi-Fi Amplifier Kit

Y-753

**\$23<sup>50</sup>**

Low-cost, authentic hi-fi amplifier. Response,  $\pm 1$  db, 30-20,000 cps. Input for crystal phono or tuner; chrome-plated chassis is punched for preamp kit below, to permit use of magnetic phono. Only 0.5 volt drives amplifier to full output. Separate bass and treble controls. Only 1% harmonic distortion. Matches 8-ohm speaker. 7 x 13 x 6". With all parts, tubes and instructions. Shpg. wt., 13 lbs.

Model Y-753. Net only. **\$23.50**  
Y-235. Preamp Kit. **\$ 3.10**  
Y-757. Metal Cover. **\$ 3.95**

# knight-kits

THE VERY FINEST MUSICAL QUALITY—SO EASY TO BUILD  
MONEY-SAVING HI-FI EVERYONE CAN AFFORD

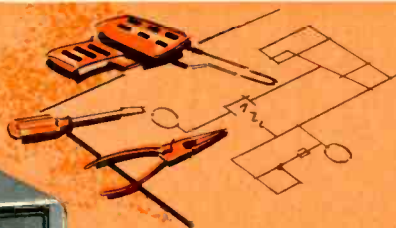

**So Easy To Build**  
Anyone can build  
KNIGHT-KIT HI-FI.  
No experience re-  
quired to get top  
results!



## knight-kit High Fidelity Preamp Kit

Model Y-754

**\$39.95**

- Exclusive Printed Circuit Switches and Boards
- Equalization  $\pm \frac{1}{2}$  db of Recommended Accuracy
- 8 Inputs Including Tape Head
- Self-Powered
- DC on All Tube Filaments
- Custom-Styled

Only \$3.99 down

Sensational Hi-Fi design at amazing low cost. Provides precise record equalization guaranteed within  $\frac{1}{2}$  db of recommended accuracy!—more accurate than all but the most expensive factory-built preamps. Includes exclusive new KNIGHT-KIT printed circuit switches for easy, error-free assembly; 2 printed circuit boards eliminate all other wiring, except for power supply and control leads—so easy to build. Has built-in power supply; includes premium 12AY7 and ECC82 tubes. Frequency response,  $\pm 0.5$  db, 10-50,000 cps. Has 8 inputs: Tape Head; G.E. Phono; Pickering Phono; Ceramic; Microphone; Auxiliary; Tape Preamp; Tuner. Level adjustment for tuner input. Includes separate Bass and Treble controls; separate Level and Loudness controls; Rumble Filter switch; DC on all tube filaments; cathode follower output; 2 extra AC outlets. You get every advanced hi-fi feature in this easy-to-build preamplifier at the lowest possible cost. Includes beautiful custom-styled French-gray case, with tapered chrome-finished legs, 4 x 13 x 8". With all parts, tubes, step-by-step instructions; ready for easy assembly. Shpg. wt., 12 $\frac{1}{2}$  lbs. Model Y-754. Hi-Fi Preamp Kit. Net only **\$39.95**

## knight-kit 25-Watt Hi-Fi Basic Amplifier Kit

Model Y-755

**\$44.50**

- Hi-Fi Response,  $\pm 0.5$  db, 10 to 120,000 cps
- Only 0.15% Distortion at 30 Watts Output
- Printed Circuit Wiring Board • Chrome-Plated Chassis
- Williamson-Type Circuit with Over 25 Watts Output

Only \$4.45 down

Here's superb Hi-Fi performance at less than half the cost of a comparable commercially-assembled unit. Williamson-type linear-deluxe circuit delivers over 25 watts of virtually undistorted reproduction. Ideal for use with the KNIGHT-KIT preamp at left. Includes printed circuit board for simplified, error-free assembly. Remarkable hi-fi response,  $\pm 0.5$  db, 10-120,000 cps at 20 watts. Harmonic distortion, 0.15% at 30 watts; IM, 0.4% at 20 watts. Hum level, 85 db below 25 watts output. Output impedances, 4, 8 and 16 ohms; output tubes, 2-5881. Includes balance control for precise matching of the output tubes; variable damping control for maximum performance with any speaker system—prevents low-frequency distortion from overdamping or underdamping. Very attractive black and chrome styling, 6 $\frac{1}{4}$  x 14 x 9". An outstanding engineering achievement in a basic hi-fi amplifier, delivering performance equal to the finest commercially assembled units. Includes all parts and tubes; with step-by-step instructions, ready for easy assembly. Shpg. wt., 25 lbs.

Model Y-755. 25-Watt Amplifier Kit. Net only **\$44.50**  
Y-759. Metal Cover for above; black finish. 5 lbs. Net **\$4.25**



## knight-kit 20-Watt Hi-Fi Amplifier Kit

Y-750

**\$35.75**

Complete with full set of controls and built-in preamplifier. Response,  $\pm 1$  db, 20-20,000 cps; distortion 1% at 20 watts. Inputs for magnetic phono, microphone, crystal phono or recorder, and tuner. Compensation positions for 78 and LP records. Separate bass and treble controls. Output impedances, 4, 8, 16 and 500 ohms. Chrome-plated chassis. 7 x 13 x 8 $\frac{3}{4}$ ". Ready for easy assembly. Shpg. wt., 20 lbs.

Model Y-750. Net only **\$35.75**  
Y-758. Metal Cover **\$4.15**

## knight-kit 2-Way Hi-Fi Speaker System Kit

Model Y-789

**\$49.95**

Only \$4.99 down

- Easy to Assemble—Pre-Finished Enclosure
- High Fidelity Response, 45 to 14,000 cps
- 12" Woofer and Horn-Type Tweeter
- A Wonderful Money-Saving Speaker Value

**BIG SAVINGS**—assemble your own quality KNIGHT-KIT 2-way speaker system—it's quick and easy! The cabinet is *pre-finished* in full-grained, high luster blonde or mahogany—you just assemble 7 pieces, mount the speaker components and enjoy rich, thrilling hi-fi sound—at incomparably low cost. Special Jensen-engineered baffle features "ducted port" construction to bring out the full beauty of bass notes, perfectly matching the Jensen woofer and compression tweeter; genuine L-pad control is rear-mounted to permit adjustment of tweeter for best tonal balance. Impedance, 16 ohms. The assembled unit delivers a frequency response of 45 to 14,000 cps. Enclosure measures 26 x 19 x 14". Beautifully styled to blend in any room. Kit includes Jensen 12" woofer, Jensen compression-type tweeter, pre-finished wood parts (with grille cloth installed), acoustic material, glue, hardware and step-by-step instructions. Absolutely no furniture finishing required. *Specify blonde or mahogany finish when ordering.* Shpg. wt., 33 lbs.

Model Y-789. 2-Way Speaker System Kit. Net only **\$49.95**



**knight-kit HI-FI IS AVAILABLE ON EASY TERMS TO FIT YOUR BUDGET**

www.americanradiohistory.com

Fascinating

ALLIED **knight-kits**

FOR EXPERIMENTERS AND HOBBYISTS

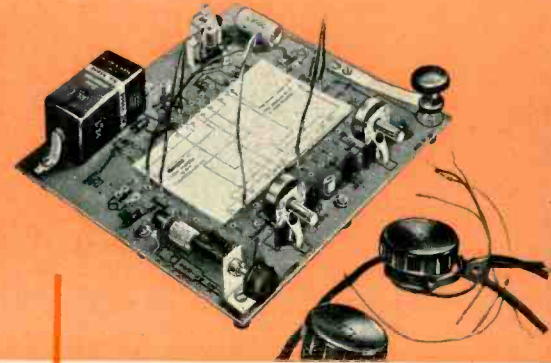

**knight-Kit 2-Transistor Pocket Radio Receiver Kit**

- Model Y-262 • Loud, Clear Local Reception  
 • Newest Printed Circuit Board  
 • Built-in Loop Antenna  
 • Complete Kit—Nothing Else To Buy

**\$14.65**

It's fun to build this pocket-size two-transistor radio—and you'll enjoy its crystal-clear local broadcast-band reception wherever you go! Fits in your pocket, or with its button-down flap, can be worn from your belt. Completely self-contained with built-in ferrite loopstick antenna—no external antenna needed. Extremely efficient reflex type 2-transistor circuit actually does the work of 3 transistors! Printed circuit board reduces building time to about one hour. Has air-dielectric variable capacitor for easy, accurate station tuning. Operates for months and months on long-life alkaline battery supplied. Sensitive miniature earpiece provides crystal-clear tone. Handsome tan carrying case, plastic-impregnated, is styled to resemble leather; only 4x3 $\frac{3}{4}$ x1 $\frac{1}{4}$ ". Kit includes all parts, transistors, earpiece, battery and case. Shpg. wt., 1 $\frac{1}{2}$  lbs.

Model Y-262. Net only ..... **\$14.65**

**knight-Kit "Trans-Midge" Transistor Receiver Kit**

- Model Y-767 • Tiny, cigarette-pack-size one-transistor radio kit—fascinating to build—so low-priced. This novel miniature receiver will provide endless listening pleasure the moment assembly is completed.

**\$2.45**

Covers the local AM broadcast band with exceptional sensitivity and selectivity. Special features include: Efficient, slug-tuned coil for excellent station separation; external knob for easy station tuning; low-drain transistor operating for months from single penlight cell supplied; hinged-back, red plastic case. Kit includes all parts, transistor, battery, compact case and easy-to-follow instructions for quick assembly. (External antenna and headphones required.) Shpg. wt., 8 oz.

- Model Y-767. Net only ..... **\$2.45**  
 J-149. 4000 Ohm Headphones. 1 lb. .... **\$2.15**  
 C-100. Antenna Kit. 1 $\frac{1}{2}$  lbs. .... **\$1.03**

**knight-Kit 10-Circuit Transistor Lab Kit**

- Model Y-299 • Sensational experimenters' transistor kit—an electronic marvel! Perfect for experimenter, student or hobbyist.

**\$15.75**

Assemble basic parts once, then complete project after project (10 in all), by simply plugging leads into proper jacks on printed circuit board—no wiring changes needed. You learn how transistors operate by "plugging in" to make any one of the following circuits; AM radio for strong headphone reception; 2-stage audio amplifier; wireless broadcaster; code practice oscillator; electronic timer; electronic switch; electronic flasher; photoelectronic relay; voice-operated relay; capacity-operated relay. Includes all parts, 2 transistors, battery, headphones, circuit leads, relay, photocell, special guide cards for each project, explanation of each circuit. 3 lbs.

Model Y-299. Net only ..... **\$15.75**

**knight-Kit 5-Transistor Superhet Personal Portable Radio Kit**

- Model Y-766 • Styled to Equal the Finest  
 • Push-Pull Audio Drives 3 $\frac{1}{2}$ " Speaker  
 • Printed Circuit for Easy Building  
 • 200 Hour Battery Playing Life

**\$29.95**

Beautiful, easy-to-build transistorized personal portable with every ultra-modern design feature: 5 Texas Instrument Co. transistors; latest printed circuit chassis for easy, error-free assembly; bigger-than-average 3 $\frac{1}{2}$ " speaker; class B push-pull audio output; built-in high-gain ferrite loopstick antenna; plus phone jack output for private listening. Provides sensitive reception of the AM broadcast band with exceptional tone quality. Ultra-smart high-impact ivory plastic case has handsome gold trim with ebony accents; includes pull-out handle; only 7 $\frac{1}{2}$ x3 $\frac{3}{4}$ x1 $\frac{1}{4}$ ". With all parts, transistors, 9 volt transistor radio battery, carrying case and instructions anyone can easily follow. Shpg. wt., 2 lbs.

Model Y-766. Net only ..... **\$29.95**

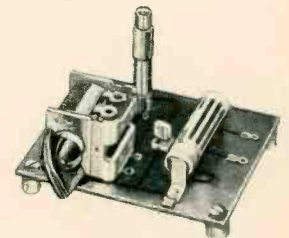

**1-Transistor Radio Kit**

- Model Y-765 • Offers excellent AM local broadcast headphone reception. Printed circuit board for easy assembly. Operates from single penlight cell for months. Complete with all parts, transistor and penlight cell. (Antenna and headphones required.) Shpg. wt., 1 lb.

Model Y-765. Net only ..... **\$3.95**

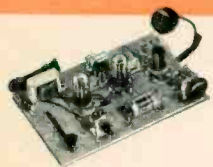

**"10-In-One" Electronic Lab Kit**

- Model Y-265 • Famous experimenters' kit. Builds any of 10 fascinating projects, including broadcast receiver, wireless phono oscillator, code practice oscillator, signal tracer, relays, etc. Shpg. wt., 5 lbs.

Model Y-265. Net only ..... **\$12.65**

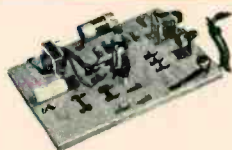

**"6-In-One" Electronic Lab Kit**

- Model Y-770 • A favorite with beginners. After basic wiring is completed, you make circuit changes without soldering. Builds any of six favorite projects, including radio, wireless broadcaster, etc. Shpg. wt., 3 lbs.

Model Y-770. Net only ..... **\$8.45**



**Crystal Set Hobby Kit**

- Model Y-261 • Entertaining, educational. Delivers clear headphone reception of local broadcast stations. With all parts, ready for easy assembly. (Antenna and headphones required.) Shpg. wt., 1 lb.

Model Y-261. Net only ..... **\$2.15**



**Wireless Broadcaster Kit**

- Model Y-705 • Play music or make announcements through your radio set—no connection to set required! Loads of fun—easy to build. Works up to 50 feet from set. Shpg. wt., 3 lbs.

Model Y-705. Net only ..... **\$9.50**

ORDER FROM **ALLIED RADIO** 100 N. WESTERN AVE. • CHICAGO 80, ILL

www.americanradiohistory.com



FUN TO BUILD . . . INSTRUCTIVE . . . LATEST CIRCUITS FOR TOP PERFORMANCE

WIDEST CHOICE OF QUALITY HOBBYIST KITS



Interruption of light beam triggers relay, which in turn sounds chime or bell, turns on lights, etc.



### knight-kit Photoelectronic Relay Kit

**Model Y-702** Advanced-design, ultra-sensitive photoelectronic relay—build it yourself and save! Dozens of uses: for automatic control of lights, door announcer, burglar alarm, counting devices, etc. Provides dependable operation up to 250 feet with white light, up to 125 feet with "unseen" light (red filter) from Light Source Kit listed below. Selectable operation, with "trip" for burglar alarm to provide continuous ringing of alarm; and "auto" if relay is to operate each time beam is broken (for chimes, counting devices, turning on lights at darkness). Has SPST relay operated from thyatron; 6.3 v. terminals provide power for accessories. For 105-120 v. 50-60 cy. AC use. 6 lbs.  
**Model Y-702.** Relay Kit. Net only. **\$13.50**  
**Model Y-703.** Light Source Kit. With bulb and red filter. Shpg. wt., 3½ lbs. Net. **\$6.75**

### knight-kit "Ocean Hopper" All-Wave Radio Kit

**Model Y-740** This top-performing regenerative receiver puts a world of listening pleasure at your finger-tips. Tuning range (using coils listed below) is virtually world-wide; covers 155 kc to 35 mc. including every type of radio transmission: AM broadcast, marine, aircraft, distress channels, direction-finding, Amateur, frequency standard, foreign broadcast, and police. With bandspread tuning. For use with headphones or 3-4 ohm PM speaker. Kit is supplied with standard broadcast band coil and all tubes and parts. (Less extra coils, headphones, speaker and cabinet.) Shpg. wt., 5 lbs.  
**Model Y-740.** Net only. **\$11.95**  
**Y-746.** Cabinet for above. 1½ lbs. Net **\$2.90**  
 Extra coils available: Long Wave Coil (155-470 kc), Net 79c. Short Wave (1.65—4.1 mc; 2.9—7.3 mc; 7—17.5 mc and 15.5—35 mc), Each 65c.

### knight-kit "Space-Spanner" Bandswitching World-Wide Radio Kit

**Model Y-243** • Broadcast or Short Wave Reception  
 • Sensitive Regenerative Circuit  
 • Convenient Bandspread Tuning  
 • Built-In Loudspeaker  
**\$15.95**  
 Imagine the thrill of hearing overseas broadcasts on a precision receiver you've built yourself—and then, at the flip of a switch, being able to tune to your favorite local broadcast station! Bandswitch selects exciting short wave, including foreign broadcasts, amateur calls, aircraft, police and marine radio on the 6.5 to 17 mc range, as well as standard 540-1700 kc broadcasts. Features highly sensitive regenerative circuit. Includes built-in 4" PM speaker and beam-power tube for strong volume and clear tone. Headphone connectors are available for private listening; switch cuts out speaker. Controls: Bandspread, Main Tuning, Antenna Trimmer, Bandswitch, Regeneration, Volume. 7x10x6". Easy to build from step-by-step instruction manual. For 110-120 v., 50-60 cy. AC or DC. (Less cabinet.) Shpg. wt., 5 lbs.  
**Model Y-243.** Net only. **\$15.95**  
**Y-247.** Cabinet for above. Shpg. wt. 2 lbs. Net. **\$2.90**



### "Ranger II" Superhet Receiver Kit

**\$17.25** Popular Broadcast band receiver built and enjoyed by thousands. Features built-in antenna, automatic volume control, ball-bearing tuning condenser, PM dynamic speaker. Handsome plastic cabinet. Easy to assemble. AC or DC operation. Shpg. wt., 8 lbs.  
**Model Y-735.** Net only. **\$17.25**

### knight-kit 2-Way Intercom System Kit

**Model Y-295** • Low Cost—Easy to Assemble  
 • High Gain—Clear Tone  
 • Handsome Metal Cabinets  
 • Includes 50-Foot Cable  
**\$14.75**  
 Easy to build at lowest cost—ideal for home, office, shop or school. Consists of Master unit and Remote unit. Remote unit may be left "open" for answering calls from a distance, for "baby sitting", etc. Remote also may be set for "private" operation—cannot be "listened-in" on, but it can be called and can originate calls. Master unit includes high-gain 2-stage amplifier, combination volume control and on-off switch, plus pilot light. Each unit has 4" PM dynamic speaker. System responds to even a whisper. Handsome Antique white cabinets, each 4¾x6½x4¾". With all parts, tubes and 50-ft. cable (up to 200-ft. may be added). For 110-120 v., AC or DC. 8 lbs.  
**Model Y-295.** Master and one Remote. Net only. **\$14.75**  
**Y-296.** Extra Remote Station Kit. 3 lbs. **\$3.75**

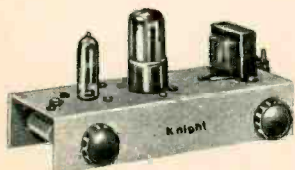

### Phono Amplifier Kit

**\$9.45** Build it yourself—and save! Ideal for use in a portable phonograph—just add record player and 3-4 ohm speaker. 1½ watts output. Inverse feedback circuit. Easy to assemble. Shpg. wt., 3 lbs.  
**Model Y-790.** Net only. **\$9.45**



### Electronic Photoflash Kit

**\$28.50** Ideal for color or black and white photography. 1/700th-of-a-second flash; 50 watt/second output. Synchronizes with any camera with X or O shutter. (Less battery.) Shpg. wt., 4 lbs.  
**Model Y-244.** Net only. **\$28.50**



### Code Practice Oscillator Kit

**\$3.95** Ideal for beginners learning the code. Transistorized circuit. Operates for months from single penlight cell supplied. Clear, crisp 500 cycle tone. Jacks for headphones; screw terminals for key. 1 lb.  
**Model Y-239.** Net only. **\$3.95**



### Phono Oscillator Kit

**\$5.85** "Broadcasts" recorded music through any standard radio set up to 50 feet away. No direct connection to set required. Easy to build—fun to use. Shpg. wt., 2 lbs.  
**Model Y-760.** Net only. **\$5.85**

FINEST ELECTRONIC EQUIPMENT IN EASY-TO-BUILD MONEY-SAVING KIT FORM

www.americanradiohistory.com



**knight-kit Low-Cost Tube Tester Kit**

Model Y-143

- With 16 Filament Voltages
- 600 Latest Tube Types Listed
- Easy-to-Read 4½" Meter
- Tests Series-String TV Tubes

**\$29<sup>75</sup>**

Expertly designed for complete, up-to-date coverage of tube types. Tests *series-string TV tubes*; tests 4, 5, 6 and 7 pin large, regular and miniature types, octals, loctals, 9-pin miniatures and pilot lamps. Tests for open, short, leakage, heater continuity and performance (by amount of cathode emission). Big 4½" square meter has clear "GOOD-?-REPLACE" scale. With line-voltage indicator and line-adjust control. Choice of 16 filament voltages from 0.63 to 117 volts to check virtually all receiving tubes; blank socket for future type tubes. Universal-type selector switches permit selection of any combination of pin connections. Single-unit, pre-assembled 10-lever function switch simplifies and speeds assembly. Up-to-date illuminated roll chart lists over 600 tube types. Counter model case, 5 x 14 x 10". Easy to build. 14 lbs.

- Model Y-143. Net only ..... **\$29.75**  
 Y-142. Portable Case model. 15 lbs. Net ..... **\$34.75**  
 Y-141. Picture Tube Adapter. 1 lb. Net ..... **\$ 4.25**

**knight-kit RF Signal Generator Kit**

Model Y-145

**\$19<sup>75</sup>**

Build this wide-range, extremely stable RF signal generator—save two-thirds the cost of a comparable wired instrument! Large, semi-circular dial is clearly calibrated; range is covered in 5 separate bands for close accuracy in setting individual frequencies. Ideal for aligning RF and IF stages in radio and TV sets and for troubleshooting audio equipment. Delivers output on fundamentals from 160 kc all the way out to 112 mc; useful harmonics to 224 mc. Has built-in 400-cycle sine-wave audio oscillator for modulating RF; audio is also available externally. Features high-stability Colpitts circuit. Convenient jack for external modulation. Maximum audio output 10 volts; RF output over 0.1 volt on all ranges. Step and continuous-type attenuator controls. Supplied with precision-wound coils that require no adjustment. 7 x 10 x 5". Shpg. wt., 11 lbs.

Model Y-145. Net only ..... **\$19.75**

**knight-kit 1000 Ohms/Volt VOM Kit**

Model Y-128

**\$16<sup>95</sup>**

Exceptional accuracy and versatility at amazing low cost. Ideal for service shop, lab or Amateur use. Large 4½", 400 microamp meter with separate scales for AC and DC voltage and current, decibels and resistance. Uses 1% precision resistors; has 3-position function switch and 12-position range switch. 38 ranges include: AC and output volts, 0-1-5-10-50-500-5000 (1000 ohms/volt sensitivity); Resistance, 0-1000-100,000 ohms and 0-1 meg (center scale readings of 60, 150 and 1500 ohms); Current, AC or DC, 0-1-10-100 ma and 0-1 amp; Decibels, -20 to +69 in 6 ranges. Precision resistors are used as shunts and multipliers to assure exceptional accuracy of measurements. With all parts, battery, test leads and black bakelite case with convenient carrying handle, 6¾ x 5¼ x 3¾". A great value in an easy-to-build quality instrument. Shpg. wt., 2½ lbs.

Model Y-128. Net only ..... **\$16.95**

**knight-kit Vacuum Tube Voltmeter Kit**

Model Y-125

**\$24<sup>95</sup>**

- 200 µa Movement, 4½" Meter
- Includes AC, Peak-to-Peak
- Balanced-Bridge, Push-Pull Circuit
- 1% Film-Type Resistors

Top buy in an extremely stable, highly accurate VTVM. Easy to assemble—entire chassis is printed circuit board. Perfect for radio-TV service work, lab and Amateur use. Features low-leakage type switches; 1% film-type precision resistors; balanced-bridge, push-pull circuit (switch to any range without readjusting zero set); zero center scale and direct-reading db scale; polarity reversing switch. Ranges: Input Resistance, 11 megs; DC and AC rms, 0-1.5-5-15-50-150-500-1500; AC Peak-to-Peak, 0-4-14-40-140-1400-4000; Response, 30 cycles to 3 mc; Ohms, 0-1000-10K-100K and 0-1-10-100-1000 megs; db, -10 to +5. Includes all parts, tubes, battery, test leads and portable case, 7¾ x 5¼ x 4-3/8". Easy to assemble. Shpg. wt., 6 lbs.

- Model Y-125. Net only ..... **\$24.95**  
 Y-126. Hi Voltage Probe; extends DC to 50,000 v ..... **\$ 4.75**  
 Y-127. Hi-Frequency Probe; extends AC to 250 mc ..... **\$ 3.45**



**6V-12V Battery Eliminator Kit**

**\$32<sup>95</sup>**

High current rating; continuously variable filtered output; delivers 15 amps at 6 volts, 10 amps at 12 volts. May be used as battery charger. Two meters provide simultaneous current and voltage readings. Shpg. wt., 18 lbs.

Model Y-129. Net only ..... **\$32.95**



**Transistor Checker Kit**

**\$8<sup>50</sup>**

Checks gain ratio of all types of transistors; checks germanium and silicon diodes; checks for continuity and shorts. A valuable instrument at very low cost. Easy to assemble. Shpg. wt., 2½ lbs.

Model Y-149. Net only ..... **\$8.50**



**Flyback Checker Kit**

**\$19<sup>50</sup>**

Checks condition of all types of horizontal output transformers and deflection yokes, as well as TV linearity and width coils. 4½" meter; widest range in its field. Shpg. wt., 6 lbs.

Model Y-118. Net only ..... **\$19.50**



**Sweep Generator Kit**

**\$43<sup>75</sup>**

Extreme linearity on a par with costly lab instruments; fundamentals to 250 mc; output flat within 1 db; electronic blanking. Easy, money-saving assembly. Shpg. wt., 16 lbs.

Model Y-123. Net only ..... **\$43.75**



**Capacitor Checker Kit**

**\$12<sup>50</sup>**

Tests capacitors while in the circuit! Has widest range—20 mmf to 2000 mfd. Exclusive circuit for cancelling lead capacity. "Magic Eye" indicator. Save 60% over factory-wired units. 5 lbs.

Model Y-119. Net only ..... **\$12.50**

**ADVANCED-DESIGN INSTRUMENTS FOR SERVICE, INDUSTRIAL AND RESEARCH USE  
IN EASIEST-TO-BUILD, MONEY-SAVING KIT FORM**



**knight-kit 20,000 Ohms/Volt VOM Kit**

**Model Y-140** Outstanding quality and performance at money-saving low price. Features 1% precision multipliers; 4 1/2" meter accurate within 2% of full scale deflection; 50 microamp sensitivity for 20,000 ohms/volt input resistance on DC; front panel "Zero adjust"; single switch to select function and range. 32 ranges: AC, DC and output volts, 0-2.5-10-50-250-1000-5000; Resistance, 0-2000-200,000 ohms and 0-20 meg.; DC ma, 0-0.1-10-100; DC amps, 0-1-10; Decibels, -30 to +63 in six ranges. Moisture-resistant film-type resistors for extreme accuracy. Carefully engineered circuit design achieves high sensitivity and extremely versatile application. Kit includes all parts, battery, test leads and black bakelite case with highly legible white markings; size 6 3/4 x 5 1/4 x 3 3/4". Easy to assemble. Shpg. wt., 5 lbs.

**Model Y-140.** Net only ..... \$29.50

**\$29.50**



**knight-kit High-Gain Signal Tracer Kit**

**Model Y-135** A remarkable value in an easy-to-build instrument which permits visual and aural signal tracing of RF, IF, video and audio circuits. Has highest gain in its price class. Traces signal from antenna to speaker. Reproduces signal at plate or grid connection of any stage. Identifies and isolates "dead" stages. Features: usable gain of 91,000; "magic eye" with calibrated attenuators for signal presence indication and stage-by-stage gain measurements; built-in 4" PM speaker; combination 2-position probe, one for RF (6 mmf. input), the other for audio. Provides noise test; built-in watt-meter calibrated from 25 to 1000 watts; provision for external scope or VTVM. Binding posts provide output transformer and speaker substitution test, plus external 280 volts B+. With all parts, tubes and probe. 7x10x5". 12 lbs.

**Model Y-135.** Net only ..... \$26.50

**\$26.50**



**knight-kit 5" Wide-Band Oscilloscope Kit**

**Model Y-144**

- 5 mc Width for Color TV
- Horizontal Sweep to 600 kc
- 25 mv/inch Sensitivity
- Z-Axis Input
- Printed Circuit Construction

Only \$6.90 down

Equals or betters the performance of commercially wired scopes costing far more. Two printed circuit boards and laced wiring harness assure wiring accuracy and cut assembly time. Ideal for lab use, color TV servicing and high frequency applications. Wide sweep range—15 to 600,000 cps. Vertical response, ± 3 db, 5 cps to 5 mc; only 1 db down at 3.58 mc color burst. High vertical sensitivity of .025 rms v/inch. Input capacity, 20 mmf. Outstanding features: cathode follower inputs; 2nd anode provides 1400 volts high-intensity trace; push-pull amplifiers; positive and negative locking; frequency-compensated attenuator; Z-axis input; one volt P-P calibrating voltage; astigmatism control; retrace blanking circuit; DC positioning control. Includes CRT. 14 1/2 x 9 1/2 x 16". 40 lbs.

**Model Y-144.** Net only ..... \$69.00  
**Y-148.** Demodulator Probe. Net ..... \$ 3.45  
**Y-147.** Low Capacity Probe. 12 mmf. Net ..... \$ 3.45

**\$69.00**



**Voltage Calibrator Kit**

**\$12.75** Permits use of any scope as precision peak-to-peak AC voltmeter. Puts a true square-wave voltage on scope screen. Selects any voltage between .01 and 100 volts; feeds external signal direct to scope for instant comparison. Shpg. wt., 5 lbs.

**Model Y-136.** Net only ..... \$12.75

**knight-kit 5" General-Purpose Scope Kit**

**Model Y-146**

- Phantastron Linear Sweep
- 25 mv/inch Sensitivity
- Printed Circuit Board
- Retrace Blanking Circuit

**\$42.00**

Only \$4.20 down

Feature for feature the world's best oscilloscope kit value. A stand-out in its class with all these fine features: *Printed Circuit* wiring board and laced harness for quick, error-free assembly. *Phantastron Sweep Circuit* for high linearity of sweep from 15 to 150,000 cps. *25 Millivolts Per Inch Sensitivity*—3 times that of similarly priced scope kits. *Calibration Voltage*—1 volt peak-to-peak square wave, fully regulated. *Vertical Amplifier*—frequency response ± 3 db, 3 cps to 1.5 mc (± 6 db to 2.5 mc). Includes: Directly coupled positioning controls; retrace blanking circuit; frequency-compensated vertical input attenuator; positive and negative internal sync; high 2nd-anode voltage for high-intensity trace: input capacity, 45 mmf. Kit includes CRT. 9 1/2 x 13 3/4 x 17 3/4". 26 lbs.

**Model Y-146.** Net only ..... \$42.00



**Resistance Substitution Box**

**\$5.95**

Easily determines resistor values required in a circuit. Makes available 36 standard 1-watt resistance values in 2 ranges between 15 ohms and 10 megohms, with 10% accuracy. Slide switch selects range; 18-position switch for value selection. Shpg. wt., 2 lbs.

**Model Y-139.** Net only ..... \$ 5.95



**Capacitance Substitution Box**

**\$5.95**

Makes it easy to find capacitor values needed in a circuit. Provides 18 standard values from .0001 mfd to .22 mfd, ± 20%. All values are 600 volt, except .15 and .22, which are 400 volt. 18-position selector switch. Shpg. wt., 2 lbs.

**Model Y-138.** Net only ..... \$ 5.95



**Audio Generator Kit**

**\$31.50**

Excellent design; range, 20 cps to 1 mc; less than .25% distortion; 600 ohm output. Ideal for hi-fi testing; offers the flat response of a lab standard. Shpg. wt., 16 lbs.

**Model Y-137.** Net only ..... \$31.50



**R/C Tester Kit**

**\$19.50**

Measures capacitance and resistance. Balanced-bridge circuit; indicates power factor; tests capacitors at rated voltage. Large, easy-to-read dial and "magic eye." Shpg. wt., 10 lbs.

**Model Y-124.** Net only ..... \$19.50

**EASY TERMS AVAILABLE**

Take advantage of the most liberal Easy Pay plan in electronics. On Knight-Kit orders totaling \$45 or more—just 10% down, small monthly payments thereafter. Low carrying charges—no "red tape."



**knight-kit All-Band Amateur Receiver Kit**

Model Y-726 • Tunes 540 kc to 31 mc  
 • Built-In Q-Multiplier  
 • Constant Running HF Oscillator  
 • Worthy of the Advanced Ham Operator  
 • Printed Circuit Bandswitch  
 • Printed Circuit Board • 1.5  $\mu$ v Sensitivity

**\$104<sup>50</sup>**

Only \$10.45 down

A sensational communications receiver value with all the selectivity, sensitivity and features of high-priced commercial units. Uses printed circuitry throughout, including the exclusive new KNIGHT-KIT printed circuit band-switch, for remarkably easy assembly. Covers 540 kc to 31 mc in 4 ranges; calibrated, electrical bandspread on 80-10 meter Ham bands; slug-tuned Hi-Q coils; continuous, VR tube-regulated B+ applied to HF oscillator lets you switch from standby to receive with no drift; built-in Q-multiplier peaks desired signal or nulls interference; delayed AVC; provision for crystal calibrator (below). Sensitivity, 1.5 microvolts for 10 db signal-to-noise ratio. Selectivity: variable from 300 cps to 4.5 kc at 6 db down. Exalted BFO injection. Controls: Main tuning, bandspread, band selector, Q-multiplier selectivity, Q-multiplier tune, null-off-peak, BFO pitch, RF gain, AF gain, BFO-MVC-AVC-ANL, off-stby-rec-cal, antenna trimmer, and phone jack. Cold-rolled  $\frac{1}{8}$ " steel chassis. Handsome metal cabinet, 10 x 10 x 16 $\frac{1}{2}$ ". (Less phones, 8-ohm loudspeaker and S-meter.) 23 lbs.

Model Y-726. Amateur Receiver Kit. Net. . . . \$104.50  
 Y-727. S-Meter Kit for above. 1 lb. Net. . . . \$9.50

**knight-kits FOR THE RADIO AMATEUR**

**knight-kit 50-Watt CW Transmitter Kit**



Model Y-255

**\$38<sup>95</sup>**

Only \$3.89 down

- Ideal for the Novice
- Pi Antenna Coupler
- Bandswitching—80 to 10 Meters

There's exceptional value in this very popular bandswitching transmitter kit. Compact and versatile, it's the perfect low-power rig for the beginning novice as well as the seasoned veteran. Has bandswitching coverage of 80, 40, 20,

15 and 10 meters. Rated at 50 watts—actually operates at up to 60 watts on 80 and 40 meters. Oscillator is efficient 6AG7; final is reliable 807. Crisp, clean, cathode keying of oscillator and final. Built-in pi coupler permits use with random length antennas. Has highly effective TVI suppression. Other features not usually found in transmitter kits at this low price include: Ceramic-insulated final tank capacitor; pre-assembled switches; pre-wound parasitic chokes; ceramic coil forms; coax connector; crystal and VFO socket on front panel; power take-off jack for accessory equipment. Meter reads either plate or grid current of final. Takes crystal or VFO without circuit changes. Cabinet interior and chassis are copper-finished. Size, 8 $\frac{1}{2}$  x 10 $\frac{1}{2}$  x 8 $\frac{1}{4}$ ". With tubes and all parts for easy assembly. (Less crystal and key.) Shpg. wt., 19 lbs.

Model Y-255. 50-Watt Transmitter Kit. Net only. . . . \$38.95

**knight-kit Self-Powered VFO Kit**



Model Y-725

**\$28<sup>50</sup>**

Only \$2.85 down

Complete with built-in power supply! Careful design and voltage regulation assure high stability. Excellent oscillator keying characteristics for fast break-in without clicks or chirps. Full TVI suppression. Has plenty of bandspread; separate calibrated scales for 80, 40, 20, 15, 11 and 10 meters; vernier drive mechanism. 2-chassis construction keeps heat from frequency determining circuits. Output cable plugs into crystal socket of transmitter. Output: 40v on 80, 20v on 40. With Spot-Off-Transmit switch for spot frequency tuning. Extra switch contacts for operating relays and other equipment. Attractive metal cabinet, 8 $\frac{3}{4}$  x 6 x 6". Ready for easy assembly. Shpg. wt., 8 lbs.

Model Y-725. VFO Kit. Net only. . . . \$28.50

**knight-kit 100 Kc Crystal Calibrator Kit**



Model Y-256  
**\$10<sup>50</sup>**

Crystal frequency standard at very low cost. Gives marker every 100 kc up to 32 mc. A "must" for marking band edges. Mounting flanges for installation in or back of receiver cabinet. Size only 1 $\frac{1}{2}$  x 1 $\frac{1}{2}$  x 3". Requires 6.3 v. at 0.15 amp and 150-300 v. DC at 3-6 ma. Trimmer for zero-beating with WWV; On-Off switch. Complete with tube, crystal, all parts and easy-to-follow instructions. Shpg. wt., 1 lb.

Model Y-256. 100 Kc Crystal Calibrator Kit. Net only. . . . \$10.50



Model Y-253

**\$5<sup>85</sup>**

**knight-kit Amateur RF "Z" Bridge Kit**

Measures standing wave ratio (SWR) and impedance-of antenna systems; ideal for adjusting antenna systems for optimum results. Measures impedances from 20 to 400 ohms up to 100 mc; SWR to 150 mc. Any VOM may be used for null indicator. With coax input and output connectors. Meters both input and bridge voltage. Calibrated dial gives direct impedance reading; includes 1% precision resistor for precise calibration adjustment. With all parts and handy plasticized SWR chart (less meter). 2 $\frac{1}{2}$  x 3 x 4 $\frac{1}{2}$ ". Shpg. wt., 1 $\frac{1}{2}$  lbs.

Model Y-253. "Z" Bridge Kit. Net only. . . . \$5.85

**ORDER BLANK**

**ALLIED RADIO**

100 N. WESTERN AVE., CHICAGO 80, ILL.

ALLIED RADIO, Dept. PF, 100 N. Western Ave., Chicago 80, Ill.

Ship me the following KNIGHT-KITS:

Quantity	Description	Model No.	Price

\$ . . . . . enclosed. (For parcel post, include postage—express is shipped collect).

My Down Payment in the amount of \$ . . . . . is enclosed. Send Time Payment form.

Name . . . . .

Address . . . . .

City . . . . . Zone . . . . . State . . . . .

ALL PRICES NET F. O. B. CHICAGO



*Our 37th Year*



**FREE 1958**  
**404-PAGE**  
**ALLIED**  
**CATALOG**

See the 1958 ALLIED 404-Page Catalog for complete listings of more than 50 KNIGHT-KITS, covering Hi-Fi, Hobby, Test Instrument and Amateur Kits. The 1958 ALLIED Catalog is your complete Buying Guide to the world's largest stocks of everything in Electronics.

Send FREE 404-Page 1958 ALLIED Catalog.

# Servicing transistor AUTO RADIOS

*Part I—How transistor sets differ from the familiar tube circuit; a detailed look at rf, mixer, oscillator and if stages*

By JACK DARR

THE experienced technician will not run into many problems in servicing transistor auto radios, aside from the difficulties common in all auto-radio work. Of course, a bench power supply with good regulation and filtering, is a must. I use a pair of standard 6-volt storage batteries, with a small trickle charger and a switch to select either 6 or 12 volts for the set being serviced. This gives almost perfect voltage regulation. (Except for the times I forget to add water to the batteries!)

An ac-powered battery-eliminator supply can be used, if it has good regulation and a very low hum level. The voltage should be adjustable over a fairly wide range as there is a wide variation in the current demand, especially in signal-seeking tuner sets. On tube sets, the current used by the solenoid, tuner mechanism, etc., represents only a small part of the 10 amps or so drawn by the set. With the much-lower-drain transistor sets, if the voltage is set for the small drain, 2 amps or so, the added drain of the tuner may cause an excessive voltage drop unless the power supply has excellent regulation. Delco recommends setting the bench power supply to 16 volts when testing automatic tuner type sets to avoid binding of the solenoid or better still, floating a 12-volt battery across the line to improve regulation.

When bench-testing the hybrid sets using low-voltage tubes or sets using these tubes throughout, excessive hum in the power supply can cause trouble. Floating a battery across the power supply eliminates this difficulty by smoothing out variations in voltage.

All-transistor sets tend to be quite compact. Set designers have taken advantage of transistors to reduce the size of the cases. However, heat-radiating fins and power transistors take up some room, although the whole thing is still quite a bit smaller than a tube set. Many recent sets are removed from the front, coming out through the dash, rather than the old familiar down-and-back method. One precau-

tion should be observed, however. Because there is a voltage on the case of the power transistor, the set should never be removed from the dash before disconnecting the power leads, or with the power on. If the transistor's case is shorted to ground during removal, the transistor may be damaged. Also, when replacing the set after servicing, be sure that the choke cable, speedometer shafts and other bare metal objects under the dash are cleared away from the transistor's case to prevent grounding it.

While the familiar vibrator buzz is gone, there are still a few indications that make for convenience in the car tests. Even in the hybrid sets, using transistors only in the output stages, there will be a slight thump in the speaker when the switch is turned on. These sets require the normal warmup time, 30-50 seconds, while all-transistor sets will begin to play almost immediately. Otherwise, diagnosis and testing in the car is exactly the same as with older sets.

### Noise problems

The same assortment of noises that plagued the old sets will cause the same troubles in the newer ones. One additional headache may cause trouble. With tube sets using low-voltage tubes, a high level of generator ripple may be fed through into the audio input stage, causing noise in the speaker. This can be reduced or eliminated entirely by additional filtering in the supply circuits and by servicing the generator and voltage regulator. If the car's bat-

tery is not up to par, the increased internal resistance under heavy charging rates may cause an increase in the noise level. This would also be true with transistorized sets. So, if an unexplained noise persists, check the car's battery very carefully.

Tube testing in the low-voltage series may present a problem. Although I have not had the courage to try it, it is quite likely that potentials present in the average tube tester, especially the transconductance type, will prove far above the maximum allowable voltages for these new tubes. Therefore, tube testing should be limited to substitution, at least until a set of test settings has been developed. With the very close spacing between elements, necessary in these tubes to achieve the needed transconductance, flashovers may occur even in perfectly good tubes, under the high potentials used on short tests. It is probably possible to build up a plug-in adapter for any standard tube tester, which will reduce voltages for these tests.

### Troubleshooting techniques

The technician encountering his first all-transistor auto radio will find that basic procedures differ little from those used in the past. The old reliable method of locating a defective stage by performance checks and analysis is still valid. He will find himself using a signal generator for stage-to-stage tests far more than he has been accustomed to! Some basic differences will feel very peculiar to him, after many years of servicing tube sets—voltage measurements, for example.

First, most important and most likely to be overlooked is the matter of battery supply polarity when hooking a set up on the bench. **THE BATTERY SUPPLY MUST HAVE THE SAME POLARITY AS THAT USED IN THE CAR!!** Failure to observe this will result in immediate damage to the transistors! The technician who has been doing two-way radio work or the old-timer who remembers the days of the synchronous vibrator will soon become accustomed to checking this point. The newer crop of technicians, who have never seen anything but interrupter type vibrators with rectifier tubes, may have to post warning notices over their benches (on the face of the battery eliminator is an effective spot)! This will avoid expensive transistor replacements!

Some of the old quick-checks used by

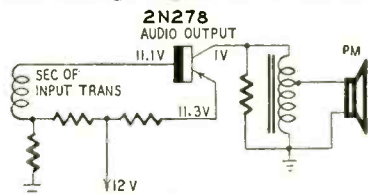
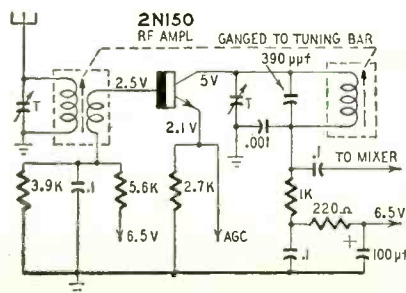

Fig. 1—Ground the transistor's base in this audio output stage and say goodbye to the transistor.

Fig. 2—Rf amplifier circuit found in Delco Brougham 7268085.



# RADIO

service technicians can lead to trouble in transistor sets. For instance, the practice of grounding the grid of a tube to produce a click in the speaker *cannot be used with transistors!* Delco issues a strong warning against this in their *Testing Tips*.

In the transistor output circuit of Fig. 1, a p-n-p 2N278 is used. With a negative battery-ground connection, the transistor has a normal forward bias of 0.2 volt (from emitter to cathode). If the base (the grid) is grounded, this bias is changed to 11.2 volts, and the transistor burns out in a matter of a few *microseconds!*

Therefore, when testing for signal continuity in a transistor circuit, touch the base with a fingertip or a small screwdriver, being very careful not to let the screwdriver short to ground, and listen for the pop. Taking voltage measurements using a vtvm will probably produce enough pop in the speaker to assure that the stage is working. Touching the audio amplifier (driver) stage's input will produce enough buzz or hum for a positive test, just as it would in a tube set. An audio signal generator, set at a fairly low output level (2 or 3 volts), with a small blocking capacitor in the input lead, will be very useful. Most shop signal generators have a 400-cycle af output; use this for making stage-to-stage tests, if necessary.

Another precaution, this one familiar to PA men and most hi-fi addicts, is the need for loading the transistor output at all times. The transistor is a very-low-impedance device—the impedance from collector to emitter is relatively low, especially as compared with the plate resistance of a vacuum tube. A large increase in this impedance, such as would result if the secondary of the output transformer were suddenly opened, causes collector voltage to rise to a very high level. If this happens and the voltage rise should exceed the collector's maximum rating, the transistor is instantly and severely damaged. So before turning on the radio, be sure that the speaker is connected. If it is left off and a signal passes through the set, the resultant burst of voltage may severely damage the output transistor. Conversely, if the speaker voice coil should open, as often happens in auto-radio work, look for a defective output transistor if the radio has been operated with the speaker open.

## Voltage and current

Perhaps the strangest thing of all to the vacuum-tube technician will be the very peculiar voltage measurements found in transistor sets. Up till now, he has always found positive voltages on the plate or output element, negative voltages on the grid and positive voltages on the cathode. His high voltage has been running from 150 to 200, especially in auto-radio work. Now, he's in for a rude shock: he will find only 8 to 12 volts at what he is sure is the plate, the same voltage at the grid, and possibly no voltage at all at the cathode. In some circuits, he may be worse off. In the grounded-emitter circuit used for so many power output stages, he will be quite disconcerted to find only 1 volt at the collector, which can be either positive or negative, 11.8 volts on the emitter, and 12 volts at the base! Until he can force himself to orient his thinking to the lower voltages and peculiar polarities found in transistor circuits, he's in for some trouble.

Seriously speaking, the technician who tries to go directly from tube circuits to transistors *will* find himself confused unless he has taken the time to prepare himself thoroughly for it. This is not difficult or expensive. Practically all major set manufacturers have made transistor and transistor-circuit data available through parts supply houses and other sources, mostly free, or for a very nominal sum. Delco, G-E, Motorola, Philco, RCA and many others have this material, and it can usually be had for the asking. Therefore, I will not attempt to cover in this limited space any basic transistor theory. It is available in so many other places that it should be unnecessary. I will try to give you some idea of the differences between tube and transistor circuits, and some of the things you can expect to find when the transistor sets begin to show up on your workbench.

Actually, there is no difference in the primary function of tube and transistor radio receivers! Each picks up an rf signal, amplifies it, converts it to af, then feeds it into a speaker. The common circuits are all there. They may be in slightly different forms, but the functions are present.

Parts values differ radically and very few parts, outside of resistors and capacitors, are interchangeable be-

tween tube and transistor sets. Resistors will be much smaller, because of the lower voltages, and capacitors will be much larger, at what seem to be ridiculous working voltages: 6, 12, 15, etc. Transformers are different because of the low impedances found in transistor circuits. Rf and if transformers are very much different, sometimes consisting of only a tapped coil of a few turns. Output transformers also differ; the autotransformer is found here, too.

Rf gains of up to 100 per stage are quite common in tube sets. Because of lower gain, at present at least, transistor sets are unable to achieve this efficiency, so more stages are used, especially in the radio's if strip—the Cadillac set has three if amplifiers, for example.

Oscillator circuits are conventional: with feedback from collector to base, coupling through a transformer. The mixer stage functions like a common tube circuit, the cathode-coupled type. The input rf signal is fed to the emitter, while the oscillator signal is fed to the base. The two signals combine inside the transistor in the normal manner. The 262-kc if output is selected by the action of the input if transformer, just as it is in tube type radios.

The rf stage, as used in Delco sets (see Fig. 2) uses a 2N150, connected in a common-emitter circuit. A matching transformer couples the high impedance of the antenna to the low input impedance of the 2N150, with a step-down in the transformer. The base is returned to the junction of the two resistors, which form a voltage divider across the 6.5-volt line. This places a 2.5-volt forward bias on the base. This positive voltage at the base attracts electrons from the emitter and causes collector current to flow. As the collector current and a small base current return through the emitter circuit, the 2,700-ohm resistor in the circuit causes a small voltage drop. In a tube circuit, this is the equivalent of self-bias, with the bias resistor in the cathode circuit. Although the emitter is positive with respect to ground, it is negative with respect to the base, a 0.4-volt forward bias being placed on the input diode. Age bias voltage is also applied to the emitter, regulating the stage's gain.

In Fig. 3, a 2N149 transistor is shown connected in a tuned collector

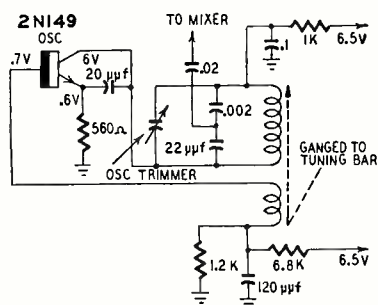

Fig. 3—Typical oscillator stage in transistor auto radios.

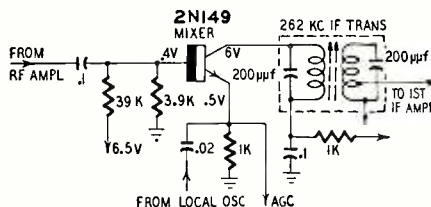

Fig. 4—Rf amplifier's output is fed to base and oscillator output to emitter of mixer stage.

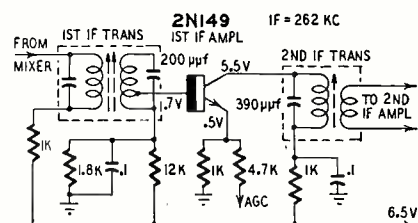

Fig. 5—A Delco if stage. Most transistor auto radios have three if amplifiers.

## RADIO

circuit. It uses a tickler winding for base feedback. Forward base-emitter driving current is picked up from the tap on the voltage-divider resistors, 6,800 and 1,200 ohms, across the 6.5-volt line. Tuning is set by the collector tank. This one has a slug-tuned coil. The 560-ohm self-bias resistor in the emitter circuit has a degenerative effect since the drop across it tends to cause the emitter to go positive on the conducting half of the cycle. This prevents excessive collector current flow and avoids tank-circuit loading for better stability.

Oscillator voltage is capacitance coupled to the mixer from a low-impedance point on a capacitance divider across the tank. This provides the proper impedance match for the input to the mixer stage's emitter, also a low impedance point.

The mixer (Fig. 4) is roughly equivalent to a triode mixer. The input or rf signal is fed to the base of the 2N149, and the oscillator signal is fed into the emitter. The by now familiar voltage-divider arrangement provides the necessary forward bias. The emitter circuit uses a 1,000-ohm resistor to stabilize collector current. Oscillator signal voltage, fed in at this point, will produce additional emitter voltage. This is an ac signal which drives the emitter into conduction on the positive swing, supplying a rectified emitter voltage which keeps the mixer operating near the class-B point for best non-linear detection characteristics. If the oscillator is not working, then the emitter voltage in the mixer stage will be less than the base voltage, an easy point to check.

Actual mixing of the signals takes place inside the transistor. The resultant if is selected by the tuned circuit of the primary of the first if transformer. It is then fed on through the if stages to the detector and audio section.

### The if stages

It is not possible, as yet, to obtain a gain per stage from the transistor to equal that obtainable from tubes. Therefore, the designer of the transistor set uses one more transistor. Most transistor sets have a total of three if amplifiers, instead of the conventional one or two. Fig. 5 is a typical if stage. A 2N149 is used in a common-emitter circuit. Conventional-appearing if transformers are used. The major difference is the low-impedance windings to match the transistors. Age, as in the mixer and rf stages, is applied to the emitter through a 4,700-ohm resistor. Three of these stages form the if strip.

Next month we will continue to tour the transistor auto radio. The detector, age control, age amplifier, audio pre-amp and audio output stages will be discussed. Methods of testing transistors, what to do while servicing in the car and how to cure auto noises will also be described. TO BE CONTINUED

# NEW improved model Simpson 260!

TRADEMARK

**RUGGED  
PRINTED  
CIRCUIT!**

still  
only  
**\$43.95**  
Complete with leads and  
Operator's Manual.  
Also available in  
Roll-Top model at  
only . . . \$49.95

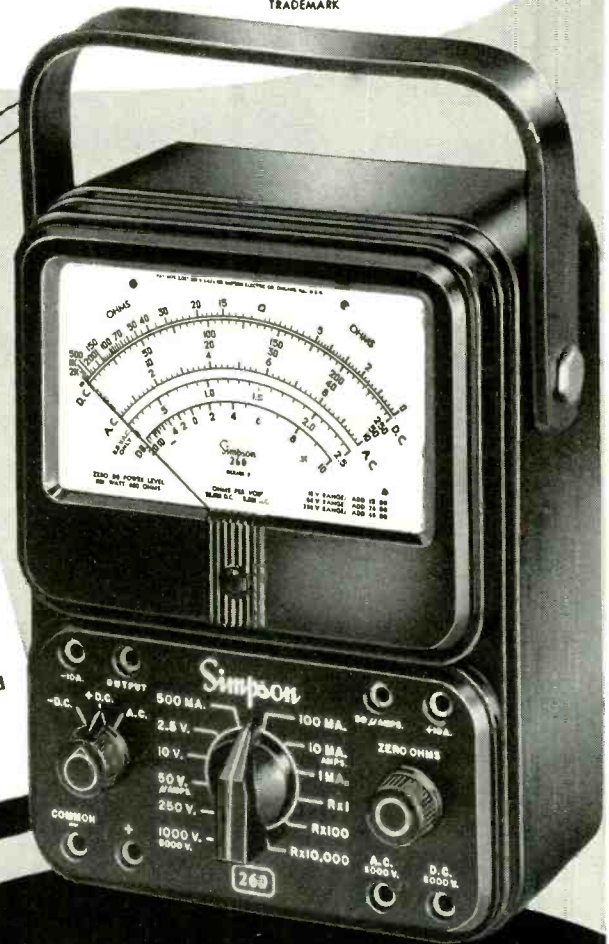

**... the VOM that outsells  
all others combined**

## MANY NEW FEATURES MAKE THE 260 MORE VALUABLE THAN EVER!

- POLARITY REVERSING SWITCH
- 50 MICROAMPERE—250 MILLIVOLT RANGE
- EASIER-TO-READ SCALES
- LESS CIRCUIT LOADING
- POPULAR DBM RANGES
- FULL-WAVE BRIDGE RECTIFIER SYSTEM
- RUGGED PRINTED CIRCUIT
- ALL COMPONENTS EASILY ACCESSIBLE

### ● IMPROVED FREQUENCY RESPONSE IN A. C. MEASUREMENTS

See it at your Distributor, or write

## SIMPSON ELECTRIC COMPANY

5200 West Kinzie Street, Chicago 44, Illinois

Phone: ESTebrook 9-1121

In Canada: Bach-Simpson Ltd., London, Ontario

WORLD'S LARGEST MANUFACTURER OF ELECTRONIC TEST EQUIPMENT



Superior's New Model TD-55  
EMISSION TYPE



New!



# Streamlined TUBE TESTERS

FOR

The Experimenter or Part-time Serviceman, who has delayed purchasing a higher priced Tube Tester. The Professional Serviceman, who needs an extra Tube Tester for outside calls. The busy TV Service Organization, which needs extra Tube Testers for its field men.

• You can't insert a tube in wrong socket. Separate sockets are used, one for each type of tube base. • "Free-point" element switching system Any pin may be used as a filament pin and the voltage applied between that pin and any other pin, or even the "top-cap". • Checks for shorts and leakages between all elements. Provides a super sensitive method of checking for shorts and leakages up to 5 Megohms between any and all of the terminals. Continuity between various sections is individually indicated. • Elemental switches are numbered in strict accordance with R.M.A. specification. The 4 position fast-action snap switches are all numbered in exact accordance with the, standard R.M.A. numbering system.

Speedy, yet efficient operation is accomplished by: Elimination of old style sockets used for testing obsolete tubes (26, 27, 57, 59, etc.) and providing sockets and circuits for efficiently testing the new Noval and Sub-Minar types.

Model TD-55 comes complete with operating instructions and charts and streamlined carrying case.

**\$26<sup>95</sup>**  
NET



Superior's  
New Model TV-40

## PICTURE TUBE TESTER

Not a Gadget—Not a Make-Shift Adapter, but a Wired Picture Tube Tester With a Meter for Measuring Degree of Emission—at Only \$15.85

Of course you can buy an adapter for about \$5—which theoretically will convert your standard tube tester into a picture-tube tester; or a neon type instrument which sells for a little more and is supposed to be "as good as" a metered instrument. Superior does not make nor do they recommend use of C.R.T. adapters or neon gadgets because a Cathode Ray Tube is a very complex device, and to properly test it, you need an instrument designed exclusively to test C. R. Tubes and nothing else.

Tests ALL magnetically deflected tubes

... in the set... out of the set... in the carton!

Tests all magnetically deflected picture tubes from 7 inch to 30 inch types.

- Tests for quality by the well established emission method. All readings on "Good-Bad" scale.
- Tests for inter-element shorts and leakages up to 5 megohms.
- Test for open elements.

**EASY TO USE:** Simply insert line cord into any 110 volt A.C. outlet, then attach tester socket to tube base (ion trap need not be on tube). Throw switch up for quality test... read direct on Good-Bad scale. Throw switch down for all leakage tests.

Comes absolutely complete—nothing else to buy. Round cornered molded bakelite case. Only...

**\$15<sup>85</sup>**  
NET

Superior's  
New  
Model TW-11



## STANDARD PROFESSIONAL TUBE TESTER



- Tests all tubes, including 4, 5, 6, 7, Octal, Lockin, Hearing Aid, Thyratron, Miniatures, Sub-miniatures, Novals, Sub-minars, Proximity Fuse Types, etc.
- Uses the new self-cleaning Lever Action Switches for individual element testing. All elements are numbered according to pin-number in the RMA base numbering system.
- Model TW-11 does not use combination type sockets. Instead individual sockets are used for each type of tube. Thus it is impossible to damage a tube by inserting it in the wrong socket.
- Free-moving built-in roll chart provides complete data for all tubes. Printed in large easy-to-read type.

**NOISE TEST:** Phono-jack on front panel for plugging in either phones or external amplifier detects microphonic tubes or noise due to faulty elements and loose internal connections.

### EXTRAORDINARY FEATURE SEPARATE SCALE FOR LOW-CURRENT TUBES

Previously, on emission-type tube testers, it has been standard practice to use one scale for all tubes. As a result, the calibration for low-current types has been restricted to a small portion of the scale. The extra scale used here greatly simplifies testing of low-current types.

The model TW-11 operates on 105-130 Volt 60 Cycles A.C. Comes housed in a beautiful hand-rubbed oak cabinet complete with portable cover.

**\$47<sup>50</sup>**  
NET

# TRANS-CONDUCTANCE TUBE TESTER

The new Model TV-12



### TESTING TUBES

- ★ Employs improved TRANS-CONDUCTANCE circuit. An in-phase signal is impressed on the input section of a tube and the resultant plate current change is measured. This provides the most suitable method of simulating the manner in which tubes actually operate in Radio & TV receivers, amplifiers and other circuits. Amplification factor, plate resistance and cathode emission are all correlated in one meter reading.
- ★ NEW LINE VOLTAGE ADJUSTING SYSTEM. A tapped transformer makes it possible to compensate for line voltage variations to a tolerance of better than 2%.
- ★ SAFETY BUTTON—protects both the tube under test and the instrument meter against damage due to overload or other form of improper switching.

- ★ NEWLY DESIGNED FIVE POSITION LEVER SWITCH ASSEMBLY. Permits application of separate voltages as required for both plate and grid of tube under test, resulting in improved Trans-Conductance circuit.

### TESTING TRANSISTORS

A transistor can be safely and adequately tested only under dynamic conditions. The Model TV-12 will test all transistors in that approved manner, and quality is read directly on a special "transistor only" meter scale.

Model TV-12 housed in handsome rugged portable cabinet sells for only

**\$72<sup>50</sup>**  
NET

ALSO TESTS  
TRANSISTORS!

**EXAMINE BEFORE YOU BUY!  
USE APPROVAL FORM ON NEXT PAGE**



New!



Superior's  
New Model

76

IT'S A CONDENSER BRIDGE

IT'S A RESISTANCE BRIDGE

IT'S A SIGNAL TRACER

IT'S A TV ANTENNA TESTER



✓ CAPACITY BRIDGE SECTION  
4 Ranges: .00001 Microfarad to .005 Microfarad; .001 Microfarad to .5 Microfarad, .1 Microfarad to 50 Microfarads; 20 Microfarads to 1000 Microfarads. Will also measure the power factor of all condensers from .1 to 1000 Microfarads.

✓ RESISTANCE BRIDGE SECTION  
2 Ranges: 100 ohms to 50,000 ohms; 10,000 ohms to 5 megohms.

✓ SIGNAL TRACER SECTION  
With the use of the R.F. and A.F. Probes included with the Model 76, you can make stage gain measurements, locate signal loss in R.F. and Audio stages, localize faulty stages, locate distortion and hum, etc.

✓ TV ANTENNA TESTER SECTION  
Loss of sync., snow and instability are only a few of the faults which may be due to a break in the an-

tenna, so why not check the TV antenna first? Locates a break in any TV antenna and measures the location of the break in feet from the set terminals.

Complete with R.F. and A.F. probes and test leads

\$26<sup>95</sup> NET

SHIPPED ON  
APPROVAL  
NO MONEY  
WITH ORDER  
NO C.O.D.



Superior's  
new Model  
TV-50

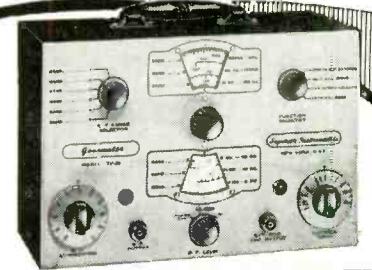

## GENOMETER

A versatile all-inclusive GENERATOR which provides ALL the outputs for servicing:  
A.M. Radio • F.M. Radio • Amplifiers • Black and White TV • Color TV

### 7 Signal Generators in One!

- ✓ R. F. Signal Generator for A.M.
- ✓ R. F. Signal Generator for F.M.
- ✓ Bar Generator
- ✓ Cross Hatch Generator
- ✓ Color Dot Pattern Generator
- ✓ Audio Frequency Generator
- ✓ Marker Generator

**R. F. SIGNAL GENERATOR:** Provides complete coverage for A.M. and F.M. alignment. Generates Radio Frequencies from 100 Kilocycles to 60 Megacycles on fundamentals and from 60 Megacycles to 180 Megacycles on powerful harmonics. • **VARIABLE AUDIO FREQUENCY GENERATOR:** In addition to a fixed 400 cycle sine-wave audio, the Genometer provides a variable 300 cycle to 20,000 cycle peaked wave audio signal. • **BAR GENERATOR:** Projects an actual Bar Pattern on any TV Receiver Screen. Pattern will consist of 4 to 16 horizontal bars or 7 to 20 vertical bars. • **CROSS HATCH GENERATOR:** Genometer will project a cross-hatch pattern on any TV picture tube. The pattern will consist of non-shifting horizontal and vertical lines interlaced to provide a stable cross-hatch effect. • **DOT PATTERN GENERATOR (FOR COLOR TV):** The Dot Pattern projected on any color TV Receiver tube by the Model TV-50 will enable you to adjust for proper color convergence. • **MARKER GENERATOR:** The following markers are provided: 189 Kc., 262.5 Kc., 456 Kc., 600 Kc., 1000 Kc., 1400 Kc., 1600 Kc., 2000 Kc., 2500 Kc., 3579 Kc., 4.5 Mc., 5 Mc., 10.7 Mc., (3579 Kc. is the color burst frequency.)

MODEL TV-50 comes absolutely complete with shielded leads and operating instructions.

Only

\$47<sup>50</sup> NET

**TRY ANY**  
of the instruments on this or  
on the facing page, for 10 days  
before you buy. If completely satis-  
fied then send down payment and pay  
balance as indicated on coupon. No  
Interest or Finance Charges Added!

If not completely satisfied return  
unit to us, no explanation  
necessary.

MOSS ELECTRONIC DISTRIBUTING CO., INC.  
Dept. D-418, 3849 Tenth Ave., New York 34, N.Y.

Please send me the units checked. I agree to pay down payment within 10 days and to pay the monthly balance as shown. It is understood there will be no finance or interest charges added. It is further understood that should I fail to make payment when due, the full unpaid balance shall become immediately due and payable.

Name \_\_\_\_\_

Address \_\_\_\_\_

City \_\_\_\_\_ Zone \_\_\_\_\_ State \_\_\_\_\_

All prices net, F.O.B., N.Y.C.

- Model TW-11 ..... Total Price \$47.50  
\$11.50 within 10 days. Balance \$6.00  
monthly for 6 months.
- Model 76 ..... Total Price \$26.95  
\$6.95 within 10 days. Balance \$5.00  
monthly for 4 months.
- Model TD-55 ..... Total Price \$26.95  
\$6.95 within 10 days. Balance \$5.00  
monthly for 4 months.
- Model TV-40 ..... Total Price \$15.85  
\$3.85 within 10 days. Balance \$4.00  
monthly for 3 months.
- Model TV-12 ..... Total Price \$72.50  
\$22.50 within 10 days. Balance \$10.00  
monthly for 5 months.
- Model TV-50 ..... Total Price \$47.50  
\$11.50 within 10 days. Balance \$6.00  
monthly for 6 months.

# Rediscovery of

# FM

# Broadcasting

*Once almost down and out, FM is on the upswing again*

By DAVID LACHENBRUCH



Blaupunkt Kolon 3-way auto radio has FM, AM and longwave bands.

**T**HIS year, for the first time since the very early 1950's, you'll see FM radios displayed by nearly all major manufacturers—and a greater assortment of imported and minor-brand FM sets than ever before.

This spring or summer, you're likely to see the first AM-FM automobile radios bearing the imprint of top U. S. car radio manufacturers.

Is it for real this time? Is FM going to catch on after 10 disappointing years?

It's still too early to tell. But this much is apparent—FM is experiencing a very definite boost in popularity which seems sure to accelerate in 1958.

It's a small increase, but it shows up at both the broadcasting and the receiving ends of the business. The downward trend in number of stations on the air and in production of receiving sets has halted for the first time since early 1950. If the signs of FM's health were plotted on a graph, 1956-57 would show up as the beginning of a small upward bump (see Fig. 1). The new signs of FM life bear close watching by everyone whose livelihood—or interest—is geared to radio.

### A sick industry

Ask almost any broadcaster and he'll tell you that FM is still a very

sick industry, a far cry from the virile newcomer who seemed destined to knock AM radio out of the spectrum after World War II—until television came along.

The number of FM stations on the air began tapering from its peak of 730 late in 1949, dwindling to 536 by early 1956. Then the casualties virtually stopped, and the number of operating stations even increased slightly to 544 by September, 1957.

Then, last summer, the FCC's normally quiet FM section was stunned by a comparative avalanche of applications for new stations. During a single 8-week period, the commission received a total of 24 applications—an average of 3 a week, compared with fewer than one a week in the same period the preceding year. Applications on file for new stations now total about 50.

For the first time in years, the FCC has more applications than available channels in some big cities—making it necessary to hold hearings among applicants for contested frequencies.

In the New York City area, where 16 FM stations are operating or authorized, there are 6 applications for the 2 vacant channels. In Los Angeles, where 17 are on the air with 1 more ready to start, 5 applicants are vying for 2 remaining channels. In Philadel-

phia, 7 are operating and there are 4 applicants for the 4 available assignments.

These cases are exceptions, of course. In most locations—even big cities like Chicago—FM channels are going begging. But these illustrations are indications of the broadcaster's current reappraisal of FM's possibilities.

### Independent programming

There were other signs of a renewed interest in FM in 1957. Westinghouse Broadcasting Co. ended the repeater status of its FM outlets in Pittsburgh, Pa., and Portland, Ore., programming them separately from their AM companions—with classical music exclusively. Westinghouse also applied for a new FM station in Boston to replace the one it took off the air 2 years ago, and ordered brand-new transmitting equipment for its Cleveland FM outlet. Both of these will also be independently programmed with serious music.

A few other large-network-affiliated outlets began programming their FM stations independently from AM—Washington's WMAL is an example. And NBC applied for a new FM station in Philadelphia as a companion for its AM and TV stations there, but currently has no plans for separate FM programs.

Many FM-only stations, and independently programmed FM's, report a definite increase in the amount of mail received from listeners—generally considered a reliable indication of a pickup in audience size.

During the long years of FM's post-1949 famine, one question frequently asked in the broadcasting industry has been: If FM is dead, why won't it lie down? Why did considerably more than half of the peak 730 stations stay on the air, when official FCC figures show only a handful of them making a profit from FM operations?

The National Association of Radio & Television Broadcasters, in a recent questionnaire to FM broadcasters, asked each one to give its own reason. The most recurrent answers were:

1. By duplicating AM programs on the FM transmitter, it costs virtually nothing to stay on the air.
2. FM listeners are a loyal bunch,

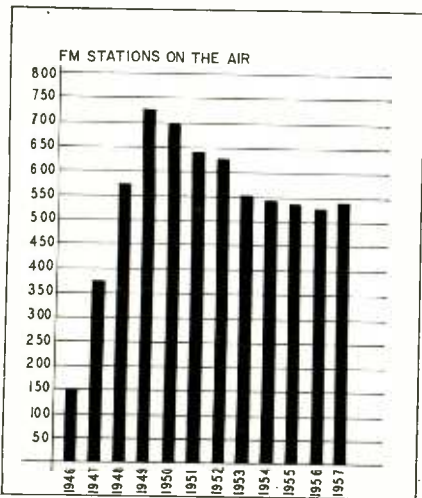

Fig. 1 (left)—FM stations on the air. Slight upturn began early in 1957 along with sharp increase in applications.

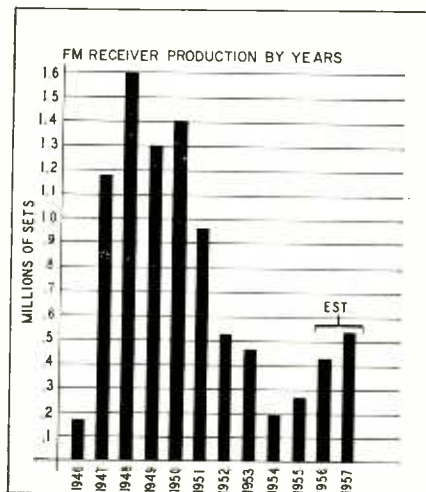
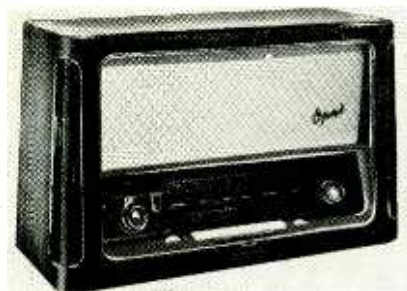
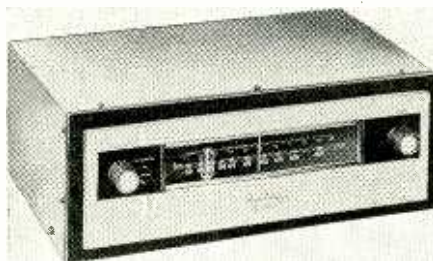

Fig. 2 (right)—FM receiver production by years, including TV sets with continuous tuners which tune FM band. Without such sets, FM set production would have dipped to about 878,000 in 1949, staying at about this level in 1950-51.



Telefunken *Opus* covers FM, AM and shortwave bands.



Pilot's FM-530, FM tuner.

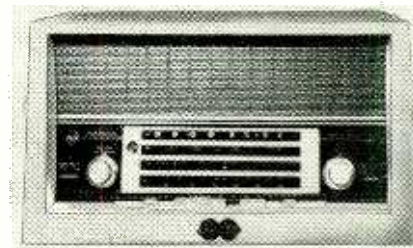

RCA International receiver, European made, has FM, AM, 2 shortwave bands.

and it would be poor public relations to turn the station off.

3. FM gives daytime-only AM stations an opportunity to provide some nighttime coverage.

4. Duplicating programs on FM extends the coverage of low-powered AM stations.

5. Local sports events, carried on FM only, have a big following.

6. The possibility of future developments in the FM band makes it worth while to keep a foot in the door.

It's impossible to estimate just how many FM dials are actually being twisted. About 8,000,000 sets have been produced since FM started up after the war, but how many have been scrapped or are standing idle, nobody knows.

There aren't even any current statistics on FM receiver production or sales. The industry's record keeper, Electronic Industries Association (formerly RETMA), stopped keeping track several years ago when manufacturers' interest in FM approached the vanishing point.

Before EIA (or RETMA as it was then) stopped counting, it estimated 1,175,000 sets were produced in 1947, peaking to a high point of 1,600,000 in 1948 (see Fig. 2). Then came the drop, with annual output dipping to a little over half a million by 1952. In subsequent years, production probably fell to about 200,000 annually, reaching this lowest ebb in 1954.

A turning point came in 1955. That year, it's estimated that production of sets and tuners increased to 275,000. The uptrend continued in 1956, with sales climbing well over 400,000, and an educated guess would put 1957 sales somewhere above half a million. Not a boom by any means—but a step up.

### Hi fi and FM

What did it? All of the probable answers revolve around high fidelity and the education of the American ear.

Though audio aficionados had been hooking up components for best possible musical reproduction for years, their purchases of FM tuners (made by nearly 20 small manufacturers) never comprised a numerically important factor for nation-wide FM. But their enthusiasm was so contagious that by 1955 it had spread to some important manufacturers, who decided that hi fi might become a magic word for the mass market.

The time was ripe. Phonograph records had attained a quality far beyond the ability of the average phonograph to reproduce. The natural companion to hi-fi recordings was hi-fi radio—FM.

But in 1956, the first big year for packaged hi fi, most of the 500,000 units sold under the hi-fi label did not contain FM. The number doubled in 1956 and a greater proportion of them had FM tuners. In 1957, it's estimated that some 1,700,000 packaged hi-fi units were sold. It's improbable that anywhere near half of them had FM, but the proportion increased again.

Distributors in some cities now report that it's practically impossible to sell packaged hi-fi units without FM.

At least some of the credit for America's recently renewed interest in FM is due the Germans. In Germany, where FM has virtually replaced AM because of the crowded broadcast band, manufacturers with such jawbreaking names as Grundig, Telefunken and Blaupunkt began exporting their generally excellent FM-AM-SW sets to the U. S. The Germans are believed to have sold as many as 50,000 here in 1956 and perhaps 75,000 in 1957. American manufacturers sat up and took notice.

### More American sets

During the long FM famine, only one major U. S. manufacturer—Zenith—continually produced FM receivers in quantity. Late in 1954, just before the FM upturn began, a small American manufacturer—Granco Products, Inc.—experimentally turned out a \$30 FM-only set with a circuit based on the design of its uhf TV converter. This clicked, and Granco claims its sales of FM sets and tuners hit 100,000 in 1956, and even more in 1957.

Other American manufacturers have decided to try again. For their 1958 lines they have announced not only hi-fi sets which include FM tuners, but such items as FM-AM clock radios and table models. Among those now offering or preparing to offer FM sets are: Motorola (its first since 1952), Admiral (first since 1954), RCA (which will import a specially made set from Germany), G-E, Philco, Arvin, Columbia, Magnavox, Stromberg-Carlson and Olympic. British radio manufacturers are also hoping to crack the 1958 U. S. markets with their FM sets. At least one Japanese manufacturer plans to export FM tuners to this country.

Also from Germany, along with German-made automobiles, came FM auto radios. Again, U. S. manufacturers plan to follow suit. It's understood that both Motorola and Philco have FM car radios on the drawing boards for introduction this spring or summer.

Last summer, the FCC asked for the TV industry's comments on a proposal to facilitate highway FM reception with standard buggy-whip auto antennas by permitting FM stations to use vertical polarization in place of the traditional horizontal polarization. Commenting on this proposal, some FM stations pointed out that the FCC rules already permit circular or elliptical polarization which could produce the same effect without any changes in the rules. (However, no station is currently using circular or elliptical polarization). Other stations expressed the view that present transmissions can be picked up satisfactorily by conventional auto radio antennas, that if there is any reception problem at all, it will be in areas far distant from FM stations.

All of these signs point to a definite increase in public awareness of FM. But FM station operators have their eyes on another development which they hope will permit them to keep serving a small and loyal public audience, and make money too.

This is multiplexing (see "Multiplexing and You," RADIO-ELECTRONICS, October, 1957)—now permitted by the FCC on a regular basis. The commission has more than 50 applications by existing FM stations who want to begin this service, and a number of them have already started.

Stations plan many ingenious uses for the multiplexing technique. Among them are background music for stores, factories and offices; specialized programs beamed to schools; special home-study courses, etc.—all to be offered simultaneously with, and in addition to, regular FM broadcasts.

Equipment has already been developed for binaural radio using a single FM channel. Some day soon, multiplex FM receivers may well be a companion to binaural tape players in the home.

Which way FM? The signs of renewed activity in the 8-108-mc band are not of boom proportions. But there is more hope today than at any time since 1949 that this superior form of radio finally will take its well deserved place under the audio sun. END

# FASTER RADIO REPAIRS

By JOHN B. LEDBETTER

If you have deserted the field of radio servicing for TV, stop a moment and reconsider, even if you are "snowed under" with TV repairs. Radio servicing not only helps to pay your bills, it keeps you in closer contact with radio owners who in most cases will be prospects for TV receivers, antennas, converters and other accessories.

Since time is your most valuable asset, these notes have been selected to help you save it. Some troubles may sound routine, but they can result in quite a waste of time if you are not prepared for them.

**1. Oscillation, usually appearing as birdies or squeals, evenly spaced throughout broadcast band.**

a. *Radiation from second detector.* If the set is not ac-dc, pull out the oscillator or converter tube. If the oscillation stops, trouble is probably caused by radiation from the second detector back to the front end (usually through the loop antenna or poorly shielded rf or converter stage.) If the set is ac-dc, check the same possibilities by shorting the converter tuning capacitor with a small screwdriver. See that all leads

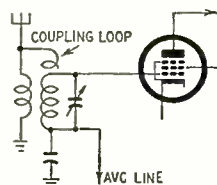

Fig. 1—Coupling loop circuit couples antenna to converter grid coil.

from the second detector are as short as possible and are dressed away from if, rf and antenna leads. In some cases, a copper or aluminum sheet installed between the loop antenna and the set (grounded to the chassis) will cure radiation trouble and may improve performance. Also try increasing spacing between antenna and chassis by 1 inch or so.

b. *Feedback from if strip.* If radiation in either of the above cases continues after the oscillator or converter has been disabled, the trouble is originating in the if section. Check all decoupling bypass capacitors in these stages. These sometimes open or become intermittent, and in some cases have changed value enough to produce resonance or feedback at the intermediate frequency. Check for gassy if tubes (instability and resultant oscillation from this cause is fairly common). Check each stage for correct alignment.

c. *Feedback from wiring.* Check ac (heater) leads and dress away from grid circuits keeping as close to the chassis as possible. Keep maximum separation between grid and plate cir-

cuits. Check cathode and screen bypass capacitors for opens, changed values or a cold-soldered joint.

d. *Capacitive coupling between tube elements.* If the set is designed to use metal tubes, see if they have been replaced with glass types. If designed for glass, use a GT instead of the G (these reduce microphonic tendencies and keep internal capacitances at a minimum). Keep all wiring as short as possible and be sure coupling capacitors are not crowding adjacent terminals on the tube socket. If a particular stage is critical even after these precautions, try a metal tube or check operating voltages for abnormal readings.

**2. Oscillation or squeals from about 700 kc to lower end of band.**

*Image interference from stations on high end of band.* This is the result of poor selectivity or low Q in antenna and rf tuned circuits. About the only remedy (outside of adding an rf stage) is to shift the intermediate frequency slightly so images of higher-frequency stations will not beat with the desired low-frequency stations. Adding a broad-tuning rf stage to most midget sets is impractical, but you may be surprised at how effective this will be on some of the older (and larger) receivers.

**3. Oscillation occurring only at low end of band.**

Sometimes caused by blocking or undesirable coupling from antenna or rf stage. Check alignment of receiver and realign at proper if frequency. Check for undesirable line-cord radiation by bypassing each side of the ac line to ground with a .05- to 0.1- $\mu$ f molded capacitor.

**4. Turntable hum.**

Most common cause, especially in ac-dc receivers, is insufficient capacitance in the ac line-to-ground bypasses. Often .01  $\mu$ f is used, and in some cases this is not enough. Replace with .05 or 0.1  $\mu$ f.

**5. Intermittent reception.**

a. *Defective paper coupling capacitor in second detector, first audio or output stage.* Try replacing with .01- to .05- $\mu$ f 600-volt molded units.

b. *Leaky coupling loop.* This wire loop is used in many small and old-model receivers to couple the rf and oscillator, or antenna and converter grid coil (Fig. 1). The insulation sometimes absorbs moisture and makes these wire loops a hard-to-locate source of low gain or intermittent trouble.

**6. Noisy tuning capacitor.**

a. *Collection of dirt, grease, etc. in bearings or on wiper contacts.* Clean

with carbon tetrachloride. Apply a small amount of Lubriplate or similar noncorrosive lubricant.

b. *Flakes or dirt between tuning capacitor plates* This was a common fault in older sets which used plated capacitors. If the receiver uses a transformer power supply, remove the rectifier tube, unsolder the grid connection from the stator of the tuning capacitor and apply high-voltage ac from one of the rectifier plate pins to the stator with a test probe. Rotating the capacitor will burn out the flakes in short order. (In some receivers, it may be necessary to straighten the plates to prevent rubbing.)

**7. Microphonic howl in home; OK at shop.**

a. *Low line voltage at customer's home.* A tube which may operate satisfactorily in your shop can be microphonic in the customer's home under certain line-voltage conditions. (This is particularly true with three-way portables which use 1.4-volt tubes.) You can catch most of these offenders with an isolation transformer with a variable tap, or with a 115-volt bulb (20 to 60 watts) in series with the secondary (see Fig. 2). Low emission and drifting oscillator conditions will

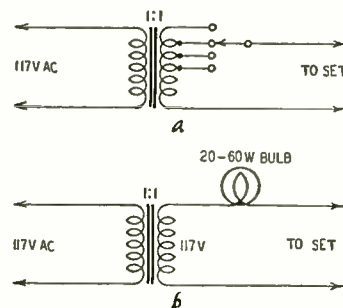

Fig. 2—Two methods of lowering line voltage; a— isolation transformer with variable secondary; b—110-volt lamp in series with secondary.

show up (along with a few other troubles) if the set is given a test run at reduced line voltages.

**8. Sound comes on suddenly after set has warmed up; is sometimes accompanied by microphonics or "pinging" noise.**

Defective oscillator or audio tube. 12SA7, 12SQ7 and similar types are frequent causes of this trouble.

If the above notes seem too simple in this complex business of servicing, remember—it is the simple things which trip you up! Nine times out of ten, you will remember your most difficult or time-consuming jobs as those which were caused by a simple or too-obvious defect. As the time-worn axiom states, we sometimes "can't see for lookin'." END

# VANGUARD 108

Author using Vanguard 108 with his Hammarlund HQ-110 receiver.



Track the US satellites with this simple two-tube 108-mc converter, which also has other uses

By RICHARD GRAHAM

**T**UNING in our own Vanguard satellite promises to be one of the thrills of this year. However, because the frequency of radio transmissions from the Vanguard is beyond the tuning range of most receivers, many will miss out on this event. But you won't miss out on this or the satellites to follow, if you build this Vanguard 108 converter.

Basically, the converter is a device that translates the 108-mc transmissions from the satellite to a frequency of 8 mc which can be heard on your shortwave receiver. The receiver will read frequency directly if you mentally add 100 to the reading on the dial. For example, 8 mc on the receiver dial corresponds to 108 mc and 7 mc to 107 mc.

Since the transmitted power output from the US satellite will not exceed 0.1 watt, the converter has to use low-

noise high-gain circuitry which must be adjusted for peak efficiency for satisfactory results. The ability to receive the satellite satisfactorily depends almost entirely on the converter's gain and noise figure. The receiver, if it is of average quality, plays a relatively minor part. (At vhf frequencies, the receiver's ability to detect a signal is limited only by the noise generated in the antenna resistance and the front-end tubes.)

The Vanguard 108 combines reasonably high gain and low-noise circuitry at a reasonable cost. It uses standard TV tubes, which are inexpensive and readily available. Some improvement in the gain and noise figure could be obtained by using some very special and very expensive Western Electric types. This is fine for those actually engaged in satellite tracking, but for the casual but interested observer the

economic difference<sup>2</sup> is worth the small sacrifice in performance.

### Circuit description

The Vanguard 108 has only two tubes and its circuitry (see schematic) resembles that of many TV and FM receiver front ends. The converter uses the popular cascode circuit for the rf amplifier. This is followed by a mixer oscillator using a dual-purpose pentode-triode.

The converter can be generally described as a broad-band fixed-tuned type. This means that all of the tuned circuits are "fixed" and do not require adjustment while the converter is in use. All necessary tuning is done with the receiver only. This is possible because the converter's tuned circuits are broad enough to permit tuning over  $\pm 2$  mc around the center frequency of 108 mc without any significant change in performance.

The signal from the antenna is applied to tapped coil L1. This is adjusted to resonate with capacitor C1 and the input capacitance of the tube to 108 mc. This drives the grid of the cascode rf amplifier. This stage uses a 6BZ7 dual triode which is the latest in a series of tubes designed specifically for this purpose. The cascode amplifier is noted for its low noise characteristic. It is equivalent to a single grounded-cathode triode with zero plate-to-grid capacitance, and with a mutual conductance and noise resistance equal to that of the first triode tube in the circuit.<sup>3</sup>

A glance at the circuit shows that effectively the two triodes of V1 are in series. The first triode functions as a grounded-cathode and the second as a grounded-grid amplifier. The cathode of the second triode is driven instead of its grid, which is placed at ac ground by bypass capacitor C3. The output of this second triode is untuned and is capacitance-coupled to the grid of the pentode half of the 6U8 which serves as the mixer.

L2 acts as a neutralizing coil. In practice, this coil is not too critical and therefore needs no adjustment. However, the purist who wants the most from the converter and who has a way

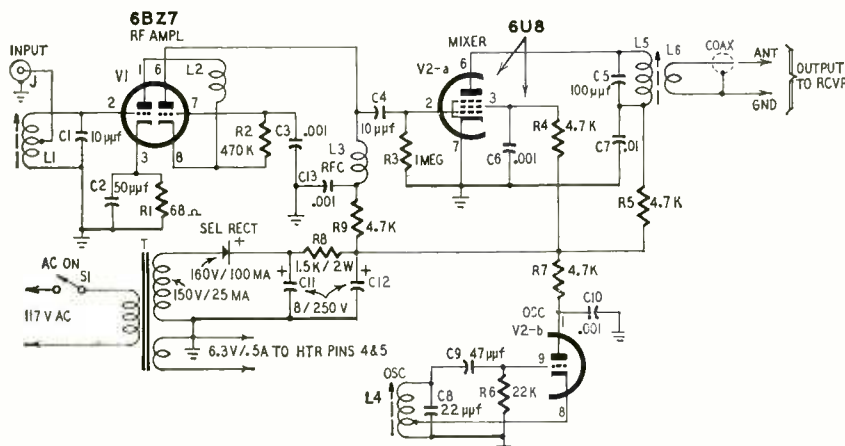

- R1—68 ohms
- R2—470,000 ohms
- R3—1 megohm
- R4, 5, 7, 9—4,700 ohms
- R6—22,000 ohms
- R8—1,500 ohms, 2 watts
- All resistors 1/2 watt, 10% unless noted
- C1, 4—10  $\mu$ f
- C2—50  $\mu$ f
- C3, 6, 10, 13—.001  $\mu$ f
- C5—100  $\mu$ f
- C7—.01  $\mu$ f
- C8—22  $\mu$ f
- C9—47  $\mu$ f
- C11, 12—8  $\mu$ f, 250 volts, electrolytic
- All capacitors 600-volt ceramics unless noted
- J—coaxial connector
- L1—4 turns No. 16 tinned wire, 1-wire diameter spacing tapped in center, wound on Cambridge-Thermionic type LS-3 form with white-coded core

- L2—1 3/4 turns No. 16 tinned wire, 1/4-inch diameter, air-wound, self-supporting
- L3—Rf choke, Z-144 Ohmite
- L4—3 turns No. 16 tinned wire, 1-wire diameter spacing tapped at 1 turn from ground end, wound on Cambridge-Thermionic LS-3 form with white-coded core
- L5—18 turns No. 30 enameled wire, closewound on Cambridge-Thermionic LS-3 form with white-coded core
- L6—2 turns hookup wire, wound over L5
- RECT—selenium rectifier, 100 ma, 160 volts
- S—spsst toggle
- T—power transformer: primary 117 volts; secondary 150 volts, 25 ma; 6.3 volts, 0.5 amp (Stancor P-8181 or equivalent)
- V1—6BZ7
- V2—6U8
- Chassis, 5 x 3 x 2 inches
- Miscellaneous hardware

Circuit of the Vanguard 108 converter.

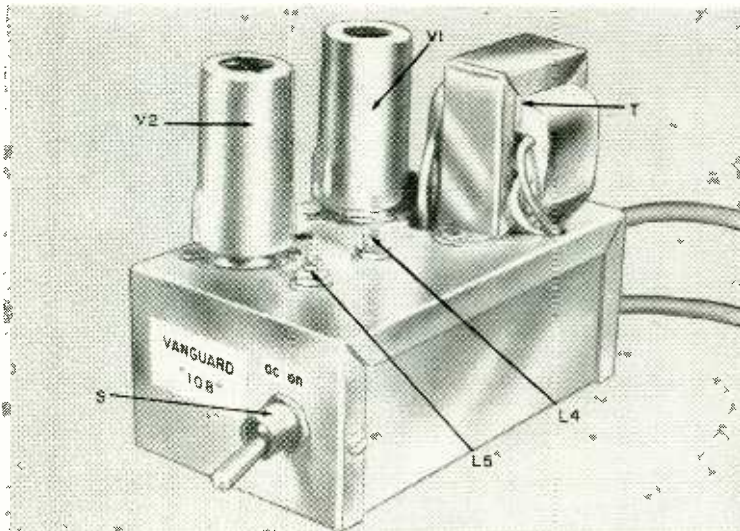

Closeup of the finished unit.

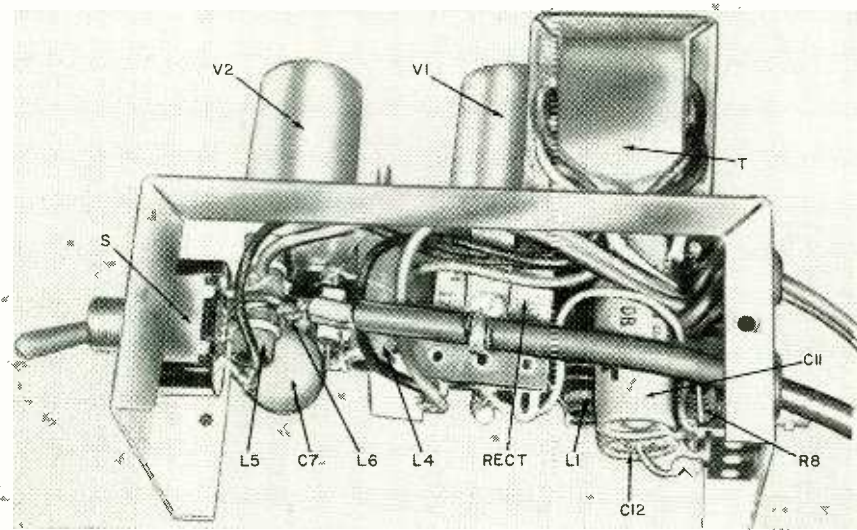

Underchassis view of the converter.

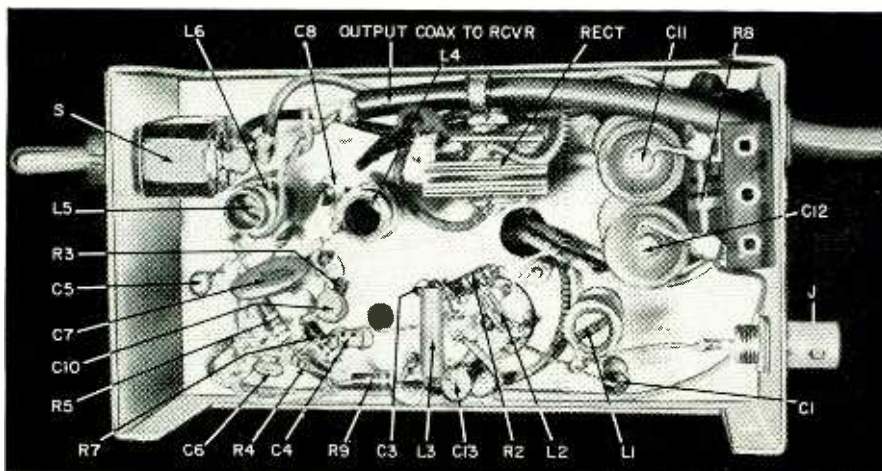

Another look inside the unit. Short leads are used on all components.

to measure noise figure,<sup>4</sup> can adjust it for a minimum noise figure.

The triode half of V2 is an oscillator of the Hartley variety. It is adjusted by L4 to operate at a fixed frequency of 100 mc. The oscillator signal is coupled to the pentode mixer by stray capacitances in the tube and wiring. The oscillator operates 8 mc lower than the incoming signal rather than 8 mc higher, because in this way the receiver reads an exact 100 mc below the actual incoming signal.

The difference frequency of 8 mc in the plate circuit of the mixer is selected by the tuned circuit consisting of the adjustable inductor L5 and fixed capacitor C5. A link (L6) wound over coil L5 provides a low-impedance output for coupling to the receiver's antenna terminals. To insure stability, the plate and screen circuit of each stage is decoupled with a 4,700-ohm resistor and a bypass capacitor.

The power supply uses a Stancor P-8181 power transformer which is intended for TV booster service. This supplies the 150 volts necessary for proper operation of the cascode amplifier. It also allows the use of the more economical resistance type of power supply filter. Otherwise the circuit is a conventional selenium halfwave transformer-fed power supply.

**Construction hints**

The Vanguard 108 is built into a 5 x 3 x 2-inch Minibox which acts as a shielded chassis. This avoids any possible interference with FM sets in the immediate vicinity. The general layout of the components can be seen in the photographs. I strongly suggest, unless you are fairly familiar with vhf circuitry, that the layout shown be used.

As can be seen in the photographs, lead length in rf circuits, particularly those performing rf bypass functions, is practically nonexistent. Short leads to a good ground connection go a long way toward preventing oscillation and birdies.

The rf output should be coupled to the receiver's antenna terminals with a short length of coax. Neither type or length of the cable is particularly critical. I used a piece of RG 59/U, 20-inches long. Keep the unshielded connection at the receiver end of this cable as short as possible. Sensitive receivers do not need much of an antenna to pick up objectionable signals directly at 8 mc. These might mask the desired converted signal at 108 mc.

If your receiver picks up signals in the vicinity of 6 to 10 mc with the antenna terminals shorted, it is a sign that the receiver needs additional shielding or power-line filtering is needed where the line comes into the receiver chassis.

**Alignment**

Alignment of the Vanguard 108 is quite simple and straightforward. It requires a source of 108 mc, which can be in the form of a signal generator

## RADIO

or a grid-dip meter. After the unit has been completed and visually checked, it is ready for alignment. The first step is to set up the Vanguard 108 with the receiver antenna, just as it will be used in practice.

Set the receiver to 8.0 mc. It is this frequency that will correspond to a received frequency of 108 mc with the Vanguard 108. Turn the converter on and set the grid-dip meter to 108 mc. If a signal generator is used, connect a small antenna (12 inches or so) to the generator's output terminal. Now adjust oscillator coil L4 until a carrier is heard. It can be identified as the grid-dip meter or signal generator simply by turning off the instrument being used. Next, adjust output coil L5 for maximum signal from the receiver by watching the receiver's S-meter or an output meter across the speaker voice-coil terminals. Now adjust coil L1 for maximum signal. The type of antenna and transmission line may make a slight modification of input coil L1 necessary. If it does not peak up, squeeze or spread the turns, as necessary, until it is in range of the tuning slug of L1.

At this point, check the oscillator frequency to insure that it is *below* the incoming signal. As stated earlier, adjust the oscillator to 100 mc. Then it is necessary only to add 100 mc to the receiver frequency reading to obtain the true received frequency. As you recall, from superhetrodyne theory, the chosen 8-mc if frequency can be obtained when the oscillator frequency is at either 100 (108 mc minus the if) or at 116 (108 mc plus the if). However, it is only when the oscillator is at 100 mc that the frequency is read by adding 100 mc.

This can be checked by adjusting the frequency of the signal generator or grid-dip meter slightly upward, say to 110 mc. Now tune the receiver to approximately 10 mc. The carrier from the generator should be picked up if the oscillator is on the correct frequency. If it isn't heard, tune to 6 mc. The carrier should now be heard, which will indicate that the converter's local oscillator is on the wrong frequency and L4 should be readjusted to a lower frequency. Once again, due to wiring differences, some spreading or squeezing of the turns may be necessary to get the inductance of the coil within the proper range.

Of course the accuracy of the equipment used to align the Vanguard 108 will determine the frequency accuracy of the converter receiver system. One way of checking the accuracy of the system and perhaps make the final touchup on the Vanguard 108 local oscillator is by using local FM stations around the high end of the FM band. For example, if a local FM station is at 106.5 mc, the receiver connected to the Vanguard 108 converter should pick up this signal at 6.5 mc. The signal will appear quite broad. However, the center or carrier frequency will be the

point where the least audio garble is heard.

Another method, available to those not so fortunate as to have a convenient FM station on the high end of the FM band, is simply to use an FM tuner of known calibration accuracy to check the oscillator's frequency.

It's worth making sure that the oscillator frequency is precisely set at 100 mc since this will help to insure that, when the satellite goes up, you won't miss it by having to fool around with converter adjustments. As we all know, the thing travels fast and won't be heard long enough or often enough to permit much adjustment.

The antenna used should come under careful consideration. With a transmitter power of 0.1 watt, the signal will inevitably be very weak and receiving equipment must be in top operating condition. A good antenna, one that is directive and hence has high gain, and is rotatable will give the signal a welcome boost. Even a rotatable TV antenna has something to offer in this respect.

One aspect of building this converter should be not overlooked. Vhf is a busy world these days. Once the thrill of satellite hunting has subsided, the unit can always be converted to a host of other uses, either by simple realignment or by adding or taking turns from the coils. Removing one turn from L1 and L4, plus squeezing, will bring the 144-mc ham band within your tuning range. Similarly, police, fire, taxi, aircraft and other community and industrial services abound, requiring only minor modification to bring them within your tuning range. END

### REFERENCES

<sup>1</sup> A good discussion of circuit and tube noise can be found in *Electronic and Radio Engineering*, 4th edition, by E. F. Terman, pages 434-442.

<sup>2</sup> The ultimate in performance can be had with a converter design described in "A Low-Noise 108/144-Mc Converter," by Mason P. Southworth, *QST*, November, 1956.

<sup>3</sup> The design characteristics of the cascode amplifier is described in *Radiotron Designer's Handbook*, pages 914 and 533-534.

<sup>4</sup> A discussion on noise generators can be found in "Noise Generators—Their Uses And Limitations," *QST*, July, 1953.

Other good general references on satellites are:

"Tracking the U.S. Satellites," by Jordan McQuay, *RADIO-ELECTRONICS*, December, 1957.

"Monitoring the Russian Satellite," by Robert F. Scott, *RADIO-ELECTRONICS*, December, 1957.

"A Low-Noise Preamplifier for Satellite Tracking," by V. R. Simas, *QST*, December, 1956.

"Radio Tracking of the Earth Satellite," by Roger L. Easton, *QST*, July, 1956.

"Calibration of the Mark II Mini-Track (Using Stars as Signal Sources)," by Roger L. Easton, *QST*, April, 1957.

"Mark II Mini-Track Base-Line Components (Constructional Details of Antenna System for Satellite Tracking)," by Roger L. Easton, *QST*, July, 1957.

"Telemetered Data Checks Vanguard Flight," by F. W. Phalen, *Electronic Industries and Tele-Tech*, July, 1957.

"Precision Steering at 18,000 M P H.," by Otto Berger, *Radio and TV News*, September, 1957.

"Satellite Tracking," *QST*, September 1957.

"A Radio Telescope," *QST*, September, 1957.

"Sputnik—What Are Its Technical Implications?" *Electronic Industries and Tele-Tech*, November, 1957.



**GUY LOMBARDO**  
makes his tape  
recordings on



**That's not  
the reason why  
you should use**



**Here's why  
you should use**



It's the best-engineered tape in the world ... gives you better highs... better lows... better sound all around! Saves your tape recorder, too—because the **IRISH FERRO-SHEEN** process results in smoother tape ... tape that can't sand down your magnetic heads or shed oxide powder into your machine. Price? Same as ordinary tape!



Available wherever quality tape is sold.  
**ORRadio Industries, Inc., Opelika, Alabama**  
Export: Morhan Exporting Corp., New York, N. Y.  
Canada: Atlas Radio Corp., Ltd., Toronto, Ontario



## HOW FAR CAN YOU GO IN ELECTRONICS WITHOUT A DEGREE?

### LESS THAN TWO YEARS AGO, 20-YEAR-OLD TIM WICKHAM HAD ASKED HIMSELF THIS QUESTION.

Today, firmly established as a Computer Units Field Engineer with IBM, Tim knows some of the answers. His story of how he assumed important engineering responsibilities on one of our country's biggest electronics projects makes encouraging reading for every technician who feels himself handicapped by lack of a formal degree.

"I always wanted to be an electronics engineer," Tim says, "ever since I first tinkered with hi-fi in my high school days. But my formal education ended when I entered the Marines in 1953. In spite of the excellent radar training I received in the Service, I still had doubts as to how far I could go in my chosen field without a degree."

### HEARS ABOUT IBM—AND SAGE

A few months prior to his discharge, Tim began to look into the opportunities for a civilian career. He heard about IBM, learned that IBM was willing to invest thousands of dollars training the right men to assume engineering responsibilities in the Project SAGE program. "Could I do it?" Tim asked himself. To be brief, Tim could—and did. Two months later Tim reported to Kingston, N. Y., to begin training as an IBM Computer Units Field Engineer.

### SAGE—PROJECT OF NATIONAL SIGNIFICANCE

SAGE—for which Tim was trained—means Semi-Automatic Ground Environment. It is part of America's radar warning system—a chain of defense that will ulti-

mately ring our country's perimeter. At the heart of this system are giant electronic computers, built for the project by IBM. These computers receive data from Texas towers, picket ships, reconnaissance planes, ground observers—analyze the data for action by the Strategic Air Command and other defense units. "These computers are the largest in the world," Tim points out. "Each contains 58,500 vacuum tubes plus 170,000 diodes."

### BECOMES FIELD ENGINEER

"My five months' training at Kingston were a revelation," Tim remembers. "Here were top-notch courses in advanced electronics, taught by instructors who really knew their business—and had a personal interest in your progress. We had classroom lectures in which we learned about basic computers, logic, programming, general machine operation—how everything worked together. Instead of a lab, we worked in actual test areas, along with the regular test area personnel. Incidentally, IBM went out of its way to make our stay at Kingston pleasant. They helped us with housing accommodations and we received a living allowance over and above salary during our training period."

### INSTALLS WORLD'S LARGEST COMPUTER

His training completed, Tim was assigned to the Project SAGE site at Newburgh, N. Y. "The giant computer was ready for installation," Tim recalls, "but before it could be moved into its new building, 300 miles of cable had to be laid. Then we made interconnections and brought in the power. Next came the testing phase—a long procedure, as you may imagine for a computer of this size. Then we set



up the auxiliary equipment. Finally, when everything was ready, the Air Force ran its acceptance tests—a stiff trial with no if's, and's or but's permitted. I'm happy to say we got an unqualified OK.

"My present work," continues Tim, "is in the Tape Section of the computer. I'm responsible for the maintenance of the Central Computer Tape System which includes eight tape drives (a means of storing information) and two tape adapter frames which adapt information for admittance into the Central Computer. A Computer Units Field Engineer like myself works about three months in each of the computer's three sections, giving him a chance to learn the whole computer."

#### A NEW ENGINEERING DIMENSION

"IBM has proved to me," Tim says, "that a degree is not the only measure of a man's ability, or the only indication of what he can do when given the opportunity. Around me at the site I see a lot of men who were once considered 'just technicians'—men who have had a new engineering dimension added to their careers—all because IBM will spend time and money to train technicians for engineering responsibilities. I know this better than ever, now that I'm on the job. I'm on the Education Committee at the Newburgh site and I see what IBM will do to train men. My job on the committee is to find out what the men want. Then, IBM supplies courses, instructors, classrooms—everything that's needed."

#### YOUR CAREER OPPORTUNITY WITH IBM

Since Tim Wickham joined IBM and the Project SAGE program, opportunities are more promising than ever. This long-range program is destined for increasing national importance and IBM will invest thousands of dollars in the right men to insure its success.

If you have two years' education and/or experience in electronics—gained through technical schooling or military service—you can become a member of this important, permanent, expanding project as a Computer Units Field Engineer.

You'll receive twenty weeks' training at Kingston, N. Y., with full pay, plus living allowance, before assignment to a permanent location. You'll receive salary, not wages, plus overtime pay. And, of course, you'll receive the liberal IBM company-paid benefits.

Mr. N. H. Heyer  
Room 649M  
Military Products Division  
IBM Corp., Kingston, N. Y.

WRITE TODAY TO:

You'll receive a prompt reply. Personal interviews arranged in all areas of the United States if your résumé of experience and education indicates you have the qualifications.



DATA PROCESSING • ELECTRIC TYPEWRITERS • MILITARY PRODUCTS  
SPECIAL ENGINEERING PRODUCTS • SUPPLIES • TIME EQUIPMENT



Checking panel wiring of Simplex console



Trouble-shooting a computer frame



Discussing a problem in computer magnetic tapes



Working on SAGE magnetic input drums



Classroom lecture in computer logic

*Small enough to nestle in the palm of your hand, it has 4 stages of audio amplification*

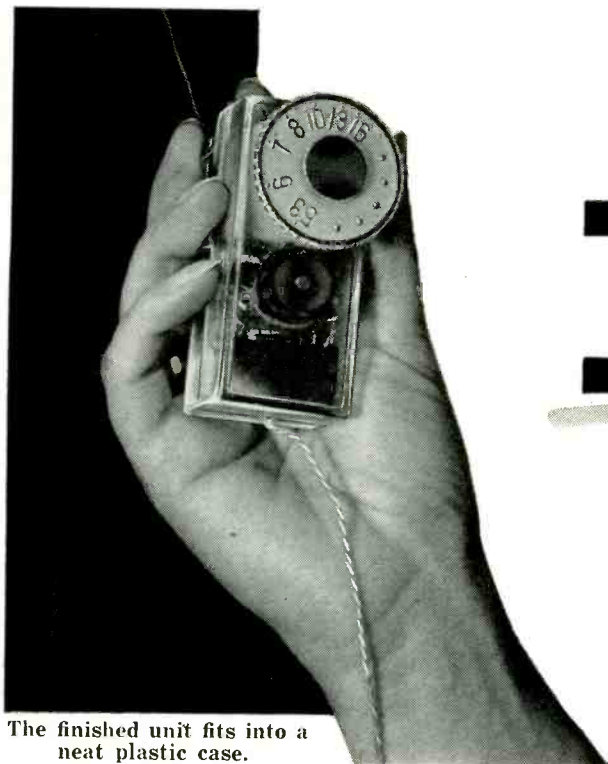

The finished unit fits into a neat plastic case.

# TINY-TRAN

# POCKET RADIO

By FORREST H. FRANTZ, SR.

**B**EEN yearning for a really portable radio? One that will fit in your pocket and pick up stations without immobilizing you? A radio that's selective enough to separate strong local stations? Don't look any further; the Tiny-Tran will fill the bill!

The Tiny-Tran doesn't shackle you to an antenna or ground. You don't have to hold a lead and let your body serve as an antenna either. Here's an example of Tiny-Tran's performance: I live 15 miles from the nearest radio stations (in Dallas and Fort Worth); Tiny-Tran in my shirt pocket picks up eight stations without any external antenna and I can listen comfortably while walking.

I've wanted a radio as small as this

for a long time. I've tried to miniaturize transistor audio amplifiers, use regenerative transistor detectors and, on occasion, I've even resorted to "odd ball" body-mounted antenna schemes. The results, though they seemed good at the time, are rather dismal, now that I've used Tiny-Tran.

The experimenter bent on extreme miniaturization for pocket radio operation has, until recently, faced almost insurmountable odds. Although transistors are small and other components have been miniaturized, he has still been hampered by resistor dimensions and space requirements for making electrical (non-short-circuiting!) connections.

Two recent developments have changed the picture. These are manu-

facturing as well as engineering breakthroughs:

1. The packaged, printed-circuit, four-stage transistor amplifier manufactured by Centralab and designated the TA-11. Dimensions: 1.175 x 0.665 x 0.25 inch!

2. The miniature flat ferrite-strip antennas such as the Miller 2004. Q: 500 at 790 kc! Dimensions: 2 7/8 x 3/4 x 1/8 inch, when removed from its masonite mounting board!

Tiny-Tran's small size (2 7/8 x 1-3/16 x 1 inch) and excellent performance are possible because of these components. The TA-11 subminiature transistor amplifier is expensive—about \$35—but (to me at least) the compactness that it affords and the simplicity it lends to the Tiny-Tran more than compensate

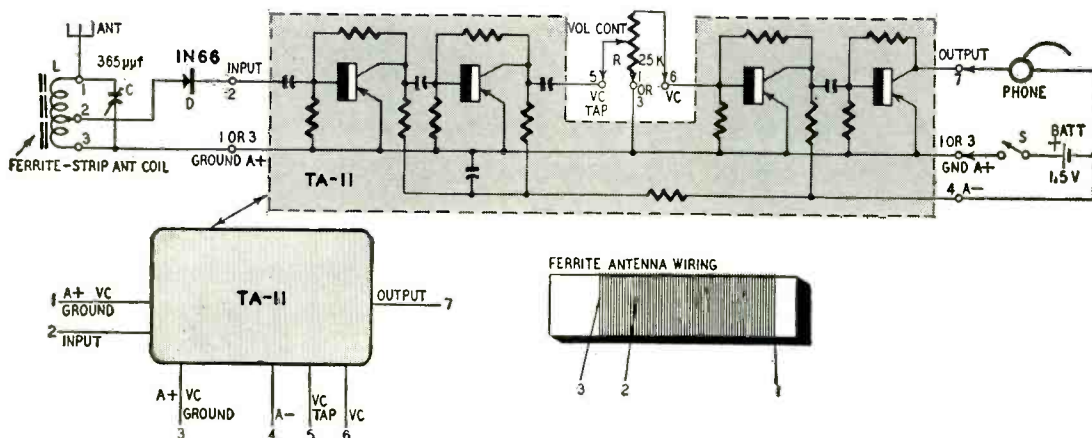

R—pot, 25,000 ohms, subminiature, with spst switch (Centralab B16-217 or equivalent)  
 C—365  $\mu$ f, miniature variable (Lafayette MS-274 or equivalent)  
 S—spst switch on R

D—IN66 diode  
 L—ferrite antenna (Miller 2004 or equivalent)  
 Packaged transistor amplifier, Centralab TA-11  
 BATT—1.5-volt penlight cell (Eveready 912 or equivalent)

Knobs  
 Plastic case, 2-7/8 x 1-3/16 x 1 inch (Lafayette MS-157 or equivalent)  
 Earphone, impedance 8,000 ohms, dc resistance 2,000 ohms (Lafayette MS-260 or equivalent)  
 Miscellaneous hardware

Circuit of Tiny-Tran receiver.

more things to sell...  
and help you sell...

# your INDEPENDENT SERVICE



NEW THREE-PIECE WINDOW DISPLAY

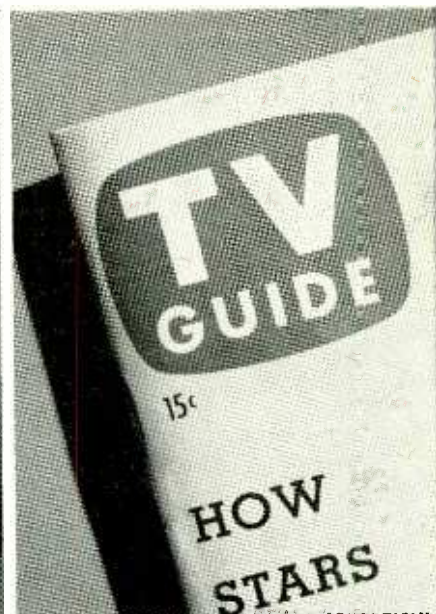

MORE INDEPENDENT SERVICE ADVERTISING

## Complete Line of Tie-in Materials

- |                       |                      |
|-----------------------|----------------------|
| "Your Future" booklet | Flange sign          |
| Window display        | Postal cards         |
| Decalcomania          | TV and radio scripts |
| Outdoor sign          | Ad mats              |
| Indoor clock-sign     | Consumer booklet     |
| Clock                 | Doorknob hangers     |

*Reliable Products  
through Advanced-  
Engineering*



### HOW TO GET THEM

See your CBS Tube Distributor. Or write for PA-187 folder and order form illustrating all the tie-in materials for this the only *complete* program selling your Independent Service. Tie in today. And be sure to specify CBS tubes, always. Help us help you keep your Independent Service Program growing.

**CBS-HYTRON**, Danvers, Massachusetts  
A Division of Columbia Broadcasting System, Inc.

FOR THE BEST IN ENTERTAINMENT TUNE TO CBS

# It pays to SPECIALIZE!

Let these Rinehart  
how-to-do-it books train you  
for good pay in specialized fields

These famous Rinehart books are complete,  
easy to understand, fully authentic. Start  
your training with them at home today for  
more interesting work and bigger pay.

## CASH IN ON HI-FI SERVICE AND CUSTOM BUILDING



1

**HIGH FIDELITY TECHNIQUES**  
by John H. Newitt is a 494-page  
guide for hobbyists, servicemen  
and custom builders. Shows how  
to get better hi-fi results at less cost;  
how to service hi-fi; compares different  
techniques and methods and is crammed  
full of construction tips and ideas. 203  
illustrations. Price \$7.50.

Make your hobby pay for itself!

## BE AN EXPERT ON MAGNETIC RECORDING



2

**MAGNETIC RECORDING** by S. J.  
Begun covers every phase of wire  
and tape recording equipment, compo-  
nents, measurements and application  
—from high fidelity work to broadcasting,  
from movies to industrial installations, secret  
communications and all the rest. 146 illu-  
strations help make every step absolutely  
clear. Price \$5.00

## REPAIR ANY HOME ELECTRICAL APPLIANCE



3

This 370-page Rinehart **ELECTRICAL  
APPLIANCE SERVICE MANUAL**  
brings you complete, easy repair in-  
structions for practically every appli-  
ance used in modern homes. Even includes  
appliance refinishing methods. Gives you the  
"know how" to add a profitable sideline to  
your radio-TV service . . . or to build a  
full-time appliance repair business. Price  
\$5.00

## LEARN TO FIX OR REWIND ANY ELECTRIC MOTOR



4

Train for something really differ-  
ent! This giant 560-page **ELEC-  
TRIC MOTOR REPAIR** guide  
opens a fascinating big pay field,  
even to beginners. Covers all repairs  
**PLUS** complete rewinding of practi-  
cally every AC or DC motor or generator  
. . . also motor controls. Approved by  
instructors, repair specialists and  
unions. Price \$8.95

Over 100,000 copies in use!

## LEARN TO USE INSTRUMENTS BETTER AND FASTER!



5

**BASIC ELECTRONIC TEST IN-  
STRUMENTS** helps you work better  
and faster on service jobs. Shows  
how to put old instruments to new  
uses; teaches you to interpret readings,  
etc. A complete, fully understandable in-  
strument training course. Explains over  
60 instruments including the latest  
types . . . outlines work-saving short-  
cuts. 254 pages. Price \$4.95

## STUDY 10 DAYS FREE!

Dept. RE-18, RINEHART & CO., Inc.,  
232 Madison Ave., New York 16, N. Y.  
Send following book or books for 10-DAY FREE  
EXAMINATION. (Circle the books you want):

1 2 3 4 5

In 10 days, I will either remit price indicated  
above for each book (plus postage) or return book  
to you and owe nothing. (SAVE! Send cash with  
order and we pay postage. Same 10 day re-  
turn privilege with money refunded.)

Name \_\_\_\_\_

Address \_\_\_\_\_

City, Zone, State \_\_\_\_\_

OUTSIDE U. S. A.—Add 50¢ for each book to cover handling  
Cash with order. Money refunded if you return books in 10 days.

## RADIO

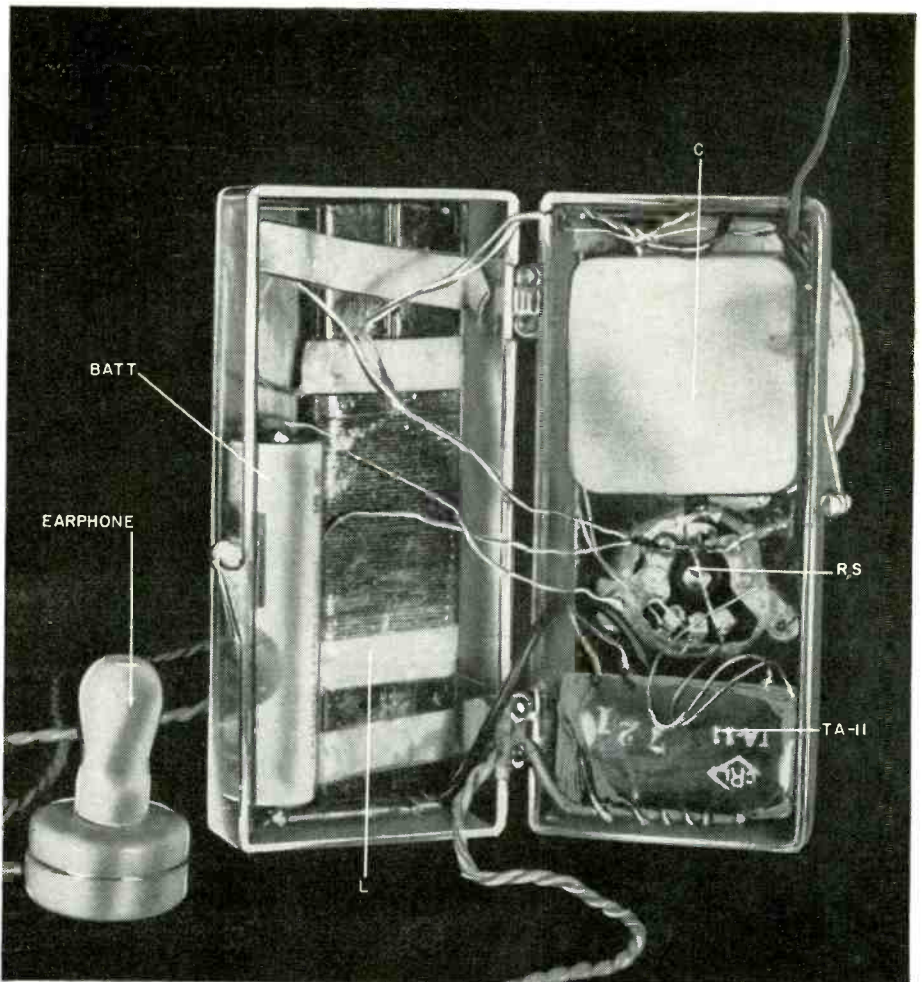

Opening the case shows parts placement.

for the expenditure. Other miniature  
parts are also essential, but these have  
been available for some time.

### The circuit

The circuit of the Tiny-Tran is  
straightforward (see diagram). The  
high-Q antenna provides adequate selec-  
tivity in a diode detector circuit. The  
extreme sensitivity of this high-Q cir-  
cuit also accounts for the radio's good  
station pickup characteristics.

The rectified signal at the output of  
the detector is not strong enough for  
direct headphone operation without an  
external antenna. To eliminate the need  
for an antenna, considerable audio  
amplification is required. The TA-11  
furnishes this amplification. Its gain is  
better than 73 db. That's a voltage gain  
of approximately 4,500!

Volume is controlled by a miniature  
volume control between the second and  
third transistor amplifier stage. A spst  
switch on the volume control turns the  
set on and off. The energy source con-  
trolled by this switch is a penlight cell.

Several of the amplifier's character-  
istics are of particular interest. Current  
drain ranges from 3.6 to 4.4 ma, input  
and output design impedances are 1,000  
ohms and power output is 1 mw max-  
imum with 15% distortion. At 0.36 mw,  
distortion is only 2%. Frequency re-

sponse is within 5 db from 250 to 20,000  
cycles. Not hi fi, but certainly listen-  
able.

### Now build it

It won't take very long to make your  
Tiny-Tran. The first time I worked  
with the TA-11 amplifier, I bread-  
boarded the basic circuit in less than  
10 minutes. After I forced myself to  
stop playing with this simple setup  
that produced such intriguing results,  
I undertook the more tedious task of  
packaging the circuit. Even this can be  
done in less than 30 minutes. Here's a  
suggested procedure:

1. Drill the plastic case. Make starter  
holes with a small drill for the volume  
control and tuning capacitor shafts.  
Then ream the holes out to size. This  
precaution prevents cracking the case.  
My reamer wasn't large enough to make  
the volume-control hole, but I managed  
to melt the hole to size with a soldering  
gun. The small holes for fastening the  
tuning capacitor and the volume control  
are drilled directly. Notches at the top  
of the case (for the antenna) and at  
the bottom (for the headphone lead)  
are melted out with a soldering gun.

2. Mount the components as shown  
in the photos.

Remove the antenna coil from its  
Masonite mounting strip. This is done

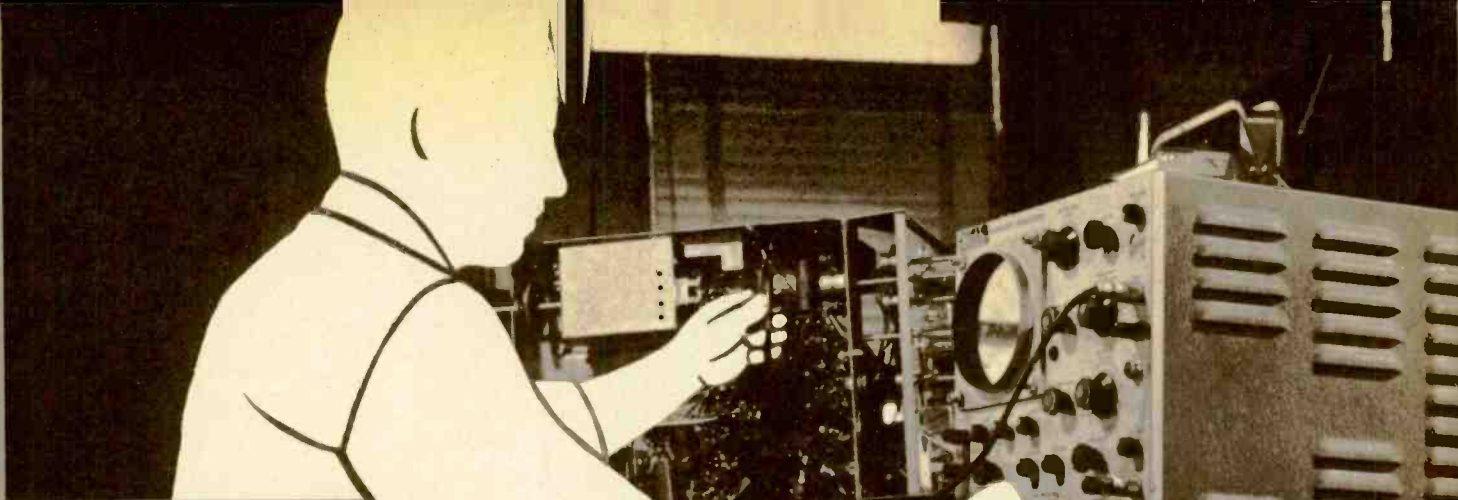

**MR. ELECTRONICS MAN:**

**If you're willing to lose your job tomorrow to a technically-trained man, don't read this!**

But if you're interested in an honest-to-goodness career in the vigorous young electronics industry, here's how you can step ahead of job-competition, move up to a better job, earn more money, and be sure of holding your technical job, even if the brass is firing instead of hiring.

The "how" is CREI home-study training in the growing electronics field. CREI offers you advanced, professional home study training in Electronic Engineering Technology including SERVO-MECHANISMS; COMPUTERS; RADAR; AUTOMATION; AERONAUTICAL ELECTRONICS; BROADCASTING; COMMUNICATIONS AND MANUFACTURING, and the ELECTRONIC PRINCIPLES ASSOCIATED WITH GUIDED MISSILES. TELE-METERING, ASTRONAUTICS, and INSTRUMENTATION. You don't have to be a college graduate. You *do* have to be willing to study—at home. You can do it while holding down a full-time job. Thousands have. Since 1927 CREI has provided alert young men with the technical knowledge that leads to more responsibility, more job security, more money. And CREI has constantly kept pace with the rapid expansion and progress in electronic achievement. 30 years of experience qualifies CREI to train you.

What qualifies you for CREI? If you have the equivalent of a high school education, and are good at mathematics, and have some electronic experience—you can qualify for CREI training and for the benefits which await you upon graduation. But remember this: CREI starts with fundamentals and takes you along at your own speed. You are not held back by a class, not pushed to keep up with others who have more experience or education. You set your own pace. CREI instructors guide you through the lesson material and *grade* your written work personally. You master the fundamentals, then get into more advanced phases of electronics engineering principles and practice. Finally you may elect training at career level in highly specialized principles of electronic engineering technology as applied to guided missiles, servomechanisms, radar computers, telemetering, automation, instrumentation and other ultra modern applications.

*How good is CREI training? Ask an elec-*

tronics engineer. Ask a high-school or college physics teacher. Ask a radio station engineer. Check up on our professional reputation: CREI courses are accredited by the Engineers' Council for Professional Development; CREI is a member of the National Council of Technical Schools.

Look at this partial listing of organizations that recommend CREI training for their own personnel: United Air Lines, Canadian Broadcasting Corp., Trans-Canada Airlines, Douglas Aircraft Co., The Martin Co., Columbia Broadcasting System, All-American Cables and Radio, Inc., Gates Radio Co., Canadair Ltd., Federal Electric Corp. and U. S. Information Agency (Voice of America). Finally, ask a CREI graduate to tell you about our Placement Bureau, which has more requests for trained men than we can fill.

What's the next step? Certainly get more information than we can cram into one page. The postcard below, *completely* filled out, will bring you a fact-packed booklet. It describes courses offered, career opportunities, full details about the school, and tuition details.

**FREE BOOKLET! MAIL THIS POSTAGE-FREE POSTCARD TODAY**

**CAPITOL RADIO ENGINEERING INSTITUTE**

ECPD Accredited Technical Institute Curriculo • Founded 1927

3224 16th St., N.W., Washington 10, D. C.

Dept. 141-E

(R.N. Feb. 58)

**I<sub>2</sub>B<sub>2</sub>**

Please send me your course outline and FREE illustrated Booklet "Your Future in the New World of Electronics" . . . describing opportunities and CREI home study courses in Electronics Engineering Technology.

- CHECK FIELD OF GREATEST INTEREST
- Radar, Servo and Computer Engineering Technology
  - Electronic Engineering Technology
  - Broadcast (AM, FM, TV) Engineering Technology
  - Television Engineering Technology
  - Aeronautical Electronic Engineering Technology

Name \_\_\_\_\_ Age \_\_\_\_\_

Street \_\_\_\_\_

City \_\_\_\_\_ Zone \_\_\_\_\_ State \_\_\_\_\_

Check:  Home Study  Residence School  Korean Veteran

To help us answer your request intelligently, please give the following information:

EMPLOYED BY \_\_\_\_\_

TYPE OF PRESENT WORK \_\_\_\_\_

EDUCATION:

YEARS HIGH SCHOOL \_\_\_\_\_

YEARS COLLEGE \_\_\_\_\_

IN WHAT BRANCH OF ELECTRONICS ARE YOU MOST INTERESTED \_\_\_\_\_



The data that launched thousands  
of careers is yours **FREE**

TELLS how you can be successful in  
**ELECTRONICS . . . including:**

Television . . . Broadcasting . . . Guided Missiles . . . Radar . . .  
Instrumentation . . . Computers . . . Automation . . . Astro-  
nautics . . . Servomechanisms . . . Aeronautical Electronics  
. . . Telemetry . . . Communications . . . Manufacturing

Send for your Free Copy today!

This is a brand new edition of the book which has launched thousands of men on good-paying careers in radio-TV-electronics.

It brings you completely up to date—answers important questions on newest career developments in electronics, including Radar, Guided Missiles, Servomechanisms, Computers, as well as Aeronautical Electronics, Broadcasting (AM, FM, TV), Military, Navy and CAA Electronics, Communications and Electronics Manufacturing.

This book, "Your Future in the New World of Electronics," also shows you how CREI Home Study leads the way to greater earnings in the booming electronics world.

However, CREI does not promise you a "snap." With accredited technical school curricula such as CREI offers, you must study to convert your ambition into technical knowledge which you can sell in the fabulous field of Electronics.

Since its founding in 1927, CREI has provided thousands of professional electronics men with technical educations. During World War II, CREI trained thousands for the Armed Services. Leading firms recommend CREI training for their own personnel. Among them: United Air Lines, Canadian Broadcasting Corporation, Trans-Canada Airlines, Douglas Aircraft Co., The Martin Co., Columbia Broadcasting

System, All-American Cables and Radio, Inc., Gates Radio Co., Canadair, Ltd., Federal Electric Corp., and U. S. Information Agency (Voice of America).

CREI courses are prepared by recognized experts, in a practical, easily understood manner, and constantly revised to meet the new electronic challenges of our time. You get the benefit of time-tested study assignments under the personal supervision of a CREI staff instructor. Your studies are accomplished on your own time, during hours selected by you, and controlled by your own will power. This complete training is the reason that graduates find their CREI diplomas keys-to-success in even the most advanced of electronic applications. CREI alumni hold top positions in America's leading firms.

At your service is the CREI Placement Bureau, which finds positions for advanced students and graduates. Although CREI does not guarantee jobs, requests for personnel far exceed current supply. Now is the time of decision for you. Luck will not propel you forward unless it finds you trained. Contacts won't budge you an inch unless you have the skill to back them up. The answer is: Technical Training . . . and willingness to learn. Together they will bring you increased earnings in the new Age of Electronics. Fill

out the postcard below *completely* and mail it now. We'll promptly send you your free copy of "Your Future in the New World of Electronics." The rest—your future—is up to you!

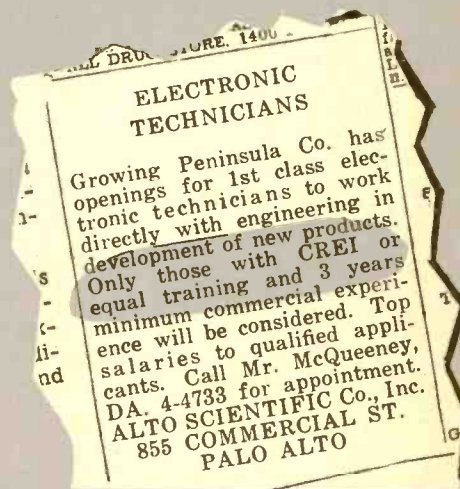

**Industry Calls For  
CREI Training  
By Name . . .**

**SO SHOULD YOU!**

Here you see an actual help wanted ad from the San Francisco Examiner, one of many which specify "CREI or equal" training. This shows that industry approves CREI training, even insists on it.

**CREI ALSO OFFERS RESIDENCE TRAINING** at the same high technical level in Washington, D. C. Classes start at regular intervals. Qualified residence school graduates earn degree, "Associate in Applied Science." Check coupon if you prefer residence study.

**VETERANS:** If eligible for training under the new G.I. Bill of Rights, check the coupon for full information.

1st Class  
Permit No. 288-R  
Sec. 34.9 P.L.R.  
Washington, D. C.

**BUSINESS REPLY CARD**  
No Postage Stamp Necessary If Mailed in United States

3c Postage Will Be Paid By  
**CAPITOL RADIO ENGINEERING INSTITUTE**  
**3224 16th Street, N.W.**  
**Washington 10, D. C.**



## RADIO

by loosening the tape which holds it in place. Trim the tape to a length to go just around the antenna and protect the end turns. Use cellophane tape to fasten the loop to the case.

3. Proceed with the wiring. Wire the ferrite-loop antenna, tuning capacitor and diode detector combination first. Take the usual precautions in soldering semiconductor leads and in handling Litz wire.

Next place the TA-11 inside the front half of the case and fasten the earphone lead temporarily in place with cellophane tape. Wrap the TA-11 output lead (numbered 7) around one phone lead tip. Wrap all the lead length you can around this tip, but don't put tension on the TA-11 lead. *Do not solder this connection!* With cellophane tape, fasten the phone tip securely to the side of the case.

Now connect leads 5 and 6 to the volume control. By running the leads up the side of the case and bending them back on themselves you can avoid cutting them. There's enough space and the leads are stiff enough to prevent short circuits. If you wish, slip fine spaghetti over these leads. Connect lead 1 to the volume control and the ground side of the tuning capacitor. Lead 2 is brought up around the variable capacitor and connected to the diode. Lead 3 connects to the switch. The other side of the switch is connected to the plus side of the battery. Put a piece of thin plastic spaghetti (may be stripped from plastic-covered hookup wire) on lead 4 of the TA-11 and wrap the end of this lead around the second phone tip. *Do not solder this connection.* Solder the end of this phone tip to the negative end of the battery. The phone tip and battery should be cleaned with a file prior to soldering. Secure the phone tip and battery with cellophane tape.

Finally, solder the antenna wire and tape it in place. I used 12 inches of No. 18 silk-covered wire. If you are going to use your radio in a city speckled with radio stations, the antenna is unnecessary. (Perhaps some reader will come up with a small telescoping antenna that will handle any eventuality.)

### Make it smaller

Examination of the Tiny-Tran layout will probably prompt many experimenters to ask why I didn't make the radio smaller. The question is a fair one because it is quite apparent that it can be miniaturized further. There's plenty of space in the case and the tuning capacitor's shaft can be shortened. A smaller battery could be used. By taking advantage of these space-saving possibilities, Tiny-Tran's size can be cut in half. I didn't resort to these measures because the wiring would have been more difficult. Besides, with the usual experimenter's initiative to do more things with new gadgets, I'll probably expand Tiny-Tran to a Speaker-Tran by next issue. END

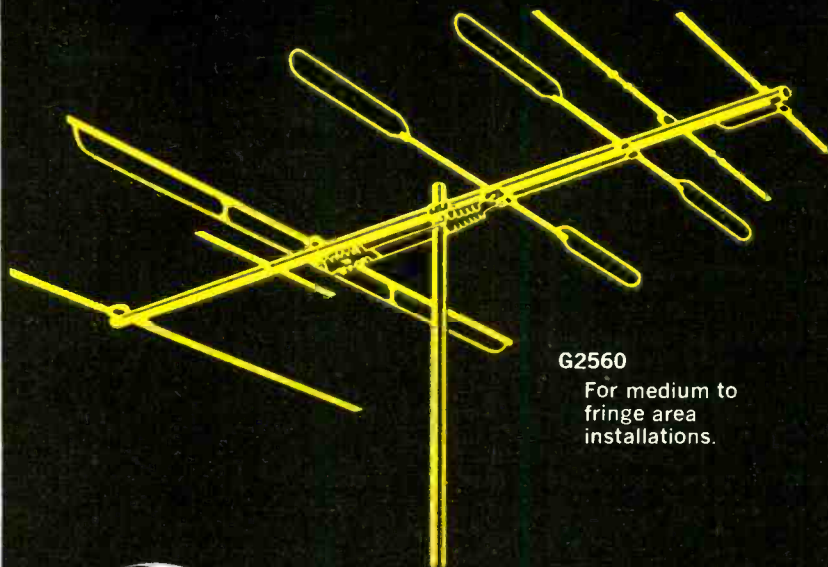

G2560

For medium to fringe area installations.

*The magnificent*

TAACD  
GOLDEN

*Topliner*<sup>TM</sup>

without equal for performance,  
quality and value

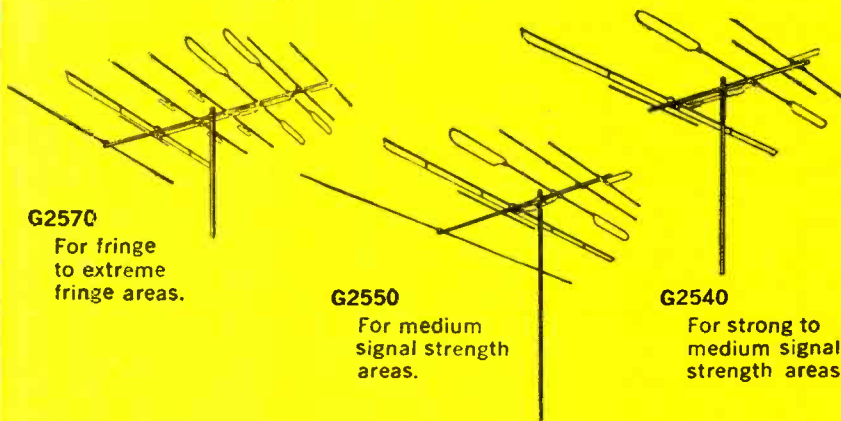

G2570

For fringe to extreme fringe areas.

G2550

For medium signal strength areas.

G2540

For strong to medium signal strength areas.

*Write for complete technical details...*

TAACD  
*Topliners*<sup>Trade-mark</sup>

TECHNICAL APPLIANCE CORPORATION, SHERBURNE, N. Y.

In Canada: Hackbusch Electronics, Ltd., Toronto 4, Ont.

# TRANSISTORS

## SENSITIZE RELAY CIRCUITS

*Eight circuits that will increase the usefulness of your relay control*

By EDWIN BOHR

**T**RANSISTORS can multiply the sensitivity of conventional control circuits by tens, hundreds or thousands of times. Transistor relay control circuits are excellent for extending the sensitivity of photoelectric devices, garage-door openers, radio remote control, carrier-current circuits and the like.

Most of the popular crystal diode circuits can be souped up and given new vitality. Just select a suitable transistor relay from this article and you're in business. Transistor relay control circuits can be used in hundreds of ways.

But several limiting factors enter into any consideration of dc transistor amplification.

### Sensitive relays

Very sensitive relays are expensive and fragile, and the contact adjust-

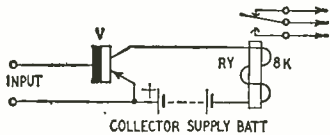

Fig. 1—Typical transistor relay circuit.

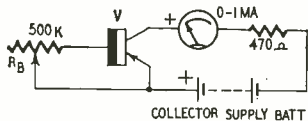

Fig. 2—Experimental circuit shows effects of leakage and temperature.

ments are always delicate. Except for moving-coil types, the contact movement is exceedingly small. Armature movement is almost invisible on many types.

With these conditions, vibration sensitivity and contact sticking from the slightest overload are real headaches. Such troubles, however, disappear when relays are used and adjusted to operate from signals larger than 25 mw.

A specific example is the Sigma type 4F relay with an 8,000-ohm coil. This relay, adjusted to operate with a coil current of 2 ma, is reliable despite large inductive contact loads (the type usually found in model control circuits), vibration, temperature changes and dust.

This relay also operates pretty well on 1.5 ma if the armature air gap and spring tension are carefully adjusted. But, attempts to increase this relay's sensitivity further take it out of the

good old "idiot-proof" category and place it in the "apologetic" group.

You know what we mean. An apologetic component is one with just enough margin of satisfactory operation to operate perfectly until we want to boast or demonstrate performance to someone important. Then it fails. Of course we can make a hurried screwdriver adjustment and get it to work. But, somehow, the sweetness of the moment is lost.

A Sigma 4F relay, adjusted for 30-mw operation, plus transistor amplification, will replace almost any special sensitive relay including polarized types. And there are many advantages in such an arrangement. Relay operation time—in most instances—is greatly improved; the cost is less and the complete unit is more immune to vibration, dirt, and contact wear. The characteristics of these two devices, the transistor and mechanical relay, are mutually complementary.

### Typical circuit

For some time, transistor circuits for driving relays have appeared in popular technical magazines. Unfortunately, many of them have suffered from misapplication and poor design. Before going further, let's look at one of these circuits.

Fig. 1 shows a typical transistor relay circuit. The relay coil is simply connected in the collector circuit of a grounded-emitter stage. Current supplied to the base is amplified and operates the relay.

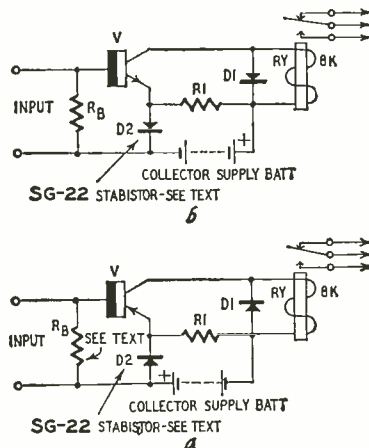

Fig. 3—Improved circuit eliminates heat and leakage problems: a—for p-n-p transistors; b—for n-p-n types.

This circuit is usable only with *good-quality low-gain* transistors at very moderate power levels. Preferably, the collector potential should be limited to 6 volts or less and the collector current to a couple of ma. These limitations hold two serious defects to a minimum.

The first defect results from leakage and temperature-induced transistor currents. These currents, in the grounded-emitter circuit, are amplified by the transistor—just like an input signal would be.

At temperatures of 90°F and higher, currents of this type are troublesome. High-gain transistors amplify these currents enough to keep the relay closed, even when there is no input signal. This condition becomes worse with higher collector currents and voltages.

The second defect is circuit-imposed. When the relay is energized, magnetic energy, of course, is stored in the coil windings. If the transistor input signal is suddenly removed, the magnetic field collapses and throws a high flyback voltage across the transistor. The flyback from a sigma type 4F, for example, is enough to cause early transistor failure.

### Experimental circuit

If you have a transistor and a few spare minutes, a simple experiment clearly shows these first effects of leakage and temperature.

Set up the circuit shown in Fig. 2. A multimeter with a current range of less than 1 ma is ideal for the collector indicator. The 470-ohm collector resistor is a safety, current-limiting device. Initially, the collector can be at about 6 volts.

Any handy transistor will do if it is an alloy-junction type. (Many of the more common transistors are alloy-junction types. Among them are the CK721, CK722, 2N77, 2N104, 2N105, 2N107, 2N109, 2N139, 2N180, 2N229, 2N233, GT14 and OC70.) Fig. 2 shows battery polarity for a p-n-p type. If an n-p-n alloy transistor is used, reverse the collector battery polarity.

Before starting the experiment, short the transistor base directly to the emitter. Then connect the collector battery and read the current. It should be no more than 50 or 75 ma. Now increase the base-to-emitter resistance  $R_B$  and notice the rising collector current. De-



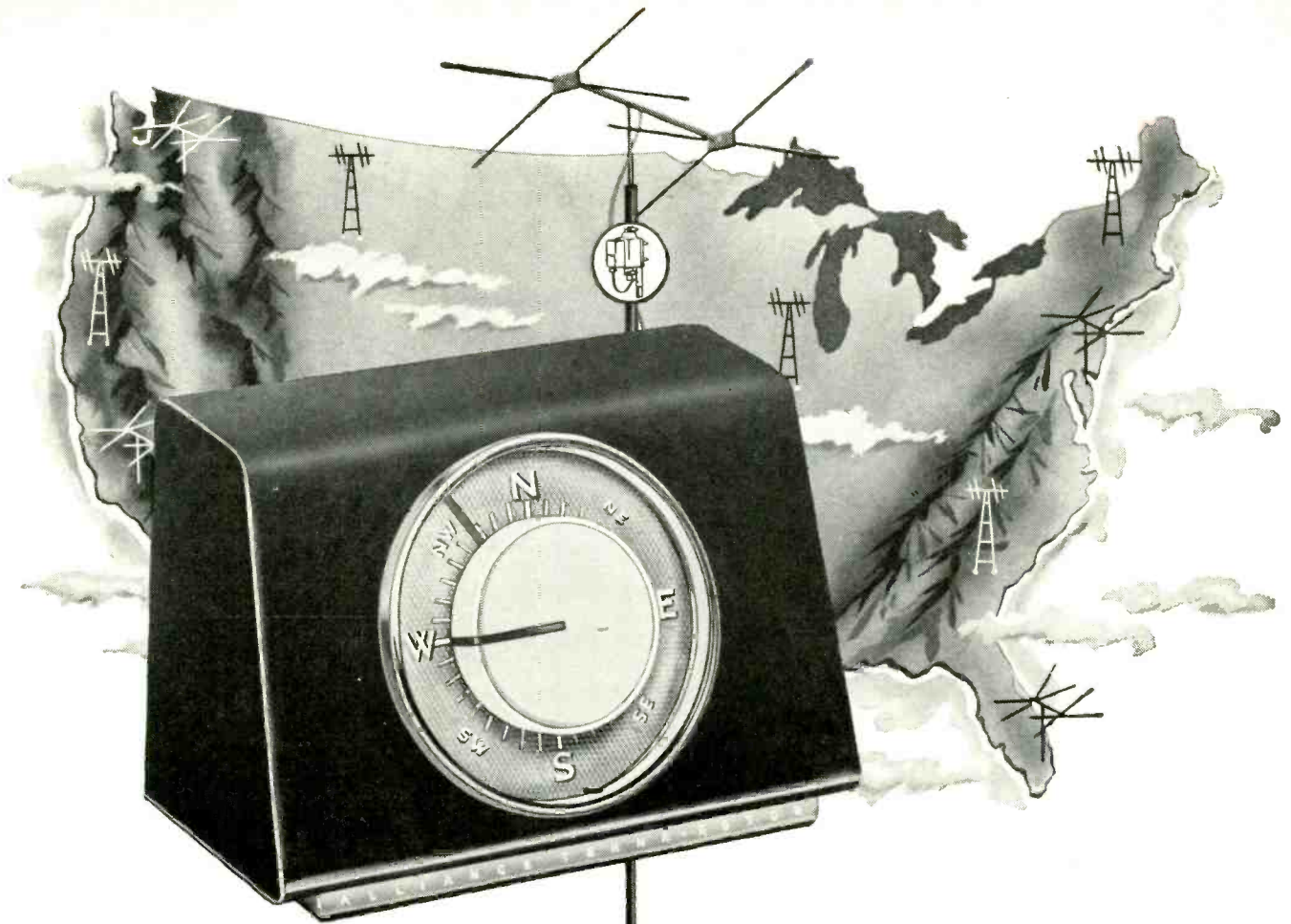

# Alliance Tenna-Rotor *the recognized leader!*

First today with 4 million sold . . . first tomorrow in the 37-million black-and-white and color market now ready for rotators.

Selling is easier when you sell a recognized name. And in its field only Alliance Tenna-Rotor has achieved the status of "nationally-known brand." Let someone else do costly "missionary work." You'll enjoy faster turn-over and higher profits with Alliance Tenna-Rotor.

Look at the market and you'll see why it's time to move fast! *Color TV* . . . network color program time up 67% this season! And these sensitive signals demand Tenna-Rotor's accurate tuning. A poor color picture is much more annoying than a poor black-and-white picture. *Station Changes* . . . new towers, new stations, channel reassignments, UHF and VHF. Every local change is your cue to sell the superiority of Alliance Tenna-Rotor over "stay-put" antennas. This means that there is still a big market in black-and-white—millions of viewers who need Alliance Tenna-Rotor to get better pictures and more stations.

Alliance, the leader, backs you with consistent national advertising that is now in its eighth year.

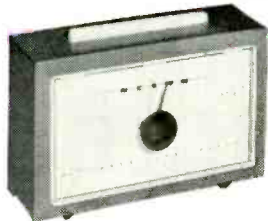

**MODEL T-12** with exclusive Tenna-Teller Pointer. Strikingly modern in Mahogany, \*Ivory and Forest Green.  
Retail . . . . . \$34.25



**MODEL K-22** the pace-setter in economy plus style. Now with indicator light. Mahogany finish.  
Retail . . . . . \$24.50

\*Add \$2.00 for Ivory and Forest Green.

**MODEL U-98** (shown above) first and finest fully automatic rotator. Smartly styled in Mahogany, \*Ivory and Forest Green.  
Retail . . . . . \$44.25

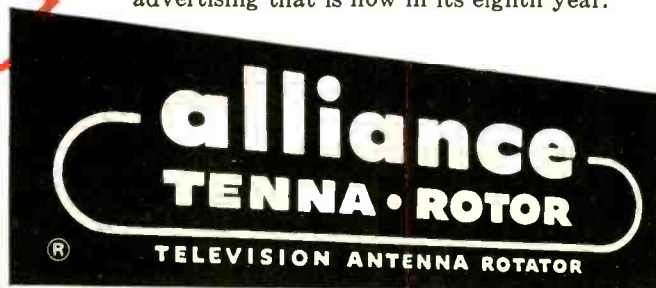

THE ALLIANCE MANUFACTURING COMPANY, INC., ALLIANCE, OHIO (DIVISION OF CONSOLIDATED ELECTRONICS INDUSTRIES CORP.)

## ELECTRONICS

pending upon the individual transistor's characteristics and the room temperature, the collector current may climb to more than 1 ma with 500,000 ohms resistance between base and emitter. Lower values decrease the current.

Grasp the transistor between your fingers. Added heat from your body will cause the current to rise also. Cool the transistor, if you wish, with a small piece of ice held in Saran Wrap and collector current will drop *tremendously*.

Increasing collector voltage at room temperature causes an increase in the meter reading. Reduce collector voltage and the current decreases. These effects

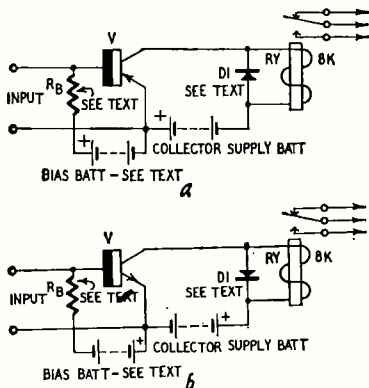

Fig. 4—Separate bias battery replaces one crystal diode. a—for p-n-p transistors; b—for n-p-n types.

are more pronounced with high-gain transistors. Prove it to yourself. If you have high-and low-gain transistors, try both kinds.

If a silicon transistor were subjected to these experiments, it would show no effects. The initial collector current under any conditions would probably be too small to read on the *microamp* meter range.

This experiment shows us that ambient temperature is not a problem, as long as the base-to-emitter resistance is very low. Temperature effects are reduced by using low collector voltages. High-gain transistors amplify temperature effects even more, with resulting larger indications.

With these facts in mind, let's improve transistor relay performance by circuit modifications.

### Improved circuit

The circuits in Fig. 3 eliminate the difficulties just mentioned. The elements responsible for this improvement are back bias and relay coil damping.

Diode D2 is a silicon unit, a type SG-22 Stabistor (Transitron Electronics Corp., 168 Albion St., Wakefield, Mass.), that maintains an essentially constant drop of 0.5 volt in its forward direction. This 0.5-volt bias effectively swamps out temperature currents by preventing them from flowing through the emitter.

Resistor  $R_B$  returns the base to ground. The lower the value of this resistance the more effective the bias. Even for very-high-gain transistors, 2,000 ohms should be low enough—

10,000 ohms may be satisfactory for low-gain units.

Resistor  $R_1$  supplies the bleeder current through diode D2. For a collector supply voltage of 22,  $R_1$  should be about 27,000 ohms.

D1, across the relay winding, acts as a damper to short out the flyback voltage but not the actuating signal. If the diode were wired in backward, the relay would not operate. This diode is a general-purpose germanium unit such as the 1N34.

Notice that the maximum available relay current is the collector voltage divided by the coil resistance (8,000 ohms). The Sigma requires about 18 volts. A few extra volts of margin are always necessary. So 22 volts is about right. More voltage will exceed the conservative ratings of most transistors. If a 4,000-ohm relay were used, the collector supply voltage could be cut in half but the driving current, of course, would be doubled. A collector supply of 12 volts is satisfactory for a 4,000-ohm coil. Resistor  $R_1$  is changed, for this condition, to 15,000 ohms.

Circuits similar to those in Figs. 3-a and -b appear in a Transitron Electric Corp. application note titled "Transistor Relay Circuits."

Fig. 3-a is specifically for p-n-p transistors and Fig. 3-b for n-p-n types. Grown-junction transistors, the 2N170 for example, are not suitable because of their low rating.

These circuits are sensitive to input signals of only one polarity. Fig. 3-a responds to negative signals and 3-b to positive signals. The bases (inputs) of these two circuits can be connected, forming a polarized two-way relay. Thus each of the two relays would respond only to a specific input-signal polarity.

### Battery-bias circuit

Figs. 4-a and 4-b are almost identical to the previous circuits. However, separate batteries supply the bias rather than constant-voltage diodes. One or

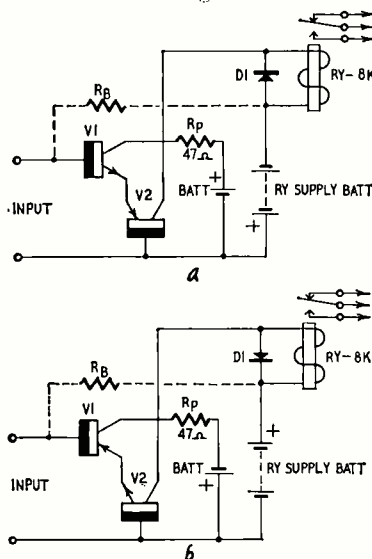

Fig. 5—Two-transistor circuit provides additional gain; a—keyed by positive inputs; b—keyed by negative inputs.

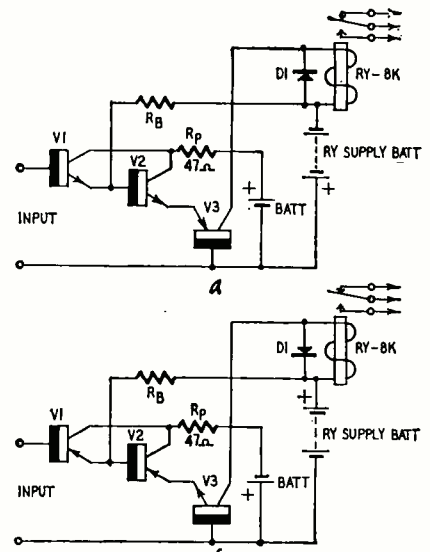

Fig. 6—Ultimate relay control circuit uses three transistors: a—keyed by positive inputs; b—keyed by negative inputs.

more additional dry cells are necessary.

For a single 1.5-volt bias battery and a high-gain transistor,  $R_B$  should be roughly 6,000 ohms. For 3 volts of bias, double this value. The advantage of increased bias voltage and resistance is reduced input shunting. Otherwise, the results are the same as far as reducing temperature effects is concerned.

If maximum gain is necessary, the value of the resistor  $R_B$  is selected to hold the collector current down to about 0.25 ma at the highest operating temperature. This means using fairly high values of resistance, about 47,000 ohms for a 1.5-volt bias. Using a transistor like the 2N43, it is possible to obtain current gains of 60 under these conditions.

Figs. 5-a and 5-b provide us with the ultimate in a simple, ultra-reliable, low-cost, transistor relay circuit. This circuit separates the functions of current amplification and relay driver.

Two transistors are used. The relay driving transistor is connected with its base grounded. There are a couple of advantages in using a grounded-base transistor driver. First, because this circuit provides *no* current gain—only power gain—temperature and leakage currents are reduced and inconsequential. Second, the grounded-base circuit is electrically more robust. It can withstand higher collector voltages and currents. Grounded-base circuits absolutely cannot be damaged from thermal runaway.

This relay driving transistor (V2) should be a *low-priced* unit since a high-priced, high-gain transistor in the grounded-base connection gives no better performance than a low-gain unit.

The input transistor (V1) provides the current gain and functions at a very low collector voltage. Since the burden of supplying power has been removed to a grounded-base circuit, this input transistor operates at near optimum for minimum temperature and

## ELECTRONICS

leakage effects. Grown-junction transistors like the 2N78, 2N150, 2N165, 2N168A and 2N293 (or any low-power transistor) may be used in this input stage.

One of the transistors must be p-n-p and the other n-p-n. Because of the reversed characteristics of these two classes of transistors, amplified current from the input transistor flows from its emitter into the emitter of the grounded-base transistor. Fig. 5-a is sensitive to positive input signals and Fig. 5-b to negative signals.

The optimum working conditions for the first stage obviate the need for reverse bias, unless the temperatures are high or the transistor very poor in regard to leakage or  $I_{co}$  temperature effects.

If a reverse bias is needed—indicated by high relay coil current with no input



Fig. 7—Simple circuit protects transistors against excessive input.

signal—it can be taken from the relay collector supply through resistor  $R_b$ , shown in dashed lines.  $R_b$  should have a value of about 10,000 ohms per volt of relay collector voltage.

A small resistor is in series with the input transistor's collector. It protects the transistor from excessive collector current, caused by input-signal overloads.

### Very-high-gain circuit

Tacking on another current amplifier, we come up with the high-gain amplifiers of Figs. 6-a and 6-b. Depending upon the gains of the two current-amplifying transistors, these circuits give current gains from about 75 to over 2,000.

Usually a reverse bias is necessary for these high-gain circuits. Use the values given for  $R_b$  in the preceding circuits (10,000 ohms). Or, and this is even better, connect a 100,000-ohm thermistor such as the VECO 51R2 in place of  $R_b$  and connect it to a tap on the relay collector battery that will reduce relay current to say 50 ma. A tap of 3 or 4.5 volts, from the relay collector battery, would be typical.

Fig. 7 is a circuit to protect the input transistors from accidental burnout due to excessive input signals. Use the same diode type as D1 in the preceding diagrams. This circuit is used when more than 10 ma of input signal could exist. Grown-junction transistors have a delicate base lead that is faster than the fastest fuse. This circuit protects your transistor by offering a high resistance to large signals, but little resistance to small signals.

These circuits are useful for amplifying the outputs of self-generating selenium photocells, the CdS or new CdSe photocells, thermistor thermometers, small dc signals from radio control circuits, and for innumerable industrial applications. I have shown you some first-class transistor-relay circuits. Now let's see what you can do. END

Convince yourself at no risk that CENTURY instruments are indispensable in your every day work.

# SHIPPED ON APPROVAL SEND NO MONEY — NO C.O.D.

Examine instruments for 10 days before you buy . . . Only then, when satisfied pay in "easy to buy" monthly installments.



Save valuable servicing time and earn extra money with the FC-1

handsome hand-rubbed oak carrying case

Model FC-1W \$58<sup>50</sup> factory wired

Model FC-1K \$48<sup>50</sup> semi-kit

## Just 2 settings on the NEW FAST-CHECK TUBE TESTER

Model FC-1

tests all tubes completely, accurately and in seconds — RIGHT ON THE SPOT

The FC-1 is the only tube tester in its price range to give a complete tube test of over 600 tube types in seconds without multiple switching or annoying checking of roll charts. You make every call pay extra dividends by merely showing your customer the actual condition and life expectancy of the tube. The extra tubes you sell each day will pay for the FAST-CHECK in a very short time.

### WIDE RANGE OF OPERATION

Checks quality of over 600 tube types, which covers more than 99% of all TV and radio tubes in use today, including the newest series-string TV tubes, auto battery-type 12 plate-volt tubes, 0Z4s, magic eye tubes and gas regulators. Checks for cathode-heater and cathode-grid shorts and detects inter-element leakage up to 1.5 megohms. Checks for life expectancy.

Model AD-1 PICTURE TUBE ADAPTER — Also available for the FC-1. Checks all picture tubes (including the new short-neck 110 degree RCA-type picture tubes) for cathode emission, shorts and life expectancy. Also rejuvenates and restores cathode emission of weak picture tubes. Model AD-1 (factory wired only) . . . \$4.50

### OUTSTANDING VALUE FEATURES

Checks each section of multi-purpose tubes simultaneously. If one section is defective the tube will read "Bad" on the meter scale. 41 tube sockets accommodate all present and future tube types. Less than 10 seconds required to test any tube. Large D'Arsonval type meter is extremely sensitive, yet rugged . . . with two multi-color "Good-Bad" scales. Selection of 12 filament voltages. Line isolated. 7-pin and 9-pin straighteners mounted on panel. Large easy-to-read quick reference chart for over 600 tube types in use today. New tube listings furnished periodically.

Here's an in-circuit condenser tester that does the whole job!

## The IN-CIRCUIT CONDENSER TESTER Model CT-1

Actually steps in and takes over where other in-circuit condenser testers fail. The tremendous range of operation makes it an absolute must for every serviceman.

**Checks in-circuit:** Quality . . . including leakage, shorts, opens, and intermittents. Value of all condensers 200 mmfd. to .5 mfd. Electrolytics for quality — any size. Transformer, socket and wiring leakage capacity.

**Checks out-of-circuit:** Quality . . . including leakage, shorts, opens and intermittents. Value of all condensers 50 mmfd. to .5 mfd. Electrolytics for quality — any size. High leakage to 300 megohms. New or unknown condensers.

### JUST A FEW FEATURES OF THE CT-1

Ultra-sensitive 2 tube drift-free circuitry. Multi-color scale gives simultaneous readings of both quality and value in-circuit or out-of-circuit. Cannot damage circuits. Electronic eye balance indicator for even greater accuracy. Line isolated. Fully shielded.

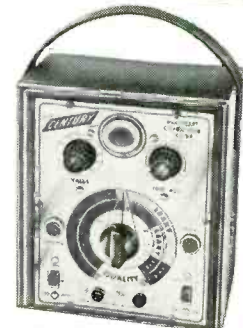

Model CT-1W \$34<sup>95</sup> factory wired

Model CT-1K \$24<sup>95</sup> kit form

## CENTURY ELECTRONICS CO., INC.

111 Roosevelt Ave., Dept. 101, Mineola, N.Y.

Please rush the instruments checked for a 10 day examination period. If satisfied I agree to pay the down payment within 10 days and the monthly installments as shown. If not completely satisfied I will return the instrument within 10 days and there is no further obligation. It is understood there will be NO CARRYING CHARGES. Should I fail to make payment when due, the full unpaid balance shall become due and payable at once.

Name.....

Address.....

City..... State.....

Prices Net F.O.B. Mineola, N.Y.

- Model FC-1W (wired).....\$58.50  
\$13.50 within 10 days. Balance \$11.00 monthly for 4 months.
- Model FC-1K (semi-kit).....\$48.50  
\$12.50 within 10 days. Balance \$9.00 monthly for 4 months.
- Model AD-1 CRT Adapter.....\$4.50
- Model CT-1W (wired).....\$34.95  
\$9.95 within 10 days. Balance \$5.00 monthly for 5 months.
- Model CT-1K (kit).....\$24.95  
\$9.95 within 10 days. Balance \$5.00 monthly for 3 months.

# POWER FAILURE ALARM

*A robot reporter that calls attention to even momentary interruptions.*

By **GEORGE P. PEARCE**

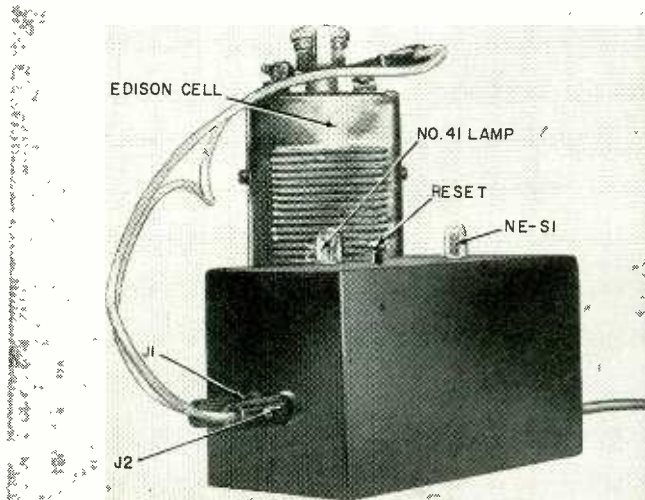

The Robot Reporter hooked to its external battery.

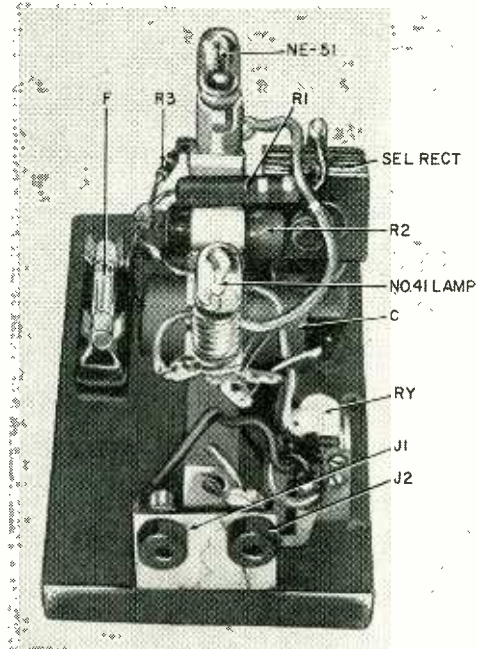

Component layout inside the case.

It is very important with some electronic assemblies — motor-operated devices, battery charging equipment, automatic timers, etc.—to know if the electric power has failed even momentarily because relays may have dropped to open circuits, time records may be messed up and many important tests need corrections for power failures.

At the first glance this may seem very simple. All that appears necessary is to put a 117-volt relay across the power line and watch it. Power failure trips the relay and, when you notice that the armature has fallen, you know there has been a power failure. Unfortunately, this is not practical. For the first few days you may glance at the relay frequently but it soon becomes a familiar sight and then is rarely noticed.

The most satisfactory setup is that which—when power fails—operates a small relay arrangement that instantly switches on a warning light. This type of indicator is very satisfactory, for the light promptly catches the eye. Power for the light is supplied by a small storage cell. The cell is constantly charged by rectifying the small current required to energize the relay

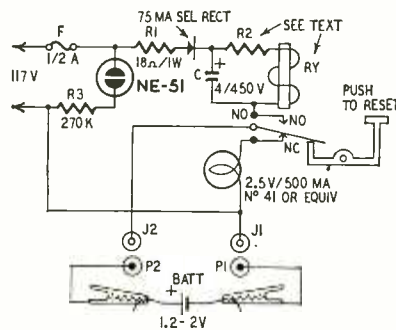

- R1—18 ohms, 1 watt
- R2—see text
- R3—270,000 ohms, 1/2 watt
- C—4 uf, 450 volts
- BATT—1.2-2 volts, Edison cell or equivalent
- F—1/2 amp
- J1, 2—banana jacks
- PI—2.5 volt, 500 ma (No. 41 or equivalent)
- RECT—selenium, 75 ma, 130 volts
- RY—see text
- Neon lamp, NE-51
- Pilot lamp, 2.5 volts, 500 ma (No. 41 or equivalent)
- Pilot-lamp assembly, bayonet base
- Pilot-lamp assembly, screw base
- Alligator clips (2)
- Case
- Chassis
- Miscellaneous hardware

Fig. 1—Circuit of the handy indicator.

and passing the direct current the same as a trickle charger does.

(Operators of frozen-food lockers, hatcheries and similar businesses may require immediate notice of power

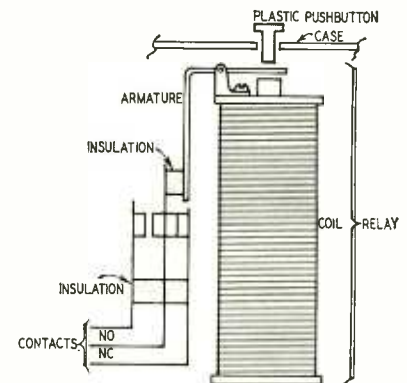

Fig. 2—Adding reset button to relay.

failure. In these cases, the pilot lamp may be replaced by a buzzer or bell and the battery voltage raised to the level needed to operate the alarm.—*Editor.*)

A very simple and dependable design is shown in the photos and Figs. 1 and 2.

### How it works

This little robot can be plugged into any standard circuit that requires a continuous check. It is designed so that the instant the circuit is energized, the

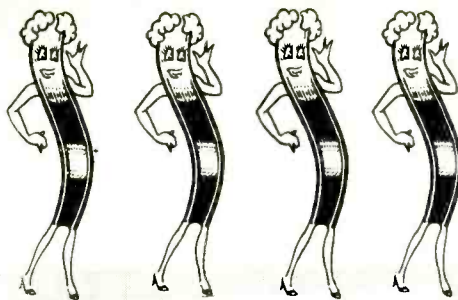

## Which one can prove her QUALITY?

Most brands of twin lead look alike! Also, the price brands make the same claims of quality and performance as the top quality brands.

### What Reason . . . What Proof

Can you give your customer that he is getting something better when he pays a little more for twin lead?

WITH  
**Columbia**  
**PERMALINE**

Your Customer has the reason

So GOOD that it's  
GUARANTEED up to 25 YEARS!

DISTINCTIVE APPEARANCE

HIGH MOLECULAR WT. POLYETHYLENE

DEVELOPED AFTER YEARS OF RESEARCH

See your Jobber . . .

Ask him about Permaline — and ask to see the Laboratory Report on weathering studies of Polyethylene.

Once you "Try" COLUMBIA . . . you'll want to always "Buy" Columbia . . . Because only, but only COLUMBIA gives you a complete guarantee for 25 YEARS.

AVAILABLE AT ALL LEADING DISTRIBUTORS

**Columbia**  
**WIRE & SUPPLY CO.**  
2850 IRVING PK. RD., CHICAGO 18

## E-L-E-C-T-R-O-N-I-C COMPUTERS

Instruction in Analog and Digital computers, Automation, Computer language, Robots and Electronics. Low priced courses for beginners and advanced experimenters. Courses start at \$12.50. Study a few hours per week. Time payments available.

EBEX school,  
1015 Atkin Ave., Salt Lake City 6, Utah

- Send free catalog
- Send info on digital computer kits
- Send info on robot construction

Name .....

Address .....

## ELECTRONICS

NE-51 glows. As long as it is glowing, you know that the power is on. Suppose, some time during the night a power failure occurs. The neon lamp goes out, the relay drops out and the No. 41 warning lamp is switched on. The Edison cell will keep the warning lamp lit for about 4 days. This provides ample reserve, even over weekends.

Power may come back in a second or perhaps not for several hours, but the warning light will immediately signal the first person who approaches that there has been a power failure. The engineer in charge can check promptly all parts that may have been affected. After the check, a slight tap on the plunger (white button) closes the relay armature, cuts the warning light out of the circuit and starts the storage battery on its recharging cycle.

The alarm advises the operator when any of the following events occur:

1. No power failure. Indicated by the neon lamp burning and the warning lamp out.

2. Power failure was corrected; power restored. Indicated by the neon lamp and the warning lamp being lit.

3. Power failure; power still off. Indicated by the neon lamp being out and the warning lamp lit.

When the alarm is not in use, the warning lamp must be loosened in its socket or the storage cell disconnected. Otherwise the lamp will burn until the battery runs down. This is a good arrangement for, when the alarm is next used, the warning lamp should light before power is switched on and the plunger pressed down to lock the armature. Thus, the cell and lamp are automatically checked. The life of the lamp is unusually long in this service because it is designed for 2.5 volts whereas the cell gives only 1.2 volts. If a brilliant light is desired use a lower voltage lamp.

It is important to note that the amount of current through the relay is controlled by resistor R2. This current must be only strong enough to hold the armature closed after it has been shut by pushing the plunger. The current must not be strong enough to attract the armature automatically to its closed position. The relay I used has a 300-ohm coil and requires 45 ma to close automatically. But 25 ma is enough to hold it closed. Thus, if a 25-ma current is flowing, as soon as the armature is manually closed, it stays closed until power fails.

Resistor R2 was selected to permit only 25 ma to flow with a 117-volt line potential. The current flowing is not too critical and it is not necessary to measure it with a milliammeter. A little experimenting with various resistors is all that is required. First use, say 5,000 ohms. If it does not hold the relay closed, use smaller resistances until one is found that will pass enough current to hold the relay closed and yet not enough to cause it to automatically close when it is connected to the monitored circuit.

END

## NOW READY! McGraw-Hill's New

### Train-Yourself Course

6 BIG VOLUMES

Including HOME COURSE OUTLINE!

Shows how to Get Ahead Fast.

# FIX TV RADIO

AND

# RECORD CHANGERS RIGHT AWAY

AT LAST—at Amazing LOW COST—The Most Complete TV-Radio Repair Course Ever Published. TELLS and SHOWS How to Do Every Job Quickly and Easily—Make GOOD MONEY, Full or Spare Time

AFTER 10 YEARS OF PREPARATION — McGraw-Hill's new 6-Volume Course brings you everything you need to know to "cash in" on the TV-RADIO boom. Over 2,350 pages of money-making "know-how" by top factory engineers and electronic experts. THREE giant REPAIR MANUALS tell and show how to FIX every trouble the easy way! TWO TROUBLE-SHOOTER MANUALS tell exactly WHERE to begin, WHAT tools to use, HOW to increase your professional speed. Complete Home Study Volume guides you every step of the way, tells how to get ahead fast—build up your own business, full or spare time.

### BIG MONEY — Spare or Full Time

No previous training needed. NO complicated formulas. PLAIN ENGLISH pictures and directions cover ANY kind of job on EVERY set—tubes, circuits, speakers, new a-c/d-c portables. Color TV, even what to charge for typical jobs!

### SEND NO MONEY

Try Course 10 days FREE. (We pay shipping!) If you don't agree it can get you started in a money-making repair business — return it, pay nothing. Otherwise keep it. Earn while you learn; and pay the low cost on easy terms. Mail coupon NOW. McGraw-Hill Book Co., Dept. RE-1, 327 West 41st St., N. Y. City 36.

### PARTIAL CONTENTS

① Television and Radio Repairing — 566 pages. 700 pictures, diagrams. By John Markus, Feature Ed., Electronics Magazine.

② Practical Radio Servicing — 599 pages. 473 illus. By William Marcus, Alex Levy, Electronic Training Experts.

③ Profitable Radio Troubleshooting — 330 pages. 153 "how-to" illus. By William Marcus, Alex Levy.

④ Profitable TV Troubleshooting—Short-cuts to spot and fix every trouble. By Eugene A. Anthony, Service Consultant, General Elec. Company.

⑤ Repairing Record Changers — 278 pages. 202 A-B-C pictures. By Eugene Ecklund, Eng. DuMont Lab., Inc.

⑥ Complete Home Course Outline — How to get the most out of your Course. By John Markus.

FREE THREE Valuable Repair Aids TV, RADIO and CIRCUIT Detect-O-Scopes Total Retail Value \$3.00

FREE—THREE amazing DETECT-O-SCOPE Charts. TV and RADIO Scopes enable you to spot tube troubles in a jiffy. CIRCUIT Scope spots circuit troubles. Make fix-it jobs easier, faster. ALL THREE (worth \$3) FREE.

THIS COUPON SAVES YOU \$11.85

McGraw-Hill Book Co., Dept. RE-1, 327 West 41st St., New York 36, N. Y.

Send me—postpaid—for 10 days FREE TRIAL the 6-Vol. McGraw-Hill TV, Radio and Changer Servicing Course. If okay, I'll remit only \$4.95 in 10 days; then \$5.00 monthly for 5 months. (A total saving of \$11.85 on the regular price of the Course and Detect-O-Scopes.) Otherwise, I'll return Course in 10 days; pay nothing.

ALSO send FREE (to keep whether or not I keep the Course) the 3 TV, RADIO, and CIRCUIT DETECT-O-SCOPE CHARTS,—total value \$3.00.

Name..... (Please Print Clearly)

Address.....

City..... Zone No. (if any)..... State.....

CHECK HERE if you prefer to enclose first payment of \$4.95 with coupon. Same easy pay plan; same 10-day return privilege for full refund.

RE-1

# 'SCOPES ARE "GOLD MINES"

... When you learn to use them RIGHT ... on all kinds of service jobs!

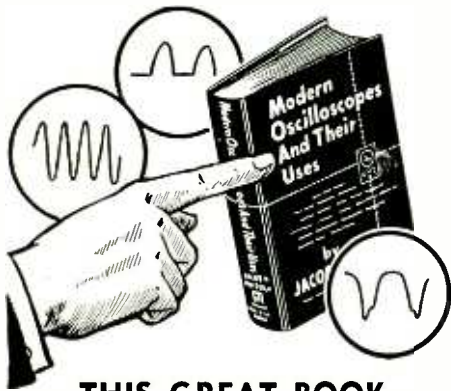

**THIS GREAT BOOK TELLS ALL YOU NEED TO KNOW ABOUT THEM!**

## Big 2nd Edition

Contains Latest Data and More Than 30 Extra Pictures.

Includes use of 'scopes in color TV ... black and white TV ... Radio ... Industrial Electronics ... Teaching ... even in atomic energy work!

Here's the "secret" of servicing any radio or Television set ever built ... easier, better and faster!

In plain language, MODERN OSCILLOSCOPES AND THEIR USES brings you the data on 'scopes that you really need. It teaches you when, where and exactly how to use oscilloscopes on all types of jobs.

You can learn how to handle tough jobs easier and faster than you may have thought possible. Every detail is clearly explained—from making connections to adjusting components and setting the controls.

### WORK EASIER—BETTER—FASTER

Equally important, you learn how to analyze oscilloscope patterns accurately and in less time. Almost 400 illustrations including dozens of pattern photos make every step perfectly clear.

This famous book—now in its revised 2nd Edition—is more widely used than any other of its type. That's because it gets right down to "brass tacks" in a way you can hardly fail to understand. No complicated mathematics. No involved theoretical discussions. You learn exactly how to use your oscilloscope on all types of AM, FM and television service (including color TV). You learn each step of the work fully—from locating troubles fast to handling tough realignment jobs.

### PRACTICE 10 DAYS FREE!

Dept. RE-18, RINEHART & CO., INC.  
232 Madison Ave., New York 16, N.Y.

Send 2nd Edition of MODERN OSCILLOSCOPES for 10-day FREE EXAMINATION. I will then remit \$6.50 (plus postage) promptly in full payment or return book and owe you nothing. (SAVE! Send \$6.50 with order and we pay postage. Same 10-day return privilege with money refunded.)

Name.....

Address.....

City, Zone, State.....

OUTSIDE U.S.A.—Price \$7.00, cash with order. Money back if you return book in 10 days.

## ELECTRONICS

# Sensitive Photocell

By I. QUEEN

EDITORIAL ASSOCIATE

THE cadmium sulphide (CdS) photocell is far more sensitive than previous cells and compares well with germanium phototransistors. Photocells have been used for two general purposes: for control, as with a relay, and for measuring light intensity. The CdS cell can be used for both since it can supply over 1-ma output where required, yet its response is linear at low illumination. It is sensitive to X-rays, gamma rays and infra-red.

The cadmium sulphide cell has one disadvantage and one big advantage when compared with the popular selenium cell which needs no power supply; the cadmium type must be supplied with either ac or dc up to about 200 volts. This is not an important problem, since the needed power is very small. The big advantage is sensitivity. A typical selenium cell puts out 13  $\mu$ a at 100 foot-candles. The type CL-2P Clairex (cadmium sulphide) cell puts out 100  $\mu$ a at 2-foot-candles. This comparison is made with cells having approximately the same diameter ( $\frac{1}{4}$  inch).

Because of its small size and high sensitivity, the CL-2P and similar cells may be pinpointed directly on a luminous target. Also, it may be hidden in a convenient location or made inconspicuous. For extremely high sensitivity, it is a simple matter to rig up some sort of optical or focusing system to increase the illumination on the cell.

Although the CdS cell requires a high voltage to excite it, the current input is fortunately very small. Therefore a transistor oscillator and diode voltage doubler is sufficient. The diagram shows such a power supply which puts out 60 volts or more for a photocell. This circuit is described in more detail in RADIO-ELECTRONICS for December, 1955, page 61. Briefly, the transistor oscillates at af, which is stepped up and then rectified by the diodes. The penlight cells must supply only about 3 ma so they will have long life. When size AA cells are used, this represents an operating cost of about .04 cent per hour.

Just what do we mean by high sensitivity? Well, here are typical measurements made on the photocell powered by a transistor oscillator.

An output of about 100  $\mu$ a through 100,000 ohms (that is, about 10 volts) is available from the following sources of illumination: a 14-watt fluorescent lamp at a distance of 2 feet; the beam from a two-cell flashlight at 5 feet; a clear sky through a window, even after sunset. A supersensitive relay will easily operate on this output. For example, a Barber-Colman type O high-impedance relay operates on about 100  $\mu$ a at 1 volt.

The above output is by no means the maximum obtainable from the circuit. It

may be increased by applying greater input power to the transistor oscillator. One method is to reduce the base resistance. Alternatively, three or four cells may be used to power the oscillator, to increase the output voltage and power.

As examples of weaker light measurements, the following sources provide about 25  $\mu$ a output through 25,000 ohms: a pair of 40-watt incandescent lamps at a distance of 8 feet or a pilot lamp (No. 47) at 6 inches. A lighted match deflects the meter to 6  $\mu$ a at a distance of 6 inches.

The optimum load for the photocell is not a critical value. It lies between 10,000 and 50,000 ohms.

Many practical applications suggest

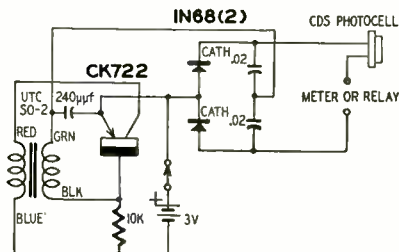

1—10,000-ohm resistor,  $\frac{1}{2}$  watt; 1—240- $\mu$ F capacitor; 2—.02- $\mu$ F capacitors; 1—CK722 transistor; 2—IN68 crystal diodes; 1—spst switch; 1—audio transformer, 1:3; primary impedance 10,000 ohms, secondary 90,000 (UTC SO-2 or equivalent); 1—3-volt battery for transistor supply; 1 chassis.

Power supply used with the photocell.

themselves for this circuit. Any weak sources of illumination may be compared, measured or calibrated. For example, one common method of measuring rf power is to measure its heating effect on a filament. The brilliance of the filament is compared with that of a known lamp fed from a known source. For example, if a lamp gives the same illumination as that of a 25-watt lamp fed from the line, rf power is 25 watts.

The density of filters, films or paper may be measured and compared. For example, a filter may be placed between the cell and a standard source of illumination and the meter will indicate the amount of light transmitted. The small window of the cell ( $\frac{1}{4}$ -inch diameter) permits accurate measurements.

Even the light reflected from a dark wall or other surface will give readings of several microamperes. With suitable calibration the instrument becomes a photographic exposure meter.

The angle from which light can fall on this photocell is easily controlled. The cell is fitted into a polystyrene tube whose inner diameter is  $\frac{1}{4}$  inch. This makes a neat fit. The tube should be painted black. As the cell is pushed deeper into the tube, the shield becomes more effective and the angle more limited. END

build with  
the best...

# JBL signature loudspeakers!

The careful work you do in building your high fidelity sound system will be shown off to best advantage if you use precision-made JBL SIGNATURE Loudspeakers. These are the most efficient units to be found anywhere, made with the most exacting care, meticulous attention to detail. Remember, it takes no more effort on your part to build with the best.



**MODEL D130**  
15" Extended  
Range  
Loudspeaker

The only 15" extended range speaker made with a 4" voice coil is the world-famous JBL Signature D130. The large voice coil stiffens the cone for crisp, clean bass; smooth, extended highs. Your basic speaker, the D130 works alone at first, later becomes a low frequency driver when you add a JBL Signature high frequency unit and dividing network to achieve the ultimate excellence of a JBL Signature two-way system.



**MODEL D208**  
8" Extended Range  
Loudspeaker

A precision transducer in every sense of the word, the famed JBL Signature 8" D208 is made with the same care and precision as the larger units in the James B. Lansing Sound, Inc., line. If space and cost are major considerations, the D208, properly enclosed, provides the most lastingly satisfactory sound you can get. It is widely used in top quality systems where extension speakers are desired for areas other than the main listening room.



**MODEL D123**  
12" Extended  
Range  
Loudspeaker

With outstanding "presence" and clean response throughout the entire audio spectrum, the D123 features an unusual shallow construction. Only 3 1/4" deep, it is designed to mount flush with the wall, between studding, in any standard wall or partition. Frequently, the D123 is used in multiples in "infinite baffle" wall installations. In this case the JBL Signature D75 is a logical high frequency unit to add when you advance to a two-way system.



**MODEL D75**  
High  
Frequency Unit

Another exclusive for James B. Lansing Sound, Inc., is the ring radiator in the JBL Signature D75 high frequency unit. A ring, rather than a diaphragm, radiates into the annular throat of an exponential horn. The result is high frequency reproduction of unmatched smoothness and clarity, absolutely free of resonances and strident peaks. The horn is beautifully machined from aluminum, the entire unit a gratifying, solid piece of fine craftsmanship. Designed for crossover at 2500 cycles with the JBL Signature N2500 Network.



**MODEL 175DLH** High Frequency Assembly

The acoustical lens is only available on JBL Signature high frequency units. The 14 element lens on the 175DLH disperses sound within the listening area over a 90° solid angle, smoothly, with equal intensity regardless of frequency. The acoustical lens is the greatest contribution to life-like high frequency reproduction in 20 years, and it was developed for use with high fidelity equipment by James B. Lansing Sound, Inc. In addition to the lens the 175DLH consists of a high precision driver with complex phasing plug and a machined aluminum exponential horn. Designed for crossover at 1200 cycles with the JBL Signature N1200 Network.

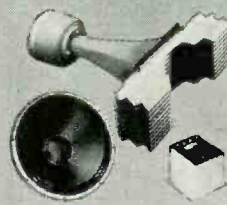

**JBL Signature  
Two-way  
Systems Are  
Available  
As Kits**

**086 KIT** This two-way system is made up of units which have been acclaimed by impartial authorities as the finest available anywhere today. Included in the kit are the 150-4C Low Frequency Driver, N500H Network, 375 High Frequency Driver, 537-509 Horn-Lens Assembly. These are the same units—including the serpentine acoustical lens—which are used in the Hartfield... units designed originally for installation in the most modern theaters in the world.

There are many more kits and loudspeakers in the JBL Signature line. Whatever your needs, you will find exactly the right unit or system in the complete JBL Signature catalog. Send for your free copy. A limited number of technical bulletins are also available. Please ask only for those in which you are vitally interested.



means  
**James B. Lansing Sound, Inc.**

**JAMES B. LANSING SOUND, INC., 2439 Fletcher Dr. • Los Angeles 39, Calif.**  
Please send me the following:

Free Catalog of JBL Signature Products  Name and address of Authorized JBL Signature Audio Specialist in my community

TECHNICAL BULLETINS ON:

D130  D123  D208  175DLH  D75  375  150-4C

Name \_\_\_\_\_

Address \_\_\_\_\_

City \_\_\_\_\_ Zone \_\_\_\_\_ State \_\_\_\_\_

# "ONE DOLLAR"

buys as much as \$15 worth

DEDUCT 10% ON ANY ORDER OF \$10 OR OVER

Plus a FREE SURPRISE PACKAGE

- 100 - ASSORTED FUSES popular sizes .....\$1
- 100 - ASSORTED 1/2 WATT RESISTORS .....\$1
- 70 - ASSORTED 1 WATT RESISTORS .....\$1
- 35 - ASSORTED 2 WATT RESISTORS .....\$1
- 10 - 6' ELECTRIC LINE CORDS with plugs .....\$1
- 5 - TV CHEATER CORDS with both plugs .....\$1
- 4 - 50' SPOOLS HOOK-UP WIRE 4 colors .....\$1
- 100' - TWIN LEAD-IN WIRE 300Ω heavy duty .....\$1
- 3 - \$1 RATCHET GUYWIRE ANCHORS .....\$1
- 50' - FLAT 4-CONDUCT. WIRE, many purposes .....\$1
- 1 - \$7 INDOOR TV ANTENNA hi-gain 3 section .....\$1
- 20 - ASST. TV KNOBS, ESCUTCHEONS, Etc. ....\$1
- 15 - ASSORTED ROTARY SWITCHES \$15 worth. ....\$1
- 100' - FINEST NYLON DIAL CORD best size .....\$1
- 200 - SELF TAPPING SCREWS #8 x 1/2" .....\$1
- 50 - ASST. TUBULAR CONDENSERS .....\$1
- 5 - ELECTROLYTIC CON. 100/50 - 50/25v .....\$1
- 35 - ASST. RADIO KNOBS screw and push-on. ....\$1
- 100 - KNOB SPRINGS standard size 3/8" x 1/2" .....\$1
- 100 - ASSORTED KNOB SET-SCREWS .....\$1
- 25 - ASSORTED CLOCK RADIO KNOBS .....\$1
- 400 - ASST. H'DWARE, screws, nuts, rivets, etc. ....\$1
- 50 - ASST. SOCKETS octal, noval and miniature. ....\$1
- 50 - ASST. MICA CONDENSERS some in 5% .....\$1
- 50 - ASST. CERAMIC CONDENSERS .....\$1
- 10 - ASST. VOLUME CONTROLS less switch .....\$1
- 5 - ASST. VOLUME CONTROLS with switch .....\$1
- 20 - ASST. PILOT LIGHTS popular types .....\$1
- 10 - PILOT LIGHT SKTS. bayonet type, wired .....\$1
- 50 - ASST. TERMINAL STRIPS 1, 2, 3, 4 lug. ....\$1
- 10 - ASST. RADIO ELECTRO. CONDENSERS .....\$1
- 5 - ASST. TV ELECTROLYTIC CONDENSERS .....\$1
- 15 - ASST. TV COILS sync. peaking, width, etc. ....\$1
- 25 - ASST. MICA TRIMMER CONDENSERS .....\$1
- 50 - TUBULAR CONDENSERS .02-400v. ....\$1
- 50 - TUBULAR CONDENSERS .001-600v. ....\$1
- 20 - TUBULAR CONDENSERS .047-600v. ....\$1
- 50 - TUBULAR CONDENSERS .01-400v. ....\$1
- 3 - ELECTROLYTIC COND. 40/40-450v. ....\$1
- 3 - ELECTROLYTIC COND. 80-450v. ....\$1
- 3 - ELECTROLYTIC COND. 50/30-150v. ....\$1
- 3 - ELECTROLYTIC COND. 40/40-450v. ....\$1
- 3 - ELECTROLYTIC COND. 20/20-475,350v. ....\$1
- 3 - ELECTROLYTIC COND. 50/25/10-150v. ....\$1
- 15 - TUBULAR CONDENSERS .015-1800v. ....\$1
- 10 - HV TUBULAR CONDENSERS .006-1800v. ....\$1
- 10 - HV TUBULAR CONDENSERS .008-2000v. ....\$1
- 10 - HV TUBULAR CONDENSERS .005-3000v. ....\$1
- 10 - HV TUBULAR CONDENSERS .001-6000v. ....\$1
- 10 - HV TUBULAR CONDENSERS .005-6000v. ....\$1
- 35 - MICA COND. 20-100 mmf & 15-250 mmf .....\$1
- 35 - MICA COND. 20-470 mmf & 15-1000 mmf .....\$1
- 35 - MICA COND. 20-680 mmf & 15-100K mmf. ....\$1
- 35 - CERAMIC COND. 20-25 mmf. & 15-47 mmf. ....\$1
- 35 - CERAMIC COND. 20-68 mmf & 15-1500 mmf. ....\$1
- 35 - CERAMIC COND. 20-250 mmf & 15-880 mmf. ....\$1
- 50 - 100Ω 1/2 WATT RESISTORS 5% .....\$1
- 75 - 680Ω 1/2 WATT RESISTORS 10% .....\$1
- 75 - 470KΩ 1/2 WATT RESISTORS 10% .....\$1
- 50 - 3.3Ω 1 WATT RESISTORS 10% .....\$1
- 50 - 15KΩ 1 WATT RESISTORS 10% .....\$1
- 50 - 470KΩ 1 WATT RESISTORS 10% .....\$1
- 25 - 2.2Ω 2 WATT RESISTORS 5% .....\$1
- 25 - 3.3Ω 2 WATT RESISTORS 5% .....\$1
- 25 - 10KΩ 2 WATT RESISTORS 5% .....\$1
- 10 - ASST. WIREWOUND RES. 5, 10, 20 watts. ....\$1
- 3 - AUDIO OUTPUT TRANSFORMERS 50L6 type. ....\$1
- 3 - AUDIO OUTPUT TRANS. 6K6 or 6V6 type .....\$1
- 3 - I.F. COIL TRANSFORMERS 456 kc .....\$1
- 3 - I.F. COIL TRANSFORMERS 10.7 mc FM .....\$1
- 4 - OVAL LOOP ANTENNAS ass't hi-gain types. ....\$1
- 3 - LOOPSTICK ANT. new ferrite, adjustable .....\$1
- 12 - RADIO OSCILLATOR COILS 456 kc .....\$1
- 3 - 1/2 MEG VOLUME CONTROLS with switch .....\$1
- 5 - 50K VOLUME CONTROLS less switch. ....\$1
- 3 - VARIABLE CONDENSERS 420/162 mmfd. ....\$1
- 10 - SURE GRIP ALLIGATOR CLIPS .....\$1
- 1 - 5" PM SPEAKER alnico #5 magnet .....\$1
- 5 - SETS SPEAKER PLUGS, wired .....\$1
- 10 - SETS PHONO PLUGS and PIN JACKS. ....\$1
- 2 - \$2.50 SAPPHIRE NEEDLES 4000 playings. ....\$1
- 5 - DIODE CRYSTALS 2-IN21 2-IN23 1-IN64. ....\$1
- 1 - TV VERT. OUTPUT TRANS. 10 to 1 ratio. ....\$1
- 5 - TV CRT. SOCKETS with 18" leads. ....\$1
- 5 - HI-VOLT. ANODE LEADS with 18" leads. ....\$1
- 1 - TV SYNCHROGUIDE TRANSFORMER #205R1 .....\$1
- 1 - TV SYNCHROLOC TRANSFORMER #208T8 .....\$1
- 1 - LB SPOOL ROSIN CORE SOLDER 40/60. ....\$1
- 6 - SPIN TIGHT SOCKET SET 3/16" to 7/16". ....\$1
- 3 - TV ALIGNMENT TOOLS 5", 7", 12". ....\$1

HANDY WAY TO ORDER—Simply tear out advertisement and pencil mark items wanted, enclose with money order or check. You will receive a new copy of this ad for re-orders.

ON SMALL ORDERS—Include stamps for postage, excess will be refunded. Larger orders shipped express collect.

**BROOKS RADIO & TV CORP.**  
84 Vesey St. Dept. A, New York 7, N.Y.



It has always been the purpose of this column to review new recordings with the accent on the technical and aural excellence achieved by each record. For our purposes, the fidelity of a recording is just as important as its musical and aesthetic excellence, if not more so. In the past, we have restricted ourselves principally to the review of long-playing discs. However, high-fidelity reproduction now includes another important recording medium: prerecorded tapes.

The potential of prerecorded tape rests in stereophonic recordings. A good guess is that in less than 10 years the stereophonic recording will replace the present long-playing record in popularity. We say this confidently because a practical dual-channel, single-groove stereophonic LP is certain to be developed and perfected during the next decade.

Some stereo playback systems incorporate a third speaker placed midway between the outer two and connected so that it produces an output which is the sum of both stereo channels. This "bridge" speaker is sometimes helpful for minimizing the "hole-in-the-middle" effect which is present, to some extent, in two-channel stereo recordings. This is because the two stereo microphones are a considerable distance from the musical instruments on the center of the stage and those instruments are recorded at lower volume than they are actually performing. On playback, the lower volume of these center instruments is heard as an apparent volume "hole" midway between the two outer speakers. We did not include a bridge speaker in our setup for reviewing because the evaluation of the "hole-in-the-middle" effect present in each stereo tape is an important indication of the quality of the recording technique used.

A new year is upon us. For our new tape and disc column, 1958 is full of promise, with provocative record developments in the offing. We will share some of this excitement with you monthly in our expanded column.

### THE BEST STEREO TAPES OF 1957

Best Recording: For Outstanding Fidelity and Performance. BERLIOZ: *Symphonie Fantastique*—Munch: BSO (RCA Victor GCS-6; \$18.95)

Best Chamber Work:

STRAVINSKY: *L'Histoire du Soldat*—Mandell: Ars Nova (Sonotape SWB-8013; \$11.95)  
Best Symphonic Band:

*Brass and Percussion*—Morton Gould Band (RCA Victor CCS-30; \$10.95)

Best Orchestral Suite:

BIZET: *Carmen Suite*—Paray: DSO (Mercury MDS-3; \$12.95)

Best Choral Work:

*Christmas Hymns and Carols*—Robert Shaw Chorale (RCA Victor CCS-86; \$10.95)

Best Organ Work:

*Boardwalk Pipes*—Elmore (Mercury MDS-5; \$12.95)

Best Stereo Demonstration:

*Sounds of the Subway* (Sonotape SWB-8013; \$11.95)

Best Stereo Concerto:

BEETHOVEN: *Concerto in D*—Heifetz: Munch: BSO (RCA Victor FCS-24; \$16.95)

Best Dance-Band Recording:

*The Mightiest Little Band*—Lenny Herman (Livingston 1083-BN; \$11.95)

Best Collection and Packaging:

*The Orchestra*—Stokowski Orchestra (Capitol ZH-8; \$16.95)

Best Stereo Sampler:

*Demonstration Tape Number Two* (Concert Hall BX-37; \$4.)

## "OUTPERFORMS THEM ALL"



I. J. Saltzman, Globe Sound Service, Jamaica, N. Y., experienced commercial sound engineer, says: "On side by side comparison test, the CJ-44 outperforms them all."

## NEW! ATLAS "King Cobra-Jector" CJ-44



Shown with GB-1 Universal Mounting Bracket.

Complete with "Acousti-Match" Built-in Driver Unit  
List \$72.50  
NET \$43.50

A wide-angle, all-purpose, all-weather Public Address Speaker, complete with integral high-power super-efficient "Acousti-Matched" driver unit. "Acoustic-Matched" means "Controlled Response" within the frequency limits most useful in P. A. and high level music reproduction. "Controlled Response" offers conversion efficiency never before obtainable in high-powered speakers. "Controlled Response" results in smooth reproduction — free from peaks which so often create and sustain acoustic feedback.

The CJ-44 conserves costly amplifier output power — fewer speakers do a complete job. The speaker horn is easily rotated for horizontal or vertical dispersion patterns.

The CJ-44 is the only high-powered P. A. speaker that can be equipped with the new Atlas Universal Mounting Bracket, permitting quick and secure directional adjustment on both planes. Simple to make a horizontal or vertical adjustment as a final "touch-up" to the installation.

The CJ-44 is designed for the "tough jobs." No gimmicks, no fluffs, no wild claims — just a reliable super-efficient speaker for all applications.

Input Power: 30 watts constant  
50 watts peak

Input Impedance: 16 ohms

Response: 150-9,000 cps

Dimensions: Bell 23" x 13";  
Over-all length 19"

Net Weight: 16 lbs.

Write for free Catalog 57.





**STEREOPHONIC RECORDINGS**

- STRAUSS: Die Fledermaus Overture**  
*Tales of Vienna Woods*  
*Blue Danube Waltz*  
 Barbirolli conducting Halle Orchestra  
 Mercury MDS5-4
- CARPENTER: Adventures in a Perambulator**  
 Hanson and Eastman-Rochester Symphony  
 Mercury MDS5-2
- Music for Hi-Fi Bugs**  
 Pete Rugolo and Orchestra  
 (Stacked only) Mercury MDS3-1

Mercury continues its issue of stereotapes that really show this medium off. The first two have the Olympian dynamic range which can be achieved so impressively on tape. Neither of these is as spectacular as previous Mercury tapes reviewed here, but the *Adventures* with its rather small sound and in-turn presentation of various sections of the orchestra is especially good in the directional effects, while the Strauss, presenting a big orchestra in big sound, is sure to impress.

The first Mercury pop is also excellent, with fine drums, very good string bass and lots of highs. Multiple miking produces a rather contrived but excellent stereo effect.

**Chicago-New York Audio Show Stereophonic Demonstration Tape**  
 Sonotape CNY (stacked or staggered)  
 (7-inch, playing time—14 minutes) \$6.95

It was interesting to note how the New York Audio Fair's top stereo demonstration tape fared in the living room. The effect is not as impressive at home. First, the Audio Fair setup used four speakers, two outer stereos, a center bridge and monaural, and a rear effects. When relegated to two stereo speakers, without the lighting effects used at the Fair, most of the impact is lost. The tape impresses those who have never heard stereo before but has little lasting value. The announcements get tiring with repetition. The musical selections are too

short; before you settle down with a selection, it's over. However, because of this brevity, there's plenty of variety here—riveters, spirituals, elephants, Christmas carols, four-engine bombers, howling alleys and, oh yes, full symphony orchestras. The fidelity and stereo effectiveness are very good and typical of Sonotape stereo quality. Not recommended for continued listening, but good for showoff material for stereo's power.

**Havana in Hi-Fi**  
 Richard Hayman and his Orchestra  
 Mercury MDS2-2 (stacked only)  
 (7-inch, playing time—33 minutes) \$12.95

Place an unusually large orchestra in front of two Telefunken U-47 capacitor mikes, add a gifted conductor, choose the right music and you've got the ingredients for hi-fi excitement. In *Rhapsodero* the mikes are close and the sonic impact of biting brass and percussive bass drum contrasted with soft solo guitar realistically recreates the impact so characteristic of Latin American music. The full fidelity of blaring brass and powerful bass at almost unbearably high power levels, so typical of the "living presence" technique, is thrilling in all quick-tempo rhythms. On the other hand, the lush, swaying lilt of South American sensuous rhythm is also faithful captured. Besides *Rhapsodero*, there's *My Hopeful Heart*, *Cordoba*, *Tropical Merengue*, *Maria-La-O*, *Caminito*, *La Comparsa*, *I Won't Stand in Your Way* and *Amor Que Bonito*. Only in the spacious realm of stereo can this changing, Cuban portrait be fully appreciated.

**Demonstration Tape No. 2: Highlights From Best Sellers**  
 Various Artists

Concert Hall BX-37  
 (stacked or staggered)  
 (7-inch, playing time—31 minutes) \$4

Through experience we have come to expect little from demonstration tapes of this type. This one's different. Concert Hall's refreshing approach produces a notable demonstration tape that contains seven selections from their stereo



USE *Jason W. Sams*  
**"AUTO RADIO REMOVAL" MANUALS**



**THE ONLY BOOKS OF THEIR KIND**

These books really help you solve the toughest problem in auto radio servicing. They give you step-by-step instructions for the easy removal of radio, power supply and speaker units from all 1955, 1956 and 1957 standard and sports model automobiles. Complete information is provided for each car covered: tools required for removal; phantom view of dash panel with radio in place (quickly locates chassis mounting nuts, bolts, cables, antenna and speaker leads); photo showing actual removal of radio. Includes rear-deck speaker data for each model; shows if cutout is provided, speaker size, and whether speaker control is included or required. Includes summary of preliminary servicing procedures which should be performed to determine whether radio removal is required to effect repair.

**ARR-57.** Covers all 1957 American stock and sports models. 120 pages, 5 1/2 x 8 1/2".

**ARR-56.** Covers all 1956 American stock and sports models. 104 pages, 5 1/2 x 8 1/2".

**ARR-55.** Covers all 1955 American stock and sports models. 104 pages, 5 1/2 x 8 1/2".

EACH VOLUME \$2.95 ONLY.....

SEE THESE BOOKS AT YOUR ELECTRONIC PARTS DISTRIBUTOR OR MAIL COUPON TO HOWARD W. SAMS TODAY



**FREE TRIAL COUPON**

Howard W. Sams & Co., Inc. Dept. 2-AA8  
 2201 E. 46th Street  
 Indianapolis 5, Ind.

Send me the book(s) checked below, for 10 days FREE examination. In 10 days, I will pay for the book(s), plus small delivery costs, or return them postpaid. (We pay delivery costs if you remit with this coupon; same return privilege.)

- ARR-57.  ARR-56.  ARR-55.

Name.....

Address.....

City.....Zone.....State.....

(outside U.S.A. priced slightly higher)

this.....

makes

this

.....

when you buy the fabulous

**AUDAX TONEARM KIT**

A screwdriver...15 minutes of your time...and the fabulous Audax tonearm kit—that's all you need to own your own compass-pivot Audax Professional Tonearm at a big saving! You'll find accurate assembly of this exclusive kit a very simple affair—with assurance that the final result will be as fine as factory-assembled units! Use any cartridge with your Audax arm. Thrill to the wonderful new difference it makes in your high fidelity system! See your dealer right now!

12" Tonearm Kit \$14.55 16" Tonearm Kit \$17.55

**AUDAX** • Div. of Rek-O-Kut Co., Inc., Dept. RA-5 38-19 108 St., Corona 68, N. Y.

**TRANSFORMER NEWS FROM TRIAD**

**YOKE SERVICING SIMPLIFIED**

CHANGE THIS

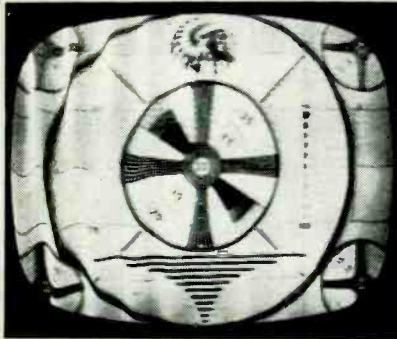

This is caused by improper value of horizontal damping network—or network mounted on wrong terminal.

TO THIS

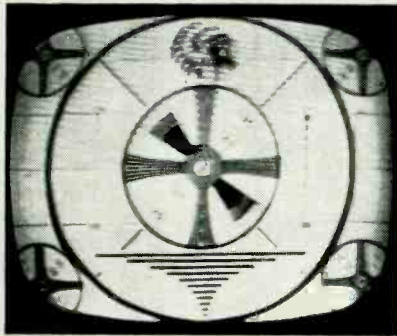

WITH THIS

FLYBACK	YOKE	NETWORK	VERT. OUT
738079 D-44	708176 Y-19(-3)	NW-1	738081 A-111X
738068 <sup>(1)</sup> D-43	708174 Y-41(-3)	NW-1	738066 A-118X
738078 <sup>(2)</sup> D-95 <sup>(2)</sup>	708174 Y-41(-3)	NW-4	738076 A-118
738099 <sup>(2)</sup> D-81	708176 Y-19(-3)	NW-1	

Correct yoke servicing\* information as listed in Triad's Television Replacement Guide TV-57. It is available at your distributor.

\*Bonus information to the PTM offered only by Triad.



4055 REDWOOD AVENUE, VENICE, CALIF.  
812 E. STATE STREET, HUNTINGTON, IND.  
A SUBSIDIARY OF LITTON INDUSTRIES

NEW RECORDS (Continued)

best sellers, and most of the excerpts are complete. Missing is the almost inevitable announcer with the long-winded sales pitch that made previous demonstrators annoying at first and unbearable in subsequent hearings. No 2-second samples here, but a full 31 minutes of music. Sam Price and his Kaycee Stompers play *Jonah Whales Again* from HX-16, the Varieton Concert Orchestra plays Waldteufel's *España* in its entirety from HX-27. *Sleepy Lagoon* by Marco Gregory's Orchestra is taken from HX-34, followed by an excerpt from HX-24, Ravel's *Ma Mere L'Oye* with the Padeloups Orchestra. The delightful Lahar *Merry Widow* (HX-17) is featured, followed by the finale of Beethoven's *Symphony No. 2 in D* with the powerful Frankfurt Opera Orchestra (HX-35), and, finally, the last movement of Gershwin's *Concerto in F* displaying the talent of pianist Sondra Bianca (from HX-30).

**IBERT: Escapes (Ports of Call)**  
Charles Munch conducting Boston Symphony Orchestra  
RCA Victor ACS-57 (stacked only)  
(7-inch, playing time—15 minutes)  
**\$6.95**

Ibert's score for *Escapes* calls for an unusually elaborate percussion section—military drum, four kettledrums, tambourine, bass drum, cymbals, xylophone, triangle, gong, castanets and celeste. This is ideal for the fame of the Boston Symphony rests in its percussion section and its drama. This charming work is rich with contrasts that show off this powerful orchestra and stereo to best advantage. The climax of the *Valencia* section is a truly exciting experience with snare drum, tambourine, kettle drums and strings on the left and brass and more percussion on the right, filling the entire room with sound. The transients are sharp, yet the orchestra is poetically smooth and silky. The performance is excellent, too. Good, relaxed stereo listening.

*Note: Records below are 12-inch LP and play back with RIAA curve unless otherwise indicated.*

**GERSHWIN: Concerto for Piano in F Rhapsody in Blue**  
Eugene List, Piano  
Hanson conducting Eastman-Rochester Symphony Orchestra  
Mercury MG-50138

The opening of the *Concerto* on this disc offers one of the most spectacular demonstrations of high fidelity you are likely to find, with terrific drums and big cymbals in near-life-sized dynamic peaks. Plenty of fireworks later on as well, and an excellent piano, to boot. The popularity of the music should make it all the more in demand. Though the peaks on this seem even more Olympian than usual for Mercury, they are also cleaner than usual and less likely to overdrive pickups, except on the inner grooves. The performance seems to me to be topnotch and altogether artistically the most satisfying version of this music for me, both artistically and sound-wise.

**Landmarks of a Distinguished Career**  
Stokowski

Capitol P-8399

For the third of its Stokowski recordings, Capitol has produced a concert of six popular classics. These are his very fine orchestral transcription of Bach's *Tocatta and Fugue in D Minor*, *Claire de Lune* and *Afternoon of a Faun* by Debussy, *Finlandia* and *Swan of Tuonela* by Sibelius, and *Blue Danube Waltz*. Unless you have definite and sophisticated ideas about music, this cannot fail to please, both for music and sound. The recording is up to the very high standard set by the previous two in this series—bright, clean, well-balanced and exceptionally well-defined despite the liveness. Between them, the works give a sampling of every variety of sound from the restful to the brassy, and show off the symphony orchestra beautifully. Both in tutti and solo the instruments are very natural, especially the string basses. END

Name and address of any manufacturer of records mentioned in this column may be obtained by writing Records, RADIO-ELECTRONICS, 154 West 14 St., New York 11, N. Y.

note:  
*Estimated 13/4 million portable TV sets to be sold in '57!*  
**Here's Your MARKET...**

for the  
**MOSLEY Flush Mount TV Socket**

**LOW LOSS**

**NEAT**

**EFFICIENT**



MODEL F-1PK

The tremendous demand for portable TV sets opens another BIG market for good set-to-antenna plug-in outlets. MOSLEY Flush Sockets meet this need—supplying attractive, convenient, customer-approved wall outlets for every installation requirement.

Without MOSLEY TV Outlets, portable TV—in most areas—ceases to be portable! Let MOSLEY TV Outlets spark YOUR Portable TV Sales!

For a complete line of up-to-date TV Accessories and Electronic Components send for our "57" catalog.

**Mosley Electronics, Inc.**

8622 ST. CHARLES ROCK ROAD  
ST. LOUIS 14, MISSOURI

**TAPE RECORDERS**

WHOLESALE PRICES

**HI-FI COMPONENTS**

NATIONAL BRANDS

WRITE FOR FREE CATALOGUE

**CARSTON**

215-TD E. 88 ST.  
NEW YORK 28, N. Y.

**LMB**

**"SAL-MET"**

LMB Presents The New

FREE 1957 CATALOG covering the full precision engineered line of original box chassis as manufactured by LMB including new Miniature, new Jiffy, new T.F., new Utility Boxes. Eleven different types, 160 different stages and sizes. A ready reference for engineers, experimenters, or anyone using metal boxes. Send for your FREE CATALOG now! "SAL-MET" Non-corrosive Flux—solders copper to aluminum, aluminum to aluminum, any metal to any metal using conventional solder and regular soldering methods. Send for both LMB and "SAL-MET" Catalogs.

LMB, 1011 Venice Blvd., Los Angeles 15, Calif.

# New Tubes & Semi-conductors

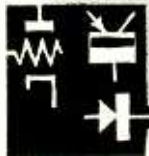

This month brings a 12-volt auto-radio tube, a 30-mc tetrode transistor, a 250-mc drift transistor and selenium replacements for the 6AL5.

## 12DL8

A multiunit tube of the 9-pin miniature type containing two diodes and a high-perveance power tetrode. It is intended for use in hybrid automobile receivers in which tube and transistor electrode voltages are obtained directly from a 12-volt storage battery. In these

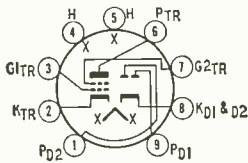

12DL8

sets the diode units are used for AM signal detection while the tetrode section acts as the driver for the transistor of power output stage.

Announced by both RCA and Sylvania, typical operating characteristics of the 12DL8 are:

$V_{b1r}$	12.6
$I_{b1r}$ (approx) (ma)	550
$V_p$	12.6
$V_{g2}$ (by rectification through a 2.2-megohm resistor)	-2
$V_{g2}$ (peak af from 100,000-ohm source)	2.5
$V_{g1}$	12.6
$I_r$ (zero sig) (approx) (ma)	40
(max sig) (ma)	8
$I_{g1}$ (ma)	75
$R_{load}$ (ohms)	800
Total harmonic distortion (%)	10
Max Sig power output (mw)	40
$R_{g2}$ (max) (megohms)	10
Maximum ratings each diode $I_r$ (ma)	5

## 2N384

A hermetically sealed drift transistor of the germanium p-n-p type, designed primarily for military and industrial use as an oscillator up to 250 mc or as an rf amplifier in compact mobile communications equipment. The 2N384, announced by RCA, features a base region in which the impurity distribution is carefully controlled to produce a built-in accelerating field.

Maximum ratings for class-A rf amplifier service are:

$V_{CB}$	-30
$V_{EB}$	-0.5
$I_C$ (ma)	-10
$I_E$ (ma)	10
$P_c$ (at 25° C) (mw)	120
(at 55° C) (mw)	70
(at 71° C) (mw)	35

# PRECISION

...manufacturers of fine electronic test instruments for over 25 years...

## INTRODUCES

# P A C O

quality test instruments in kit form

For the first time— a line of test instrument kits engineered and produced under the auspices of a major test equipment manufacturer... and conveniently available directly from your own local electronic parts distributor.

**PRECISION's** 25 years of experience is your assurance of PACO's superior quality, styling, performance and value.

### COMING SOON...

- Model G-30 — RF Signal Generator
- Model Z-80 — Audio-RF Signal Tracer
- Model M-40 — High Sensitivity V-O-M



Model V-70  
VACUUM TUBE VOLTMETER KIT  
wide-range • peak to peak.  
Net Price: \$31.50



Model B-10; BATTERY ELIMINATOR KIT  
• less than 0.3% ripple output  
• no external filter adaptors required  
Net Price: \$41.95

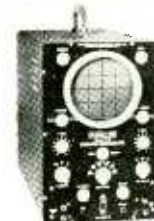

Model S-50  
5" CATHODE RAY OSCILLOSCOPE KIT  
push-pull vertical and horizontal amplifiers.  
Net Price: \$47.50



Model C-20  
RESISTANCE - CAPACITY-RATIO  
BRIDGE KIT  
10 mmfd to 2000 mfd  
1/2 ohm to 200 megohms.  
Net Price: \$20.95

Available and on display at leading electronic parts distributors. Write for descriptive bulletin.



Model T-60; TUBE CHECKER KIT  
full free-point lever selector system  
Net Price: \$36.75  
Matching, hinged, removable cover;  
Net Price: \$3.95

# P A C O

## ELECTRONICS CO., INC.

70-31 84th Street, Glendale 27, L. I., N. Y.

A DIVISION OF **PRECISION** Apparatus Company, Inc.

Export: 458 Broadway, New York 13, New York  
Canada: Atlas Radio Corp., Ltd., 50 Wingold Ave., Toronto 10, Ont.

... another  
**MALLORY**  
 service-engineered  
 product

*Months under Water...*



prove  
**MALLORY**  
 "GEMS"

*moisture proof*

To demonstrate how well Mallory "Gem" tubular capacitors resist moisture, we put some in plastic tubes filled with water. Months later, their internal resistance remains unchanged . . . proving there has been no moisture absorption.

Sure, you don't expect to submerge the capacitors you install. But when you're looking for top performance, even under the toughest humidity—always ask for Mallory "Gems."

Get your stock today from your Mallory distributor. He carries them in all popular ratings for by-pass and coupling applications.

P. R. MALLORY & CO. Inc.  
**MALLORY**

P. R. MALLORY & CO. Inc., INDIANAPOLIS 6, INDIANA

- Capacitors
- Vibrators
- Resistors
- Power Supplies
- Mercury and Zinc-Carbon Batteries
- Controls
- Switches
- Rectifiers
- Filters

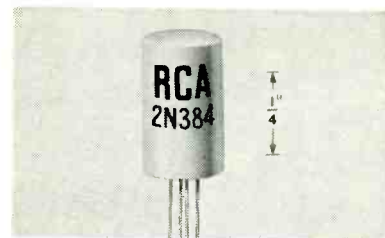

Basing is the same as the 2N274 (New Tubes and Semiconductors RADIO-ELECTRONICS, October, 1957).

**3N32, 3N33, 3N34**

These grown-diffused silicon tetrode transistors are especially designed and tested for amplifier applications at frequencies up to 30 mc.

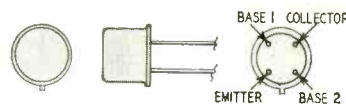

**3N32, 3N33, 3N34**

Made by Texas Instruments, the maximum ratings of these units are:

$V_C$	30
$I_C$ (ma)	10
$I_{B1}$ (ma)	5
$I_{B2}$ (ma)	5
Total power dissipation	
at 25°C (mw)	125
at 100°C (mw)	50
at 125°C (mw)	25
$I_{CO}$ ( $V_C = 20$ , $I_E = 0$ )	
(max $\mu a$ )	0.2
$BV_{CO}$ ( $I_C = 10 \mu a$ , $I_E = 0$ )	
(min)	30

3N32, 33, 34

Power gain, common emitter ( $V_C = 20$ , $I_E = -1$ ma, $I_{B2} = -0.3$ ma)			
(min db)	20	18	16
Frequency (mc)	4.3	12.5	30

**17BWP4**

Another addition to the line of 110° picture tubes, the 17BWP4 is a 17-inch rectangular glass tube made by Sylvania. It has a spherical faceplate,

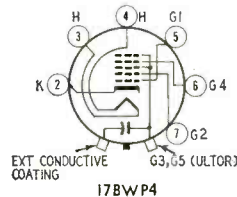

aluminized screen and a straight gun design which needs no ion trap. Its 6.3-volt 600-ma heater has an 11-second warmup time.

Maximum ratings are:

Ultor voltage	17,600
$V_{G1}$ (pos value)	1,000
(neg value)	550
$V_{G2}$	550
$V_{G1}$	
(neg bias value)	154
(neg peak value)	220
(pos bias value)	0
(pos peak value)	2

Peak heater-cathode voltage (htr neg with respect to cath)

(15-sec warmup)	450
(after warmup)	200
(htr pos with respect to cath)	200

**2N297**

A p-n-p alloy junction germanium power transistor designed for use in high-current switching and audio-frequency power amplifier applications.

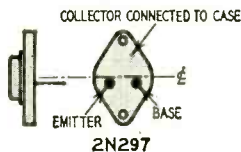

Announced by Clevite, the unit's maximum ratings are:

$V_{CB}$	-60
$V_{EB}$	-9
$I_E$ (amps)	5
Total power (watts)	15
Junction temperature ( $^{\circ}C$ )	85

**Selenium replaces 6AL5**

Selenium rectifiers, designed to replace 6AL5's in TV circuits have been released by G-E and Bradley Labs (illustrated).

The G-E assembly is center-tapped by connecting the two cathodes together.

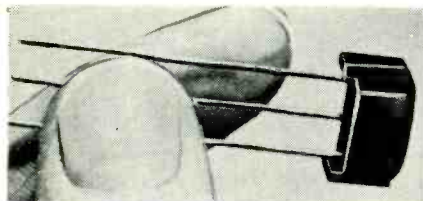

It is rated to handle a forward current of 0.5 ma at 2.0 volts dc, reverse current of 5  $\mu$ a at -20 volts dc.

The Bradley Labs unit can be used where the peak inverse voltage does not exceed 40. Specifications are: maximum applied voltage, 26 rms; maximum dc output voltage, 20.

**2N341**

A grown-junction, n-p-n silicon transistor designed for use in audio or servo amplifier stages requiring medium power output, this Texas Instruments

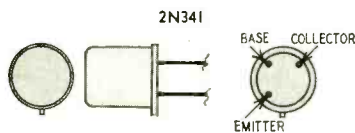

transistor has a welded case with a glass-to-metal hermetic seal between case and leads.

Maximum ratings at 25 $^{\circ}C$  case temperature are:

$V_C$	125
$I_C$ (ma)	40
$P_C$ (mw)	1,000
at 100 $^{\circ}C$	400
at 125 $^{\circ}C$	200
Power gain ( $V_{CE} = 67.5$ , $I_C = 10$ ma) (min db)	30

**Other types**

A xenon thyratron, type 7086, has been announced by RCA for use in welding and X-ray tube operation.

The 7092, a radiation-cooled high-power industrial triode for applications in ultrasonic, induction or dielectric heating equipment, has been presented by Amperex. END

... another  
**MALLORY**  
service-engineered  
product



New  
**MALLORY**  
Push-Pull Switch

*modernizes any set*

Put "1957-model" convenience into nearly any radio or TV set that needs a volume control replacement—by installing a Mallory control with the new push-pull line switch.

Pull the shaft—the set goes on. Push—and it's off. No more need to readjust volume every time the user turns the set on. No more accelerated wear on the low end of the control element.

Your customers will appreciate this new idea in switches that's making such a hit on the newest sets. Order now from your Mallory distributor in the ratings you need.



*Shaft adapters to fit any style knob.*



P. R. MALLORY & CO. Inc., INDIANAPOLIS 6, INDIANA

- Capacitors • Vibrators • Resistors • Controls • Switches • Filters
- Rectifiers • Power Supplies • Mercury and Zinc-Carbon Batteries



A. A. Ghirardi



J. R. Johnson



# ...here's how to LEARN SERVICING R-I-G-H-T!

Complete training in modern professional methods . . . only \$13 . . . 3 months to pay!

## FIX ANY RADIO OR TV SET EVER MADE...easier...better...faster

Radio & TV Receiver TROUBLESHOOTING AND REPAIR

by Ghirardi & Johnson

822 pages, 417 illustrations Price \$7.50

(See special offer in Coupon)

This big, 822-page book brings you the kind of PROFESSIONAL training that helps you handle the toughest radio-television-electronic service jobs as slick and as accurately as you now do the easy ones!

For service beginners, Radio & Television Receiver TROUBLESHOOTING AND REPAIR is a complete, easily understood professional training course. For experienced servicemen, it is the ideal way to "brush up" on specific jobs; to develop better troubleshooting methods and shortcuts; and to find quick answers to puzzling service problems.

Step by step, it takes you through each service procedure . . . from locating troubles quicker and with less testing to repairing them faster and better.

You learn to deal with any kind of trouble in any kind of receiver. No guesswork. No aimless testing.

Here are just a few of the subjects covered: Components and Their Troubles; Basic Troubleshooting Methods; "Static" and "Dynamic" Testing; Practical Troubleshooting Tips and Ideas; AC/DC, 3-way Portable and Battery-set Problems; Servicing Communications Receivers; A Complete Guide to Television Service; AM, FM and TV Realignment Made Easy; Resistor, Capacitor, Inductor and Transformer Problems; Servicing Tuning, Selector and Switching Mechanisms; Loudspeakers; Servicing Recorders and Record-playing Equipment . . . and dozens more. Use coupon. Read it for 10 days at our risk.

## LEARN BASIC CIRCUITS...and watch service "headaches" disappear!

Radio & TV Receiver CIRCUITRY AND OPERATION

by Ghirardi & Johnson

669 pages, 417 illustrations Price \$6.75

(see special offer)

It's amazing how much easier you can repair radio and television sets and even industrial electronic equipment when you know all about its circuits. You locate troubles in a jiffy because you know what to look for and where to look. You handle jobs lots faster, better . . . and more profitably.

Radio & Television Receiver CIRCUITRY AND OPERATION gives you a complete understanding of basic circuits as well as their variations. It teaches you to recognize them . . . to understand their peculiarities . . . to

know their likely "troubleshooting" . . . and how to eliminate guesswork and useless testing.

Throughout, this new book brings you the kind of above-average professional training that fits you for the bigger, better-pay jobs. Covers all circuits used in modern television and radio receivers, amplifiers, phono pick-ups, record players, etc.

Price only \$6.75 . . . or see money-saving combination offer in coupon, 10-day FREE examination.

### 10-DAY FREE EXAMINATION...Pay as You Learn!

**Save \$1.25!**

Make your training library complete. Have ALL the latest data at your fingertips. Get both these books at only \$13.00 for the two . . . YOU SAVE \$1.25

Dept. RE-18, RINEHART & CO., INC.  
232 Madison Ave., New York 16, N.Y.

Send books indicated for 10-day FREE EXAMINATION. I will then either remit price indicated (plus postage) or return books post-paid and owe you nothing.

Radio & TV TROUBLESHOOTING AND REPAIR (Price \$7.50)       Radio & TV CIRCUITRY AND OPERATION (Price \$6.75)

SPECIAL COMBINATION OFFER! Both books only \$13.00. (Regular price separately \$14.25). You save \$1.25. Combination offer is payable at rate of \$3 (plus postage) after 10 days if you decide to keep books, and \$3 a month thereafter until \$13.00 has been paid.

Name.....

Address.....

City, Zone, State.....

OUTSIDE U.S.A.—\$8.00 for TROUBLESHOOTING & REPAIR; \$7.25 for CIRCUITRY & OPERATION. \$14.00 for both books; cash with order only. Money refunded if you return books in 10 days.



### NEW YEAR'S RESOLUTIONS

1. To treat my customers with the greatest respect.
2. To give as prompt service as possible.
3. To pay my bills promptly and get the discount.
4. To buy wisely, knowing discounted merchandise can be most expensive.
5. To buy from distributors who recognize our mutual problems.
6. To try to obtain new members for my association.
7. To work in my association for the promotion of the service fraternity.
8. To work when I work and try to have time for more relaxation.
9. To improve my technical knowledge and skill.
10. To charge enough to make a reasonable profit, but not enough to be unfair.
11. To expand my business by more aggressive advertising.

(This item appeared last year in the *Raster*, an official publication of the Electronic Service Council of the Ozarks. We thought it was interesting enough to rate another trip around.—Editor)

### HOT-CHASSIS PROTECTION

The safety committee of the National Alliance of Television & Electronic Service Associations (NATESA) has recommended that all members take immediate steps to protect themselves on all cases involving hazards caused by "hot TV chassis service."

According to the council, as reported in *NATESA Scope*, should such a set be serviced, the last servicer could be held responsible. It is suggested that a statement similar to that below be made part of the delivery ticket.

"This TV set is of the 'hot-chassis' type. We have exercised all possible precaution to eliminate danger in handling. However, since the set is outside our control, we can assume no responsibility for electrical shock and other hazards."

This statement may save you from damage claims.

### \$5 SERVICE CHARGE

Service dealers in Queens, N.Y., have increased their service charge to \$5. One dealer, France's Radio & Refrigeration, feels that customer acceptance of the increase is excellent. At the time the rate was raised the firm discovered that the customer who turned to another dealer for service was the individual who would have complained no matter what the price.

The Guild News, published by the Radio Television Guild of Long Island, reports that the movement has been under way for about eight months.

The paper also stated that "dealers, by charging \$5, are at last realizing the cost of their overhead and a reasonable amount for themselves. The dealers who have been ostriches and maintain \$2 and \$3 service charge have not recognized the value of their own labors."

**TORONTO TECHNICIANS UNFIT?**

Edward Reale, director of the Toronto Radio Electronics Technicians Association, Toronto, Canada, has said that of the 1,200 "so-called" television and appliance service technicians, less than half are qualified to work on TV sets. The statement was made at an association meeting held to develop ways of eliminating dishonest and incompetent technicians from the group.

Mr. Reale was strongly criticized for his stand, but the 74 members at the meeting agreed that fewer than 100 technicians in the area could measure up to the standards the association has set for its members. A resolution requiring all members to pass a tough examination within a year was passed. Grades of technician proficiency were set and a list of operating standards proposed.

**ESFETA OPPOSES PAY TV**

The Empire State Federation of Electronic Technicians Association went strongly on record in opposition to pay TV at its regular meeting held in Rochester Nov. 10, 1957. Max Liebowitz of New York City led the opposition to toll viewing, urging that the organization oppose any form of TV transmission that would rob the public of its right of free access to the present television channels. ESFETA urged all its member groups to write their Congressmen, the FCC and other Government

agencies involved, strongly protesting pay TV.

The meeting also discussed plans for opposing any attempted unjust licensing measures at the State capital. Secretary George Carlson, 69 Forest Heights, Jamestown, N.Y., appealed to all nonaffiliated associations to forward their addresses to him so that ESFETA can keep them informed of activities in the State Legislature.

**FOUR-WAY CLINICS TO BE HELD**

Service information on transistors, color television, high fidelity and tape recorders is to be disseminated through a series of two-day clinics under the auspices of the RCA Service Co. E. C. Cahill, president of the company, stated they would be held in most of the major centers of the nation. A booklet covering each of the four products demonstrated is given to each service technician attending.

**THE REAL MEANING**

A number of clichés seem to be universal with the electronics service customer, according to *The Raster*, official service publication of the Electronic Service Council of the Ozarks. A few are listed with what we believe is the real meaning.

- "It's just a bad tube." *It's a 24CP4A.*
- "I don't think there is much wrong." *He's been working on the set.*
- "It won't take you a minute to fix it." *I don't want to pay for more than a minute's work.*
- "The bill is too high." *Fifty cents would be too high.*
- "There's not much wrong, it just quit." *It's a dog.*
- "I could have fixed it myself if I had the right tools." *I tried to fix it with the screwdriver I had.*
- "I don't want to spend much on this radio, but I want it fixed up good. It's a keepsake, been in the family a long time." *IT SURE HAS!*

**MINILOG**



**Miniature desk-top Analog Computer solves: Algebra—Calculus—Simultaneous equations—Differential equations.**

*Designed for Schools and Engineers for solving practical and theoretical problems of wide variety.*

**Contains: 10 ten-turn potentiometers; 10 operational amplifiers; dual regulated power supply; switching equipment.**

**Completely built at \$690**  
fob EBE INC., SLC, Utah

-----

**EBE Inc. Computer Mfrs.**  
1015 Atkin Ave., Salt Lake City 6, Utah

- Reserve one Minilog
- Send additional data on Minilog
- Send data on other items

Name .....

Address .....

**ENGINEERING**

**B. S. DEGREE IN 27 MONTHS**



Prepare for unlimited opportunities of the Electronic Age! Earn your B.S. DEGREE IN 27 MONTHS in Aeronautical, Chemical, Civil, Electrical or Mechanical Engineering; in 36 MONTHS in Mathematics, Chemistry, Physics. Intensive, specialized courses. Comprehensive training in electronics, television, advanced radio theory and design, math, nuclear physics and elec. eng. Engineering Science preparatory courses. Low rate. Graduates in demand. Spacious campus; 20 bldgs., dorms, gym, playing field. Earn part of your expenses in Fort Wayne, G. I. approved. Enter March, June, Sept., Dec., Catalog.

**INDIANA TECHNICAL COLLEGE**  
1718 E. Washington Blvd., Fort Wayne 2, Indiana

Please send me free information on B.S. ENGINEERING DEGREE IN 27 MONTHS as checked.

- Electronics
- Civil
- Chemical
- Mechanical
- Aeronautical
- Electrical
- Physics

B.S. DEGREE IN 36 MO. in: Math.  Chem.  Physics

Name .....

Address .....

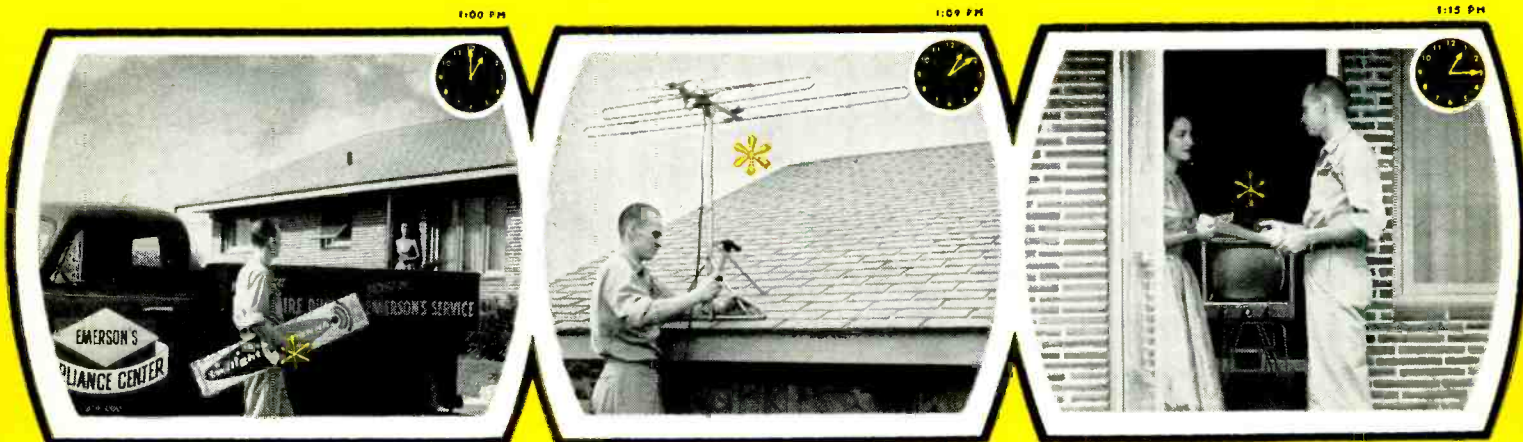

**Picture of a smart TV technician making a dollar a minute on his way back from lunch**

**\* "Naturally... it's the GOLD Twilight Antenna by Winegard Co. RE-1 BURLINGTON, IOWA"**

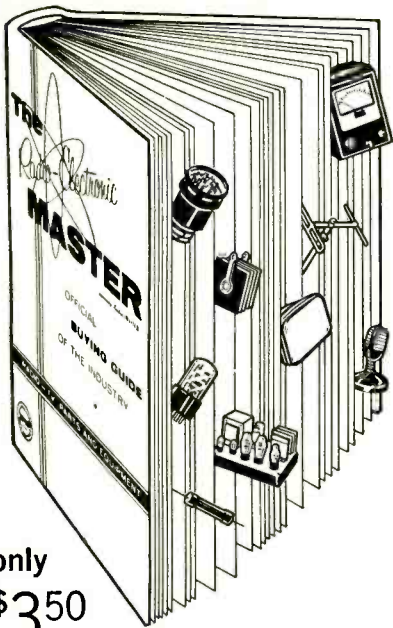

only  
\$350  
at your distributor

# 1958 RADIO-ELECTRONIC MASTER

(22nd edition)

biggest, most authoritative buying guide ever published

## TV - RADIO - AUDIO - ELECTRONICS

Completely catalogs over 150,000 standard electronic parts and equipment necessary to radio-TV-audio servicing, as well as electronic research, design and maintenance. It places the entire electronic industry at your fingertips!

1584 pages  
The world's largest and most referred to electronic buying guide contains...

direct-from-the-factory product information covering 150,000 items produced by 350 manufacturers

- ★ complete descriptions
- ★ specifications
- ★ prices
- ★ 11,500 illustrations

When you BUY and SELL DESIGN... ASSEMBLE... REPAIR You can immediately find out

What product best fills your needs?

How does it compare with other makes?

What does it look like?

What does it cost?

... because the MASTER is systematically arranged in 18 product sections with all similar products grouped together.

Save time and money

**SERVICEMEN**—Buy, sell and bill direct from The MASTER. It shows list prices. **HAMS, EXPERIMENTERS**—At your fingertips, those hard-to-get items found only in The MASTER. **HI-FI FANS**—Pre-select components in your home. Hear them demonstrated at your dealer. **ENGINEERS**—Specify and design more rapidly... all the latest data in one bound volume.

Remember, no matter what product or component you require... YOU FIND IT FASTER IN THE MASTER!

Act now—the supply is limited

Get your 1958 MASTER today at local parts distributor or write for list.

**THE RADIO-ELECTRONIC MASTER** 60 Madison Avenue, Hempstead, N. Y.

# Patents

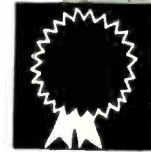

## SKINDIVER'S TELEPHONE Patent No. 2,798,902

Daniel Richard Kursman, Philadelphia, and Sig-mund P. Rosen, Plymouth Meeting, Pa.

Skindivers and swimmers can now communicate directly and without connecting wires. This new transceiver can be made compact and portable.

For transmitting speech, S1 is in the position shown, and the solid line shows the signal path. A balanced modulator receives two signals, one

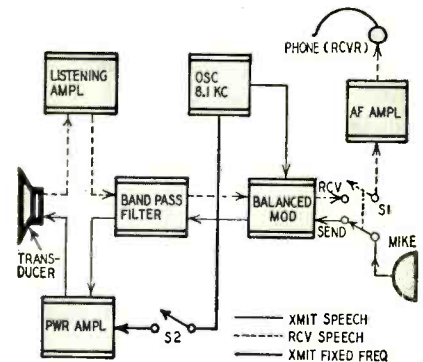

from a microphone, the other from a fixed-frequency oscillator. The fixed frequency itself is balanced out, and the filter passes only the upper sideband. When the speech frequencies are 250 to 3,000 cycles, this sideband ranges from 8.3 to 11.1 kc. It is amplified and transmitted through the water by a conventional underwater transducer.

To receive, S1 is thrown to its other position. The same transducer acts as pickup. The underwater vibrations cause it to generate a voltage at frequencies from 8.3 to 11.1 kc. Follow the dashed line in the diagram. This sideband is amplified and noise is removed by the filter. Now it beats against the fixed 8.1-kc frequency in the modulator, resulting in speech frequencies from 200 to 3,000 cycles, the original signal.

Both the receiver and microphone can be fitted into a skindiver's mask. Transmitting power of 0.6 watt generates sufficient signal to be heard about 2,000 yards. S2 is a test switch. When closed, a fixed-frequency signal is transmitted.

## INSTANTANEOUS AGC

Patent No. 2,782,268

William E. Ayer, San Carlos, Calif. (Assigned to United States of America as represented by Secretary of the Navy)

It is difficult to design agc for a radar receiver, because the signal is pulsed. Agc must be quick-

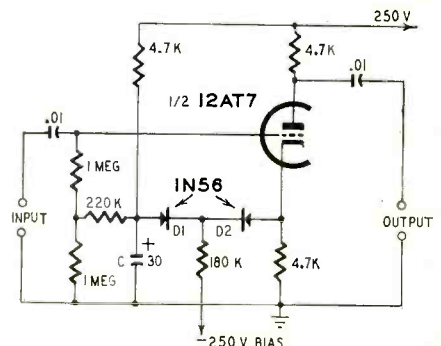

acting. Further, it must operate on both positive and negative pulses. This diagram shows a video stage using a new agc circuit.

The triode may be half a 12AT7. Normally both D1 and D2 conduct due to the large nega-



tive potential at their cathodes. Then when signals are weak, capacitor C effectively bypasses the cathode resistor and gain is at a maximum.

When a strong negative pulse arrives, the tube's cathode current drops. The cathode goes sufficiently negative to block D2. For all practical purposes, C no longer bypasses. Due to cathode degeneration, gain drops quickly and considerably. A strong positive pulse drives the cathode more positive, blocking D1. Again the cathode resistor is unbypassed and gain is low. In each case the strong pulse (positive or negative) instantly removes the bypassing effect of C so there is no time lag.

**SPEECH BRIGHTENER**

Patent No. 2,799,734

Glen D. Camp, Chevy Chase, Md. (Assigned to Melpar, Inc., Alexandria, Va.)

Most speech sounds carry fairly steady power over an interval of time, but a few (notably

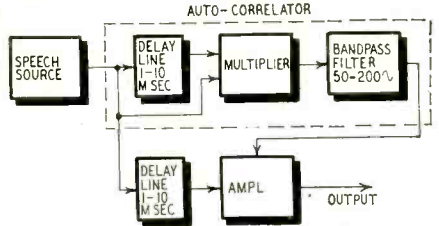

s, z, t, d, k, ch) fluctuate rapidly. Since these sounds have the same characteristic of noise, they tend to get lost passing through noise limiters. These sounds need extra amplification if speech is to remain brilliant and easy to understand.

The steady components are distinguished from those like noise by an auto-correlator network (see diagram). There are two signal paths to the multiplier, one through a delay line. This delay has little effect on waveforms that vary slowly, so the multiplier inputs are nearly identical. This means that the output is proportional to the square of the input.

On the other hand, noiselike components are highly irregular and each pulse lasts but an instant. Due to the delay, each such variation

appears as two distinct pulses at the multiplier. Each receives minimum amplification because of lack of coincidence. Gain is maximum during presence of noiselike components, since these are essentially higher frequencies which cannot pass through the bandpass filter and do not appear at the output.

Output from the auto-correlator becomes avc for the amplifier. Thus gain is maximum during presence of the noiselike components which account for minimum avc. During passages of the more steady tonal sounds, avc is greatest and amplifier gain is minimum. This brightens the speech.

The second time delay equalizes for the time required for a signal to pass through the auto-correlator.

**IMPROVED ELECTRONIC FLASH**

Patent No. 2,775,718

William Dubilier, New Rochelle, N. Y.

This well-known inventor discloses an improved flashlamp for photographic purposes. It can be made at low cost and has long life. The side view of Fig. 1 shows that it has two main electrodes, A and B. Also, there is an auxiliary electrode C which extends from B. The front of the bulb is a Fresnel lens with a number of convex sections. The rear has a reflective surface and carries a conductive layer which connects one pin to the upper electrode A. Electrode B is tied to the other pin.

The camera shutter release operates in two steps. First, it closes battery switch S1 (Fig. 2). This charges capacitors C1 and C2. The "ready light" is a small gas tube that indicates when the battery circuit has been switched on. As the charge nears completion, current through R1 drops off and the ready light is extinguished. This indicates that the speed light is ready to be flashed.

When the shutter release is advanced further, it closes S2, the flash switch. C2 sends a high-voltage high-frequency pulse through T. This initiates an auxiliary discharge at electrode C. The main discharge follows at once, and C1 delivers its full power across A and B. Resistor R3 dissipates any voltage still remaining across capacitor C1, and the flashlamp is ready for the next cycle of use.

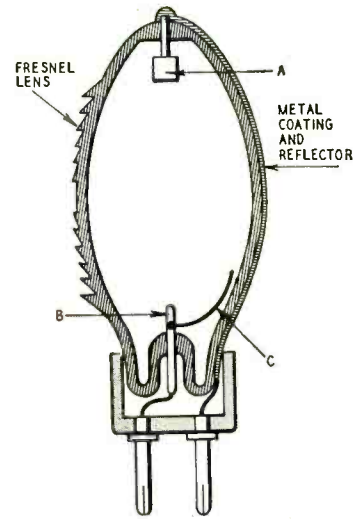

Fig. 1

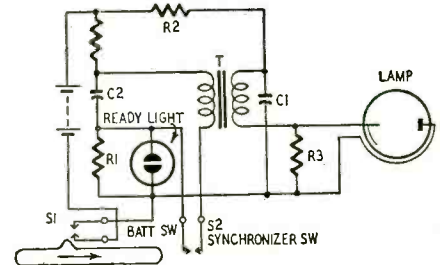

Fig. 2

For indoor photography, the battery could be replaced with a power unit operated from the line.

# NOW! You Can Fix ANY Mechanical Trouble In ANY Record Changer ... FAST!

## RECORD CHANGER TROUBLES IN 5 MINUTES

With This Dependable New COYNE Handbook!

**SHOWS YOU WHAT ... WHERE ... HOW!**

*The first and only book of its kind!* Tells you how to spot causes of record changer mechanical troubles, and also tells you how to fix the troubles, right then and there! There's no guessing; no record changer experience required. Amazing CHECK-CHARTS describe the symptoms and their causes. PHOTOGRAPHS show exactly where causes of trouble are located. EXPLANATIONS, in simple non-technical language, tell how to fix the troubles. Fully indexed by make and model number; covers every American make of changer, plus most foreign makes. Includes HI-FI, THREE AND FOUR SPEED, AND SINGLE SPEED RECORD CHANGERS. You don't have to read the entire book. Just refer to the section covering the record changer you're working on. You'll find the answers quickly. Amazing book more than pays for itself in time and work saved on just one service call!

**VALUABLE ... PRACTICAL ... COMPLETE!**

With "Pin-Point Record Changer Troubles" any Radio-TV man can fix fully 90% of the mechanical troubles right in the home, without even removing the record changer from the cabinet! Covers all mechanical troubles; helps you quickly spot many electronic troubles. Over 320 spiral bound pages with 750 clear, time-saving photos. Fits easily into tool kit for handy on-the-job reference. This book uses the same easy-to-understand, down-to-cases system as "Pin Point TV Troubles In 10 Minutes"—the first of Coyne's "Pin Point" series.

(Educational Book Publishing Division)

**COYNE ELECTRICAL SCHOOL**

500 S. Paulina St., Dept. 18-T1, Chicago 12, Illinois

**SAVES TIME!**

**ELIMINATES GUESSING!**

**EASY TO USE!**

**JUST OFF THE PRESS!**

TRY IT FREE FOR 7 DAYS!

To prove how valuable this amazing handbook can be to you, we'll rush a copy to you ON FREE TRIAL. Send no money, just the coupon. When the book arrives, put it to use. After 7 days, send only \$3.95 plus postage or return the book and owe nothing. You take no risk. Take advantage of this FREE TRIAL offer NOW!

MAIL COUPON NOW!

Educational Book Publishing Division  
COYNE ELECTRICAL SCHOOL, Dept. 18-T1,  
500 S. Paulina St., Chicago 12, Ill.

O.K.! I want to try your new trouble-shooting handbook: "Pin-Point Record Changer Troubles In 5 Minutes". Rush a copy for 7 days FREE TRIAL per your offer.

Name..... Age.....

Address.....

City..... Zone..... State.....

Check here if you are enclosing \$3.95. We pay postage. 7-day money-back guarantee.

**YOU CAN REALLY**

*Cash in*

**ON THE  
STEADY  
PUBLIC ADDRESS MARKET**

**ON THE  
HI-FI BOOM**

with  
**QUAM**  
*Adjust-a-Cone*<sup>®</sup>  
**SPEAKERS**

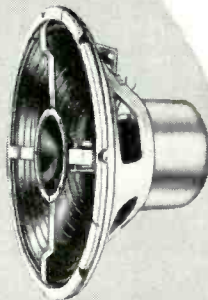

*Do you have the latest Quam catalogs? Available free from your distributor or by writing direct to us. Catalog 56 lists the entire Quam line. Catalog 69 describes the hi-fi line in detail.*

Extra profits for you when you go after these two hot markets. For small budget hi-fi installations, you can't beat Quam extended range and coaxial speakers, which provide the perfect way to give your customers fine audio reproduction at low cost. And for fine quality public address, Quam is truly the quality line. Special voice coil impedances are available, and Quam makes the only public address speakers on the market featuring the famous patented Adjust-a-Cone Suspension.

*ask for QUAM, the quality line, for all your speaker needs*

**QUAM-NICHOLS COMPANY**

**236 E. MARQUETTE RD. • CHICAGO 37, ILLINOIS**

**CASTLE TELEVISION TUNER SERVICE**  
**OVERHAULED UHF — VHF TV TUNERS**

Aligned to Original Standards  
Oscillator Tracking Assured by  
Crystal Controlled Generators

**IMPORTANT**

Price includes **WORN** parts only.

**F.O.B. CHICAGO**  
or **TORONTO.**

**DOES NOT** include tubes needed; nor parts missing or damaged by abuse and negligent handling.

152 MAIN ST.,  
TORONTO 13, ONT.,

**CANADA**

OXford 4-5637

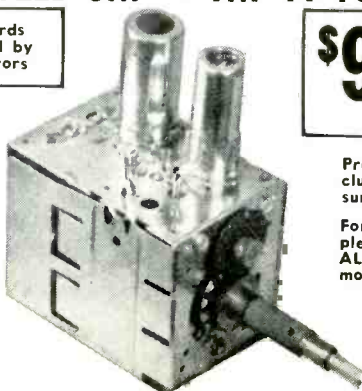

**\$9.95**

Dealer Net  
**EACH TUNER**  
(VHF or UHF)

**90 DAYS WARRANTY**

Prepaid remittances must include return postage and insurance.

Forward defective tuner complete with **GOOD** tubes and **ALL** parts. Quote make and model.

1723 W. LUNT AVE.,  
CHICAGO 26, ILL.,

**U.S.A.**

AMBassador 2-7505

try  
**This**  
one



**SOLDERING-IRON REST**

Are you always misplacing that soldering-iron rest carried in your toolbox? Here's one that is always there when you most need it—it's attached to the iron! Cut a length of heavy wire from a wire clotheshanger, bend the



rest to shape around your iron's barrel and bend out the ends to form feet. If the rest fits loosely, pinch the coiled section lightly with pliers.

There's no danger of accidentally burning the customer's carpet with this soldering-iron rest!—*John A. Comstock*

**STANDOFF FOR  
SLOPING ROOFS**

On a long roof run of antenna lead-in I had to get the wire tied down to keep it from blowing around. The customer insisted that he would tolerate no screw holes through his shingles. I finally de-

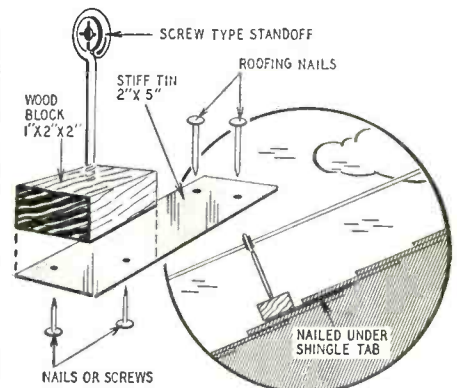

vised a method that would leave no marks or cause any leaks. A block of wood is fastened to a strip of tin (see diagram). The standoff is screwed into the wood block. The remainder of the metal strip goes under the shingles, where it is nailed down.—*A. Zanelli*

**MERCURY-CELL MOUNT**

With the ever growing popularity of transistors, the need for mercury cells has also increased. Since soldering leads to a mercury cell is somewhat difficult, mounting the cell and making good electrical contacts is a problem.

One way to beat this is to fasten a standard capacitor mounting clip (a) (one which holds the cell snugly) and a piece of copper with a 90° bend (b) onto a thin strip of wood or some

TRY THIS ONE (Continued)

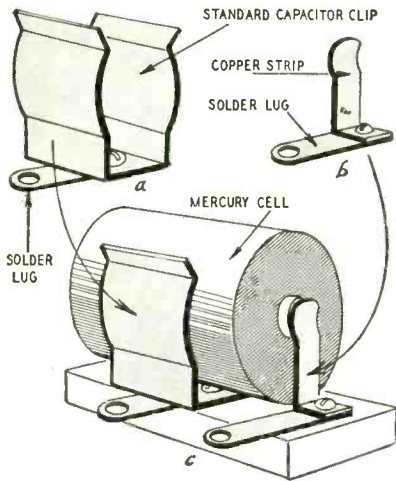

other insulator. Place solder lugs under the mounting screw.

Slip the mercury cell into the clip and push it forward (c) until its negative post makes contact with the copper strip. The clip will hold the cell in this position. Now you have a simple mount that provides for easy and rapid replacement of dead batteries.—Leonard Lyons

### PIPE-CLEANER HEAT SINK

A moistened pipe cleaner makes a good thermal shunt when soldering transistors, diodes, small bantam electrolytics, etc. Simply wet the pipe cleaner and give it a twist or two

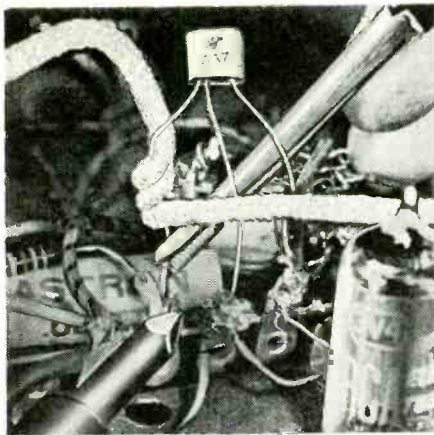

around the wire lead to the transistor, etc., as shown in the photo. The pipe cleaner adds a safety factor to a pair of tweezers or pliers also used for a similar purpose. You don't need an extra hand to hold the pipe cleaner in place either.—A. R. Clawson

### KNOB FROM TOOTHPASTE-TUBE CAP

Subminiature ferrite coils with micrometric screws are a big improvement over the earlier hard-to-tune types. Yet tuning is still very difficult because the shaft's diameter and the screw slot are very small. I have found that toothpaste-tube caps make ideal knobs for these coils. Drill a hole in the cap slightly smaller than the shaft's diameter. Then cover the end of the shaft with a good grade of multipurpose

**YOU NEED THIS...**

**FREE GIANT ALL NEW 1958 BA CATALOG**

A COMPLETE BUYING GUIDE FOR EVERYTHING IN

**RADIO • TV ELECTRONICS**

**BA 1958**  
ANNUAL CATALOG 581

SINCE 1927

**172 KING-SIZED PAGES**

**EVERYTHING IN RADIO TV AND ELECTRONICS**

**100'S OF NEW ITEMS LISTED HERE FOR 1ST TIME**

**21 PAGES OF BARGAINS NOT IN ANY OTHER CATALOG**

**Guarantee**  
We guarantee everything in our Catalog to be of the quality and value represented. We can return a defective item to the manufacturer and give the buyer a refund for such apparatus.

**RUSH COUPON TODAY!**

**BURSTEIN-APPLEBEE CO. Dept. M, 1012-14 McGee St., Kansas City 6, Mo.**

Send Free 1958 B-A Catalog No. 581.

NAME \_\_\_\_\_

ADDRESS \_\_\_\_\_

CITY \_\_\_\_\_ STATE \_\_\_\_\_

## RAD-TEL Powerhouse of Values! TRANSFORMER PRICE RIOT!!

Part No.	H.V. Sect.	MA	Rec.	Fil.	Fil. Volts	Triod Equip.	Stancor Equip.	List Prices	Price
455	710 VCT @	250	5.0 @ 3A	6.4 @ 2.5	R40	T8169	\$25.00	\$2.20	
454	596 VCT @	250	5.1 @ 4A	6.4 @ 2.5A	R37	.....	27.50	3.20	
456	560 VCT @	300	5.0 @ 5A	6.8 @ 10.1A	.....	.....	37.70	3.50	
458	560 VCT @	300	5.0 @ 5A	6.8 @ 6A	.....	.....	37.50	3.20	
451	700 VCT / 412 VCT 175/	100	5.0 @ 3A	5. @ 2A	R40	.....	37.50	3.20	
442	512 VCT	54	6.4 @ 2.4	.....	.....	.....	7.00	2.20	
488	440 VCT	50	6.4 @ 2.4	.....	.....	.....	5.75	2.20	
443	520 VCT	52	6.4 @ 2.3	.....	.....	.....	12.50	2.30	
490	156 V	125	6.4 @ 5.1	6.4 @ 0.6	.....	.....	21.25	2.20	
508	686 VCT	300	5.0 @ 6A	6.5 @ 7.5A	R62	P8340	37.50	4.20	
509	640 VCT	130	5.0 @ 3A	6.4 Ct. 3A	.....	.....	21.75	3.00	

**PHONO MOTORS**  
All 60-C—105/117V  
Mod. M-4-78 rpm 98c  
Mod. M-15-33 rpm 98c  
Your Choice . . .

**All 117V 60 Cycle Primary**  
Lots of 3 May Be Assorted  
—Deduct 5%  
Lots of 10—Deduct 10%



Write For FREE Catalog Of Tubes & Parts  
Subject to prior sale. No C.O.D.'s, please, on this sale.  
Allow for postage.

55 Chambers Street, Newark, N.J.

# RIDER BOOKS ARE THE EASY, LOW-COST WAY TO GREATER ELECTRONIC KNOW-HOW!

## FIVE NEW RIDER BOOKS

### STEREOPHONIC SOUND

by Norman H. Crowhurst  
World-famous audio authority Norman H. Crowhurst's new book is the first true assessment of this exciting new medium for realistic sound. It covers the theory of stereophonic sound, the differences it can make in reproduction, what goes into making it successful, and what is needed to bring out the best in systems available or likely to be available. The book applies all this information to selecting the proper loudspeakers and components for the best stereo reproduction. It also covers stereo systems and techniques used for motion pictures. Soft cover, 128 pp., 5½x8½", illus. #209.....\$2.25

### HOW TO READ SCHEMATIC DIAGRAMS

by David Mark  
Covering the symbols and abbreviations used in schematic diagrams related to the electronics field, this book starts with individual components and carries through to receivers and similar equipment. Components and circuits are identified and explained. Soft cover, approx. 160 pp., 5½ x 8½", illus. #208.....\$3.50

### REPAIRING HI-FI SYSTEMS

by David Fidelman  
This book deals with finding the troubles and repairing faults in hi-fi equipment with no test instruments—simple equipment—and elaborate equipment. Typical troubles are analyzed and repaired through a system of logical steps. This book is broad in scope, yet maintains a simplified level. Soft cover, approx. 170 pp., 5½x8½", illus. #205.....\$3.90

### HIGH FIDELITY SIMPLIFIED (3rd Edition)

by Harold D. Weiler  
Gives you the complete up-to-the-minute hi-fi story, and answers all questions about tuners, changers, amplifiers, tape recorders, speakers, record players, etc. No other book like it! Soft cover, 216 pp., 5½x8½", illus. #142.....\$2.50

Coming in February . . .

**BASICS OF DIGITAL COMPUTERS** by John S. Murphy

For a career in the fastest-growing segment of the electronics industry read this 3-volume "Picture-Book" course.

## Famous RIDER "Picture-Book" Courses...

**BASIC TELEVISION** by Dr. Alex. Schure  
The whole world of black and white television is before you for only \$10.00. You can master the basics of television easily, rapidly and thoroughly with this 5-volume "learn by pictures" training course.

It's so easy to learn

Here's how this easy, illustrated course works. Every page covers one complete idea! There's at least one big illustration on that same page to explain it! You build a thorough, step-by-step knowledge at your own pace—as fast as you yourself want to go.

No experience, education needed

**BASIC TELEVISION** uses the same methods that have proven so successful in the famous Rider picture books on electricity and electronics. All that is assumed is that you have a knowledge of radio. Every phase of television is made instantly clear—explained in plain English supported by carefully prepared, large and exciting drawings that make every idea crystal clear.

#198, soft cover 5 volumes, \$10.00 per set;  
#198-H, cloth bound in a single binding, \$11.50

### BASIC ELECTRICITY

### BASIC ELECTRONICS

### BASIC SYNCHROS & SERVOMECHANISMS

by Van Valkenburgh, Nooger Neville, Inc.

The fabulous picture-text books that teach faster and easier! The theory, principles, and practice of electricity, electronics, and synchros and servos are here presented in a manner that permits a rapid grasp of the fundamentals of these vitally important subjects. Over 2,000 specially prepared illustrations present, explain, and make every topic discussed picture-clear.

#### Basic Electricity

#169, soft cover, 5 vols., 624 pp., per set \$10.00  
#169H, cloth bound in single binding...\$11.50

#### Basic Electronics

#170, soft cover, 5 vols., 550 pp., per set \$10.00  
#170H, cloth bound in single binding...\$11.50

#### Basic Synchros and Servomechanisms

#180, soft cover, 2 vols., 270 pp., per set \$5.50  
#180H, cloth bound in single binding...\$6.95

## INCREASE YOUR KNOW-HOW WITH THESE RIDER BOOKS...

- TV Picture Tube-Chassis Guide by Rider Lab Staff
- #204, soft cover, 68 pp. ....\$1.35
- Marine Radiotelephone Permit Q & A Manual (3rd class operator) by Milton Kaufman
- #206, soft cover .....\$1.35
- Energy by Sir Oliver Lodge, F.R.S.
- #200, soft cover, 64 pp. ....\$1.25
- Getting Started in Amateur Radio by Julius Berens W2PIK
- #199, soft cover, 136 pp. ....\$2.40
- Hi-Fi Loudspeakers & Enclosures by Abraham D. Cohen
- #176, MARCO cover, 360 pp. ....\$4.60
- #176H, cloth bound .....\$5.50
- How to Service Tape Recorders by C. A. Tuthill
- #167, soft cover, 160 pp. ....\$2.90
- Basic Vacuum Tubes & Their Uses by Rider & Jacobowitz
- #171, soft cover, 208 pp. ....\$3.00
- #171H, cloth bound .....\$4.50
- How to Use Meters by John F. Rider
- #144, soft cover, 144 pp. ....\$2.40
- Fundamentals of Transistors by Leonard Krugman
- #160, soft cover, 144 pp. ....\$2.70
- Introduction to Color TV (2nd Edition) by Kaufman & Thomas
- #156, soft cover, 160 pp. ....\$2.70
- How to Select and Use Your Tape Recorder by David Mark
- #179, soft cover, 148 pp. ....\$2.95
- Television — How it Works (2nd Edition) by J. Richard Johnson
- #101, leather finish MARCO, 352 pp. ....\$4.60
- #101H, cloth bound .....\$5.50
- Repairing Television Receivers by Cyrus Glickstein
- #191, soft cover, 212 pp. ....\$4.40
- Transistor Engineering Reference Handbook by H. E. Marrows
- #193, cloth bound, 9x12", 288 pp. ....\$9.95

RIDER BOOKS

FREE! Handsome genuine leather, gold-stamped bookmark, if you write today for FREE 1957 Catalog RE-1.

Buy these and many other RIDER BOOKS at your electronics parts jobber, book store or department store book department. Look for the Rider Bookseller.

If your favorite store does not sell the Rider books you want, order direct. Add state, city tax where applicable. Canadian prices 5% higher.



TRY THIS ONE (Continued)

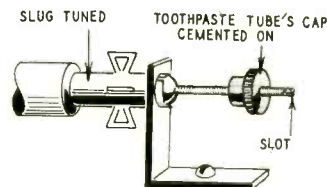

cement and force the cap on the shaft. Let it dry for 24 hours and it will remain tight and tune like a charm. If you hold the threaded shaft with a pliers, be sure you place a sheet of cardboard over the threads to prevent damage. Ferrite coils make ideal inductances for tuning controls in transistor circuits. The addition of the toothpaste cap permits very fine, easy and rapid adjustment.—Joseph Amoroso

## POP-UP TOOL BOX

Your tool box with the lift-out tray will be handier with the modification shown, which raises the tray automati-

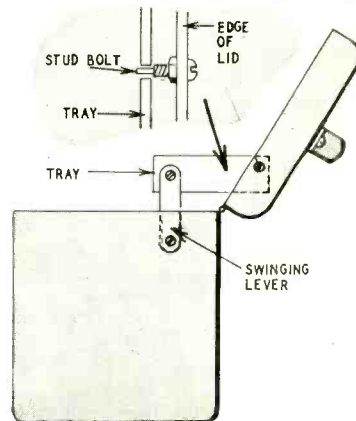

cally when the lid is opened. Mount the front of the tray with swinging levers of sheet metal at each end. Determine the dimensions by trial. Support the tray's back edge with studs through the lid, located to project through holes in the tray.—Hugh Lineback END

## Thirty-Five Years Ago

In Gernsback Publications

### HUGO GERNSBACK, Founder

Modern Electrics	1908
Wireless Association of America	1908
Electrical Experimenter	1913
Radio News	1918
Science & Invention	1920
Television	1927
Radio-Craft	1929
Short-Wave Craft	1930
Television News	1931

Some larger libraries still have copies of ELECTRICAL EXPERIMENTER on file for interested readers.

In January, 1924, *Science and Invention* (formerly *Electrical Experimenter*)

Path of Trans-Atlantic Radio Message. The Radio Invasion Continues.

New French Power Tube.

Radio Makes Transoceanic Circle.

Latest Designs in Radio Cabinets.

Radio Transmission of Photographs, by

A. P. Peck.

The Biography of a Vacuum Tube. Untuned Primary Receiver, by W. L. Pearce.

Radio for the Beginner (No. 23), by Armstrong Perry.

The Radio Oracle.



JOHN F. RIDER PUBLISHER, Inc. 116 West 14th Street, New York 11, N. Y.

In Canada: Charles W. Pointon, Ltd. 6 Alcina Ave., Toronto, Ontario

# new Devices



**STEREO TAPE SYSTEM, model 3-Stereo.** Built-in balanced amplifiers. In-line stereo heads. 40-16,000 cycles. Three speeds: 7½, 3¾ and 1¾ inches per second. Speaker system, model 266, is

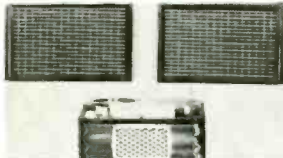

matched to the amplifiers. Each enclosure contains model 165BK 8-inch dual-cone speaker. Stereo playback, monaural record.—Tandburg, 10 E. 52 St., New York.

**MAGNETIC TAPES.** Long wearing. Smoother oxide surface decreases head wear. Long Wear No. 148 in reels of 1,200, 2,500 and 5,000 feet, uses 1.5-mil back-



ing. No. 149 in reels of 1,800, 3,600 and 7,200 feet, uses 1-mil backing. Scotch brand.—Minnesota Mining & Mfg. Co., 900 Bush St., St. Paul 6, Minn.

**IMPEDANCE DIVIDING NETWORK, model N2600.** Either set of output terminals can be switched from 16-32 ohms. Two

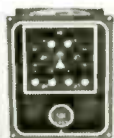

16-ohm drivers can be connected in series when the appropriate switch is in 32 position.—James B. Lansing Sound, Inc., 3249 Casitas Ave., Los Angeles 39, Calif.

**HIGH-FIDELITY SYSTEM, model PT-1055.** FA-550 tuner, 410A, 20-watt-amplifier, 4-way 5-speaker system consisting of 15-inch woofer, 8- and 6-inch mid-range and two 3-inch tweeters and a Garrard RC-88 record changer with variable-reluctance cartridge and diamond-sapphire styli. One-cabinet system.—Pilot Radio Corp., 37-06 36th St., Long Island City 1, N. Y.

**EXPERIMENTAL PHONO CARTRIDGE, XP-3.** 0.7-mil diamond stylus. Flat response from 10-20,000 cycles within 0.2 db. Tracks at from 2-4 grams stylus pressure.—Fairchild Recording Equipment Co., 10-40 45th Ave., Long Island City 1, N. Y.

**RIBBON VELOCITY MICROPHONE, Trig Sixty Special.** Response: 50-12,000



cycles  $\pm 2$  db. Bidirectional. Triple horseshoe magnet supports relatively long corrugated limp aluminum ribbon encircled with 4 breath shields. Impedance, 50 ohms.—Fen-tone Corp., 106 5th Ave., New York 11, N. Y.

**TV TONE ADAPTER.** Small loop antenna placed near TV chassis picks up 4.5-mc frequency-modulated signal from set. Delivers high quality audio signal output to existing hi-fi system.—Tapetone Inc., Webster, Mass.

**SPEAKER SYSTEM, 110.** 12-inch coaxial speaker, CA-112, with L-C



dividing network covers 40-14,000 cycles. Complete unit measures 30 x 20 x 14 inches. Mahogany, blond or walnut hand-rubbed finishes.—Sonotone Corp., Saw Mill River Road, Box 200, Elmsford, N. Y.

**HI-FI SPEAKERS.** 9 new models include a 3-way 15-inch Triax, model G-600; 4 type CX coaxial 3-element units in both 12- and 15-inch sizes; two Duax 2-ele-



ment units in 12- and 15-inch sizes; and 2 Unax extended-range speakers.—Jensen Manufacturing Co., 6601 S. Laramie Ave., Chicago 38, Ill.

**SPEAKER SYSTEM, Hartley Luth Holton.** Uses 220 speaker. 1-18,000 cycles, handles 20 watts.



Input impedance, 4-8 ohms. 5-lb. magnet.—Hartley Products Co., 521 E. 162 St., New York 51, N. Y.

**POWER AMPLIFIER AND PREAMP, Quartet 344A.** 20-22,000 cycles, 20 watts, 138-db gain, 32-db bass control range, 35-db treble control range. 6 inputs: 3 low level and 3 high

## YOU CAN BUILD A TOROID TRANSISTOR POWER SUPPLY\*

(D.C. to D.C. Converter)

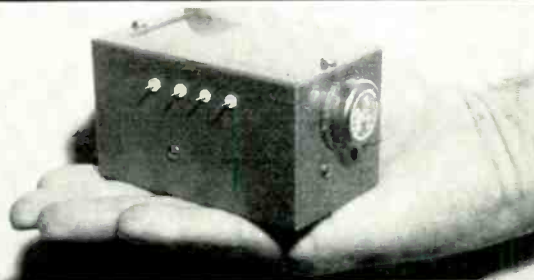

\*using this  
**TOROID  
TRANSFORMER**  
**\$16.00\***

\*Plus 50c for packing and mailing  
Quantity prices on request

Delivers 225 and 450 volts  
D.C. simultaneous. Available  
in 12 or 24 volts. Maximum  
power 90 watts (transmitter  
intermittent service). 40 watts  
continuous.

AND  
**TRANSISTORS**  
2 Recommended Types—Both for  
**\$11.00**

**MORE EFFICIENT!**  
(80-90%)

**LESS WEIGHT!**  
(1/10 weight of  
equivalent Dynamotor  
Power Supply)

**LESS SPACE!**  
(90-watt output from  
2" X 2" X 4" unit)

**LOW HEAT  
GENERATION!**

**GREATER  
RELIABILITY!**

- ⚡ Designed especially for mobile and portable equipment.
- ⚡ Each transformer tested in actual power supply unit and FULLY GUARANTEED!
- ⚡ Complete construction details furnished.
- ⚡ Special TOROID units and components to specifications on request.
- ⚡ Manufactured by makers of world-famous Sun Air Aircraft Transceivers.

### SUNAIR ELECTRONICS, INC.

Dept. 07  
Broward International Airport  
Fort Lauderdale, Florida

I am enclosing  check  money order in the amount of \$16.50 for a TOROID TRANSFORMER, or in the amount of \$27.50 for a Toroid Transformer and two matching power Transistors.  12 volts  24 volts

Name .....

Address .....

City.....Zone.....State.....

level. — **Altec Lansing Corp.**, 1515 S. Manchester Ave., Anaheim, Calif.

**FM-AM TUNER, model 90-T.** Cascode rf amplifier, FM muting, AM bandwidth control and built-in audio control center. Control center has 4 input jacks for magnetic cartridge, tape playback head, plus stereo channel, TV sound, ceramic or crystal cartridge. Less than 0.1% dis-



tortion for 3 volts output. Response  $\pm 1$  db from 25-40,000 cycles. Hum and noise 80 db below signal for 2-volt output. **Model 90-R** same without audio control center.—**Fisher Radio Corp.**, 21-21 44th Drive, Long Island City 1, N. Y.

**FM-AM TUNER, Bantam KN-100.** FM has ave and temperature-compensated oscillator.



Sensitivity: 3.5  $\mu$ v for 20-db quieting on FM; 10  $\mu$ v for AM. 10-kc whistle filter in AM section. Indoor dipole antenna for FM and adjustable ferrite loop for AM.—**Allied Radio Corp.**, 100 N. Western Ave., Chicago 80, Ill.

**HI-FI TUNER, AM-FM, model 300.** FM selectivity, 3  $\mu$ v for 20-db quieting. 2-mc wide-band detector and 10-kc sharp-tuned

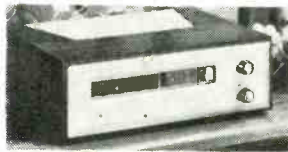

whistle filter. Outputs include main, multiplex and tape. 2-position AM bandwidth switch for normal and hi-fi programs.—**H. H. Scott, Dept. P**, 111 Powdermill Rd., Maynard, Mass.

**CAPACITOR ANALYZER, model TO-5.** Measures capacitance, power factor, leakage current,

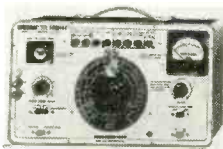

insulation resistance of capacitors and turns ratio of iron-core transformers. Capacitance ranges from 1  $\mu$ f-20,000  $\mu$ f. All capacitors are automatically discharged when range selector switches are released.—**Sprague Products Co.**, 125 Marshall St., North Adams, Mass.

**VOLT-OHM-MILLIAMMETER, model 260, series III.** Polarity reversing switch to end lead reversal. Printed circuitry. 50-ma-250-mv range. Dbm ranges from -20 to +50 Dbm, 1 mv in 600 ohms. Ac sensitivity, 5,000 ohms



per volt. Frequency response, 5-500,000 cycles. Full-wave bridge-rectifier system.—**Simpson Electric Co.**, 5200-18 W. Kinzie St., Chicago 44, Ill.

**VAN DE GRAAFF GENERATOR.** Produces 350,000 volts at 12  $\mu$ a. Can draw 18-inch



spark. Uses 1/20-hp 3,500-rpm motor and precision ball bearings. Available in kit or finished form.—**F. B. Lee**, 230 Hampton Pkwy., Kenmore 17, N. Y.

**TUBE TESTER, model FC-1.** Two panel settings to check for quality, shorts, life expectancy of more than 600 tube types. 41 tube sockets accommodate all



present tube types. 7- and 9-pin tube pin straighteners mounted on panel.—**Century Electronics Co., Inc.**, 111 Roosevelt Ave., Mineola, N. Y.

**GENERAL-PURPOSE SCOPE.** *Handscope model 466.* 5-inch



screen, filter type graticule and universal-fit bezel. For industrial maintenance, production testing and general electronic servicing.—**Simpson Electric Co.**, 5200-18 W. Kinzie St., Chicago 44, Ill.

**SWEEP GENERATOR, LSW-40 (illus.).** Range: 2 260-mc in 2 bands. Continuously variable sweep width of 0-12 mc. 3-volt



rms sine-wave scope sweep output with phase control. Rf output: 100 mv. **Model LSG-30,** combination marker generator and vertical-horizontal bar generator. **LSG-50,** TV-FM sweep, marker and alignment generator.—**Lafayette Radio**, 165-08 Liberty Ave., Jamaica 33, N. Y.

**RF SIGNAL GENERATOR, model TU576.** For servicing land

TOWARD THE ULTIMATE IN TV RECEPTION

**DeRO** PROVEN by Performance!

THE NEW Switch in Base Duo • JUVENATOR

For Use In Parallel & Series Filament Circuits NEW MODEL RPS-2

The very latest in video engineering achievement—eliminates all loose leads and hanging switches. Now switch instantly from Parallel to Series or reverse.



LIST \$2.95

- Cures over 95% of all CRT tube failures
- Small, compact one-piece construction.

JOBBER—WRITE FOR DETAILS

Look for this display!



This colorful, small space counter merchandiser identifies DeRO's quality and engineering—your guarantee of satisfaction. Look for it!

POPULAR WITH SERVICEMEN

FREE Write for latest catalog



**DeRO** ELECTRONICS

134 NASSAU RD. ROOSEVELT, L. I., N. Y.

NOW . . . Check Vibrators In ANY Tube Checker

Another Sencore Time-Saver

**“VIBRA-DAPTOR”**

MODEL VB-2

2 ADAPTORS IN 1

Checks Both Three and Four Prong Vibrators

• Merely plug into any tube checker. Set for 6AX4 (or 6SN7) for 6 Volt Vibrators and 12AX4 (or 12SN7) for 12 Volt Vibrators.

• Two lamps viewed through top of adaptor indicate whether or not vibrator needs replacing.

• Rugged — Made of steel.

• Replaceable but unbreakable #51 indicating lamps.

• Operates easily with Sencore LC2 Leakage Checker.

• Complete instructions screened on front.

At leading distributors everywhere

MANUFACTURED BY **SENCORE**

**SERVICE INSTRUMENTS CORP.**

171 OFFICIAL RD. ADDISON, ILL.

Cut out this ad for further

ONLY \$275 DEALER NET

POPULAR SENCORE PRODUCTS

- Transistor Tester
- Leakage Checker
- Filament Tester
- Handy "36"
- Vibra-Daptor

# BUILD 16 RADIO

## CIRCUITS AT HOME

with the New Deluxe 1958

PROGRESSIVE RADIO "EDU-KIT"

### A COMPLETE RADIO COURSE

only

# \$22<sup>95</sup>



Reg. U.S. Pat. Off.

Now Also Includes

★ TRANSMITTER

★ SIGNAL TRACER

★ SIGNAL INJECTOR

★ CODE OSCILLATOR

★ No Knowledge of Radio Necessary

★ No Additional Parts or Tools Needed

★ EXCELLENT BACKGROUND FOR TV

★ School Inquiries Invited

★ Attractively Gift Packed

### NO NEED TO SPEND HUNDREDS OF DOLLARS FOR A RADIO COURSE

The "Edu-Kit" offers you an outstanding PRACTICAL HOME RADIO COURSE at a rock-bottom price. Our Kit is designed to train Radio & Electronics Technicians, making use of the most modern methods of home training. You will learn radio theory, construction practice and servicing.

You will learn how to build radios, using regular schematics; how to wire and solder in a professional manner; how to service radios. You will work with the standard type of punched metal chassis as well as the latest development of Printed Circuit chassis.

You will learn the basic principles of radio. You will construct, study and work with RF and AF amplifiers and oscillators, detectors, rectifiers, test equipment. You will learn and practice code, using the Progressive Code Oscillator. You will learn and practice trouble-shooting, using the Progressive Signal Tracer, Progressive Signal Injector, Progressive Dynamic Radio & Electronics Tester & the accompanying instructional material.

You will receive training for the Novice, Technician and General Classes of F.C.C. Radio Amateur Licenses. You will build 16 Receiver, Transmitter, Code Oscillator, Signal Tracer and Signal Injector circuits, and learn how to operate them. You will receive an excellent background for Television.

Absolutely no previous knowledge of radio or science is required. The "Edu-Kit" is the product of many years of teaching and engineering experience. The "Edu-Kit" will provide you with a basic education in Electronics and Radio, worth many times the complete price of \$22.95. The Signal Tracer alone is worth more than the price of the entire Kit.

### THE KIT FOR EVERYONE

You do not need the slightest background in radio or science. Whether you are interested in Radio & Electronics because you want an interesting hobby, a well paying business or a job with a future, you will find the "Edu-Kit" a worth-while investment.

Many thousands of individuals of all ages and backgrounds have successfully used the "Edu-Kit" in more than 79 countries of the world. The "Edu-Kit" has been carefully designed, step by step, so that you cannot make a mistake. The "Edu-Kit" allows you to teach yourself at your own rate. No instructor is necessary.

### PROGRESSIVE TEACHING METHOD

The Progressive Radio "Edu-Kit" is the foremost educational radio kit in the world, and is universally accepted as the standard in the field of electronics training. The "Edu-Kit" uses the modern educational principle of "Learn by Doing." Therefore you construct, learn schematics, study theory, practice trouble-shooting—all in a closely integrated program designed to provide an easily-learned, thorough and interesting background in radio.

You begin by examining the various radio parts of the "Edu-Kit." You then learn the function, theory and wiring of these parts. Then you build a simple radio. With this first set you will enjoy listening to regular broadcast stations, learn theory, practice testing and trouble-shooting. Then you build a more advanced radio, learn more advanced theory and techniques. Gradually, in a progressive manner, and at your own rate, you will find yourself constructing more advanced multi-tube radio circuits, and doing work like a professional Radio Technician.

Included in the "Edu-Kit" course are sixteen Receiver, Transmitter, Code Oscillator, Signal Tracer, and Signal Injector circuits. These are not unprofessional "breadboard" experiments, but genuine radio circuits, constructed by means of professional wiring and soldering on metal chassis, plus the new method of radio construction known as "Printed Circuitry." These circuits operate on your regular AC or DC house current.

### A COMPLETE RADIO COURSE—NOTHING ELSE TO BUY

You will receive all parts and instructions necessary to build 16 different radio and electronics circuits, each guaranteed to operate. Our Kits contain tubes, tube sockets, variable, electrolytic, mica, ceramic and paper dielectric condensers, resistors, the strips, coils, hardware, tubing, punched metal chassis, Instruction Manuals, wire, solder, etc.

In addition, you receive Printed Circuit materials, including Printed Circuit chassis, special tube sockets, hardware and instructions. You also receive a useful set of tools, a professional electric soldering iron, and a self-powered Dynamic Radio & Electronics Tester. The "Edu-Kit" also includes Code Instructions and the Progressive Code Oscillator, in addition to F.C.C.-type Questions and Answers for Radio Amateur License training. You will also receive lessons for servicing with the Progressive Signal Tracer and the Progressive Signal Injector, a High Fidelity Guide and a Quiz Book. You receive all parts, tools, instructions, etc. There is nothing else to buy. Everything is yours to keep.

### FREE EXTRAS

- SET OF TOOLS
- SOLDERING IRON
- ELECTRONIC TESTER
- TESTER INSTRUCTION MANUAL
- HIGH FIDELITY GUIDE
- QUIZZES
- TELEVISION BOOK
- RADIO TROUBLE-SHOOTING BOOK
- MEMBERSHIP IN RADIO-TV CLUB
- CONSULTATION SERVICE
- FCC AMATEUR LICENSE TRAINING
- PRINTED CIRCUITRY
- PLIERS-CUTTERS
- ALIGNMENT TOOL
- CERTIFICATE OF MERIT

### SERVICING LESSONS

You will learn trouble-shooting and servicing in a progressive manner. You will practice repairs on the sets that you construct. You will learn symptoms and causes of troubles in home, portable and car radios. You will learn how to use the professional Signal Tracer, the unique Signal Injector and the dynamic Radio & Electronics Tester. While you are learning in this practical way, you will be able to do many a repair job for your friends and neighbors, and charge fees which will far exceed the price of the "Edu-Kit." Our Consultation Service will help you with any technical problems you may have.

J. Stataitis, of 25 Poplar Pl., Waterbury, Conn., writes: "I have repaired several sets for my friends, and made money. The "Edu-Kit" paid for itself. I was ready to spend \$240 for a Course, but I found your ad and sent for your Kit."

### FROM OUR MAIL BAG

Ben Vaterlo, P. O. Box 21, Magna, Utah: "The Edu-Kits are wonderful. Here I am sending you the questions and also the answers for them. I have been in Radio for the last seven years, but like to work with Radio Kits, and like to build Radio Testing Equipment. I enjoyed every minute I worked with the different kits; the Signal Tracer works fine. Also like to let you know that I feel proud of becoming a member of your Radio-TV Club."

Robert L. Shuff, 1534 Monroe Ave., Huntington, W. Va.: "Thought I would drop you a few lines to say that I received my Edu-Kit, and was really amazed that such a bargain can be had at such a low price. I have already started repairing radios and phonographs. My friends were really surprised to see me get into the swing of it so quickly. The Troubleshooting Tester that comes with the Kit is really swell, and finds the trouble. If there is any to be found."

### PRINTED CIRCUITRY

At no increase in price, the "Edu-Kit" now includes Printed Circuitry. You build a Printed Circuit Signal Injector, a unique servicing instrument that can detect many Radio and TV troubles. This revolutionary new technique of radio construction is now becoming popular in commercial radio and TV sets.

A Printed Circuit is a special insulated chassis on which has been deposited a conducting material which takes the place of wiring. The various parts are merely plugged in and soldered to terminals.

Printed Circuitry forms the very basis of Automation Electronics.

### UNCONDITIONAL MONEY-BACK GUARANTEE

ORDER DIRECT FROM AD  
RECEIVE FREE BONUS RESISTOR AND CONDENSER KITS WORTH \$7.00

- Send "Edu-Kit" Postpaid. I enclose full payment of \$22.95.
- Send "Edu-Kit" C.O.D. I will pay \$22.95 plus postage.
- Send me FREE additional information describing "Edu-Kit."

Name \_\_\_\_\_

Address \_\_\_\_\_

PROGRESSIVE "EDU-KITS", INC.

497 Union Ave., Dept. 136G, Brooklyn 11, N.Y.

JANUARY, 1958

135

Information  
ELECTRONICS

NEW DEVICES (Continued)

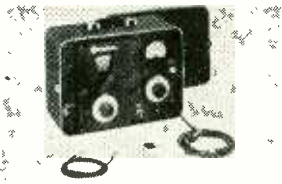

mobile communications systems. 6, calibrated direct-reading scales cover 25-54, 140-175-, 400-470- and 890-960-mc bands. Each range calibrated to 0.5%. Signal is stable to within .001%. Output voltage variable from 0.1-100,000  $\mu$ v.—Motorola Inc., Dept. SG, 4501 W. Augusta Blvd., Chicago 51, Ill.

**TUBE TESTER KIT, model T-60.** Checks AM-FM-TV tubes,



including series-string types. 5-inch meter. Illuminated roll chart. Accessories include picture-tube test cable and 110° adapter.—Paco Electronics Co. Inc., 70-31 84th St., Glendale 27, N. Y.

**GRID CIRCUIT TESTER, model**

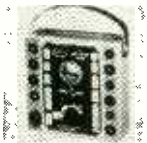

**GCT-8.** Checks condition of control grid of vacuum tubes for control grid emission, gassy tubes and internal shorts.—Seco Manufacturing Co., 5015 Penn Ave. S., Minneapolis, Minn.

**TRANSISTOR CHECKER, model TRC1.** Tests for opens, shorts, current gain and leakage on all transistors and forward-to-reverse currents on crystal diodes

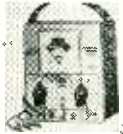

and rectifiers.—Service Instruments Corp. (SENCORE), 171 Official Rd., Addison, Ill.

**REPLACEMENT FLYBACKS.** HVO-67 exact replacement for Sylvania 241-0019; HVO-70 for Bendix NH 265051-1,-2; HVO-71 for Sparton PC-70010 and PC-70012; HVO-72 for Sparton PC-70015; HVO-73 for Sparton PC-70019; HVO-74 for Sparton PC-70025.—Merit Coil & Transformer Corp., 4427 N. Clark St., Chicago 40, Ill.

**WIRE TANTALUM CAPACITORS, type WT.** Polar construc-

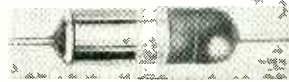

tion. Case and attached lead form cathode terminal. All units color-coded to indicate capacitance and voltage ratings. Oper-

ating temperature range: -20° C to 50° C.—Aerovox Corp., 740 Belleville Ave., New Bedford, Mass.

**METALLIZED CAPACITORS, type RLR.** Metallized Mylar un-

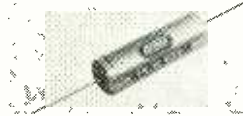

cased unit. For potted assemblies, military and commercial applications.—Astron Corp., 255 Grant Ave., E. Newark, N. J.

**SILICON RECTIFIERS.** For radio, TV and other electronic equipment. Screws onto the chassis or plugs into a holder. Typical unit ratings, 750 ma at 400 volts. Other values for commercial purposes range from 750 - 1,000 ma at between 100 and 400 volts.—Audio Devices Inc., Rectifier Div. 620 E. Dyer Rd., Santa Ana, Calif.

**INDOOR ANTENNA, model PB4 Piggy Back.** Attaches to rear of TV set. Out of sight when not in use. For vhf and uhf.—Clear Beam Antenna Corp., 21341 Roscoe Blvd., Canoga Park, Calif.

**INDOOR TV ANTENNA, Vi-Fi.** Vhf and uhf models. Tuner



matches antenna to channel frequencies. Transformer coupling for matching to set impedance.—Amphenol Electronics Corp., 1830 S. 5th Ave., Chicago 50, Ill.

**TV SET COUPLERS.** Mount to the antenna mast. Use permits all wiring runs outside the house to TV rooms. Completely encapsulated to protect components from weather. Model AC-40 for coupling two 300-ohm sets; AC60 for 3 sets; AC70 for

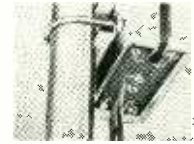

4 sets.—JFD Mfg. Co. Inc., 6101 16th Ave., Brooklyn 4, N. Y.

**FM ANTENNA KIT, No. A-124.** Turnstile design with self-supporting base. No alignment or

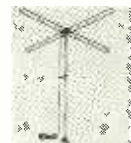

orientation needed. All mounting hardware supplied.—Telco Electronics Mfg. Co., 400 S. Wyman St., Rockford, Ill.

**TV ANTENNAS, Colortennas.** Gold-anodized aluminum. Impervious to staining, spotting, tarnishing, fading and corrosion. Includes all 11 helix and single

# DX-16 Super Deluxe TV KIT 70° or 90° — operating all 21", 24" and 27" PICTURE TUBES

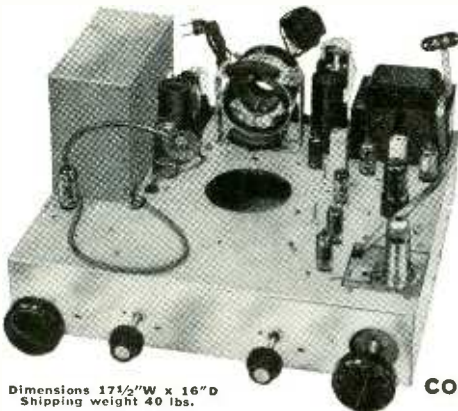

Dimensions 17 1/2" W x 16" D  
Shipping weight 40 lbs.

**NEW IN DESIGN — Mounts Horizontally, Vertically or Sideways.**

- ★ Produces a Superior 16-Tube Chassis with 30-Tube performance.
- ★ Latest advanced Intercarrier Circuitry and Multi-section Tubes.
- ★ Standard Cascode Tuner for Selectivity and Fine Definition.
- ★ 5 Microvolts Video Sensitivity (20 volts peak to peak at CRT grid).
- ★ Fast Action AGC for Drift Free, Steady and Clear Pictures.
- ★ 3 Hi-gain Video I.F. Stages for excellent Contrast and Details.
- ★ AGC Level and Area Control, for adjusting reception to signal area.
- ★ All Video and I.F. Coils factory pre-aligned and tuned.
- ★ Horizontal Sweep Circuit is the famous RCA Synchroguide Network.
- ★ Large 250 ma Power Transformer—not a hot chassis.
- ★ Large 12" Concert-tone Speaker.

**COMPLETE with LIFE-SIZE step-by-step Building Instructions (less tubes & CRT) \$69.97**

**COMPLETE with SET of WESTINGHOUSE TUBES** 4-6B6 and 6U8, 6X4, 12BH7, 6SN7, 6BQ6, 6W4, 1X2B, 5U4, 6J6 and 6BQ7 included in the Tuner. (less CRT)... **\$79.97**

**COMPLETE with SET of WESTINGHOUSE TUBES** WESTINGHOUSE 21" 70° or 90° Aluminized CRT... **\$99.97**

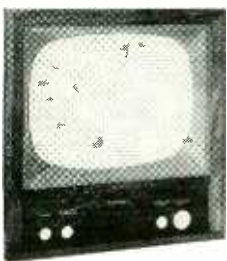

## BUILD YOUR OWN TV CABINET FOR ANY TV CHASSIS

Comparable to the type that Top Mfrs. use on their higher priced TV Sets.

**CABINET KIT with 90% of the job done, includes—**

- **FRONT SECTION** complete as pictured in Solid Mahogany, Walnut or Blond Korina.
- **TOP, SIDES, BACK** with CRT CUP, MASK, SAFETY GLASS, ETC. and Easy-to-follow Instructions.

Front, Top and Sides supplied in a beautiful Piano Finish or in Natural (unfinished) for your own color application. Knob panel un-drilled (or drilled on receipt of your template). For matching Mask specify type of CRT used. Same price for Mahogany, Walnut or Blond.

**21" CABINET KIT** 26"H, 25"W, 22"D **\$24.95**      **24" or 27" CABINET KIT** 30"H, 28 1/2"W, 22"D **\$32.47**

(Also available for 17" CRT) Maximum Shipping Wt. 36 Lbs.  
**FRONT SECTION** for WALL INSTALLATIONS Includes Mask, Safety Glass, Decals and Easy-to-follow Illustrated Instructions. **21" ... \$17.45**      **24" or 27" ... \$22.97**

**BROOKS RADIO & TV CORP., 84 Vesey St., New York 7, N.Y. TELEPHONE COrtland 7-2359**

JANUARY



# Use Delco Radio Service Parts!

8-inch "Hi-Fi" speaker, No. 8007 offers the most highs, the most lows, the most watts in a medium-price speaker. Designed for replacement use and high fidelity audio systems.

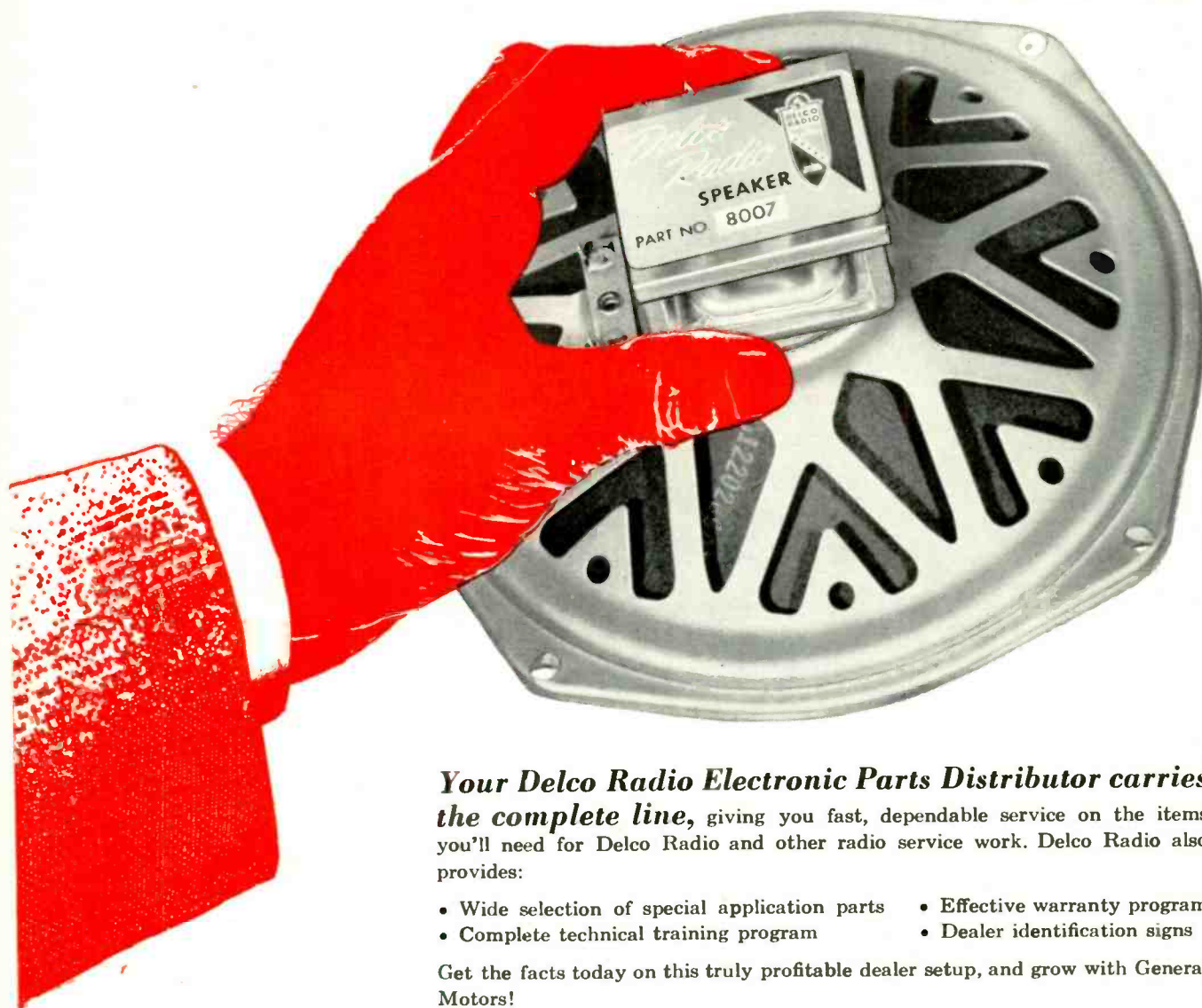

*Your Delco Radio Electronic Parts Distributor carries the complete line*, giving you fast, dependable service on the items you'll need for Delco Radio and other radio service work. Delco Radio also provides:

- Wide selection of special application parts
- Complete technical training program
- Effective warranty program
- Dealer identification signs

Get the facts today on this truly profitable dealer setup, and grow with General Motors!

Available everywhere through Electronic Distributors associated with ...



## DELCO RADIO

DIVISION OF GENERAL MOTORS, KOKOMO, INDIANA

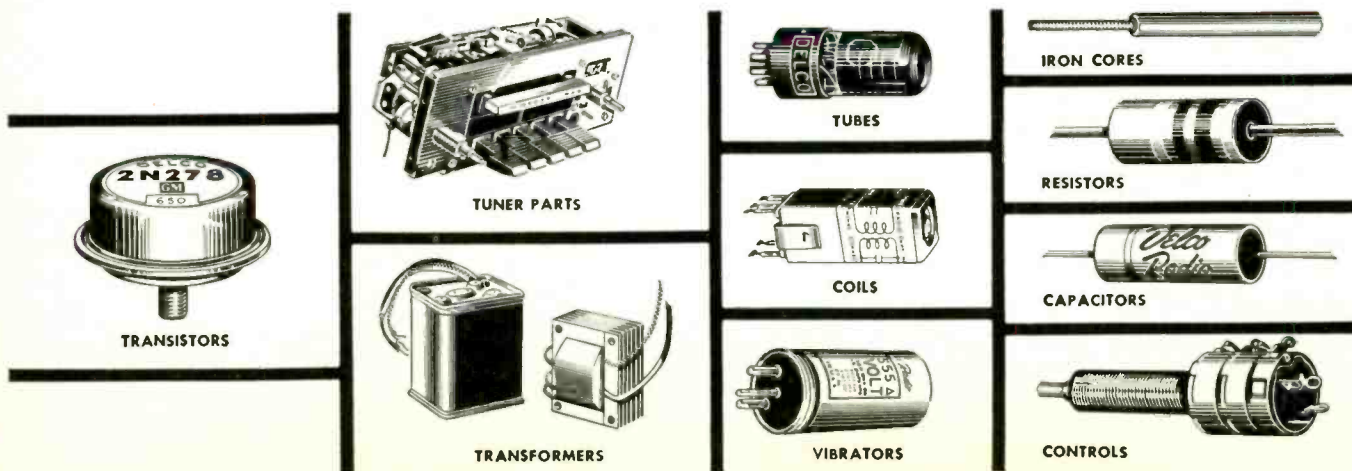

# LEARN MORE! EARN MORE!

WITH H. G. CISIN'S TV SERVICE BOOKS

## New! Guide To BASIC ELECTRICITY



Learn electricity at home this easy way, without time-wasting correspondence. Information you need and want is at your finger-tips, clearly explained and illustrated. First two vols.'s just off press.

Send for these two new books at once—we guarantee you will be more than satisfied.

Vol. 1 (No. E1).....\$50c  
Vol. 2 (No. E2).....\$50c

## ABC OF COLOR TV



This easily understood new book takes the mystery out of Color TV.

Fully illustrated. Covers basic color principles, color transmission and reception, the color signal, color tubes. Helps you cash in on this profitable new field.

No. R1.....\$1

## TV CONSULTANT



The TV serviceman's silent partner. New rapid methods of pinpointing faults. Tells WHAT to do and HOW to do it. Includes UHF, COLOR and use of test instruments. NO MATH. NO THEORY. NO FORMULAS. Just practical servicing info covering all types of TV sets.

No. L1.....\$2

## RCA & ADMIRAL TROUBLE INDICATING TV TUBE LOCATION GUIDES



These two books contain the most complete compilation of RCA and ADMIRAL tube location guides ever published. The RCA volume includes all TV models from the earliest 1947 sets to latest models, more than any 5 ordinary tube chart books.

The ADMIRAL book includes over 1500 Admiral TV models from the earliest sets to the newest 1956 models. Also contains a PICTURE GUIDE to TV tube troubles.

RCA GUIDE—No. A1.....\$1 ADMIRAL GUIDE—No. M1...\$1

## TV PIX GUIDE



Pictures show off-recurring faulty TV conditions. Probable causes are explained and logical cures suggested. A second section clearly defines and explains technical TV terms. Over 70 illustrations.

1957 Edition  
No. G1.....\$1

## TV TUBE SUBSTITUTION GUIDE



Tube replacements for TV & radio sets. All fit same sockets and NEED NO CHANGES IN WIRING. Book also contains complete data on PICTURE TUBE replacements, many directly, others with only slight changes.

No. S1...Only 50c

## TV TUBE LOCATORS Vol's 1 & 2

TROUBLE INDICATING TUBE LOCATION GUIDES for thousands of TV models from Admiral to Zenith. Tell which tubes to replace to cure every trouble due to tube defects.

Vol. 1 covers 1947 to 1953 models. Vol. 2, just off press, covers 1954 to 1957 sets including newest portables.

Vol. 1 (No. K1).....\$1  
Vol. 2 (No. K2).....\$1.50



## RAPID TV TROUBLE SHOOTING METHOD

New Edition

Norel TV servicing method enables a novice to diagnose TV troubles as rapidly as an expert.

PIX, raster and sound troubles are listed and given code numbers. When combined they tell exact location of trouble.

No. T1.....\$1



## SHOOT TV & RADIO TROUBLE FAST

Quickest radio & TV trouble shooter locates radio & TV faults in record-breaking time, regardless of make or model. Section on printed circuits. Only book containing radio & TV trouble tracing in one vol.

No. T2.....\$1.50



## NEW DEVICES (Continued)

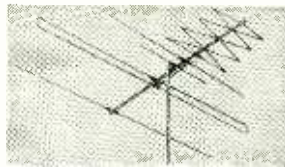

and stacked Fireball models.—JFD Mfg. Co., Inc., 6101 Sixteenth Ave., Brooklyn 4, New York.

**PIX TUBE REJUVENATOR, Kure-All.** For parallel or series circuits. Claimed to cure open-cathode and heater-cathode shorts; control grid shorts, slow



heating or low emission. Base design fits all TV picture-tube sockets without adapters.—Anchor Products Co., 2712 Montrose Ave., Chicago 18, Ill.

**PORTABLE RADIO, all-transistor Trans-Oceanic.** 8 bands

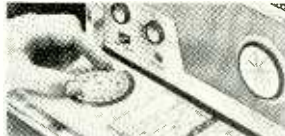

with electronic bandsread to stretch distance between stations on dial. 13 lbs., including batteries. Ordinary flashlight batteries power set up to 300 hours.—Zenith Radio Corp., 6001 W. Dickens, Chicago 39, Ill.

**TRANSISTOR RADIO KIT, model TR4-K.** 4 transistors and a diode. Flat ferrite antenna,



printed circuit board and 2½-inch speaker.—Superex Electronics Corp., 4-6 Radford Place, Yonkers, N. Y.

**CUTTING PLIERS, No. 207-5C.** 5½ inches long. Shear cutting blade cuts dead soft or extreme-

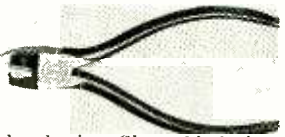

ly hard wire. Shear blade is replaceable. Coil spring separates jaws.—Mathias Klein & Sons, 7200 McCormick Rd., Chicago 45, Ill.

**PRINTED-CIRCUIT SWITCHES.** Rotary, 8- or 12-position types. For plug-in installation



on printed-circuit boards. Dip-soldering circuit board makes all switch contacts in one process.—Knight Electronics Corp., 210 S. Desplaines St., Chicago 6, Ill.

**CABLES.** Full line with molded-on connectors. 10 to 72 inches with various combinations of phono pin plugs and jacks, alligator clamps, spade lugs and



phone jacks. Transparent plastic envelopes.—Walsco Electronics Manufacturing Co., 100 W. Green St., Rockford, Ill.

**PRINTED-CIRCUIT SOLDERING KIT.** 4 interchangeable tips fit this manufacturer's regular model 250A soldering gun. Tip No. 5209 designed for removal of circuits in straight line. No. 5208 for multiple connections requiring simultaneous removal;

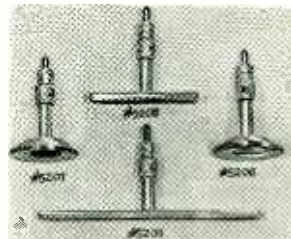

No. 5207 for removing all standard sockets from printed-circuit boards; No. 5206 for removal of difficult components like if cans.—Gregg Electric Co., 2 S. Broadway, Lawrence, Mass.

**TUBE CADDIES, Pacemaker TC-100 (left).** With meter and tools, holds 262 tubes or less.



Pacemaker Jr. TC-200 (right), 143 tubes or less.—Argos Products Co., 310 Main St., Genoa, Ill.

**SOLDERING AIDS,** miniaturized. Two types. Specially designed for printed-circuit appli-



cations.—Available from CBS-Hytron tube distributors.

**CAPACITOR, type RQL.** Mylar metallized in a hermetically sealed case. Reliable at temper-



atures up to 125° without derating.—Astron Corp., 225 Grant St., E. Newark, N.J.

**TURNTABLE, G. I. Special.** 33½ rpm. 50- or 60-cycle operation by shifting the drive belt to the appropriate step on the turntable's pulley.—Components Corp., Denville, N. J. END

All specifications given on these pages are from manufacturers' data.

**FREE—\$2 WORTH OF BOOKS—FREE—** with every purchase of entire CISIN TV LIBRARY of 19 valuable TV service books listed above. Regular price \$16.50—yours for only \$14.50.

**FREE:** With all orders of \$5 or over, new TV Tube Substitution & Trouble Chaser Chart.

**IF JOBBER IS OUT OF STOCK MAIL "NO RISK" TRIAL ORDER COUPON**

5-day Money Back Guarantee

H. G. CISIN, Dept. E-45, AMAGANSETT, L.I., N.Y.

Enclosed find \$..... RUSH POSTPAID following books:

K2—\$1.50  A1—\$1  T2—\$1.50  TT2—50c  
 K1—\$1  M1—\$1  T1—\$1  TT3—50c  
 L1—\$2  G1—\$1  S1—50c  TT4—50c  Enclosed find \$14.50.  
 D5—\$1  R1—\$1  TT1—50c  TT5—50c  Send entire Cisin TV  
 E1—50c  E2—50c  TT6—50c  LIBRARY listed above.

Name.....

Address.....

City..... Zone..... State.....

# Technotes



## MOPAR 821X AUTO RADIO

After the set blew a replacement 14-amp fuse, I pulled it out of the car for a check. Not having 6-volt power at the bench, I checked for opens, shorts and in-betweens.

Tubes, vibrator, buffer and filter capacitors appeared normal, but the B-plus filter resistor, a 2,200-ohm unit,

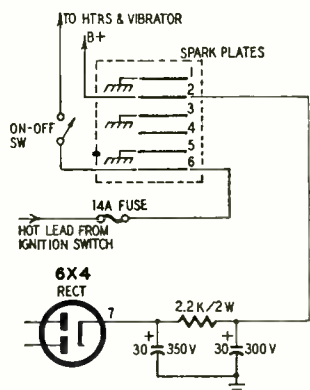

was cooked down to around 300 ohms and indicated a dead short in the B-plus line.

A check of all components failed to locate the short until the spark-plate assembly was suspected. It was dismantled by filing and punching out the rivets. A small hole burned in the insulation between plates 1 and 2 proved to be our trouble.

The spark plates were reassembled with a layer of electrical tape backing up the defective insulation. And, with the set reinstalled, the total damage amounted to one 2,200-ohm 2-watt resistor, two fuses and a lot of valuable time.

The moral of all this? Spark plates are not as rugged and dependable as they appear.—Paul B. Lavallee

## FLYBACK SINGING

Flyback transformer "singing" is a high-pitched whine occurring at 15,750 cycles and is caused by an inherent mechanical resonant condition. The core is usually the vibrating medium although a loose lead connected to the transformer or a loose turn of wire within the transformer itself is also often responsible for this condition. Singing is usually objectionable and sometimes nerve-racking to those whose hearing is acute at high frequencies. (Most people can't hear it.)

To eliminate or minimize this condition, tighten and dress all leads; tighten all screws on the terminal board and mounting bracket, being careful

# GIANT EXPANSION SALE!

OUR LARGER QUARTERS ALLOW US TO BRING YOU THE ADVANTAGES OF TRUE VOLUME BUYING! TONS OF RADIO PARTS BOUGHT FOR THIS SALE! NOWHERE ELSE CAN YOU GET SO MUCH VALUE FOR YOUR DOLLAR!

## FAMOUS DOLLARBUYS!

- 70 COILS & CHOKES. RF, IF, ANT., Large variety, incl. slug-tuned. Wt. 2 lbs. Reg. \$15.
- 3 LBS. HARDWARE. Reg. \$8. Approx. 2000 pcs. ass'd. screws, brackets, etc.
- 40 MOLDED CONDENSERS. Black Beauties, porcelain, etc. Reg. \$8. 0001 to .1 mf. to 1000 V. Oils incl. Wt. 1 lb.
- 40 PRINTED CIRCUIT PARTS. Diodes; carbon, precision resistors; chokes; molded, ceramic cond.; boards. Reg. \$15.
- 150 RESISTORS! 1/2, 1 W, 10 values; 5 ohms to 10 meg. 3/4", too. Reg. \$15.
- 2 TRANSISTOR TRANSFORMERS. UTC "ouner" type. Reg. \$10. 7-Derstage; 1x4.4x3 1/2". Imp. ratios unknown. Color-coded leads.
- WORLD'S SMALLEST RADIO KIT. 2 1/2x1 1/4x3/4" w/ permeability tuner, diode, all parts, directions. Reg. \$3.50
- SEVEN 25-ft ROLLS WIRE. Reg. \$3.75. Ass'd. colors, standing, insulation. ±18 to 24. Wt. 2 lbs.
- 80 CARBON RESISTORS. Insulated, IRC, A-B, etc. Many 1 K, 5/7, 1/2, 1 W, 10 ohms to 10 meg. 30 values. Reg. \$16.
- 2 SUB-MINI SOLENOIDS. 1 x 3/8 x 3/8". Change elec. energy to mech. 12 VDC @ 300 ma. actuates plunger. Wt. 2 oz. Reg. \$5
- 70 TUBULAR CONDENSERS. Reg. \$12. Paper, molded, oil. .0002 to .25 mf. to 2000V. Wt. 2 lbs.
- 40 TUBE SOCKETS. Reg. \$8. 4 to 14 prong. Bakelite, ceramic, mica. Shield types, too! Wt. 2 lbs.
- 40 SUB-MINI RESISTORS. Only 1/4" long. 20 values; 15 ohms to 10 meg. Color-coded. Reg. \$6.
- 4 OUTPUT TRANSFORMERS. 30L6, 35L6, 6V6, 6GB4 to 3 1/2 ohm v.c. Wt. 1 lb. Reg. \$6.50.
- 6-PC. NUTDRIVER SET. Plastic handle. 3/16, 7/32, 1/4, 5/16, 11/32, 3/8, 7/16" steel socket wrenches in plastic case. Wt. 1 lb. \$3 value.
- 15-PC TWIST-DRILL SET. 1/16 thru 1/4" x 64ths; in graduated plastic holders. Reg. \$4.
- 40 PRECISION RESISTORS. Carbonfilm, Wilkors, etc. 1/2 to 1 W. ass'd. Wt. 1/2 lb. Reg. \$18.
- 100 RADIO PARTS—surprise assortment. Reg. value over \$15! Wt. 3 lbs.
- 60 TERMINAL STRIPS & BOARDS. wide variety solder lug, binding, etc. Wt. 1 lb.
- 30 DISC CONDENSERS. Transistor & printed circuit types. Reg. \$8.
- 50 PLUGS & RECEPTACLES. Audio, power, chassis, panel & spkr. types. Wt. 2 lbs.
- 80 MICA CONDENSERS. Silver, 5% incl. 30 values; .00001 to .01 mf. to 1000V. Wt. 1 lb. Reg. \$5.
- 40 POWER RESISTORS. W.W. Candohm, vitreous, sand-coated. 15 values; 5 to 50W, 35 to 11000 ohms. Wt. 2 lbs.
- 15 VOLUME CONTROLS. Reg. \$10. Singles & duals to meg. Wt. 1 lb.
- 10 "POLY" BOXES. Clear plastic, minged, w/snap locks. Ass'd. sizes. Reg. \$2.50.
- 60 ASSORTED KNOBS. Bakelite, plastic; including set-screw types. Wt. 2 lbs. Reg. \$9.
- 10 ELECTROLYTICS. Ass'd. capacitor types to 500 mf. Wt. 3 lbs. Reg. \$14.
- 20 ROTARY SWITCHES. Ass'd. gangs, insulation, contacts. Wide variety! Reg. \$18. Wt. 3 lbs.
- 100 CERAMIC CONDENSERS, color-coded. Ass'd. types, including discs. Reg. \$15.
- 3 VARI-LOOPSTICKS, adjustable. Transistor circuits, 500-1500 Kcs. Reg. \$3.99
- 6 FERRI-LOOPSTICK CORES. Ass'd. flat & tubular, 5 to 7" long. Hi-Q. Wt. 1 1/2 lbs.
- 2 WORLD'S SMALLEST VARIABLES. Scoop! 10-365. 1 1/2 sq. w/1" shafts.
- MINI-METER BUY! 1 1/4" Ground, chromed, 0-6 amps. AC, for model railroads, power supplies.
- 75-PC. RESISTOR SPECIAL! All types, ass'd.; power, carbon, transistor, precision. 30 values—worth \$15. Wt. 1 lb.
- 65-PC CONDENSER SPECIAL! All types, ass'd.; impoled, oil, ceramic, paper, mica, etc. Reg. \$15. Wt. 2 lbs.
- 55 P-N-P TRANSISTOR. Famous make, hermetically sealed.
- DIODE KIT #1—SIH-con. 6 ass'd. pop. types. Some work. \$12.
- DIODE KIT #2—Germanium, crystal, 6 ass'd. Glas & hermet. sealed. Reg. \$8.
- DIODE KIT #3—SIH-con. 6 ass'd. pop. crystal, ass'd. Reg. \$12.
- APPLIANCE MOTOR. 3000 rpm, 115 vac. For cooling, hobby, hundreds of other uses. Reg. \$4.
- HEAVY DUTY POWER TRANSFORMER. 115 vac to 300-0-300 @ 250 mils. 5V @ 3A, 6.3 @ 8A. Gaseous, w/color-coded leads. Wt. 17 lbs. Reg. \$15.
- 18,000 OHM RELAY. by Clare. DPDT, mini type. Reg. \$8.
- 40 MINI CONDENSERS. Wide assortment of pop. values; by leading mfrs. Reg. \$8.
- 6-PC PRE-AMP KIT. For magnetic cartridges. Chassis, all parts, diagram. Less B5C7 tube (B8C extra). Wt. 1 lb. Reg. \$4.50.

FREE! YOUR CHOICE OF ANY \$1 ITEM WITH EVERY \$10 ORDER!

Regency ALL-TRANSISTOR VEST POCKET RADIO COMPLETELY WIRED! \$14.95 ONLY



Imagine! Cigarette-case-sized (3x 2x1") transistor radio fits into shirt pocket! Spectacularly engineered by famous Regency designers; uses reflex circuitry, with RF, DET., AMP. stages. No external ground, antenna or hanging wires. Amazing sensitivity, selectivity, volume. Plays anywhere! Tunes 540 to 1500 Kcs. Sensitive hearing-aid phone; 1000-hour batteries. Ready to play! GUARANTEED! SATISFACTION.

THREE-TUBE AC/DC AMPLIFIER

Fully wired, reg. \$5. Sep. vol., tone controls. Lowest price ever! \$2.99

Tubes, \$1.91 extra.

3-SPEED PICKUP

With turnover cartridge, 2 sapphire needles. High output, Hi-Fi type. Reg. \$8. Only \$2.99

SOLDERING GUN

Scoop! Light weight, controlled heat for transistor & printed circuit work. \$4.99

12" HI-FI PM SPEAKER

50 to 10,000 cps. Use with tweeter as nifty coax. 3-4 ohm v.c. \$4.44 Only

ANY SIZE ORDER ENROLLS YOU IN OUR UNIQUE "CREDIT BONUS" PLAN TO EARN FREE KITS!

HEARING-AID PHONES with cords

Crystal.....\$1.39  
Dynamic (5,000 ohm) 1.69

POCKET MULTI-TESTER



3 1/2x2x1 1/2" bakelite case, 100/ohms/V. Zero adj. 0/15/150/1000 AC & DC V; 0/150 ma; 0/100-1000 ohms. w/test leads and battery. In orig. pack. \$13 value! \$6.99

HI-FI TWEETER

Metal-cased, cone. Freq. response, 3,000 to 18,000 cps. Max. rating, 20 W. 2 7/8 x 2 1/2" w/flat surface mg. bracket. Elsewhere \$5.95 to \$12. Two types: 8 ohm, 16 ohm \$3.99 imp. each

CROSSOVER NETWORK

Crossover freq. 2500 to 3500 cps. For 8 and 16 ohm v.c. to match above tweeter. Reg. \$14. \$6.99 only

"SLIM JIM" CRYSTAL MIKE

60 to 10,000 cps. Sleek, lightweight aluminum; 4 3/8 x 1 1/2" dia. ON-OFF sw. cable, conn. Ship. \$14.95 \$4.88

SUPER-SENSITIVE RELAY

Needs only 100-500 mliproamps, 0.5 VDC. Adj. SPDT contacts, 4000 ohm coil. Reg. \$10. \$2.98 only

25 NEON BULBS

Type NE2. Less than half-price! Hundreds of uses in radio and hobby circuitry. \$1.00

HOW TO ORDER

Check items wanted. Return entire ad w/check or MO including sufficient postage; excess returned. C.O.D. orders, 25% down. Rated, net 30 days. Print name, address, amount money enclosed, in margin. (Canada postage: 45c 1st lb., 28c ea. add'l. lb.) Export Orders Invited

# LEKTRON

Above "DOLLARBUYS" only \$1 each!

131 EVERETT AVE. CHELSEA 50, MASS.

Attention → Servicemen, Technicians, Industry and Hi-Fi Owners

Do you like the quality and the economy of buying kits, but lack the time to assemble and wire them? Dale Kit Builders make this astounding offer.

You buy the kit of your choice, and have it sent to us. We will assemble, wire and test any test equipment or hi-fi kit on the market today. All kit construction guaranteed.

Compare our prices with those of companies offering kit and wired instruments, see the savings. Just add 1/3 to the cost of your kit, and that is our fee, with a \$10 minimum fee.

Ship all kits to us prepaid, we will acknowledge receipt of all kits, and give you an estimate as to when it will be ready. All constructed kits will be returned C.O.D.

No partially assembled or wired kits will be accepted.

## DALE ELECTRONIC KIT BUILDERS

478 Woodbine St. Uniondale, N.Y.

"FOR  
OUTSTANDING  
PERFORMANCE  
AND  
TROUBLE-FREE  
OPERATION  
YOU CAN DEPEND ON  
**BENCO**  
TV EQUIPMENT"

A complete range of TV equipment for hotels, motels and community systems.

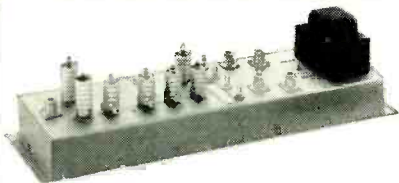

**SUPER-40—BROAD BAND AMPLIFIER**

Completely new design—Four 75 ohm inputs, each separately controlled—Modified cascode input, giving extremely low noise figure—Most versatile amplifier for present day conditions. **\$115<sup>00</sup>**  
Total output up to 4 volts.

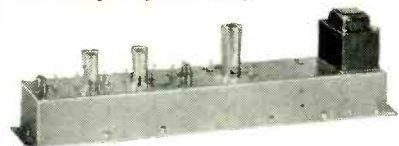

**CO-2 CRYSTAL CONTROLLED CONVERTER**

Converts any VHF to any other VHF channel. Provides Low to High, High to Low, Low to Low, High to High, or off channel conversions in a single unit. Virtually no forbidden channels. **\$179<sup>50</sup>**

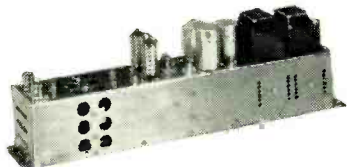

**H. C. A.—VERY HIGH OUTPUT AMPLIFIER**

Designed for all applications where a high output voltage is required. Capable of driving a low band signal through 2 1/2 miles of K-14 type cable. **\$250<sup>00</sup>**  
5 volts maximum output.

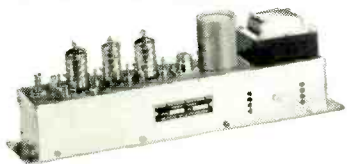

**S. P. A. SINGLE CHANNEL PRE-AMPLIFIER**

For head end of multiple systems. 40 db gain—built-in overload control. Low noise cascode input. Economically priced at **\$59<sup>95</sup>**

Prices are suggested user net.

**USE THIS HANDY COUPON**

Benco Television Associates Ltd.,  
27 Tabor Road,  
Rexdale, Ontario, Canada  
Please send me full information on

- Super "40"
- CO-2
- H.C.A.
- S.P.A.

Name .....

Address .....

City..... Prov. State.....

**TECHNOTES (Continued)**

not to crack the transformer core or terminal board. Pack insulating wax or carbon compound between the core and terminal board and between the core and mounting bracket. If the difficulty still persists, as it sometimes does in more stubborn cases, mount the flyback transformer with rubber shock mounts and tighten the mounting screws securely. Also try readjusting the horizontal drive, width, and horizontal linearity controls.—*Warren J. Smith*

**SNIVET CURE**

A General Electric 9-inch portable (model 9T001) had dark smudges on the right-hand side of the picture. A bypass to ground at the screen grid of the horizontal output tube re-

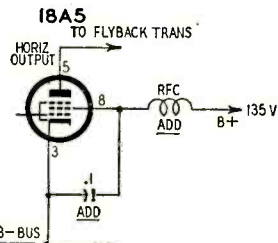

duced the intensity of the smudges (the snivets) somewhat but not enough to be considered a cure. As the accompanying schematic shows, a filament choke was installed in series with the 135-volt B-plus feed to the output tube's screen grid to finish the job.

This filter prevented radiation of the disturbances at the horizontal output's screen grid all over the set via the 135-volt B-plus bus.—*James A. McRoberts*

**NO B — Y, BLUE SCREEN**

We have had a couple of sets come in with this trouble. An RCA CTC5 came

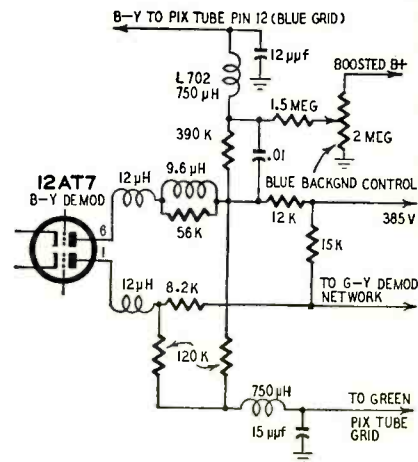

in with a complaint that the screen had a predominant blue tint on monochrome programs. A check of the circuit showed no B—Y signal applied to the color picture tube. Further work pinned it down to L702. The coil had opened, cutting off the signal to the picture tube. The coil was replaced and the blue tint disappeared.—*L. Warren* END

**Can you think . . . faster than this Machine?**

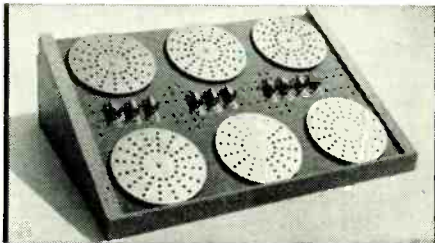

Control Panel of GENIAC set up to do a problem in check valve research.

Be careful before you answer. GENIAC the first electrical brain construction kit is equipped to play tic-tac-toe, cipher and encipher codes, convert from binary to decimal, reason (in syllogisms) as well as add, subtract, multiply and divide. Specific problems in a variety of fields—actuarial, policy claim settlement, physics, etc.—can be set up and solved with the components. Connections are solderless and are completely explained with templates in the manual. This covers 33 circuits and shows how new ones can be designed.

You will find building and using GENIACs a wonderful experience; one kit user wrote us: "This kit has opened up a new world of thinking for me." You actually see how computing, problem solving, and game play (Tic-tac-toe, nim, etc.) can be analyzed with Boolean Algebra and the alternate solutions transformed directly into circuit diagrams. You create form over 400 specially designed and manufactured components a machine that solves problems faster than you can express them.

Schools and colleges, teachers of science or math, engineering, philosophy or psychology will find these excellent demonstrators of circuitry, solutions in symbolic logic, theory of numbers, cybernetics and automation.

Note: Teachers take advantage of our 10% discount to educational institutions and for group purchases.

SEND for your GENIAC kit now. Only \$19.95 with over four hundred components and parts, fully illustrated manual and wiring diagrams. We guarantee that if you do not want to keep GENIAC after one week you can return it for full refund plus shipping costs.

**—MAIL THIS COUPON—**

**SCIENCE KITS, Dept. RE-18, Oliver Garfield Co.**  
126 Lexington Ave., N.Y. 16, N.Y.

Please send me:  
1 GENIAC Electric Brain Construction Kit and Manual.  
**\$19.95** (East of Mississippi) .....  
**\$20.95** (Elsewhere in United States) .....  
**21.95** (Outside the United States) .....

Returnable in seven days for full refund if not satisfied.

I enclose \$..... In full payment.

My name and address are attached.

**COLMAN Electronic Products**

**TV PICTURE TUBE CONVERSION KIT**

Complete conversion kits for replacing metal tubes with glass tubes. Kit contains everything except the picture tube. Average conversion less than one hour.

**FROM THIS TO THIS**

9

Different Kits for RCA, Emerson, Stewart-Warner, Silvertone, True-tone, Coronado, Hallicrafters, Firestone, CBS-Columbia, Airline, Arlington, Wells-Gardner, Arvin, Crosley, Fedway.

In stock at leading parts jobbers everywhere.

**COLMAN TOOL & MACHINE CO.**  
P. O. Box 7026—Amarillo, Texas  
Canadian Representative: Wm. Cohen Ltd., 7000 Park Ave., Montreal, Canada



**THE FUND REACHES  
\$12,294.37**

**HELP -  
FREDDIE-WALK  
FUND**

As we enter 1958, the Help-Freddie-Walk Fund, through the generosity of our readers, has collected almost \$12,500 for little Freddie Thomason, son of a radio technician of Magnolia, Ark., and born without arms or legs.

We have not heard from the Thomasons for some time but, believing that "no news is good news," we are certain that Freddie is making steady progress in his fight to adjust to the normal life of a 7-year-old.

It goes without saying that we are sincerely grateful for all donations, no matter how small, but at this time we would like to say a special "thank you" to John Stefanuk of New York City, who has contributed \$50 to the fund, and to Walter C. Hieber, Jr., radio and television technician of Maracaibo, Venezuela, who wrote us at length congratulating us on our efforts in Freddie's behalf and enclosed his check for \$25. We would also like to thank Meridian TV Service of Washington, D. C., who for several months have sent in almost-weekly donations.

Won't you send in your contribution as soon as possible? All donations are

acknowledged by letter and are forwarded to Magnolia, where they are allocated according to Freddie's needs. *Make out all checks, money orders, etc., to Kiwanis Club of Magnolia, Ark.* Send all contributions to:

Help-Freddie-Walk Fund  
c/o RADIO-ELECTRONICS  
154 W. 14 St., New York 11, N. Y.  
RADIO-ELECTRONICS Contributions  
as of July 10, 1957.....\$11,691.87  
FAMILY CIRCLE Contributions..... 602.50  
Anonymous, Philadelphia, Pa..... 1.00  
Norman Fletcher, Toledo, Ohio..... 1.00  
Cdr. Gantz, USN, Seattle, Wash..... 5.00  
Walter C. Hieber, Jr.,  
Maracaibo, Venezuela..... 25.00  
Clayton Loyd, Oneida, Tenn..... 15.00  
John MacDonell, Jersey City, N. J..... 10.00  
Meridian TV Service,  
Washington, D. C..... 32.00  
Alexander Rys, Minneapolis, Minn..... .10  
H. B. Scroggs, Baltimore, Md..... 1.00  
Peter Shvaykus, Singac, N. J..... 2.00  
John Stefanuk, New York, N. Y..... 50.00  
**TOTAL CONTRIBUTIONS as of**  
Nov. 11, 1957.....\$12,436.47

**CORRECTIONS**

There is an error in the coil table for the 108-mc converter described in the article "Tracking U.S. Satellites" on page 45 of the December issue. L4 is listed as 19 turns of No. 16 wire. It should be 9 turns as specified in the schematic.

Transformer T5 in the "7-Transistor Pocket Radio", November, 1957, is a Lafayette type MS-341. An error in the manufacturer's original specifications led us to list its primary impedance as 18,000 ohms. It is 25,000 ohms.



No matter what part of radio, electronic, communications or electrical work you plan to do, this is the most important training of all.

**Complete training in  
BASIC  
ELECTRICITY**

Your key to Success  
in Radio-Electronics

**Includes BASIC ELECTRONICS**

... general and industrial ... even covers transistors and their uses.  
**BRINGS YOU THE COMPLETE "KNOW HOW" OF:** Circuits & Currents; Controls; Electromagnetism; Capacitance; Inductance; Resistance; Phase Relations; Generators; Motors; Transformers; Rectifiers; Wiring; Illumination; Instruments & Measurements; Tubes; Amplifiers; Oscillators; Transistors; Industrial Electronics & Automation; X-Rays; Power Factor; Servos ... and dozens more.

All electrical equipment from industrial units to TV sets; from guided missile controls to hi-fi systems are based on the same fundamental electrical principles.

Learn these principles thoroughly ... and then everything else comes 10 times as easy!

You'll understand new circuits and new equipment in a jiffy. You'll have a firm grasp of ALL electrical-electronic matters that will amaze you. And you'll be far better fitted for interesting, good-paying jobs along almost any electrical line. Rufus Turner's new 396-page BASIC ELECTRICITY manual brings you the kind of practical training that can pay off in a dozen different ways!

From basic currents and circuits to electromagnetism ... from polyphase systems to oscilloscopes ... right down the line to transistors, tubes, sound reproduction and even telemetering, BASIC ELECTRICITY covers the entire field.

**TRAINING THAT SHOWS YOU HOW!**

300 pictures make things doubly clear! You get practical examples of reactance, phase relations, impedance ... even power factor. You see how and why to make measurements by various methods. "Set up" diagrams teach you to extend meter ranges or to measure speed, strain, thickness, etc. Essentials such as motors, generators, batteries, etc., are fully covered. Complicated controls are explained ... with no need for advanced mathematics to understand them.

Send coupon! You be the judge without risking a cent!

**10-DAY FREE EXAMINATION**

Dept. RE-18, RINEHART & CO., INC.  
232 Madison Ave., New York 16, N. Y.

Send Turner's 396-page BASIC ELECTRICITY manual for 10-day FREE EXAMINATION. If book is satisfactory, I will then send you \$6.50 (plus postage) promptly in full payment. If not, I will return book within 10 days and owe nothing. (Save! Send \$6.50 with order and we pay postage. Same 10-day return privilege with money refunded.)

Name.....  
Address.....  
City, Zone, State.....

OUTSIDE U.S.A.—Price \$7.00 cash with order. Money back if you return book within 10 days.

SAVE 1/2 — PAY PART-BY-PART — HAVE FUN  
**Assembling the SCHOBER  
ELECTRONIC  
ORGAN in KIT form**

**NO SPECIAL  
SKILLS  
NEEDED**

Now you can afford a real, full concert organ, just like those made by the foremost organ manufacturers. Because over 1/2 the cost is saved when you assemble it yourself. And it's REALLY EASY: only 24 separate units, all with printed circuits, and detailed-to-the-smallest-step instructions. In addition, you purchase each of the 24 kits when you are ready for it — and can afford it.

You'll get a real kick out of putting the Schober Electronic Organ\* together — and then sitting down and pulling the stops for Strings, Trumpets, Clarinets, Diapasons, Flutes, etc. Electronic Percussion optional; chimes available.

**Compact CONSOLE**

One of the many exclusive features of this exceptional organ is the handsome console, in a wide variety of finishes. It is equally at home in a traditional or modern setting, and takes little more space than a spinet piano.

**Free Literature**

Complete descriptive booklet and price list are available on request. And, if you wish to hear the glorious pipe organ tone of the Schober Electronic Organ, a 10" long-playing demonstration recording is available for \$2. This is refundable when you order. Write today and see what a fine instrument you can get at such a great saving.

**The SCHOBER ORGAN CORP.**

2248-B Broadway, New York 24, N. Y.

\*Designed by Richard H. Dorf  
JANUARY, 1958

**WILL YOUR REPLACEMENT  
Fuse Resistor  
BURN OUT AGAIN?**

Another  
Sencore  
Time-  
Saver

Not if you use —  
The NEW SENCORE  
"FUSE-SAFE"  
CIRCUIT TESTER

Save costly call backs by testing the circuit before replacing fuse, fuse resistor or circuit breaker.

Individual scale for each value fuse resistor — no interpretation, just read in red or green area.

- ★ Measures line current and up to 1100 watts of power at 115 volts using line cord and socket.
- ★ Two convenient current ranges — 0 to 2 amps and 0 to 10 amps. Test leads clip in place of fuse or fuse resistor.
- ★ 5 ohm, 10 watt resistor prevents TV circuit damage and simulates operating conditions.

As Recommended by Leading Manufacturers

Mfg by **SERVICE INSTRUMENTS CORP.**  
171 OFFICIAL RD., ADDISON, ILL.

**\$8.95** DEALER NET  
MODEL FS-3  
AC-DC or both as needed for Fuse Resistor Circuits

Cut out this ad now for further information

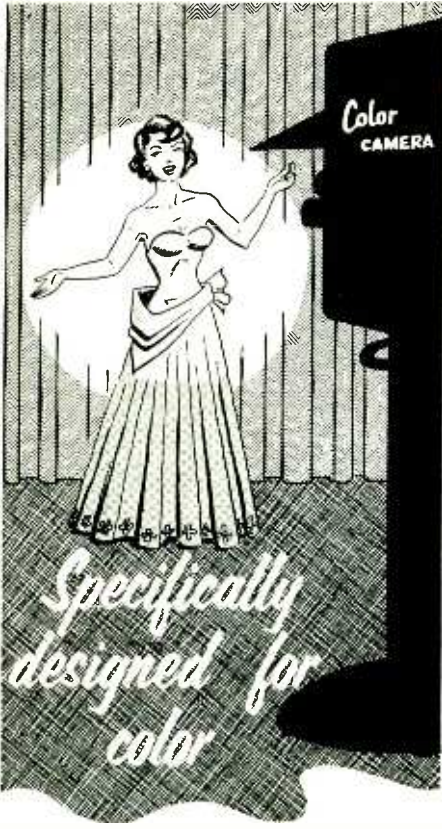

**TRIO®  
COLORITE**

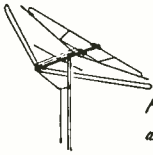

For color or black and white in areas formerly using Conicals and Conical Yagis

**TRIO®  
COLOR  
ROYAL**

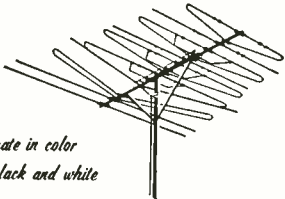

For the Ultimate in color reception or black and white

TRIO COLOR ANTENNAS FEATURE THE

**magna-chrome**  
element system

FOR:

high forward gain

Sharper, Clearer Pictures High Signal-to-Noise Ratio

flat frequency response

Improved Contrast on Black & White

Perfect Reproduction of the Color Signal

highest front-to-back ratio

For Freedom From Co-channel Interference

**TRIO®** Manufacturing Company  
ORIGOSVILLE, ILLINOIS

Export Sales Div., Scheel International Inc.,  
5909 N. Lincoln Ave., Chicago, U.S.A.  
Cable Address: HARSHEEL

## radio-electronic Circuits



### TV DIAL LAMP CONTROL

Dial lights on TV sets are often too dim, or contrariwise, bright enough to distract the viewer. Patent No. 2,743,433, issued to B. S. Parment and assigned to Motorola, describes a system that turns on the dial lights when the viewer approaches the set to adjust its controls. The circuit is shown with typical resistance and capacitance values. Tube types were not specified

drives V1 just to the point of saturation.

The amplified output of V1 is applied to the plate of rectifier V2. The grid of the dc amplifier (V3) is biased positive by a connection through R2 and R1 to a voltage divider consisting of 10,000 ohms from B plus and 47,000 ohms to ground. V2 rectifies the signal applied to its plate and develops

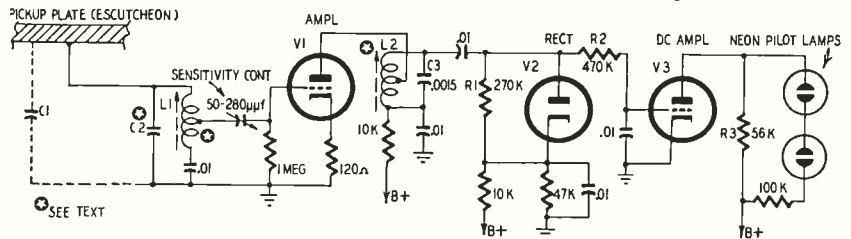

in the patent drawing. Experimenters may try typical voltage-amplifier type triodes in the amplifiers and half of a 6AL5, a germanium diode or a similar rf detector diode in the rectifier circuit.

Coil L1 is tuned to a harmonic of the horizontal sweep frequency by C1 and C2, and L2 is tuned to the same frequency by C3. C1 is the capacitance between a metal control escutcheon and the chassis or ground. The .01-µf capacitor in series with L1 helps to insulate the escutcheon from the chassis.

When the set is operating, a harmonic of the flyback pulse is picked up by the escutcheon and a sine-wave signal is fed to the grid of V1. The variable grid capacitor combines with the input capacitance of V1 to form a capacitive voltage divider. It is adjusted so the signal applied to the grid

a voltage across R1 that opposes the positive voltage on V3's grid. The negative voltage on V2's plate and V3's grid overcomes the positive bias and drives V3 to cutoff.

When the viewer's hand approaches the controls, the capacitance of C1—the capacitance between the escutcheon and ground—changes, detuning the input circuit and reducing the signal applied to V1. The rectified voltage developed across R1 drops, reducing the bias on V3's grid and permitting it to conduct.

R3 draws plate current through R2 and develops a voltage drop across it. This voltage is applied to the neon or gaseous type pilot lamps through a 100,000-ohm limiting resistor. V3 cuts off and the lamps go out as soon as the viewer's hand moves away from the control escutcheon.

## QUALITY + ECONOMY = The Original, Dependable NO-NOISE TUNER-TONIC With Perma-Film



### BEWARE OF IMITATIONS!

- Cleans, lubricates, restores all tuners, including water type
- Won't change or affect capacities, inductance or resistance
- Won't harm insulations or precious metals nor attack plastics
- Eliminates all noise, oxidation and dirt indefinitely
- Use for TV, radio and FM
- Non-toxic, non-inflammatory
- Insures trouble-free performance

6 oz. Aerosol Can. **\$3.25**  
Net to Servicemen

### VOLUME CONTROL and CONTACT RESTORER With Perma Film

- Cleans
- Lubricates
- Protects

NOT A CARBON TET SOLUTION

2 oz. bottle, Net to Servicemen **\$1.00**

6 oz. Spray Can, Net to Servicemen **\$2.25**



Also available in 8 oz. bottles and quart cans At Your Nearest Distributor

### ELECTRONIC CHEMICAL CORP.

813 Communipaw Avenue

Jersey City 4, N.J.

**DO YOU  
HAVE the  
EARS**



**for EASY LISTENING?**

**NOW YOU CAN HAVE EASY  
LISTENING at a LOW COST**

Easy listening—velvet smooth response over the entire audio range—that's what you get in a new Utah Unidrive Coaxial High Fidelity Reproducer. Engineered for exceptionally fine frequency extension of both the bass and extremely high registers—a Unidrive will give you unsurpassed tonal quality—with minimum distortion—a velvet smoothness that is a revelation and a real pleasure to hear.

The Utah Unidrives are unique in design and assembly technique. A single, high efficiency magnet drives two perfectly matched and balanced high and low frequency cones with mechanical crossover, to achieve an efficiency heretofore unattainable in conventional designs. A newly developed skiver roll cone treatment immeasurably increases speaker lifetime.

See and hear the new Utah Unidrives at your dealers today. Available in six models and five sizes—6 X 9", two 8", two 12" and 15". Starting at the unbelievably low price of only \$15.95.

**utah** RADIO PRODUCTS CORPORATION  
HUNTINGTON, INDIANA  
Expt. Dept. Fidevox International, Chi., Ill.

**CONVERT TO COLOR TV**  
COLORDAPTOR—A simple 10-tube circuit and rotating color wheel converts any-size black-and-white TV, direct view or projection, to receive compatible color TV. COLORDAPTOR is simply attached to TV set, does not affect normal operation and can be built from parts experimenters have on hand.  
Complete specifications including theory of operation, complete simplified construction plans, schematic and sample color filters..... **\$1.95**  
Essential parts kit containing all special parts—coils, delay line, crystal, color filters—  
Up to 16" sets— **\$19.95** 17" and larger— **\$20.95**  
All other COLORDAPTOR parts, kits, motors, etc. available. Write for information and prices.  
COLORDAPTOR, 1798 Santa Cruz, Menlo Park, Calif.

**RADIO-ELECTRONIC CIRCUITS (Continued)**

Optimum values for L1, C2 and L2 may be determined experimentally. L1 and L2 may be tapped TV linearity or width coils such as the J. W. Miller type 6323 with an inductance range of approximately 0.5 to 5 mh. C2 can be an adjustable mica padder with a maximum capacitance of around .001  $\mu$ f.

**SURFACE-BARRIER SUPERREGEN**

This circuit, although quite simple, has great sensitivity. I proved this to myself one night while tuning across the bands. Using a 4-foot test lead as an antenna, I picked up WWV on 15 mc, and a local ham. I could even hear the California ham he had contacted on 10 meters. (I'm in Belleville, Ill.)

I use tapped capacitance feedback, which eliminates the need for a tapped coil. For L you can use a Cambridge

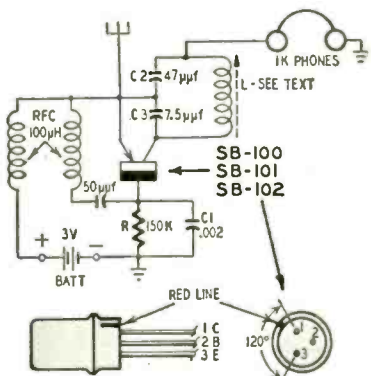

Thermionic LS3-5-, 10- or 30-mc coil, depending on the desired operating range.

Quenching action takes place in the transistor's base circuit, with R and C1 determining the quench frequency. Variations in the values of R and C1 are left to the builder, but be careful not to make R too small and exceed the transistor's current rating.

Values of C2 and C3, which form part of the tank circuit, may be changed to obtain the desired operating range, but take care to maintain the proper ratio of these two capacitors. If this ratio is not maintained, oscillation will not occur. The earphones can be replaced with a transformer, and a transistor audio amplifier added.—Donald S. Belanger, K9HGT

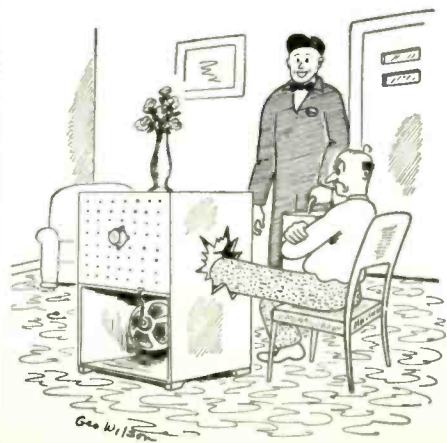

"Didn't work this time, did it?"

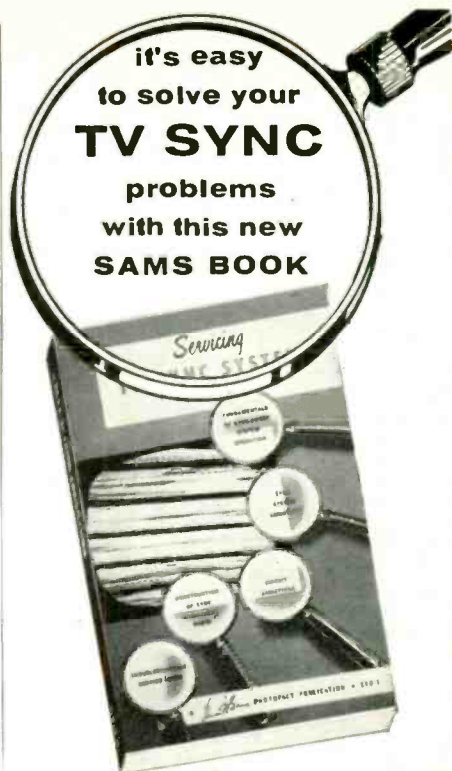

**"Servicing TV Sync Systems"**

by Jesse Dines

Valuable time-saving book for Service Technicians. Covers fully the theory of operation, circuit function and circuit variations of the 18 different types of sync systems used in TV receivers. Explains various types of sync separator, horizontal and vertical oscillator, and horizontal AFC circuits used in sync systems. Methods of analyzing and troubleshooting these circuits are supported by actual picture tube photos and waveforms illustrating types of sync troubles. Includes valuable data on oscillator coils, transformers and printed electronic circuits used in sync systems. Has chapter on practical servicing hints. This book will definitely help the technician to better understand and more easily service any type of sync system trouble. Written clearly and simply for quick and easy understanding. 320 pages; 221 illustrations, 5½ x 8½".

PRICE **\$3.95**  
ONLY

SEE THIS MONEY-EARNING BOOK AT YOUR ELECTRONIC PARTS DISTRIBUTOR OR MAIL COUPON TO HOWARD W. SAMS...

**FREE TRIAL COUPON**

Howard W. Sams & Co., Inc., Dept. 2A-8  
2201 E. 46th Street  
Indianapolis 5, Indiana

Send me Jesse Dines' book "Servicing TV Sync Systems" for 10 days FREE examination. In 10 days I will pay for the book, plus small delivery cost, or return postpaid.  
We pay delivery costs if you remit with this coupon. Same return privilege.

Name.....  
Address.....  
City..... Zone..... State.....  
(outside U.S.A. priced slightly higher)

**Perma-Power**



# TRANSISTOR POWER SUPPLY

MODEL A-400

Especially designed to operate, service and test transistor portable radios and low power transistor circuits.

Highest quality components combined with careful engineering make this instrument extremely reliable and useful for laboratory and service applications.

**\$64.50**

from Electronic Parts Distributors only

"TRULY A VARIABLE BATTERY"

## SPECIFICATIONS

Input: 115 Volts 50/60 cycles  
 Output Voltage: 0-15 Volts and 0-30 Volts  
 Output Current: 0-15 MA and 0-60 MA  
 Accuracy: 2% on both voltage and current  
 Ripple: Less than 500 microvolts (.002% at full output)  
 Regulation: 1.2 Volts Maximum; Zero to full load current  
 Internal Impedance: Less than 20 ohms DC to Radio Frequencies (including 7.0 ohm Meter Fuse, optionally removable)  
 Terminals: 5-Way Binding Post  
 Size: 10" x 6 1/2" x 5 3/4"  
 Weight: 16 pounds

## FEATURES

- Continuously adjustable output using variable autotransformer control.
- Two output voltage ranges for accurate setting of all transistor battery voltages.
- Two output current ranges monitor current for single transistor or entire set.
- Extremely low ripple for testing lowest level transistor circuits.
- Very low internal impedance providing excellent regulation.
- Precision D'Arsonval meters provide laboratory accuracy.
- Milliammeter protected by front panel fuse; additional internal line fuse.
- Output isolated from line and case.
- Attractive Slope — Front, Maroon Hammerloid Cabinet — Rubber feet.

**Perma-Power**

Manufactured by COMPANY 3100 N. ELSTON AVENUE CHICAGO 18, ILL

There's always something new being developed by Perma-Power

technical Literature



**TEST INSTRUMENTS**, including vom's, vtvm's, scopes, tube testers and signal generators, are presented in a colorful folder. A brief description and illustrations accompany each item.—Hickok Electrical Instrument Co., 10514 Dupont Ave., Cleveland 8, Ohio

**ELECTRONIC KITS**, including test equipment, amateur equipment and hi-fi units, are described and illustrated in this detailed 57-page 1958 catalog. Vtvm's, oscilloscopes, transmitters, receivers, amplifiers and many other such items are presented—Heath Co., 305 Territorial Rd., Benton Harbor, Mich.

**HI-FI COMPONENTS** are described in three bulletins. *ST-75* features turntables, tuners and complete systems; *ST-76* lists speakers, enclosures and speaker systems; *SK-77* describes complete systems and individual units.—Lafayette Radio, 165-08 Liberty Ave., Jamaica 33, N. Y.

**CAPACITORS**. Subminiature electrolytics are described in *Engineering Bulletin TE-250*; Mylar-metallized capacitors in *RM-300*; flat and round miniature Mylar dielectric types in *RM-325*; and metallized Mylar units in *RM-375*.—Astron Corp., 255 Grant Ave., E. Newark, N. J.

**SPEAKERS AND SPEAKER SYSTEMS** are presented in a 12-page catalog covering the manufacturer's entire line. Full product descriptions, specifications and application information are to be found. Enclosures and do-it-yourself kits are also included.—University Loudspeakers Inc., 80 S. Kensico Ave., White Plains, N. Y.

**ELECTRONIC COMPONENTS, Catalog 58**. A grouping of many types of electronic parts, with brief descriptions and illustrations thereof, fills its 226 pages.—Radio Shack, 167 Washington St., Boston 8, Mass.

**OK METHODS MANUAL C4** gives detailed advice on how to assemble and use many of this manufacturer's connectors. Single- and multiple-contact units are listed in the manual's 44 illustrated pages.—Amphenol Electronics Co., 1830 S. 54 Ave., Chicago 50, Ill.

**TEFLON INSULATED WIRE, Bulletin 8050**. Military specification wire, standard and Teflon-insulated are listed along with their specifications in an illustrat-



"You're using my Jensen Needle again, I see."



...watch for new catalog No. 581 it's terrific!



"COMPARE IT WITH MERIT"

MERIT COIL & TRANSFORMER CORP. 4427 N. CLARK ST., CHICAGO 40, ILLINOIS



ed 4-page pamphlet.—Belden Manufacturing Co., 4647 W. Van Buren St., Chicago 44, Ill.

**ALL ABOUT FM ANTENNAE** and their installation by L. F. B. Carini is a handy booklet about types and characteristics of various FM antennas. An 8-page directory, listing commercial FM stations in the United States, and their frequencies is included.—Apparatus Development Co., Inc., Wethersfield 9, Conn. 25c.

**AMATEUR RADIO EQUIPMENT** is described in this colorful 24-page catalog No. 957. Viking transmitters and accessories are presented. Circuit diagrams of many items are also shown.—E. F. Johnson Co., Waseca, Minn.

**RESISTOR COLOR CODER** is a device to help read resistor color codes. Indicators are set opposite the colors for reading the resistor's value. The color coder is 3 x 3 1/4 inches with colors printed on a white background. EIA (formerly RETMA) 10% standard values are listed on the reverse side.—General Cement Manufacturing Co., 400 S. Wyman St., Rockford, Ill. 25c.

**MANUFACTURER'S SWITCH CATALOG** offers complete specifications for this firm's complete line of rotary, slide and lever switches. This new catalog, available to interested parties, presents switches capable of handling power

from a kilowatt to a microwatt.—Centralab, 900 E. Keefe Ave., Milwaukee, 1, Wis.

**ELECTRONIC CONNECTOR**, a 4-page quarterly publication, announces the firm's recent product developments and, specifically, designs in electronic connectors.—H. H. Buggie, Inc., Box 817, Toledo 1, Ohio.

**MIT LINCOLN LABORATORY'S** fundamental research program and other activities are covered in an illustrated 12-page booklet. Subjects includes the SAGE system, heavy radar, memory devices, transistor digital computers, scatter communications and systems analysis.—MIT Lincoln Laboratory, Box 24, Lexington, Mass.

**SPEAKER CATALOG.** An attractive, descriptive folder outlines the complete line of Wigo speakers.—United Audio Products, 202 E. 19 St., New York 3.

**INDICATOR LIGHTS, Form L-159.** Sub-miniature indicator lights that incorporate the NE-2D neon glow lamp are described and illustrated in this 4-page brochure. The units shown are designed for panel mounting.—Dialight Corp., 60 Stewart Ave., Brooklyn, N. Y.

**REGULATED DC POWER SUPPLY** is described and illustrated in *Bulletin 250*. Specifications, too, are presented for this laboratory unit.—Opad Electric Co., 69 Murray St., New York. END

**CATALOG OF Professional Quality Kits "DIRECT FROM FACTORY"**

**FREE** 

- TV KITS
- INSTRUMENT KITS
- HI-FI KITS, SPEAKERS
- HI-FI CABINETS (Largest Selection)
- Electronic PHOTOFLASH Kits

PAY AS YOU WIRE with Transvision "SPLIT-KITS." A few dollars gets you started. Each Kit is split into a few packages. You can order one at a time as you wire.

Also **RECORDS** at **BIGGEST DISCOUNT!**  
RCA - CBS All Labels

TRANSVISION, INC., New Rochelle, N. Y.

Rush FREE Catalog of KITS, HI-FI Equipment Cabinets, Records, etc

Name \_\_\_\_\_

Address \_\_\_\_\_

City \_\_\_\_\_ State \_\_\_\_\_

Just Out

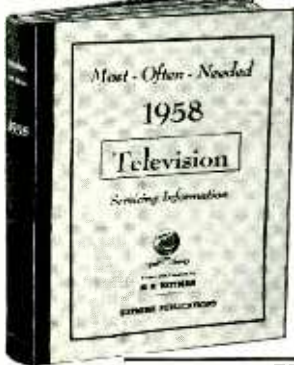

# New SUPREME 1958 TV Manual

## AMAZING BARGAIN

The new 1958 TV manual is the scoop of the year. Covers all important sets of every make in one giant volume. Your price for this mammoth manual is only \$3. This super-value defies all competition. Other annual volumes at only \$3 each. Factory service material simplifies repairs. Includes all data needed for quicker TV servicing. Practically tells you how to find each fault and make the repair. More pages, more diagrams, more service data per dollar of cost.

## TELEVISION SERVICING COURSE

Let this new course help you in TV servicing. Amazing bargain, complete, only \$3, full price for all lessons. Giant in size, mammoth in scope, topics just like a \$200.00 correspondence course. Lessons on picture faults, circuits, adjustments, short-cuts, UHF, alignment facts, hints, antenna problems, trouble-shooting, test equipment, picture analysis. Special, only **\$3**



## Companion RADIO COURSE, Introduction to TV

Here is your complete radio training in 21 easy-to-follow lessons. Covers fundamentals, fault finding, use of test equipment. Everything in radio, introduction to TV. Self-test questions. New edition. Special, only... **\$2.50**

17 RADIO VOLUMES

## RADIO DIAGRAMS

Here is your complete source of all needed RADIO diagrams and service data. Covers everything from the most recent 1957 radios to pre-war old-timers; home radios, auto sets, combinations, changers, III-FI, FM, and portables. Sensational values. Only \$2 for most volumes. Every manual has extra large schematics, all needed alignment facts, parts lists, voltage values, trimmers, dial stringing, and helpful hints. Volumes are large in size, 8 1/2 x 11 inches, about 190 pages. See coupon at right for a complete list of these radio manuals.



**Supreme Publications**

## COVERS ALL POPULAR SETS

Here is your service data for faster, easier TV repairs. Lowest priced. Best by comparison. *Supreme TV* manuals have all needed service material on every popular TV set. Helpful, practical, factory-prepared data that will really make TV servicing and adjustment easy for you. Benefit and save with these amazing values in service manuals. Only \$3 per large volume. The choice of wise servicemen.



## SIMPLIFIES TV REPAIRS

These giant TV manuals have complete circuits, needed alignment facts, curves, service hints, all factory production changes, voltage charts, waveforms, and double-page schematics. Here are your authentic service instructions to help you do expert work quicker; and priced at only \$3 per large yearly manual. Repair any TV model ever made by having in your shop all 13 volumes as listed in coupon. Your special price for all, only \$36. Or try the new 1958 TV manual to see what an amazing bargain you get for \$3. Send no-risk trial coupon today.

The repair of any television set is really simple with *Supreme TV* service manuals. Every set is covered in a practical manner that will simplify trouble-shooting and repair. This is the help you need to find toughest faults in a jiffy. Each \$3 TV volume covers a whole year of service material. New *Television Servicing Course* will aid you in learning TV. Be wise, buy *Supreme Manuals* only once each year instead of spending dollars every week.

## NO-RISK TRIAL ORDER COUPON

### SUPREME PUBLICATIONS, 1760 Balsam Rd., Highland Park, ILL.

- Radio Servicing Course, complete, 21 lessons, \$2.50
  - 1957 Radio Manual, \$2.50
  - 1956 Radio Diagrams, \$2.50
  - 1955 Radio Manual, only \$2
  - 1954
  - 1953
  - 1952
  - 1951
  - 1950
  - 1949
  - 1948
  - 1947
  - 1946
  - 1942
  - 1941
  - 1940
  - 1939
  - 1926-1938 Manual, \$2.50
  - Radio & TV Master Index, 25¢
- These annual RADIO volumes specially priced at only each... **\$2.50**
- THIS GROUP ONLY \$2 EACH**

Rush today TV manuals checked  below and Radio manuals at left. Satisfaction guaranteed.

- New 1958 Television Servicing Manual, only... \$3.
- Additional 1957 TV, \$3.
- 1956 Television Manual, \$3.
- Additional 1955 TV, \$3.
- 1953 Television Manual, \$3.
- 1951 Television Manual, \$3.
- 1949 TV Manual, \$3.
- New Television Servicing Course, complete... \$3.
- Early 1957 TV, \$3.
- Early 1955 TV, \$3.
- 1954 TV Manual, \$3.
- 1952 TV, \$3.
- 1950 TV, \$3.
- 1948 TV Manual, \$3.

I am enclosing \$..... Send postpaid.  
 Send C.O.D. I am enclosing \$..... deposit.

Name: \_\_\_\_\_

Address: \_\_\_\_\_

# PHAOSTRON

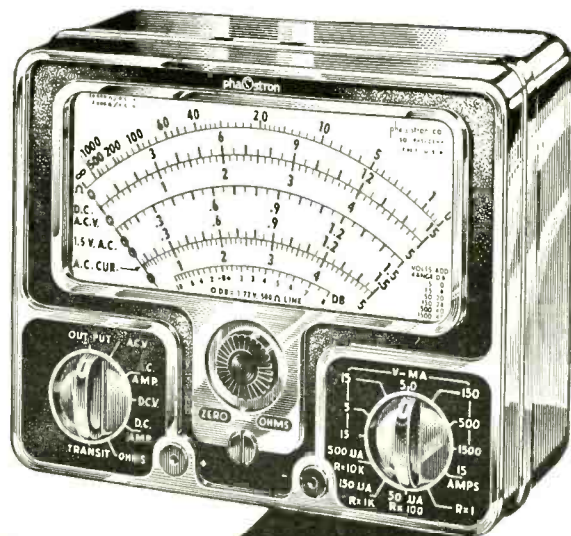

Here Is The Best Value Ever Offered In An Electrical Measuring Instrument...

#### METER PROTECTION

The meter movement is protected up to 1000 times overload by rectifier network.

## "555A"

### A.C.-D.C. V.O.M.

**ONLY THE PHAOSTRON "555A" V.O.M. (VOLT OHM MILLIAMMETER) MEASURES A. C. and D.C. CURRENT and VOLTAGE AS WELL AS RESISTANCE AND HAS ALL THESE FEATURES:**

- Unbreakable Metal Case of Highly Polished Chrome
- Separate Range and Function Switches
- Anti Magnetic Shielding
- Easy-to-Read, Large 4-Color Scales
- 43 Unduplicated Ranges
- Only 2 jacks
- 3% D.C....4% A.C. Permanent Accuracy

#### ACCESSORIES AVAILABLE

Genuine Leather Carrying Case \$7.95  
Panel Mounting Adapter \$1.50

#### NEW LOW PRICE

Not \$49.50, but priced lower than ever before. Complete with probes and batteries. (Replaces former model 555)

NOW ONLY

**\$44<sup>95</sup>**

Write today for full details or ask your dealer

## PHAOSTRON INSTRUMENT AND ELECTRONIC COMPANY

151 Pasadena Avenue, South Pasadena, California

**FREE! 360 pages of the Newest in**

**ELECTRONICS**  
HIGH FIDELITY • RADIO • TV



**NEW CATALOG 1958**

Offers you a fast, efficient, dependable way of selecting the finest components in the field at the lowest prices.

**NEWARK**  
ELECTRIC COMPANY

Write Dept. RE-1  
223 W. Madison St. • Chicago 6, Illinois  
4736 W. Century Blvd. • Inglewood, Calif.

## SPRAY or DROP it

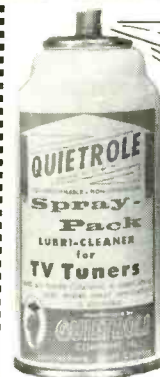

the NEW  
**QUIETROLE**  
Spray-Pack

or the  
**QUIETROLE**  
Bottle with the  
Eye Dropper Cap

Now QUIETROLE offers you both types of containers. Either way assures you of the same unflinching results that QUIETROLE is known for.

Make your next purchase QUIETROLE, get both and learn the difference between quality and poor substitutes. QUIETROLE is the original product of its kind, it is a FIRST of the Industry and you can depend on it to end your noisy control and switch troubles.



manufactured by  
**QUIETROLE**  
COMPANY  
Spartanburg, South Carolina

# Business and People



Cornell-Dubilier Electric Corp., South Plainfield, N. J., designed a new self-

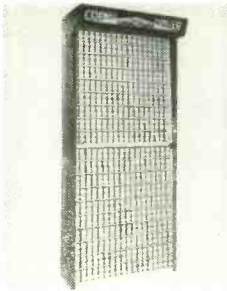

service display rack for distributors of its twist-prong electrolytic capacitors.

Electronic Instrument Co. Inc., Brooklyn, N. Y., recently held a sales meeting in New York for its representatives. Design and promotional plans for its 1958 EICO high-fidelity and test instrument lines were outlined. Photo shows Harry R. Ashley and Phil A. Portnoy, EICO president and vice president, respectively (third and fourth from left



front row), with the representatives who attended the meeting.

Jensen Industries, Inc., Forest Park,



Ill., is merchandising its silicon-treated Record Sweep phono tone-arm attach-

ment with a new display-stock card.

JFD Manufacturing Co., Brooklyn, N. Y., was granted a patent for its Magic Genie indoor TV antenna.

ORRadio Industries, Opelika, Ala., has come up with a "Tape It Off the Air" promotion for its Irish-brand re-



ording tape. Complete promotional kits are available to distributors.

Rek-O-Kut, Inc., manufacturer of recording turntables, tone arms and cartridges, opened a new \$250,000 plant in Corona, N. Y.

Sarkes Tarzian Rectifier Div., Bloomington, Ind., designed new display pack-



**Abraham Marcus,**  
co-author of famous  
best-seller  
"Elements of Radio"  
makes amazing  
offer!



## TRY MY TV and RADIO REPAIR COURSE FREE FOR 1 MONTH

"If you haven't earned at least \$100 in spare time during that period you pay not a cent."

Here it is! The most amazing guarantee ever offered on any radio-TV course anywhere! We'll send you Abraham Marcus' course to use FREE for one full month! If in that time you haven't actually made \$100 fixing radios and TV sets, just return the books to us and pay not a penny!

Why do we make this sensational offer? First, because these books are so easy to use. They are written in the same clear, easy-to-understand language that made the author's "Elements of Radio" a 1,000,000-copy best-seller. Second, because these books get right to the point—tell you what to do in 1-2-3 fashion. For example, once you master the first few chapters of the TV book you are ready for business—ready to do service jobs in the field—jobs that account for over 80% of all service calls.

DON'T WAIT! you risk nothing when you send the coupon at right. You don't have to keep the books and pay for them unless you actually make extra money fixing radios and TV sets. Even when you decide to keep them, you pay on easy terms. Mail the coupon now.

### WHAT YOU GET IN THESE 3 GIANT VOLUMES

**ELEMENTS OF TELEVISION SERVICING.** Analyzes and illustrates more TV defects than any other book, and provides complete step-by-step procedure for correcting each. You can actually SEE what to do by looking at the pictures. Reveals for the first time all details, theory and servicing procedures for the RCA 28-tube color television receiver, the CBS-Columbia Model 205 color set, and the Motorola 19-inch color receiver.

**RADIO PROJECTS.** Build your own receivers! Gives you 10 easy-to-follow projects, including crystal detector receiver—diode detector receiver—regenerative receiver—audio-frequency amplifier—tuned-radio-frequency tuner—AC-DC superheterodyne receiver—etc.

**RADIO SERVICING Theory and Practice.** Here is everything you need to know about radio repair, replacement, and readjustment. Easy-to-understand, step-by-step self-training handbook shows you how to locate and remedy defects quickly. Covers TRF receivers; superheterodyne receivers; Shortwave, portable, automobile receivers, etc. Explains how to use testing instruments such as meter, vacuum-tube voltmeters, tube checkers, etc., etc.

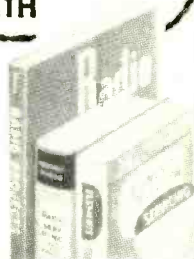

### MAIL THIS COUPON

Prentice-Hall, Inc., Dept. 5744-AT  
Englewood Cliffs, New Jersey

Please send me Abraham Marcus' TV & RADIO REPAIR COURSE (3 volumes) for 10 days FREE examination. Within 10 days I will either return it and owe nothing, or send my first payment of \$5.60. Then, after I have used the course for a FULL MONTH, if I am not satisfied I may return it and you will refund my first payment. Or I will keep the course and send you two more payments of \$5.60 a month for two months.

Name .....

Address .....

City..... Zone..... State.....

Best Value of the Year!

**2 1/2 AMP. RUGGED DUTY  
1/4" THOR SPEEDRILL**

with Geared Chuck and  
Key—AC-DC—2400 RPM  
BRAND NEW! OUR PRICE



\$14.95

plus 50¢ pp. & hdg.

If your work calls for a "rugged" drill with POWER TO SPARE, insist on a 2 1/2 Amp. Job... and make sure it's THOR! No finer drill made! Solid steel, heat treated helical gears; thrust taken on hardened steel ball and plate; gears permanently packed and sealed in LIFETIME grease! Switch, trigger and lock assembly simplifies locking and releasing trigger. You'll be wise to buy 2 at this price. Supplies limited!

**29-PC. CHROME VANADIUM  
DRILL SET**



Specially made for speed drilling. In sturdy plastic tool roll. Finest alloy steel drills hardened and precision ground to the sharpest, longest lasting cutting edge obtainable; will easily and cleanly bite through hardwoods, plastics, aluminum, iron and the toughest steels. Unconditionally guaranteed for thousands of drillings. Full jobber length. Sizes by 64ths from 1/16" to 1/2". There are only a limited quantity of these imported German sets available at this low \$6.49 price. So hurry! NOW.....ppd. \$6.49

Also available with Turned Down Shanks to fit all 1/4" drills. In individual pocket roll. ppd. \$8.95

Send check or money order. If C.O.D., fees extra.  
Money-Back Guarantee.

**ONLY 75c EACH**

for the FINEST QUALITY Imported  
**PRECISION PLIERS**

Flat Nose • Combination • Diagonal  
Cutter • End Cutting Nippers • Round  
Nose • One Side Flat—One Side Round •  
Snipe



FOR JEWELERS, OPTICAL WORKERS, HOBBYISTS, CRAFTSMEN OF ALL KINDS! These superb European instruments are of deep-forged, heat-treated high quality tool steel, fabricated to most exacting specifications. All-over ground and polished to smooth hard surfaces. Smooth working joints with just the right tension. Jaws meet perfectly to safely and securely hold even the most delicate objects in the hard-to-reach corners and angles. Each plier is 4" long and a veritable gem of precision and strength.

75c each all 7 for \$5.00

**60 Pc. Set Wire Gauge  
Chrome VANADIUM DRILLS**



Top quality German import, high test Chrome Vanadium Drills designed for speed drilling through toughest steels, woods, plastic, iron and aluminum. Precision ground long-lasting cutting edges. Guaranteed to give years of satisfaction. A full 60 pc. set. Nos. 1 thru 60. A \$14.95 Value. Now Only \$5.40 plus 35¢ pp. and hdg.

Same set above available with Huet Metal Index container. Only \$6.65 plus 35¢ pp. and hdg.

Also Available—20-PC. SET NOS. 61-80 WIRE GAUGE DRILLS Finest steel! Tops for precision work in woods, plastic, iron, aluminum, etc. Includes plastic kit with marked pocket for each drill. Only \$2.50 ppd.

**SCOTT-MITCHELL HOUSE, Inc., Dept. P-1, 611 Broadway, New York 12, N. Y.**

**TAPE RECORDERS**

HI FI COMPONENTS  
Tapes—Accessories  
UNUSUAL VALUES  
Send for Free Catalog

**DRESSNER**  
69-02 RE: 174 St.  
Flushing 65, N. Y.



**MERITAPE**  
Low Cost. High  
Quality Record-  
ing Tape—in  
boxes or cans.

**GARAGE DOOR  
OPENER**

Actuator Mechanism \$24.50  
EASY TO INSTALL, SAFE, RELIABLE

WRITE for interesting free information TODAY  
P. E. HAWKINS CO.  
631 PROSPECT DEPT. R-E KANSAS CITY 24, MO.

**NEW! IMPROVED!**

**SENCORE**  
TRC4  
**TRANSISTOR  
CHECKER**

Another Sencore Time-Saver

America's newest, most popular test instruments

**NOW CHECKS:**  
★ Transistors for opens, shorts, leakage and current gain. Includes new gain test on power transistors.  
★ Crystal Diodes checks forward to reverse current ratio on all diodes.  
★ Selenium Rectifiers checks forward and reverse currents.

Controls are accurately set for each transistor by referring to replaceable set-up chart on rear. Test leads or socket provides for fast hook-up. See your parts distributor.

**ONLY \$17.95**  
Dealer Net  
Cannot become obsolete. Approved by leading manufacturers.

**SERVICE**  
Mfg by INSTRUMENTS CORP.  
171 OFFICIAL RD., ADDISON, ILL.

Cut out this ad now for further information

*Dave Rice's*  
**OFFICIAL  
ORDER BOOK**  
for every TV-Radio service call

Triplicate forms serve as order form, invoice and office record with spaces for complete information on every job. Separate listings for receiving tubes, pax tube, parts, serial numbers, labor and tax charges, signatures, etc. 75c a book, \$6.50 for dust-proof box of 10.

... and for customer's prices on every replacement part, *Dave Rice's*

**OFFICIAL PRICING DIGEST**  
listing over 60,000 items. \$2.50  
In stock at your distributor, or write

**ELECTRONIC PUBLISHING CO. INC.**  
180 North Wacker Drive Chicago 6, Illinois

**BUSINESS AND PEOPLE (Continued)**

ages for its silicon rectifiers. The Kit Paks hold 20 M-500 TV conversion kits or 20 M-150 radio replacement kits.

University Loudspeakers, White Plains, N. Y., is participating with Fred Waring and his Pennsylvanians in a 10-week National Hi-Fi Holiday Tour. University developed an elaborate sound



reinforcement system to improve listening in theatres and auditoriums where the concerts will be held. Photo shows engineer testing the system.



Lawrence Le-Kashman, widely known in the hi-fi, radio and television industries, has resigned as vice president of the David L. Bogen

Company & Presto Recording Co., Paramus, N.J., to rejoin Electro-Voice, Inc., Buchanan, Mich., as vice president in charge of sales. Prior to joining the Bogen organization in 1956, Mr. Le-Kashman had been vice president of Electro-Voice for over four years, and previously had been associated for several years with the RCA Tube Division, Harrison, N.J., resigning as advertising manager to join Electro-Voice.

Frederick H. Guterman was elected a vice president of Allen B. Du Mont Labs., Clifton, N. J. He is general manager of the Industrial and Military Equipment Div. He came to Du Mont some months ago from American Bosch Arma Corp.



Daniel P. Knowland, Jr., was promoted to assistant general manager of Heath Co., Benton Harbor, Mich. He had been comptroller and assistant secretary.



Lester A. Bogen, president of Bogen-Presto, Paramus, N.J., division of the Siegler Corp., announced a new alignment of the sales department. Mortimer Sumberg who was distributor sales manager of David Bogen Co. becomes responsible for all commercial sales to distributors for both Bogen

and Presto. Thomas L. Aye, who joins the organization, will manage the sales of professional products and David E. Pear will continue as advertising and sales promotion manager. Mr. Aye was formerly sales representative for Presto in the New York Metropolitan area and prior to that was a partner in Henry Geist & Co. Mr. Bogen reports that sales for Bogen products for the third quarter of 1957 were up 49% over last year and Presto's sales up 15%.

A. L. (Al) Pezman was appointed sales manager of Trio Manufacturing Co., Griggsville, Ill. He has been associated with the firm for four years in executive post and prior to that had wide sales and advertising experience.



Donald T. Lucas was promoted to manager of receiving tube sales for Raytheon Manufacturing Co. Paul R. Keeler (below left) was named mana-



ger of Government relations and C. W. Duncan, sales engineer of receiving tubes, TV picture tubes, transistors and semiconductor diodes. Lucas who has been with Raytheon since 1948, will work out of the Franklin Park, Ill., plant. Duncan, who has had 11 years' experience as a TV design engineer, will also work out of Franklin Park. Keeler will maintain his office in Newton, Mass.

Lee Gunter, Jr., (left) and Robert Troxel were named chief development engineer and chief products engineer



respectively, of Shure, Bros. Inc., Evanston, Ill. Both have been with the company for more than 12 years.

**Obituary**

Gerard Swope, former president of the General Electric Co., died at the age of 84. Mr. Swope, who started with G-E in 1895 as a helper at \$1 a day, became its president in 1922 and remained in that position until his retirement in 1939 at the age of 67. He was also a director of the National Broadcasting Co., RCA Photophone Co., RCA Victor, RCA Radiotron Co., and 14 other companies in the electric, electronics and power fields. END

# NOW-GET TOP PERFORMANCE FROM TAPE RECORDERS

HERE'S A GLIMPSE AT SOME OF THE HIGHLIGHTS

- ELEMENTS OF A TAPE RECORDER
- CHARACTERISTICS OF A HIGH-QUALITY TAPE AMPLIFIER
- HEAD CHARACTERISTICS
- TAPE CHARACTERISTICS
- BIAS CURRENT
- EQUALIZATION REQUIREMENTS
- EQUALIZATION CIRCUITS
- OSCILLATORS
- RECORD LEVEL INDICATORS
- MINIMIZING NOISE AND HUM

**ELEMENTS OF TAPE RECORDER CIRCUITS—**

By Burstein and Pollak. Gernsback Library Book No. 67. 224 Pages. Paper cover ed. \$2.90. Deluxe hard cover ed. \$5.00

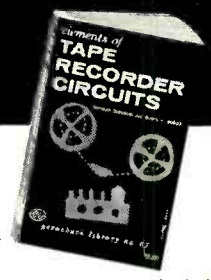

Hi-fi fans! Technicians! Here's the book you asked for! ELEMENTS OF TAPE RECORDER CIRCUITS answers all your questions on the electronic aspects of tape recorders. Shows you what to look for when you buy—explains what various types will and will not do—gives you details on how to push the performance up to the best possible level. The authors, two of the most highly regarded experts in the industry, were commissioned to write this book in answer to the demands of our readers. They cover all the points you want to know—how tape recorders work—what to expect from inexpensive models—what the better ones will do—how to get maximum performance in any type. They even teach you basic design principles (with a minimum of simple arithmetic) so you can modify your equipment for better results. Ideal for both audiophile and technician! Use the coupon below for this and other G/L books.

MAIL THIS COUPON TODAY

**GERNSBACK LIBRARY, Inc. Dept. 18A**  
154 West 14th Street, New York 11, N.Y.

Here's my remittance of \$..... Please send me the books checked below.

<input type="checkbox"/> Paper cover.....	\$2.90	<input type="checkbox"/> Hard cover.....	\$5.00
---	--------	--	--------

Paper cover editions

<input type="checkbox"/> Basic Audio Course No. 66.....	\$2.75	<input type="checkbox"/> Rapid TV Repair. No. 60.....	\$2.90
<input type="checkbox"/> Understanding Hi-Fi Circuits. No. 64.....	\$2.90	<input type="checkbox"/> High-Fidelity Circuit Design. No. 56. Deluxe hard cover ed. only.....	\$5.95
<input type="checkbox"/> Transistor Circuits. No. 63.....	\$2.75	<input type="checkbox"/> Transistors—Theory and Practice. No. 51.....	\$2.00
<input type="checkbox"/> Transistor Techniques. No. 61.....	\$1.50	<input type="checkbox"/> High-Fidelity—Design. Construction. Measurement. No. 48.....	\$1.50
<input type="checkbox"/> Maintaining Hi-Fi Equipment. No. 58.....	\$2.90	<input type="checkbox"/> Basic Radio Course. No. 44. Hard cover only.....	\$2.25

NAME \_\_\_\_\_  
STREET \_\_\_\_\_  
CITY \_\_\_\_\_ ZONE \_\_\_\_\_ STATE \_\_\_\_\_

**5-TRANSISTOR POCKET RADIO!**

Size of cigaret package. Needs no external antenna. 800-mile range. Loud volume. Operates 600 hours on 12½c flashlight battery. Printed circuit. Complete kit \$28.50. Fully wired \$36.50. Free literature.

**GARDINER ELECTRONICS CO. Dept. 12**  
254½ East Indian School Road Phoenix, Arizona

**MORSE CODE**

SENDING • RECEIVING • SPEED

Complete Instructions. Made Easy with 45 or 78 RPM Record.

7 INCH 45 RPM... SEND \$1.25 12 INCH 78 RPM... SEND \$2.25  
Prices include Postage and Handling

**UNCLE SAM RECORDINGS • Dept. B-1**  
59 East Van Buren Street Chicago 5, Illinois

Sold by leading hobby shops, radio-electronic dealers, hi-fi record shops, chain and department stores everywhere. Dealers, Jobbers and Mail Order firms inquiries invited.

# TELEVISION

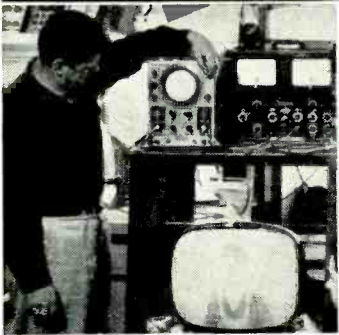

**AT HEADS YOU LEARN BY DOING IN MODERN ELECTRONICS LABORATORIES**

**HEALD ENGINEERING COLLEGE**  
Established 1863  
Van Ness at Post, RE  
San Francisco, Calif.

Never before in American history has the need been so great for Trained Engineers and Technicians. No other type of training can compare with actual shop practice you get at Heads under expert instructors.

**Bachelor of Science Degree, 27 Months**

- Electronics Engineering (B.S. Degree)
- Electrical Engineering (B.S. Degree)
- Television Technician (9 Months)  Color TV
- Electronics Technician (12 Months)
- Mechanical Engineering (B.S. Degree)
- Civil Engineering (B.S. Degree)
- Architecture (B.S. Degree)

Heald College ranks **FIRST** West of the Mississippi in "Who's Who in America"

Approved for Veterans  
**DAY AND EVENING CLASSES**  
Write for Catalog and Registration Application.  
New Term Starting Soon.

Your Name \_\_\_\_\_  
Address \_\_\_\_\_  
City \_\_\_\_\_  
State \_\_\_\_\_

# STAN-BURN

## CATHODE RAY TUBE SPECIALS ONE YEAR GUARANTEE

G.E.	Type	STAN BURN	G.E.	Type	STAN BURN
\$15.80	10BP4	\$10.00	24.75	17LP4	\$18.00
19.10	12LP4A	13.95	37.00	19AP4A	24.00
28.35	12CP4	28.35	11.50	20CP4	18.95
30.25	12UP4	15.00	33.60	20CP4B	21.95
20.75	13CP4	13.75	36.00	21AP4	25.00
15DP4	14.50	29.75	21EP4A	20.15	
33.75	18AP4	18.50	34.85	21EP4B	23.25
32.20	18DP4A	15.25	30.90	21FP4	21.15
33.75	16GP4	18.75	37.00	21MP4	26.00
23.50	16KP4	15.75	29.75	21YP4	22.00
28.40	16KP4A	18.75	34.85	21YP4A	25.00
31.50	16LP4A	16.25	28.30	21ZP4	21.00
31.50	16WP4	16.25	33.60	21ZP4B	24.00
23.50	17BP4	15.75	100.00	24AP4	56.00
28.40	17BP4B	18.75		(6 mos. guar.)	
30.75	17CP4	20.50	48.40	24CP4A	38.00
33.90	17GP4	21.50	50.00	24DP4A	39.00

\*ALUMINIZED—INQUIRE FOR ANY TUBE TYPE NOT LISTED. STAN-BURN CRT TUBES RCA LICENSED—MFD. BY LINCOLN. All orders of 6 or more STAN-BURN CRT are subject to additional 10% discount. PRICES SUBJECT TO CHANGE WITHOUT NOTICE.

## WHY PAY MORE?

HI-FI COMPONENTS • KITS  
RECORD PLAYERS • TAPE RECORDERS • TUNERS • AMPLIFIERS • SPEAKERS • ELECTRONIC PARTS & TUBES • Etc.

Top brand nationally adv. merchandise in this and other Radio & TV magazines yours at lowest cost. Send us your list. Give Mfr's name and Model No. of item. Write for '57 catalogs to Dept. RE-1 today.

**BRAND NEW IMPORTED TAPE RECORDERS**  
Clear, sharp music and speech reproduction. Dual track, 5 tube balanced amp., 6" tape reel, Magic Eye tube, numerical footage counter, tone control, and grey leatherette case, portable, compact mechanism, weighs under 17 lbs. AMAZING VALUE!  
SINGLE SPEED (3 3/4).....\$64.95  
DUAL SPEED (3 3/4 and 7 1/2)..... 74.95  
FREE reel of tape with each recorder!

**HI-FI DIAMOND NEEDLES—1 Yr. Guar.**  
Diamond needles reduce record wear and needle noise thus retabling full frequency response and tonal qualities of your records for a longer period of time.  
SINGLE DIAMOND needle.....\$7.95  
DIAMOND SAPP dual needle..... 8.95  
Shipment PPD. (specify cartridge make)

## RECORD CHANGERS

COLLARO RC-456 4 speed changer...\$33.81  
GARRARD RC-88 4 speed changer... 53.41  
GARRARD RC-98 4 speed changer... 66.15

**FREE** wood mounting base, record wiping cloth and 45 RPM spindle with all orders for Collaro and Garrard changers, with this ad.

VM 4 SPEED HI-FI CHANGER—Model 1210 with Ronette or Astatic flip-over cartridge.....\$22.95

MONARCH Model UABU 4 SPEED AUTO. INTERMIX CHANGER less crystal cartridge.....\$19.95

RONETTE (phono fluid) cartridge flip-over type.....\$2.98  
SONOTONE cartridge, flip-over.....\$2.98  
45 RPM SPINDLE for V.M. or Monarch.....\$1.98

WOOD MOUNTING BASE for V.M. or Monarch.....\$3.95  
MOUNTING BOARD unfinished for V.M. or Monarch.....\$1.50

**NEW GENERAL ELECTRIC HI-FI VARIABLE RELUCTANCE CARTRIDGE.** Replaces discontinued RPX050 type. Full range reproduction 20-20,000 cycles. Four gram tracking force for minimum record and stylus wear.  
4G050—Dual Sapphire needles.....\$8.77  
4G052—Diamond, Sapphire needles...\$18.99

## KITS!

We stock the following manufacturers complete line of kits—see reference pages.  
EICO see pages 39-30  
PRECISE see page 148  
BORGEN  
GROMMES  
DYNAL see pages 148-149  
ARKA see page 146  
ELECTRO-VIS  
Inside Back Cover  
CABINART  
THERMASTER see page 131  
All domestic orders will be shipped prepaid. Send us your list. Order by Mfr. and Model No. of item.

\$20 WORTH OF ELECTRONIC PARTS IN GRAB-BAG consisting of: porcelain sockets, coils, speaker, transf., resist., cond., ONLY.....\$1.98 (plus 50c postage)

**1957 PHONOLA PHONOGRAPHS**  
All models have 4 speed automatic changers in portable carrying cases, shuts off after last record, jam proof, turnover cartridge, sapp needles, attractive modern styling with tone and volume controls:  
#757 ECONOMY MODEL—tone and volume controls simulated leatherette, crystal cart.....\$37.50  
#857 DUO-FI—2 speakers, 2 tone grey leatherette, 45 RPM spindle, ceramic cart..... 49.00  
#957 HI-FI—2 special HI-FI speakers, ebony starlite leatherette, 45 RPM spindle, ceramic cart..... 56.50  
#1057 HI-FI—3 special HI-FI speakers, 3 controls (base, treble & Vol.), ceramic cart., Diamond Sapp needles, 45 RPM spindle, Luggage Tan leatherette..... 78.00

NATIONALLY ADVERTISED IN LIFE, POST, ESQUIRE

## YOU NAME IT—WE HAVE IT

Complete line of T.V. & Radio receiving tubes, coils, transf., controls, antennas & accessories—No Minimum Order—DEALER DISCOUNTS! Thousands of satisfied HI-FI enthusiasts and dealers will vouch that STAN-BURN GIVES THE BEST DEAL POSSIBLE!  
EXPORT INQUIRIES AND OFFERS INVITED.  
Terms: 20% with order. Balance C.O.D. All prices F.O.B. NEW YORK Warehouse.  
Write for our latest price list and Hi-Fi Catalog RE-1. All Prices Subject to Change Without Notice.

**STAN-BURN RADIO and ELECTRONICS CO.**  
558 CONEY ISLAND AVE. • B'KLYN 18, N. Y.

# Books



TV AND RADIO TUBE SUBSTITUTION GUIDE, Harry G. Cisin, Amagansett, N. Y. 5 1/2 x 8 1/2 inches. 22 pages. 50c.

The 1957 edition of this handy booklet lists direct replacements for many common types of vacuum tubes. Saves the need of a second trip when you're out on a job and don't have the tube you need. All tubes listed fit into the same socket without any wiring changes. A chart of 600-ma series-stringing tubes with controlled warmup is also presented. In a separate section is a TV picture tube substitution guide. As practical as the first section, it emphasizes substitution rather than conversion. Many of the recommended substitutions can be made without changes of any kind.—LS

INTRODUCTION TO SEMICONDUCTORS, by W. Crawford Dunlap, Jr. John Wiley & Sons, Inc., 440 Fourth Ave., New York, N. Y. 5 3/4 x 9 inches, 417 pages, \$11.75.

Written for students and engineers, this book goes into considerable detail to explain what a semiconductor is and why it behaves as it does. Transistors, rectifiers, photocells and thermistors are covered. The author stresses physical aspects rather than mathematical, using graphs and charts often.—IQ

LEARNING ELECTRICITY FUNDAMENTALS, by Leonard R. Crow. Howard W. Sams & Co., Inc., 2205 E. 46 St., Indianapolis 5, Ind. 5 1/2 x 8 1/2 inches, 408 pages. \$5.95.

Electricity is a fascinating subject, and according to this author its study is more important than that of any other scientific subject. Certainly it is well explained here, and written so that all may understand. The reader learns how to experiment with electricity, to wire doorbells and automatic alarms and even how to wire a house safely. Motors, magnets and transformers and their applications are described. Except for simple Ohm's law, there is no math.

BASIC PHYSICS (Vols. I and II) by Alexander Efron. John F. Rider, Publisher, Inc., 116 W. 14th St., New York, 11, N.Y. 6 1/4 x 9 1/2 inches, 724 pages.

In every branch of physics, basic research has paid off in practical benefits to mankind. Modern physics includes heat, sound, light, chemistry, mechanics, electronics and atoms. This book is complete and up to the minute. It describes multiple-stage rockets, transistors, thermistors and

# HI-FI ENGINEERED FOR THE FUTURE

ENGINEERING-STYLING-PERFORMANCE

# ARKAY STEREO

# HI-FI KITS AND PREWIRED

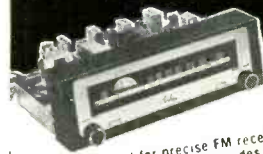

ARKAY FM-8 Professional Standard FM TUNER

Engineered for precise FM reception Arkay "Miracle Ear Sensitivity" provides 10 uV for 20 db quieting. Freq. Response 20-20,000 cps. Outstanding features include 3 tuned RF stages, dual limiters, Armstrong FM Foster Seeley discriminating feature, variable AFC Sient tuning system, tuning meter, cathode follower, high-level & Binaural FM (multiplex) outputs, 0-100 log scale for station pinpointing, self-contained AC power supply plus many other extras.  
KIT \$39.95 WIRED \$59.95  
ARKAY AM-5 AM TUNER Most sensitive AM tuner. "Miracle Ear" 2 uV for 20 db s/n Wide & Narrow Band 3 gang tuning cond 10kc whistle filter  
KIT \$23.45 WIRED \$35.95  
HI-FI AM-FM Tuner AFC. Sensitive. KIT \$32.00 WIRFD \$49.95



ARKAY MODEL FL-30 HI-FI AMP PRE-AMP  
An engineering masterpiece TRANSlSTORIZED front end assures finest in HI-FI sound. Freq response, 1/2 db 10-40,000 cps. @ 30 10-40,000 cps. 50 watt peak outputs for magnetic pickup, tuner, tape & 2 aux. Complete with step-by-step plans, handsome black cabinet & rose gold panel.  
KIT \$49.95  
WIRED.....\$74.95

ARKAY STEREO AT SENSIBLE PRICES! At last the economical audiophile can enjoy "living sound!"

MODEL SA-25—Just attach your present amp to this dual channel pre-amp & 25 watt amp. KIT \$59.95 WIRED \$89.95  
MODEL SP 6—Dual channel pre-amp with cathode follower. KIT \$34.95 WIRED \$47.95  
MODEL ST-11—Binaural stereo tuner highly sensitive AM & FM reception. KIT \$47.95 WIRED \$69.95

## SEE N'HEAR THESE ARKAY UNITS!

<p>Arkay FL-10—12 watt amp pre-amp—only \$28.95</p>	<p>Arkay A-12—Amp pre-amp for binaural. Output 12 watts. Est. 11V assembled \$22.95</p>	<p>Arkay FL-5—5 watt amp—gives true hi-fi performance. kit for beginner \$12.25</p>
<p>Arkay B12—High Efficiency Speaker System Kit 17x17x15 1/2" Simule-Nail, glue and stain \$12.95. Model B-12S with Co-ax. speaker and Bal. \$25.00</p>	<p>Arkay TR-6—All-transistor port superhet kit output better 275 mill watts \$40—1620 kc. Superbet tone. Const. extremely simple \$37.50</p>	<p>Arkay TR-5 Personal Portable—5 transistor printed circuit printed layout component board assembled 3 hr High impact styrene case jack for pvt. listening \$31.45</p>

Prices 5% higher west of Mississippi  
FREE! At your dealer or write for complete catalogues of Stereo & Monaural HI-FI, Radio & TV, Kits & Wired.

**arkay** 120 CEDAR STREET  
LEADERS IN AUDIO, TV & HI-FI EQUIPMENT  
NEW YORK 6, N. Y.

At Your Dealer Insist on Hearing the Fabulous "LIVING SOUND" STEREO

## OPPORTUNITY ADLETS

Rates—50c per word (including name, address and initials). Minimum ad 10 words. Cash must accompany all ads except those placed by accredited agencies. Discount, 10% for 12 consecutive issues. Misleading or objectionable ads not accepted. Copy for March issue must reach us before January 15, 1958.

**RADIO-ELECTRONICS,**  
154 West 14 St., New York 11, N. Y.

**COMPLETE YOUR HIGH SCHOOL** at home in spare time with 61-year-old school. Texts furnished. No classes. Diploma. Information booklet free. **AMERICAN SCHOOL,** Dept. X19, Drexel at 58th, Chicago 37, Ill.

**UP TO 50% DISCOUNT** on brand new Hi-Fi, speakers, components, amplifiers and tuners, tape recorders, etc. Write for individual quotations on your specific needs. **CLASSIFIED HI-FI EXCHANGE, RE,** 2375 East 65 St., Brooklyn 31, N.Y.

**DISCOUNTS to 50%** Cameras, Hi-Fi, Proj., Tape Recorders. Individual quotations only. No catalogs. **LONG ISLAND AUDIO-CAMERA EXCHANGE,** 3 Bay 26th Street, Brooklyn 14-R, N.Y.

**DRAFTING, DESIGN, BLUEPRINT READING.** Good paying. Easy to learn at home. Minimum age 17. Write **UTILITIES ENGINEERING INSTITUTE,** Dept. TR-1, 2525 Sheffield, Chicago 14, Ill.

**HIGH-FIDELITY SPEAKERS REPAIRED.** AMPRITE Speaker Service, 70 Vesey St., New York 7, N.Y. BA 7-2580.

**CASH PAID!** Sell your surplus electronic tubes. Want unused, clean transmitting, special purpose, receiving, TV types, magnetrons, klystrons, broadcast, etc. Also want military & commercial lab test and communications gear. We swap too, for tubes or choice equipment. Send specific details in first letter. For a fair deal write, wire or telephone: **HARRY,** 512 Broadway, New York 12, N.Y. WALKER 5-7000.

**RECORDERS, HI-FI, Tapes.** Free Wholesale Catalogue. **CARSTON,** 215-T East 88th St., New York 28, N.Y.

**THREE LINE Rubber stamp \$1.** **ELDRIDGE INDUSTRIES** 152 Rosemont Ave., Trenton 8, N.J.

**PROFESSIONAL Electronic Projects—Organs, Tuners, Intercoms, Counters, etc.** \$1 each. List Free. **PARKS,** Box 946 Redwood City, Calif.

**LONG PLAYING RECORDS 20 to 50% Discount** Brand-New Factory Fresh Unplayed—All Labels—Send 20c for catalogue to **RECORD SALES,** 1110 Wintburn, Houston 4, Tex.

**DIAGRAMS! Repair Information! Radios—Amplifiers—recorders \$1, Televisions \$1.50.** Give make, model, chassis. **TV MILTIE,** Box 101EA, Hicksville, N.Y.

**LABORATORY QUALITY** equipment and Military Surplus Electronics bought, sold. **ENGINEERING ASSOCIATES,** 434 Patterson Road, Dayton 3, Ohio.

**UNUSUAL CONFIDENTIAL QUOTATIONS** on all your "Hi-Fi" requirements. No Catalogs. **KEY ELECTRONICS,** 120 Liberty Street, N.Y. 6, N.Y. EVERGREEN 4-6671.

**DIAGRAMS FOR REPAIRING RADIOS \$1.** Television \$2. Give make, Model. **DIAGRAM SERVICE,** Box 672-RE, Hartford 1, Conn.

**WANTED: Electronics technicians** desiring educational achievement accreditation in electronics. **CRAMWELL RESEARCH INSTITUTE, INC., EM-7,** Adams, Mass.

**ALL MAKES OF ELECTRICAL INSTRUMENTS AND TESTING** equipment repaired. **HAZELTON INSTRUMENT Co.,** 128 Liberty Street, New York, N.Y.

**1500 PERSONALIZED 5/8" x 1 1/2" Labels \$1.** Your 3 line name & address printed with blue ink on fine quality white gummed paper. Money back guaranteed. **HAMILTON-WARD,** Dept. 11B, Westfield, Mass.

**TELEVISION Tuner Repairs.** **DAN'S TELEVISION LABORATORY,** 606 Sunrise Highway, Babylon, N.Y.

**COMPLETE Television Sets \$11.95.** **JONES TV,** 1115 Rambler, Pottstown, Pa.

**LEARN WHILE ASLEEP!** Details free. **RESEARCH ASSOCIATION,** Box 610-RE, Omaha, Nebraska.

**PORT ARTHUR COLLEGE—Training for FCC Licenses.** Enrollment Monthly. **PORT ARTHUR,** Texas.

**"PRINTING PRESSES, Type, Supplies, lists 3c.** **TURNBAUGH SERVICE,** Mechanicsburg, Pa."

# This book helped me boost my servicing income!

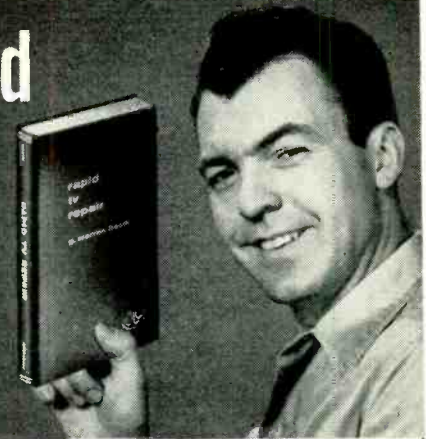

## How to get this \$4.60 book for only \$3.35

### THE G/L TECHNICIANS' BOOK CLUB

has helped thousands of service technicians everywhere

- Learn More
- Do Faster Servicing
- Earn More Money
- Save money on the books they need to get ahead.

#### Here's how it can help you!

This unique club offers deluxe hard-cover editions of today's best practical servicing and theory books by well known authors. **AT A DISCOUNT OF 27%!** Through mass printing and

### RAPID TV REPAIR—By G. Warren Heath

You too can handle more jobs—make more money! Now you can get to the root of the toughest TV troubles in minutes with this remarkable book! Lists hundreds of troubles alphabetically—gives causes, symptoms and cures and tells you in what circuits the trouble is most likely to occur. No theory—all practical data. Cross referenced, indexed, illustrated. Troubleshooting charts help you find troubles faster. And this is only one of the helpful books you can get through the **G/L TECHNICIANS' BOOK CLUB!**

direct distribution we can offer you these \$4.60 books **AT THE WHOLESALE PRICE OF \$3.35**—and we pay the postage!

#### How the Club Works

- To enroll, select the book you want on the coupon below. **SEND NO MONEY.** Please select only one! The book you choose will be sent to you on a No-Risk 10-day inspection plan.
- If you like the book keep it and send us your remittance. If you don't

just send it back.

- A new book is published every three months—you receive your personal copy on the same No-Risk inspection plan as soon as it comes off the press.
- Keep only the books you want—pay only for those you keep.
- You agree to take a minimum of only 4 books—over the whole enrollment period. You may cancel anytime after that. No time limit—no contract to sign.

### —These Books Already Published—

Select **RAPID TV REPAIR**—or any one of these books.

**Servicing Color TV**—By Robert G. Middleton. Answers all your questions about chroma circuits, matrix testing, the flyback system, test equipment and much more troubleshooting charts help you find the toughest trouble quickly.

**TV—It's a Cinch**—By E. Aisberg. All about TV theory from studio to picture tube. Written in breezy conver-

sational style illustrated with hundreds of specially-drawn humorous sketches.

**Servicing Record Changers**—By Harry Mileaf. Make extra money servicing changers.

**The V.T.V.M.** By Rhys Samuel. Get more out of this electronic workhorse.

**Sweep and Marker Generators for Television and Radio.** By

Robert G. Middleton. A must for television servicing.

**Probes**—By Bruno Zucconi and Martin Clifford. How to use probes for better servicing with today's complex test instruments.

**The Oscilloscope**—By George Zwick. Are you getting full use of your 'scope? This book shows you how!

### Books To Be Published Soon

- **RAPID RADIO REPAIR**—By G. Warren Heath
- **TV AND RADIO TUBE TROUBLES**—By Sol Heller

- **SERVICING TAPE RECORDERS**
- **WORKING WITH THE 'SCOPE**—By Alfred Haas

## MAKE MORE MONEY SAVE MORE MONEY

Servicing is now a \$2 billion industry, and it's growing all the time. Are you prepared to get your share of the profits it has to offer qualified men? With the **G/L TECHNICIANS' BOOK CLUB** you can be sure. Don't miss this opportunity. Join the club today. You'll be amazed how much you can save on books—how much you can add to your income.

**SEND NO MONEY! MAIL THIS COUPON TODAY!**

### SEND IN THIS COUPON TODAY

**GERNSBACK LIBRARY, INC., Dept. 18C**  
154 West 14th St., New York 11, N.Y.

Enroll me in the **G/L TECHNICIANS' BOOK CLUB.** Begin my membership with the book checked below. Please check one only.

- |   |   |
|---|---|
| <input type="checkbox"/> <b>RAPID TV REPAIR</b>             | <input type="checkbox"/> <b>SERVICING RECORD CHANGERS</b> |
| <input type="checkbox"/> <b>SERVICING COLOR TV</b>          | <input type="checkbox"/> <b>PROBES</b>                    |
| <input type="checkbox"/> <b>TV—IT'S A CINCH</b>             | <input type="checkbox"/> <b>THE OSCILLOSCOPE</b>          |
| <input type="checkbox"/> <b>THE V.T.V.M.</b>                |   |
| <input type="checkbox"/> <b>SWEEP AND MARKER GENERATORS</b> |   |

Name..... please print

Street.....

City..... Zone..... State.....

# LOOK FOR THESE at your distributors

## Tarzian "Kit-Paks"

### M-500 CONVERSION KITS FOR TELEVISION

At no extra cost, provide your customers with the best television picture their set can deliver. Replace weak selenium rectifiers with Tarzian silicon rectifiers. A complete kit, with instructions, is supplied. Constant output voltage maintains full size picture throughout the full life of the rectifier. Replaces all selenium rectifiers rated 200 to 500 ma and 130 volts.



### M-150 REPLACEMENT KITS FOR RADIOS

A low cost silicon rectifier that will fit into any small size receiver yet deliver enough power for the largest console sets. A variety of mounting methods is provided by adaptors included with the kit. The Tarzian M-150 replaces all seleniums rated 150 ma or less.

Why stock over 12 types of bulky selenium rectifiers  
when two types of silicon will handle almost all of your replacements.  
Buy them by the kit or by the carton.

Be sure to send for Service Notes #1 and #4 that completely describe Tarzian Silicon rectifiers for replacement use.

# Sarkes Tarzian

## Rectifier Division

DEPT. R-2, 415 NORTH COLLEGE AVENUE  
BLOOMINGTON, IND., PHONE 2-1435-6-7

In Canada: 700 Weston Rd., Toronto 9, Tel. Rogers 2-7535 • Export: Ad Auriema, Inc., New York City

atomic energy. The basic experiments and discoveries by Thomson, Maxwell, Newton, Fermi and Einstein are clearly described. Algebra, geometry and logarithms are used to a limited extent.

The book is divided into two parts. Vol. I provides an overall view of physics for the beginner. Vol. II covers more advanced ground and in greater detail. Hundreds of illustrations and many problems are presented to help the self-student. The course meets requirements of college boards.—I.Q.

**COMMERCIAL OPERATOR'S LICENSE GUIDE—Elements 1 and 2**, by Martin Schwartz. American Electronics Co., 1203 Bryant Ave., New York 59, N.Y. 48 pages. 75c.

This text is one of a series that covers the test for a commercial operator's license given by the FCC. Separate books cover the many elements. This one concerns itself with Basic Law and Basic Operating Practice. A question-and-answer type presentation forms the instructional sections. Sample FCC type practice examinations using multiple-choice questions let the reader test himself.—LS

**WHO'S WHO IN ELECTRONICS**, Electronic Periodicals, Inc. 2775 S. Moreland Blvd., Cleveland 20, Ohio. 8 3/4 x 11 1/4 inches. 495 pages, \$10.

An index to supply sources of electronic components and equipment. Thumb-nailed sections list components by manufacturers, manufacturers by geographical locations, trade names, field representatives by manufacturer, representatives by state and city and distributors and their products by state and city. RFS

**THE HOW AND WHY OF HIGH FIDELITY**, by Milton Sleeper. Heath Co., 305 Territorial Road, Benton Harbor, Mich. 6 1/2 x 9 1/2 inches, 47 pages. 25c

This hi-fi guide book is written by a pioneer radio writer and publisher of high-fidelity magazines. Without technical terms he tells how to get started in this fascinating and rewarding hobby and shows the advantages of assembling from a kit. Although concerned with the products of one particular manufacturer, the booklet outlines plans for a complete hi-fi outfit whether its sound source is to be FM, tape or disc (or all). Simple diagrams illustrate ways to connect components to form systems ranging from 20 to 70 watts.—IQ

**SMALL APPLIANCE SERVICING**, by P. T. Brockwell, Jr. McGraw-Hill Book Co., 330 W. 42 St., New York, N. Y. 5 1/2 x 8 1/4 inches, 180 pages. \$4.50.

A basic guide to operating principles and preferred servicing and testing techniques for electric irons, toasters, mixers, roasters, percolators, waffle grills, sandwich grills, and rotisseries. Also includes a chapter on establishing and conducting a profitable appliance servicing business.—RFS END



# SCHOOL DIRECTORY

## ENGINEERING DEGREES



E.E.  
Option Electronics  
Earned through  
**HOME STUDY**  
Residence Classes Also Available  
**PACIFIC INTERNATIONAL UNIVERSITY**  
(Operating as a College of Engineering only at present)  
5719-M, Santa Monica Blvd.,  
Hollywood 38, Calif.

## GET INTO ELECTRONICS

V.T.I. training leads to success as technicians, field engineers, specialists in communications, guided missiles, computers, radar and automation. Basic and advanced courses in theory and laboratory. Assoc. degree in electronics in 29 mos. B.S. in electronic engineering obtainable. ECPD accredited, G.I. approved. Graduates in all branches of electronics with major companies. Start Sept., Feb. Dorms, campus. H.S. grad or equivalent. Catalog.

VALPARAISO TECHNICAL INSTITUTE  
Dept. C Valparaiso, Indiana



## ELECTRONICS

PREPARE FOR A GOOD JOB!  
BROADCAST ENGINEER  
RADIO SERVICING AUTOMATION

TELEVISION SERVICING  
BLACK & WHITE—COLOR

APPROVED FOR VETERANS AND SURVIVORS OF VETERANS  
BUILDING AIR CONDITIONED  
SEND FOR FREE LITERATURE

BALTIMORE TECHNICAL INSTITUTE  
1425 EUTAW PLACE, BALTIMORE 17, MD.

## CRYSTAL CONTROLLED CONVERTERS

POLICE • FIRE • COMMERCIAL



- ✓ Precision—Stability
- ✓ Sensitivity
- ✓ Easy Installation

**\$32.50**

• A compact converter supplied with commercial tolerance crystals, self contained automatic noise limiter. Also models with squelch. Ideal for mobile or home use.

### TUNERS

Enjoy FM Programs While You Drive.

- FM BROADCAST
- 30-50 MC
- 108-176 MC

from **\$22.50**

WRITE FOR LITERATURE



**KUHN ELECTRONICS**

20 GLENWOOD CINCINNATI 17, OHIO

## college grads get ahead faster!

... have higher incomes ... advance more rapidly. Grasp your chance for a better life. Share rewards awaiting college-trained men. Important firms visit campus regularly to employ Tri-State College graduates. Start any quarter. Approved for Vets.

### Bachelor of Science Degree in 27 months

Complete Radio Engineering courses (TV, UHF, FM, Electronics). Also Mechanical, Civil, Electrical, Chemical, Aeronautical Engineering in 36 months a B.S. in Business Administration (General Business, Accounting, Motor Transport Management Majors). Superior students faster. More professional class hours. Small classes. Enrollment limited. Beautiful campus. Well-equipped labs. Prep courses. Enter Mar., June, Sept., Jan. Earnest, capable students (whose time and budget require accelerated courses and modest costs) are invited to write Jean McCarthy, Director of Admissions for Catalog and "Your Career in Engineering and Commerce."



**TRI-STATE COLLEGE**  
2418 College Avenue, Angola, Indiana

## ELECTRONICS ENGINEERING DEGREE IN 27 MONTHS

Prepare for unlimited opportunities in electronics! B.S. degree in 27 months, mathematics, electrical engineering, TV, advanced radio theory and design. Modern labs. Low tuition—earn board. Also Aero., Chemical, Civil, Electrical, Mech. Engineering. B.S. degree in 36 mo. in Math., Chem., Physics. Also prep courses. G.I. apr. 20 bldgs., dorms, gym. Enter March, June, Sept., Dec. Catalog. Keeping Pace With Progress.

**INDIANA TECHNICAL COLLEGE**  
1518 E. Washington Blvd., Fort Wayne 2, Ind.

### CODE SENDING SPEED

Be a "key" man. Learn how to send and receive messages in International Morse code. Communicate with operators around the globe. Learn at home quickly through famous Candler System. Used by best operators. Qualify for Amateur or Commercial License. Write for FREE BOOK.

**CANDLER SYSTEM CO.**  
Dept. 3-A, Box 928, Denver 1, Colo., U.S.A.

## BE QUALITY WISE... BUY QUAL-KITS!



**HI-FI AMP. KIT**  
Complete 6 tube-10 watt amplifier Push-pull beam power output, built-in pre-amp. 5 position selector switch, 3 position record equalization, LP, RIAA, Eur. Response 1/2 db. 20-20,000 cps. Output 10 watts at less than 2% IM. Low noise level and harmonic distortion. **\$28.50**

Every kit complete with 28 page fully illustrated instruction and assembly manual. Cover and legs optional. \*Add 10 percent for new federal tax



**HI-FI AM-FM TUNER KIT**  
Advanced 7 tube circuit plus Rectifier for full sensitivity and selectivity. Distortion less than 1%. Sensitivity is 5 uv for 30 db quieting on FM, 25 uv AM. Armstrong FM Circuit with limiter. Foster-Seeley Discriminator. 20-20,000 cps response. Full AFC control — no drift. Easy assembly. **\$28.95\***

Write for FREE catalog and name of nearest dealer carrying these remarkable units

## QUALITY-ELECTRONICS

319 Church St. Dept. RE-1 New York 13, N. Y.

Your choice of school is highly important to your career in



**INDUSTRIAL ELECTRONICS**



**RADIO-TELEVISION**



**ELECTRONICS COMMUNICATIONS**

Become an **ELECTRICAL ENGINEER** or an **ENGINEERING TECHNICIAN** at

## MSOE in Milwaukee

Choose from courses in:

**ELECTRICAL ENGINEERING**  
Bachelor of Science degree in 36 months—Communications or Electrical Power.

**ENGINEERING TECHNOLOGY**  
Associate in Applied Science degree in 18 months—Electronics Communications, Electrical Power, or Computers.

MSOE — located in Milwaukee, one of America's largest industrial centers—is a national leader in electronics instruction—with complete facilities, including the latest laboratory equipment, visual aid theater, amateur radio transmitter — offers 93 subjects in electrical engineering, electronics, radio, television, electrical power, and electricity.

Advisory committee of leading industrialists. Courses approved for veterans. Over 50,000 former students. Excellent placement record. Previous educational, military, and practical experience is evaluated for advanced credit.



QUARTERS BEGIN SEPTEMBER, JANUARY, MARCH, JULY

Choose wisely—your future may depend on it. Mail coupon today!

## MILWAUKEE SCHOOL OF ENGINEERING

Dept. RE-158, 1057 N. Milwaukee St. Milwaukee, Wis.

Please send free illustrated career booklet (please print)

I'm interested in.....  
Name..... Age.....  
Address.....  
City..... State.....  
 I am  I am not eligible for veterans benefits  
(discharge date)

HQ FOR THE 5 TOP NAMES IN TV & RECEIVING TYPE

# TUBES

AT SENSIBLE PRICES!

- Individually boxed • First quality only
- Brand New

WRITE FOR LATEST TUBE CATALOG FREE!  
Receiving, transmitting, special purpose tubes, diodes, transistors, etc. lists

## Electronic Equipment Specials

- T-23/ARC-5 transmitter—100 to 156 Mcs like new with tubes..... \$14.95
- T-126/ARC-5 transmitter—Same as T-23 except 100 to 146 Mcs..... 13.95
- Shallerose 0.5, 10 and 20 Kv. Kilovoltmeter, Brand New, 10 sealed cartons, log \$255.00, Special..... 37.50
- PRECISION VARIABLE CAPACITOR—double-spaced, heavy brass end plates—ceramic insul. 15 Mmf. to 115 Mmf. straight line freq. 4 1/4" x 3 1/2" x 3". Ideal for VFO, etc. @ \$3.95 ea., 2 for..... 6.00
- GEIGER COUNTERS—RCA..... Brand New jobber boxed close out prices—WRITE for price—6 different models.

## RCA PLATE TRANSFORMER

- Pri. 115 V.-60 Cy., Tapped at 105V. Secondary 1100 volts CT @ 250 Ma. 63 V. at 5 Amps, 5 volts @ 3 Amps (125 volt bias winding). Ideal for low-power transmitters, power amplifiers, etc. Fully cased. Brand new in original cartons @ \$6.95 ea., 2 for..... 11.00
- POWER SUPPLY KIT—Containing the transformer described above plus two 10 MFD, 600 V. oil condensers and one 10 Hy. 400 Ma. filter choke. All brand new..... 9.95
- MD-7 Modulator (w/dyn.) uses PP1625's..... 9.95
- BC-456 Modulator (w/dyn.)..... 4.95
- Xmfr-Prim: 115 VAC/60 cy.-Sec: 28 V. @ 10 amps..... 4.50
- Eldico High-Pass Filter @ 75c ea., 6 for..... 4.00
- Glas-Line Non-Metallic Guy-Line @ \$2.89/100 ft..... 5/1.00
- BC-457A (4-5.3 Mcs.) Xmtr. New/like new..... 4.95
- BC-458A (5-3.7 Mcs.) Xmtr. New/like new..... 4.95
- GE RF Ammeter. 0 to 4 amps RF. 2" round..... 3.95
- Westinghouse Choke, 10 Hy. @ 200 Ma..... 1.95
- Cabinet w/hinge top, 8"Hx10"Wx8"D. Orig. used for Eldico 500 Watt antenna tuner. Grey finish New. @ \$2.95 ea., 2 for..... 5.00
- Cabinet w/hinge top. Grey crackle finish. 8"Hx14"Wx8"D. New. Excellent for mobile rig. amplifier. Enclosed cab. @ \$3.50, 2 for..... 6.00
- 6 Foot Line Cords. Extra-heavy zip cord w/plug..... 5/1.00
- FTR Miniature Choke—2 Hys. @ 130 Ma. 2 1/2" high, 1 1/2" wide, 1" deep. Herm. sealed Brand New. 40c ea. (10 for \$3.00, 100 for \$25.00)
- Plate Xmfr. Prim: 115/60 cy. Sec: 1100 VCT @ 220 Ma. 4 1/2" x 4" x 4" Grey finish, upright mt. Eldico TR2 Brand New. @ \$4.95 ea., 3 for..... 10.00
- NC Power Xmfr. Brand new, exact replacement for NC-240 National Receivers. Also used in NC-100, 101-X, etc @ \$5.95 ea., 2 for..... 10.00
- Walnut Instrument case. Brand new, 10"Hx 8"Wx3"D. Used for instruments, etc. 3 for..... 9.00

## INFRA-RED CL-2 LAMP

The device that makes license free transmission a reality! 2 way voice or MCW can be transmitted over concentrated invisible infra-red rays. Information on how to construct a 2-way transmitter-receiver station available. See p. 93, Oct. '57 Radio Electronics, CL-2 LAMP 2/info (worth \$50.00)..... 10.00

## 2-COLOR TUBE CARTONS

Keeps your tube stock neat. New safety partition prevents tube breakage. Distinctively lithographed in glossy red and black. The most distinctive tube carton available today. Minimum quantity: 100 of any one size. Write for case lot prices. Packed 1000 to case.

SIZE FOR TUBE PER 100  
Miniature..... 6AN7, etc..... \$1.00  
GT..... 6SN7, etc..... 1.25  
Large GT..... 1B3, etc..... 1.50  
Large G..... 5U4G, etc..... 2.00

WHITE GLOSSY BOXES  
Completely blank. No printing or color. Otherwise same as above. Same high quality same low prices. Specify "WHITE" when ordering. When color is not stated, 2 color cartons will be shipped.

## TUBE STACKERS

White glossy only. Mini-stacker holds 10 Mini tube cartons; "GT" stacker holds 10 "GT" cartons.  
SIZE PER EACH  
Mini-stacker..... 1 1/2" x 2"  
GT..... 2" x 2"

Per Case of 1000 Stackers..... \$12.50

All cartons and stackers F.O.B. N.Y.C.

WRITE FOR "BARRY'S" JANUARY 1958 "GREEN SHEET"

TERMS 25 per cent deposit with order, balance C.O.D. All Merchandise guaranteed for cost of merchandise only. F.O.B. N.Y.C. MINIMUM Order \$10.00. Subject to price variation and stock depletion.

**BARRY ELECTRONICS CORP.**

512 Broadway, Dept. RE, N.Y. 12, N.Y.  
Phone: Walker 5-7000

## ADVERTISING INDEX

Radio-Electronics does not assume responsibility for any errors appearing in the index below.

- Alliance Manufacturing Co., Inc. .... 113
- American Microphone..... 84
- Allied Radio Corp. .... 13, 85-92
- Amperex Electronic Corp. .... 16
- Amphenol Electronics Corp. .... 78
- Arkey Inc..... 150
- Atlas Sound Corp. .... 120
- Audax, Div. of Rek-o-kut Co., Inc. .... 142
- B & K Manufacturing Co. .... 79
- Barry Electronics Corp. .... 154
- Bell Telephone Labs. .... 22
- Benco Television Associates Ltd. .... 140
- Brooks Radio & Television Corp. .... 120, 136, 154
- Burstein-Applebee Co. .... 131
- CBS-Hytron ..... 107
- Capitol Radio Engineering Institute ..... 109-110
- Carston Studios ..... 122
- Castle Television Services Ltd. .... 130
- Centralab Div. of Globe Union ..... 12
- Century Electronics Co., Inc. .... 115
- Cisin (H.G.) ..... 138
- Cleveland Institute of Radio Electronics ..... 10-11
- Colman Tool & Machine Co. .... 140
- Colordaptor ..... 143
- Columbia Record Club ..... 9
- Columbia Wire & Supply Co. .... 117
- Coyne Electrical School..... 17, 129, 155
- Dale ..... 139
- Delco Radio Div. of General Motors ..... 137
- DeRo Electronics ..... 134
- DeVry Technical Institute ..... 7
- Dressner ..... 148
- DuMont (Allen B.) Labs. .... Inside Front Cover
- EBE Inc. .... 127
- Ebex School ..... 117
- EICO ..... 29, 30
- Electro-Sonic Labs. .... 18
- Electro-Voice, Inc. .... Inside Back Cover
- Electronic Chemical Corp. .... 142
- Electronic Instrument Co. .... 29, 30
- Electronic Publishing Co., Inc. .... 148
- Elgin National Watch Co. (Electronics Div.) ..... 84
- Esse Radio Co. .... 158
- Gardiner Electronics Co. .... 149
- Garfield (Oliver) Co. .... 140
- General Cement Mfg Co. .... 81
- Gernsback Library Inc..... 149, 151
- Grantham School of Electronics ..... 27
- Hawkins (P.E.) Co. .... 148
- Heald Engineering College ..... 149
- Heath Co. .... 62-77
- IBM ..... 104-105
- Indiana Technical College ..... 127
- Jensen Industries ..... 144
- Karlson Associates..... 155
- Kuhn Electronic Products ..... 153
- LMB ..... 122
- Lafayette Radio ..... 156-157
- Lansing (James B.) Sound, Inc. .... 119
- Lectron Inc. .... 139
- Mallory (P. R.) & Co., Inc. .... 124-125
- McGraw-Hill Book Co., Inc. .... 117
- Merit Coil & Transformer Corp. .... 144
- Mosley Electronics Inc. .... 122

## 21" TV CONVERSION KIT

NOW... Anyone with even a limited knowledge of TV—can Convert any Size, any Make TV RECEIVER to operate 21" or any 70" Picture Tube.

COMPLETE SET OF ESSENTIAL PARTS includes matched set of Todd 70° COSINE DEFLECTION YOKE and TODD HV FLYBACK TRANSFORMER, FOCALIZER, 20KV FILTER, DRIVE TRIMMER, LINEARITY COIL, CONDENSERS, RESISTORS.

Your price... **\$13.97** List Price \$33.50  
Incl. CONVERSION MANUAL with Step-by-Step Instructions & Diagrams.

Similar Kit for 24", 27" or any 90° CRT **\$15.98**

## PULSE KEYED AGC KIT

Finest, most accurate and the easiest Kit to install in any make TV RECEIVER including the No. 830. Improves performance and insures a steady picture on all channels.

COMPLETE SET OF PARTS **\$4.59**  
Including 6AU6 tube & Instructions

## TV CRYSTAL-CLEAR LUCITE MASKS

Framed in Rich Goldleaf Finish

Tube Size	Overall Dimensions	
17"—Rectangular	13 1/8" x 16 1/2"	\$ 4.56
21"—Rectangular	16 1/2" x 21 1/4"	6.92
24"—Rectangular	20 1/4" x 25 3/4"	11.84
27"—Rectangular	20 1/4" x 26"	12.18

On 17" and 21" specify type number of CRT used

## TV PLASTIC OPEN MASKS

Used in conjunction with safety glass

17"—Rectangular	15 3/4" x 18 1/2"	\$1.49
21"—Rectangular	18" x 22 1/2"	2.38
24"—Rectangular	21" x 26"	4.93
27"—Rectangular	21" x 26"	4.93

On 17" and 21" specify type number of CRT used

## TV SAFETY GLASS in HANDY SIZES

16" x 20"	\$2.94	18" x 22 1/2"..... \$5.16
16" x 22"	3.97	21" x 26"..... 5.87

\*Available in new tinted grey 50c extra

CATALOG mailed on request

**BROOKS 84 Vesey St., New York 7, N.Y.**

## RONETTE new hi-fi cartridge



## tropic powered

No humidity problems

## requires no preamp,

however, when used with preamp performance exceeds expensive magnetic pickups.

- Response: flat from 30 to 24000 cps
- IM distortion negligible even at very high velocities because of extremely small moving mass.
- Output: .4 volts @ 1 sec/cm.
- Ronette exclusive Stylomatic\* design permits quick and positive stylus replacement with no tools whatsoever.
- No hum problems—no turntable pull.
- With 1 and 2.5 mil sapphire styli.
- Diamond styli available. \*Trade Mark

See your nearest Ronette distributor or write to:

**Ronette Acoustical Corp.**  
190 Earle Avenue · Lynbrook, N.Y.

## RADIO AND TV SERVICEMEN

make more money with this



### SECO Model 107 TUBE TESTER

3 complete tests in one handy instrument

Here's the tube tester every serviceman has been asking for! Designed for outstanding performance and accuracy—provides 3 important tests: Dynamic Mutual Conductance Test of all popular radio and TV amplifier tubes—Cathode Emission Test for all tubes by free point selector system—nationally accepted Grid Circuit Test developed and patented by Seco. Saves you valuable time—quickly pays for itself by justifiably culling and selling more tubes for you!

Completely self-contained in compact portable carrying case. Furnished with handy flip-chart for fast, easy tube set-up data. **\$13950 net**



Write today for free literature  
MANUFACTURING CO.  
5015 Penn Ave. So., Mpls., Minn.

## stereo lays an egg ...without Stereophonic Projection!

YOU MISS UP TO 90% OF TRUE  
STEREOPHONIC SOUND WITHOUT ALL  
OF THESE KARLSON FEATURES—



- ★ Accurate Phasing and Full Integration of All Signals
- ★ Large Dynamic Range for steep wave fronts at any Volume Level
- ★ Uniform Illumination of Listening Area to Make Stereo Sound Effective at All Locations

## the **Karlson** PATENTED\* ENCLOSURE

uses the only acoustical transducer capable of providing critical combination of performance features necessary to true Stereophonic Sound.

\*Pat #2,816,619

For free technical information on compatible single and dual channel stereo mail coupon to

KARLSON ASSOCIATES, INC.  
Dept. RE8, 1610 Neck Road,  
Brooklyn 29, N.Y.

NAME .....

CITY.....STATE.....

ADDRESS.....

Moss Electronic Distributing Co.,  
Inc. ....96-97

National Radio Institute .....3, 19-20  
National Schools ..... 5  
Newark Electric Co. ....134

Opportunity Adlets .....151  
ORRadio Industries Inc. ....103

PACO Electronics Co., Inc.....123  
Perma-Power Co. ....144  
Phaestron Instrument & Electronic  
Co. ....146  
Prentice-Hall, Inc. ....147  
Progressive Edu-Kits, Inc. ....135

Quality Electronics .....153  
Quam-Nichols Co. ....130  
Quietrole Co., Inc.....146

RCA Electron Tube  
Division .....Back Cover  
RCA Institutes Inc.....25  
Radio-Electronic Master.....128  
Rad-Tel Tube Co. ....131  
Raytheon Manufacturing Co. .... 8  
Rek-O-Kut Co., Inc. ....142  
Rider (John F.) Inc. ....132  
Rinehart & Co., Inc.

.....108, 118, 126, 141  
Rohn Manufacturing Co. ....26  
Ronette Acoustical Corp. ....155

Sams (Howard W.) & Co.,  
Inc. ....24, 121, 143  
Sarkes Tarzian, Inc. ....152  
Schober Organ Co. ....141  
Scott (Hermon Hosmer) .... 21  
Scott-Mitchell House, Inc. ....148  
Seco Manufacturing Co. ....155  
Service Instruments Corp.

.....134, 146, 148  
Shure Brothers, Inc. ....16  
Simpson Electric Co. ....95  
South River Metal Products Co. ....155  
Spayberry Academy of  
Radio-Television.....23  
Stan-Burn Radio & Electronics .....150  
Sunair Electronics, Inc. ....133  
Supreme Publications .....145

Technical Appliance Corp.  
(Taco) .....111  
Telco Electronic Mfg. Co.....81  
Transvision Inc. ....145  
Triad Transformer Corp. ....122  
Trio Manufacturing Co. ....142  
Tung-Sol Electric Co. .... 6

Uncle Sam Recording .....149  
United Catalog Publishers.....128  
University Loudspeakers, Inc. .... 28  
Utah Radio Products Corp. ....143

Winegard Co. ....127

Zenith Radio Corp. ....14-15, 99

### SCHOOL DIRECTORY PAGE 153

Baltimore Technical Institute  
Candler System Co.  
Indiana Technical College  
Milwaukee School of Engineering  
Pacific International University  
Tri-State College  
Valparaiso Technical Institute

BRANCH ADVERTISING OFFICES: Chicago: 1413  
Howard St. Tel. ROGers Park 4-8000, Los Angeles: Ralph  
W. Harker and Associates, 600 South New Hampshire.  
Tel. DUnkirk 7-2328, San Francisco: Ralph W. Harker  
and Associates, 444 Market St. Tel. GARfield 1-2481.

FOREIGN AGENTS: Great Britain: Atlas Publishing  
and Distributing Co., Ltd., 18 Bride Lane, London E.C. 4.  
Australia: McMillan's Agency, Melbourne. France: Bren-  
tano's, Paris 2e. Belgium: Agence et Messageries de la  
Presse, Brussels. Holland: Trilectron, Heemstede.  
Greece: International Book & News Agency, Athens.  
So. Africa: Central News Agency, Ltd., Johannesburg,  
Capetown, Durban, Natal; Universal Book Agency, Jo-  
hannesburg. India: Broadway News Centre, Dalar,  
Bombay #14. Pakistan: Paradise Book Stall, Karachi 3.

ask the  
"Man-on-the-Roof"  
why he prefers

South River

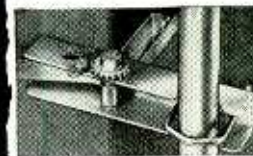

TWO  
TO A  
SET

## CHIMNEY MOUNT RATCHET TYPE

Model RT (Galv. Banding)  
Model RT-ST (Stainless Banding)

FAST, SIMPLEST, MOST  
CONVENIENT EVER MANUFACTURED

Mounts in 2 simple steps. Com-  
pletely factory assembled with no  
eyebolts, banding clips, nuts, etc.,  
to handle. Furnished with flat-lay,  
non-coiling banding, heavy gauge,  
embossed, welded steel construction.  
Forged, heat treated Alum. ratchets.

Write For Our Latest Catalog

**SOUTH RIVER**  
METAL PRODUCTS CO., INC.  
South River, New Jersey

pioneer &  
outstanding  
producer of  
finest line  
of antenna  
mounts

LEARN

Television  
RADIO-COLOR-TV  
Electricity  
ELECTRONICS  
IN THE GREAT SHOPS OF COYNE

TRAIN QUICKLY! OLDEST, BEST  
EQUIPPED SCHOOL OF ITS KIND IN U.S.

Veterans and Non-Veterans—Get practical training  
in top opportunity fields. Prepare now for a better job  
and a real future. Advanced education or previous  
experience not needed. Employment service to  
graduates.

Enroll NOW—Pay Later

Finance Plan and Easy Payment Plan. Also Part  
Time Employment help for students. Training in  
Refrigeration and Electric Appliances can be included.

FREE BOOK Clip coupon for Big Free Illus-  
trated Book. No obligation and  
No Salesman Will Call. Act NOW.

B. W. Cooke, Jr., President

OPERATED  
NOT FOR PROFIT  
Established 1899  
500 S. Paulina, Chicago  
Dept. 18-5C

B. W. COOKE, Jr., Pres.

COYNE Electrical School

500 S. Paulina St., Chicago 12, Ill. Dept. 18-5C

Send FREE BOOK and full details on:

- TELEVISION-RADIO  
 ELECTRICITY-ELECTRONICS

NAME .....

ADDRESS.....

CITY.....STATE.....

# Exclusive Lafayette Money-Saving Values

## PROFESSIONAL TRANSCRIPTION TURNTABLE AND VISCOUS-DAMPED TONE ARM THE FINEST TRANSCRIPTION TURNTABLE AND TONE ARM FOR THE PROFESSIONAL USER AND THE AUDIOPHILE

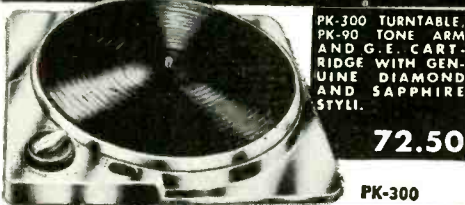

**PK-300 TURNTABLE, PK-90 TONE ARM AND G.E. CARTRIDGE WITH GENUINE DIAMOND AND SAPPHIRE STYLUS.**

**72.50**

**PK-300**

**ILLUMINATED BUILT-IN STROBOSCOPE & VIEWER**

**COMBINATION**

**DEAL**



**PK-90**

### LATEST IMPROVED MODEL PK-300 TRANSCRIPTION TURNTABLE

New 3-speed instrument with built-in stroboscope and viewer for exact speed determination, and magnetic brake for instantaneous speed variation. Precision engineered to meet professional standards for wow, rumble and flutter content. Heavy 12" cast aluminum rim-driven turntable. Variable speed control permits adjustment of each speed within  $\pm 7\%$  using efficient frictionless magnetic brake. Heavy-duty constant speed 4-pole induction motor freely suspended and isolated by shock-mountings to eliminate vibration transfer. R-C filter network suppresses "pop" in speaker. Truly a delight for the connoisseur. Size:  $13\frac{1}{2}'' \times 14''$  and requires  $2\frac{3}{4}''$  clearance above and  $3\frac{3}{4}''$  below motorboard. For 110-130V and 60/50 cycle AC. Power consumption 12 watts. Handsome hammertone gray finish. Shpg. wt., 20 lbs.

Net 49.50

### PK-90 VISCOUS-DAMPED TONE ARM

This transcription arm assures dependable and stable operation, utilizing the "floating action" principle of "viscous-damping." The arm is supported at a single point by a pivot and jewel bearing having negligible friction. Damping is accomplished by a silicone fluid occupying the gap between a ball and socket. This damping control permits high compliance and negligible tracking error, and prevents damage to either record or stylus should the tone arm be accidentally dropped. Low frequency resonance, skidding and groove-jumping are likewise minimized. The tone arm accepts all records up to 16" and accommodates virtually all hi-fi cartridges by means of precisely engineered adapters which simplify installation and provide proper stylus pressure.

This tone arm is a quality companion to the PK-300 with matching finish. Shpg. wt.,  $2\frac{1}{2}$  lbs.

Net 11.95



**PK-160**

### TRANSCRIPTION MANUAL PLAYER

with TONE ARM and TWO PLUG-IN HEADS

- MAGNETIC BRAKE FOR FINE ADJUSTMENT OF EACH SPEED
- 4-POLE, HEAVY DUTY TRANSCRIPTION-TYPE MOTOR
- ACCOMMODATES ALL POPULAR CARTRIDGES
- STYLUS WEIGHT ADJUSTMENT SCREW ON TONE ARM

All the important features of professional transcription players have been incorporated in this precision turntable. Extremely smooth and quiet heavy duty 4-pole motor plays 78, 45 and  $33\frac{1}{3}$  RPM records. Exclusive magnetic brake, controlled by knob on base plate, permits instantaneous fine adjustment of each speed. Stroboscope disc included checks speeds. Speed selector safety switch protects mechanism by making it necessary to pass through OFF position when switching from one speed to another. 10" weighted turntable has rubber traction mat.

Mounting plate has pickup rest and ON-OFF switch. Size 12-15/16" left to right. 10 7/8" front to rear. Requires 2 3/4" clearance below motor board and 3" above. With AC line cord, 2 plug-in heads, output cable, 45 RPM adapter. For 105-120V., 60 cycles AC. Shpg. wt., 12 lbs. (NOTE: For protection in shipping, tone arm is separate. Just fasten to mounting plate.)

PK-160—Less cartridge and base ..... Net 25.95

PK-164—Same as above except equipped with new genuine GE VRII Triple Play Magnetic Cartridge with diamond-sapphire cartridge..... Net 37.50

PK-162—Wood base for PK-160. Shpg. wt., 5 lbs. .... Net 3.95

PK-163—Unfinished mounting board only. Shpg. wt., 1 lb. .... Net .95

### TV-FM SWEEP & MARKER ALIGNMENT GENERATOR

Compare it with instruments at twice the price!

- SWEEP RANGE 3MC-260MC
- MARKER RANGE 3MC-225MC
- COMBINATION CRYSTAL AND VARIABLE MARKER—1% ACCURATE
- SUPPLIED WITH 4.5MC CRYSTAL 0.002% ACCURATE
- SWEEP WIDTH 0-12MC CONTINUOUSLY VARIABLE
- 2-5" DIALS



**LSG-50 79.50**  
FACTORY WIRED AND TESTED

The Lafayette LSG-50 is a factory-wired and calibrated precision instrument for fast alignment of IF and RF stages of TV and FM receivers. Accurate, linear electromagnet sweep system covers 3MC-120MC and 140MC-260MC. Sweep width continuously variable 0-12MC. 3 volts RMS, 60 cps sine wave (for oscilloscope) available from front panel. Marker covers 3MC-225MC in 4 ranges. Combination of crystal and variable marking. Marker calibration accuracy better than 1%. 4.5MC crystal mounts on front panel and accurate to 0.002%. Extra input for external marker. The built-in marker may be used independently of the sweep. RF output 100,000 microvolts, controlled by 3-step (X1, X10, X100) and continuously-variable fine adjustment attenuators. Output impedance 75 ohms, unbalanced. CONTROLS: Sweep Width, Horizontal Phase, Retrace Blanking with Off position, Marker Amplifier, RF Attenuators, Sweep Range Selector, Marker Range Selector. Crystal socket, pilot light, external marker input also on front panel. 2 easy-to-read dials with vernier-driven dial pointers. Sturdy gray wrinkle metal cabinet with handles. Complete with tubes, 75 ohm output and external marker input cables, 4.5MC crystal. Size 9" x 13 1/2" x 6". Shpg. wt., 20 lbs.

MODEL LSG-50..... Net 79.50

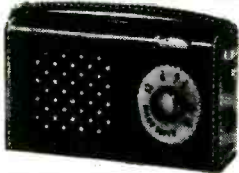

**6 TRANSISTOR SUPERHET RECEIVER KIT**

- 100% SUBMINIATURIZED
- SENSITIVE, SELECTIVE, STABLE
- PUSH-PULL OUTPUT — PLENTY OF POWER
- AN INCOMPARABLE VALUE

The Lafayette KT-119 6 Transistor Superhet Transistor Kit provides superior commercial quality with maximum sensitivity, selectivity and stability. The circuit features 6 selected transistors and crystal diode, a specially matched set of 3 IF's, Oscillator coil, high Q loop, and audio transformer coupling. Has efficient 2 1/2" speaker and earphone jack for private listening. Complete with all parts, transistors, pre-punched chassis and easy to follow step-by-step instructions. 6 1/2" x 3 1/2" x 1 1/2". Shpg. wt., 3 lbs.

KT-119—Complete Kit—Less Case & Battery ..... Net 29.95

BATTERY RCA VS300..... Net 1.23 BURGESS P6..... Net .77

MS-339—Sturdy, attractive brown leather case with carrying strap for KT-119. Shpg. wt., 1 lb. .... Net 2.95

MS-366—Sensitive matching earphone Net 1.29

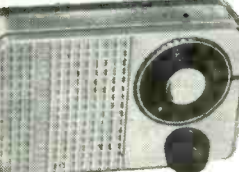

**3 TRANSISTOR SUPERHET POCKET RADIO KIT**

- A TRUE POCKET SUPERHET RECEIVER
- NO EXTERNAL ANTENNA
- NO EXTERNAL GROUND

A remarkable sensitive, super-selective pocket superhet receiver with astonishing performance over the complete broadcast band. Uses 2 high-frequency and one audio transistor plus efficient diode detector and features 2 specially matched IF transformers for maximum power transfer. The components are housed in a professional looking beige plastic case. The receiver's appearance enhanced by attractive maroon and silver station dial. Sensitive built-in ferrite antenna eliminates need for external antenna. A designer's dream in a true pocket superhet receiver! Complete with all parts, transistors, battery, case, dial and easy to follow step-by-step instructions. 4 1/2" x 2 1/2" x 1-1/16". Shpg. wt., 1 lb.

KT-116—Complete Kit, less earphone ..... Net 16.95

MS-260—Super Power Dynamic Earphone ..... Net 3.95

### NEW POCKET AC-DC VOM MULTITESTER

2,000 ohm per volt sensitivity on both DC and AC  
160 ua 3" METER 1% PRECISION RESISTORS  
SILVER CONTACT SELECTOR SWITCH  
FULL SCALE RANGES

D.C. Volts: 0-10; 0-50; 0-500; 0-1000 Volts—A.C. Volts: 0-10; 0-50; 0-500; 0-1000 volts—D.C. Current: 500 ua and 500 ma—Resistance: 0-10K; 0-1 Meg—Decibels: —20 to +22; +20 to 36 db (0 db—0.775 V)—Capacity: 250 mfd. to 2 mfd.—.005 mfd to 1 mfd—Output Ranges: 0-10; 0-50; 0-500; 0-1000 volts.

Best Buy in America! A very accurate and sensitive VOM. This Multitester is a complete instrument (not a kit) with high quality and sensitive 160 microamp meter; 2000 ohm per volt on both AC and DC. Single selector switch, 1% precision resistors, 3" meter. Features extreme versatility, accuracy and ruggedness. In attractive plastic front panel, with metal bottom for ruggedness and shielding. First capacity range requires 50 volt AC source. Second capacity range requires 10 volt AC source. Size 4 1/4" x 3 3/4" x 1 1/2". Complete with test leads and batteries. Shipping weight 4 lbs.

RW-27A ..... Complete 8.95

### HIGH SENSITIVITY 20,000 OHM PER VOLT DC 10,000 OHM PER VOLT AC MULTITESTER

LOOK AT THESE FULL SCALE RANGES!

D.C. Volts: 0-6; 0-30; 0-120; 0-600; 0-1200; 0-6000 Volts—A.C. Volts: 0-6; 0-30; 0-120; 0-600; 0-1200 Volts—Resistance: 0-10K; 0-100K; 0-1 Meg; 0-10 Megohms—D.C. Current: 0.60 Microamp; 0-6; 0-60; 0-600 Millamps—D.C. Capacity: —20 to +17 db (0db—0.774V)—Capacity: .0001-.01; .005-.15 mfd—Inductance: 20-2000 millihenry—Output Ranges: 0-6; 0-30; 0-120; 0-600; 0-1200 Volts.

The new Lafayette high sensitivity Multitester is a complete instrument (not a kit). In addition to its unusual sensitivity of 20,000 OHMS PER VOLT ON D.C. AND 10,000 OHMS PER VOLT ON A.C., and the extraordinary number and scope of its ranges, it is packed with features that would make it cost at least twice as much if made in this country. Uses 1% precision resistors, silver contacts on selector switch, 35 ua 3" meter. Dependable, rugged and accurate. Even the test leads are heavy duty with high voltage insulation. Voltage source required for low capacity range is 120V for high range capacity and inductance scale is 6V A.C. Attractive plastic front with metal bottom. Size 6 1/4" x 4 1/4" x 2 1/2". Complete with batteries and leads. Shipping weight 4 1/2 lbs.

RW-30A ..... Singly, Each 19.95

in lots of 3, Each 19.25

**Lafayette Radio** 165-08 Liberty Ave.  
JAMAICA 33, N. Y.

INCLUDE POSTAGE WITH ORDER

100 SIXTH AVE., NEW YORK, N. Y.  
BOSTON, MASS., 110 Federal St. PLAINFIELD, N. J., 139 West 2nd St.  
NEWARK, N. J., 24 Central Ave. BRONX, N. Y., 542 E. Fordham Rd.

**FREE!**  
**LAFAYETTE**  
**CATALOG**

*A Must For  
Every Hi-Fi  
Enthusiast*

*Lafayette*



**NEW 180 PAGE ELECTRONIC CATALOG FEATURING THE BEST BUYS IN THE BUSINESS**  
The newest and largest assortment of Electronic, Radio and TV parts, Hi-Fi and Public Address Components and systems, Test Equipment, tubes, Transistor Kits and miniaturized components for transistor circuitry, Ham Equipment, Builders Kits, Tools, Books, Microscopes, Binoculars, Telescopes, Cameras, and Drafting Equipment.—**ALL AT LOWEST PRICES**—Catering to the economy minded dealer, serviceman, engineer, technician, experimenter and hobbyist. **CRAMMED FULL OF MONEY SAVING BUYS. SEND FOR YOUR FREE COPY TODAY.**

**Introduces Hi-Fi Gems**  
... at prices everyone can afford

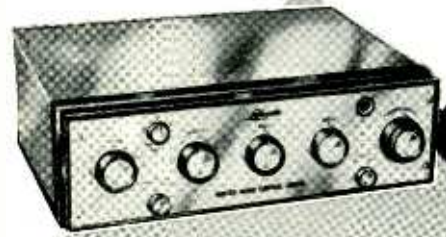

**KT-300  
IN KIT  
FORM  
39.50**



**KT-400  
IN KIT  
FORM  
69.50**

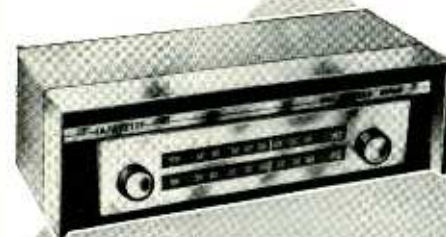

**LT-40  
FM-AM  
"MUSIC  
MATE"  
TUNER  
64.50  
LESS  
CASE**

**NEW! "MUSIC MATES" TUNER AND AMPLIFIER COMPLETELY WIRED AND TESTED**

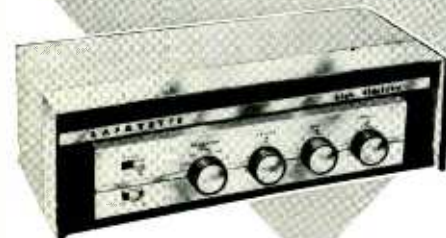

**LA-40  
15 WATT  
"MUSIC  
MATE"  
AMPLIFIER  
43.50  
LESS  
CASE**

**LAFAYETTE MASTER AUDIO CONTROL CENTER with BINAURAL CHANNEL AND DUAL VOLUME CONTROL.**

• Self-Powered • DC On All Filaments • 24 Positions of Equalization  
• Tape Head Input, High Impedance • Dual Cathode Follower Output Stages  
This is not only the finest hi-fi preamp characterized by unmatched features, but it has been functionally designed to keep pace with the conversion of your present hi-fi system to binaural (Stereophonic) sound. Incorporates an extra channel and dual volume control for binaural reproduction. Features include DC on all tube filaments, negative feedback in every stage, dual cathode follower output stages and latest printed circuit construction. Less than 0.07% IM distortion and less than 0.07 harmonic distortion at 1V. Hum and noise level better than 80 db below 3V. Uniformly flat frequency response over entire audible spectrum. 7 inputs for every type of phono, tuner or tape. Tasteful styling, brilliantly executed. Size 12 3/4 x 9 1/2 x 3 3/4". Shpg. wt., 10 1/2 lbs.

**KT-300**—Lafayette Master Audio Control Kit Complete with cage and detailed assembly instructions. Net **39.50**  
**LT-30**—Same as above completely wired and tested with cage and instruction manual. Net **59.50**

**DELUXE 70 WATT BASIC AMPLIFIER**

• Conservatively Rated At 70 Watts • Inverse Feedback • Variable Damping  
• Metered Balance And Bias Adjust Controls • Available In Kit and Wired Form  
Here's ultra-stability in a 70 watt basic power amplifier employing highest quality components conservatively rated to insure performance and long life. Features matched pair KT 88's and wire range linear Chicago output transformer, variable damping control, meter for bias and balance and gold finish chassis. Frequency response 10-100,000 cps ± 1db. Hum and noise 90 db below full output. IM distortion less than 1 1/2% at 70 watts, less than 0.3% below 30 watts. Harmonic distortion less than 2% at 70 watts from 20 to 20,000 cps ± 1 db. Output impedance 4, 8 and 16 ohms. Handsome decorative cage perforated for proper ventilation. Size 14 1/2 x 10 x 7 3/4" including cage and knobs. Shpg. wt., 40 lbs.

**KT-400**—Lafayette 70 watt Deluxe Basic Amplifier Kit complete with cage and detailed assembly instructions. Net **69.50**  
**LA-70**—Same as above completely wired and tested with cage and instruction manual. Net **94.50**

**Lafayette CUSTOM HI-FI "MUSIC MATES" STYLE MATCHED TUNER AND AMPLIFIER**

**MODEL LT-40 "MUSIC MATE" DELUXE FM-AM TUNER**

• ARMSTRONG CIRCUIT • AFC DEFEAT • FOSTER-SEELEY DISCRIMINATOR  
• TEMPERATURE COMPENSATED OSCILLATOR • MEETS FCC RADIATION REQUIREMENTS

A sensitive, selective, stable FM-AM tuner. Temperature compensated oscillator and AFC assure drift-free performance and "locking-in" of stations once they are tuned. The Armstrong circuit with limiter and Foster-Seeley discriminator uses 6 tubes, a rectifier and 2 long-life matched germanium diodes. Superior frequency response, hum and distortion specifications assure excellent reception. Has built-in antennas for both AM and FM as well as provision for outdoor antenna. Finished in attractive dark maroon and gold. Size 13 1/2" W x 5 7/8" D x 4-3/16" H. Shpg. wt., 10 lbs. Available with cage for shelf use or without cage for custom mounting.

**Lafayette LT-41**—FM-AM Tuner (Less Cage) Net **64.50**  
**Lafayette LT-40**—FM-AM Tuner (With Cage) Net **67.50**

**MODEL LA-40 15 WATT "MUSIC MATE" AMPLIFIER**

• 20-20,000 CPS ± .5DB • TAPE HEAD AND RECORD EQUALIZATION  
• LESS THAN 1% DISTORTION • PUSH-PULL EL84 OUTPUT TUBES  
• RUMBLE FILTER • 5 INPUT CHANNELS • LOUDNESS CONTROL

Brilliantly engineered, beautifully styled and moderately priced, this deluxe amplifier matches the tuner in both decor and performance. Utilizes new premium quality EL84 tubes in push-pull. In addition to separate bass, treble and volume controls, has 3 position loudness switch to retain correct tonal balance. 5 inputs, fully equalized, for Crystal or Ceramic Phono, Magnetic Phono, Tape, Tuner and Aux. A hum adjustment control minimizes subsidiary hum. Rumble filter switch to eliminate motor vibration. Speaker and tape output. Output impedances 4, 8 and 16 ohms. Has all of the prerequisite features for a fine hi-fi system. Size 12 1/2" W x 8 3/4" D x 4 1/4" H. Shpg. wt., 12 lbs.

**Lafayette LA-41**—Amplifier (Less Cage) Net **43.50**  
**Lafayette LA-40**—Amplifier (With Cage) Net **46.50**

**NEW "DYNA-SLIM" MICROPHONE**

- HIGH IMPEDANCE — 50,000 OHMS
- ON-OFF SWITCH • "QUICK-SLIP" ADAPTER

New dynamic, high output microphone with all the features of "mikes" costing 3 times Lafayette's price! Output level —55db. Smooth response from 60 to 10,000 cycles. Omnidirectional head. External on-off switch. Slips on or off stand adapter in a wink. Standard 3/8" — 27 adapter permits tilting mike for multi-angle use. Satin black and chrome finish. Complete with detachable cable and connector. 8" long, 1 1/4" max. dia. tapered panel. Shpg. wt., 2 lbs.

**PA-43** Net **6.95**



*Lafayette Radio* DEPT JA P. O. BOX 511 JAMAICA 31, N. Y.

NAME \_\_\_\_\_  
ADDRESS \_\_\_\_\_  
CITY \_\_\_\_\_ ZONE \_\_\_\_\_  
STATE \_\_\_\_\_

**SEND FREE CATALOG 305**

**CUT OUT AND MAIL TODAY!**

**'HUNTERS & SPORTS HEATERS'**

Kerosene or Gasoline Heater  
Reduced to \$4.95

Brand new, Evans blue flame heater. Output approx. 50,000 BTU. Ideal for garage or shack where not confined. Size: 10" dia. x 12" high. Cost Govt. many times our low price. Shipped in orig. packing; wt. 47 lbs. \$4.95

**HRU-28A GENERATOR—\$79.50**

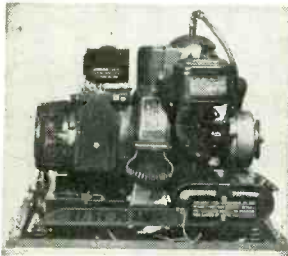

Homelite gasoline generator 28.5 V. DC at 1500 R.P.M. 3400 RPM motor speed. Electric or rope start. Use to power surplus aircraft radio equipment, cabin or marine power, aircraft starting, etc. These units rebuilt like new by the U.S. Air Force and have not been run since. Size 21 1/2" x 24 3/8" x 17 1/2". Wt. 15 lbs. Original AF boxed. Guaranteed. Ship. wt. 210 lbs. Instruction book included.

**M-1 Odograph, over 55,000 value—\$89.50**

See Nov. 1944 Electronics for Full Description

This is a survey instrument for automatically drawing a map of the terrain over which the Jeep or other vehicle to which it is attached traverses. These instruments mfgd. currently by Monroe Calculating Machine Co. and sold in excess of \$5,000. Our surplus purchase allows passing on these machines at this value. Order early, only 200 in stock. Units have been rebuilt by Corps of Engineers, U.S. Army and guaranteed good condition. Ideal for prospectors, oil companies, power line and farm use. Nothing else needed for operation except vehicle. Many are using the compass unit for automatic pilots on boats—many, many applications. A real machine. Ship. wt. approx. 300 lbs. Our Price \$89.50 ea.



**Freq. Crystals... Less Than 5c Ea.**

Imagine crystals costing Govt. \$3.50 to \$12.50 ea. In this assortment, 100 brand new; various freqs.; plenty in hand. Practically all types of holders; all mounted; guaranteed to oscillate. Assortment of 100. Ship. wt. 4 lbs. \$4.95



**Andover Power Plants \$185 ea.**

This is the D2 plant that has been always in such great demand for use as portable welders and auxiliary power. Delivers 28.5 V. DC up to 200 amps. continuous. The lightweight aircraft type motor on these plants had a Govt. acquisition cost of \$2937.00 ea. Motor is 2 cylinder 4 cycle aircooled with hi-tension magneto type shielded ignition rated at 10 HP at 3200 RPM. Entire unit weighs approx. 125 lbs. Guaranteed good condition. Ship. wt. 300 lbs. Price \$185. Engines only from above plant for only \$125 ea. Ship. wt. 250 lbs.

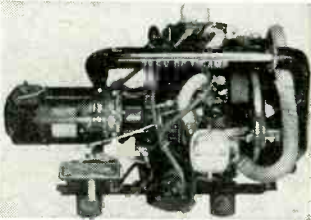

**Metal Locators—\$39.50**

The famous SCR-625 mine detector which has been found to be unexcelled for locating hidden metallic objects such as pipes, treasure, etc. Hundreds in use by prospectors, mining companies, plumbers, veneer mills, etc. Comes complete in carrying case and checked ready for operation with addition of batteries below. Case size 25 1/2" x 18" x 8 1/2". Operating carrying wt. approx. 15 lbs. Ship. wt. 55 lbs. Price \$39.50 ea. Batteries for above SCR-625 \$4.25 set.

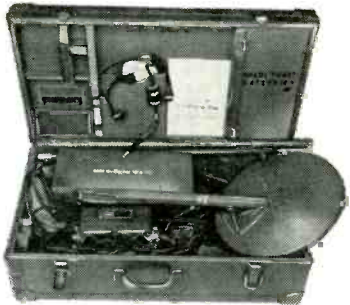

**SYNCHROS, SELSYNS, AUTOSYNS!!!  
At Money-saving prices !!!  
Large Quantity—20,000 in stock  
110 V. 60 Cycle Units**

Type	Approx. Wt. lbs.	Approx. Length (In.)	Approx. Dia. (In.)	Used	Price
5G Navy	5	6.0-6.8	3.4-3.6	\$5.00	\$20.00
5F Navy	5	6.0-6.8	3.4-3.6	5.00	none
5DG Navy	5	6.0-6.8	3.4-3.6	5.00	none
5CT Navy	5	6.0-6.8	3.4-3.6	5.00	none
XV CT Army	5	6.0-6.8	3.4-3.6	none	20.00
Sperry 78360 voltage TH	5	6.0-6.8	3.4-3.6	none	20.00
Sperry 78359 voltage REC.	5	6.0-6.8	3.4-3.6	none	20.00
6G Navy	8	6.4-7.5	4.5	7.50	20.00
7G Navy	18	8.9-9.2	5.8	10.00	30.00
7DG Navy	18	8.9-9.2	5.8	10.00	20.00
<b>400 Cycle Units</b>					
1J1G1 GE	1.5	4.3	2.9	none	3.50
5F Navy	5	6.0-6.8	3.4-3.6	3.50	none
5G Navy	5	6.0-6.8	3.4-3.6	3.50	none
5DG Navy	5	6.0-6.8	3.4-3.6	3.50	none



CT-Control Transformer; D-Differential Motor; DG-Differential Generator; F-Follower; G-Generator; Mfgd. by Bendix, Ford Instrument Co. and General Electric. Specify, Bendix, Ford and GE in stock.

**G-E SELSYN 2J1G1 \$4.95 PR.**

Brand new small size Selsyn for beam direction indicator and other devices. 97.5 volt 400 cycle. Connect rotors in series on 115 V. Will operate for intermittent duty on 60 cycles; approx. size 2 1/2" dia. x 4 1/2" long. Shpg. wt. 3 lbs. per pair. Sale Price.....pr. \$4.95

**PORTABLE HEATER**

**\$99.50**

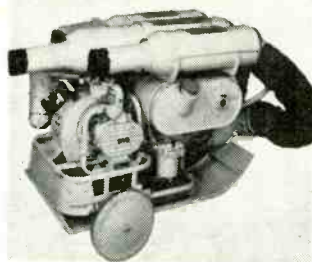

100,000 BTU self-contained heater. Model D-1 mfgd. by Stewart Warner. Super-charged blasted heated air is uncontaminated and ideal for quickly heating garages, aircraft, construction or emergency use. Heat may be directed at will thru any of three flexible ducts up to 35 ft. from heater. Ducts compress into top metal tubes on unit when not in use. 2 H.P. engine operates entire heater. Units are like new, rebuilt by Air Force. Original cost \$600. Ship. wt. approx. 300 lbs.

**LEEDS & NORTHRUP MICROMAX RECORDERS**

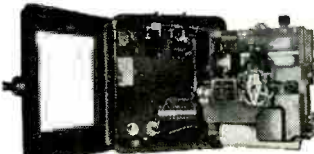

Strip type recorder used for controlling and recording wide variety of processes. Used originally for temp. range of 350-550° C. but may be changed for other applications. Operates on Wheatstone bridge principle using AC galvanometer movement. Original cost several times our low price. Removed from demilitarized equipment which in many cases was new. Sold as used but guaranteed, or money back if not satisfied. Ship. wt. approx. 165 lbs. \$179.50 ea.

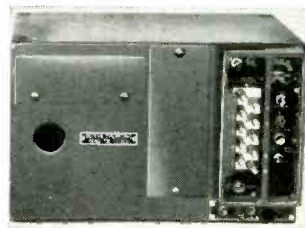

**BC-604 Transmitter—\$9.95 ea.**

30 watt crystal controlled on 10 preselected channels in range of 20-27.9 Mc. F3 emission. Operates from 12 V. or 24 V. DC (dynamotor not supplied). Tubes and meter supplied worth the price of entire unit. Size 18" x 10" x 12". Excellent in new condition. Ship. wt. approx. 100 lbs. ea. Price \$9.95 each.

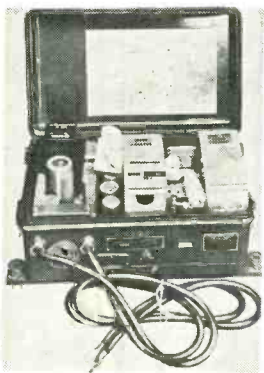

**Mobile Hams Attention!**

**6-12-24 V. VIBRATOR POWER SUPPLY \$9.95**

PE-237 Non-synchronous vibrator type. Input: 6 V. 36 amp., 12 V. 17 amp., or 24 V. 9.5 amp. DC. Output: 525 V. DC. .095 amp., 1105 V. DC. 1.2 Ma., 6.5 V. DC. 2 amp., 6 V. DC 1/2 amp., 1.35 V. DC. 450 Ma. Higher current drain may be obtained with no ill effect. This power supply has been successfully used for powering the BC 604 Nmr. below. Steel brown crackle case size 20 1/2" x 11" x 10". Ship. wt. 119 lbs. ea. Excellent to new condition. Price \$9.95 ea.

**30 AMP. BATTERY CHARGER WHILE SUPPLY LASTS—\$12.50 ea.**

Cost Government \$300 ea. Our purchase of large quantity allows this bargain. Ward-Leonard Mfgd. Type ED 33510. Charging rates up to 30 amps. on 12-30 volt battery combinations (6-1.5 cell). Operates from 110 V.D.C. size 20" wide x 20" high x 10" deep. Shipped in original overseas pack with spares and cord. Wt. 65 lbs. Ship. wt. 145 lbs.

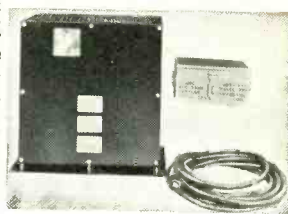

**Receiver R-1/ARR-1—\$1.95**

A two-stage RF superhet converter in range of 234-258 Mc. 220 Mc. converter, or other uses. Uses 4-654 acorn tubes supplied. In compact aluminum case 10" x 3 1/2" x 3 1/2". Elements operate from 12 or 24 V. by merely throwing switch contained in unit. Complete with conversion article as in Jan. 1949 "Radio-TV News." Brand new demilitarized units (input coil insulation broken—easily repaired). Used units that are not demilitarized also available—specify new or used. Ship. wt. 4 lbs. Price \$1.95 ea. 12 or 24 V. co-axial antenna relay for above or other mobile transmitter-receiver equip. New.....\$1.25 ea.



**SEXTANT \$254 value \$17.95**

Air Force Bubble-type sextant at low price to move quickly a large quantity surplus purchase. These instruments come in original carrying case complete with telescope but less battery case used for artificial light source (this can be made from 2-cell flashlight). Mfg. by Anasco or Fairchild. Optics alone worth this price if you have no need for sextant. Ship. wt. approx. 10 lbs.

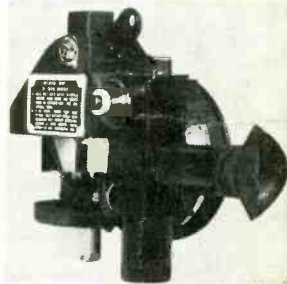

**110 V. RECTIFIER SPECIAL—\$2.85**

New G.E. dry disc rectifiers for changing 115 V. AC to DC. Has one amp. rating—more intermittent or with forced air cooling. Size approx. 9" 3/4" x 3 1/2". Ship. wt. 10 lbs.



**TS-9 Handset—\$1.99**

Ideal for your mobile rig. Contains 250 ohm rec. element and single button carbon mike transmitter unit. Will replace your T-17 hand mike or other \$14 mike. Excellent to new condition. Ship. wt. 5 lbs. Price.....\$1.99 ea.



**SURPLUS ENGINE—New—\$17.95**

2.3 H.P. 2 cy. horizontal engine manufactured by or for Jacobsen. Ball bearing crankshaft. Weighs only 8 1/2 lbs. Attach your own coil and battery. Ideal for air-propelled boats, ice sleds, models, etc. \$17.95 Shipped as shown with propeller but less hub for attachment.



**New Torque Amplifier Only \$7.95**

FOR USE WITH SYNCHROS SIZE 5, 6, 7

Provide torque amplification and ease in rotation of input shaft. Rotating power applied to input shaft is reproduced in any direction on the output shaft. Torque supplied entirely by a 1/40 HP 110 V. DC motor through gear and planetary drive hookup. Speed varies directly with rotation of input shaft with noticeable loss of accuracy. Motor requires capacitor of 83-120 mfd. for starting. Designed for use on run control devices and cost the Govt. hundreds of dollars to mfg. In cast aluminum case. Size: 12" h. x 5 3/8" w. x 7 1/2" d. Wgt. 23 lbs. Packed in original wood box. Shpg. wt. 45 lbs. Brand New.....\$7.95 Starting capacitor for above Torque Amplifier. New.....\$1.00

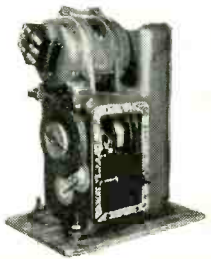

**ESSE RADIO CO. 42 WEST SOUTH ST. INDIANAPOLIS 25, IND.**

REMIT SHIPPING CHARGE AND INSTRUCTIONS WITH ALL ORDERS. OTHERWISE ORDER WILL BE SHIPPED EXPRESS COLLECT. ALL ITEMS GUARANTEED TO YOUR SATISFACTION OR MONEY REFUNDED IF RETURNED PREPAID WITHIN 10 DAYS OF RECEIPT

*Easy to Build . . . Ready to Assemble . . .*

# SUPERLATIVE *Electro-Voice*<sup>®</sup> SPEAKER ENCLOSURE KITS

**Octaves and Frequencies**

10	8192 to 16,384 cps
9	4096 to 8192 cps
8	2048 to 4096 cps
7	1024 to 2048 cps
6	512 to 1024 cps
5	256 to 512 cps
4	128 to 256 cps
3	64 to 128 cps
2	32 to 64 cps
1	16 to 32 cps

**TREBLE**

**BASS**

Model T350  
VHF Driver  
Net: \$60.00

Model T25A —  
Net: \$58.00  
HF Driver with  
Model 6HD Horn —  
Net: \$22.00

Model 118 — Net: \$78.00  
(2) Model 828HF  
Drivers with  
(2) A8419 Horns

Model 18WK  
LF Driver —  
Net: \$120.00

X2635  
4-wcy Crossover —  
Net: \$75.00

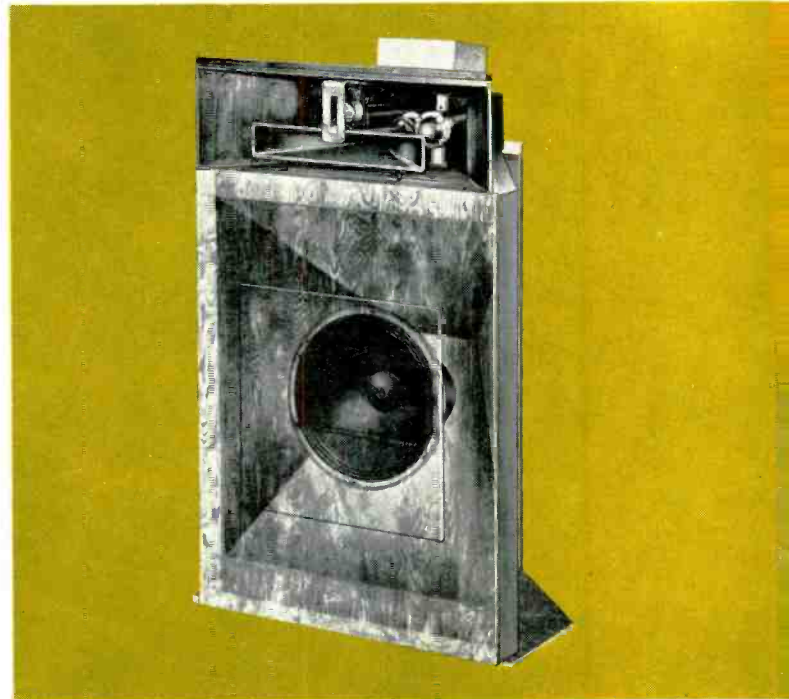

**Low-Bass Section** Employing an advanced principle of folded corner-horn loading, the new Patrician IV utilizes high-fidelity's only 18-in. low-frequency driver, Model 18WK. The taper rate has been extended to 35 cps. The first three octaves, to the first crossover point at 200 cps., are reproduced by a tremendous bass driving section . . . the largest, most highly developed ever designed for a home audio system. When the Patrician is placed in a corner, the entire room becomes part of the bass horn, allowing the large wave lengths of the second and the upper part of the first audible octave to be formed properly.

**Mid-Bass Section** A separate horn employed as an indirect radiator with its two complementary Model 828HF driver units takes over for only the next 1½-octave range to 600 cps. Because no metal horn presently developed satisfactorily reproduces down to 200 cps, the horn load for the intermediate bass drivers is fabricated of wood and the A8419 phenolic tubes of the Mid-bass speakers.

**Treble Section,** The vital "presence" range—from 600 to 3,500 cps or the next 2½ octaves, the Electro-Voice Model T25A treble driver exhausts into a 600-cycle Model 6HD diffraction horn. This diffraction horn is another exclusive Electro-Voice design. The principles of optical diffraction are employed to disperse high frequencies far more uniformly than possible with conventional cellular type horns.

**Very-High Section** The range above 3,500 cps, extending beyond the range of hearing, is reproduced by the new Model T350 Super-Sonax very-high-frequency driver. Again the exclusive Electro-Voice diffraction horn is used. Through the Model T350, the remaining octaves of the upper audible register are completely accomplished with practically no measurable distortion.

**Crossover Network** To allocate the various portions of the spectral energy to the respective driver units, the Model X2635 crossover network divides the amplifier power into four separate portions, and eliminates upper harmonic and intermodulation distortion from one driver in the region covered by the next.

## Completely Engineered for the Ultimate in Sound Reproduction!

Now you can own an acoustically correct Electro-Voice high-fidelity, folded-horn speaker enclosure for your home music system and save up to one half! Build it yourself . . . seven models to choose from . . . wall types . . . corner models . . . for full-range loudspeakers . . . for separate two, three and four-way systems. Everything is ready to assemble . . . all parts pre-cut, shaped and drilled. Simply follow the easy, step-by-step instructions included.

### Model KD1 PATRICIAN IV Interior Assembly

For those desiring the utmost in reproduced music, the bass section design extends the lows and uses room walls as extensions of the exponential horn air load. Indirect radiation and employment of low crossover frequency allows exploitation of the sealed cavity feature, assuring more than one full octave of added bass with unprecedented efficiency, providing direct front radiation of higher frequencies and musical balance.

Size: 57½" high, 34½" wide, 26⅞" deep.

Shipping weight: 135 lbs. Net: \$118.00

## ELECTRO-VOICE INVITES YOU TO EXPLORE THE WORLD OF SOUND!

See your Electro-Voice Distributor. For facts about high fidelity, write for Bulletin W81

*Electro-Voice*

ELECTRO-VOICE, INC. BUCHANAN, MICHIGAN  
Export: 13 East 40th Street, New York 16, U.S.A. Cables: ARLAB

When the Diagnosis is  
 "That WASHED-OUT Look"...

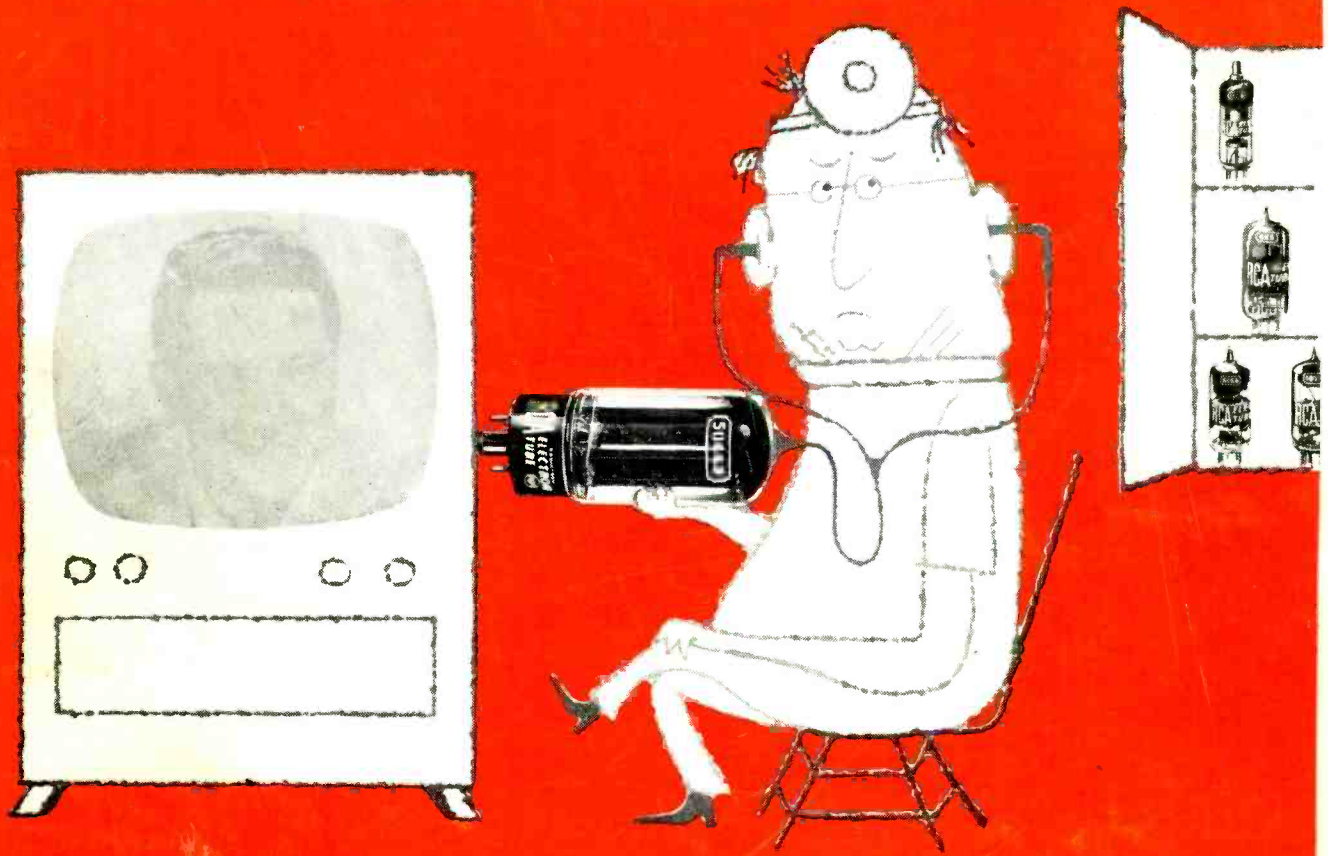

pep up the picture with

**RCA TUBES**

Light output is low, focus okay...but, oh, that "washed-out look"! You can fix it quick. Check the front end and video-if tubes, low- and high-voltage tubes. If new tubes are indicated, "pep up" the picture with the most dependable tubes for TV replacement—TOP QUALITY RCA TUBES.

Selected materials, advanced manufacturing processes, costly and painstaking inspection techniques, combine to give you maximum assurance of top-performance when you replace with RCA TUBES.

For the top-quality brand—always ask your tube distributor for RCA, of course!



**RECEIVING TUBES**

RADIO CORPORATION OF AMERICA  
 Electron Tube Division Harrison, N. J.



**RCA MICROSCOPIC INSPECTION  
 OF POPULAR TV RECEIVING TYPES  
 Helps Reduce Costly Callbacks!**

RCA Quality-Control Procedures include microscopic inspection of popular TV receiving types! Specially trained inspectors help reduce costly callbacks in the field. You gain the valuable assurance from this extra care that you can always service your customers with the confidence that RCA TV Receiving Types are top quality Replacement tubes.

