

# Radio-Electronics

TELEVISION • SERVICING • HIGH FIDELITY

HUGO GERNSBACK, Editor

Improving Sound  
In Old Radios



Don't Be A  
Shock Absorber!



Transistor  
Pocket  
Portables



Heat Adjuster  
For Transistor  
Test or Design

(See page 4)

35c

U.S. and Canada





...and think—  
if you're an  
independent service  
man your best  
buy is

Ask your distributor  
for your copy of the  
new Du Mont Picture  
Tube Data Chart



CATHODE-RAY TUBE DIVISION, ALLEN B. DU MONT LABORATORIES, INC.  
750 Bloomfield Avenue, Clifton, N. J.

# Learn Radio-Television

## Servicing or Communications by Practicing at Home in Spare Time

N.R.I. SENDS kits with which you practice building circuits common to Radio and TV sets. You LEARN-BY-DOING to locate Radio-TV troubles. As part of N.R.I. Servicing Course, you build Vacuum Tube Voltmeter and AC-DC receiver. Use VTVM to conduct experiments. Earn extra money fixing sets in spare time.

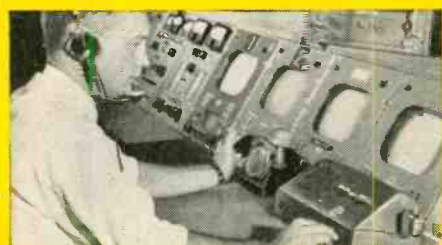
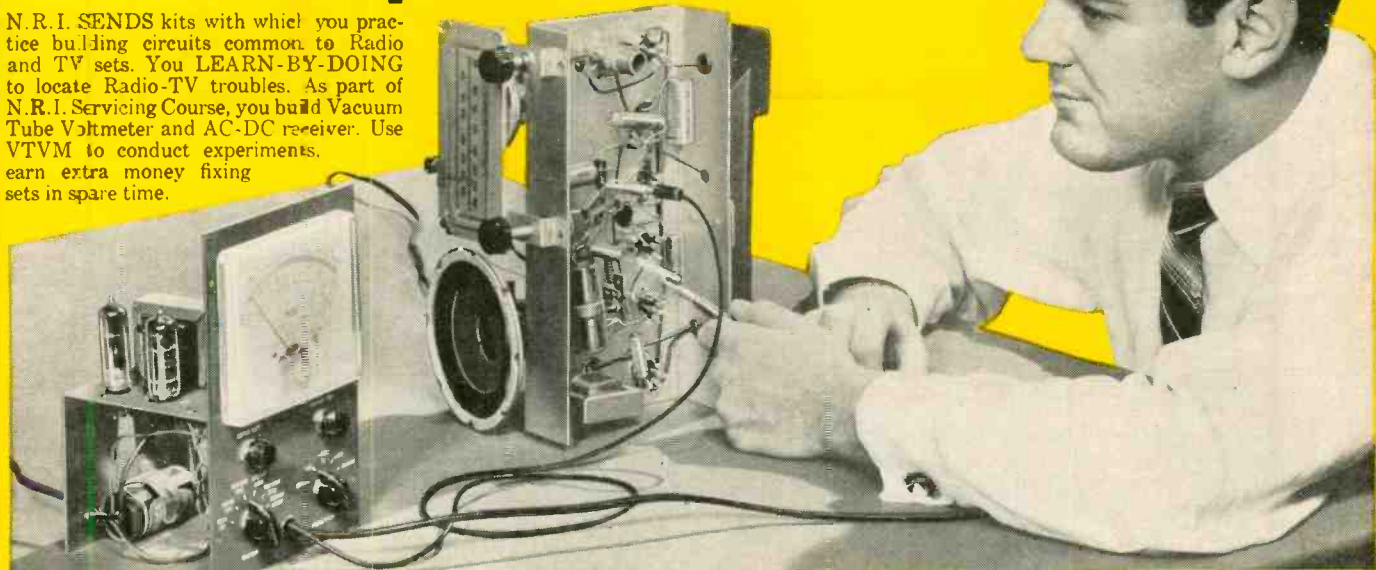

RADIO-TV BROADCASTING (see above) offers important positions as Operators and Technicians. RADIO-TV SERVICING Technicians (see below) needed in every community. Their services are respected, their skill appreciated.



## Fast Growing Field Offers You Good Pay, Success, Bright Future



J. E. SMITH  
Founder

Bigger than ever and still growing fast. That's why Radio-TV has special appeal to ambitious men not satisfied with their job and earnings. More than 4,000 Radio and TV stations. More than 150 million home and auto Radios, 40 million TV sets. Color TV promises added opportunities. For the

trained man, there are good jobs, bright futures in Radio-TV Servicing or Broadcasting. Training PLUS opportunity is the ideal combination for success. So plan now to get into Radio-TV. The technical man is looked up to. He does important work, gets good pay for it. Radio-Television offers that kind of work. NRI can supply training quickly, without expense of going away to school. Keep your job while training. You learn at home in your spare time. NRI is the OLDEST and LARGEST home study Radio-TV school. Its methods have proved successful for more than 40 years.

### Added Income Soon - \$10, \$15 a Week in Spare Time

Soon after enrolling, many NRI students start to earn \$10, \$15 a week in spare time fixing sets. Some pay for their training and enjoy extra luxuries this way. Some make enough to start their own Radio-TV shops. NRI training is *practical*—gets quick results. Easy to understand, well illustrated lessons teach you basic principles. And you LEARN-BY-DOING by practicing with kits of equipment which "bring to life" things you study.

### Find Out What NRI Offers

NRI has trained thousands for successful careers in Radio-TV. Study fast or slow—as you like. Diploma when you graduate. Mail coupon now. Paste it on a postcard or mail in envelope. ACTUAL LESSON FREE. Also 64 page catalog that shows opportunities, shows equipment you get. Cost of NRI courses low. Easy terms. NATIONAL RADIO INSTITUTE, Dept. 7CF, Washington 9, D. C.

## N.R.I. TRAINED THESE MEN FOR SUCCESS



"I was repairing Radios by 10th lesson. Now have good TV job." M. R. LINDEMUTH, Fort Wayne, Ind.



"Doing spare time repairs on Radio and TV. Soon servicing full time." CLYDE HIGGINS, Waltham, Mass.

"I had a successful Radio repair shop. Now I'm Engineer for WHPE." V.W. WORKMAN, High Point, N.C.



"There are a number of NRI graduates here. I can thank NRI for this job." JACK WAGNER, Lexington, N. C.



## VETERANS Approved Under G.I. Bills

MARCH, 1957

# Radio-Electronics

Formerly RADIO CRAFT • Incorporating SHORT WAVE CRAFT • TELEVISION NEWS • RADIO & TELEVISION\*

## EDITORIAL

- 33 The Elusive Electron—Hugo Gernsback

## ELECTRONICS

- 34 Transistorized Scintillation Counter—Louis A. Kueker
- 37 Rotary Transistor Heater (Cover Feature)
- 38 Electrostyl to Revolutionize Stenography?—A. V. J. Martin
- 40 Why Should Impedances Be Matched?—H. P. Manly

## TELEVISION

- 43 Flat TV Tube Almost Here—Eric Leslie
- 46 Don't Be a Shock Absorber—Cyrus Glickstein
- 49 TV DX—Robert B. Cooper
- 50 Television Service Clinic—Conducted by Jerry Kass
- 124 Target for DX'rs

## AUDIO—HIGH FIDELITY

- 52 Second Speaker Adds Realism—Norman H. Crowhurst
- 55 High-Fidelity Drivers and Inverters—Joseph Marshall
- 57 Phase-Swing Vibrato Easy to Build and Apply—Richard H. Dorf
- 60 Improving Sound in AM Radios—Albert Stratmoen

## TEST INSTRUMENTS

- 62 Portable TV Pattern Generator, Part III—Earl T. Hansen
- 79 Flying-Spot Pattern Generator—Robert F. Scott
- 82 Improved Transistor Checker—Edwin Bohr
- 91 Balancing Meter Pointers—Charles Erwin Cohn
- 95 Rf Capacitance Meter—I. Queen

## RADIO

- 97 Two Transistor Pocket Portables—Leonard J. D'Airo
- 102 Variable Dc Heater Supply Uses Tuned Filters—Valentine Sanford
- 105 Modernize Your AM-FM Tuner—Frank J. DiElsi
- 109 Battery Eliminator—Nathaniel Rhita

- 123 Abbreviations and Symbols
- 153 Books
- 145 Business
- 24 Correspondence
- 122 Miscellany
- 118 New Devices
- 131 New Records
- 126 New Tubes and Semiconductors
- 139 Patents
- 148 People
- 128 Question Box
- 136 Radio-Electronic Circuits
- 151 Technical Literature
- 113 Technicians' News
- 134 Technotes

## ON THE COVER

(More on page 37)

Believe it or not, the cylindrical hedgehoglike device on the cover is an oven (or refrigerator if desired) for maintaining transistor temperatures during measurement.

Color original courtesy  
Raytheon Mfg. Co.,  
Newton, Mass.

Hugo Gernsback  
.....Editor and Publisher  
M. Harvey Gernsback  
.....Editorial Director  
Fred Shunaman  
.....Managing Editor  
Robert F. Scott  
.....W2PWG, Technical Editor  
I. Queen  
.....Editorial Associate  
Matthew Mandl  
.....Television Consultant  
Elizabeth Stalcup  
.....Production Manager  
Angie Pascale  
.....Editorial Production  
Wm. Lyon McLaughlin  
.....Tech. Illustration Director  
Sol Ehrlich  
.....Art Director  
Lee Robinson  
.....General Manager  
John J. Lamson  
.....Sales Manager  
G. Aliquo  
.....Circulation Manager  
Adam J. Smith  
.....Director, Newsstand Sales  
Robert Fallath  
.....Promotion Manager



Average Paid Circulation over 184,000

Associate Member Institute of High Fidelity Mfrs., Inc.

Chicago, Ill., by Gernsback Publications, Inc. Second-class mail privileges authorized by the United States Post Office at New York, N. Y., under Post Office No. 1445. Published by Universal, International and Pan-American Copyright Conventions. Single copies 35c. Pan-American countries \$1.50. For two years; \$9.00 for three years; single copies 35c. Pan-American countries \$1.50. For two years; \$9.00 for three years. For one month for change of address. 144 West 14th St., New York 11, N. Y. Telephone ALgonquin 5-7755. Hugo Gernsback, Editor.

144 West 14th St., New York 11, N. Y.

\*Trademark registered U. S. Pat. Office.

RADIO-ELECTRONICS

**GREATEST  
ADVANCE IN  
SHOP-METHOD  
HOME TRAINING**

# EARN MORE MONEY... GET INTO TELEVISION ELECTRONICS - RADIO

**Learn ALL 8 PHASES in ONE MODERN HOME-STUDY COURSE**  
At Home - In Spare Time

## YOU GET ALL THIS NEWEST PRACTICAL EQUIPMENT

- Parts to build a modern TV set, including all tubes plus a large screen Picture Tube
- Parts to build a powerful Superhet Receiver, standard broadcast and short wave
- Parts to conduct many experiments and build Continuity Checker, RF Oscillator, TV Circuits, Audio Oscillator, TRF Receiver, Signal Generator
- A Valuable Professional Multitester



**19 BIG KITS  
YOURS TO KEEP**

## YOUR NATIONAL SCHOOLS TELERAMA COURSE COVERS ALL 8 PHASES

- |                                    |                                |
|------------------------------------|--------------------------------|
| 1. TELEVISION, INCLUDING COLOR TV  | 5. PREPARATION FOR FCC LICENSE |
| 2. RADIO, FM AND AM                | 6. AUTOMATION                  |
| 3. INDUSTRIAL ELECTRONICS          | 7. RADAR AND MICRO WAVES       |
| 4. SOUND RECORDING AND HI FIDELITY | 8. COMMUNICATIONS              |

## YOU ARE NEEDED IN THE TELEVISION-ELECTRONICS-RADIO INDUSTRY!

You can build a secure future for yourself if you get into Electronics NOW! Today's shortage of trained technicians creates tremendous opportunities. National Schools Shop-Method trained technicians are in constant and growing demand for high-pay jobs in Broadcasting and Communications, Electronic Research, Servicing and Repair, and many other branches.

Let National Schools, a Resident Technical School for over 50 years train you for today's unlimited opportunities in electronics! Our Shop Method trains you to be a MASTER-TECHNICIAN. Completely up to date, developed by experienced instructors and engineers, your Telerama Course will teach you all phases of the industry quickly, clearly and correctly. You can master the most modern projects, such as Color TV, printed circuits - even prepare for FCC License without taking a special

course. You can handle sales, servicing, manufacturing, or make good money in your own business. SEND FOR FACTS TODAY!

**EARN AS YOU LEARN.** Many of our students earn their entire tuition and more in Spare Time jobs we show them how to do while learning.

**YOU GET EVERYTHING YOU NEED** - Clear, profusely illustrated lessons, shop-tested manuals, modern circuit diagrams, practical job projects - all the valuable equipment shown above

- many other materials and services - consultation privilege with our qualified staff, and Graduate Employment Service. EVERYTHING YOU NEED for outstanding success in Electronics.

## RESIDENT TRAINING AT LOS ANGELES

If you wish to take your training in our Resident School at Los Angeles, the world's TV capital, start NOW in our big, modern Shops, Labs and Radio-TV Studios. Here you work with latest Electronic equipment - professionally installed - finest, most complete facilities offered by any school. Expert, friendly instructors. Personal attention. Graduate Employment Service. Help in finding home near school - and part time job while you learn.



**FREE!**

Fully illustrated "Career" Book in TV-Radio-Electronics. PLUS actual sample lesson - yours at no cost, no obligation. CLIP COUPON NOW... MAIL IT TODAY!



MEMBER



# APPROVED FOR G. I. TRAINING NATIONAL SCHOOLS

4000 S. FIGUEROA ST., LOS ANGELES 37, CALIF.  
187 N. LA SALLE ST., CHICAGO 1, ILL.  
IN CANADA: 811 W. HASTINGS ST., VANCOUVER, B. C.

MARCH, 1957



# INTRODUCING BOGEN FLEX-PAK<sup>®</sup>

custom flexibility in packaged PA

portable . . . or permanent . . . make more sales, more profits

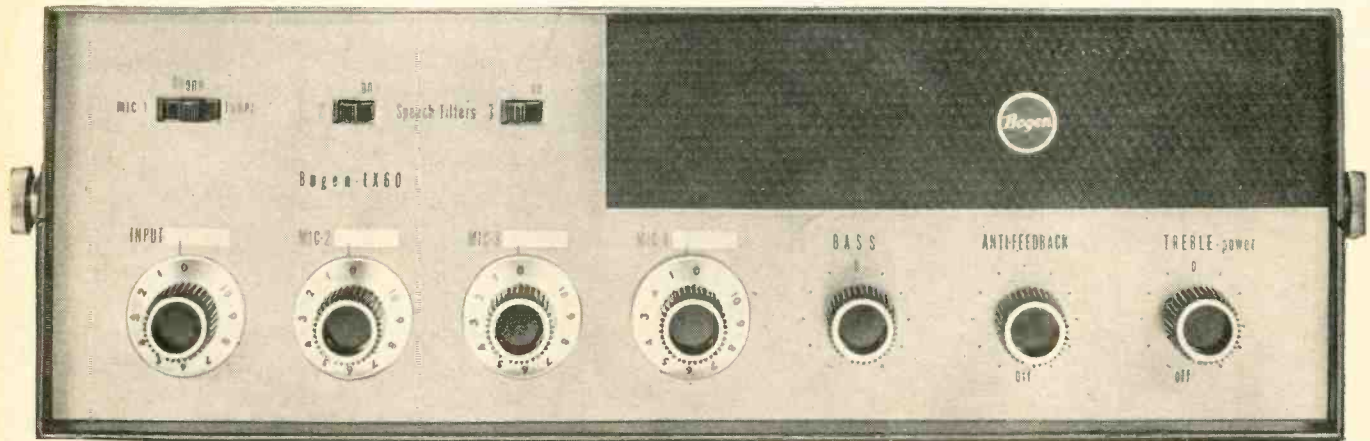

## HOW'S THIS FOR EASY SERVICE ... EASY INSTALLATION



Loosen 4 thumbscrews and the lid's off for easy access and fast servicing.



Folds back when not in use in easy-sliding accessory wall-mount.

Meet Bogen's Flex-Pak public address line. Here's true portability. Here's easy servicing. And here's all the flexibility, performance and dependability you'll need to satisfy 90% of your commercial applications—without going to the additional effort and delay of expensive custom designs. You can offer Flex-Pak systems in every price range,

at practically every popular wattage. Get in touch with your Bogen representative or write for all Flex-Pak specifications and prices. NOTE: We also supply famous—make indoor and outdoor speakers, microphones and other accessories for all your Bogen public address system installations. Mail coupon now for the exciting details.

### Two of 12 New Amplifiers In The Exciting Flex-Pak PA Line



#### Deluxe LX30 30-Watt Amplifier

4 Microphone Inputs (panel switch converts one microphone channel for phono or tuner), Built-In Remote Gain-Control Circuit, Exclusive Feedback Control, Speech Filters, Separate Bass and Treble Tone Controls  
Size: H. 16 1/4", D. 13", Wgt.: 25 lbs.



with accessory Manual Phono

#### Superb L330 30-Watt Amplifier

3 Microphone Inputs (panel switch converts one microphone channel for phono or tuner), Speech Filters, Separate Bass and Treble Tone Controls  
Size: H. 5 3/8", W. 14 1/4", D. 13", Wgt.: 24 lbs.

### MAIL THIS COUPON TODAY FOR DESCRIPTIVE BROCHURES AND PRICES

Dept. NO, David Bogen Co., Inc., P. O. Box 500, Paramus, N. J.  
Gentlemen: Please send me descriptive literature and price information on your BOGEN FLEX-PAK public address equipment.

NAME \_\_\_\_\_

FIRM \_\_\_\_\_  
check one  dealer  jobber  sound specialist

ADDRESS \_\_\_\_\_

CITY \_\_\_\_\_ ZONE \_\_\_\_\_ STATE \_\_\_\_\_

Please send me 24-page, illustrated brochure, "What You Should Know About Sound Systems."

Please send me your 56-page, illustrated book, "Understanding High Fidelity," by L. H. Bogen and L. Biancolli. (I enclose 25c.)

**en**  
SYSTEMS  
AFFILIATE

**DEVRY TECH CAN PREPARE YOU  
IN SPARE TIME AT HOME AS AN**

# ELECTRONICS TECHNICIAN!



## No Previous Technical Experience or Advanced Education Needed!

Laborers and bookkeepers, store clerks, farmers, salesmen — men of nearly every calling — have taken the DeVry program and today have good jobs or service shops of their own in Electronics.

Here's proof positive that it can be done — done by men like yourself — men who had no previous technical experience, no advanced education.

If you are 17 to 55, we will tell you free how you may prepare for exciting, interesting jobs in Automation Electronics, Radar, Guided Missiles, Communications, Industrial Electronics and many others shown at right. Here is a chance of a lifetime to prepare to cash in on one of today's fastest growing fields. Mail the coupon for details.

DeVry Tech's amazingly practical home method enables you to spend minimum time to get maximum knowledge. In fact, you get exactly the same type of basic training equipment used in our Chicago and Toronto training laboratories — among the finest!

Send coupon for free facts NOW!

### Live-Wire Employment Service

DeVry Tech's Placement Department is in contact with some of the best-known employers in the Electronics field. The service is free to all graduates—and DeVry Tech's record in helping to place men has been outstanding.



### Draft Age?

We have valuable information for every man of draft age; so if you are subject to military service, be sure to check the coupon.

### What a DeVry Tech Diploma Meant to These Men!



**G. F. Beane, W. Virginia,** was a truck driver. He took the DeVry Tech Training Program, and is now a technical electronics sales representative.



**Edward Hahn, Illinois.** Was a laborer, now an electronics project engineer with Televiso, Inc. DeVry Tech training helped him prepare for his present position.



**Nick Barton, Illinois,** came directly from high school to DeVry Tech. Now has his own service shop and tells us he is "literally snowed with work."



**George D. Crouch, California,** was a retail store clerk. He took the DeVry Program, and today is in the servicing field for himself.

"One of North America's Foremost Electronics Training Centers"



Accredited Member of  
National Home Study Council

**DEVRY TECHNICAL INSTITUTE**

CHICAGO 41, ILLINOIS

FORMERLY

**DEFOREST'S TRAINING, INC.**



## AN INDEX

to a  
**BETTER JOB,  
A BRIGHTER  
FUTURE**

COMMUNICATIONS

RADAR

GUIDED  
MISSILES

TELEVISION

MICRO-WAVES

RADIO

INDUSTRIAL  
ELECTRONICS

COMPUTERS

AUTOMATION  
ELECTRONICS

### Sample Lesson **FREE!**

See for yourself how DeVry Tech trains you for real opportunities in Electronics. We'll also give you a free copy of an interesting booklet, "Electronics and YOU."



Mail Coupon For



**R**adiart vibrators are the Standard of Comparison for quality, performance and dependability in the industry! Men who know . . . management, jobbers . . . and servicemen . . . ALL agree that experience over the years has dictated that RADIART vibrators are the ones to buy and use.

AND . . . the complete line of COMMUNICATION vibrators offers the correct replacement for 6 volt and 12 volt applications.

Be sure you have the new vibrator replacement guide... write for your FREE copy...

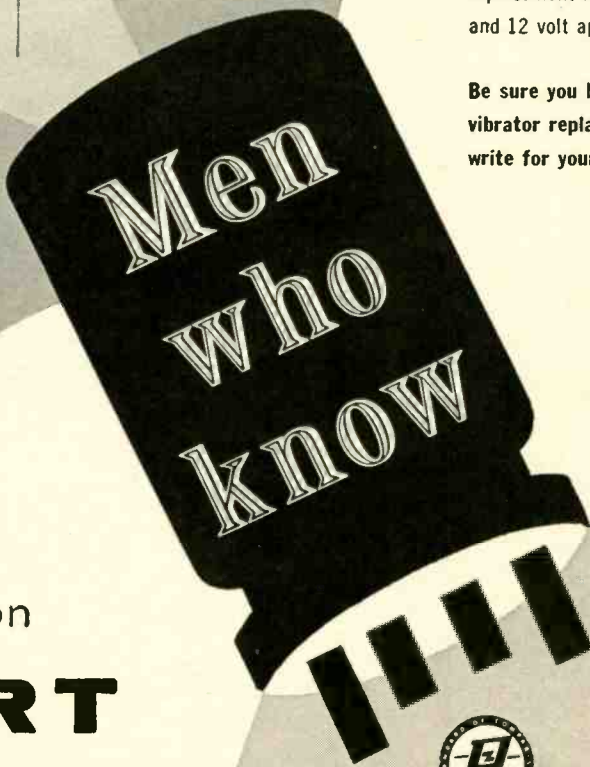

depend on

**RADIART  
VIBRATORS**

replacement line



THE **RADIART** CORP.  
CLEVELAND 13, OHIO

A Subsidiary of  Cornell-Dubilier

RADIO-ELECTRONICS



# HOW TO PASS Your FCC Commercial LICENSE EXAMS\*

**GET YOUR FCC LICENSE IN A HURRY!**

**We Guarantee\***

to train you  
until you receive

**Your FCC License**

\* See Free Catalog for complete details

**Cleveland Institute training results in success  
with commercial FCC examinations**

*.... easily .... and quickly*

**Here's Proof:**

Name and Address	License	Time
Walter Eggers, Pacific Grove, Calif. ....	1st	12 weeks
Paul Reichert, West Salem, Ohio.....	2nd	10 weeks
Harold Phipps, LaPorte, Indiana.....	1st	28 weeks
John H. Johnson, Boise City, Okla.....	2nd	12 weeks
James Faint, Johnstown, Pa.....	1st	26 weeks

**(Names and addresses of trainees in your area sent on request)**

**Cleveland Institute training results in job offers like these:**

**Radio Operators & Technicians**

American Airlines has openings for radio operators and radio mechanics. Operators start at \$334.53 per month. Radio mechanic's salary up to \$1.99 per hour. Periodic increases with opportunity for advancement. Many company benefits.

**Electronic Technicians**

Convair Electronics Department: Radio and Radar Mechanics, Electronics Technicians, and Junior Engineers are wanted for a special program on fire control development and installation. Beginning rate: \$365 and up.

**And our trainees get good jobs**

**Salary Increased**

"I recently secured a position as Test Engineer with Melpar, Inc. A substantial salary increase was involved. My Cleveland Institute training played a major role in qualifying me for this position."

Boyd Daugherty  
105 Goodwin Ct., Apt. C  
Falls Church, Va.



**Eastern Airlines**

In a year and a half, he received his first class FCC License. He is continuing his training with Cleveland Institute. His goal is much higher than his present position with Eastern Airlines, so he is adding technical "know-how" to his practical experience.

Bob Thompson  
2935 Ironwood Drive  
Nashville 14, Tennessee

**CLEVELAND INSTITUTE OF RADIO ELECTRONICS**  
Desk RE-3, 4900 Euclid Bldg., Cleveland 3, Ohio

We can train you to pass your License Exams if you've had any practical experience —amateur, military, radio servicing, or other. Our proven plan can help put you on the road to success.

\*Your FCC ticket will be recognized by employers as proof of your technical ability.

**MAIL COUPON NOW**

and get  
all 3 books  
**FREE**

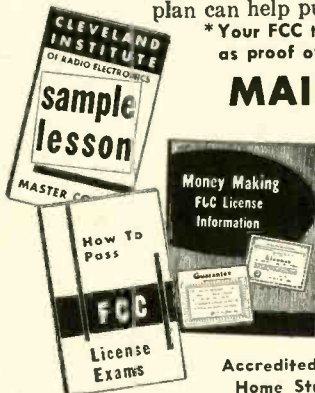

Accredited by National Home Study Council

# there is ONE pickup for calibrating and evaluating records! (including test records)

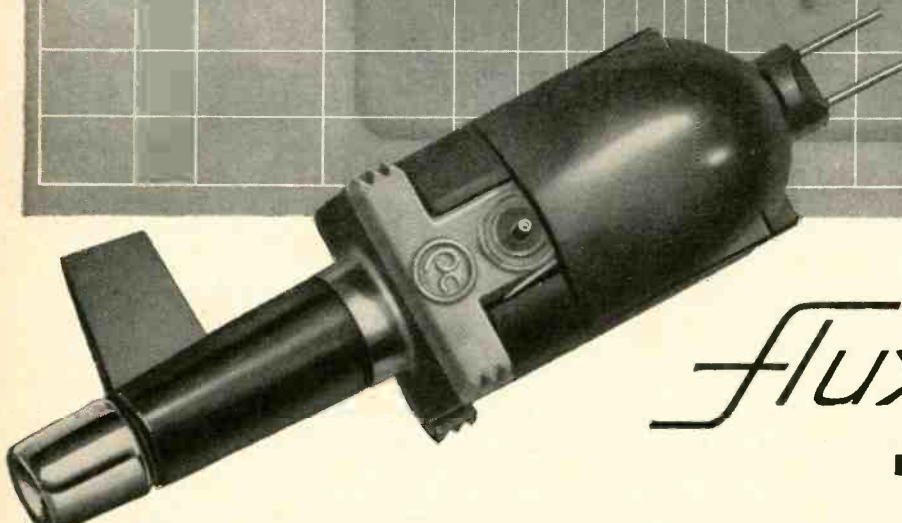
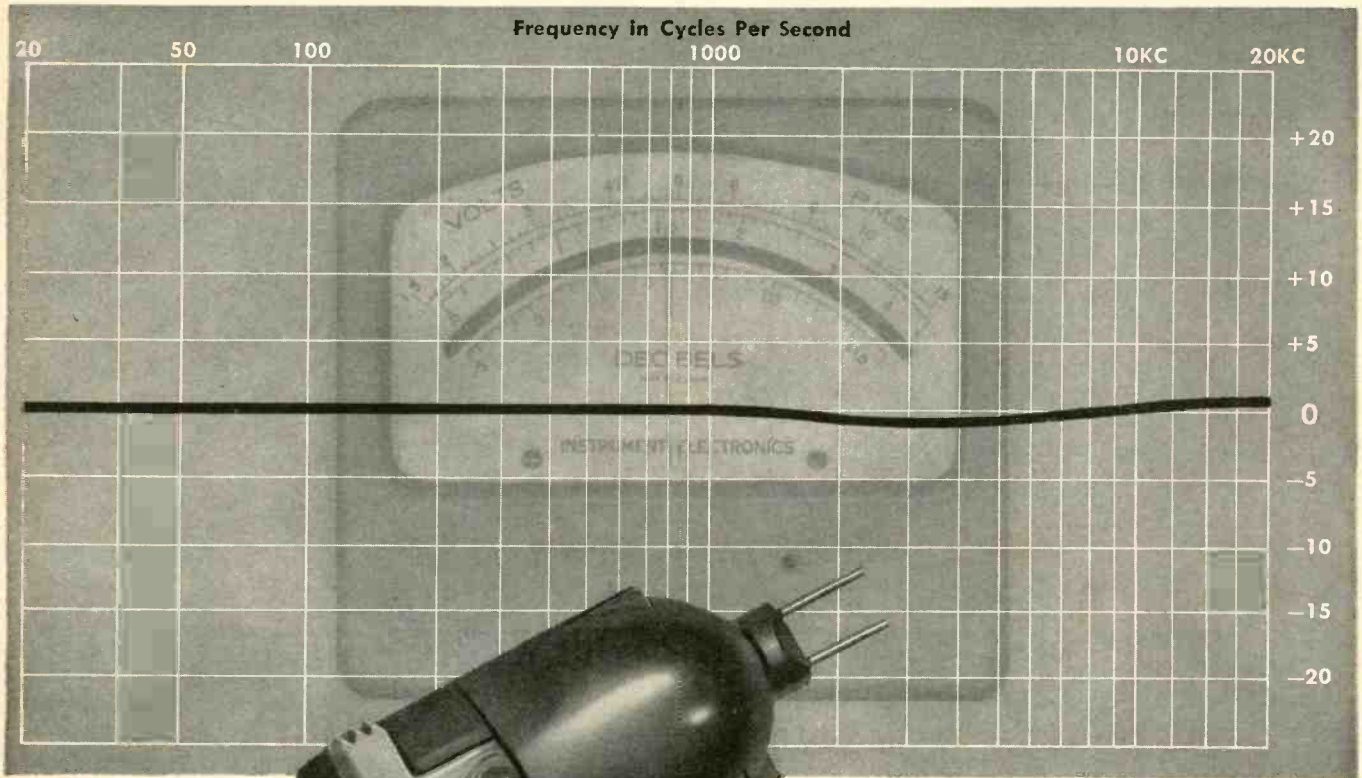

## THE *Fluxvalve* PICKUP

Important as it is to the recording industry, the FLUXVALVE PICKUP was originally developed for professional studios, particularly recording studios where accurate correlation between lacquer, master and pressings is essential, and has been difficult. Now with the FLUXVALVE magnetic turntable pickup with which to make precise and *reproducible* recordings, a vital control step is simplified. For a new listening experience, ask your dealer to demonstrate the FLUXVALVE . . . words cannot describe the difference . . . you will hear it!

CO., INC. OCEANSIDE, N. Y.

For those who can hear the difference"

Dealers everywhere. For the one nearest you and for detailed literature: write Dept. P-10  
NEW YORK / CANADA: CHARLES W. POINTON LTD., 6 ALCINA AVE., TORONTO

RADIO-ELECTRONICS

Music to suit your every mood!



# FREE ANY 3

OF THESE SUPERB HIGH-FIDELITY

## 12" COLUMBIA <sup>LP</sup> RECORDS

If you join the Columbia <sup>LP</sup> Record Club now—and agree to accept as few as 4 selections during the coming 12 months

YES! You may have FREE, ANY 3 of these best-selling 12" Columbia <sup>LP</sup> records. We make this unique offer to introduce you to the money-saving program of the Columbia <sup>LP</sup> Record Club . . . a program that selects for you each month the greatest works in every field of music—performed by the world's finest artists, brilliantly reproduced on Columbia <sup>LP</sup> records.

**HOW THE CLUB OPERATES:** To enjoy the Club's benefits—mail the coupon, indicating which one of the four Club divisions best suits your musical taste: Classical; Jazz; Listening and Dancing; Broadway, Movies, Television and Musical Comedies.

Each month you will receive free the Club Magazine which describes the current selections in all four divisions. You may accept or reject the monthly selection for your division . . . or take records from the other Club divisions . . . thereby assuring you the widest possible choice of recorded entertainment. Or you may tell us to send you NO record in any month. Your only obligation is to accept as few as 4 selections from the almost 100 that will be offered during the next 12 months. The records you want are mailed and billed to you at only \$3.98 (original cast Broadway Shows somewhat higher), plus a small mailing charge.

**FREE BONUS RECORDS GIVEN REGULARLY:** The 3 records sent to you now represent an "advance" of the Club's bonus system—given to you at once. After you have fulfilled your membership obligation by purchasing four records, you will receive an additional free Bonus record of your choice for every two additional Club selections you accept. Bonus records are superb 12" Columbia <sup>LP</sup> records—the very best of the world-famous Columbia <sup>LP</sup> catalog—just like those shown here.

Indicate on the coupon which 3 records you want free, and the division you prefer. Then mail the coupon at once. You must be delighted with membership or you may cancel it by returning the free records within 10 days.

**COLUMBIA <sup>LP</sup> RECORD CLUB Terre Haute, Ind.**

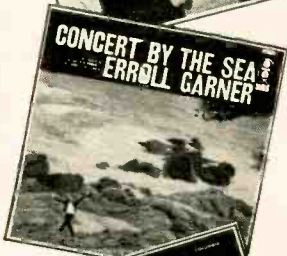

### Mail Entire Coupon Now!

**COLUMBIA <sup>LP</sup> RECORD CLUB, Dept. 685**  
Terre Haute, Indiana

Please send me as my FREE gift the 3 records indicated here: (Select the records you want by checking the 3 boxes in the list at the right) . . . and enroll me in the following Division of the Club:

(check one box only)

- Classical       Listening and Dancing       Jazz  
 Broadway, Movies, Television and Musical Comedies

Each month you will send me the Columbia <sup>LP</sup> Record Club Magazine which describes the records offered in all four Club divisions. I have the privilege of accepting the monthly selection in the division checked above, or any other selection described, or none at all. My only obligation is to accept a minimum of four records in the next 12 months at the regular list price plus a small mailing charge. After accepting 4 records, I will receive a free Bonus record for every two additional records I purchase. If not delighted with membership, I may cancel within 10 days by returning all records.

Name .....  
(Please Print)

Address .....

City..... Zone..... State.....

CANADA: Prices slightly higher. Address 11-13 Soho St., Toronto 2B  
If you wish to have this membership credited to an established Columbia Records dealer, authorized to accept subscriptions, please fill in the dealer's name and address also.

Dealer's Name .....

Dealer's Address .....

### CHECK THE 3 RECORDS YOU WANT:

- |   |   |
|---|---|
| <input type="checkbox"/> Tchaikovsky: Nutcracker Suite; The Sleeping Beauty Ballet Philadelphia Orchestra, Ormandy, cond.                                       | <input type="checkbox"/> Concert by the Sea Erroll Garner — recorded in an actual performance at Carmel, Calif.—playing 11 numbers — <i>Red Top, Where or When</i> , etc. |
| <input type="checkbox"/> Day Dreams Doris Day sings 12 popular songs—including <i>Sometimes I'm Happy, You Go To My Head</i> , etc.                             | <input type="checkbox"/> Levant Plays Gershwin 3 works— <i>Rhapsody in Blue; Concerto in F; An American in Paris</i> .  |
| <input type="checkbox"/> King of Swing: Vol. I Benny Goodman and Original Orch. Trio Quartet. <i>Ridin' High, Moonglow</i> —9 more.                             | <input type="checkbox"/> The Voice Frank Sinatra in 12 songs that first made him famous — <i>Love, Fools Rush In</i> , etc.   |
| <input type="checkbox"/> My Fair Lady Percy Faith and his Orchestra play music from this hit show.  | <input type="checkbox"/> Rimsky-Korsakov: Scheherazade Philadelphia Orch., Ormandy, conductor. A superb performance of this exotic score.                                 |
| <input type="checkbox"/> Brahms: Double Concerto; Variations on a Theme by Haydn; Tragic Overture Stern, violin; Rose, cello; N. Y. Philharmonic, Walter, cond. | <input type="checkbox"/> Music of Jerome Kern Andre Kostelanetz and his Orchestra play 20 Kern favorites.   |
| <input type="checkbox"/> Songs from Walt Disney's Magic Kingdom 12 happy songs from famous Disney films.  | <input type="checkbox"/> Jazz: Red Hot & Cool Dave Brubeck Quartet in <i>Love Walked In, The Duke</i> —5 more.  |

® "Columbia", <sup>LP</sup>, <sup>LP</sup> Marcas Reg.



## Independent Service Dealers:

### TV-RADIO SERVICE IS YOUR BUSINESS

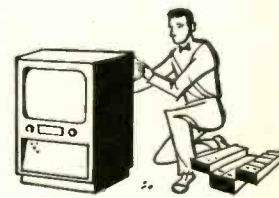

### SERVING YOU IS OUR BUSINESS

That's why we say, use Raytheon TV and Radio Tubes for your replacement work. We have no "captive service" organizations to compete with you for TV and Radio service business — we leave the service business to you. Serving you is our only interest.

First, we serve you with the finest TV and Radio Tubes — Raytheon Tubes — designed to meet the varying needs of the many set manufacturers and

perform perfectly in all makes and models of sets.

Second, we serve you Raytheon Tubes promptly and efficiently through a network of independent Raytheon Tube Distributors with trained personnel eager to help independent dealers in every way.

Third, we serve you with the exclusive Raytheon Bonded Electronic Technician Program. If you can qualify, you become

part of a nationally recognized and advertised organization, yet you retain your own independence. As a Raytheon Bonded Electronic Technician, you're identified as a dependable businessman capable of fast, efficient TV and Radio service on all makes and models of sets. You will have the exclusive Western Union "Operator 25" tie-in bringing business to you, along with many other important advantages.

*Ask your Raytheon Sponsoring Bonded Tube Distributor to give you the Raytheon Bonded story.*



#### RAYTHEON MANUFACTURING COMPANY

Receiving and Cathode Ray Tube Operations

Newton, Mass. • Chicago, Ill. • Atlanta, Ga. • Los Angeles, Calif.

Raytheon makes all these { Receiving and Picture Tubes, Reliable Subminiature and Miniature Tubes, Semiconductor Diodes and Transistors, Nucleonic Tubes, Microwave Tubes.



*Excellence in Electronics*

# Here's a NEW Way to Reach the Top in TV SERVICING

ALL PRACTICE METHOD—  
PROFESSIONAL TECHNIQUES

**Includes 17" picture tube, all other tubes, components for TV receiver. Also 5 inch professional type Scope and highly accurate Signal Generator. Training low in cost; monthly terms.**



**I**F YOU HAVE some Radio or Television experience, or if you know basic Radio-Television principles but lack experience — NRI's Professional Television Servicing course can equip you to go places in TV servicing. This advertisement is your personal invitation to get a free copy of our booklet which describes this training in detail.

## You Get Color-TV Textbooks Early

The day you enroll, N.R.I. sends you special Color-TV books to speed your knowledge and understanding of this vast, growing phase of Television. Many full color pictures and diagrams help you recognize defects and help you learn how to correct them quickly and properly. To cash in on the coming Color-TV boom you'll need the kind of knowledge and experience this N.R.I. training gives.

## You Learn-By-Doing "All The Way"

This is 100% learn-by-doing, practical training. We supply all the components, all tubes, including a 17" picture tube, and comprehensive manuals covering a thoroughly planned program of practice. You learn how experts diagnose TV receiver defects quickly. You see how various defects affect the performance of a TV receiver—picture, sound and color; learn to know the causes of defects, accurately, easily, and how to fix them.

You do more than just build circuits. You get practice recognizing, isolating and fixing innumerable TV receiver troubles. You get actual experience aligning TV receivers, eliminating interference, using germanium crystals to rectify the TV picture signal, obtaining maximum brightness and definition by properly adjusting the ion trap and centering magnets, etc. There isn't room to list all the servicing experience you get.

MARCH, 1957

Graduate C. Dority of Silver Spring, Md., says:

*"Your course is so thorough that anyone interested in the challenge of servicing shouldn't miss this opportunity. I can find my way around a TV Chassis as easy as I can my own home as a result of your course."*

James D. McIngvale of Lake Cormorant, Miss., says:

*"I have serviced about 95% of common TV complaints and quite a few that are not common. A year ago I would not have known where to start. Now I am able to put my finger right on the defective part. I can now fix a TV receiver defect in minutes when it used to take hours."*

## Get Details Free—Mail Coupon

Once again—if you want to go places in TV servicing, we invite you to find out what you get, what you practice, what you learn from NRI's course in Professional Television Servicing. See pictures of equipment supplied, read what you practice. Judge for yourself whether this training will further your ambition to reach the top in TV servicing. We believe it will. We believe many of tomorrow's top TV servicemen . . . for black and white, UHF and Color-TV . . . will be graduates of this N.R.I. training. Mail the coupon now. There is no obligation. National Radio Institute, Dept. 7CFT, Washington 9, D.C.

**Oldest and Largest Home Study  
Radio-Television School**



The books...

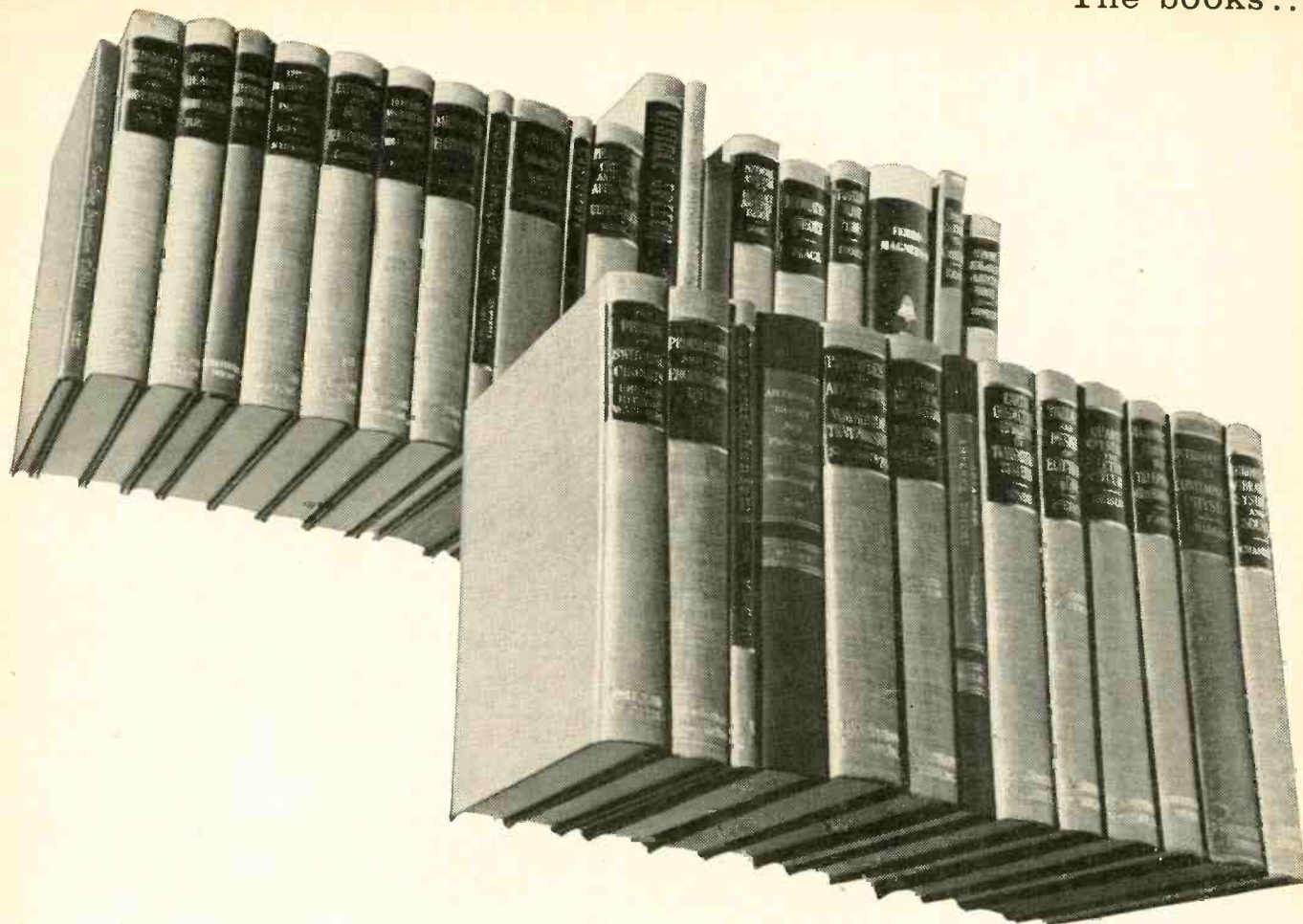

## How the scientific world shares in fruits of the telephone art

In their work to improve telephony the scientists and engineers of Bell Telephone Laboratories make important findings in many sciences. They thoroughly report these findings in professional journals and magazines. But sometimes, as knowledge accumulates in a vital field, a "treatment in depth" is prepared in book form.

Bell Laboratories authors have written 36 books to date and others are in preparation. Many have become classics in the Laboratories' primary field of communications. Many have become standard works of wide application because

benefits they receive from the published works of others.

The pictures on the opposite page show some Bell Laboratories authors of technical books. A complete listing of titles may be obtained by sending in this coupon.

Publication Department, Dept. 32

**BELL TELEPHONE LABORATORIES**

463 West Street, New York 14, N. Y.

Gentlemen:

Please send me a listing of titles, authors and publishers of books written by Bell Telephone Laboratories authors.

Name.....

Street.....

City..... State.....

**BELL TELEPHONE LABORATORIES**

*World center of communications research and development*

RADIO-ELECTRONICS

## ...the authors

Most of the books written by Laboratories authors are published by D. Van Nostrand Company. Other publishers include John Wiley & Sons and McGraw-Hill. Subjects include speech and hearing, mathematics, transmission and switching circuits, networks and wave filters, quality control, transducers, servomechanisms, quartz crystals, capacitors, visible speech, earth conduction, radar, electron beams, microwaves, waveguides, antennas, traveling-wave tubes, semiconductors, ferromagnetism.



**Harold S. Black, B.S.**  
in E.E., Worcester  
Polytechnic Inst.,  
author of "Modulation  
Theory."



**John R. Pierce, Ph.D.,**  
California Inst. of Tech.,  
author of "Traveling-  
Wave Tubes."



**Richard M. Bozorth,**  
Ph.D., California Inst.  
of Tech., author of  
"Ferromagnetism."



**W. Thornton Read,**  
M.S., Brown University,  
author of "Dislocations  
in Crystals."



**Hendrik W. Bode,**  
Ph.D., Columbia  
University, author of  
"Network Analysis and  
Feedback Amplifier  
Design."



**Walter A. Shewhart,**  
Ph.D., University of  
California, author of  
"Economic Control of  
Quality of Manufactured  
Product."

# News Briefs



**ELECTROLUMINESCENCE** has taken its place among practical electrical lighting equipment, announced Sylvania's vice president, Frank J. Healy at a recent meeting which celebrated production of the 200,000th Panelescent lamp.

The electroluminescent lamp is essentially a capacitor with a phosphor dielectric. The backing plate of the capacitor is a piece of enameling steel and the front plate a thin transparent conducting layer. Ordinary 117-volt 60-cycle current is applied to the two surfaces, causing the phosphor to glow.



**Dr. Erwin F. Lowry of Sylvania with his latest development, a high-intensity electroluminescent lamp which operates from a high-frequency source.**

Higher efficiency is obtained with higher frequencies and voltages, and some practical applications with 400-cycle 600-volt supplies have been made.

Panelescent lamps have been used for 3 years, in luminous dials on Sylvania radios and on thermometer dials. Other present commercial applications include luminous signs on airplanes.

Brightness levels obtainable up to the present are rather low, preventing the use of electroluminescent lamps for general illumination although they make acceptable night lights. The inherent possibilities of the phenomenon are, however, such that in the future electroluminescent lamps may have greater efficiency than either the fluorescent or incandescent types that now dominate the lighting field.

**TRIPLE-TRACK TAPE** recording by the Chicago Symphony Orchestra, the first of its kind ever made, was demonstrated recently by RCA Victor. Designed to give the utmost in high-fidelity stereophonic sound, the system

uses three separate sound tracks on 1/2 inch recording tape, each of which is picked up from a separate microphone. The three separate recordings are fed to loudspeakers located in the same general position as the microphones, thus giving a three-dimensional effect to the music.

**ARMSTRONG MEDAL** of the Radio Club of America has been awarded to Melville Eastham of General Radio at the club's 47th anniversary banquet. The award was made "... in recognition of his outstanding contributions to the art of precision measurements in the radio and electronic field."

The citation continued: "For 50 years a design engineer, Mr. Eastham's effort made available to many workers in the electronic art reliable test equipment of a standardized nature which previously did not exist or had to be specially assembled as a laboratory setup."

Mr. Eastham was the founder of the General Radio Co. and now holds the title of honorary president. He was president of the firm from 1915 to 1944 and chief engineer from 1915 to 1950.

**ANTI-COLLISION RADAR**, referred to in this column last November has hit a snag with an announcement by Collins Radio that it was discontinuing its program of developing equipment as outlined in its proposal to the Air Transport Association, last August. Cancelling more than \$10 million in orders covering some 900 sets of anti-collision radar, Collins said that its research to date raised serious doubts that the equipment can be made to meet the practical needs of airlines. The company stated that it is continuing to work actively on the anti-collision program and is supplementing its work with consulting arrangements with other organizations.

**MODULAR TV DESIGN** may be biggest technical innovation in television receivers in 1957. One 17-inch Motorola now on the market uses printed-circuit chassis into which are plugged 17 modular plates which contain the equivalent of 127 conventional components. Some Emerson chassis have a horizontal deflection circuit composed of 4 modules which replace some 40 components. Emerson reports production of more than 100,000 small radios using modules without a single complaint about them.

**BRITISH TV TRADITION** gave way to public demand when the ban on tele-

# H. H. Scott Presents an FM Tuner that DEFIES Obsolescence!

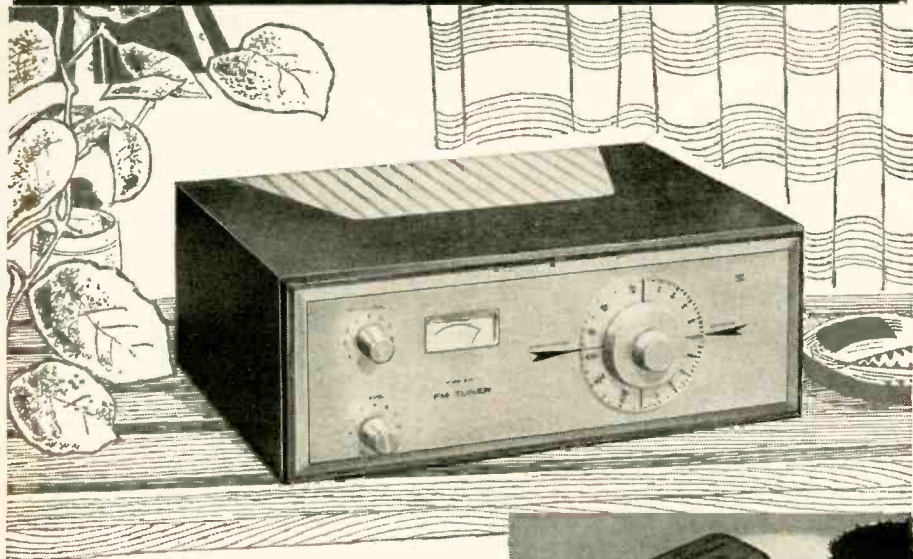

H. H. Scott Model 310-B FM Tuner \$159.95 (Mahogany Case \$19.95)

Other H. H. Scott tuners from \$119.95. All prices slightly higher West of Rockies. All tuners meet FCC radiation specifications

**Exclusive wide band design ...  
new silver sensitive front end ...**

## Most Sensitive ... Selective FM Tuner Ever Made!

High Fidelity Magazine says:

*"The 310 seems as close to perfection as is practical at this time".*

One look at all the features ... one listen to the superlative sound ... and you'll agree!

Wide band circuit design, heavy silver plating in the RF section, and three stages of full limiting make possible noise-free reception of even the weakest stations. Three IF stages insure maximum selectivity with virtual elimination of adjacent and co-channel interference.



### Silver Sensitive Front End Makes Distant Stations Sound Close By!

H. H. Scott never compromises on design. The front-end pictured above is a good example. Silver is one of the best conductors known, yet only H. H. Scott heavily silver-plates their cascade RF section for maximum gain and most reliable performance. This Scott exclusive assures a sensitivity of 2 microvolts throughout the entire FM Band.

### Look at these many features and specifications that defy obsolescence:

- Sensitivity 2 microvolts on 300 ohm antenna terminals for 20 db of quieting (equivalent to 1 microvolt with matched 75 ohm antenna)
- Planetary drive tuning • Logging Scale
- Dynaural Interstation Noise Suppressor cuts out FM roar between stations • Illuminated Signal Strength and tuning meter • Separate tape recorder and multiplex outputs • 2½ db capture ratio permits virtually noise free reception of stations only slightly stronger than interference on the same channel • Easily panel mounted, matches all H. H. Scott amplifiers • Dimensions in mahogany case 13½ x 5 x 9½.



H. H. Scott, Inc.  
385 Putnam Avenue, Cambridge, Mass.  
Export Dept: Telesco International Corp.  
36 West 40th Street, New York 18, N.Y.

### Mail Now For New Catalog

Rush me your new catalog E-3 and complete technical specifications on the new H. H. Scott line for '57.

NAME \_\_\_\_\_

ADDRESS \_\_\_\_\_

CITY \_\_\_\_\_ STATE \_\_\_\_\_

casting from 6 to 7 p.m. was lifted. This quiet period was reserved to encourage school children to finish homework without distraction and to permit parents to get younger children to bed before the evening's TV began. The Government also abolished rules that weekday programs must not start before 9 a.m. or finish after 11 p.m. However, it refused to modify its ban on Sunday telecasting before 2 p.m. and between 6:15-7:25 p.m.

### Calendar of Events

**Pittsburgh High-Fidelity Music Show**, March 8-10, Sheraton Penn Hotel, Pittsburgh, Pa.  
**1957 Nuclear Congress and International Atomic Exposition**, March 11-15, Convention Hall, Philadelphia, Pa.

**IRE National Convention and Radio Engineering Show**, March 18-21, New York Coliseum, New York, N. Y. (RADIO-ELECTRONICS will exhibit in Booth 4103.)

**Third Annual National Television Servicemen's Week**, March 25-30.

**High-Fidelity Music Show**, March 29-31, Hotel Lord Baltimore, Baltimore, Md.

**High-Fidelity Music Show**, April 5-7, Hotel Benjamin Franklin, Philadelphia, Pa.

**14th Annual Radio and Electronic Components Show**, April 6-11, Grosvenor House and Park Lane Hotel, London, England.

**IRE Annual Convention, IRE Conference on Electronics Show and General National Electronics Conference**, April 11-19, Shamrock Hotel, Houston, Tex.

**Convention of the Council of Radio & Television Service Assns.**, April 12-14, Ritz Carlton Hotel, Atlantic City, N. J.

**National Symposium on Telemetry and Exhibits**, April 14-16, Sheraton Hotel, Philadelphia, Pa.

**International Symposium on the Role of Solid State Phenomena in Electric Circuits**, April 23-25, Engineering Societies Building, New York.

**Seventh Region IRE Conference and Electronics Show**, April 24-26, Balboa Park, San Diego, Calif.

**81st Convention of the Society of Motion Picture & Television Engineers**, April 28-May 3, Shoreham Hotel, Washington, D. C.

**IRE HAS HONORED** Oswald Garrison Villard, Jr., professor at Stanford University, with the Morris Liebmann Memorial award. Villard's "contributions in the field of meteor astronomy and ionosphere physics which led to the solution of outstanding problems in radio propagation" are cited as the



reason for the award, which is made annually to an IRE member who has made some important recent contribution to the radio art.

Donald Richman, supervising engineer  
(Continued on page 22)



# ALLIED'S 1957

value-packed 356-page  
**CATALOG**

*free!*

the only **COMPLETE** catalog  
for everything in electronics

*World's Most Complete Stocks*

- Latest Hi-Fi Systems and Components
  - Super-Value KNIGHT-KITS
- P.A. Systems & Accessories • Recorders & Supplies • TV Tubes, Antennas, Accessories
  - Amateur Receivers, Transmitters, Station Gear • Test and Lab Instruments
  - Specialized Industrial Electronic Equipment • Huge Listings of Parts, Tubes, Transistors, Tools and Books . . .

Get ALLIED'S 1957 Catalog—it's *complete*, up-to-date—356 pages packed with the world's largest selection of quality electronic equipment at lowest, money-saving prices. Get *every* buying advantage at ALLIED: fastest shipment, expert personal help, lowest prices and guaranteed satisfaction . . .

send for the leading electronic supply guide



*Our 36th year*

## ALLIED RADIO

World's Largest Electronic Supply House

MARCH, 1957

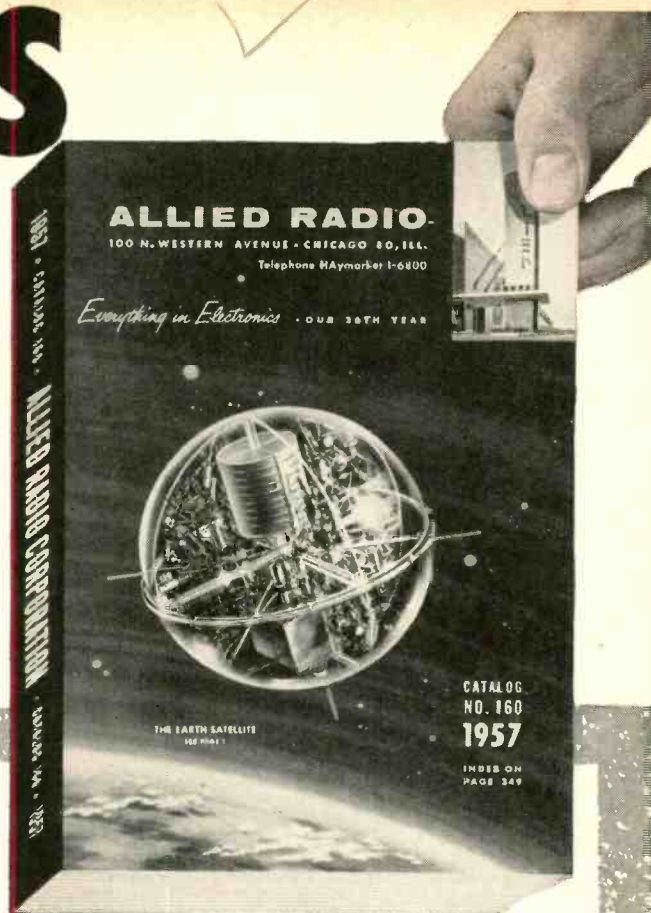

### FEATURING

#### SUPER-VALUE knight-kits

The very finest electronic equipment in money-saving kit form—Test Instruments, Hi-Fi Kits, Ham Kits, Hobbyist Kits. Easiest to build and you **SAVE MORE!**

#### EVERYTHING IN HI-FI:

World's largest selection of quality Hi-Fi components and complete music systems. **MORE PEOPLE BUY THEIR HI-FI FROM ALLIED THAN ANYWHERE ELSE IN THE WORLD!**

#### EASY-PAY TERMS:

Only 10% down, up to 18 months to pay. Available on orders over \$45. Fast handling—no red tape.

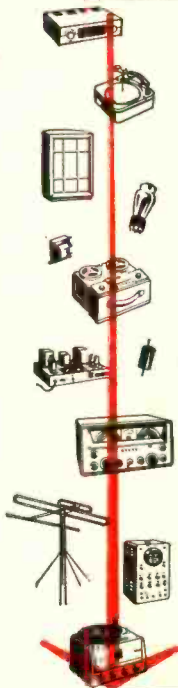

FROM RCA SERVICE COMPANY:

# DOUBLE challenge for alert technicians...

**1** Serve your own future best

**2** Serve your nation's future, too

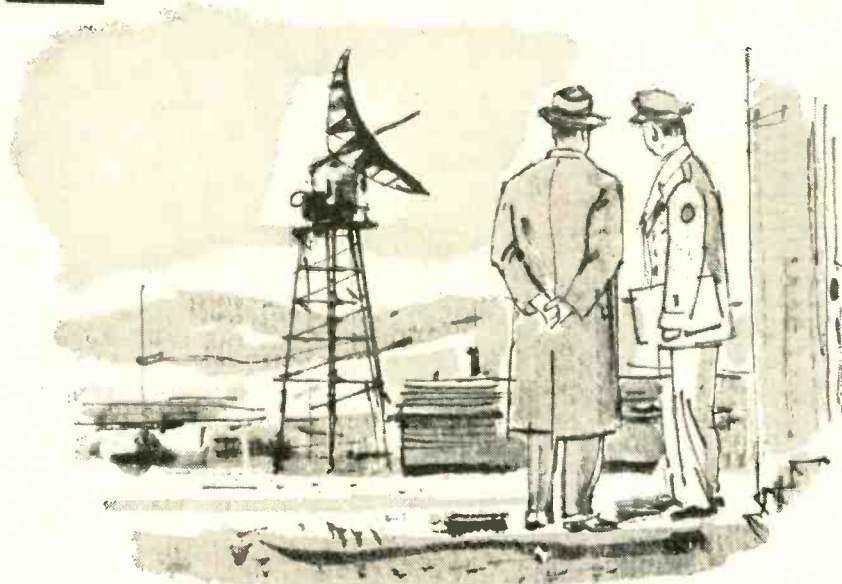

**Double challenge** brightens your future as an RCA technician. First, the challenge of RCA's projects, ranking high on the roster of military defenses. There's the attraction, too, of work far out on electronics horizons, with never a routine rut. At RCA, your sense of accomplishment receives every satisfaction, every reward.

**Seven fields** of technical work open at RCA...

Instructing—Field Engineering—Equipment Maintenance—Equipment Installation—Test and Repair—Technical Writing—Factory Field Support.

**Many locations** to choose with RCA...

You may choose work with RCA at Alexandria, Va.; Cocoa Beach, Fla.; Cherry Hill, N.J.; or Tucson, Ariz.

Talk to RCA Engineering Management in Person!

Will an RCA representative be near you in the next 60 days?

Here is our partial schedule:

March 18, 19—Milwaukee  
March 20, 21—Ft. Worth  
March 23, 24—St. Louis  
March 25, 26—Kansas City  
March 28, 29—Chicago  
April 1, 2—Denver  
April 5—Salt Lake City  
April 8, 9—Columbus  
April 10—Winston-Salem  
April 11, 12—Detroit  
April 13, 14—Dallas  
April 17, 18—Atlanta

ve Mr. James Bell  
y- Employment Manager  
O: Dept. Y-8C  
RCA Service Company, Inc.  
Cherry Hill, Camden 8, N.J.

**RCA SERVICE COMPANY, INC.**

# Your independent service business can grow

Advertisements like this are appearing every month in all local editions of TV Guide to help you.

Ask your CBS Tube distributor how you can have *your* name, address and telephone number listed on the facing page in your local edition.

Join with other *independent* service-dealers . . . *independent* parts distributors . . . and CBS Tubes. Working together, we can build a strong *independent* service industry.

CBS is taking the lead for you . . . and in an important way. Month after month this advertising campaign is reaching millions of TV homes. And it is telling them why they should always call their neighborhood independent service-dealer whenever their radio or television sets need service.

**Remember:** Your continuous purchases of CBS tubes make this *independent* service-dealer campaign possible. So help keep it going. Say, "I want CBS tubes!"



**CBS-HYTRON** Danvers, Massachusetts  
A Division of  
Columbia Broadcasting System, Inc.

MARCH, 1957



**PICTURE TUBES DO GET DIRTY! SO CALL YOUR INDEPENDENT SERVICE-DEALER AND . . .**

**Have your Picture Tube cleaned today!**



Just like windows and mirrors, the inside of the glass front on your TV set gets dirty. And the face of your picture tube — the TV screen — gets even more fogged up with dust and dirt, smoke and fumes. See for yourself. Have your picture tube cleaned today. You can't imagine how much clearer . . . brighter . . . and more enjoyable your TV picture will be!

**CALL YOUR INDEPENDENT SERVICE-DEALER FOR HIS SPECIAL "PICTURE TUBE CLEAN-UP."**

He is *your* neighbor. He pays taxes in *your* community. His children go to the same schools and churches as *yours*. And he knows his standing and reputation depend upon the care and thoroughness with which he services your community's radio and television sets. What is more, he is trained to service any make of set. So patronize your neighborhood independent radio and television service-dealer.

© CBS-HYTRON, Danvers, Mass.  
A Division of Columbia Broadcasting System, Inc.



Ask him for CBS tubes. There are no better tubes made . . . and CBS tubes have this seal.



This emblem is one way to identify your independent radio and television service-dealer. Look for it.

**Tie-in:** Ask your distributor for free window display, P-130. And for free, 4-page PA-131 folder giving complete details about your Independent Service campaign . . . and about other specially imprinted tie-in material.

# BUILD THE BEST-

BUILD ALLIED'S OWN

# knight-kits

ALLIED stakes its 36-year reputation in the Electronics field on your complete success and fullest satisfaction with KNIGHT-KITS. Join the thousands who have discovered the ultimate in value in...



## knight-kits

**LOWEST COST** because our giant buying power passes biggest savings on to you...you do the easy assembly and your finished instrument is equal in performance and appearance to equipment selling for several times the KNIGHT-KIT cost. (Easy Payment Terms available, too.)



## knight-kits

**EASIEST TO BUILD** because KNIGHT-KIT "Step-and-Chek" instruction manuals are marvels of clarity—it's just like having a good instructor at your side. Proved professional design and premium quality parts help insure your building success.



## knight-kits

**MONEY-BACK GUARANTEE:** When properly assembled, KNIGHT-KITS fully meet published specifications, or we refund your money.

WHEN YOU BUILD A KNIGHT-KIT  
YOU BUILD THE BEST



For a Complete Selection of  
Famous knight-kits

**SEE PAGES 85-91**

Available Only From

**ALLIED RADIO**

100 N. Western Ave., Chicago 80, Ill.

### NEWS BRIEFS

neer at Hazeltine Corp., received the Vladimir K. Zworykin award "for contributions to the theory of synchronization, particularly that of color subcarrier reference oscillator synchronization in color television."

Georg Gobau, inventor of the G-line, was awarded the Harry Diamond Memorial Prize for his "many contributions to ionospheric research and circuit theory and for his discovery of the surface wave transmission principle," said the statement issued by the Institute of Radio Engineers.

**CHANGE IN CALL LETTERS** to WNBC from WKNB-TV (Channel 20) New Britain-Hartford, Conn. represents the only station change this month.

The following alphabetically corrects our Television Station List of January, 1957:

The correct call letters for channel 2 in Denver, Colo., are KTVR and not KFEL-TV.

KLEW-TV, Lewistown, channel 3, should be deleted from the Illinois group. It appears correctly under Idaho. WILL-TV, Champaign-Urbana, Ill., is on channel 12, not 2.

KNEW-TV, Monroe, La., channel 8, should read KNOE. Also, KLESE-TV, Monroe, La., channel 13, should be added to that state's listing.

In Minnesota, KMGM-TV are the proper call letters for KEYD-TV, Minneapolis-St. Paul, channel 9.

For the state of Nebraska, the city of Hastings was spelled inaccurately. WOW-TV, Omaha, is on channel 6, not 3, and KLRJ-TV, Henderson, channel 2 should be removed. (KLRJ-TV is on channel 2 in Henderson, Nev.)

WGDA, Albany, N. Y., channel 41 is properly WCDA, and WHAM-TV, Rochester, channel 5, has changed its call letters to WROC-TV.

WHYY-TV., Philadelphia, Pa., channel 35, had not yet begun operation at time of writing.

CHEK-TV, Victoria, channel 6, should have been included among the Canadian stations.

We are grateful for the interest and co-operation of those readers who contributed to this list of corrections. Once again, thanks!

**CANCER DETECTION** may be possible with the help of a new application of closed-circuit television that provides immediate comparative data of chemical activity within live normal and cancer cells. The new technique was made possible by the development of an ultra-violet-sensitive TV camera tube and is undergoing experimental examination at the National Institutes of Health, Bethesda, Md.

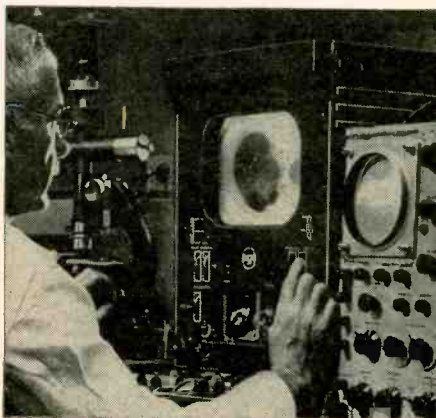

The RCA ultraviolet TV system is being used with a high-power microscope and a special oscilloscope to obtain direct observations and oscilloscope measurements of the metabolism of living cells, and promises a new speed and facility in the analysis of cells and tissues. The system uses a

(Continued)

standard black-and-white TV camera with its regular vidicon tube replaced with the experimental ultra-violet-sensitive camera tube.

**SUPER-MAGNET** made from invisible iron "dust" may soon be realized. Dr. T. O. Paine of G-E's Instrument Department, speaking before the American Association for the Advancement of Science, said that the unique properties of this magnet are achieved by controlling precisely the size and shape of individual iron particles so small that there are more than a billion billion in a pound. He said that, theoretically, the ultrafine-particle iron magnet can be made 10 times stronger than the best available magnets. Already, experimental units equal to the strongest commercial magnets have been made.

**END OF THE VACUUM TUBE** was stated as an assured fact in at least one field by James Weiner of Remington Rand at the recent Eastern Joint Computer Conference in New York City. "The vacuum tube," he said "is on the way out except for some extremely specialized applications" where such factors as high temperatures might be involved. Solid-state devices—state devices—both transistors and diodes—are replacing them in the newer computers.

In another address to the conference, Sir Robert Watson-Watt, radar pioneer, who humorously referred to himself as the "great-grandfather of the computer," pointed out that many of the electronic problems of computer design and construction had been solved and that the most important present problem was relating the machine to the "only partially electronic man." The slovenly use of language is a serious problem, he said, and we must pay attention to semantics and "some radical redesign of the humans who have to suffer with our products."

**SIDNEY YOUNG WHITE**, co-developer of the Loftin-White direct-coupled audio amplifier, died Jan. 23, at the age of 55. The Loftin-White amplifier was one of the first steps toward high-fidelity amplification.

Mr. White worked for General Electric, Schenectady, N. Y., from 1916 to 1918. He then became a marine radio operator and in 1924 joined the Loftin-White Laboratories, which handled Telefunken patents in this country and in the late 'twenties developed the famous amplifier which bears the name of the partners. Later he was vice president of Sound Communications Corp. and a partner in the Mantle Lamp Co. and Aladdin Industries, concentrating on radio-electronic development. In the 'forties he served with General Communications Corp., Boston, Mass.

Mr. White held a large number of patents in the electronics field. He was interested in ultrasonics, shortwave circuitry and facsimile in addition to audio. END

# how long would it take you to solve this service problem?

**SYMPTOM:** Loss of both vertical  
and horizontal synchronization.

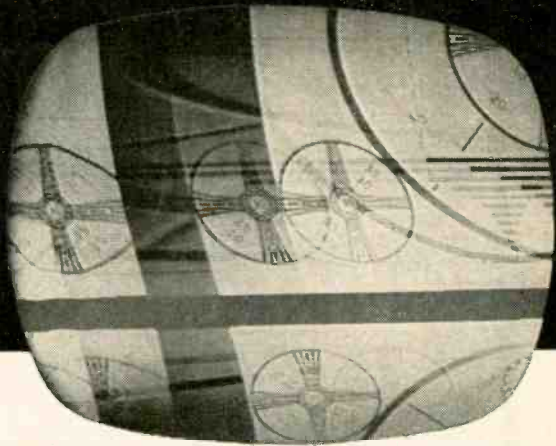

## PHOTOFACT helps you lick problems like this in just minutes for only **2½¢** per model!

Let's take a look at this problem: The loss of both vertical and horizontal synchronization is very often a result of defective components in the sync circuits. So look for the following possible causes—

- 1 Defective tube in sync or noise-limiter stages
- 2 Video-coupling capacitor (C51) shorted, leaky, or open
- 3 Plate resistors (R45, R48, R49) open or too high in voltage
- 4 Shorted or leaky coupling capacitor (C53)
- 5 Sync isolation resistor (R33) open or too high in value
- 6 Resistance of voltage divider (R46) changed in value
- 7 Improper cathode bias in R47

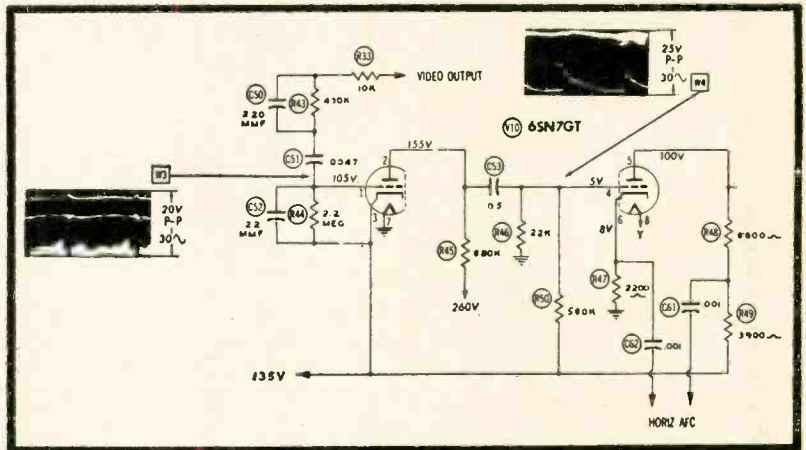

With a PHOTOFACT Folder by your side, you trouble-shoot and solve this problem in just minutes. Here's how: Check the sync tube (V10). You locate the tube in just seconds on the Tube Placement Chart you'll always find in each PHOTOFACT TV Folder. It also shows the locating lug for use in replacement when the sockets are "hidden."

Now, if the tube isn't the culprit in this case, use a scope and check for

proper waveform and amplitude of signal at pin 1 of V10. The correct waveform is shown right on the Standard Notation Schematic featured exclusively in all PHOTOFACT Folders. Waveform incorrect?—check for defective R33 or C51. Waveform okay?—then:

Check waveform at Pin 4 of V10. Something wrong?—check voltages (they're always on the schematic). Resistance check?—use the handy, easy-

to-read resistance chart. In just minutes you can check for defective part R45, R46 or C53. Waveform okay?—then:

Check voltages and/or resistances at pins 5 and 6 of V10 to determine if R47, R48, or R49 is defective. The exclusive PHOTOFACT chassis photos (with call-outs keyed to schematic) help you quickly locate faulty parts. The complete parts list shows ratings and proper replacements...

Use the servicing method you prefer: checking of waveform, voltage or resistance—they're all at your finger-tips in PHOTOFACT. For only 2½¢ per model, PHOTOFACT helps you solve your service problems in just minutes—helps you service more sets and earn more daily!



### MONEY BACK GUARANTEE!

Got a tough repair? Try this—at Howard W. Sams' own risk: see your Parts Distributor and buy the proper PHOTOFACT Folder Set covering the receiver. Then use it on the actual repair. If PHOTOFACT doesn't save you time, doesn't make the job easier and more profitable for you, Howard W. Sams wants you to return the complete Folder Set direct to him and he'll refund your purchase price promptly. GET THE PROOF FOR YOURSELF—TRY PHOTOFACT NOW!

**FREE**



### FOR SERVICE TECHNICIANS ONLY

Fill out and mail coupon today for Free subscription to the Sams Photofact Index —your up-to-date guide to virtually any receiver model ever to come into your shop. Send coupon now.

### HOWARD W. SAM'S & CO., INC.

Howard W. Sams & Co., Inc.  
2205 E. 46th St. Indianapolis 5, Ind.

Put me on your mailing list to receive the Sams Photofact Index and Supplements. My (letterhead) (business card) is attached.

I'm a Service Technician:  full time;  part time

My Distributor is: \_\_\_\_\_

Shop Name \_\_\_\_\_

Attn: \_\_\_\_\_

Address: \_\_\_\_\_

City \_\_\_\_\_ Zone \_\_\_\_\_ State \_\_\_\_\_

IT'S **Blue Chip**  
Quality

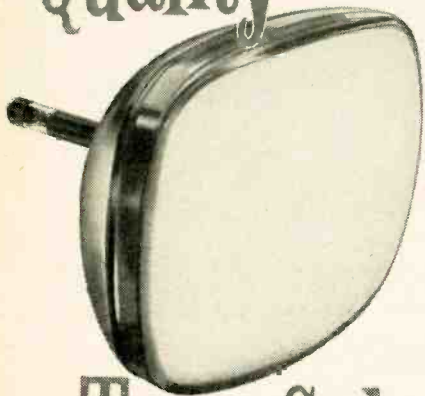

IT'S **Tung-Sol**  
Quality



Tung-Sol receiving tubes for TV, radio and Hi-Fi replacement are exactly the same as those supplied to leading independent set makers. This one fine quality is your assurance of long, trouble-free service that keeps customers with you year after year. Tell your supplier you'd rather have Tung-Sol Tubes. TUNG-SOL ELECTRIC INC., Newark 4, N. J.

**TUNG-SOL**  
MAGIC MIRROR ALUMINIZED  
PICTURE TUBES  
RECEIVING TUBES

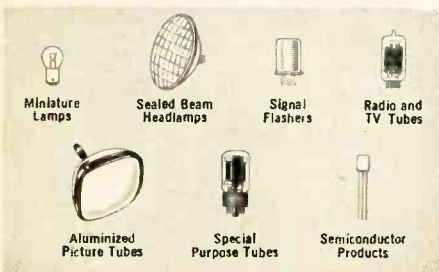

## Correspondence



### CAPTIVE SERVICE

Dear Editor:

In the Technician's News column last month, you raised the question "What is captive service?"

Now that independent service has been aroused by the recent activities of some major television manufacturers, it behooves us to know the meanings of the terms *factory service* and *captive service*. Are they one and the same, or is there a difference? If there is a difference, how are we affected by them? Factory service can be defined as "service offered on a fee or no-charge basis by a manufacturer or one of his subsidiaries."

The RCA Service Co. is an example of this type of operation. Here is a company set up by a set manufacturer operating in competition with the independent service industry. Of course, the prestige gained by using the name of the parent company is a factor not to be overlooked. But this type of operation is legal and the competition it offers can and has been met successfully by independent service.

Now what about captive service? Here is a highly specialized form of factory service. The dictionary defines *captive* as "made or held prisoner, as in war; kept in confinement or restraint, etc." Here then is where we can draw the line! When a manufacturer or his subsidiary restrains the consumer from exercising his own free choice of a service agency—that is captive service. You remember that in the pioneer days of television, RCA made it mandatory for the consumer to buy a 1-year service contract from the RCA Service Co. with every television set they sold. That was captive service. This practice was finally dropped and the consumer was given the option of choosing between factory and independent service. The very fact that the RCA Service Co. had been providing 100% of the service on RCA sets across the nation, compared with the fact that they now service only approximately 8% of all RCA sets, points up the fact that independent service can successfully meet factory-service competition, and it also indicates the public's preference.

Today another giant in the TV industry, through one of its subsidiaries, is experimenting with captive service. We have a situation where a distributor bills a dealer for a 1-year service contract for unsold television sets on his floor. As a result, when the

consumer buys his set he pays a hidden charge for a 1-year service contract and is restrained from making his own free choice of a service agency. This is captive service at its worst—and it is this type of probably illegal maneuvering that the independent service industry should be up in arms against. This is not open competition! This cannot be fought by providing better, faster and more economical service, the tools that have competed so effectively in the past against factory service. This practice, coupled with ads like those of G-E in *Life* and *Saturday Evening Post*, the difficulties in obtaining exact replacement parts, plus the apparent hard-headed attitude of the men in the "ivory tower" were responsible for the "Unite to Fight" drives and "brand-switching" that resulted.

MURRAY BARLOWE

Barlowe Television  
Bethpage, N. Y.

### TUBE TESTERS

Dear Editor:

I was greatly interested in the article on "Tube Testers" by Walter Swontek in the November, 1956, issue. He makes several good points, but I must take exception with him on one major point in his "ten commandments for testers." He says, as his first general rule, that it is generally much faster to swap tubes in the customers' homes than to test them.

Our experience has been exactly the opposite when using a quick-test type of tube checker. An orderly process for swapping tubes goes something like this: The service technician removes an if amplifier tube from the chassis and sees that it is a 6CB6. He then takes a new 6CB6 from his tube caddy, removes it from the carton and places it in the socket from which the original tube came. After waiting over a minute for the new tube to warm up, he must then judge whether the picture is better than it was with the old tube in the circuit. If the new tube does not improve the picture noticeably, he removes the new tube from the socket, puts it back into the carton, replaces it in his caddy and puts the original tube back into the set. He then goes on to the next tube.

All this takes considerable time, and this procedure obviously will not reveal any defects caused by the cumulative effect of several tubes which have become weaker at the same time. Furthermore, the trial-and-error method is not



Mr. Ray Snyder  
Manager  
Coyne Book  
Publ. Div.

You Get  
This Valuable Book

**FREE**

Just for Examining  
COYNE'S NEW 7-VOLUME SET

*"Applied Practical Radio-Television"*  
**ON 7 DAYS FREE TRIAL!**



**OVER 2900 PAGES OF PRACTICAL RADIO AND TELEVISION FACTS AT YOUR FINGER TIPS**

- Vol. 1. APPLICATION OF TELEVISION-RADIO PRINCIPLES: 304 pages, covers resonance & tuning, amplifiers, oscillators, etc.
- Vol. 2. RADIO, TELEVISION & FM RECEIVERS: 403 pages, covers rectifiers, high frequency, short wave, FM, antennas, etc.
- Vol. 3. RADIO-TELEVISION CIRCUITS: 326 pages, covers power tubes, de-coupling, distortion, photo-tubes, phase inverters, etc.
- Vol. 4. LATEST INSTRUMENTS FOR SERVICING RADIO-TELEVISION: 343 pages, covers all types of testing instruments.
- Vol. 5. TELEVISION SERVICING & TROUBLE-SHOOTING MANUAL: 400 pages, practical servicing of all types of TV sets, UHF, booster, color TV, etc.
- Vol. 6. TECHNICAL DICTIONARY: 300 pages, over 4,000 definitions of terms, symbols and abbreviations used in Radio-TV, Electronics, Electricity.

**\*PLUS TV CYCLOPEDIA!**

A "must" for the TV servicemen. Quick answers to all TV problems in A-B-C order, cross-indexed. 900 pages, fully illustrated; covers hundreds of facts on servicing, installation, alignment, UHF, transistors, much more.

Now! The most liberal "get-acquainted" offer you've ever seen! Think of it—Coyne gives you this big, brand new book, "150 Radio-Television Picture Patterns and Diagrams Explained," ABSOLUTELY FREE. This up-to-the-minute, easy-to-use practical book gives you complete 11" x 22" Schematic Diagrams covering 170 models Radio and Television Sets. Also analysis of TV Servicing with picture tube patterns. *This valuable book is a FREE GIFT to you*, for just asking to see the great new Coyne 7-book set, "Applied Practical Radio-Television"!

**AT LAST! MONEY-MAKING "KNOW-HOW" ON TRANSISTORS, COLOR TV AND SERVICING**

You get all the right answers quickly to today's TV-RADIO servicing problems in Coyne's great new 7-volume set. Right at your finger-tips is the TV-Radio knowledge that makes you worth more money! Over 5,000 practical facts and data are fully covered in easy-to-understand fashion in volumes 1 through 5. Every step is completely explained—from principles of radio and television to installing, servicing, trouble-shooting, and aligning including full facts on COLOR TV and TRANSISTORS. Hundreds of photos, illustrations, charts and diagrams help you understand quicker. Volume 6—NEW Coyne *Technical Dictionary* helps you quickly understand latest terms, symbols and abbreviations. For speedy on-the-job use, I'll also include famous 900 page Coyne TELEVISION SERVICING CYCLOPEDIA—covering today's television problems in easy-to-find alphabetical order. Use this complete 7-volume TV-RADIO LIBRARY FREE for 7 days.

**ACT NOW—SEND NO MONEY!**

Just mail the coupon for Coyne's 7-volume set on 7 days free trial. I'll include the book of 150 TV-RADIO Patterns & Diagrams. If you keep the set, pay \$2 in 7 days and \$2 per month until \$24.50 plus postage is paid. (Cash price, \$22.95) Or you can return the library at our expense in 7 days and owe nothing. *Either way, the book of TV-Radio Patterns is yours to keep FREE!* Take advantage of this offer AT ONCE!

**MAIL COUPON TODAY**

**FREE BOOK—FREE TRIAL COUPON!**

Mr. Ray Snyder, Manager, Educational Book Publishing Division  
COYNE ELECTRICAL SCHOOL  
500 S. Paulina St., Dept 37-T1, Chicago 12, Ill.

O.K., Mr. Snyder! I'll take advantage of your Get-Acquainted Offer! Send new 7-book set, "Applied Practical Radio-Television" for 7 days FREE TRIAL per your offer. Include TV-RADIO Patterns & Diagrams Book FREE!

Name.....  
Address.....  
City..... Age.....  
Where Employed..... Zone..... State.....  
 Check here if you want library sent C.O.D. you pay postman \$22.95 plus C.O.D. postage on delivery. 7-day Money Back Guarantee.

**COYNE ELECTRICAL SCHOOL**

500 So. Paulina St., Dept. 37-T1, Chicago 12, Ill.



UNI-DIRECTIONAL

"MONOPLEX"

MODEL 737A



SEMI-DIRECTIONAL

"SONODYNE"

MODEL 51

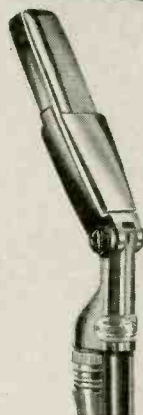

BI-DIRECTIONAL

"GRADIENT"

MODEL 315

You have your choice of three

SHURE

moderately priced general-purpose microphones

Where quality is essential, yet cost is a factor—you can rely on these SHURE Microphones

FOR PUBLIC ADDRESS • HOME RECORDING • COMMUNICATIONS • PAGING AND INTERCOM SYSTEMS

MODEL 737A "MONOPLEX": Uni-directional, moisture-proofed crystal microphone—reduces feedback by 67%! Can be used under adverse conditions of background noise where conventional microphones would be practically useless. "Humi-seal" Crystal for trouble-free operation even in humid climates. High impedance unit with excellent response to 10,000 cps. Output -54.0 db.

LIST PRICE \$46.00

MODEL 51 "SONODYNE": Semi-directional, dynamic microphone. Switch for low, medium, or high impedance makes it three microphones in one! Ideal for recording and "close-talking" applications. Frequency response is 60-10,000 cps, Output -52.5 db. Unusually rugged microphone; can be used in any climate, indoors or outdoors.

LIST PRICE \$49.50

MODEL 315 "GRADIENT": Bi-directional high fidelity microphone with multi-impedance switch. Picks up sound equally from front and rear; is "dead" at sides. Ideal for interview broadcasting or group recording. Frequency response 50-12,000 cps. Provides exceptional voice and music reproduction. Particularly useful in installations where feedback is a problem. Output -57 db.

LIST PRICE \$85.00

All three units have rugged, die-cast metal cases and are finished in a rich satin chrome.

SHURE BROTHERS, INC.

Microphones ~ Electronic Components

212 HARTREY AVENUE • EVANSTON, ILLINOIS

"In Electronics Since 1925"

CORRESPONDENCE

(Continued)

really too convincing to the customer.

We have found that in the customers' home the service technician can test the tubes faster than he can swap them because the tubes are warm when taken out of the circuit and plugged into the checker. Thus, instantaneous readings of shorts, mutual conductance and grid emission can be made.

Furthermore, it can hardly be called "excess effort" for any service technician to carry a 12-pound tube checker which enables him to do a better servicing job and make more money.

Service Manager HENRY GRONSKI  
Central Television Service, Inc.  
Chicago, Ill.

PARTS LIST

Dear Editor:

In reference to your notice on page 62 of the November, 1956, issue of RADIO-ELECTRONICS, entitled "For Your Convenience," I am 100% for the idea, only more so.

I have been a constant reader of your publication for over 10 years and it has always been a source of constant irritation to me that, in photographing your articles for construction, you don't photograph enough different views or angles. And don't be afraid to place adequate labels on the various parts in the pictures; some of us just don't have time to keep up with all the latest and newest components.

One more thing, when you give parts lists don't be afraid to specify the manufacturer, the manufacturers' part number, etc. In November, 1956, on page 40, in the parts list the author gives "T1—isolation transformer." Why not "UTC isolation transformer No.—?"

Berkeley, Calif. ROBERT C. MILLER

(Manufacturers' part numbers are given in parts lists where a particular component must be of some special size or shape, or when the component is made by very few manufacturers and may be hard to obtain. Giving part numbers for easily available components such as .01-μf capacitors would be unfair to other manufacturers who might make equally good components. —Editor.)

MORE STEREO EQUIPMENT

Dear Editor:

In reading your article "Stereo Tape Comes of Age," in the December, 1956, issue, I was disappointed to find that Bell Sound Systems stereo equipment was not included. I assume that this omission was due to your closing the editorial content of that issue prior to receiving our publicity release.

Bell possesses, comparatively speaking, a rather complete line of stereo equipment. The product group ranges from the stereo conversion kit to a complete stereo package system which comprises the BT-76 stereo playback tape recorder and the model 300D sound cabinet.

DONALD A. BRINKS  
Advertising & Sales Promotion  
Bell Sound Systems, Inc.  
Columbus, Ohio

END





For Electronic Knowledge and Skill Quickly, Easily...at Low Cost

# READ RIDER BOOKS

Latest in the Famous  
Rider Basic Series

**BASIC POWER ELECTRICITY**  
by Anthony J. Pansini

The important subject of electricity as used in the industrial and power utilities field is made crystal clear in this 'picture-text' course. The pictorial approach for the utmost in visualization is combined with clear, concise text to give a down-to-earth explanation of this subject that is rigorously correct technically.

Written by an expert in the training field, it is tailored to teach industrial electricity as it is actually used in the power electricity field. The examples which explain the text reflect industrial and power electricity numerics. Polyphase as well as single phase machinery and circuitry details receive elaborate treatment. Price to be announced.

**BASICS OF PHOTOTUBES & PHOTOCELLS**  
by David Mark

This book is devoted to the explanation of the principles and practices surrounding phototubes and photocells, with the utmost in visual presentation to make the subject most understandable. It is tantamount to a 'picture course' . . . yet it is authoritative and modern.

Soft Cover, 136 pp., 5 1/2 x 8 1/2", illus.  
#184.....Only \$2.90

**TRANSISTOR ENGINEERING REFERENCE HANDBOOK**

by H. E. Marrows

Covering transistor performance characteristics, operating specifications, manufacturing processes, applications, testing, sources etc. Related components—electrical characteristics, physical dimensions, sources, etc.

The most complete handbook for use in engineering, scientific research and manufacturing of transistor devices. Authoritative—informative—up-to-the-minute.

Cloth Bound, 288 pp., 9 x 12", illus.  
#193.....Only \$9.95

**PICTORIAL MICROWAVE DICTIONARY**

by Victor J. Young & Meredith W. Jones

This pictorial dictionary, written by two acknowledged experts in the microwave field, presents with *rigorous accuracy* the microwave language.

Derivation, explanation, definition, and illustration are combined in such fashion as to give the reader *complete* coverage of the microwave activity. Organization of the dictionary makes it easy to use . . . and very understandable.

Soft Cover, 5 1/2 x 8 1/2", illus.  
#188.....Only \$2.95

**INTRODUCTION TO PRINTED CIRCUITS**

by Robert L. Swiggert

Gives complete coverage to the various manufacturing processes, practical applications and the servicing techniques peculiar to printed circuits.

Soft Cover, 112 pages, 5 1/2 x 8 1/2", illus.  
#185.....Only \$2.70

**HOW TO INSTALL & SERVICE INTERCOMMUNICATION SYSTEMS**

by Jack Darr

The growth of the intercom as a modern tool of business presents an important service and installation opportunity. This book covers completely installation and maintenance of commercial intercommunication equipment. Basic amplifiers, special speakers, switching arrangements, a-c and a-c/d-c systems, wireless systems, cabling networks, all-call systems, paging systems, remote and master systems, one and 2-way intercom systems, installation for home and industrial use, outdoor wiring, and system requirements for particular applications are discussed. Complete servicing techniques and tools and equipment needed for troubleshooting are covered. Illustrations of test setups are included. Design and installation techniques also covered. Intercom terminology defined.

Soft Cover, 152 pp., 5 1/2 x 8 1/2", illus.  
#189.....Only \$3.00

**REPAIRING TELEVISION RECEIVERS**

by Cyrus Glickstein

The most modern completely practical book, written by an expert with long experience in television receiver repair. Devoted to troubleshooting and repair techniques which are modern, yet down-to-earth. Covers the use of simple as well as elaborate test equipment of all kinds. Profusely illustrated.

Soft Cover, 212 pp., 5 1/2 x 8 1/2", illus.  
#191.....Only \$4.40

**SERVICING TV AFC SYSTEMS**

by John Russell, Jr.

This book discusses the trouble, location, and repair of the major types of AFC circuits used today . . . as well as some of the less common AFC systems the technicians may encounter. Waveforms, components, common faults, and their diagnosis are presented in a manner that affords the reader a *thorough* understanding of AFC circuits. Supplemented by more than 75 illustrations.

Soft Cover, 128 pp., 5 1/2 x 8 1/2", illus.  
#192.....Only \$2.70

**TV TUBE LOCATION & TROUBLE GUIDE**

(RCA) by Rider Lab. Staff

This book shows the tube locations for all RCA TV receivers produced between 1947 and 1956. It lists the tube complement, key voltages, and common troubles correlated with the tubes that may be responsible for them. Complete chassis and model index.

Soft Cover, 56 pp., 5 1/2 x 8 1/2", illus.  
#194.....Only \$1.25

**PICTURE BOOK OF TV TROUBLES, Vol. 7 (Sound Circuits & L-V Power Supplies)**

by Rider Lab. Staff

Volume 7 of this famous and extremely popular series shows the effects of faults in the Sound and L-V Power Supply circuits by examples of incorrect waveforms at specific test points. The component at fault is identified. Soft Cover, 64 pp., 5 1/2 x 8 1/2", illus.

#168-7.....Only \$1.50

**BASIC SERIES** by

Van Valkenburgh, Nooger & Neville, Inc.

The fabulous picture-text books that teach faster and easier! The theory, principles, and practice of electricity, electronics, and synchros and servos are here presented in a manner that permits a rapid grasp of the fundamentals of these vitally important subjects. Over 2,000 specially prepared illustrations present, explain, and make every topic discussed picture-clear.

**Basic Electricity**

#169, soft cover, 5 vols., 624 pp., per set \$10.00  
#169II, cloth bound in single binding...\$11.50

**Basic Electronics**

#170, soft cover, 5 vols., 550 pp., per set \$10.00  
#170H, cloth bound in single binding...\$11.50

**Basic Synchros and Servomechanisms**

#180, soft cover, 2 vols., 270 pp., per set \$5.50  
#180H, cloth bound in single binding...\$6.95

**Hi-Fi Loudspeakers & Enclosures**

by Abraham D. Cohen,  
#176, MARCO cover, 360 pp.....\$4.60

#176H, cloth bound.....\$5.50

**How to Service Tape Recorders**

by C. A. Tuthill,  
#167, soft cover, 160 pp.....\$2.90

#167H, cloth bound.....\$4.40

**How to Troubleshoot a TV Receiver**

by J. Richard Johnson  
#152, soft cover, 128 pp.....\$1.80

**Basic Vacuum Tubes & Their Uses**

by Rider & Jacobowitz,  
#171, soft cover, 208 pp.....\$3.00

#171H, cloth bound.....\$4.50

**How to Use Meters John F. Rider;**

#144, soft cover, 144 pp.....\$2.40

**Fundamentals of Transistors**

by Leonard Krugman,  
#160, soft cover, 144 pp.....\$2.70

**Introduction to Color TV (2nd Edition)**

by Kaufman & Thomas,  
#156 soft cover, 160 pp.....\$2.70

**How to Select and Use Your Tape Recorder**

by David Mark,  
#179, soft cover, 148 pp.....\$2.95

**Obtaining & Interpreting Test Scope Traces**

by John F. Rider,  
#146, soft cover, 190 pp.....\$2.40

**Television — How it Works (2nd Edition)**

by J. Richard Johnson,  
#101, leather finish MARCO, 352 pp.....\$4.60

#101-II, cloth bound.....\$3.50

**PICTURE BOOK OF TV TROUBLES**

by Rider Lab. Staff

Vol. 1: Horizontal AFC-Oscillator Circuits  
#168, 80 pp.....Only \$1.35

Vol. 2: Vertical Sweep-Deflection Circuits  
#168-2, 96 pp.....Only \$1.80

Vol. 3: Video I-F & Video Amplifier Circuits  
#168-3, 96 pp.....Only \$1.80

Vol. 4: Automatic Gain Control Circuits  
#168-4, 96 pp.....Only \$1.80

Vol. 5: Horizontal Output & H-V Circuits  
#168-5, 108 pp.....Only \$1.80

Vol. 6: Horizontal & Vertical Sync Circuits  
#168-6, 120 pp.....Only \$1.80

AND...

ALL WHO WANT THE **BEST** IN TV SERVICE INFORMATION

RCA PHILCO ADMIRAL EMERSON SYLVANIA HOFFMAN  
ON GE CROSLEY MOTOROLA ZENITH WESTINGHOUSE PACKARD-BELL

(other manufacturers later on)

...ASK YOUR JOBBER ABOUT  
**RIDER'S NEW SDO**

("single diagram only")

ONLY **50¢** PER CHASSIS!

Buy these and many other RIDER BOOKS at your electronics parts jobber, book store or department store book department. Look for the Rider Bookseller. If your jobber, book store, or department store does not sell the Rider books you want—Order direct by checking book desired in this ad. Add state and city sales tax where applicable. Canadian prices approximately 5% higher.

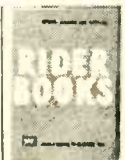

Write for FREE 1957 Spring Summer catalog

**JOHN F. RIDER PUBLISHER, INC.**

116 West 14th Street, New York 11, N. Y.

In Canada:  
Charles W. Pointon, Ltd.  
6 Alcina Ave., Toronto, Ontario  
In Canada, all prices approximately 5% higher.

# FULL **C** **O** **L** **O** **R** TV

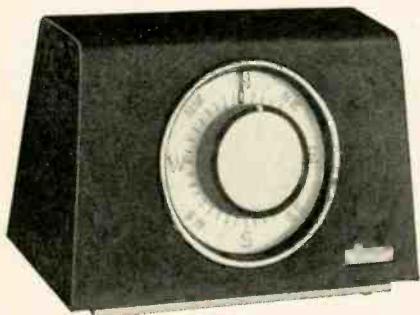

**MODEL U-98**—first and finest fully automatic rotator. Eye-appealing decorator colors—Ivory, Forest Green and Standard Mahogany Grain. Retail . . . . . **\$44.25**

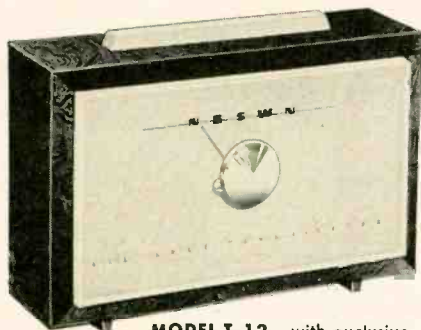

**MODEL T-12**—with exclusive Tenna-Teller Pointer—highly accurate. Striking, modern design. Forest Green and Ivory or Standard Mahogany. Retail . . . **\$34.25**  
Decorator Colors priced \$2.00 extra.

## demands reliable



**DON'T ASK VIEWERS TO PUT UP WITH A 'STAY-PUT' ANTENNA!**

- TV authorities admit the higher sensitivity of color.\*
- Viewers won't tolerate weak, washed out color!
- Maximum directivity with ALLIANCE TENNA-ROTOR is the best insurance for top antenna performance—for FULL COLOR!

**Wherever you find Color TV, it will pay you to recommend Alliance!**

● Every color TV buyer is a potential Tenna-Rotor sale . . . even in metropolitan areas. Because the "**fringe**" area for color is closer to the transmitter! Viewers who might tolerate black and white TV that's "so-so", will **not** put up with irritating, "ghosty" color. And independent interviews **at point of sale** show that color TV customers find it **easy** to say Yes to Alliance Tenna-Rotor!

*\*Many TV authorities agree that color is more sensitive than black and white. "Chromatic gradation" with color that's ghosty, is harder on the eyes than black and white. Many recommend properly installed outdoor antennas with rotators, to improve directivity of the antenna, to help overcome interference and reduce annoying effects caused by the higher sensitivity of color, and the normal characteristic of color to "drop out" quicker.*

### Meet the Constant Changes in Television!

Alliance Tenna-Rotor makes any good outside antenna more directional. New stations, channel changes, new lowers, more power, UHF-VHF . . . AND NOW COLOR! They all add up to Alliance Tenna-Rotor!

**THE ALLIANCE  
MANUFACTURING COMPANY, INC.**

*(Division of Consolidated Electronics Industries Corp.)*

**ALLIANCE, OHIO**

In Canada—ALLIANCE MOTORS, Schell Avenue, Toronto 10

**RCA** offers you the  
finest training  
at home in  
Radio-TV  
electronics,  
TV servicing,  
Color TV

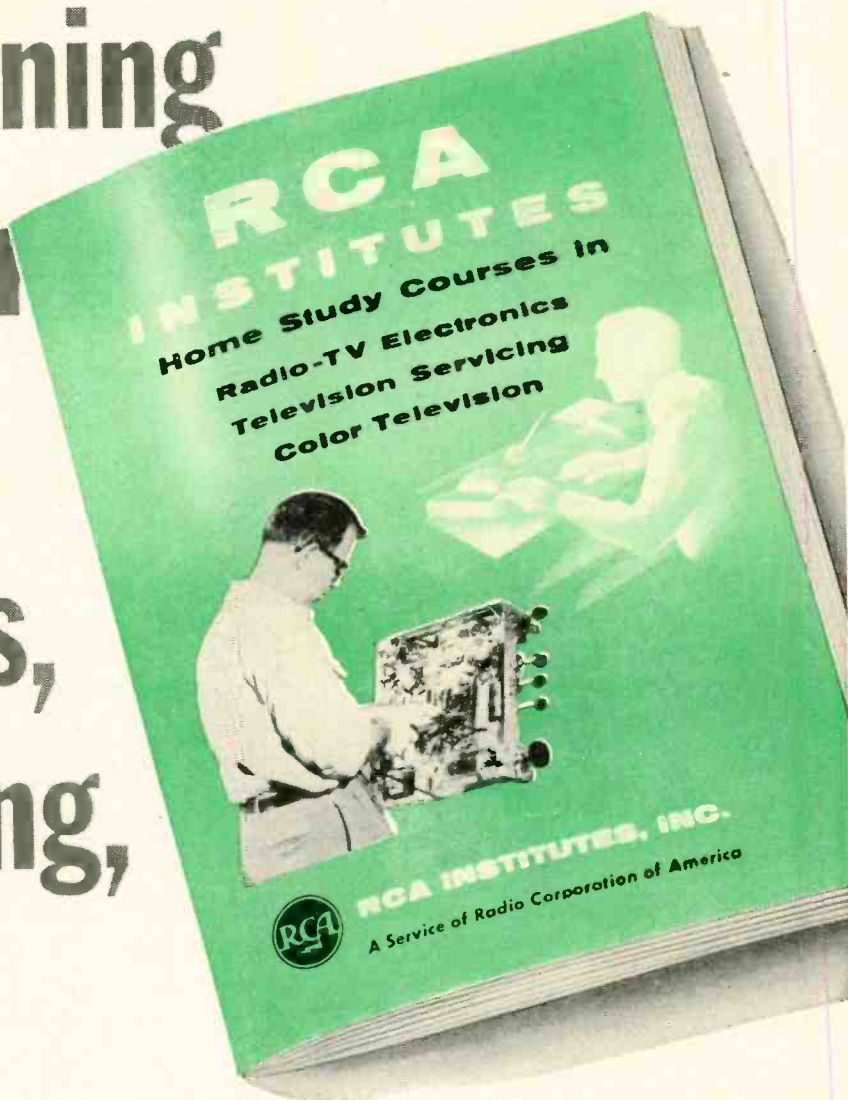

**SEND FOR THIS FREE  
BOOK NOW!**

The instruction you receive and equipment you get (and keep) will start you on your way. Pay-as-you-learn. You pay for only one study group at a time. This 52 page book contains complete information on Home Study Courses for the beginner and the advanced student.



**RCA INSTITUTES, INC.**

A SERVICE OF RADIO CORPORATION OF AMERICA

[www.americanradiohistory.com](http://www.americanradiohistory.com)



## WHAT HAS THIS SPEAKER SWIVEL MOUNT TO DO WITH . . .

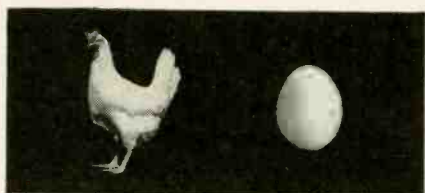

### Another great University first

As we've been saying . . . University "firsts" are worth having, worth working toward, worth waiting for. Not the *first* "Universal" joint to be incorporated into a bracket design, the new University omni-swivel bracket *is* the first that really works. It is also the only bracket that can fit directly on  $\frac{1}{2}$  inch pipe. Its *positive-lock* design, precision die-cast construction and versatility of application set new standards by which others will be judged.

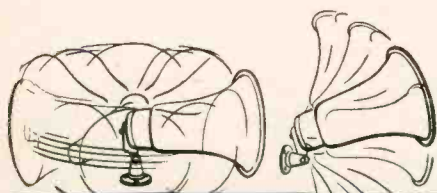

### Progress that makes waste

As we've been saying . . . *being* the first is not as important to University as being first with a new design of *proven* quality . . . even if it means discarding achievements that no longer meet *our own* high standards. The serrated, die-cast swivel bracket being replaced by the new omni-swivel, is still superior to any other on the market today . . . yet we willingly discard it for the sake of true progress, the most important commodity University has to offer.

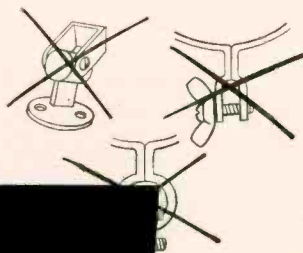

### Engineering that makes the difference

As we've been saying . . . the integrity and quality of good engineering is often where you can't see it, or touch it. Yet, these are what make the *difference* in brands . . . differences that spell success or failure of operation, really great value or a poor purchase. The drawing of the new University omni-swivel bracket unveils the ingenuity, meticulous detail and far-sighted design that are the ingredients of *every* University product.

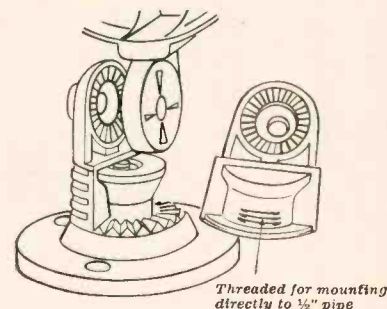

**NEW! 12-WATT Williamson-type HIGH FIDELITY INTEGRATED AMPLIFIER HF12**



with Preamplifier, Equalizer & Control Section  
**KIT \$34<sup>95</sup> WIRED \$57<sup>95</sup>**

Compact, beautifully packaged & styled. Provides complete "front-end" facilities and true high fidelity performance. Direct tape head & magnetic phono inputs with NARTB (tape) & RIAA (phono) feedback equalizations. 6-tube circuit, dual triode for variable turnover bass & treble feedback-type tone controls. Output Power: 12 w cont., 25 w pk. IM Dist. (60 & 6000 cps @ 4:1): 1.5% @ 12 w; 0.55% @ 6 w; 0.3% @ 4 w. Freq. Resp.: 1 w: ±0.5 db 12 cps - 50 kc; 12 w: ±0.5 db 25 cps - 20 kc. Harmonic Dist.: 20 cps: 2% @ 4.2 w; 1/2% @ 2.5 w; 30 cps: 2% @ 11 w; 1/2% @ 6.3 w; 40 cps: 1% @ 12 w; 1/2% @ 9.3 w; 2000 cps: 1/2% @ 12 w; 10 kc: 1% @ 10 w; 1/2% @ 6 w. Transient Resp: excellent square wave reproduction (4 usec rise-time); negligible ringing, rapid settling on 10 kc square wave. Inverse Feedback: 20 db. Stability Margin: 12 db. Damping Factor: above 8, 20 cps - 15 kc. Speaker Connections: 4, 8, 16 ohms. Tone Control Range: @ 10 kc, ±13 db; @ 50 cps, ±16 db. Tubes: 2-ECC83/12AX7, 1-ECC82/12AU7, 2-EL84, 1-EZ81. Size: HWD: 3 3/4" x 12" x 8 1/4". 13 lbs. COMING SOON

**NEW! 50-WATT Ultra-Linear HIGH FIDELITY POWER AMPLIFIER**

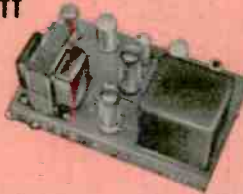

**HF50 KIT \$57<sup>95</sup> WIRED \$87<sup>95</sup>**

Like the HF60 shown below, the HF50 features virtually absolute stability, flawless transient response under either resistive or reactive (speaker) load, & no bounce or flutter under pulsed conditions. Extremely high quality output transformer with extensively interleaved windings, 3, 8, & 16 ohm speaker connections, grain-oriented steel, & fully potted in seamless steel case. Otherwise identical to HF60. Output Power: 50 w cont., 100 w pk. IM Distortion (60 & 6000 cps @ 4:1): below 1% at 50 w; 0.5% @ 45 w. Harmonic Dist.: below 0.5% between 20 cps & 20 kc within 1 db of rated power. Freq. Resp.: ±0.5 db 6 cps -60 kc; ±0.1 db-15 cps -30 kc at any level from 1 mw to rated power; no peaking or raggedness outside audio range. All other specs identical to HF60 below.

**NEW! 50-WATT Ultra-Linear HIGH-FIDELITY INTEGRATED POWER AMPLIFIER HF52**  
with Preamplifier, Equalizer & Control Section  
**KIT \$69<sup>95</sup> WIRED \$109<sup>95</sup>**

Combines a power amplifier section essentially identical to the HF50 power amplifier with a preamp-equalizer control section similar to HF20 below. Provision for use with electronic crossover network & additional amplifier(s). See HF50 for response & distortion specs; HF60 for square wave response, rise-time, inverse feedback, stability margin, damping factor, speaker connections; HF20 for preamplifier, equalizer & control section description. Hum & noise 60 db below rated output on magnetic phono input (8 mv input for rated output), & 75 db below rated output on high level inputs (0.6 v input for rated output).

**7 NEW BEST BUYS by**



**NEW**



**HIGH FIDELITY PREAMPLIFIER**

#HF61A KIT \$24<sup>95</sup>, WIRED \$37<sup>95</sup>

With Power Supply: #HF61 KIT \$29<sup>95</sup>, WIRED \$44<sup>95</sup>

Will not add distortion or detract from the wide-band or transient response of the finest power amplifiers at any control settings. High quality feedback circuitry throughout plus the most complete control & switching facilities. Heavy-gauge solid brushed brass panel, concentric controls, one-piece brown enamel steel cabinet for lasting attractive appearance. Feedback-type, sharp cut-off (12 db/octave) scratch & rumble filters. Low-distortion feedback equalization: 5 most common recording curves for LPs & 78s including RIAA. Low-distortion feedback tone controls: provide large boost or cut in bass or treble with mid-freqs & volume unaffected. Centralab printed-circuit Senior "Compenrol" loudness control with concentric level control. 4 hi-level switched inputs (tuner, tv, tape, aux.) & 3 low-level inputs (separate front panel low-level input selector permits concurrent use of changer & turntable). Proper pick-up loading & attenuation provided for all quality cartridges. Hum bal. control. DC superimposed on filament supply. 4 convenience outlets. Extremely flat wideband freq. resp.: ±1 db 8-100,000 cps; ±0.3 db 12-50,000 cps. Extremely sensitive. Negligible hum, noise, harmonic or IM distortion. Size: 4-7/8" x 12-5/16" x 4-7/8". 8 lbs.

See us at Booth 3407 IRE Show

See the "BEST BUYS" NOW IN STOCK at your nearest distributor. Fill out coupon on other side for FREE CATALOG.

Prices 5% higher on West Coast.

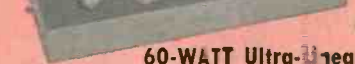

**60-WATT Ultra-Linear**

**HIGH FIDELITY POWER AMPLIFIER #HF60 with ACRO TO-330 OUTPUT TRANSFORMER KIT \$72<sup>95</sup> WIRED \$99<sup>95</sup>**

Superlative performance, obtained through finest components & circuitry. EF86 low-noise voltage amplifier direct-coupled to 6SN7GT-B cathode coupled phase inverter driving a pair of Ultra-Linear connected push-pull EL34 output tubes operated with fixed bias. Rated power output: 60 w (130 w peak). IM Distortion (60 & 6000 cps at 4:1): less than 1% at 60 w; less than 0.5% at 50 w. Harmonic Distortion: less than 0.5% at any freq. between 20 cps & 20 kc within 1 db of 60 w. Sinusoidal Freq. Resp.: at 1 w: ±0.5 db 5 cps - 100 kc; at 60 w: ±0.1 db 15 cps to 35 kc at any level from 1 mw to rated power; no peaking or raggedness outside audio range. Square Wave Resp. excellent from 20 cps to 25 kc, 3 usec rise-time. Sensitivity: 0.55 v for 60 w. Damping Factor: 17. Inverse Feedback: 21 db. Stability Margin: 16 db. Hum: 90 db below rated output. ACRO TO-330 Output Transformer (fully potted). Speaker Taps: 4, 8, 16 ohms. CZ34 extra-rugged rectifier (indirectly-heated cathode eliminates high starting voltage on electrolytics & delays B+ until amplifier tubes warm up). Input level control. Panel mount fuse holder. Both bias and DC - balance adjustments. Std octal socket provided for pre-amplifier power take-off. Size: 7" x 14" x 8". 30 lbs. Matching cover Model E-2 \$4.50.

**NEW**

**NEW COMPLETE with FACTORY-BUILT CABINET - 2-WAY HI-FI SPEAKER SYSTEM #HF51 \$39<sup>95</sup>**

Genuine 2-way book-shelf size speaker system. Jensen heavy duty 8" woofer (6.8 oz. magnet) & matching Jensen compression-driver exponential horn tweeter with level control. Smooth clean bass & crisp extended highs free of coloration or artificial brilliance. Factory-built tuned bass reflex birch hardwood cabinet (not a kit) constructed to high quality standards. Neutral acoustical grille cloth framed by a smooth-sanded solid birch molding. Freq. Resp. measured 2 ft. away on principal axis in anechoic chamber with 1 watt input - Woofer: ±4 db 80-1800 cps; Tweeter: ±2 db 2800-10,000 cps; Crossover Region: 1800-2800 cps, shift in level over this region depends on tweeter level control setting. Power-handling capacity: 25 watts. Size: 25" x 11" x 9". 19 lbs. Wiring Time: 15 min.

84 Withers Street, Brooklyn 11, N. Y.



**COMPLETE with Preamplifier, Equalizer & Control Section 20-WATT Ultra-Linear Williamson-Type HIGH FIDELITY AMPLIFIER #HF-20 KIT \$49<sup>95</sup> WIRED \$79<sup>95</sup>**

A low-cost, complete-facility amplifier of the highest quality that sets a new standard of performance at the price, kit or wired. Rated Power Output: 20 w (34 w peak). IM Distortion (60 & 6000 cps/4:1) at rated power: 1.3%. Max. Harmonic Distortion between 20 & 20,000 cps at 1 db under rated power: approx. 1%. Mid-band Harmonic Distortion at rated power: 0.3%. Power Response (20 w): ±0.5 db 20-20,000 cps; ±1.5 db 10-40,000 cps. Freq. Resp. (1/4 w): ±0.5 db 13-35,000 cps; ±1.5 db 7-50,000 cps. 5 feedback equalizations for LPs & 78s. Low-distortion feedback tone controls: large boosts or cuts in bass or treble with mid-freqs & volume unaffected. Loudness control & separate level set control on front panel. Low Z output to tape recorder. 4 hi-level switched inputs: tuner, tv, tape, aux.; 2 low-level inputs for proper loading with all cartridges. Hum bal. control. DC superimposed on filament supply. Extremely fine output transformer: interleaved windings, tight coupling, careful balancing, grain-oriented steel. 8 1/2" x 15" x 10". 24 lbs. Matching cover Model E-1, \$4.50.



Turn page for other EICO ad.

**the specs are  
the test that tells  
who's best!**

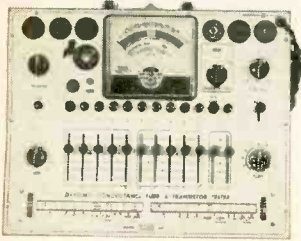

for **COLOR & Monochrome**  
TV servicing

**NEW! DYNAMIC  
CONDUCTANCE TUBE &  
TRANSISTOR TESTER #666**

**KIT \$69.95 WIRED \$109.95**

Unexcelled testing thoroughness & accuracy. Checks transistor collector current & Beta using internal dc power supply. Tests all receiving tubes including subminiatures (& Color & Monochrome tv pic tubes with accessory adapter). Composite indication of mutual conductance, plate conductance, & peak emission. Simultaneous sel. of any 1 of 4 combinations of 3 plate, 3 screen, & 3 ranges of control grid voltage. Grid voltage variable over 3 ranges with 5% accurate pot. New series-string voltages for 600, 450 & 300 ma types. 5 ranges meter sens. with 1% precision shunts & 5% accurate pot. 10 SIX-position lever switches for free-point connection of every tube pin or cap. 10 pushbuttons for rapid insert of any tube element in leakage circuit & speedy sel. of individual tube sections. Direct reading of inter-element leakage in ohms. New gear-driven rollchart. Steel case with cover & handle. Sensitive 200  $\mu$ a meter.



**NEW**

for **COLOR & Monochrome**  
TV servicing

**TV-FM SWEEP GENERATOR  
& MARKER #368**

**KIT \$69.95 WIRED \$119.95**

The **FINEST** service instrument of this type ever offered in either kit or wired form at ANY price! Outstanding ease & accuracy in FM & TV (including Color) alignment. Entirely electronic sweep circuit with accurately biased inductor: superb linearity on both sides of selected center freq. Newly-designed AGC circuit automatically adjusts osc. for max. output on each band with min. amplitude variations. Sweep gen. range 3-216 mc in 3 **OVERLAPPING FUND. BANDS**. Sweep width continuously variable from 0.3 mc lowest max. deviation to 0-30 mc highest max. deviation. Variable marker gen. range from 2-75 mc in 3 **FUND. BANDS** plus a calibrated harmonic band (60-225 mc). Variable marker calibrated with int. xtal marker gen. 4.5 mc xtal included. Ext. marker provision. Double pi line filter. Edge-lit hair-lines eliminate parallax.

Turn page for other EICO ad



**FREE 1957  
EICO CATALOG!**

Tells you how to **SAVE 50%** on  
your test equipment costs!

 <p><b>TUBE TESTER #625</b> KIT \$34.95 Wired \$49.95</p> <ul style="list-style-type: none"> <li>tests 600 mil series string type tubes</li> <li>illuminated roll-chart</li> </ul>	 <p><b>NEW COLOR &amp; Monochrome DC-5 MC LAB &amp; TV 5" OSCILLOSCOPE #460</b> KIT \$79.95 WIRED \$129.50</p>	 <p><b>5" PUSH-PULL OSCILLOSCOPE #425</b> KIT \$44.95 Wired \$79.95</p> <p><b>7" PUSH-PULL OSCILLOSCOPE #470</b> KIT \$79.95 Wired \$129.50</p>																					
 <p><b>VACUUM TUBE VOLTMETER #221</b> KIT \$25.95 Wired \$39.95</p> <p><b>DELUXE VTVM #214 (7 1/2" METER)</b> KIT \$34.95 Wired \$54.95</p>	 <p><b>RF SIGNAL GENERATOR #320</b> KIT \$19.95 Wired \$29.95</p> <p>150 kc-34 mc, calibrated harmonics to 102 mc. Pure or mod. RF, &amp; Colpitts osc. 400 cps sine outputs.</p>	 <p><b>NEW! REDI-TESTER #540</b> KIT \$12.95 Wired \$15.95</p> <p>Multi-range ac/dc voltmeter, ammeter, ohmmeter, wattmeter, leakage checker for home &amp; auto repairs.</p>																					
 <p><b>#944 FLYBACK TRANSFORMER &amp; YOKE TESTER</b> KIT \$23.95 Wired \$34.95</p> <ul style="list-style-type: none"> <li>fast check all flybacks &amp; yokes in or out of set.</li> <li>spots even 1 shorted turn!</li> </ul>	 <p><b>RF SIGNAL GENERATOR #324</b> KIT \$26.95 WIRED \$39.95</p> <p>150 kc-435 mc with ONE generator!</p>	 <p><b>DELUXE RF SIGNAL GENERATOR #315</b></p> <p>1% accuracy on all 7 ranges. Range 75 kc-150 mc. Volt reg.</p> <p>KIT \$39.95 Wired \$59.95</p>																					
 <p><b>6V &amp; 12V BATTERY ELIMINATOR &amp; CHARGER #1050</b></p> <p>Sep. volt-meter &amp; ammeter KIT \$29.95 Wired \$38.95</p>	 <p><b>DELUXE MULTI-SIGNAL TRACER #147</b></p> <p>Sep. hi-gain RF &amp; lo-gain audio inputs. Special noise locator. Calibrated wattmeter. KIT \$24.95 Wired \$39.95</p>	 <p><b>R-C BRIDGE &amp; R-C-L COMPARATOR #950B</b></p> <p>Reads 0.5 ohms -500 megs, 10 mmd-5000 mfd power factor. KIT \$19.95 Wired \$29.95</p>																					
 <p><b>PEAK-to-PEAK VTVM #232 &amp; UNI-PROBE (pat. pend.)</b> KIT \$29.95 WIRED \$49.95</p>	 <p><b>20,000 Ohms/Volt MULTIMETER #565</b> KIT \$24.95 Wired \$29.95</p>  <p><b>1000 Ohms/Volt MULTIMETER #536</b> KIT \$12.90 Wired \$14.90</p>	<p><b>VTVM PROBES</b></p> <table border="1"> <tr> <td>Peak-to-Peak</td> <td>KIT \$4.95</td> <td>Wired \$6.95</td> </tr> <tr> <td>RF</td> <td>\$3.75</td> <td>\$4.95</td> </tr> <tr> <td>High Voltage Probe-1</td> <td></td> <td>\$6.95</td> </tr> <tr> <td>High Voltage Probe-2</td> <td></td> <td>\$4.95</td> </tr> </table> <p><b>SCOPE PROBES</b></p> <table border="1"> <tr> <td>Demodulator</td> <td>\$3.75</td> <td>\$5.75</td> </tr> <tr> <td>Direct</td> <td>\$2.75</td> <td>\$3.95</td> </tr> <tr> <td>Low Capacity</td> <td>\$3.75</td> <td>\$5.75</td> </tr> </table>	Peak-to-Peak	KIT \$4.95	Wired \$6.95	RF	\$3.75	\$4.95	High Voltage Probe-1		\$6.95	High Voltage Probe-2		\$4.95	Demodulator	\$3.75	\$5.75	Direct	\$2.75	\$3.95	Low Capacity	\$3.75	\$5.75
Peak-to-Peak	KIT \$4.95	Wired \$6.95																					
RF	\$3.75	\$4.95																					
High Voltage Probe-1		\$6.95																					
High Voltage Probe-2		\$4.95																					
Demodulator	\$3.75	\$5.75																					
Direct	\$2.75	\$3.95																					
Low Capacity	\$3.75	\$5.75																					

For **FREE 1957 catalog, mail coupon NOW!**



84 Withers St. • Brooklyn 11, N. Y.

Prices 5% higher on West coast and subject to change without notice.

EICO, 84 Withers Street  
Brooklyn 11, New York C-3

Send **FREE 1957 Catalog** and name of neighborhood EICO jobber.

Name.....

Home Address.....

City.....Zone.....State.....

Occupation.....

Over a Decade of Know-How & Value Leadership in Kits & Instruments — Over 1 Million Sold to Date!

## THE ELUSIVE ELECTRON

... *Electronics Is Built on a Little Known Entity* ...

**T**HE term *electron* was originated by Dr. G. Johnstone Stoney in 1891, in a paper to the *Scientific Transactions of the Royal Dublin Society*. Lord Kelvin at about the same time used the word *electrion*, but it was never adopted extensively.

In the early days of the electron, the term was understood to mean a negative electrical charge. We then had the electron or corpuscular theory. Indeed, the very concept of the electron has kept changing constantly since 1891 and in all probability will keep changing in the future, as we shall see. Thus, the original electron—the corpuscle—carried a certain definite and constant charge of negative electricity. In those days this corpuscle was supposed to be an exceedingly minute speck of negatively electrified *matter*.

An atom was thought to consist of a definite number of these negative corpuscles associated with a positively electrified nucleus. Thus the simplest form, the hydrogen atom, was believed to have one electron rotating rapidly around a central positive nucleus.

Physicists and mathematicians soon felt that they had a fair insight into the puzzling electron. Various physical concepts emerged from their labors. While they did not know the *shape* of the negative corpuscle, Larmor assumed it to be a mathematical point (having position but no dimension) yet possessing a finite electrical charge, which creates a certain stress in the surrounding ether. Others believed that “the corpuscle has some kind of spatial extension though it may not have definite boundaries.” As late as 1917, Nicholson, before the Physical Society of London, still suggested that “the corpuscle is a strain in the ether.” Other theories assumed the corpuscle to be spherical, “at all events when it is at rest.” The confusion as to the nature of the electron, one notes, was vast.

Einstein brought new light into the situation when he postulated that the geometrical properties of space render the hypothesis of the ether unnecessary. Scientists soon abandoned not only the old ether theory but the corpuscle as well. But the electron emerged unscathed, albeit imbued with new properties.

Our modern knowledge of the electron is chiefly due to the brilliant work of the Nobel Prize winner, Prof. Robert Andrews Millikan of the California Institute of Technology. Millikan started his famous oil-drop experimental work in 1909 and continued it for many years. He finally constructed a very ingenious apparatus to prove that all electrical charges are built up from a definite number of units—electrons—all *exactly alike*. He succeeded in *trapping single electrons and measuring their value directly*.

Thus, for instance, textbooks tell us that it takes the combined mass of 1,837 electrons to equal the mass of one hydrogen atom. Further, it would take about 100,000 electrons placed in a row and contacting each other to reach across the width of one atom. If this doesn't mean much, we can put it another way: 10,000,000,000,000 electrons placed in a straight line and touching another would just measure about 1½ inches long!

This perhaps gives us an insight into the extreme minuteness of the elusive electron. But scientists are beginning to question the “mass” and the “size” of the electron in view of new research.

No sooner have we learned certain properties of the electron than other and more perplexing ones are discovered. Thus since 1913 we have used Nobel Prize winner Prof. Niels Bohr's model of the revolving electron in an orbit around a positive nucleus. Then, in 1924, the French scientist Prince Louis-Victor de Broglie postulated the theory that the electron should have a *dual nature* akin to light—it should be *both* wave and matter (particles). It was not long before experimental proof was forthcoming through a setup of a barrier with slits and a fluorescent screen. It proved indeed the dual nature of the electron, which now no longer can be thought as a “mathematical point” or a “sphere.” It also seems to be part and parcel of an undulating wave. Only one thing is certain: we will not for a long time to come know the *true* nature of the electron and we may as well be prepared for many new surprises in the future.

At this point we should listen carefully to the sage words of Nobel Prize winner Millikan:

“What then is electricity? Of its ultimate nature we know very little, precisely as we know very little of the ultimate nature of matter or of mind or, indeed, of the ultimate nature of anything. Science does not deal with ultimates, but rather with relations between observed or observable phenomena. Our ignorance of ultimates, however, does not prevent us from setting up a sharp, quantitative definition of an electrical charge, which anyone can understand. . .

“... All electrical currents are caused by the slow travel of a well-nigh infinite number of these electrons along the wire which carries the current. All light or other short-wavelength radiations are caused by changes in positions of electrons within atoms. All atoms are built up out of definite numbers of positive and negative electrons. All chemical forces are due to the attractions of positive for negative electrons. All elastic forces are due to the attractions and repulsions of electrons. In a word, **MATTER ITSELF IS ELECTRIC IN ORIGIN.**”—H. G.

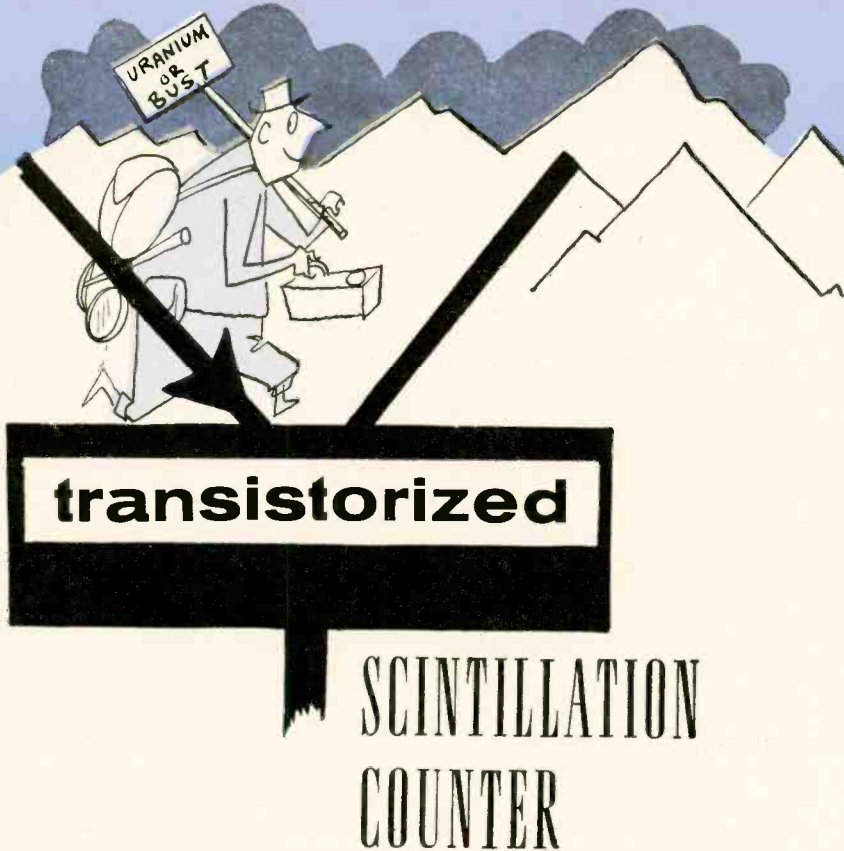

By LOUIS A. KUEKER

Join the search for uranium ore with this really portable unit. Low current drain and long battery life make it dependable

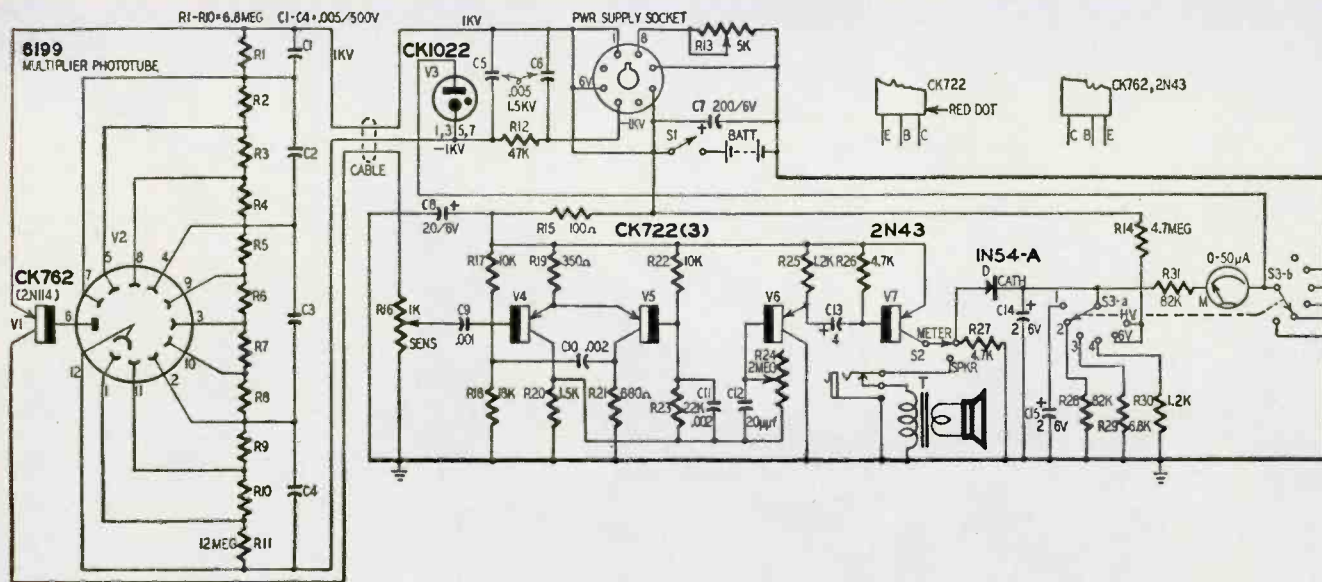

- R1—10—6.8 megohms
- R11—12 megohms
- R12—47,000 ohms
- R13—5,000-ohm pot
- R14—4.7 megohms
- R15—100 ohms
- R16—1,000-ohm pot
- R17—22—10,000 ohms
- R18—18,000 ohms
- R19—350 ohms
- R20—1,500 ohms
- R21—680 ohms
- R23—22,000 ohms
- R24—2-megohm pot
- R25—30—1,200 ohms
- R26—4,700 ohms
- R27—4,700 ohms
- R28, 31—82,000 ohms
- R29—6,800 ohms

- All resistors 1/2 watt
- C1—4—.005  $\mu$ f
  - C5, 6—.005  $\mu$ f, 1,500 volts
  - C7—200  $\mu$ f, 6 volts, electrolytic
  - C8—20  $\mu$ f, 6 volts, electrolytic
  - C9—.001  $\mu$ f
  - C10, 11—.002  $\mu$ f
  - C12—20  $\mu$ f, ceramic
  - C13—4  $\mu$ f, 6 volts, electrolytic
  - C14—2  $\mu$ f, 6 volts, electrolytic (see text)
  - C15—2  $\mu$ f, 6 volts, electrolytic
- All capacitors 600 volts unless noted
- T—output transformer, primary impedance 200 ohms, secondary 3.2 ohms (Argonne AR-140 or equivalent)
  - V1—CK762 (2N114)
  - V2—6199 photomultiplier
  - V3—CK1022 voltage regulator
  - V4, 5, 6—CK722
  - V7—2N43

- Sodium iodide crystal (see text). From National Radiac, Inc., 10 Crawford St., Newark, N. J.
- M—50- $\mu$ a meter
- S1—spst switch
- S2—spdt switch
- S3—2-pole 6-position wafer switch
- PWR SUPPLY—high-voltage power supply, approximately 1,180 volts at 23  $\mu$ a, Universal Atomics Corp., 50 Bond St., Westbury, N. Y.
- J—phone jack, shorting
- SPKR—3.2-ohm loudspeaker
- BATT—6-volt battery (Burgess F4P1 or equivalent)
- Battery connector
- Power supply plug and receptacle
- Coaxial cable, 6-foot length, RG58/U or RG59/U
- D—IN54-A germanium diode
- C14+—male and female coaxial cable connectors
- Probe container (see text)
- Cabinet (see text)
- Circuit board

Fig. 1—The transistorized scintillation counter. The high-voltage power supply is not shown.



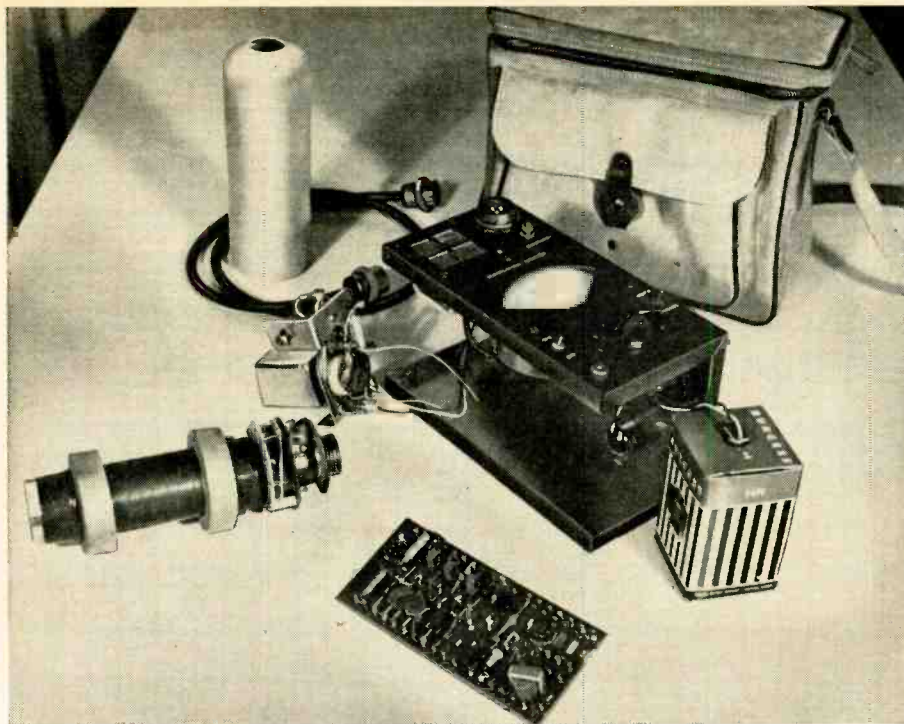

The various components that make up the scintillation counter.

THE increasing interest in uranium ores and prospecting, especially by weekend and vacation amateurs, has caused a boom for manufacturers of Geiger and scintillation counters. The demand for scintillator and Geiger-counter circuits by those interested in building their own instruments has increased correspondingly. Although scintillation counters are considerably more expensive than Geiger units, their greater sensitivity compensates for the added cost. Since RADIO-ELECTRONICS and other publications have described the principle of operation, this article confines itself to construction details of a transistorized scintillation counter.

This counter was developed and built primarily for portability and dependability. The resulting circuit, Fig. 1, not only satisfies those specifications to a high degree but also has a number of advantageous features:

1. Long-life transistor circuitry. The photomultiplier and voltage-regulator tubes are the exceptions and they draw no filament current.
2. Extremely low current drain, resulting in long battery life.
3. Standard 6-volt batteries. Complete replacement cost is only \$1.15 compared to between \$8 and \$15 for most commercial models.
4. Light weight. Author's unit in a larger-than-necessary cabinet weighs less than 8 pounds, including the leather carrying case.
5. Self-contained voltage checks, ideal for field maintenance and adjustment.
6. Simplicity of construction and operation. Only two adjustments are necessary and these are stable for long periods of time.

As a means of radiation detection, scintillation counters generally utilize a material which emits a small pulse of light upon penetration by a gamma ray. At the present time the most practical and widely used material is a thallium-activated sodium iodide crystal. Since a sodium iodide crystal, if unprotected, absorbs water rapidly from the air and becomes useless after a short time, only a hermetically sealed unit should be used. I purchased a 1½ by 1-inch National Radiac crystal for \$100. It makes an excellent companion unit for the RCA 6199 photomultiplier tube. Other crystal sizes may be used—a 1 by 1-inch unit costs approximately \$60. However, the sensitivity of the counter depends on the size of the crystal and this should be borne in mind when purchasing one. For airborne use a crystal size of 1 by 2 inches or larger should be employed.

Crystals are usually mounted in a thin aluminum case with one side an ultra-violet-transmitting glass window. For best results this transparent window should optically match the glass surface of the photomultiplier tube. To do this a clear silicone liquid is placed between the two surfaces before mounting. The supplier of the crystal will probably furnish a small amount of this silicone fluid if requested when ordering the crystal.

Light pulses coming from the sodium iodide crystal, as a result of gamma-ray penetration of the crystal, are converted into electrical pulses and amplified approximately 1,000,000 times by the 10-stage photomultiplier tube. The output of negative pulses is fed into common-emitter transistor (p-n-p) amplifier stage V1 which amplifies and inverts the pulses and feeds them to the

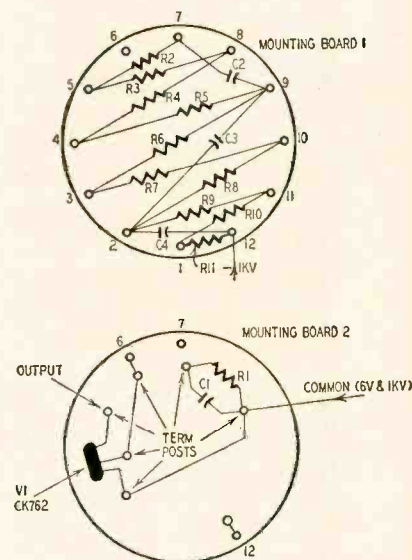
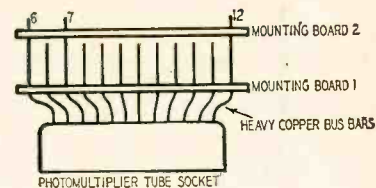

Fig. 2—Wiring of the mounting boards holding voltage divider and transistor amplifier for photomultiplier tube.

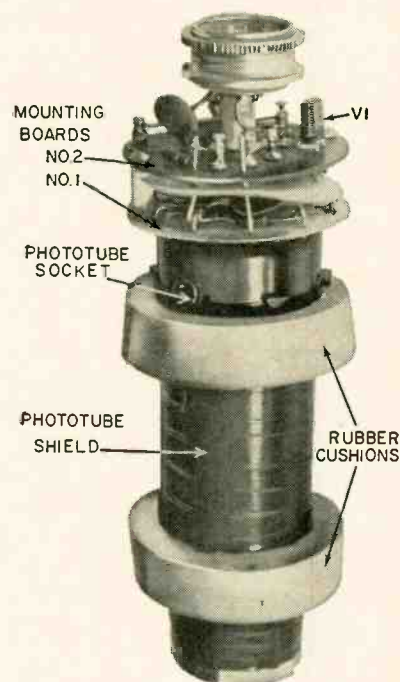
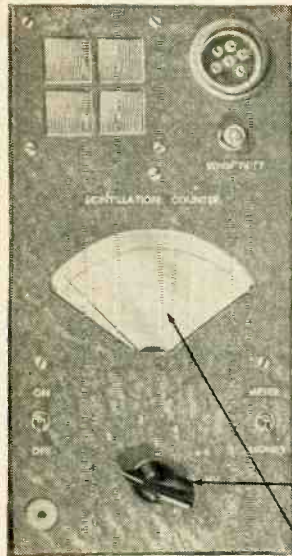

Fig. 3—Interior of the probe. Mounting boards are wired as in Fig. 2.

normally on side of a one-shot multivibrator. Because of the high-frequency characteristics of these pulses (rise time approximately 0.25 microsecond) a high-frequency transistor, such as a CK762, is used for V1.

Since the output of the photomulti-



Front-panel view of the scintillation counter.

plier tube consists of pulses of varying amplitudes, the one-shot multivibrator V4-V5 converts these pulses into pulses of equal amplitude and duration. Now all that needs to be done is to rectify the output of the multivibrator and measure the average current resulting from the pulses and we have an indication of the intensity of gamma radiation.

The common-emitter transistor stage V7 following the one-shot multivibrator and buffer stage V4 has the characteristic of drawing practically a constant current for a given base current over a wide collector-voltage range above a minimum voltage of approximately 1.5. Since the current pulse input from the

buffer stage is always the same, capacitor C14 is given an equal charge through diode D for each pulse until the frequency of the pulses is sufficient to charge the capacitor to about 4.6 volts or higher. If kept below this value by shunt resistors, the resulting average current will be a linear function of the pulse frequency.

The 2N43 transistor used for V7 is a power unit. In the circuit shown this transistor charges capacitor C14 with pulses around 15  $\mu$ sec long and 35-40-ma peak current. By incorporating switch S3, a small output transformer and a 2½- or 3-inch speaker, we have the added feature of aural as well as visual indication. Adding a shorting type phone plug provides headphone operation as well, if desired.

Construction details

The probe is extremely important and great care should be taken in its assembly. The sodium iodide crystal, in its container, is mounted directly against the flat face of the photomultiplier tube with a small amount of the silicone fluid between the two faces. Mounting can be done simply with tape or a special home-made clamp may be used. The tube should be completely covered with tape down to its base to make the unit light-tight.

A photomultiplier tube is affected by fields such as that of the Earth, so some type of magnetic shielding is necessary. I used thin flexible steel sheeting and wrapped the tube with a number of layers, but such material is not ordinarily available. A 20-gauge steel tube of sufficient diameter to house the photomultiplier tube and just long enough to reach from the base to the top of the tube will be suitable.

The voltage-dividing network for the photomultiplier tube and the first transistor stage were all mounted on the tube socket and a terminal board attached to the socket. See Figs. 2 and 3.

The whole probe assembly, plus a connector, were mounted in a home-made Fiberglas container but any number of suitable containers may be used. However, dense materials should be avoided on the crystal end of the probe as the sensitivity of the unit will suffer.

Use sponge-rubber cushioning to hold the photomultiplier tube and crystal in place. The dimensions of my probe container are 2¾ inches in diameter by 8 inches long.

Since the load impedance of V1 is low (1,000 ohms), it is not necessary to use a shielded cable between the probe and the counter. The only requirements that the cable, jacks and plugs must meet are to withstand at least 1,500 volts and have very high resistance between pins and leads.

When connecting transistors into the circuit, remember that, although transistors are rugged and will give long service when used within their limits, they cannot stand heat or improper voltages. If soldered directly, the leads should be as long as possible and the

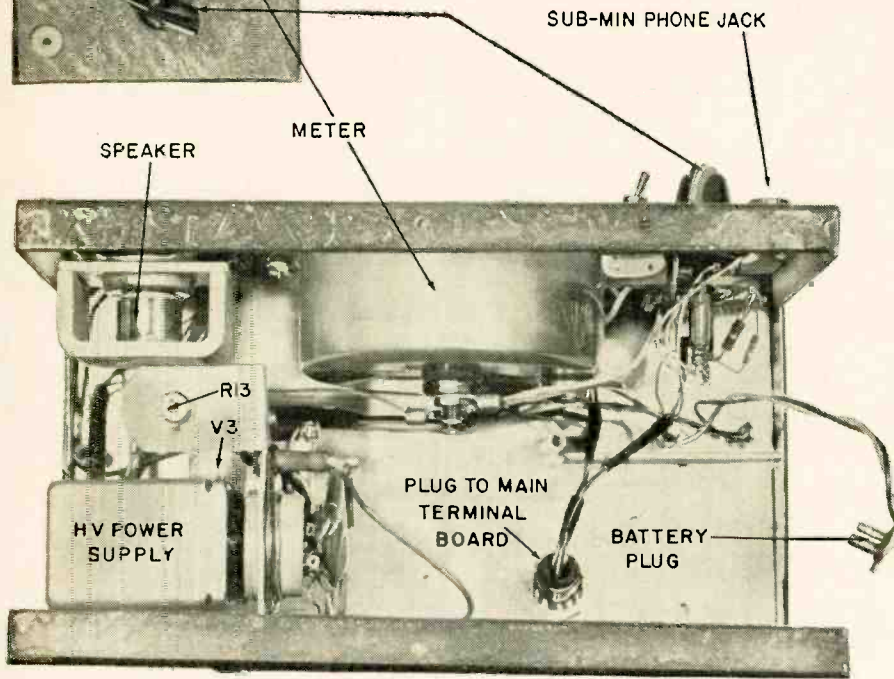

Underchassis view—high-voltage power supply is in lower left corner.

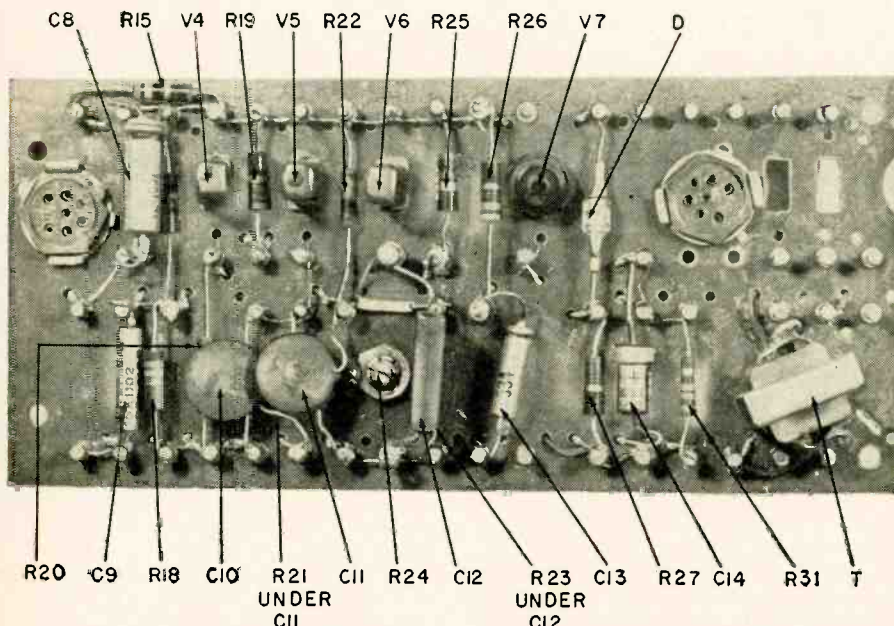

Fig. 4—Mounting board for counter and amplifier circuits.

soldering should be done quickly while holding the lead between the connection and the transistor with a pair of pliers to help dissipate the heat. It is preferable to use small in-line subminiature sockets to eliminate this danger.

The one-shot multivibrator, buffer and power amplifier are mounted on a terminal board (Fig. 4) mounted in the case and connected to the metering circuit through a short cable and connector.

The meter circuit is extremely simple and requires no zero control. It does, however, require a 50- $\mu$ a meter to give a satisfactory deflection when using the most sensitive scale. Due to the small quiescent current of V5, the meter will read slightly above zero with no signal input. Because of the circuit, the meter will never have more than approximately a 25% overload on any scale so there is no danger of accidentally burning it out.

The size of capacitor C14 is not critical and may be any value from about 1 to 5  $\mu$ f. The larger the value, the longer the time constant and the smoother the meter indications will be although the response will be slower. A value of 2  $\mu$ f is recommended as a good compromise. C15 was added in parallel with C14 for the first scale position of the meter switch. With the values of resistance and capacitances given, the meter will have approximate scales of 200, 500, 2,500 and 10,000 pulses per second.

If a pulse generator is available and the multivibrator is triggered by pulses of known frequencies, resistors R28, R29 and R30 may be changed to give any scales desired. Since this circuit is a constant-current circuit, the value of C14 has no effect on the average meter reading for any constant input frequency unless the capacitor is too small.

### Power supply

The recent appearance of commercially available high-voltage transistor power supplies, as well as articles on building your own, greatly simplifies construction. The Universal Atomics Corp. model 1150/6/30, will give an output of 30  $\mu$ a at 1,150 volts. This output is adjustable over a reasonable range of voltage and current by R13. Incidentally, accidental shorts across the 1,000-volt supply will have no harmful effects! If you want to build your own supply, you'll find details on page 58 of the Feb., 1957, issue.

The manner in which the high-voltage output, the 6-volt supply and ground are arranged may be puzzling. The plus 1,000-volt line is tied to the 6-volt line and the minus 6-volt line is grounded. Actually, it makes very little difference which side of the 6-volt supply the 1,000-volt line is tied to as far as operation is concerned. However, by hooking them together, only three wires are needed for connection to the probe. By grounding the 6-volt line, an ordinary two-contact phone jack with a

shorting type switch may be used for headphone operation instead of resorting to a three-contact phone jack and plug or insulating the phone jack from the chassis.

The total current drain from the single 6-volt battery (under average operating conditions) is 25 ma, considerably less than required for a flashlight bulb! For miniaturization, five mercury batteries, such as the Mallory TR14OR, connected in series will give about 60 hours of continuous operation and much longer life under intermittent operation. A larger battery such as the Burgess F4P1 or equivalent, at a cost of \$1.15, should give two or three weeks of normal field use.

The cabinet used is 4½ x 5 x 9 inches. This size was required to use a 4½-inch meter which I had on hand. Also, this size very conveniently fits into a camera gadget bag with room for the probe and cable.

### Adjustments

After assembly, first adjust the power supply. Vary R13 until approximately 15 to 20  $\mu$ a flows through the voltage-regulator tube V3 or a total current of approximately 30  $\mu$ a through both V3 and the voltage-dividing network of the photomultiplier tube. By using the 50- $\mu$ a meter with the switch in the high-voltage position, the current through V3 can be adjusted in the field as the battery voltage drops with use.

The sensitivity control R16 is the

only other adjustment. This can be set approximately by switching to position 1 of the meter switch and adjusting for a reading of about one-fifth full scale as a normal background count. Be sure that radioactive materials or samples are far enough away from the probe not to affect the reading.

If radioactive materials or samples are available, the sensitivity control can be set by adjusting for the best signal-to-noise or sample-to-background ratio of meter readings. To do this, adjust R16 so that the meter reads about one-fifth full scale on background count. Now place the radioactive sample next to the probe and note the reading. Repeat this procedure with different positions of the sensitivity control and compute the sample-to-background ratio for each setting. The position of the control that gives the best ratio is the position desired. Once properly set, this control should require very little adjustment during use. An occasional field check of the operation of the scintillation counter may be had by carrying a radioactive sample along for a test. A sample can be obtained from:

Ken Research, Inc., 831 5 Ave., River Edge, N. J. Calibrated radium standard kit. Less than \$5.

Tracerlab, Inc., 130 High St., Boston, Mass. Radium button No. R-20, \$3.60.

E. Earle Fletcher, 3209 Madera Drive, N. E., Albuquerque, N. M. Uranium rock samples, 25 cents each.

New Brunswick Laboratory, U. S. Atomic Energy Commission, P. O. Box 150, New Brunswick, N. J. Calibrated samples, analyzed and marked with uranium percentage. Write for particulars. END

## COVER FEATURE

### ROTARY TRANSISTOR HEATER

For purposes of comparison, standardization, life testing, etc., the important transistor characteristics of cur-

rent gain, noise and cutoff current must be measured at some convenient reference temperature. The multicavity heater shown in the cover illustration is a cylindrical, rotary design used extensively in the Semiconductor Division of Raytheon Manufacturing Co. It consists of a central stud of aluminum, 2 inches in diameter and 4 inches high with holes to accommodate the thermoswitch and heaters, and an outer cylinder of the same height with a central hole machined to fit the stud with a very small clearance. The only connection to the cavity cylinder is thermal and no stops, pigtailed or slip rings are required. The cavities slant downward approximately 10° to develop a restraining force against the weight of the test adapter and cord and are machined with milling cutters to fit various transistor cases. With proper choice of heater wattage, the reference temperature may be maintained to approximately  $\pm 0.2^\circ$  C over a range of 0–200° C. Values below room temperature require a heat bleeder consisting of an aluminum plate leading into a box of dry ice.



# L'electrostyl to revolutionize stenography?

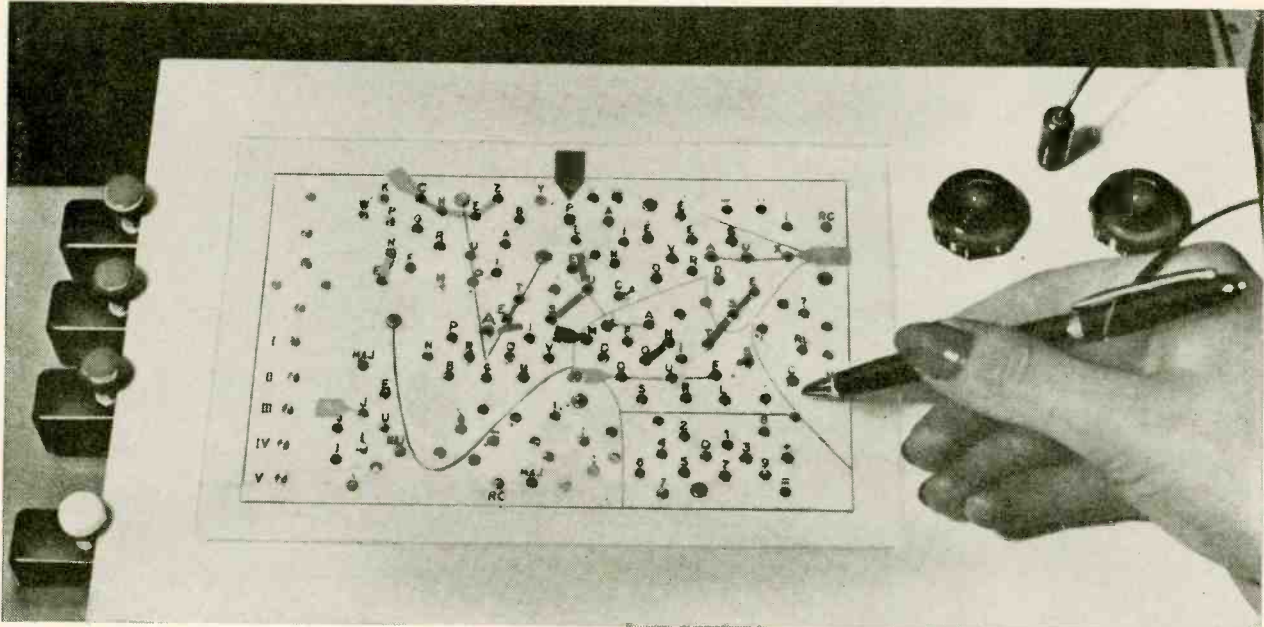

The Electrostyl "keyboard." Common letters are repeated as often as expedient.

By A. V. J. MARTIN \*

**T**HE necessity for improved efficiency in business offices has led to the use of dictating machines, eliminating the stenographer. All the secretary has to do is listen to the dictated record, usually sentence by sentence, and type the text. This part of the job has been somewhat improved by the use of so-called noiseless machines and by the electric typewriter. However, much progress remains to be done in that direction, and a new machine which combines stenography with instantaneous and automatic typewriting provides an interesting and unique solution to the problem.

The Electrostyl, a recent French invention by A. Ducrocq, is an electronically controlled typewriting machine. Formerly editor-in-chief *Television* (Paris, France).

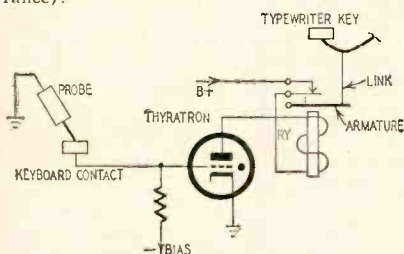

How the present Electrostyl operates

chine in which the conventional keyboard has been replaced by a flat panel. The operator does not use keys, but a single conducting probe drawn, pencil-fashion, from point to point on the panel. Each of a number of positions on this panel corresponds to a letter or a sign, and the letters have been disposed in such a way that the more common syllables or words can be made with very simple movements of the pencil probe. The most frequently used letters have been assigned several positions. Several improvements are added to this basic scheme, such as a memory to store frequent complete sentences, available at one touch only.

The Electrostyl can be divided in three parts: the keyboard and its probe, the electronic equipment and the electric typewriter.

There is no doubt that, in the future, a special typewriter will be devised to utilize fully the possibilities of the Electrostyl. For the time being, an IBM electric has been put to good use. The entire machine is used in the usual way except for its keyboard, which is actually hidden under a metallic cover. What, then, actuates the keys? This is the role of the electronic system. Each key carries a steel wire, securely anchored at the other end to the moving

armature of a relay. For the present experimental models, such an arrangement is quite practical.

## The electronic equipment

The electronic equipment is housed in the small metallic desk supporting the typewriter. When the operator, with her pencil probe, touches even lightly and for a short time a contact on the letter board, the thyatron corresponding to this particular contact fires and energizes a relay which pulls down the correct key of the typewriter. The accompanying diagram shows a possible way of wiring the circuit. The thyatron is normally cut off by the bias applied to its grid; when the probe touches the contact, the grid is shorted to ground and the thyatron fires. Its plate current energizes the relay, whose moving armature pulls down the typewriter key. Simultaneously, the relay actuates a contact to cut off the thyatron plate voltage and reset the circuit. Needless to say, this explanatory diagram is much simpler than the circuit actually used in the Electrostyl.

The electronic part is not an unduly complicated piece of equipment. It consists mainly of 57 tubes, 45 coils and relays, 10 special relays, and assorted

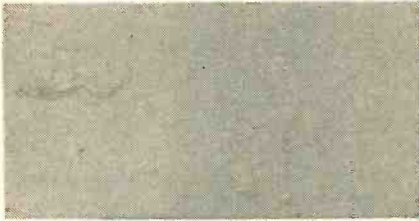

This French "stenodactylographe" combines stenography and typewriting in one operation.

Banks of relays that pull the keys down are seen at the left in the photo.

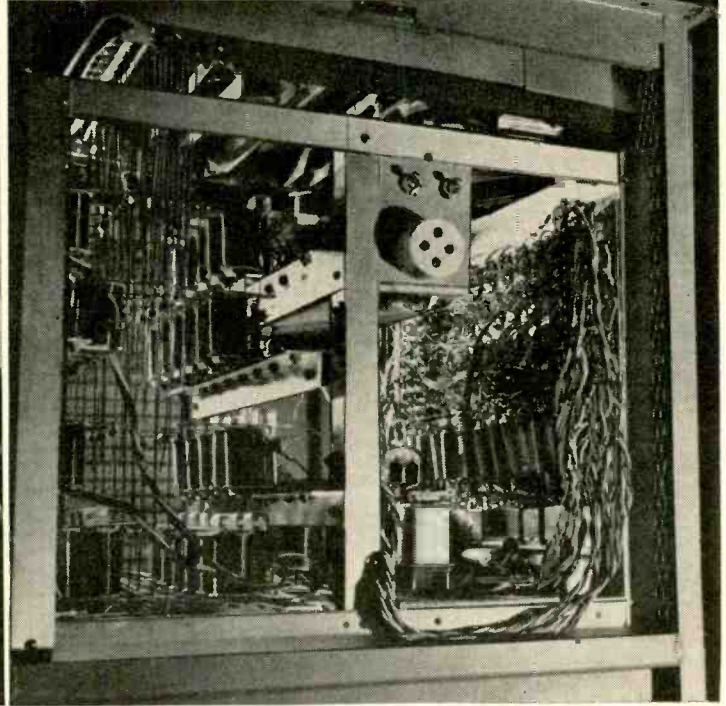
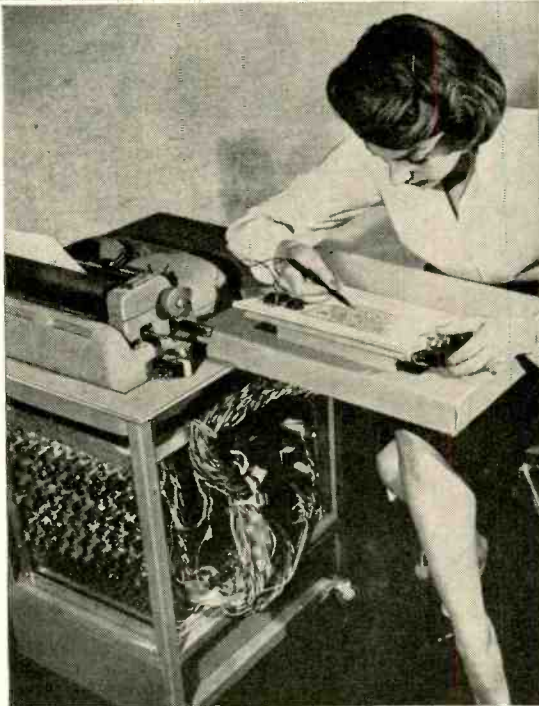

other components. The wiring, however, uses 50 miles of wire.

### The keyboard

The keyboard departs radically from the conventional system. It consists of a flat insulating sheet into which are embedded over a hundred metallic contacts. The probe itself looks exactly like a ballpoint pen.

The main work was to design the board so that the distribution of letters led to the utmost speed and efficiency. This was accomplished with the help of a specialist in deciphering, who conducted an exhaustive statistical analysis of the language, French in this case. The most frequent letters, such as E, S, A, R, are repeated and placed at various strategic points. Other letters have been so disposed as to provide very simple "stenographic" moves for frequent groups of letters, such as *et, de, en*, etc., and finals, such as *tion, elle, ette*.

New boards will, of course, have to be designed for other languages. The Electrostyl, however, will be universal, since any board can be used and can be plugged in through a multiplug connector.

Two special contacts are used to shift to capital letters. One is a "one-

letter" contact, shifting to capital only for the next letter. The other is a "permanent capital" useful for a series of capital letters. These two contacts correspond more or less to the capital shift and the shift lock of the typewriter. An intricate system of time delays and interlocking relays is necessary for its satisfactory working.

For numbers or signs corresponding to a shift to capital, no special additional contact is necessary, the shift being automatic.

A set of pushbuttons puts the usual controls of the IBM electric machine under the hand of the operator.

An electronic memory is an integral part of the Electrostyl: it may store up to 16 sentences of 50 letters or signs each, and could be enlarged if necessary. Any of the stored sentences—for example the beginnings or ends of letters—is available at a single touch of a contact. (An obvious extension of the storage facility would be to write identical circulars, each one being really an original.) Another possibility is to store sentences "written" on the keyboard until typing is ordered, thus allowing corrections or modifications before typing. The memory unit is simply made of 16 50-position, telephone step relays.

Of course, since electric circuits play the role of an intermediary between the keyboard and the typewriter, the two can be placed any distance apart. This opens up completely new prospects. An immediate idea is to have the typewriter in a separate room and do away with the noise. Automatic systems can feed the paper and collect it once typed.

Numerous other features can be added to the basic machine just described. Undoubtedly, use will bring important improvements.

### The future

Besides the immediate typing of the dictated letter, the Electrostyl offers several important advantages. It is very easy to memorize the moves corresponding to syllables, and the special stenography can be learned in a short time by the average operator. It is much less tiring to shift the probe than to work a conventional keyboard. An improvement in this direction has already been suggested; it consists of grooves in the keyboard corresponding to the usual syllables and guiding the probe.

Other possibilities are the use of such machines for typographic composition and remote printing. END

# Why should impedances be matched?

*An attempt to clear up a problem which has probably attracted more misconceptions to itself than any other in the world*

By H. P. MANLY

**D**ID you ever connect the plate of an audio output tube to B plus through the 3.2-ohm speaker voice coil instead of through the primary of the output transformer? Speech and music still come from the speaker, though you may need a hearing aid. Music may have been hi fi with the transformer, but it will be very lo fi with only the voice coil.

When the tube "looks at" the voice coil through the transformer, the tube doesn't see the very small impedance of the voice coil. Rather the tube sees an impedance as great as its own internal resistance and into this big *reflected impedance* puts very nearly its limit of

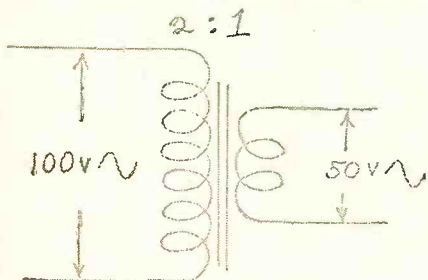

Fig. 1—Transformer with voltage (turns) ratio of 2:1 and impedance ratio of 4:1.

audio output power. That power gets into the voice coil because we have *matched* the internal resistance of the tube with impedance of the voice coil.

The impedance which matches internal resistance of the audio tube is in the primary of the transformer—it could be nowhere else. Now, all of us have learned that impedance depends on reactance and that reactance depends on inductance and frequency. The transformer primary has inductance because it consists of many turns of wire on an iron core. Yet, in a transformer, primary impedance won't be changed materially by using twice as many turns or half as many, provided the number of secondary turns is doubled or halved at the same time and provided the secondary isn't open-circuited. This is one of the peculiar things about a transformer.

It would seem that primary impedance, whatever its value, should be constant at any one frequency. But it isn't. If you measure primary impedance with 2 ohms resistance across the secondary, then put 4 ohms across the secondary, the primary impedance nearly doubles. With 8 ohms across the secondary, the primary impedance will

nearly double again. Were there such a thing as an ideal transformer, with no winding resistance and no losses of any kind, its primary impedance would go up and down in exact proportion to changes of secondary load.

Let's take a transformer like that of Fig. 1. The primary has twice as many turns as the secondary. If we apply 100 volts to the primary, the secondary voltage will be 50. If the secondary is open-circuited, no power will be drawn from the transformer and the primary impedance will be very high. But if we put a load of 50 ohms across the secondary, 50 watts (1 ampere at 50 volts) will be dissipated in the load. This 50 watts comes from the primary, which will draw 1/2 ampere at 100 volts. The impedance of the primary—because it has a greater number of turns than the secondary—is 200 ohms. And 100 ohms across the secondary would mean 25 watts output at 50 volts. The primary current would then be 1/4 ampere and the primary impedance would be 400 ohms (1/4 ampere at 100 volts).

## Sources and loads

All the way from antenna input to picture tube or speaker in every TV or radio set there are transfers of signal power. Each part which furnishes power is a source. All those which receive

power are loads. Our audio tube is a source and the transformer primary is its load. The transformer primary is a source and the secondary its load. When source and load impedances or resistances are equal, they are matched and there is greatest possible transfer of power from source to load.

To learn why there is greatest power transfer let us experiment with a source and some loads. The emf for our source will be induced in the secondary winding of the small heater transformer of Fig. 2. When the primary is connected to an ac power line, an alternating emf of 7.2 volts is induced in the secondary. As long as line voltage holds steady, this emf won't change. Secondary resistance is only 0.5 ohm. When 1.8 amperes of current are taken from the secondary, there will be 0.9-volt drop in the 0.5-ohm internal resistance and terminal voltage will come down to 6.3.

Internal resistance of 0.5 ohm isn't enough for easy experimenting so we shall connect in series with the secondary a fixed resistor of 180 ohms. Then, considering the secondary and this series resistor as a unit (Fig. 3), they form a source having 7.2 volts emf and very close to 180 ohms internal resistance.

Three other resistors will act as loads. (Incidentally, these and the source

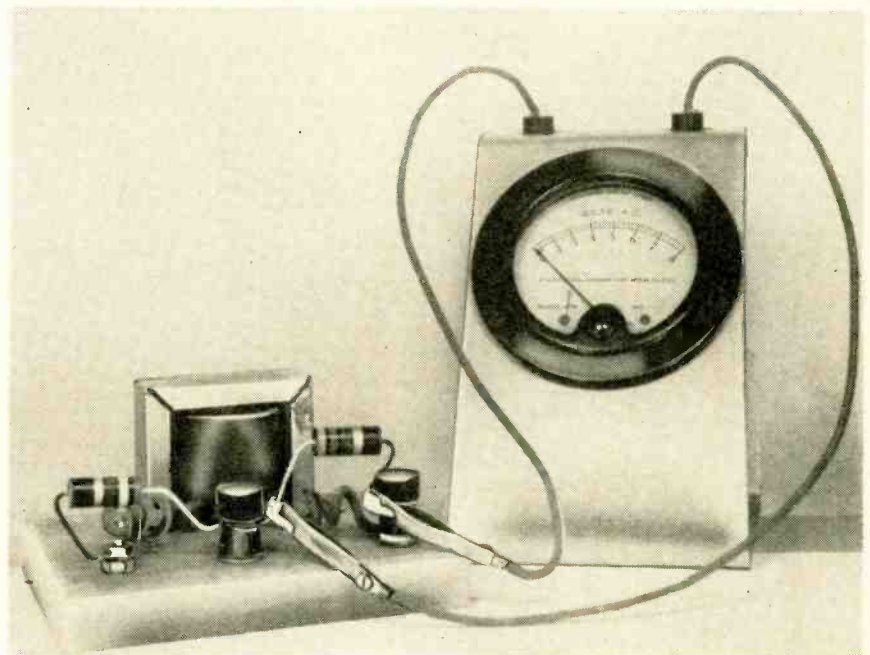

Fig. 2—Setup for experiments in impedance matching.

resistor need be of only 1/2-watt rating.) Values of the other resistors are 90, 180 and 360 ohms. One provides a load of half the source resistance, a second is equal to source resistance and the third is double the source resistance.

The three load resistors are connected, one at a time, as at A, B and C of Fig. 4. Source emf will divide proportionately to source and load resistances. But instead of figuring proportions it is easier to measure the voltages with a voltmeter connected first across the source resistor and then across whichever load resistor is being used.

To determine milliwatts of power dissipated in any resistor first square the number of volts across the resistor, then multiply by 1,000 and divide by the number of ohms. The results for Fig. 4 are listed in the table below.

POWERS IN A SOURCE AND ITS LOADS

	Ohms		Milliwatts		Total
	Load	Source	Load	Source	
A	90	180	64	128	192
B	180	180	72	72	144
C	360	180	64	32	96

This table shows three important things.

1. Most power is transferred to the load when resistances of source and load are equal.
2. The greater the load resistance, the less power is wasted in the source and the less is the total power used in source and load.
3. Equal powers are transferred to any two load resistances or impedances which are a multiple and its reciprocal with respect to source resistance. For example, the 360-ohm load is twice and the 90-ohm load is half the source resistance.

The numbers 2 and 1/2 are reciprocals. Load powers are equal (64 milliwatts) with the 360-ohm and 90-ohm loads.

You may measure or compute any number of combinations of source and load resistances or impedances, using any emf in the source. Powers into two loads will be equal every time the ratios of resistances or impedances in load and source are reciprocals, such as 2 and 1/2 or 4 and 1/4 and so on (Fig. 5.) Dark bars represent power transferred into a load, light bars power dissipated in the source.

The bars show that smaller loads leave more and more of the total power in the source, where it does nothing but produce heat. With greater loads more and more of the total power goes into the load where it can be useful.

Reflected impedances

Earlier we talked about a 3.2-ohm voice coil and some audio output tubes. Let us suppose their internal resistances are 2,200 ohms. With the voice coil connected directly into the tube plate circuit only a tiny fraction of total audio power went into the speaker. All the rest was lost in the tube. With a matching transformer between tube and voice coil, about half the total audio power went into the speaker and only half was lost in the tube. Fig. 5 shows this half-and-half ratio to be maximum possible power transfer.

It was said also that the reflected impedance which the tube sees in the transformer primary is not due to inductance of the primary winding. This reflected primary impedance is due to impedance of the voice coil connected

to the secondary and to the multiplying effect of the turns ratio of transformer windings.

Any impedance connected to a secondary winding is reflected into the primary proportionately to the square of the turns ratio. When we matched 2,200 ohms internal resistance of the tube and had only 3.2 ohms connected to the secondary, the transformer must have had a turns ratio of 26 to 1, or 26 times as many turns in the primary as in the secondary. The square of 26 is 676. Multiplying 3.2 by 676 gives 2,163. And there you have a very close match for the 2,200 ohms of internal resistance in the tube.

To determine the turns ratio required for any matching job divide the larger impedance by the smaller, then take the square root of that quotient. The resulting root is an exact turns ratio. We might divide 2,200 ohms by 3.2 to obtain a quotient of 687.5, whose square root is 26.22. A small fraction more or less makes no practical difference, so a turns ratio of 26 to 1 is entirely satisfactory.

The internal resistance of a tube is computed by dividing small changes in plate voltage by the small changes in plate current produced by these plate voltage changes. But when you look at characteristics and operating data for beam power tubes you won't find any listings of internal resistance based on plate voltage and current. There will, however, be recommended values of load resistance for maximum power output with least distortion.

Sweep generator matching

So far we have talked of only one method—use of an iron-core trans-

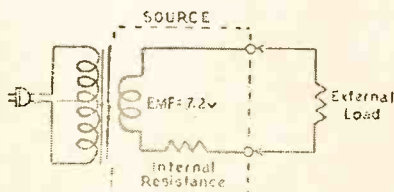

Fig. 3—Ac power source with artificial internal resistance.

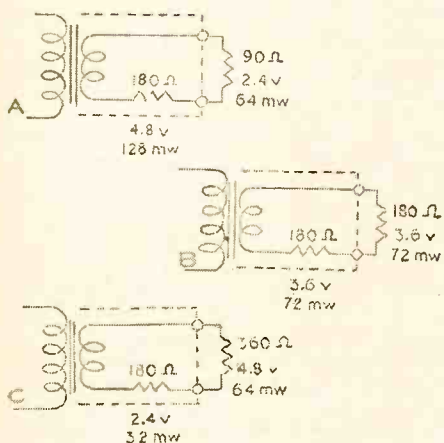

Fig. 4—Voltage across and power in three different loads.

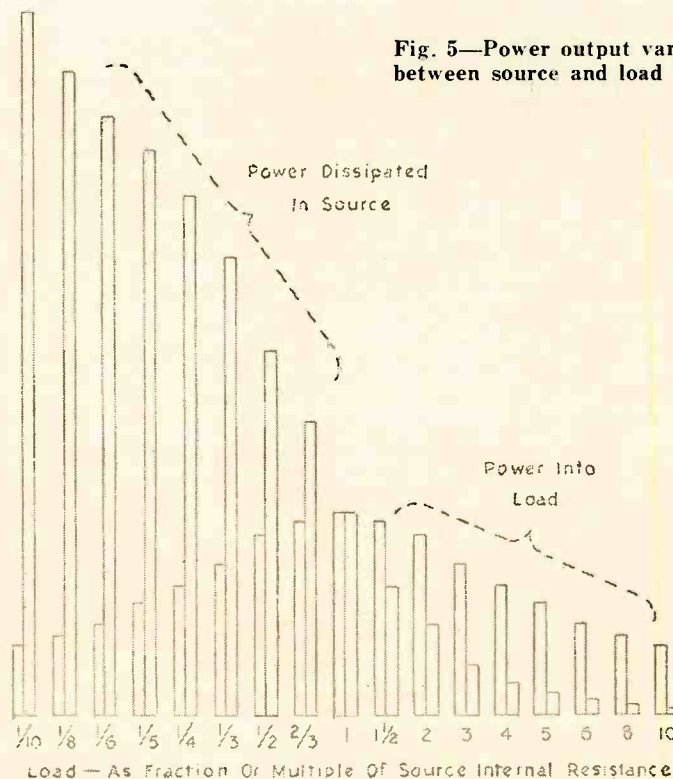

Fig. 5—Power output varies with ratio between source and load impedances.

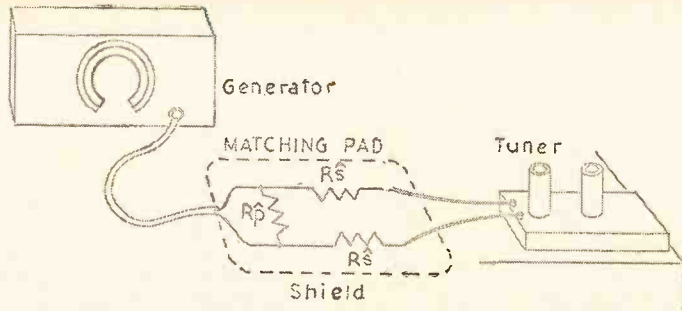

Fig. 6—Matching pad between sweep generator and tuner.

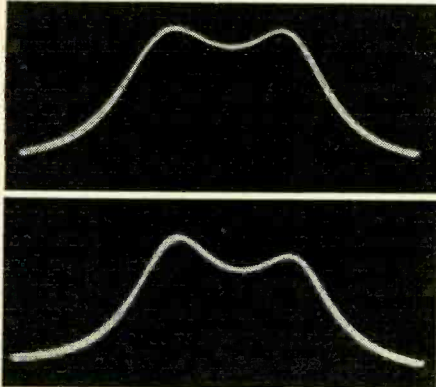

Fig. 7-a, top—Frequency response of properly matched generator and tuner; and b, bottom, improperly matched.

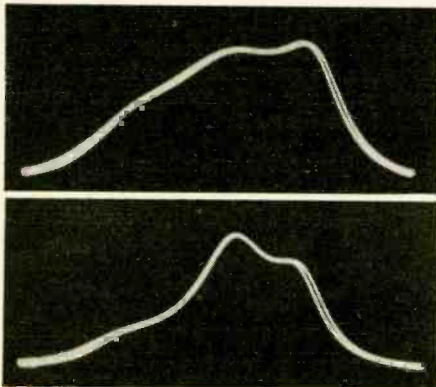

Fig. 8-a, top—Response with single series resistor; b, bottom—with generator connected direct to tuner.

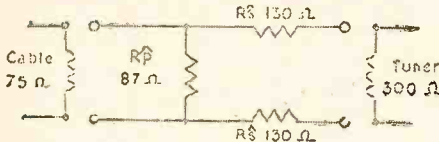

Fig. 9—Design of pad for matching sweep generator and tuner.

former—for matching unlike impedances. There are many others. Television and radio technicians are familiar with resistor combinations (networks) called matching pads. Another name is cable terminations. They are used or should be used on the receiver end of coaxial cables from signal generators to tuner terminals during alignment.

The most widely used matching pad or cable termination has three resistors connected as in Fig. 6. In series between the two conductors of the coaxial cable and the two antenna terminals of the tuner are two resistors  $R_s$ , of equal

value. Across the cable conductors is a third resistor  $R_p$ .

The cable may be considered as an extension of the signal generator circuits. This makes the receiver end of the cable our signal source. One of the properties of a coaxial cable is its characteristic impedance, which does not vary with cable length or with frequency. Impedances of generally used cables have nominal values of 50, 75 or 95 ohms.

Resistors for matching pads are of such values that the cable sees its own impedance or something close to this impedance when looking into the cable end of the pad. At the antenna terminals of tuners in most modern television receivers the nominal or approximate impedance is 300 ohms. When the tuner looks into its side of the matching pad, it sees 300 ohms or close to it.

Before we try to select pad resistors to match a generator and tuner let's see what happens when cable and tuner impedances are suitably matched and when they are not. Fig. 7-a is a frequency response taken from the mixer of a tuner to whose antenna input a sweep generator is connected through a proper matching pad. Tuner alignment indicated by this response allowed excellent received performance.

Using the same pad on the end of a cable of different characteristic impedance changed the response as at Fig. 7-b. Going back to the original cable but using a pad designed for a cable of different impedance gives a generally similar change of response. The high-frequency side of the response is down about 15%—not too bad in itself but a possibility for trouble after signals go through the if amplifier to the video detector.

Fig. 8-a shows what happens with only a single resistor on one of the cable conductors. Finally, with no resistors at all, with the original cable connected directly to the tuner terminals, the response changed as at Fig. 8-b. Vertical gain of the scope was adjusted to bring all these responses to equal heights for easy comparison of gains at various frequencies.

Any of the response traces resulting from wrong matching might be altered to make them appear similar to the true response of Fig. 7-a. It would be only a matter of manipulating the tuner adjustments for rf grid, rf plate, mixer grid and bandwidth.

Supposing you were to work with a

wrong cable termination and were to change the tuner adjustments to make a bad frequency trace look good. That would be bad for the original satisfactory response would be gone. Program signals at various video frequencies would be over- or underamplified and pictures would suffer.

The purpose of matching a generator cable to a tuner input is not to obtain maximum power transfer but to avoid over- or underamplification of different frequencies (frequency distortion). It is to avoid wave reflections which would send much of the signal energy at certain frequencies back to the generator rather than into the tuner.

There is bound to be a large loss of signal power or voltage in any matching pad. With the cable looking into its own impedance in the pad, half of the generated signal energy will go into the pad and half will remain in the generator and cable, just as when using a matching transformer. Much of the signal energy that does get into the pad will be dissipated in passing through the series resistors. As a result, signal voltage into the tuner with a pad in use will be only about 15% of the voltage with the generator cable connected directly to tuner antenna input terminals.

How to design a matching pad for use between a 75-ohm cable and a 300-ohm tuner is illustrated in Fig. 9. Looking from the cable end we come first to 87 ohms at  $R_p$ . In parallel with this 87 ohms is a series combination of two 130-ohm resistors and the 300-ohm tuner input. The series combination totals 560 ohms. Effective resistance of 560 and 87 ohms in parallel is 75.3 ohms—close match for 75-ohm coaxial cable.

Looking from the tuner end we have first the two 130-ohm resistors. Between these two resistors is 87 ohms at  $R_p$  and 75 ohms in the cable. These latter two resistances or impedances are in parallel with each other. Their effective parallel resistance is 40.3 ohms. Adding this 40.3 ohms to 260 ohms in the two series units gives 300.3 ohms—an excellent match for the 300-ohm input to the tuner.

Resistors of 130 ohms with 5% tolerance are standard types. But there is no standard 87-ohm value. An 87-ohm unit might be selected from stock resistors by using an accurate ohmmeter. Otherwise a standard 91-ohm 5% resistor might be used. It would raise pad impedance to about 78 ohms on the cable side.

We could provide satisfactory matching for a 50-ohm cable by using one 56-ohm shunt resistor and two 130-ohm series units, all of which are standard values.

For a 95-ohm cable we might use 120-ohm resistors in all three positions for a fair match. Better matching would be secured by using the ohmmeter to select a shunt resistor of 114 or 115 ohms, then using two 130-ohm resistors in the series positions. END



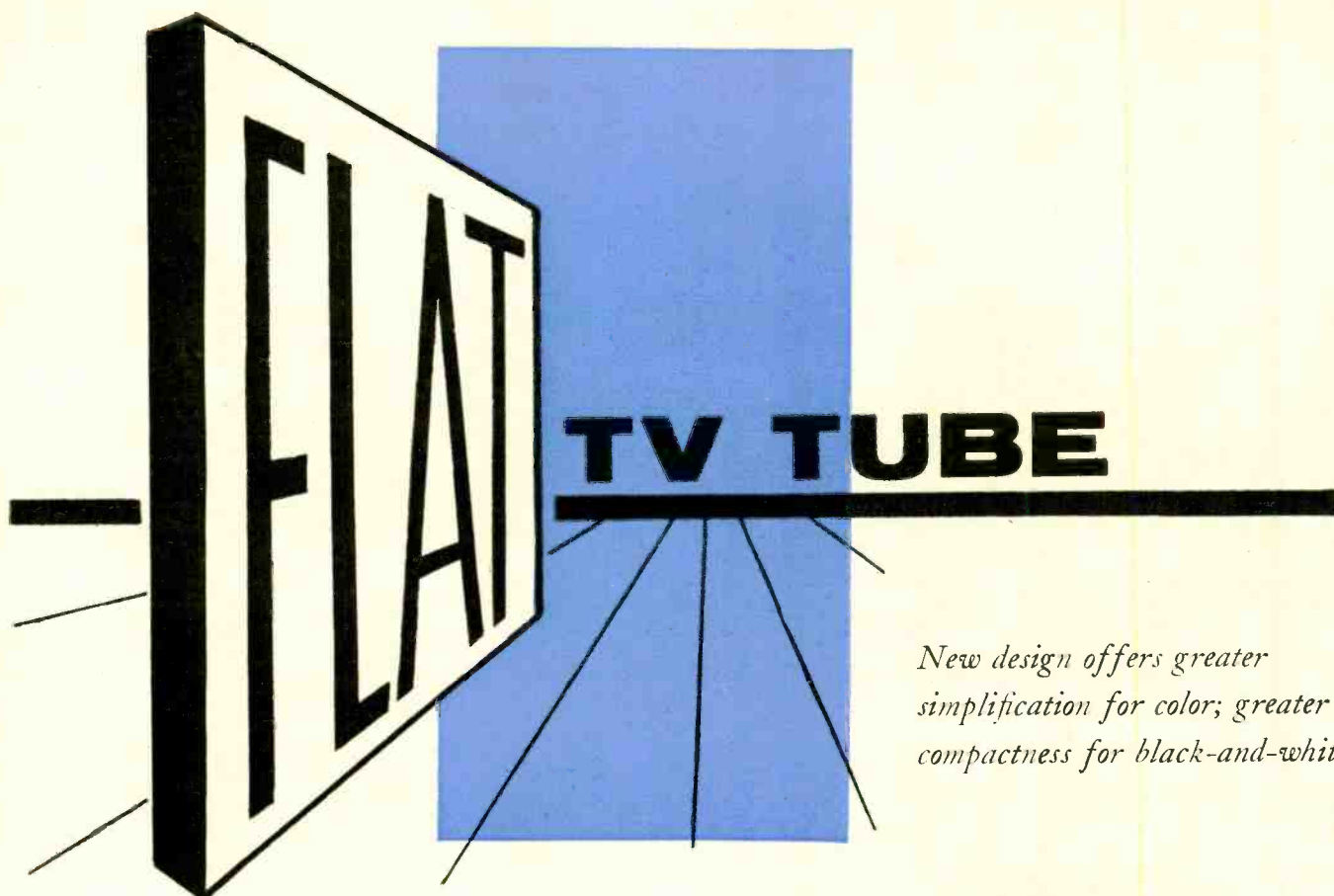

*New design offers greater simplification for color; greater compactness for black-and-white*

By ERIC LESLIE

THE picture-on-the-wall TV tube, predicted by several authorities in the field, has at last reached the advanced laboratory stage. Developed in England, it has been produced only in continuously pumped tubes up to the present time though work to produce sealed-off models is now in progress. The new tube is expected to have several advantages other than compactness, especially as a color tube.

Invented by Dr. D. Gabor of London, American patent applications were made as early as 1952 though Dr. Gabor described his invention for the first time only in October, 1956. Work on the project has been carried on at the Imperial College of Science and Technology (London) for the last three years, and patent rights in the tube have been assigned to the National Research Development Corp. For this reason it is often referred to as the NRDC tube.

(Another flat cathode-ray tube, invented by W. Ross Aiken of the Kaiser Aircraft & Electronics Corp., Oakland, Calif., differs somewhat in details but is so similar to the Gabor tube in fundamentals that Kaiser and NRDC have pooled their flat-tube patents in a world-wide agreement.)

In this discussion terms like front,

back, top and bottom refer strictly to the picture-on-the-wall. It is necessary to keep this in mind since the tube is bound to be compared subconsciously with more conventional types, and confusion can result because some things in this model are not where they might be expected to be. For example, the phosphor screen is on the front or face, but the electron gun assembly projects its beams downward near the back, parallel to the face instead of toward it as in conventional tubes. See Fig. 1.

The flat tube, which may be only 4.5 inches deep (front-to-back) for a 21-inch screen, is divided internally into two still flatter portions by a magnetic screen or shield (Figs. 1, 2). Behind this screen is the electron gun(s) and some of the deflecting equipment; ahead of it the phosphor screen, the shadow mask (in color tubes) and the *vertical scanning array*, a most important feature.

The electron-gun assembly is mounted at the top rear center and sends the beam directly downward through acceleration and focusing elements (Figs. 1, 2). It passes through the x-axis or horizontal (line) deflection plates (deflection is electrostatic in this tube) and then through two sets of trimmer plates, which compensate for any misalignment.

Next the beam comes to one of the two most important and interesting features of the new tube, the *reversing lens*. Shown probably most clearly in Fig. 1, it is a combination of electrodes that turns the beam around at the bottom of the tube and starts it upward again at the front, between the vertical scanning array and the phosphor screen. The reversing lens is made up of a *repeller*, which actually turns the beam, at cathode potential, and *side and central electrodes*, at ulior potential. The lens not only reverses the beam but increases the horizontal deflection angle as much as four times. Thus flat TV tubes may be made with a deflection angle between  $110^\circ$  and  $120^\circ$ , a figure previously unheard-of in electrostatic-deflection tubes and only now being approached by magnetic types. The lens also compensates for the overfocusing inherent in electrostatic-deflection tubes so that the beam remains in perfect focus throughout the length of the horizontal line scan. The beam is further trimmed and straightened to the vertical by an electromagnetic lens or *magnetic collimator*.

#### The vertical scanning array

Now we have a beam scanning horizontally the full width of the tube, but with no control of vertical deflection.

## TELEVISION

Left to itself, it would simply trace a line along the inside top of the tube. What is needed is some influence to stop it at a given height and bend it forward to strike the face. The same influence should draw the spot from top to bottom during each field, then permit it to snap back to the top of the frame at each vertical retrace period.

The element that does this is like nothing else that has ever been put into a picture tube. It consists of a sheet of insulating material on which horizontal conducting lines are printed. These lines are connected electrically to absolutely nothing in the tube. This sheet is mounted ahead of the magnetic screen, about  $\frac{1}{8}$  inch away from it, and its ends are folded around into a pair of loops (Fig. 3) so that the spot can be made to strike the conducting lines at the end of each scan. The lines are tipped upward at the ends—as shown in the figure—as they reach the end folds. In the Gabor tube the conducting lines are rather numerous (about 120) but the number is not critical nor is it related in any way to the number of horizontal scanning lines.

(The Kaiser tube is said to have a scanning array of only seven conductors, energized externally by seven special tubes.)

The phosphor screen on the faceplate of the tube is maintained at or near the ultor voltage. If all the conducting lines of the scanning array were equally positive, the scanning beam would rise without any deflecting effect—it would be traveling in an equipotential field. If, however, the first few top conducting lines of the array were made negative, the beam would find a negative field above and behind it and a highly positive one (the phosphor screen) ahead of it. The beam would be bent sharply forward. This is what actually happens and lower lines are made negative progressively—as we shall see in the next paragraph—so that a negative wave sweeps down the array, with only a few conducting lines forming a boundary region (called the *transition area*) between positive and negative portions of the array. At the end of each field it is necessary to charge all the conducting lines to a high potential again, so the beam is able to reach the top of the tube to start scanning the next field. Strange as it may seem, the opposite functions of charging and discharging the electrically isolated scanning array are both performed by the scanning beam.

### How it's done

It will be convenient to start at the beginning of a field, when the whole scanning array is positive, without troubling ourselves at the moment to ask how it got that way. The beam

rises to the top of the tube and is deflected forward by a conducting strip at the top of the deflecting array, maintained at cathode potential (Fig. 3). It is also focused by the focusing action of the strong electrostatic deflection. Just after each line flyback, at the beginning of the scan, the spot is held momentarily inside the left fold of the scanning array. The beam strikes the upward-slanted top lines and supplies electrons to them. This makes the top few lines of the array more negative and tends to push the beam down. The staggered-upward design in the end loops causes each successive scan to make the upper lines more negative and to contact lower lines as the beam is forced further down. Thus the whole array becomes progressively negative. By adjusting the beam strength, the time required to make the scan travel from top to bottom of the tube can be made that of a field ( $1/60$  second in the American system of television).

At the end of each field the beam is held in the fold at the *right* end of the array during the period of vertical

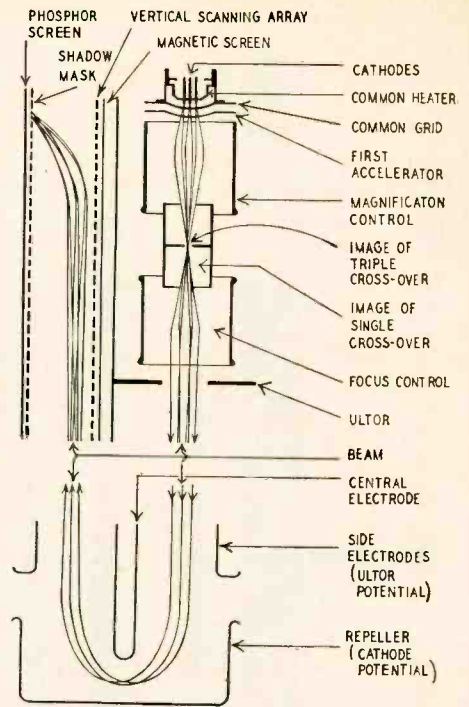

Fig. 1—The reversing lens shows up clearly in this cross-section view.

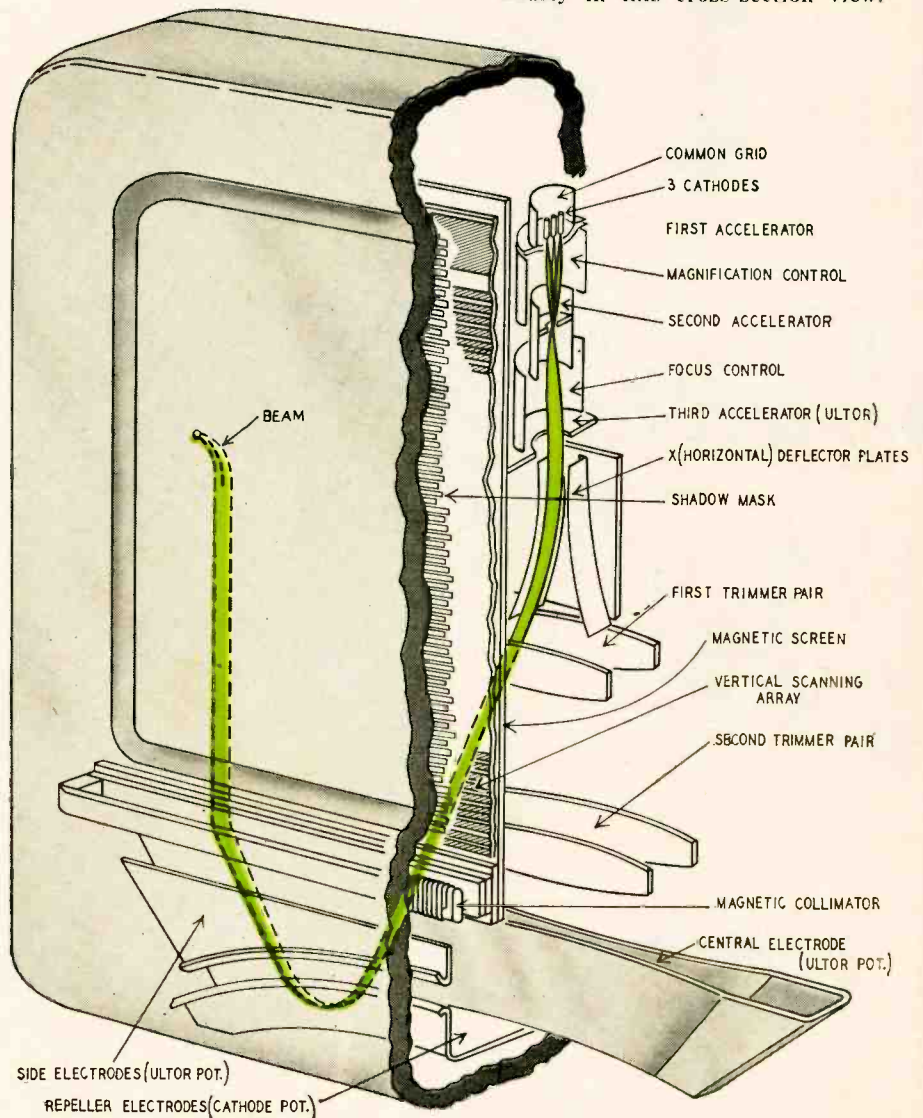

Fig. 2—Cutaway view, with beam deflected toward the left.

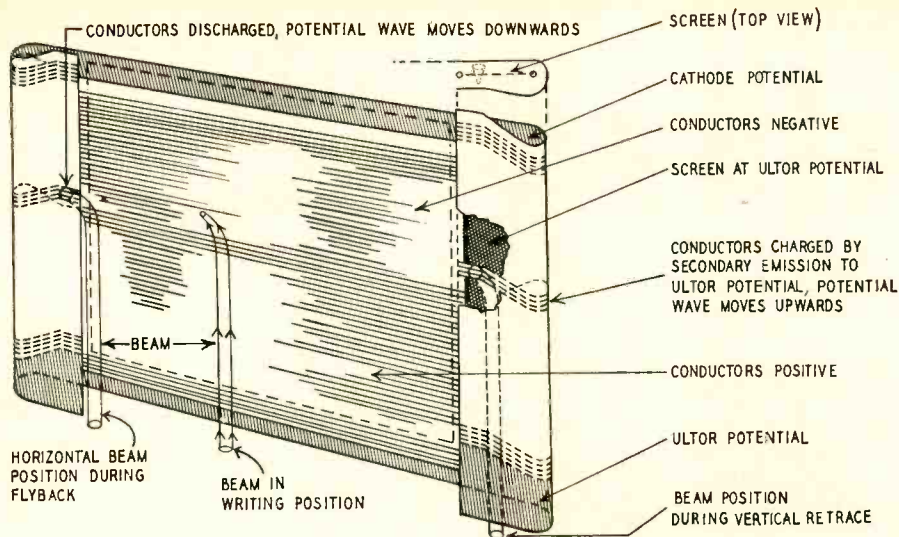

Fig. 3—The vertical scanning array, most striking feature of the tube.

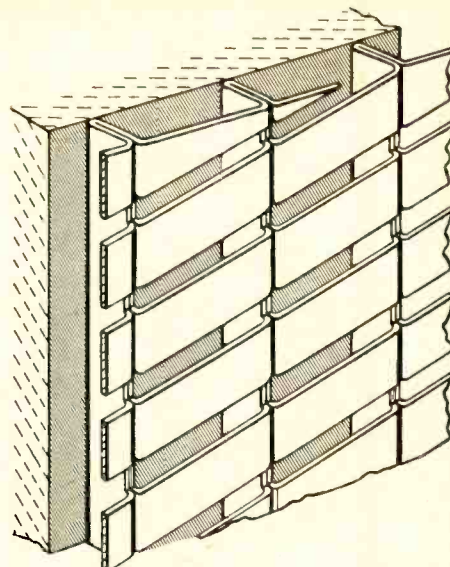

Fig. 5—Section of shadow mask.

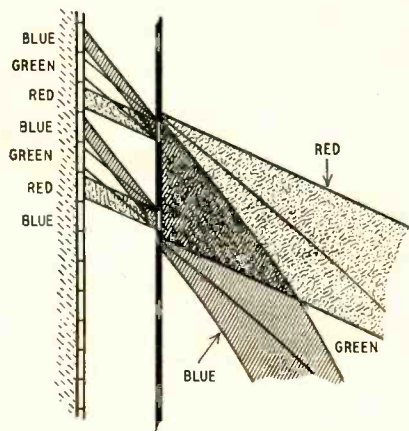

Fig. 4—Path taken by color beams through the shadow mask.

design than a conventional black-and-white type but more simple than the three-gun shadow-mask color tube. It also offers some advantages in receiver circuitry, both in color and in black-and-white. The set requires no vertical deflection circuits and, because of the low power required for horizontal deflection, the line (horizontal) scanning circuitry is simpler than in conventional receivers. The synchronizing circuits necessary to keep the horizontal and vertical scan in step with the transmitted signals need be no more complex than in present-day TV circuitry.

The most important advantage is that the three color guns are placed so close together that the three beams are handled as a single beam by the accelerating, focusing and deflecting electrodes. (This eliminates a number of corrections and controls needed on the ordinary color tube, in which the guns are mounted some distance apart and all aimed at the same spot on the phosphor screen.) The three color beams separate just before the final bend and are brought together (Fig. 4), but at different angles, just at the shadow mask.

Due partly to the large convergence angle, the mask can be placed within .025 inch of the screen. Therefore it can be affixed directly to the inside of the tube face, eliminating alignment difficulties which help make the manufacture of color-mask tubes expensive. The mask, incidentally, is slotted (Fig. 5) in present experimental models instead of punched with round holes. The screen is laid simply by dropping the three color phosphors directly onto the tube face through the slots in the mask, with the tube held at a different angle for each color. This is made possible by the close spacing of mask and face-plate and is another factor which would reduce the cost of production.

But manufacture—in quantity at any rate—is not in view in the immediate future. The most important hurdle between the present stage of development and that of a home picture tube is the problem of making a sealed-off tube. There are minor problems, most of them practically solved. From the present information, it is impossible to forecast when we may expect to have flat picture tubes for home TV receivers. END

retrace. At this end the beam reaches the conducting lines only after passing through a mesh screen held at a high positive potential (the ultor voltage). The beam knocks electrons loose from the surfaces of the conducting lines, and the highly positive screen attracts most of these electrons to it. Due to this secondary emission the conducting lines rise in voltage very rapidly as they lose electrons to the screen.

As each line in turn becomes more positive the beam drifts upward, remaining in the transition area (between positive and negative field) till it reaches the top of the screen and is ready to snap over to the left and start scanning the next field. Design of the stagger angle of the lines, the screen and its spacing from the array, and adjustment of the voltage applied to it, make the time the beam takes to reach the top of the tube exactly that of vertical retrace required by the system of transmission. Thus this electrically isolated element replaces vertical deflection oscillators, amplifiers and coils in the receiver.

**Some advantages**

The tube is more complicated in

**Next Month in Radio Electronics**

**Miniature Sine- and Square-Wave Generator**

By I. Queen

A transistorized 2 x 4-inch job that produces results comparable to many larger instruments.

**Self-Powered Transistor Radios**

By Dr. Hans Erich Hollman

How the station can be made to furnish the power for its own reception, or even re-radiation on another frequency.

**Class-B Transistor Hearing Aid**

The complementary symmetry circuit in this transistorized hearing aid makes it extremely light and compact while increasing volume and clarity.

By CYRUS GLICKSTEIN\*

# Don't be a

*Think you know when a chassis is safe! You might be surprised.*

TV SERVICING is sometimes a shocking experience. This doesn't necessarily refer to most of the programs seen on the screen while checking the controls. Nor even to some of the customers or canine receivers that the average technician runs into periodically. The reference is simply to the kind of jolt the technician gets when he touches a live circuit accidentally. A TV chassis can have more kicks than a pony ballet; even old China hicks are not immune to an occasional buzz. Fortunately, the common electrical shock in TV servicing is rarely dangerous, provided the technician has no organic physical defect and his general health is good. But these jolts are annoying at best and may become dangerous because of side effects—pulling a hand away quickly against the sharp corner of a chassis, dropping or breaking a picture tube, etc. Under special

conditions, *some of these shock hazards are potentially fatal.*

Occasional shocks in the course of servicing may be due to carelessness. In a surprising number of cases, it is not the basic cause. The shock may result from an unfamiliar circuit connection, an unpredictable type of component breakdown or simply a lack of published information concerning possible shock hazards. As a result, most technicians receive their education concerning the shocking facts of life the hard way. This article may provide a slightly less painful method of obtaining some of this information.

### Less-familiar hazards

1. Most technicians think they are relatively safe from shock when they turn the power off in a series-filament set and that the only hazards then are charged capacitors and glass picture tubes which may retain a charge. This assumption is valid if power is turned off by removing the cheater cord from the chassis. However, if the line cord is still connected to the chassis and the power switch is turned off, the technician can still get across the full line voltage in series-filament receivers by touching the chassis and an external ground. For example, the set in Fig. 1 has the power switch in the off position. The hot side of the line is connected to the top of the filament string. This means that the hot side of the line is connected to the chassis *through the filament string.*

By touching the chassis and an external ground, the technician's body is put in series with the filaments across the line. That is, the entire series circuit is connected between the hot side of the line and external ground. Since body resistance is much higher than the total filament resistance, practically the entire line voltage is applied across the body.

Incidentally, a common external ground is the metal wall outlet plate (or mounting bolt, if the plate is insulated).

(Grounded outlet boxes and cover plates or mounting bolts are not as prevalent as many of us assume. Knob-and-tube wiring is still used in many older buildings and nonmetallic sheathed cable without a grounding wire and nonmetallic outlet boxes in many newer installations. Therefore, never assume that a ground is available at all outlets. An isolation transformer is the

safest precaution when servicing transformerless equipment.—*Editor*)

A basic precaution, therefore, is to avoid touching any external ground and the chassis at the same time, even with the power off, when the receiver's line cord or cheater cord is still connected to the outlet and the set. Even better, power should always be turned off by disconnecting the cheater cord from the set rather than by using the power switch, before digging into the set.

2. A related problem is making voltage or signal-tracing checks in the home on an energized series-filament chassis. In such cases technicians often make a voltage check between the chassis and the outlet plate or mounting bolt, using a voltmeter or a neon tester, with the power on. (See Editor's note above.) If line voltage is found (117-volt reading on the voltmeter or the neon tester lights), the cheater cord plug must be reversed at the outlet. The chassis is now connected to the ground side of the line when the power switch is on. The recommended procedure for working on an energized chassis. However, this is exactly the connection which makes the chassis hot if the power switch is turned off and the line cord is left connected to the outlet.

In some equipment, the on-off switch is in the hot side of the line—the lead supplying the low-voltage rectifier. With this arrangement, the chassis will be hot and dangerous whether the switch is open or closed when the plug is inserted one way and at ground potential and safe with the switch open or closed when the plug is reversed. Therefore, it is all the more necessary to follow the precautions noted under 1, when power is turned off for making various other checks.

While some checks must be made with the power on, it is a good policy to keep such checks to a minimum. Tubes, for example, should be changed with the power off. When checks must be made on a live chassis, use one hand only whenever possible.

In servicing series-filament sets in the shop, a 1-to-1 isolation transformer should be used (Fig. 2). This avoids making the chassis of the serviced set hot to external ground or other test equipment.

3. Technicians may sometimes be called in to service sets in stores or home basements with concrete floors.

\*Author of *Repairing Television Receivers* (John F. Rider Publisher, Inc.).

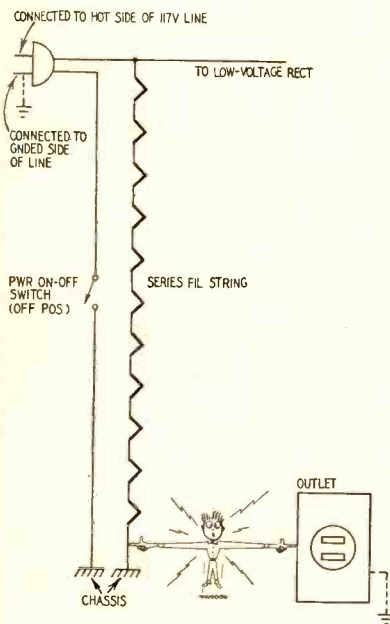

Fig. 1—Even with power switch off, possibility of shock exists.

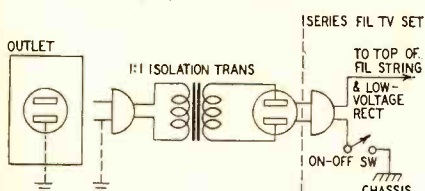

Fig. 2—Isolation transformer removes chassis from ground potential.

# Shock Absorber

Such floors are good electrically conducting grounds; they can become booby traps, especially when servicing series-filament sets. When standing on a concrete floor you can get a shock simply from touching the chassis with one hand, even though the power is off (if the hot side of the line is connected to the top of the filament string and the switch is in the cold side) or with the power on (if the hot side of the line is connected to the chassis through the power switch). Standing on an insulating material and following the precautions listed under 1 and 2 will prevent possible shocks between the chassis and the concrete floor.

In the same way a shock can result from touching the arm of an electric record player while standing on a concrete floor, outdoor patio, grass lawn, etc. This occurs if an ac-dc unit is used and the hot side of the line is connected to the chassis (and pickup arm) when the power is turned on. In such cases, reversing the plug in the outlet disconnects the hot side of the line from the pickup arm and shock is avoided when the arm is touched. Needless to say, operating an ac-dc record player in areas with conducting floors is not advisable.

4. Cartridge fuses have been developed recently for TV use to prevent accidental or intentional substitution of overrated fuses (fuses with too high a current rating). These special fuses are made with a flange on one end. The width of the flange varies according to the current rating of the fuse. Therefore, a substitute fuse which has too high a current rating has too wide a flange to fit into a fuse holder provided for a fuse with a lower current rating.

These fuses are commonly mounted on the chassis inside the cabinet. The fuse end, which is not insulated, projects from the end of the fuse holder. To change the fuse, the back cover is removed, thereby opening the interlock and shutting off power to the chassis. This eliminates shock hazard. The fuse end can be safely grasped and the fuse removed and replaced. (If there is a possibility of a charged capacitor in the fused circuit, the end of the fuse should first be grounded to the chassis.)

However, when a cheater cord is used on a set having this type of fuse, extreme care must be taken when working near the fuse. With power applied to the set, touching the exposed end of the fuse and the chassis may result in

a severe shock *even if the fuse is blown*. The exposed end may be connected to the side of the circuit still receiving power (Fig. 3).

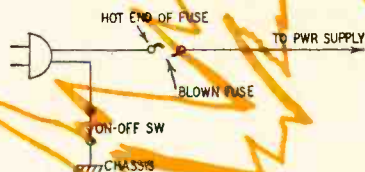

Fig. 3—Anyone touching hot end of fuse and chassis is across the ac line.

When making checks on a live chassis, avoid touching the fuse end. In changing fuses make certain line voltage is not applied to the receiver by disconnecting the set's line cord (or cheater cord) from the chassis.

5. Changing any type of blown cartridge fuse with the power on may provide a nasty jolt if both ends of the fuse clip are touched (or, in some circuits, one end and the chassis). The full source voltage in the circuit is across the open fuse (Fig. 4). By touching both ends of the fuse clip the technician completes the circuit and places his body in series with the other circuit components. The amount of voltage across the body depends on the ratio of body resistance to the resistance of the other elements in the series circuit.

6. On the basis of the points outlined previously, it may seem that a shock can be caused only when the body or any part of it is placed across the two terminals of a voltage source or when the body completes a break in the circuit with power applied. This is true enough in low-voltage circuits, but there is one additional rule in high-voltage circuits.

Some technicians may be of the opinion that no shock will be felt if a high-voltage point is touched with one hand only, provided nothing else in the circuit or elsewhere is touched and the shoes are insulated from ground—in other words, if contact is made with only one high-potential terminal, not both. This is an erroneous assumption. Remember, an arc can be drawn from the anode of a high-voltage rectifier or horizontal output tube with the tip of a screwdriver. No internal or external path to ground is required. For example, when the high-voltage ac on the anode is positive, the electrostatic charge attracts an excess of electrons to the tip of the screwdriver, which is held close to the anode, and makes the tip highly negative instantaneously. The resulting difference of potential between anode and screwdriver tip is sufficient to ionize the air between the two points and cause arcing (current flow). When the ac voltage on the anode becomes negative and induces a positive potential in the screwdriver tip, current flows in the reverse direction in the arc.

The point to remember concerning possible shock hazards in an energized high-voltage circuit is simply this: Not only avoid direct body contact but keep a respectful distance between any portion of the energized high-voltage circuit and the body.

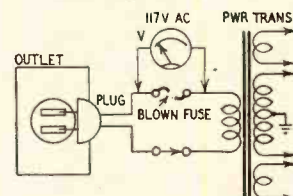

Fig. 4—The full line voltage is across the open fuse.

## TELEVISION

The more commonly known shock hazards in TV sets are worth listing to refresh the memories of those who know them and to warn off those who have been fortunate enough to avoid them so far.

### Familiar shock hazards

1. A glass picture tube retains a charge for a considerable period after the anode connector is removed. Although the shock may be minor, touching a charged tube may cause the technician to drop the tube, swing his elbow against the neck and possibly break it or cause other dangerous secondary effects. It is good practice to

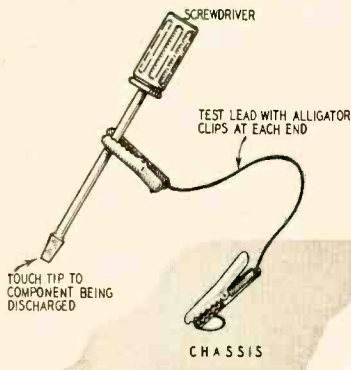

Fig. 5—Simple method of grounding charged components.

turn the power off and short the tube and high-voltage circuits before touching any component in this area. Grounding can be done very simply by using a screwdriver and a test lead with alligator clips at both ends (Fig. 5). One end of the lead is clipped to the chassis, the other end to the metal shank of a screwdriver with an insulated handle. The tip of the screwdriver is then touched several times to the picture-tube anode button and anode connector and the anodes of the horizontal output and high-voltage rectifier (Fig. 6). Low-voltage filter capacitors should be similarly grounded before touching them.

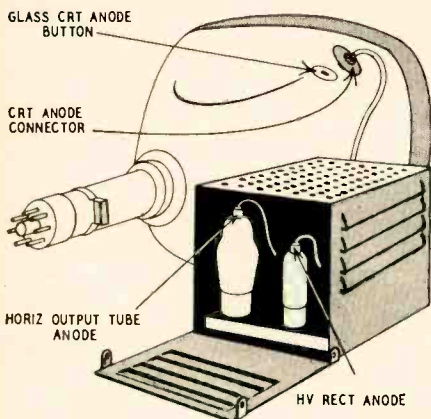

Fig. 6—Key points to discharge in high-voltage circuit before servicing.

2. Sometimes the horizontal oscillator tube is taken out to kill the high voltage in transformer type sets in the course of making various checks around the

horizontal output stage. While there may be no high voltage with the power on, there still is about 300 volts dc on the anode of the horizontal output tube.

3. A common source of shock danger is the large number of exposed B-plus points in newer sets. This includes sets with printed-circuit wiring and receivers with many top-chassis check points. Take special care to avoid contact with these points.

4. Cases of shock have resulted from touching a TV antenna and an external ground, such as a metal pipe on the roof. This occurs in series-filament sets when there is a shorted coupling capacitor between the transmission line and the antenna coil in the tuner (Fig. 7). The antenna is connected directly to the chassis through the shorted capacitor and part of the antenna coil. The chassis, in turn, connects to the hot side of the ac line either directly or through the filament string.

5. The great danger of putting up TV antennas in the vicinity of high-tension lines, especially if metal ladders are used, is obvious. The risk is deadly. Antennas should never be installed near enough to such lines to make contact possible under any combination of circumstances, either directly or through a falling antenna mast or ladder.

6. Miscellaneous shock possibilities in a TV set include:

a. A loose deflection yoke cap which may expose high-voltage points.

b. Turning the chassis over with the power on, making it easy to poke fingers into a live circuit and practically inviting a charge.

c. Using a metal screwdriver instead of an insulated probe for tapping suspected parts with the power on. Accidentally touching the screwdriver shank with the finger may result in a shock.

d. Changing tubes with the power on, especially if an uninsulated metal picture tube is used in the set.

e. Haphazardly increasing the capacitance of a line filter capacitor in a set using a power transformer. This increases the potential shock hazard of the chassis and should be avoided. The line filter (Fig. 8) connects the chassis to external ground through the capacitor. This places the chassis at ground potential for signal voltages but does not connect the chassis directly to ground for 60-cycle ac. Therefore, if the chassis and an external ground are touched simultaneously as shown in Fig. 8, only a fraction of the line voltage is applied across the body and a correspondingly smaller shock results. In most cases the shock is not perceptible. The line voltage divides across the capacitive reactance of the

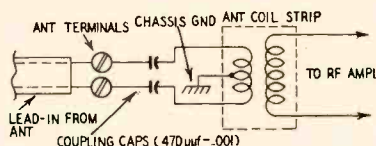

Fig. 7—A shorted antenna coupling capacitor can make the antenna hot to ground.

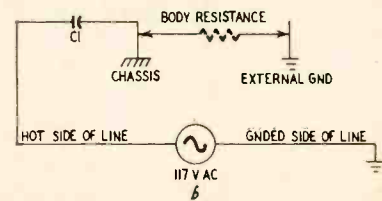
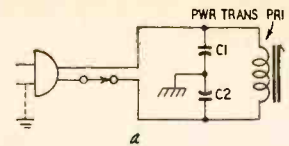

Fig. 8—Actual (a) and equivalent (b) circuits of power transformer primary with respect to chassis and ground.

capacitor and the body resistance in series. Naturally, the higher the capacitance, the lower the reactance and the more voltage across the body.

### Dangerous voltages and currents

The amount of voltage which may be fatal to an individual depends on his general physical condition, body resistance and the parts of the body exposed to shock. For example, a shock between the fingers of one hand would be less serious than the same degree of shock between the two hands, causing a current through the chest. Basically, the quantity of current passing through the body determines how dangerously the shock is. This, in turn, depends on the applied voltage and the resistance of the body at the time. One additional factor is the type of voltage, dc or ac, and the frequency, if ac. Generally, low-frequency ac voltage (60-cycle) is more dangerous than direct current.

Body resistance varies widely with different people. When the skin is wet and more conductive, body resistance goes sharply down.

On the basis of these considerations, 60-cycle line voltage can give extremely uncomfortable but not dangerous shocks to people in good health, wearing normal clothing and with no abnormal conditions of body humidity or conductivity. As mentioned previously, however, dangerous side effects may result. On the other hand, if the body is wet and a good contact is made with ground (as in a bath or shower), touching the hot side of the 117-volt 60-cycle line may be fatal.

Flyback high-voltage supplies in TV receivers usually have such poor regulation that any excess current drain caused by human contact results in a sharp reduction in output voltage. Here again, the shock hazard under normal conditions is probably less dangerous than possible side effects. This is also true of shocks from low-voltage power supplies delivering dc outputs up to 300 volts. The shock is likely to be less hazardous than the reaction to it.

The only sensible approach to the problem of shock hazards in TV servicing is: Use every possible precaution—*don't be a shock absorber!* END



By ROBERT B. COOPER

**F**2 skip, Es and meteor scatter all combined to make the last months prior to the expected sunspot peak pretty fair for television dx-ing. (For the benefit of new readers, E, F1 and F2 are ionized layers of the atmosphere, E being the lowest—about 60 miles—and F2 the highest—around 200 miles. The E layer may occur in patches of varying height, causing *sporadic* reception.)

Throughout the eastern section of the country, sporadic-E was widespread and more frequent than in past years. RADIO-ELECTRONICS observers report E skip on 14 days during November alone. This is more than three times the usual number of this type of opening for the month of November. An unusual feature of the November openings was the time of day involved. Unlike past years when wintertime sporadic-E was an evening phenomenon, this season's seems to be showing up in the morning hours.

One of the few afternoon openings produced some very rare double-hop sporadic-E for a wintertime opening. It occurred on Jan. 3, between such areas as the California coast and the southeastern portion of the country. Such openings should not be passed off as freakish, however. During 1948-50 several double-hop wintertime E-layer openings are on record. Since this was the period of the last sunspot cycle peak, perhaps we should take a lesson from history. It is also interesting to note that wintertime sporadic-E increased manyfold during the same period of high sunspot activity. All of this seems to point toward a lessening of the seasonal tendency of E skip for the next few years.

F2 skip activity (long-range skip in the order of 2,200 miles and up) during the last of November and on into December and January held up much better than expected. As the current 11-year sunspot cycle was expected to peak in January, 1957, conditions should level out and remain more constant for the next 12-18 months. Due to the varying distances and angles between the Sun and the Earth's ionosphere, skip conditions via the F2 layer will vary from season to season of the year.

For those interested, F2 skip patterns may be simplified to the following statements: F2 dx reception from areas to the east and west of your location should occur during the fall months, while F2 reception from areas to the north and south of your location

will usually be a springtime occurrence.

Reception of the audio portion of many European television stations is reported by observers from Maine to Texas. At least one fellow we know of has taken the time to construct a converter to receive the European transmissions. Gordon Simkin of Harve de Grace, Md., is using a tunable converter covering the range of 40-60 mc. Thus far, most of the reception from the *other side* by dx-er Simkin has been in the range of 40-55 mc. Daily reception from such places as London, Paris, Berlin and Budapest began in late October and was still going strong at this writing. Reception has been seen as early as 0730 EST and often lasts as late as 1400 EST.

Calvin R. Graf of San Antonio, Tex., has been doing what so many others report doing, namely, using a short-wave communications receiver to listen for the TV signals. Calvin uses a simple dipole cut to 41.5 mc, and listens for signals on his Hallicrafters SX-28A. Reception from France, England, Ireland, Germany and Switzerland is noted as an almost daily occurrence between 0830 and 1230 CST.

Meteor-scatte dx-ing continues to attract newcomers to its fold. Jerry Don Burch of Hot Springs, Ark., reports nine stations logged 44 times during November. The average distance is nearly 800 miles.

#### Late winter possibilities

As this appears in print, we should be in the winter slump. We should, but will we? As has been noted many times, the sunspot peak is upon us. What this means in terms of dx conditions, other than the F2 dx, is not known. We have already seen an increase in the amount of fall E skip so perhaps the same will hold over into the spring months.

During the last cycle, television was just getting its start. Fringe-area reception was at its best in the 50-mile range and anything beyond that was considered dx. Transmitting power was pitifully low, receivers inadequate and antennas simple. But even so, an occasional dx report showed up. Among these was a report of reception of American television stations in France in the spring of 1948. This, we believe, may be duplicated on a large scale during the next 12 months. Unfortunately, reception of European television broadcasts on American receivers appears only as interference lines similar to co-channel interference. This is due to the difference in TV

standards in use in Europe and in America.

Conditions look much better to the south. The greater majority of our South American neighbors use American standards (525 lines, 30 frames, etc.). Information issued by the National Bureau of Standards, Central Radio Propagation Laboratory, Washington, D. C., in the form of the CRPL F2 predictions, looks very promising. These charts show that excellent skip conditions should exist between such areas as the Gulf states and northern South America on a daily basis during the month of March. Channel 2, Caracas, should be seen daily in the southern portion of the country and on occasions in all areas. On the West Coast, similar reception should be possible between the Hawaiian Islands and the Southwestern states. All of this skip will be a daytime phenomenon, occurring in the morning hours and on until shortly after noon, on most days.

Very little definite information can be given on F2 skip, other than that listed above. For this reason RADIO-ELECTRONICS is extremely interested in any reports of such reception.

#### April predictions

The first two weeks of April should be very similar to March in all forms of dx. Around the 15th of the month, the summer session of E skip should begin to make its appearance over the more southern areas of the country. The rate of occurrence for E skip will rise rapidly after this date and be going strong as the end of the month approaches. An annual meteor shower will occur during the period of April 15-21, peaking in the morning hours of the 17th and evening of the 18th.

#### Report forms

RADIO-ELECTRONICS makes television dx-ing report forms available to reporters to this column. They may be obtained free of charge simply by addressing a postcard to TV DX Column, RADIO-ELECTRONICS, 154 West 14 St., New York 11, N. Y.

#### F2 station listing

In response to those who have asked for a listing of those television stations that may be received via the F2 skip route, we publish this partial list of those most likely to be seen.

#### Europe:

41.25 mc, Paris, France, audio  
41.5 mc, London, England, audio  
45.0 mc, London, England, video  
48.25 mc, England, audio  
48.25 mc, Switzerland, video  
51.75 mc, England, video  
53.25 mc, England, audio

#### South America:

Channel 2 (U. S. standards)  
Caracas, Venezuela  
San Juan, Puerto Rico  
Rio de Janeiro, Brazil (Portuguese)  
Mexico City, Mexico  
Channel 3 (U. S. standards)  
Sao Paulo, Brazil  
Mexico City, Mexico (relay)  
Guatemala City, Guatemala

#### Other:

Channel 2:  
Honolulu, Hawaii  
Anchorage, Alaska  
Fairbanks, Alaska  
Channel 3:  
Hawaii (relay)

END

  
**TV Service**
  
**CLINIC**
  
 conducted by
   
**JERRY KASS**

**T**HE WORD "interference" is generally taken to mean picture or sound distortion produced by some undesired external signal. However, a considerable amount of interference may be due solely to defects within the TV receiver. Proper diagnosis of these can save many hours wasted in checking and experimenting with antennas, transmission lines and external traps.

One of the most troublesome causes of internal interference is regeneration in the if amplifier. This fault severely distorts the if response curve, greatly boosting some frequencies and attenuating others. As a result, depending upon the if waveshape, the picture may be smeared, lacking in detail or contain ghostlike reflections.

Regeneration can be checked by sweeping a signal through the if amplifier and observing the waveform across the video detector load resistor with an oscilloscope. (See Fig. 1.) In most cases the response curve will have a severe peak and it will be difficult to align the if amplifier. While making this check, pass your hand near the amplifier—hand capacitance will usually cause large changes in the response curve. To correct this condition, check the entire if amplifier for open bypass capacitors. Dress all plate and grid leads for minimum coupling. Keep all filament and B wiring dressed close to the chassis and away from grid leads.

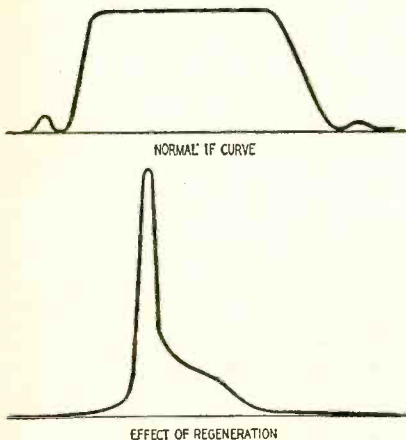

Fig. 1—Curves show effect of feedback. Peaked curve is one of many caused by circuit regeneration

This changes circuit capacitances so the if amplifier should be realigned even if the regeneration is eliminated.

In some cases regeneration is not due to defective components or wiring and is caused simply by some if peaking (often the result of alignment without test equipment). This condition can usually be cured by placing a larger-than-normal bias on the agc bus of a particular receiver during alignment. A typical bias box is shown in Fig. 2. The reduced gain will usually halt the regeneration and permit normal if alignment. If this trouble follows tube or other component replacement, try several tubes or check lead dress. In severe cases of if oscillation, the picture will display a vertical-line interference pattern.

Another form of internal interference is sound bars in the picture. This can appear as a varying number of horizontal bars that change in number and intensity with the incoming audio modulation, or the familiar 4.5-mc fine-beat pattern. Generally the sound bars are the result of slope detection of the FM audio signal. Of course, these sound bars disappear when no sound is being transmitted or when the tuner is turned to an inactive channel. Sound bars on every active channel indicate poor if alignment—that is, the sound if carrier is given too much amplitude in the response curve. Many receivers have co-channel sound traps which can be adjusted to eliminate the sound bars.

Other causes of sound bars include microphonic tubes, with the vibration usually set up by the loudspeaker. A simple check on this is to lower the volume and observe if the bars disappear. Another check is to keep the volume up and remove the loudspeaker from the cabinet or the chassis. Microphonic tubes can usually be checked by simple tapping, while observing the picture. The defective tube can be anywhere in the video chain from the rf amplifier to video output. Only a microphonic video amplifier has the stage response to pass an audio signal on an inactive channel.

Sound bars only at high volume may also be caused by poor filtering of the audio output stage plate supply. Large swings in plate current modulate the

B-supply voltage and cause variations in picture brightness. This often gives the appearance of picture blinking rather than sound bars.

A 4.5-mc beat interference is the result of the video detector passing FM sound variations on to the video amplifier and picture tube. The over-200 black-and-white vertical lines so produced (4,500,000/15,750) give the appearance of a weaving herringbone pattern. The vertical lines are the result of the frequency, the weave the result of the FM audio variations. This trouble can be corrected by tuning the 4.5-mc sound trap or adding one in the video amplifier, or reducing the sound response in the if waveform.

Barkhausen oscillations are another form of local interference. These are produced in the horizontal output stage, radiated and picked up by the antenna input circuit. The effect is one or more vertical lines at the left side of the picture. They are most prominent on weak stations where the agc voltage is low and if gain is high. Cures consist of replacing the horizontal output tube, adjusting horizontal drive, dressing the antenna input lead away from the high-voltage compartment and adjusting an ion-trap magnet around the horizontal tube. Also check for a poor contact on the plate cap.

Aside from the previously mentioned sound bars, microphonics may affect the sound and the raster. Produced by mechanical vibrations which cause changes in circuit capacitances, microphonic stages create FM "signals" which easily pass the ratio detector and are heard at the loudspeaker. When produced in the sweep circuits, microphonics cause linearity changes in the vertical sweep and a pulling effect in the horizontal (very noticeable with a microphonic afc tube). Many sets in the field contain heavy lead slugs over the rf oscillator tube to dampen the mechanical vibration.

Microphonics is not limited to tubes—it can be caused by coils, capacitors and

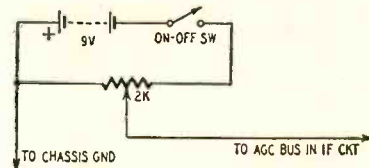

Fig. 2—Diagram of typical bias box.

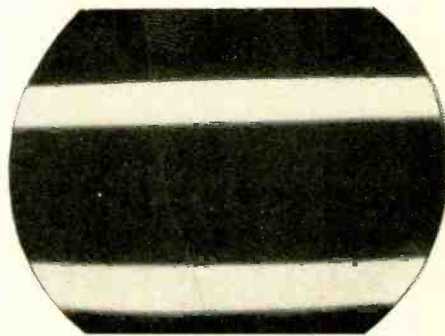

Fig. 3—Pattern produced by 120-cycle signal from full-wave power supply.



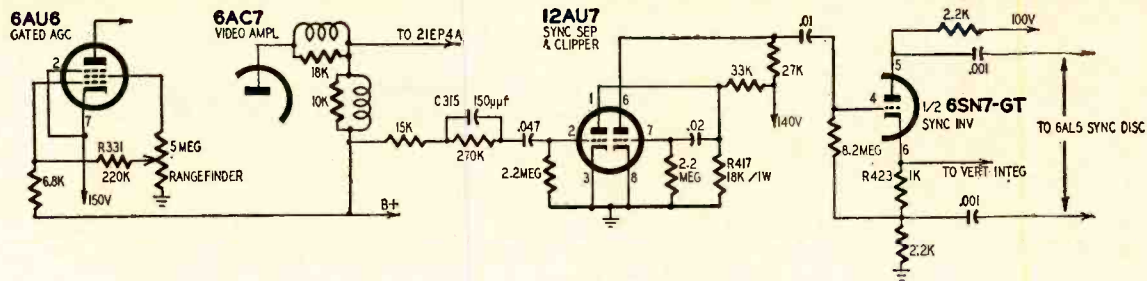

Fig. 4—Sync circuit in Admiral 22C2.

wiring, also. The solution is to cement offending coils and capacitors in place, and keep leads short and firm.

Other common forms of internal interference are hum and buzz, discussed in previous TV Clinic articles. A 60-cycle hum is usually caused by heater-cathode tube leakage and produces a broad horizontal bar in the picture or modulates the raster. Hum at 120 cycles is produced by a defect in the B-supply circuit and produces two horizontal bars or raster modulation as in Fig. 3. Buzz may be of the inter-carrier type, frequently caused by a detuned ratio detector; cross-modulation buzz, caused by an overloaded if stage; high-voltage buzz; vertical deflection buzz and mechanical vibration of transformers.

Frequently, horizontal streaking and "diathermy effect" are caused by high-voltage arcing. This is often difficult to isolate. The arcing produces radiations much like the Barkhausen oscillations. However, arcing can damage high-voltage components and must be located. Check all high-voltage wiring—avoid sharp bends, dress wires away from chassis or ground leads, smooth out solder connections and use high-voltage dope when in doubt.

On the older split-sound chassis there was occasionally a beat pattern in the picture on certain channels caused by sound if harmonics picked up by the rf amplifier. These can be checked easily by removing the last sound if amplifier. The interference does not vary with volume control settings. The best cure is wire dress and thorough grounding of the discriminator transformer.

There have been very few reports of if harmonic interference in intercarrier chassis. However, in weak-signal areas this is possible. For example, a set having an if of 25.75 mc will have its third harmonic at 77.25 mc, in the passband of channel 5. An if of 26.1 will produce a third harmonic of 78.3 mc, also possibly producing a beat pattern in channel 5. In each of these cases some relief may be had by realigning the if and oscillator at a slightly lower frequency. With sets using an if of 45.75 mc the fourth harmonic at 183 mc falls directly in the passband of channel 8 (180–186 mc). This type of interference can be spotted by varying the fine-tuning control which will cause a noticeable change in the interference pattern.

There are, of course, many other kinds of picture and raster distortions, but these are easily spotted by the service technician as not being external to the set. Thus, in an interference problem, first determine whether it is internal or external to the TV receiver.

### Improving sync

An Admiral 22C2 chassis has very poor vertical and horizontal sync. I live in a fringe area and this sort of thing is fairly common. However, the sync in this set is at a point where constant adjustments are necessary to maintain sync. I have a good antenna installation and get acceptable performance on other sets. The front end and the if amplifier have been carefully aligned and all tubes checked. The contrast range is all right and the brightness has plenty to spare.

B plus at the filament of the 5U4-G is 300 volts, just about normal for this set. The agc circuit seems to be working OK and so I have concentrated on the sync circuits. All parts have been checked and several replaced.—B. R.,

It is, of course, possible that there is nothing wrong with this chassis and the answer may be in a better antenna installation. All the symptoms point to less-than-ideal operation of the sync circuits. Thus, if you have thoroughly checked all components in these circuits you might try the following modifications: A change almost certain to help is to increase the plate voltage of the sync separator. This can be done by increasing the value of R417 (Fig. 4), part of a voltage divider which controls the pin 1 plate voltage. The present voltage is about 45. Increase R417 to about 70,000 ohms. This will provide a plate voltage of about 90 volts.

In many circuits similar to this, sync stability was improved by increasing the value of R423. It is now 1,000 ohms and should be increased to approximately 5,000 ohms. Often, the same or superior sync performance can be obtained by changing C315 from its present 150 µf to some larger value, perhaps about 500 µf. Which of these two methods is superior will have to be determined experimentally.

Getting away somewhat from this circuit, changing R331 in the screen grid circuit of the gated agc tube from its present value to approximately 500,000 ohms will reduce the agc voltage and provide better contrast and sync stability. In making the above changes

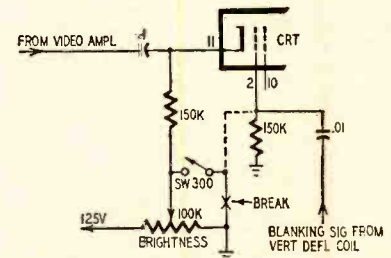

Fig. 5—Modified circuit of on-off switch saves brightness control in Westinghouse V-2344 TV chassis.

bear in mind that they are for fringe areas and may provide poor operation in strong signal areas.

### Beam eliminator

I have run into several cases where the brightness control was burned out in Westinghouse V-2344 chassis. On one receiver the pot was replaced twice. Another of these sets is in the shop now with the same trouble. Customers complain of often hearing a loud crack whenever the set is turned off. The brightness control circuit is designed to eliminate a bright spot on the screen when the set is turned off, and this it does very nicely.

I have checked for excessively high B voltages, but the pot is fed by a B voltage of 125, as per schematic. All other voltages measure properly and I would like to know why these controls are going bad and what can be done about it.—T. R., Des Moines, Iowa

As you say, the brightness control is in a beam-eliminator circuit and the wiring is not unusual. However, observe the operation of switch SW300 (Fig. 5), which is part of SW500, the on-off switch. When the set is turned on, SW300 is open and normal brightness control operation takes place—the closer the center arm is moved toward 125 volts, the greater the negative bias on the tube. When the set is turned off, SW300 closes, removing the positive voltage on the cathode. If the brightness control is set at a low level, the closing of SW300 places a small portion of the brightness pot between B plus and ground. The resultant arcing could burn out the brightness control.

The simple modification shown in broken lines in Fig. 5 would eliminate this trouble. Now, when the set is turned off and SW300 closes, the center arm of the brightness pot is connected to ground through the 150,000-ohm control-grid resistor.

END

## AUDIO—HIGH FIDELITY

Not so frequently used is the long-tailed pair or cathode-coupled inverter shown in Fig. 3-c. It is, in effect, a combination of grounded-cathode and grounded-grid sections. The upper section is a normal grounded-cathode amplifier obtaining its drive through the grid. The lower section is a grounded-grid amplifier obtaining its drive through the cathode. The current variations produced by the signal on the grid of the upper tube through the common cathode resistor also affect the plate current of the lower tube but in an opposite direction. Therefore, the two plates deliver signals 180° out of phase. This is one of the two finest inverters, well balanced because of the large common cathode resistor and providing almost normal gain. It is used in the Regency 300 amplifiers.

Not often used in commercial equipment but finding great favor in custom-built hi-fi amplifiers is the cross-coupled inverter shown in Fig. 4-a and used in the Childs, White and Golden Ear circuits. It is rather difficult to explain the operation of this inverter briefly. I think it is most easily understood if we look at the circuit of Fig. 4-b which consists of the input cathode follower and only one of the two cross-coupled tubes.

The second tube measures the voltage difference between the two cathodes of the input cathode follower. This is proportional to the signal applied to the two grids. Actually, this circuit is, in essence, a vtm. If we add the other

cross-coupled stage, we have another vtm but one which reads the difference in opposite phase. Therefore, the same signal will produce voltages of opposite phase at the plates of the two cross-coupled tubes.

The circuit has many other ramifications which are immaterial for the moment. It has the virtue of being completely balanced and dynamically self-balancing at all frequencies. Unlike the cathodyne and the long-tailed pair, the cathodes are at relatively low potentials and therefore hum problems are minimized. The cross-coupled inverter is often used in direct coupling to a driver stage for it permits excellent balance of two or more direct-coupled stages. In the Golden Ear circuit both the inverter and the driver stage are neutralized to extend high-frequency response.

The off grids of both the long-tailed pair and the cross-coupled inverter provide very convenient points for applying negative feedback. Because the inputs are uncritical as to resistance the feedback parameters are easily juggled to provide the best effect, particularly minimum ringing. It is possible to use the lowest tap on the output transformer and still maintain a high enough resistance so as not to load either the transformer or the circuit to which feedback is applied. This is highly desirable because the smaller the portion of the secondary used for feedback, the smaller the effective leakage reactance and therefore the greater the insurance against ringing and instability.

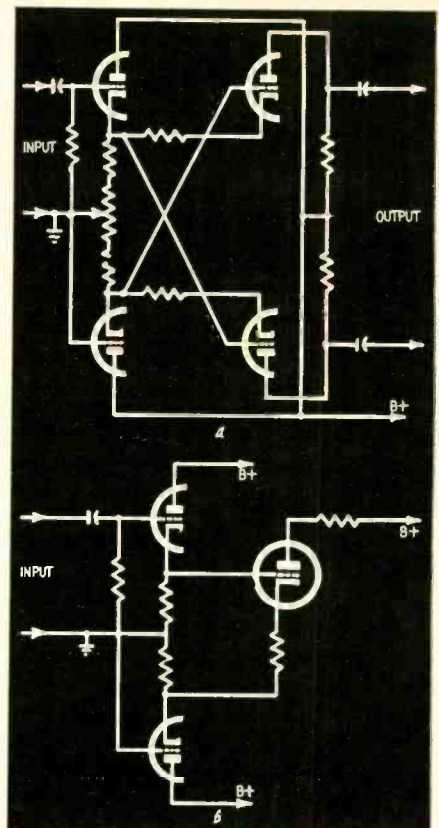

Fig. 4—Diagram shows circuit and simplification of cross-coupled amplifier.

The material in this article appears in part in the book *Maintaining Hi-Fi Equipment*, by Joseph Marshall (Gernsback Library No. 58).

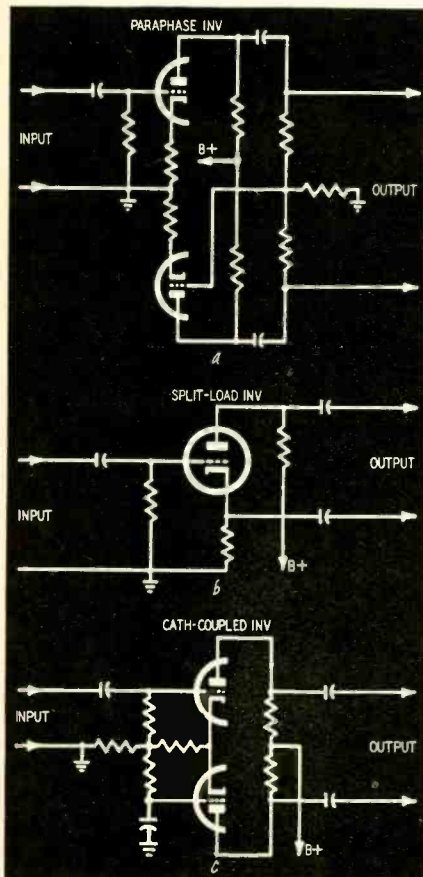

Fig. 3—Various inverter stages.

## VENDITOR CAVEAT EMPTOR

RADIO-ELECTRONICS has changed the old adage from "Let the Buyer Beware" to "Let the Seller Beware", particularly if he happens to be pushing substandard, used tubes.

Under our policy mail-order tube advertisers cannot advertise unless they warrant that their tubes are:

- New and unused
- Not mechanical or electrical rejects
- Not washed or rebranded  
(see page 57 January 1956 issue)

As far as we know, RADIO-ELECTRONICS is the only generally-distributed magazine in the industry which gives its readers this extra protection.



phase-  
swing  
**VIBRATO**  
easy  
to build  
and apply

By RICHARD H. DORF\*

ONE of the most important and appealing attributes of the music played on almost all instruments is either vibrato or tremolo. Tremolo is a regular variation in volume level and vibrato is a regular variation in frequency. Both take place at rates between about five and eight times per second and lend a very pleasant effect to the music. Tremolo (amplitude swing) is used in a few instruments where vibrato is impossible—reed organs (and the older Hammond organs), the harmonica and to some extent in pipe organs. Vibrato, however, is generally conceded to be much the pleasanter of the two and is employed wherever possible. The violinist's left hand is almost always moving rhythmically, for example, producing the vibrato frequency variations by continually changing the point where he stops a string.

Most electronic organs and similar electronic instruments produce vibrato by varying the voltage applied to one or more of the elements of the oscillator tubes. With the ordinary oscillator, varying the plate voltage will produce frequency change and this effect is used for vibrato. With other instruments, however, such as those in which the tones are provided by reeds, this is impossible. Either tremolo must be used or some other method arrived at for producing vibrato. The problem is general when it comes to sounds where the tone generators themselves cannot be varied in frequency—the electric guitar is an example. Amplifiers are used with guitars, but the best the amplifier maker has been able to do is insert a tremolo circuit which changes the gain of the amplifier at the proper rate to produce the necessary effect.

One way to solve the problem and produce a vibrato-frequency variation where the tone source itself cannot be tampered with is to use the phase-modulation principle of FM transmitters. A phase change can be detected

as a frequency change as long as the phase is continuing to change. Thus, if the phase of the audio signal, taken at any point in the system, can be kept swinging, the ear will hear apparent frequency changes. If the phase is swinging at the rate of five to eight times per second, the result is a vibrato. The larger the phase change, the greater will be the vibrato "depth" or frequency swing; the higher the rate of swing, the faster will be the vibrato.

This basic approach was first used by Hammond when the vibrato scanner (described in this magazine and in the writer's book *Electronic Musical Instruments*) was invented. This device consists of a long delay line composed of many filter elements into which the "straight" signal is fed. At each element junction the signal phase is somewhat altered. A number of stacked capacitor plates are connected to each junction and a motor-driven rotor passes through each set of stators the required number of times per second, picking up from each stator a signal somewhat different in phase. Output is a true frequency vibrato.

The first all-electronic circuit to do this job is used in the Wurlitzer electronic organ, which is operated from wind-driven reeds whose frequency cannot conveniently be varied for vibrato. In the Wurlitzer system, described in this magazine, a pair of permanent phase-shift circuits divides the signal into two paths, each of which has a phase which varies with frequency but so arranged that the phases of the two paths are always about 90° apart. Each of the two signals is fed to a grid of a duo-triode and the plates are tied together. A vibrato-frequency switching signal causes the two triodes to cut off and conduct out of phase so that first one and then the other signal predominates. The output signal thus swings over a phase range of 90°.

#### New Schober circuit

The circuit diagrammed in Fig. 1 was designed for the Schober electronic

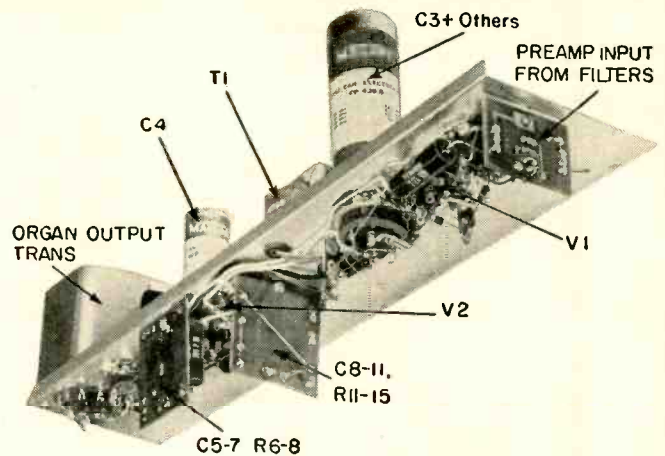

Preamplifier assembly of Schober electronic organ, assembled from kits, contains the vibrato circuit. Two printed-circuit cards hold oscillator components and frequency distribution networks.

organ kits by the writer. The Schober organ uses master-oscillator-frequency-divider tone generators. These were deliberately designed to be so stable that variation of tube-element voltages would cause no appreciable frequency swing. Varying the plate voltage of the master oscillators between 200 and 300 produces no audible change in pitch. The Schober tone generators are therefore on a par with other tone generators such as reeds or piano strings, in that vibrato cannot be produced by acting directly on them.

For this reason, vibrato must be produced by some system which will act on the tones at some point after they emerge from the generators. So far as is known, the only way of doing so is by using a phase-swing circuit.

The first thought was an arrangement such as was described for the Wurlitzer organ. This circuit was more complicated than necessary, using as it does five triodes as a minimum, plus two very complex phase-shift networks. In addition, the vibrato-frequency switching signal is applied to the grids of the switching triodes along with the signal and is harder to remove from the output because the resulting "signal-to-thump" ratio is rather low.

Research and development produced the circuit of Fig. 1, which may be used in any application where vibrato is desired and cannot be produced by acting directly on the tone generators. A maximum of four triodes is required and three is a sufficient number if low bass response is not important. The number of resistors and capacitors is limited and the space requirement is small. The vibrato-frequency signal is efficiently eliminated from the output without using any inductors or fancy feedback filters, and at the same time the vibrato effect is reduced at the low bass frequencies where it is generally acknowledged to be undesirable.

A familiar phase-shift circuit is diagrammed in Fig. 2. The signal passes through a capacitor which causes the

\* Electronics consultant, New York.

## AUDIO—HIGH FIDELITY

current to lead the voltage by an angle anywhere up to almost (but not quite)  $90^\circ$ . The leading current passes through the resistor, across which it creates a voltage drop. The resistive voltage drop is in phase with the current causing it so that the signal voltage across the resistor may be a maximum of almost  $90^\circ$  out of phase with the generator voltage. It would appear that by varying the capacitance or the resistance cyclically in some way, we could create a periodic phase swing which would give vibrato.

The fly in this particular jar of ointment, however, is that the circuit is entirely frequency-sensitive. The phase varies with the frequency—which would not be serious since we do not care what the actual phase is at any time as long as it is varying over a wide angle. But the circuit is also a high-pass filter so that, in frequency ranges where the resistance would be small enough with respect to the capacitive reactance to produce any appreciable phase change, the values would also produce an output varying with frequency at the rate of 6 db per octave! If the circuit were used nonetheless, with either the capacitance or resistance swinging in value, the output would vary along with the swings in value and we would get a very large percentage of amplitude modulation or tremolo, which is not desirable.

Fig. 3 shows a much more useful phase-shift circuit, noted by the writer in an article by R. C. Moses in the July, 1953, issue of *Radio-Electronic Engineering*. As originally used, the

purpose of the circuit was to aid in phase-angle measurements but it is ideal for vibrato use.

The signal is first divided into two parts which are  $180^\circ$  out of phase with respect to a center point. This can be done, as any technician knows, with a transformer having a center-tapped secondary. The circuit has two very important advantages. First, it is capable of phase swings of (theoretically) as much as  $180^\circ$ ; second, the output level remains constant regardless of frequency or phase angle.

The phase swing can easily be demonstrated without any mathematics by using the theory of extremes. Let us suppose first that the resistor has an infinitely large value while the capacitive reactance is finite. Assuming that the transformer secondary impedance is low and that the impedance of the load to which the output is connected is very high, the upper output lead is effectively connected directly to the top of the transformer winding. (The capacitive reactance has no appreciable voltage-dropping effect since negligible current is passing through it due to the high load resistance.) The lower output lead is connected to the transformer center tap. The output voltage therefore is taken directly from the upper half of the transformer and has the phase appearing on that half.

Let us now assume that the capacitor is so small as to have infinitely high reactance and that the resistor value is finite. The same situation prevails as before except that now the upper output lead is effectively connected to

the bottom half of the transformer and the output phase is opposite to what we obtained the first time. Obviously, then, by varying the values of the R and C we can obtain phase angles up to  $180^\circ$  apart. Of course, as a practical matter, neither R nor C

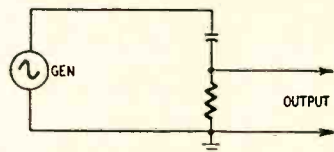

Fig. 2—The usual phase-shift circuit is frequency-sensitive.

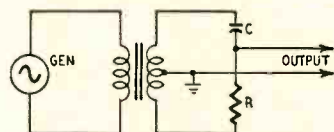

Fig. 3—Basic circuit shows how the new phase shifter operates. For other purposes a vacuum-tube phase splitter may be used instead of the transformer. Output amplitude is constant regardless of frequency or phase angle.

can be made to have infinite impedance so we cannot realize the theoretical maximum. However, phase swings of  $120^\circ$  or somewhat more are entirely practical. It is easy to see that there will be a phase angle midway between that across either half of the secondary when the impedances of R and C are equal and that the phase varies on either side of this value as one or the other impedance becomes lower.

The reason why the output level remains the same is also not hard to see without mathematics. Lowering the impedance of either the R or C element effectively brings the upper output lead closer to that end of the transformer winding nearest to the diminished impedance. At center phase, with both impedances equal, the output draws equally from both transformer halves. As the upper lead effectively moves closer to one end of the transformer, it also moves proportionately farther from the other, so constant output is maintained. It should be noted again, however, that this is true only when the transformer secondary impedance, including reflected impedance, effects from the primary, is low compared to either impedance across the secondary. If it is high, there will be enough voltage drop across the winding halves due to variation in current when the total impedance across the winding changes to upset matters somewhat.

The circuit of Fig. 3 is still frequency-sensitive in one respect—actual output phase. When the impedances of R and C are equal, output phase is midway between that of either half of the secondary. The reactance of C, however, depends on frequency. Therefore, this midway phase can be had at only one frequency for any one set of values for R and C. The effect is not important for vibrato use since a very large band of frequencies passing through the circuit still changes in

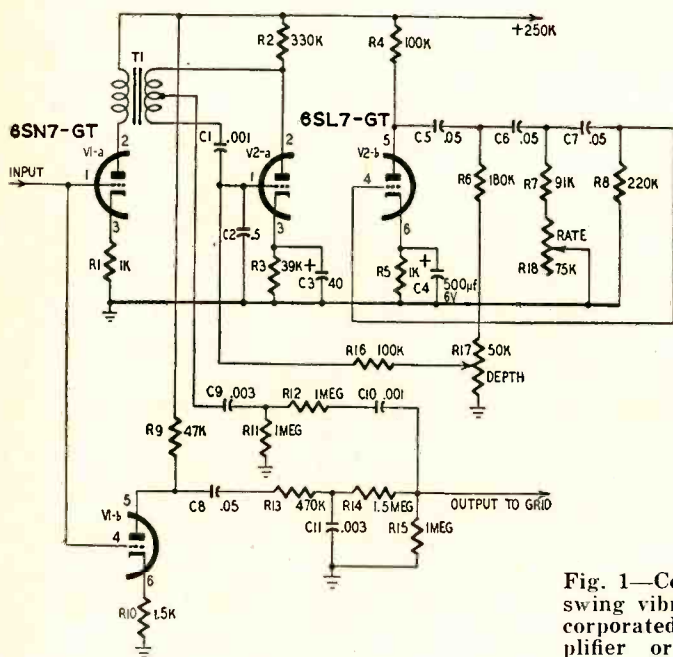

Fig. 1—Complete phase-swing vibrato can be incorporated in an amplifier or preamplifier.

(All resistors not otherwise stated,  $\frac{1}{2}$  watt. Capacitors may be 400 or 600 volts, preferably 600)

R1, R5—1,000 ohms  
R2—330,000 ohms  
R3—39,000 ohms  
R4, R16—100,000 ohms  
R6—180,000 ohms  
R7—91,000 ohms, 5%  
R8—220,000 ohms

R9—47,000 ohms  
R10—1,500 ohms  
R11, R12, R15—1 megohm  
R13—470,000 ohms  
R14—1.5 megohm  
R17—50,000-ohm pot, linear taper  
R18—75,000-ohm pot, linear taper  
C1, C10—.001  $\mu$ f  
C2—.05  $\mu$ f  
C3—40  $\mu$ f, 50 v  
C4—500  $\mu$ f, 6v

C5, C6, C7, C8—.05  $\mu$ f  
C9, C11—.003  $\mu$ f  
V1—6SN7-GT  
V2—6SL7-GT  
T1—Audio interstage transformer, single 10,000-ohm plate-to-push-pull grids, primary-to-half-secondary turns ratio 3:1 (Stancor A-4723 or equivalent).  
Sockets for tubes, wiring, chassis or boards, hardware, etc.

phase when an element is varied. Whether a particular frequency varies between  $50^\circ$  and  $80^\circ$ , for instance, or between  $70^\circ$  and  $100^\circ$  is not of great significance. The ear cannot tell what the phase of a signal is in relation to that of another signal; it can only tell that the phase is *changing*—and that information is detected as a frequency change. As long as we can produce changes of phase in signals over a wide frequency band, we have just what we need.

### The practical circuit

For vibrato purposes we must find a way of making either the resistance or capacitance vary widely at a rate between about five and eight times per second. Probably some method of doing that could be worked out with voltage-sensitive resistors or capacitors, but any such method immediately available is likely to be complex and expensive. The easy way is shown in Fig. 4.

In Fig. 4 the circuit of Fig. 3 is preserved with a small amount of rearrangement. The series capacitance and resistance are still placed across the center-tapped transformer secondary. However, they are interchanged from Fig. 3, with the capacitor connected to the bottom end of the winding. The important points are two. First, the resistor has been replaced by the plate resistance of a triode tube. Second, the ground has been switched from the transformer center tap over to the junction between the resistance and capacitance. The circuit is still the same, but the ground is in a convenient place for the tube and we now have an easily variable resistance.

The plate resistance—the effective resistance between plate and cathode—of a tube depends, if other factors are fixed, on the grid voltage. If the grid is positive, large current flows from cathode to plate, indicating low resistance. If it is negative, small current flows, indicating high resistance. The range of plate resistance available with a high- $\mu$  triode such as the 6SL7-GT is large and suitable for this use. The plate resistor, necessary to put positive supply voltage on the plate, is purposely made high (330,000 ohms, Fig. 1). It is effectively shunted across the plate-to-ground leg of the circuit and simply limits the maximum resistance available in this leg.

When a 5–8-cycle signal is applied to the grid, the plate resistance varies. Since the effect is exactly the same as would be produced by varying the resistor of Fig. 3, the signal output phase varies as well and we have obtained vibrato. The amplitude of the 5–8-cycle signal determines the effective frequency swing of the vibrato (usually called *width* or *depth*) and the exact frequency of the controlling signal determines the vibrato rate. Since both can easily be controlled, we have a vibrato circuit with full control of both factors, ideal for use in organs, guitars and special effects, etc.

### Construction

As used in the Schober electronic organ kits, the vibrato circuit is on the preamplifier chassis. The signal enters the vibrato section after passing through the tone-color filters and a one-stage preamplifier tube. The output of the circuit is fed to a potentiometer, the arm of which is connected to the grid of a 6J5 output stage. The output of the 6J5 feeds through a transformer to a 500-ohm line. Output level in the line is 2 volts maximum.

The diagram of Fig. 1 contains a few details not apparent from our previous discussions. V1-a is the input tube, plate-loaded by transformer T1 in accordance with Fig. 4. R1 is the cathode-bias resistor, which may be bypassed if more gain is required. The transformer can be any unit with suitable primary impedance and a fairly low secondary impedance, center-tapped. Among standard commercial units a Stancor A-4723 is suitable. This is a 10,000-ohm plate-to-push-pull-grounds unit with turns ratio of 3:1 of the primary to half the secondary. If the rolloff above about 6,000 cycles which this transformer gives cannot be tolerated, use a better-quality transformer.

V2-a is the triode shown in Fig. 4 and C1 is the capacitor. C1 is returned to the grid of V2-a rather than to ground directly for a good reason. The plate-current variations of V2-a which appear across R2 tend to go through to the circuit output and produce large movement of the speaker, decreasing its linearity and increasing distortion as well as being audible as a train of thumps. Since the V2-a vibrato-frequency grid signal is  $180^\circ$  out of phase with that on the plate, returning the lower end of the transformer winding to the grid has some effect in cancelling the low-frequency signal. C1 is effectively grounded for audio, however, and for phasing purposes, since C2 is practically a short circuit to ground for audio.

The vibrato-frequency oscillator is V2-b in a standard phase-shift circuit. Oscillator output is taken from a voltage divider made up from the two series resistors R6 and R17 which constitute the first shunt leg of the phase-shift circuit. R17 is a potentiometer and moving the arm upward sends more signal to the grid of V2-a, increasing vibrato depth. The vibrato rate is controlled by R18, which varies the size of the second shunt leg of the network. As this resistance is made smaller, rate rises. In the Schober organ a three-point switch is used instead of the potentiometers. There are two vibrato rates and two depths. Position 1 gives slow, shallow vibrato; position 2 a slow, deep vibrato; position 3 a vibrato fast and deep. This system is used because in actual organ playing there is usually not enough time between notes to make two potentiometer adjustments.

Despite the partial cancellation of

the vibrato-frequency switching signal obtained by connecting C2 to the tube grid, a good portion of it would go through to the output if output were taken directly from the transformer center tap. It is necessary, therefore, to divide the signal into two paths. One, taken from the transformer, contains the "vibrated" signal but attenuates that portion of it below about 100 cycles to eliminate the vibrato-frequency thumps. The other, taken from the input signal through V1-b supplies "unvibrated" the low-frequency portion missing from the first path.

The transformer center-tap output

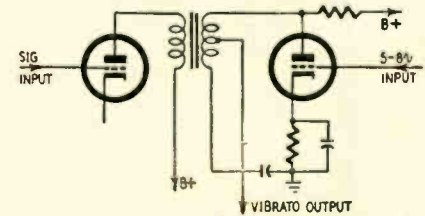

Fig. 4—Circuit of Fig. 3 rearranged for vibrato use.

signal passes through C9 and R11 as the first leg of a high-pass filter and, after isolation by R12 to avoid disturbing the slope of the curve, through C10 and R15 as the second leg. The output of V1-b passes through one low-pass element R13–C11. C8 is simply a dc blocking capacitor. The reason the two networks are not exactly complementary is that the bass appearing through the vibrato circuit has first been attenuated because T1 has not a particularly good bass response. More bass must be supplied by the V1-b circuit, therefore, than has been lost through the high-pass network. Both networks combine to give a flat response from 30 cycles up at the output point. In the Schober organ there is a rolloff due to the transformer at the upper frequencies but this is a part of the voicing of the organ. If it is not desirable, a higher-quality transformer can be used for T1 or an additional network can be taken from the plate of V1-b to add the highs.

The output of the circuit of Fig. 1 must be connected to an open grid; no blocking capacitor is required. Any appreciable impedance which would tend to shunt R15 will change the frequency response. If the level is to be adjustable, R15 can be made a potentiometer, with the arm connected to the following grid.

The circuit as a whole should be used at the latest possible point in the system to obtain the highest possible signal-to-noise ratio. Up to about 1 volt, or even more can be applied to the grid of V1-a. If it is desirable to have an off-on switch for vibrato, it should be a normally closed switch connected between the junction of R6 and R17 and ground. When this point is grounded, the oscillator stops and there is no vibrato. As soon as the point is ungrounded vibrato starts smoothly. END

# improving sound in AM radios

*Old sets can be modified  
to compete with  
good modern receivers*

By ALBERT STRATMOEN

AM radios usually fall short of high-fidelity standards, both as to frequency response and harmonic distortion. Sideband discrimination is, in most cases, a result of the small spacing between channels and cannot be remedied except for nearby stations whose signal overrides that of adjacent channels. Harmonic distortion, however, can be reduced greatly by careful design. This article describes the steps taken to minimize such distortion as well as hum in a pre-war radio, the Delco R-1118. The revised circuit, with shortwave bands omitted for simplicity, is shown in the diagram. The methods used can be easily adapted to other makes and models.

The improvement results from the following changes:

1. Sharp-cutoff pentodes in the rf and if stages to minimize modulation distortion.
2. A split-load diode detector whose output is balanced to ground, thus eliminating a phase-inverter circuit.
3. All push-pull audio stages to minimize hum and distortion.
4. Triode output tubes of adequate size, operating class A<sub>1</sub> for low distortion and constant plate voltage for all stages.

As many as possible of the original tubes and parts were used to cut costs. More modern tubes should be substituted if the originals are weak. This may require smaller sockets. I have used 6B4's in the output stage, even though they are not considered modern. They required no change of sockets or heater voltage. Otherwise I would have used 2A3's, which are still in good standing. The 6J7's have been manufactured for years but are still on the preferred list because of their excellent performance

as audio-frequency amplifiers. I consider them the best tubes for linear rf amplifiers too, but others such as the 6AU6 could be used.

Remote-cutoff tubes are usually recommended to minimize modulation distortion on strong signals where the *avc* voltage is high, but this improvement is achieved at the expense of linearity. A sharp-cutoff pentode is more linear at moderate values of bias. If we have the input signal under control so as to keep the *avc* bias from exceeding this limit, the sharp-cutoff tubes are definitely superior and the improvement in tone quality is noticeable.

Resistor R1, used in conjunction with the tuning eye, permits this. Except on very strong signals the control should be at maximum to permit proper *avc* action. Actually, in this case, the 6J7's behave like semiremote types as the screen voltage rises with the bias, thus tending to counteract the effect of the more negative grid without introducing curvature.

The second-detector circuit could be called a split-load diode. It contributes materially to the improvement in tone quality. At first glance it may seem to be a full-wave detector. This is not the case—the diodes are in series whereas in the push-pull detector they are back-to-back. A single diode could be used as

far as rectification is concerned but its capacitance to ground would unbalance the load. Germanium diodes could be used to advantage here as they have practically no capacitance to ground and no contact potential. Therefore, a single one could be used but it should have a high back resistance—at least 1 megohm. As these are fairly expensive, two cheaper ones could be used in series and they might as well be connected to opposite sides of the transformer secondary for symmetry. I recommend a Sylvania 1N35 double diode as superior to the 1N34. The diodes and filter could be built into the shield can both to save space and to provide shielding.

Note that this circuit is balanced for both rf and af, the balance depending only on matching of components. While it cannot be used as an inverter for audio amplifiers, it does seem to be ideal for radios. All the filter components as well as the load resistance should be matched. The balanced volume control is the weak point as dual units are seldom well balanced.

It is desirable, for at least two reasons, to have a high input voltage to the diodes—if possible, at least 10 volts. Rectification is more linear and ac loading is minimized. Ac loading simply means that the load on the diodes is lower for ac than for dc, due

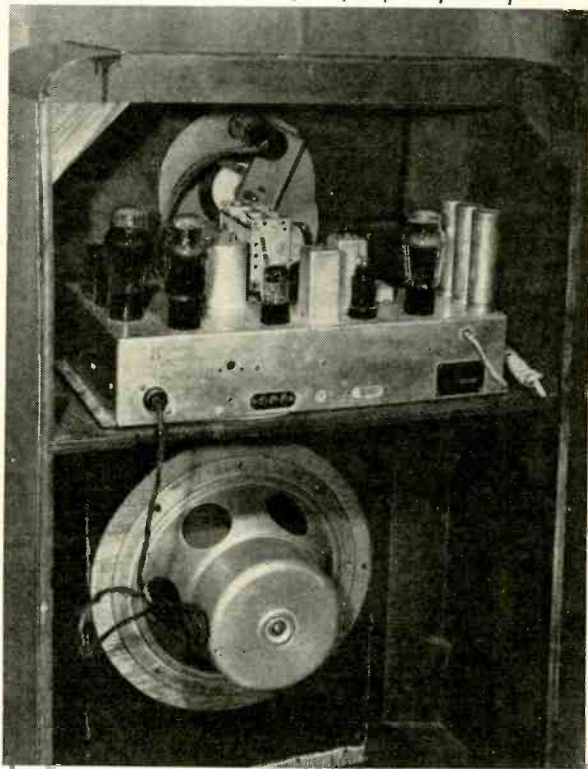

Rear view of pre-war Delco used as model, by author, for improving sound.

to some circuit that is coupled by capacitors. As a result, the diodes reach and exceed cutoff at high percentages of modulation, causing disagreeable distortion. The grid circuit of the 6C5's is an ac load but its effect is small, especially if the signal level is high enough to permit backing off the volume control.

The avc and tuning-eye circuits in most sets also contribute to ac loading but, by obtaining the voltage from the primary of the transformer, ac loading of the secondary is reduced. Resistor R2 prevents excessive loading of the primary which could cause some distortion. With the constants given, the avc voltage is satisfactory although it doesn't close the tuning eye. Because sharp-cutoff pentodes are more sensitive to grid-voltage change, avc action is about as good as conventional sets with remote pentodes and full-voltage avc.

Hum usually enters the signal in the audio stages, especially the first stage where high-impedance circuits carry small signals. The high detector output and all push-pull stages minimize hum to a remarkable degree. Both hum from the power supply as well as second-harmonic distortion balances out. Variable resistor R3 across the heater also helps to reduce hum.

I consider the 2A3 the finest audio tube available for outputs up to 10 watts. Its 6-volt counterparts, the 6A3 and octal-based 6B4-G, are not quite as good because of the greater heater voltage but they are still good tubes. Their low plate resistance acts as a brake on any spurious excursions of the speaker cone. Thus, feedback isn't necessary. This greatly simplifies design of the audio stages as response curves can be readily adjusted without fear of trouble from phase shift. I have purposely reduced the size of the blocking capacitors to minimize cabinet resonance which was noticeable on bass drumbeats. I have also used the original transformer. Both of these would

be out of the question if negative feedback around the output transformer were used. However, if one has a really good speaker system and a set that has provisions for broadening the response for local reception, the response should be made flatter. Larger blocking capacitors and a high-quality output transformer would accomplish that, although inverse feedback should be used for highest fidelity.

A push-pull class-A<sub>1</sub> output stage has lower distortion than any other type and the plate current is constant up to the point of grid-current flow. This helps to reduce distortion in all stages as the plate supply voltage is constant. In the case of the 6B4-G, class A<sub>1</sub> operation at 250 volts on the plate requires 60 ma per tube and a load resistance of 2,500 ohms per tube or 5,000 ohms plate to plate. The supply voltage should be 295 if self-bias is used and the bias resistor should be 375 ohms. Either less plate current or a lower plate load results in class-AB<sub>1</sub> operation. I have lowered the plate supply to 215 volts, increased the bias resistor to 425 ohms and thus maintained class-A<sub>1</sub> operation at 40 ma per tube. Maximum power output under these conditions is a little better than 3 watts but they certainly seem to carry a long way. A 250-volt supply will give a power output of better than 4 watts.

The full current from the rectifier goes through the speaker field. This field coil is 2,500 ohms and wasn't designed for that much current but it seems to be able to take it without getting hot. The increased field strength increases both sensitivity and quality. I believe the former makes up for the lower plate voltage so the quality increase is a bonus.

There is bound to be a loss of sensitivity as a result of these changes. The split-load detector cuts the signal voltage in half. The triode output tubes require at least twice the voltage swing that the original 6F6's needed. Also,

it is desirable to have an excess of signal at the input to the detector. Because of these factors it will usually be necessary to increase gain by some method. In my set it is still good, probably due to the sensitive speaker, but in many this will not be the case.

The best way to increase the signal is to use a good antenna. The increase then doesn't result in more noise, hum, instability or selectivity, all of which are undesirable for good fidelity. Another alternative is to add an untuned if stage between the first detector and the original if tube. There is some danger of oscillation when this is done, so the leads should be short. Decoupling may be necessary in the plate and screen supply as well as the avc return. Even a tuned stage could be used if all the transformers were adjusted to decrease selectivity—moving the coils closer together or detuning them should do this. However, one can get into a lot of oscillation troubles with three if transformers.

It is a good idea to do a complete rebuilding job when making these changes. All paper and electrolytic capacitors should be replaced. I scoured the chassis and the speaker frame, replaced the speaker grille and refinished the cabinet. Replacing the grille is an especially easy way to dress up an old set.

If there is a choice of sets to rebuild, try to find one with an rf stage, push-pull output stage and provision for broadening the response for local reception. If you cannot find one with all these features, you could probably get an if transformer with variable response. Many service technicians have junk radios around and some have this feature. Airline receivers manufactured from 1936 to 1940 had it in the larger models.

I believe that service technicians could increase their income and prestige by offering this service to their customers. END

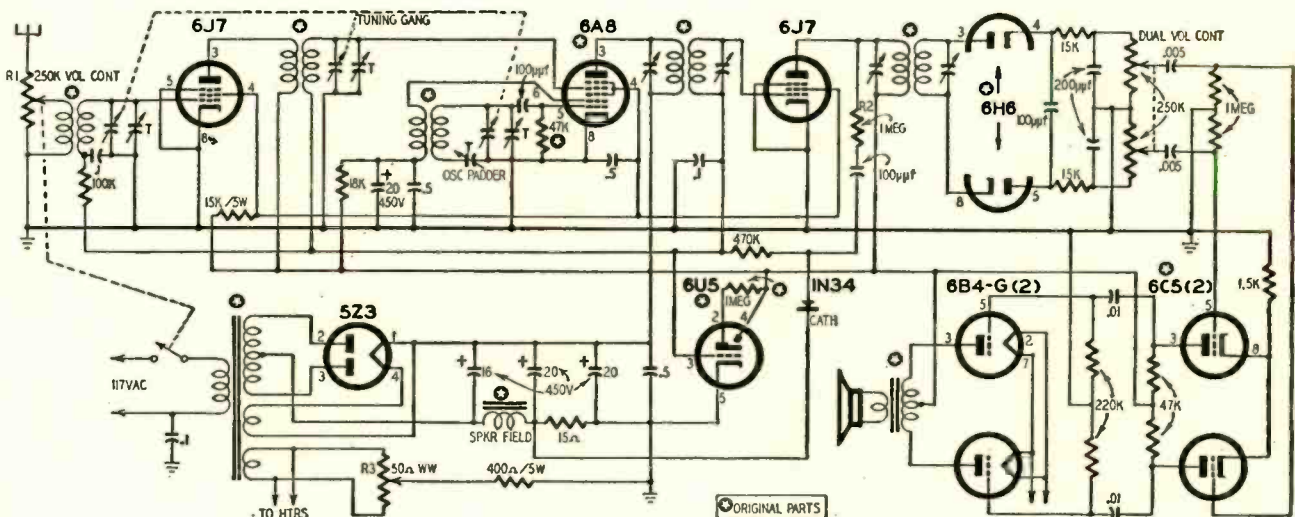

How the circuit of the Delco R-1118 looked after it was modified.



## Portable TV Pattern Generator

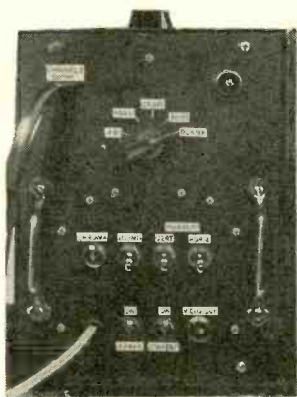

Part III—

*Adjustment details and  
operating notes on the versatile  
unit discussed last month*

By EARL T. HANSEN

**B**EFORE starting to adjust the generator check the supply voltages and make sure they are within about 20% of the values shown on the diagram. Then check all blocking oscillators with a scope to make sure they are at least oscillating at some frequency. If not, find out why. Try reversing one of the windings on the blocking oscillator transformer in question. If the winding is reversed it may oscillate at some high frequency but will not block.

The next step is to adjust the sine-wave stabilizing coils L4, L6 and L8. Turn the generator off and allow the tube cathodes to cool. The object is to adjust each of these coils to resonate about 5% higher than its operating frequency. This is done with the aid of an audio oscillator. This setting is approximate. The exact setting will be checked later. Connect the ground leads of the scope and audio oscillator to the generator chassis. Connect the scope probe to the cathode of V3-a (top of L4). Temporarily connect a 10,000-ohm resistor to the same point. Feed the output of the audio oscillator to the other end of the resistor. Adjust the audio oscillator to 34 kc. If in doubt as to the accuracy of the oscillator, set it a little higher. Start with the core of L4 all the way in and screw it out until a definite maximum is seen on the scope. Move the scope probe and resistor to the cathode of V3-b and L6. Set the audio oscillator to 17 kc and tune L6 for maximum. Repeat with L8, using a frequency of 4800 cycles. The audio os-

cillator can be set aside and the generator turned on.

The following adjustments must be made in proper sequence. You must be sure one stage is correct before going on to the next. A wide-band (4-mc) scope with a low-capacitance probe is a necessity. Connect the scope to the cathode of V1-a. Use a rather fast sweep rate (50 kc, positive sync). There may be some indication of oscillation in this stage although not at the crystal frequency. Start with the core fully within the coil. Adjust the slug of L1 until the scope shows a considerable increase in amplitude, indicating crystal resonance. The signal on the scope should look like Fig. 11. Adjust L1 for the highest and sharpest spikes.

Connect the external sync of the scope to the cathode of V1-a along with the low-capacitance probe and adjust the scope sweep until six pulses are present, including the one that triggers the sweep and may be lost in retrace.

Move the scope probe over to either plate of V2. Leave the scope sync on the cathode of V1 and do not change the sweep frequency. Adjust the scope attenuator and gain to show normal vertical deflection. Adjust R8 until there are three complete cycles of the 189-kc square wave on the scope. Adjust the control to the center of the lock-in range.

Remove the external sync to the scope and return to internal positive sync. Connect the scope probe to the junction of R70, C7 and D2. Remove V4 from its socket. Adjust R13 (31.5-

kc adjustment) until there are five small pulses between each of the larger ones, as in Fig. 12. This indicates that the oscillator is being triggered by every sixth pulse for proper frequency division. If the 31.5-kc oscillator seems unwilling to lock in steadily, disconnect one side of C10 temporarily. The random oscillation of V3-b may be triggering it erratically. There should be no trouble in getting it to lock in now.

Move the scope probe over to the cathode of a V3-a and check the waveform there. It should appear very much like that of Fig. 13.

Reconnect C10 and place the low-capacitance scope probe on the grid of V3-b. Adjust R16 until one pulse appears in the center of the grid discharge curve (Fig. 14).

L5 and L7 have adjustable powdered-iron cores. The core on L7 should be turned until fully within the coil. No further adjustment will be necessary. Turn L5 into the coil about halfway. The position of this core will affect the width of the horizontal pulse and the frequency of the blocking oscillator. Replace V4 in its socket. Connect the scope probe to the grid of V4-a and adjust R19 for six pulses on the grid discharge slope (Fig. 15). This indicates the seventh pulse is triggering the oscillator. The cathode sine-wave stabilizing waveform should appear about the same as in the two preceding stages. Move the scope to the grid of V4-b and adjust R22 for four pulses on the slope as in Fig. 16.

With the scope on the grid of V5-a,



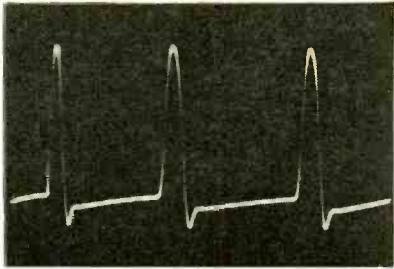

Fig. 11—Waveform at cathode of V1-a is about 10 volts peak-to-peak.

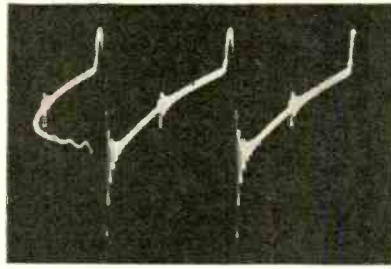

Fig. 14—Waveform at grid of V3-b. One pulse on grid discharge slope shows frequency division by 2.

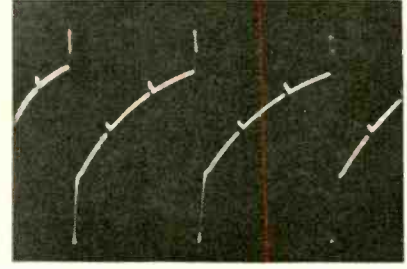

Fig. 17—Waveforms at grid of V5-a.

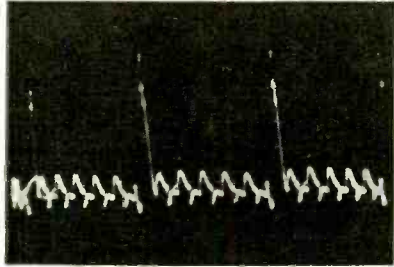

Fig. 12—Signal at junction of R70 and C70. Five pulses between each large pair indicates frequency division by a factor of 6.

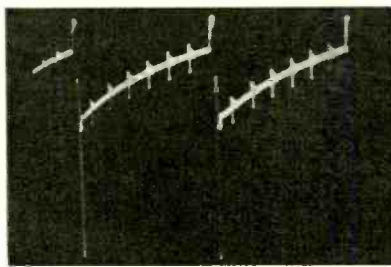

Fig. 15—Signal at grid of V4-a. Six pulses on slope show frequency division by factor of 7.

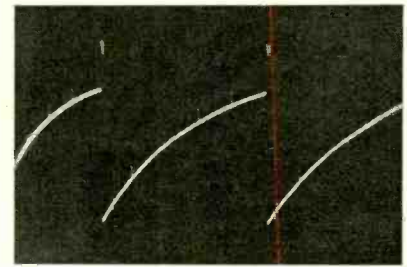

Fig. 18—Pattern shows division by 5 at grid of 60-cycle oscillator.

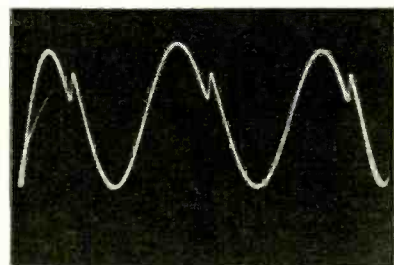

Fig. 13—Typical waveform across cathode coils of V3-a, V3-b and V4-a. Pip on upper part of downward slope occurs when the blocking oscillators conduct.

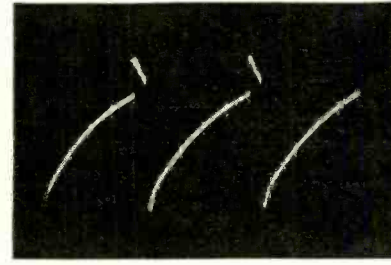

Fig. 16—Four pulses on V4-b's grid waveform show a countdown of 5-to-1.

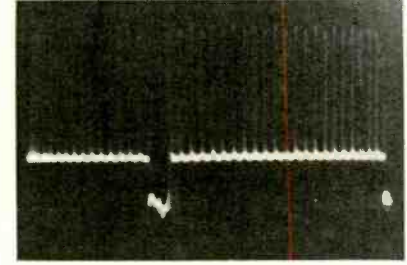

Fig. 19—Waveform at video output with generator set for vertical lines and 7,875-cycle sweep.

adjust R25 for two pulses on the slope as in Fig. 17.

Place the probe on the grid of V5-b. Adjust R28 for four pulses on the slope as shown in Fig. 18. Connect the scope once more to the junction of C7 and R70 and, if necessary, readjust R13 for the proper frequency division.

For this and any future adjustments it should not be necessary to remove tubes or otherwise disable circuits. Proceed to check and readjust each succeeding stage as before. Set each control in the center of its lock-in range. Do not adjust the cathode stabilizer coils at this time.

Turn the generator off and let the tubes cool. Remove crystals 3 and 4. Check the resonant frequencies of L9 and L10 with a grid dip meter. Each coil should tune several megacycles either side of its respective crystal frequency. Prune if necessary.

Replace the crystals and turn the generator on. Connect a vtvm to the grid of V10-b. Be sure there is an isolating resistor in the probe. Start with the core of L10 all the way out and slowly turn it in until a negative voltage is indicated on the vtvm (set to 10-volt scale). This indicates oscillation. Keep

turning the core until voltage drops abruptly. Back the core out about  $\frac{1}{4}$  turn beyond the point where oscillation resumes. If oscillation is indicated regardless of the core position, the 2-turn feedback winding is coupled too tightly to the plate winding and the spacing should be increased. If it fails to oscillate at all, increase the coupling or check the phasing of the winding.

It is possible to obtain strong oscillation on the third instead of the fifth harmonic of the crystals if the core is turned in too far. Keep this in mind. Turn the sound switch on, move the vtvm to the grid of V10-a and adjust L9 in the same manner as L10 above. These crystal oscillator circuits are not the one suggested on the instruction sheet with the crystals. However, the crystal manufacturer has approved them for use with these low-power harmonic crystals when the plate voltage is kept below approximately 75. The accuracy of these crystals was found to be far better than the guaranteed .01%.

Connect the rf output of the generator to a field-strength meter. Switch the sound carrier off. Temporarily ground the pin 7 of the 6CS6 tube

(V9). Tune the field-strength meter to the channel-3 picture carrier. The reading should be well over 10,000  $\mu$ v. Turn the sound carrier oscillator on. Tune the field-strength meter to this carrier and adjust the twisted-wire gimmick (C46) until the output voltage indicates about one-half the picture carrier value.

If no field-strength meter is available, twist the two ends of the insulated wire for about  $\frac{1}{8}$  inch. Remove the ground from the pin 7 of V9. Connect the 300-ohm output lead to the antenna terminals of a monochrome receiver. Switch sound, chroma and markers off. Set the function switch for vertical lines (position 1). By adjusting the fine tuning of the receiver, a series of vertical lines should be seen, as in Fig. 4 (Part I). If the lines are steady, frequency adjustments of V1, V2 and V3 can be assumed to be correct. Fig. 19 shows the waveform at the video output terminal.

Set the function switch for horizontal lines. The pattern of Fig. 5 (Part I) should be seen. If so, circuit adjustments for V4 and V5 are correct.

Switch to CROSSHATCH and see the pattern shown in Fig. 6 (Part I).

## TEST INSTRUMENTS

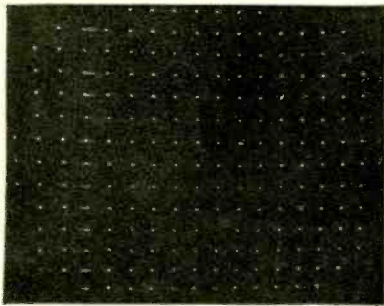

Fig. 20—Typical dot display.

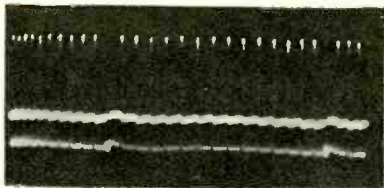

Fig. 21—Proper sync-to-video ratio. Signal from TV video detector, scope sweep speed is 30 cycles.

There should be no weaving and interlace should be good. The high modulation level of the generator makes it necessary to reduce the contrast and brightness somewhat to see the scanning-line structure clearly to check interlace.

Switch to BLANK. If the set has dc coupling or restoration, the raster will be dark; otherwise it will be light gray. Set the function switch to DOTS. Adjust fine tuning, brightness and contrast for dots like those in Fig. 20. If the dots are weak or missing, increase the value of R40. If vertical or horizontal lines appear in the background, decrease the value R40 by shunting with a higher value resistor.

Connect the scope probe to the video detector load resistor in the receiver. Set the function switch for horizontal lines. Set the scope sweep speed to 30 cycles. Waveforms similar to Fig. 21 should be seen. Compare the amplitude of the vertical sync pulse to the spikes (video). The sync pulses should be approximately one-fourth the total peak-to-peak amplitude of the signal on the scope. If the sync is too great, lower the value of R54. If the sync is short, increase the value of this resistor.

Switch the generator to standby and tune in a regular TV station on the receiver. With the scope sweep set to half the horizontal rate (7,875 cycles), carefully note the width of normal horizontal sync pulses. Switch the generator on and compare the width of these horizontal pulses with those from the station. The pulse width in the generator can be decreased slightly by turning the core of L5 out a few turns. Adjust R16 to restore sync to the generator. Conversely, the pulse can be widened by turning the core into the coil more. It is important that the horizontal pulse be the correct width. If it is too wide, it may blank out a portion of the chroma burst. If too narrow, it will not gate agc circuits properly with resultant receiver overloading.

If the scope has an expanded sweep, compare the width of the vertical sync pulse from the generator (Fig. 22) with that of a TV station. However, the width of the vertical pulse is not at all critical, provided it is wide enough to insure good vertical lock at the receiver. The vertical pulse width is determined by the value of C21 and the inductance of T4.

Set the function switch for the crosshatch pattern. Connect the scope to the cathode of V3-a. Adjust the core of L4 for maximum amplitude on the scope. Then back the core out (decrease inductance) until the signal on the scope is approximately two-thirds the maximum. This will be the permanent setting. Adjust R13, if necessary, to restore the normal crosshatch pattern on the receiver screen.

Move the scope probe to the cathode of V3-b and adjust L6 and R16 the same as above. With the scope probe on

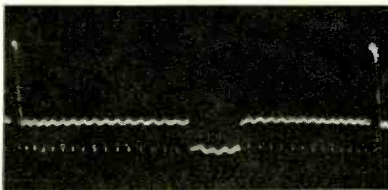

Fig. 22—Signal of Fig. 21 expanded 10 times to show correct width of the vertical sync pulse.

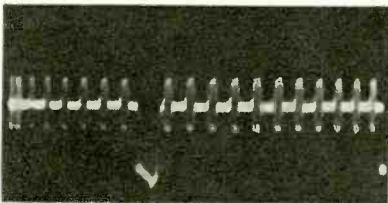

Fig. 23—Color bar waveform at video output jack. Unit set to BLANK with chroma on. Scope speed 7,875 cycles.

the cathode of V4-a, repeat with L8 and R19. By constantly monitoring the pattern on the receiver screen it is easy to see when one circuit is out of adjustment and just as easy to reset the adjustment to the center of the lock-in range. Check each of the other potentiometer adjustments and note the effect of the pattern when each is misadjusted. Connect the scope probe to the video out test point (J1). Adjust the scope sweep to 7,875 cycles and set the generator function switch to BLANK. Switch the chroma on. The color bar pattern of Fig. 23 should be seen. Adjust L3 for maximum amplitude of the chroma bursts. Note that the first burst should closely follow the sync pulse. If the sync pulse is delayed slightly, cutting into the burst pulse, try a slight readjustment of R16 and possibly R13 to shift the horizontal pulse to the left of the actual burst sync.

Connect the generator to a color set and observe the color bar pattern. Use a set with the wide-band I-Q system if possible. If the bars show a different color on the leading or trailing edge of each bar compared to the center, re-

adjust L3 to eliminate this phase shift caused by the gating transient.

This completes the adjustment. The generator should then be aged by operating for about 24 hours, after which the potentiometer adjustments should be checked to see that they are set to the midpoint of the lock-in range. It is unlikely that future adjustment will be necessary, unless tubes or other components are changed.

### Operation

The sound and chroma should be turned off when using the generator for dots and lines. This allows the display to be sharpened by the fine-tuning control without running into beat interference (Fig. 3-b, Part I). The actual use of the color bar pattern in color receiver adjustment and trouble shooting has been covered in service manuals and in many previous publications. For this reason only this brief explanation. Do not use excessive contrast or chroma settings on the receiver. If the set is properly adjusted, the 3d bar will be bright red, the 6th blue and the 10th green (see Fig. 3-a, Part I). Since the output of the generator is quite high, it may be necessary to reduce the agc setting very slightly on some sets to prevent overload.

To check picture centering, both markers are added to the blank raster. Use a straightedge and a marking pencil and make an X in the center of the TV set safety glass. When the picture is properly centered, the X will fall on the dark bar to the right of the bright bar. Vertically it should lie midway between the two central horizontal lines. (See Fig. 24.)

The video output terminal provides composite video information at a level and polarity equal to that in the average TV receiver's video detector. This signal can be fed directly to the grid of the video amplifier for signal substitution and tracing. Although the output connector used is associated with shielded cable, a single *unshielded* lead should be used to transfer the signal if the chroma information is to be retained. A shielded cable has too much capacitance. A separate ground clip should of course be used to connect the two chassis. END

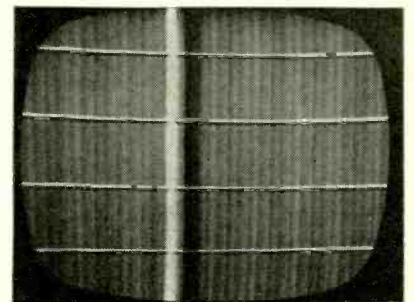
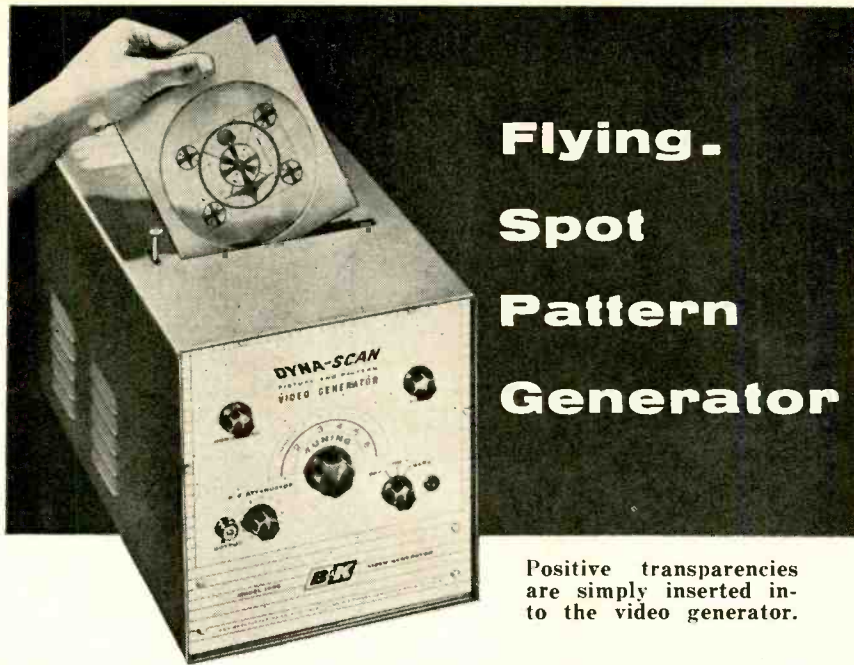

Fig. 24—Blank raster with vertical and horizontal markers on. Dark bar to right of bright one indicates raster center, horizontally. Vertically, center, is midway between second and third horizontal lines.



## Flying-Spot Pattern Generator

Positive transparencies are simply inserted into the video generator.

*Useful new service instrument reproduces a 3x4-inch positive transparency*

By ROBERT F. SCOTT

TECHNICAL EDITOR

TEST equipment manufacturers are constantly developing new instruments and improving old types to enable the service technician to provide better and faster service. A recent test instrument to hit the market is the radically new B&K Dyna-Scan 1000 picture and pattern generator.

The Dyna-Scan 1000 is a versatile flying-spot type picture and pattern generator reproducing any 3 x 4-inch positive transparency. As a servicing instrument it may be used to check linearity, contrast, age action, sync stability, bandwidth and resolution in monochrome and color sets. It supplies white dots and bars for adjusting and checking static and dynamic color convergence.

Outside of the servicing field it may be used with several receivers to form an inexpensive closed-circuit TV chain for advertising stores, and for visual paging in hospitals, at conventions and other gatherings. It can also be used as a modulator for amateur TV transmissions.

In a flying-spot scanner the bright unmodulated raster of a cathode-ray tube is used as a light source. The scene to be transmitted is on a transparency—similar to a photograph negative—placed between the C-R tube

screen and a sensitive phototube. As the electron beam scans the screen, more or less light passes through the transparency and reaches the phototube. The varying light is converted to a pulsating dc and used to modulate an rf carrier or is fed directly to the video amplifier in a receiver or monitor.

A part of the deflection voltages used to produce the raster in the scanner is fed directly to or used to synchronize the sweep and blanking circuits in the receiver or monitor to reproduce the scene or pattern being generated.

### The Dyna-Scan circuit

Fig. 1 is a partial block diagram of the model 1000 video generator. The vertical and horizontal oscillator and output circuits develop the sweep and blanking signals to produce the raster on the scanner screen. The vertical oscillator is synchronized with the 60-cycle power line to improve stability and minimize jitter in the picture.

Light from the raster passes through the transparency or slide and strikes the cathode of the phototube. The video signal available at the output is mixed with sync and blanking signals and modulates the rf oscillator output.

Horizontal oscillator V4 (Fig. 2) is a conventional cathode-coupled multi-

vibrator stabilized by a ringing circuit consisting of L and C13. Its frequency is varied over a narrow range by the HORIZONTAL control, a 50,000-ohm potentiometer, to sync it with the horizontal oscillator in the receiver or monitor. The output of V4 drives a horizontal output circuit just like that in many TV sets. The flyback pulses are rectified to produce 13 kv for the second anode of the scanner tube. Pulses from the secondary of the width coil are applied to the grid of modulator V2-a and used as sync pulses.

Vertical oscillator V3-a is a blocking type circuit synchronized with the power line by pulses taken from one side of the rectifier plate winding on the power transformer. The vertical output stage (V3-b) and its size and linearity controls are standard TV type circuits. C28 and R48 take a part of the signal from the plate of V3-b and convert it into sharp pulses on the modulator grid for sync and blanking. Pulses from the vertical output stage are also applied to the cathode of the scanner tube to blank the raster during the retrace time.

### Built-in linearity check

Linearity of the sweep circuits in the Dyna-Scan can be checked by built-in vertical and horizontal bar generators that produce a crosshatch pattern on the screen of the scanner tube. When S1 is thrown to BARS, horizontal bars are generated by the NE-2 neon tube in a relaxation oscillator circuit synchronized to the power line through the vertical oscillator. The number of bars is set with the HORIZONTAL BARS control. Vertical bars are formed by blocking oscillator V9 synchronized with the horizontal sweep circuit by a voltage tapped off the plate of V4-b. The signal from the NE-2 oscillator is applied to the grid and the signal from V9 is fed to the cathode of the scanner tube.

(Continued on page 80)

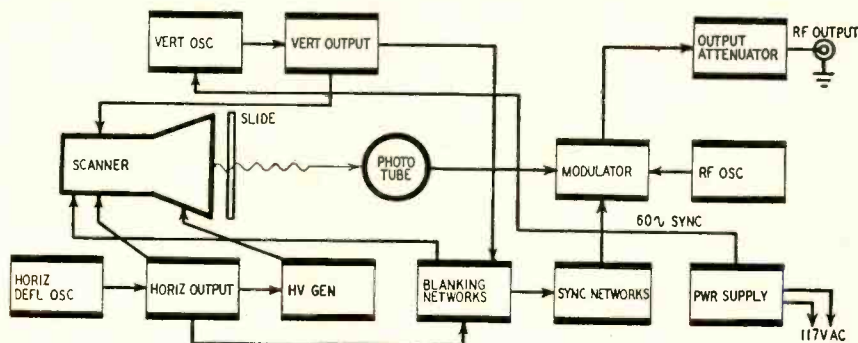

Fig. 1—Partial block diagram shows stage layout of the generator.

New



MODEL O-11  
Shpg. Wt.  
21 Lbs.

\$69<sup>50</sup>

- \* An improved model of what was already an outstanding instrument.
- \* Performance is unmatched in this price range.
- \* Incorporates the extra features required for color TV servicing.

*Extra!*

**A FULL YEAR TO PAY**

SEND FOR DETAILS OF HEATH  
TIME-PAYMENT PLAN.

**5  
BIG  
REASONS  
WHY**



**HEATH  
COMPANY**

A SUBSIDIARY OF DAYSTROM, INC.

**BENTON HARBOR 20, MICH.**

**HEATHKIT ETCHED CIRCUIT, PUSH-PULL**

## 5" Oscilloscope Kit COLOR TV

The previous Heathkit oscilloscope (Model O-10) which was already a most remarkable instrument, has been improved even further with the release of the Heathkit Model O-11. It incorporates all the outstanding features of the preceding model, *plus* improved vertical linearity, better sync stability, especially at low frequencies, and much-improved over-all stability of operation, including less vertical bounce with changes in level. These improvements in the Model O-11 circuit make it even more ideally suited for color TV servicing, and for critical observations in the electronic laboratory. Vertical response extends from 2 CPS to 5 MC without extra switching. Response only down 2.2' DB at 3.58 MC. The 11-tube circuit features a 5UP1 cathode-ray tube. Sync circuit functions effectively from 20 CPS to better than 500 kc in five steps. Modern etched circuit boards employed in the oscilloscope circuit cut assembly time almost in half, permit a level of circuit stability never before achieved in an oscilloscope of this type, and insure against errors in assembly. Both vertical and horizontal output amplifiers are push-pull. Built-in peak-to-peak calibrating source — step-attenuated input — plastic molded capacitors and top-quality parts throughout — pre-formed and cabled wiring harness — and numerous other "extra" features. A professional instrument for the servicershop or laboratory. Compare its specifications with those of scopes selling in much higher price brackets. You can't beat it!

**1 FEWER DOLLARS BRING MORE REAL QUALITY.**

- Factory-to-you sales eliminate extra profit margin.
- "Build-it-yourself" eliminates labor charge.
- Heath purchasing power cuts component costs.

**2 PERSONAL SERVICE ASSURES CUSTOMER SATISFACTION.**

- You deal directly with the manufacturer.
- We are interested in you before and after sale.

# Heathkits®

**ARE YOUR BEST BUY...**

**3 PROVEN DESIGNS MEAN RELIABLE PERFORMANCE.**

- Research and development efforts concentrated on kits only.
- All kits guaranteed to meet advertised specifications.

**4 EVERY KIT BACKED BY WORLD-WIDE REPUTATION.**

- The world's largest manufacturer of electronic equipment in kit form.
- Producer of more than a million electronic kits for the home workshop and industry.

**5 EASY TIME-PAYMENT PLAN TO FIT YOUR BUDGET.**

New HEATHKIT ETCHED CIRCUIT

# 5" Oscilloscope Kit

- \* Brand new model with improved performance specifications.
- \* Full 5" scope for service work at a remarkably low price.
- \* Attractively styled front panel in charcoal gray with sharp white lettering.
- \* Easy to build from step-by-step instructions and large pictorials. Not necessary to read schematic.

**GREATEST SELECTION . . .**

Whether your particular special interest is in servicing, ham-radio, high-fidelity, or just experimenting—there are Heathkits to fill your needs. You can equip an entire service shop or lab, buy a complete ham station or high-fidelity system, or set up a really deluxe home workshop, by choosing from the more than 70 different "do-it-yourself" electronic kits by Heath. Just glance through the kits displayed in this ad, and you will get some idea of the tremendous array of low-priced, high-quality electronic equipment available.

This new and improved oscilloscope retains all the outstanding features of the preceding model, but provides wider vertical frequency response, extended sweep-generator coverage, and increased stability. A new tube complement and improvements in the circuit make these new features possible. Vertical frequency response is essentially flat to over 1 mc, and down only 1½ DB at 500 kc. The sweep generator multivibrator functions reliably from 30 to 200,000 CPS, almost twice the coverage provided by the previous model. Deflection amplifiers are push-pull, and modern etched circuits are employed in critical parts of the design. A 5BP1 cathode-ray tube is used. The scope features external or internal sweep and sync, one volt peak-to-peak reference voltage, 3-position step-attenuated input, adjustable spot-shape control, and many other "extras" not expected at this price level. A calibrated grid screen is also provided for the face of the CRT, allowing more precise observation of wave shapes displayed. The new Model OM-2 is designed for general application wherever a reliable instrument with good response characteristics may be required. Complete step-by-step instructions and large pictorial diagrams assure easy assembly.



MODEL OM-2  
**\$42<sup>50</sup>**

Shpg. Wt.  
21 Lbs.

## HEATHKIT LOW CAPACITY PROBE KIT

Oscilloscope investigation of high frequency, high impedance, or broad bandwidth circuits encountered in television requires the use of a low-capacity probe to prevent loss of gain, circuit loading, or waveform distortion. The Heathkit low-capacity probe may be used with your oscilloscope to eliminate these effects. It features a variable capacitor, to provide correct instrument impedance match. Also, the ratio of attenuation can be varied.

No. 342

**\$3<sup>50</sup>**

Shpg. Wt. 1 Lb.

## HEATHKIT ELECTRONIC SWITCH KIT

This handy device allows simultaneous oscilloscope observation of two signals by producing both signals, alternately, at its output. It features an all-electronic switching circuit, with no moving parts. Four switching rates are selected by a panel switch. Provides actual gain for input signals, and has a frequency response of ± 1 DB from 0 to 100 kc. Sync output provided to control and stabilize scope sweep. Will function at signal levels as low as 0.1 volt. This modern device finds many applications in the laboratory and service shop. It employs an entirely new circuit, and yet is priced lower than its predecessor.

MODEL S-3 J

**\$21<sup>95</sup>**

Shpg. Wt. 8 Lbs.

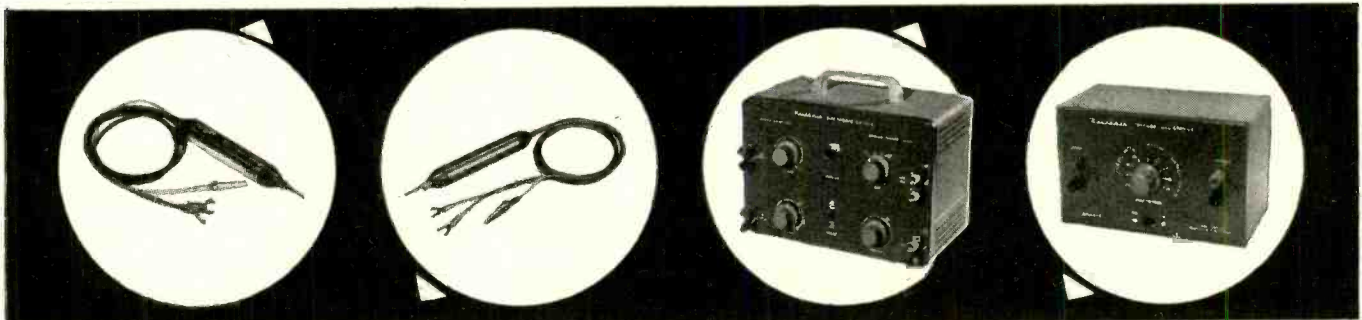

## HEATHKIT SCOPE DEMODULATOR PROBE KIT

Extend the usefulness of your oscilloscope by employing this probe. Makes it possible to observe modulation of RF or IF carriers found in TV and radio receivers. Functions much like an AM detector to pass only modulation of signal, and not the signal itself. Among other uses, it will be helpful in alignment work, as a signal tracer, and for determining relative gain. Applied voltage limits are 30 volts (RMS) and 500 volts DC. It uses an etched circuit board to simplify assembly.

NO. 337-C

**\$3<sup>50</sup>**

Shpg. Wt. 1 Lb.

## HEATHKIT VOLTAGE CALIBRATOR KIT

This entirely new voltage calibrator produces near-perfect square wave signals of known amplitude. Precision 1% attenuator resistors assure accurate output amplitude, and multivibrator circuit guarantees good, sharp square waves, as distinguished from clipped sine waves. Output frequency is approximately 1000 CPS. Fixed outputs selected by panel switch are: .03, 0.1, 0.3, 1.0, 3.0, 10, 30, and 100 volts peak-to-peak. Allows measurement of unknown signal amplitudes by comparing to known peak-to-peak output of VC-3 on an oscilloscope. Will also double as a square wave generator at 1000 cycles for determining gain, frequency response, or phase-shift characteristics of audio amplifiers. Equally valuable in the laboratory or in radio and TV service shops.

MODEL VC-3

**\$12<sup>50</sup>**

Shpg. Wt. 4 Lbs.

## HEATHKIT ETCHED CIRCUIT VACUUM TUBE



MODEL  
V-7A

**\$24.50**

Shpg. Wt.  
7 lbs

- \* Easy to build — a pleasure to use.
- \* 1% precision resistors employed for high accuracy.
- \* Etched circuit board cuts assembly time in half.

## Voltmeter Kit

The fact that this instrument is the world's largest-selling VTVM says a great deal about its accuracy, reliability, and overall quality. The V-7A is equally popular in the laboratory or service shop, and represents an unbelievable test equipment bargain, without a corresponding sacrifice in quality. Its appearance reflects the performance of which it is capable. A large 4½" panel meter is used for indication, with clear, sharp calibrations for all ranges. Front panel controls consist of a rotary function switch and a rotary range selector switch, zero-adjust, and ohms-adjust controls. Precision 1% resistors are used in the voltage divider circuits and etched circuits are employed for most of the circuitry. This makes the kit much easier to build, eliminates the possibility of wiring errors, and assures duplication of laboratory instrument performance. This multi-function VTVM will measure AC voltage (rms), AC voltage (peak-to-peak), DC voltage, and resistance. There are 7 AC (rms) and DC voltage ranges of 0-1.5, 5, 15, 50, 150, 500, and 1500. In addition, there are 7 peak-to-peak AC ranges of 0-4, 14, 40, 140, 400, 1400, and 4000. 7 ohmmeter ranges provide multiplying factors of X1, X10, X100, X1000, X10K, X100K, and X1 megohm. Center-scale resistance readings are 10, 100, 1000, 10K, 100K ohms, 1 megohm, and 10 megohms. A DB scale is also provided. The precision and quality of the components used in this VTVM cannot be duplicated at this price through any other source. Model V-7A is the kind of instrument you will be proud to own and use.

### HEATHKIT Etched Circuit RF PROBE KIT

This RF probe extends the frequency response of any 11-megohm VTVM so that it will measure RF up to 250 megacycles within ± 10%. Employs printed circuits for increased stability and ease of assembly. Ideal for extending service and laboratory applications of your Heathkit VTVM.

No. 309-C  
**\$3.50**

Shpg. Wt. 1 lb.

### HEATHKIT 20,000 OHMS/VOLT VOM KIT

Sensitivity of this instrument is 20,000 ohms-per-volt DC and 5,000 ohms-per-volt AC. Measuring ranges are 0-1.5, 5, 50, 150, 500, 1500, and 5000 volts for both AC and DC. Also measures current in the ranges of 0-150 microamperes, 15 ma, 150 ma, 500 ma, and 15 a. Resistance ranges provide multipliers of X1, X100, and X10,000, resulting in center scale readings of 15, 15,000, and 150,000 ohms. DB ranges cover from -10 db to +65 db. Housed in attractive black bakelite case with plastic carrying handle, this fine instrument provides a total of 25 meter ranges on its two-color scale. It employs a sensitive 50 microampere, 4½" meter and features all 1% precision multiplier resistors. Requires no external power, and is, therefore, valuable in portable applications where no AC power is available.

MODEL MM-1  
**\$29.50**

Shpg. Wt. 6 lbs.

### ETCHED CIRCUIT PEAK-TO-PEAK PROBE KIT

Use this peak-to-peak probe with your 11-megohm VTVM to measure peak-to-peak voltages directly on the DC scales of the instrument. Will measure p-to-p voltages in the frequency range of 5 kc to 5 mc. Employs etched circuit boards for increased circuit stability and simplified construction. Extend the usefulness of your VTVM. NOTE: Not required for the Heathkit V-7A VTVM.

No. 338-C  
**\$5.50**

Shpg. Wt. 2 lbs.



### HEATHKIT 30,000 VOLT DC HIGH VOLTAGE PROBE KIT

This probe provides a multiplication factor of 100 on the DC ranges of the Heathkit 11-megohm VTVM. Precision multiplier resistor mounted inside the two-color plastic probe body. Plenty of insulation for completely safe operation, even at highest TV potentials. Designed especially for TV service work.

No. 336  
**\$4.50**

Shpg. Wt. 2 lbs.

### HEATHKIT HANDITESTER KIT

The Model M-1 measures AC or DC voltage at 0-10, 30, 300, 1000, and 5000 volts. Direct current ranges are 0-10 ma, and 0-100 ma. Ohmmeter ranges are 0-3000 (30 ohm center scale) and 0-300,000 ohms (3,000 ohms center scale). Uses a 400 microampere meter for sensitivity of 1000 ohms-per-volt. A very popular test device for the home experimenter, electricians, and appliance repairmen, and for use as an "extra" instrument in the service shop. Its small size and rugged construction make it perfect for any portable application. Easily slips into your tool box, glove compartment, coat pocket, or desk drawer. Top quality, precision components employed throughout.

MODEL M-1  
**\$14.50**

Shpg. Wt. 3 lbs.



**HEATH COMPANY**  
A Subsidiary of Daystrom, Inc.  
BENTON HARBOR 20, MICH.

# Voltmeter Kit

- \* Brand new circuit for extended frequency response and added stability.
- \* Ten accurate ranges from 0-.01 to 0-300 volts.
- \* Modern, functional panel styling. "On-off" switch at both extreme ends of range switch.



MODEL AV-3  
**\$29<sup>95</sup>**

Shpg. Wt.  
5 Lbs.

## CONTROLLED QUALITY . . .

Incoming parts inspection, and inspection of material coming off of our own production line assures you of the finest "build-it-yourself" kit that money can buy. Each kit contains all the components you need for assembly—and you can have confidence in the quality of the parts themselves. In addition to this inspection procedure, an extensive proof-building program for each new kit guarantees easy-to-follow instructions and reliable performance.

This brand new AC vacuum tube voltmeter emphasizes stability, broad frequency response, and sensitivity. It is designed especially for audio measurements, and low-level AC measurements in power supply filters, etc. Employs a cascode amplifier circuit with cathode-follower isolation between the input and the amplifier, and between the output stage and the preceding stages. An extremely stable circuit with high input impedance (1 megohm at 1000 CPS). Response of the AV-3 is essentially flat from 10 CPS to 200 kc, and is usable for tests even beyond these frequency limits. Increased damping in the meter circuit stabilizes the meter for low frequency tests. Nylon insulating bushings at the input terminals reduce leakage, and permit the use of the 5-way Heath binding post.

The extremely wide voltage range covered by the AV-3 makes it especially valuable not only in high-fidelity and service work, but also in experimental laboratories. AC (RMS) voltage ranges are 0-.01, .03, .1, .3, 1, 3, 10, 30, 100, and 300 V. Decibel ranges cover -52 DB to +52 DB. An entirely new circuit as compared to the previous model. Employs 1% precision multiplier resistors for maximum accuracy. Handles AC measurements from a low value of one millivolt to a maximum of 300 volts.

## HEATHKIT AUDIO WATTMETER KIT

This instrument measures audio power directly at 4, 8, 16, or 600 ohms. Load resistors are built in. Covers 0-5 MW, 50 MW, 500 MW, 5 W, and 50 W full scale. Provides 5 switch-selected DB ranges covering from -10 DB to +30 DB. Large 4½" 200 microampere meter and precision multiplier resistors insure accuracy. Frequency response is ± 1 DB from 10 CPS to 250 kc. Functions from AC power line. Use in the audio laboratory or in home workshop.

MODEL AW-1

**\$29<sup>50</sup>**

Shpg. Wt. 6 Lbs.

## HEATHKIT AUDIO ANALYZER KIT

This multi-function instrument combines an AC VTVM, an audio wattmeter, and an intermodulation analyzer into one case, with combined input and output terminals and built-in high and low frequency oscillators. The VTVM ranges are .01, .03, .1, .3, 1, 3, 10, 30, 100, and 300 volts (RMS). Wattmeter ranges are .15 MW, 1.5 MW, 15 MW, 150 MW, 1.5 W, 15 W, 150 W. IM scales are 1%, 3%, 10%, 30%, and 100%. Provides internal load resistors of 4, 8, 16, or 600 ohms. A valuable instrument for the engineer or serious audiophile.

MODEL AA-1

**\$49<sup>95</sup>**

Shpg. Wt. 13 Lbs.

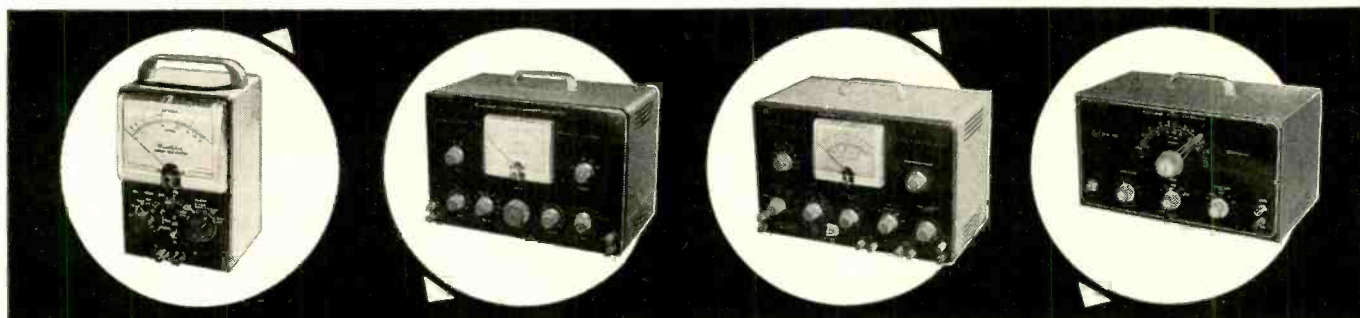

## HEATHKIT HARMONIC DISTORTION METER KIT

The HD-1 is equally valuable for the audio engineer or the serious audiophile. Used with a low-distortion audio signal generator, this instrument will measure the harmonic content of various amplifiers under a variety of conditions. Functions between 20 and 20,000 CPS, and reads distortion directly on the panel meter in ranges of 0-1, 3, 10, 30, and 100 percent full scale. Built-in VTVM for initial reference settings and final distortion readings has voltage ranges of 0-1, 3, 10, and 30 volts. 1% precision resistors employed for maximum accuracy. Features voltage regulation and other "extras". Meter calibrated in volts (RMS), percent distortion, and DB.

MODEL HD-1

**\$49<sup>50</sup>**

Shpg. Wt. 13 Lbs.

## HEATHKIT AUDIO OSCILLATOR KIT

Producing both sine waves and square waves, the Model AO-1 covers a frequency range of 20 to 20,000 CPS in three ranges. An extra feature is thermistor regulation of output for flat response through the entire frequency range. AF output is provided at low impedance, and with low distortion. Produces good sine waves, and good, clean square waves with a rise time of only two micro-seconds for checking square wave response of audio amplifiers, etc. Designed especially for the serviceman and high-fidelity enthusiast. A real dollar value in test equipment.

MODEL AO-1

**\$24<sup>50</sup>**

Shpg. Wt. 10 Lbs.

## HEATHKIT



MODEL  
AG-9

**\$34<sup>50</sup>**

Shpg. Wt.  
8 Lbs.

- \* Less than 0.1% distortion — ideal for hi fi work.
- \* Large 4½" meter indicates output.
- \* Step-type tuning for maximum convenience.

# Audio Generator Kit

This particular audio generator is "made to order" for high fidelity applications. It provides quick and accurate selection of low-distortion signals throughout the audio range. Three rotary selector switches on the front panel allow selection of two significant figures and a multiplier for determining audio frequency. In addition, it incorporates a step-type output attenuator and a continuously variable attenuator. Output is indicated on a large 4½" panel meter calibrated in volts and in db. Attenuator system operates in steps of 10 db, corresponding with the meter calibration. Output ranges are 0-.003, .01, .03, .1, .3, 1, 3, and 10 volts rms. A "load" switch provides for the use of a built-in 600 ohm load or an external load of higher impedance when required. Output and frequency indicators accurate to within  $\pm 5\%$ . Distortion is less than .1 of 1% between 20 cps and 20,000 cps. Total range is 10 cps to 100 kc. New engineering details combine to provide the user with an unusually high degree of operating efficiency. Oscillator frequency selected entirely by the switch method means that accurate resetability is provided. Comparable to units costing many dollars more, and ideal for use in critical high fidelity applications. Shop and compare, and you will appreciate the genuine value of this professional instrument.

### HEATHKIT RESISTANCE SUBSTITUTION BOX KIT

The RS-1 contains 36 10% 1-watt resistors ranging from 15 ohms to 10 megohms in standard RETMA values. All values are switch-selected for use in determining desirable resistance values in experimental circuits. Many applications in radio and TV service work.

MODEL RS-1  
**\$5<sup>50</sup>**

Shpg. Wt. 2 Lbs.

### HEATHKIT CONDENSER SUBSTITUTION BOX KIT

This kit contains 18 RETMA standard condenser values that can be selected by a rotary switch. Values range from 0.00001 mfd to 0.22 mfd. All capacitors rated at 400 volts or higher. Capacitors are either silver-mica, or plastic molded.

MODEL CS-1  
**\$5<sup>50</sup>**

Shpg. Wt. 2 Lbs.

### HEATHKIT AUDIO GENERATOR KIT

The Model AG-8 is a low cost, high performance unit for use in service shop, or home workshop. It covers the frequency range of 20 cps to 1 mc in five ranges. Output is 600 ohms, and overall distortion will be less than .4 of 1% from 100 cps through the audible range. Output is available up to 10 volts, under no load conditions, and output remains constant within  $\pm 1$  db from 20 cps to 400 kc. A five-step attenuator provides control of the output. Precision resistors are employed in the frequency determining network.

MODEL AG-8  
**\$29<sup>50</sup>**

Shpg. Wt. 11 Lbs.

### HEATHKIT DECADE CONDENSER KIT

Precision, 1% silver-mica capacitors are employed in the Model DC-1 in such a way that a selection of precision capacitor values is provided ranging from 100 mmf (.0001 mfd) to 0.11 mfd (110,000 mmf) in 100 mmf steps. Extremely valuable in all types of design and development work. Switches are ceramic wafer types.

MODEL DC-1  
**\$16<sup>50</sup>**

Shpg. Wt. 3 Lbs.

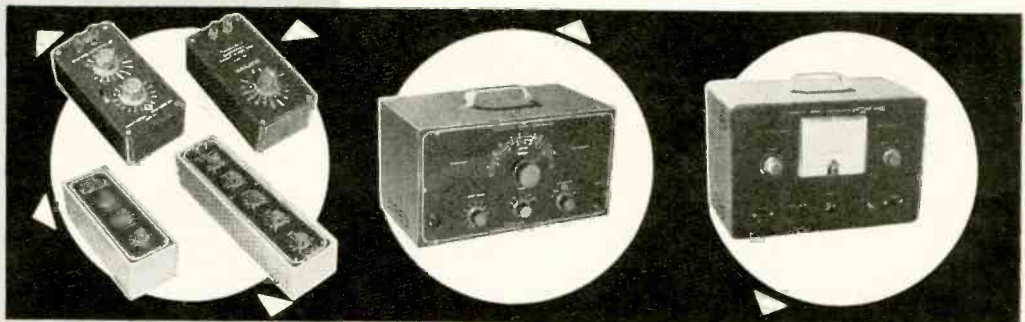

### HEATHKIT DECADE RESISTANCE KIT

The Model DR-1 incorporates twenty 1% precision resistors arranged around five rugged switches so that various combinations of switch positions will provide a total range of 1 ohm to 99,999 ohms in 1-ohm steps. Switches are labeled "units," "tens," "hundreds," "thousands," and "ten thousands." Use it for ohm-meter calibration in bridge circuits as test values in multiplier circuits, etc.

MODEL DR-1  
**\$19<sup>50</sup>**

Shpg. Wt. 4 Lbs.

### HEATHKIT VARIABLE VOLTAGE REGULATED POWER SUPPLY KIT

This power supply is regulated for stability, and the amount of DC output available from the power supply can be controlled manually from zero to 500 volts. Will provide regulated output at 450 volts up to 10 ma, or up to 130 ma at 200 volts output. In addition to furnishing B-plus, the power supply provides 6 volts AC at 4 amperes for filaments. Both the B-plus output and the filament output are isolated from ground. Ideal power supply for use in experimental work in the laboratory, the home workshop, or the ham shack. Large 4½" panel meter indicates output voltage or current.

MODEL PS-3  
**\$35<sup>50</sup>**

Shpg. Wt. 17 Lbs.



**HEATH COMPANY**  
A Subsidiary of Daystrom, Inc.  
BENTON HARBOR 20, MICH.



### BONUS PERFORMANCE . . .

If a single word had to be selected to describe Heath Company advertising policy, it would be "conservative." By this we mean that the performance specifications and features are not exaggerated, and that the descriptions are accurate. We specify performance on the conservative side so you can be sure of equaling or exceeding our specifications. In almost every instance our kits will do more than we claim. Extra care in construction, and calibration against an accurate standard can extend performance well beyond advertised levels.

## HEATHKIT

# Signal Generator Kit

- \* No calibration required with pre-aligned coils.
- \* Modulated or unmodulated RF output.
- \* 110 mc to 220 mc frequency coverage.

Here is an RF signal generator for alignment applications in the service shop or the home workshop. Thousands of these units are in use in service shops all over the country. Produces RF signals from 160 kc to 110 mc on fundamentals on five bands. Also covers from 110 mc to 220 mc on calibrated harmonics. RF output is in excess of 100,000 microvolts at low impedance. Output is controllable with a step-type and a continuously variable attenuator. Front panel controls provide selection of either unmodulated RF output or RF modulated at 400 cps. In addition, two to three volts of audio at approximately 400 cps are available at the output terminals for testing AF circuits. Employs a 12AU7 and a 6C4 tube. Built-in power supply uses a selenium rectifier.

One of the most outstanding features about the Model SG-8 is the fact that it can be built in just a few hours, even by one not thoroughly experienced in electronics work. Complete step-by-step instructions combined with large pictorial diagrams assure successful assembly. Pre-aligned coils make calibration from an external source unnecessary.



MODEL SG-8

**\$19<sup>50</sup>** Shpg. Wt. 8 Lbs.

### HEATHKIT LABORATORY GENERATOR KIT

This laboratory RF signal generator covers from 100 kc to 30 mc on fundamentals in five bands. The output signal may be pure RF, or may be modulated at 400 cycles from 0 to 50%. Provision for external modulation has been made. RF output available up to 100,000 microvolts. Output controlled by a fixed step and a variable attenuator. Output impedance is 50 ohms. Panel meter reads RF output or percentage of modulation. Incorporates voltage regulated B+ supply, double shielding of oscillator circuits, copper plated chassis, and other "extras."

MODEL LG-1

**\$48<sup>95</sup>**

Shpg. Wt. 16 Lbs.

### HEATHKIT TV ALIGNMENT GENERATOR KIT

This improved sweep generator model provides essential stability and flexibility for work on FM, monochrome TV, or color TV sets. Covers 3.6 mc to 220 mc in four bands. Provides usable output even on harmonics. Sweep deviation from 0-42 mc, depending on base frequency. All-electronic sweep circuit eliminates unwieldy mechanical arrangements. Includes built-in crystal marker generator providing output at 4.5 mc and multiples thereof, and variable marker covering 19 to 60 mc on fundamentals and from 57 to 180 mc on harmonics. Effective two-way blanking.

MODEL TS-4A

**\$49<sup>50</sup>**

Shpg. Wt. 16 Lbs.

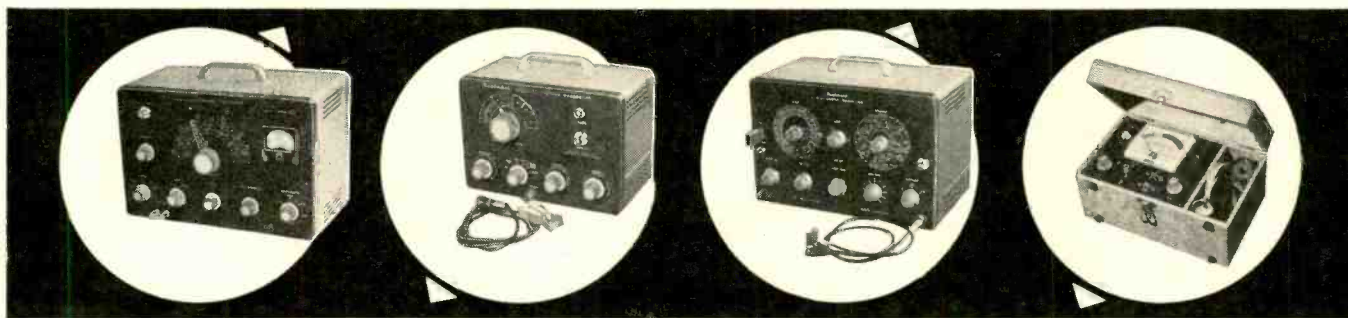

### HEATHKIT LINEARITY PATTERN GENERATOR KIT

This instrument supplies information for white dots, cross-hatch pattern, horizontal bar pattern, or vertical bar pattern. It feeds video and sync signals to the set under test, with completely controlled gain, and unusual stability. Covering channels 2 to 13, the LP-2 will produce 5 to 6 vertical bars and 4 to 5 horizontal bars. The dot pattern presentation is a *must* for the setting of color convergence controls in the color TV set. Panel provision made for external sync if desired. Use for adjustment of vertical and horizontal linearity, picture size, aspect ratio, and focus. Power supply is regulated for added stability. Essential in the up-to-date TV service shop.

MODEL LP-2

**\$22<sup>50</sup>**

Shpg. Wt. 7 Lbs.

### HEATHKIT CATHODE RAY TUBE CHECKER KIT

This instrument checks cathode emission, beam current, shorted elements, and leakage between elements in electro-magnetic picture tube types. It eliminates all doubt for the TV serviceman, and even more important, for the customer. Features its own self-contained power supply, transformer operated to furnish normal test voltages for the CRT. Employs spring-loaded switches for maximum operator protection. Large 4½" meter indicates CRT condition on "good-bad" scale. Luggage-type portable case ideal for home service calls. Special "shadowgraph" test permits projection of light spot on screen. Also gives relative check of picture tube screen coating.

MODEL CC-1

**\$22<sup>50</sup>**

Shpg. Wt. 10 Lbs.

## HEATHKIT



MODEL  
TC-2

**\$29<sup>50</sup>**

Shpg. Wt.  
12 Lbs.

- \* Attractive counter-style cabinet.
- \* Wiring-harness simplifies assembly.
- \* Large 4½" meter with two-color "good-bad" scale.
- \* Separate tube element switches prevent obsolescence.

## Tube Checker Kit

This fine piece of test gear checks tubes for quality, emission, shorted elements, open elements, and filament continuity. Will test all tube types normally encountered in radio and TV service work. Sockets provided for 4, 5, 6, and 7-pin large, rectangular, and miniature types, octal and loctal types, the Hytron 9-pin miniatures, and pilot lamps. Condition of tubes indicated on a large 4½" meter with multi-color "good-bad" scale. An illuminated roll chart is built right in, providing test data for various tube types. This tester provides switch selection of 14 different filament voltage values from 0.75 volts to 117 volts. Individual switches control each tube element. Close tolerance resistors employed in critical test circuits for maximum accuracy. A professional instrument both in appearance and performance.

The Model TC-2 is very simple to build, even for a beginner. It employs a color-coded cable harness for neat, professional under-chassis wiring. Comes with attractive counter style cabinet, and portable cabinet is available separately. At this price, even the part-time serviceman can afford his own tube checker for maximum efficiency in service work.

### HEATHKIT TV PICTURE TUBE TEST ADAPTER

Designed especially for use with the Model TC-2 tube checker. Use it to test TV picture tubes for emission, shorts, etc. Consists of 12-pin TV tube socket, 4 ft. cable, octal connector, and necessary technical data. Not a kit.



MODEL 355

**\$4<sup>50</sup>**

Shpg. Wt.  
1 Lb.

### HEATHKIT PORTABLE TUBE CHECKER KIT

This portable tube checker is identical, electrically, with the Model TC-2. However, it is housed in an attractive and practical carrying case, finished in proxylon impregnated material. The cover is detachable, and the hardware is brass plated. This rugged unit is ideal for home service calls or any portable application.



MODEL  
TC-2P

**\$34<sup>50</sup>** Shpg. Wt.  
15 Lbs.

### HEATHKIT VISUAL-AURAL SIGNAL TRACER KIT

Although designed primarily for radio receiver work, this valuable instrument finds extensive application in FM and TV servicing as well. Features a high-gain channel with demodulator probe, and a low-gain channel with audio probe. Will trace signals in all sections of a radio receiver and in many sections of a FM set or TV receiver. Uses built-in speaker and electron beam eye tube for indication. Also features built-in wattmeter and a noise locator circuit. Provision for patching speaker and/or output transformer into external set.

MODEL T-3

**\$23<sup>50</sup>**

Shpg. Wt. 9 Lbs.

### HEATHKIT DIRECT READING CAPACITY METER KIT

Operation of this instrument is simplicity itself. One has only to connect a capacitor to the terminals, select the proper range, and read the capacity value directly on the large 4½" meter calibrated in mmf and mfd. Ranges are 0 to 100 mmf, 1,000 mmf, 0.01 mfd, and 0.1 mfd full scale. Precision calibrating capacitors supplied. Not susceptible to hand capacity effects. Residual capacity less than 1 mmf. Especially valuable in production line checking, or in quality control.

MODEL CM-1

**\$29<sup>50</sup>**

Shpg. Wt.  
7 Lbs.



### HEATHKIT CONDENSER CHECKER KIT

The Model C-3 consists of an AC powered bridge for both capacitive and resistive measurements. Bridge balance is indicated on electron beam eye tube, and capacity or resistance value is indicated on front panel calibrations. Measures capacity in four ranges from .00001 mfd to .005 mfd, .001 mfd to .5 mfd, .1 mfd to 50 mfd, and 20 mfd to 1000 mfd. Measures resistance in two ranges, from 100 ohms to 50,000 ohms, and from 10,000 ohms to 5 megohms. Selection of five different polarizing voltages for checking capacitors, from 25 volts DC to 450 volts DC. Checks paper, mica, ceramic, and electrolytic capacitors. Indicates power factor of electrolytic condensers.

MODEL C-3

**\$19<sup>50</sup>**

Shpg. Wt. 7 Lbs.



**HEATH COMPANY**  
A Subsidiary of Daystrom, Inc.  
BENTON HARBOR 20, MICH.

**PIONEER DESIGN . . .**  
 New and unique approaches to instrument and equipment designs are a Heath Company tradition. We concentrate all our development efforts on kit projects, since this is our prime activity—and not just a sideline. This logically results in more efficient, more reliable circuit designs—and you benefit from this constant engineering progress. Buying from the undisputed leader in the electronic kit field assures you of completely modern equipment, with outstanding advanced design features.

**HEATHKIT**

**Impedance Bridge Kit**

- \* ½% precision resistors and silver-mica capacitors.
- \* Battery-type tubes, no warm-up required.
- \* Built-in phase shift generator and amplifier.

The Model IB-2 is a completely self-contained unit. It has a built-in power supply, a built-in 1000 cycle generator, and a built-in vacuum tube detector. Provision has been made on the panel for connection to an external detector, an external signal generator, or an external power supply. A 100-0-100 micro-ampere meter on the front panel provides for null indications. Measures resistance from 0.1 ohm to 10 megohms, capacitance from 10 mmf to 100 mfd, inductance from 10 mh to 100 h, dissipation factor (D) from 0.002 to 1, and storage factor (Q) from 0.1 to 1000. ½ of 1% decade resistors employed for maximum accuracy. Typical accuracy figures are: resistance, ±3T; capacitance ±3%; inductance, ±10%; dissipation factor, ±20%; storage factor, ±20%. Employs a Wheatstone bridge, a Capacity Comparison bridge, a Maxwell bridge, and a Hay bridge. Special two-section CRL dial provides maximum convenience in operation. Use the Model IB-2 for determining values of unmarked components, checking production or design samples, etc. A real professional instrument.



MODEL IB-2  
**\$59<sup>50</sup>** Shpg. Wt. 12 Lbs.

**HEATHKIT "Q" METER KIT**

The Q Meter permits measurement of inductance from 1 microhenry to 10 millihenries, "Q" on a scale calibrated up to 250 full scale, with multiplying factors of 1 or 2, and capacitance from 40 mmf to 450 mmf, ±3 mmf. Built-in variable oscillator permits testing components from 150 kc to 18 mc. Large 4½" panel-mounted meter is feature. Very handy for checking peaking coils, chokes, etc. Use to determine values of unknown condensers, both variable and fixed. Compile data for coil winding purposes, or measure RF resistance. Distributed capacity, and Q of coils.

MODEL QM-1  
**\$44<sup>50</sup>**  
 Shpg. Wt. 14 Lbs.

**HEATHKIT ISOLATION TRANSFORMER KIT**

This device isolates equipment under test from the power line. It is rated at 100 volt-amperes continuously, or 200 volt-amperes intermittently. AC-DC sets may be plugged directly into the IT-1 without the chassis becoming "hot." Additionally, since the IT-1 is fused, it is ideal for use as a buffer between the power line and a questionable receiver, or a new piece of equipment. Protects main fuses. Features voltage control, allowing control of the output from 90 volts to 130 volts. Panel meter monitors output voltage. A very handy device at an extremely low price.

MODEL IT-1  
**\$16<sup>50</sup>**  
 Shpg. Wt. 9 Lbs.

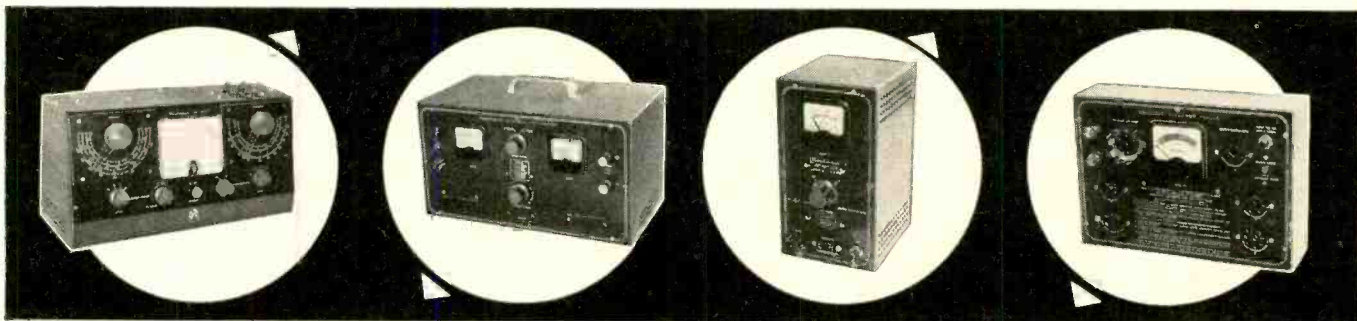

**HEATHKIT 6-12 VOLT BATTERY ELIMINATOR KIT**

This completely modern battery eliminator will supply DC output in two ranges for both 6-volt and 12-volt automobile radios. The output is variable for each range, so that operating voltage can be raised or lowered to determine how the receiver functions under adverse conditions. Range is 0-8 volts DC or 0-16 volts DC. Will supply up to 15 amperes on the 6-volt range, or up to 7 amperes on the 12-volt range. Two 10,000 microfarad output filter capacitors insure smooth DC output. Two separate panel meters indicate output voltage or output current. Makes it possible to test automobile radios inside at the workbench. Will also double as a battery charger.

MODEL BE-4  
**\$31<sup>50</sup>**  
 Shpg. Wt. 17 Lbs.

**HEATHKIT 6-VOLT VIBRATOR TESTER KIT**

This instrument functions very much like a tube checker, to test auto radio vibrators. Vibrator condition is indicated on a simple "good-bad" scale. Tests for proper starting and overall quality of operation, of both interrupter and self-rectifier types of 6-volt vibrators. The model VT-1 is designed to operate from any battery eliminator capable of delivering continuously variable output from 4 to 6 volts DC at 4 amperes or more. It is an ideal companion unit for the Heathkit Model BE-4 battery eliminator. The construction book for the VT-1 contains vibrator test chart for popular 6-volt vibrator types. A real time saver!

MODEL VT-1  
**\$14<sup>50</sup>**  
 Shpg. Wt. 6 Lbs.

## HEATHKIT DX-100 PHONE AND CW



**MODEL  
DX-100**  
Shpg. Wt.  
107 Lbs.

**\$189<sup>50</sup>**

Shipped motor freight unless otherwise specified.  
\$50.00 deposit required on c.o.d. orders.

- \* Phone or CW on 160, 80, 40, 20, 15, 11 and 10 meters.
- \* Built-in VFO, modulator, and power supplies.
- \* High quality components used throughout for reliable performance.
- \* Features 5-point TVI suppression.

## Transmitter Kit

The Heathkit DX-100 transmitter is in a class by itself in that it offers features far beyond those normally received at this price level. It takes very little listening on the bands to discover how many of these transmitters are in operation today. A truly amazing piece of amateur gear. The DX-100 features a built-in VFO and a built-in modulator. It is TVI suppressed, and uses pi network interstage coupling and output coupling. Will match antenna impedances from approximately 50 to 600 ohms. Extensive shielding is employed, and all incoming and outgoing circuits are filtered. The cabinet features interlocking seams for simplified assembly and minimum RF radiation outside of the cabinet. Provides a clean strong signal on either phone or CW, with RF output in excess of 100 watts on phone, and 120 watts on CW. Completely bandswitching from 160 through 10 meters. A pair of 1625 tubes are used in push-pull for the modulator, and the final consists of a pair of 6146 tubes in parallel. The VFO dial and meter face are illuminated, and all front panel controls are located for maximum convenience. Panel meter reads driver plate I, final grid I, final plate I, final plate voltage, and modulator current. The chassis is constructed of heavy #16 gauge copper-plated steel. Other high-quality components include potted transformers, ceramic switch and variable capacitor insulation, silver-plated or solid-silver switch terminals, etc. All coils are pre-wound, and the main wiring cable is pre-harnessed. The kit can be built by a beginner from the comprehensive step-by-step instructions supplied. It is a proven, trouble-free rig, that will insure many hours of "on-the-air" enjoyment in your ham shack.

### HEATHKIT COMMUNICATIONS TYPE ALL BAND RECEIVER KIT

This receiver covers 550 kc to 30 mc in four bands, and is ideal for the short-wave listener or beginning amateur. It provides good sensitivity and selectivity, combined with good image rejection. Amateur bands clearly marked on illuminated dial scale. Employs transformer type power supply—electrical bandspread—antenna trimmer—separate RF and AF gain controls—noise limiter—headphone jack—

**MODEL AR-3**  
**\$29<sup>95</sup>**

and automatic gain control. Has built-in BFO for CW reception.  
**CABINET:** Fabric covered cabinet with aluminum panel as shown. Part 91-15A. Shipping weight 5 Lbs. \$4.95

INCLUDING NEW  
EXCISE TAX  
(Less Cabinet)  
Shpg. Wt. 12 Lbs.

### HEATHKIT VFO KIT

You can go VFO for less than you might expect. Here is a variable frequency oscillator that covers 160, 80, 40, 20, 15, 11, and 10 meters with three basic oscillator frequencies, that sells for less than \$20. Provides better than 10 volt average RF output on fundamentals. Plenty of drive for most modern transmitters. Requires a power source of only 250 VDC at 15 to 20 ma. and 6.3 VAC at 0.45A. Incorporates a regulator tube for stability. Illuminated frequency dial reads frequency directly on the band being employed. Temperature-compensated capacitors offset coil heating.

**MODEL VF-1**

**\$19<sup>50</sup>**

Shpg. Wt. 7 Lbs.



### EASY ON THE BUDGET!

You can buy Heathkits on an easy time-payment plan that provides a full year to pay. Write for complete details and special order blank.

### NEW HEATHKIT CW TRANSMITTER KIT

The brand new Heathkit Model DX-20 Transmitter is one of the most efficient little rigs available today. Featuring an entirely new circuit, it is ideal for the novice, and even for the advanced-class CW operator. A 6DQ6A final amplifier provides plate power input of 50 watts. A 6CL6 oscillator is employed, and a 5U4GB rectifier. The transmitter features one-knob bandswitching to cover 80, 40, 20, 15, 11 and 10 meters. It is designed for crystal excitation, but may be excited by an external VFO. A pi network output circuit matches antenna impedances between 50 and 1000 ohms. Front panel controls are functionally located for your convenience. If you appreciate a good signal on the CW bands, this is the transmitter for you!

**MODEL DX-20**

**\$35<sup>95</sup>**

Shpg. Wt. 18 Lbs.



**HEATH COMPANY**  
A Subsidiary of Daystrom, Inc.  
**BENTON HARBOR 20, MICH.**

**DOLLAR-SAVING ECONOMY . . .**  
 There would be no particular achievement in selling inexpensive merchandise at a low price—although it is being done every day. However, there is something to crow about when, through tremendous purchasing power and factory-to-you distribution, Heath Company can offer top-quality equipment, using name-brand components, at such low prices. This is real economy, as opposed to the so-called "bargains". Needless to say, there is a big difference.

**HEATHKIT PHONE AND CW**

**Transmitter Kit**

- \* 6146 final amplifier for full 65-watt plate power input.
- \* Phone and CW operation on 80, 40, 20, 15, 11, and 10 meters. Pi network output coupling.
- \* Switch selection of three crystals — provision for external VFO excitation.



**MODEL DX-35**  
**\$56<sup>95</sup>** Shpg. Wt. 24 lbs.

The DX-35 features a 6146 final amplifier to provide 65 watts plate power input on CW, with controlled carrier modulation peaks up to 50 watts on phone. In addition, it is a most attractive transmitter. Modulator and power supplies are built-in, and the rig covers 80, 40, 20, 15, 11, and 10 meters with a single band-change switch. Pi network output coupling provided for matching various antenna impedances. A 12BY7 buffer stage provided ahead of the final amplifier for plenty of drive on all bands. 12BY7 oscillator and 12AU7 modulator. Provision for switch selection of three different crystals. Crystals reached through access door at rear. Front panel controls marked "off—CW—stand-by—phone", "final tuning", "antenna coupling", "drive level control", and "band change switch". Panel meter indicates final grid current or final plate current. A perfect low-power transmitter both for the novice, and for the more experienced operator. A remarkable power package for the price. Incidentally, the price includes tubes, and all other components necessary for assembly. As with all Heathkits, comprehensive instruction manual assures successful assembly.

**HEATHKIT ANTENNA IMPEDANCE METER KIT**

This instrument employs a 100 microampere panel meter and covers the impedance range of 0-600 ohms for RF tests. Functions up to 150 mc. Used in conjunction with signal source, such as the Heathkit Model GD-1B grid dip meter, the Model AM-1 will determine antenna resistance and resonance, match transmission lines for minimum standing wave ratio, determine receiver input impedance, etc. Will also double as a phone monitor. A very valuable device for many uses in the ham shack.

**MODEL AM-1**  
**\$14<sup>50</sup>**  
 Shpg. Wt. 2 lbs.

**HEATHKIT "Q" MULTIPLIER KIT**

The QF-1 functions with any receiver with an IF frequency between 450 and 460 kc that is not AC-DC type. Operates from the receiver power supply, requiring only 6.3 VAC at 300 ma. and 150 to 250 VDC at 2 ma. Simple to connect with cable and plugs supplied. Provides additional selectivity for separating two signals, or will reject one signal and eliminate heterodyne. A big help on crowded bands. Provides an effective Q of approximately 4,000 for sharp "peak" or "null". Tunes to any signal within the IF bandpass of the receiver, without changing main receiver tuning dial.

**MODEL QF-1**  
**\$9<sup>95</sup>**  
 Shpg. Wt. 3 lbs.

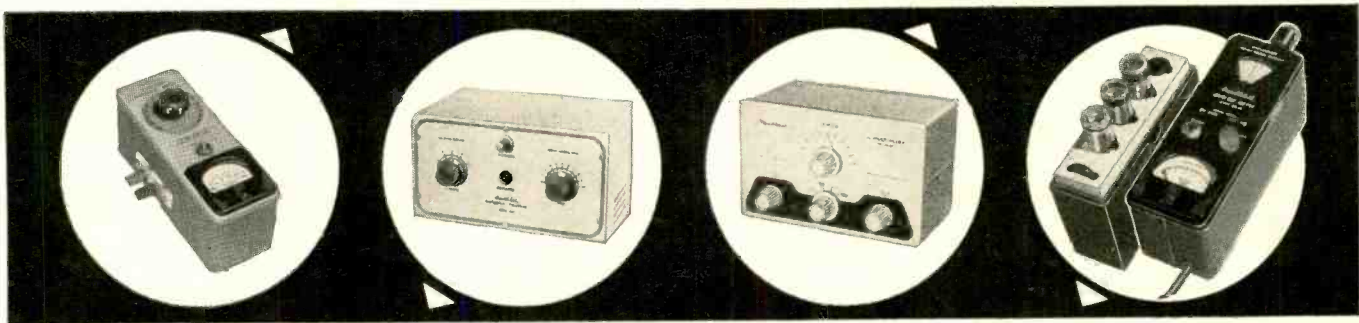

**HEATHKIT ANTENNA COUPLER KIT**

This device is designed to match the Model AT-1 transmitter to a long-wire antenna. In addition to impedance matching, this unit incorporates an L-type filter which attenuates signals above 36 megacycles, thereby reducing TVI. Designed for 52 ohm coaxial input. Handles power up to 75 watts, 10 through 80 meters. Uses a tapped inductor and variable capacitor. Neon RF indicator on front panel. Copper-plated chassis—high quality components throughout—simple to build. Eliminates waste of valuable communications power due to improper matching. A "natural" for all AT-1 transmitter owners.

**MODEL AC-1**  
**\$14<sup>50</sup>**  
 Shpg. Wt. 4 lbs.

**HEATHKIT GRID DIP METER KIT**

The grid dip meter was originally designed for the ham shack. However, its use has been extended into the service shop and laboratory. Continuous frequency coverage from 2 mc to 250 mc with pre-wound coils. 500 microampere panel meter employed for indication. Use for locating parasitics, neutralizing, determining RF circuit resonant frequencies, etc. Coils are included with kit, as is a coil rack. Front panel controls include sensitivity control for meter, and phone jack for listening to zero-beat. Will also double as an absorption-type wavemeter.

**MODEL GD-1B**  
**\$19<sup>95</sup>**  
 Shpg. Wt. 4 lbs.

## HEATHKIT BROADCAST BAND



**MODEL BR-2**  
(Less Cabinet)  
Shpg. Wt. 10 Lbs.

**\$18<sup>95</sup>**

INCLUDING NEW  
EXCISE TAX\*

### ATTENTION BEGINNERS . . .

This kit is an ideal "first project" if you have never built a Heathkit before. A good chance to "learn by doing."

- \* Miniature tubes and high-gain IF transformer.
- \* Rod-type built-in antenna. Good sensitivity and selectivity.
- \* 5½-inch PM speaker.
- \* Provision for phono jack.
- \* Transformer-operated power supply.

## Receiver Kit

You need no previous experience in electronics to build this table-model radio. The Model BR-2 receiver covers 550 kc to 1620 kc and features good sensitivity and selectivity over the entire band. A 5½" PM speaker is employed, along with high gain miniature tubes and a new rod-type built-in antenna. Provision has been made in the design of this receiver for its use as a phonograph amplifier. The phono jack is located on the back chassis apron. A transformer operated power supply is featured for safety of operation, as opposed to the usual AC-DC supply commonly found in "economy radio kits." Don't let the low Heathkit price deceive you. This is the kind of set you will want to show off to your family and friends after you have finished building it.

Construction of this radio kit is very simple. Giant size pictorial diagrams and detailed step-by-step instructions assure your success. The construction manual also includes an explanation of basic receiver circuit theory so you can "learn by doing" as the receiver is built. The manual even provides information on resistor and capacitor color codes, soldering techniques, use of tools, etc. If you have ever had the urge to build your own radio receiver, the outstanding features of this popular Heathkit deserve your attention.

**CABINET:** Proxylin impregnated fabric covered plywood cabinet available for the BR-2 receiver as shown. Complete with aluminum panel, reinforced speaker grill, and protective rubber feet. Shipping weight 5 lbs., part No. 91-9A. . . . . \$4.95\*

### HEATHKIT PROFESSIONAL RADIATION COUNTER KIT

This sensitive and reliable instrument has already found extensive application in prospecting, and also in medical and industrial laboratories. It offers outstanding performance at a reasonable price. Front-panel meter indicates radiation level, and oral indication produced by panel-mounted speaker. Meter ranges are 0-100, 600, 6,000 and 60,000 counts per minute, and 0-.02, .1, 1 and 10 milliroentgens per hour. The probe, with expansion cord, employs type 6306 bismuth counter tube, sensitive to both beta and gamma radiation. It is simple to build, even for a beginner.

MODEL RC-1

**\$79<sup>95</sup>**

Shpg. Wt. 8 Lbs.

### HEATHKIT CRYSTAL RECEIVER KIT

The crystal radio of Dad's day is back again, but with big improvements! The Model CR-1 employs a sealed germanium diode, eliminating the critical "cat's whisker" adjustment. It is housed in a compact plastic box, and features two Hi-Q tank circuits, employing ferrite core coils and variable air tuning capacitors. The CR-1 covers the standard broadcast band from 540 kc to 1600 kc, and no external power is required for operation. Could prove valuable for emergency signal reception. This easy-to-build kit is a real "learn by doing" experience for the beginner, and makes an interesting project for all ages.

MODEL CR-1

**\$7<sup>95</sup>**

INCLUDING NEW  
EXCISE TAX\*  
Shpg. Wt. 3 Lbs.

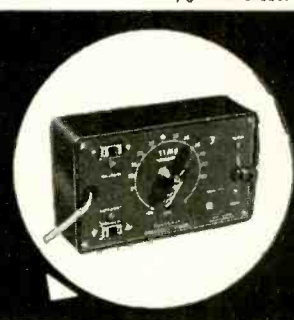
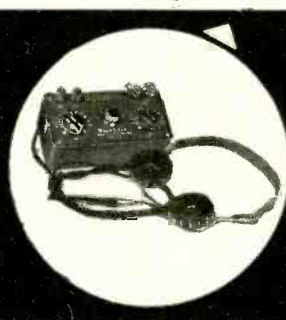

\* Amazing new circuit for high efficiency.

- \* Compact, portable and rugged.
- \* Stable circuit requires only one 67½ volt "B" battery and two 1½ volt "A" batteries.

### HEATHKIT ENLARGER TIMER KIT

The Model ET-1 is an easy-to-build device for use by amateur or professional photographers in controlling the timing cycle of an enlarger. It covers the range of 0 to 1 minute with a continuously variable, clearly calibrated scale. The timing period is pre-set, and the timing cycle is initiated by depressing the spring-return switch to the "print" position. Front panel provision is made for plugging in the enlarger and a safelight. The safelight is automatically turned "on" when the enlarger is "off". Handles up to 350 watts. The timing cycle is controlled electronically for maximum accuracy and reliability. Very simple to build in only one evening, even by a beginner.

MODEL ET-1

**\$11<sup>50</sup>**

Shpg. Wt. 3 Lbs.



**HEATH COMPANY**

A Subsidiary of Daystrom, Inc.

BENTON HARBOR 20, MICH.

# Preamplifier Kit

## COMPREHENSIVE INSTRUCTIONS . . .

The step-by-step assembly instructions provided with each Heathkit are the finest available anywhere. Each manual begins at the beginning, and assumes no previous training or experience on the part of the kit builder. This means that our kits can be built successfully by anyone who can follow instructions. As a matter of fact, new manuals are tested by having the kit built by someone in our office who has had no previous experience in electronics. This is your guarantee of complete and thorough instruction material.

- \* 5 switch-selected inputs, each with its own level control.
- \* Equalization for LP, RIAA, AES, and Early 78's.
- \* Separate bass and treble tone controls, and special hum control.
- \* Clean, modern lines and satin-gold enamel finish.

Literally thousands of these preamplifiers are in use today, because the kit meets or exceeds specifications for the most rigorous high-fidelity applications, and will do justice to the finest available program sources. Provides a total of 5 inputs, each with individual level controls (three high-level and two low-level). Frequency response is within 1 DB from 25 CPS to 30,000 CPS, or within 1½ DB from 15 CPS to 35,000 CPS. Hum and noise are extremely low, with special balance control for absolute minimum hum level. Tone control provides 18 DB boost and 12 DB cut at 50 CPS, and 15 DB boost and 20 DB cut at 15,000 CPS. Cabinet measures only 12-9/16" W. x 3¾" H. x 4¾" D, and it is finished in beautiful satin-gold enamel. 4-position turnover and 4 position roll-off controls provide "LP," "RIAA," "AES," and "early 78" equalization, and 8, 12, 16, and 1 flat position for roll-off. Derives operating power from the main amplifier, requiring only 6.3 VAC at 1 ampere and 300 VDC at 10 MA. Easy to construct from step-by-step instructions and pictorial diagrams provided.

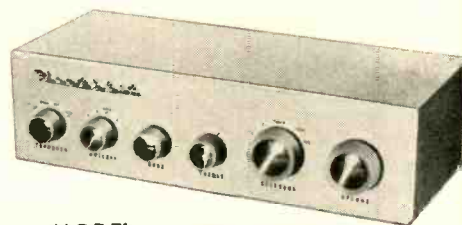

MODEL WA-P2 (With Cabinet)  
Shpg. Wt. 7 Lbs.

**\$19<sup>75</sup>**

## HEATHKIT HIGH FIDELITY FM TUNER KIT

- \* Illuminated slide-rule dial covers 88 to 108 MC.
- \* Modern circuit emphasizes sensitivity and stability.
- \* Housed in attractive satin-gold cabinet to match WA-P2 and BC-1.

This amazing new FM tuner can provide you with real high-fidelity performance at an unbelievably low price level. Covering 88 to 108 MC, the modern circuit features a stabilized, temperature-compensated, oscillator, A.G.C., broadbanded

IF circuits, and better than 10 UV sensitivity for 20 DB of quieting. A high gain, cascaded, RF amplifier is used ahead of the mixer to increase overall gain and reduce oscillator leakage. It employs a ratio detector for high efficiency without sacrifice in high-fidelity performance. IF and ratio transformers are pre-aligned, as is the front end tuning unit. This means the kit can be constructed by a beginner, without elaborate test and alignment equipment. The FM-3A is designed to match the WA-P2 preamplifier and the BC-1 AM **MODEL FM-3A** tuner. An illuminated slide-rule dial is employed for frequency indication. Step-by-step instructions and large pictorial diagrams assure success.

**\$25<sup>95</sup>**

INCLUDING NEW EXCISE TAX  
(With Cabinet)  
Shpg. Wt. 7 Lbs.



## HEATHKIT BROADBAND AM TUNER KIT

This AM tuner has been designed especially for high-fidelity applications. It incorporates a low-distortion detector, a broadband IF, and other features essential to usefulness in high-fidelity. Special voltage-doubler detector employs crystal diodes for low distortion. Sensitivity and selectivity are excellent. Audio response is ± 1 DB from 20 CPS to 2 kc, with 5 DB of pre-emphasis at 10 kc to compensate for station roll-off. Covers the standard broadcast band from 550 to 1600 kc. Incorporates a 10 kc whistle-filter and provides a 6 DB signal-to-noise ratio at 2.5 UV. RF and IF coils are pre-aligned, and power supply is built-in. Incorporates AVC, two outputs, and two antenna inputs.

MODEL BC-1  
**\$25<sup>95</sup>**  
INCLUDING NEW EXCISE TAX  
(With Cabinet)  
Shpg. Wt. 8 Lbs.

## HEATHKIT ELECTRONIC CROSS-OVER KIT

This unusual device functions to separate low frequencies and high frequencies so that they may be fed to separate amplifiers and to separate speakers. This eliminates the need for conventional cross-over circuits, since the Model XO-1 does the complete job electronically. Cross-over frequencies of 100, 200, 400, 700, 1,200, 2,000 and 3,500 CPS are selectable with front panel controls on the XO-1, and a separate level control is provided for each channel. Minimizes inter-modulation distortion problems. Handles unlimited power, since frequency division is accomplished ahead of the power stage. Attenuation is 12 DB per octave, with sharp "knee" at cut-off frequency.

MODEL XO-1  
**\$18<sup>95</sup>**  
Shpg. Wt. 6 Lbs.

## HEATHKIT ADVANCED-DESIGN



**MODEL W-5M**  
Shpg. Wt. 31 Lbs.  
Express Only

**\$59<sup>75</sup>**

### MODEL W-5

Consists of Model W-5M plus Model WA-P2 pre-amplifier.

Shpg. Wt. 38 Lbs.  
Express only... \$79.50

- \* Full 25 watt output with KT-66 output tubes.
- \* All connectors brought out to front chassis apron.
- \* Protective cover over all above-chassis components.

## HIGH FIDELITY

# Amplifier Kit

This 25 watt unit is our finest high-fidelity amplifier. Using a special design peerless output transformer, and KT-66 output tubes by Genalex, the Model W-5M provides performance characteristics unsurpassed at this price level. Frequency response is  $\pm 1$  DB from 5 to 160,000 CPS at 1 watt. Harmonic distortion is less than 1% at 25 watts and 1M distortion is less than 1% at 20 watts (60 and 3,000 CPS, 4 to 1). Hum and noise are 99 DB below 25 watts. Damping factor is 40 to 1. Input voltage for 5 watts output is 1 volt. Tubes employed are a pair of 12AU7's, a pair of KT-66's and a 5R4GY rectifier. Measures 13-3/32" W. x 8 1/2" D. x 8 1/4" H. Output impedance is 4, 8, or 16 ohms. Featured, also, is the "tweeter saver" which suppresses high frequency oscillation, and a new type balancing circuit requiring only a voltmeter for indication. This balance is easier to adjust, and results in a closer "dynamic" balance between output tubes. The Model W-5M provides improved phase shift characteristics, reduced IM and harmonic distortion, and improved frequency response. Conservatively rated high-quality components are used throughout to insure years of trouble-free operation. No technical background or training is required for assembly. Step-by-step instructions are provided for every stage of construction, and large pictorial diagrams illustrate exactly where each wire and component is to be placed. An amplifier for music lovers who can appreciate subtle differences in performance. Just ask the audiophile who owns one!

### HEATHKIT DUAL-CHASSIS—WILLIAMSON TYPE HIGH FIDELITY AMPLIFIER KIT

This 20-watt high-fidelity amplifier employs the famous Acro-sound Model TO-300 "ultra-linear" output transformer and uses 5881 output tubes. The power supply is built on a separate chassis, and the two chassis are inter-connected with a power cable. This provides additional flexibility in mounting. Frequency response is  $\pm 1$  DB from 6 CPS to 150 kc at 1 watt. Harmonic distortion is only 1% at 21 watts, and 1M distortion is only 1.3% at 20 watts. (60 and 3,000 CPS). Output impedance is 4, 8, or 16 ohms. Hum and noise are 88 DB below 20 watts. A very popular high-fidelity unit employing top-quality components throughout.

MODEL W-3M: Shpg. Wt. 29 Lbs. Express only... \$49.75

MODEL W-3: Consists of Model W-3M plus Model WA-P2 pre-amplifier. Shpg. Wt. 37 Lbs. Express only... \$69.50

### HEATHKIT SINGLE CHASSIS—WILLIAMSON TYPE HIGH FIDELITY AMPLIFIER KIT

The 20-watt Model W-4AM Williamson type amplifier is a tremendous high-fidelity bargain. Combining the power supply and main amplifier on one chassis, and using a special-design output transformer by Chicago Standard brings you savings without a sacrifice in quality. Employing 5881 output tubes, the frequency response of the W-4AM is  $\pm 1$  DB from 10 CPS to 100 kc at 1 watt. Harmonic distortion is only 1.5% at 20 watts. Output impedance is 4, 8, or 16 ohms. Hum and noise are 95 DB below 20 watts.

MODEL W-4AM: Shpg. Wt. 28 Lbs. Express only... \$39.75

MODEL W-4A: Consists of Model W-4AM plus Model WA-P2 pre-amplifier. Shpg. Wt. 35 Lbs. Express only... \$59.50

### HEATHKIT 7-WATT AMPLIFIER KIT

This amplifier is more limited in power than other Heathkit models, but it still qualifies as a high-fidelity unit, and its performance definitely exceeds that of many so-called "high-fidelity" phonograph amplifiers. Using a tapped-screen output transformer of new design, the Model A-7D provides a frequency response of  $\pm 1\frac{1}{2}$  DB from 20 to 20,000 CPS. Total distortion is held to a surprisingly low level. Output stage is push pull, and separate bass and treble tone controls are provided. Shpg. Wt. 10 Lbs.

MODEL A-7E: Similar to the A-7D, except that a 12SL7 tube has been added for pre-amplification. Two inputs, RIAA compensation, and extra gain.

MODEL A-7D  
**\$17<sup>95</sup>**

INCLUDING NEW EXCISE TAX

**\$19.95<sup>†</sup>**

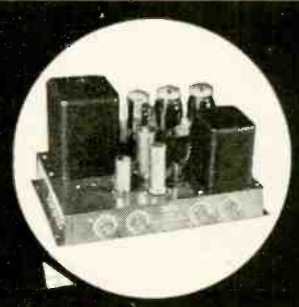
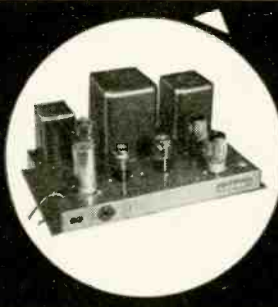
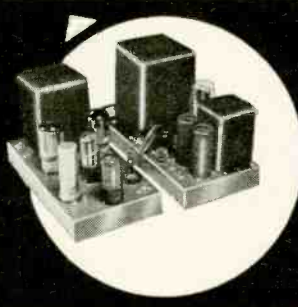

### HEATHKIT 20-WATT HIGH FIDELITY AMPLIFIER KIT

This high-fidelity amplifier features full 20-watt output using push pull 6L6 tubes. Built-in preamplifier provides 4 separate inputs, selected by a panel-mounted switch. It has separate bass and treble tone controls, each offering 15 DB boost and cut. Output transformer is tapped at 4, 8, 16, and 500 ohms. Designed primarily for home installations, but also used extensively for public address applications. True high-fidelity performance with frequency response of  $\pm 1$  DB from 20 CPS to 20,000 CPS. Total harmonic distortion only 1% (at 3 DB below rated output).

MODEL A-9B  
**\$35<sup>50</sup>**

Shpg. Wt. 23 Lbs.



**HEATH COMPANY**  
A Subsidiary of Daystrom, Inc.  
BENTON HARBOR 20, MICH.



All prices marked with a † include a new federal excise tax that now applies to receivers, tuners and some amplifiers, even though they may be in kit form. Since the tax is in effect as of July 5, 1956, we have no choice but to reflect it in our kit prices. This note is just to let you know we are not increasing our prices on some kits, but merely including this new tax in them.

Thank you,  
HEATH COMPANY

HEATHKIT HIGH FIDELITY

Range Extending  
SPEAKER SYSTEM KIT

- \* High quality speakers of special design — 15" woofer and compression-type super-tweeter.
- \* Easy-to-assemble cabinet of furniture-grade plywood.
- \* Attractively styled to fit into any living room. Matches Model SS-1.



MODEL SS-1B

**\$99<sup>95</sup>**

Shpg. Wt. 80 Lbs.

This range extending unit is designed especially for use with the Model SS-1 speaker system. It consists of a 15" woofer, providing output between 35 and 600 CPS, and a compression-type super-tweeter that provides output between 4,000 and 16,000 CPS. Cross-over frequencies are 600, 1,600, and 4,000 CPS. The SS-1 provides the mid-range, and the SS-1B extends the coverage at both ends of the spectrum. Together, the two speaker systems provide output from 35 to 16,000 CPS within ± 5 DB. This easy-to-assemble speaker enclosure kit is made of top-quality furniture-grade plywood. All parts are pre-cut and pre-drilled, ready for assembly and the finish of your choice. Complete step-by-step instructions are provided for quick assembly by one not necessarily experienced in woodworking. Coils and capacitors for proper cross-over network are included, as is a balance control for super-tweeter output level. The SS-1 and SS-1B can provide you with unbelievably rich audio reproduction, and yet these units are priced reasonably. The SS-1B measures 29" H. x 23" W. x 17½" D. The speakers are both special-design Jensens, and the power rating is 35 watts. Impedance is 16 ohms.

HEATHKIT HIGH FIDELITY SPEAKER SYSTEM KIT



MODEL SS-1

**\$39<sup>95</sup>**

Shpg. Wt. 30 Lbs.

- \* Special design ducted-port, bass-reflex enclosure.
- \* Two separate speakers for high and low frequencies.
- \* Kit includes all parts and complete instructions for assembly.

This speaker system is a fine reproducer in its own right, covering 50 to 12,000 CPS within ± 5 DB. However, the story does not end there. Should you desire to expand the system later, the SS-1 is designed to work with the SS-1B range extending unit — providing additional frequency coverage at both ends of the spectrum. It can fulfill your present needs, and still provide for the future. The SS-1 uses two Jensen speakers; an 8" midrange-woofer, and a compression-type tweeter. Cross-over frequency is 1,600 CPS, and the system is rated at 25 watts. Nominal impedance is 16 ohms. The cabinet is a ducted-port bass-reflex type. Attractively styled, the Model SS-1 features a broad "picture-frame" molding that will blend with any room decorating scheme. Pre-cut and pre-drilled wood parts are of furniture grade plywood. The kit is easy-to-build, and all component parts are included, along with complete step-by-step instructions for assembly. Can be built in just one evening, and will provide you with many years of listening enjoyment thereafter.

HEATH COMPANY A Subsidiary of Daystrom, Inc. BENTON HARBOR 20, MICH.

ORDER BLANK

NOTE: All prices subject to change without notice.

Enclosed find ( ) check ( ) money order for \_\_\_\_\_  
Please ship C.O.D. ( ) postage enclosed for \_\_\_\_\_ pounds.

On Express orders do not include transportation charges — they will be collected by the express agency at time of delivery.

ON PARCEL POST ORDERS include postage for weight shown. ORDERS FROM CANADA and APO'S must include full remittance.

Name \_\_\_\_\_

Address \_\_\_\_\_

City & Zone \_\_\_\_\_ State \_\_\_\_\_

(PLEASE PRINT)

SHIP VIA

- Parcel Post
- Express
- Freight
- Best Way

QUANTITY	ITEM	MODEL NO.	PRICE

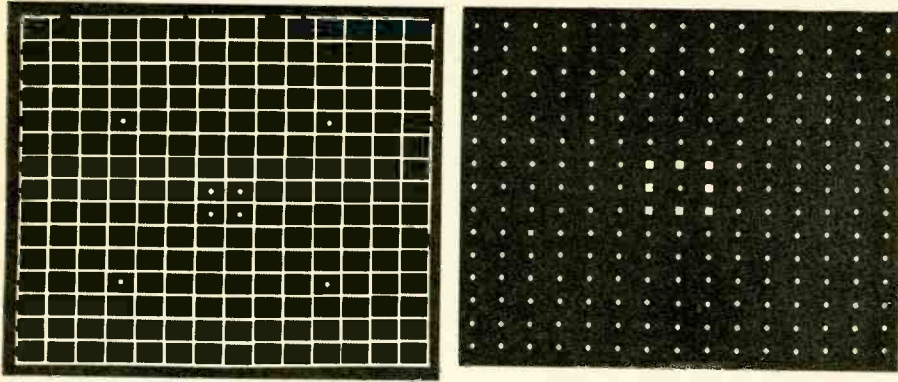

Typical transparencies used with generator: Pattern of white dots is used for static convergence adjustments—center dot is surrounded by squares for identification. White-line pattern has dots in certain squares for raster centering.

(Continued from page 65)

Video information is developed by the 931-A photomultiplier tube. Light striking the cathode (pin 11) causes it to emit electrons which are drawn to the first dynode, pin 1. Each electron striking dynode 1 causes secondary electrons to be emitted and added to the initial electron stream. The secondary electrons from dynode 1 are drawn to dynode 2 which is 40 volts more positive than dynode 1. Secondary

electrons from dynode 2 are drawn to dynode 3 and so on until those from dynode 9 are drawn to the collector or plate (pin 10).

The current reaching the plate is many thousands of times greater than that leaving the cathode. The amplified video signal developed across load resistor R3 is applied to the grid of modulator V2-a. Shunt and series peaking circuits maintain the desired frequency response.

Plate voltage for the 931-A is obtained from the 570-volt boosted B-plus source through filter resistors R1 and R62. Dynodes 9 through 1 and the cathode are supplied progressively lower voltages from a voltage divider consisting of R1 through R13. Potentiometer R13 controls the gain, and thus the output of the photomultiplier, by varying the voltages on the dynodes.

Modulator and rf circuits

V2-b is a Hartley oscillator covering channels 2 through 6 on fundamentals and 7 through 13 on harmonics. Its output is taken from the cathode and fed to the cathode of modulator V2-a through a 5.6- $\mu$ f capacitor. The rf signal applied to V2-a's cathode is amplitude-modulated by the video and sync signals applied to the grid and appears across the 180-ohm plate load resistor shunted by the 1,000-ohm output control. The RF ATTENUATOR setting can be reduced until snow develops in the picture and the technician can use this to compare the sensitivity and operation of age circuits in different receivers, determine the relative effectiveness of boosters and check insertion losses in antenna pads, etc. END

Fig. 2—Schematic diagram of B&K model 1000 picture and pattern generator, a complete flying-spot scanner and transmitter.

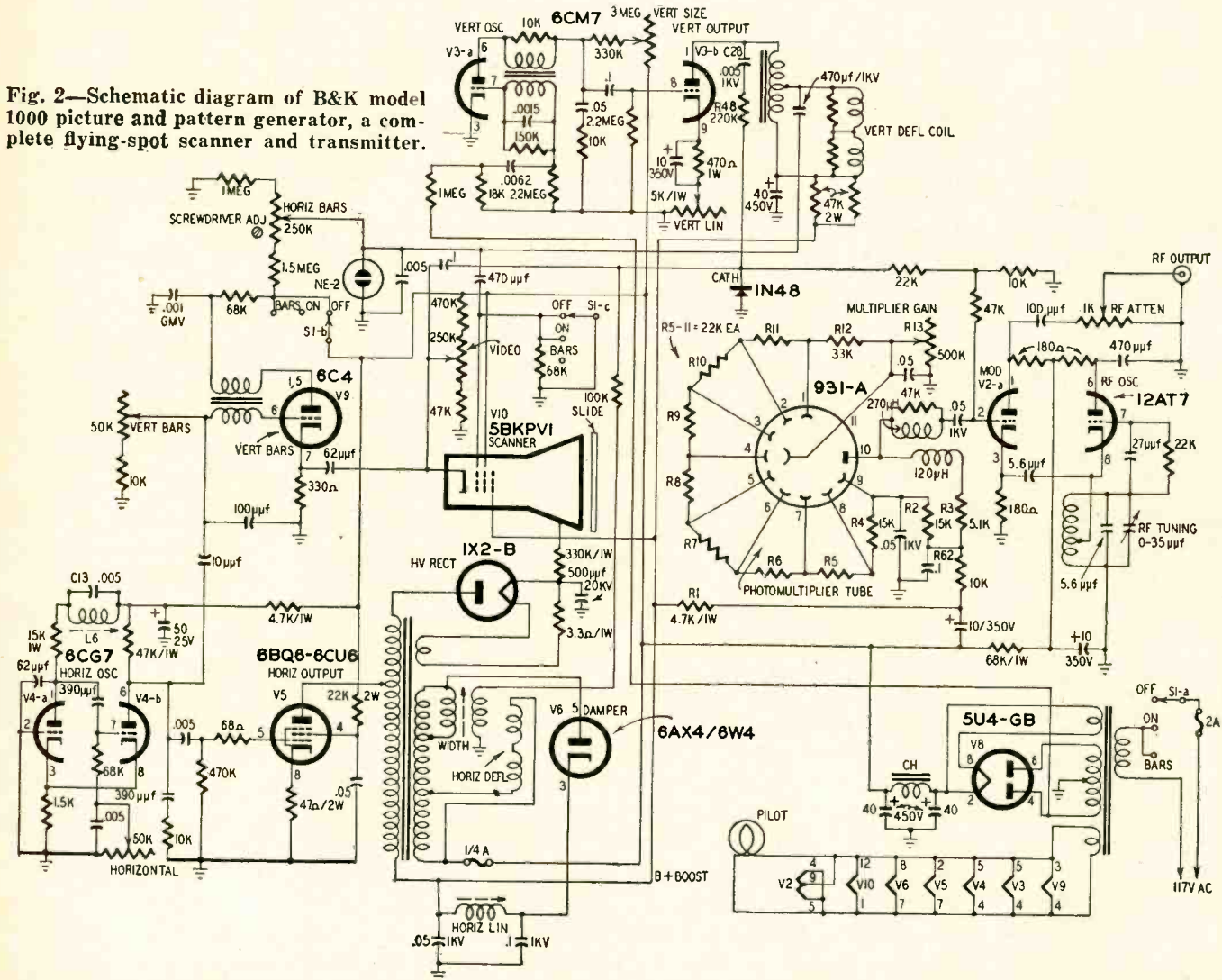

# RCA CUSTOM CONVERTIBLE SPEAKER SYSTEMS

hi-quality . . . hi-fidelity . . . anywhere and any way you like it!

Soft and sweet or loud and lively . . . in your den or in your living room, RCA CUSTOM CONVERTIBLE SPEAKER SYSTEMS offer *the finest in sound satisfaction*.

Buy with confidence! RCA CUSTOM CONVERTIBLE SPEAKER SYSTEMS, through exclusive RCA bottom-porting,

are readily convertible for use as INFINITE BAFFLE . . . BASS REFLEX . . . CORNER DRIVER . . . to suit your room acoustics, and your personal taste. Custom-built appearance is readily obtainable . . . panels and grill cloths can be removed and interchanged easily for matching or contrasting effects.

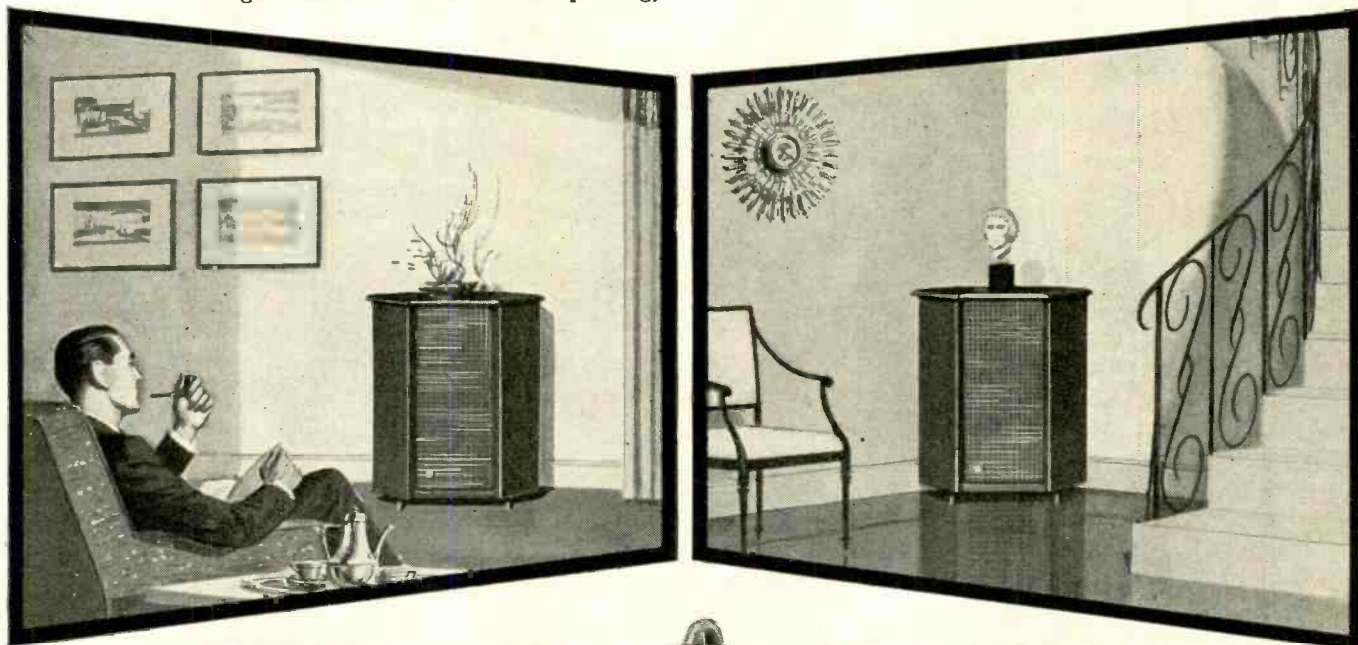

**RCA 501S1 Biaxial Speaker**—compares with models two or three times the price! Features 14.5 ounce Alnico-V magnet and 8-ohm voice coil. Its 12-inch woofer employs



Olson-developed foam damping ring; 3-inch tweeter is mounted off-axis to minimize crossover interference; high frequency response extends beyond 18,000 cps.

**Suggested User Price (optional) \$33.50**

**RCA 502S1 Direct Radiator Speaker**—outstandingly smooth, unsurpassed in its frequency range to 16,000 cps. Features same construction as 501S1 and incorporates



medium-weight curved cone for smoothness, range, damping, and sensitivity to equal sound pressure of higher power speakers using double the power input.

**Suggested User Price (optional) \$25.25**

**RCA Enclosures**—Beauty in cherry or blonde cabinetry, the solid Honduras Mahogany will enhance room decor with the expensive look and feel of fine woods. Built for a lifetime of use, RCA enclosures feature mortise-and-tenon joints, glue-block

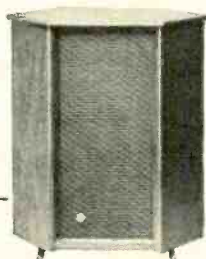

reinforcements and wood-screw clamping. For 12-inch speakers.

**Suggested User 300W1 Cherry \$69.95**  
**Price (optional) 301W1 Blonde \$74.50**

**301X1 Adapter Panel**—converts 12-inch enclosures for use with 8-inch speakers. **Suggested User Price (optional) \$2.45**



**RADIO CORPORATION of AMERICA**

COMPONENTS DIVISION

CAMDEN, N. J.

RCA SPEAKERS FOR TV • RADIO • PHONOGRAPH • HIGH FIDELITY • PUBLIC ADDRESS • AT RCA DISTRIBUTORS EVERYWHERE!

By EDWIN BOHR

Simple unit measures current gain, checks for noise, detects short circuits and measures  $I_{co}$

# Improved Transistor Tester

**N**O transistor test unit has ever before offered so much for so little. It measures transistor current gain, checks for noise and short circuits and in combination with an ordinary multimeter, measures  $I_{co}$ . The cost is low. So low, in fact, that it will pay for itself after only a few uses or service jobs.

This test unit is simple to operate and foolproof. It inherently protects the transistor should the operator flip the wrong switch or make some other mistake—a very important feature. The tester is the result of several redesigns and has a minimum of control knobs and operating procedure. It has one of the most simple transistor-test circuits to be conceived. Yet it combines features found only in the most expensive laboratory models.

The tester functions on a true ac amplification principle with emitter current held at a correct operating value by a constant-current supply. In addition, it operates the transistor in a temperature-stabilized circuit, eliminating current creep and actual current runaway sometimes experienced with high-gain transistors. All parts, purchased new, will cost from \$7-\$10. Using parts from his shop, a friend built a similar (see photo) test unit for only \$3.

The most important function is the beta-gain measurement. Beta is the grounded-emitter current gain of a junction transistor and is just as significant as is transconductance for the vacuum tube.

Beta is measured by an oscillator circuit with feedback controlled by a dial calibrated in current gain. The dial is rotated until oscillations are barely sustained. Beta is then read directly from the dial. High-gain transistors require very little feedback and vice versa.

Most cheap testers use a dc method of measuring beta that is not altogether satisfactory. This tester operates completely on a small-signal ac amplification principle.

To approach a true measurement of beta, the collector load should be very low and the base should look into a very high impedance. This is accomplished with a small transistor transformer deliberately connected wrong, providing a severe mismatch between collector and base. This is exactly what we want for measuring beta. At the same time, this transformer provides the phase reversal necessary for positive feedback and oscillation.

The value of beta changes with emitter current. For testing ordinary transistors, an emitter current of 1 ma is a standard that is being widely adopted—it is used in this simple tester.

Because the emitter current is supplied through a 4,700-ohm resistor, the emitter current is constant and insensitive to the characteristics of the transistor under test. This feature, together with a separate bias supply

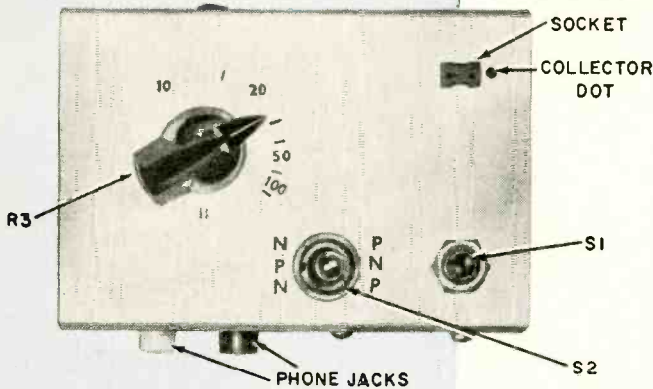

Author's model. Unit uses subminiature components.

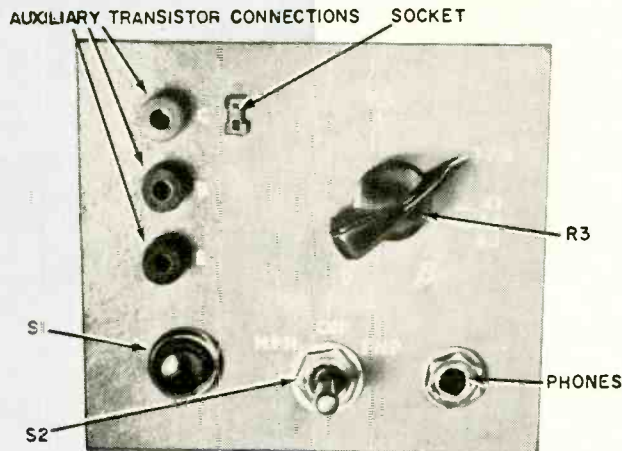

Using parts around the shop, this unit was built at a cost of \$3. Jacks at left provide connections for any type transistor.

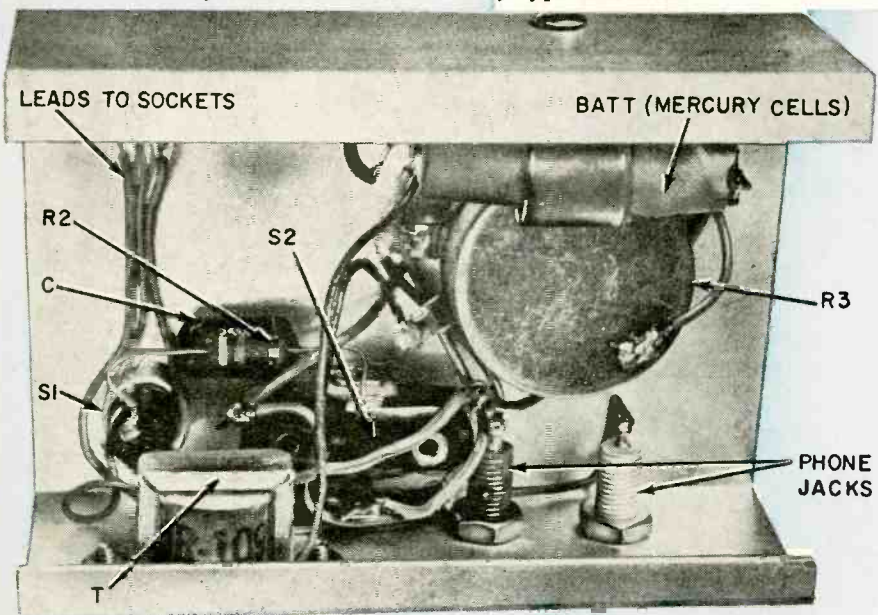

Underchassis view of the transistor tester shows parts layout.

## TEST INSTRUMENTS

and low dc resistance in the base, provides the tops in temperature stability.

Two battery supplies are used, one for the emitter bias and the other for the collector supply. To accommodate either n-p-n or p-n-p transistors, the functions of these two batteries are simply swapped by a dpdt switch. A pushbutton energizes the bias supply for beta measurements and opens the circuit for  $I_{co}$  determinations.

### Beta measurement, shorts

To measure beta, plug in earphones, set S2 to the proper position and press S1. Now rotate the feedback knob until a loud tone is heard. Rotate the knob again so the oscillation is just audible and read the beta value directly from the dial.

The tester indicates gains from less than 10 to 200. This covers the range of transistors now in production. Any transistor with a beta of less than 10 should be considered subnormal.

A short from collector to base is one of the most common failures for the diffused-junction transistor and it is easy to identify on the tester. Just set S2 for the type of transistor and listen for a loud click in the phones as the transistor is plugged in. This indicates a shorted transistor; a very feeble click is normal. For this test do not push S1. A shorted transistor will not indicate gain on the beta measurement.

### Noise

For a qualitative noise indication, set up the tester for a beta measurement but rotate the beta or feedback knob just below the point of oscillation. A transistor with poor noise characteristics will produce a frying and sputtering noise in the phones. The noise from a good unit is very low, just audible. Selected low-noise transistors cannot be heard at all.

### Cutoff current

Cutoff current, the dc collector current for zero emitter current, also known as  $I_{co}$ , can be measured with an auxiliary microammeter. Transistors with a high  $I_{co}$  are not desirable since they are more temperature-sensitive than normal. Too, it may indicate a transistor deteriorating because of surface contamination of the semiconductor material.

For an  $I_{co}$  measurement, set S2 and plug the leads from a multimeter microamp or milliamp range into the phone jacks. If the meter reads backward when the transistor is plugged in reverse the meter leads. Do not press S2.

A typical  $I_{co}$  reading should fall between 1-10 microamps.  $I_{co}$  varies with temperature and it makes an interesting experiment to warm the transistor with heat from your hand or cool it with a piece of ice and watch the current variation.

### Calibration and construction

With the table of potentiometer resistance values versus beta, it is

very simple to calibrate the dial. The values contained in this table were gathered from several calibration checks with very accurately measured standard transistors.

To calibrate your own dial, connect an ohmmeter to the pot, set it to the resistance positions contained in the table, and mark the corresponding beta values. Decals can be cut out and affixed to the panel at each of these positions.

CALIBRATION DATA	
R3 1,000 ohms	BETA uncalibrated
525	10
350	15
275	20
185	30
135	40
100	50
65	75
45	100
20	200

When measuring this resistance, one of the transformer leads to the pot must be disconnected. The resistance is measured from the slider to the battery end of the potentiometer. These calibration values will be valid only if

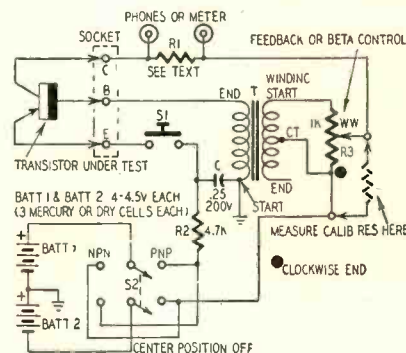

- R1—(see text)
- R2—4,700 ohms, 1/2 watt
- R3—1,000-ohm potentiometer (see text)
- C—0.25  $\mu$ f, 200 volts
- T—driver type transformer, primary 10,000 ohms, secondary 2,000 ohms (Argonne AR-109 or equivalent)
- BATT 1, 2—3 penlight or mercury cells (Mallory RM-625RT or equivalent)
- S1—spst pushbutton, normally open
- S2—dpdt switch, center position off
- Transistor socket (retainer ring type)
- Knob
- Jacks (2), miniature, for phones
- Cabinet or small chassis

### Circuit of the improved transistor test instrument.

the same type of transformer and value of emitter bypass capacitor is used.

Construction is very flexible and may be adapted to any cabinet or parts the constructor wishes to use. The photographs show one model built on one of the new miniature aluminum chassis that are also very inexpensive. Another photograph shows a model built on a prestwood panel. This photo shows a beta position of zero, but actually represents a very low value of beta and not zero.

The feedback transformer is the Argonne AR-109, available from Lafayette Radio. Either a wirewound or carbon control may be used. The wirewound types have better stability but the carbons operate more smoothly. Either type should be regular-sized

# BUILD THE BEST— BUILD ALLIED'S OWN knight-kits

ALLIED stakes its 36-year reputation in the electronics field on your complete success and fullest satisfaction with KNIGHT-KITS. Join the thousands who have discovered the ultimate in kit value...

## knight-kits

**LOWEST COST** because our giant buying power passes biggest savings on to you... you do the easy assembly and your finished instrument is equal in performance and appearance to equipment selling for several times the KNIGHT-KIT cost. (Easy Payment Terms available, too.)

## knight-kits

**EASIEST TO BUILD** because KNIGHT-KIT "Stop-and-Check" instruction manuals are marvels of clarity—it's just like having a good instructor at your side. Proved professional design and premium quality parts help insure your building success.

## knight-kits

**MONEY-BACK GUARANTEE:** When properly assembled, KNIGHT-KITS fully meet published specifications, or we refund your money.

**WHEN YOU BUILD A KNIGHT-KIT  
YOU BUILD THE BEST**

For a Complete Selection of  
Famous knight-kits  
**SEE PAGES 85-91**

Available Only From  
**ALLIED RADIO**  
100 N. Western Ave., Chicago 80, Ill.

# All new ultra-compact amplifier SONOTONE HFA-150

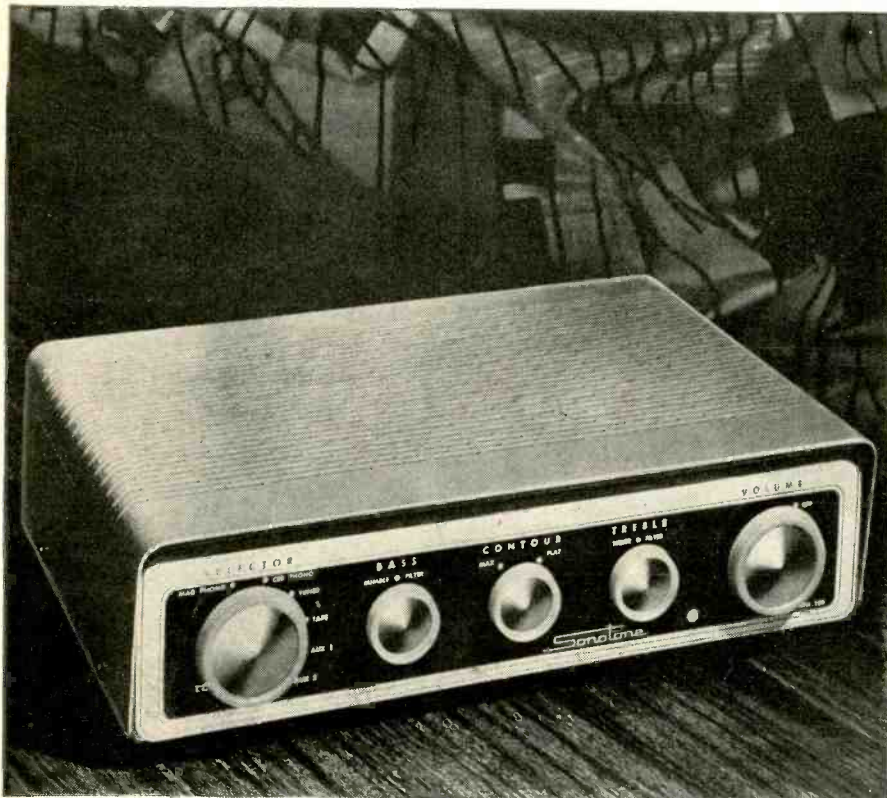

## 15-WATT POWER AT A 10-WATT PRICE!

No amplifier on the market today can compare with the all-new Sonotone HFA-150. Full 15-watt power—superb sound—plus more new, useful “firsts” than any other amplifier at any price.

**ONLY 3" HIGH—12" WIDE!** For the first time, a complete power and control amplifier this compact...without an iota of performance being sacrificed to compactness. The ultra-smart cabinet cover is available in a choice of colors—another Sonotone first!

**SIX INPUTS!** For the first time, a quality amplifier in this price range that gives you single switch choice

of 6 inputs. Three of these inputs have *individual pre-set level controls!*

**SEPARATE CONTOUR CONTROL!** For the first time you get new, exclusive push-pull rumble and noise filters. Bass, treble and volume controls with a *separate* continuous contour control, infinitely variable from flat to 26 db of contour compensation.

The Sonotone HFA-150 is, unquestionably, the greatest value in *fine* high fidelity components in many years. Make seeing and hearing it a “must”!

**ONLY \$79<sup>50</sup> NET**

Optional cover \$3.50 Net

Write for detailed information without obligation to:

Electronic Applications Division

**SONOTONE**® CORPORATION

ELMSFORD, N. Y.



## TEST INSTRUMENTS

rather than miniature. Linear-taper pots were used in the original units but the semilogarithmic are also suitable. They possess one additional advantage. The high beta values will be spread out and easier to read if the log control is connected so the resistance changes fast at the clockwise end of rotation.

A 2,000-ohm resistor is connected across the earphone terminals. This is the correct value if 2,000-ohm phones are used. But 1,000-ohm phones will require no resistor. Phones higher than 2,000 ohms should not be used.

It is convenient, but not necessary, to have a center-position-off n-p-n-p-n-p switch. To identify the collector pin of the transistor socket, I “spotted” the chassis with a drill bit and filled it with a dot of red color-coding lacquer. As an added convenience the emitter, base and collector connections may be brought out to jacks or binding posts.

A total of six penlight or mercury cells power the tester. Ordinary batteries, in series, will have outputs of  $\pm 4.5$  volts and the mercury cells 4 volts. The Mallory RM-625-RT is suitable. This type has a metal tab, connected to the negative terminal, that can be bent and soldered to the side of the next cell for series connection.

Be quick when soldering to either mercury or regular dry cells or the cells probably will be damaged. Check the cells when the job is finished.

### Beta values

The typical values of beta for the different transistors are available from manufacturers' data sheets. For example, Amperex rates the OC-71 at 47, Raytheon's CK722 is 22 and G-E lists the 2N107 as having a beta of 19. *These values are only representative.* A transistor picked from stock may typically have a beta of -50%—+100% of this value.

The February, 1956, issue of RADIO-ELECTRONICS provides a listing of transistor characteristics that should prove useful. It lists the CK722 as having a beta of 12. It should be listed as 22. A larger and more complete listing of transistor characteristics is contained in the January, 1956, issue of ELECTRONICS, available at most large city libraries.

Sometimes the gain figures are listed as alpha rather than beta. They can be converted to beta figures by the simple relation

$$\text{Beta} = \frac{\text{Alpha}}{1 - \text{Alpha}}$$

This little tester is one of the most handy and useful test units I have. Its accuracy is sufficient for all servicing and experimental work. For any of the readers interested in having their transistors checked or measured for use as a standard, I will accurately measure beta on a laboratory instrument. Just send the transistor and 25c to the author at: 1708 McAllister Drive, Huntsville, Ala. It will be measured and returned the same day. END



# BUILD THE BEST—

get the most for your money in ALLIED'S own

# knight-kits!

THE FINEST ELECTRONIC EQUIPMENT IN MONEY-SAVING KIT FORM

### LOWEST COST

Our huge buying power means the biggest savings for you. You do the easy assembly and your finished instrument is equal in performance and appearance to equipment selling for several times the low KNIGHT-KIT price.

### LATEST DESIGN

Months of research, development and field-testing go into each KNIGHT-KIT to bring you proved, advanced design. To assure top performance, premium quality parts are supplied in each kit. KNIGHT-KITS are guaranteed to meet published specifications, OR YOUR MONEY BACK.

### EASIEST TO ASSEMBLE

All chassis and panels are punched; all parts are clearly marked; even the resistors are mounted on cards, and keyed for easy identification. Each instruction manual is a marvel of "Step-and-Chek" clarity. You get professional results even without experience.

**MONEY-BACK GUARANTEE: KNIGHT-KITS FULLY MEET PUBLISHED SPECIFICATIONS, OR WE REFUND YOUR MONEY.**



**FEATURING PHANTASTRON LINEAR SWEEP CIRCUIT**

## knight-kit LOW-COST GENERAL-PURPOSE 5" OSCILLOSCOPE KIT

### Feature for Feature the World's Best Oscilloscope Value

Model F-146

**\$49<sup>50</sup>**

This new oscilloscope delivers performance equal to wired units costing several times more and defies comparison with any other 'scope kit at anywhere near its price. It's the ideal choice for radio and TV servicing, audio work and hundreds of other applications—meets 90% of all 'scope requirements. Here are some of the features that make this kit a standout in its class: *Phantastrom Sweep Circuit*—versions of this circuit are used in \$1,000 'scopes; provides high linearity of sweep from 15 to 150,000 eps. *Regulated Calibration Voltage*—fully regulated square wave calibrating voltage is injected into signal circuit by spring return switch. *25 Millivolts Per Inch Sensitivity*—three times the sensitivity of other 'scope kits in its price class. *Retrace Blanking*—found only in high-priced 'scopes. *Vertical Amplifier*—frequency response  $\pm 3$ db from  $\epsilon$  cps to 1.5 mc ( $\pm 6$ db to 2.5 mc). Input controls are frequency-compensated. Rise time, .25 micro-seconds. Impedance, 3.3 meg. and 45 mmfd. Includes positive and negative internal sync. Outstanding construction features: CRT protected by heavy rubber ring; sturdy steel case with disappearing handle. For easy assembly: pre-cut color-coded wire; resistors carded and keyed to match instructions; printed circuit; laced wiring harness; "Step-and-Chek" construction manual with wall-size picture diagrams. Supplied with all tubes including CRT, all parts, graph screen, wire, 30 der. Size, 9 $\frac{1}{4}$  x 13 $\frac{1}{4}$  x 17 $\frac{1}{4}$ ". Shpg. wt., 26 lbs.

Model F-146. Complete 5" Oscilloscope Kit. Net only	<b>\$49.50</b>
F-148. RF Demodulator Probe Kit. Net	<b>\$3.45</b>
F-147. Low Capacity Probe Kit. Net	<b>\$3.45</b>



Model F-123

**\$44<sup>75</sup>**

## knight-kit TV-FM SWEEP GENERATOR KIT

### Guaranteed Linearity • Fool-proof Calibration • Wide-Range • Electronic Blanking

All-new; precision-designed for lab use, TV and FM servicing, production line testing. Covers 300 kc to 2F0 mc continuous on 4 bands (all fundamentals). Center frequencies of VHF TV channels appear on scales. Exclusive KNIGHT-KIT sweep circuit assures perfect linearity—RF sweep output in excess of 0.15 volts, flat within 1 db, is available on all bands. Sweep width continuously variable, 0-13 mc. Dual crystal marker oscillator and input for variable marker (FF Signal Generator on next page is ideal). Phase control provides blanking shift, 0 to 180°. Step-type and continuous output controls; separate marker amplitude control. Filter connected to 0-50 mc output jack provides 20 db attenuation of frequencies above 50 mc to assure pure, fundamental output. Sweep voltage for 'scopes on front panel. Professional-looking blue-finish steel case with gray panel. Has "disappearing" handle. 8 $\frac{1}{2}$  x 12 x 7 $\frac{1}{2}$ ". With all parts, tubes, test cable, solder and multi-color pre-cut wire. Less crystal. Shpg. wt., 13 $\frac{1}{2}$  lbs.

Model F-123. TV-FM Sweep Generator Kit. Net only	<b>\$44.75</b>
P-286. 4.5 mc Crystal (.005%). Net	<b>\$4.80</b>
P-143. 5.0 mc Crystal (.02%). Net	<b>\$3.95</b>
P-145. 10.7 mc Crystal (.02%). Net	<b>\$3.95</b>

### EASY PAYMENT TERMS

If your total KNIGHT-KIT order is over \$45, take advantage of our liberal Time Payment Plan—only 10% down. Write for application form today.

ALL PRICES NET F.O.B. CHICAGO

SEE FOLLOWING PAGES >

order from **ALLIED RADIO** 100 N. WESTERN AVE., CHICAGO 80, ILL.

# ALLIED'S own knight-kits... better by far



## knight-kit 5" ALL-PURPOSE WIDE-BAND OSCILLOSCOPE KIT

2 Printed Circuit Boards • 5 Mc Width for Color TV

Model F-144

**\$69<sup>00</sup>**

Wide-band, 5" Oscilloscope; equals or betters the performance of commercially-wired scopes costing several times the price. Two printed circuit boards and laced wiring harness assure wiring accuracy and reduce assembly time. Ideal for lab use, color TV servicing and high frequency applications. Provides unusually wide sweep range—from 15 to 600,000 cps. Locks in at frequencies as high as 9 mc. Vertical response, 5 cycles to 5 mc. Response, down only 1 db at 3.58 mc color burst frequency; down only 3 db at 5 mc. High vertical sensitivity of 25 mv/inch. Input capacity 20 mmf and 3.5 megs. Outstanding features: cathode-follower vertical and horizontal inputs; 2nd anode provides 1400 volts high-intensity trace; push-pull vertical and horizontal amplifiers; positive and negative locking; faithful square wave response; frequency-compensated attenuator; Z-axis input for intensity modulation; one volt P-P calibrating voltage; astigmatism control; blanking circuit to eliminate retrace lines; DC positioning control. Complete with CRT, all tubes and parts. Handsome, professional, blue-finished steel case with "disappearing" handles. 14½ x 9½ x 16". Shpg. wt., 40 lbs.

Model F-144. Wide-Band 5" Oscilloscope Kit. Net only ..... **\$69.00**  
 F-148. Demodulator Probe. Net. \$3.45. F-147. Low Capacity Probe. 12 mmf. Net. ... \$3.45

## NEW knight-kit VOLTAGE CALIBRATOR KIT

Model **\$12<sup>75</sup>**  
 F-136



Permits the use of any scope as a precision peak-to-peak AC voltmeter. Provides a true square-wave voltage on scope screen. Range switch and calibrated potentiometer permit selecting any voltage between .01 and 100 volts, in 4 ranges. Fifth position of switch feeds external signal to scope for comparison. Constant output on line volt. variation from 80-135 v. ±6% on all ranges. Shunt capacitance only 15 mmf. Use any 20,000 ohms/volt VOM or a VTVM for initial calibration. Direct coupling of output provides ground reference for DC scopes. Portable case, 7¾ x 5¼ x 4¾". Ready to build. Shpg. wt., 5 lbs.

Model F-136. Voltage Calibrator Kit. Net. ... **\$12.75**

## knight-kit LOW COST RF SIGNAL GENERATOR KIT

Model F-145 **\$19<sup>75</sup>**



Build this wide-range extremely stable RF signal generator and save two-thirds the cost of a comparable wired instrument. Ideal for alignment of RF and IF stages in radio and TV sets, and for troubleshooting audio equipment. Delivers output on fundamentals from 160 kc all the way out to 110 mc; useful harmonics to 220 mc. Has built-in 400-cycle sine-wave audio oscillator for modulating RF; audio is also available externally. Features high-stability Colpitts circuit with precision-wound coils—no calibration necessary. Has input for external modulator. Maximum audio output, 10 volts. RF output, over 100,000 micro-volts. Step and continuous-type output attenuators. With all parts, tubes, wire and solder. Portable case, 7 x 10 x 5". Shpg. wt., 10 lbs.

Model F-145. RF Signal Generator Kit. Net only ..... **\$19.75**

## knight-kit AUDIO GENERATOR KIT

Model F-137 **\$37<sup>50</sup>**



An ideal audio frequency source for checking audio circuits and speaker response. Covers: 20 cps to 1 mc in 5 ranges. Output voltage: 10 volts into 600 ohms impedance. Offers the flat response of a lab standard—±1 db to 1 meg. Generator imp., 600 ohms. Less than .25% distortion from 100 cps through the audible range; less than .5% when driving 600 ohm load at maximum output. Cont. var. step-attenuated output. 17 lbs.

Model F-137. Audio Generator Kit. Net only ... **\$37.50**



Model F-135 **\$26<sup>50</sup>**

## knight-kit VISUAL-AURAL SIGNAL TRACER KIT

A remarkable value in an instrument which permits visual and aural signal tracing of RF, IF, video and audio circuits—has highest gain in its price class. Traces the signal from the antenna to the speaker. Reproduces signal at plate or grid connection of any stage. Identifies and isolates "dead" stages. Features: usable gain of 91,000; "magic eye" with calibrated attenuators for signal presence indication and stage-by-stage gain measurements; built-in 4" PM speaker; single probe with plug-in head gives instant choice of RF or audio tracing. Provides noise test; built-in watt meter calibrated from 25 to 1000 watts; provision for external scope or VTVM. Blue-finish steel case. Shpg. wt., 13 lbs.

Model F-135. Signal Tracer Kit. Net only ..... **\$26.50**



Model F-129 **\$37<sup>95</sup>**

## NEW knight-kit 6-12 VOLT BATTERY ELIMINATOR KIT

A valuable new unit for servicing auto radios, mobile gear, etc. Delivers continuously variable filtered DC output from 0 to 15 volts. Provides DC output at 0-8 volts or 0-15 volts. Continuous current rating: 12.5 amps at 6 volts, 10 amps at 12 volts. Can also be used as battery charger. Oversize rectifiers and transformer for better regulation and long life. Two meters provide simultaneous current and voltage readings; ranges: 0-15 volts DC: 0-20 amps DC. Doubly protected: fused primary and automatic-reset overload relay for secondary. Heavy-duty binding posts. Blue-finish steel case with "disappearing" handle. With all parts, solder and pre-cut wire. 9 x 12¼ x 7¾". Shpg. wt., 20 lbs.

Model F-129. Power Supply Kit. Net only ..... **\$37.95**

## knight-kit RESISTANCE SUBSTITUTION BOX KIT

Model F-139 **\$5<sup>95</sup>**



Model F-139. Resis. Sub. Box Kit. Net. **\$5.95**

## knight-kit CAPACITANCE SUBSTITUTION BOX KIT

Model F-138 **\$5<sup>95</sup>**



Model F-138. Cap. Sub. Box Kit. Net. **\$5.95**

**QUALITY ELECTRONIC TEST EQUIPMENT IN MONEY-SAVING KIT FORM**



...easiest to build...you get more...YOU SAVE MORE



4 1/2" Meter

Model F-128 \$16.95

**knight-kit**  
**1000 OHMS/VOLT VOM KIT**

Exceptional accuracy and versatility at amazing low cost. Ideal for service shop, lab and Amateur use. Uses 4 1/2" meter (400 microamp movement) with separate scales for AC voltage and current, DC voltage and current, decibels and resistance. 38 ranges include: AC, DC and output volts, 0-1-5-10-50-100-500-5000 (1000 ohms/volt sensitivity); Resistance, 0-1000-100,000 ohms and 0-1 meg.; Current, AC or DC, 0-1-10-100 ma and 0-1 amps; Decibels, -20 to +69 in 6 ranges. Uses 1% precision resistors. 3-position function switch and 12-position range switch. Complete kit with bakelite case, (6 3/4 x 5 1/4 x 3 3/4"), battery, pre-cut wire, solder and test leads. Shpg. wt., 2 1/2 lbs.

Model F-128, 1,000 ohms/volt VOM Kit. Net only \$16.95



Model F-140 \$29.50

**knight-kit**  
**20,000 OHMS/VOLT VOM KIT**

Outstanding quality and performance at extremely low cost. Features 32 ranges; full vision 4 1/2" meter; accuracy ±2% of full scale; 50 microampere sensitivity for 20,000 ohms/volt input resistance on DC; front panel "zero adjust" Single switch selects function and range. Range: AC, DC and output volts, 0-2.5, 10-50-250-1000-5000; Resistance, 0-2000-200,000 ohms and 0-20 meg.; DC ma, 0-1-10-100; DC amps, 0-1-10; Decibels, -30 to +63 in 6 ranges. Uses precision 1% multipliers. Moisture-resistant film-type resistors. Complete kit with bakelite case (6 3/4 x 5 1/4 x 3 3/4"), batteries, pre-cut wire, solder and test leads. Shpg. wt., 5 lbs.

Model F-140, 20,000 ohms/volt VOM Kit. Net only \$29.50

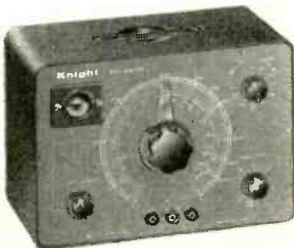

**knight-kit RESISTOR-CAPACITOR TESTER KIT**

Model F-124 Measures capacitance and resistance by accurate bridge method; checks for opens and shorts in paper, mica and ceramic capacitors; shows power factor of electrolytics. Large dial shows capacitance and

\$19.50

resistance at a glance; balanced-bridge circuit with "magic eye" null indicator measures power factor from 0-50%. Tests capacitors with rated voltages applied. 5 test voltages: 50, 150, 250, 350, 450. Capacitance ranges: 10 mmf to 1000 mfd in 5 ranges. Resistance ranges: 100 to 50,000 ohms and 10,000 ohms to 5 megs. Accuracy, ±10%. Automatic discharge feature prevents after-test shock. Blue-finished steel case, 5 x 3 x 2". With tubes and all parts. Shpg. wt., 8 lbs.

Model F-124, Resistor-Capacitor Tester Kit. Net only \$19.50



**NEW knight-kit TRANSISTOR & DIODE CHECKER KIT**

Model F-149 Checks leakage-to-gain ratio and noise level of all junction, point contact and barrier transistors. Also checks diodes, forward and reverse current conduction of selenium rectifiers; useful for continuity and short checks. Easy-to-read meter. Features: spring-return leakage gain switch; calibration control; separate sockets for PNP and NPN transistors. Headphones or signal tracer may be used with checker for noise measurements. Case, 5 x 3 x 2". With 22 1/2 volt battery. 2 1/2 lbs.

Model F-149, Transistor Checker Kit. Net \$8.50

**EASY PAYMENT TERMS:** If your total KNIGHT-KIT order is over \$45, take advantage of our liberal Time Payment Plan —only 10% down. Write for application blank.

ALL PRICES NET F.O.B. CHICAGO



**knight-kit VTVM KIT with Printed Circuit Board**

Model F-125 An extremely stable, and highly accurate VTVM. Greatly simplified wiring—entire chassis is a printed

\$24.95

circuit board. Maximum convenience in arrangement of scales; 3X AC and DC scale design permits utilization of best portion of each scale for most accurate readings. Also measures peak-to-peak for FM and TV work. Ranges: AC P-P volts, 0-4-14-40-140-400-1400-4000; AC rms volts and DC volts, 0-1.5-5-15-50-150-500-1500; resistance, 0-1000-10K-100K ohms and 0-1-10-100-1000 megohms; db scale, -10 to +5. AC response, 30 cycles to 3 mc. Low-leakage switches and 1% precision resistors. Balanced-bridge circuit. 4 1/2" meter, 200 microamp movement. Polarity reversing switch. Input res., 11 megs. Shpg. wt., 6 lbs.

Model F-125 Printed Circuit VTVM Kit. Net only \$24.95

F-126. Hi-Voltage Probe; extends DC to 50,000 Volts \$4.75  
F-127. Hi-Frequency Probe; extends AC to 250 mc. \$3.45



**Model F-143 knight-kit LOW-COST TUBE TESTER KIT**

Offers high accuracy, top versatility and convenience at lowest cost. Tests 4, 5, 6 and 7-pin large, regular and miniature types, octals, loctals, 9-pin miniatures and pilot lamps. Features test for new 600 ma series string tubes. Tests for open, short, leakage, heater continuity and quality (by amount of cathode emission). 4 1/2" square meter with clear "GOOD?-REPLACE" scale. With line-voltage indicator and line-adjust control. Choice of 14 filament voltages from .63 to 117 volts. Blank socket for future type tubes. Universal-type selector switches for any combination of pin connections. Single-unit, 10-lever function switch. Entire switch assembly is installed as a single unit—saves time and greatly simplifies construction. Illuminated roll chart lists over 600 tube types. Shpg. wt., 14 lbs.

Model F-143, Counter Model Tube Tester Kit. Net only \$29.75

Model F-142, Portable Model Tube Tester Kit. Net only \$34.75

F-141, TV Picture Tube Adapter for above. Net only \$3.75

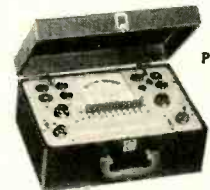

PORTABLE MODEL



**knight-kit LOW-COST "IN-CIRCUIT" CAPACITOR CHECKER KIT**

Tests capacitors while they are still wired in the circuit! Saves time and bother; an essential instrument for the service technician. Just press a button and the "magic eye" instantly shows opens and shorts (not leakage). Tests opens and shorts on any capacitor of 20 mmf or greater capacity, even if it is in parallel with a resistance as low as 50 ohms. Tests for shorts may be made on any capacitor even when it is shunted by as low as 20 ohms. Blue-finish steel case, 7 3/4 x 5 1/4 x 5". With tubes, all parts, wire and solder. Easy to assemble. Shpg. wt., 5 lbs.

Model F-119

\$12.50

Model F-119, Cap. Checker Kit \$12.50

order from **ALLIED RADIO** 100 N. WESTERN AVE., CHICAGO 80, ILL. →

# ALLIED'S own MONEY-SAVING knight-kits

FAMOUS knight-kits FOR HOBBYISTS & EXPERIMENTERS... FASCINATING, INSTRUCTIVE...



knight-kit  
"SPACE SPANNER"  
BAND SWITCHING  
RECEIVER KIT

Model S-243 **\$15<sup>95</sup>**

Thrilling Short Wave and Broadcast

Famous 2-band AC-DC receiver in easy-to-build kit form at a very low price. Pulls in thrilling short-wave (6 to 17 mc) and standard broadcast. It's fun listening to amateur, aircraft, police and marine radio. Features highly sensitive regenerative circuit. Bandswitch selects broadcast or short wave. Has 4" PM speaker and beam-power output tube for plenty of volume; headphone connectors for weak signal listening; slide switch cuts out speaker. Uses 12AT7 regenerative detector and audio amplifier, 50C5 power output, 35W4 rectifier. Six controls: Bandspread; Main Tuning; Antenna Trimmer; Bandswitch; Regeneration; Audio Gain. Includes tubes and all parts. 7 x 10½ x 6". Shpg. wt. 4½ lbs.

Model S-243. "Space Spanner" Receiver Kit. Net only..... **\$15.95**  
S-247. Matching Cabinet for above. 2 lbs. Net..... **\$2.90**

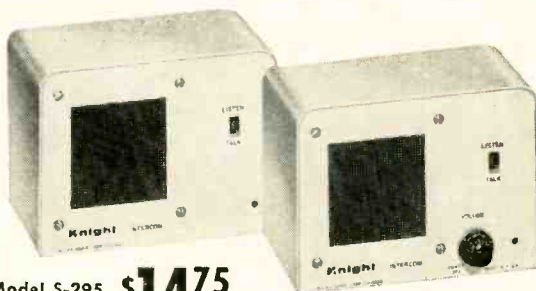

Model S-295 **\$14<sup>75</sup>**

NEW knight-kit TWO-WAY INTERCOM KIT

New low-cost, easy to build intercom system kit. Ideal for use in home or office. Consists of Master unit and Remote unit, each with press-to-talk switch. Remote unit may be left "open" for answering calls from a distance, for "baby-sitting", etc. Remote may also be connected for "private" operation—cannot be "listened-in" on, but it can be called and can originate calls. Master unit includes high-gain 2-stage amplifier; each unit has 4" PM dynamic speaker. Complete with Antique White cabinets (4¼ x 6½ x 4¾"), all parts, tubes and 50 feet of cable (up to 200 feet of cable can be added). For AC or DC. Shpg. wt., 7 lbs.

Model S-295. Two-Way Intercom Kit. Net only. **\$14.75**



Model S-740 **\$11<sup>75</sup>**

knight-kit

"OCEAN HOPPER" RECEIVER KIT

Tops for exciting broadcast, long wave and short wave reception. Highly sensitive regenerative-type circuit. Excellent headphone reception; can be used with 3-4 ohm PM speaker on strong broadcast band stations. Supplied with plug-in coil for standard broadcast; covers long wave and popular short wave bands with coils below. Pulls in thrilling foreign broadcasts, police, amateurs and aircraft. Controls: Main Tuning, Bandspread, Antenna Tuning. Off-On-Regeneration. With all parts and tubes (less extra coils and headset). AC or DC. Shpg. wt., 5 lbs.

Model S-740. "Ocean Hopper" Kit..... **\$11.75**

EXTRA PLUG-IN COILS

S-741. Long Wave, 155-470 kc. Net..... **79¢**  
S-742. Short Wave, 1.65-470 kc. }  
S-743. Short Wave, 2.9-7.3 mc. } Net  
S-745. Short Wave, 7-17.5 mc. } each..... **65¢**  
S-744. Short Wave, 15.5-35 mc. }



Model S-735 **\$17<sup>25</sup>**

knight-kit

"RANGER II" SUPERHET RADIO KIT

Thousands have built and enjoyed the "Ranger" Broadcast Band Receiver. Carefully engineered for easy construction and powerful, sensitive performance. Latest Superhet circuit; tunes 540 to 1680 kc; covers entire broadcast band and exciting police calls. Features automatic volume control, built-in preformed loop antenna, ball-bearing tuning condenser. Develops excellent tone quality from Alnico V PM dynamic speaker. Supplied with following tubes: 12SA7GT converter; 12SK7GT IF amp.; 12SQ7GT det.-AVC-audio; 50L6GT audio output; 35Z5GT rect. Complete with handsome brown plastic cabinet (6 x 9 x 5) tubes, speaker, all parts, and instruction manual. AC or DC operation. Shpg. wt., 8 lbs.

Model S-735. "Ranger II" Superhet Radio Kit. Net only..... **\$17.25**



Model S-730 **\$19<sup>95</sup>**

knight-kit

3-WAY PORTABLE RADIO KIT

A low-cost portable radio covering the full standard broadcast band from 535 kc to 1650 kc. Delivers excellent reception on AC or DC current or from self-contained batteries. Sensitive Superhet circuit features automatic volume control, economical operation. Includes powerful 5" Alnico PM dynamic speaker, efficient ferrite loop-stick antenna. Supplied with following tubes: 1R5 converter; 1U4 IF amplifier; 1U5 detector-AVC-audio; 3V4 audio output. Complete with attractive portable case (7¾ x 10 x 5¼"), tubes, speaker, all parts and instruction manual. Shpg. wt., 6 lbs.

Model S-730. 3-Way Portable Radio Kit (less batteries). Net. **\$19.95**

J-651. Battery Kit for above.... **\$2.50**

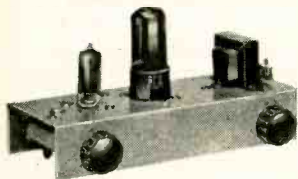

knight-kit LOW COST PHONO AMPLIFIER KIT

Model S-790 **\$8<sup>95</sup>**

It's easy to build this fine-performing, low-cost compact phono amplifier. Ideal for use in a portable phonograph—simply add any record player and a 3 to 4-ohm speaker. Amplifier works with crystal or ceramic cartridges. Inverse feedback circuit for rich, clean tone quality. Delivers full 1½-watt output with less than .25 volt input. Includes efficient tone control; has AC outlet, controlled from amplifier switch. Complete with tubes and all parts. Size only 4½ x 7 x 4"—fits into almost any portable phono case. Shpg. wt., 3 lbs.

Model S-790. Phono Amplifier Kit. Net only..... **\$8.95**

FAMOUS knight-kit CRYSTAL SET KIT

Model S-261 **\$2<sup>15</sup>**

Thousands of beginners have started in radio and electronics by building the KNIGHT-KIT crystal set. This feature-packed set delivers loud, clear reception of local broadcast stations. A germanium crystal diode detector assures high sensitivity and simple operation—no crystal adjustment required. "Hi-Q" coil boosts sensitivity. Ball-bearing variable capacitor for easy tuning. With all parts and simple-to-follow instructions. Shpg. wt., 1 lb.

Model S-261. Crystal Set Kit. Net only..... **\$2.15**

S-267. Accessory Kit. 2000-ohm headphones and all parts for outdoor antenna..... **\$2.95**



Buy with confidence from ALLIED—America's Pioneer in Electronic Kits

# finest quality electronic equipment in lowest-cost kit form

EASY-TO-BUILD HIGH PERFORMANCE KITS • WIDELY USED BY MANY LEADING TRAINING SCHOOLS



## NEW knight-kit ELECTRONIC PHOTOFASH KIT

**Model S-244**  
**\$28<sup>50</sup>**

New feature-packed photoflash kit—designed for top quality dependability—available at a money-saving low price. Ideal for black and white or color photography. Xenon-filled reflector-bulb assembly gives over 10,000 flashes at less than 1/2¢ each! 1/700-second flash freezes the fastest action. Has 50 watt-second output. Provides light approximating daylight in spectral quality; permits the use of outdoor-type film indoors. Film guide number for color (ASA10) is 45. Designed for "X" or "O" shutters only. Requires sync cable (available from any photo supply dealer) and either battery or AC supply listed below. Complete outfit with battery weighs only 3 1/2 lbs. Kit includes all parts, carrying case and easy-to-follow instructions. Shpg. wt., 3 lbs.

- Model S-244. Electronic Photoflash Kit. Net... **\$28.50**
- S-246. AC Power Supply Kit. Easy to assemble... **\$3.75**
- J-626. Battery for above (Burgess U-200)..... **\$8.47**

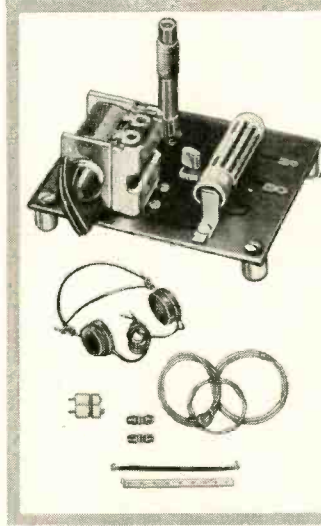

## knight-kit TRANSISTOR RADIO KIT

Printed Wiring • Works from Penlight Cell

**Model S-765** **\$4<sup>35</sup>** Smooth Variable Capacitor Tuning

Experiment with the marvel of transistors! Printed circuit requires no wiring—just assemble with a few solder connections and enjoy excellent reception over the full AM broadcast band. No tubes to burn out—no crystal. Compact—fits in the palm of your hand—operates for months from a single penlight cell. Transistor provides plenty of power for strong headphone reception. Complete with all parts, transistor and penlight cell. Shpg. wt., 8 oz.

- Model S-765. Transistor Radio Kit **\$4.35**
- S-266. Accessory Kit. 4000-ohm headphones and all parts for outdoor antenna..... **\$3.15**

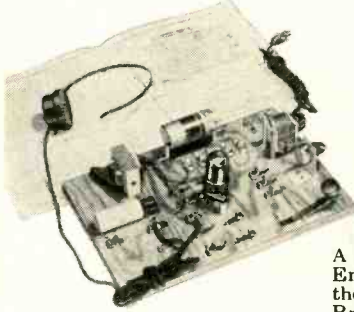

## FAMOUS knight-kit LAB KITS

### 6-IN-1 RADIO LAB KIT

**Model S-770** Build Any of 6 Electronic Projects  
**\$7<sup>95</sup>**

A fascinating and instructive kit. Enables you to build any one of the following projects: Standard Broadcast Receiver; Wireless "Home Broadcaster"; Code Practice Oscillator; Code Practice Broadcaster; Signal Tracer; Sine Wave Generator. Perfect for beginners. Once basic wiring is completed, circuits may be changed without soldering. Safe to build and operate; only tools needed are screwdriver, pliers and soldering iron. The ideal kit for students and beginners in electronics. Kit includes mounting board, tube, all parts and easy-to-follow instruction manual. Less headphone (also serves as mike). Shpg. wt., 6 lbs.

- Model S-770. "6-in-1" Lab Kit. Net only..... **\$7.95**
- J-112. Single 1000-ohm headphone for above..... **\$1.05**
- C-100. Antenna kit for above..... **\$1.05**

### 10-IN-1 LAB KIT

**Model S-265** Build Any of 10 Electronic Projects  
**\$12<sup>65</sup>**

A wonderfully instructive electronics kit. Ideal for experimenters, beginners—fun to build. Construct a sensitive Broadcast Receiver; Amplifier (for phono or mike); Wireless Phono Oscillator; Home "Broadcast Station"; Code Practice Oscillator; Capacity-Operated Relay, or any one of four other fascinating projects. Low voltages; safe to build and operate. Only tools needed are soldering iron, screwdriver and pliers. Perfect for self-instruction in circuit fundamentals, and packed with practical applications. Kit includes mounting board, tubes, all parts, hardware, microphone, and 12-page builders' manual. Shpg. wt., 10 lbs.

- Model S-265. "10-in-1" Lab Kit. Net only..... **\$12.65**
- J-112. Single 1000-ohm headphone for above..... **\$1.05**
- C-100. Antenna Kit for above..... **\$1.05**

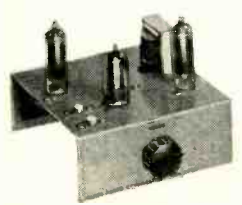

## knight-kit WIRELESS BROADCASTER KIT

**Model S-705** This fascinating unit makes it possible to "broadcast" with phonograph or microphone through any standard radio receiver up to 50 feet away—without any connection to the set. May be used with crystal or magnetic cartridge, or with microphone.  
**\$9<sup>50</sup>**

Broadcasts a clear, full-toned signal. High-gain stage permits using magnetic cartridge without need for external preamp. Complete with all parts, tubes, wire and solder (less microphone). 4 1/2 x 5 x 6". Easy to assemble. Shpg. wt., 3 lbs.

- Model S-705. Wireless Broadcaster Kit. Net only..... **\$9.50**
- S-556. Microphone for above with 5-ft. cable..... **\$3.95**

## knight-kit PHONO OSCILLATOR KIT

**Model S-760** This low-cost phono oscillator may be used with any crystal phonograph for "broadcasting" recorded music through any standard radio receiver up to 50 feet away. Requires no direct connection to radio set. Operates on any frequency between 600 and 800 kc. Has controls for adjustment of modulation level and selection of clear frequency on radio receiver. Uses 50L6GT tube and 35Z5GT rectifier. Complete with all parts, tubes and instructions. 4 1/4 x 4 1/4 x 4 1/2". Shpg. wt., 1 lb.  
**\$5<sup>85</sup>**

- Model S-760. Phono Oscillator Kit. Net only..... **\$5.85**



## knight-kit CODE PRACTICE OSCILLATOR KIT

**Model S-239** Transistor Circuit—Powered by Penlight Cell  
**\$3<sup>95</sup>**

An ideal code practice oscillator. Uses transistor circuit. Extremely low current consumption—powered by single penlight battery. Provides crisp, clear tone (400 to 600 cps). Has input jack for earphone; screw-type terminal strip for key. In compact bakelite case (2 3/8 x 3 3/4 x 1 1/2") with anodized aluminum panel. Complete with all parts, transistor, battery and easy-to-follow instructions. Shpg. wt., 1 lb.

- Model S-239. Code Practice Kit.... **\$3.95**
- See Next Page for Amateur Kits

ALL PRICES NET F.O.B. CHICAGO

order from **ALLIED RADIO** 100 N. WESTERN AVE., CHICAGO 80, ILL. →

# ALLIED'S own knight-kits give you the most for your money

## BUILD YOUR OWN QUALITY HI-FI AMPLIFIER!

**knight-kit**  
**BASIC 25-WATT**  
**LINEAR-DELUXE**  
**HI-FI AMPLIFIER KIT**

Model S-755  
**\$44<sup>50</sup>**

Williamson-Type Circuit  
 Printed Circuit Board  
 Chrome-Plated Chassis



This super-quality hi-fi basic amplifier is designed to satisfy the most critical listener. Intended for use with tuners incorporating built-in preamp or with separate preamp. Incorporates latest Williamson-type circuit and has potted matched transformers. Delivers maximum output of 45 watts. Frequency response is:  $\pm 0.5$  db. 10 cps to 120 kc, measured at 20 watts. Harmonic distortion is only .15% right up to 30 watts. Intermodulation distortion is only .27% at 10 watts and only .4% at 20 watts, using 60 cps and 7 kc, 1:4 ratio. Hum level is  $-85$  db below full rated output. Output impedance, 4, 8, 16 ohms. Input voltage for 25-watt output is 1.8 volts. Uses two 12AU7's, two 5881's, and a 5V4. Etched circuit is utilized in voltage amplifier and phase inverter stages to speed assembly. Has output tube balancing control, variable damping control, and on-off switch. Handsome chrome-plated chassis, 14 x 9 x 2". Overall height, 7". A deluxe true hi-fi amplifier equal in performance to amplifiers selling at over twice the price. Complete with all parts and tubes. Easy to assemble. Shpg. wt., 27 lbs.

Model S-755. Basic 25 Watt Hi-Fi Amplifier Kit. Net only ..... **\$44.50**  
 S-759. Metal enclosure for above; black finish. 3 lbs. Net..... **\$4.25**

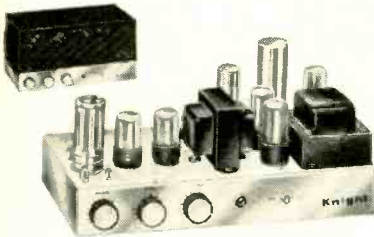

**knight-kit**  
**10-WATT HI-FI AMPLIFIER KIT**

Model S-753  
**\$23<sup>50</sup>**

**Chrome-Plated Chassis**

Famous for wide response and smooth reproduction at low cost. Only 0.5 volt drives amplifier to full output. Frequency response:  $\pm 1$  db. 30-20,000 cps at 10 watts. Harmonic distortion less than 0.5% at 10 watts. Intermod. distortion less than 1.5% at full output. Controls: on-off-volume, bass, treble. Input for crystal phono or tuner. Chromed chassis; punched to accommodate magnetic cartridge preamp. Matches 8 ohm speakers. Shpg. wt., 14 lbs.

Model S-753. Amplifier Kit. Net.... **\$23.50**  
 Model S-235. Preamp Kit for above... **\$3.10**  
 S-757. Metal Enclosure. 3 lbs..... **\$3.95**

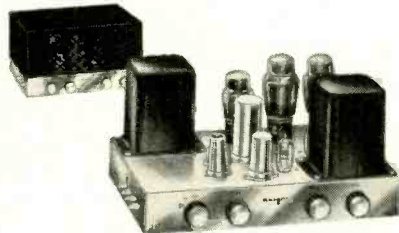

**knight-kit**  
**20-WATT HI-FI AMPLIFIER KIT**

Model S-750  
**\$35<sup>75</sup>**

**Chrome-Plated Chassis**

True hi-fi for less! Frequency response,  $\pm 1$  db. 20-20,000 cps at 20 watts. Distortion, 1% at 20 watts. Hum and noise level: tuner input, 90 db below 20 watts; phono 72 db below 20 watts. 4 inputs: magnetic phono, microphone, crystal phono or recorder, and tuner. Controls: Bass, Treble, Volume, Selector. With compensation positions for 78 and LP records. Built-in Preamp. Outputs: 4, 8, 16 and 500 ohms. 23 lbs.

Model S-750. 20-Watt Kit. Net.... **\$35.75**  
 S-758. Metal Enclosure. 3 lbs..... **\$4.15**  
 S-752. Chrome-plated escutcheon for cabinet installation of amplifier. Net.... **\$1.40**

## LOW-COST TOP QUALITY KITS FOR THE HAM



**knight-kit**

Model S-255 **50-WATT CW TRANSMITTER KIT**  
**\$38<sup>95</sup>**

**Built-in Pi-Type Antenna Coupler**

Check the features packed into this new transmitter kit and you'll see why it's one of the greatest Amateur values ever offered. Compact and versatile, it is the perfect low-power rig for the beginning Novice or seasoned veteran. Features: 50 watts input to 807 final; high-efficiency 6AG7 modified-Pierce oscillator takes crystal or VFO without circuit changes; bandswitching coverage of 80, 40, 20, 15, 11-10 meters; pi-section antenna output matches line impedances from 50 to 1200 ohms —permits use with any type of antenna; no separate antenna tuner required. Crisp, clean, cathode keying of oscillator and final. Power take-off plug supplies filament and B-plus voltages for other equipment. Copper-finished chassis and cabinet interior, filtering, shielding, bypassing, and coaxial SO-239 antenna connector provide excellent TVI suppression. Meter reads either plate or grid current of final. Jacks for VFO, crystal and key. Supplied with all parts and tubes. Less crystal and key. 8 $\frac{3}{4}$  x 11 $\frac{3}{4}$  x 8 $\frac{3}{4}$ ". Shpg. wt., 18 lbs.

Model S-255. 50-Watt Transmitter Kit. Net... **\$38.95**



**knight-kit**  
**SELF-POWERED**  
**VFO KIT**

Model S-725  
**\$28<sup>50</sup>**

Complete with built-in power supply! Careful design and voltage regulation assure high stability. Excellent oscillator keying characteristics for fast break-in without clicks or chirps. Full TVI suppression. Has plenty of bandspread: separate calibrated scales for 80, 40, 20, 15, 11 and 10 meters; vernier drive mechanism. 2-chassis construction keeps heat from frequency determining circuits. Output cable plugs into crystal socket of transmitter. Output on 80 and 40 meters. With Spot-Off-Transmit switch for "no swish" tuning. Extra switch contacts for operating relays and other equipment. With all parts and tubes. 8 lbs.

Model S-725. Self-Powered VFO Kit. Net.... **\$28.50**



**NEW knight-kit**  
**AMATEUR RF**  
**"Z" BRIDGE KIT**

Model S-253  
**\$5<sup>85</sup>**

Measures standing wave ratio (SWR) and impedance of antenna systems; also for adjusting antenna

networks for optimum results. Any VOM may be used for null indicator. High accuracy with 20,000 ohm/v VOM. Correction factor info supplied for other VOM's. With coax input and output connectors. Meters both input and bridge voltage. Calibrated dial gives direct impedance reading; includes 1% precision resistor for precise calibration adjustment. With all parts and handy plasticized SWR chart. 1 $\frac{1}{2}$  lbs.

Model S-253. "Z" Bridge Kit. Net only ..... **\$5.85**

## ALLIED RADIO

100 N. WESTERN AVE., CHICAGO 80, ILL.

our  
 35th year

ALLIED RADIO CORP., Dept. O2-C-7, 100 N. Western Ave., Chicago 80, Ill.

Ship me the following KNIGHT-KITS:

Quantity	Description	Model No.	Price

\$ \_\_\_\_\_ enclosed. For parcel post include postage (express is shipped collect).

Name \_\_\_\_\_

Address \_\_\_\_\_

City \_\_\_\_\_ Zone \_\_\_\_\_ State \_\_\_\_\_

← *Order Today*

## LATEST ALLIED knight-kits



**NEW** for the  
Serviceman

**knight-kit  
FLYBACK  
CHECKER KIT**

Model Y-118 **\$19.50**

Race through TV deflection circuit repairs for extra servicing profits with this new Flyback and Yoke Tester! Instantly checks all types of standard horizontal output transformers as well as linearity and width coils. Positively indicates shorted turns for any coil with a "Q" greater than 1, and inductance between .003 and 2 henries. Determines continuity of any circuit with resistance from zero to .5 meg. Checks wider range of inductances than any other similar unit. Has highly legible  $4\frac{1}{2}$ " meter. Uses 6S4-A pulsed oscillator circuit. Supplied with all parts and test leads.  $7\frac{1}{4} \times 5\frac{1}{4} \times 5"$ . Shpg. wt.  $5\frac{1}{2}$  lbs.

Model Y-118. Flyback Checker Kit. **\$19.50**  
Net.....

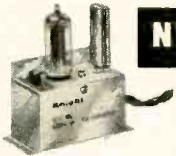

**NEW** for the Ham

**knight-kit  
100 KC CRYSTAL  
CALIBRATOR KIT**

Model Y-256 **\$10.50**

New universal frequency calibrator to fit any communications receiver—priced so low every Ham can afford it. Uses hermetically-sealed 100 KC crystal. Generates 100 KC markers all the way up to 35 mc. Compact case is only  $3 \times 1\frac{1}{2} \times 1\frac{1}{2}$ "; has universal mounting flanges for mounting in any of several positions. Requires only 6.3 v. at .15 amps and 150-350 v. at 3-6 ma. Includes crystal zeroing trimmer and on-off switch which mounts on case. Connects to receiver input. Uses 6AK6 as electron-coupled oscillator. Complete with formed and punched case, 100 KC crystal, tube, all parts and instructions. Shpg. wt., 1 lb.

Model Y-256. Crystal Calibrator Kit. **\$10.50**  
Net.....

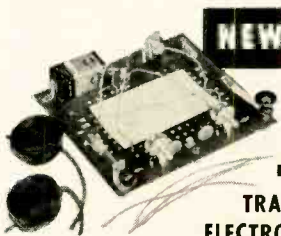

**NEW** for the  
Experimenter

**knight-kit  
TRANSISTORIZED  
ELECTRONIC LAB KIT**

Model Y-299 **\$15.45**

It's sensational—learn how transistors operate—see all the projects you can make with this all-

new electronic marvel! You just assemble the basic parts once. Then you complete project after project (10 in all), just by inserting the "plug-in" leads into the proper jacks on the printed-circuit board—without additional soldering! You can complete and enjoy any of these: a fine AM radio; a wireless home "broadcaster"; phono amplifier; code practice oscillator; electronic timer, switch or flasher; voice-operated, capacity-operated and photoelectric relays. It's the most fascinating experimenters' kit ever developed! Includes all parts, two transistors, battery, headphones and special cards showing you how to plug in each project. Shpg. wt., 3 lbs.

Model Y-299. Transistorized Lab Kit. **\$15.45**  
Net.....

← use order blank  
on opposite page

## TEST INSTRUMENTS

# BALANCING METER POINTERS

By CHARLES ERWIN COHN

IN quality meters, means are provided for balancing the pointer assembly. This insures that the meter will read accurately in all positions. Most meters are properly balanced when they leave the factory, but you occasionally may run across one which is not. This can be seen by a shift in the zero setting when the meter is held in a vertical and then a horizontal position. If the meter is to be used in a variety of positions, as in a multimeter, or if accuracy is important, it is desirable to have the meter properly balanced. This can be done with only a small screwdriver and a lot of care. A quality meter is extremely delicate and a false move can do irreparable damage. Therefore,

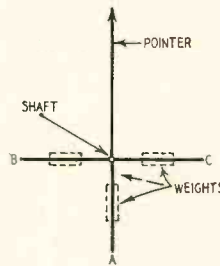

Fig. 1—A meter pointer assembly.

care is more important than the screwdriver!

Fig. 1 shows a pointer assembly, a four-spoked affair consisting of the pointer and rods A, B, C. Each rod carries a sliding weight consisting of a wrapping of fine wire—and these weights govern the balance. Weight A counterbalances the weight of the pointer when the pointer is horizontal; weights B and C control the balance when the pointer is vertical. All share responsibility when the pointer is at an angle.

The procedure for balancing is: remove the three small screws spaced

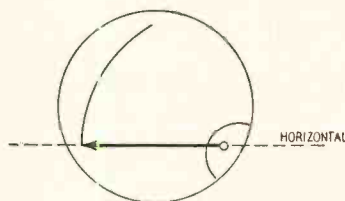

Fig. 2—Pointer horizontal adjustment.

## SENSATIONAL NEW knight-kit HI-FI FM TUNER KIT



**knight-kit  
HI-FI BASIC FM TUNER KIT**

Model Y-751 **\$37.75**

- Featuring deluxe custom high-fidelity styling
- With latest AFC and Flywheel Tuning Control
- Latest printed circuit—no critical wiring required



Advanced Tuner Circuit—noise-free and highly sensitive. Automatic Frequency Control "locks in" on station; AFC disabling feature helps tune in weak stations.

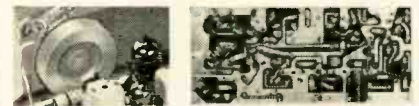

Flywheel Tuning—Weighted flywheel tuning mechanism permits velvet-smooth, accurate station selection over entire band.

Printed Circuit—all critical wiring is already completed—greatly simplifies assembly and reduces wiring time. Circuit board clearly shows placement of basic components.

### INCOMPARABLE HI-FI KIT VALUE

Here is not only the best-looking tuner kit your money can buy, but the only FM tuner kit offering all these features: *Printed circuit* for easy assembly; *automatic frequency control* for "lock-in" tuning of stations, with disabling feature for tuning in weak stations; *pre-adjusted RF coils on rigid forms*—no further adjustment required; *pre-aligned I.F.'s*; *front ventilation*—an integral part of panel design (no unsightly perforations on cabinet.)

**SPECIFICATIONS:** *Tuning Range:* 88-108 mc. *Output:* 2 volts at 1000 microvolt input. *IF Bandwidth:* 200 kc. *Audio Response:* 20-20,000 cps with only 0.6% distortion. *2 Output Jacks:* one for feeding amplifier, the other for tape recorder. *Sensitivity:* 10 microvolts for 20 db quieting across entire band. Cascade broadband RF amplifier. Drift-compensated oscillator. Ideal for use with the Model S-750 KNIGHT-KIT 20-Watt Amplifier kit (see opposite page), or any amplifier equipped with phono-tuner switch. In beautiful gray cabinet with polished aluminum control panel; 4 x 13 x 8"; illuminated lucite pointer highlights station selection. Complete, ready for easy assembly. Shpg. wt., 12 lbs.

Model Y-751. Basic FM Tuner Kit. **\$37.75**  
Net.....

### SPECIAL TUNER-AMPLIFIER OFFER

Exclusive hi-fi value—the new FM tuner kit, plus the 20-watt amplifier kit on opposite page (including metal enclosure) for only \$73.65! Buy this matched Hi-Fi combination and save \$4.00! Shpg. wt. 35 lbs. Model Y-761. Knight-Kit Tuner and 20-Watt Amplifier. Net..... **\$73.65**  
Only \$7.37 down on our Easy Pay Plan

← ORDER FROM **ALLIED RADIO**  
use order blank on opposite page

What does the future hold for you?

# Electronic Technicians

If you seek further training or education, Hughes, located in sunny Southern California, is the place for you. As the West's leading center for advanced electronics, Hughes offers its electronic technicians the opportunity to work on some of the most advanced equipment in existence. On joining the organization you will participate in programs which provide everything from "on the job" training to specially designed Hughes courses.

Also, you may take advantage of the Hughes-sponsored evening courses offered in all of the nearby universities. Every year dozens of Hughes technicians receive their degrees!

The all-around experience and education you receive will qualify you to be a leader in the future age of electronics.

Hughes offers you top pay! And chances are, Hughes will pay all of your moving and travel expenses. Find out more about what Hughes can now offer you.

## WRITE TODAY

For further information concerning these opportunities at Hughes, write to Mr. John C. Bailey at the address below.

*Scientific Staff Relations*

# HUGHES

RESEARCH AND DEVELOPMENT LABORATORIES  
HUGHES AIRCRAFT COMPANY, CULVER CITY, CALIFORNIA

## TEST INSTRUMENTS

around the meter case near the back and carefully withdraw the movement from the case. Hold the movement with the dial horizontal, in which position the balance has no effect, and move the slotted zero-adjusting lug to zero the pointer. Then hold the meter with the dial vertical and the pointer horizontal. Check this by sighting against a surface known to be level. Have the zero end of the scale lowermost as in Fig. 2. If the pointer moves off scale, weight A

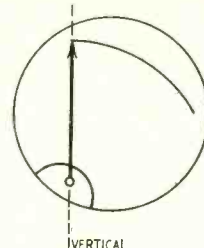

Fig. 3—Pointer vertical adjustment.

should be moved out; if it moves up scale, weight A should be moved in. Do these weight-moving operations very carefully with the tip of a small screw driver, being especially watchful of the delicate hairspring. Hold the pointer still by holding your finger against the end of rod A.

When this adjustment is right, hold the meter with the dial and the pointer vertical, pointing upward (Fig. 3). Again check this by sighting against something vertical. If the pointer moves up scale, move weight B out or C in; if it moves off scale, do the opposite. This done, check the work by moving the meter from dial horizontal to dial vertical and note whether the zero setting shifts. Repeat the adjustments if necessary to obtain the desired accuracy.

When the adjustments are complete, move the zero-adjusting lug to a vertical position. Move the zero-adjusting screw on the case so the projection on the inside is at the bottom and reinsert the movement in the case. Replace the three case screws and the job is finished. END

## Thirty-Five Years Ago In Gernsback Publications

### HUGO GERNSBACK, Founder

Modern Electric .....	1908
Wireless Association of America .....	1908
Electrical Experimenter .....	1913
Radio News .....	1919
Science & Invention .....	1920
Television .....	1927
Radio-Craft .....	1929
Short-Wave Craft .....	1930
Television News .....	1931

Some larger libraries still have copies of **ELECTRICAL EXPERIMENTER** on file for interested readers.

### In March, 1923, *Science and Invention* (formerly *Electrical Experimenter*)

The Sleep Eliminator, Coming Inventions No. 8, by H. Gernsback.  
Talking Across the Atlantic.  
Receives Radio Broadcast Under River.  
Secrecy in Radio at Last, by A. P. Peck.  
Radio for the Beginner, by Armstrong Perry.  
Amplifier for Your Present Tuner, by Bert T. Bonadventure.  
Winners of \$100.00 Radio Interference Preventer Contest.  
Garden Hose Saves Day for Radio.

# GET IN ON THE TV

# BOOM!



L. C. Lane, B.S., M.A.  
President, Radio-Television Training Association. Executive Director, Pierce School of Radio & Television.

## TRAIN FOR A TOP-PAY JOB AS A TELEVISION TECHNICIAN

**NO PREVIOUS EXPERIENCE NEEDED — study AT HOME in your SPARE TIME**

Next to the atom and hydrogen bombs, the biggest noise being made today is by the booming radio-television-electronics industry.

Now, while the boom is on in full force, is the time for you to think about how you can share in the high pay and good job security that this ever-expanding field offers to trained technicians.

Just figure it out for yourself. There are more than 490 television broadcasting stations operating right now

and hundreds more to be built; more than 40 million sets in the country and sales increasing daily. Soon moderately priced color television sets will be on the market and the color stampede will be on.

All these facts mean that good jobs will be looking for good men. You can be one of those men if you take advantage of my training now — the same training that has already prepared hundreds of men for successful careers in the radio-television-electronics field.



**YOU GET ALL THESE IN THE BASIC COURSE**

AF-RF Signal Generator  
Super-Het Radio Receiver  
C-W Telephone Transmitter  
Public Address System  
Combination Voltmeter-Ammeter-Ohmmeter

No experience necessary! You learn by practicing with professional equipment I send you. Many of my graduates who now hold down good paying technician jobs started with only grammar school training.

If you have previous Armed Forces or civilian radio experience you can finish your training several months earlier by taking my FM-TV Technician Course. Train at home with kits of parts, plus equipment to build YOUR OWN TV RECEIVER. ALL FURNISHED AT NO EXTRA COST!

After you finish your home study training in the Radio-FM-TV Technician Course or the FM-TV Technician Course you get two weeks, 50 hours, of intensive Laboratory work on modern electronic equipment at our associate school in New York City, Pierce School of Radio & Television. NO EXTRA COST.

With our TV Studio Technician Course (Advanced training for men with previous radio or TV training or experience) I train you at home for an exciting top-pay job as the man behind the TV camera. Work in the TV studios or "on location" at remote pick-ups! Optional N.Y.C. additional training.

**RADIO-FM-TV TECHNICIAN TRAINING**

**FM-TV TECHNICIAN TRAINING**

**EXTRA LABORATORY TRAINING IN NEW YORK CITY AT NO EXTRA COST!**

**TV STUDIO TECHNICIAN TRAINING**

**LEARN BY DOING**—As part of your training I give you the equipment you need to set up your own home service shop and prepare for a BETTER-PAY JOB. You build and keep a Television Receiver designed to take any size picture tube up to 21-inch, (10-inch tube furnished. Slight extra cost for larger sizes.) ... also a Super-Het Radio Receiver, AF-RF Signal Generator, Combination Voltmeter-Ammeter-Ohmmeter, C-W Telephone Transmitter, Public Address System, AC-DC Power Supply. Everything supplied, including all tubes.

**EARN WHILE YOU LEARN**—Almost from the very start you can earn extra money while learning by repairing radio-TV sets for friends and neighbors. Many of my students earn enough from spare time earnings to pay for their entire training ... start their own profitable service business.

**FCC COACHING COURSE**—Qualifies you for Higher Pay! Given to all my students AT NO EXTRA COST. Helps you qualify for the TOP JOBS in Radio-TV that demand an FCC license! Full training and preparation at home for your FCC license.

## VETERANS!

My School fully approved to train Veterans under new Korean G.I. Bill. Don't lose your school benefits by waiting too long. Write discharge date on Postage-Free card below.

**CUT OUT AND MAIL TODAY! POSTAGE FREE!**

**Yours FREE**

NO STAMP NEEDED!  
WE PAY POSTAGE!

Dear Mr. Lane: Send me your NEW FREE BOOK and FREE SAMPLE LESSON that will show me how I can make TOP MONEY in TELEVISION. I understand I am under no obligation.

(PLEASE PRINT PLAINLY)

Name \_\_\_\_\_ Age \_\_\_\_\_

Address \_\_\_\_\_

City \_\_\_\_\_ Zone \_\_\_\_\_ State \_\_\_\_\_

I AM INTERESTED IN:

- Radio-FM-TV Technician Course
  - FM-TV Technician Course
  - TV Studio Technician Course
  - Color-TV Course
- (send me Color-TV Brochure only)

**VETERANS!**  
Write discharge date

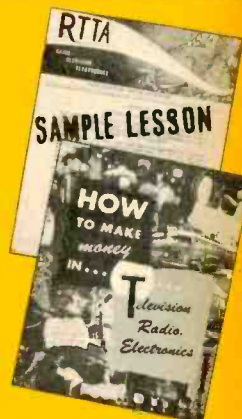

# Radio-Television Training Association

52 EAST 19th STREET • NEW YORK 3, N. Y.

Licensed by the State of New York • Approved for Veteran Training

# There's a "POT of GOLD" waiting for YOU — at the end of this COLOR-TV servicing rainbow!

## Introducing RTTA's COLOR-TV TECHNICIAN COURSE

(advanced training for men who have had radio and TV experience)



Color television receivers will demand installation, set-up, adjustment and servicing by highly trained specialists—training and skill which you can acquire in your spare time, at home through RTTA's up-to-the-minute COLOR TELEVISION TECHNICIAN COURSE. All of the latest information and methods for the servicing and maintenance of all color TV receivers and equipment. Trains you thoroughly, accurately and reliably. You will be on a par with the best, anywhere! *To qualify for this specialized training it is necessary to have had previous radio, television training or experience.*

The step-by-step approach found so successful in teaching our Radio-FM-TV Course, FM-TV Technician Course and TV Studio Technician Course is used in this new, up-to-the-minute COLOR TELEVISION TECHNICIAN COURSE. With the RTTA way, you set your own pace for learning—as rapidly or as moderately as suits your own personal convenience. Lessons are written in easy-to-understand language that everyone can follow. They

are illustrated throughout enabling you to grasp the full meaning of concepts immediately.

The course begins with an introduction to the Laws of Color and defines the differences between the transmission and reception of black-and-white and of color television. Starting at the transmitter you are guided through the development of, and transmission of, the composite Color TV signal. With an over-all view of how the receiver functions each circuit is then analyzed. A knowledge of how Color TV circuits work, both as individual and as cooperative units in the receiver, prepares you for all future developments in the field of Color TV. You also receive thorough instruction on test instruments, alignment, as well as servicing. The RTTA Color TV Course features all of the latest information.

For a complete description of the course, send today for your FREE copy of the RTTA COLOR TV Course Brochure.

### SYLVANIA SELECTS RTTA's COLOR TELEVISION COURSE FOR ITS EDUCATIONAL PROGRAM

Service dealers throughout the U.S. will soon be able to learn Color Television from the best available information.

The selection of RTTA's COLOR TELEVISION COURSE by Sylvania Tube Division, one of the nation's top manufacturers of receiving tubes and picture tubes is an added assurance to you of the tremendous value of this course. We are proud of this endorsement by Sylvania. It indicates the outstanding merit of the RTTA course. We know that a company such as Sylvania which has earned its fine reputation over the

years through the high standard of its products and through leadership, would extend such recognition only after careful cooperation and examination by its staff of experts and engineers. They concluded that the RTTA course offers the best opportunity of studying Color Television on a practical basis—to learn the subject thoroughly.

The Color Television Technician Course is being made available to authorized Sylvania Dealers throughout the 48 states who are interested in expanding their knowledge and experience in Color TV servicing.

SEE OTHER SIDE

CUT OUT AND MAIL TODAY!—POSTAGE FREE!

FIRST CLASS  
Permit No. 62058  
(Sec. 34.9, P. L. & R.)  
New York, N. Y.

#### BUSINESS REPLY CARD

No Postage Stamp Necessary if Mailed in the United States

POSTAGE WILL BE PAID BY

RADIO-TELEVISION TRAINING ASSOCIATION

52 EAST 19th STREET, Dept. AB-1

NEW YORK 3, N.Y.

#### 14 THOROUGH LESSONS

- 1 AN INTRODUCTION TO COLOR
- 2 FORMATION OF THE COLOR SIGNALS
- 3 THE CHROMA SIGNALS
- 4 GENERAL OPERATION OF THE COLOR TELEVISION RECEIVER
- 5 PICTURE TUBES FOR COLOR TELEVISION RECEIVERS — PART I
- 6 PICTURE TUBES FOR COLOR TELEVISION RECEIVERS — PART II
- 7 DETAILED OPERATION OF THE COLOR TELEVISION RECEIVER
- 8 THE CHROMINANCE CHANNEL
- 9 COLOR TELEVISION CIRCUITS — PART I
- 10 COLOR TELEVISION CIRCUITS — PART II
- 11 ADJUSTING THE COLOR TV RECEIVER
- 12 COLOR TV TEST EQUIPMENT
- 13 TROUBLESHOOTING THE COLOR TV RECEIVER
- 14 SERVICING PROCEDURE

SEND FOR YOUR ENROLLMENT APPLICATION TODAY!



# RF

# CAPACITANCE METER

*Transistorized  
1-mc oscillator—  
detector provides  
accurate measurement*

By I. QUEEN  
EDITORIAL ASSOCIATE

**N**OTHING is as difficult to identify as the value of a small capacitor. These come in a variety of shapes—button, disc, tubular, postage stamp, feedthrough, etc. Often they are so small there is little space to color-code or stamp their value. The tiny markings are soon blurred or erased by handling and the unit becomes an unknown quantity. Even when the marking is clear it may be desirable to measure the capacitor before connecting it into some critical circuit. The instrument described here measures directly up to 300  $\mu\mu\text{f}$ . TV technicians, hams, experimenters and others who use small capacitors will find this tester valuable.

Capacitance is often measured on a bridge circuit powered from a 60-cycle or af source. However, the smaller capacitors are generally used in high-frequency circuits so it is preferable to measure them at a high frequency. In fact, commercial and military specifications call for measuring small capacitors at 1 mc, as is done here.

Fig. 1 shows a pickup circuit L-C coupled to a 1-mc oscillator; a meter

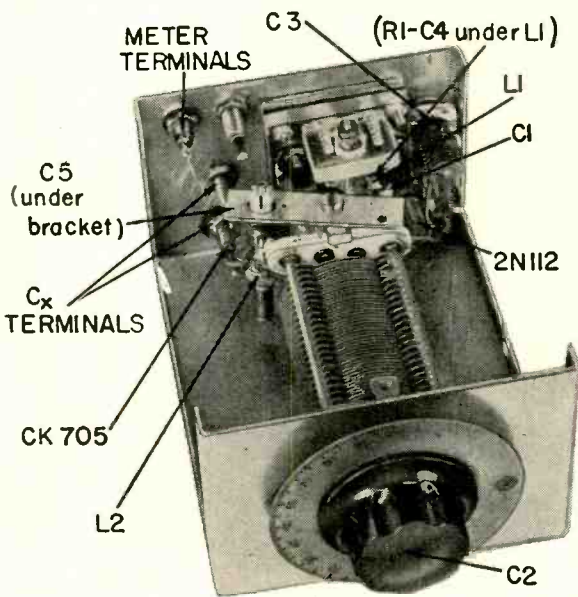
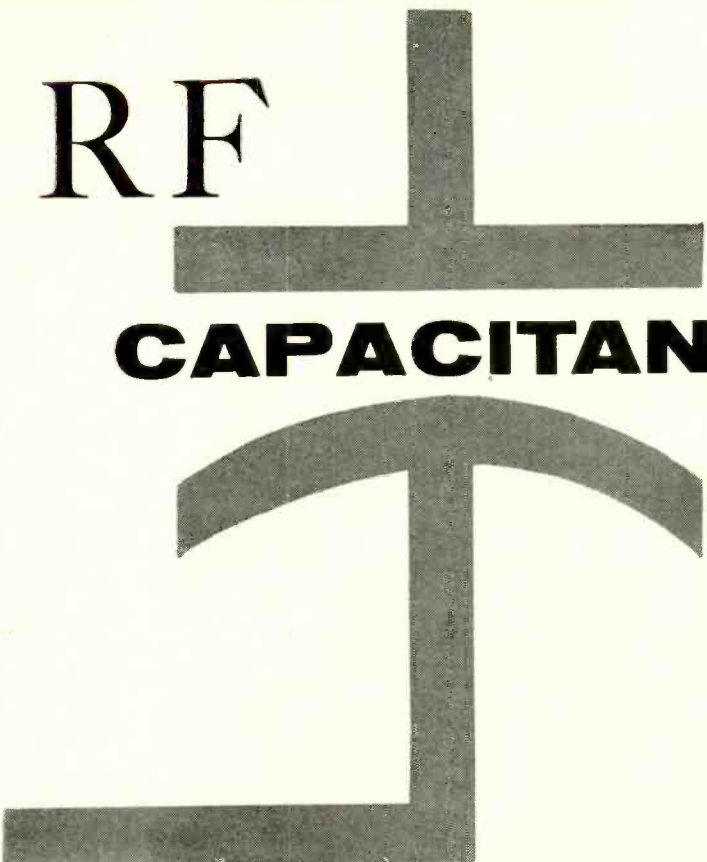

Internal layout of capacitance meter.

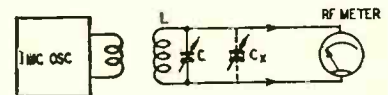
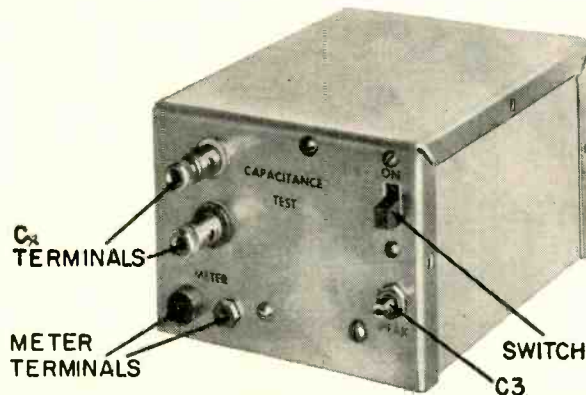

Fig. 1— Basic hookup of equipment.

indicates resonance. Before  $C_x$  (the unknown) is connected, calibrated capacitor  $C$  is set to maximum, at which point L-C is tuned to 1 mc. This is shown by maximum deflection on the meter.

When  $C_x$  is connected, the circuit is detuned. To restore resonance,  $C$  must be reduced by the value of  $C_x$ . By calibrating the  $C$  dial, the unknown capacitance may be read directly. This is a very simple and effective method. A laboratory instrument of this type can be relied upon to about 4% accuracy. This home-made unit is transistorized so it is independent of line voltage and is compact.

The coupling between the oscillator and pickup circuit must be loose. When



Panel view—only connections are the unknown capacitance and dc meter.

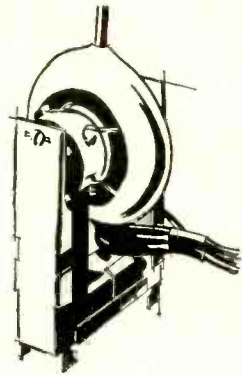

HVO-63 replaces Zenith part S-19408

# ONLY MERIT

... always first with the latest

*exact replacement*

*exceed original equipment specifications to eliminate call-backs ... and no electrical or mechanical changes are necessary.*



HVO-66 replaces part 24K736488 in 85 Motorola models and chassis



MDF-85 for G.E. RLD-041 & 045



HVO-62 replaces Magnavox part 360580-1, 360604-1, 360610-1



BC-359 sub-miniature IF output transformer for printed circuits—455KC



MDF-84 for G.E. RLD-025

# MERIT

MERIT COIL AND TRANSFORMER CORP.  
4427 N. Clark St., Chicago 40, Ill.

## TEST INSTRUMENTS

circuits are closely coupled they give a double-hump or flat-topped response. This may be OK for TV and FM reception but must be avoided here. For accurate measurements, the tuning must be sharp and this calls for very loose coupling.

The complete schematic is shown in Fig. 2. The oscillator uses a Raytheon 2N112 (formerly called CK760) high-frequency transistor. Although an ordinary CK722 *might* work well in this circuit, it is not designed for the frequency. Even if an efficient CK722 were at hand, it would probably require relatively high voltage, perhaps 15 or more, to oscillate reliably at 1 mc. The 2N112 requires only a few collector volts and even a single 1.5-volt cell has been found satisfactory.

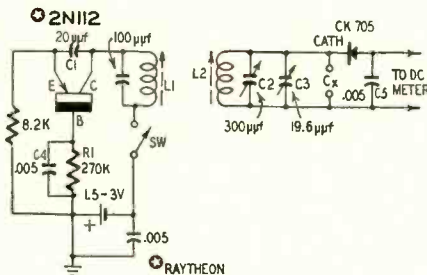

1—8,200, 1—270,000 ohms, 1/2-watt resistors; 1—20, 1—100 µf, 3—,005 µf, capacitors; 1—Raytheon 2N112 transistor; 1—CK705 detector; 1—variable capacitor, 300 µf, double bearing, straight-line capacitance; 1—variable capacitor, 19.6 µf (E. F. Johnson 20M11 or equivalent); 2—broadcast-band antenna ferrite coils; 1—1.5-volt penlight cell; 1—spst switch; 1—chassis, approximately 3 x 4 x 5-inch case; 1—small section of polystyrene; 2—jacks; 2—binding posts; 1—tuning dial.

Fig. 2—Schematic diagram of the 1-mc oscillator and tuned-detector circuits.

Oscillator coil L1 is a variable broadcast-band ferrite-core antenna coil shunted by a fixed capacitor. Feedback capacitor C1 should be large enough to produce reliable oscillation. Some circuits may require a larger value than 20 µf. The oscillator is slug-tuned to 1 mc by listening for the signal on a nearby broadcast receiver. If necessary, couple a lead from the oscillator near the antenna terminal of the receiver to pick up sufficient signal.

Variable ferrite-core antenna coil L2 is tuned by C2. This capacitor must be rugged, preferably with double bearings, since it is the standard. It should have *straight-line capacitance* characteristics (semicircular plates). This means that capacitance will vary uniformly with rotation over most of the dial. Also, C2 should have *fairly large capacitance* to give an adequate measurement range. The capacitor used here has a maximum value of 300 µf; is about 3 inches long with 43 plates 1½ inches in diameter; has double bearings.

Capacitor C3 is a tiny variable unit made by the E. F. Johnson Co. It has a maximum capacitance of about 20 µf. It resonates the pickup circuit and compensates for any slight drift that may occur from time to time. Also, it can be used to measure very low capacitance (in the order of a few

µf) in the same way C2 measures larger values.

### Calibration and construction

After L1 is tuned to 1 mc, L2 is coupled near it. Between 1 and 1½ inches should be correct. As a trial, watch the output meter and make sure that there is no flat-top response or a double hump. If there is, back off the coupling as necessary. At optimum coupling the dc output should be about 12 µa. This can be read conveniently on a meter with a maximum deflection of 20, 25, 50 and even 100 microamps. Tighten L2 in its optimum position.

Rotate C2 to maximum capacitance and set its dial to *zero*. Set C3 to about mid-scale. Now tune L2 for resonance as indicated on the meter. This completes the calibration and the instrument is ready for measurements.

With a 0-100 dial, the calibration is so accurate that a hand-made scale or auxiliary chart has not been found necessary. Here is a sample of measurements:

Capacitance	Dial
50	16
100	33
150	51
200	66
250	85
300	100

Capacitance measurements will probably be less accurate than with resistance. Most resistors are sold with a maximum tolerance of 1 to 10%. Capacitors may have a tolerance of 5 to 20%. As mentioned, a *lab* instrument for measuring low capacitance may have a possible error of 4%.

The maximum range of measurement of this instrument is the difference between minimum and maximum capacitance of the standard capacitor. For example, the one used here has a maximum capacitance of 300 µf, a minimum of 12 µf. Theoretically then it can measure up to 288 µf, although careful measurements (see above) show a maximum very near 300 µf.

The instrument is housed within a 3 x 4 x 5-inch aluminum Flexi-Mount case. The standard capacitor is mounted at one end (see photo) and L2 is screwed onto a bracket on the capacitor. The oscillator circuit (including transistor, L1 and a single-size cell) is on a small polystyrene subbase. This makes it easy to construct and adjust the oscillator as a separate unit before it is put into the aluminum box.

Before making a measurement at any time, set C2 to maximum (zero on the dial) and adjust C3 for maximum deflection.

Note that no meter is included in the aluminum box. Most constructors will want to use an external meter for this purpose. A 0-50-microamp meter (or one more sensitive) is recommended. However, even a 0-100 meter can be used. Full-scale deflection is not required. Only the peak reading must be observed. END

# two transistor pocket portables



External appearance of Fig. 2 set.

By LEONARD J. D'AIRO

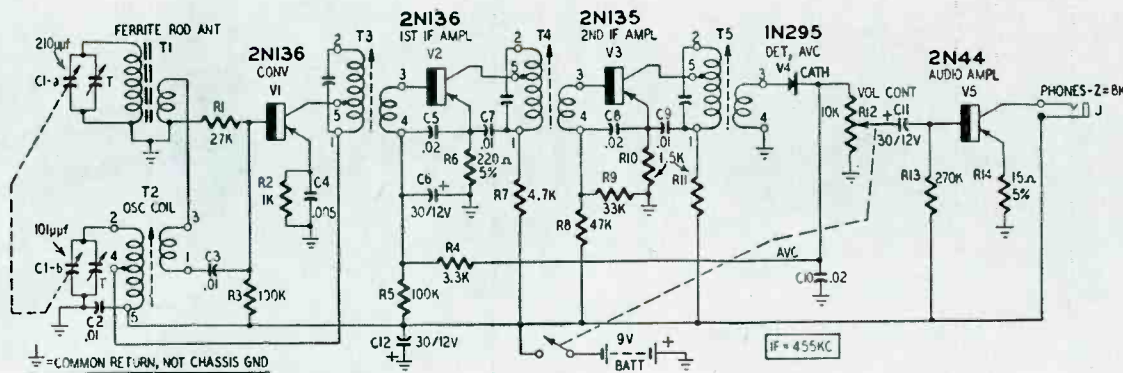

- R1—27,000 ohms
- R2—1,000 ohms
- R3, 5—100,000 ohms
- R4—3,300 ohms
- R6—220 ohms, 5%
- R7—4,700 ohms
- R8—47,000 ohms
- R9—33,000 ohms
- R10, 11—1,500 ohms
- R12—10,000-ohm pot with switch (Lafayette VC-28)
- R13—270,000 ohms

- R14—15 ohms, 5%
- All resistors 1/2 watt, 10%, unless otherwise noted.
- C1-a, -b—miniature variable capacitor. Antenna section 210 μf; oscillator section 101 μf (Lafayette MS-270)
- C2, 3, 7, 9—01 μf, disc ceramic
- C4—005 μf, disc ceramic
- C5, 8, 10—02 μf, disc ceramic
- C6, 11, 12—30 μf, 12 volts, miniature electrolytic
- V1, 2—2N136
- V3—2N135

- V4—1N295
- V5—2N44
- T1—antenna coil (see text) (Lafayette MS-329)
- T2—oscillator coil (Lafayette MS-265)
- T3, 4, 5—miniature if transformers (Lafayette MS-188)
- BATT—9-volt mercury battery (RCA VS309 or equivalent)
- J—miniature phone jack
- Earphone—8,000-ohm impedance (Lafayette MS-260)
- Cabinet
- Chassis or laminate board

Fig. 1—Schematic of slightly larger set. Two if stages are used.

**P**ERFORMANCE equal to that obtained from a conventional portable radio is available with either of the two pocket portable receivers described in this article. Each receiver uses four transistors in a superheterodyne circuit, with good sensitivity and selectivity.

One receiver (Fig. 1) uses four transistors and a diode: converter, 2N136; first if amplifier, 2N136; second if amplifier, 2N135; detector-avc, 1N295; audio amplifier, 2N44. A 9-volt mercury battery supplies the power; current drain is 4 ma and audio output is 8 mw maximum. The overall power gain is 110 db. The second receiver (Fig. 2) uses two CK760/2N112's as converter and if amplifier, and two 2N132's as class-B detector-avc and audio amplifier. Power requirements for this receiver are 6 volts (mercury battery) at a current drain of 2 ma. Maximum audio output is 2 mw and overall power gain is 90 db. The estimated battery life for either receiver is 250 hours plus.

### Circuit description

The converter stage is a self-excited oscillator in which the incoming signal is applied to the base. This signal mixes

with the rf generated to produce an if of 455 kc which is then amplified. The receiver in Fig. 1 uses two stages of if amplification to drive the diode detector, while only one stage is used in the Fig. 2 receiver. A single stage of amplification here is sufficient to drive a class-B detector. No neutralization of the if

amplifiers is required in this receiver.

In Fig. 2 a class-B detector is used since it has the advantage of providing about 10 db of audio power gain and a suitable avc voltage, besides acting as a detector. The avc voltage is obtained from the detector collector and is applied to the base of the if amplifier.

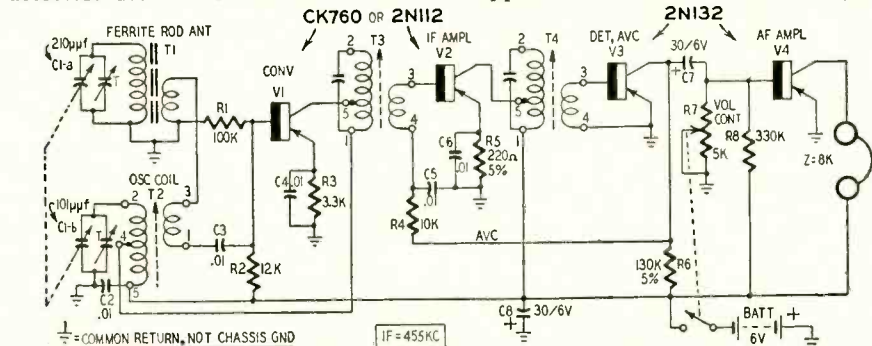

- R1—100,000 ohms
- R2—12,000 ohms
- R3—3,300 ohms
- R4—10,000 ohms
- R5—220 ohms, 5%
- R6—130,000 ohms, 5%
- R7—5,000-ohm pot with switch (Lafayette VC-42)
- R8—330,000 ohms
- All resistors 1/2 watt, 10%, unless otherwise noted.
- C1-a, -b—miniature variable capacitor. Antenna section 210 μf; oscillator section 101 μf (Lafayette MS-270)

- C2, 3, 4, 5, 6—01 μf, disc ceramic
- C7, 8—30 μf, 6 volts, miniature electrolytic
- V1, 2—CK760/2N112
- V3, 4—2N132
- T1—antenna coil (see text) (Lafayette MS-329)
- T2—oscillator coil (Lafayette MS-265)
- T3, 4—miniature if transformers (Lafayette MS-188)
- BATT—6-volt mercury battery (RCA VS310 or equivalent)
- Earphone—8,000-ohm impedance (Lafayette MS-260)
- Cabinet
- Chassis or laminate board

Fig. 2—Schematic of smaller set—audio stage is impedance-coupled.

## RADIO

Under no-signal conditions the voltage at the detector collector is approximately equal to the supply voltage (since this transistor is biased at cutoff) and, therefore, the if amplifier operates at maximum gain. When a signal is applied the detector collector draws current, through the load resistor, and the collector voltage drops. This lower voltage, which is applied to the if amplifier base, reduces the gain of this stage and prevents overloading and distortion on strong signals.

Avc action in the first receiver is much the same as in a conventional radio with the diode rectifying the rf and the avc voltage applied to the base of the first if amplifier to control the gain of this stage.

The output of the detectors in both receivers is capacitance-coupled to the af amplifiers. In Fig. 1 the volume control is the diode load resistor with the arm connected to the base of the audio amplifier. In Fig. 2 the volume control is part of the audio amplifier base-bias network. Varying the control varies the base bias which in turn varies the gain of the amplifier. The audio amplifiers are both single-ended class-A stages operating into an 8,000-ohm load impedance.

A flat ferrite-core antenna coil is used in preference to the round, or rod, type. It has the advantage of exposing a greater surface area, which provides for a better capture of signals. This means higher sensitivity and less directional qualities. The core measures  $2\frac{5}{8} \times \frac{3}{4} \times \frac{3}{16}$  inch and is wound with approximately 110 turns of 10-48 Litz wire, tapped at 6 turns for the converter base. The inductance of the coil is  $395 \mu\text{h}$  and the unloaded Q is 250.

The oscillator coil is Lafayette Radio part No. MS-265 used without any electrical modification. For the smaller set (Fig. 2), though, the overall height is reduced so that it will fit into the case. The form is pushed down through the base until the coil is about  $\frac{1}{16}$  inch above the base. The form and part of the base are then cut, just below the terminals, and trimmed to fit in the case. Fig. 3 shows the coil before and after modification.

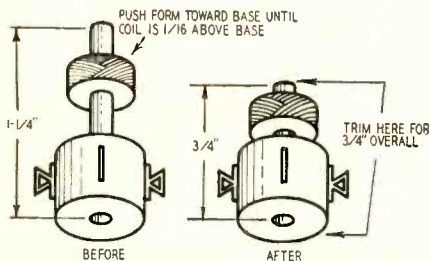
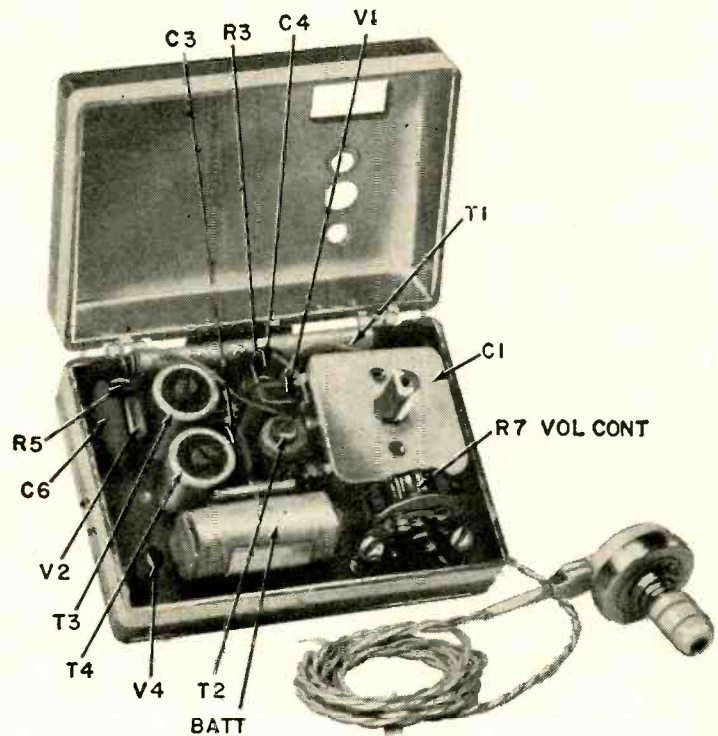
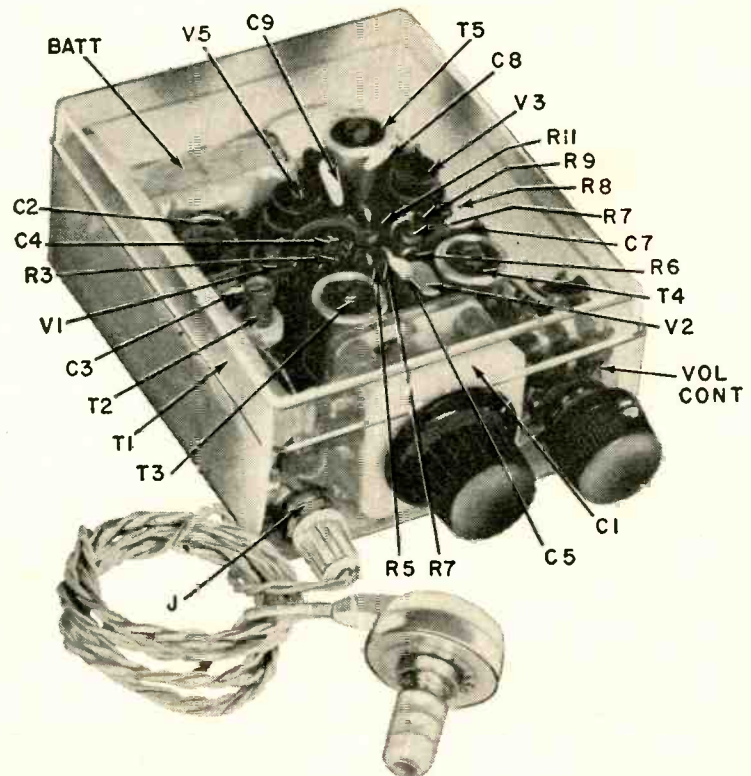

Fig. 3—Modification of oscillator coil.

A miniature variable capacitor measuring  $1\text{-}1/16$  inches square by  $\frac{5}{8}$  inch deep tunes the antenna and oscillator coils over a frequency range of from 540 to 1650 kc. Tracking is obtained by cut plates and trimmers on the capacitor. Capacitance for the antenna section



Top view shows components layout of the transistor receiver in Fig. 1.



Opened cabinet cover reveals parts layout in Fig. 2 transistor receiver.

# SHOW ANY PICTURE or PATTERN

at any time — ON ANY TV SET

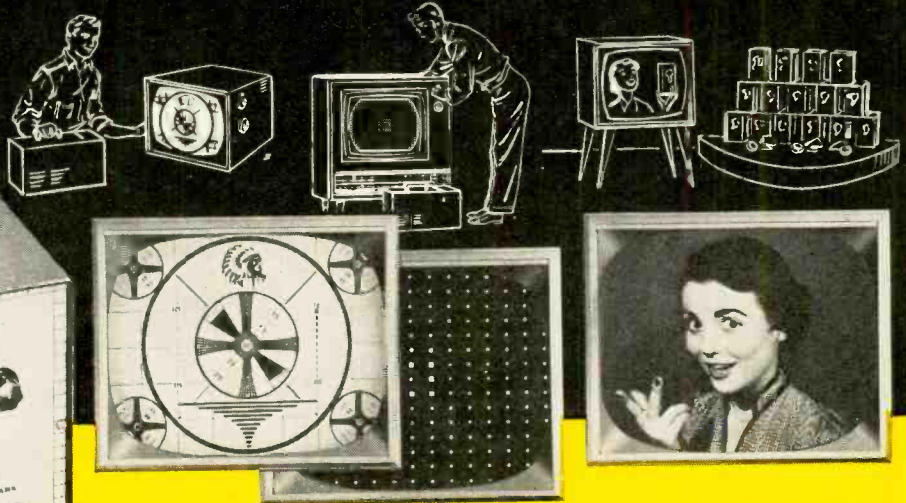

### For Both Black & White and Color TV

Provides standard Indian Head Test Pattern for proper TV set alignment and stable White Dot and White Line Patterns for color convergence adjustments.

### For Merchandising & Industrial Uses

Provides closed circuit TV system. Transmits pictures or messages for advertising, educational and commercial visual communication.

MODEL 1000



# DYNA-SCAN PICTURE AND PATTERN VIDEO GENERATOR

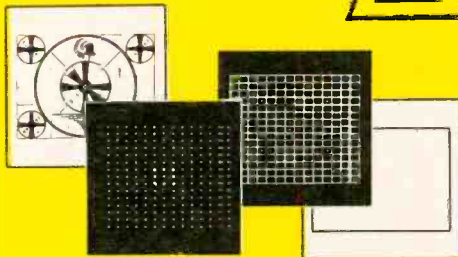

### 3 Test Pattern Transparencies and One Clear Acetate Supplied

- 1 Indian Head Test pattern
- 2 White Dot Pattern
- 3 White Line Crosshatch Pattern

These are broadcast quality transparencies and assure accurate, high-definition TV images. You can also transmit your own transparencies of any subject you wish. The clear acetate can be used for special messages. Extra transparencies and acetate available.



Make the most of this *Complete Flying Spot Scanner*. It produces a composite video and sync signal that operates any standard black & white or color TV receiver. Can be used with one or more TV sets or fed into a master antenna system or community antenna system. Maximum resolution capability is well in excess of 450 lines; band width in excess of 5 mc. Projects and reproduces pattern or picture with high definition from any slide transparency. Transmits messages typed or written on clear acetate. Makes convenient stand-by and break-in for community distribution operation. Rugged compact, portable, and ready to operate.

NET \$199<sup>95</sup>

See your B&K Distributor, or Write for Bulletin No. 1000-E

**B & K MANUFACTURING CO.**

3726 N. SOUTHPORT AVENUE · CHICAGO 13, ILL.



Model 950 Dyna-Scan Pickup and RF Generator only. Enables you to make your own picture and pattern video generator at a saving. Supplied with three test pattern transparencies and one clear acetate.

Net, \$69.95



Model 500 DYNA-QUIK Dynamic mutual conductance tube tester. Accurately tests tubes faster. Net, \$109.95



Model 400 CRT Cathode Rejuvenator Tester. Tests and repairs TV picture tubes. Net, \$54.95



Model 750 CALIBRATOR Designed to check and adjust test instruments with laboratory accuracy. Net, \$54.95

# \$100,000

## GUARANTEED PERFORMANCE

Each and every Hi-Lo is backed by a money back guarantee. For the best reception, unsurpassed clear pictures, specify Hi-Lo, with the exclusive highest gain, spiral designs which are covered by the following U.S. patent numbers: 2,495,579; 2,583,745, 2,724,773; 2,748,387; 2,755,466; and Canadian Patents 1951 and 1956; other patents pending.

Hi-Lo is covered by a \$100,000.00 insurance policy issued by one of the largest insurance companies.\*

**New...**  
Just what  
you asked  
for!

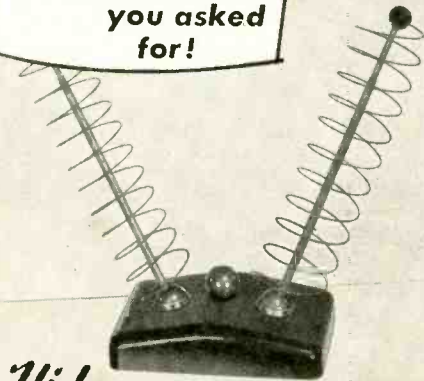

**Hi-Lo** Model 505 — Channels 2-83  
The spiral antenna that is designed for maximum performance featuring the NEW TELESCOPING DIPOLES. This versatile antenna swivels on ball and socket in any direction. Gold spirals, plastic base blend with any room. LIST . . . \$14.95

**New...**  
For every  
TV  
owner

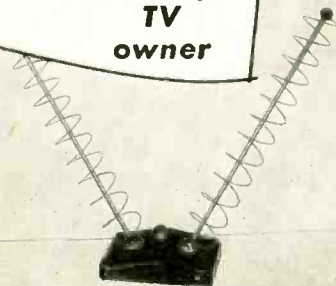

**Hi-Lo** Model 404 Channels — 2-83.  
NEW INDOOR ANTENNA  
that swivels with a gentle touch of your little finger. Dipoles swivel on ball and socket in every direction. Golden spirals and decorative plastic base blend with all furniture. RECEPTION IS GUARANTEED. LIST . . . \$12.95

\*name upon request

INSIST ON THE GENUINE Hi-Lo Spiral Antennas!  
Known and accepted everywhere, Hi-Lo is manufactured and GUARANTEED by the best antenna manufacturer in the world. Hi-Lo is consumer accepted and approved.

**Hi-Lo TV ANTENNA CORP.**  
1122-26 Newport Avenue  
Chicago 13, Illinois

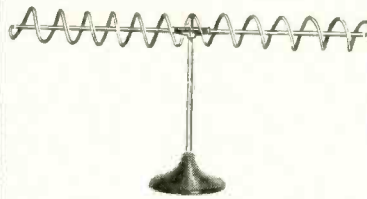

**Hi-Lo** Model 101 — Channels 2-13.  
The original and world famous antenna that is wanted, demanded and used for GUARANTEED FINEST RECEPTION. No rods to adjust. Provides clearest pictures faster. LIST . . . \$9.95



**Hi-Lo** Model 303 — Channels 14-83.  
The UHF ANTENNA with the highest signal gain that is specially designed for ALL UHF areas. Luxurious gold upright and crossbar. LIST . . \$5.95

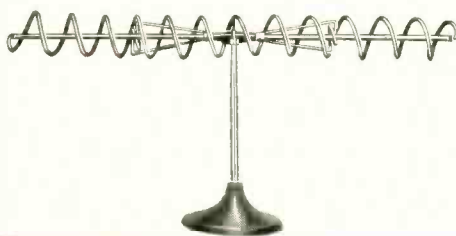

**Hi-Lo** Model 202 — Channels 2-83  
PEAK PERFORMANCE which is unsurpassed is guaranteed with this antenna . . . for ANY and EVERY area. The gleaming gold upright, shiny spirals, bakelite base, aluminum bars, modern design

. . . all make this YOUR BEST ANTENNA BUY.

LIST . . . \$9.95

## RADIO

is 210  $\mu\text{f}$  maximum; for the oscillator section 101  $\mu\text{f}$  maximum.

### Construction

The larger (Fig. 1) of the two sets was built into a plastic case measuring  $2\frac{3}{4} \times 3\frac{1}{4} \times 1\frac{1}{2}$  inches. To eliminate wires printed circuitry was used. All components, with the exception of the tuning capacitor, volume control and phone jack, are mounted on the board. The photographs show the wiring and parts layout of the printed-circuit board. When mounting components, the leads should be cut or trimmed *after* soldering so that no mistakes in lead length can be made, thereby making the part useless. The if cans used measure only  $\frac{1}{2}$  inch high by  $\frac{1}{2}$  inch in diameter and are made for printed-circuit mounting. The terminal locations and schematic of these transformers are shown in Fig. 4. The 9-volt battery is mounted by a battery holder mounted on the board. The battery has two snap-fasteners which facilitate replacement.

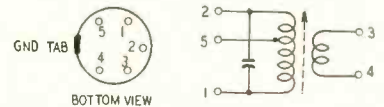

Fig. 4—The schematic diagram and terminal location of the if transformers.

The smaller set (Fig. 2) is about the same size as a package of cigarettes. It was built into a plastic case measuring  $2 \times 2\frac{7}{8} \times 1$  inch, the inside of which was coated with bronze paint to give it an attractive appearance. No printed circuitry was used here since I ran out of copper laminate board. Components for this receiver were mounted above and below the board. The detector transistor, electrolytic capacitors and resistors were all mounted below the board; all other components above. The tuning capacitor, however, is not mounted on the board but directly to the case. Two bushings  $\frac{3}{8}$  inch long are used to support the capacitor. The shaft of this capacitor is cut so that about  $\frac{1}{8}$  inch protrudes above the case so that the dial can be attached. The volume control protrudes through a cutout in the case.

It is not necessary to follow the same layout and construction of these receivers that I have used. It is always best to leave these details to the ingenuity and imagination of the reader because in 9 cases out of 10 there is room for improvement.

### Alignment

The if transformers, when purchased, are set at 455 kc and the only alignment necessary is that of the front end. The procedure followed is standard for all receivers. The oscillator slug is adjusted for the low-frequency end, the trimmer capacitor is adjusted for the high-frequency end. In some cases it may be necessary to peak the if coils. If the antenna and oscillator sections do not track, it may be necessary to add or remove a few turns from the antenna coil by trial and error.

END

*Right* from the carton...

*Right* for the set!



No guessing...  
No fussing...  
No wasting  
precious time and effort.

**CLAROSTAT**

Right from the "RTV"\* green carton, you get the right replacement control matched to original specifications.



*Ask your Clarostat distributor  
for "RTV"\* Replacements!*



\* Reg. U. S. Pat. Off.

*Controls and Resistors*  
CLAROSTAT MFG. CO., INC. • DOVER, NEW HAMPSHIRE

In Canada: CANADIAN MARCONI CO., LTD., Toronto 17, Ont.,

# variable DC heater supply uses tuned filters

*6- and 12-volt unit  
for car radios uses  
unique 120-cycle traps*

By VALENTINE SANFORD

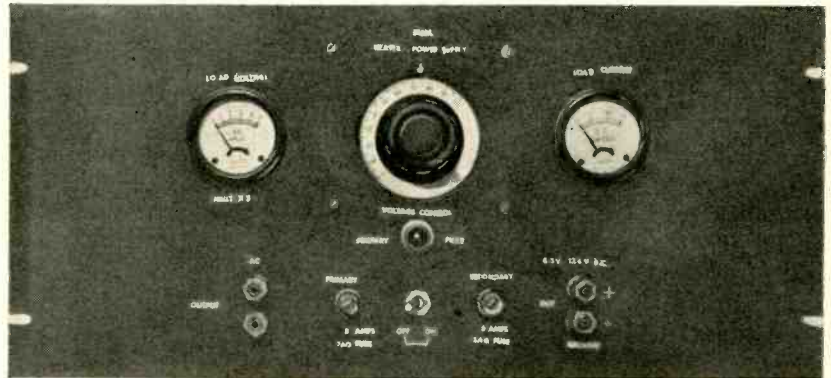

**T**HIS power supply was designed for servicing 6- and 12-volt car radios. Filament transformers, which act as chokes and traps simultaneously, provide filtering. To obtain the same filtering would require very large, low-resistance chokes. A fuse, used as the series arm of the pi filter, provides protection as well as attenuation of the ac component in the output voltage. To improve the regulation, which is always poorer with capacitor-input filters, a variable bleeder was added. It can be adjusted for changing loads.

This variable power source (see diagram) may also serve as a battery charger, heater supply for preamplifier or any other purpose where low-voltage dc is required.

### Circuit operation

To vary the dc output without wasting too much power, variable transformer T1 is included for accurate adjustment of the ac input to the rectifier transformer. For a 6- and 12-volt dc output T1 is adjusted so that the parallel secondaries of the rectifier transformer T2 deliver 9 and 14 volts rms, respectively. The transformer isolates the line voltage from the output, and can deliver 6 amperes. The bridge rectifier delivers 7 and 13 volts dc when the input is 9 and 14 volts rms, respectively.

The full-wave bridge rectifier is followed by three pi filter sections. The first two consist of three 4,000- $\mu$ f capacitors and two 6-volt filament-transformer secondaries. The primaries of these transformers constitute the traps which resonate at 120 cycles. They are shunted with three 0.5- $\mu$ f capacitors in parallel. Since the inductance of different transformers may vary, it will be necessary to experiment with the amount of capacitance to obtain resonance at 120 cycles, as indicated by lowest ripple in the output.

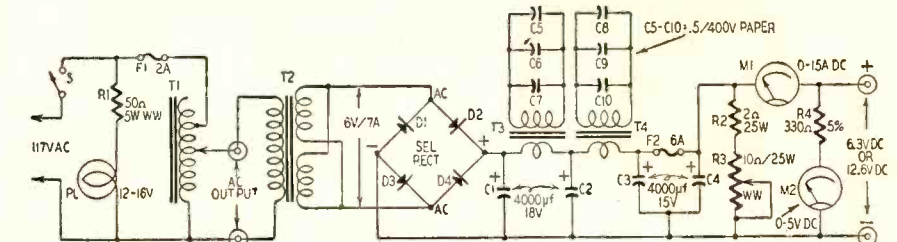

- R1—50 ohms, 5 watts, wirewound
- R2—2 ohms, 25 watts, wirewound
- R3—10 ohms, 25 watts, wirewound, adjustable
- R4—330 ohms, 1/2 watt, 5%
- C1, C2, C3, C4—4,000  $\mu$ f, 25 volts
- C5, C6, C7, C8, C9, C10—0.5  $\mu$ f, 400 volts
- T1—variable transformer, 0-132 volts, 1.25 amps (Superior Powerstat type 10 or equivalent)
- T2—power transformer for selenium rectifiers, secondary volts 12.6 or 25.2 @ 7 or 3.5 amps, Merit P-2963 or equivalent
- T3, T4—filament transformers, 6.3 volts @ 6 amps (Stancor P-3064 or equivalent)

- D1, D2, D3, D4—full-wave selenium rectifier, 26 volts ac input, output 6-20 volts @ 6 amps (Federal 2104S or equivalent)
- F1—2-amp fuse and assembly
- F2—6-amp fuse and assembly
- PL—pilot lamp and assembly, 12-16 volts (G-E 1815 or equivalent)
- M1—ammeter, 0-15 amps
- M2—voltmeter, 0-5 volts
- S—sps switch
- Binding posts (4)
- Chassis, approximately 7 x 13 x 2 inches
- Panel for chassis

Complete schematic diagram of variable dc heater power supply.

The traps provide a 2-to-1 improvement in the ripple output. Their action is as follows: The primary or the 117-volt side, when resonated at 120 cycles (even though the Q of the tank is low), reflects a high ac impedance into the secondary without the accompanying dc drop. A regular choke for a filament supply would be prohibitive in cost and size. Therefore, the filament transformers are a better solution to the ripple problem.

The last section consists of two 4,000- $\mu$ f capacitors shunting the output fuse. The voltage divider consists of the fuse, which has a resistance of 0.1 ohm, and C4, which has a 0.3-ohm reactance at 120 cycles.

To improve regulation a 12-ohm bleeder resistor is connected across the output. The bleeder is actually made up of two resistors; a fixed resistor of 2 ohms in series with a rheostat of 10 ohms. The latter can be adjusted to draw 10% of the load with always a fixed minimum resistance in the circuit.

The ripple output of this unit varied from 0.1 to 0.25 volt rms when the load was varied from 4 to 6 amperes. This power supply was checked with a dummy resistor of 2 ohms connected across the output. From no load to full load the regulation was

$$\frac{17 - 12}{12} = \frac{5}{12} = 41.7\%$$

### Construction and protection

The unit is fused at the primary with a 2-ampere slow-blowing fuse; at the output by a 6-ampere slow-blow type. The power supply has no chassis ground, but a floating one which can be grounded by the user. Should a negative supply be desired, the positive side can be grounded, thus providing a source of negative power. A wire mesh cover will be used to enclose the unit for ventilation and maximum protection.

### Alternatives

Although the built-in voltmeter and ammeter are of the iron-vane type,



# ROHN

Give what the buyer  
**WANTS**

## towers

the  
"Magic  
Triangle"\*

\* pat. pending



**HOT  
DIPPED  
GALVANIZED**

**UNEQUALLED  
DESIGN!**

**LIFETIME  
OF  
DEPENDABLE  
PERFORMANCE**

These 3 BIG sales features are ROHN Exclusives... features that have been proved positively. Sell—recommend—install ROHN... the world's largest manufacturer of this type of tower... you have the BEST by far!

**ROHN** Manufacturing Co.

116 Limestone, Bellevue Peoria, Illinois Ph: 4-9156

**MAIL THIS COUPON FOR FREE LITERATURE**

Rohn Manufacturing Company  
116 Limestone, Bellevue  
Peoria, Illinois

Gentlemen: Please rush me complete details on  
the full line of Rohn Towers and Accessories.

Firm \_\_\_\_\_

Name \_\_\_\_\_ Title \_\_\_\_\_

Address \_\_\_\_\_

City \_\_\_\_\_ State \_\_\_\_\_

The popular ROHN No. 6 Tower (and ROHN Package Towers) feature the exclusive "Magic Triangle"... the machine produced triangular tower bracing that adds ruggedness, sturdiness and dependability far above any other similar tower!

And, speaking of "similar" towers, there are NONE in existence. ROHN "Superior Design" Towers are far ahead with more exclusive features... with more research... with greater acceptance than any other tower!

See a ROHN Representative or Authorized Distributor for the FULL Rohn Story... it's one you should know!

All models of Rohn Towers are suitable for home TV installations... makes possible elimination of guy wires to give a self-supporting installation of gleaming galvanized steel!

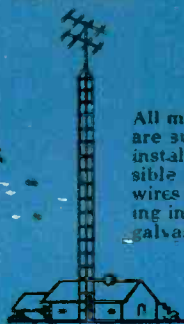

Communication towers, heavy duty towers, fold-over towers are also available. The Rohn catalog shows a complete line including all types installation equipment, bases, roof towers, tubing and dozens of accessories.



**PROUDLY DISPLAY THE NEW DECAL**

Colorful, new Rohn window decals are available to authorized Rohn Distributors, Dealers and Servicemen. Get yours today and display it proudly.

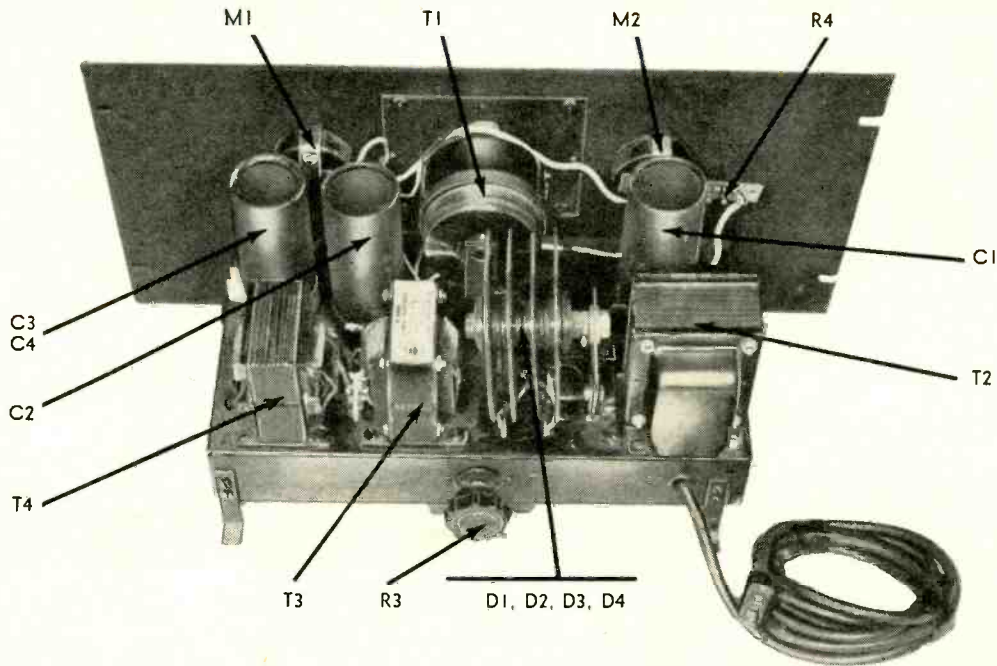

Top-chassis view—selenium rectifier is now available in square form.

their accuracy, checked against a Weston standard meter, was found to be within 10%. This is adequate for most work around the shop. If greater accuracy is desired, a better voltmeter or ammeter may be substituted at the output binding posts. To reduce the cost of this unit I recommend a bridge-rectifier transformer that has two taps, 9 and 14 volts, which may be selected by a switch, thus eliminating the need for a variable transformer. This arrangement provides two fixed output voltages, 6 and 12 dc, depending upon the tap selected.

If it is desired to make this unit more compact by building it in a portable case and if the ripple requirement is not too severe, the following things may be eliminated: two pi sections, the variable bleeder and the ac binding posts. These posts were provided to make available a variable ac source to check, in an emergency, car radios with a defective vibrator by feeding the ac directly to the vibrator transformer. Even though the vibrator transformer is not intended to be operated at 60 cycles, for purposes of diagnosing the trouble, the car radio can be run in this fashion.

There is nothing critical about the layout except that the electrolytic capacitors must be placed at a distance from components which generate much heat, such as dropping resistors. I used a 12-16-volt pilot light with a dropping resistor in series across the input side of T1. This was the only one available in the junkbox. Those of you who may consider the pilot light a luxury may eliminate it.

The wiring was done from point to point with No. 12 wire to minimize voltage drops. The capacitors across the primaries must have at least a 600-volt

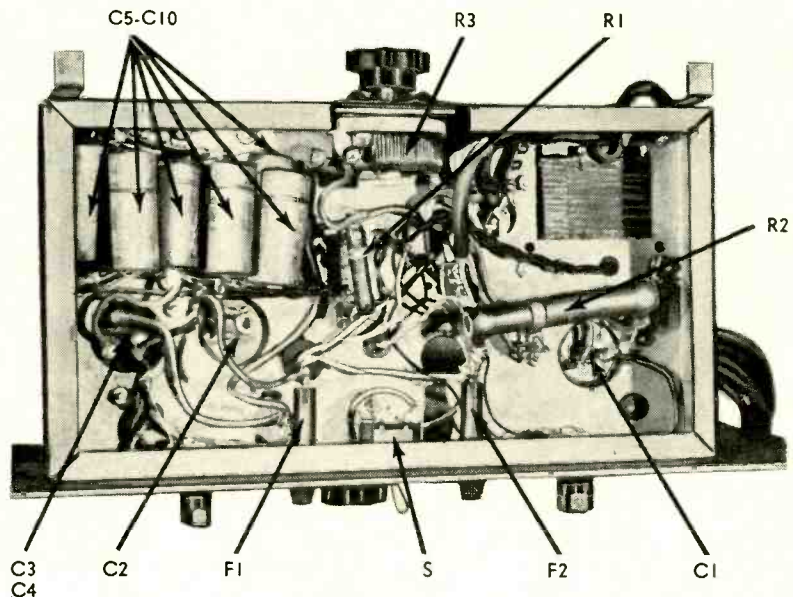

Bank of capacitors form part of 120-cycle trap.

rating because of the high voltage developed across them at resonance. They were mounted across two rows of multiple tie points. The chassis is not level with the front panel but raised in the back by two small brackets. This was done to provide maximum ventilation underneath the unit.

The fuses were mounted on the front panel to permit rapid replacement in the event of a short on the output or input side. The location of the rectifier transformer with respect to the filament transformers was chosen to minimize pickup of stray fields. The chassis is held to the front panel by the primary power switch, input and output binding posts and the two fuse holders. The panel was hand-painted with black

wrinkle paint and air-dried; lettering on the front panel was done with decals. Meter M2 is a 0-5-volt unit in series with multiplier R4 which extends the range three times—0-15 volts.

In the future, when this unit is rebuilt, it will incorporate a new feature—a selenium rectifier used as a voltage regulator. The half-wave rectifier will be connected across the output in reverse, i e, cathode to the plus side, and used as a voltage-sensitive resistor. Furthermore, to help filtering with a less number of pi sections, each shunt capacitor will be series-resonant with an appropriate choke, at 120 cycles. Until such time when a new unit is built, the existing one fills the needs for which it is intended. END

# MODERNIZE YOUR AM FM TUNER

By FRANK J. DiELSI

**M**ANY tuners in use today could be improved considerably by adding any or all of the following features: a grounded-grid rf stage for FM to increase sensitivity, afc to reduce the distortion and noise due to FM drift and mistuning, a double tuning eye for both AM and FM, a cathode-follower audio stage with a variable-cutoff whistle filter for AM (Fig. 1).

Although all of these circuits were added to the very compact Approved V-12 tuner, they can easily be added to any other tuner since most of them have much more spare room for the additional components.

**Grounded-grid rf amplifier** — The grounded-grid rf amplifier was built on

a separate small bracket and mounted close to the original input stage of the FM section. L1 can be wound on R1 and adjusted for maximum gain, or a small slug-tuned coil form may be used. All grounds should be short and direct to pins 2 and 6 of the 6AB4 socket. The lead from C1 to the grid of the following stage should be as short as possible. If this grid is loaded down with a resistor, it should be removed since the added load of the 6AB4 plate circuit, including R2, is sufficient for the required bandwidth.

**Afc**—To install afc in this tuner the 6J6 FM oscillator socket was removed and the hole enlarged to accommodate a nine-pin socket for the 6BK7-A. Half of this tube was wired as the

normal oscillator without any circuit changes. The other half became the reactance control connected across the oscillator tuned circuit. This part of

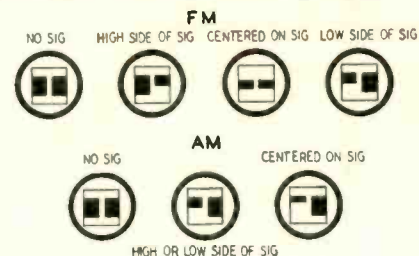

Fig. 2—Patterns on 6AL7 dual-eye tube when tuning through a signal.

the tube acts as a reactance that varies in relation to the phase and amplitude of the control voltage coming from the discriminator, thus correcting for drift and mistuning. C3 is the only connection between the normal oscillator circuit and the afc half of the 6BK7-A. C2 and R3 filter the audio component from the control voltage which also feeds the tuning eye tube. If the afc tends to pull the receiver off tune, reverse the secondary leads of the discriminator transformer. The oscillator will have to be realigned with the afc off to compensate for the different capacitance of the 6BK7-A.

**Tuning eye**—A 6AL7-GT dual-eye tube was used to indicate both limiter and discriminator voltages. Fig. 2 shows the different patterns when tuning through a signal. By connecting the second deflecting electrode (pin 4) to the arm side of the audio selector switch S1-b, the eye tube was also made to indicate the AM avc voltage.

**Whistle filter**—Since this tuner already had a cathode-follower audio stage, the installation of a variable-cutoff 10-kc whistle filter for AM re-

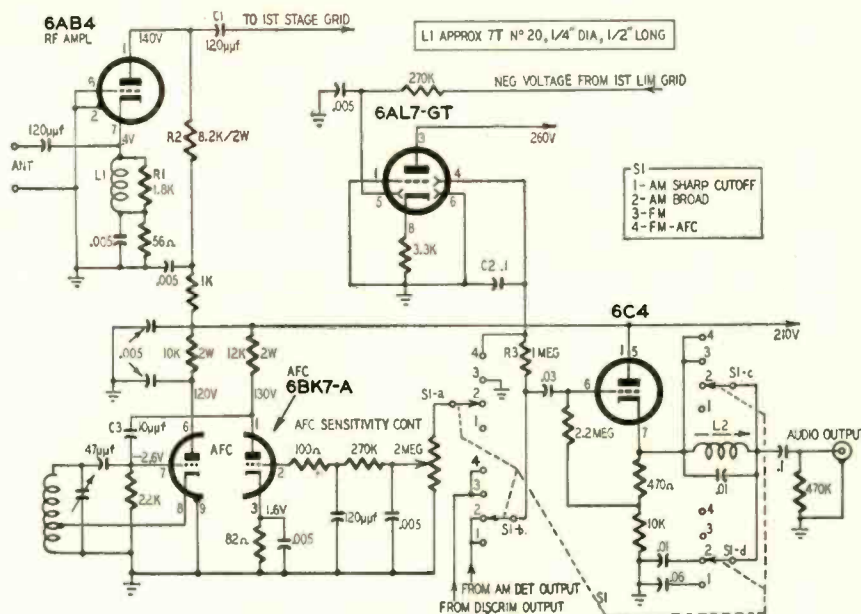

Fig. 1—Various circuitry modifications for improved tuner performance.



## Is a Degree Essential for an Electronic Engineering Career?



"Student" Fred Gunther in the IBM school

**Fred Gunther has no degree. Yet, today, at IBM, Fred is a Computer Systems Engineer on America's biggest electronics project. His story is significant to every technician who feels that lack of formal training is blocking his road to the top.**

Let's go back to 1950 and watch Fred Gunther, at 18, as he goes about the business of determining his life's work. Fred spent almost a year interviewing with prospective employers. Then, perhaps due to the fact that his high school background didn't prepare him for work in an area of his interest, he entered the Navy for a four-year hitch.

Fred learned something very valuable in the Service, as have many other men who eventually discover the electronics field. His aptitude tests revealed him as an excellent electronics prospect, and he received ten months' training in electronics fundamentals and radar. Upon his discharge in 1955, he was an Electronics Technician, First Class.

Something even more important to Fred's career occurred during his Service hitch. He began to hear such terms as "automation" . . . "data processing" . . . "electronic computer." "Then, one evening, while glancing through the paper," he recalls, "I spotted a story about Project SAGE."

### What is Project SAGE?

SAGE means Semi-Automatic Ground Environment. It is America's giant radar system—a chain of defense that will ultimately ring our country's entire perimeter. Heart of this system is the electronic computers, which digest data filtered in from Texas towers, picket ships, reconnaissance planes, ground observers. The computers analyze this information for action by the Strategic Air Command and other defense units. These computers are the largest in the world. Each contains perhaps a million parts—occupies an entire city block. They are built for the Project by IBM.

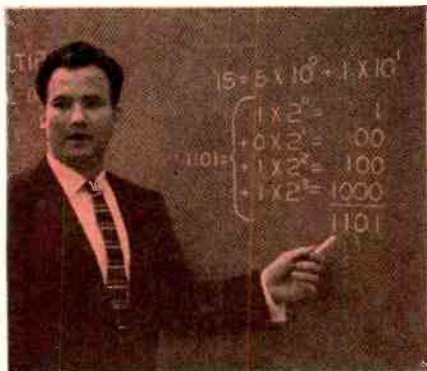

Answering instructor's questions

### Fred joins IBM

SAGE fascinated Fred, for it embodies the most advanced electronic concepts. And, when he learned that IBM would train him for six months, at full salary, plus a living allowance, to become a Computer Units Field Engineer, he seized the opportunity. Fred started his new electronics career in the IBM school, with twenty other technicians. He attended classes 8 hours a day. Courses consisted of some 20 subjects—computer circuitry and units, maintenance techniques—everything he would need to become a full-fledged Computer Units Field Engineer.

### Assigned to McGuire AFB

His six months' training completed, Fred was assigned in May, 1956, to McGuire Field, where the first of the giant SAGE computers is located. Here he supervised the cable installation for this vastly complicated electronic giant. He helped to set up the computer, interconnect its many sections, check it out and make it ready for operation. Fred spent five months

at McGuire, but his education was not yet completed.

### Becoming a Computer Systems Engineer

"I like to think it was due to my interest and grade of work," Fred says, "but at any rate, last November I was invited to return to Kingston for further training—to become, in fact, a Computer Systems Engineer. Naturally, I was proud and pleased, for this training would give me a much greater range of understanding . . . make me more valuable to the company and myself . . . and give me a chance to assume actual engineering responsibility." Fred is once more



at the operating console of the computer

putting in a full 8-hour training day—both classroom and lab. By the time you read this message, he will have completed his new education and be ready for assignment as a Computer Systems Engineer to an area of his choice.

### What does the future hold?

"First off, I'll probably go back to McGuire," Fred says. "My home is nearby and there's still a vast amount of work to be done at this computer site. The future? It's hard to even set a goal in a field as rapidly moving as this, but with my IBM training back of me, the future sure looks good. I've advanced from radar technician to Computer Systems Engineer in sixteen months—and received a valuable electronics education besides!"

### How about YOU?

Since Fred Gunther joined IBM Military Products and the Project SAGE program, opportunities are more promising than ever. This long-range program is destined for increasing national importance, and IBM

will invest thousands of dollars in the right men to insure its success.

If you have 2 years' technical schooling—or equivalent experience—IBM will train you for 6 months as a *Computer Units Field Engineer*.

If IBM considers your experience equivalent to an E.E., M.E., or Physics degree, you'll receive 8 months' training as a *Computer Systems Engineer*.

After training, you will be assigned to an area of your choice within the United States. You receive salary, not wages, plus overtime pay. In addition, every channel of advancement in the entire company is open,



Home to the family, Pemberton, N. J.

and IBM is a leader in a field that is sky-rocketing in growth. And, of course, you receive the famous IBM company-paid benefits that set standards for industry.

WHY NOT WRITE—today—to Nelson O. Heyer, Room 3103, IBM Corp., Kingston, N. Y.? You'll receive a prompt reply. Personal interviews arranged in all areas of the United States if your résumé of experience and education indicates you have the qualifications.

CUSTOMER ENGINEERS: Opportunities are also available, locally, for servicing IBM machines, after training with pay.

Be sure to visit the IBM booth at the I.R.E. Show, March 18 through 21.

**IBM**

**MILITARY PRODUCTS**

- DATA PROCESSING
- ELECTRIC TYPEWRITERS
- TIME EQUIPMENT
- MILITARY PRODUCTS



**LOOKING?**  
for the right dual-control replacement

You'll find it's  
**ALWAYS IN STOCK** at your  
**Centralab Fastatch®**  
distributor

- With Centralab's unique Fastatch system, your distributor can afford to carry a complete line of dual-concentric replacements for all popular TV, radio, and auto sets.
- Each Fastatch control unit is factory assembled, tested, and guaranteed.
- Ask your Centralab distributor's salesman or counterperson about Fastatch duals. Or send coupon for bulletin 42-218.

**Centralab**

A DIVISION OF GLOBE-UNION INC.

998J East Keefe Avenue, Milwaukee 1, Wisconsin

B-5622

Send me Fastatch bulletin 42-218.

Name \_\_\_\_\_

Company \_\_\_\_\_

Address \_\_\_\_\_

City \_\_\_\_\_ Zone \_\_\_\_\_ State \_\_\_\_\_



**RADIO**

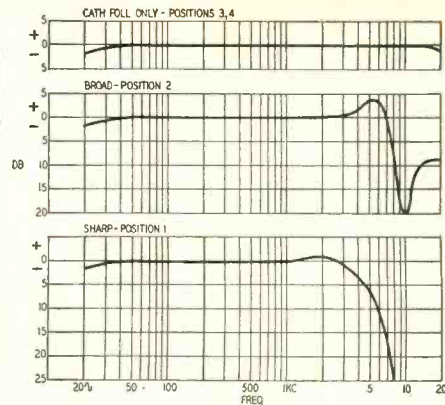

Fig. 3—Whistle-filter characteristics.

ception was simplified because it was possible to install the filter at the low-impedance output of the cathode follower instead of at the AM detector output where stray capacitances and hum pickup caused difficulties.

In the broad position the filter has a 4-db rise of 5 kc (Fig. 3) which compensates for some of the attenuation of the highs due to the if selectivity. In the sharp position the filter starts attenuating at about 3 kc. This position helps reduce static noises and monkey-chatter on weak AM stations with co-channel interference. L2 (20-60 mh), which should be mounted away from any power transformer or filter choke, is adjusted for minimum 10-kc adjacent-channel heterodyne with the switch in the broad position.

A six-pole five-position selector switch was used although only four poles and four positions are shown in the schematic. One additional pole is used to switch the B plus from AM to FM. The remaining pole and position may be reserved for any additional changes such as a tape recorder or TV sound position.

The cost and time involved in making these changes will be more than repaid in added enjoyment from your AM-FM tuner. **END**

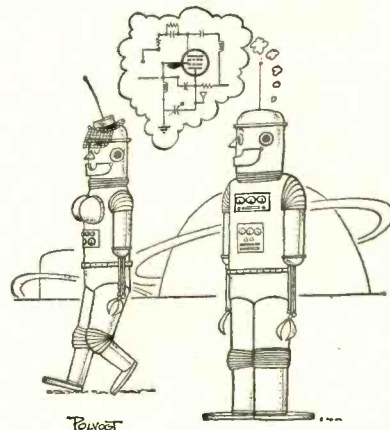

Power

*Ac power supply for transistors provides 6.5 volts regulated, 0-8 volts unregulated*

# BATTERY ELIMINATOR

By NATHANIEL RHITA

**A** BATTERY is a convenient portable source of power but it can be costly and its current capacity is rather low. An ac-operated substitute can be very useful in the home, shop or shack, wherever a power line is available. This is especially true during long periods of experimenting with new transistor circuits. During such tests partial shorts or power supply overloads may occur and a battery can be ruined in no time at all. Here is a compact device that supplies approximately 6 volts output with *excellent regulation and practically no ripple*.

The unit supplies either of two outputs, as desired—regulated 6.5 volts, unregulated but variable voltage from zero to 8. In either case the output current far exceeds the drain that may be obtained from any but very large batteries. There is no trace of hum at the output when a pair of phones is connected across the terminals, either directly or through a blocking capacitor.

The power supply (Fig. 1) uses a bridge rectifier across a 6.3-volt filament transformer. Large capacitors do

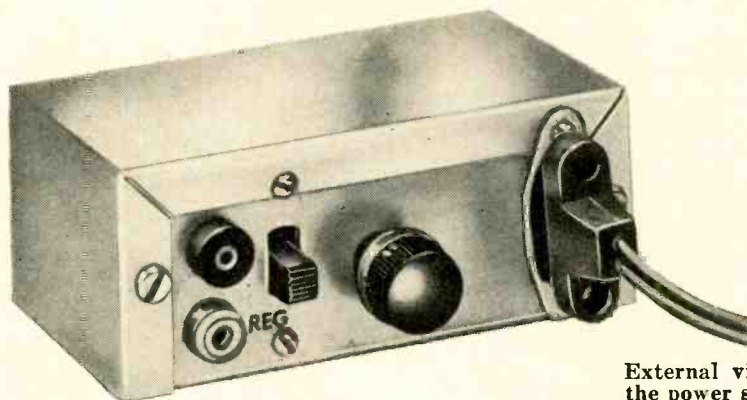

External view of the power supply.

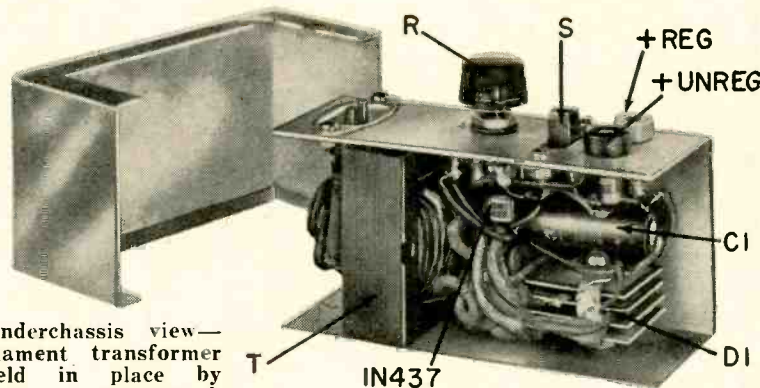

Underchassis view—filament transformer held in place by cover when mounted.

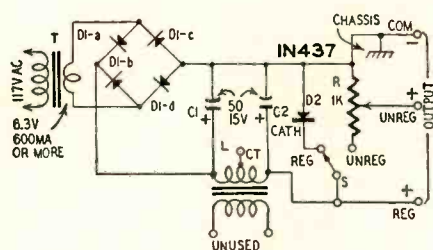

- R—1,000-ohm potentiometer (Lafayette VC-32 or equivalent)
  - C1—50  $\mu$ f, 15 volts
  - C2—50  $\mu$ f, 15 volts
  - L—filter choke, dc resistance 11 ohms (primary of Argonne AR-122 or equivalent)
  - D1—selenium bridge rectifier (see text)
  - D2—IN437 silicon diode
  - S—spdt switch
  - T—filament transformer, 6.3V, 600 ma or more
- Pin jacks (3) (photo shows 2, however additional ground jack would be useful)  
Small cabinet  
Line cord and power receptacle (see text)

Fig. 1—Schematic of the power supply.

the excellent filtering job. Regulation is provided by a Raytheon IN437 silicon diode. It maintains an output of 6 volts,  $\pm 1$  volt, with load currents of 15 ma or more. The diode used here regulates at 6.5 volts.

The following table shows the volt-

ages available in the *regulated* position:

Drain (ma)	Voltage
0	6.5
10	6.5
15	6.4
25	6.3
30	6.1

In the *unregulated* position the voltage may be varied from 8 volts down. Here are typical values:

Drain (ma)	Voltage
0	8.0
7	7.5
14	7.1
30	6.3

These were measured with the potentiometer set for maximum voltage.

By way of comparison, an AA or Z type cell (large penlight) will last only 40 hours or less when drained at 10 ma continuously. At the end of that period its output would fall to 1 volt. With the ac-operated supply, the source would be just as good as new at the end of that period, and of course its voltage would be unchanged.

Several unusual features are incorporated into this power unit to make

it a compact, useful and convenient device. I wanted a transformer that was small and inexpensive so a 6.3-volt 1-ampere filament type was chosen. I removed the mounting bracket which left it 1½ inches square by 1⅞ inches. This fit easily into an aluminum Flexi-Mount box, 4 x 2½ x 1⅞ inches. No mounting arrangement was necessary since the box cover (when put on) held the transformer firmly in place. Other transformers may require a box of a different size.

A full-wave bridge rectifier was necessary to obtain the full 6.5 volts or more. This requires four rectifier elements, obtained by disassembling a standard 117-volt selenium rectifier which usually has five or more elements in series. A Radio Receptor unit 5M4 was used here. This has five elements, of which four are needed in the bridge arrangement.

The rectifier stack is taken apart easily by filing down the rivet holding the elements. Each element has a selenium-coated side and a plain metallic surface. Choose four elements and reassemble them onto the insulating sleeve

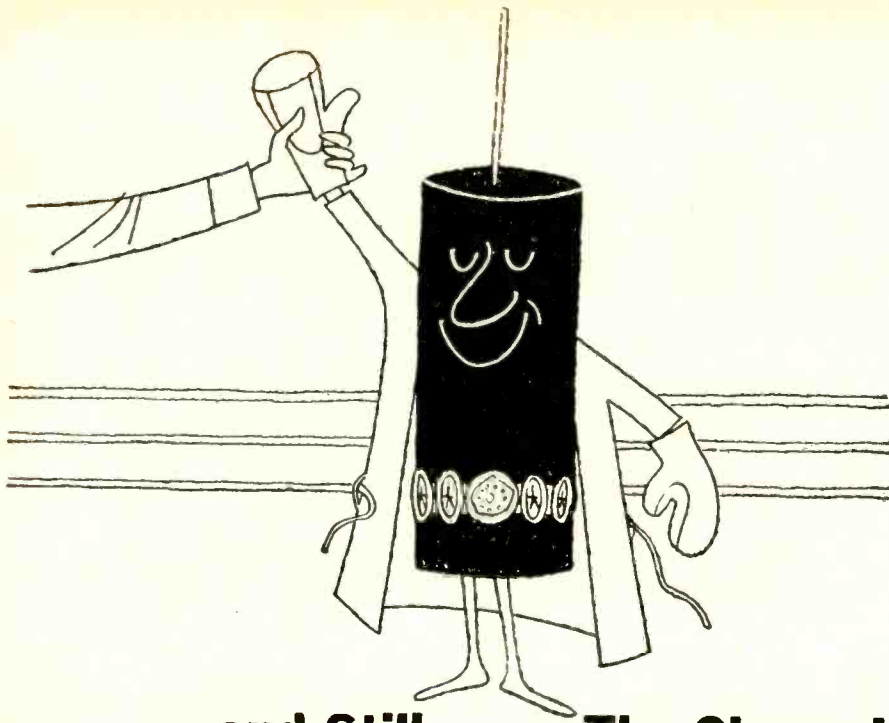

## ...and Still The Champ! Cornell-Dubilier "CUBS"®

YES, THE "CUB" has come through like a real champ in its battle with—high humidity—sizzling temperatures—shattering vibration—and punishing endurance. In the molded tubular class, THE "CUB" rates second to none. THE "CUB" like the "Blue Beaver" is made exclusively for the service trade—for full profit and customer satisfaction. You can bet your reputation on the C-D "CUB" when it comes to tubulars. Ask your nearby C-D Distributor for catalog or write Cornell-Dubilier Electric Corporation, South Plainfield, N. J.

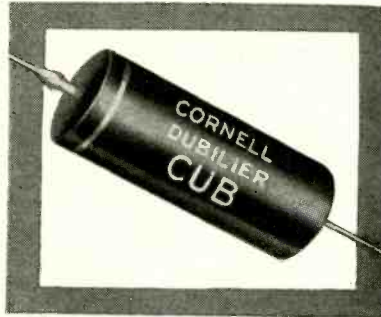

## Cornell-Dubilier capacitors

South Plainfield, N. J.; New Bedford, Worcester & Cambridge, Mass.; Providence & Hope Valley, R. I.; Indianapolis, Ind., Sanford, Fuquay Springs & Varina, N. C.; Venice, Calif., & subsidiary, The Radiart Corporation, Cleveland, Ohio.

# ISS

## YOUR FUTURE CAREER IN PEACETIME ATOMIC ENERGY

NOW PREPARE YOURSELF FOR THE UNLIMITED OPPORTUNITIES OFFERED BY THE NATION'S FASTEST GROWING INDUSTRY ATOMIC ENERGY!

SEND TODAY FOR FREE INFORMATION  
CLIP AND MAIL TO

INSTITUTE OF SCIENTIFIC STUDIES  
248 Arlington Avenue, Elmhurst 13, Illinois



- Complete, basic nuclear energy training, quickly, easily the ISS home study way.
- Top-notch leaders in the atomic energy field bring you this practical program.
- A high school education qualifies you for this fast-growing field.
- Pay-as-you-learn. No salesman will call.

NAME \_\_\_\_\_

ADDRESS \_\_\_\_\_

CITY ZONE STATE \_\_\_\_\_

Send information on ISS Group Study Plan

## RADIO

from which they originally came. Two elements are mounted in one direction (for example, with the selenium surface toward one direction) and the other pair in the opposite direction. (See Fig. 2.)

A lug (with large enough center hole to fit on the insulating sleeve) is

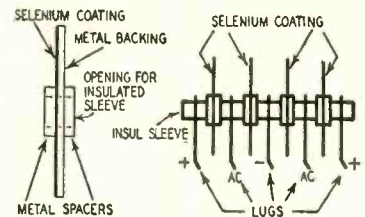

Fig. 2—Bridge rectifier construction.

needed between each element so the completed stack needs five lugs. Then, the two outer lugs are wired together, leaving four connections to the external circuit. A large machine screw and nut hold the stack together *tightly*. The same screw also holds the rectifier stack against one side of the box.

If the two outer lugs contact the selenium surfaces, as they do in Fig. 2, these make up the *positive* output terminal. The center lug is *negative* and the other two connect to the ac input. Once this stack is completed the elements can be checked to make sure that the lugs make proper contact. Each element should measure about 7,000 ohms in the forward direction and about 0.5 megohm in the opposite direction.

The choke coil presented a real problem. It had to have very low resistance because the permissible drop is so low. Also, it had to be very compact if it is to fit into the small box. I decided on using the primary winding of a class-B output unit. The Argonne AR-122 (obtained from Lafayette) fills the bill nicely. I use the entire primary. Disregard the centertap and the secondary.

The silicon diode is Raytheon 1N437, a tiny unit about ¼ inch square with two flexible leads. A black dot on the diode indicates its cathode terminal which is connected to the *positive* side of the circuit. This is important—the diode won't last long if connected in the opposite way.

Current through the diode must be adjusted for not over 20 ma. Measurement in Fig. 1 showed a flow of 18 ma, so no other change was found necessary. If current is much higher than 18–20 ma, resistance must be added in series with the diode or choke to avoid overload. If the current is much less, the resistance of the choke is too high, the transformer is not delivering sufficient voltage or the input capacitor C1 is not large enough.

Fig. 3 shows the diode characteristics at 25° and 100°C. Above a few milliamperes into the diode (in the reverse direction) its voltage remains constant to within tenths of a volt; the action is somewhat like that of a VR tube. Any load across the diode is regulated to a high degree. As the load accepts *more* current, the diode passes *less* current.



**HIGH POWER**   **LOW POWER**   **AC POWER**   **DC POWER**

# POWER-LAB

BY **precise** OPERATES YOUR WHOLE BENCH & SHOP

**KIT or WIRED**

YOU'LL START AND END EACH WORKING DAY WITH THE POWER-LAB

For the first time in the industry, one instrument takes the place of more than 11 pieces of equipment and makes you wonder why no one ever did this before . . . the most useful, often used, test device in your shop.

Here's the story . . . now, you can get all this COMPLETE IN ONE KIT (kit or wired):

- ★ A BATTERY ELIMINATOR
- ★ A BATTERY CHARGER
- ★ A HIGH CURRENT LINE VOLTAGE VARIAC
- ★ AN AC LINE VOLTAGE METER
- ★ AN AC LINE AMMETER
- ★ AN AC LINE WATTMETER
- ★ AN AC LINE ISOLATION TRANSFORMER
- ★ A LOW VOLTAGE, HIGH CURRENT AC SUPPLY
- ★ A DC LINE VOLTAGE VARIABLE SUPPLY
- ★ A DC HIGH CURRENT AMMETER
- ★ AN AGC BIAS BOX



MODEL 711  
(100 Watts of Isolation) — 711K — **\$49.95** kit  
711W — **\$64.95** wired

MODEL 713  
(300 Watts of Isolation) — 713K — **\$62.95** kit  
713W — **\$79.95** wired

When you buy POWER-LAB by Precise, you get all the advantages of owning a battery eliminator or servicing auto radios (even signal seekers), an AC-DC Converter, a supply for transistor sets, AND OF MAINTAINING A CONSTANT 115 volts in checking on TV set variations. You can even run the set down to 105 volts for testing for horizontal jitter and back up to 125 volts for high voltage breakdown, thereby eliminating the cause of many call-backs due to arcing . . . PLUS

. . . PLUS . . . PLUS . . . the 101 uses you'll find each day for POWER-LAB versatility.

Just look at these specs . . . the switches used are more than ample to carry related loads required and the quality of every component is EXCELLENT. You could easily pay three to four times the price of the POWER-LAB for the equipment to perform only a few of the functions of the POWER-LAB!

ALL SPECS BELOW ARE FOR MOD. 711 AND 713 UNLESS OTHERWISE SPECIFIED

	VOLTS	MAXIMUM	CONTINUOUS
Low Voltage DC	2 ranges 0-15v Full Wave 0-30v Full Wave Bridge	20 amps* 20 amps*	10 amps* 10 amps*
Low Voltage AC	0-24v		20 amps
High Voltage AC	No Isolation 90-140 volts	20 amps 2000 watts	10 amps 1000 watts
High Voltage AC	Model 713 with Isolation 90-140 volts		3 amps 300 watts
High Voltage AC	Model 711 with Isolation 90-140 volts		1 amp 100 watts
High Voltage DC	110-180 volts	.1 amp**	.075 amp**

There's NO OTHER INSTRUMENT LIKE THE POWER-LAB ON THE MARKET. Here again, Precise engineering is proud to be the first to supply a need that has too long existed in the service trade.

Your Distributor will be proud to show you THE POWER-LAB

Prices slightly higher in the West. Prices and specifications subject to change without notice.

\*Depending on voltage.  
\*\*May be increased up to 10 amperes at additional cost.

WRITE FOR CATALOG RE 3-7

SEE THE MANY MORE PRECISE INSTRUMENTS AND PROBES AT YOUR DISTRIBUTOR TODAY!

**precise** DEVELOPMENT CORP. OCEANSIDE, NEW YORK, U.S.A.

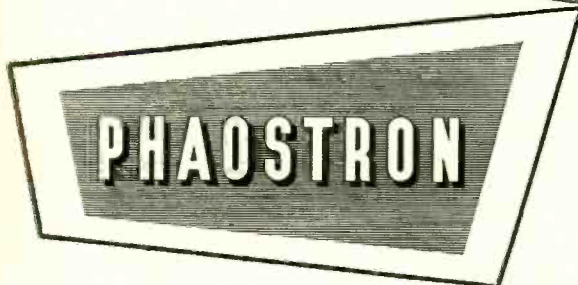
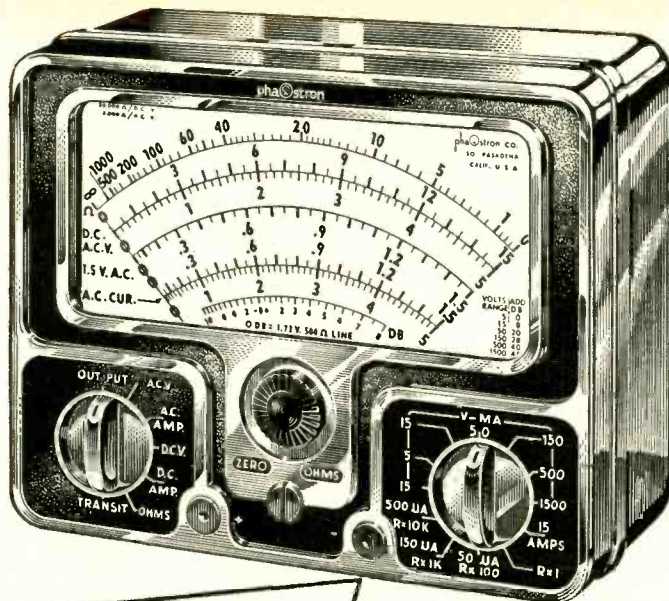

## 555A VOM

### YOU NEED THESE FEATURES:

Meter Movement Protection up to 500 times overload is provided by a rectifier network.

The 555A Measures: AC Current, DC Current, AC Voltage, DC Voltage, Output, Resistance

43 Unduplicated Ranges

Separate Range and Function Switches

Double Magnetic Shielding

3% DC, 4% AC Permanent Accuracy

Easy to Read, Four Color Scales 4 7/8" long

Metal Case with Die Cast Bezel 6 1/8" x 4 3/8" x 2 1/8"

Sensitivity: 20,000 Ohms/Volt DC, 2000 Ohms/Volt AC

Complete with Probes and Batteries at your Parts Distributor **\$44.50**

**PHAOSTRON INSTRUMENT AND ELECTRONIC COMPANY**

151 Pasadena Avenue, South Pasadena, California

## RADIO

But since the diode maintains a constant voltage, so does the load.

The 1N437 is rated to regulate at 6 volts,  $\pm 1$  volt. The one used here supplies about 6.5 volts, which is just right for most transistor applications. However, an unregulated feature has been added to this power supply. When the switch is thrown, the diode is taken out of the circuit and a 1,000-ohm potentiometer is substituted. This eliminates the regulation but supplies a slightly higher voltage that may be controlled down to zero. Maximum voltage is about 8. The potentiometer has to be tiny to fit in the box. A "dime-size" type VC-32 is obtainable from Lafayette. It is only 3/4 inch in diameter and requires a 1/4-inch hole for mounting.

Large capacitors must be used for C1 and C2. The first delivers the necessary high voltage to the rectifier, the second eliminates all hum. They are each 50  $\mu$ f at 15 volts, so there is an adequate safety factor. These are also obtainable from Lafayette. The switch is a slide type spdt.

In keeping with the tiny size of all components, the power plug and socket are of the "cheater" type used in TV receivers. Cinch makes a male plug suitable for panel mounting for this purpose, and any cheater cord may be used in conjunction with it.

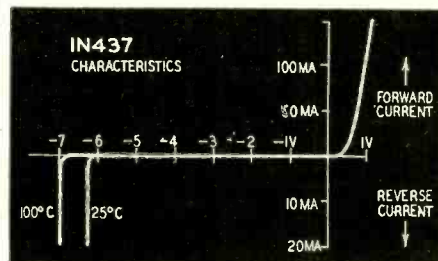

Fig. 3—Silicon rectifier curves.

This battery eliminator is useful for any transistor application except where an instrument or radio is to be carried about or used outdoors. It saves battery costs and does away with the gradual efficiency loss as a battery ages.

For constructors who wish to regulate other values of voltage rather than 6 volts, the following table is given. It lists three other Raytheon type regulator diodes and the average current through them.

Type	Regulated Volts	Current (ma)
1N436	4 $\pm$ 1	25
1N438	8 $\pm$ 1	15
1N439	10 $\pm$ 1	20



"I had to install that filter. There's a diathermy machine in the neighborhood that's driving me crazy."

# Technicians' News

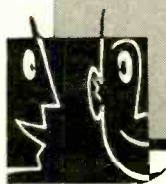

## G-E TO COOPERATE

TV receiver components will from now on be made available to service dealers through G-E distributors now franchised for receiving and picture tubes, stated J. H. Miller, manager of product service for G-E's Appliance and TV Receiver Division. The statement was made at a press conference in New York held to declare the company's new policy. "Our national product service advertising campaign in *Life* and the *Saturday Evening Post* has been discontinued," Mr. Miller also reported, saying further that the company was taking steps to insure that any ad mats supplied to local dealers would not contain expressions that could be interpreted as derogatory to independent servicemen.

Miller further stated that more than 95% of the service calls made on G-E TV sets in 1956 were made by independents, and went on to say that "in the vast majority of markets throughout the United States our distributors have appointed, and we expect will continue to appoint, independent service organizations as authorized G-E TV receiver repair stations."

At about the same time, G-E announced a depth course in professional service management, to be made available through franchised tube distributors; the issuance of special service shop plans and the establishment of a service school at Syracuse covering both monochrome and color. Qualified independent service dealers would be given an opportunity to attend, it was stated, and the course material would later be published and made available to the entire service industry.

## RCA PRAISES INDEPENDENTS

In an "open letter to the service industry" RCA's president Frank Folsom pointed out that "the electronics industry has reached its present high level largely because of the outstanding performance of the servicing profession. Reflecting the importance of its contribution, service last year achieved a \$2.8 billion volume—one-quarter of the entire electronics industry's gross income."

The letter, apparently written to clarify RCA's policies with regard to servicing in view of the captive service controversy, stated, among other things "... full customer satisfaction depends on a vigorous and healthy independent service industry and therefore RCA will continue to make available to the servicing profession the information

# 4 IDEAS

for getting even more use from your  
*Weller* SOLDERING GUN

Your Weller Soldering Gun is the most useful tool in your shop. Service technicians find new, practical uses for it every day. Here are some time-saving applications:

**1 CIRCUIT AND COMPONENT DEFECT ANALYSIS.** Energized tip of Weller Gun is substituted for signal generator to find defective components in both audio amplifier section and picture circuit. Quickly uncovers thermal intermittance trouble.

**2 REACHES COMPONENTS THROUGH CHASSIS CUT-OUTS.** Weller Guns, with their long, thin electrodes, reach recessed tube sockets and connections through small chassis cut-outs. Pre-focused twin spotlights light up this hard-to-get-at work.

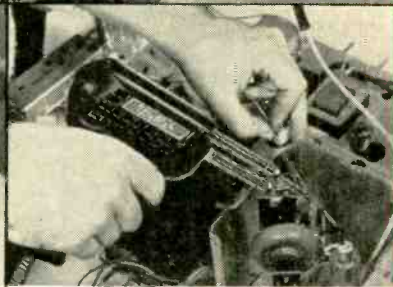
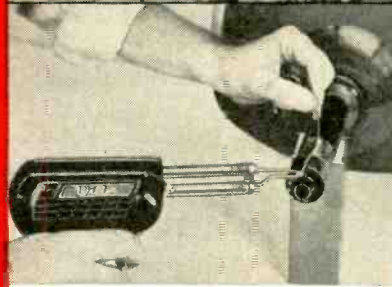
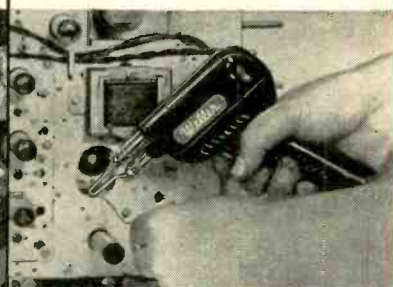

**3 NEW SOLDER FOR CATHODE TUBE BASE PIN.** Defectively soldered (or loose) base pin is re-soldered to remove imperfections. New solder is then applied to establish uninterrupted contact. Weller Gun is ideal for this type of repair.

**4 SOLDERING BROKEN TERMINAL LEADS.** Weller Soldering Gun permits controlled application of heat. Solder is maintained at correct viscosity. This enables serviceman to produce rounded joints and prevent corona discharge in high-voltage compartment.

## *Weller* SOLDERING KIT 8100K IDEAL FOR ALL SERVICE WORK



Complete kit for the price of the gun alone! Latest type Weller Gun—Model 8100, over 100 watts, with triggermatic heat control. 2 pre-focused spotlights. Reaches through small openings into dark places. Kit includes Wire Soldering Brush, wire-twisting Soldering Aid, Kester Solder. Top value at \$7.95 list.

SEE THE FULL LINE OF PROFESSIONAL MODEL WELLER GUNS AT YOUR ELECTRONIC PARTS DISTRIBUTOR

*Weller* ELECTRIC CORP. • EASTON, PA.  
601 Stone's Crossing Road



Here's your first line of defense  
against one of TV's biggest service problems

## Sylvania Deflection Tubes

—upgraded and triple-tested for dependable  
performance in TV's hardest working  
deflection systems

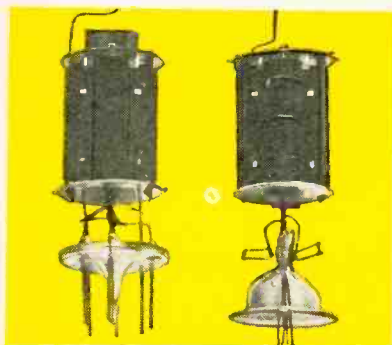

Notice how much more rugged the Sylvania wafer stem mount looks (left). That's because the wafer stem results in shorter construction with more points of support and heavier, sturdier leads.

If you haven't yet tried these new Sylvania deflection tubes—you're in for a pleasant and profitable surprise.

They've been carefully redesigned and thoroughly tested to meet the challenge of hard-working deflection systems, tightly engineered circuits and the "runaway" conditions which often result when components age and change in value.

Sylvania's wafer stem construction minimizes the effects of electrolysis resulting from gases driven off by high tube operating conditions. The wafer stem provides wider

spacing between leads and permits the use of heavier lead wires.

The wafer stem adds mechanical ruggedness to these tubes by providing three-point support and reduces internal arcing by increasing the spacing between the plate pigtail lead and the tube mount.

These improvements were made as the result of thorough testing and experimentation to determine points of breakdown in earlier types. Now, these tests serve as important quality control measures for the production of these new deflection types.



# SYLVANIA

SYLVANIA ELECTRIC PRODUCTS INC.  
1740 Broadway, New York 19, N. Y.  
In Canada: Sylvania Electric (Canada) Ltd.  
Shell Tower Building, Montreal

LIGHTING • RADIO • ELECTRONICS • TELEVISION • ATOMIC ENERGY  
114 RADIO-ELECTRONICS



**Test No. 1—Static Life Test**

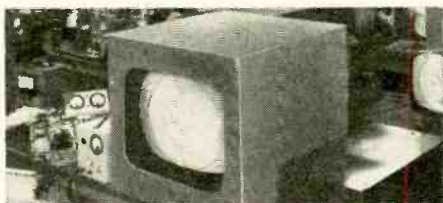

The static life test operates the tube under dc circuit conditions near maximum plate and screen dissipations and dc cathode current. Characteristics are con-

trolled for maximum and minimum values and is considered at the end of its life when characteristics drop below or rise above specified limits.

**Test No. 2—TV Life Test**



Sylvania deflection tubes are testing in stock models of representative TV manufacturers. Tests are conducted at accelerated line voltages so that tubes are operated at a considerably high level. These

accelerated conditions of 130-volt line increase failure rate 2.37 times to provide important design and production information which results in better quality and dependability for you.

**Test No. 3—Dynamic Life Test**



These dynamic life test racks enable Sylvania to approximate TV set operating conditions which can be controlled. Thus, an operating standard is established

against which all deflection tubes can be tested.

Look for and specify Sylvania's new deflection tubes in the new carton.

**Learn how you can earn  
this famous course  
in  
COLOR TV SERVICING**

Sylvania has just taken another step in its continuing effort to help the independent radio and TV service dealer. Your Sylvania Distributor can tell you how you can earn the popular Radio-Television Training Association's Color TV Technician course. RTTA is one of the most respected names in home study training methods—has trained thousands in the fundamentals of black-and-white TV and is now doing the same in color servicing.

**A Sylvania Exclusive!**

When you earn RTTA's color course offered by Sylvania you get a special supplementary lesson in full color. It's a Sylvania extra which serves as a capsule survey of color television which will help you with lesson details.

See your Sylvania Distributor or mail the coupon below and find out how you can start learning color TV right away.

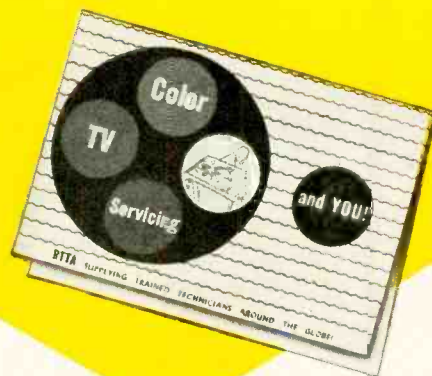

Sylvania Electric Products Inc.  
Dept. C35N  
1740 Broadway, New York 19, N. Y.

Please send me full details on how I can earn the RTTA home-study course in color TV

Name \_\_\_\_\_

Service Co. \_\_\_\_\_

Address \_\_\_\_\_

City \_\_\_\_\_

State \_\_\_\_\_

# PERFECT HARMONY

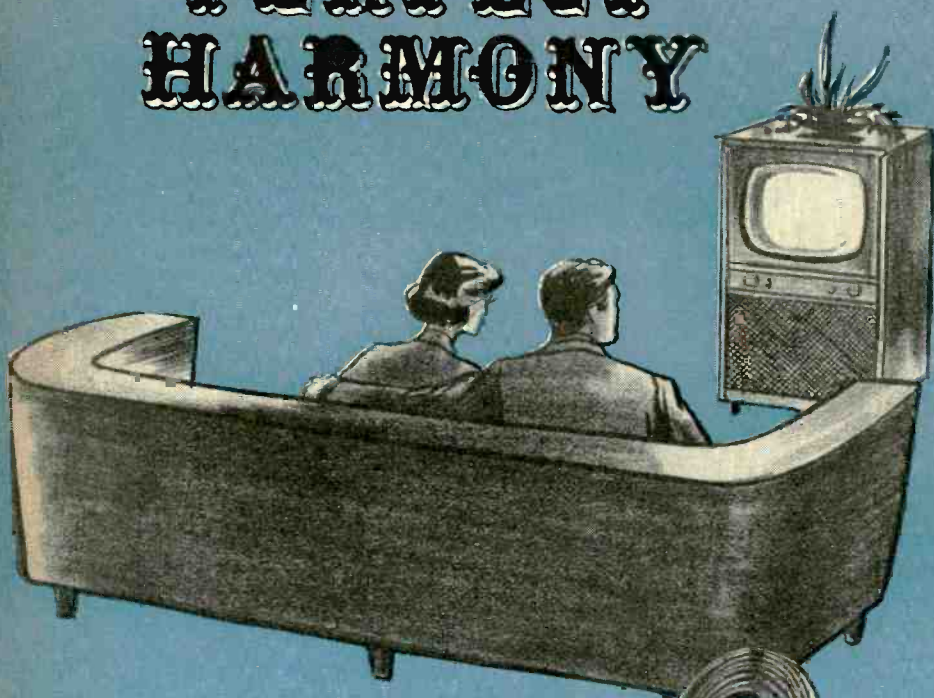

**AMPHENOL**

## NEW INDOOR TWIN LEAD

300 ohm *Indoor* Twin Lead by AMPHENOL, beautiful, clear natural color for perfect interior decoration harmony, pure virgin polyethylene used for guaranteed performance!

Aside from its natural, clear color, *Indoor* is a twin to AMPHENOL's famous 214-056 standard Twin Lead. *Indoor* is available in handy hanks of 25, 50, 75 and 100 feet, and in reels of 500 and 1000 feet.



Mark-ups on AMPHENOL Twin Lead harmonize with your profits, too! Check your AMPHENOL Distributor.



AMPHENOL ELECTRONICS CORPORATION  
chicago 50, illinois



and knowledge it acquires in its own operations. . . . Independent service organizations must have equal opportunity to compete with RCA factory service for consumer service arrangements on RCA sets. It is our further belief that in any plan under which the original price of the TV receiver includes service through the warranty period, dealers must have full freedom to provide their own service or provide the service through independent service organizations or RCA factory service. In the exercise of this choice the dealer must not be restricted to 'captive service.'

"RCA believes that good customer service requires broad distribution of replacement parts. It will continue its long-established policy of making all repair and replacement parts available to the service industry through all of its distributors."

Other points in the letter stressed that the company would continue to recognize the independent service industry in its advertising and printed literature, and that it would continue its service organization's program for procuring replacement parts and other material on a basis fair and competitive with the independent service dealers.

### SERVICE GROUPS ELECT

With the beginning of the new year a number of service associations have elected officials. Following the practice of rotating officers, common in many technicians organizations, this has resulted in a number of new names appearing. However, the Federation of Radio-TV Servicemen's Associations of Pennsylvania re-elected Bert A. Bregenzler to his third term as president. Vice president is Dave Krantz of Philadelphia, and corresponding secretary, Leon J. Helk of Carbondale.

The Long Island Guild, New York, elected Christopher Stratigos of Rockville Centre president and Bob Barasch of Lindenhurst, secretary.

TESA-Chicagoland's new president is Joseph Issak of General TV, and Sidney Terman of Certified TV Service is secretary.

Buffalo, re-elected Irving J. Toner president and made Homer G. Johnson secretary.

Pasadena, Calif., elected Frank Fisher president and Ron Kealy secretary.

### NATESA ADDS THREE MORE

Three new affiliates: TESA-NEMO (headquarters in Hannibal, Mo.); Green Bay TV Service Dealers' Association, Green Bay, Wis., and TV Service Guild Association, Moline, Ill., are reported by the National Alliance of Television Electronic Service Associations. This brings the number of NATESA affiliates to 70, stated Vincent Lutz, NATESA membership coordinator. The Hannibal group is headed by Frank Brashears; Gordon

Olsen is president of the Green Bay association, and Harold Young of the one in Moline.

**BBB ATTACKS IN DETROIT**

A number of Detroit firms have been cited by the Better Business Bureau as having offered service to home owners at \$1 to \$3 when investigation showed that the actual cost to the customer almost invariably ran much higher. In one case (Penway Television Corp.) in an advertisement which mentioned "only \$3.95 . . . including all parts, labor and material," the Bureau pointed out that there was an additional charge of from \$34.95 to \$82.95 for joining the Penway plan. In other cases the BBB directed fire at TV set dealers who offered \$10 delivery and installation charges and then attempted to sell both higher-cost sets and installations than those advertised.

**ONE-YEAR FREE SERVICE**

A free one-year service policy and free one-year warranty on picture tube and all parts including labor has been offered by the Emerson-Midwest Corp., Emerson Chicago distributor, on two portable TV sets. The service and warranty is by Emerson Factory Service, according to an ad in the Chicago Sun Times by Hudson-Ross, TV and appliance dealer. It was reported from New York that the Chicago offer followed a recent promotion by Emerson-New

York, and that other Emerson distributors could do likewise. It was also pointed out that one of the features of the plan was that the set owner must bring his TV receiver to the shop for servicing—no outside calls were included in the free service.

**ALASKA GROUP JOINS TESA**

TESA of Fairbanks, Alaska, has applied for membership in the National Alliance of Television Electronic Service Associations (NATESA). This is the first full affiliate outside of the boundaries of the 48 states, according to Vincent J. Lutz, NATESA coordinator of membership extension. The officials of TESA-Fairbanks are Roland Cowan, president; John Gudschinsky, vice president; Pete Michanow, secretary; and Dave Thomas, treasurer. Membership consists of 10 firms representing 90% of the TV service organizations in the area.

**COLOR TV TOO COMPLEX?**

According to Louis N. Ridenour, atomic scientist, color television receivers are so complicated "a little technician" should go along with each set sold. Mr. Ridenour, now director of missile research of Lockheed Aviation, also recommended that color telecasting be shifted to the uhf band because "there is space there to do a more ample job." The statements were made to a Congressional hearing on automa-

**10 TIMES AS HARD?**

A major repair on a portable television receiver may in some cases take ten times as long as the same repair on a console receiver. This was the opinion of a number of service technicians checked by the *Retailing Daily* recently. The compactness of the portables, they said, might require disassembling the entire set before a repair could be made.

On the other hand, the technicians reported, the portables were holding up pretty well under normal operation and were no more likely to break down than larger sets. **END**



"Business has doubled since we started selling these!"



**NOW!** Take The "Headache" Out of TV Trouble Shooting

Amazing Handbook Helps You Accurately

**PinPoint TV TROUBLES IN 10 MINUTES**

**SAVES TIME . . . MAKES YOU MORE VALUABLE!**

Now for the first time—a practical procedure for spotting the cause of trouble in *any* TV set—FAST! Overcomes the most difficult, most time-consuming TV trouble shooting problems. There's no guesswork! Quick, simple tests tell you in which of 5 TV set sections to find the cause of the trouble. Fool-proof *Check Charts* help you locate the exact trouble spot at once, from as many as 700 possibilities. Not a book for the "tinkerer" or home owner who tries to fix his own TV set—IT'S A BOOK WRITTEN FOR TV SERVICEMEN TO SAVE TIME AND MONEY. The hours and aggravation it can save you on a *single* servicing job more than pays for this amazing handbook. Helps you make more money as an expert speedy TV trouble-shooter!

**NEEDED BY EVERY TV SERVICEMAN**

"Pinpoint TV Troubles in 10 Minutes" is one of the most valuable "tools" you can carry on a servicing call. Amazingly practical. Over 300 spiral bound fast reference pages with 50 time-saving Check Charts; dozens of important diagrams and tests; explanations of circuits and designs. Fits easily into tool kit for handy on-the-job reference. Prepared and guaranteed by the famous Coyne Electrical School. Costs nothing to examine on Coyne's liberal FREE TRIAL offer.

DOES AWAY WITH GUESSWORK!

NOTHING LIKE IT BEFORE!

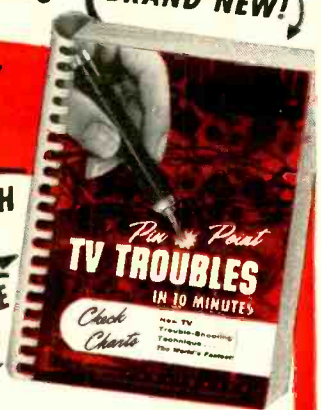

**USE IT ON 7 DAYS FREE TRIAL!**

You must see this sensational new handbook to believe how much time it can save you—how it makes your days more productive and your work easier. Send no money, just the coupon. We'll rush your copy to you on FREE TRIAL. Try it yourself. Then, after 7 days either send only \$3.95 plus postage, or return the book and owe nothing. Take advantage of this no-risk offer NOW!

**MAIL COUPON NOW!**

Educational Book Publishing Division  
COYNE ELECTRICAL SCHOOL, Dept. 37-TP  
500 S. Paulina St., Chicago 12, Ill.

YES! Rush new TV trouble shooting handbook: "Pinpoint TV Troubles in 10 Minutes" for 7 days FREE TRIAL per your offer.

Name..... Age.....

Address.....

City..... Zone..... State.....

Check here if you are enclosing \$3.95. We pay postage. 7-day money back guarantee.

**COYNE ELECTRICAL SCHOOL**  
Educational Book Publishing Division  
500 S. Paulina St., Dept. 37-TP Chicago 12, Illinois

# new Devices



**HIGH-FIDELITY COAXIAL SPEAKERS.** Double coaxially mounted cones with single voice coils. 6-watt 8-inch to 25-watt



18-inch units.—**Duotone Co., Inc.,** Keyport, N. J.

**3-WAY SWITCH, S-203 Selecto-Switch.** Selects components of hi-fi system, operates speakers singly or in combination, switches from uhf to vhf, TV to FM and operates singly any



one of three TV sets from one antenna. Positive-acting rotating inductor. Solderless connections. 2 mounting ears. 3 x 1 3/4 x 1 inch.—**Anchor Products Co.,** 2712 W. Montrose Ave., Chicago.

**5-VOLT PHONO CARTRIDGE, W9.** 3-speed, dual-needle and dual-voltage crystal. Response to 10,000 cycles. Needle can be speedily replaced without tools



or removing cartridge from tone arm.—**Shure Brothers,** 225 W. Huron St., Chicago 10, Ill.

**POWER AMPLIFIER, HF60.** Kit or wired. EF86 low-noise voltage amplifier direct-coupled to 6SN7GTB cathode-coupled phase inverter which drives pair of Ultra-Linear-connected push-pull EL34 output tubes operated



with fixed bias. Rated power output 60 watts (130 peak). 1M distortion (60 and 6,000 cycles at 4:1) less than 1% at 60 watts and less than 0.5% at 50 watts. Harmonic distortion less

than 0.5% at any frequency between 20-20,000 cycles within 1 db of 60 watts. Sinusoidal frequency response at 1 watt is  $\pm 0.1$  db, 5-90,000 cycles; at 60 watts  $\pm 0.1$  db 16-90,000 cycles. Square-wave response from 20-25,000 cycles with 3- $\mu$ sec rise time. Sensitivity 0.55 volt for 60 watts. Damping factor: 17. Inverse feedback: 21 db. Input level control. Bias and de-balance adjustments. 25 pounds. 7 x 14 x 8 inches.—**Electronic Instrument Co.,** 84 Withers St., Brooklyn 11, N. Y.

**TEST RECORD, Series 60.** Tests audio systems without instruments. 12-inch LP. True

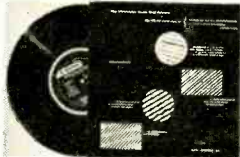

musical pitches based on chromatic intervals of the tempered scale instead of mathematical frequencies. Covers 8 octaves of the musical range. Tone bursts allow testing and detection of cabinet resonances and cone breakup in speakers. With pressed-in Strobolabel and 8-page booklet.—**Cook Laboratories, Inc.,** 101 Second St., Stamford, Conn.

**VARIABLE-SPEED HIGH-FIDELITY TURNTABLE, Connoisseur.** 12-inch nonmagnetic lathe-turned sand casting custom-fitted to spindle. Clearance between spindle shaft and bearings for thin oil film prevents contact. Synchronous hysteresis motor. 4% speed variation. Lightweight tone arm of non-cantilever, moving-coil iron with interchangeable plug-in



heads for standard and micro-groove records.—**Ercona Corp., Electronic Div.,** 551 Fifth Ave., New York 17, N. Y.

**ENCLOSURES, Model 30** lift-top equipment cabinet with 2

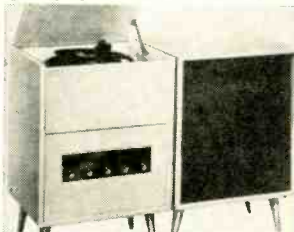

compartments. Upper player compartment 19 1/2 x 14 1/2 inches with 6 inches height above play-

er board. Lower tuner-amplifier compartment 13 x 19 1/2 x 14 1/2 inches. Equipment panel can be removed and used for storage. 46 pounds. *Model 31,* matching bass-reflex enclosure, has 4.5-cubic foot baffle. 44 pounds.—**G & H Wood Products Co.,** 99 N. 11th St., Brooklyn, N. Y.

**MICROPHONE, Unidyne.** 41% higher output than earlier models. For use with low-gain pub-



lic-address systems and tape recorders.—**Shure Brothers, Inc.,** 222 Hartrey Ave., Evanston, Ill.

**REPLACEMENT TV COMPONENTS, DY-22A** deflection-yoke

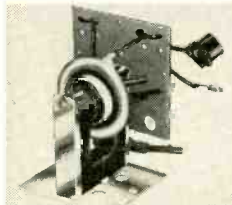

replacement for Hoffman part No. 5192A, *HO-250* flyback replacement for Raytheon part No. 12E24612, *HO-251* flyback replacement for Airline, Coronado, Firestone, Raytheon and Truetone part No. 12E23939.—**Chicago Standard Transformer Corp.,** 3501 W. Addison, Chicago.

**ELECTROLYTIC, style EY.** For printed circuits and automatic assemblies. Hermetically sealed.



Utilizes pure foil and special high-gain etch process. Wide range of values.—**Astron Corp.,** 255 Grant Ave., E. Newark, N. J.

**WRAPAROUND RECTIFIER.** 65-mil selenium. 7 individual cells placed flat against each other. No center hole. Provides thermal coupling to chassis which acts as heat sink, permits flexibility of mounting and

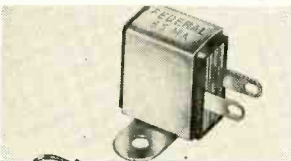

protects rectifier.—**Federal Telephone & Radio Co., Components Div.,** 100 Kingsland Rd., Clifton, N. J.

**LOOPSTICKS.** 11 flat and transistor-matched models. Instruc-

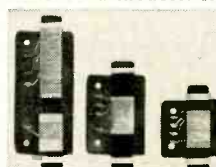

tions, including 9 suggested circuits and summary of transistor receiver design.—**Superex Electronics Corp.,** 4 Radford Pl., Yonkers, N. Y.

**MULTIBAND TANK, MB-40DL.** For push-pull or single-ended circuits, grid circuits with approximately 20-watt input and final plate circuits of transmitters when power input to the stage does not exceed 40 watts loaded. 3.2-9.0-mc and 12-34-mc tuning range. Sufficient overlap for amateur bands. No plug-in coils or bandswitching necessary. Input or output in form of 2 parallel-connected coupling coils—one fixed, other mounted to a shaft. 300-ohm impedance but links can be reduced by 1 or 2 turns for 50-

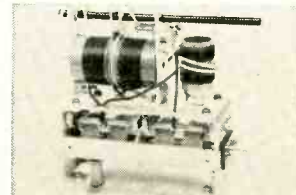

or 70-ohm coax.—**National Co., Inc.,** 61 Sherman St., Malden 48, Mass.

**ANTENNA, K-6.** Either single- or two-bay construction.



Molded insulator locks phasing system in place. Sure-grip mast clamp.—**Kay-Townes Antenna Co.,** Rome, Ga.

**VEHICULAR COMMUNICATION ANTENNA, M1.** For transmitting and receiving in amateur mobiles, broadcast reception, industrial services, emergency communications, civil defense, etc. Can be mounted on any body surface from horizontal to vertical plane.



Three separate parts: Base, with 3/8-inch-24 thread to accept rod or spring has aluminum, 2-inch-diameter swivel with Bakelite mounting insulator and heavy steel backup plate; heavy-duty spring designed for 96-inch maximum whip length, and center braid permits maximum electrical conductivity; taper-ground stainless steel 96-inch whip fits directly to either base or spring, bends to 90° and can be cut to any length.—**Antenna Specialists Co.** 12435 Euclid Ave., Cleveland 6, Ohio.

**BOOSTER, Model RPS-2.** For use in parallel- and series-filament circuits. Special transformer for switchover. Parallel and series windings each connected to respective lugs into which circuit-selector lead is inserted.—**DeRo Electronics,**



Superior's New Model 670-A

# SUPER-METER

A COMBINATION VOLT-OHM MILLIAMMETER PLUS CAPACITY, REACTANCE, INDUCTANCE AND DECIBEL MEASUREMENTS.



**ADDED FEATURE:**  
Built in ISOLATION TRANSFORMER reduces possibility of burning out meter through misuse.

**SPECIFICATIONS**

D.C. VOLTS: 0 to 7.5/15/75/150/750/1,500/7,500 Volts  
A.C. VOLTS: 0 to 15/30/150/300/1,500/3,000 Volts  
OUTPUT VOLTS: 0 to 15/30/150/300/1,500/3,000 Volts  
D.C. CURRENT: 0 to 1.5/15/150 Ma. 0 to 1.5/15 Amperes  
RESISTANCE: 0 to 1,000/100,000 Ohms 0 to 10 Megohms

CAPACITY: .001 to 1 Mfd. 1 to 50 Mfd. (Good-Bad scale for checking quality of electrolytic condensers.)

REACTANCE: 50 to 2,500 Ohms 2,500 Ohms to 2.5 Megohms

INDUCTANCE: .15 to 7 Henries 7 Henries to 7,000 Henries

DECIBELS: -6 to +18 +14 to +38 +34 to +58

The Model 670-A comes housed in a rugged crackle-finished steel cabinet complete with test leads and operating instructions.

**\$28.40 NET**

Superior's New Model TV-60

20,000 OHMS PER VOLT

# ALLMETER

**SPECIFICATIONS**

8 D.C. VOLTAGE RANGES (At a sensitivity of 20,000 Ohms per Volt) 0 to 15/75/150/300/750/1500/7500/30,000 Volts.

7 A.C. VOLTAGE RANGES: (At a sensitivity of 5,000 Ohms per Volt) 0 to 15/75/150/300/750/1500/7500 Volts.

3 RESISTANCE RANGES: 0 to 2,000/200,000 Ohms, 0-20 Megohms

2 CAPACITY RANGES: .00025 Mfd. to 30 Mfd.

5 D.C. CURRENT RANGES: 0-75 Microamperes, 0 to 7.5/75/750 Milliampere, 0 to 15 Amperes

3 DECIBEL RANGES: -6 db to +58 db.



**AUDIO SIGNAL TRACER SERVICE:** Functions in the same manner as the R.F. Signal Tracing service specified at right except that it is used for the location of cause of trouble in all audio and amplifier systems.

**FEATURES**

Giant recessed 6 1/2 inch 40 Microampere meter with mirrored scale. Built-in Isolation Transformer. Use of the latest type printed circuit and 1% multipliers assure unchanging accurate readings.

Model TV-60 comes complete with book of instructions; pair of standard test leads; high-voltage probe; detachable line cord; R.F. Signal Tracer Probe and Audio Signal Tracer Probe. Pliofilm bag for all above accessories is also included. Price complete. Nothing else to buy. ONLY

**R.F. SIGNAL TRACER SERVICE:** Enables following the R.F. signal from the antenna to speaker of any radio or TV receiver and using that signal as a basis of measurement to first isolate the faulty stage and finally the component or circuit condition causing the trouble.

**\$52.50 NET**

Superior's New Streamlined Model TD-55

# TUBE TESTER



**FOR** { The Experimenter or Part-time Serviceman, who has delayed purchasing a higher priced Tube Tester.  
The Professional Serviceman, who needs an extra Tube Tester for outside calls.  
The Busy TV Service Organization, which needs extra Tube Testers for its field men.

**CHECKS FOR SHORTS AND LEAKAGES BETWEEN ALL ELEMENTS** - Model TD-55 provides a super sensitive method of checking for shorts and leakages up to 5 Megohms between any and all of the terminals. Continuity between various sections is individually indicated. "FREE-POINT" ELEMENT SWITCHING SYSTEM - Model TD-55 incorporates a newly designed element selector switch system which reduces the possibility of obsolescence to an absolute minimum. Any pin may be used as a filament pin and the voltage applied between that pin and any other pin, or even the "top-cap." ELEMENTAL SWITCHES ARE NUMBERED IN STRICT ACCORDANCE WITH R.M.A. SPECIFICATION - The 4 position fast-action snap switches are all numbered in exact accordance with the standard R.M.A. numbering system. Thus, if the element terminating in pin No. 7 of a tube is under test, button No. 7 is used for that test.

Speedy, yet efficient operation is accomplished by: 1. Simplification of all switching and controls. 2. Elimination of old style sockets used for testing obsolete tubes (26, 27, 57, 59, etc.) and providing sockets and circuits for efficiently testing the new Noval and Sub-Minar types.

Model TD-55 comes complete with operating instructions and charts. Housed in rugged steel cabinet. Use it on the bench - use it for field calls. A streamlined carrying case, included at no extra charge, accommodates the tester and book of instructions.

**\$26.95 NET**

Superior's new Model TW-11 STANDARD PROFESSIONAL

# TUBE TESTER



- Tests all tubes, including 4, 5, 6, 7, Octal, Lock-in, Hearing Aid, Thyatron, Miniatures, Sub-miniatures, Novals, Sub-Minars, Proximity fuse types, etc.
- Uses the new self-cleaning Lever Action Switches for individual element testing. Because all elements are numbered according to pin-number in the RMA base numbering system, the user can instantly identify which element is under test. Tubes having tapped filaments and tubes with filaments terminating in more than one pin are truly tested with the Model TW-11 as any of the pins may be placed in the neutral position when necessary.
- The Model TW-11 does not use any combination type sockets. Instead individual sockets are used for each type of tube. Thus it is impossible to damage a tube by inserting it in the wrong socket.
- Free-moving

built-in roll chart provides complete data for all tubes. All tube listings printed in large easy-to-read type.

- NOISE TEST: Phono-jack on front panel for plugging in either phones or external amplifier will detect microphonic tubes or noise due to faulty elements and loose internal connections.

- SEPARATE SCALE FOR LOW-CURRENT TUBES - Previously, on standard emission type tube testers, it has been standard practice to use one scale for all tubes. As a result, the calibration for low-current types has been restricted to a small portion of the standard scale. The extra scale used here greatly simplifies testing of low-current types.

The Model TW-11 operates on 105-130 Volt 60 Cycles A.C. Comes housed in a beautiful hand-rubbed oak cabinet complete with portable cover.

**\$47.50 NET**

# SHIPPED ON APPROVAL NO MONEY WITH ORDER - NO C.O.D.

We invite you to try before you buy any of the models described on this and the following page. If after a 10 day trial you are completely satisfied and decide to keep the Tester, you need send us only the down payment and agree to pay the balance due at the monthly indicated rate. (See other side for time-payment schedule details.)

**NO INTEREST  
OR FINANCE  
CHARGES ADDED!**

If not completely satisfied, you are privileged to return the Tester to us, cancelling any further obligation.

**SEE OTHER SIDE!**

**Cut out and mail TODAY!**

All prices net, F.O.B., N.Y.C.

**FIRST CLASS**  
Permit No. 61430  
New York, N. Y.

**BUSINESS REPLY CARD**

No Postage Stamp Necessary if Mailed in the U. S.

**VIA AIR MAIL**

POSTAGE WILL BE PAID BY -

**MOSS ELECTRONIC DIST. CO., INC.**

**3849 TENTH AVENUE**

**NEW YORK 34, N. Y.**

Superior's  
New  
Model

# 76

## For the first time ever: ONE TESTER PROVIDES ALL THE SERVICES LISTED BELOW!



### IT'S A CONDENSER BRIDGE

with a range of .00001 Microfarad to 1000 Microfarads (Measures power factor and leakage too.)

### IT'S A SIGNAL TRACER

which will enable you to trace the signal from antenna to speaker of all receivers and to finally pinpoint the exact cause of trouble whether it be a part or circuit defect.

### IT'S A RESISTANCE BRIDGE

with a range of 100 ohms to 5 megohms

### IT'S A TV ANTENNA TESTER

The TV Antenna Tester section is used first to determine if a "break" exists in the TV antenna and if a break does exist the specific point (in feet from set) where it is.

#### SPECIFICATIONS

#### ✓ RESISTANCE BRIDGE SECTION

2 Ranges: 100 ohms to 50,000 ohms; 10,000 ohms to 5 megohms. Resistance can be measured without disconnecting capacitor connected across it. (Except, of course, when the R C combination is part of an R C bank.)

As Design Engineers, we the undersigned would like to say that the Model 76 is in our opinion the best combination unit of its kind we have been privileged to design. Although it is comparatively a low-priced tester, it will, after you become acquainted with its multiple services, be your most frequently used instrument.

S. LITT  
L. MELENKEVITZ

#### ✓ CAPACITY BRIDGE SECTION

4 Ranges: .00001 Microfarad to .005 Microfarad; .001 Microfarad to .5 Microfarad; .1 Microfarad to 50 Microfarads; 20 Microfarads to 1000 Microfarads. This section will also locate shorts, and leakages up to 20 megohms. And finally, this section will measure the power factor of all condensers from .1 to 1000 Microfarads. (Power factor is the ability of a condenser to retain a charge and thereby filter efficiently.)

#### ✓ SIGNAL TRACER SECTION

A built-in high gain pentode voltage amplifier, plus a diode rectifier, plus a direct coupled triode amplifier are combined to provide this highly sensitive signal tracing service. With the use of the R.F. and A.F. Probes included with the Model 76, you can make stage gain measurements, locate signal loss in R.F. and Audio stages, localize faulty stages, locate distortion and hum, etc. Provision has been made for use of phones and meter if desired.

#### ✓ TV ANTENNA TESTER SECTION

Loss of sync., snow and instability are only a few of the faults which may be due to a break in the antenna, so why not check the TV antenna first? The Model 76 will enable you to locate a break in any TV antenna and if a break does exist, the Model 76 will measure the location of the break in feet from the set terminals. 2 Ranges: 2' to 200' for 72 ohm coax and 2' to 250' for 300 ohm ribbon.

Model 76 comes complete with all accessories including R.F. and A.F. Probes; Test Leads and operating instructions. Nothing else to buy . . . . . Only

**\$26<sup>95</sup>**  
NET



Superior's New Model TV-50

# GENOMETER

A versatile all-inclusive GENERATOR which provides ALL the outputs for servicing:  
A. M. Radio • F. M. Radio • Amplifiers • Black and White TV • Color TV

#### 7 Signal Generators in One!

- ✓ R.F. Signal Generator for A.M.
- ✓ R.F. Signal Generator for F.M.
- ✓ Audio Frequency Generator

- ✓ Bar Generator
- ✓ Cross Hatch Generator
- ✓ Color Dot Pattern Generator
- ✓ Marker Generator

**R. F. SIGNAL GENERATOR:** Provides complete coverage for A.M. and F.M. alignment. Generates Radio Frequencies from 100 Kilocycles to 60 Megacycles on fundamentals and from 60 Megacycles to 180 Megacycles on powerful harmonics.

**VARIABLE AUDIO FREQUENCY GENERATOR:** In addition to a fixed 400 cycle sine-wave audio, the Genometer provides a variable 300 cycle to 20,000 cycle peaked wave audio signal.

**BAR GENERATOR:** Projects an actual Bar Pattern on any TV Receiver Screen. Pattern will consist of 4 to 16 horizontal bars or 7 to 20 vertical bars.

**MARKER GENERATOR:** The following markers are provided: 189 Kc., 262.5 Kc., 456 Kc., 600 Kc., 1000 Kc., 1400 Kc., 1600 Kc., 2000 Kc., 2500 Kc., 3579 Kc., 4.5 Mc., 5 Mc., 10.7 Mc., (3579 Kc. is the color burst frequency.)

**CROSS HATCH GENERATOR:** Genometer will project a cross-hatch pattern on any TV picture tube. The pattern will consist of non-shifting horizontal and vertical lines interlaced to provide a stable cross-hatch effect.

**DOT PATTERN GENERATOR (FOR COLOR TV):** The Dot Pattern projected on any color TV Receiver tube by the Model TV-50 will enable you to adjust for proper color convergence.

**MODEL TV-50** comes absolutely complete with shielded leads and operating instructions. Only

**\$47<sup>50</sup>**  
NET

# SHIPPED ON APPROVAL NO MONEY WITH ORDER — NO C. O. D.

MOSS ELECTRONIC DISTRIBUTING CO., INC.  
Dept. D-312, 3849 Tenth Ave., New York 34, N. Y.

Please send me the units checked. I agree to pay down payment within 10 days and to pay the monthly balance as shown. It is understood there will be no finance or interest charges added. It is further understood that should I fail to make payment when due, the full unpaid balance shall become immediately due and payable.

- |   |   |
|---|---|
| <input type="checkbox"/> Model TD-55 . . . . . Total Price \$26.95<br>\$6.95 within 10 days. Balance \$5.00<br>monthly for 4 months.  | <input type="checkbox"/> Model TV-50 . . . . . Total Price \$47.50<br>\$11.50 within 10 days. Balance \$6.00<br>monthly for 6 months. |
| <input type="checkbox"/> Model TV-60 . . . . . Total Price \$52.50<br>\$12.50 within 10 days. Balance \$8.00<br>monthly for 5 months. | <input type="checkbox"/> Model 670-A . . . . . Total Price \$28.40<br>\$7.40 within 10 days. Balance \$3.50<br>monthly for 6 months.  |
| <input type="checkbox"/> Model TW-11 . . . . . Total Price \$47.50<br>\$11.50 within 10 days. Balance \$6.00<br>monthly for 6 months. | <input type="checkbox"/> Model 76 . . . . . Total Price \$26.95<br>\$6.95 within 10 days. Balance \$5.00<br>monthly for 4 months.     |

Name .....

Address .....

City ..... Zone ..... State .....

All prices net, F.O.B., N.Y.C.

We invite you to try before you buy any of the models described on this and the preceding page. If after a 10 day trial you are completely satisfied and decide to keep the Tester, you need send us only the down payment and agree to pay the balance due at the monthly indicated rate.

## NO INTEREST OR FINANCE CHARGES ADDED!

If not completely satisfied, you are privileged to return the Tester to us, cancelling any further obligation.

### SEE OTHER SIDE!

◀ Cut out and mail TODAY!

(Continued)



134 Nassau Rd., Roosevelt, N.Y.

**PREASSEMBLED CONICALS.** *Snapout Rigid-Rigs.* More than 14 models in single- and double-bay units. Preassembled. All-channel. Serrated saddle type mast clamp. High tension locks on insulator head and rear ele-

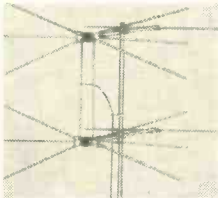

ment plate. 1-inch-diameter seamless aluminum crossarm. End-sealed 3/8 inch aluminum elements. All-rivet construction. —Medal Mfg. Co., Sharon, Pa.

**TRANSISTORIZED RADIO KITS.** *TK-101* (illustrated). Transistorized superhet kit. 4 transistors. Printed-circuit chassis. Self-contained speaker with 180-mw output. External phone jack. High-gain ferrite loopstick antenna. 6 x 4 x 2 in.



*TK-101*, a 2-transistor regenerative receiver kit. Crystal diode. Variable loopstick. Subminiature volume control and driver transformer. 15-volt battery. 1 x 2 x 3 inches. —Tran-Kit Electronics, 467 S. 5th Ave., Mount Vernon, N. Y.

**POCKET RADIO.** Ultraminature. 4 transistors. Hearing-aid type earphone. Runs on small 600-hour flashlight battery.



2 7/8 x 2 x 1 inch. 3 1/2 ounces. —Gardiner Electronics Co., 2545 E. Indian School Rd., Phoenix.

**ALIGNMENT INSTRUMENT.** *Radaligner Model V.* For 10-145 mc. Fundamental-frequency sweeping oscillator continuously variable in 6 overlapping bands calibrated on a direct-reading dial. Sweep widths variable to 60% of center frequency below 50 mc, 30 mc above 50 mc. Rf output voltage 1.0 volt rms into 70 ohms, age gives  $\pm 0.5$ -db flatness over widest sweep and tuning range. Birdie "pip" marker generated by separate CW oscillator continuously variable from 5-170 mc in 6 overlapping bands and calibrated to

$\pm 1\%$  on separate direct-reading dial. 11 individually switched, crystal-controlled pulse type markers at customer-specified frequencies for separate and

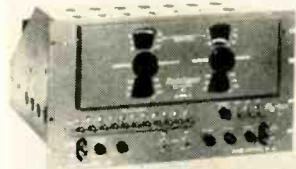

simultaneous operation. —Kay Electric Co., 14 Maple Ave., Pine Brook, N. J.

**FLYBACK CHECKER KIT.** For checking all types standard horizontal output transformers, deflection yokes and linearity controls. Uses 6S4-A tube in pulsed-oscillator circuit. 4 1/2-inch meter with colored "Good-Bad" scale areas. With parts,



test leads, solder, wire diagrams and detailed schematics. —Allied Radio Corp., 100 N. Western Ave., Chicago 80, Ill.

**STUBBY SCREWDRIVERS.** *SK-20 Kit.* 4 quick-change points in durable transparent plastic kit with snap-fastener top. Double-ended blades, one with 3/16-inch regular and No. 1 Phillips point, the other 1/4-inch regular and No. 2 Phillips. Press-fitted hex sleeve in center to fit 7/16-inch spring-loaded hex bushing imbedded in handle. 1 1/4 x 2-inch handle doubles as 7/16-inch nut driver. —Xcelite, Inc., 28 Bank St., Orchard Park, N. Y.

**VOLTAGE - REGULATED MULTIBIAS SUPPLY.** *model 230.* 4 simultaneous bias voltages to substitute for avc, agc, chroma, etc. Each output individually adjustable and filtered from voltage-regulated source. 3 controls variable from 0 to -15 volts and one from



0 to -150 volts. —Precision Apparatus Co., Inc., 70-31 84th St., Glendale 27, N.Y.

**CORE MAGNET METER MOVEMENT.** Sintered rings and pole faces. Precision die-cast brackets. Shock-mounted jewel assemblies. 2 1/2 inches round. Clear plastic case. Custom styles available. —Phaotron Instrument & Electronic Co., 151 Pasadena Ave., S. Pasadena, Calif.

All specifications given on these pages are from manufacturers' data.

# Build 16 Radio

CIRCUITS at Home with NEW DELUXE 1957 PROGRESSIVE RADIO "EDU-KIT"

\$22.95 Only

Reg. U.S. Pat. Off.



A Practical Home Radio Course

- ★ No Knowledge of Radio Necessary
- ★ No Additional Parts or Tools Needed
- ★ Excellent Background for TV
- ★ School Inquiries Invited
- ★ Attractively Gift Packed

Now Includes

- ★ TRANSMITTER
- ★ SIGNAL TRACER
- ★ SIGNAL INJECTOR
- ★ CODE OSCILLATOR

FREE SET OF TOOLS, PLIERS—CUTTERS, TESTER, SOLDERING IRON, ALIGNMENT TOOL

### WHAT THE "EDU-KIT" OFFERS YOU

The "Edu-Kit" offers you an outstanding PRACTICAL HOME RADIO COURSE at a rock-bottom price. Our kit is designed to train Radio & Electronics Technicians, making use of the most modern methods of home training. You will learn radio theory, construction, servicing, basic Hi-Fi and TV repairs, code, FCC amateur license requirements.

You will learn how to identify radio symbols, how to read and interpret schematics, how to mount and layout radio parts, how to wire and solder, how to operate electronic equipment, how to build radios. You will receive a basic education in radio, worth many times the small price you pay, only \$22.95 complete.

### THE KIT FOR EVERYONE

The Progressive Radio "Edu-Kit" was specifically prepared for any person who has a desire to learn radio. The "Edu-Kit" has been used successfully by young and old in all parts of the world, by many Radio Schools and Clubs in this country and abroad. It is used for training and rehabilitation of

Armed Forces Personnel and Veterans throughout the world.

The Progressive Radio "Edu-Kit" requires no instructor. All instructions and parts are included. Every step is carefully explained. You cannot make a mistake.

### PROGRESSIVE TEACHING METHOD

The Progressive Radio "Edu-Kit" is the foremost educational radio kit in the world, and is universally accepted as the standard in the field of electronics training. The "Edu-Kit" uses the modern educational principle of "Learn by Doing." Therefore, you will construct radio circuits, perform jobs and conduct experiments to illustrate the principles which you learn.

You begin by examining the various radio parts included in the "Edu-Kit." You then learn the function, theory and wiring of these parts. When you build a simple radio. With this first set, you will enjoy listening to regular broadcast stations, learn theory, practice testing and troubleshooting. Then you build a more advanced radio, learn more advanced theory and techniques. Gradually, in a progressive manner and at your own rate, you will find yourself constructing more advanced multi-tube radio circuits, and doing work like a professional Radio Technician.

Included in the "Edu-Kit" course are sixteen Receiver, Transmitter, Code Oscillator, Signal Tracer, and Signal Injector circuits. These are not unprofessional "breadboard" experiments, but genuine radio circuits, constructed by means of professional wiring and on a professional chassis, plus the new method of radio construction known as "Printed Circuitry." These circuits operate on your regular AC or DC house current.

In order to provide a thorough, well-integrated and easily-learned radio course, the "Edu-Kit" includes practical work as well as theory; troubleshooting in addition to construction; training for all, whether your purpose in learning radio be for hobby, business or job; progressively-arranged material, ranging from simple circuits to well-advanced topics in Hi-Fi and TV. Your studies will be further aided by Quiz materials and our well-known FREE Consultation Service.

### THE "EDU-KIT" IS COMPLETE

You will receive all parts and instructions necessary to build 16 different radio and electronics circuits, each guaranteed to operate. Our Kits contain tubes, tube sockets, variable electrolytic and paper dielectric condensers, resistors, wire strips, coils, hardware, tubing, painted metal chassis, Instruction Manuals, etc.

In addition, you receive Printed Circuit materials, including Printed Circuit chassis, special tube sockets, hardware and instructions. You also receive a useful set of tools, a Professional electric soldering iron, and a self-powered Dynamic Radio & Electronics Tester. The "Edu-Kit" also includes Code Instructions and the Progressive Code Oscillator, in addition to F.C.C.-type Questions and Answers for Radio Amateur License training. You will also receive lessons for servicing with the Progressive Signal Tracer and the Progressive Signal Injector, a High Fidelity Guide and a Quiz Book.

### TROUBLE-SHOOTING LESSONS

You will learn trouble-shooting and servicing in a progressive manner. You will practice repairs on the sets that you construct. You will learn symptoms and causes of troubles in home, portable and car radios. You will learn how to use the professional Signal Tracer, the unique Signal Injector and the Dynamic Radio & Electronics Tester. While you are learning in this practical way, you will be able to do many a repair job for your friends and neighbors, and charge fees which will far exceed the price of the "Edu-Kit." Our Consultation Service will help you with any technical problems you may have.

J. Stataitis, of 25 Poplar Pl., Waterbury, Conn., writes: "I have repaired several sets for my friends, and made money. The "Edu-Kit" paid for itself. I was ready to spend \$240 for a Course, but I found your ad and sent for your Kit."

### FREE EXTRAS

- SET OF TOOLS
- RADIO & ELECTRONICS TESTER
- ELECTRIC SOLDERING IRON
- TESTER INSTRUCTION MANUAL
- MEMBERSHIP IN RADIO-TV CLUBS
- CONSULTATION SERVICE
- HI-FI GUIDE
- QUIZZES
- TV BOOK
- FCC AMATEUR LICENSE TRAINING
- RADIO BOOK
- PRINTED CIRCUITRY

—90 DAY UNCONDITIONAL MONEY-BACK GUARANTEE—

ORDER FROM AD—RECEIVE FREE BONUS RESISTOR AND CONDENSER KITS WORTH \$7.00

- Send "Edu-Kit" Postpaid. I enclose full payment of \$22.95.
- Send "Edu-Kit" C.O.D. I will pay \$22.95 plus postage.
- Send me FREE additional information describing "Edu-Kit." Include FREE valuable Radio and TV Servicing Literature. No obligation.

Name.....  
Address.....

PROGRESSIVE "EDU-KITS" INC., 497 Union Ave., Room 126C, Brooklyn 11, N.Y.



# RCA

ANNOUNCES OPPORTUNITIES

## In Guided Missile Test Instrumentation For Electronic Technicians

At the following locations

<b>PATRICK AIR FORCE BASE, FLORIDA</b>  Engineering development technicians Radar Communications Test Equipment	<b>CAPE CANAVERAL</b>  Radar Radio Telemetry	Timing Telephone Optics
--	--	-------------------------------

Enjoy pleasant Florida living and working at these locations.  
Liberal company benefits. Relocation assistance.

### INTERESTING DOWN-RANGE ASSIGNMENTS

Radar	Telemetry	Telephone
Radio	Timing	Optics

These positions are located on the Islands shown on the map above. Salary, 30% incentive, meals and lodging furnished. Return to U.S. every 3 months.



For information and arrangements for personal interview, send complete resume to:

**Mr. H. C. Laur**  
 Technical Employment, Dept. N-15C  
 Missile Test Project  
 RCA Service Co., Inc.  
 P.O. Box 1226, Melbourne, Florida



## RADIO CORPORATION of AMERICA

MISCELLANY



**THE FUND REACHES  
\$12,201.17**

## HELP - FREDDIE-WALK FUND

It has been quite some time since we last reported on the progress of little Freddie, born armless and legless, the son of radio technician Herschel Thomason, of Magnolia, Ark. Little Freddie continues to be well and happy and, except for his handicap, just about all that you would expect a healthy 8-year-old to be.

As he grows older, of course new problems will arise. Adjustments must be made, psychologically and physically. It isn't an easy task, but with the love and understanding of his family and the encouragement he has been receiving from the friends he has made through RADIO-ELECTRONICS, he is sure to come through with flying colors.

On a purely economic level, however, the future is even more challenging. The cost of the artificial arms and legs which will help Freddie to become a responsible and self-sufficient adult is tremendous. The Help-Freddie-Walk Fund is once again appealing to readers of RADIO-ELECTRONICS for aid.

We would like to make special mention of the following group donations received and listed below.

We know readers will want to make a special effort to contribute to this worthy cause. No amount is too small to receive acknowledgment and the sincere thanks of all of us here as well as the Thomason family. *Make out all checks, money orders, etc., to Herschel Thomason.* Send all contributions to:

Help-Freddie-Walk Fund  
 c/o RADIO-ELECTRONICS  
 154 West 14 St.  
 New York 11, N.Y.

<b>RADIO-ELECTRONICS Contributions as of</b>	
April 10, 1956.....	\$11,416.86
<b>FAMILY CIRCLE Contributions.....</b>	<b>602.00</b>
Anonymous, Encinitas, Calif.....	2.00
Anonymous, Rialto, Calif.....	2.00
Anonymous, Fairfield, Conn.....	5.00
Anonymous, Miami, Fla.....	5.00
Anonymous, Northampton, Mass.....	1.00
Anonymous, Harrison, N.J.....	1.00
Anonymous, New York, N.Y.....	2.00
Anonymous, White Plains, N.Y.....	10.00
Anonymous, U.S.S. Yellowstone.....	1.11
Anonymous, Alexandria, Va.....	5.00
Richard Biddahl, Rockford, Ill.....	3.00
A. J. Burke, Syracuse, N.Y.....	5.00
Cub Scout Pack 155, Dens 3 and 4, Los Angeles, Calif.....	5.00
A. W. Culloden, Sydney, Australia.....	1.00
Floyd E. Frakes, Berkeley, Calif.....	20.00
Mrs. John L. Glatz, Tucson, Ariz.....	.50
Grade-4 Pupils, Grand Centre School, Alberta, Canada.....	7.00
Mary Krull, Passaic, N.J.....	5.00
W. Liberman, North American Instruments, Inc., Altadena, Calif.....	10.00
A. F. Lucas, Jr., Stratford, Conn.....	5.00
Joe McCauley, Middletown, Ky.....	3.00
Morrissey Family, Worcester, Mass.....	3.00
Alfred B. Nash, Port Credit, Canada.....	5.00
National Radio Institute Alumni Assn., Detroit, Mich.....	12.00
National Radio Institute Alumni Assn., Springfield, Mass.....	15.00
Thomas Pantages, Marlboro, Mass.....	2.00
Peerless Radio Distributors, Inc., Jamaica, N. Y.....	25.00
Paul's TV-Electronics Service, Fort Lauderdale, Fla.....	1.00
Alexander Rys, Minneapolis, Minn.....	.20
Mr. and Mrs. Wallace W. Sanderson, Rosindale, Mass.....	5.00
J. R. Simpson, Washington, D. C.....	2.00
Lt. Sammy J. Spradlin, Seattle, Wash.....	10.00
R. E. Tresenrider, Columbus, Ohio.....	1.00
Z. Zaks, Haifa, Israel.....	2.00

**TOTAL CONTRIBUTIONS as of Jan. 10, 1957, \$12,201.17**

RADIO-ELECTRONICS

# ABBREVIATIONS and Symbols

By CHARLES S. KIMBALL

(Continued from February, page 102)

TEM —In waveguide propagation, transverse electromagnetic waves; also known as E-waves.  
TERM —Terminal.  
TEX —Overseas teletype exchange (RCA).  
TG —Torque generator.  
Theta (Θ) Greek letter symbol for:  
—Angular phase displacement.  
—Time constant.  
—Reluctance.  
—Angles.  
TI —Traffic Identification (radar).  
TM —In waveguide propagation, transverse magnetic waves.  
TP —Test point.  
tp(g) —Tuned plate tuned grid (oscillator).  
TRANS —Transformer.  
—Transmission.  
trf —Tuned radio frequency.  
Trmk —Track range markers (radar).  
TSM —Trouble shooting manual.  
TT —Transmitting terminal (radio).  
TTY —Teletype.  
—Teletypewriter.  
TU —Transmission unit.  
TV —Television.  
TVI —Television interference.  
TWT —Travelling wave tube (radar).  
TWX —Teletype message.  
—Teletype exchange (Bell System).

## U

UAM —Underwater-to-air missile.  
uhf —Ultra-high frequency (band).  
UL —Underwriters Laboratory.  
UPO —Undistorted power output (amplifier).  
USM —Underwater-to-surface missile.  
UV —Ultraviolet (light).

## V

V —Volt.  
—Voltmeter.  
—Type of antenna consisting of two horizontal long wires arranged to form letter V and fed at apex with currents of opposite polarity.  
—In radar, band of frequencies from 45,000 to 55,000 mc.  
—In mathematics, a vector.  
—Velocity.  
—Volt-ampere.  
—Variable.  
vac, vdc —Volt: ac, dc.  
VC —Voice coil.  
VERT —Vertical.  
VFO —Variable-frequency oscillator.  
vhf —Very high frequency.  
VIB —Vibrator.  
VIDF —Vertical (side) intermediate distributing frame (telephony).  
VLF —Very low frequency (band below 30 kc).  
VM —Velocity modulation.  
—Voltmeter.  
VMDF —Vertical (side) main distributing frame (telephony).  
VOGAD —Voice-operated gain-adjusting device (telephony).  
VOL —Volume.  
vom —Volt-ohmmeter.  
voma —Volt-ohm-milliamperemeter.  
VOR —Vhf omnidirectional range (Navigation).  
VR —Voltage regulator.  
vswr —Voltage standing wave ratio.  
VT —Vacuum tube.  
vtvm —Vacuum-tube voltmeter.  
VU —Volume unit.

## W

W —Watts.  
—Work.  
—Energy in Joules.  
WAR —Weather Advocate Radar.  
wh —Watt-hours.  
wv —Working voltage.  
ww —Wirewound (resistors).

## X

X —Reactance in ohms.  
—Band of radar frequencies extending from 5,200 to 11,000 mc.  
In mathematics:  
—Symbol for multiplication.  
—Symbol for an unknown.  
—Designation for abscissa.  
—Static disturbances.  
Xc —Capacitive reactance.  
Xi —Inductive reactance.  
Xmtr —Transmitter (radio and radar).  
Xtal —Crystal.

# Simpson...the most Complete Line of VOM's

Select the one that fits your needs!

MODEL

# 260

world's most  
popular!

Over half a million Model 260's have been sold to date! 20,000 Ohms per volt. You'll find it wherever quick, accurate, electrical checks are needed. It's so handy, so dependable, so sensibly priced! Ask your jobber. Price, including Adjust-A-Vue Handle, only ... **\$43.95**

Carrying Cases from **\$7.75**

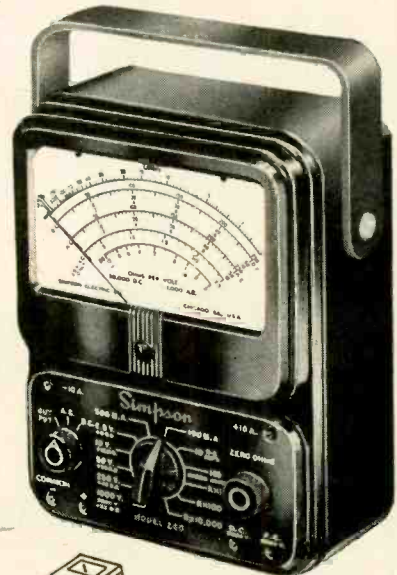

MODEL 262

*Deluxe!*

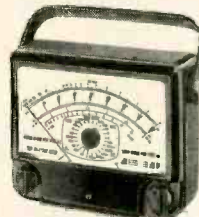

the new VOM with a 7" meter

20,000 Ohms per volt DC and 5,000 Ohms per volt AC sensitivity ... 33 ranges ... compact 7" case with Adjust-A-Vue Handle ... **\$59.50**

Carrying Case ... **\$ 9.95**

MODEL 269

100,000  
Ohms  
per volt!

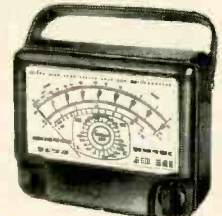

Most sensitive VOM

available! A Volt-Ohm-Microammeter with a big 7" meter in a compact 7" case ... 33 ranges ... Adjust-A-Vue Handle ... **\$88.00**

price complete ... **\$ 9.95**

NEW!

- ➔ MIDGETESTER Model 355—New shirt-pocket size Volt-Ohmmeter **\$34.95**
- MODEL 240—Small VOM; 14 ranges; up to 3000 volts AC or DC **\$28.95**
- MODEL 230—Small VOM; 12 ranges; up to 1000 volts AC or DC **\$27.95**
- ROTO RANGER Model 221—25 Separate meters at turn of a switch **\$75.00**
- LABORATORY STANDARD—For instrument calibration. Price an application.

# Simpson ELECTRIC COMPANY

World's Largest Manufacturer of Electronic Test Equipment

5200 W. Kinzie St., Chicago 44, Ill.

• ESTebrook 9-1121

In Canada: Bach-Simpson, Ltd., London, Ontario

# LIFE'S "LITTLE" PROBLEMS

ARE EASILY  
SOLVED  
WITH

## LITTLE SPACE

QUAM has a full line of shallow speakers, covering all popular applications.

## LITTLE TIME

QUAM speakers mount quickly and easily in the most difficult installations because of QUAM's unusual mounting bracket.

## LITTLE MONEY

QUAM speakers cost no more—and frequently cost less—than other speakers of the same size and magnet weight.

# QUAM

*Adjust-a-Cone*

# SPEAKERS

*ask for QUAM, the quality line, for all your speaker needs*

Quam speakers are listed in Photofact Folders, Counterfacts, File-O-Matic, and Radio's Master.

A FREE copy of the latest QUAM catalog, listing over 100 replacement speakers, is available from your distributor, or from the Quam-Nichols Company.

## QUAM-NICHOLS COMPANY

236 East Marquette Road Chicago 37, Illinois

Stral Advertising Co. Job No. 227

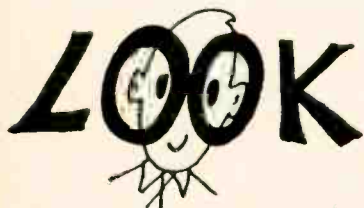

What

**Radio-Electronics**

has in store for you in the months ahead

- How to Construct a Class-B Transistor Hearing Aid
- Texas Towers Guard Our Coasts
- A Simple Transistorized Sine-and-Square-Wave Generator
- A Transistor Preamp for Your VTVM
- Build a Bookshelf Audio Amplifier
- Practical Slant on Color TV Servicing

The APRIL issue of RADIO-ELECTRONICS goes on sale March 26 at all better parts distributors and newsstands

SUBSCRIPTION RATES

One year \$4.00  
RADIO-ELECTRONICS

Two years \$7.00

Three years \$9.00

154 West 14th Street, New York 11, N.Y.

## ABBREVIATIONS

(Continued)

Y	—Letter designation for type of three-phase circuit arrangement in which circuit configuration is shaped like letter Y.
Z	—Impedance.
Z <sub>c</sub>	—Characteristic Impedance.
Z <sub>i</sub>	—Plate load impedance of vacuum tube.
Z <sub>p</sub>	—Plate impedance of vacuum tube.
Zeta (Z)	The Greek letter symbol for: <ul style="list-style-type: none"> <li>—Coordinates.</li> <li>—Coefficients.</li> </ul>

END

## Target for Dx'ers

New goal for the television dx'ers is Australia, just beginning to televise. Though the distance may seem fantastic, it is not impossible on their channels 1 and 2 in the present portion of the sunspot cycle. In fact, Australians heard American FM at a roughly similar period in the last and less intense sunspot cycle.

Australia follows the European Continental TV standards, roughly similar to our own but adapted to a 50-cycle power supply. For example, the field and frame frequencies are 50 and 25 per second, respectively, compared to our 60 and 30. Vestigial sideband transmission is used, with a 7-mc-wide channel. The picture carrier is 1.25 mc from the low end and the sound 0.25 from the high, making picture and sound carriers 5.5 mc apart. Modulation is AM and negative, with black level at 75% of maximum and white between 10 and 15%. Line frequency is 15,625 cycles per second.

The Australian sound is FM like ours, but with a deviation of  $\pm 50$  kc. The transmitters are to be equipped to handle frequencies from 30 to 15,000 cycles. Treble pre-emphasis in accordance with the characteristics of a 50- $\mu$ sec pre-emphasis network is used. Sound and picture transmissions are horizontally polarized.

Unfortunately, Australian channels are not equivalent to ours. While practically all Australian picture and sound carriers fall somewhere inside an American channel, most are in such a position it would be difficult or impossible to bring them in without an exceptionally wide fine-tuning control. No doubt some enthusiasts will adjust their receivers to pick up one or more Aussie channels (particularly if local stations are in another part of the spectrum). The 5.5-mc separation between picture and sound would create further difficulties on intercarrier receivers—it is doubtful if the sound if's could be realigned so far off frequency.

There are at least five Australian TV stations on the air, a Government station ABM at Sydney (Australian channel 2, 63-70 mc, with picture carrier at 64.25 and sound at 69.75 mc) and another Government station expected to be on the air in January from Melbourne, also on channel 2 (Australian). Commercial stations TCN and ATN are broadcasting from Sydney from Australian channels 7 and 9 (pix 182.25, sound 187.75 and pix 196.25, sound 201.75 mc, respectively) and HSV from Melbourne (channel 7). GTV was also expected to start in Melbourne on channel 9 early in 1957.

END

IN GLAMOROUS NEW YORK CITY—ALL EXPENSES PAID PLUS \$100 CASH

# WIN A WEEKEND AT THE WALDORF FOR 2

## IN THE PYRAMID TWIST-MOUNT CAPACITOR CONTEST

TOTAL—147 WONDERFUL PRIZES—PLUS A PRIZE TO EVERY ENTRANT . . . SERVICEMEN, ENTER NOW! YOU CAN'T LOSE!

IT'S EASY TO WIN ANY ONE OF THESE WONDERFUL PRIZES:

**GRAND PRIZE:** Weekend at New York's fabulous Waldorf Astoria Hotel for 2, guest of Pyramid. Air transportation from your home to New York and return. Weekend of entertainment including a visit to the famous Gaslight Club, dinner at the Waldorf's Starlight Roof, and breakfast at the Waldorf. Air transportation CAPITAL Airlines Viscount.

**1st PRIZE:** One 4-drawer steel file cabinet plus your choice of 50 sets of PHOTOFACT folders. Value: \$120.45.

**FIVE 2nd PRIZES:** 5 CR-30 PRECISION Cathode Ray Tube Testers. dlr. net \$109 ea.

**TEN 3rd PRIZES:** 10 CRA-2 PYRAMID Capacitor-Resistor Analyzers. dlr. net \$92.50 ea.

**TWO 4th PRIZES:** 2 SW-54 NATIONAL Short Wave Receivers. dlr. net \$59.95 ea.

**TEN 5th PRIZES:** 10 JENSEN professional speaker units consisting of a D-30 lifetime driver unit and RT-20 rectangular horn. dlr. net \$44.40 per set.

**FIFTEEN 6th PRIZES:** 15 TW CHANNEL MASTER 7 element "traveling wave" TV antennas, Model 350. dlr. net \$33 ea.

**EIGHTEEN 7th PRIZES:** 18 PYRAMID Pyra-Pak kits consisting of \$69.95 in Pyramid capacitors, metal tool box and tool kit. dlr. net \$29.95.

**THIRTY-FIVE 8th PRIZES:** 35 PYRAMID gift certificates entitling you to \$10. (dlr. net) of Pyramid capacitors at your distributor.

**9th PRIZE:** WALCO twin-point diamond phono needle. dlr. net \$30. For G.E. Var. Rel. Cartridge.

**FIFTY 10th PRIZES:** 50 WALCO needles for G.E. twin-point sapphires. \$3.50 dlr. net.

AND to all entrants a kit of 5 bypass and coupling capacitors featuring the Pyramid type IMP.

It's easy to win any one of 147 big prizes—just follow these simple rules: Identify the unnamed Pyramid T-M capacitor in the TV set schematic appearing on this page. Give the Pyramid stock number, name and model number of TV set. Then mail your entry to Pyramid. Use coupon on this page or obtain additional blanks from your distributor. A different schematic will appear in these servicemen's magazines for 4 months. Prizes will be awarded on a points-earned basis as follows: 5 points for Contest No. 1; 10 points for Contest No. 2; 15 points for Contest No. 3; 20 points for Contest No. 4; and 10 points each contest for neatness. Possible perfect score: 90 points. However it is not necessary to achieve a perfect score to be declared a prize winner.

So act quickly...send in your entries early each month...you can't lose.

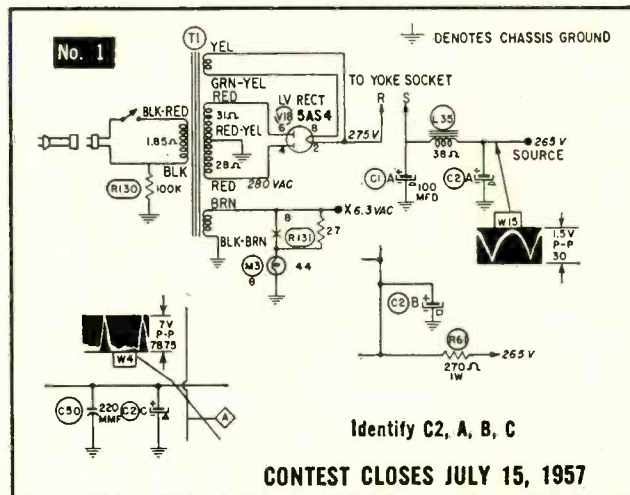

A PHOTOFACT STANDARD NOTATION SCHEMATIC © Howard W. Sams & Co., Inc.

**JUDGES:** M. Harvey Gernsback, editor director, Radio-Electronics  
 Oliver Read, Dsc, publisher, Radio & Television News  
 Howard W. Sams, Chmn. Board, Howard W. Sams, Inc.



**HELPFUL HINTS**

The unidentified capacitor in each entry will be a Pyramid Twist-Mount. All schematics are of TV sets made in the U. S. by a known manufacturer within the past 2 years.

Schematics for reference may be those published by the TV set manufacturers, Howard Sam's Photofacts, or by any other accepted publisher. You may enter as often as you like but be sure to include a box top (showing stock number) of any Pyramid Twist-Mount Capacitor, with your letterhead or business card with each entry.

**WHO MAY ENTER**

Any Radio-TV serviceman or employee of a Radio-TV service company may enter. Officers, employees, (members of their families) of Pyramid Electric Co. or its advertising agency are not eligible to enter the contest. All entries are limited to residents of the continental U. S. over 21 years of age.

All entries become the property of Pyramid Electric Co., none will be returned and the decisions of the judges are final. In case of ties, duplicate prizes will be awarded. This contest is subject to all federal, state and local laws and regulations.

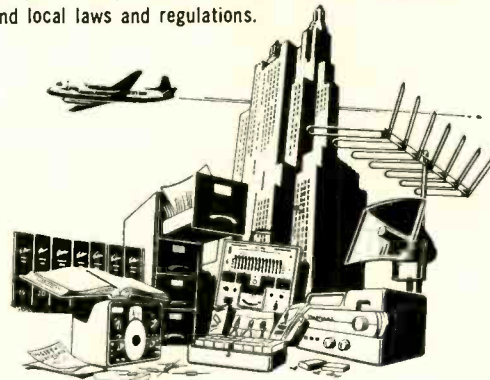

**MAIL THIS ENTRY BLANK NOW!**

Pyramid Twist-Mount Contest, Dept J  
 Pyramid Electric Co.  
 P.O. Box 635, Tyler Park Station, North Bergen, New Jersey

Entry No. (1) (2) (3) (4)—(check one)—is: Pyramid stock No. \_\_\_\_\_

Twist-Mount values \_\_\_\_\_

Set manufacturer's name \_\_\_\_\_ TV set model No. \_\_\_\_\_

I enclose a box top (indicating stock number) of any Pyramid Twist-Mount Capacitor together with my business card or letterhead or my employer's.

Contestant's name \_\_\_\_\_ Position \_\_\_\_\_

Contestant's address \_\_\_\_\_

City \_\_\_\_\_ Zone \_\_\_\_\_ State \_\_\_\_\_

Employer's Firm name \_\_\_\_\_

Employer's address \_\_\_\_\_

City \_\_\_\_\_ Zone \_\_\_\_\_ State \_\_\_\_\_

My jobber's name and address \_\_\_\_\_

**ENTER AS OFTEN AS YOU LIKE—FOR ADDITIONAL ENTRY BLANKS SEE YOUR JOBBER.**

Capacitors, Selenium Rectifiers—for original equipment, for replacement  
**PYRAMID ELECTRIC COMPANY** North Bergen, New Jersey

... another  
**MALLORY**  
 service-engineered  
 product



# Etched Cathode

stops  
 costly  
 "call-backs"

Some capacitors develop hum after a few weeks' service. The reason is loss of capacitance—caused by build-up of cathode oxide film.

This can't happen in Mallory FP capacitors . . . because they have *etched cathode* construction. Standard in all FP's and also in popular Mallory tubular electrolytics, etched cathode prevents gradual capacitance loss that can lead to annoying hum and costly call-backs. And you get this extra value in Mallory capacitors *without premium price*.

See your Mallory distributor for full facts about what etched cathode does for capacitors. It's another good reason why you're always sure of top performance when you use Mallory!

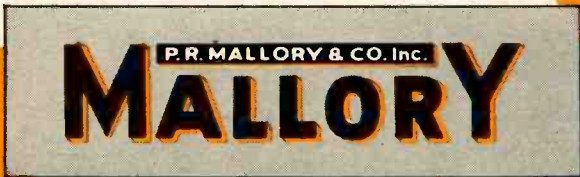

- Capacitors
- Vibrators
- Resistors
- Power Supplies
- Mercury and Zinc-Carbon Batteries
- Controls
- Switches
- Rectifiers
- Filters

## New Tubes & Semi-conductors

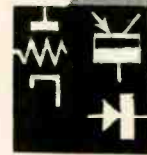

### KT88

A hi-fi power amplifier made by General Electric of England and designated the Genalex KT88, the beam-power tube may be used in pairs in either triode, pentode or Ultra-Linear push-pull circuits. Ultra-Linear operation is recommended when the maximum output coupled with lowest distortion is required.

In typical operation as a class-AB push-pull Ultra-Linear amplifier, the following operating conditions are suggested: plate voltage, 450; screen grid voltage, 450; plate (and screen) current, 100 ma (zero signal), 240 ma (maximum signal); control grid bias, 65 volts (fixed); power output, 65 watts; distortion, 3%.

The KT88 is capable of providing 100 watts output when operated in an Ultra-Linear circuit with a plate voltage of 560. It has a plate dissipation rating of 35 watts, with heater requirements of 6.3 volts at 1.8 amps. The base connections of the KT88 are the same as those of the KT66, and the electrical characteristics rather similar to those of the 6550.

The Genalex KT88 is distributed in the U. S. by British Industries Corp., Port Washington, N. Y.

### 6CQ8

A nine-pin miniature tube containing a medium- $\mu$  triode and a sharp-cutoff tetrode, the 6CQ8 is intended for both black-and-white and color TV receivers. Announced by RCA, the 6CQ8 is especially useful as a combined oscillator and mixer tube in tuners of TV receivers which have an if of approximately 40 mc. The triode unit is useful not only as a vhf oscillator but also as an rf amplifier, phase splitter, sync clipper and sync separator. The tetrode unit is also useful as a sound or video if amplifier.

Separate cathodes for each unit with individual base-pin terminals provide circuit flexibility, especially in applications requiring series connection for both units across a common plate supply, and an internal shield to prevent electrical coupling between the triode and the tetrode units. The 6CQ8 has a 450-ma heater for series-string applications. Base connections are the same as that of the 6U8.

### 1N573, 1N575, 1N581

A new line of germanium rectifiers specifically for use in television set power supplies has been announced by



G-E. According to G-E, the complete absence of aging effects in the germanium units allows full rated performance over the entire life of the rectifier. The 1N573, 1N575 and 1N581 feature an extremely low forward voltage drop, thus providing a high dc output.

The 1N573 (see photo) is a half-wave rectifier capable of 250-ma dc output. The 1N575 is also a half-wave rectifier but is designed for 350-ma dc output. Type 1N581 consists of two germanium rectifiers connected in a voltage-doubler arrangement and has a dc output rating of 250 ma.

The full-cycle average full-load voltage drop for the 1N573 is rated at a maximum of 0.15 volt; for the 1N575 0.30; for the 1N581 0.15 volt each section. The load capacitor for all three rectifiers is recommended to be in the range of 100 to 300  $\mu$ f. The maximum peak inverse voltage rating for the three rectifiers is 380. They are designed to be used with a 4-ohm surge resistor.

### 2N270

The 2N270 is an alloy-junction transistor of the germanium p-n-p type. It is intended particularly for large-signal audio-frequency applications such as in single- or double-ended power output stages and high-gain class-A driver stages of radio receivers and audio-frequency amplifiers.

In class-A amplifier service a single 2N270 can deliver a maximum-signal power output of approximately 60 mw with a power gain of 34 db. In class-B push-pull arrangement, two 2N270's can deliver a maximum-signal power output of approximately 500 mw with a power gain of 32 db. Audio amplifiers utilizing the 2N270 may be designed to provide the indicated power gains at low distortion and with high efficiency.

The 2N270 features stable characteristics and excellent uniformity of characteristics from unit to unit. In addition, the low collector saturation current permits the design of audio-frequency amplifiers which can operate under varying ambient temperature conditions and, at the same time, provide both high efficiency and a high degree of operating stability.

The current-transfer ratio of this transistor is nearly constant over the full range of the output-signal swing, even when the peak output-signal current reaches the peak collector current rating. This feature minimizes distortion at high power outputs when low supply voltages are employed.

The collector dissipation of the 2N270, depending on circuit conditions may be as high as 150 mw. Maximum ratings for the 2N270 as an af amplifier operating class A or class B: collector-to-base voltage -12 (dc, for inductive load), -25 (peak); collector current -75 ma (dc), -150 ma (peak); emitter current -75 ma (dc), -150 ma (peak). END

P. R. MALLORY & CO. Inc.  
**MALLORY**

...the battery line  
*designed for you*

in performance  
profit  
promotion



This year's news in batteries is the Mallory Battery Program!

It's more than "just another battery line." It's a brand new concept of battery performance, battery value and battery promotion—all rolled up in a program that produces growing sales for you *all year 'round*.

Get into the fast-growing transistor radio market for mercury batteries—pioneered by Mallory. They end your problems with shelf life... give your customers new standards of long life, constant power, economy. And for tube type portables, you can depend on the new full line of Mallory zinc-carbon batteries.

See your Mallory distributor today... and get full facts on the Mallory Battery Program!

P. R. MALLORY & CO. Inc.  
**MALLORY**

P. R. MALLORY & CO. Inc., INDIANAPOLIS 6, INDIANA

• Capacitors • Vibrators • Resistors • Power Supplies • Controls  
• Switches • Rectifiers • Filters • Mercury and Zinc-Carbon Batteries

# what kind of microphone do you need?



a hand-held microphone?

The Slendyne "535"

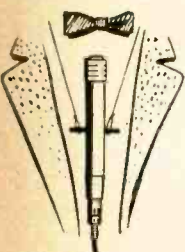

a lavalier microphone?

The Slendyne "535"

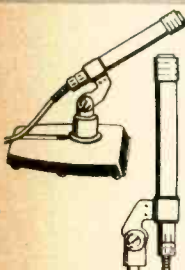

a desk or floor stand microphone?

The Slendyne "535"



a dual-impedance microphone?

The Slendyne "535"



a microphone with on-off switch?

The Slendyne "535"

• The Slendyne can be transferred from one application to another — in seconds — without disconnecting the cable.

The Slendyne "535" is an omnidirectional dynamic probe microphone with a frequency range of 60 to 13,000 cps.

It is a rugged unit, designed to provide fine-quality performance for years — without deviation from its original circuit standards.

List Price \$70.00

**SHURE** The Mark of Quality

SHURE BROTHERS, INC.

Microphones ~ Electronic Components

212 Hartrey Avenue • Evanston, Illinois

# Question Box



## MOBILE AMPLIFIER FOR TUNER

Can you supply a diagram for a power supply and amplifier for a Gonset model 3010 40-50-mc FM tuner and provide a microphone input so I can use the unit as a 6-10-watt mobile PA system? The unit is to operate from a 6-volt storage battery and supply the heaters and 150-180 volts at 15 ma for the tuner plates.—G. L. K., San Francisco, Calif.

Here is a diagram of an amplifier and power supply that should work nicely

high-impedance crystal or dynamic microphone with comparatively high output.

The vibrator supply is conventional. It should deliver 285 to 330 volts dc at 100 ma or more. The transformer may be a Triad V-7A, Thordarson 22R19 or equivalent. The buffer capacitor value is typical for this circuit but it should be adjusted for minimum drain on the battery.

If you plan the layout of components

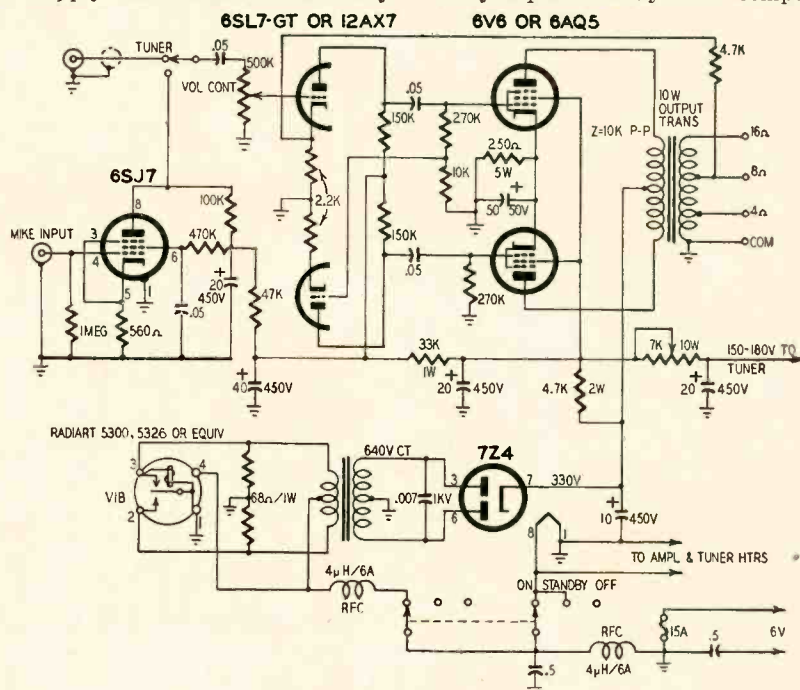

with the Gonset and similar communications tuners and can be adapted for use with some FM and AM broadcast tuners in mobile installations. The amplifier delivers approximately 10 watts output. The 6SJ7 microphone pre-amplifier should supply sufficient gain for full output when using almost any

on paper before beginning construction, you should not have any difficulty in building the unit to fit space available under the dash or in the glove compartment. Take care to shield the 6SJ7 and 6SL7-GT against the hum fields surrounding the vibrator and vibrator transformer.

## CAPACITOR CHECKER

In the article "Quick Capacitor Checker" in the January, 1953, issue, the author mentions installing a dpdt switch to turn off the checker and short the capacitor under test. Please show how I can hook up the six terminals on a dpdt slide switch that I want to use on the checker. As I see it, I need only four connections so a dpst switch would do.—C. H. C., Chicago, Ill.

To use a dpst switch, you would have to use a special type with one circuit open when the other is closed. It is much

simpler to use a dpdt switch connected as shown.

When checking paper, mica and ceramic capacitors, disconnect one side completely from its associated circuit and connect across the red and black test leads. A good capacitor causes the neon lamp to flash briefly on the initial charge. Intermittent or continuous flashing indicates leakage. A steady glow shows that the capacitor is shorted. The NE-2 will not glow or flash at all if the capacitor is open.



**FROM DELCO RADIO** come the **speakers** with highest performance. You trust them... so do your customers!

Engineering skills of Delco Radio and General Motors combine to offer a full line of speakers for home and auto radios, phonographs, TV, and Hi-Fi. National advertising behind the Delco Wonder Bar Radio develops a bigger service market for you! For fast service call your UMS-Delco Electronics Parts Distributor.

**14 Standard Models:** Designed and built to R.E.T.M.A. standards with heavily plated metal parts and Alnico-V magnets. Precision felted cones give uniform response over full operating frequency range. All are fully dustproof and dependable.

**Dual-Purpose Hi-Fi Model 8007:** A superior speaker for custom-built audio systems and for replacements in AM, FM, TV and phonograph sets. Size 8", 50 to 12,500 CPS frequency range; Alnico-V magnet; 10-watt power rating; 4.1 v.c. impedance; 1 3/16" voice coil.

**DELCO**



**RADIO**

DIVISION OF GENERAL MOTORS, KOKOMO, INDIANA



A GENERAL MOTORS PRODUCT—A UNITED MOTORS LINE  
Distributed by Delco Electronic Parts Distributors

A complete line of original equipment service parts from the  
**WORLD LEADER IN AUTO RADIO**

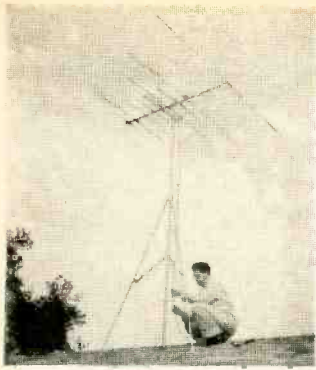

cut your roof time

90%

with

**Winegard**

**one-man, one-call TV Antennas!**

**ONE MAN**—Save hours you now spend on antenna installation. *One man* can install a WINEGARD TV Antenna in a matter of minutes. Only WINEGARD features "Umbrella-Ease" construction for ONE-MAN installation. Comes from the factory as a completely assembled *installation!* Just open like an umbrella! Most models anodized *after* assembly so *all* surfaces are corrosion and rust resistant. Gleaming gold color (exclusive with Winegard) complements the finest home... adds extra sales appeal.

**ONE CALL**—Don't spend valuable hours on return calls! Install a WINEGARD antenna—and be sure your customer's happy, the *first* time! "In-the-studio" clarity is assured with all these exclusive WINEGARD features: \*ALL-12-CHANNEL high gain performance—especially designed for COLOR! \*Optional POWER-PACK for signal-building boost on all channels! \*Patented ELECTRO LENS intensifies signal, increases gain.

and...

**ONE STANDARD OF WINEGARD QUALITY!**

The unmatched quality story of WINEGARD antennas is hitting hard at *your* customers in the pages of SATURDAY EVENING POST, FARM JOURNAL, BETTER HOMES AND GARDENS, HOUSE BEAUTIFUL, TOWN JOURNAL, SUNSET, TV GUIDE and other national magazines. And quality strengthens the selling story all across WINEGARD'S complete line of television antennas.

WINEGARD Complete Antenna Installations start as low as \$17.95. Ask your Parts Distributor for complete information or write:

 **Winegard**  
company

3000 Scotten Blvd., Burlington, Iowa



Colorceptor  
\$29.95 list

\*Pat. No. 2700105

NEW RECORDS

(Continued)

Except again for some overcutting, the overall sound is excellent and the recording should please.

Spotlight on Brass

Vox DL-300

This is the second of a series which will eventually cover all families of instruments. The recording is done close-up to approximate the sound of the instrument to the performer rather than to the listener. The harmonics are thus very prominent and the sound very brassy, the record presenting a far severer test of reproducing system capabilities—especially in the range between 1,000 and 10,000 cycles—than it would if recorded more remotely. On a fine, very flat system free of resonances, the brassiness will be free of unnatural stridency; but a rising response will result in stridency and peaks will be revealed in definite distortion. As recorded, the differences between the various instruments are very sharp and distinct. The record presents an exceptional test of tweeter coloration and of crossover distortion and multiple-speaker homogeneity. The difference in sound of metal and paper tweeter cones is quite plain, and a shift of tonal homogeneity as the range shifts from one speaker to another around the crossover points is also discernible. The recording is pressed directly off master stamper and the quality is exemplary.

Easy Listening Vol. 4

Audiophile AP-35

This might be subtitled "Spotlight on the Well-Tempered Percussives" for it presents fine examples of the piano, celeste, vibraharp, xylophone, chimes and marimba. The piano is not quite as unique in its naturalness as the one on AP-33 and 34, although this impression is possibly due only to the difference in the tone quality of the two pianos. The percussives are presented with a clarity and purity of tone which should delight any owner of a tweeter system capable of reproducing them with equal clarity and purity. The presence is typically Audiophile, which means that on a first-class single-channel speaker system with a wide sound-source effect it will bring the band right into the livingroom at least as vividly as the better stereo recordings. Besides piano and percussives there are excellent drums, a very fine double bass and some good guitar passages.

SCHUBERT: Overtures

Alfonso and Estrella

Rosamunde

Italian in C Major

Italian in D Major

Winograd and Philharmonia of Hamburg

MGM E-3362

A bright, well balanced recording with just live enough presence. Good drums and clean except for some distortion in several peaks.

BEETHOVEN: Sixth Symphony (Pastoral)

Munch conducting the Boston Symphony

RCA-Victor LM-1997

There are no tastes as finicky as those about the right interpretation of Beethoven. If you like your Pastoral played very romantically and sentimentally, this is *not* for you. Munch plays it a trifle dryly but, if that suits you as well as it suited me, you'll find this a beautifully defined version with a lovely sound which seems far more naturally pastoral than more opulent versions.

Seventh Symphony

Reiner conducting the Chicago Symphony

RCA-Victor LM-1991

Some like this performed in a pompous rather funeral pace. Reiner gives it a more sprightly and bright treatment. It suits me fine. The recording is first rate with a nice liveness and brightness, excellent definition, very clean strings and a lovely string bass.

Name and address of any manufacturer of records mentioned in this column may be obtained by writing Records, RADIO-ELECTRONICS, 154 West 14th St., New York 11, N.Y.



## MOVING?

If you're moving, please don't forget to send us your old address as it appears on the address label of your current copy of the magazine, including the numbers shown beside your name, as well as your new address. If we receive this information before the 20th of the month, you will continue getting the magazine without interruption. Your cooperation will be most helpful and greatly appreciated.

We, too, have a new address:

**Subscription Department**  
**RADIO-ELECTRONICS**  
154 West 14 St.  
New York 11, N.Y.

# NOW—you can master TV

## THIS EASY WAY!

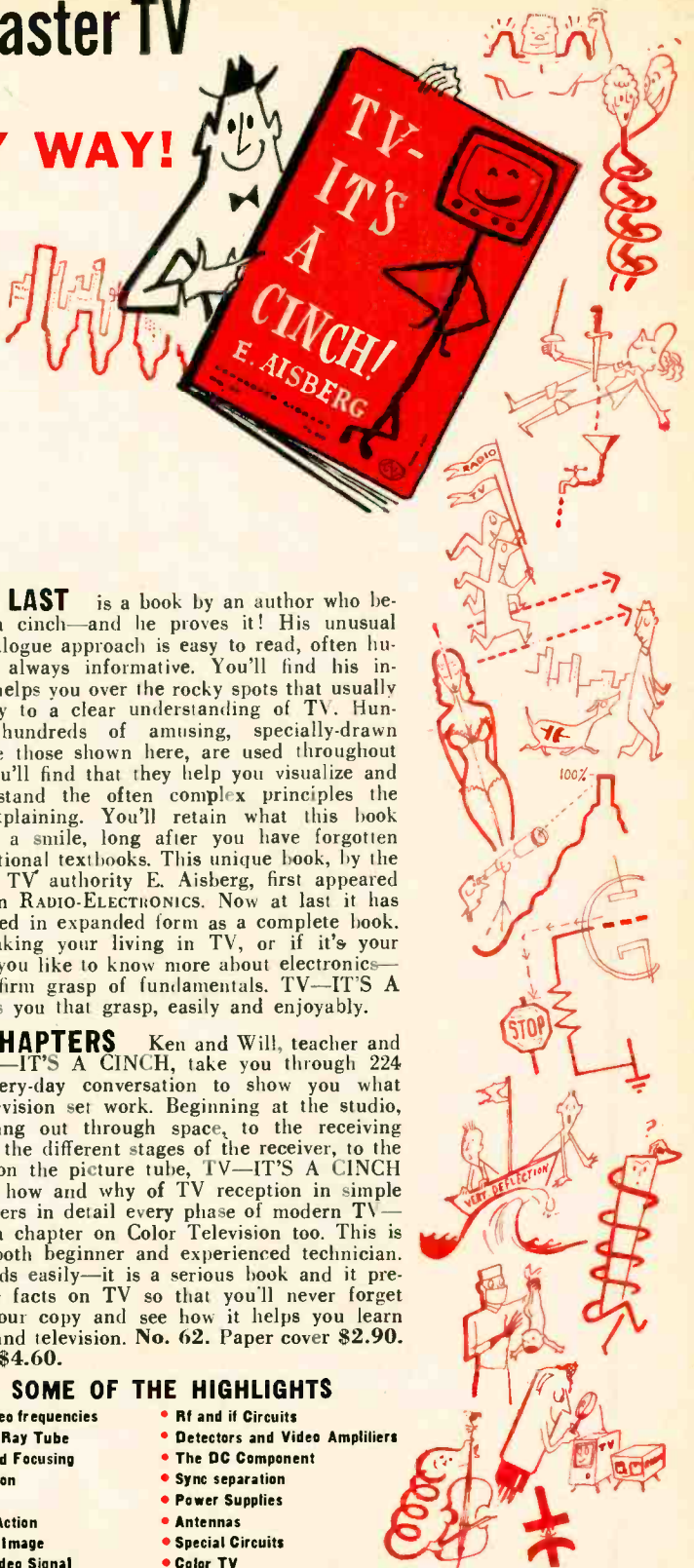
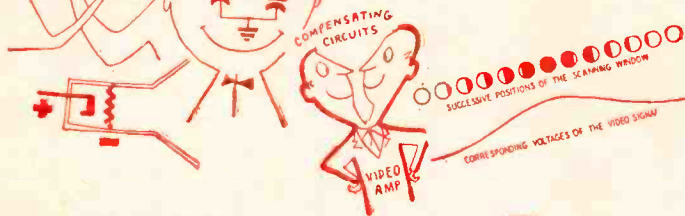

### HAVE YOU READ THESE OTHER GERNSBACK BOOKS?

#### SERVICING AND TEST INSTRUMENTS

- #60—**Rapid TV Repair**—Handiest, most practical servicing manual yet written! Lists hundreds of tough TV troubles alphabetically. Cross referenced where necessary. Will help you cut down trouble shooting time, earn more money. 224 pages. Thoroughly illustrated. Paper cover \$2.90. Hard cover \$4.60.
- #59—**Servicing Record Changers**—Simple text, clear line illustrations show you how to make extra money servicing changers. 224 pages. Paper cover \$2.90. Hard cover \$4.60.
- #57—**The V.T.V.M.**—Get better results with this necessary instrument. Explains many new uses. 224 pages. Paper cover \$2.50. Hard cover \$4.60.
- #55—**Sweep and Marker Generators for Television and Radio**—Bob Middleton shows you how to align sets faster and more accurately. 224 pages. Paper cover \$2.50. Hard cover \$4.60.
- #54—**Probes**—Inside tips on how to increase your test equipment's utility with special probes. 224 pages. Paper cover \$2.50. Hard cover \$4.60.
- #52—**The Oscilloscope**—Practical hints on how to use the scope for faster servicing. 192 pages. Paper cover \$2.25. Hard cover \$4.60.
- #50—**TV Repair Techniques**—Hints by experts on how to solve tough TV troubles. 128 pages. Paper cover only \$1.50.
- #49—**Radio & TV Test Instruments**—How to build 22 test instruments for modern servicing. 128 pages. Paper cover only \$1.50.
- #46—**Television Technotes**—Causes, symptoms and cures of over 600 specific troubles. 128 pages. Paper cover only \$1.50.

#### AUDIO—HIGH FIDELITY

- #66—**Basic Audio Course**—A thorough course in fundamentals. Covers everything from the nature of sound to recording techniques. 224 pages. Paper cover \$2.75. Hard cover \$5.00.
- #58—**Maintaining Hi-Fi Equipment**—Hi-Fi expert Joseph Marshall describes the specialized approach needed to service hi-fi equipment. Covers acoustic as well as electronic troubles. 224 pages. Paper cover \$2.90. Hard cover \$5.00.
- #56—**High-Fidelity Circuit Design**—Includes the famous Cooper series on feedback which appeared originally in RADIO-ELECTRONICS, plus much additional new material. 304 pages. Hard cover only \$5.95.
- #48—**High-Fidelity—Design, Construction, Measurements**—Three-way approach to better hi-fi performance. Complete section on building amplifiers. 128 pages. Paper cover only \$1.50.

#### TRANSISTORS

- #61—**Transistor Techniques**—New low cost handbook on transistors for the practical man. Gives scores of hints on how to use transistors in modern electronic equipment. Covers testing, performance, construction, care and measurements. 96 pages. Paper cover only \$1.50.
- #51—**Transistors—Theory and Practice**—Rufus P. Turner's book remains one of the finest and most popular ever written on transistors. Covers theory, characteristics, tests, uses in well-known circuits, plus a guide to commercial transistors. 114 pages. Paper cover only \$2.00.

#### RADIO CONTROL—FUNDAMENTALS—MISCELLANEOUS

- #53—**Radio-Control Handbook**—How-to-do-it book on constructing complete systems as well as components. 192 pages. Paper cover only \$2.25.
- #43—**Model Control By Radio**—Covers theory and practice for both beginner and expert. 112 pages. Paper cover only \$1.00.
- #47—**Radio & TV Hints**—300 hints, gimmicks, short cuts on radio, TV, hi-fi, ham radio and other phases of electronics. 112 pages. Paper cover only \$1.00.
- #44—**Basic Radio Course**—John T. Frye's easy-reading classic on fundamentals covers everything from Ohm's law to advanced servicing techniques. A must for the practical man who's weak on theory. 176 pages. Hard cover only \$2.25.
- #45—**Radio Tube Fundamentals**—How and why tubes work as they do in modern circuits. 96 pages. Paper cover only \$1.00.

**HERE AT LAST** is a book by an author who believes TV's a cinch—and he proves it! His unusual colloquial dialogue approach is easy to read, often humorous, and always informative. You'll find his informal style helps you over the rocky spots that usually close the way to a clear understanding of TV. Hundreds and hundreds of amusing, specially-drawn sketches, like those shown here, are used throughout the book. You'll find that they help you visualize and easily understand the often complex principles the author is explaining. You'll retain what this book teaches with a smile, long after you have forgotten many conventional textbooks. This unique book, by the international TV authority E. Aisberg, first appeared as a series in RADIO-ELECTRONICS. Now at last it has been published in expanded form as a complete book. If you're making your living in TV, or if it's your hobby, or if you like to know more about electronics—you need a firm grasp of fundamentals. TV—IT'S A CINCH gives you that grasp, easily and enjoyably.

**17 BIG CHAPTERS** Ken and Will, teacher and pupil in TV—IT'S A CINCH, take you through 224 pages of every-day conversation to show you what makes a television set work. Beginning at the studio, and continuing out through space, to the receiving antenna and the different stages of the receiver, to the final image on the picture tube, TV—IT'S A CINCH explains the how and why of TV reception in simple terms. It covers in detail every phase of modern TV—yes, there's a chapter on Color Television too. This is a book for both beginner and experienced technician. While it reads easily—it is a serious book and it presents all the facts on TV so that you'll never forget them. Get your copy and see how it helps you learn and understand television. No. 62. Paper cover \$2.90. Hard cover \$4.60.

#### HERE ARE SOME OF THE HIGHLIGHTS

- V.h.f. and video frequencies
- The Cathode Ray Tube
- Deflection and Focusing
- Synchronization
- Time Bases
- Sawteeth in Action
- The Electron Image
- Composite Video Signal
- Rf and if Circuits
- Detectors and Video Amplifiers
- The DC Component
- Sync separation
- Power Supplies
- Antennas
- Special Circuits
- Color TV

**GERNSBACK LIBRARY, 154 West 14th St., New York City**

- |   |   |
|---|---|
| <input type="checkbox"/> 62 TV—It's a Cinch   | <input type="checkbox"/> 42 <input type="checkbox"/> 43 <input type="checkbox"/> 44 <input type="checkbox"/> 45 <input type="checkbox"/> 46 |
| <input type="checkbox"/> 47 <input type="checkbox"/> 48 <input type="checkbox"/> 49 <input type="checkbox"/> 50 | <input type="checkbox"/> 51 <input type="checkbox"/> 52 <input type="checkbox"/> 53 <input type="checkbox"/> 54                             |
| <input type="checkbox"/> 55 <input type="checkbox"/> 56 <input type="checkbox"/> 57 <input type="checkbox"/> 58 | <input type="checkbox"/> 59 <input type="checkbox"/> 60 <input type="checkbox"/> 61 <input type="checkbox"/> 66                             |

Hard cover editions  
(By mail only)

- |  |
|--|
| <input type="checkbox"/> 52H <input type="checkbox"/> 54H <input type="checkbox"/> 55H |
| <input type="checkbox"/> 57H <input type="checkbox"/> 58H <input type="checkbox"/> 59H |
| <input type="checkbox"/> 60H <input type="checkbox"/> 62H <input type="checkbox"/> 66H |

See your distributor—or use this coupon.

Enclosed is my remittance of \$.....  
Please send me the books checked, postpaid.  
Prices 10% higher in Canada.

Name ..... please print

Street .....

City..... State.....

**FREE!**  
FOR THE  
ASKING

the **NEW**  
**INDISPENSABLE**  
**1957**  
**STANCOR**  
TV  
**TRANSFORMER**  
**REPLACEMENT**  
**GUIDE**

JUST RELEASED: 8 new exact replacement flybacks for Raytheon, G.E., RCA, Sentinel, Philco, and Admiral



to every  
serviceman



The most complete, up-to-date TV transformer replacement guide published:

- 72 pages of valuable information
- Easy-to-read, easy-to-find listings, indexed alphabetically by manufacturer, model and chassis numbers
- Easy-to-find exact replacement flyback listing of manufacturer and manufacturer's part number
- Schematic diagrams of all flybacks
- Complete specifications on 260 Stancor TV transformers and related components

Get the new Stancor Replacement Guide from your Stancor distributor or by writing to Chicago Standard . . . NOW!

**CHICAGO STANDARD TRANSFORMER CORPORATION**  
3509 ADDISON STREET • CHICAGO 18, ILLINOIS

EXPORT SALES: Roburn Agencies, Inc., 431 Greenwich St., New York 13, N.Y.



**MORSE CODE**

Learn Morse Code—FAST  
by SOUND with

**UNCLE SAM'S RECORDING**

Code signals are transmitted at SLOW speed to allow you time to DUPLICATE them in DIDAH language or whatever instrument you have to work with . . . also at FAST speed so that you will be FAMILIAR with how they SOUND when you hear them on the air.

Send ONLY \$1.25 for your 7 inch 45 RPM Record  
Dealer and Jobber Inquiries Invited!

**UNCLE SAM RECORDINGS** Dept. B-3  
59 E. VanBuren St. Chicago 5, Illinois

ALWAYS  
READY

TO HELP YOU  
TO TEST YOU  
TO TEACH YOU

GIVES YOU  
MESSAGES TO  
DECODE

Give to the

**RED CROSS**

**INVENTORS**

Send for  
**PATENT INFORMATION**  
Book and  
**INVENTORS RECORD**  
without obligation

**GUSTAVE MILLER**  
37-RE WARNER BUILDING  
WASHINGTON 4, D. C.

**REGISTERED PATENT**  
**ATTORNEY**

**ASSOCIATE EXAMINER**  
U.S. PAT. OFF. 1922-1929

Patent Attorney & Advisor  
U.S. Navy Dept. 1930-1947  
**PATENT LAWYER**

**Technotes**



**PHILCO RF CHASSIS 97**

This set had very weak sound on the strongest stations with a negative picture and some smearing. The trouble was due to high resistance leakage in the capacitor (1,500  $\mu$ f) coupling the first sound if to the video detector—first video amplifier. The leakage upset the grid bias on both the first sound if and the first video if, producing the symptoms in both sound and picture simultaneously.—John P. Anderson

**SOLDER FLUX REMNANTS  
CAUSE LOW OUTPUT  
AND OSCILLATOR DRIFT**

The turret tuner strip shown in the picture was removed after the third visit by a service technician on the same complaint—weak signal on this channel and drift which could be corrected by readjusting the fine-tuning control.

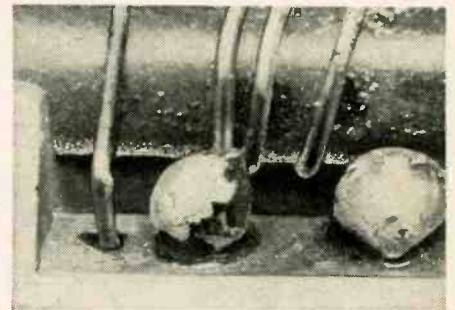

Examination of this coil strip at the shop disclosed that solder flux remnants had leaked around the coil collecting the dirt visible in the photo, and caused the darkened areas near the coil terminals. The excess flux and dirt were removed with a rag moistened in naphtha. The coil was given a light coating of lacquer after drying. It was installed in another set and worked nicely.—A. R. Clawson

**THE TINFOIL PATCH**

This complaint was black-and-white reception only on an early 15-inch Raytheon color receiver. Tube replacement in the chrominance channels failed to restore color reception. The response of the black-and-white picture when the fine tuning control was mis-adjusted seemed to indicate that the chrominance section was working, and it was suspected that the color sync was at fault.

Fortunately, before digging into the color sync system, a color bar signal was applied to the receiver from a

## TECH NOTES

(Continued)

generator and the color bars were re-produced, although a check could not be made on the usual channel since the generator was fixed-tuned. This meant that either the front end was defective or the antenna was unsuitable for color reception.

Then we spotted a patch of tinfoil on the lead-in, near the wall. A quick check showed that, when the tinfoil was slid along the lead-in or removed completely, the color sync was OK and satisfactory color pictures were obtained. It was found that the same lead-in was also used occasionally on a black-and-white receiver and that the tinfoil patch had been placed to build up contrast for reception of a weak station. As it worked out, the best location of the patch for the monochrome station was poor for the color burst signal and knocked the burst down so far that the color sync failed to lock in.—R. M. Centerville

### BENDIX T19 CHASSIS

Service data for this chassis was published prior to a production change which added an adjacent-channel trap in the grid circuit of the first if amplifier tube. Subsequent schematics have indicated this change. However, there has been no notice bringing this to the attention of service technicians nor has alignment data for this trap been given.

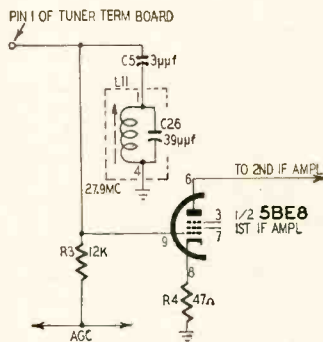

To align this adjacent-channel trap (see diagram) set the signal generator to 27.9 mc and connect a vtvm between the video detector test point and ground. Then adjust coil L11 for minimum response on the meter.—Bendix Television & Radio Service News Letter

### VIDEO DETECTOR CRYSTAL

Whenever the video detector crystal in the RA-340/341 and 342/343 Du Mont chassis is suspected of faulty operation, check it by substitution. This method is recommended because front-to-back resistance measurements of a crystal have little value in determining whether it will operate properly in a video detector stage.

Always check the alignment of the last video if transformer when a crystal substitution is made because the new crystal will probably have a different loading effect on the transformer.—Du Mont Service News **END**

MARCH, 1957

# CENTURY TV TEST EQUIPMENT

• SAVES VALUABLE TIME  
• INCREASES YOUR PROFITS  
• MAKES TV SERVICING EASIER

### SPEAKER SUBSTITUTER

NOW you can pull the chassis and leave the speaker in the cabinet. No more mounting and dismounting... Special speaker connector plugs for RCA, Dumont, Admiral... Also a Signal Tracer and Voltage Checker... \$22.50 net



Model SS-1

Here are test instruments developed and produced by CENTURY to meet your every day service call needs... Brilliantly designed to save your valuable time and make extra dollars for you... Down to earth prices and rugged, durable quality are your assurance of the greatest value in test equipment.

---

### CRT TESTER-REJUVENATOR

Built in power supply enables you to test and repair all picture tubes in or out of set... Check cathode emission... short and open elements. Estimate remaining life of tube... clear inter-element shorts and leakage... restore emission. \$19.95 net



Model CRT-1

### ANTENNA LINE TESTER

The only instrument designed to check twin-lead antenna lines with open end antennas for breaks, where a continuity test is not possible. Tests from inside the house whether antenna line is at fault—and locates break even under insulation. \$19.95 net



Model ALT-1

NOW CENTURY INTRODUCES AN ECONOMY LINE  
at sensationally low prices

### TRANSISTOR CHECK

This new amazingly low priced instrument combines with your VOM to make an accurate and dependable transistor tester. The TC-1 tests all transistors in or out of the set for current gain... leakage... open... short. Checks all crystal diodes for forward to backward gain... Equipped with test leads that enable the serviceman to leave transistor in circuit while checking. \$6.95 net



Model TC-1

### REJUVA CHECK

The lowest price picture tube test and repair instrument available. Fits snugly in your tube caddy, ready to test, repair and rejuvenate any CRT right in the set. The ingenious RJC-1 powered by TV chassis checks cathode emission—shorts and open elements... Clears inter-element shorts and leakage. Restores emission... No other equipment needed to do the job... \$7.95 net



Model RJC-1

## Century Electronics Co., Inc.

111 ROOSEVELT AVE., MINEOLA, N. Y.

FREE! COMIC AD CARD KIT

FREE CATALOG TOO!—shows our complete line of TV Service Reports, Call Books, Phone Message Books, Job Tickets, Service Pricing Guide, File Systems, Service Contracts, Parts Warranties, P. O. Forms, Statement Books, Label Books, Sketch Pads, Cash Books, etc. See them at your parts jobber. **WRITE NOW!**

Oelrich Publications 4308 Milwaukee Ave. Chicago 41, Illinois

## TAPE RECORDERS

Tapes—Accessories  
Nationally Advertised Brands  
**UNUSUAL VALUES**  
Send for Free Catalog  
**DRESSER**  
69-02 RE: 174 St.  
Flushing 65, N. Y.

MERITAPE

Low Cost. High Quality Record. in a Tape—in boxes or cans.

## EASY TO LEARN CODE

It is easy to learn or increase speed with an Instructograph Code Teacher. Affords the quickest and most practical method yet developed. For beginners or advanced students. Available tapes from beginner's alphabet to typical messages on all subjects. Speed range 5 to 40 WPM. Always ready—no QRM.

ENDORSED BY THOUSANDS!

The Instructograph Code Teacher literally takes the place of an operator-instructor and enables anyone to learn and master code without further assistance. Thousands of successful operators have "acquired the code" with the Instructograph System. Write today for convenient rental and purchase plans.



INSTRUCTOGRAPH COMPANY

4701 Sheridan Rd., Dept. RC, Chicago 40, Ill.

*Your* **ERIE** Distributor Has  
**"PAC"** Replacement  
 Modules

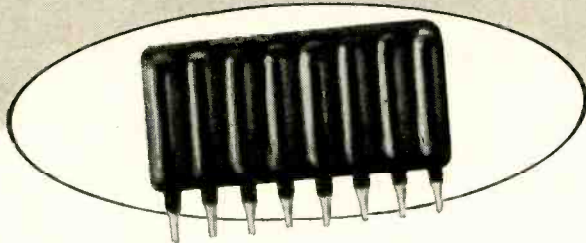

## for Servicing 1957 Auto Radios

PAC is a group of interconnected capacitors and resistors, combined in a single-insertion unit. Several popular 1957 model automobile and truck radios employ this new concept in component packaging. When servicing these auto radios, a complete PAC (Pre Assembled Circuit) module can be quickly and easily replaced.

Your **ERIE** Distributor has PAC Replacement Modules in stock. See him for complete information and prices.

**ERIE** ELECTRONICS DISTRIBUTOR DIVISION  
 ERIE RESISTOR CORPORATION  
 Main Offices: ERIE, PA.  
 Factories: ERIE, PA. • LONDON, ENGLAND • TRENTON, ONTARIO

## radio-electronic Circuits

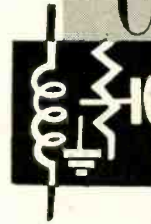

### PROTECTING SELENIUM RECTIFIERS

The common conception of the waveform of ac line voltage is the clean, smoothly recurrent sine curve given in the textbooks. In many instances, however—especially in industrial areas—this is not entirely the case. Voltage spikes, or transients as they are called, may be impressed on the line from a variety of sources including anything from heavy industrial machines to lightning. Lightning causes transients, not necessarily as a result of actually striking the line but most often because of the voltage induced on the line when a lightning discharge occurs.

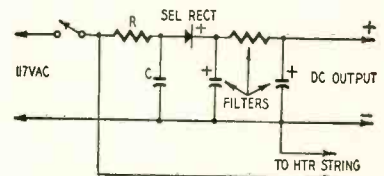

While line-voltage transients are not often easy to detect, a spike of sufficient amplitude can puncture a selenium rectifier or an electrolytic capacitor. Damage is most likely to result when a transformerless type power supply is used. Merely interposing a power transformer between the power line and the rectifier will not necessarily guarantee freedom from this type of trouble, however.

In general, it is simple and inexpensive to protect a transformerless power supply against possible damage from line transients. The short duration and the rapid rise-and-fall time of these voltage spikes give them much the same characteristics as a single alternation of a high-frequency signal. A 600- to 1,000-volt paper capacitor of .02 to .05  $\mu$ f is a very effective shunt at high frequencies while it has little bypassing ability at 60 cycles. A satisfactory method of shunting line transients is shown in the schematic diagram. A capacitor C of the aforementioned capacitance has been connected across the input to the power supply, and the surge-control resistor R, is inserted in the line at the input side of the rectifier. The resistor is in series with the selenium rectifier so it will protect it against current surges equally well on either side, but connecting it on the input side between C and the power line enables capacitor C to do a slightly better job of eliminating transients. This R-C combination will also help

GET INTO ONE OF THESE  
 TOP OPPORTUNITY FIELDS

# ELECTRICITY

— Electronics or  
**TELEVISION**

— Radio-Color TV

TRAIN IN THE GREAT SHOPS OF

# COYNE

OLDEST, BEST EQUIPPED  
 SCHOOL OF ITS KIND IN U. S.

Veterans and Non-Veterans—Prepare for a better job NOW that offers a real future, too! Get practical training in TELEVISION—RADIO—ELECTRICITY—ELECTRONICS—(Refrigeration & Electric Appliance Repair can be included). Learn on real equipment—no advanced education or previous experience needed. Lifetime employment service to graduates.

Finance Plan—enroll now, pay most of tuition later. Part time employment help to students.

**FREE BOOK** Clip coupon for Big Free Illustrated Book. No salesman will call. Act NOW.

B. W. COOKE, President

# COYNE

FOUNDED 1899  
**ELECTRICAL SCHOOL**

A TECHNICAL TRADE INSTITUTE OPERATED NOT FOR PROFIT  
 500 S. PAULINA ST., CHICAGO, DEPT. 37-81H  
 ELECTRICITY • TELEVISION • RADIO • REFRIGERATION • ELECTRONICS

B. W. COOKE, Pres., COYNE ELECTRICAL School  
 500 S. Paulina St., Chicago 12, Ill., Dept. 37-81H

Send FREE BOOK and details on:

- TELEVISION-RADIO
- ELECTRICITY-ELECTRONICS

NAME.....

ADDRESS.....

CITY..... STATE.....

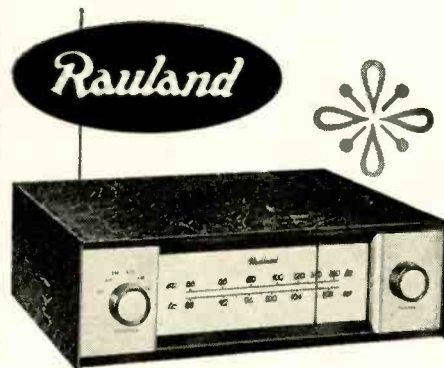

## "Golden Series" HI-FI

The "GOLDEN GATE" AM-FM Tuner...with an FM sensitivity of 3 microvolts for 20 db of quieting—and a host of other remarkable features...

one of a complete line of advanced design high fidelity tuners, amplifiers and components...

hear these quality RAULAND units at your Hi-Fi dealer or write for details...

**RAULAND-BORG CORPORATION**  
 3515 W. Addison St., Dept. A, Chicago 18, Ill.



protect the rectifier from rf energy radiated to the power line by amateur transmitters, dielectric heating equipment, diathermy machines, etc. In stubborn cases, an rf choke connected in series with resistor R will be most helpful. The choke should be rated to carry the normal current requirements of the power supply.—*Frank H. Tooker*

**QUIETING RELAYS**

Relays tend to chatter at their pull-in and dropout points when used alone in a tube's plate or cathode circuit. The trouble is particularly prevalent on thyatron circuits with an ac plate supply.

The most common solution to the problem is to shunt the relay coil with a capacitor as in Fig. 1. An electrolytic

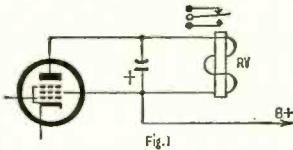

Fig. 1

is required with an ac supply. Its value is relatively critical and is best found by experiment. About 20  $\mu$ f is suitable for a 5,000-ohm coil while less capacitance is needed for a coil of lower resistance or impedance. The capacitor's voltage rating should exceed the peak value of the voltage in the circuit or 1.4 times the rated rms value.

The capacitance required in a hard-tube circuit such as a 6V6, 25L6, etc. in relay duty is much smaller than required for an ac-supplied thyatron. Here a paper capacitor of around 0.1 to 0.5  $\mu$ f is usually satisfactory. A value of 0.25  $\mu$ f will be about correct for a 5,000-ohm relay coil.

A diode rectifier can be used in place of the capacitor or shunted across it as in Fig. 2. The capacitor can be omitted or replaced by one of a much

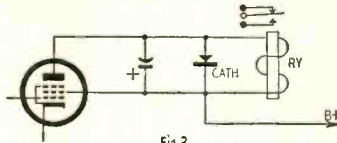

Fig. 2

smaller value. The diode can be a selenium type with a 50-65-ma current rating for an ac-supplied thyatron circuit.

If a hard tube is used, a general-purpose germanium diode like the 1N64 is ample to handle the inductive kick. With a rectifier, the action of the relay is far sharper and cleaner than with a capacitor.

In either circuit, the capacitor value is critical when the relay's dropout time is important. Larger values make the relay hold in longer after the tube cuts off. Too much capacitance may even make the relay chatter in the vicinity of the dropout current point.

—*James A. McRoberts*

**BEST BUY IN HI-FI**

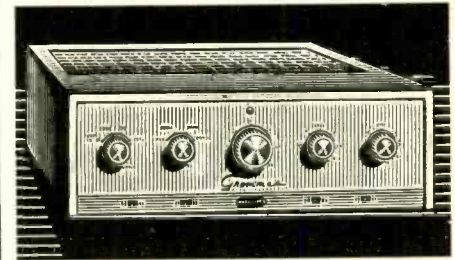

**10PG 10 Watt Hi-Fi Amplifier**

Here is new styling with a full set of controls providing exceptional flexibility in a moderately priced amplifier. Simple efficient flat compact design features modern feedback circuitry, record compensator, loudness control, wide range bass and treble controls, rumble and scratch filters, and six inputs, including one for tape head. Frequency Response:  $\pm 0.5$  DB. 20 to 20,000 CPS. Distortion: 2% harmonic and 3% intermodulation at 10 watts. Cabinet Charcoal Gray and Brass.

Net Price to user..... **62.50**

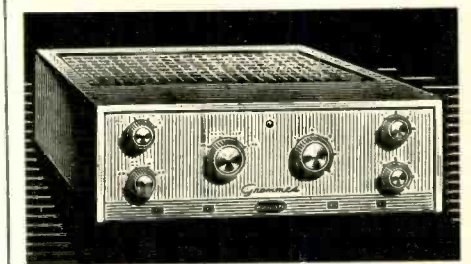

**15PG 12 Watt Hi-Fi Amplifier**

The best buy in the medium priced field. The all new deluxe 15PG features the most advanced circuitry, the highest quality components and greater flexibility of controls. It provides feedback throughout, separate turn-over and roll-off record compensators, new loudness control, wide range bass and treble controls, rumble and scratch filters, and six inputs including tape head. Frequency Response:  $\pm 0.5$  DB. 20 to 30,000 CPS. Distortion: 1% harmonic and 2% intermodulation at 12 watts. Cabinet in charcoal gray with brushed brass trim and front panel.

Net Price to user..... **72.50**

**20PG 20 Watt High Fidelity Amplifier**

An all new amplifier with all the new features of the deluxe 15PG plus higher power in the output stage. Frequency Response:  $\pm 0.5$  DB. 15 to 30,000 CPS. Distortion: 1% harmonic and 2% intermodulation at 20 watts.

Net Price to user..... **89.50**

See the "Best Buy in Hi-Fi" at your High Fidelity Dealer or write

**Grommes**

Division of Precision Electronics, Inc.  
Dept. RE-3, 9101 King Street,  
Franklin Park, Illinois

Send Free Hi-Fi Equipment Brochure.

Name .....

Street .....

City.....Zone.....State.....

**RADIO - ELECTRONICS**  
TELEVISION • SERVICING • HIGH FIDELITY

Build This Upside-Down Amplifier

"... the only solution is to use one of the new wide-range crystal pick-ups. I selected the Ronette To-284-P which combines the virtues of smooth frequency with extremely low intermodulation Distortion. ... the response curve of the Ronette shows a very gentle rise to about 5 Kc and then a gradual slope to about 10 Kc. ... Output voltage from the Ronette cartridge is enough to drive the amplifier without the preamplifier stage..."



*George L. Augspurger, November 1956 Issue*

Your distributor has a complete line of Ronette cartridges and microphones.

See him today.

**Ronette Acoustical Corp.**  
190 Earle Avenue, Lynbrook, N. Y.



**FIX OLD RADIOS IN A JIFFY!**

Fix 'em good as new... without lost time or needless testing

Often, it takes more time than it's worth to fix old radios... but NOT when you own this 3 1/2-pound, 744-page RADIO TROUBLESHOOTER'S HANDBOOK! Just look up the old make and model. Handbook tells exactly what is likely to be wrong—shows exactly how to fix it. No wasted time. No needless testing. Gives common trouble symptoms for over 4,800 old home receiver models, auto radios and record changers by 202 manufacturers. Includes hundreds of pages of old tube and component data no longer available from any other source.

**CUT SERVICE TIME IN HALF!**

Even beginners can repair old sets which might otherwise be thrown away because service data is lacking! Handbook more than pays for itself first time you use it! Covers old sets made by Airline, Apex, Arvin, Atwater Kent, Belmont, Bosh, Brunswick, Clarion, Crosley, Emerson, Fada, G-E, Kolster, Majestic, Motorola, Philco, Pilot, RCA, Silvertone, Sparton, Stromberg and dozens more. The only service guide of its kind.

**10 DAY FREE EXAMINATION**

Dept. RE-37, RINEHART & CO., Inc.  
232 Madison Avenue, New York 16, N. Y.

Send RADIO TROUBLESHOOTER'S HANDBOOK for 10-day examination. If I decide to keep book, I will then send \$6.95 plus postage. Otherwise, I will return book promptly and owe you nothing. (SAVE! Send \$6.95 with order and we pay postage. Same 10-day return privilege with money refunded.)

Name .....

Address .....

City, Zone, State .....

OUTSIDE U.S.A.—Price \$7.50 cash with order only. Money back if you return book in 10 days.

# ARKAY Kits... lead the field

New!

## ANOTHER ARKAY WINNER!!

**SPECIFICATIONS:**  
**POWER**—30 watts @ 1% IM.  
**FREQ. RESPONSE**  $\pm 1/2$  db.—10-50,000 cps.  
**HUM**—120 db. below rated output (Actually zero)  
**CONTROLS**—(6) Func. selector, loudness, bass, treble, level set, 5-position level compensation control.  
 • 2 EL-34/6CA7 Super-Lin. Williamson  
 • Special output for simultaneous tape recording and monitoring.



**KIT**  
**\$49.95**  
 Wired & tested \$74.95

## ARKAY Model FL-30 Hi-Fi AMP-PRE-AMP

Featuring a transistorized front end for use with a reluctance pick-up, this engineering masterpiece assures the finest in HI-FI reproduction. Record equalization for more than 30 labels (LP, RIAA, & EUR). Complete with rose gold panel and black cabinet.



### ARKAY Model FL-10 Hi-Fi Amplifier

A super lin. Williamson 12-watt Hi-Fi amplifier with built-in pre-amp, 18 watt peak with a frequency response of 20-40,000 cps. 4 controls including record equalization (LP, RIAA, EUR). Output impedances, 4, 8, & 16 ohms. Special output for simultaneous tape recording and monitoring. **\$28.95**  
 Wired & tested \$43.95.

### Another ARKAY First

**SPECIFICATIONS:**  
**ELECTRICAL RATING**—9 volt transistor energizer  
**OPERATING FREQUENCIES**  
**TUNING RANGE**—540 to 1620 KC  
**I.F. AMPLIFIER**—455 KC  
**POWER OUTPUT**—275+ milliwatts  
**SPEAKER**—large alnico V permanent magnet  
**TRANSISTOR COMPLEMENT**  
 X1 oscillator-converter  
 X2 1st I.F. amplifier  
 X3 2nd I.F. amplifier  
 D1 diode detector—AGC takeoff  
 X4 class B driver  
 X5 class B output  
 X6 class B output

**\$37.50**

Federal Excise Tax Included

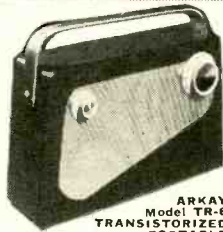

**ARKAY Model TR-6 Transistorized Portable Superhet Receiver**

The model TR-6 is a newly designed all transistor portable superhet receiver, push-pull Class B output providing clear crisp output better than 275 milliwatts. Construction is extremely simple because of the advanced engineering techniques employed in its design.



### ARKAY Model HFT-7 Hi-Fi AM-FM Tuner

4 UV sensitivity for 20 db quieting. Automatic frequency control with provisions for AFC erase. Allows pinpoint, high selectivity tuning. Foster-Seeley discriminator, high efficiency AM loop stick antenna and temperature compensated oscillator circuit. **New!**  
**Wired & Tested \$49.95**

Kit Less Cover \$32.00  
 Cover for Above \$3.95  
**FM only—\$25.75**  
 Fed. Ex. Tax Incl.



### ARKAY Model B-8 Hi-Fi Speaker System

Frequency Response: 10 to 20,000 cps. Cross-over Frequency: 1600 cps. Power Rating: 25 watts. Impedance 16 ohms. Features a bass reflex, ducted port enclosure with a low frequency speaker and a compression driven horn of special design. A variable balance control w/network provides smooth continuous adjustment of the H/F speaker. **\$35.95**  
 Fed. Ex. Tax Incl.



### ARKAY Model 14T21 NEW! TV KIT

Very latest design used in sync. circuits results in excellent stability with extremely low noise characteristics. A. G. C. circuit results in maximum sync. hold characteristics. The only vertical chassis construction, series-string-heater type tubes, vertical retrace blanking circuits, and many more features. **\$79.50**

RADIO-ELECTRONIC CIRCUITS (Continued)

### NEW R-C OSCILLATOR

The usual R-C oscillator consists of an amplifier with a frequency-selective phase-shift network in a feedback loop between its plate and grid. The tube provides sufficient amplification to sustain oscillation. This type of circuit is not readily adapted to direct coupling to following stages and the phase-shift network is well above ground potential.

Some have tried to overcome these objections by using a cathode follower. However, this generally requires a set-up transformer or an amplifier in the feedback loop to raise the feedback voltage to the level needed for sustained oscillations.

This new circuit, described in patent No. 2,769,088, uses a cathode follower with the feedback network between grid and cathode and supplying enough output to sustain oscillation without using a transformer or an auxiliary amplifier. This circuit (see diagram) can be direct-coupled to a following stage and its feedback network is at or close to ground potential.

Assume that a change in grid po-

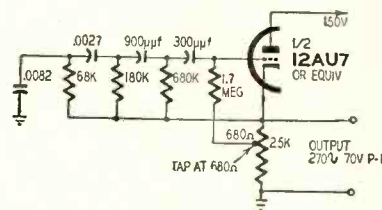

tential produces a 1-volt signal between cathode and ground. The feedback network produces a voltage between grid and cathode that is 180° out of phase with that between cathode and ground. The signal voltage fed to the grid through the phase-shift network combines with the original signal between cathode and ground to develop a grid-ground signal greater than that between cathode and ground. Thus, the signal effectively returned to the grid is in phase with and greater than the original disturbance, so oscillations are sustained. **END**

**FREE!**

Get the new, big catalogue & specifications of the remarkable ARKAY line—Now at your local dealer!  
 Prices 5% higher West of the Mississippi

**ARKAY • 120 Cedar Street • N.Y.,**

### OPPORTUNITY ADLETS

Rates—15¢ per word (including name, address and initials) Minimum ad 10 words. Cash must accompany all ads except those placed by accredited agencies. Discount, 10% for 12 consecutive issues. Misleading or objectionable ads not accepted. Copy for May issue must reach us before March 15, 1957

**RADIO-ELECTRONICS,**  
 154 West 14 St., New York 11, N. Y.

HIGH-FIDELITY SPEAKERS REPAIRED. Ambridge Speaker Service, 70 Vesey St., New York 7, N.Y. BA 7-2580.

EARN COLLEGE DIPLOMA. Engineering, Sciences, through correspondence. AUREC, Central Valley, N.Y.

CASH PAID! Sell your surplus electronic tubes. Want unused, clean transmitting, special purpose, receiving, TV types, magnetrons, klystrons, broadcast, etc. Also want military & commercial lab test and communications gear. We swap too, for tubes or choice equipment. Send specific details in first letter. For a fair deal write, wire or telephone: BARRY, 512 Broadway, New York 12, N.Y. Walker 5-7000.

TELEPHONE Extension in your car. Answer your home telephone by radio from your car. Complete diagrams and instructions. \$1.25 A. CARRIER CO., 734 - 15th St., N.W., Washington 5, D.C.

20-50% DISCOUNTS on Hi-Fi, tape recorders, tape, accessories, photographic equipment, individual quotations only. No catalogs. CLASSIFIED CAMERA, 2375-R East 65 St., Brooklyn 34, N.Y.

EAVESDROP with a pack of cigarettes. Miniature transistorized radio transmitter. Complete diagrams and instructions. \$1.25 A. CARRIER CO., 734 - 15th St., N.W., Washington 5, D.C.

WANTED: Electronics men to qualify for Engineering Degree equivalence by comprehensive examination. No courses. Excellent employment opportunities waiting. GRAMWELL INSTITUTE, RE-7, Adams, Mass.

"RULE OTHERS WITH THOUGHTS." No promises. But satisfaction—or refund. \$2. DELMAR WISDOM, 846-S5 Sunnyside, Chicago 40, Ill.

All Types of Electronic Devices Constructed. Kits Wired. ELECTRONIC SERVICE ENGINEERS. Poreau, Okla.

125 WATERMARKED Letterheads (8 1/2 x 11), 125 Envelopes, \$3. FENDER-RE, Carson, Iowa.

ALL MAKES OF ELECTRICAL INSTRUMENTS AND TESTING equipment repaired. Hazelton Instrument Co., 128 Liberty Street, New York, N.Y.

COMPLETE Television Sets \$11.95. JONES TV, 1115 Rambler, Pottstown, Pa.

RECORDERS, Hi-Fi, Tapes, Wholesale prices. Catalogue. KARSTAN, 215 East 88th St., New York 28, N.Y.

DIAGRAMS FOR REPAIRING RADIOS \$1. Television \$2. Give make, Model. DIAGRAM SERVICE, Box 672-RE, Hartford 1, Conn.

WANTED: AN/APR 4, other, "APR.", "TS-", "IE", ARC-1, ARC-3, ART-13, BC-348, etc. Microwave Equipment. Everything Surplus. Special tubes. Tee Manuals, Lab Quality Equipment, Meters. Fast Action. Fair Treatment. Top Dollar! Littell, Fairhills Box 26, Dayton 9, Ohio.

DISGUSTED OF "HI" HI-FI Prices? Unusual Discounts on all your High Fidelity requirements. Write now. KEY ELECTRONICS CO., 120 Liberty St., New York 6, N.Y.

"DIAMOND NEEDLES \$8.95. We retip your sapphire needle with best diamond available. Send needle only. PACKARD RADIO, 67 Littlefield, Puytucker, R.I."

(Continued on page 139)

# Patents



## ANTENNA MADE OF AIR

Patent No. 2,760,055

Charles C. Laster, Jr., Burlington, N. C. (Assigned to Western Electric Co., Inc., New York, N. Y.)

Since the beginning of radio, antennas have been made of metal conductors. This inventor points out that ionized air is also a conductor and may be used as an antenna. This eliminates the need for towers and supports.

A column of air may be ionized either by radioactive materials or by an X-ray machine. Fig. 1

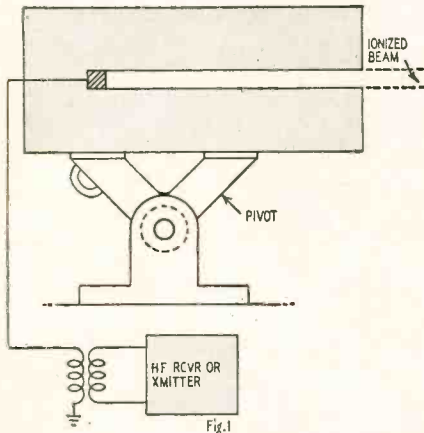

shows an arrangement using radioactive material set deep within the bore of a lead cylinder. A pivot makes possible pointing the "antenna" in any direction. The end of the antenna is coupled to a receiver or transmitter.

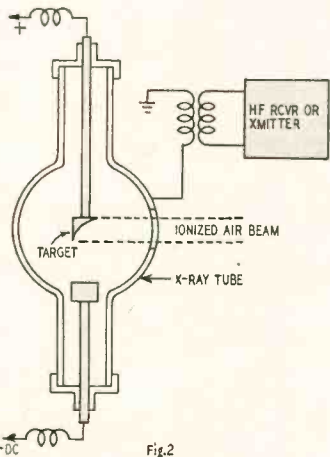

Fig. 2 shows the X-ray method. A high-voltage dc is fed into the tube. Its target emits a powerful stream of X-rays to ionize an air column. The target support may be rotated to orient the antenna.

## KINESCOPE BRIGHTENER

Patent No. 2,757,316

Norman A. Ackerman, Chicago, Ill. (Assigned to Perma-Power Co., Chicago)

Although the patent for this device has been issued only recently, the invention has now been in common use for several years. This is because the brightener fills a definite TV need. A kinescope, like any thermionic tube suffers from reduced emission after being used for several months or a year. The brightener extends its life by boosting the filament voltage. The in-

### CRT 400 PROVES REAL MONEY-MAKER

Here's what Joe Driscoll of TV Trouble Shooters, St. Paul, Minnesota says: "It has made more money for us than any other instruments, with the possible exception of tube checkers. We make an additional charge each time we use the instrument in the home to check or correct picture tube conditions. We have been able to convince customers much easier that their old tubes need replacing and have enjoyed a nice profitable business from the sale of new picture tubes without leaving any doubt whatever in the customer's mind that he needed a new tube."

This is typical of the experience of thousands of servicemen using the CRT 400. It cuts service-operating costs...brings new profits...builds customer good-will...quickly pays for itself. Also saves money on TV set trade-in reconditioning. Has 4½-inch plastic meter. Easily portable. **NET \$54.95**

See Your Distributor today or Write for Bulletin No. 400-E

Makers of CRT, DYNA-QUIK, DYNA-SCAN and CALIBRATOR

**B & K MANUFACTURING CO.**

3726 N. Southport Ave. Chicago 13, Illinois



## OPPORTUNITY ADLETS

(Continued from page 138)

**SPECIALIZED MAGAZINES**—5,166 publications—current copies. Also 1,148 Self-Help Books. All trades, professions, sports, hobbies, etc. List FREE. PUBLICATIONS, 34DZ North Ritter, Indianapolis 19, Ind.

**PROFESSIONAL Electronic Projects**—Organs, Timers, Intercoms, Counters, etc. \$1 each. List Free. PARKS, Box 946 Redwood City, Calif.

**WANT A VERY LOW RESONANCE SPEAKER?** Ask your dealer to demonstrate the RACON "bi-compliance", floating cone, foam-suspension loudspeaker, or write for literature and prices to RACON ELECTRIC CO., 1261 Broadway, New York 1, N. Y.

**LONG PLAYING RECORDS** 20 to 50% Discount Brand-New Factory Fresh Unplayed—All Labels—Send 20c for catalogue to RECORD SALES, 1110 Wintern, Houston 4, Tex.

**LEARN WHILE ASLEEP!** Details, complete instructions \$2. Satisfaction guaranteed. RESEARCH ASSOCIATION, P.O. Box 610-H, Omaha, Nebr.

Patents, Copyrights. SANDERS, Registered Patent Attorney, 6430 Evans, Chicago 37, Ill.

**SELL YOUR WAY TO WEALTH!** WANTED: Surplus military and commercial aircraft electronics: ARN-7, ARC-3, 51R-3, APN-9, BC-348, RTA-1B, BC-788, I-152, L-5, MN-53, 188-4, BC-610, CW-3, test equipment and ALL VACUUM TUBES. Top prices paid! For fattest checks—sell to REXI R. L. SANETT, WREX, 1524 S. Edris Drive, Los Angeles 35, Calif. Phone: REpublic 5-0215.

**FREE Monthly Hi-Fi Bulletin.** Write for quotation on any components. SOUND REPRODUCTION INC. 34 New St., Newark, N.J. Mitchell 2-6816.

**WANTED: ART 13, ARCS, ARCL, BC788, and other Military Surplus JAMES S. STIVEY INC.** 4908 Hampden Lane, Bethesda, Md.

**EARN THOUSANDS.** Overseas, American Jobs. All trades. Transportation paid. **FREE INFORMATION.** Write TRANSWORLD, Dept. R, 200 West 34 St., New York 1, N. Y.

**DIAGRAMS!** Repair Information! Radios—Amplifiers—recorders \$1. Televisions \$1.50. Give make, model, chassis. TV MILITARY, Box 101EA, Hicksville, N.Y.

**PROTECT** inventions without patents or copyright. TECHNICAL SERVICES, Woodcliff Station, 282 North Bergen, N.J.

## IMPORTANT NEWS FOR SERVICE TECHNICIANS

new subscription plan keeps you right up-to-date on  
**HOWARD W. SAMS**

## "TELEVISION TUBE LOCATION CHARTS"

get this sturdy loose-leaf binder and stay right up-to-the-minute with Chart releases issued regularly every three months!



Now you won't have to wait a year or more to obtain your tube location charts on the current TV receivers! Subscribe to the new Sams Television Tube Location Guide service, and get *current* coverage at 3 month intervals. A sturdy, deluxe binder is supplied to you as part of the service, and the releases come to you already punched and ready for easy filing. Here's what your subscription includes:

Current Charts Every Three Months  
Complete Cumulative Indexing Service  
Deluxe Binder for Easy Filing

**YOU GET A FULL YEAR'S SUBSCRIPTION INCLUDING \$3.95 THE BINDER FOR ONLY . . .**

Subscribe today at your Sams Distributor and start getting your current Sams Television Tube Location Charts NOW!

**HOWARD W. SAMS & CO., INC.**  
2205 East 46th Street  
Indianapolis 5, Indiana

**SUBSCRIBE TODAY!**

### PATENTS

(Continued)

ventor suggests an increase to 6.8 volts, then 7.25 and 7.8 progressively, as emission continues to drop.

A simple brightener consists of a socket-plug combination which plugs into the receiver kinescope socket. The kinescope plugs into the adapter. The adapter contains a transformer (or autotransformer) to boost the filament voltage.

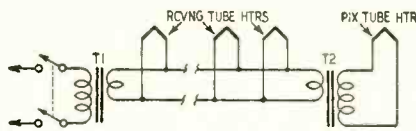

In the diagram T1 is the filament transformer for the receiving tubes. Generally it is part of the power transformer. T2 is the booster transformer.

### THERMIONIC GENERATOR

Patent No. 2,759,112

Winston Caldwell, Nashville, Tenn.

This generator works on the principle that a heated filament emits electrons, thus converting heat directly into electricity. When used in conjunction with a blast furnace, jet engine or solar rays, electricity may be generated from heat ordinarily wasted.

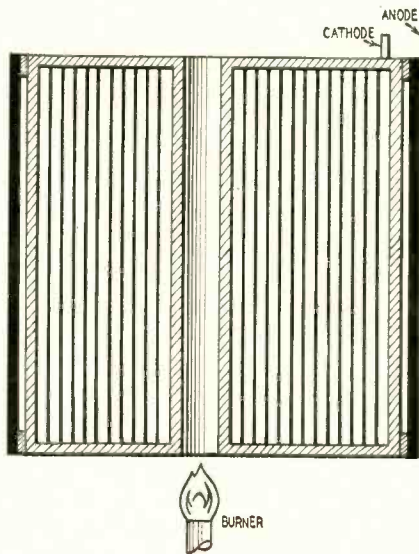

The device may be a large cylinder as shown in the diagram. The outer surface acts as the anode of a diode. It is isolated from the interior by a high vacuum. Within the cylinder is the cathode, made up of a large number of nickel-alloy coated wires. This metal emits electrons when heated.

Each wire emits electrons when the cathode is heated. The electrons can flow easily from wire to wire, since these are closely packed. Many of these charges will flow outward from the cathode to the anode. If the external circuit is closed, they flow through and can do useful work.

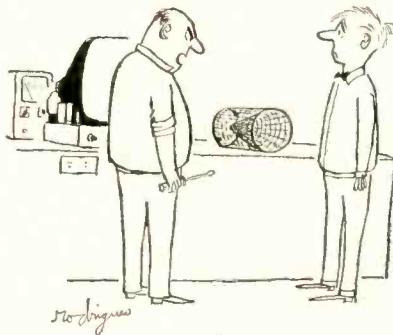

"Well, those jokers down at the jobbers are pulling your leg. That's no ion trap!"

# hi-LOW with ATLAS

high quality low price

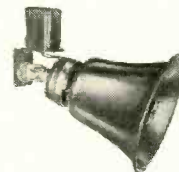

**PAGING & TALK-BACK SPEAKERS**  
6 sizes and types.  
All impedances from 4 to 45 ohms.  
From 5 to 15 watts.  
From \$15.00 to \$24.00 NET.



**WEATHERPROOF LINE MATCHING TRANSFORMERS**  
For constant impedance or constant voltage systems.  
\$5.00 NET.



**HIGH-POWERED PUBLIC ADDRESS SPEAKERS**  
Four sizes from 2 1/4' to 6' air column.  
From \$10.00 to \$39.00 NET.



**U-L APPROVED EXPLOSION-PROOF SPEAKERS**  
For hazardous applications. Several sizes, all classes.  
From \$66.00 to \$75.00 NET.



**SUPER-POWER DRIVER UNITS**  
For all purposes, powers, frequencies.  
From \$15.00 to \$30.00 NET.



**MIKE STANDS & ACCESSORIES**  
All sizes and types: boom stands, desk stands, adapters, fittings, etc.



**New!**

**NEW! SWITCHBOARD MIKE SUPPORT**  
Adjustable 12" goose neck. Use as desk support, for dispatcher office, dais, table, etc.  
#SB-1 . . . \$7.80 NET.



**NEW! "CHESTY" NECK-SUPPORTED MIKE STAND**

Quick, easy 3-way adjustment. Lightweight. Multiple uses.  
#NS-1 . . . \$3.00 NET.

**New!**



**NEW! MIKE FOOT SWITCH**  
Hand, foot or knee operation—shielded, grounded, noise-free, dependable, damage-proof.  
#FS-1 . . . \$7.20 NET.

SEND FOR COMPLETE FREE CATALOG



**ATLAS SOUND CORP.**  
1443 39th St., Brooklyn 18, N. Y.  
In Canada: Atlas Radio Corp., Ltd., Toronto, Ont.

**You can have  
the finest sound  
reproduction  
throughout all  
frequency ranges  
without distortion**

You will hear a remarkable difference in the clarity of Norelco \*Full Response Speakers. In a single speaker, twin-cones reproduce low frequencies, middle range, as well as the higher frequencies extending beyond the audible range—without distortion.

*Norelco F.R.S.*  
speakers are available  
5", 8" or 12" sizes in  
standard impedances.  
Priced from \$6.75 to \$59.98  
Blue prints are available  
for the do-it-yourself  
enclosure builder.



**WHY ARE NORELCO  
FRS SPEAKERS  
SO EXCEPTIONAL?**

They have incorporated a number of technical refinements which are evident the moment you listen. The air gap has been made long so that the coil is completely enclosed in an even magnetic field at all times. A copper ring has been fitted into the deep air gap to keep the voice coil impedance constant over the whole frequency range; this avoids incorrect matching. High flux densities are obtained through the use of "Ticonal" magnet steel.

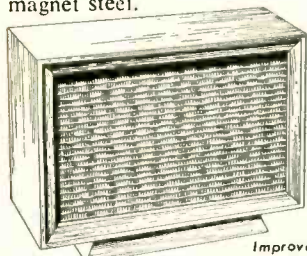

*Norelco FRS  
Improved Bass Reflex  
Enclosures are available in  
three sizes; FRS Enclosures I, II and III.  
Priced from \$33.75 to \$119.95.*

Norelco speaker-matched enclosures are scientifically designed acoustical boxes which enhance the exceptional tone qualities of FRS speakers; bringing out their true performance values.

Norelco FRS Speaker Enclosures are available in three sizes to match the characteristics of the speaker in use. Supplied in either mahogany or blond, these enclosures incorporate a removable base permitting the enclosures to be placed horizontally or vertically to suit any room arrangement or decor.

**ADD TO...** and improve any sound system with *Norelco*®

\*FULL RESPONSE SPEAKERS



Write today to Dept. D-3 for brochures and prices of these unique speakers.  
**NORTH AMERICAN PHILIPS CO., INC.**  
100 E. 42nd St., New York 17, N.Y.

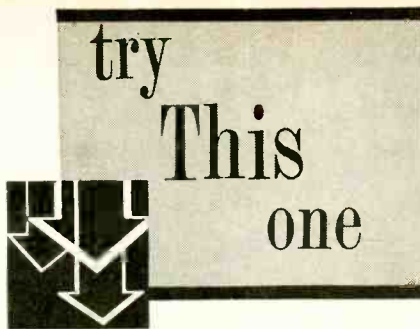

**SUBSTITUTION PROBE**

Resistance-capacitance substitution boxes are a great help to the technician and experimenter but have several disadvantages: The two long test leads required are often clumsy and awkward to work with. The value of capacitance or resistance found by using the substitution box is contained within the box and is not available as a replacement part.

This substitution probe has several advantages: There is only one test lead. The capacitor or resistor to be tried is taken from the spare-parts box and is available as a replacement. The component being substituted is visible at all times and you will be more aware of its voltage and wattage ratings. The probe can also be used to hold small continuity and signal-tracing circuits.

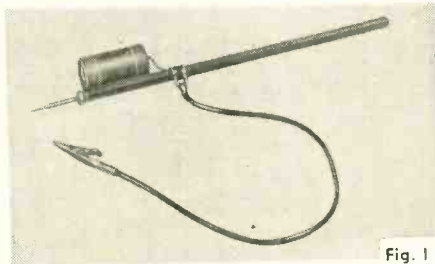

Fig. 1

The construction of the probe is shown in Fig. 1. A 2-inch length of 1/8-inch brass welding rod is threaded for 3/4 inch on one end and a knurled nut is run up to the end of the threads. Screw on a hex nut to within 1/8-inch of the knurled nut. (This allows one lead of the test component to be clamped between the two nuts when the probe is completely assembled.) This leaves about 1/2 inch of rod that is screwed into a hole of slightly smaller diameter drilled into the end of a 9-inch length of 3/8-inch fiber rod. File a point on the other end of the welding rod as shown in the photo. File or grind the corners off the hex nut so it is flush with the sides of the rod.

The test lead is a length of insulated

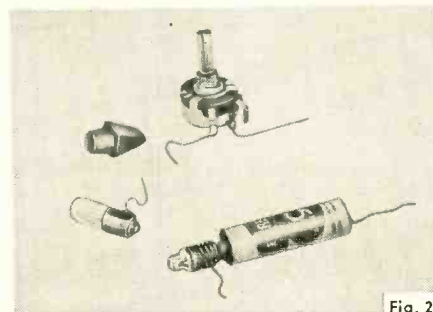
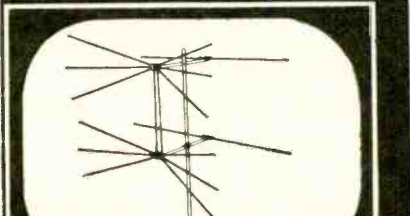
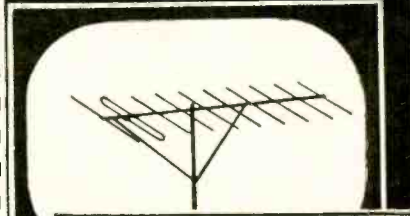

Fig. 2

*The Medaline*  
**OFFERS OVER  
200  
ANTENNA MODELS**



**FAMOUS CONICAL LINE**  
Over 40 models in "quick-rig"  
and part-preassembled units.  
Precision engineered for highest gain. America's low-priced, top-quality line!



**PREASSEMBLED YAGI**  
Both 5 and 10 element models  
with many exclusive design  
features. Wide spaced elements assure unsurpassed performance.

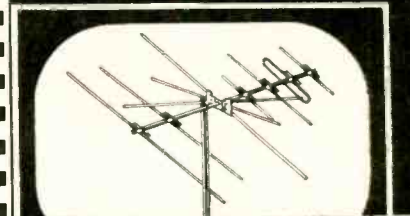

**STURDY CONICAL-YAGI**  
Preassembled fringe antenna  
with top-flight performance.  
Exclusive construction features permit fast, profit-making installations.



**PROFIT-PACKED KITS**  
Complete with any type antenna. Attractive display carton sells-on-sight. Other low price CAPTAIN KITS designed especially for servicemen.

**FREE!** Medaline Memo Pad!  
Distributor areas open!

**MEDAL**

MFG. CO.  
P. O. Box 292  
Sharon, Penna.

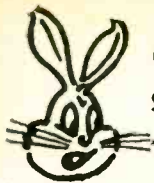

# "MARCH-MAD" \$1 SALE!

FREE! ANY \$1 ITEM  
FREE WITH EACH \$10 ORDER!

## Write today for FREE 8-PAGE FLYER OF BARGAINS

Transistor, Subminiature Hobby Parts & Equipment • Audio • Tools • Electronics

WORLD FAMOUS DOLLARBUYS!

- WIRE BY THE POUND** at scrap prices! Hundreds factory cut pinned hookup lengths. Ass'd. colors, sizes, stranding. \$1 2 1/2 lbs. Reg. \$8
- SIX TIMING DEVICES.** Multi-ganged gun mechanism, timed for 3 secs. Hand wound, accurate. \$1 Reg. \$3 ea. Wt. 1/2 lb.
- SURPRISE PACKAGE!** Every kit an experimenter's dream! 100 useful hobby radio parts. Wt. 3 lbs. Reg. \$15.
- 4 MICROSWITCHES.** Sensitive, bakelite encased. Metal leaf & dime size too. Ass'd. contacts: 15 VAC. 10A. Reg. \$10.
- 60 PLUGS & RECEPTACLES.** Wide variety chassis, speaker, panel audio, power types. Wt. 2 lbs. Reg. \$8.
- 12 POPULAR CONTROLS.** Volume, bias, radio and TV types. Dual & switch. too. Pop. sizes. \$10. Wt. 1 lb. Reg. \$1
- 2 CARBON MIKE XFMRS.** 200 ohm to hi-imp. Grid. Encased. 2" sq. Wt. 1 lb. Reg. \$6.
- 12 "TIP" JACKS.** ICA, Johnson, molded red & black types. Test equipment, panels, transis. \$1 for radios. Reg. \$3
- THREE 600 RELAYS** for mobile, low voltage use. Operate on 4 to 12 VDC. SPST. 10 A. Wt. 1 lb. Reg. \$3 ea.
- 15-PC. TOGGLE JACK BOX sets.** 9 band handle toggle switches, 3 phone jacks, 3 steel socket receptacles. Wt. 3 lbs. \$1
- 15W HI-FI OUTPUT XFMR.** UTC PA series. Push-pull 610's to 4. 8 & 500 ohm secondaries. Encased. Wt. 3 lbs. Reg. \$8.
- 15 TRIMMERS.** Standard Brands. Ceramic, ass'd. values. Single & dual. Wt. 1/2 lb. Reg. \$16.
- 3 OUTPUT XFMRs.** For 501B & 6V6 tubes to 1/2 lb. Reg. \$6.
- 000-999 COUNTER.** Veeeder Rod. Reset type; direct drive. Lowest price anywhere! Hundreds of uses. Reg. \$3
- 0-60 MIN. PHOTO TIMER.** Famous Rhodes "Mark" Time. Built-in 115VAC micro-switch. Lens knob & escutchion. Wt. 1 lb. Reg. \$6.
- SCOOP: TWO 7" LOOP STICS.** Heavy ferrite core, 5/8" dia. Extremely hi-Q. For superhets, transistors. Wt. 1/2 lb. \$1 Reg. \$5.
- 12 ROTARY & PANEL SWITCHES.** Single & double gangs, micro, power, push, A.C. Wt. 3 lbs. Reg. \$15
- BENCH VISE.** Heavy steel, w/clamp type base. 1 1/2" jaws. Reg. \$1 \$2.50.
- 16 PRINTED CIRCUITS** on 8 x 16" boards. Design your own, many uses! Wt. 1 lb. Reg. \$5.
- 4 SUB-MINI REIFIERS** designed for printed & transistor circuits. 1/2 wave. 1 x 3/8", w/ leads. Reg. \$6.
- 2 TRANSISTOR COUPLERS.** Eliminate transf. & r/c coupled amp. stages. 100K imp., 5000 DC ohms; center tapped. 7/8" x 1/8". Reg. \$3.
- 3 LBS. HARDWARE.** 2000 pcs. ass'd. screws, springs, washers, etc. Reg. \$8.
- WORLD'S SMALLEST RADIO KIT.** 2 1/2 x 1 1/4 x 3/4". Permeability tuner, diode, pre-drilled case. All parts, instructions. Reg. \$1 \$3.50.
- SUN BATTERY & photo-cell.** 1 1/2" dia. Better than famed B2M! Reg. \$1 \$5.
- 125 RESISTORS.** Carbon. 1/2 to 2W. 40 values: 5 ohms to 10 megs. \$1 \$97. 100 Reg. \$15.
- HOBY TRANSFORMER.** 115VAC. 60 cycle to 24V @ 3 Amps. Full transformer for shop, surplus gear, hobbyists. Wt. 3 lbs. Reg. \$6.
- 2 TRANSISTOR LOOP-STICs.** tapped. Match input impedance for better selectivity. \$1
- G-E PREAMP KIT** for magnetic cartridges. Chassis, parts, diagram. Less 68C7 (88c extra). Wt. 1 lb. Reg. \$4.50.
- 40 MINIATURE CONDENSERS.** Ass'd. miniature, subminiature, printed circuit types: Centralab, Sprague. \$1
- 30 POWER RESISTORS.** W.W. candohm, sand-coated. Various 15 values: 5 to 50W. 35 to 1000 ohms. Wt. 2 lbs. Reg. \$1 \$8.
- 30 PRECISION RESISTORS.** W.W. & carbofilm. 30 values, 56 ohms to 1 M. 1/2 lb. & 2W. 1% tol. Reg. \$21.
- 25 TUBE SOCKETS.** 4 Johnson, miniature, subminiature, octals, zippers. Tube shields, too. \$1 Wt. 2 lbs. Reg. \$8.50
- 10 ELECTROLYTICS.** FP & twist, tubular, rect. Ass'd. sizes, 8 to 500 mmf. to 50V. Wt. 3 lbs. Reg. \$15.
- 8-PC NUTDRIVER SET.** plastic handle, 3/16, 7/32, 1/4, 5/16, 1/32, 3/8, 7/16" steel socket wrenches in plastic case. Wt. 1 lb. \$3 \$1 value.
- 15-PC. TWIST DRILL SET.** 1/16 thru 1/4" by 64ths; in graduated plastic holders. Reg. \$1 \$4.
- 30 POPULAR BULBS.** 1.1 to 6V, screw and bayonet types, miniature. Wt. 1/2 lb. Reg. \$1 \$2.40.
- 100 CERAMIC CONDENSERS.** Ass'd. types, top makers. 30 values, color-coded. Discs, too. \$1 Reg. \$15.
- 4 CRYSTAL DIODES.** Most commonly used: 1N34, 1N56, 1N58, 1N89 in poly bag. Reg. \$1 \$5.
- 100 COIL FORMS.** 15 types. Assorted sizes, insulation. Reg. \$15. \$1
- 60 TUBULAR CONDENSERS.** 30 types, .0005 to 0.5mf to 15-00V. Wt. 2 lbs. Reg. \$1 \$12.
- 70 TERMINAL STRIPS** and boards. 15 types. 1 to 20 screw and solder points. Wt. 1 lb. Reg. \$1 \$5.
- 70 RESISTORS.** Insulated IRC. A-B. Inc. 5 ohms to 10 megs: 1/2, 1 & 2 W. 10% & 5%. Wt. 1/2 lb. Reg. \$10
- 70 MICA CONDENSERS.** 30 values: .00001 to .01 mf to 1000V. Silver. 5%. too. Wt. 1 lb. Reg. \$5.
- 8 TRANSISTOR SOCKETS.** For subminiature tubes, too. Mica filled. \$1 Reg. \$3.
- 4 SILICON DIODES.** 1N21, two 1N22, 1N-23. Reg. \$15. \$1
- 40 SUBMINIATURE RESISTORS.** In poly box. 1/2" long! 20 values, 15 ohms to 10 megs. 1/2 W. Reg. \$5. \$1
- 5000 OHM RELAY.** by Allied Control. 4PDT. for plate and control circuits. 15 ma. Reg. \$1 \$6.50.
- 60 TRANSFORMERS & COILS.** IF, RF, ant., slug-tuned, 25 types! Wt. 3 lbs. \$1 Reg. \$15.

Check items wanted. Return entire kit w/check or M.O. including sufficient postage; excess returned. C.O.D. orders, 25% down. Rated, net 30 days. Print name, address, amount money enclosed, in margin. RE-3

**HOW TO ORDER**

# Lektron Specialties

131-133 Everest Ave. Chelsea 50, Mass.

142

## HICKOK Model 690

### VHF-UHF Marker Generator

- Crystal controlled frequency coverage from 4.25 to 225 mc on fundamentals — harmonic output on UHF.
- Optically magnified screen permits most accurate marker setting.
- Write for technical details...

**THE HICKOK ELECTRICAL INSTRUMENT CO.**  
10531 Dupont Ave., Cleveland, Ohio

## TV — It's a Cinch!

### Want Proof?

See page 133

## ELECTRONIC COMPUTERS

**MINILOG**, new radically low-priced analog computer. For education and research. Wired or kit form.

Complete instruction in computers, AUTOMATION, ROBOTS, electronics, mathematics. Courses range from beginner's level up to commercial. Over 30 courses taught! Prices range from \$5 to \$52. You may build actual computers as you go along by taking any one of our **COMPUTER KITS**.

Plans for digital or analog type computer \$3. Set of 50 diagrams for experimenters \$2.

We teach mathematics by the new method tool designed for fast effective learning: **FUNCTIONAL MATHEMATICS**. From simple algebra to calculus and differential equations in one integrated course. Try a lesson at our cost.

We offer the **ANALOG EXPERIMENTAL KIT** for home-builders, complete computer when assembled. Price: \$46.50 plus shipping. Best suited for beginners in this field.

Send for **FREE** introductory copy of **ELECTRONIC BRAINS EXPERIMENTER MAGAZINE**

**ELECTRONIC BRAIN ENTERPRISES, INC.**  
1015 Atkin Ave.  
Salt Lake City 6, Utah

## utah FABULOUS "G" SERIES SOUND REPRODUCERS

**FABULOUS IS THE ONLY WORD FOR THEM**

NEW SPEAKER MODELS WITH A FREQUENCY RESPONSE FOR EVERY APPLICATION

- MID RANGE EXTENDED TWEETER WOOFER COAXIAL
- High Frequency Model GT5F List Price \$8.75
- Mid Range Model GM8J List Price \$13.80
- Woofer Model G15P List Price \$42.65
- Coaxial Model G12J List Price \$39.75

Are ideal for single or multiple installations, additions in Hi Fi systems or for bi-naural applications. Their fabulous features of superb range, response and overall perfection of performance — and unbelievable low price — makes Utah's new "G" series your best buy in Hi Fi. The incomparable, precision combination of molded, seamless cones permanently welded with indestructible adhesive to rugged 8 ohm. voice coils powered by oriented grain Alnico V magnets, assures you of full power handling capacities.

Write for complete Fabulous "G" Catalog and technical folder.

See the FABULOUS "G" at your dealers today.

**UTAH RADIO PRODUCTS CORP.**  
HUNTINGTON, INDIANA  
Export Dept. Rocke International, N. Y. C.

**ON THE JOB**  
when it counts

RADIO-ELECTRONICS

TRY THIS ONE

(Continued)

wire with a clip on one end and a 3/8-inch grid clip on the other. To insert a substitute grid component, simply tighten one lead between the two nuts and slip the other between the grid clip and the rod as in Fig. 1.

Fig. 2 shows a potentiometer ready for use in the probe, a penlight bulb and cell used when checking continuity of low-resistance circuits and a 1/4-watt neon lamp used as a high-voltage indicator. The tip of the flashlight bulb is soldered to the positive battery terminal and short lengths of wire are soldered to the brass lamp base and the bottom of the battery. Only one lead is needed on the neon lamp. The pencil eraser is slipped over the other end of the probe and used as a tube tapper.

-Michael J. Sies

### ISOLATION TRANSFORMER

Before servicing a portable TV set the technician should determine whether or not the chassis is connected to one side of the power line. If so, it must be isolated from the line to prevent unwanted voltages from developing between the set and the test equipment and causing false indications or damaging the instruments. Isolation also minimizes shock hazard.

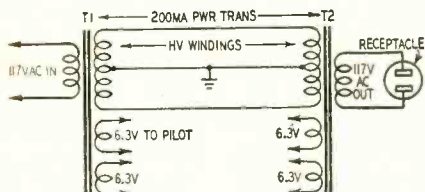

Isolation transformers supplying sufficient current to operate the average portable TV set are not always readily available in the shop. The diagram shows how two new or salvaged TV power transformers can be connected to provide the necessary isolation. The high-voltage secondaries are paralleled with the center taps grounded. The filament windings are not used unless an indicator lamp is needed. In this case, use any one of the windings.

The transformers should be in the 200-ma class and have similar high-voltage characteristics. Check the voltage output of the secondary of T2 with an ac voltmeter before using the unit to supply a receiver. The output should not exceed 120 volts under load or you may damage the set.—Geo. D. Philpott

### COOLING HOT JACKS

It is customary, for reasons of economy, to use plug-in meters in many types of commercial and amateur electronic equipment, particularly in circuits that need only occasional adjustment. Where one side of the circuit is at ground potential, the conventional two-circuit jack and plug is electrically satisfactory and entirely safe.

Where both sides of the circuit are above ground, the jack ferrule (bushing) and frame are customarily insulated from the metal panel by insulat-

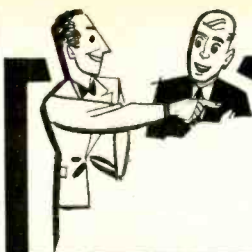

"miracles with microvolts"

## Low Noise Type S.P.A. Single Channel TV Pre-Amplifier

Designed for Head End of Medium Size Installation

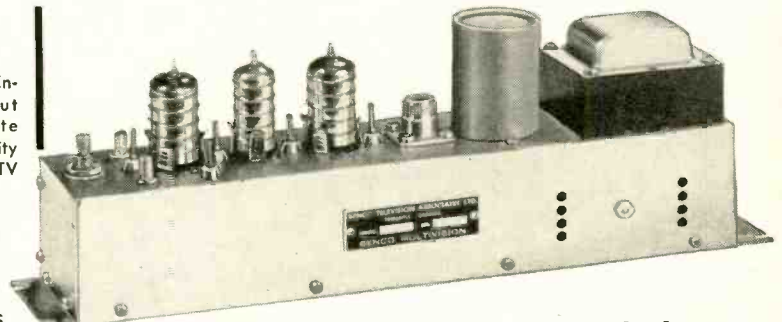

Send today for information about Benco's complete line of community and apartment TV Equipment

AMPLIFIERS

MAST BOOSTERS

APARTMENT SYSTEMS

AERIAL MIXERS

COMMUNITY SYSTEM EQUIPMENT

Completely self contained, can be used alone or in parallel for multi-channelled operation.

- 40 DB GAIN ● 6 MEGACYCLE BANDWIDTH ● MAX. OUTPUT 0.5 VOLTS ● VARIABLE OUTPUT LEVEL CONTROL
- AUTOMATIC OVERLOAD CONTROL ● NOISE FIGURE; LO-BAND 4DB, HI-BAND 6 DB ● INPUT & OUTPUT 75 OHMS

PRICE **\$59.95**  
Suggested User Net

# BENCO

TELEVISION ASSOCIATES LTD.

278 BRIDGELAND AVENUE, TORONTO 10, CANADA

## TERADO Trav-Electric CONVERTERS

MOBILE POWER



Give You **110 A.C. HOUSE CURRENT ANYWHERE**  
You Drive or Cruise

LIST

**\$11.95 UP**

For 6 and 12 Volt Car Batteries—Capacities: 10 to 125 Watts

### NO INSTALLATION

Just plug into cigar lighter on dash of car, truck, or boat—and away we go

- OPERATE PORTABLE TV,
  - SMALL DO-IT-YOURSELF
  - TOOLS WHEREVER NEEDED
- One of the great conveniences of our electronic age



PORTABLE TV



DICTION

**101 USES**



ALL ELECTRIC SHAVERS



DO-IT-YOURSELF HOBBY TOOLS

SEE YOUR ELECTRONIC PARTS DEALER OR JOBBER

## TERADO COMPANY

DESIGNERS & MFRS. OF ELECTRONIC EQUIPMENT SINCE 1927  
1057 RAYMOND AVE., ST. PAUL 14, MINNESOTA

## TV TELLS HOW TO ANSWER RADIO T.V. QUESTIONS SERVICE LIBRARY



**\$8 COMPLETE 2 VOLUMES**

Get this Information for Yourself 7 DAY TEST—PAY ONLY \$1 MO.

HERE IS LATE INFORMATION IN A HANDY FORM FOR RADIO AND TELEVISION REPAIRMEN, SERVICEMEN AND STUDENTS

AUDELS T.V. RADIO SERVICE LIBRARY—Over 1500 Pages—1085 Illustrations & Diagrams. 1001 Important Facts & Figures on Modern T.V., Radio, Electronic Devices at your fingers' ends. Highly Endorsed.

**INCLUDES TRANSISTORS** and Transistor Circuits, Rectifiers, Record Changers, P. A. Systems, Tape Recorders, Phonograph Pick-ups, F.M., Auto Radio, Radio Compass, Short Wave, Radar, etc.

**ASK TO SEE IT!**  
**IT WILL PAY TO KNOW—**  
The Basic Principles—Construction—Installation—Operation—Repairs—Trouble Shooting. Shows How to get Sharp, Clear, T.V. Pictures. Install Aerials—How to Test. Explains Color Systems, Methods of Conversion Terms, etc. Includes Ultra High Frequency—Valuable for Quick Ready Reference and Home Study.



MAIL ORDER

AUDEL, Publishers, 49 W. 23 St., New York 10, New York  
Mail AUDELS T. V. RADIO SERVICE LIBRARY (2 Volumes) \$8 on 7 days free trial. If O. K. I will remit \$1 in 7 days and \$1 monthly until \$8 is paid. Otherwise I will return them.

Name \_\_\_\_\_  
Address \_\_\_\_\_  
Occupation \_\_\_\_\_  
Employed by \_\_\_\_\_

RE-3

# The Most Popular Line In America!



EXPORT SALES DIV., SCHEEL INTERNATIONAL INC., 5909 N. Lincoln Ave., Chicago, U.S.A. Cable Address: HARSHEEL

## TRY THIS ONE

ing washers. Failure or omission of these washers has costly consequences, as many builders of a popular high-fidelity kit amplifier can testify. Even more serious, in many installations, is the danger of touching the hot jack bushing and something grounded at the same time. This results in a shock, the danger from which depends upon the voltages involved. Use of bright red insulating washers, as is done in some military installations, while plainly indicating the danger does not remove it.

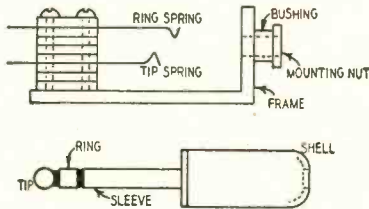

In a wide variety of equipment, the hot-bushing danger can be entirely eliminated, at negligible cost, by use of three-circuit telephone jacks and plugs, an entirely standard communication item, constructed as shown. The plug has three conducting elements—the tip, ring and sleeve; the jack has springs to contact the ring and tip. The sleeve contact is made with the jack bushing. Telephone type plugs, such as the Switchcraft PJ-068, are so constructed that short circuits on insertion and removal are practically impossible.

By connecting the two hot leads of the meter to the tip and ring of the plug and the two hot circuits to be monitored to the corresponding jack springs, the ferrule is always electrically cold—at ground potential—and danger from shocks is minimized.

The same type of jack and plug is useful for connecting dual shielded leads quickly. Experience shows that telephone type three-circuit components will stand 350 volts continually in ordinary environments and about 250 volts in high-humidity locations such as New Orleans or Manaus.—Ronald L. Ives

END



"Herman is our inside man."



"Gosh, Martha, these records sound so clear with this JENSEN NEEDLE that you'd swear those musicians were right here in this very room."

# pfK

pre-finished Kits

PFK-120/150

PFK-500

PFK-300

designed by Paul Klipsch

Now you need only a screw-driver to put together a furniture-finished Klipsch speaker enclosure, indistinguishable from factory-assembled Rebel 3, 4 or 5. Also available as conventional, unfinished kits.

**Write for Complete Catalog!**  
 36 pages . . . 16 other hi-fi kits . . . 29 equipment cabinets . . . 4 matched speaker systems . . . 20 hi-fi accessories.

# cabinart '57

Cabinart

99 North 11th Street  
Brooklyn 11, N. Y.

largest manufacturer of cabinets and kits for hi-fi  
a division of G&H Wood Products Co., Inc.



# Business



## Merchandising and Promotion

Sylvania Electric Products, New York, announced a new packaging plan



for its renewal receiving tubes which includes a newly designed package and a five-pack carton.

Rohn Manufacturing Co., Peoria, Ill., is offering service technicians and dis-

tributors a new four-color window and general-use decal to promote the use of its TV communications towers and accessories.

RETMA announced that over 475 prizes had been donated by companies in the industry for winners in the RETMA-Boys' Life Magazine Radio Listening Contest, including Gernsback Library Books and subscriptions to RADIO-ELECTRONICS.

Blonder-Tongue Labs., Westfield, N.J., designed a self-service TV acces-



sory display board which mounts five of its best selling accessories.

Duotone Corp., Keyport, N. J., designed a counter display for its microscopes which service technicians may

# ONE DOLLAR BUYS

As much as \$15 worth—Everything Brand New and sold to you with a money back guarantee.

- 15 - ASSORTED ROTARY SWITCHES.....\$1
- 100 - ASSORTED 1/2 WATT RESISTORS.....\$1
- 70 - ASSORTED 1 WATT RESISTORS.....\$1
- 35 - ASSORTED 2 WATT RESISTORS.....\$1
- 3 - TV CARTWHEEL CONDENSERS 20kv.....\$1
- 100 - FUSES 1 AMP standard size 1 1/4" x 1/4".....\$1
- 100 - TUBULAR CONDENSERS .02-100v.....\$1
- 100' - FINEST NYLON DIAL CORD best size.....\$1
- 200 - SELF TAPPING SCREWS #8 x 1/8".....\$1
- 400 - ASST. SCREWS, NUTS, WASH, RIVETS.....\$1
- 50 - ASST. TUBULAR CONDENSERS 85°.....\$1
- 35 - ASST. RADIO KNOBS screw and push-on.....\$1
- 100 - KNOB SPRINGS standard size 3/4" x 1/2".....\$1
- 50 - ASST. SOCKETS octal and miniature.....\$1
- 50 - ASST. MICA CONDENSERS some in 5%.....\$1
- 50 - ASST. CERAMIC CONDENSERS.....\$1
- 10 - ASST. VOLUME CONTROLS less switch.....\$1
- 5 - ASST. VOLUME CONTROLS with switch.....\$1
- 20 - ASST. PILOT LIGHTS #44, 46, 47, 51.....\$1
- 10 - PILOT LIGHT SGTs, bayonet type, wired.....\$1
- 50 - ASST. TERMINAL STRIPS 1, 2, 3, 4 lug.....\$1
- 10 - ASST. RADIO ELECTRO. CONDENSERS.....\$1
- 5 - ASST. TV ELECTROLYTIC CONDENSERS.....\$1
- 10 - ASST. TV COILS sync, peaking, width, etc.....\$1
- 10 - 6 FT. ELEC. LINE CORDS with plug.....\$1
- 5 - TV CHEATER CORDS with both plugs.....\$1
- 200' - HOOK-UP WIRE & SOLDER KIT.....\$1
- 100' - TWIN LEAD-IN WIRE 300Ω heavy duty.....\$1
- 50' - FLAT 4-CONDUCT. WIRE, many purposes.....\$1
- 10 - AC-DC ANTENNA HANKS each 20 feet.....\$1
- 25 - ASST. MICA TRIMMER CONDENSERS.....\$1
- 50 - TUBULAR CONDENSERS .1-200v.....\$1
- 50 - TUBULAR CONDENSERS .02-400v.....\$1
- 50 - TUBULAR CONDENSERS .001-600v.....\$1
- 25 - TUBULAR CONDENSERS .01-600v.....\$1
- 20 - TUBULAR CONDENSERS .25-600v.....\$1
- 20 - TUBULAR CONDENSERS .047-600v.....\$1
- 3 - ELECTROLYTIC COND. 50/30 - 150v.....\$1
- 5 - ELECTROLYTIC COND. 100/50 - 50/25v.....\$1
- 3 - ELECTROLYTIC COND. 80 - 450v.....\$1
- 3 - ELECTROLYTIC COND. 40/10/10 - 450v.....\$1
- 3 - ELECTROLYTIC COND. 40/40 - 450v.....\$1
- 5 - ELECTROLYTIC COND. 250/1000 - 10/6v.....\$1
- 15 - TUBULAR CONDENSERS .015-1600v.....\$1
- 10 - HV TUBULAR CONDENSERS .006-2000v.....\$1
- 10 - HV TUBULAR CONDENSERS .03-2000v.....\$1
- 10 - HV TUBULAR CONDENSERS .005-3000v.....\$1
- 8 - HV TUBULAR CONDENSERS .001-6000v.....\$1
- 5 - HV TUBULAR CONDENSERS .005-6000v.....\$1
- 20 - 10KV CARTWHEEL COND. total list \$35.....\$1
- 35 - MICA COND. 20 - 30 mmf & 15 - 100 mmf.....\$1
- 35 - MICA COND. 20 - 470 mmf & 15 - 1000 mmf.....\$1
- 35 - MICA COND. 20 - 3000 mmf & 15 - 10K mmf.....\$1
- 35 - CERAMIC COND. 20 - 1 mmf & 15 - 47 mmf.....\$1
- 35 - CERAMIC COND. 20 - 68 mmf & 15 - 1500 mmf.....\$1
- 35 - CERAMIC COND. 20-2500 mmf and 15-680 mmf.....\$1
- 50 - 100Ω 1/2 WATT RESISTORS 5%.....\$1
- 75 - 680Ω 1/2 WATT RESISTORS 10%.....\$1
- 75 - 470KΩ 1/2 WATT RESISTORS 10%.....\$1
- 50 - 3.3Ω 1 WATT RESISTORS 10%.....\$1
- 50 - 3900Ω 1 WATT RESISTORS 10%.....\$1
- 50 - 15KΩ 1 WATT RESISTORS 10%.....\$1
- 50 - 27KΩ 1 WATT RESISTORS 10%.....\$1
- 50 - 120KΩ 1 WATT RESISTORS 10%.....\$1
- 50 - 150KΩ 1 WATT RESISTORS 5%.....\$1
- 50 - 470KΩ 1 WATT RESISTORS 10%.....\$1
- 50 - 2.2 MEGΩ 1 WATT RESISTORS 10%.....\$1
- 25 - 2.2Ω 2 WATT RESISTORS 5%.....\$1
- 25 - 3.3Ω 2 WATT RESISTORS 5%.....\$1
- 25 - 270Ω 2 WATT RESISTORS 10%.....\$1
- 25 - 470Ω 2 WATT RESISTORS 10%.....\$1
- 25 - 100KΩ 2 WATT RESISTORS 10%.....\$1
- 10 - ASST. WIREWOUND RES. 5, 10, 20 watts.....\$1
- 3 - AUDIO OUTPUT TRANSFORMERS 50L8 type.....\$1
- 3 - AUDIO OUTPUT TRANS. 6K6 or 6V6 type.....\$1
- 3 - I.F. COIL TRANSFORMERS 456kc.....\$1
- 3 - I.F. COIL TRANSFORMERS 10.7 mc FM.....\$1
- 4 - OVAL LOOP ANTENNAS ass't. hi-gain types.....\$1
- 3 - LOOPSTICK ANT. new female, adjustable.....\$1
- 12 - RADIO OSCILLATOR COILS 456kc.....\$1
- 3 - 1/2 MEG VOLUME CONTROLS with switch.....\$1
- 1 - 4" PM SPEAKER alnico #5 magnet.....\$1
- 1 - 5" PM SPEAKER alnico #5 magnet.....\$1
- 5 - SETS SPEAKER PLUGS, wired.....\$1
- 2 - \$2.50 SAPPHIRE NEEDLES 4000 playings.....\$1
- 2 - SELENIUM RECTIFIERS 1-65ma, 1-100ma.....\$1
- 5 - DIODE CRYSTALS 2-IN21 2-IN23 1-ING4.....\$1
- 1 - \$7 INDOOR TV ANTENNA hi-gain 3 section.....\$1
- 1 - TV UNIV. FOCALIZER adjusts for any ohmage.....\$1
- 1 - TV VERT. OUTPUT TRANS. 10 to 1 ratio.....\$1
- 5 - TV CRT. SOCKETS with 18" leads.....\$1
- 5 - HI-VOLT. ANODE LEADS with 18" leads.....\$1
- 2 - TV 1ST & 2ND SND. I.F. COILS #201K1.....\$1
- 1 - TV SYNCHROGUIDE TRANSFORMER #20BR1.....\$1
- 1 - TV SYNCHROLOG TRANSFORMER #20BT8.....\$1
- 1 - TV RATIO DETECTOR TRANS. 4.5mc.....\$1
- 1 - SET TV KNOBS standard type incl. decals.....\$1
- 1 - LB SPOOL ROSIN CORE SOLDER 40/60.....\$1
- 6 - SPIN TIGHT SOCKET SET 3/16" to 7/16".....\$1
- 3 - TV ALIGNMENT TOOLS 7", 12", 18".....\$1

HANDY WAY TO ORDER—Simply tear out advertisement and pencil mark items wanted, enclose with money order or check. No letter needed, envelope address is sufficient. You will receive a new copy of this ad for re-orders.

ON SMALL ORDERS—Include stamps for postage, excess will be refunded. Larger orders shipped express collect. Resistor & condenser code charts FREE with each order.

**BROOKS RADIO & TV CORP.**  
84 Vesey St. New York 7, N.Y.

## SENCORE FILAMENT CHECKER

Another Sencore Time-Saver

MODEL FC-4



- ★ COMPLETELY NEW
- ★ MORE VERSATILE
- ★ LOWER COST

Quickly finds any open filament. Especially handy for servicing series filament TV sets and radios; only checker that checks all octals, lactals, 7 and 9 pin miniatures automatically.

Only \$295

DEALER NET WITHOUT LEADS \$2.75

Continuity and voltage tester — no switches, merely plug in test leads.

AT LEADING DISTRIBUTORS EVERYWHERE Mfg by **SENCORE SERVICE INSTRUMENTS CORP.** 171 OFFICIAL RD., ADDISON, ILL.

- POPULAR SENCORE PRODUCTS
- Transistor Tester
  - Leakage Checker
  - Filament Tester
  - Voltage Regulator
  - Bias Supply

## GET MORE WORK OUT OF YOUR OSCILLOSCOPE!

Learn to service ANY radio or TV easier and faster!

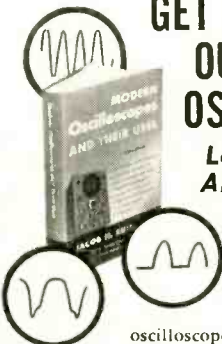

Here, in a brand new 2nd edition, is THE book that really shows you how to use

oscilloscopes!

Clearly as A-B-C, MODERN OSCILLOSCOPES AND THEIR USES tells you exactly when, where and how. You learn to locate either AM or FM radio or television troubles in a jiffy. Even tough realignment jobs are made easy. No involved mathematics! Every detail is clearly explained—from making connections to adjusting circuit components and setting the oscilloscope controls. And you learn to analyze patterns fast and RIGHT!

### NEW 2nd EDITION!

Includes latest data on use of 'scopes in color TV, industrial electronics, teaching... even in atomic energy work. Over 400 pages and over 400 clear pictures. Dozens of pattern photos make things doubly clear.

### PRACTICE 10 DAYS FREE!

Dept. RE-37, RINEHART & CO., Inc.  
232 Madison Ave., New York 16, N. Y.

Send new, 2nd edition of MODERN OSCILLOSCOPES AND THEIR USES for 10-day examination. If I like book, I will then send \$6.50 (plus postage) in full payment, or return book postpaid and owe you nothing.

Name.....

Address.....

City, Zone, State.....

OUTSIDE U.S.A.—Price \$7.00, cash with order only. Money back if you return book in 10 days.

# ASTRON

## Aids

### FOR SERVICEMEN

#### Estimating and Pricing Guide

Handy, pocket-sized Replacement Catalogue containing illustrations, descriptive copy, and complete breakdown of catalogue numbers, sizes, capacitance, working voltage, and list price. It saves valuable time for you every day. Free Servicing Aid AC-4D.



#### General Capacitor Catalogue

Complete line of Astron capacitors illustrated and explained in detailed 8 1/2 x 11 coated stock catalogue. Valuable information written in an easy-to-understand style. Diagrams, charts, and descriptive copy concerning each type. Service Replacement Capacitor Catalogue number AC-5.



#### Popular Astron Swing Bins

Practical capacitor servicing kit. Sturdy, clear plastic swivel trays mounted as one unit for your convenience. Will keep capacitors off the work bench

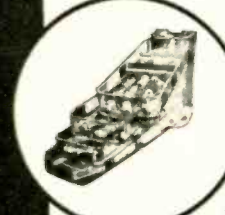

— and in place where you know they'll be found... completely visible from any angle, any position... neat, compact and handy. Three different styles available: Swing Bin Sr. 9 shelves 166 Blue-Point® Plastic Paper Tubular Capacitors Swing Bin Jr. 6 shelves 90 Blue-Point® Plastic Paper Tubular Capacitors Swing Bin Baby 4 shelves 45 Blue-Point® Plastic Paper Tubular Capacitors

Available nationally through authorized ASTRON distributors.

# ASTRON CORPORATION



255 GRANT AVENUE  
EAST NEWARK, N. J.

BUSINESS

(Continued)



use to inspect high-fidelity phonograph needles.

Cornell-Dubilier Corp., South Plainfield, N. J., recently completed a 25-minute color-sound film "Capacity Unlimited" showing the facilities of its 17 plants in 7 states.

RCA mailed TV service technicians an attractive brochure promoting the third annual National Television Servicemen's Week, March 25-30. It explains how RCA will plug the event on TV and radio, and in its advertising, and describes the various sales aids available.

Jensen Industries, Forest Park, Ill., has solved the problem of what to do with Christmas displays "the morning

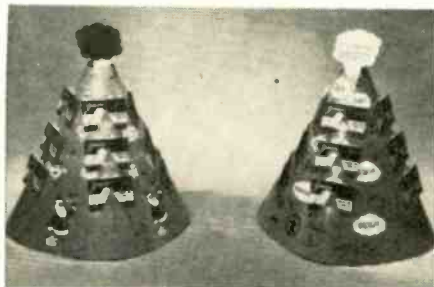

after." By turning its phono needle Christmas tree display inside out, it becomes an Indian tepee display which can be made to emit puffs of smoke.

#### New Plants and Expansions

P. R. Mallory & Co. has relocated its Distributor Division in a new plant at 1302 East Washington St., Indianapolis, Ind.

Sylvania Electric Products acquired 13.5 acres of additional land in Mountain View, Calif., for future expansion of its electronics facilities.

Cannon Electric Co., Eastern Division, moved into new quarters in Salem, Mass. The division was formerly known as the Diamond Division while located in Wakefield, Mass.

# STAN-BURN

## CATHODE RAY TUBE SPECIALS

ONE YEAR GUARANTEE

G. E. Type	STAN-BURN	G. E. Type	STAN-BURN
\$15.80 10BP4	\$10.00	\$30.75 17CP4	\$20.50
19.10 12LP4	13.95	32.90 17CP4S	21.50
12QP4	10.50	24.75 17LP4	18.00
18.75 12UP4	15.00	37.00 19AP4A	24.00
20.45 14CP4	13.75	28.65 20CP4A	18.95
15DP4	14.50	32.10 20CP4B*	21.95
33.75 16AP4	18.50	36.00 21AP4	25.00
32.20 16DP4A	18.25	39.75 21EP4A	20.15
23.50 16KP4	15.75	30.90 21EP4B	23.25
27.20 16KP4A*	18.75	30.90 21FP4	21.15
33.75 16CP4	18.75	37.00 21MP4	26.25
31.50 16LP4A	15.25	29.75 21YF4	22.00
31.50 16WP4	15.25	100.00 24AP4	56.00
23.50 17BP4	13.75	48.60 24CP4A*	38.00
27.50 17BP4B	18.75	47.75 24CP4B*	39.00

\*Aluminized—Inquire for any tube type not listed. Stan-burn CRT tubes RCA licensed—Mfd. by Lincoln. Prices subject to change without notice.

\$20 WORTH OF ELECTRONIC PARTS IN GRAB-BAG consisting of: Porcelain sockets, coils, speaker, trans, resist, cond. ONLY \$1.98 (plus 50c postage)

#### TAPE RECORDERS—Famous Brand

List Pr.	SPECIAL	List Pr.	SPECIAL
\$249.95	\$169.00	\$120.95	\$79.95
199.95	129.00	71.95	59.95

Write for complete illustrated details.

**KITS:** We stock the following manufacturers complete line of kits—see reference pages. EICO...see pages 31-32 ARKAY...see page 136 QUALITY...see page 140 PRECISE...see page 111 JENSEN...see page 137 ELECTRO-VOICE...see third cover

All domestic orders will be shipped prepaid for a limited time. Send us your list. Order by Manufacturer and Model Number of Item.

- VM 4 SPEED HI-FI CHANGER—Model 1210 with Ronette, Sonotone or Astatic fill-over cartridge \$22.95
- RC 456 4-speed Collaro, BRAND-NEW, Special. \$33.81
- 45 RPM SPINDLE for above.....\$2.98
- MONARCH Model UAGU 4 SPEED AUTO. INTERMIX cartridge with crystal cartridge.....\$24.95
- Same with GOLD RING 4500 S.S. ....\$25.95
- Same with G.E. RFX050A .....\$26.95
- Same with G.E. RFX052A Diam. sapph. ....\$38.95
- 45 RPM SPINDLE.....1.88
- TU-8 MONARCH 3 Speed MOTOR & TURN-TABLE UNIT (less arm) NEW LOW PRICE..... 3.95
- RCA 21" ADAIR Table Model TV.....\$159.95
- AMPLIFIER KIT—Model SBHF20—A terrific low cost high fidelity 20 WATT ampl. with equalizer and control sect. 1M dist. (80 cps) at rated power: 1.3% Power resp. ±0.5 db 20-20,000 cps; ±1.5 db 10-40,000 cps; Freq. resp. ±0.5 db 13-35,000 cps; ±1.5 db 7-50,000 cps; Harm. Dist. approx. 1% Mid-band Harm Dist. 0.30%.....\$44.95
- COMPLETE KIT, READY TO BUILD.....\$44.95
- WIRED. READY TO PLAY.....69.95
- DELUXE AMPLIF. KIT—Model SBFL30—An ultra fine 30 watt amp. Kit with transistorized pre-amp. Assures high gain low noise front end. Freq. Response: —1db 10-40,000 cps. —1/2 db 20-20,000 cps. below 28 watts. 6 tubes, 6 controls in ebony cab. with gold panel. Complete with all parts, tubes, punched chassis, diagrams and manual of instruction, less solder and wire.....\$44.95
- HI-FI AM-FM TUNER KIT—Model SBHF77—A choice companion to the Amplifier. Features: Foster-Seelye Disc, Grounded Grid Amplif. AFC with prov. for erase. Freq. Range: FM-88 to 108 mc. AM-535 to 680 kc. 7 tubes with sel. rect. Size 5 1/4 x 9 1/2 x 8" deep. Complete ready to build with all parts, tubes, illustrated manual. Shipping Wt. 9 lbs. Model SBHF77.....\$29.95
- Model SBFM6. For FM reception only.....\$22.95
- Cover for above models.....3.50

### SPECIAL COMBINATION! GARRARD-RC 121 4 SPEED HI-FI UNIT

Includes: GE RFX050A magnetic cartridge, BOGEN RR510C AM-FM-RECEIVER (tuner & amplifier on a single compact chassis. 10 watt amplif., flat freq. resp., low dist. Autom. Freq. Control for precise tuning. Includes volume, tone, and function selection plus connections for a tape recorder). SP12B ELECTRO-VOICE 12" SPEAKER (50-50 cps, 20 watts, Resp. 30-13,000 cps, 16 ohm imp. Sens. rfg 46 db. Crossover 4500 cps. 1 lb. Alnico V magnet 1 3/4" dia.). BASE REFLEX CABINET (Modern design, completely insulated heavy plywood construction) and RECORD CHANGER BASE.

A \$250.00 VALUE— **\$199.95**

YOURS FOR ONLY.....  
For DIAMOND NEEDLE on LP additional.....\$11.00 Specify BLOOMER OR MAROON GAN FILLS discs.  
You may choose other components in place of above. Send us your list for lowest package price.

**DEALERS:** Write for low cost prices and "56 models"—HALL-CRAFTERS, SUPERIOR, NATIONAL, PRECISION, KICKOCK, TECHMASTER, G.E., WESTINGHOUSE, T. WAJESTIC, CRANE, GUY KITS, DELCO, GEN. MOTORS, BOGEN, GARRARD, KARLSON, HARMON-KARDON, ELECTRO-VOICE, UNIVERSITY, H. M. SCOTT. Address Inquiries Dept. RE-3.

**COMPLETE HIGH FIDELITY DEPARTMENT. SEND US YOUR LIST FOR LOWEST QUOTATIONS ON ANY ITEM**  
We invite export inquiries and offers. Our export department give special attention to expediting foreign orders at minimum commissions. We are authorized distributors for United Motors, all Delco and Gen. Motors Auto Radio parts in stock.  
We also carry a complete line of popular makes of Radio Tubes at 50/10 discount. Also many other special purpose and transmitting types, and all electronic test equipment at lowest prices. Send us a list of your requirements for prompt quotations. Terms: 20% with order. Balance C.O.D. All Prices F.O.B. NEW YORK Warehouse. Minimum order \$5.00. Write for our latest price list and Hi-Fi Catalog RE-3. All Prices Subject to Change Without Notice

**STAN-BURN RADIO and ELECTRONICS CO.**  
558 CONEY ISLAND AVE. • B'KLYN 18, N. Y.

RADIO-ELECTRONICS

Ronette Acoustical Corp. acquired a one-story building in Lynbrook, N. Y.

Premier Metal Products, New York, added an additional 5,000 square feet of warehouse facilities to its present plant.

**Mergers and Acquisitions**

Van Norman Industries, parent company of Insuline Corp. of America, merged Bingham-Herbrand Corp., car parts maker into its organization as a wholly owned subsidiary.

Hazeltine Corp., Little Neck, N. Y., merged with its wholly owned subsidiary, Hazeltine Electronics Corp., which it will operate as the Hazeltine Electronics Division. There will be no change in management, personnel or operations.

Sightmaster Corp., New Rochelle, N.Y., acquired Mutual Electronic Industries Corp., also of New Rochelle, manufacturer of cable and panel equipment and triaxial connectors for military and commercial use.

**Business Briefs**

... Winegard Co., Burlington, Iowa, manufacturer of TV antennas, reports orders in hand for the first quarter of this year far ahead of any previous year, according to John Winegard, president of the company. The Guarantee Sales Promotion Program, started this month, is meeting with enthusiastic approval everywhere. The promotion plans for 1957 will reach all channels of merchandising from the technician to the consumer. The company is backing the promotion with extensive advertising, including leading consumer magazines.

... RETMA president. Dr. W. R. G. Baker, vice president of General Electric, stated that the radio-electronics-TV industry has increased by 15% in 1956 and he predicted growth by another 10% in 1957. He pointed out that 11.5 million transistors were produced in 1956 and that this figure should reach 22 million by the end of 1957.

... Brand Name Surveys, Chicago, conducted its fourth annual survey of brand preferences in electronic components among service technicians last month. Questionnaires were mailed to more than 20,000 radio-TV technicians throughout the United States, requesting information on their brand preferences for a number of replacement components. They were also asked the reasons for their preferences. Survey results will be used by participating manufacturers as a means of improving their products for service technicians' use.

... 1957 Electronic Parts Distributors Show management advised that advance registration will again be in effect this year for the show which will be held in Chicago May 20-23. Attendance, expected to top 12,000, is limited to distributors and manufacturers and their representatives. A feature of the show this year will be small round-table discussions for distributors by top management personnel. END

**BEGIN YOUR  
RADIO ENGINEERING YEAR  
WITH MORE THAN 800 NEW IDEAS!**

No wonder engineers say the radio-electronics year begins in March! This year, the manufacturers and suppliers for this 12 billion dollar and still growing industry require 4 floors of the Coliseum to show you their new ideas.

834 exhibitors representing more than 80% of the industry's productive capacity will display all that's new in equipment, component parts, instruments and production at *The Radio Engineering Show*. Attending the Show gives you an opportunity to talk with the men responsible for these newest advances in radio-electronics. The 55 technical sessions of *The IRE National Convention*, with over 200 new papers presented by 22 different professional groups, will also inform you of up-to-the-minute developments in your specialized field of electronics.



Begin the year right. See and hear all that's new in 1957 radio-electronics. Plan to attend or, better still, make your reservations today!

**REGISTRATION:** IRE Members \$1.00  
Non-members \$3.00  
**MARCH 18-21**

The **IRE** National Convention  
Waldorf-Astoria Hotel and  
The Radio Engineering Show  
Coliseum  
New York City

The  
Institute of  
Radio  
Engineers



1 East 79th Street, New York 21, N. Y.

ask the  
**"Man-on-the-Roof"**  
why he prefers  
*South River*

**SN - 50  
CHIMNEY MOUNT  
SNAP-IN TYPE**

with unique U-Bolt INSTEAD OF SCREWS for easy one hand "Spintite" fastening. Hot Dip Galvanized — 12 Ft. Straps. two to a set. Same Unique U-Bolts used on Snap-in Wall Brackets. Also Available with Stainless Steel Banding.

Write for new 1957 catalog

**SOUTH RIVER**  
METAL PRODUCTS CO., INC.  
South River, New Jersey

pioneer & outstanding producer of finest line of antenna mounts.

**COYNE**  
TRAINS YOU  
IN SPARE TIME  
AT HOME

COYNE QUALITY TRAINING AT LOWEST COST

**TELEVISION**  
RADIO-COLOR TV

Only from famous COYNE do you get this modern up-to-the minute TV Home Training. Easy to follow instructions—fully illustrated with 2150 photos and diagrams. Not an old Radio Course with Television tacked on. Includes UHF and COLOR TV. Personal guidance by Coyne Staff. *Practical Job Guides* to help you EARN MONEY QUICKLY IN A TV-RADIO SALES AND SERVICE BUSINESS—part time or full time. COSTS MUCH LESS—pay only for training—no costly "put together kits."

**SEND COUPON FOR FREE BOOK**  
SEND COUPON BELOW for Free Book and full details including EASY PAYMENT PLAN. NO COST OR OBLIGATION—NO SALESMAN WILL CALL.

B. W. COOKE, Jr., Pres. **COYNE** ELECTRICAL SCHOOL FOUNDED 1899

A TECHNICAL TRADE INSTITUTE OPERATED NOT FOR PROFIT  
500 S. Paulina Dept. 37-HT4 Chicago 12, Illinois

**COYNE ELECTRICAL SCHOOL**  
Television Home Training Div.  
500 S. Paulina St., Chicago 12, Ill., Dept. 37-HT4

Send FREE BOOK and details of your Television Home Training offer.

Name \_\_\_\_\_  
Address \_\_\_\_\_  
City \_\_\_\_\_ State \_\_\_\_\_

YOUR AEROVOX  
**TV**  
ELECTROLYTIC  
CAPACITOR  
REPLACEMENTS



**TYPE AFH (85°C)  
TWIST-PRONG  
ELECTROLYTICS...**

the most complete line in the industry, more exact-duplicate replacements than anyone else. All AFH units offer improved hermetic-sealing, sturdy terminals and mounting prongs; hi-purity aluminum foil construction throughout.



**TYPE PRS (85°C)  
TUBULAR  
ELECTROLYTICS...**

compact capacitors in aluminum cans with cardboard insulating sleeves. Available in a complete selection of singles, duals, triples and multiples. Insulated, stranded copper wire leads standard on all units.



**TYPE PR WAX-  
FILLED TUBULAR  
ELECTROLYTICS...**

popular and economical units in cardboard tubes manufactured to the same high standards as more expensive metal-cased types. These are exact-duplicate replacements for TV receivers and antenna rotating devices.



**TYPE SRE  
"BANTAM"  
ELECTROLYTICS...**

Small in size but big in performance. Hermetically sealed in aluminum cans and furnished with cardboard insulating sleeves. Perfect for limited space assemblies and miniaturized low voltage circuits.

All these popular Aerovox TV electrolytic capacitors are always carried in stock by your local Aerovox Distributor. Ask him for your free copy of the complete Catalog with detailed listings and information on all Aerovox components.



**AEROVOX CORPORATION**

**DISTRIBUTOR SALES DIVISION  
NEW BEDFORD, MASS.**

In Canada: AEROVOX CANADA LTD., Hamilton, Ont.  
Export: Ad Auriema, Inc., 89 Broad St., New York, N. Y.  
Cable: Auriema, N. Y.

# People



Gail S. Carter was appointed assistant to Charles Koch, president of Merit Coil & Transformer Corp., Chicago, and elected to the board of directors. He was previously vice president of Permo, Inc. and sales manager of Pentron Corp., and is well known throughout the industry. Mr. Koch stated that in his new position Mr. Carter would be responsible for the company's sales, advertising and promotional activities. He added that the appointment was made in line with the company's expansion program which includes introduction of a complete line of industrial coils and transformers this year. Arnold Litteken remains as a vice president of Merit.



Bert Conway returned to Aerovox Corp., New Bedford, Mass., as executive vice president. He held the same position from 1946 to 1952 and has extensive experience in the automotive and aviation industries.



Max E. Markell was appointed manager of equipment sales for the RCA Components Division, Camden, N. J. He joined the RCA Tube Division in 1945 as senior salesman, equipment sales, in the Eastern equipment sales district.



W. E. Foster and Carl Russert were appointed vice presidents of General Industries Co., Elyria, Ohio. Foster was formerly manager of the Plastic Division and Russert treasurer and as-



sistant secretary of the company. Morris Barchard was named manager of the Plastic Division and C. M. Norris, assistant manager.

Frank D. Lintern was named assistant distributor sales manager of Elec-

# Low-Cost Power Transistors

**FOR EXPERIMENTERS  
AND RADIO AMATEURS**

Now you can build a variety of economical transistorized amplifiers capable of real power output . . . 10 watts in Class B push-pull. The CBS 2N255 and 2N256 feature high power coupled with high current amplification and their construction permits high heat dissipation. These alloy-junction germanium transistors are also designed for six-volt (2N255) and twelve-volt (2N256) battery operation . . . ideal for mobile use.



**2N255 ... \$2.95 net**



**2N256 ... \$3.45 net**

It's easy to put these transistors to work. CBS Power Transistor Applications, PA-16, gives complete data . . . operating notes . . . and six simplified power transistor circuits. Pick up this free booklet . . . and get your low-cost 2N255 and 2N256 transistors at your CBS Tube distributor's — today.

*Reliable products through  
Advanced-Engineering*



**semiconductors**

**CBS-HYTRON**

Semiconductor Operations, Lowell, Mass.

A Division of

Columbia Broadcasting System, Inc.

RADIO-ELECTRONICS



tro-Voice, Inc., Buchanan, Mich. C. E. Seaman was appointed sales manager of Power-Point phonograph cartridges. Lintern comes to the company from Jack Yount Sales Co., Dallas, and Seaman had been field sales representative for Voice of Music, Chicago.

**Obituaries**

Lt. Gen. Lewis A. Pick, U. S. Army (Ret.) member of the executive committee of ORRadio Industries, Inc., Opelika, Ala., and former chief of the U. S. Army Corps of Engineers, at Walter Reed Hospital, Washington, D. C.

Morton Lee, sales manager for a number of products of British Industries Corp., Port Washington, N. Y., at his home in Roslyn Heights, N. Y.

**Personnel Notes**

... William R. Anton and George Avalon were promoted to vice-presidents of Sales, and Manufacturing, respectively, of Permo, Inc., Chicago. Anton, former sales manager continues in charge of the sale and promotion of all company products including "Fidelitone" record-

ing tape, and phonograph needles and accessories, and "Permo-Point" coin phonograph needles. Avalon will be responsible for research, engineering and production.

... Harold S. Geneen, executive vice president of Raytheon Manufacturing Co., Waltham, Mass., was elected a director of the firm.

... Henry F. Argento joined Philco Corp., Philadelphia, as vice president and general manager of the Government & Industrial Division. He was formerly an executive with Raytheon. Philco also announced the promotion of three vice presidents to newly created positions as executive vice presidents: Joseph H. Gillies, operations; Larry F. Hardy, consumer products; Dr. Leslie J. Woods, research and engineering; John M. Otter, executive vice president of Philco since 1954, was named executive vice president-marketing.

... B. D. Bachin was appointed manager-technical products service, of the Eastern Region of the RCA Service Co., with headquarters in New York. Other newly appointed regional managers include: M. E. Wheaton, Mideast region, Philadelphia; C. L. Swinney, Southeast region, Atlanta; W. W. Gilreath, Southwest region, Dallas; E. D. Van Dyne, West-Central region, Kansas City; F. W. Hamre, Central region, Chicago; H. M. Madison, Western region, Hollywood, Calif., and H. E. Frisbie, East-Central region, Cleveland.

**3 big reasons why QUIETROLE**  
Reg. U. S. Pat. Off.

is "The Choice of Better Service Dealers Everywhere"

- 1 MERIT
- 2 QUALITY
- 3 RELIABILITY

The original product for quieting noisy controls and switches... the universal lubri-cleaner for TV and radio...

Say "QUIETROLE" to your distributor... be sure you get it.

**NO GUM! NO GOO! NO GRIME!**

Carried by recognized jobbers everywhere!

manufactured by

**QUIETROLE COMPANY INC.**  
Spartanburg, South Carolina

IN CANADA: Active Radio & TV Distributors  
58 Spadina Ave., Toronto 2B, Ont.

**Another Sencore Time-Saver**

**SENCORE TUBE and CAPACITOR LEAKAGE CHECKER**

A highly accurate tester for detecting leakage between tube elements. "Two Testers in One"

MODEL LC-2

Only \$24.95  
DEALER NET KIT - \$19.95

A reliable instrument for indicating capacitor leakage with 50 volts applied. Quickly indicates • Grid to cathode leakage • Grid emission • Heater to cathode leakage • Gassy tubes.

A must for servicing grid circuits

Checks 70 Critical Tube Types AT LEADING DISTRIBUTORS EVERYWHERE Mfg by

**SENCORE SERVICE INSTRUMENTS CORP.**  
171 OFFICIAL RD., ADDISON, ILL.

POPULAR SENCORE PRODUCTS

- Transistor Tester
- Leakage Checker
- Filament Tester
- Voltage Regulator
- Bias Supply

# BUILD THE BEST - BUILD ALLIED'S OWN knight-kits

ALLIED stakes its 36-year reputation in the Electronics field on your complete success and fullest satisfaction with KNIGHT-KITS. Join the thousands who have discovered the ultimate in kit value in...



## knight-kits

**LOWEST COST** because our giant buying power passes biggest savings on to you... you do the easy assembly and your finished instrument is equal in performance and appearance to equipment selling for several times the KNIGHT-KIT cost. (Easy Payment Terms available, too.)



## knight-kits

**EASIEST TO BUILD** because KNIGHT-KIT "Step-and-Check" instruction manuals are marvels of clarity—it's just like having a good instructor at your side. Proved professional design and premium quality parts help insure your building success.



## knight-kits

**MONEY-BACK GUARANTEE:** When properly assembled, KNIGHT-KITS fully meet published specifications, or we refund your money.

**WHEN YOU BUILD A KNIGHT-KIT YOU BUILD THE BEST**



For a Complete Selection of Famous knight-kits  
**SEE PAGES 85-91**

Available Only From

**ALLIED RADIO**  
100 N. Western Ave., Chicago 80, Ill.

## Examine FREE



## Prentice-Hall ELECTRONICS & UHF LIBRARY

Edited by  
W. L. EVERITT

5 VOLUMES 1662 ILLUSTRATIONS

Pay Easy Installments If You Keep the Set

Turn to this new, up-to-date Library with complete confidence, for dependable facts on any phase of modern electronic theory and practice. These volumes, by outstanding authorities, give you thorough guidance—clearly written, logically arranged, profusely illustrated.

### Electronic Fundamentals and Applications

By Prof. John D. Ryder,  
Dean, College of Engineering, Michigan State University  
Complete, logical, easy-to-follow treatment of (a) physical principles underlying electron tubes, (b) characteristics of vacuum tubes, (c) all basic tube circuits. Includes: Electron Ballistics, Cathode-Ray Tubes, Emission of Electrons, Space Charge in Vacuum Tubes, Diode Rectifiers, Triodes, Multi-Element Tubes, Small-Signal Amplifier Circuits, Audio-Frequency Amplifiers, Radio-Frequency Amplifiers, Oscillator Circuits, Modulation Systems, Wave-Shaping Circuits, Gaseous Conduction, Gas Diodes, Gas Control Tubes and Circuits, Photoelectric Cells, Solid-State Electronics.

### Electromagnetic Waves and Radiating Systems

By Prof. Edward C. Jordan,  
Head, Dept. Electrical Engineering, Univ. of Illinois  
Covers entire field of electromagnetic engineering. Includes propagation as well as radiation and transmission. Full treatment of UHF transmission lines, wave guides, antennas, slot antennas, radiation and diffraction, ground-wave and sky-wave propagation.

### Ultra High Frequency Engineering

By Thomas L. Martin  
Head, Dept. of Electrical Engineering, Univ. of Arizona  
Theory and technique of ALL the new fields of electronic engineering: Radar, Telemetry, Electronic computing, Facsimile, Television, Blind landing systems, Pulse-time modulation, Ionosphere measurements . . . and the others.

### Networks, Lines and Fields

By Prof. John D. Ryder,  
Dean, College of Engineering, Michigan State University  
Network transformations and theorems, Resonance, Impedance transformation and coupled circuits, Filters, General transmission line, High-frequency line, Equations of the electromagnetic field, Radiation, Transmission and reflection of plane waves at boundaries, Guided waves between parallel plates, Wave guides.

### Elements of Television Systems

By George E. Anner, University of Illinois  
Complete basic theory, plus current practice, covering: Closed TV systems, Commercial, Telecasting Systems, Color TV Systems. Gives clear exposition of all phases of picture transmission, including the new technique of dot interlace.

## SEND NO MONEY—EXAMINE FREE

Just mail coupon below to get complete 5-Volume Set on 10 DAYS' FREE TRIAL. If not completely satisfactory, return in ten days and owe nothing. Or keep the set and pay only \$7.50 down and \$8 a month for five months until full price of \$47.50 is paid. Or I will return the Library in ten days and owe nothing.

Prentice-Hall, Inc., Dept. 5744-D-1  
Englewood Cliffs, N.J.

Send me the Prentice-Hall ELECTRONICS & UHF LIBRARY (5 Volumes) for ten days' free examination. If fully satisfied in ten days I will send you \$7.50 plus few cents postage and then \$8 a month for five months until full price of \$47.50 is paid. Or I will return the Library in ten days and owe nothing.

Name.....  
Address.....  
City and State.....

## Almo Offers the Best

### Buy on PORTABLE TV TABLES



1" Steel Tubing, Clear Plastic 3" Casters, 19" High, Arms extend from 19" to 33"  
TT-3 Satin Black Finish  
Single Lot Price \$3.95  
12 Lot Price \$3.75  
TT-4 Gold Tone Finish  
Single Lot Price \$4.95  
12 Lot Price \$4.50

3/4" Steel Tubing, Translucent 2" Casters, 18" High, Arms extend from 19" to 31"

TT-1 Satin Black Finish  
Single Lot Price \$2.95  
12 Lot Price \$2.75  
TT-2 Gold Tone Finish  
Single Lot Price \$3.95  
12 Lot Price \$3.75



SWIVEL TYPE  
1" Steel Tubing, Ball Bearing Swivel Top, Plastic Guides, 17" High, Arms extend from 19" to 31"  
TT-5 Satin Black Finish  
Single Lot Price \$4.30  
12 Lot Price \$4.15

NOW AVAILABLE AT THE  
**Almo RADIO CO.**  
913 ARCH ST., PHILA., PA.  
ATLANTIC CITY, CAMDEN & TRENTON, N. J.  
NORRISTOWN, PA.; WILM., DEL.; SALISBURY, MD.

## Can you think faster than this Machine?



Control Panel of GENIAC set up to do a problem in check valve research.

Be careful before you answer. GENIAC the first electrical brain construction kit is equipped to play tic-tac-toe, cipher and encipher codes, convert from binary to decimal, reason (in syllogisms) as well as add, subtract, multiply and divide. Specific problems in a variety of fields—actuarial, policy claim settlement, physics, etc., can be set up and solved with the components. Connections are solderless and are completely explained with templates in the manual. This covers 43 circuits and shows how new ones can be designed.

You will find building and using GENIAC a wonderful experience; one kit user wrote us: "This kit has opened up a new world of thinking for me. . . You actually see how computing, problem solving, and game play (Tic-tac-toe, Nim, etc.) can be analyzed with Boolean Algebra and the algebraic solutions transformed directly into circuit diagrams. You create from over 400 specially designed and manufactured components a machine that solves problems faster than you can express them."  
Schools and colleges, teachers of science or math, engineering, philosophy or psychology will find these excellent demonstrators of circuitry, solutions in symbolic logic, theory of numbers, cybernetics, and automation.

Note: Teachers take advantage of our 10% discount to educational institutions and for group purchases.  
SEND for your GENIAC kit now. Only \$19.95 with over four hundred components and parts, fully illustrated manual and wiring diagrams. We guarantee that if you do not want to keep GENIAC after one week you can return it for full refund plus shipping costs.

### MAIL THIS COUPON

SCIENCE KITS, Dept. RE37, Oliver Garfield Co.  
126 Lexington Ave., N.Y. 16, N.Y.

Please send me:  
I GENIAC Electric Brain Construction Kit and Manual.  
\$19.95 (East of Mississippi) .....  
\$20.95 (Elsewhere in United States) .....  
\$21.95 (Outside the United States) .....

Returnable in seven days for full refund if not satisfied.  
I enclose \$..... in full payment.  
My name and address are attached.

## CRYSTAL CONTROLLED CONVERTERS

POLICE • FIRE • COMMERCIAL



- ✓ Precision—Stability
  - ✓ Sensitivity
  - ✓ Easy Installation
- \$32.50**

• A compact converter supplied with commercial tolerance crystals, self contained automatic noise limiter. Also models with squealer. Ideal for mobile or home use.

### TUNERS

- Precision FM Programs While You Drive.
  - FM BROADCAST
    - 30-50 MC
    - 108-176 MC
- from **\$22.50**



WRITE FOR LITERATURE

**KUHN ELECTRONICS**  
20 GLENWOOD CINCINNATI 17, OHIO

## LOST OUR LEASE!

MUST CLEAR WAREHOUSE!  
Sacrificing \$50,000 stock at 5c on Dollar!  
Our Loss Your Gain!

## GIANT KIT

for Experimenters, Servicemen, Repairmen  
40-50 lbs. of BRAND NEW, usable parts for ham transmitters and receivers. Consists of: Wire wound and metallized resistors; By-pass and filter condensers; Variable, padding, and trimming condensers; Input, Output, Power transformers; RF and Audio-filter Chokes; Volume Controls; Assorted Knobs; Hook-up Wire; Gang switches; Chassis; Voltage Dividers; Receiving and transmitting sockets, all sizes; PLUS MORE!

Total Retail Value over \$100.00  
Only 200 kits at..... **\$9.95**  
Freight or express shipments only. FOB Newark. No COD. Full amount must accompany each order.

**UNITED RADIO COMPANY**  
58 Market Street, Newark, N.J.

## TELEVISION & ELECTRONIC TECHNICIANS

Working for Peanuts?  
Join the crusade for the independent serviceman.

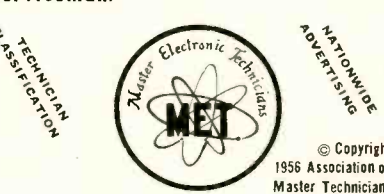

Help stop the squeeze by big business that is attempting to deprive the independent electronic serviceman of his profit and livelihood. If you are interested in becoming a Master Electronic Technician, for complete details, write

Association of Master Technicians  
765 South Street  
Boston 31, Mass.

# technical Literature

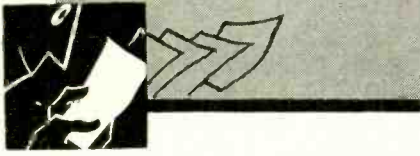

## COMPOSITION RESISTOR

Bulletin B-1A gives comprehensive data on the construction, characteristics, solderability, heat dissipation, color coding, resistance values and tolerances of type BT fixed-composition resistors. Detailed charts and graphs further facilitate the correct choice of product.

International Resistance Co., 401 No. Broad St., Philadelphia 8, Pa.

## CARTRIDGES

The reader will find *In The Groove* a source of information on the various popular types of cartridges, their basic design, construction and operation.

Fairchild Recording Equipment, 10-40 45th Ave., Long Island City 1, N. Y.

## SEMICONDUCTOR PRODUCTS

Over 80 transistor and diode types are included in a new and enlarged *Semiconductor Products* booklet. Of its five pages, over one full page gives representative physical specifications.

Raytheon Mfg. Co., Receiving & Cathode-Ray-Tube Operations, 55 Chapel St., Newton 58, Mass.

## CAPACITORS

GET-2671 contains descriptive information and lists ratings and dimensions of the manufacturer's molded PVZ tubular capacitors.

General Electric, Schenectady 5, N. Y.

## \$3 TELEVISION COURSE

A new descriptive circular highlights a correspondence television course at only \$3 and lists other related aids to the home student.

Supreme Publications, 1760 Balsam Rd., Highland Pk., Ill.

## CERAMIC CAPACITORS

Catalog No. 616 presents a complete line of standard ceramic capacitors and invites customers' inquiries about those of special design for specific electrical and mechanical requirements.

Cornell-Dubilier Electric Corp., So. Plainfield, N. J.

## TWIST-MOUNT ELECTROLYTIC CAPACITORS

A new interchangeability guide for twist-mount electrolytic capacitors for the jobber and service technician matches manufacturer's catalog number with replacement stock and catalog numbers. On the last page of the booklet is a complete list of the replacement line itself.

Pyramid Electric Co., 1445 Hudson Blvd., North Bergen, N. J.

**XCELITE Hand Tools**  
PREFERRED BY THE EXPERTS



#99 JR Set

NEW  
99-X10  
Shaft  
makes your  
99-PR  
and 99-JR  
sets more  
useful  
than ever!

SNAP IN

THIS EXTRA

8"

REACH!

Fits all nut  
driver and  
single end  
screwdrivers  
in 99  
sets

One end snaps firmly into your 99-PR or 99-JR handle — nut driver or single end screwdriver snaps into other end of extension shaft. You've added 8" for those hard-to-reach jobs. Your distributor has them.

## XCELITE, INCORPORATED

Dept. J, Orchard Park, N. Y.

In Canada—Charles W. Pointon Ltd., 6 Alicia Ave., Toronto, Ontario

For Originality  
LOOK TO XCELITE

BA's NEW 1957

172 PAGE **FREE CATALOG**



COMPLETE GUIDE TO EVERYTHING IN RADIO, TV, ELECTRONICS

100's OF BRAND NEW ITEMS LISTED HERE FOR THE VERY FIRST TIME

INCLUDES 23 PAGES OF AMAZING BARGAINS, NOT FOUND IN ANY OTHER CATALOG

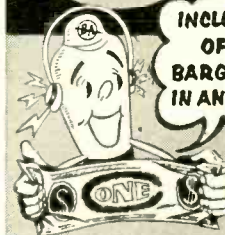

SEND FOR IT TODAY!

BURSTEIN-APPLEBEE CO. Dept. S, 1012-14 McGee St., Kansas City 6, Mo.

Send Free BA Catalog No. 571.

NAME \_\_\_\_\_

ADDRESS \_\_\_\_\_

CITY \_\_\_\_\_

STATE \_\_\_\_\_



## Join the G/L Technicians' Book Club

Keep up with all the new developments in servicing. Get a new book every four months at a saving of 27%

Write for details

Gernsback Library, Dept. 37  
154 West 14th St.  
New York 11, N.Y.

# TECHNICAL WRITERS

Fascinating career for persons with a flair for writing plus a scientific education, background and experience in any of the following fields:

**RADAR (Communication)**

**ELECTRONICS**

**PHYSICS**

**COMPUTERS**

We need writers to prepare instructional and course material on large scale digital computers and related devices. Military training in the field of writing is often satisfactory. Let us decide whether your qualifications meet our requirements. Send complete resume to:

**Mr. R. K. Patterson**

**Remington Rand Univac**

DIVISION OF SPERRY RAND CORPORATION

UNIVAC PARK • ST. PAUL 16, MINNESOTA

**NOW!**

Step ahead faster  
as an

**INDUSTRIAL  
ELECTRONICS  
TECHNICIAN**



Turn your experience into a big, new better-paying career!

Day by day industrial plants are adding more electronic devices—for sorting, counting, checking almost any control job you can name. Cash in on industry's great need for men who can keep these devices in top working order. Make more money, feel more secure, doing work that is second nature to you. With what you already know about electronics you have a long head start in a field just beginning to boom. GET INTO IT RIGHT NOW with the help of

## PRACTICAL INDUSTRIAL ELECTRONICS LIBRARY

No long sessions on math or theory! These 4 practical volumes show you how to keep the plant's electronic equipment working . . . how to locate and correct tube and circuit troubles . . . how to install, service, and maintain even brand new equipment without being stumped by new circuits!

**FREE TRIAL—EASY TERMS!**

4 volumes (1369 pp., 1102 illus.)  
Chute's Electronics in Industry

Miller's Maintenance Manual of Electronic Control

Markus & Zeluff's Handbook of Industrial Electronics Circuits

Henney & Fahnestock's Electron Tubes in Industry

McGraw-Hill Book Co., Dept. RE-3,  
321 W. 41st St., N.Y.C. 36

Send me the Practical Industrial Electronics Library for 10 days' examination on approval. In 10 days I will send \$2.50, then \$4.00 a month until \$22.50 is paid. (A saving of \$4.50 under the regular price of \$27.00.) Otherwise I will return books postpaid. (Print)

Name.....  
Address.....  
City..... Zone..... State.....  
Company.....  
Position..... RE-3

For price and terms outside U.S. write  
McGraw-Hill Int'l., N.Y.C.

SAVE 1/2 — PAY PART-BY-PART — HAVE FUN

Assembling the Schober

**ELECTRONIC ORGAN** in KIT form



**NO SPECIAL SKILLS NEEDED**

Now you can afford a real, full concert organ, just like those made by the foremost organ manufacturers. Because over 1/2 the cost is saved when you assemble it yourself. And it's REALLY EASY: only 24 separate units, all with printed circuits, and detailed-to-the-smallest-step instructions. In addition, you purchase each of the 24 kits when you are ready for it — and can afford it.

You'll get a real kick out of putting the \*Schober Electronic Organ together — and then sitting down and pulling out the stops for Strings, Trumpets, Clarinets, Diapasons, Flutes, etc.

### Compact CONSOLE

One of the many exclusive features of this exceptional offer is the handsome console, made by hand in Old World Craftsman manner. It is equally at home in a traditional or modern setting, and takes little more space than a spinet piano.

### Free Literature

Complete descriptive booklet and price list are available on request. And, if you wish to hear the glorious pipe organ tone of the Schober Electronic Organ, a 10" long playing recording by Dr. C. A. J. Parmentier, renowned organist, is available for \$2. This is refundable when you order. Write today and see what a fine instrument you can get at such a great saving.

### The SCHOBER ORGAN CORPORATION

2248-E Broadway, New York 24, N.Y.

\*Designed by Richard H. Dorf

TECHNICAL LITERATURE (Continued)

### SERVICE AIDS

Vol. 1, No. 4, of *Tips for the Serviceman* offers the experimenter a story on high-gain amplifiers for selenium photocells.

*International Rectifier Corp., El Segundo, Calif.*

### MAGNETRON AND TRAVELING-WAVE TUBES

Information on the features and applications of magnetrons and traveling-wave tubes, their theory of operation, operating considerations and applications and techniques for measurement of important electrical parameters, can be found in *Booklet MT-301*. Illustrations show the structural parts of both tube types, typical performance characteristics, test methods.

*RCA Tube Division, Commercial Engineering, Harrison, N. J., 50c.*

### RECORDING SUPPLIES

Two new catalogs will be helpful in the area of voice and music reproduction. *Replacement Manual RM-56* deals with cartridges, magnetic recording heads, phonograph needles and kits. *General Catalog No. 56* features microphones and electronic components.

*Shure Brothers, Inc., 222 Hartrey Ave., Evanston, Ill.*

### TEST EQUIPMENT

A new test equipment catalog describes and illustrates a number of pieces of test equipment for the technician, engineer and dealer.

*Hickok Electrical Instrument Co., 10514 Dupont Ave., Cleveland 8, Ohio*

### TUBES

This comprehensive chart entitled *Preferred Tubes Replacement Guide* lists types and prices of hundreds of tubes for British and European equipment, particularly high-fidelity audio amplifiers, FM and AM tuners, tape recorders and television sets. Cross-reference data show the interchangeability of these tubes with American and European brands.

*International Electronics Corp., (Mul-lard Products), 81 Spring St., New York 12, N. Y.*

### TRANSISTOR CIRCUITS

A series of pamphlets introduces this manufacturer's electronic products. *J-780* presents his complete line of components for transistor circuits. *J-781* announces and details a build-it-yourself all-transistor receiver. *J-782* shows the construction of the Little Handy, a two-transistor signal tracer.

*Thordarson-Meissner, 7th & Belmont, Mt. Carmel, Ill.*



Any or all of these catalogs, bulletins, or periodicals are available to you on request direct to the manufacturers, whose addresses are listed at the end of each item. Use your letterhead—do not use postcards. To facilitate identification, mention the issue and page of RADIO-ELECTRONICS on which the item appears. UNLESS OTHERWISE STATED, ALL ITEMS ARE GRATIS. ALL LITERATURE OFFERS ARE VOID AFTER SIX MONTHS.



still **TOPS...**  
in the  
**2-Set**  
market!



the  
**MOSLEY**  
*Dual-Match*  
**TV Coupler**

- tops for...
-  Impedance match
  -  Signal transfer
  -  2-Set isolation

With the **MOSLEY Dual-Match TV Coupler** "convenience" becomes a byword for the folks who have that *extra TV* for the den or play-room!

The *Dual-Match Coupler* is efficient, solderless, compact and so easily installed on baseboard or set—yet priced so low you are assured complete customer satisfaction.

Available at Radio and Television Parts Distributors, Coast-to-Coast.

MOSLEY 902 List Price **\$ 2.95**

**Mosley Electronics, Inc.**  
6022 ST. CHARLES ROCK ROAD, ST. LOUIS 14, MISSOURI

**LMB "SAL-MET"**  
LMB Presents The New  
FREE 1957 CATALOG covering the full precision engineered line of original box chassis as manufactured by LMB including new Miniature, new Jiffy, new T.F., new Utility Boxes. Eleven different types, 160 different shades and sizes. A ready reference for engineers, experimenters or anyone using metal boxes. Send for your FREE CATALOG now! "SAL-MET" Non-corrosive Flux—solders copper to aluminum, aluminum to aluminum, any metal to any metal using conventional solder and regular soldering methods. Send for both LMB and "SAL-MET" Catalogs.  
LMB, 1011 Venice Blvd., Los Angeles 15, Calif.

# Books

**COLOR TV TRAINING MANUAL**, by C. P. Oliphant and Verne M. Ray. Howard W. Sams & Co., Indianapolis, Ind. 8½ by 11 inches, 258 pages. \$6.95.

Specially slanted toward the service technician, this book provides a good coverage of the color television field to date. The text is broken into three sections, covering principles of the color TV system, color receiver circuits and servicing the color receiver. In addition there are several foldout charts that greatly aid in the explanation of the color television system.

**DICTIONNAIRE FRANCAIS - ANGLAIS** des termes relatifs à L'ELECTROTECHNIQUE, L'ELECTRONIQUE et aux applications, compiled by Henry Piraux. Editions Eyrolles, 61 Blvd. Saint-Germain, Paris 5, France. 168 pages. 1,035 Fr.

A French-English technical dictionary of over 10,000 words and terms related to sound, atomics, movies, lighting, electricity, plastics, optics, nuclear physics, radar, radio, television, telephony, telegraphy, and so on. Very useful to English-speaking technicians with a working knowledge of French.

**AUDIO CONTROL HANDBOOK FOR RADIO AND TV BROADCASTING**, by Robert S. Oringel. Hastings House Publishers, Inc. New York. 145 pages. \$6.50.

A manual to acquaint the newcomer to the field with the equipment, techniques and applications of the various types of audio apparatus and accessories used in the many phases of broadcasting and recording. Complete with a glossary of pertinent terms and photographs illustrating the various hand signals used for communicating in the studio and control room.

**TELEVISION ENGINEERING, Vol. 2**, by S. W. Amos and D. C. Birkinshaw. Philosophical Library, 15 E. 40 St., New York, N. Y. 5½ x 8½ inches, 270 pages. \$15.

This is Vol. 2 of a series of training manuals prepared for BBC personnel. Although its technical level is higher than the minimum for service technicians, it will appeal to those who wish a clearer understanding of video circuits and how to design them. A knowledge of algebra and vectors is assumed.

The first chapter shows TV patterns resulting from circuit defects. The remainder of the book is concerned with

avoid  
a costly  
mistake  
in your  
high fidelity system

send for this new  
**REK-O-KUT** booklet  
*colorfully illustrates...  
factually describes...* the  
important advantages of  
playing your records on a  
precision turntable!

**FREE — SEND COUPON TODAY!**

NAME \_\_\_\_\_  
ADDRESS \_\_\_\_\_  
CITY \_\_\_\_\_ ZONE \_\_\_\_\_ STATE \_\_\_\_\_

**REK-O-KUT COMPANY, INC.**  
38-01 Queens Blvd.  
Long Island City 1, N. Y. RE

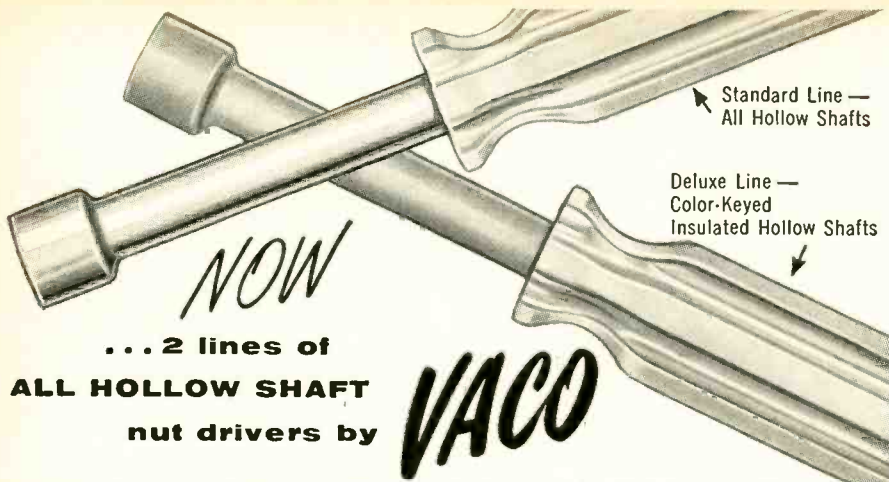

**... 2 lines of ALL HOLLOW SHAFT nut drivers by**

**VACO**

All VACO Nut Drivers NOW Hollow Entire Shaft Length. A Size For Every Need!

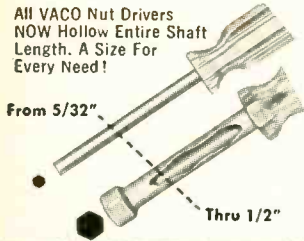

Now you can get *hollow shaft* nut drivers at economy prices with VACO'S standard line... or color-keyed, insulated hollow shafts with VACO'S deluxe line. Both have *extra hard long wearing sockets* and both are unconditionally guaranteed.

Displayed on the VACO Vari-Board at your jobber  
**VACO PRODUCTS CO., 317 East Ontario St., Chicago 11, Ill.**  
 In Canada: Atlas Radio Corp., Toronto 10

**GARAGE DOOR OPENER** Actuator Mechanism **\$24.50**  
 EASY TO INSTALL. SAFE. RELIABLE  
 WRITE for interesting free information... TODAY  
**P. E. HAWKINS CO.**  
 631 PROSPECT DEPT. R-E KANSAS CITY 24, MO.

**REVOLUTIONARY TEST CONNECTOR**



Ask your Jobber for E-Z Hook Test Probes. Amazingly simple... fully insulated... Patented Hook type design... nothing like it. Greatest improvement in selfholding connectors in years. New... different operating principle. Scientifically designed for better, safer connections. It's terrific. Get one today. E-Z Hook Test Products, 1536B Woodburn, Covington, Ky.

*Dave Rice's*  
**OFFICIAL ORDER BOOK**  
 for every TV-Radio service call



Triplicate forms serve as order form, invoice and office record with spaces for complete information on every job. Separate listings for receiving tubes, pix tube, parts, serial numbers, labor and tax charges, signatures, etc. 75c a book, \$6.50 for dust-proof box of 10.

... and for customer's prices on every replacement part, *Dave Rice's*

**OFFICIAL PRICING DIGEST**  
 listing over 60,000 items. \$2.50  
 In stock at your distributor, or write  
**ELECTRONIC PUBLISHING CO. INC.**  
 180 North Wacker Drive Chicago 6, Illinois

**BE QUALITY WISE... BUY QUAL-KITS!**



**HI-FI AMP. KIT**  
 Complete 6 tube-10 watt amplifier. Push-pull beam power output, built-in pre-amp. 5 position selector switch, 3 position record equalization, LP, RIAA, Eur. Response 1/2 db. 20-20,000 cps. Output 10 watts at less than 2% IM. Low noise level and harmonic distortion. **\$28.50**

Every kit complete with 28 page fully illustrated instruction and assembly manual. Cover and legs optional.



**HI-FI AM-FM TUNER KIT**  
 Advanced 7 tube circuit plus Rectifier for full sensitivity and selectivity. Distortion less than 1%. Sensitivity is 5 uv for 30 db quieting on FM, 25 uv AM. Armstrong FM Circuit with limiter. Foster-Seeley Discriminator. 20-20,000 cps response. Full AFC control — no drift. Easy assembly. **\$28.95\***

Write for FREE catalog and name of nearest dealer carrying these remarkable units.

\*Add 10 percent for new federal tax  
**QUALITY-ELECTRONICS**  
 319 Church St. Dept. R-E3 New York 13, N. Y.

**ENGINEERING B. S. DEGREE IN 27 MONTHS**

Prepare for unlimited opportunities of the Electronic Age! Earn your B.S. degree in 27 months at Indiana Technical College. Intensive specialized course. Comprehensive training in electronics, television, advanced radio theory and design, math and electrical engineering. Modern laboratories. Low rate. **B.S. DEGREE IN 27 MONTHS** in Aeronautical, Chemical, Civil, Electrical, and Mech. Engineering; in 36 MONTHS in Mathematics, Chemistry, Physics. Also Engineering Science preparatory courses. G. I. approved. Enter March, June, Sept., Dec. Earn part of your expenses in Fort Wayne. Catalog.

**INDIANA TECHNICAL COLLEGE**  
 1737 E. Washington Blvd., Fort Wayne 2, Indiana  
 Please send me free information on B.S. ENGINEERING DEGREE IN 27 MONTHS as checked.  
 Electronics  Chemical  Aeronautical  
 Civil  Mechanical  Electrical  
**B.S. DEGREE IN 36 MO. in:** Math.  Chem.  Physics   
 Name.....  
 Address.....

video amplifiers, low- and high-frequency compensation, passband and gain considerations, feedback and noise. The important working equations are derived (in several appendices) then plotted as universal (normalized) curves applicable to any frequency. From them, numerical examples are worked out by the authors.—IQ

**THE WORLD AT A TWIRL**, compiled by Ken Boord. (First ed., Summer, 1956) Kenneth R. Boord, 948 Stewartstown Road, Morgantown, W. Va. 11 x 8 1/2 inches, 126 pages. \$2.50 postpaid.

The first serious American attempt in recent years to produce a comprehensive shortwave station log, this work fills a pressing need. The log portion of the book covers 54 large pages, with stations arranged alphabetically by countries. Schedules and frequencies are given. This section is followed by a listing of English-language broadcasts from all countries, arranged by time. All times are given in Greenwich, now sometimes called Universal, Time (UT).

The log portion is preceded by some 50 pages of introductory, historical and explanatory material which will be appreciated by the newcomer and old-timer alike.—FS

**HOW TO MAKE GOOD TAPE RECORDINGS**, by C. J. LeBel. Audio Devices, Inc., 444 Madison Ave., New York 22, N. Y. 5 1/4 x 8 inches, 151 pages. Paper \$1.50, cloth \$2.50

Tape recording, like photography, has become a great national hobby as well as profession. In this handbook, the novice, amateur, educator and engineer learn how to make recordings for fun and profit. Starting with fundamental theory, it tells how to select a recorder, how to operate and how to maintain it. The style is interesting and clear, the information practical and helpful.

If you want to know how to record a wedding or party, how to make special sound effects or put on a show, you will find these topics covered here. Microphone technique, binaural recording, and tape editing are also discussed.—IQ

**MATHEMATICS FOR ELECTRONICS**, with Applications, by Henry M. Nodelman and Frederick W. Smith. McGraw-Hill Book Co., New York. 391 pages. \$7.

Attempting to produce a mathematical work free from the curse of the classical approach, the authors open with a chapter of case histories of practical applications, showing how mathematics has aided in science and engineering, followed by a chapter showing electronic applications of calculus. This is followed by a discussion of dimensional systems, the algebra of circuit analysis, theory and applications of series, differential equations, elementary Laplace transforms and Boolean algebra. The book closes with a study plan in mathematics for specialists in electronics.—FS

**HANDBOOK OF PREFERRED CIRCUITS, Navy Aeronautical Equipment (NAVAER 16-1-519).** by J. H. Muncy. Government Printing Office, Washington 25, D. C. Approximately 204 pages. \$1.75.

A selection of 32 preferred electronic circuits for use in Navy aeronautical equipment. The first part (136 pages) includes voltage regulators, multivibrators, blocking oscillators, video detectors, amplifiers, limiters, age and squelch circuits, frequency dividers and noise limiters. Circuit specifications are given and tolerances are listed for all pertinent parts.

The second part contains notes explaining the steps which led to the selection and design of each preferred circuit and is of particular value to the engineer whose interest extends beyond an immediate problem.

**RAPID TV REPAIR,** by G. Warren Heath. No. 60, Gernsback Library. Gernsback Library, Inc., 154 W. 14th St., New York, N. Y. 5 1/2 x 8 1/2, 224 pages. Soft cover, \$2.90, hard cover, \$4.60.

The TV technician must know how to give speedy service if he wants to become and remain successful. With the growing complexity of circuits, even the most experienced technician will find ready help in these pages. The contents are arranged alphabetically for easy location of TV topics and defects. "Pix" troubles are found under P, "retrace" under R, "corona" under C, and so on. The symptom is followed by the recommended and detailed service procedure to clear it up.

An efficient cross-index makes it easy to find the desired page, and the many schematics and patterns will aid the radio repairman.—IQ

**THE RADIO-ELECTRONIC MASTER**—Official Buying Guide of the Industry, 1957 (21st) Edition. United Catalog Publishers, Inc. New York. 1534 catalog pages. \$2.95 through electronic parts distributors.

A catalog listing approximately 386 makes and brands of parts, equipment, tools and accessories for the TV, radio and electronic industries. A 15-page directory gives names, addresses and phone numbers of manufacturers whose products are listed.

**AUTOMATIC RECORD CHANGER AND TAPE RECORDER SERVICE MANUAL, Vol. 8 (CM-8).** Howard W. Sams & Co., Indianapolis 5, Ind. Pages not numbered. \$3.95.

A compilation of Photofact folders covering 1955 and 1956 models of record changers and tape recorders. The index lists all types and models listed in this and previous volumes. A cross-reference index identifies the makes and models of changers used in various radios and phonographs. END

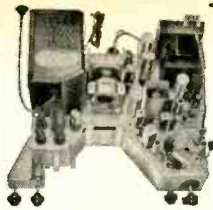

Build your own

SUPER DE LUXE  
31-TUBE

#630 TV CHASSIS

#630 SUPER DELUXE 31-TUBE TV KIT

OPERATES 21" and all 70" PICTURE TUBES • Engineered in strict adherence to the genuine RCA #630 plus added features • FULL 4MC BANDWIDTH • CASCODE TUNER • COSINE DEFLECTION YOKE • LARGER POWER TRANSFORMER • KEYS AGC • 12" SPEAKER • CONDENSERS and RESISTORS at rated capacities and tolerances. You receive a COMPLETE SET OF PARTS and TUBES, everything needed is included (less CRT). All I.F. Coils and Transformers are factory pre-aligned and tuned. You will enjoy building it with "LIFE-SIZE" easy to follow step-by-step ASSEMBLING INSTRUCTIONS" included with each KIT. Wire and solder included.

slashed to \$99.99

WESTINGHOUSE OR CBS PICTURE TUBES

BRAND NEW in Factory Sealed Cartons—With a Full Year Guarantee

17" 70° #17BP4A \$22.66	21" 70° #21EP4B \$32.21	24" 90° #24CP4A \$48.99	27" 90° #27EP4A \$74.31
90° #17AVP4A Aluminized	90° #21ALP4A Aluminized	Aluminized	Aluminized



HOTTEST "DO-IT-YOURSELF" SENSATION  
TV FRONT PANEL ASSEMBLY

For CABINET BUILDING & WALL INSTALLATIONS

This New TV FRONT PANEL ASSEMBLY introduces a new concept in Cabinet building. Nine tenths of the job is done. The completed Cabinet will cost you less than one half of market value and will be comparable with the type and quality used in the highest priced TV Receivers.

All you add are Masonite (sold in prefinished matching colors) Sides, Top and other simple fittings. The magic of Masonite and the simplicity of our step-by-step instructions, assure gratifying results.

This TV PANEL is invaluable for WALL INSTALLATION or for use as a NEW FRONT to modernize an old TV Cabinet.

Each TV FRONT PANEL ASSEMBLY is truly custom-built of genuine SOLID Mahogany, Walnut or Blond Korina in a handrubbed finish. For those who want to match their own colors, we supply any PANEL in natural (unfinished).

Complete As Pictured—in any finish, including Mask, Safety Glass, Decals, Knob Panel blank or drilled on receipt of your template. Building Instructions incl. On 21" PANEL. Specify type of Picture Tube used.

21" 25 1/4"W x 25 3/4"H.....	\$17.45
24" or 27" 28 1/2"W x 30"H.....	\$22.97

21" TV CONVERSION KIT

Convert any Size, any Make TV RECEIVER to operate the 21" or ANY 70" PICTURE TUBE.

BASIC TV CONVERSION KIT—Matched SET 70° YOKE & FLYBACK TRANSFORMER \$9.78  
CONVERSION MANUAL Instruction Diagrams

COMPLETE SET OF ESSENTIAL PARTS includes matched set of Todd 70° COSINE DEFLECTION YOKE and TODD HV FLYBACK TRANSFORMER, FOCALIZER, 20KV FILTER, DRIVE TRIMMER, LINEARITY COIL, CONDENSERS, RESISTORS.

Your Price... \$13.97  
Incl. CONVERSION MANUAL with Step-by-Step Instructions & Diagrams.

List Price \$33.50

TV CRYSTAL-CLEAR LUCITE MASKS

Tube Size	Overall Dimensions	Price
17"—Rectangular	13 1/2" x 16 1/2"	\$ 4.56
21"—Rectangular	16 1/2" x 21 1/2"	6.92
24"—Rectangular	20 1/4" x 25 3/4"	11.84
27"—Rectangular	20 1/4" x 26"	12.88

TV PLASTIC OPEN MASKS

Tube Size	Overall Dimensions	Price
17"—Rectangular	15 3/4" x 18 1/2"	\$1.49
21"—Rectangular	18" x 21 1/2"	2.38
24"—Rectangular	21" x 26"	4.93
27"—Rectangular	21" x 26"	4.93

Specify type number of CRT used

TV SAFETY GLASS in HANDY SIZES

16" x 20".....	\$2.94	*18" x 22 1/2".....	\$5.16
16" x 22".....	3.97	*21" x 26".....	5.87

\*Available in new tinted grey 50c extra

#630 B Y TECHMASTER

COMPLETE 1957 LINE AT SPECIAL PRICES

Excitingly New

Video Theatre TV... Hi-Fi Kits

Catalog mailed on request

STANDARD CASCODE TUNER

For better all around performance. Complete with tubes and Brooks CASCODE MANUAL with step-by-step instructions and all extra parts needed. \$15.97

PULSE KEYED AGC KIT

Latest type, most accurate and the easiest Kit to install in any make TV RECEIVER including the #630. Improves performance and insures a steady picture on all channels.

COMPLETE SET OF PARTS \$4.59

Including 6AU6 tube & Instructions

WESTINGHOUSE OR CBS PICTURE TUBES

BRAND NEW in Factory Sealed Cartons—With a Full Year Guarantee

17" 70° #17BP4A \$22.66	21" 70° #21EP4B \$32.21	24" 90° #24CP4A \$48.99	27" 90° #27EP4A \$74.31
90° #17AVP4A Aluminized	90° #21ALP4A Aluminized	Aluminized	Aluminized

27" TV CONVERSION KIT

Convert any Size, any Make TV RECEIVER to operate the 27" or ANY 90° PICTURE TUBE.

BASIC TV CONVERSION KIT—Matched SET 90° YOKE & FLYBACK TRANSFORMER \$11.22  
CONVERSION MANUAL Instructions Diagrams

COMPLETE SET OF ESSENTIAL PARTS includes matched set of Todd 90° COSINE DEFLECTION YOKE and TODD 18kv FLYBACK TRANSFORMER, 30KV FILTER, 6AX4 TUBE, YOKE BRACKETS, WIDTH CONTROL, CONDENSERS, RESISTORS.

Your Price... \$15.98  
Incl. CONVERSION MANUAL with Step-by-Step Instructions & Diagrams

List Price \$39.75

Illustrations for mounting TV sets flush with wall extending into garage, closet or wall recessed.

FLYBACK TRANSFORMER RCA-type #21IT1.....	\$3.69
FLYBACK TRANS. RCA-type 21IT5.....	4.98
FLYBACK TRANS. RCA-type 21IT5 w/AGC.....	6.74
FLYBACK TRANS. RCA-type 21BT1.....	6.96
FLYBACK TRANS. GE-type 77J1.....	4.98
FLYBACK TRANS. 70° Universal, any TV.....	4.86
FLYBACK TRANS. 90° Universal, any TV.....	5.24
DEFLECTION YOKE 70° Universal, wired.....	4.92
DEFLECTION YOKE 90° Universal, wired.....	5.24
POWER TRANS. RCA #20IT6 for #630.....	14.97
VERTICAL OUTPUT TRANS. 10 to 1 ratio.....	2.69
UNIVERSAL CRT MOUNTING BRACKETS.....	6.97
FOCUS COILS 247, 360, 470, 1000, 4000Ω.....	ea. 1.97
SYNCHRO-LOL COIL RCA-type #208T8.....	1.49
SYNCHRO-GUIDE COIL RCA-type #205R1.....	1.00
RATIO DET. COIL 45mc for most TV Sets.....	1.00
STANDARD COIL take-off #XM752.....	1.00
PIC. & SOUND CONTROL 10K-1meg w/switch.....	1.14
FOCUS CONTROL wirewound 1500 ohms 4 watts.....	.98
8" PM SPEAKER finest alnico #5 magnet.....	2.19
12" PM SPEAKER finest alnico #5 magnet.....	4.67
\$30 REGAL 5-TUBE RADIO #271 complete.....	\$11.30

BROOKS RADIO & TV CORP., 84 Vesey St., New York 7, N.Y.



# SCHOOL DIRECTORY



## college grads get ahead faster!

... have higher incomes... advance more rapidly. Grasp your chance for a better life. Share rewards awaiting college-trained men. Important firms visit campus regularly to employ Tri-State College graduates. Start any quarter. Approved for Vets.

### Bach. Sc. degree in 27 months

Complete Radio Eng. courses (TV, UHF, FM, Electronics). Also Mech., Civil, Elec., Chem., Aero., Eng. 36-months in Bus. Adm. (Gen. Bus., Acctg., Motor Transport Mgt.). Superior students faster. More professional class hours. Small classes. Enrollment limited to 1550. Beautiful campus. Well-equipped labs. Prep courses. Enter Mar., June, Sept., Jan. Earnest, capable students (whose time and budget require accelerated courses and modest costs) are invited to write Jean McCarthy, Dir. Adm., for Catalog and "Your Career in Engineering and Commerce."



## TRI-STATE COLLEGE

2437 College Avenue, Angola, Indiana

### LET RCA TRAIN YOU FOR A LIFETIME CAREER IN



## TELEVISION ADVANCED ELECTRONICS

Resident classes, day and evening, start May 20th, September 3rd, November 26th and February 25, 1958. Free graduate placement service. Approved for Veterans. Send for free catalog now.



### RCA INSTITUTES, INC.

A Service of Radio Corporation of America  
350 West 4th St., New York 14, N. Y.



## FINISH HIGH SCHOOL AT HOME!

No classes to attend. Easy spare-time training covers big choice of subjects. Friendly instructors; standard texts. Full credit for previous schooling. Diploma awarded. Write now for FREE catalog!

WAYNE SCHOOL Catalog HKE-12  
2527 Sheffield Ave., Chicago 14, Illinois

## TOP-FLIGHT ELECTRONICS

Train for technical representative, field engineer, electronic specialist on missiles, computers, radar, automation, radio, color-TV. Basic and advanced theory and laboratory. Mathematics. Major firms select our graduates. Dormitories-campus. 21 months' program. High school grad. or equivalent. G.I. approved. Start April, July, Sept., Jan. Write for catalog.

VALPARAISO TECHNICAL INSTITUTE  
Dept. C., Valparaiso, Indiana



## ENGINEERING DEGREES

(UNDER AND POSTGRADUATE)  
E.E. Option Electronics  
Earned Through Home Study  
(Residential Courses Also Available)

PACIFIC INTERNATIONAL UNIVERSITY

(American College of Engineering)

Box 27724-M, HOLLYWOOD 27, CALIF.

## F.C.C. LICENSE QUICKLY!

Home Study or Resident Classes  
—FREE DETAILS—

### Grantham Schools, Desk 74-c

1505 N. Western Ave. OR 821—19th Street N. W.  
Hollywood 27, Calif. Washington 6, D. C.

Please send me your free booklet, telling how I can get my commercial FCC license quickly. I understand there is no obligation and no salesman will call.

NAME \_\_\_\_\_  
ADDRESS \_\_\_\_\_  
CITY \_\_\_\_\_ STATE \_\_\_\_\_

## ELECTRONICS

Prepare for unlimited opportunities in electronics! B.S. degree in 27 months. Intensive, specialized courses. Math, electrical engineering, TV, advanced radio theory & design. Mod. labs. Low tuition. Self-help. Also Aero., Chemical, Civil, Electrical, Mechanical Engineering. U.S. degree in 36 mo. In Math., Chem., Physics. Engineering prep. courses. G.I. approved. Enter March, June, Sept., Dec. Catalog



**INDIANA TECHNICAL COLLEGE**  
1537 E. Washington Blvd., Fort Wayne 2, Indiana

## RADIO-TV ELECTRONICS



CREI graduates in big demand. ECPD-Accredited Technical Institute Curricula. New classes start monthly. Free placement service for grads. Courses: Radio Engineering, Broadcast or TV Engineering; resident studies leading to "Associate in Applied Science" degree. Write for free Residence School catalog. Approved for veterans.

CAPITOL RADIO ENGINEERING INSTITUTE  
Dept. RE, 3224 — 16th St., N. W., Washington 10, D. C.

## ELECTRONICS

PREPARE FOR A GOOD JOB!  
BROADCAST ENGINEER  
RADIO SERVICING AUTOMATION

TELEVISION SERVICING  
BLACK & WHITE—COLOR

APPROVED FOR VETERANS AND SURVIVORS OF VETERANS  
BUILDING AIR CONDITIONED  
SEND FOR FREE LITERATURE

BALTIMORE TECHNICAL INSTITUTE  
1425 EUTAW PLACE, BALTIMORE 17, MD.

## CODE SENDING RECEIVING SPEED

Be a "key" man. Learn how to send and receive messages in International Morse code. Communicate with operators around the globe. Learn at home quickly through famous Candler System. Used by best operators. Qualify for Amateur or Commercial License. Write for FREE BOOK.

CANDLER SYSTEM CO.  
Dept. 3 C. Box 208, Denver 1, Colo. U.S.A.

## ELECTRONIC TECHNICIANS

ARE IN DEMAND  
TRAINED MEN ARE NEEDED

NOW! In just 18 months, you can complete Electronic Technicians training to enter this ever-growing industry. Day or evening classes. Opportunity for employment in local industry. Approved for Korean Veterans. Terms beginning April, July, September, Jan. Write for Catalog 111 TODAY.

INDIANAPOLIS ELECTRONIC SCHOOL  
312 E. Washington St. Indianapolis 4, Indiana

## OFFICE AUTOMATION

Prepare for the future with the only home study course instructing application of electronic computers to business clerical operations. Free Information.

### BUSINESS ELECTRONICS

Programming Branch, 420 Market Street  
San Francisco 11, Calif.

## Top Pay Jobs in TV-ELECTRONICS-RADIO

High pay, opportunity, prestige, security... all yours, as a qualified Electronics Technician! Get your training NOW in the big, recognized shops, Labs, and TV-Radio Studios at National Schools in Los Angeles, foremost since 1905. Here you work with latest Electronics equipment — professionally installed — finest, most complete facilities offered by any school. Expert, friendly instructors. Personal attention. Graduate Employment Service. Help in finding home near school. Part time job while you learn. Mail coupon NOW, TODAY... for full information.

### NATIONAL SCHOOLS

National Schools Dept. RXG-37  
4000 So. Figueroa Los Angeles 37, Calif.  
Send Free Electronics Opportunity Book Today

Name \_\_\_\_\_ Age \_\_\_\_\_  
Address \_\_\_\_\_  
City \_\_\_\_\_ Zone \_\_\_\_\_ State \_\_\_\_\_  
City \_\_\_\_\_ State \_\_\_\_\_

Your choice of school is highly important to your career in



INDUSTRIAL ELECTRONICS



RADIO-TELEVISION



ELECTRONICS COMMUNICATIONS

Become an ELECTRICAL ENGINEER or an ENGINEERING TECHNICIAN at

## MSOE in Milwaukee

Choose from courses in:  
ELECTRICAL ENGINEERING  
Bachelor of Science degree in 36 months. Communications option (radio-tv) Power option.

ENGINEERING TECHNICIAN  
Assoc. in Applied Science degree — 18 months.  
Electronics Communications  
Electrical Power.

MSOE — located in Milwaukee, one of America's largest industrial centers — is a national leader in electronics instruction — with complete facilities, including the latest laboratory equipment, visual aid theater, amateur radio transmitter — offers 93 subjects in electrical engineering, electronics, radio, television, electrical power, and electricity.

Advisory committee of leading industrialists. Courses approved for veterans. Over 50,000 former students. Excellent placement record.



Quarters Starting October, January, April, July

Choose wisely — your future depends on it. Write for more information today!

## MILWAUKEE SCHOOL OF ENGINEERING

Dept. RE-357, 1025 N. Milwaukee Street Milwaukee 1, Wisconsin

Send FREE career booklet.

I am interested in \_\_\_\_\_ (Name of course)  
Name \_\_\_\_\_ Age \_\_\_\_\_  
Address \_\_\_\_\_  
City \_\_\_\_\_ Zone \_\_\_\_\_ State \_\_\_\_\_  
If veteran, give discharge date \_\_\_\_\_ MS-57

# LAFAYETTE SENSATIONAL VALUES! IN COMPLETELY WIRED TEST EQUIPMENT at LESS than the PRICE of KITS!



## LAFAYETTE SIGNAL GENERATOR

NEVER BEFORE HAS A COMPLETELY WIRED AND TESTED INSTRUMENT OF SUCH ACCURACY AND QUALITY BEEN OFFERED AT SUCH A PRICE!

- FREQUENCY 120 KC TO 260 MC
- 120 KC TO 130 MC ON FUNDAMENTALS
- LABORATORY ACCURACY AND QUALITY

A completely wired and tested instrument not to be confused with units sold in kit form at almost the same price, but with a quality and accuracy of instruments 3 to 4 times its price. Six overlapping ranges generate signals of 120KC - 320KC, 320KC-1000KC, 1MC-3.2MC-11MC, 11MC-38MC and 37MC-130MC all on fundamentals with calibrated harmonics from 120MC to 260MC. Selector switch gives instant choice of ranges. Switch gives choice of internal modulation of 100 CPS or use of any external source at other frequencies. For audio testing the 400 cycle signal can be used separately. RF output is in excess of 100,000 microvolts and jacks are provided for choice of either high or low RF output. Stability is insured by special circuit design. Has a fine adjustment RF control. AF output is 2-3 volts, AF input is 4 volts across 1 megohm. Large clear 5 inch etched dial plate and pointer are protected by transparent plastic bezel. Common AF terminals for EXT-MOD input and INT-AP for audio tests eliminate need for special AF output connectors. Machine engraved panel lettering. Handsome gray metal case with carrying handle. Measures 6 1/2" x 10" x 4 1/2". Comes complete with pair of leads. AC line cord and plug. Operates on 105-125V 50-60 cycle AC. Shpg. wt., 8 lbs.

22.50

Outputs are unmodulated RF, modulated RF and 400 CPS audio. RF output is in excess of 100,000 microvolts and jacks are provided for choice of either high or low RF output. Stability is insured by special circuit design. Has a fine adjustment RF control. AF output is 2-3 volts, AF input is 4 volts across 1 megohm. Large clear 5 inch etched dial plate and pointer are protected by transparent plastic bezel. Common AF terminals for EXT-MOD input and INT-AP for audio tests eliminate need for special AF output connectors. Machine engraved panel lettering. Handsome gray metal case with carrying handle. Measures 6 1/2" x 10" x 4 1/2". Comes complete with pair of leads. AC line cord and plug. Operates on 105-125V 50-60 cycle AC. Shpg. wt., 8 lbs.

**NEW!**

## LAFAYETTE CAPACITANCE-RESISTANCE TESTER WITH "IN-SET QUICK CHECK"

COMPLETELY WIRED AND TESTED



- TWO INSTRUMENTS IN ONE
- CHECKS ELECTROLYTIC, PAPER, MICA AND CERAMIC CONDENSERS
- 4 DIRECT READING CAPACITY SCALES FROM .00001 MFD TO 1000 MFD
- CHECK FOR OPEN SHORTS, LEAKAGE AND INTERMITTENTS
- 2 RESISTANCE RANGES FROM 100 TO 5 MEGOHM

Here is a "must" for servicemen and lab technicians. A completely self-contained AC operated capacitance and resistance bridge, plus a quick check for in the set testing. Large 5 direct reading scale has 4 ranges of .00001-.005 MFD, .001-.5 MFD, 1-.50 MFD and 20-1000 MFD. Resistance ranges are 100-50,000 OHMS and 10,000 to 5 megohm. Quick check feature enable you to check capacitors for shorts, open or intermittent while in circuit—no need to remove them from the set till you're sure they need replacement. Leakage test switch gives

34.50

you choice of 25, 150, 250, 350 or 450 volts for checking leakage under correct potential. Separate power factor control with continuous settings from 0 to 50%. Operation is simple and accurate, using a magic-eye tube as the null detector. Attractively finished steel case with etched panel and rounded corners, measures 14 1/2" L x 8 3/4" H x 5" D. Shpg. wt. 19 lbs.

**NEW!**

## LAFAYETTE CAPACITOR-RESISTANCE TESTER

COMPLETELY WIRED AND TESTED



- COMPLETELY WIRED AND TESTED
- CHECKS ALL TYPES OF CONDENSERS FOR CAPACITY, LEAKAGE, OPEN SHORTS OR INTERMITTENT CONDITION
- DIRECT READING SCALES FROM .00001 TO 1000 MFD AND 100 TO 5 MEGOHMS

A stable and accurate bridge type circuit measures capacitance in 4 ranges of .00001-.005 MFD, .001 to .5 MFD, .1 to 50 MFD and 20 to 1000 MFD. Two resistance ranges of 100-50,000 and 10,000 to 5 megohms. Check leakage under actual load with choice of 25, 150, 250, 350 or 450 volts available by selector switch. Power factor control from 0 to 50%. Checks for leakage, open, short, or intermittent operation. All readings taken directly off scales after setting magic eye to maximum. Completely self-contained power supply. Attractively finished steel case with rounded corners and etched panel. Operates from 110V AC. Size 9 3/8" L x 7 1/8" H x 5 1/4" D. Shpg. wt. 10 lbs.

MODEL LC-15

NET 21.50

## NEW POCKET AC-DC VOM MULTITESTER

2,000 ohm per volt Sensitivity on both DC and AC

- 160 ua 3" METER
- 1% PRECISION RESISTORS
- SILVER CONTACT SELECTOR SWITCH

### FULL SCALE RANGES

DC Volts: 0-10; 0-50; 0-500; 0-1000 Volts — AC Volts: 0-10; 0-50; 0-500; 0-1000 Volts — DC Current: 500 ua and 500 ma — Resistance: 0-10K; 0-1 Meg — Decibels: -20 to +22; +20 to 36 db (0 db = 0.775 V) — Capacity: 250 mfd to 1 mfd — Output Ranges: 0-10; 0-50; 0-500; 0-1000 volts.



8.95

Best Buy in America! A very accurate and sensitive VOM. This Multitester is a complete instrument (not a kit) with high quality and sensitive 160 microamp meter (not a kit) with per volt on both AC and DC. Single selector switch, 2000 ohm precision resistors, 3" meter. Features extreme versatility, accuracy and ruggedness. In attractive plastic front panel, with metal bottom for ruggedness and shielding. First capacity range requires 50 volt AC source. Second capacity range requires 10 volt AC source. Size 4 1/2" x 3 1/2" x 1 3/8". Complete with test leads and batteries. Shipping weight 4 lbs.

## HIGH SENSITIVITY 20,000 OHM PER VOLT DC 10,000 OHM PER VOLT AC MULTITESTER



### LOOK AT THESE FULL SCALE RANGES!

DC Volts: 0-6; 0-30; 0-120; 0-600; 0-1200; 0-6000 Volts — AC Volts: 0-6; 0-30; 0-120; 0-600; 0-1200 Volts — RESISTANCE: 0-10K; 0-100K; 0-1 Meg; 0-10 Megohms — D.C. CURRENT: 0-60 Microamp; 0-6; 0-60; 0-600 Milliamps — DECIBEL: -20 to +22 db (0 db = 0.774V) — CAPACITY: .0001-.01; .005-.15 mfd — INDUCTANCE: 20-2000 millihenry — OUTPUT RANGES: 0-6; 0-30; 0-120; 0-600; 0-1200 Volts

19.95

The new Lafayette high sensitivity Multitester is a complete instrument (not a kit). In addition to its unusual sensitivity of 20,000 OHMS PER VOLT ON D.C. AND 10,000 OHMS PER VOLT ON A.C., and the extraordinary number and scope of its ranges, it is packed with features that would make it cost at least twice as much if made in this country. Uses 1% precision resistors, silver contacts on selector switch, 35 ua 3" meter. Dependable, rugged and accurate. Even the test leads are heavy duty with high voltage insulation. Voltage source required for low capacity range is 120V A.C., for high range capacity and inductance scale is 6V A.C. Attractive plastic front with metal bottom. Size 6 1/4" x 4 1/4" x 2 1/2". Complete with batteries and leads. Shipping weight 4 1/2 lbs. Single, Each 19.95. In lots of 3, Each 19.25

## BUILD A 6 TRANSISTOR SUPERHET RECEIVER

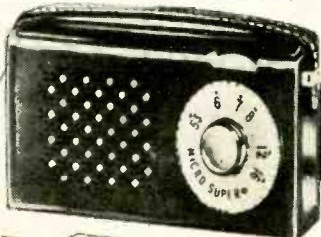

FOR GROUP AND PRIVATE LISTENING

- 100% SUBMINIATURE PARTS—NO COMPROMISES!
- LABORATORY DESIGNED—SENSITIVE, SELECTIVE, STABLE!
- CLASS B PUSH-PULL AMPLIFICATION—PLENTY OF POWER!

*Superb Performance! Incomparable Value!*

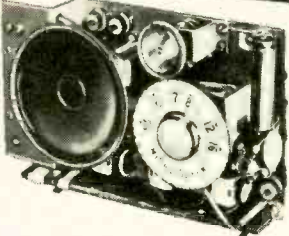

33.50

Transistor-wise Lafayette is proud to present its 6 Transistor Superhet Receiver Kit KT-119. An outstanding achievement of constant research and design, this kit represents the optimum in sensitivity, selectivity and stability. You'll be amazed at its superior commercial quality! You'll be elated with its surprising performance! The circuit, using 3 high frequency RF Transistors, 3 dependable audio Transistors and Crystal Diode, features a specially matched set of 3 I.F.'s, Oscillator, High-Q Loop, Class B Push-Pull Audio Amplification, and Transformer Coupling in audio and output stages. Special care has been taken in the design for exact impedance matching throughout to effect maximum transfer of power. Has efficient 2 3/4" speaker for exemplary reproduction, and earphone jack for private listening. Complete with all parts, transistors, pre-punched chassis, battery and easy-to-follow step-by-step instructions. 6" x 3 1/2" x 1 1/2". Shpg. wt., 3 lbs.

- KT-119—Complete Kit—Less Case.....Net 33.50
- MS-339—Sturdy, attractive brown leather case with carrying strap for KT-119. 6" x 3 1/2" x 1 1/2". Shpg. wt., 1 lb.....Net 2.95
- MS-279—Sensitive matching earphone.....Net 2.39

# LAFAYETTE RADIO

DEPT JC-1

100 SIXTH AVE., NEW YORK, N. Y.  
BOSTON, MASS., 110 Federal St.  
PLAINFIELD, N. J., 139 West 2nd St.  
NEWARK, N. J., 24 Central Ave.  
BRONX, N. Y., 542 E. Fordham Rd.

JAMAICA 33; N. Y. 165-08 Liberty Ave. Write for FREE Bargain Packed Catalog!

# FREE!

## LAFAYETTE CATALOG



# ELECTRONIC CATALOG PACKED WITH MONEY SAVERS

Packed with the largest selection of Electronic, Radio and T.V. Parts, and equipment, PA, Hi-Fi systems, tubes, antennas, Transistor Kits, parts and components, Test Equipment, new build your own kits, tools, books, Microscope, drafting equipment, Binoculars, Telescopes, All Radio, TV and Ham supplies — ALL AT GREAT SAVINGS — For the economy minded servicemen, dealer, engineer and technician. **CHUCK FULL OF BUYS! SEND FOR YOUR FREE COPY TO-DAY.**

## PROFESSIONAL TRANSCRIPTION TURNTABLE AND VISCOUS-DAMPED TONE ARM THE FINEST TRANSCRIPTION TURNTABLE AND TONE ARM FOR THE PROFESSIONAL USER AND THE AUDIOPHILE



**PK-100A TRANSCRIPTION TURNTABLE**  
New 3-speed instrument with built-in stroboscope and viewer for exact speed determination, and magnetic brake for instantaneous speed variation. Precision engineered to meet professional standards for wow, rumble and flutter content. Heavy 12" cast aluminum rim-driven turntable. Variable speed control permits adjustment of each speed within  $\pm 7\%$  using efficient frictionless magnetic brake. Heavy-duty constant speed 4-pole induction motor freely suspended and isolated by shock-mountings to eliminate vibration transfer. R-C filter network suppresses "pop" in speaker. Truly a delight for the connoisseur. Size: 13 1/2" x 14" and requires 2 3/4" clearance above and 3 3/4" below motorboard. For 110-130V and 60/50 cycle AC. Power consumption 12 watts. Handsome hummertone gray finish. Shpg. wt., 20 lbs. Net 49.50

**PK-100-A** ..... Net 49.50

**PK-90 VISCOUS-DAMPED TONE ARM**  
This transcription arm assures dependable and stable operation, utilizing the "floating action" principle of "viscous-damping." The arm is supported at a single point by a pivot and jewel bearing having negligible friction. Damping is accomplished by a silicone fluid occupying the gap between a ball and socket. This damping control permits high compliance and negligible tracking error, and prevents damage to either record or stylus should the tone arm be accidentally dropped. Low frequency resonance, skidding and groove-jumping are likewise minimized. The tone arm accepts all records up to 16" and accommodates virtually all hi-fi cart-ridges by means of precisely engineered adapters which simplify installation and provide proper stylus pressure.  
This tone arm is a quality companion to the PK-100 with matching finish. Shpg. wt., 2 1/2 lbs. Net 15.95

**PK-90** ..... Net 15.95

**COMBINATION DEAL**  
72.50



### NEW! HIGH FREQUENCY TWEETER WITH ACOUSTIC LENS DIRECT IMPORTATION MAKES THIS PRICE POSSIBLE!

- FREQUENCY RESPONSE FROM 2000 CPS TO BEYOND AUDIBILITY
- LOUVERED ACOUSTIC LENS FOR UNIFORM SOUND DISPERSION
- HANDLES 25 WATTS OF POWER
- PRICED EXCEPTIONALLY LOW

14.95

New high frequency tweeter featuring a louvered acoustic lens for uniform sound dispersion and capable of handling up to 25 watts of distortion-free power. The directional tendency of high frequency notes is overcome by the natural wide dispersion angle of the short horn and the acoustic lens which disperses and radiates the high notes smoothly throughout the entire listening area. The lens is detachable for panel mounting, with a separate base for the tweeter furnished for external mounting where desired. Aluminum voice coil has 16 ohms impedance. Size: 4 1/4" long x 3" diameter, lens extends 2 1/2". Requires a crossover network, preferably one with a level control, such as the LN-2. With full instructions. Shpg. wt., 5 lbs. Net 14.95

**NW-7** ..... Net 14.95

## LAFAYETTE MATCHED HIGH FIDELITY PHONO SYSTEM



Reg. Value  
~~158.55~~  
**SALE!**  
119.50

**Nothing Finer At This Price**  
NEVER—in the annals of HIGH-FIDELITY has a phono system of this quality—at this price—been offered. A Lafayette "best buy" system designed around the new Lafayette LA-59 amplifier. The performance of this Phono system surpasses the most critical requirements of music lovers. Twenty-four combinations of record equalization provide an almost endless variety of tone compensation to match varying recording characteristics. This system includes the famous Garrard RC-121 "Renown" 4 speed automatic and manual record changer, LAFAYETTE LA-59 18 watt amplifier with features found only in the most expensive amplifiers. G.E. triple-play—turnover cartridges with genuine G.E. DIAMOND SAPPHIRE STYLI, AND LAFAYETTE SK-58 12" coaxial HI-FI speaker. All units are supplied with plugs, jacks and prepared color-coded interconnecting cables for quick easy installation. For 110-125 volt, 60 cycle AC. Shpg. wt. 50 lbs.  
HF-154—Complete Phono System.....Net 119.50

## METAL-CASED CONE TYPE HI-FI TWEETER FREQUENCY RESPONSE 2000-16,000 CPS HANDLES 20 WATTS OF POWER

Highest quality cone type high frequency tweeter having a range from 2000 to 16,000 cycles. Especially efficient at higher end of audio spectrum where other cone type tweeters tend to lose clarity and volume. Entirely closed in a metal case with a base so that it can stand by itself or be mounted on a flat surface with mounting bracket supplied. Rated to handle 20 watts of power. A crossover network is required; the Lafayette LN-2 is ideal. Voice coil impedance 8-16 ohms. Size: 3 1/8" x 2 1/8" x 3" Diam. Shpg. wt., 3 lbs. Net 5.95

**HK-3** ..... Net 5.95



## CROSSOVER NETWORK CAPACITIVE-INDUCTIVE NETWORK WITH CROSSOVER AT 2000 CPS BUILT-IN LEVEL BRILLIANCE CONTROL

The frequencies above 2000 cycles are channeled to the high frequency tweeter by means of the high-Q inductance and capacitance comprising this efficient crossover network. The highs and lows are brought into acoustic balance by means of a continuously variable level-brilliance control. Control has a 2 1/2 ft. long cable for remote mounting. Network matches 8-16 ohm speakers with insertion loss reduced to a minimum. Enclosed in metal case 6" L x 2 5/8" H x 2 5/8" D. With full instructions. Shpg. wt., 5 lbs. Net 8.75

**LN-2** ..... Net 8.75



8.75

## 3 WAY CROSSOVER NETWORK

Carefully designed and engineered to Lafayette's own specifications. Insertion loss is well below the acceptable minimum. Crossover is at 350 and 5000 cycles. Permits full enjoyment of any 3 way system. Properly balances woofer, mid range speaker and tweeter inputs. Complete with 2 continuously valuable "presence" and "brilliance" controls for tonal adjustment and full instructions. 8" L x 3 1/4" H x 2 1/4" W. Shpg. wt., 7 lbs. Net 14.95

**LN-3** ..... Net 14.95

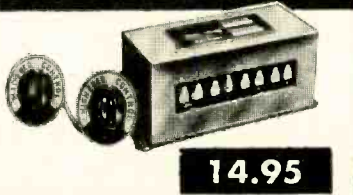

14.95

**Lafayette Radio**  
DEPT JC-2  
165-08 LIBERTY AVE.  
JAMAICA 33, N. Y.

NAME \_\_\_\_\_  
ADDRESS \_\_\_\_\_  
CITY \_\_\_\_\_  
ZONE \_\_\_\_\_  
STATE \_\_\_\_\_

SEND FREE LAFAYETTE CATALOG

**CUT OUT AND MAIL TODAY!**

# For Successful Color Servicing

## ... stay with RCA!



### THE WR-61B COLOR-BAR GENERATOR

produces crystal-controlled signals spaced at precisely 30-degree intervals... permitting adjustments of all types of demodulators... especially X and Z as well as the conventional R-Y, B-Y, G-Y, I and Q signals. A high degree of accuracy is assured since picture carrier, color subcarrier, sound carrier, bar frequency and horizontal sync pulses are all crystal controlled. Luminance signals at bar edges aid in checking color "fit" or registration. Adjustable subcarrier amplitude permits checking color-sync action. "Darkening" pedestals permit checking gain ratios or chrominance channels without an oscilloscope and without computing the relative phosphor efficiency of the kinescope. The new WR-61B is now accepted as the standard for color-phasing accuracy in many TV stations and network operations.

Price.....\$259.50\*



### THE WR-46A VIDEO DOT/CROSSHATCH GENERATOR

saves installation time, enables more precise convergence adjustments. High level video output permits direct connection to color kinescope; eliminates pattern deterioration due to bandpass characteristics of rf, if or vf amplifiers. Result—clear, extremely sharp pattern display. Permits simultaneous display of pattern with broadcast picture in background. Assures convergence adjustments at exact horizontal scanning rates. Switch selection of four separate types of patterns is provided. Vertical sync is frequency-divided from horizontal sync, resulting in interlaced scanning and exceptional freedom from "jitter," "crawl" and sync "hunting."

Price.....\$179.50\*



### THE WO-91A 5" OSCILLOSCOPE

has features usually found only in more expensive instruments. It has all the 'scope functions you need to do both Color TV and black-and-white service... Outstanding features include front-panel switching of "V"-amplifier bandwidth, response flat to 4.5 Mc in wide-band position; 12-step voltage-calibrated, frequency-compensated "V" amplifier attenuator; simplified, simultaneous waveshape display and voltage measurement on VTVM-type graph scales—peak-to-peak. Read volts directly from screen; sturdy single-unit low-capacitance/direct probe with built-in switch eliminates need for separate probe. Plus many more work-easy features!

Price.....\$239.50\*

... ask your RCA Distributor about his special offer on a new RCA Color TV Microscope!

\*User price (optional)



**RADIO CORPORATION of AMERICA**

COMPONENTS DIVISION

CAMDEN, N. J.

See your RCA Distributor for details on these outstanding RCA test instruments for Color TV!



The World's Finest P.A. and General Purpose Microphone

**Electro-Voice®**

**664 HIGH-FIDELITY  
CARDIOID DYNAMIC**

With Revolutionary Variable D\* Design

ONLY \$**82<sup>50</sup>** LIST

Without a doubt, the Electro-Voice 664 cardioid is the world's finest P. A. and all-purpose cardioid. Its amazing versatility is the result of the unique E-V variable D design. The unidirectional, high-fidelity "664" provides highly directional sound selectivity, reduces pickup due to ambient noise and reverberation up to 50%. Proper placement of the 664 discriminates against unwanted sounds, gives accurate, natural pickup of voice and music . . . smooth, peak-free response at all frequencies from 60 to 13,000 cps, *no boominess* from close talking. The 664 so outdistances the field that we confidently guarantee it to **OUTPERFORM** any other P. A. cardioid . . . **OR YOUR MONEY BACK!**

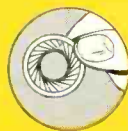

**Exclusive, indestructible Acoustalloy Diaphragm**—a single moving element—withstands high humidity, temperature extremes, corrosive effects of salt air, and severe mechanical shocks. With the E-V "664" you are sure of dependable, long-life operation indoors and outdoors.



\*E-V Pat. Pend.

**Model 664.** Variable D Super-Cardioid Dynamic Microphone. Uniform response at all frequencies from 60 to 13,000 cps. Output level, -55 db. 150 ohm and high impedance. Impedance changed by moving one connection in cable connector. Low impedance balanced to ground and phased. Acoustalloy diaphragm, shielded from dust and magnetic particles. Alnico V and Armco magnetic iron in non-welded circuit. Swivel permits aiming directly at sound source for most effective pick-up. Pressure cast case. 5/8"-27 thread. Satin chrome finish. 18 ft. cable with MC4M connector. On-Off switch. Size: 1 1/8" diam., 7 3/16" long not including stud. Net Weight: 1 lb., 10 oz. List Price . . . . . \$82.50.

1. **Model 419.** Desk Stand. Modern, sturdy design (extra). List Price \$10.00.
2. **Model 636.** Slim, trim and terrific . . . a dynamic, omnidirectional microphone that "fills the bill" for fine quality P. A. installations, and personal tape recorder applications List . . . . . \$70.00.
3. **Model 623.** Slim Dynamic—Ideal for PA recording and general use. Use on stand or in hand. Omnidirectional. Response 65 to 9,000 cps; output level- 56 db. Hi- or Lo-Z by changing one wire in connector. Pressure cast; satin chrome finish. Tilttable head. On-Off switch, Built-in MC-4 connector. 5/8"-27 thread. 7 1/2" x 1 5/16". 18' cable. Net Weight, 15 oz. List . . . . . \$55.00.
4. **Model 927.** A crystal, omnidirectional general-purpose microphone especially desirable for radio amateur and general communications use. List . . . . . \$22.50.

**Here's How it Works**

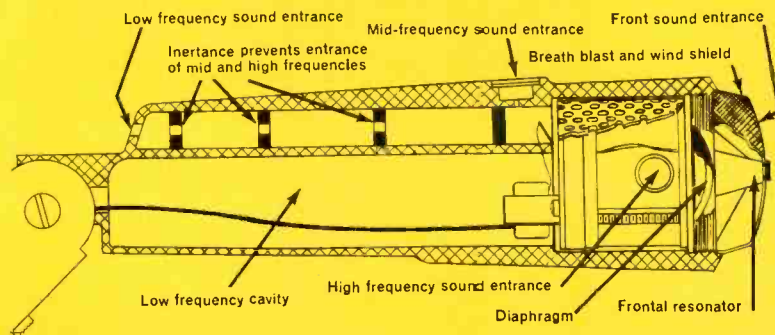

Ask a Broadcast or Recording Engineer about E-V Microphones. Write for: A.B.C.'s of Microphones, Dept. W73!

**Electro-Voice®**

ELECTRO-VOICE, INC. • BUCHANAN, MICHIGAN

Canada: E-V of Canada Ltd., 1908 Avenue Road, Toronto, Ontario  
 Port: 13 East 40th Street, New York 16, J. S. A. • Cables: ARLAB

CAN  
YOU  
QUALIFY...

to be an

## “Authorized RCA Electron Tube Dealer”?

Ask your RCA distributor how you can enjoy the prestige and profit of this powerful service dealer program. It will pay you to check into the requirements at once—and identify yourself and your shop with the greatest name in electronics—RCA. Once you qualify, you can use the arsenal of promotion materials prepared exclusively for “Authorized RCA Tube Dealers”—outdoor and indoor signs, displays, direct mail, newspaper ad mats, radio scripts, decals—everything to tell your customers you’re an “Authorized RCA Electron Tube Dealer”!



**RADIO CORPORATION of AMERICA**

Tube Division, Harrison, N. J.

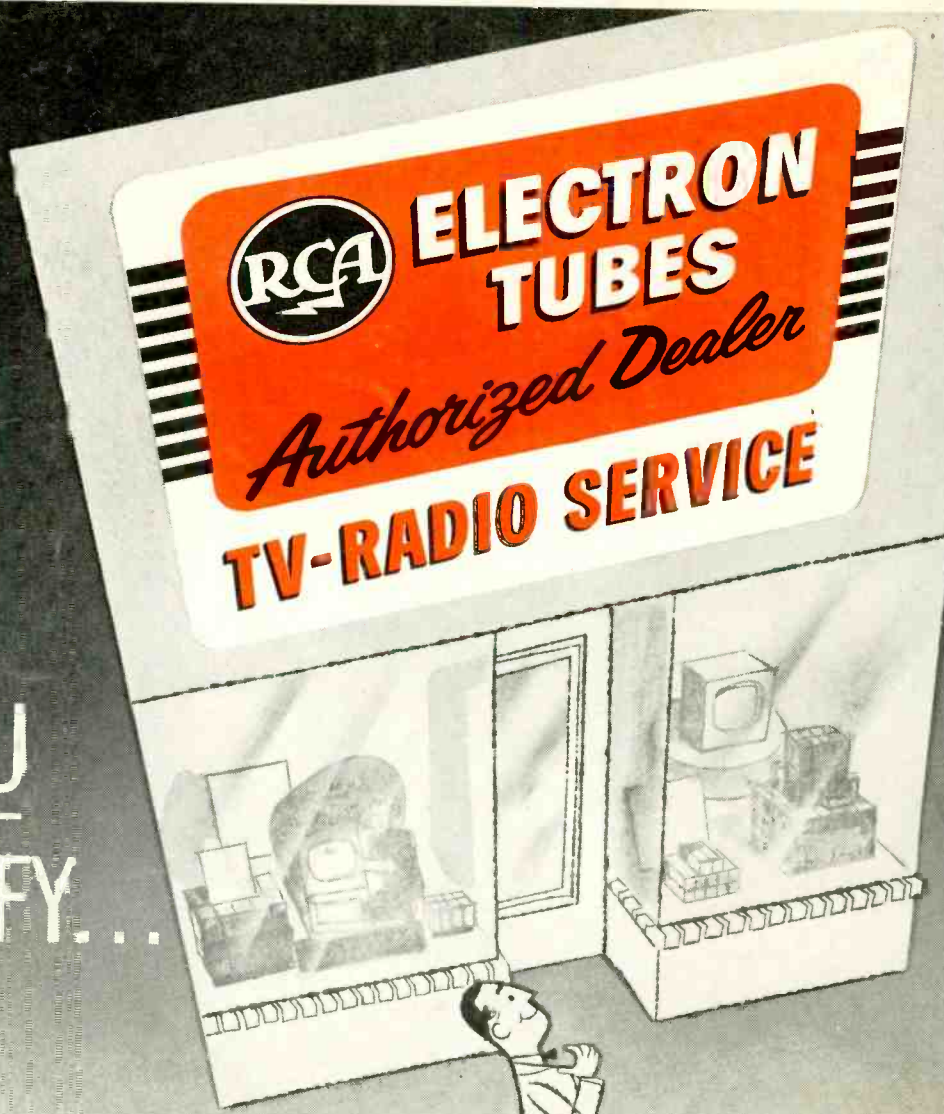

3<sup>rd</sup> Annual  
**NATIONAL TELEVISION  
SERVICEMEN'S WEEK**  
March 25-30

This is RCA's annual salute to its business partners—the TV-Radio Service Technicians of America. Big color ads in March 23rd issues of TV Guide and the Saturday Evening Post, and March 25th issue of Life—tributes on NBC network radio and TV shows, including March 16th TV Emmy Awards program and March 23rd Perry Como show. Be sure to have all your customers and prospects tune in these gala shows to see your NTSW tribute.