

RADIO - ELECTRONICS

OCTOBER 1956

TELEVISION • SERVICING • HIGH FIDELITY

HUGO GERNSBACH, Editor

Voice Coil Feedback
for
Low-Cost Hi-Fi

Adjust the Antenna
to Kill
TV Interference

Easy-to-Build
Audio-Frequency
Meter

Transistorized
Flea-Power
Transmitter

The Long-Tailed
Cascode-Pair
Amplifier

35¢

U. S. and
CANADA



Miniature Mobile 400-Watt Public-Address System

See page 4

4



1

- mutual conductance tube tester
- transistor checker
- germanium diode tester
- selenium rectifier tester

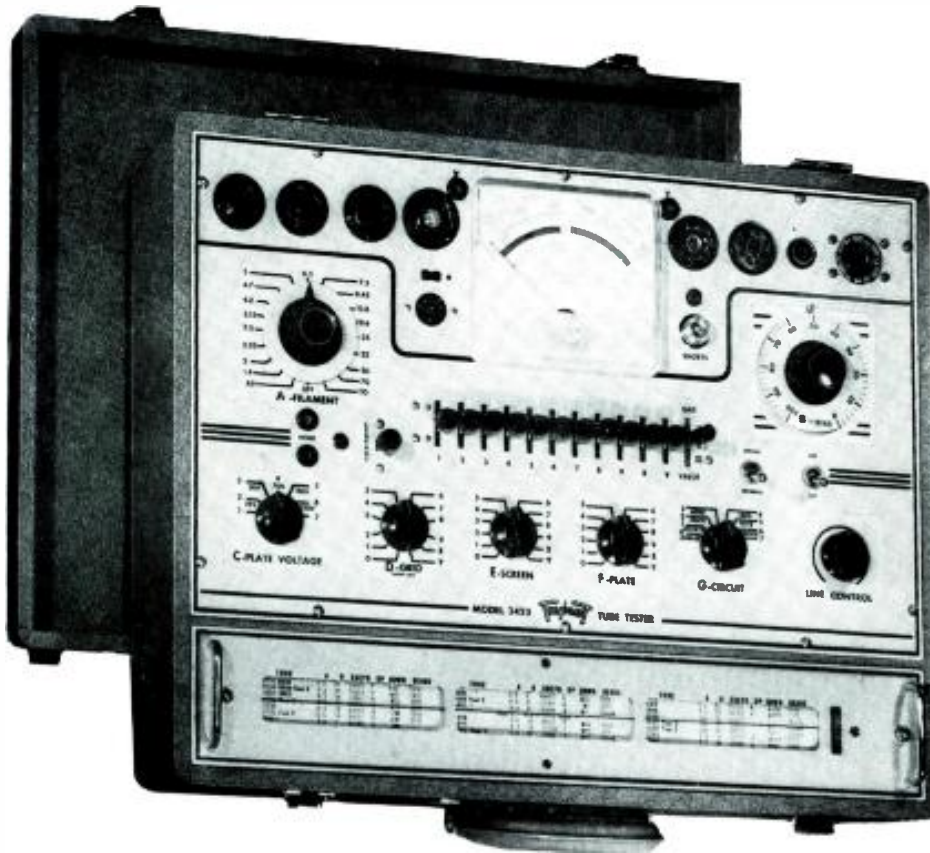

MODEL 3423 MUTUAL CONDUCTANCE TUBE TESTER \$199.50



MODEL 3413-B ... \$79.50

The first low priced tube tester to provide
• *dual sensitivity for short test*

Triplet model 3413-B combines provision for conventional short test (0.25 megohms) with high sensitivity leakage test (2.0 megohms)—will test series string tubes without adapter.

No one piece of equipment can do more for you. As the electronic field expands your tube tester must do more. **TRIPLETT TUBE TESTERS** meet this demand. More heater voltages including 3.15, 4.2 and 4.7 volts for 600 mill series string heaters. Quickly locating the bad tubes saves time. Tube sales can be a profitable business in itself.

Burton Browne Advertising

Here is the ultimate in a tube tester for today and tomorrow. A 4 in 1 value that checks for accuracy as the circuit demands depending on the tolerance of the circuit.

Model 3423 will give you no false readings to waste time. The patented circuit for the tube testing employs actual



signal (4KC) for grid and DC bias voltage making it independent of line voltage hum. It also has a complete coverage of all tube types—six plate voltages (including 0-10 variable). Micromhos scales read 0-1800, 0-6,000, 0-18,000 and 0-36,000. Leakage measured directly on meter 0-10 megohms.

Quick development of new types of tubes can obsolete any tester tomorrow that does not have the multiple switching arrangement of Model 3423 which allows making any combination of tube connections. Ask your parts distributor to demonstrate the many other extra features of this foremost tube tester. . . . Triplet automatically furnishes revised, up-to-date roll charts regularly if you promptly return registration card. (Included with tester.)

TRIPLETT ELECTRICAL INSTRUMENT COMPANY • BLUFFTON, OHIO

An Invitation . . .

To men who want to "go places" in TV SERVICING

Find out about this NEW,
ALL-PRACTICE WAY
of becoming a Professional
TV SERVICEMAN

If you have some Radio or Television experience, or if you know basic Radio-Television principles but lack experience—NRI's new Professional Television Servicing course can train you to go places in TV servicing. This advertisement is your personal invitation to get a free copy of our booklet describing this training in detail.

Learn-by-Doing "All the Way"

This is 100% learn-by-doing, practical training. We supply all components, all tubes, including a 17-inch picture tube, and comprehensive manuals covering a thorough program of practice. You learn how experts diagnose TV defects quickly. You see how various defects affect receiver performance—picture and sound; learn causes of defects, accurately, easily, and how to fix them. You do more than just build circuits. You get practice recognizing, isolating, and fixing innumerable troubles.

You get actual experience aligning TV receivers, diagnosing the causes of complaints from scope patterns, eliminating interference, using germanium crystals to rectify the TV picture signal, obtaining maximum brightness and definition by properly adjusting the ion trap and centering magnets, etc. There isn't room on this or even several pages of this magazine to list all the servicing experience you get.

UHF & COLOR TV Making New Boom

Installing front-end channel selector strips in modern UHF-VHF Television receivers and learning UHF servicing problems and their solution is part of the practice you get. To cash in on the coming color TV boom you'll need the kind of foundation in knowledge and experience this training gives.

Get Details of New Course Free

Once again—if you want to go places in TV servicing, we invite you to find out what you get, what you practice, what you learn from NRI's new course in Professional Television Servicing. See pictures of equipment supplied, read what you practice. Judge for yourself whether this training will further your ambition to reach the top in TV servicing. We believe it will. We believe many of tomorrow's top TV servicemen will be graduates of this training. Mailing the coupon involves no obligation.



Train at home easily, quickly, for TV's top servicing jobs. NRI's Professional Television Servicing course includes a 17-inch picture tube and all other tubes and components to build a complete TV Receiver, Oscilloscope, Signal Generator, H.F. Probe. Complete training, including all equipment, available now for a low introductory price—under \$200 on easy terms.



National Radio Institute, Dept. 6KFT
16th and U Sts., N.W., Washington 9, D. C.

Please send my FREE copy of "How to Reach the Top in TV Servicing." I understand no salesman will call.

Name.....Age.....

Address.....

City.....Zone.....State.....

APPROVED MEMBER NATIONAL HOME STUDY COUNCIL

RADIO - ELECTRONICS

Formerly RADIO CRAFT ■ Incorporating SHORT WAVE CRAFT ■ TELEVISION NEWS ■ RADIO & TELEVISION*

EDITORIAL

- 33 Electronics vs. Human Judgment - Hugo Gernsback

AUDIO—HIGH FIDELITY

- 34 Sound Bug (Cover Feature) - Charles Ray
 37 Loading Phono Pickups - Joseph Marshall
 40 Long-Tailed Cascade Pair - L. B. Hedge
 42 Balancing Amplifier Output With Your VTVM - James P. Rodgers
 43 Background Noise Reduction in Tape - James A. McRoberts
 45 Variable Damping - Paul Klipsch
 46 Loudspeaker Impedance Measurements - Harold Reed
 48 Feedback From the Voice Coil - Norman Crowhurst

WHAT'S NEW

- 51 Pictorial Report of New Developments

RADIO

- 52 Flea-Power Transistor Transmitter - Joseph Chernof
 53 Conelrad - A Report
 54 Transistor Radios, Part V - I. Queen
 56 Three-Tube FM Receiver - Richard Graham

TELEVISION

- 58 TV Sets With Remote Control, Part II - Henry O. Maxwell
 61 Reducing Co- and Adjacent-Channel Interference
 - Edward M. Noll and Matthew Mandl
 63 TV Service Clinic - Conducted by Jerry Kass
 79 TV DX - Robert B. Cooper
 84 ITV Pulse Generator Techniques, Part III - Edward M. Noll
 95 New Color Sets Simplify Servicing
 98 Underground TV Master Antenna - Harry J. Miller

ELECTRONICS

- 104 Confused About Transistor Types? Part I - Paul Penfield, Jr.

TEST INSTRUMENTS

- | | |
|---|----------------------------------|
| 107 Compact Audio-Frequency Meter - Elliott A. McCready | |
| 109 Transistor Checker for \$1 - Edwin Bohr | |
| 157 Books | 147 People |
| 150 Business | 128 Question Box |
| 155 Corrections | 8 Radio Month |
| 18 Correspondence | 137 Radio-Electronic
Circuits |
| 116 New Devices | 154 Technical Literature |
| 123 New Records | 121 Technicians' News |
| 125 New Tubes and
Transistors | 132 Technotes |
| 140 Patents | 144 Try This One |

Hugo GernsbackEditor and Publisher
M. Harvey GernsbackEditorial Director
Fred ShunamonManaging Editor
Robert F. ScottWZPWG, Technical Editor
Jerome KassAssociate Editor
I. QueenEditorial Associate
Matthew MandlTelevision Consultant
Elizabeth StolcupProduction Manager
Angie PascaleEditorial Production
Wm. Lyon McLaughlinTech. Illustration Director
Sol EhrlichArt Director
Lee RobinsonGeneral Manager
John J. LamsonSales Manager
G. AliquoCirculation Manager
Adam J. SmithDirector, Newsstand Sales
Robert FallerhPromotion Manager



Average Paid Circulation over 184,000

ON THE COVER

(Story on page 34)
 Vic Damon and model Dixie Lee Clark with his Sound Bug at the Kansas City Airport to assist in ceremonies celebrating the opening of a new through service by one of the major airlines.

Color original by Anderson Photo, Kansas City, Mo.

NEXT MONTH: Hi-Fi Conversions Are Profitable! • What to Do for Weak Video

Associate Member of Institute of High Fidelity Mfrs., Inc.

RADIO-ELECTRONICS, October, 1956, Vol. XXVII, No. 10. Published monthly at Mt. Morris, Ill., by Gernsback Publications, Inc. Second-class mail privileges authorized at Mt. Morris, Ill. Copyright 1956 by Gernsback Publications, Inc. All rights reserved under Universal, International and Pan-American Copyright Conventions.
SUBSCRIPTION RATES: U. S., U. S. Possessions and Canada, \$3.50 for one year; \$6.00 for two years; \$8.00 for three years; single copies 35c. Pan-American countries \$4.00 for one year; \$7.00 for two years; \$10.50 for three years. All other countries \$4.50 a year; \$8.00 for two years; \$11.00 for three years.
SUBSCRIPTIONS: Address correspondence to Radio-Electronics, Subscription Dept., 404 N. Wesley Ave., Mt. Morris, Ill., or 154 West 14th St., New York 11, N. Y. When ordering a change please furnish an address stencil impression from a recent wrapper. Allow one month for change of address.
GERNSBACK PUBLICATIONS, INC. Executive, Editorial and Advertising Offices, 154 West 14th St., New York 11, N. Y. Telephone ALgonquin 5-7755. **Hugo Gernsback**, Chairman of the Board; **M. Harvey Gernsback**, President; **G. Aliquo**, Secretary.
BRANCH ADVERTISING OFFICES and FOREIGN AGENTS listed on page 160.
POSTMASTER: If undeliverable, send Form 3578 to: **RADIO-ELECTRONICS**, 154 West 14th St., New York 11, N. Y.

*Trademark registered U. S. Pat. Office.

NATIONAL SCHOOLS

proudly presents

FOR MEN WHO WANT TO EARN MORE MONEY

TELERAMA • ALL 8 BRANCHES OF TELEVISION • ELECTRONICS • RADIO

IN ONE DYNAMIC, MODERN SHOP METHOD, HOME TRAINING COURSE

*Registration applied for

Another great advance in **HOME STUDY TRAINING**. Let National Schools, of Los Angeles, a practical Technical Resident Trade School for over 50 years, train you at home by Shop-Method, for today's unlimited opportunities in **ALL 8 BRANCHES** of the Television, Electronics, Radio Industry.

Check all you receive in *One Master Course* at One Low Tuition

1. Television — Including Color TV
2. Radio — FM and AM
3. Industrial Electronics
4. Sound Recording and Hi-Fidelity
5. Preparation for FCC License
6. Automation
7. Radar and Sonar
8. Communications

ALL OF THIS MODERN, NEWEST, PRACTICAL EQUIPMENT IS YOURS TO KEEP!

- Parts to Build a modern TV set, including large screen Picture Tube.
- Parts to build a powerful Superhet Receiver, standard broadcast and short wave.
- Parts to conduct many experiments and build Continuity Checker, RF Oscillator, TV Circuits, Audio Oscillator, TRF Receiver, Signal Generator.
- Professional Multimeter
- These are a MUST for all technicians.

YOU DO MANY PRACTICAL JOBS.

You do servicing, circuit analysis and many other down-to-earth experiments. You build a modern TV set from the ground up... with equipment kits we give you, including a new large screen picture tube and professional Multimeter, at no additional charge.

EARN AS YOU LEARN! Many of our students earn their entire tuition and more in Spare Time jobs we show them how to do while learning. **YOU GET GRADUATE ADVISORY SERVICE, TOO.**

ALL YOURS TO KEEP

L. J. ROSENKRANZ
President of NATIONAL SCHOOLS



This Master-Shop-Method course is completely up-to-date. Here in Los Angeles, the TV and Electronics center of the world, we are able to keep in constant touch with the industries' latest developments. As a student, you will quickly master all phases at home... in your spare time. Your earning power will grow with every lesson. Just as thousands of National Schools graduates do every day, you can handle servicing, manufacturing, repairing, hundreds of other jobs, or make good money in your own business. **SECURE YOUR FUTURE—NOW. SEND COUPON BELOW.**



IN THESE MODERN TV STUDIOS, SHOPS AND LABORATORIES, your Shop Method Home Study Course was developed by experienced instructors and engineers. What an advantage that is to you at home — each lesson is tested, proved, easy to understand. You can master the most up-to-date projects, such as color TV set repair, printed circuits — even prepare for F.C.C. License and industrial electronics without taking a special course. **TAKE YOUR FIRST STEP NOW TO A TOP-PAY JOB IN TV, ELECTRONICS, RADIO. SEND COUPON BELOW TODAY.**

APPROVED FOR VETERANS AND NON-VETERANS

NATIONAL SCHOOLS

4000 S. FIGUEROA ST., LOS ANGELES 37, CALIF.

187 N. LA SALLE ST., CHICAGO 1, ILL.

IN CANADA: 811 W. Hastings St., Vancouver, B. C.

NATIONAL SCHOOLS
TECHNICAL TRADE TRAINING SINCE 1905
Los Angeles, California

GET FAST SERVICE — MAIL NOW TO OFFICE NEAREST YOU!

NATIONAL SCHOOLS, DEPT. RG-106
4000 S. FIGUEROA ST. OR 187 N. LA SALLE ST.
LOS ANGELES 37, CALIF. CHICAGO 1, ILL.
Rush free TV-Radio "Opportunity" Book and sample lesson. No salesman will call.

NAME _____ BIRTHDAY _____ 19__

ADDRESS _____

CITY _____ ZONE _____ STATE _____

VETERANS: Give Date of Discharge _____

MEMBER



FREE!

Fully illustrated "CAREER" BOOK in TV, Radio, Electronics. AND actual Sample Lesson—yours at no cost, no obligation **SEND COUPON NOW—TODAY!**





for **HI-FI**



and **ALL**
phonomotor applications



MODEL D-10
4-pole, shaded pole AC induction type for tape, wire or disc recorders



MODEL RM4
Single speed, 4-pole motor



Model SS3 —
3 speed, 2 pole motor
Model SS4 — 4 speed,
2 pole motor



MODEL DR—2-speed,
4-pole motor



MODEL AX
Single speed, 2-pole motor

MODEL DSS
3-speed, 4-pole motor

On any job, large or small—from a single-speed nursery phonograph to a super-deluxe “hi-fi” instrument—you’ll always be right if you follow the lead of America’s foremost manufacturers and *Specify GI* phonomotors. GI is America’s *only complete line*—the *one* source for every phonomotor need—with quality and dependability backed by over half a century of design leadership!



THE GENERAL INDUSTRIES CO.

DEPARTMENT GR • ELYRIA, OHIO

LOOK what **RADIO-ELECTRONICS** has
in Store for you in the Months ahead!

• HINTS ON TV TUBE TROUBLES
By Cyrus Glickstein

• THE NEW MOTION-PICTURE SOUND
By Aaron Nadell

• AUDIO TRANSFORMERS
By Norman H. Crowhurst

• A SELF-CALIBRATING MARKER GENERATOR
By Richard Graham

The NOVEMBER issue of RADIO-ELECTRONICS goes on sale October 25th at better parts distributors and newsstands

SUBSCRIPTION RATES

One year \$3.50

RADIO-ELECTRONICS

Two years \$6.00

Three years \$8.00

154 West 14th St., New York 11, N.Y.

• SIMPLE TRANSISTOR SHORTWAVE RECEIVER
By Joseph Braunbeck

• IMPROVING SOUND IN AM RADIOS
By Albert Stratmoen

• A HOME INTERCOM SYSTEM
By John F. Millar

• SELLING EXTRA TELEVISION SERVICE
By Matthew Mandl

the
Radio
month



BLIND PBX OPERATORS will soon try out experimental electronic “eye” as an aid in operating private telephone switchboards. Weighing less than an ounce, the unit, developed by Bell Telephone Laboratories, consists of a tiny light-sensitive phototransistor which fits on the tip of index finger—it is the only piece of equipment that must be worn by the operator other than the standard operator’s headset.

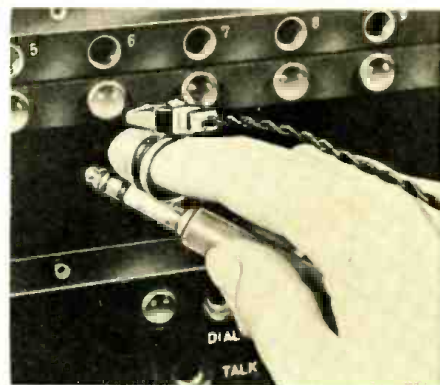

When a call comes into the switchboard, a signal is heard and a lamp lights. When a blind operator hears the signal she runs her finger, with the eye attached to it, across the rows of lamps (see photo). On reaching the lighted lamp the phototransistor is activated and the operator hears a signal through her headset. The phone cord is then plugged into the jack associated with the lighted lamp, completing the connection.

EDUCATIONAL TV NETWORK opened on a state-wide state-supported basis in Alabama. The nation’s first such network was inaugurated by Gov. James E. Folsom as station WAIQ, channel 2, went on the air from Andalusia to complete the system. The other two—stations, WBIQ, channel 10, Birmingham, and WTIQ, channel 7, Mundeford—have been on the air since early 1955. The three stations now program to 90% of Alabama.

THE SIGNAL CORPS is now using electronics in the form of data processing equipment to supply its far-flung branches throughout the world. An IBM 705 computer and associated equipment installed at the Army Signal Supply Agency, Philadelphia, receives all requisitions for supplies, locates stocks in one or more of the four main Signal Corps supply depots, decides
(Continued on page 12)

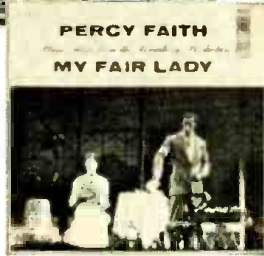

Free... Any 3

OF THESE SUPERB HIGH-FIDELITY

12" COLUMBIA RECORDS

If you join the Columbia Record Club now—and agree to accept as few as 4 selections during the coming 12 months

Only the Columbia Record Club can make an unprecedented offer like this!



- 1 Ports of Call
Philadelphia Orchestra, Ormandy, conductor. 6 popular works—Bolero, Espana, Pavana, Escapes, etc.
- 2 The Voice
Frank Sinatra in 12 songs that first made him famous—*Lover, Fools Rush In*, etc.
- 3 King of Swing: Vol. 1
Benny Goodman and Original Orch., Trio Quartet. *Riding High, Moonglow*—9 more.
- 4 My Fair Lady
Percy Faith and his Orchestra play music from this hit show.
- 5 Mendelssohn:
Violin Concerto
Tchaikovsky:
Violin Concerto
Francescatti, violin;
N. Y. Philharmonic,
Mitropoulos, conduct.
- 6 I Love Paris
Michel Legrand and
Orch. play *La Vie En
Rose, Paris*—12 more.
- 7 Jazz: Red Hot & Cool
Dave Brubeck Quartet
in *Love Walked In,
The Duke*—5 more.
- 8 Levant Plays
Gershwin
- 3 works—*Rhapsody In
Blue; Concerto in F;
An American in Paris*.
- 9 Saturday Night Mood
Dance music by 12
bands—Jimmy Dorsey,
Sammy Kaye, etc.
- 10 Beethoven:
Symphony No. 5
Mozart:
Symphony No. 40
Philadelphia Orch.,
Ormandy, conductor.
- 11 Music of Jerome
Kern
Andre Kostelanetz and
his Orchestra play 20
Kern favorites.
- 12 Ambassador Satch
European Concert Re-
cordings by the great
Louis Armstrong and
his All-Stars.

YES! You may have, FREE, ANY 3 of these best-selling 12" Columbia records. We make this unique offer to introduce you to the money-saving program of the Columbia Record Club... a program that selects for you each month the greatest works in every field of music—performed by the world's finest artists and brilliantly reproduced on Columbia records.

HOW THE CLUB OPERATES

To enjoy the benefits of the Club's program and to receive your 3 records free—mail the coupon, indicating which of the four Club divisions best suits your musical taste: Classical; Jazz; Listening and Dancing; Broadway, Movies, Television and Musical Comedies.

Each month you will receive free the Club Magazine which describes the current selections in all four divisions. You may accept or reject the monthly selection for your division. You may also take records from the other Club divisions. This unique advantage assures you the widest possible choice of recorded entertainment. Or you may tell us to send you NO record in any month. Your only obligation is to accept as few as 4 selections from the almost 100 that will be offered during the next 12 months, and you may cancel membership at any time thereafter. The records you want are mailed and billed to you at only \$3.98 plus a small mailing charge.

FREE BONUS RECORDS GIVEN REGULARLY

The 3 records sent to you now represent an "advance" of the Club's bonus system—given to you at once. After you have fulfilled your membership obligation by purchasing four records, you will receive an additional free Bonus record of your choice for every two additional Club selections you accept. Bonus records are superb 12" Columbia records—the very best of the world-famous Columbia catalog—just like those shown here. Because you are given a Columbia record free for each two records you purchase from the Club, your membership provides the best buy in records—anywhere.

Indicate on the coupon which 3 records you want free, and the division you prefer. Then mail the coupon at once. You must be delighted with membership or you may cancel without obligation by returning the free records within 10 days.

COLUMBIA RECORD CLUB
165 West 46th Street, New York 36, N. Y.

"Columbia" Mercury Reg.

MAIL THIS COUPON NOW!

COLUMBIA RECORD CLUB, Dept. 470
165 West 46th Street, New York 36, N. Y.

Please send me as my FREE gift the 3 records indicated here:
(Select the 3 records you want from the list on this page, and circle the corresponding numbers here)

1 2 3 4 5 6 7 8 9 10 11 12

and enroll me in the following Division of the Club.
(check one box only)

Classical Listening and Dancing
 Broadway, Movies, Television and Musical Comedies Jazz

Each month you will send me the Columbia Record Club Magazine which describes the records offered in all four Club divisions. I have the privilege of accepting the monthly selection in the division checked above, or any other selection described, or none at all. My only obligation is to accept a minimum of four records in the next 12 months at the regular list price plus a small mailing charge. After accepting 4 records, I will receive a free Bonus record for every two additional records I purchase. If not delighted with membership, I may cancel within 10 days by returning all records.

Name..... (Please Print)
Address.....
City..... Zone..... State.....

CANADA: Prices slightly higher. Address 11-13 Soho St., Toronto 2B
If you wish to have this membership credited to an established Columbia Records dealer, authorized to accept subscriptions, please fill in the following information:

Dealer's Name.....
Dealer's Address..... 23

Revolutionary **GEARED DOWN** 3/8" Power Drill

IDEAL FOR RADIO-TV SERVICE WORK... DRILLS

WEN



STEEL
STONE
BRICK
CEMENT
WOOD
PLASTIC
EVERYTHING
PERFECTLY

The Only Drill You Need

1/4" is too small really, for most work — 1/2" is too big. This 3/8" is just right. Gearing down from high speed to 800 RPM under load, a speed suitable for all types of drilling, not only multiplies the usefulness of this drill, but also saves you money — because now you can use and reuse regular carbon steel bits — which burn up at higher speeds. Polishing, buffing, waxing, etc., go better too at this lower speed. Features of this big powerful new WEN Drill include GENUINE 3/8" JACOBS GEARED CHUCK WITH KEY; UNIVERSAL 115 V. AC/DC 2 AMP. MOTOR for ample power and torque; HELICAL GEARS for smooth, quiet operation and long life; STURDY HANDLE for maximum safety and convenience; 6 FT. CORD, rubber covered, heavy duty; LUSTROUS SILVER GRAY CASE; COMPACT DESIGN, length 9", height 6"; LIGHT WEIGHT, only 3 1/2 lbs. — and many other features never before combined in a drill at anywhere near this price. A price that gives you a superb new 3/8" geared down, multi-useful power drill for the cost of an ordinary 1/4" job.

MODEL 707

only \$26.95

LIST

ROUNDS OUT THE WEN LINE OF HIGH GRADE—LOW COST ELECTRIC POWER TOOLS FOR HOME AND SHOP

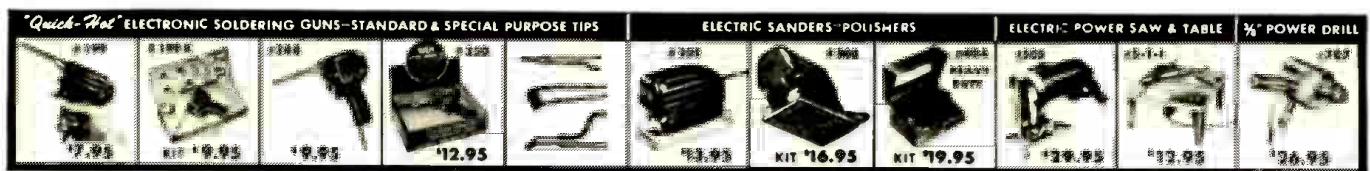

YOUR DEALER HAS THEM OR CAN GET THEM FOR YOU

WEN PRODUCTS, INC.

5808 NORTHWEST HIGHWAY
CHICAGO 31, ILLINOIS

(Export sales, Scheel International, Inc., Chicago)

HOW TO PASS Your FCC Commercial LICENSE EXAMS*

GET YOUR FCC LICENSE IN A HURRY!

We Guarantee*
to train you
until you receive
Your FCC License

* See Free Catalog for complete details
**Cleveland Institute training results in success
with commercial FCC examinations
. . . . easily and quickly**

Here's Proof:

Name and Address	License	Time
Walter Eggers, Pacific Grove.....	1st	12 weeks
Paul Reichert, West Salem, Ohio.....	2nd	10 weeks
Harold Phipps, LaPorte, Indiana.....	1st	28 weeks
John H. Johnson, Boise City, Okla.....	2nd	12 weeks
James Faint, Johnstown, Pa.....	1st	26 weeks

(Names and addresses of trainees in your area sent on request)

Cleveland Institute training results in job offers like these:

Radio Operators & Technicians

American Airlines has openings for radio operators and radio mechanics. Operators start at \$334.53 per month. Radio mechanic's salary up to \$1.99 per hour. Periodic increases with opportunity for advancement. Many company benefits.

Electronic Technicians

Convair Electronics Department: Radio and Radar Mechanics, Electronics Technicians, and Junior Engineers are wanted for a special program on fire control development and installation. Beginning rate: \$365 and up.

And our trainees get good jobs

Electronics Technician

"I am now employed by the Collins Radio Company as a Lab Technician. (This job was listed in your bulletin.) I have used the information gathered from your course in so many ways and I know that my training with Cleveland Institute helped me a great deal to obtain the job."

**Charles D. Sindelar, Cedar Rapids, Iowa
Airlines**

"I replied to the Job Opportunities you sent me and I am now a radio operator with American Airlines. You have my hearty recommendation for your training and your Job-Finding Service."

James H. Wright, Beltsville, Md.

CLEVELAND INSTITUTE OF RADIO ELECTRONICS
Desk RE-96, 4900 Euclid Bldg., Cleveland 3, Ohio.

We can train you to pass your License Exams if you've had any practical experience —amateur, military, radio servicing, or other. Our proven plan can help put you on the road to success.

*Your FCC ticket will be recognized by employers as proof of your technical ability.

MAIL COUPON NOW

and get
all 3 books
FREE



Member National
Home Study Council

Cleveland Institute of Radio Electronics

Desk RE-96, 4900 Euclid Bldg., Cleveland 3, Ohio.

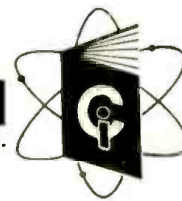

Please send Free Booklet prepared to help me get ahead in Electronics. I have had training or experience in Electronics as indicated below:

- | | |
|---|---|
| <input type="checkbox"/> Military | <input type="checkbox"/> Broadcasting |
| <input type="checkbox"/> Radio-TV Servicing | <input type="checkbox"/> Home Experimenting |
| <input type="checkbox"/> Manufacturing | <input type="checkbox"/> Telephone Company |
| <input type="checkbox"/> Amateur Radio | <input type="checkbox"/> Other |

In what kind of work are you
now engaged? _____

In what branch of Electronics
are you interested? _____

Name _____ Age _____

Address _____

City _____ Zone _____ State _____

Special Tuition Rates to Members of Armed Forces

ts TUNG-SOL®
TECHNICAL DATA
BOOKS FOR 1956



T-58 1250 pages—1000 tube types.



T-70 More than 250 pages of data on CR tubes, receiving and special purpose tubes and dial lamps.



T-31 Over 350 blueprint base diagrams for 1400 tube types.

ALL THE INFORMATION
AT YOUR FINGER TIPS

The new 1956 Tung-Sol Electron Tube Technical Data books are the most practical set of reference books in the entire industry. They contain all the information you need for everyday use. Clearly indexed and streamlined for fast reading, they open flat for rapid on-the-job reference.

Ask your Tung-Sol supplier how you can get your set.

TUNG-SOL ELECTRIC INC., Newark 4, N. J.
 Sales Offices: Atlanta, Columbus, Culver City, Dallas, Denver, Detroit, Melrose Park (Ill.), Newark, Seattle.

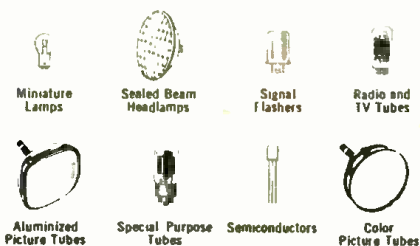

THE RADIO MONTH

(Continued from page 8)

which one is best situated for efficient service and prints a shipping order to be sent to that depot by telegraph "transceiver" the same day. More than 6,000 orders for supplies from troops maintaining communications equipment throughout the world are processed daily.

The equipment also reviews its stored information daily—a task that was formerly completed every three months. It prints recommendations for an average of 150 orders for replenishments of supplies daily. If stocks are not secured, it repeats the request daily till they are obtained. It also reviews daily any orders from troops for stocks not on hand at time of receipt of order, and prints shipping orders for such goods as soon as they are in stock.

The Signal Corps expects large savings due to closer control of supplies and possibility of carrying smaller stocks, which should result in reduced waste and loss. Even more important is the machine's tremendous reserve capacity, ready to be called on at any moment, thereby greatly increasing the Army's readiness for mobilization in the event of a national emergency.

TRANSISTORIZED TV PICKUP station developed by RCA for spot news coverage and other TV field pickup applications weighs only 19 pounds. The unit consists of a 4-pound camera and detachable electronic viewfinder. The camera uses a tiny ½-inch Vidicon pickup tube no longer than a king-size



cigarette. The back pack contains a synchronizing generator, battery power supply and a 2000-mc transmitter.

Camera and transmitter together use 70 transistors, and the ½-watt transmitter can send signals to a base station more than a mile away. The batteries contained in the back pack can operate the equipment for 5 hours and may be recharged. Conventional, and heavier, tube-operated equipment provide approximately 2 hours' operation.

Recently unveiled was another miniature (or subminiature) television camera (see photo) weighing only 10 ounces. Announced by the American

(Continued)



Broadcasting Company, the camera, manufactured in West Germany, is 4 inches long and 2 inches in diameter. The camera tube is reportedly the smallest ever made, operating with a lens ¼ inch in diameter. Unlike the RCA unit above, this camera requires cable connection back to its home base, restricting its mobility.

Calendar of Events

National Electronics Conference and Exhibition, October 1-3, Hotel Sherman, Chicago.

Canadian IRE Show and Convention, October 1-3, Automotive Bldg., Exhibition Park, Toronto, Canada.

Second Annual High-Fidelity Concert-Demonstration, October 3, Carnegie Hall, New York. (G. A. Briggs)

1956 New England High-Fidelity Music Show, October 5-7, Hotel Touraine, Boston, Mass.

80th Convention of the Society of Motion Picture and TV Engineers, October 7-12, Ambassador Hotel, Los Angeles, Calif.

Miami High Fidelity Music Show, October 12-14, Hotel McAllister, Miami, Fla.

RETMA Radio Fall Meeting, October 15-17, Hotel Syracuse, Syracuse, N. Y.

New Orleans High Fidelity Music Show, October 25-27, Hotel Roosevelt, New Orleans.

Second Annual IRE Professional Group Technical Meeting on Electron Devices, October 25-26, Shoreham Hotel, Washington, D. C.

1956 High Fidelity Show and Music Festival, November 2-5, Palmer House, Chicago. (RADIO ELECTRONICS will exhibit in Room 746).

Dallas High Fidelity Music Show, November 16-18, Hotel Adolphus, Dallas, Texas.

Saint Louis High Fidelity Music Show, November 23-25, Hotel Statler, Saint Louis, Mo.

TV SHIFT TO UHF was urged by Dr. W. R. G. Baker, RETMA president and vice president of G-E. Stating that if we are to have nation-wide competitive television service we must make effective use of the uhf channels, even if this ultimately involves having substantially all television in the uhf spectrum, Dr. Baker indorsed the Federal Communications Commission's recent action of considering a move to the uhf channels.

Recognizing that it is natural for the FCC to wish to avoid such a drastic shift because of the 37 million vhf TV receivers now in the hands of the public, Dr. Baker said that "if such a move were made over a 7-10-year period, the economic loss to the public could be reduced to the absolute minimum. . . . We are now entering the phase of volume introduction of color sets. It appears that if the transition to all-

(Continued on page 16)



**Train for a secure career
—not just another job!
Success ahead for trained men
only in**



Radio-TV-Electronics

Stop Dreaming! Start Planning!

**START YOUR CREI CAREER TRAINING
AT HOME TO INSURE MORE INCOME!**

What would a \$10 or \$20 a week raise mean to you? Only one \$10-a-week raise will repay your investment in CREI training, and leave you a profit of \$200 or more the very first year! Your increases in pay thereafter are all pure profit, and you'll be prepared for many more promotions and pay raises in the future years of your life!

WHAT YOU DO NOW—today, tomorrow, next week—will decide your success in the electronics field. Every day counts because the trained technicians are the ones who get the "plums" when promotions are handed out. How can you be sure to step ahead of competition, to earn more money, to get the position that carries more responsibility—and the pay that goes with it? The answer is contained in a CREI booklet called "Your Future in the New World of Electronics."

ERA OF COMMUNICATION

This is the era of Communication: aeronautical, marine, police and fire, industrial, land transportation. This is the era of defense orders and a manufacturing industry which last year alone sold billions of dollars worth of electronic equipment, which will top ten billion dollars (without military) this year. This is the era of electronic development, research, design, production, testing, inspection, manufacture, broadcasting, telecasting and servicing. This is the era of electronic careers—well-paid, interesting, and secure.

PRACTICAL COURSES

Your work is under the supervision of a regular staff instructor who knows and teaches what industry needs. Training is accomplished on your own time, during hours chosen by you.

KEY TO SUCCESS — As a graduate you'll find your CREI diploma the key to success in the entire field of electronics. At your service is the Placement Bureau which finds positions for advanced students and graduates. No short cuts are promised; no jobs are guaranteed—but requests for CREI-trained personnel far exceed current supply.



COLLEGE DEGREE NOT ESSENTIAL—You don't have to be a college graduate to benefit from CREI's famed courses. You do have to be willing to study at home. You can do it while holding down a full time job. Thousands have. No matter what your level of electronics experience, CREI has a course for you.

CREI's professional guidance is recognized all over the world. Since 1927 CREI has trained technicians; you find them in radio and television stations; you find them in electronics planning and manufacture; you find them everywhere and, generally, near the top. During World War II CREI trained men for the Armed Services. Leading firms choose CREI courses for group training in electronics (among them are United Air Lines, Canadian Broadcasting Corp., Trans-Canada Airlines, Douglas Aircraft Co., and Columbia Broadcasting System).

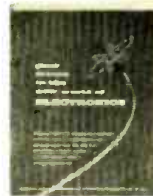

THIS CAN BE YOUR BIG YEAR!

Write today for this **FREE BOOKLET**. Tuition is reasonable, terms are easy, information is free. Fill out the coupon and mail it at once.

AVAILABLE TO VETERANS UNDER GI BILL!

FILL OUT AND MAIL TODAY—BEFORE YOU FORGET IT!

CAPITOL RADIO ENGINEERING INSTITUTE

Accredited Technical Institute Curricula

Dept. 1410-C, 3224 16th St., N.W., Washington 10, D. C.

Please send me your course outline and **FREE** Illustrated Booklet "Your Future in the New World of Electronics" . . . describing opportunities and CREI home study courses in Practical Electronics Engineering.

CHECK FIELD OF GREATEST INTEREST

- Practical Radio Electronic Engineering
- Broadcast Radio Engineering (AM, FM, TV)
- Practical Television Engineering
- Aeronautical Electronic Engineering **E**

Name Age

Street

City Zone State

CHECK: Home Study Residence School Korean Veteran

To help us answer your request intelligently, please give the following information:

EMPLOYED BY.....

TYPE OF PRESENT WORK.....

SCHOOL BACKGROUND.....

ELECTRONICS EXPERIENCE.....

IN WHAT BRANCH OF ELECTRONICS ARE YOU MOST INTERESTED?

THOUSANDS OF SERVICE DEALERS

SATISFY CUSTOMERS
SAVE REPEAT CALLS

MAKE MONEY EVERY DAY with B&K



DYNA-QUIK ^{MODEL} 500 DYNAMIC MUTUAL CONDUCTANCE TUBE TESTER

Tests over 95%

OF ALL POPULAR TV TUBES*—IN SECONDS
It's easy and profitable to check all the tubes in a TV set with DYNA-QUIK—on every service call. Cuts servicing time. Creates more on-the-spot tube sales. Saves repeat calls, protects service guarantee.

DYNA-QUIK 500 measures true dynamic mutual conductance, completely checks tubes with laboratory accuracy under actual operating conditions right in the home.

Tests each tube for shorts, grid emission, gas content, leakage, dynamic mutual conductance and life expectancy. One switch tests everything. No roll charts. No multiple switching. Makes complete tube test in as little as 12 seconds. Large 4½-inch plastic meter shows tube condition on "Good-Bad" scale or in micromhos on scales calibrated 0-6,000 and 0-18,000. Used in home or shop, DYNA-QUIK is a proved money-maker!

*Including new 600 mil series tubes.

NET **\$109⁹⁵**

Dyna-Quik 500. Easily portable in luggage-style carrying case. Size: 15¼ x 14¼ x 5¼ in. Weighs only 12 lbs. Has 7-pin and 9-pin straighteners on panel.

DELUXE—PORTABLE

CRT MODEL 400

Tests and repairs
TV Picture Tubes

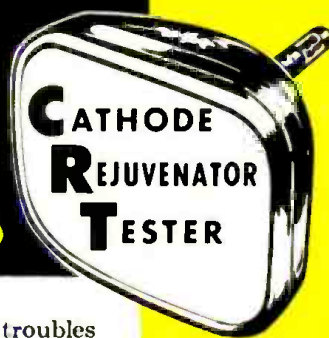

NET **\$54⁹⁵**

Deluxe CRT 400. With 4½-in. plastic meter. Weighs only 5 lbs. Luggage style carrying case. Size: 11 x 7¼ x 5".

Also available in economy model CRT 200 with 3-in. meter at \$39.95 net.

Quickly spots and corrects picture tube troubles right in the home, without removing tube from set. Restores emission, stops leakage, repairs interelement shorts and open circuits. Life test checks gas content and predicts remaining useful life. Grid cut-off reading indicates picture quality customer can expect. Eliminates tube transportation, cuts service-operating costs. Also saves money on TV set trade-in reconditioning. Earns dollars in minutes—pays for itself over and over again.

Proved In Use by Servicemen Everywhere.

See your B & K Distributor or send for facts on "Profitable TV Servicing in the Home" and Informative Bulletins 500-104-E.



B & K MANUFACTURING CO.

3726 N. Southport Ave. • Chicago 13, Illinois

MONEYBACK GUARANTEE ON THE WORLD'S FINEST SERVICE DATA!

Howard W. Sams will prove to you that
PHOTOFACT will help you solve any service problem
FASTER, EASIER, BETTER, MORE PROFITABLY

GET THE PROOF...DO THIS NOW:

1.

Choose a "Tough Nut"

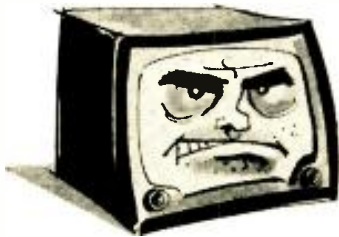

Pick a set that's been giving you plenty of trouble—the tougher the test, the better the proof. Get the make and chassis number of the set . . .

2.

See Your Parts Distributor



Look up the set in the Sams Index to PHOTOFACT Folders. In just 60 seconds you'll find the applicable Folder Set. Buy it—take it back to your shop . . .

3.

Give PHOTOFACT the "Acid Test"



With the proper PHOTOFACT Folder by your side, start solving your service problem . . .

THEN, YOU BE THE JUDGE:

If PHOTOFACT doesn't save you time, doesn't make the job easier and more profitable for you, Howard W. Sams wants you to return the complete Folder Set direct to him and he'll refund your purchase price promptly.

**TRY THE PHOTOFACT
MONEYBACK OFFER NOW**

**LEARN FOR YOURSELF HOW PHOTOFACT
SAVES YOU TIME ON EVERY SERVICE JOB...
HELPS YOU EARN MORE DAILY**

HOWARD W. SAMS, INC. • 2205 E. 46th ST. • INDIANAPOLIS, IND.

uhf is the ultimate solution, now is the time to begin the transition."

SCOTT HELT, patent administrator for the Allen B. Du Mont Laboratories, died Aug. 9 of a heart attack, at the age of 49. A radio and television engineer for several radio stations in the South and Midwest, Mr. Helt joined Du Mont in 1944 as chief engineer of the TV network.

Scott Helt was very well known and extremely popular in the electronic industry. He frequently lectured on



television engineering and taught that subject at Columbia University. His book *Practical Television Engineering* is one of the standard works on the subject. He also wrote numerous articles for technical journals. He was a member of several electrical organizations including the Institute of Radio Engineers and the American Institute of Electrical Engineers.

SEVEN NEW TV STATIONS have gone on the air since our last report:

KVIP	Redding, Calif.....	7
KUAM-TV	Agana, Guam.....	8
WBIR-TV	Knoxville, Tenn.....	10
WCYB-TV	Bristol, Va.....	5
KOTI	Klamath Falls, Ore.....	2
KVSO-TV	Ardmore, Okla.....	12
WAIQ	Andalusia, Ala.....	2

Two stations have left the air:
 WKNY-TV Kingston, N. Y.....66
 KBMT Beaumont, Tex.....31

Canadian stations now total 36 with the addition of CHLT-TV, channel 7, Sherbrooke, Que.

The total number of TV stations now operating in the U. S. and its territories is 483 (387 vhf, 96 uhf). This includes 22 noncommercial units, educational station WAIQ, above, being the most recent.

RADIO RESURGENCE is reflected by retail sales for the first 6 months of 1956—3,391,102 as against 2,429,018 for the same period of 1955. The phenomenal increase was not restricted to any particular category. It included sales of table models, clock and portable sets and transistorized units but excluded automobile receivers. During this same period TV retail sales fell off from approximately 3.2 millions in 1955 to 2.8 millions in 1956. **END**

**New Styling...
 New Features...
 A Completely New Line
 from H. H. Scott**

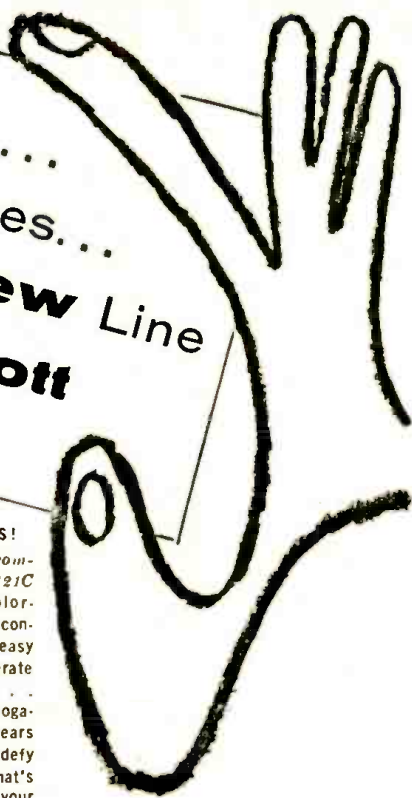

210E

3 NEW FEATURE-PACKED AMPLIFIERS!

(Models 99C, 210E complete amplifiers, 121C preamplifier) Color-marked Green Dot controls that make it easy for your family to operate your hi fi system... smartly designed mahogany cabinets... years ahead features that defy obsolescence... that's H. H. Scott for '57, your best dollar investment. See for yourself!



330B

4 NEW SUPER-SENSITIVE TUNERS!

(Models 330B, 331B AM-FM tuners; 311B, 316B FM tuners) For the first time AM that gives you audio response beyond 10 kc... FM with new wide-band circuitry that makes drift a thing of the past... AM-FM tuners equipped for Stereophonic (binaural) operation. That's H. H. Scott for '57. Hear for yourself!



280

2 COMPLETELY REDESIGNED POWER AMPLIFIERS!

(Models 240, 280) Exclusive Dynamic Power Monitor on Model 280 affords full output on music, yet protects expensive speakers against burnout... variable damping controls for perfect speaker matching... new exterior styling... clean distortion-free performance typical of all H. H. Scott components. Judge for yourself!

ALSO SEE THE NEW 710A TURNTABLE

Visit your dealer or write today for complete technical specs.

H. H. Scott Inc.
 385 Putnam Ave.
 Cambridge, Mass.



Please rush me your new catalog E-10 and complete technical specifications on H. H. Scott components for '57.

Name

Address

City

State

free!

ALLIED'S 1957 value-packed 356-page CATALOG

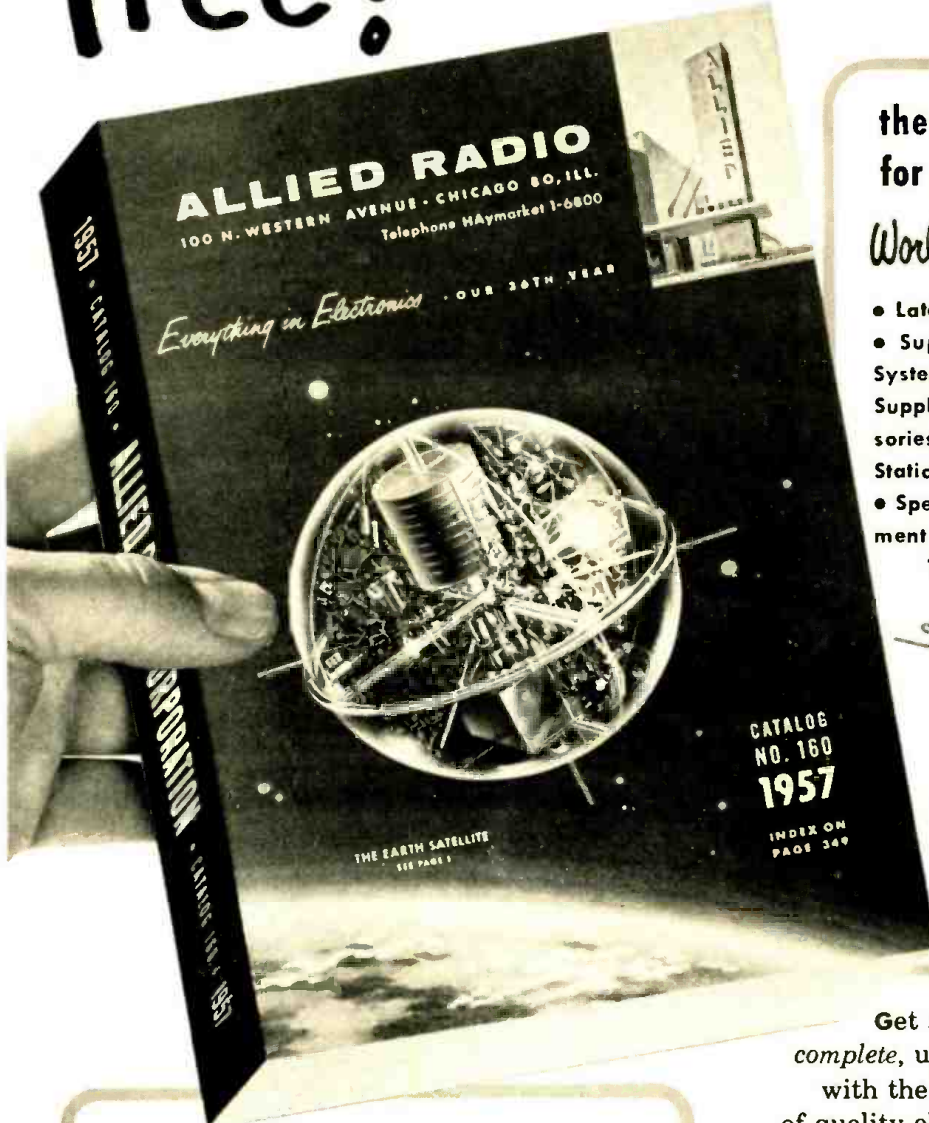

the only COMPLETE catalog
for everything in electronics

World's Most Complete Stocks

- Latest Hi-Fi Systems and Components
- Super-Value KNIGHT-KITS • P. A. Systems and Accessories • Recorders and Supplies • TV Tubes, Antennas, Accessories • Amateur Receivers, Transmitters, Station Gear • Test and Lab Instruments
- Specialized Industrial Electronic Equipment • Huge Listings of Parts, Tubes, Transistors, Tools and Books...

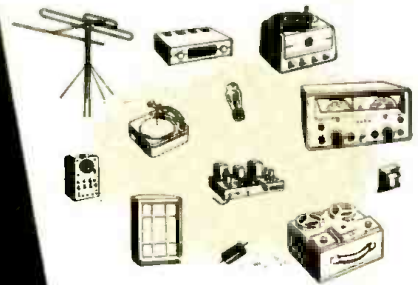

FEATURING

SUPER-VALUE knight-kits: Finest electronic equipment in money-saving Kit form—Test Instruments, Hi-Fi kits, Hobbyist kits, Ham kits. Easiest to build and you SAVE MORE.

EVERYTHING IN HI-FI: World's largest selection of quality Hi-Fi components and complete music systems—available for immediate shipment from stock. Own the best in Hi-Fi for less!

EASY-PAY TERMS: Only 10% down, up to 18 months to pay. Available on orders over \$45. Fast handling—no red tape.

Get ALLIED's 1957 Catalog—it's complete, up-to-date—356 pages packed with the world's largest selection of quality electronic equipment at lowest, money-saving prices. Get every buying advantage at ALLIED: fastest shipment, expert personal help, lowest prices, guaranteed satisfaction...

send for the leading
electronic supply guide



ALLIED RADIO CORP., Dept. 2-K-6
100 N. Western Ave., Chicago 80, Ill.

Send FREE 356-Page 1957 ALLIED Catalog

Name

Address

City Zone State



Our 36th year
ALLIED RADIO
World's Largest Electronic Supply House

OCTOBER, 1956

NOW FOR BOTH 12" AND 8" SPEAKERS

The NEW *Tiny Mite*
Model TM-812

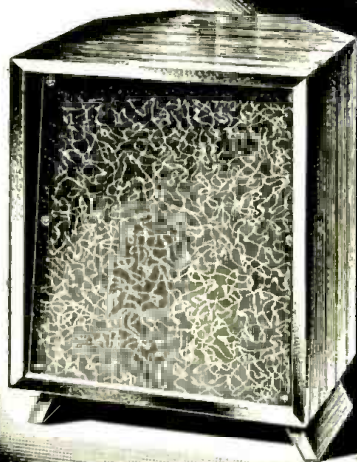

A TINY GEM WITH MIGHTY PERFORMANCE
AT AN UNBELIEVABLY LOW PRICE

It is hard to describe "sound." The picture above gives a pretty good idea of what a TINY-MITE looks like, but what it sounds like . . . that's not so easy.

If we used words like "beautiful," "sonorous," "rich-bodied," you'd conjure up some sort of mental auditory response. But at best it wouldn't be accurate. You have to actually listen with your own ears to know what "sound" really sounds like. You'd have to look twice to believe that the magnificent sound produced by the TINY-MITE was emanating from an enclosure only 21" h. x 15½" w. x 12" d.

It's no trick to achieve good results with a large enclosure, but realizing the great need for limited space enclosures, we set ourselves the goal of producing the finest small enclosure possible. . . . *This is it!*

JUST LOOK AT THESE FEATURES:

1. The *only* cornerless-corner enclosure for both 12" and 8" extended range speakers, employing highly efficient University horn-loaded phase-inversion principle.
2. Versatile design permits use in room and ceiling corners or along flat wall. All exteriors, including the back, are beautifully finished, permitting unlimited decorating possibilities.
3. Construction equals the finest cabinetry. Full ¾" wood used throughout, thoroughly braced.

4. Supplied with mounting board cut out for 12" speaker; adapter for 8" speaker with ample space for tweeter opening is available.
5. No more struggling to install speakers. Baffle board is easily removed at front of cabinet.

The TINY-MITE makes any speaker sound its best. Matching the superb quality of the TINY-MITE, University offers the largest selection of 8" and 12" 2- and 3-way Diffaxials . . . to meet any budget requirement. Visit your favorite Hi-Fi center and listen for yourself.

Mahogany . . . \$39.75
Blond 42.25
Unfinished . . 34.00

UNIVERSITY LOUDSPEAKERS, Inc., 80 South Kensico Ave., White Plains, N.Y.

LISTEN

University sounds better



Correspondence



SAFETY PROGRAM

Dear Editor:

We wish to convey our sincere thanks for the fine publicity (Radio Month, August) given our safety project in Pittsburgh. We are hopeful that the national coverage by your magazine will alert the rest of the nation to this danger.

As a follow-up, I wish to inform you that our committee also investigated the electrocution of a youngster who had the misfortune to make contact with a hot chassis and a grounded radiator. We are therefore adding one more point to our final recommendations: All TV receivers should have a safety interlock in the back which cannot be defeated by using a cheater cord.

I wish also to state that Mr. Joseph Fay, battalion chief of our Fire Prevention Bureau, feels so strongly about our recommendations that he will try to have them placed on the agenda of the convention of the National Fire Prevention Bureau. Our feeling in this matter is that local associations, by performing public services such as this, will gain in stature. Again, thanks for the coverage.

B. A. BREGENZER,
Chairman, Public Safety Committee,
RTSA of Pittsburgh, Inc.
Pittsburgh, Pa.

BASEMENT TECHNICIANS

Dear Editor:

In the August issue of your very fine magazine I ran across some bilge by H. M. Layden (page 14). I am a "basement technician," as Mr. K. M. Barbier, Jr., (same page) puts it. But I am also a college grad, having majored in electronics. I did not read Mr. Layden's beef with Mr. Wolfson but, whoever Mr. Wolfson is, I am on his side.

Mr. Layden is probably doing poorly in his electronics endeavor and, like a lot of others in his status, is complaining about us basement technicians who do a good job and charge a reasonable rate. Most of us do not make a living at it—we have jobs in electronics—but do it to make a small profit while pursuing our favorite hobby. It's a shame that Mr. Layden did not broaden his electronic knowledge to a point where he could do the same.

If Mr. Layden would learn more about radio and TV troubleshooting, he would be so covered with work that he wouldn't have time to complain about basement technicians . . . who are too busy counting their jobs to care
(Continued on page 22)

You Can Train at Home for Good Pay Jobs in RADIO-TELEVISION

Fast Growing Industry Offers Good Pay, Security, Bright Future

**LESSON AND
CATALOG FREE
MAIL CARD**

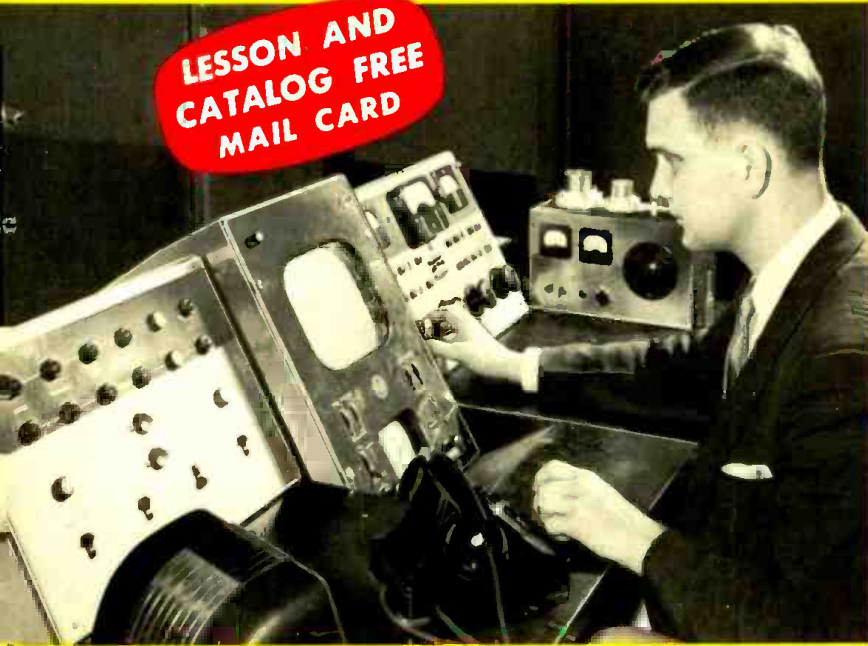

Training PLUS OPPORTUNITY is the ideal combination for success. Today's OPPORTUNITY field is Radio-Television. Over 125 million home Radios plus 30 million sets in cars and 40,000,000 Television sets mean big money, opportunity for trained Radio-Television Technicians. More than 4,000 Radio and TV Broadcasting stations offer interesting and important positions for technicians, operators. Color Television, portable TV sets, Hi-Fi, other developments assure future growth. Radio, Television are both growing. Need for trained technicians is increasing!



**J. E. SMITH
Founder**

Find Out What Oldest and Largest Home Study Radio-Television School Offers You

Since 1914—for more than 40 years—N.R.I. has been training ambitious men at home in spare time for Radio-TV. Thousands of successful graduates say N.R.I.'s 50-50 training method is a fast, easy, effective way to higher earnings, desirable jobs. Carefully planned experiments and practice with equipment supplied free of extra charge, bring basic principles, techniques to life right in your own home. Find out what dependable training can do for you.

You Learn by Doing—Get Practical Experience with Kits N.R.I. Sends

Nothing takes the place of practical experience. As part of N.R.I. Servicing Course you build AC-DC Radio Receiver and Vacuum Tube Voltmeter shown below. Use them to make tests, conduct experiments, get practical experience. All equipment yours to keep.

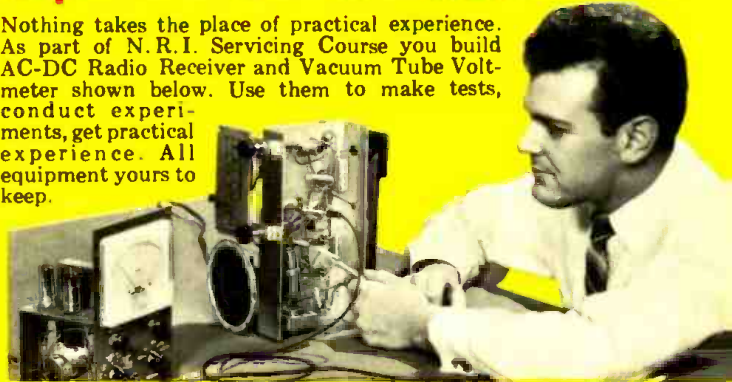

Add to Your Income Starting Soon

Make \$10-\$15 a Week Extra Fixing Sets in Your Spare Time

Soon after enrolling, many N.R.I. students start earning extra money fixing neighbors' radio sets. Many earn enough extra to pay entire cost of course and provide capital to start their own full time Radio-TV business after getting N.R.I. Diploma. If you want a job with a future, find out how you can train at home for Radio-Television. Mail Postage Free postcard for Sample Lesson. See how practical it is to learn at home. Get 64-Page Catalog, too. See equipment you get, outlines of courses, facts about opportunities in this growing field. Prices of N.R.I. Courses are low, terms easy.



See Other Side

CUT OUT AND MAIL CARD NOW

N.R.I. Training leads to good pay jobs like these. **BROADCASTING:** Chief Technician, Chief Operator, Remote Control Operator. **SERVICING:** Home and Auto Radios, P. A. Systems, Television Receivers, Electronic Controls, FM Radios, Hi-Fi. **SHIP AND HARBOR RADIO:** Chief Operator, Assistant Operator, Radiotelephone Operator. **POLICE RADIO:** Transmitter Operator, Receiver Serviceman. **GOVERNMENT RADIO:** Operator in Army, Navy, Marine Corps, Coast Guard, Forestry Service Dispatcher, Airways Radio Operator. **IN RADIO PLANTS:** Design Assistant, Transmitter Design Technician . . . **AND MANY OTHERS.**

N.R.I. TRAINED THESE MEN

Thanks N.R.I. for Good Start



"Right now I am doing spare-time repairs on Radios and Television. Going into full time servicing soon." **C. HIGGINS**, Waltham, Mass.

Quit Job to Start Business



"I decided to quit my job and do TV work full time. I love my work and am doing all right financially." **W. F. KLINE**, Cincinnati, Ohio

Engineer with Station WHPE



"I operated a successful Radio repair shop. Then I got a job with WPAQ and now I am an engineer for WHPE." **VAN W. WORKMAN**, High Point, N. C.

N.R.I. Started His Way up



"I was a cab driver earning \$35 a week. Then I enrolled with N.R.I. Now tester with TV maker." **J. H. SHEPHERD**, Bloomington, Ind.

SAMPLE LESSON AND CATALOG BOTH FREE

**NO STAMP NEEDED!
WE PAY POSTAGE**

This card entitles you to Actual Lesson on Servicing, shows how you learn Radio-Television at home. You'll also receive 64-Page Catalog.

**NATIONAL RADIO INSTITUTE, Dept. F
Washington 9, D. C.**

Please mail me the FREE sample lesson and 64-Page Catalog. (No Salesman will call.)

Name _____ Age _____

Address _____

City _____ Zone _____ State _____

Approved Member, National Home Study Council

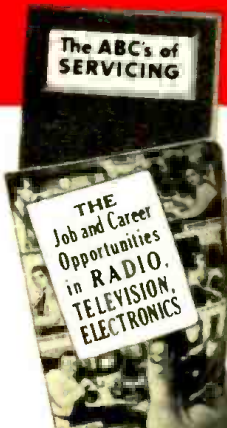

Practice Servicing-Communications with Kits of Parts N.R.I. Sends



YOU BUILD AC-DC Superhet Receiver

N.R.I. Servicing Course includes all needed parts. By introducing defects you get actual servicing experience practicing with this modern receiver. Learn-by-doing.

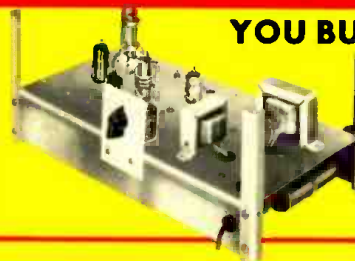

YOU BUILD Signal Generator

You build this Signal Generator. Learn how to compensate high frequency amplifiers, practice aligning typical I.F. amplifiers in receiver circuits. Make tests, conduct experiments.

YOU BUILD Broadcasting Transmitter

As part of N.R.I. Communications Course you build this low power Transmitter, learn commercial broadcasting operators' methods, procedures. Train for your FCC Commercial Operator's License.



YOU BUILD Vacuum Tube Voltmeter

Use it to earn extra cash fixing neighbors' sets; bring to life theory you learn from N.R.I.'s easy-to-understand texts.



Radio-Television Can Give You a Good Job with a Future

N.R.I. Graduates do Important Work — Get Important Pay



Chief Engineer with Station



Paid for Instruments out of Earnings



Has Own Radio-TV Business

"I am Chief Engineer of Station KGCU in Mandan, N. D. I also have my own spare time business servicing high frequency, two-way communications systems." R. BARNETT, Bismarck, N. D.

"I am doing very well in spare time TV and Radio. Sometimes have three TV jobs waiting and also fix car Radios for garages. I paid for instruments out of earnings." G. F. SEAMAN, New York, N. Y.

"We have an appliance store with our Radio and TV servicing and get TV repairs. During my Army service, N.R.I. training helped get me a top rated job." W. M. WEIDNER, Fairfax, S. D.

Here is a line of work that people respect—a vocation where you can advance, win a place for yourself, earn good pay and gain much personal satisfaction in what you are able to do. And you can learn at home in your spare time. Smart fellows everywhere are using their spare time to develop new knowledge, new skills. They know it is the trained man who gets ahead, gets the better job, drives the better car, is respected for what he knows and can do.

Be a Skilled Technician

The technical man is looked up to. He should be. He does important work, gets good pay for it. Radio-Television offers that kind of work. There are more than 40 million Televisions, 150 million home and auto Radios. Millions more are sold each year. There are splendid opportunities for the man well trained in Radio-Television Servicing or Broadcasting. Micro-Wave Relay, Aviation and Police Radio, Two-Way Communications for buses, taxis, trucks, etc. are expanding—making more jobs, greater opportunity.

You Can Train in Spare Time

Keep your job until you're ready for a better one. Learn at home. N.R.I. Courses are planned for men who can study only during spare time. You get many kits to build equipment, get practical experience. You work on circuits common to both Radio and TV. Equipment you build "brings to life" things you learn in N.R.I.'s easy-to-understand texts. Experienced N.R.I. instructors, technicians, specialists devote full time to making sure you get the best and simplest Radio-TV training. Train as fast or as slow as you like.

Tested Way To Better Pay

N.R.I. Training is practical, thorough. You get the benefit of N.R.I.'s 40 years experience training men for success in Radio-Television. Most successful N.R.I. men start without any knowledge of Radio, many without a high school education. Find out what Radio-Television training can mean to you. Make a decisive move today toward becoming one of that select group—a Radio-TV Technician. Send for Actual Lesson and 64-Page Catalog, both FREE. NATIONAL RADIO INSTITUTE, Dept. F, Washington, D.C.

See Other Side

FIRST CLASS
Permit No. 20-R
(Sec. 34.9, P. L. & R.)
Washington, D. C.

BUSINESS REPLY CARD

No Postage Stamp Necessary If Mailed In The United States

POSTAGE WILL BE PAID BY

NATIONAL RADIO INSTITUTE

16th and U Sts., N. W.

Washington 9, D. C.

SAMPLE LESSON AND CATALOG BOTH FREE

CUT OUT AND MAIL POSTAGE-FREE CARD

TEACHING A GIANT TO TAKE SHORT STEPS

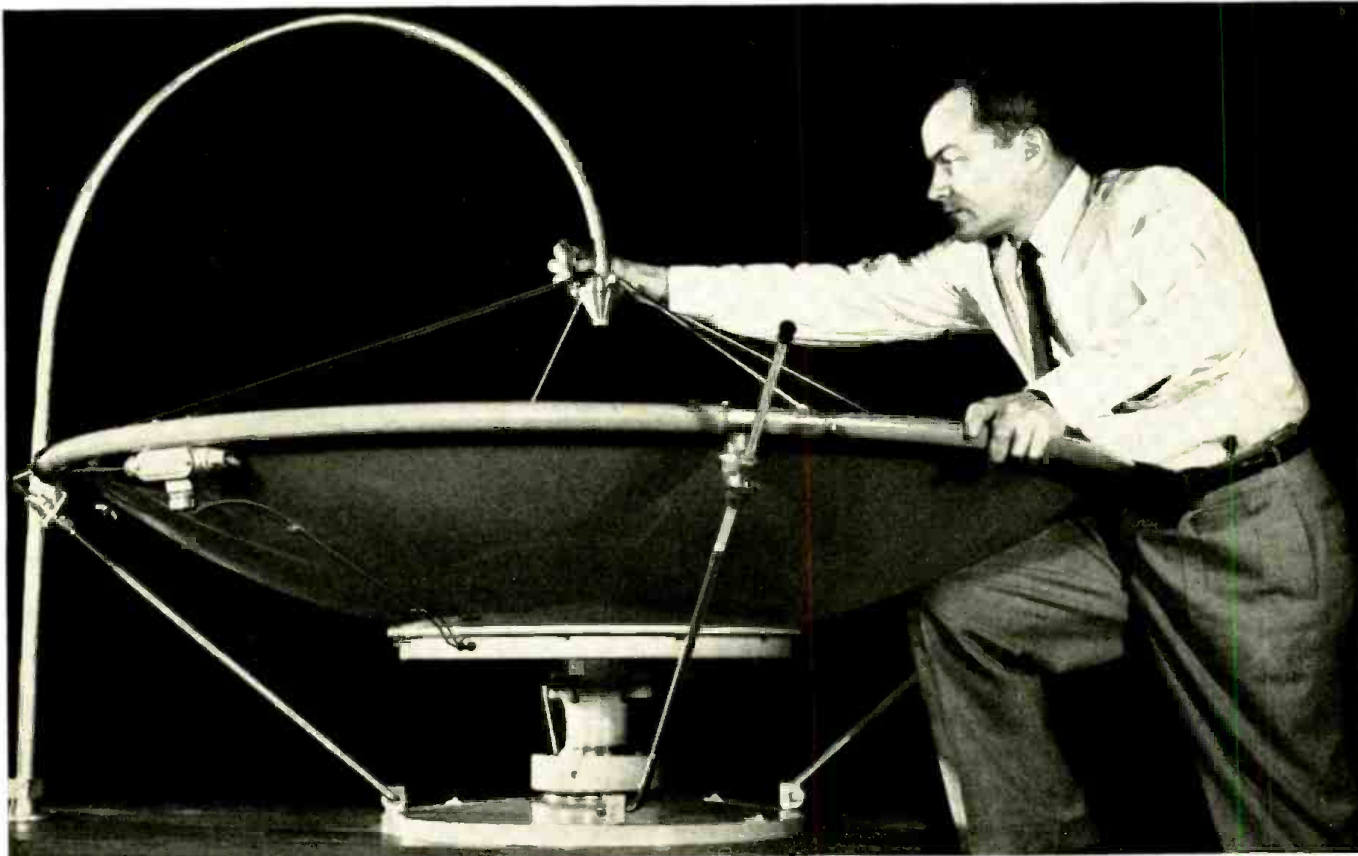

Bell Laboratories' Dr. J. W. Fitzwilliam adjusts a waveguide feed to a parabolic dish reflector. Dr. Fitzwilliam, who has a Ph.D. in physics from Massachusetts Institute

of Technology, leads the practical development of Bell's new 11,000-mc. system. Components had to be developed to operate in a frequency band not previously utilized.

The giant microwave highway that carries your TV programs along with telephone conversations from coast to coast has a versatile new partner — an entirely new microwave system which was created, and is now being developed, at Bell Laboratories. The new system operates at 11,000 megacycles — a much higher frequency than ever before used in telephone service.

Bell's present microwave systems — operating at 4000 megacycles — were designed for heavy traffic and long distances. The new system is designed especially for lighter traffic and shorter distances—up to 200 miles. Its traffic

capacity is extremely flexible. Depending on traffic needs, the system can provide only one one-way or as many as three two-way broadband channels. Each two-way channel can carry 200 telephone conversations simultaneously or one television program in color or black and white in each direction along a route. The new microwave system, which is already being operated experimentally, will be valuable in providing additional telephone service and television programs for cities in remote areas.

This is another example of how research and development work at Bell

Telephone Laboratories help the Bell Telephone System to serve you better.



Mr. L. C. Tillotson, who originated the new system, adjusts the klystron-isolator combination which made the system feasible. Mr. Tillotson, an M.S. from the University of Missouri, is in charge of research in microwave applications.

BELL TELEPHONE LABORATORIES

WORLD CENTER OF COMMUNICATIONS RESEARCH AND DEVELOPMENT



Merit

FIRST IN EXACT REPLACEMENT.

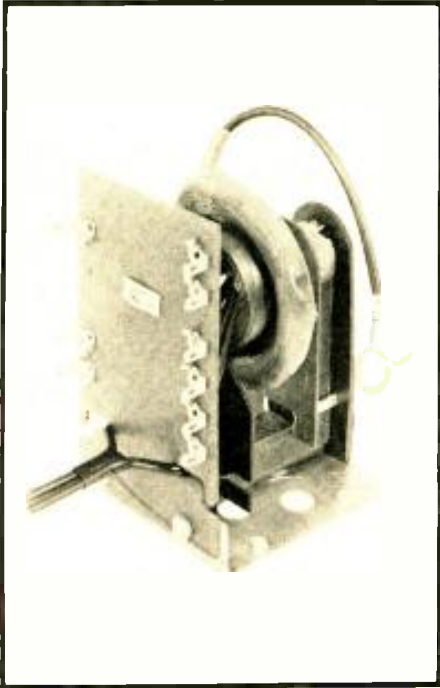

HVO-47 FOR EXACT REPLACEMENT in ANDREA, ARVIN, DUMONT, HOFFMAN, KAYE-HALBERT, PACIFIC MERCURY, PACKARD BELL, SILVERTONE, STROMBERG-CARLSON, TECHMASTER . . . another in the complete Merit line of exact and universal transformers, yokes and coils. Merit is the only manufacturer of transformers, yokes and coils who has complete production facilities for all parts sold under their brand name.

Merit

MERIT COIL & TRANSFORMER CORP.
4127 N. CLARK ST., CHICAGO 10, ILL.

CORRESPONDENCE (Continued)
(Continued from page 18)

whether he complains. Don't worry, Mr. Layden, if we do a bad job or overcharge we won't stay in business very long.

So, on behalf of the many thousands of basement technicians who have forgot more about electronics than you will ever know, I wish you good luck in your climb to success. But climb, Mr. Layden, *don't wait for the elevator!*

G. H. MULFORD

Hamilton, Ohio

COLORDAPTOR ERROR

Dear Editor:

I have constructed and operated the Colordaptor described in your January and February, 1956, issues. The article stated that, when the wheel speed is slightly low, the gray bars go in the direction of the wheel's rotation. Just the opposite is true. The statement is incorrect and is sure to mislead others attempting to determine the highly critical gear ratio for proper wheel speed.

I think you have a very fine electronics magazine.

ROSS J. McDONALD

Scarey, Ark.

FREE ENTERPRISE

Dear Editor:

The sentiments of Mr. A. W. Clement of Galion, Ohio, expressed in the correspondence column of your March issue, run counter to the best interests of service technicians.

Everyone connected with our industry, from the manufacturer to the service technician, from members of technical schools' faculties to editors of technical publications, all recognize the vital need for a code of ethics setting the standards for everyone engaged in this industry. This, alone, is sufficient answer to those who would let the inept, the untrained and the gyps, "continue without restrictions," as the gentleman from Ohio puts it.

Anyone who would let competition alone set the tone of economic life is forgetting the sweat shops, the 84-hour week and the 20-cent-per-hour wage scale that beset us only a short span ago. This country of ours did not become great because of free enterprise alone. Other factors played a decisive role in her greatness. Concern for the common good was one of these. For without the mass purchasing power of the general public, to buy the goods of mass production, greatness for this or any other country would be just a word in the dictionary.

I know, from personal experience, that many of these rugged individualist suffer from myopia and self-aggrandizement. I know too that they constitute a very minute minority in our industry and their ranks are everywhere declining day by day as enlightened self-interest continues to show us the reality of our situation.

H. M. LAYDEN

New York, N. Y.

END

*Send today
for your complete
catalog*

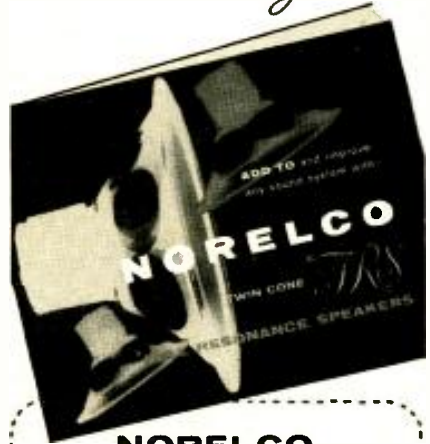

NORELCO

**F.R.S. SERIES*
**FULL RESONANCE
TWIN-CONE
SPEAKERS**



Norelco's twin-cone speakers are designed to meet the problem of high and low frequency dispersion in a single speaker. The large (heavy) cone is designed to produce good bass while the small (light) cone radiates higher frequencies.

Eliminating operating inefficiency experienced in multiple speaker cross over systems, Norelco's twin-cone is driven by a single voice coil—producing a flat response with exceptional reproduction of transients. Based on economy and value any one of the Norelco FRS twin-cone speakers is your best choice. If your neighborhood dealer does not stock Norelco write direct to North American Philips Company, Inc. giving your dealer's name and address.

ADD TO . . . and improve any
sound system with *Norelco*[®]
*FULL RESONANCE SPEAKERS



Write today to Dpt. D10 for brochures and prices of these unique speakers.

North American Philips Co., Inc.
100 E. 42nd Street
New York 17, N.Y.

RADIO-ELECTRONICS

TV Alignment Is Easy



**RCA WR-70A
RF/IF/VF MARKER-ADDER**

PRICE...\$97.50,* with four coaxial cables for connection to sweep and marker generators, and to oscilloscope.

...when you use the new

RCA WIDE-RANGE MARKER-ADDER

The RCA WR-70A Marker-Adder is designed for use in rf, if, and video sweep-frequency alignment of both color and black-and-white TV receivers. When used with alignment instruments such as the RCA WR-59C TV Sweep Generator, the WR-89A TV Calibrator, and an oscilloscope, the WR-70A produces narrow and distinct markers of high amplitude. Response-curve distortion is virtually eliminated, thereby simplifying trace-shape and frequency identification.

Note these important features:

Front-panel control provides instant choice of four different marker shapes, permitting use of type of marker best suited to response curve being observed.

- Eliminates distortion of marker or of the sweep curve by the marker due to overloading of the TV receiver circuits because the marker is added to the sweep-response signal *after the sweep signal is taken out of the receiver*. The marker signal does not go through the rf, if, or vf channels of the receiver.
- Marker "suckout" by receiver circuits is eliminated—enables simple and precise alignment of traps.
- Provides very high-Q markers—high in amplitude, narrow in width.
- Front-panel control of marker shape, amplitude, and polarity; sweep-trace amplitude, and polarity—greatly simplifies black-and-white or color-TV alignment procedure.
- Electron-tube regulator circuit for all B+ voltages provides steady trace display on CRO.

*user price (optional)

SEE YOUR RCA DISTRIBUTOR FOR DETAILS...NOW!



TEST EQUIPMENT

® Radio Corporation of America • Harrison, N. J.

FRONT PANEL SWITCH PROVIDES INSTANT SELECTION OF FOUR DIFFERENT MARKER SHAPES



Narrow-band marker
for S-curve observation



Wide-band marker
for tuner alignment

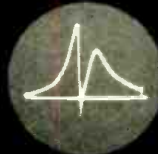

Negative-going marker
for trap adjustment

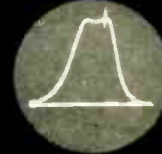

Positive-going marker
for peak alignment

Bull's-eye every time!



Examine it today
Being introduced by leading Electronic Parts Distributors

We hit the target again . . .
with this new, modern version of the
most wanted service-test instrument.

Pyramid introduces the CRA-2 Capacitor-Resistor Analyzer, a versatile, up-to-date, moderately priced test instrument. The CRA-2 is the perfect multi-purpose analyzer for the technician, serviceman and engineer, in industrial and military electronics, black and white, and color television, and all related fields.

The guesswork has been removed from circuit trouble shooting. When making leakage-current measurements, the values are read directly from the meter while the rated operating voltage is applied to the capacitor. A vacuum-tube ohmmeter circuit displays accurate insulation-resistance values on the meter for many types of capacitors. The extended range calibrated power factor control permits power factor measurements of electrolytic capacitors rated as low as 6 volts DC working and as high as 600 volts DC working. This special "QUICK CHECK" circuit performs rapid "IN CIRCUIT" test for short, open, intermittent high RF impedance and high power factor without removing or disconnecting the component from its operating circuit.

FEATURES

- "Quick Check" in circuit test for Open Circuits. Short Circuits. Intermittents. High RF Impedance. High Power Factor.
- Speedily and accurately checks: Capacitance. Power Factor. Resistance. Insulation-Resistance. Leakage Current.
- Precision meter for accurate readings of leakage current, applied voltage and insulation resistance.
- Combination Wien and Wheatstone bridge.
- Accurate vacuum-tube meter circuit.
- Parts of the highest quality are used. Wire and wiring meet military specifications.

PYRAMID ELECTRIC COMPANY

1445 Hudson Blvd., North Bergen, New Jersey

Electronics Boom Seen

Need For Television Technicians To Rise

Industry Warned About Shortage Of Trained Men

TV SALES SET NEW RECORD

Sylvania Head Expects Huge Electronic Gains

Transistor Radios Developed

RCA HEAD PREDICTS SALES BOOM FOR COLOR TV SETS

VETERANS - - NON-VETERANS

Get Into The Field That's Making Headlines



All over the nation the Television-Radio-Electronics industry is making News — News that means opportunity for YOU. You can cash in on the headlines. **I WILL TRAIN YOU AT HOME FOR A TOP-PAY JOB IN TELEVISION**

I will prepare you for a spot in America's fastest-growing industry. You can become a trained technician in your spare time without giving up your present job or social life. No experience needed.

LEARN BY DOING

Combination Voltmeter-Ammeter-Ohmmeter



C-W Telephone Transmitter

Super-Het Radio Receiver

AF-RF Signal Generator

Public Address System

L. C. Lane, B.S. B.A.
President, Radio-Television Training Association
Executive Director, Pierce School of Radio & Television

As part of your training I give you the equipment you need to set up your own home laboratory and prepare for a top-pay job or set up your own business. You build and keep an Electromagnetic TV RECEIVER designed and engineered to take any size picture tube up to 21-inch. (10-inch tube furnished. Slight extra cost for larger sizes.) . . . also a Super-Het Radio Receiver, AF-RF Signal Generator, Combination Voltmeter-Ammeter-Ohmmeter, C-W Telephone Transmitter, Public Address System AC-DC Power Supply. Everything supplied, including all tubes.

STUDY NEWEST DEVELOPMENTS

My training covers all the latest developments in the fast-growing Television-Radio-Electronics industry. You learn about FM — RADAR — COLOR TV — TRANSISTORS — PRINTED CIRCUITS, etc.

CHOOSE FROM THREE COMPLETE COURSES covering all phases of Radio, FM and TV

1. Radio, FM and Television Technician Course — no previous experience needed.
2. FM-TV Technician Course — previous training or experience in radio required.
3. TV Cameraman and Studio Technician Course — advanced training for men with Radio or TV training or experience.

EXTRA TRAINING IN NEW YORK CITY AT NO EXTRA COST!

After you finish your home study training in Course 1 or 2 you can have two weeks, 50 hours, of intensive Lab work on modern electronic equipment at our associate resident school, Pierce School of Radio & Television. **THIS EXTRA TRAINING IS YOURS AT NO EXTRA COST WHATSOEVER!**

FCC COACHING COURSE

Important for **BETTER-PAY JOBS** requiring FCC license! You get this training **AT NO EXTRA COST!** Top TV jobs go to FCC-licensed technicians.

VETERANS

My School fully approved to train Veterans under new Korean G. I. Bill. Don't lose your school benefits by waiting too long. Write discharge date on coupon.

Radio-Television Training Association

52 EAST 19th STREET • NEW YORK 3, N. Y.

Licensed by the State of New York • Approved for Veteran Training

EARN WHILE YOU LEARN

Almost from the very start of your course you can earn extra money by repairing sets for friends and neighbors. Many of my students earn up to \$25 a week . . . pay for their entire training with spare time earnings . . . start their own profitable service business.

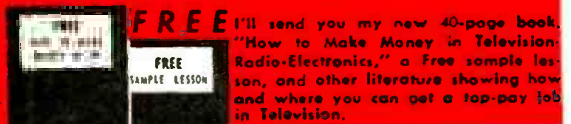

FREE I'll send you my new 40-page book, "How to Make Money in Television-Radio-Electronics," a Free sample lesson, and other literature showing how and where you can get a top-pay job in Television.

MAIL THIS COUPON TODAY!

Mr. Leonard C. Lane, President
RTTA

Dept. R-10C, 52 East 19th Street, New York 3, N. Y.

Dear Mr. Lane: Send me your **NEW FREE BOOK, FREE SAMPLE LESSON**, and **FREE** aids that will show me how I can make **TOP MONEY IN TELEVISION**. I understand I am under no obligation.

(PLEASE PRINT PLAINLY)

Name _____ Age _____

Address _____

City _____ Zone _____ State _____

I AM INTERESTED IN:

- Radio-FM-TV Technician Course
- FM-TV Technician Course
- TV Cameraman & Studio Technician Course

VETERANS!

Write discharge date

NO OBLIGATION!

FOR THE FIRST TIME IN HI-FI HISTORY...

cabinart

pfK

pre-finished Kits!

That's right! Now you can buy a loudspeaker enclosure in kit form whether you are a do-it-yourselfer or a don't-do-it-yourselfer. No more messing with shellac, furniture stain, varnish, wood putty, rogs and the rest of the gookum... this time you really need only a screwdriver to assemble a superb piece of cabinet-work with that supremely professional "CABINART" finish. Each enclosure comes with every outside piece pre-finished in beautiful hand-rubbed korina or mahogany veneers. The assembled kits are absolutely indistinguishable from their world-famous factory-assembled "CABINART" counterparts. Best of all, the money you would otherwise spend on finishing tools and materials more than makes up the price difference between a pre-finished kit and an unfinished kit.

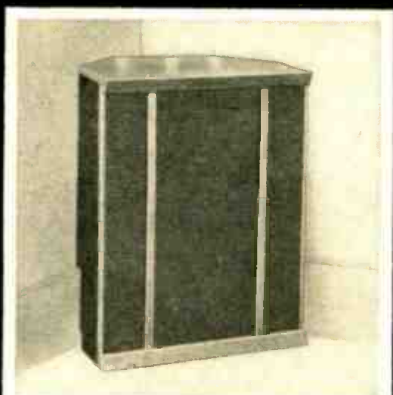

Model PFK-120/150

(pfK=Pre-Finished Kit)
Pre-finished kit version of the REBEL 4, Paul Klipsch-designed CABINART corner horn for 12" or 15" speaker systems.
PFK-120, for 12" woofer drivers:
Shipping Weight 42 lbs. \$48.00 net
Model K-12, unfinished kit \$36.00 net
Model KR-4/12, factory-assembled and finished version of same \$69.00 net
PFK-150, for 15" woofer drivers:
Shipping Weight 48 lbs. \$58.00 net
Model K-15, unfinished kit \$42.00 net
Model KR-4/15, factory-assembled and finished version of same \$87.00 net



Model PFK-300

(pfK=Pre-Finished Kit)
Pre-finished kit version of the REBEL 3, CABINART's famous Klipsch-designed corner horn for 15" speaker systems. Response down to nearly 30 cps.
Shipping Wt. 61 lbs. \$72.00 net
Model K-3, unfinished kit version of same \$49.50 net
Model KR-3, factory-assembled and finished version of same \$99.00 net



Model PFK-500

(pfK=Pre-Finished Kit)
Pre-finished kit version of the REBEL 5, the extra-compact CABINART corner horn designed by Paul Klipsch for 8" and 12" speaker systems.
Shipping Weight 34 lbs. \$36.00 net
Model KR-5, factory-assembled and finished version of same \$48.00 net
Model K-5, unfinished kit version of same \$24.00 net



Model P-610/630

Pre-finished versions of the CABINART Model 61/63 kits (folded corner horns) for 12" and 15" speakers, respectively.
P-610, for 12" speakers:
Shipping Wt. 39 lbs. \$25.95 net
Model 61 unfinished kit version of same \$19.95 net
P-630, for 15" speakers:
Shipping Wt. 39 lbs. \$29.95 net
Model 63, unfinished kit version of same \$23.95 net

pfK Cabinart

... and don't forget—

CABINART can supply you with 16 other hi-fi kits, 29 kinds of equipment cabinets, 4 matched speaker systems and 20 different hi-fi accessories.

cabinart

Write For Complete cabinart '57 Catalog

CABINART FURNITURE IS MANUFACTURED BY G & H WOOD PRODUCTS COMPANY, 99 NORTH 11 ST., BROOKLYN 11, N. Y.



IN **23,000** CITIES AND TOWNS



WESTERN UNION
"Operator 25"

is sending customers to

RAYTHEON BONDED DEALERS

Ask your Sponsoring Bonded Raytheon Tube Distributor about "Operator 25" and the many other important advantages of being a Raytheon Bonded Electronic Technician.



RAYTHEON MANUFACTURING COMPANY
 Receiving and Cathode Ray Tube Operations
 Newton, Mass. • Chicago, Ill. • Atlanta, Ga. • Los Angeles, Calif.
 Raytheon makes all these } Receiving and Picture Tubes, Reliable Subminiature and Miniature Tubes, Semiconductor Diodes, Power Rectifiers and Transistors, Nucleonic Tubes, Microwave Tubes





* jam-proof



Another reason why today's fastest
selling high fidelity record changer is **Collaro**

* Jam-Proof —

safety clutch feature
prevents damage even if tone arm is
moved or held during
change cycle.



For other features and new popular price, see your hi-fi dealer or write Dept. RK-16

ROCKBAR CORPORATION 650 Halstead Avenue, Mamaroneck, N. Y.

www.americanradiohistory.com



RCA offers you the
 finest training
 at home in
 Radio-TV
 electronics,
 TV servicing,
 Color TV

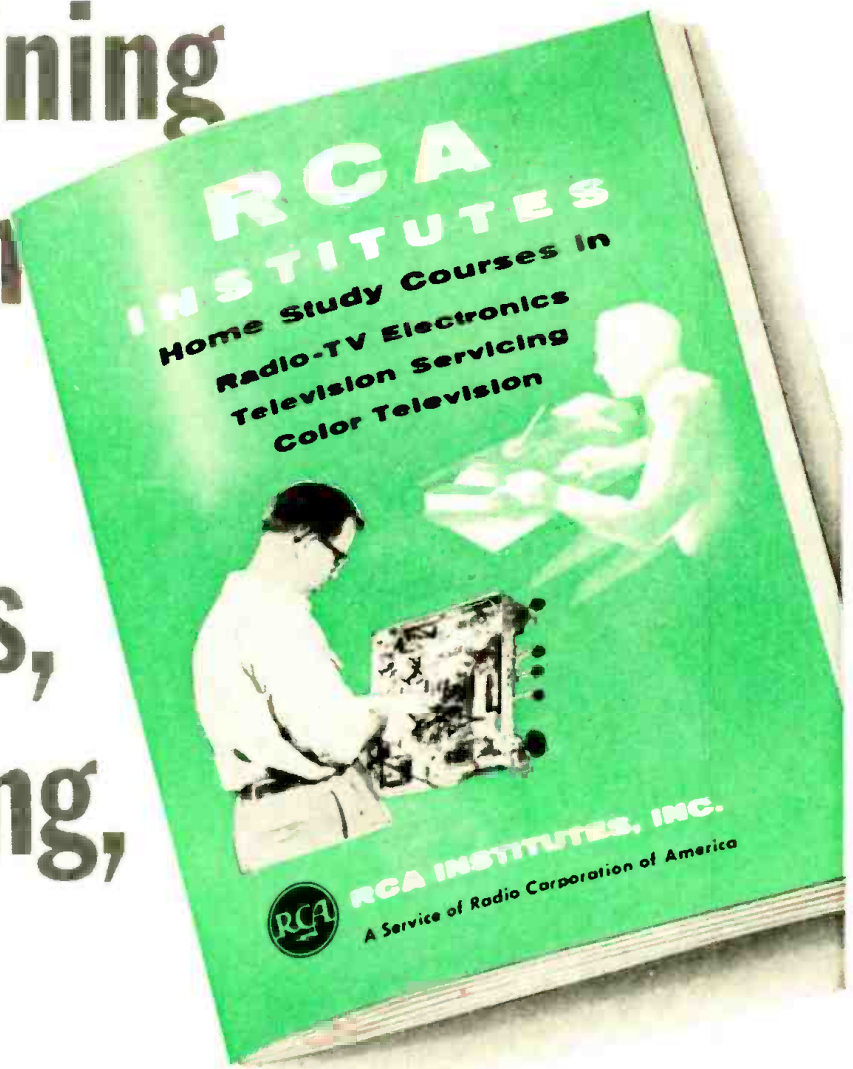

SEND FOR THIS FREE BOOK NOW!

The instruction you receive and equipment you get (and keep) will start you on your way. Pay-as-you-learn. You pay for only one study group at a time. This 52 page book contains complete information on Home Study Courses for the beginner and the advanced student.



RCA INSTITUTES, INC.
 A SERVICE OF RADIO CORPORATION OF AMERICA
 350 WEST FOURTH STREET, NEW YORK 14, N.Y.

RCA Institutes, Inc., Home Study E-106,
 350 West Fourth Street New York 14, N. Y.
 Without obligation, send me FREE CATALOG
 on Home Study Courses in Radio, Television
 and Color TV. No salesman will call.

Name Please Print
 Address
 City Zone State

**VETERANS
 KOREAN G-I**
 Check here
 PL550

the specs are the proof . . . 2 more **BEST BUYS** by **EICO**

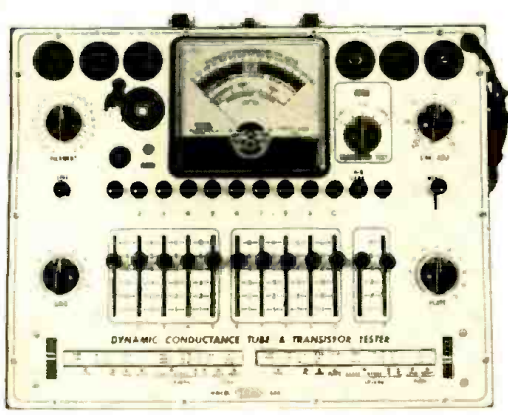

NEW! DYNAMIC CONDUCTANCE Tube & Transistor Tester #666

COMPLETE WITH MATCHING PROTECTIVE STEEL COVER AND CARRYING HANDLE
KIT \$69.95 WIRED \$109.95

Speedy, simple operation, close simulation of actual tube operating conditions, unexcelled thoroughness, sensitivity and accuracy of test, excellent electrical and mechanical design—these are the superb advantages of the #666.

APPLICATIONS: Ideal for COLOR AND MONOCHROME TV servicing: Tests all receiving tubes including 4, 5, 6 and 7-pin, octal, loctal, miniature 7 and 9-pin, subminiature 5, 6, 7-pin (in-line base) and 8-pin (circular base) receiving tubes, many small transmitting and special-purpose tubes, voltage regulators, cold-cathode rectifiers, electron-ray indicators, and ballast tubes. Tests TV picture tubes with accessory adaptor. Tests n-p-n and p-n-p transistors.

ELECTRICAL CHARACTERISTICS

TRANSISTOR TEST: Dependable industry-approved two-step test on both n-p-n and p-n-p transistors, using internal dc power supply: (1) leakage measurement of collector current and (2) direct reading of current amplification factor or Beta. Saves you the cost of a separate transistor tester.

DYNAMIC CONDUCTANCE TUBE TEST: Composite indication of mutual conductance (Gm), plate conductance (Gp) and peak emission capability. Test accuracy is assured by the following:

- Multi-circuit lever switch for speedy simultaneous selection of any one of 4 combinations of 3 plate, 3 screen and 3 ranges of control grid voltages.
- Grid voltage variable over each range with a 5% accurate wire-wound potentiometer.
- 5 ranges of meter sensitivity using 1% carbon-deposited shunts and 5% accurate wire-wound meter range potentiometer.
- 200 ua meter provides unusual sensitivity for checking tubes with low cathode current.
- Rectifiers tested near maximum rated current for extra accuracy.

Leakage Test: Direct-reading of inter-element leakage in ohms, with these features:

- Sensitive 200 ua meter permits accurate readings up to 20 megohms.
- DC leakage test voltage always applied in correct polarity to eliminate emission effects from readings.
- Accurate heater-cathode leakage readings achieved by isolation of heater and cathode from remaining tube elements during test.
- 10 push-button switches permit rapid insertion of alternate tube elements in leakage test circuit.

Each active tube element can be individually connected to any of the following busses; plate voltage, screen voltage, grid voltage, filament voltage, ground (cathode and filament return), no connection.

Multi-section tubes have each section individually tested by rapid push-button selection—while all sections are simultaneously drawing full-rated current . . . Pentodes are tested as pentodes, with no "lumping together" of tube elements.

Filament switch provides selection from 20 filament voltages; adequate for all older tube types in use as well as for the new 600, 450 and 300 ma series string tubes.

Line voltage may be read directly off the dial of the line-adjust rheostat on the panel with good accuracy.

Rollchart is extensive, up-to-date, and includes settings for all new series string type tubes.

Exceptional control accuracy makes possible a very easy method for developing accurate test settings for new tube types before such data is published on a new rollchart. Snap-in rollchart windows for easy entry of new test data.

Power: operates from 105-130 volts AC line, 50/60 cps. Provided with pilot lamp and fused for safety.

PHYSICAL SPECIFICATIONS

Components specifically selected for ruggedness in day-after-day servicing.

New gear-driven rollchart mechanism is easily assembled, provides smooth trouble-free operation. Snap-in windows permit settings for new tubes to be entered on rollchart without disassembly.

The 10 individual element push-buttons are ganged on one easily-mounted assembly through which they are interlocked mechanically and interconnected electrically to simplify mounting and wiring and assure safer operation.

The 10 SIX-position lever switches plus the two lever switches for meter shunt, and plate, screen, and range of grid voltage selection, are all ganged together to form one quick mounting assembly for not only very rapid settings but easier wiring for the kit constructor.

The only internal adjustments in this tester are two calibrating rheostats for the line adjust and leakage measurement circuits. All the equipment required to calibrate the tester is one voltmeter of any type.

The "Tube Merit" Switch, through which plate, screen, and grid voltages are applied to the tube under test, is of the spring-return type to eliminate the possibility of damage to the tube tester by continuous operation of a defective tube.

Deep-etched, heavy gauge, brushed satin aluminum panel; 4 1/2", 200 ua D-Arsonval meter movement, in clear lucite case; rugged grey wrinkle steel carrying case with matching steel cover and carrying handle for easy portability. Dimensions: 12" x 15" x 6". Weight: 20 lbs.

NEW! TV-FM SWEEP GENERATOR AND MARKER #368

KIT \$69.95 WIRED \$119.95

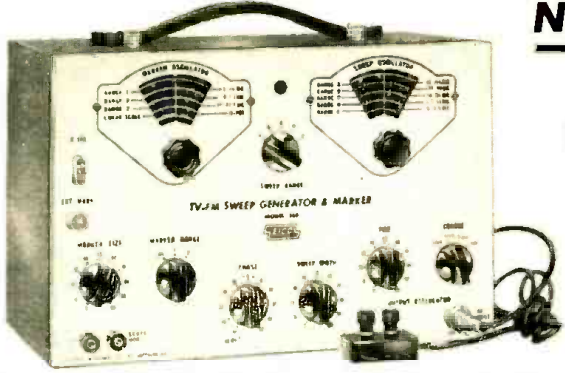

The most highly perfected service instrument of this type presently being offered in either kit or wired form at ANY price!

For accurate alignment of FM, TV Monochrome and Color sets; all RF, IF and oscillator stages, including intercarrier; all sound and video traps. High RF output for alignment of boosters, tuners, and other RF circuits without need for additional amplification.

Outstanding ease and accuracy in alignment. Entirely electronic sweep circuit with accurately biased inductor provides superb linearity on both sides of center frequency. Newly-designed AGC circuit automatically adjusts oscillator for maximum output on each band with minimum amplitude variations. Resonance-free RF choke eliminates "suck-out" points anywhere in the RF spectrum. Sweep generator range 3-216 mc in 5 OVERLAPPING FUNDAMENTAL BANDS. Sweep width continuously variable from 0-3 mc lowest maximum deviation to 0-30 mc highest maximum deviation. Variable marker generator range from 2-75 mc in 3 FUNDAMENTAL BANDS plus a calibrated harmonic band (60-225 mc). Variable marker calibrated with internal crystal marker generator, 4.5 mc crystal included. External marker provision. Edge-lit hairlines eliminate parallax. Double pi line filter. Output impedance 50 ohms. Continuously variable separate marker size control. 4-step decade "coarse" and continuously variable "fine" attenuators for both sweep and marker output together. Complete 2-way blanking eliminates return trace. Narrow range phasing control for accurate alignment. Cables included: output, scope horizontal and compensated scope vertical cables.

**NEW! COLOR and Black-&White
LAB & TV 5" OSCILLOSCOPE #460
KIT \$79.95. Wired \$129.50**



The **FINEST** professional 5 mc wide-band scope value. Ideal for research, h-f & complex waves, plus Color & Monochrome TV servicing. Flat from DC to 3.58 mc ± 1 db (color burst freq.), flat DC to 4.5 mc $+1, -3$ db. Vert. sens. 25 rms mv/in. Vert. Z 3 megs. Has the following outstanding features not found in scopes up to several times its price, kit or wired:

VERTICAL AMPLIFIER: direct-coupled (DC) thruout to eliminate l-f phase shift; push-pull thruout for negligible distortion; K-follower coupling between push-pull pentode stages for extended h-f resp. (minimizes h-f phase shift, extends useful resp. to 10 mc); full-screen undistorted vert. defl; 4-step freq-compensated decade step attenuator up to 1000:1. **SWEEP CIRCUIT:** perfectly linear sweeps, 10 cps - 100 kc (ext. cap. for down to 1 cps); pre-set TV vert. & hor. positions (30 & 7875 cps); automatic sync. ampl. & limiter eliminates sync amplitude adj. **PLUS:** direct or cap. coupling; bal. or unbal. inputs; edge-lit engraved lucite graph screen; dimmer; anti-glare filter; bezel fits std photo equip. **OTHER IMPORTANT FEATURES:** High intensity trace CRT. Finest sq. wave resp. (.06 usec rise time). Push-pull hor. ampl., flat to 400 kc, sens. 0.6 rms mv/in. Built-in voltage calibration. Intensity mod. Sawtooth & 60 cps outputs. Astigmatism control. Retrace blanking.

Instant, drift-free full-screen vert. positioning & 2X full-screen hor. positioning. Bal. cal. astig. adj. externally accessible. 5U1 CRT, 2-6AU8, 2-6CB6, 1-12AU7A, 2-6J6, 1-6AX5, 1-1V2. Deep-etched satin aluminum panel, rugged grey wrinkle steel cabinet. Designed for easy building at home with no special equipment. 15" x 8 1/2" x 16". 30 lbs.

SCOPE DIRECT PROBE* = PD: KIT \$2.75. Wired \$3.95. Eliminates strap-pick-up & signal re-radiation.

SCOPE DEMODULATOR PROBE* = PSD: KIT \$3.75. Wired \$5.75. Demodulates AM carriers between 150 kc and 250 mc.

SCOPE LOW CAPACITY PROBE* = PLC: KIT \$3.75. Wired \$5.75. For signal tracing in high frequency, high impedance & wide-band circuits (as in TV) without distortion from overloading or frequency discrimination.

for **COLOR** and Monochrome TV servicing

**New! PEAK-to-PEAK VTVM #232
& UNI-PROBE (pat. pend.)
KIT \$29.95. Wired \$49.95**



UNI-PROBE: exclusive with EICO! Terrific time-saver! Only 1 probe performs all functions—a half-turn of probe-tip selects DC or AC-Ohms.

The new leader in professional peak-to-peak VTVMs. Latest circuitry, high sensitivity & precision, wide ranges & versatility. Calibration without removing from cabinet. New balanced bridge circuit. High Z input for negligible loading. 4 1/2" meter, can't-burn-out circuit. 7 non-skip ranges on every function. 4 functions: +DC Volts, -DC Volts, AC Volts, Ohms.

Uniform 3 to 1 scale ratio for extreme wide-range accuracy. Zero center. One zero-adj. for all functions & ranges. 1% precision ceramic multiplier resistors. Measure directly peak-to-peak voltage of complex & sine waves: 0-1, 14, 42, 140, 420, 1400, 4200. DC/RMS sine volts: 0-1.5, 5, 15, 50, 150, 500, 1500 (up to 30,000 v. with HVP probe, & 250 mc with PRF probe). Ohms: 0.2 ohms to 1000 megs.

12AU7, 6AL5, selenium rectifier; xfmr-operated. 8 1/2" x 5" x 5". Deep-etched satin aluminum panel, rugged grey wrinkle steel cabinet. 7 lbs.

**New! DELUXE PEAK-to-PEAK VTVM #249
with 7 1/2" METER & UNI-PROBE (pat. pend.)
KIT \$39.95. Wired \$59.95**

All the advanced & exclusive features of #232—PLUS the extra convenience and readability of its big 7 1/2" meter. Your ideal bench instrument.

VTVM RF PROBES* #PRF-11 or PRF-25: KIT \$3.75. Wired \$4.95. Accuracy $\pm 10\%$. Use with any 11 or 25 megohm VTVM.

VTVM HV PROBE #HVP-2: Wired \$4.95. Complete with multiplier resistor. Measures up to 30 kv with any VTVM or 20,000 ohms/volt VOM.

Calibration without removing from cabinet.

*Only EICO Probes have all these features: fully shielded, rugged terminal board parts mounting; shock-mounted floating construction; spring-action, color-coding; easy parts accessibility.



150 kc to 435 mc
with ONE generator!



**New! RF SIGNAL GENERATOR #324
KIT \$26.95. Wired \$39.95**

for **COLOR** and Monochrome TV servicing

New wide-range, stable generator — better value than generators selling at 2 or 3 times its cost! Ideal for: IF-RF alignment, signal tracing & trouble-shooting of TV, FM & AM sets; marker gen.; 400 cps audio testing; lab. work. **6 fundl. ranges:** 150-400 kc, 400-1200 kc, 1.2-3.5 mc, 3.5-11 mc, 11-37 mc, 37-145 mc; 1 harmonic band 111-435 mc. Freq. accurate to $\pm 1.5\%$; 6:1 vernier tuning & excellent spread at most important alignment freqs. Etched tuning dial, plexiglass windows, edge-lit hairlines. Colpitts RF osc., directly plate-modulated by K-follower for improved mod. Variable depth of int. mod. 0-50% by 400 cps Colpitts osc. Variable gain ext. mod. amplifier: only 3.0 volts needed for 30% mod. Turret-mounted coils slug-tuned for max. accuracy. Fine & Coarse (3-step) RF attenuators. RF output 100,000 uv; AF sine wave output to 10 volts. 50-ohm output Z. 5-way jack-top binding posts for AF in/out; coaxial connector & shielded cable for RF out. Tubes: 12AU7, 12AV7, selenium rectifier; xfmr-operated. Deep-etched satin aluminum panel, rugged grey wrinkle steel cabinet. 8" x 10" x 4 3/4". 10 lbs.

The specs are the proof...

**4 NEW BEST BUYS
by EICO**

**COMPLETE
with Preamplifier, Equalizer and Control Section
New! 20-WATT Ultra-Linear Williamson-
type HIGH FIDELITY AMPLIFIER #HF20
KIT \$49.95. Wired \$79.95**

A low-cost, complete-facility amplifier of the highest quality that sets a new standard of performance at the price, kit or wired. Every detail, down to the etched, brushed solid brass control plate, is of the fine quality EICO is famous for.

Rated power output: 20 watts (34 w peak). IM distortion (60 cps: 6 ke/4:1) at rated power: 1.3%. Mid-band harmonic distortion at rated power: 0.3%. Maximum harmonic distortion between 20 and 20,000 cps at 1 db under rated power: approx. 1%. Power response (20w): ± 0.5 db 20-20,000 cps; ± 1.5 db 10-40,000 cps. Frequency response (1/4w): ± 0.5 db 13-35,000 cps; ± 1.5 db 7-50,000 cps.

5 feedback equalizations for LP's & 78's including RIAA. Variable turnover feedback tone controls do not affect volume & permit large boosts or cuts at either end of audio spectrum with mid-freqs. unaffected. Loudness control & separate level set control on front panel. Low Z output to tape recorder. 4 hi-level switched inputs: tuner, tv, tape, auxiliary (xtal/ceramic phono or 2nd tuner); 2 low-level inputs for proper loading with all leading magnetic, FM & quality xtal cartridges. Hum bal. control. Extremely fine output transformer has interleaved windings, tight coupling, careful balancing & grain-oriented steel. 8 1/2" x 15" x 10". 24 lbs.

These amazing EICO values are **NOW IN STOCK** at your nearest distributor. Examine them side-by-side with ANY competitor. You'll see for yourself why indeed EICO is your **BEST BUY**. Fill out coupon on reverse page.

TURN PAGE FOR MORE EICO VALUES...

84 Withers Street, Brooklyn 11, New York

Prices 5% higher on West Coast.

**Do you OVERPAY
for QUALITY
instruments?**

EICO's mass purchasing and world-wide distribution, together with advanced electronic design, produce values never before possible . . . to give you Laboratory Precision at Lowest Cost!

GET the MOST for YOUR MONEY! Don't buy ANY test instrument till you put the EICO INSTRUMENT (kit or wired) equivalent before you—and . . .

Compare advanced electronic design: see the latest in circuitry and features.

Compare finest components: see the famous brands you know and trust, such as GE, Centralab, Mallory, etc.

Notice ease of construction and operation: Exclusive "Beginner-Tested" Manuals make assembly and operation step-by-step, quick, crystal-clear. "You build them in one evening—they last a lifetime!"

Check 5-Way Guarantee: Only EICO gives you this exclusive complete protection! EICO guarantees components, instructions and satisfactory operation — AND guarantees service and calibration for the LIFETIME of the instrument, at less than cost of handling.

Compare feature for feature, dollar for dollar.

There's an EICO distributor right nearby in your own neighborhood — over 1200 coast-to-coast. EICO planned it that way so that you can easily examine EICO BEFORE YOU PUT DOWN ONE CENT OF YOUR MONEY!

COMPARE any of EICO's 46 models SIDE BY SIDE with ANY competitor. Then YOU judge who's giving you the MOST for your money.

Over 500,000 EICO instruments in use . . . You'll agree EICO gives you LABORATORY PRECISION AT LOWEST COST.

Turn page for other EICO ad



FREE 1956 EICO CATALOG!

Tells you how to SAVE 50% on
your test equipment costs!



TUBE TESTER #625
KIT \$34.95
Wired \$49.95

- tests 600 ml series string type tubes
- Illuminated roll-chart

Pix Tube Test Adapter\$4.50

New! GEIGER COUNTER #803
KIT \$19.95 Wired \$29.95



(less batteries)
Professional, all-electronic, sensitive, rugged—at lowest cost! Indicates by neon lamp & headphone clicks.



5" PUSH-PULL OSCILLOSCOPE #425
KIT \$44.95
Wired \$79.95

7" PUSH-PULL OSCILLOSCOPE #470
KIT \$79.95
Wired \$129.50



VACUUM TUBE VOLTMETER #221
KIT \$25.95
Wired \$39.95

DELUXE VTVM #214 (7 1/2" METER)
KIT \$34.95
Wired \$54.95



RF SIGNAL GENERATOR #320
KIT \$19.95
Wired \$29.95

150 kc-34 mc, calibrated harmonics to 102 mc. Pure or mod. RF, & Colpitts osc. 400 cps sine wave outputs.



NEW! UTILITY TESTER #540
KIT \$12.95
Wired \$15.95

Multi-range ac/dc voltmeter, ammeter, ohmmeter, wattmeter, leakage checker for home & auto repairs.



#944 FLYBACK TRANSFORMER & YOKE TESTER
KIT \$23.95
Wired \$34.95

- fast check all flybacks & yokes in or out of set.
- spots even 1 shorted turn!



Range 500 kc-228 mc on fund. Cont. sweep width control, 0-30 mc.

TV/FM SWEEP GENERATOR #360
5MC-4.5MC CRYSTAL \$3.95 ea.

KIT \$34.95
Wired \$49.95

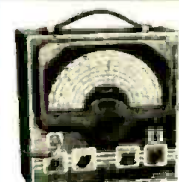

1% accuracy on all 7 ranges. Range 75 kc-150 mc. Volt reg.

DELUXE RF SIGNAL GENERATOR #315
KIT \$39.95
Wired \$59.95



Sep. volt-meter & ammeter

KIT \$29.95
Wired \$38.95

6V & 12V BATTERY ELIMINATOR & CHARGER #1050



Sep. hi-gain RF & lo-gain audio inputs. Special noise locator. Calibrated wattmeter.

KIT \$24.95
Wired \$39.95

DELUXE MULTI-SIGNAL TRACER #147



Reads 0.5 ohms -500 megohms, 10 mmfd-5000 mfd power factor.

KIT \$19.95
Wired \$29.95

R-C BRIDGE & R-C-L COMPARATOR #950B



HI-FI PREAMPLIFIER HF-61
KIT \$24.95. Wired \$37.95. With Power Supply: KIT \$29.95. Wired \$44.95

Feedback circuitry thruout! Preamplifier, tone controls, scratch & rumble filters, K-follower output.

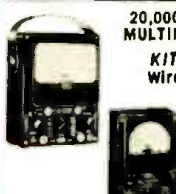

20,000 Ohms/Volt MULTIMETER #565
KIT \$24.95
Wired \$29.95



1000 Ohms/Volt MULTIMETER #536
KIT \$12.90
Wired \$14.90



VTVM PROBES KIT Wired

Peak-to-Peak \$4.95 \$6.95

RF \$3.75 \$4.95

High Voltage Probe-1 \$6.95

High Voltage Probe-2 \$4.95

SCOPE PROBES

Demodulator \$3.75 \$5.75

Direct \$2.75 \$3.95

Low Capacity \$3.75 \$5.75

For FREE 1956 catalog, mail coupon NOW!



84 Withers St. • Brooklyn 11, N. Y.

Prices 5% higher on West coast and subject to change without notice. ©56

EICO, 84 Withers Street
Brooklyn 11, New York

C-10

Send FREE 1956 Catalog and name of neighborhood EICO jobber.

Name.....
Home Address.....
City..... Zone..... State.....
Occupation.....

1945 to 1955: a decade of Know-How & Value Leadership in Kits & Instruments—over 1/2 million sold to date!

ELECTRONICS VS. HUMAN JUDGMENT

... *Andrea Doria-Stockholm Disaster Calls for Drastic Reforms* ...

THE human being, as an ancient organism in an ultra-modern, speeding, mechanized world, has recently suffered such decisive setbacks that we must evaluate his role once more and effect necessary changes to prevent him from causing continuous havoc among his fellow men.

Modern man can no longer be trusted to conduct personally his present mechanized juggernauts of destruction, be they cars, airplanes, railroad locomotives or ocean liners. Automobiles alone in the United States now kill between 37,000 to 40,000 people a year. What is the chief reason for this frightful destruction? Rarely is it the fault of the machine itself—the percentage killed due to mechanical failure is modest. The fault is overwhelmingly human error—poor judgment, carelessness and other human shortcomings.

The world was shocked, as it had not been since the *Titanic* sank in 1912, when it learned of the disastrous collision between the Italian 30,000-ton luxury liner *Andrea Doria* and the Swedish 12,200-ton motorship *Stockholm*. Out of a total of 2,451 passengers (and crews) of the two ships, there was a comparatively small loss of life—about 50 people perished. The majority were saved due to prompt action of other ships near by, summoned by radio, plus a calm sea illuminated by good moonlight after the dense fog had lifted following the collision.

What was the status of the various safety measures prior to the catastrophe? The two ships were in a dense fog, common near the Nantucket Lightship. Visibility was exceedingly poor. The time was after 11 pm. According to evidence at hand when this was written (end of July), the fog horns of both ships were working properly. The look-outs tried to pierce the dense fog. The radars on the two ships were working normally. It should also be noted that each ship had *two* separate radar installations. The radio of the two ships was operating both before and after the disaster; even the mortally stricken *Andrea Doria*—doomed to sink the following morning—kept up radio communication to the end.

Despite all these ultra-modern safeguards—at 11:22 of that fatal night of July 25—the two ships collided disastrously with a considerable loss of life, injuries to scores and a total monetary loss that may reach \$80 millions.

The inescapable reason for this catastrophe seems to be the failure of human judgment. In short, all the safeguards that could be provided by the ingenuity of man were there but man himself erred—as he will continue to err in the future if not stopped.

This major disaster is by no means the first one where ships equipped with radar in full working order collided. This has happened a number of times: On Jan. 19, 1956, the Coast Guard ice breaker *Eastwind* and the tanker *Gulfstream*. Then on July 13, 1953, the freighter *Jacob Luckenbach* was in collision with the *Hawaiian Pilot*. The radars warned the respective captains, but the humans failed.

Why? The answer is complex and a full explanation would take many pages of this magazine. Here is a partial answer by David R. Hull, vice president of Raytheon, who is also a retired captain of the United States Navy. In *Marine News* Captain Hull analyzes:

1. Cases in which the radar was not turned on, or the watch officer did not look at a properly operating radar.

2. Collisions in which radar operators fail to adjust the controls properly on their equipment. A radar set can be out of tune just as a radio set can be. But this condition is readily recognizable.

3. Collisions in which watch officers take the wrong action as a result of radar observation or simply fail to believe the radar presentation (the most common case).

4. "Radar hypnosis" akin to fatigue failures in other industries. Watch officers should not stare exclusively at the viewing console.

From such facts it might seem easy enough to indict ships' personnel with criminal negligence or worse.

Yet we will be on much safer ground if we place the blame where it *really* belongs—on ourselves, the engineering body of the electronics industry. Knowing most of the facts of radar's shortcomings it was up to us to remedy them in such a manner that we would make it difficult if not impossible for such accidents to occur.

That is the duty and responsibility of the radioelectronics industry—not the ships' personnel. We can predict now, that in the future such disastrous collisions are not likely to occur.

In due time ship operation and guiding, in our estimation, will be taken out of the hands of the master of the ship, particularly during fog and where visibility is poor. This action will be wholly automatic. The electronic gear will at all times be connected with the steering and reversing mechanism of the ship. Visual and aural warnings will be given to the bridge officers so they will know instantly when the electronic robot mechanism takes over for the time being.

Does this void the captain's authority? Not any more than when a pilot comes on board to guide the ship through a tricky harbor. At such a time, only the pilot is in charge, not the captain, as far as navigation is concerned.

Let us admit also that radar alone will probably never be sufficient by itself to stop collisions. We have other means at our command to re-inforce it and make it almost completely foolproof. Radar, it should be noted, is *not* very effective at very close range on account of "sea-return noise."

1. We have radar which detects solid bodies 20 miles away.
2. We have sonar—an excellent means to intercept other ships via underwater sound and fix their exact distance.

3. We have induction means, which with special high amplification, still to be developed, could detect ships within several miles. The induction cables would have to be strung between the ship's masts.

4. We have capacitive means which could aid, check and supplement the inductive means mentioned under 3.

5. We have efficient computers—electronic brains—which can evaluate danger and impending collision situations in fractions of seconds if fed the correct information.

If now we tie together all or part of 1, 2, 3 and 4 and feed all their information into 5, then the computer will act automatically when two ships enter into a collision course, say within 2 miles.

Instantly the computer energizes the mechanism which puts the engines in full reverse, or changes its rearward course if necessary. If both ships are properly equipped, both will back away from each other. When the danger ceases, it is then up to the captains of the respective ships to choose a new, noncollision course.

The 2-mile limit mentioned is purely arbitrary. In the case of the *Andrea Doria* it would have been quite sufficient. Going at 25 miles an hour (full speed) she would continue to go forward for about 3,500 feet *after* the engines were reversed, due to her momentum. The *Stockholm* would act likewise; therefore the two ships *would continue on their collision course for 7,000 feet before they backed away from each other*. But two international nautical miles measure 12,152 feet. Hence this gives a margin of safety of 5,152 feet, sufficient even in adverse wind and tide.

Suppose there were more than two ships? That would make no difference. The anticollision computers would sense three or more ships as well and hack or steer all ships away from each other.

It would seem to be the urgent duty of the radioelectronic industry to bring into life soon, the *Electronic Maritime Anticollision Control*. —H. G.

SOUND

By CHARLES RAY*

The Sound Bug in full-dress attire.

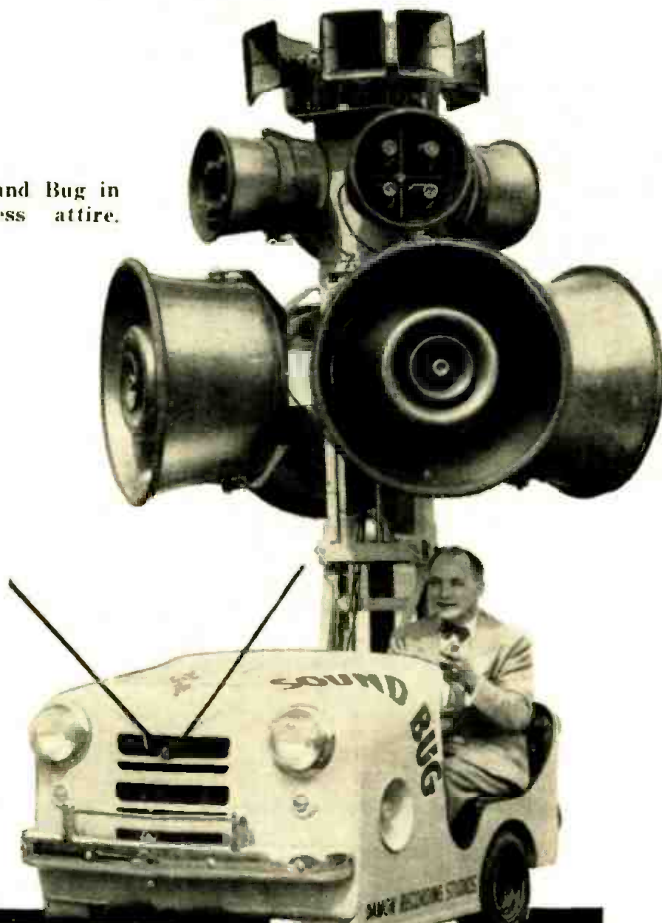

ONCE in the proverbial blue moon a new idea is born. Picture (if you can) a king-sized motorized wheelbarrow carrying two adults, 600 watts of audio, a stacked array of high-powered sound projectors, a motion-picture camera for TV and newsreel pictures and a 3-kw generator!

Necessity is the mother of invention, and it was out of necessity that the world's smallest and most versatile—and probably most power-packed—sound car was built. The designer needed a sound truck that could handle crowds in the tens of thousands (stadiums, parades, etc.) on some occasions, small gatherings (political rallies, advertising campaigns, etc.) on others. He was called on to provide recorded music under difficult conditions and to make recordings on the spot. The truck should be small, powerful, relatively fast and yet able to contain all the necessary amplifiers, speakers and tape recorders plus a well-regulated power supply. Designer Vic Damon found that what he wanted was not available through conventional sources, even with extensive alterations.

* Assistant sales manager, University Loudspeakers, Inc., White Plains, N. Y.

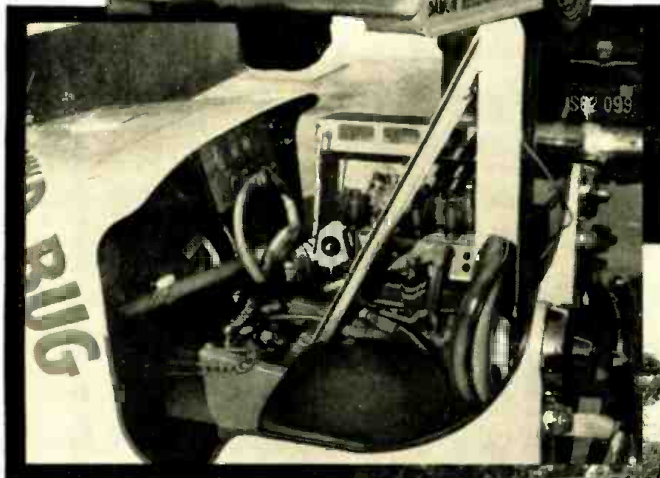

An inside view of the Sound Bug.

Sound Bug's lift gets into the act.



BUG

Damon, head of the Damon Recording Studios, Kansas City, Mo., had just about given up on the idea of having one truck do the entire job and was resigned to the fact that it would be necessary to buy and equip several vehicles. But one day when he was thumbing through a builder's catalog he saw a power wheelbarrow called "Moto-bug," a unit designed to handle heavy loads under adverse conditions in minimum space. The germ of an idea was born. After considerable experiment, this unit with six wheels (chassis only) and radically redesigned steering controls and transmission formed the basic chassis for Damon's Sound Bug (see photos).

The Sound Bug originally ran in the opposite direction, guided by a man on a step located where the front bumper now is. It originally carried up to 1,500 pounds of concrete or other building materials. All the controls were reworked to permit the Bug to operate from the present position. The body was made from modified standard automobile parts. Plastic-covered foam-rubber adjustable seats were built and installed over the fenders just above the dual rear wheels. A pulley was mounted at the front shaft of the $6\frac{1}{2}$ -horsepower Wisconsin air-cooled engine to permit V-belted to the combination 3-kw Onan generator-starter. The generator was modified for belt drive and was belted to the crank end of the engine. This generator has three functions: it acts as a 12-volt motor and starts the engine; it charges the 12-volt battery; it produces 3,000 watts of 60-cycle 110-volt power. A tachometer is driven directly from the generator shaft, assuring exactly 60 cycles when the car is not moving and approximately 60 cycles when driven in low gear at parade speeds or in high gear at cruising speed.

From the front bumper to the rear of the back bumper the Sound Bug is only 72 inches long. The car will turn completely around in a circle of 68-inch radius. The total weight of the Bug fully equipped is 1,200 pounds; cost, with all accessories, \$5,100.

Top speed for the Sound Bug is between 15 and 20 miles per hour, which is fast enough for all practical purposes. If the need arises, it can be geared faster. There are six wheels, two in front and four in the rear. The little car sports a set of deluxe horns

and, when traffic fails to allow a 45-inch opening for the Bug to get through, there is a 100-volt Navy signal horn that never fails to command immediate, if not respectful, attention for several blocks. Besides the tachometer (to ensure 60 cycles for the tape recorders), the Bug contains ac and dc meters, a power outlet, switches and controls mounted on the front panel. The 110-volt ac supply is entirely free from interference due to the use of a shielded magneto and shielded plug and cable in the engine ignition system.

A great deal of design and foresight went into the construction of the Sound Bug. For example, a toggle switch was inserted to disconnect the field circuit on the generator. This releases additional horsepower if needed for towing or pushing other vehicles and when, of course, the generator is not needed for that particular job. How well the little toggle switch performed speaks for itself. In a recent American Royal Parade, which is Kansas City's big annual event, Damon's Sound Bug was not only on the job as the public address unit, but was actually a feature of the parade itself, riding proudly behind the lead car containing the many dignitaries participating in the event. As if it were a prearranged script, the big open limousine developed engine trouble and stalled. The Bug, with all the tenacity and pugnaciousness of its namesake, not only pushed the grand marshal to the finish line amid the cheers of the hundreds of thousands of people who turned out to see this great Kansas City parade, but to the very garage itself.

As standard equipment in the Sound Bug there is a built-in AM-FM tuner and a Newcomb 10-watt ac-dc public-address amplifier for general work. For low-power jobs, two re-entrant paging speakers (University IB-8's) are flush-mounted in the body of the Bug itself, one on each side of the hood. Because of the high efficiency and distance projective qualities of these speakers, it was found that many of the smaller jobs could be handled very satisfactorily with only the 10-watt amplifier. This permitted the use of the Sound Bug at small gatherings without tying up the high-powered equipment which could then be used at the same time for additional jobs that perhaps would not require the mobility of the Bug.

Incorporated in the Bug are several tape recorders powered either from a 6-volt dc to 110-volt ac inverter or directly from the ac generator. The inverter is necessary for wow-free tape and music reproduction while driving at various speeds. For background music and for average on-the-spot recordings, a Revere model T-1100 recorder is used, running at $7\frac{1}{2}$ ips. The general quality is good and it has proved an extremely versatile machine for run-of-the-mill jobs. For recordings which require rebroadcasting at a later date for radio or TV, a model 401 Ampex is used. For assignments which require synchronous sound tracks, the Stencil-Hoffman sprocket-driven tape recorder has proven more than adequate. The tape recorders are attached directly on the back of the hydraulic lift assembly where they can easily be controlled by the driver. In this way, many jobs can be a one-man assignment.

In a recent promotion scheme in conjunction with Radio Station WHB, the Sound Bug was awarded the PA assignment. The Bug not only carried the comments of the famous disc jockey who was riding in the grand marshal's car to the crowds of people watching the Kansas City American Royal parade, but taped it for future radio broadcasting. Without the versatility of "Damon's Folly," this would have been extremely difficult and would have involved a great deal of additional equipment and expense. The possibility that the Damon Recording Studios would have gotten this job might have been remote.

For occasions where 50 to 500 watts of audio are needed, Damon uses specially built heavy-duty amplifiers with an audio output of more than 500 watts. For average jobs it was found that 50 to 200 watts of audio are sufficient. Depending on the acoustic requirements, one or two Webster Electric Racine model 100-90 four-channel 90-watt

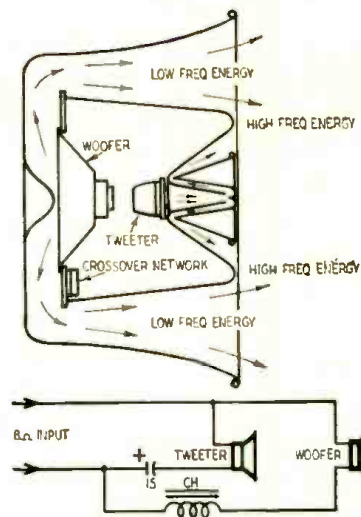

Cross-sectional view and circuitry of University model WLC coaxial speaker system, an all-weather arrangement.

AUDIO—HIGH FIDELITY

amplifiers are currently employed. They are said to be flat within 1 db from 30–20,000 cycles with a percentage of distortion comparable to many of the low-powered high-fidelity amplifiers. The tube lineup for the 100-90 is four 5879's, one 6SJ7, three 6SN7-GT's, two 6550's, two 5R1-GY's and two 0D3's.

For high power requirements of 400–500 watts, the sound specialist uses one model 100-90 bridged to another Webster Electric amplifier model 61-300, which uses a tube lineup as follows: one 6F8-G into two 6L6-G tubes which then drive four 811's in push-pull parallel. Rectifiers are one 5U4-G and two 866's. The amplifiers are interchangeable and are usually clamped on the right floorboard or on the right front seat. Amazingly, this powerful unit is light enough for one man to carry, yet puts out 400 watts without audible distortion. Damon feels that it was underrated by the manufacturer since the actual usable maximum output is 500 watts. The noise level is low and the quality of the reproduction through the entire audio spectrum entirely satisfactory. Incidentally, the manufacturer is no longer in production on these units.

The hydraulic lift which was part of the original equipment, but is completely modified, holds up to 600 watts of University loudspeakers or 500 watts plus a platform on top for the taking of TV 16-mm motion pictures (see photo). The lift can also be used exclusively for signs adequately lighted by the 3-kw generator. This Damon finds a very lucrative sideline to the main objective, leaving the two University IB-8's for soundcasting. For high-quality music reproduction four University WLC's were selected. This speaker is used in a great many outdoor theaters, handshells and stadiums throughout the country. By using the WLC, extensive auxiliary equipment was not needed in instances where high-quality reproduction was required.

The WLC is a complete high-fidelity speaker system (see diagram) comprising a heavy-duty woofer speaker, driver type high-frequency reproducer and a 1,000-cycle L-C crossover network completely contained in an all-metal dual-horn assembly. The special 12-inch woofer cone speaker is arranged in an infinite rear-baffle chamber and works in conjunction with the large folded horn. This provides optimum loading of the speaker, resulting in clean and highly efficient reproduction of low-frequencies. A heavy-duty tweeter driver unit is coaxially mounted and feeds into a radial projector which concentrically disperses the otherwise directive high-frequency energy. Since the Sound Bug may be called upon to perform in all sorts of weather conditions, the re-entrant design of both the high- and low-frequency reproducers provides complete protection against rain, snow, wind, etc. In actual practice, the wide frequency response of 50–15,000 cycles of the WLC will pene-

trate high ambient noise levels with exceptional intelligibility both for music and voice.

For additional sound reinforcement and for medium-power applications Damon uses a University Cobreflex-2 wide-angle horn with an SA-30 driver. The Cobreflex-2 is a pair of exponential horns having twin air columns in a one-piece die-cast aluminum assembly. The advanced Cobreflex-2 design provides wide-angle dispersion of sound—120° horizontally, 60° vertically—and is notably superior to multicellular and narrow-mouthed type speakers which project the field pattern less uniformly. The Cobreflex-2 concentrates energy in the horizontal plane where it is needed in covering wide areas efficiently and economically. The low-frequency cutoff of the trumpet is 250 cycles, ideal for maximum penetration of high noise levels without low-frequency masking effects. This acoustic low-end cutoff also aids in combatting reverberation effects in locations having hard reflecting surfaces. Reverberation is one of the bugaboos of parade soundcasting. For ease of installation, the 30-watt University SA-30 weatherproof driver was ideal. The very construction of this unit is such that it is ideally suited for the Sound Bug. The housing of the driver is completely die-cast aluminum, which makes it extremely durable.

Entrance to the built-in multi-

impedance line-matching transformer is made through a watertight dural gland nut, assuring positive weatherproofing after connections have been made. The transformer impedances of 45, 165, 250, 500, 1,000 and 2,000 ohms allow for any assortment of speakers to meet the varied applications Damon is called upon to handle from time to time, without difficulty.

For situations calling for unusually great acoustic output, University 4A4's were used, each of which is capable of reproducing 100 watts of audio with a minimum of size and weight. The 4A4 is unique in that its prototype was originally designed for the military. The need for this type speaker first became apparent during the early part of World War II. The speakers had to be exceptionally rugged in construction, foolproof in operation and immune to weather conditions of every kind. The 4A4 is the result of this concept, and in the Sound Bug has proved invaluable. The 4A4 projector uses four driver units in this application, each feeding into individual reflexed air columns which combine into a concentrated beam of high-intensity sound from a single bell. The 4A4's will distribute over 400 watts of power at 360°. Sufficient audio power is produced to cover as many people as could crowd into a circle 1 mile in diameter (well over a million!).

END

NEAT PRINTED-CIRCUIT AMPLIFIER

BUILT by the "etch-foil" process, this miniature phonograph amp is a beautiful example of do-it-yourself "printed-circuit" construction. It uses three low-cost 2N107 transistors: one in a preamplifier stage for crystal phono or microphone input, two in a push-pull power amplifier stage.

The circuit is simple and straight-

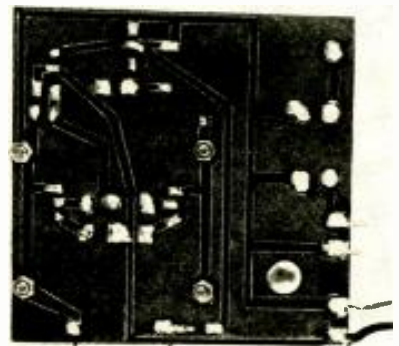

forward. The first transistor is used in a preamplifier driver stage having an input impedance of approximately 100,000 ohms to match a high-imped-

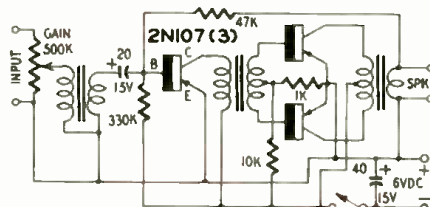

ance crystal. The audio gain control is placed at the input end.

The second stage uses two transistors in a conventional class-B push-pull audio power amplifier circuit. At its maximum rated output (with sufficient signal) the current drain for this stage at 6 volts dc is about 45 ma; idling current (no signal) 1.2 ma.

About 3 db of feedback has been built in the amplifier to reduce distortion and improve the low-frequency response. Total harmonic distortion at 1,000 cycles and 125 milliwatts output is 6.5%. The quality of the output is also in large measure dependent on the transformers used. It was not exceptionally high in this unit, especially below 300 cycles, and this weakness was traced to the transformers.—*Leonard J. D'Airo and Sol D. Prenskey.*

Finding optimum impedance for cartridge to work into; needle pressure

By JOSEPH MARSHALL

Loading Phono Pickups

MOST audiophiles take the loading of a phonograph pickup for granted. Manufacturers specify a load for their cartridges and the usual procedure is to provide this load and assume that the pickup will deliver the specified performance. When one has no means of measuring the performance, this is, to be sure, the safest thing to do. But it does not always insure the best possible performance from a given pickup in a given system.

For one thing, there is often a considerable variation in the characteristics of individual specimens of a given brand, and those that fall close to the outside tolerance may be far enough from the mean to deliver inferior performance with the specified load. For another, the manufacturer's recommendations are based on assumptions, usually not stated, about the capacitive conditions into which the pickup will work. If these assumptions do not apply to a specific installation, the specified load will not be optimum either.

Furthermore, although the influence of loading on frequency response is generally appreciated, few people realize that the load has an equally marked influence on the distortion. In many cases, therefore, pickups fail to deliver the performance of which they are capable and very often it is possible to produce a worth-while improvement by adjusting the load.



Fig. 1—Frequency response vs load of moving-coil cartridge.

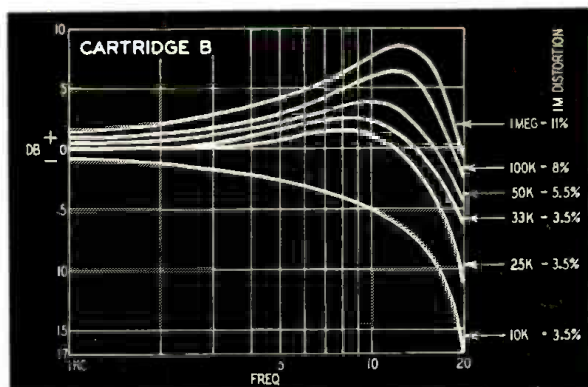

Fig. 2—Response of variable-reluctance cartridge under various loads.

AUDIO—HIGH FIDELITY

Effect of load

Increasing the load resistance of magnetic pickups increases the response at high frequencies; decreasing it lowers the response. The behavior is not identical with all types, however. Fig. 1 shows the response of a top-quality moving-coil magnetic cartridge (let's call it cartridge A) in terms of the load resistance. It was measured directly at the pickup with a vtvm through the 3-foot shielded cable usually used to connect the pickup to the control unit or preamp, and the total cable-plus-input capacitance was equal to the 200 μf most manufacturers assume when specifying load. The manufacturer specifies a load of 100,000 ohms and in Fig. 1 we see that this value did in fact produce the flattest response. In this case it takes a very considerable variation in load to produce a significant effect on the frequency response.

Moving-coil pickups have low-inductance coils and the circuit using such a pickup behaves very much like a constant-K low-pass filter whose generalized curve is well presented by the curve for the 1-megohm load—a small peak just before the cutoff point and then a steep slope beyond. And in a constant-K network a variation of resistance downward reduces the peak and moves the cutoff point downward.

But variable-reluctance pickups have coils of large inductance—up to 500 mh. The shunt capacitances of coil, cable and tube input are often high enough to resonate with this high inductance within the audio range. This produces

a more serious peak and the circuit behaves like a combination constant-K low-pass network and a parallel-resonant circuit. Fig. 2 shows the response of a medium-priced variable-reluctance cartridge (call it cartridge B) measured under the same circumstances as cartridge A. The peak is much more pronounced, the variation of response with change of load is very much more marked and critical. The resistance now reduces the Q of the resonant circuit faster than it moves the cutoff point. The specified load for this cartridge was 50,000 ohms; the curves indicate that the flattest and smoothest response with this specimen is obtained with a load somewhere between 22,000 and 33,000 ohms.

Effect of capacitance

The capacitance shunting the pickup is extremely important though usually disregarded. Fig. 3 shows the response of cartridge A with the specified load of 100,000 ohms but with various shunt capacitances, provided in this case by shunting various capacitors across the vtvm terminals. An increase in capacitance produces a peak, moves the cutoff point downward and thus produces an earlier slope in response. Up to a point the effect is not serious with this cartridge but after further increase the peak and cutoff become rather alarming.

The effect is even more serious with variable-reluctance cartridges as indicated in Fig. 4. This shows the response of cartridge B with a load of the speci-

fied 50,000 ohms but with various capacitances. The peak is more violent and the cutoff encroaches more seriously into the desired range of frequencies.

The capacitances involved are not at all unlikely in a practical installation. The shielded cable generally used with pickups has a capacitance of more than 50 μf per foot and 10 feet of it, for example, would produce well over 500 μf . The normal 3 feet of cable and the input capacitance of a well designed triode preamplifier will have a total capacitance of at least 200 μf .

Effect on distortion

Recently I made a long series of measurements of distortion vs. response and loading on some 20 cartridges. Of these 10 were specimens of a single brand; 4 others were pairs of another brand, the rest were single specimens. One typical curve (Fig. 5) will suffice to show the picture. It gives the measured IM distortion vs. the loading for cartridge B and complements Fig. 2. Distortion falls fairly steeply up to a point and remains constant after that. The point at which the distortion stabilizes is that at which the response curve is flattest and smoothest. To make this clearer I have inserted in Fig. 2, beside each curve, the IM distortion measured with that response. I found this same pattern to be true of all the other pickups measured. So that it seems safe to say that with a given pickup lowest distortion is achieved when any peaks and upward slope in response have been reduced to the smoothest and

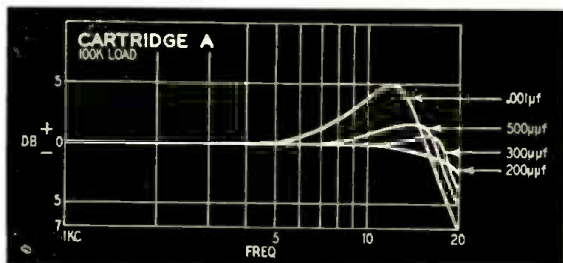

Fig. 3—Frequency response of cartridge A using various shunt capacitances.

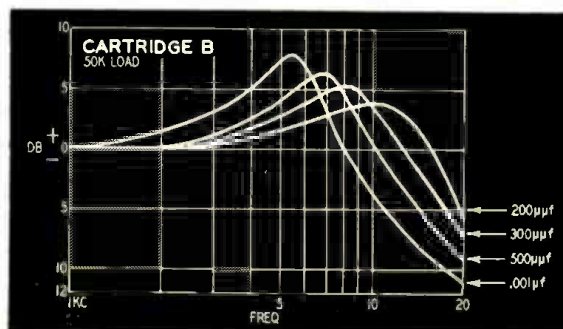

Fig. 4—Frequency response of cartridge B using various shunt capacitances.

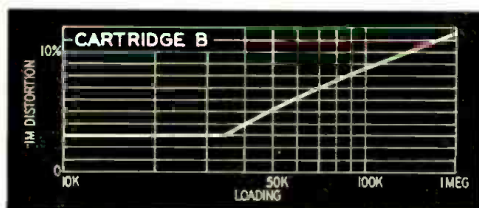

Fig. 5—Intermodulation distortion vs. loading for cartridge B.

flattest contour. A slope increase beyond that merely reduces high-frequency response with no significant effect on distortion. Thus, optimum loading not only produces the best frequency response but also lowest distortion.

Adjusting loading

These experiments suggest that where best performance is desired it is wise to check the loading and adjust it to the optimum for the specific cartridge in the specific circumstances. This will require making some frequency runs and that in turn will require a test record and an ac vtm. I prefer the Cook series 10LP record because it covers the octave between 10 and 20 kc in which most of the aberrations occur. The entire operation is a cinch with a control unit like the Pilotrol which has both a variable load control and a built-in meter. But the job can be done with more typical equipment.

The Cook record is recorded with a reasonably flat treble and it simplifies matters if the equalizer has a position which produces no de-emphasis of highs. (In some cases the position intended for old 78-rpm or European records will play back without de-emphasizing the highs.) If there is no flat position, the job can be done with the RIAA, AES or LP equalizer. The response will slope downward but the uniformity of the slope will serve as an indication—the more the slope resembles a straight line the flatter and smoother the response.

If the recommended load produces a good approximation of a smooth straight line (say within 2 or 3 db between 1,000 cycles and the point at which cutoff starts), no load adjustment is necessary. If however, the recommended load does not yield the specified curve or a reasonably close facsimile of a smooth line, adjusting the load will very probably improve matters. An examination of the curve will indicate the steps to be taken. If the curve has no peak (or just a very small one at the very extreme just before cutoff) but slopes upward or downward more than it should, a mere change of resistance will set matters right. Raise the load to tilt the curve upward and decrease it to tilt it downward.

But if the curve shows a considerable peak it may be wise to reduce the shunt capacitances. The cable should be shortened as much as possible; the preamp might be moved closer to the turntable to permit this. Every foot you shorten it will cut about 50 μf . The cable can also be replaced with one of lower capacitance. Thin (0.120-inch) mike cable does not offer much improvement because its capacitance is about 50 μf per foot, too; but the 0.200 mike cable has only half the capacitance. By shortening the length and substituting a cable of lower capacitance it may be possible to decrease the capacitance by 100 μf or more and this is enough to move a peak upward an appreciable

fraction of an octave. The peak can then be flattened by reducing the load resistance. The criterion should be a smooth and flat curve. This may reduce the response beyond 12 or 15 kc by a few db but, my experience suggests, will also result in the lowest distortion level and apparently yield the best overall performance.

Needle pressure and distortion

When making the above check on pickups I also made some checks of needle pressure vs. distortion. Most audiophiles, and technicians too for that matter, have a tendency to adjust the needle pressure to the lowest that will keep the cartridge from skipping, on the assumption that this low pressure will minimize record wear. I have found that needle pressure has a marked effect on distortion.

The table below indicates the IM distortion measured with cartridge B with

Load (ohms)	IM Distortion (%)	
	6 grams	8 grams
1,000,000	11	7½
100,000	8	5
50,000	5½	3½
33,000	3½	2
25,000	3½	2
10,000	3½	2

NOTE: The IM figures include the distortion on the record which is supposed to be under 2%. Whether this is accurate or not, the relative figures are equally significant.

various loads and two pressures—6 and 8 grams. The manufacturer recommends "6-8 grams pressure." The table shows that raising the pressure from 6 to 8 grams decreased the distortion by about 40%. A tracking check with the

five tracking bands of the Dubbings D-100 test record developed that 8 grams was the minimum pressure needed to obtain good tracking of all five bands, whereas the 6-gram pressure resulted in considerable buzzing and fuzziness on the fourth and fifth bands. This indicated that distortion was tied in with tracking ability and that the minimum pressure needed to provide best tracking also provided the lowest distortion.

Experiments with other cartridges produced similar results; the pressure that provides the best tracking also produces the least distortion. It seems wise therefore to adjust pressure for the best tracking, not the least pressure. This can be done by ear with the Dubbings D-100 record, simply try various pressures and choose the lowest one that produces good tracking on the fourth and preferably also the fifth tracking band as indicated by the cleanest tone and freedom from buzzing or fuzziness. It is highly probable that this pressure will also result in lowest record wear, too, for a poorly tracking needle, especially when it has acquired flats, can do great damage even when the pressure is very low.

Unfortunately, I could find no infallible correlation between the manufacturer's recommendation and the optimum pressure from a tracking and distortion point of view. In some cases the recommended pressure turned out to be the optimum one in my tests. Where the manufacturer specified a range (as, for example 6-8 grams) I found the higher figure to produce the better tracking. In most cases, but not always, I found that a pressure 1 or 2 grams higher than the recommended produced the best tracking and lowest distortion. In any event, choosing a low pressure on the assumption that it will save records is not a safe procedure either from the standpoint of the record or the quality of reproduction. **END**

For Your Protection

RADIO-ELECTRONICS is continually alert to maintain a high level of integrity in our advertising columns. In the case of tube advertising — which has suffered special abuses — we insist that all advertisers must warrant that their tubes are:

- New and unused
- Not mechanical or electrical rejects
- Not washed or rebranded

(See page 57 of the January, 1956, issue)

We investigate carefully when we have grounds to suspect that any advertiser is not living strictly up to these rules.

The Long-Tailed Cascode Pair

Evolution of a high-gain, stable audio amplifier

By L. B. HEDGE

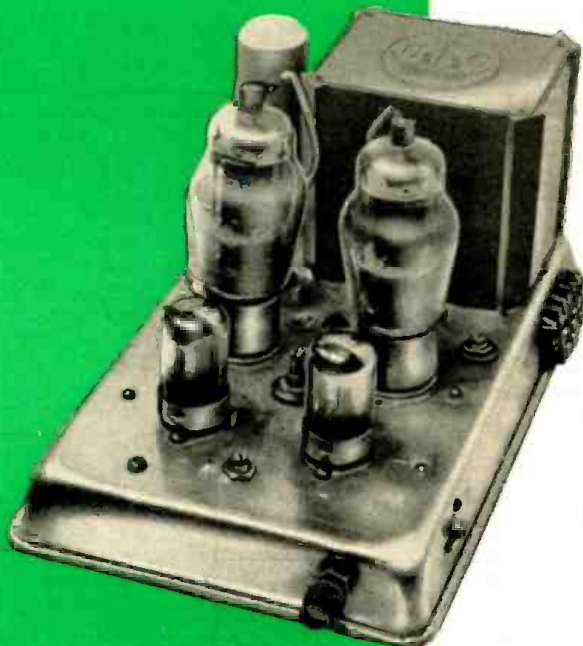

↑ Top view of complete amplifier.



← The amplifier using a universal replacement type of output transformer.

↓ Underchassis using the UTC LS-55.

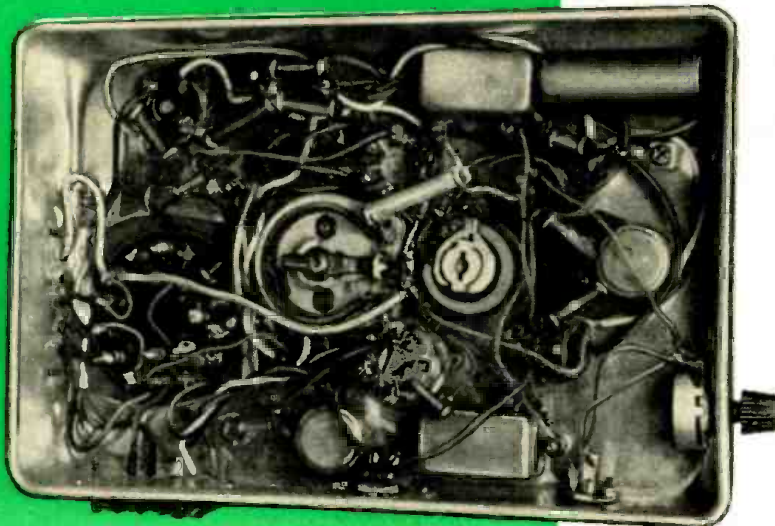

THIS circuit was developed to provide a power amplifier design that would permit a large feedback factor in a loop including an output transformer of noncritical design; a basic amplifier which could make the best use of any output transformer built into it.

Feedback in conventional amplifiers is limited by the combined phase-shift-attenuation characteristics of the transformers and interstage coupling linkages in the feedback loop. Since phase-inverter stages are usually low in gain (split-load and cathode-coupled triodes, for example), the necessary drive for a power output stage normally requires at least one stage before and one after the inverter. This leaves two R-C coupling links and the output transformer between the input and output of the amplifier even with the first stage direct-coupled as in the Williamson type of layout.

The resulting maximum phase shift is 270°. And since feedback amplifier stability requires that loop gain be reduced to less than 1 before the 180° phase-shift point is reached, the frequency range over which feedback can be kept high must be considerably smaller than the usable range of the transformer—unless the transformer is of truly exceptional design. The obvious and conventional alternatives—shortening the feedback loop by a stage, eliminating one R-C coupling by direct connection or using a very high gain stage—either compromise the effectiveness of the feedback loop or seriously complicate the power supply and isolation filter system. The search for a less involved solution led to an analysis of the cascode amplifier and the cathode-coupled inverter, and finally to a combination of the two.

The cathode-coupled phase inverter (long-tailed pair) is shown in Fig. 1. It consists—in its basic form—of a grounded-grid triode paired with a similar grid-driven tube, the two having a common cathode resistor which acts as a cathode-follower load for the

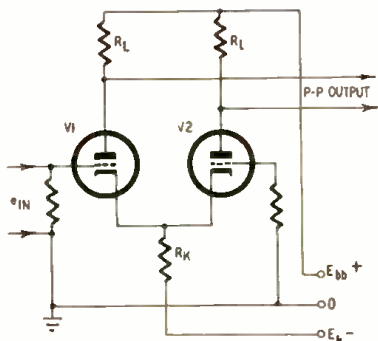

Fig. 1—Diagram of long-tailed pair.

driven tube and provides cathode drive to the grounded-grid inverter tube.

The cascode (cascade, cathode-coupled) amplifier of Fig. 2 is well known as a high-gain, low-noise, high-frequency and dc amplifier. It is widely used in television and other shortwave rf applications and in voltage-regulator control circuits for which, incidentally, it was first evolved². It uses two tri-

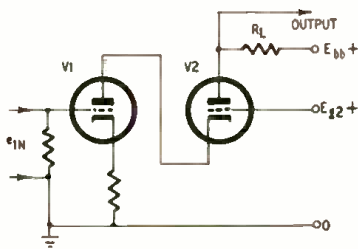

Fig. 2—The basic cascode circuit.

odes directly connected in such a way as to provide the phase reversal of a single stage. It provides amplification comparable to that of a high-gain pentode, with plate-grid operating characteristics similar to those of a triode.

Fig. 3 shows the basic long-tailed cascode pair. Since medium-mu triodes of the 6J5 class (twin types 6SN7, 7N7, etc.), when cascode-connected, have an equivalent mu of over 400 and a plate resistance of approximately 150,000 ohms, it would seem that a long-tailed cascode-pair driver using these units would provide more than adequate gain and balance. However, the cumulative

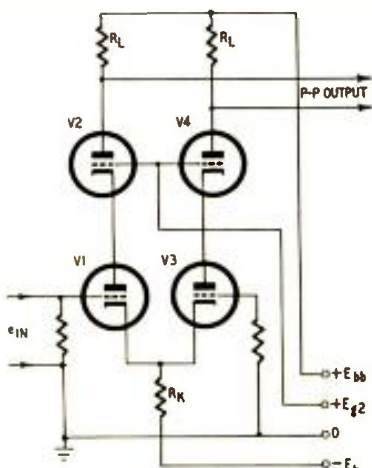

Fig. 3—Long-tailed cascode pair.

voltage drops across cathode and load resistors, of sufficient size to provide the gain and balance, will run the voltage requirement from the power supply far beyond reason. The lower plate current drawn by high-mu tubes of the 6SL7-7F7 class makes the arrangement reasonable with these tubes.

A further advantage of the Fig. 3 arrangement arises from the fact that the high gain, close balance and symmetry of the first stage make introducing the feedback signal into the grid circuit of the grounded-grid inverter not only possible but highly desirable. Although the feedback voltage can be introduced into the grid circuit of the driven tube, adequate isolation and the volume control in this circuit involve complexities completely avoided by closing the loop in the grounded-grid circuit.

The final circuit of the completed amplifier, using a pair of 1625's (12-volt 807's) driven by a pair of 7F7's in the long-tailed cascode-pair driver stage is shown in Fig. 4. The variations indicated by the alternative connections (A, B and C) for the 1625 screen grids provide pentode, Ultra-Linear³ and triode operation of the output

stage. The Ultra-Linear connection, when used with certain standard types of output transformers (UTC types LS-55 and -57, for example), provides operation approximating the original Ultra-Linear specification. The Ultra-Linear and pentode connections used with the UTC LS-55 have been tested in the circuit and a universal replacement type transformer, culled from the junkbox, was tested with triode and pentode connections to provide a kind of worst possible situation for evaluation of the complete system.

Figs. 5, 6 indicate the effectiveness of feedback in providing improved performance from the transformers and adequate drive and stability with the various connections. Fig. 5 shows the frequency response of the complete amplifier using the replacement transformer. Curve A is with 0-db feedback—0.25-volt input with triode connection; 0.12-volt input with pentode connection. Curve B is taken with 10-db feedback—0.8-volt input and triode connection. Curve C shows the effect of 10-db feedback—0.4-volt input and pentode connection. An increase in feedback from 10 to 20 db, while increasing the input voltage about three

Parts for cascode amplifier

- Resistors: 2—1,000, 2—4,700, 1—47,000, 1—68,000, 2—470,000 ohms, 1/2 watt; 1—47,000, 1—100,000, 2—220,000 ohms, 1 watt; 1—100, 1—10,000 ohms, 5 watts; 1—200-ohm 10-watt rheostat; 1—50,000, 1—500,000 ohms, 1—1 megohm, potentiometers; 1—100-ohm 5-watt potentiometer.
- Capacitors: 2—0.1 μf, 600 volts; 1—40, 1—120 μf, 150 volts; electrolytic; 2—40-μf 350-volt electrolytics; 2—20, 3—40 μf, 450 volts, electrolytics.

- Chokes and transformers: 1—5-henry, 40-ma, 300-ohm choke; 1—10-henry, 200-ma, 90-ohm choke; 1—power transformer, 750 volts ct at 200 ma, heater windings as required; 1—output transformer, universal replacement type or UTC LS-55 (or equivalent) (primary impedance 5,000 and 3,000 ohms).

- Miscellaneous: 2—7F7 or 6SL7-GT, 2—1625, 1—5T4, 1—OB2, 1—6X4 (optional); 1—450-volt 40-ma selenium rectifier (4 115-volt 40-ma units in series); 1—set of tube sockets; 1—chassis.

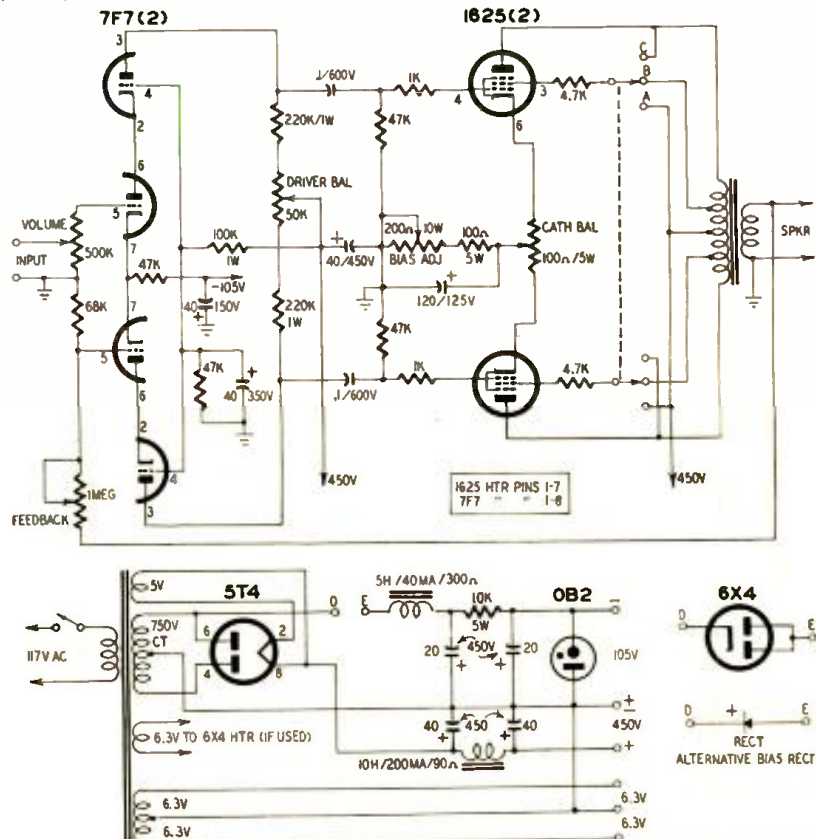
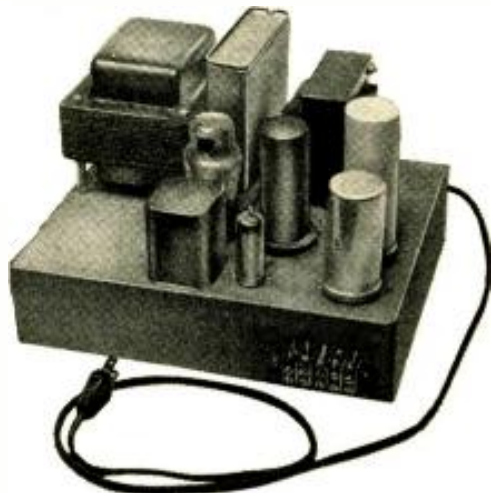

Fig. 4—Diagram of complete amplifier using long-tailed cascode-pair driver. The ± 450 in the power supply is equivalent to ground in the amplifier circuit.



Power supply for the amplifier.

times, changes the output characteristics of the amplifier less than 2 db. Table I shows the maximum output of the amplifier with harmonic distortion less than 1%.

Fig. 6 shows the amplifier response using a UTC LS-55 output transformer. Curve A is with 0-db feedback—0.16-volt input, Ultra-Linear connec-

vided by either of the connections shown in the power supply. Compensation for this additional power supply element, however, lies in the fact that every dc power connection to the amplifier feeds a balanced push-pull load. Thus, isolation filters, as well as hum and ripple filters, can be comparatively simple.

Output in watts (At 1% harmonic distortion)				
Fre- quency (cycles)	Triode		Pentode	
	Feedback 0 db	10 db	Feedback 0 db	10 db
	(Watts)		(Watts)	
30	0.1	0.5	0.1	0.5
100	1	6	1	8
1,000	3	6	3	8
10,000	3	6	3	8

Output in watts (At 1% harmonic distortion)				
Fre- quency (cycles)	Ultra-Linear		Pentode	
	Feedback 0 db	10 db	Feedback 0 db	10 db
	(Watts)		(Watts)	
30	12	18	10	15
100	12	18	12	15
1,000	12	18	12	15
10,000	12	18	12	15

Table I, amplifier using replacement transformer; Table II, amplifier using LS-55.

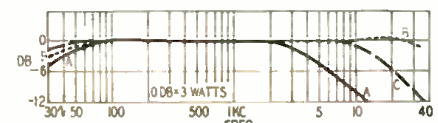

Fig. 5—Frequency response of amplifier using a replacement transformer.

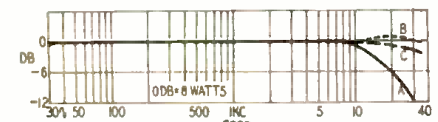

Fig. 6—Frequency response of complete amplifier using the better transformer.

tion; 0.11-volt input, pentode connection. Curve B is taken with 10-db feedback—0.52-volt input with Ultra-Linear connection. Curve C shows the effect of 10-db feedback—0.38-volt input and pentode connection. The maximum output with harmonic distortion less than 1% is shown in Table II. Here, an increase in feedback from 10 to 20 db, while increasing the input voltage about three times, changes the characteristics of the amplifier less than 1 db.

An apparent complication of the complete amplifier appears in the -105-volt cathode supply required by the driver stage. This voltage is pro-

The complete model (a bread-pan layout¹) of the amplifier with an under-chassis view is shown in the photos. As may be surmised, neither the construction, layout nor wiring is critical. The load resistors in the plate circuits should be matched or, as indicated in the wiring diagram, a balance adjustment should be provided. The output cathode bias and balance network is simple and effective, but a Williamson type layout should do as well. The cathode bypass capacitor is not necessary, but I prefer to use it since it reduces distortion if and when the output tubes, for aging or other reasons, depart from their original perfect balance.

The long-tailed cascode pair provides a noncritical solution to the problem of getting maximum quality from a given output transformer—this is one tail that does a bang-up job of wagging the dog!

References

- 1 F. E. Terman, *Radio Engineers' Handbook, Section 5*, McGraw-Hill, New York, 1943.
- 2 F. V. Hunt and R. W. Hickman, "On Electronic Voltage Stabilizers," *Rev. of Sci. Inst.*; January, 1939; p. 6.
- 3 D. Hafler and H. I. Keroes, "An Ultra-Linear Amplifier," *Audio Engineering*; November, 1951; p. 15.
- 4 L. B. Hedge, "The Bread-Pan Layout," *Audio Engineering*; August, 1953; p. 24.

BALANCE OUTPUT STAGES WITH YOUR VTVM

By JAMES P. RODGERS

FREQUENTLY the owner of a hi-fi amplifier does not own a dc ammeter with which to balance the output stage. A 0-100-ma meter often does not have much use around the shop or home unless the individual is an experimenter or ham. However, a vtm or small voltmeter is handy.

By inserting a 10-ohm ½-watt resistor across the metering position on

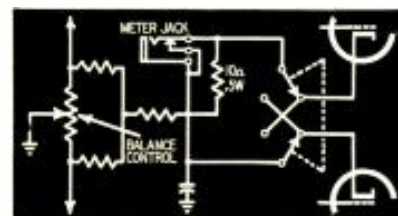

each tube the voltage drop can be read on the low voltage dc scale. The balance control can then be adjusted until the voltage reads the same for both tubes. A dpdt switch wired as shown in the diagram makes adjustment much easier.

Using Ohm's law, (I equals E/R) the plate current can quickly be calculated.

A higher-value resistor would give a greater needle deflection and make the meter reading easier but would bias the tube excessively and the reading would be less accurate.

Using this system on my amplifier, the tubes, 6L6's, balanced at 0.4 volt. From E/R I found the plate current to be 40 ma. END

*Hi-Fi
Conversions
Are Profitable!*

A case history that points the way to improving sound in many good AM radios.

●

*What to Do for
Weak Video*

TV author and teacher gives the causes, symptoms and remedies for this common TV trouble.

●

**BOTH in the NOVEMBER
RADIO-ELECTRONICS**

BACKGROUND NOISE REDUCTION IN TAPE

By JAMES A. McROBERTS

How to spot and cure mechanical and electrical defects

TAPE recorders vary considerably in inherent noise level, both electrical and mechanical. In general, the more expensive the machine the lower the noise level. Tapes too vary in quality, the price again being a rough indicator, although—as in many other things—it is not always an infallible one.

The first step in reducing background noise is to locate its point of entry into the system—on the tape or in the recording or playback circuits. Often a slight amount of noise from each of these produces a high overall level.

Since the noise content of tapes varies due to grouping or clumping of particles, tape used for a valuable recording should be checked on a good machine, preferably by listening to the output with headphones. The unmodulated (unrecorded) tape is run through the machine, the volume and tone controls set in the average position.

Fig. 1 shows the clumping of particles. These may have become imbedded in the front or the back face of the tape and produce noise. Excessive irregularity of the clumping or large amounts of foreign matter may increase the noise to an intolerable level. Some foreign matter (Fig. 2) is contributed during recording and playback if the heads, guides, pressure pads, etc., are allowed to accumulate residue which later is pressed into the tape. The remedy is to keep these places clean with a brush.

Noise level in tapes increases with age due to particles scuffing off the surfaces of the tape. Excessive pressure-pad tension or badly worn heads will damage the tape through abrasion. Examine all parts that contact the tape regularly and renew if worn. A magnifying glass of about 5× is recommended for the inspection. A tape that has become noisy due to the wear of many playbacks can be rerecorded with

appropriate filters to minimize noise between the pickup and the input to the recorder.

Playback tests

If all tapes are noisy on a recorder, including new high-quality tape, the trouble lies in the machine. A test with the machine on playback is the first localization step. The recorder should be warmed up for about 10 minutes with the transport lever on forward but without tape in the machine. Mechanical or electrical noise heard at this time cannot be due to the tape, the head (due to tape pressure against it) or the presence of the tape in the machine. Some mechanical noise can arise from the weight of the tape on the turntables. Switch the transport lever to off and then to rewind to localize mechanical noise further. Tilting the machine is advisable in all tests for the same reason.

The volume control helps pinpoint electrical noise. Noise entering before the volume control can be localized since it will be varied by the control. Sometimes hum from the power supply will be picked up and varied slightly by the control. However, most noise troubles prior to the volume control come from noisy resistors in the preamplifier. These should be replaced with low-noise units. Although the plate resistor makes the greatest noise contribution, all other things being equal a noisy cathode or grid resistor may raise havoc at times.

The preamplifier tube may be noisy and some of that noise may be due to microphonics. Tap the tube. The shock mounts on the tube socket may be old and stiff—inspect and replace. And, of course, check the tube by substitution.

Other stages may be localized by the grounded-grid procedure. Here the same attention must be paid all resistors

and components in the cathode and plate as well as grid circuits.

Following these tests we can load a tape and play it, listening for mechanical noise with the volume control turned down. We can then turn up the volume and listen, preferably with headphones. Mechanical noise can be found by inspection. Electrical noise, if any is now discernible, results from the addition of that on the tape to that caused by the pickup head. The tape, as mentioned, can be checked. The pickup head or its connections then remain. Attempt to reduce noise by resoldering the joints; if this fails, try a new head.

Another point in some typical circuits that contributes an excess of noise is the function switch. Jumping the contacts to close the circuit completely will reduce the noise level if a defective contact pair is responsible. No-noise lubricants are temporarily useful in preventing noise on such contacts. For a more permanent job, form the contacts for maximum contact area with needle-nose pliers, then apply no-noise lubricant.

Mechanical noise results from flapping belts, bent fan blades, flats on belts and pulleys, worn bearings and eccentric-drive rubbers. Listening through a piece of rubber tubing helps localize the sound to a particular area.

Recording position tests

A similar set of tests is made with the function switch on *record*. Since the tape transport will not yield any more noise than indicated in the playback tests, we are no longer concerned with mechanical noise. The test is started with no tape on the machine. The output is monitored with headphones. A microphone is plugged into the input and the recording level temporarily set. Then the microphone is removed for the listening test at this

AUDIO—HIGH FIDELITY

level—excessive noise will be evident. There may be a separate amplifier for recording. If so, the record level control will permit a breakdown into two components or sections that may be separately checked by the grounded-grid method.

If a single amplifier is used for both record and playback, then most of this work will have been done previously. The record head, if separate from the playback head, may have become noisy due to a dirty gap. Try cleaning it.

Improper bias level may be due to a defective tube or components. Use a voltmeter or whatever instrument is specified by the manufacturer to check the output of the bias oscillator and the bias supplied to the head.

Noises printed on tape

Mechanical and magnetic noise "printing" may occur on a tape due to a defective machine and even the normal reeling of the tape.

Tape wear may result in a wearing off of the magnetic coating, causing depressions in the coating like that left by the fiber hair of Fig. 2. The result of such mechanical abrasion is a disturbance of the normal uniform distribution, with a high residual noise level. Due to the limp nature of tape, excessive abrasion of the back will raise noise level.

A ridge or a depression on a capstan will compress the tape material due to roller pressure. Hard particles on or deeply worn pressure pads will cause similar tape abrasions. The abrasion due to a fixed member will show up as uniform streaks under magnification of about 10 power. Ridges due to flats, or depressions due to valleys, on a rotating member will show up at intervals on the tape. A greatly exaggerated view of such a depression passing a head gap is shown in Fig. 3. The active material is moved away from the gap, producing a noise pulse. A ridge (Fig. 4) will cause a closing of the distance between active material and the gap at the ridge, with a greater-than-normal separation immediately before and after the ridge. Some capstans and rollers print a checkerboard pattern when old—this makes noise too. An examination of the tape under a low-power magnifier will reveal such troubles.

Magnetic printing often offends, but it is not visible as is mechanical damage. Two kinds of magnetic printing can arise as with mechanical printing—repetitive, due to a rotating part; constant, due to permanent magnetism.

The constant type of magnetic printing results in tape magnetization with a constant polarity which creates a dc magnetic bias. This produces noise. The biasing is due to the tape passing some magnetized structure. A magnetized head, pressure pad, metal panel or metal dust covers may be the offender. The compass needle offers a good check for such fixed "hot" spots. The remedy is to demagnetize with an ac coil. Do

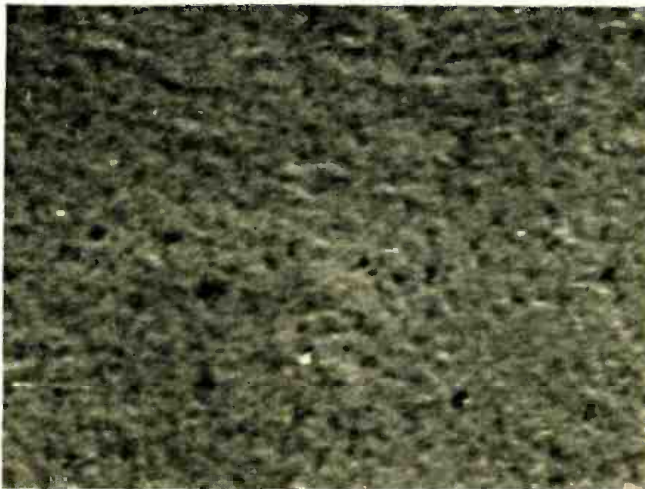

Fig. 1—Clumping of oxide particles.

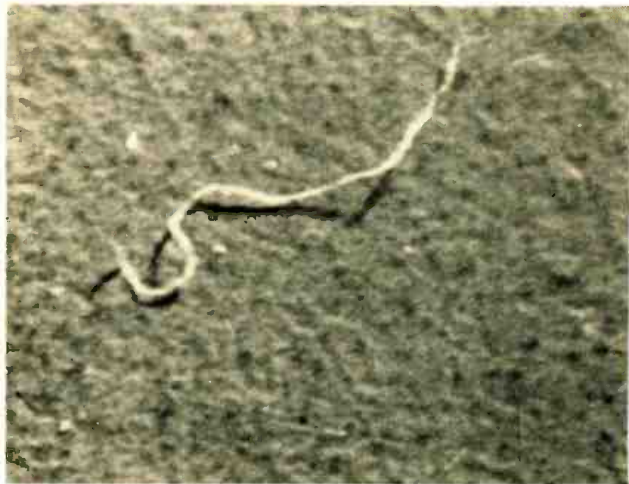

Fig. 2—Fiber hair imbedded in tape.

not use a larger magnet than a small magnetic compass for checking a head—you may make things worse.

A magnetic hot spot on a capstan roller is detected by a compass as is illustrated by Fig. 5. A hot spot will pull the needle to itself. The same side of the needle will be pulled to the hot spot even when the entire machine is turned half-way around. This check is necessary since any magnetic material will deflect a compass needle, but a magnet will attract one end and repel the other. Rotation will tell which is which. Fig. 6 depicts a hot spot on a takeup reel turntable. Such a spot will affect many turns of tape on a takeup reel as it is spooled. The result is an increase in the bias (dc) at regular intervals on the tape and produces high-noise backgrounds at these points.

Since magnetic action records on tape, even the record itself may cause an effect on adjacent layers of tape on a reel. This is called the echo effect. Loose rereeling will help separate the individual layers but the real cause is recording at too high a level. High-level recording increases the magnetic intensity of the individual magnets. Fig. 7 shows how one layer affects its neighbors.

Incomplete erasure

Erasing mechanisms must erase the old record and leave a random orienta-

tion of the magnetic structure. With poor erasing, parts of the old recording may remain to mar the new. An old, unwanted, recorded tape may be run through with the machine (several feet is enough for a test) set on record, but with microphone disconnected. The tape is rewound and the supposedly erased portion is played back. With the volume control turned up full, incomplete erasure will be evident by the playing (faintly perhaps) of the former record.

Worn tape guides may permit a recorded tape to move vertically. In a single-track machine little may happen; in a dual-track machine the slippage may permit part of the second track to be erased while recording on the first track. The remedy is new guides. The

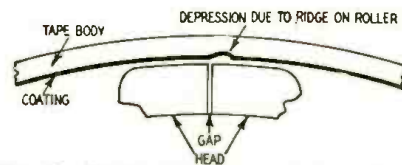

Fig. 3—Depression on coated surface.

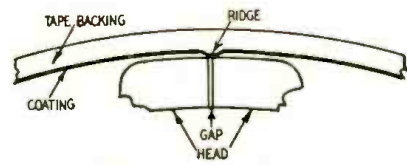

Fig. 4—Ridge on coated tape surface.

VARIABLE DAMPING

SPEAKER systems employing adequate acoustic loading do not need additional damping in the amplifier; the damping is supplied as radiation resistance giving useful output rather than dissipative loading of the back emf of the voice coil.

Variable damping can be defined as the inverse of variable internal amplifier impedance; thus a damping factor of 4 or 16 means the internal impedance of the amplifier is 1/4 or 1/16 the nominal load impedance. Since internal impedance is an accepted term of long established meaning, it is unfortunate that some amplifier makers had to clutter the terminology with new nomenclature.

Most speakers are designed to operate out of a nearly constant voltage source, implying a low-impedance output.

Every experiment so far tried using an amplifier with "variable damping" feature on our own Klipschorn or Shorthorn has shown that best results are had by disabling the variable damping feature.

Put another way, any adjustment of the damping other than for a reasonably low internal impedance of the amplifier has deteriorated the overall response.

The variable damping can be disabled by disconnecting or wiring around this part of the circuit so that a simple negative-voltage feedback system exists, giving a reasonably low internal impedance of less than 3 or 5 ohms for 16-ohm loads. Excessive feedback resulting in extremely low internal impedance almost always results in instability.

How to disconnect or wire around the variable-damping network can usually be determined by examining the circuit schematic of the amplifier in question. The amplifier manufacturer will generally be willing to give such data. However, if such is not possible, send the schematic diagram to Klipsch & Associates. If feasible, the necessary changes will be indicated.—Paul Klipsch

High-Fidelity Concert Demonstration

The Symphony Society of Greater Hartford, Conn., will present a concert and demonstration of the meaning of high fidelity at the Bushnell Memorial on October 9. Fritz Mahler will direct the 75-piece orchestra, and local audio engineers will supervise the technical program. The audience will be given the opportunity to compare "live" music with high-fidelity recordings. The event is sponsored by Gray Research & Development Co., Manchester, Conn., manufacturer of high-fidelity equipment, and the Audio Workshop, a retail high-fidelity dealer of West Hartford. Profits will be donated to the Hartford Symphony Orchestra.

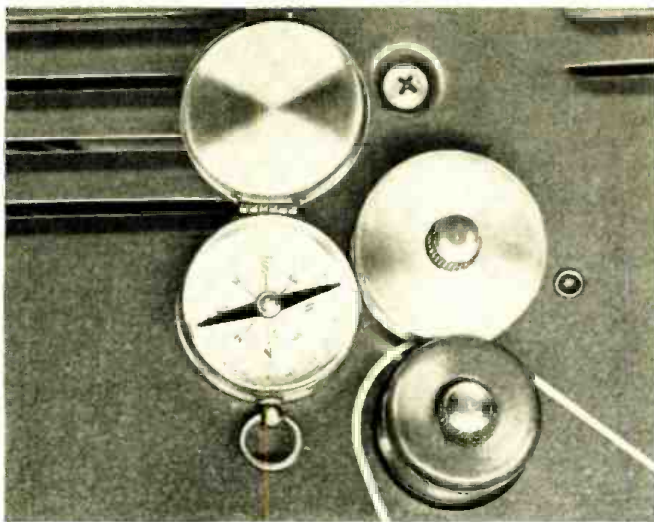

Fig. 5—Magnetic hot spot on capstan roller is detected with pocket compass.

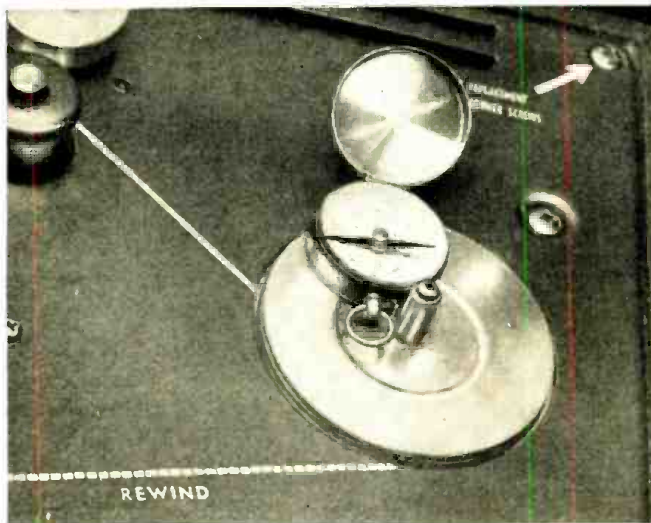

Fig. 6—Hot spot on takeup turntable.

wear may be found by inspecting the guides.

A partial magnetic short circuit of the erase head may still permit complete erasing of the old record but will raise the noise level. The effect is due to the disturbance of the bias in the

recording part of the head. Fig. 8 illustrates a typical dual-head function with the record-erase functions combined in a single head. A change in the reluctance of the erase gap will upset the magnetic flux mingling with the recording flux in the record gap. Even if the erase head is entirely separate from the record head, a partial magnetic short circuit will change the bias to the record head. Both the bias and the erase currents are supplied by the same oscillator. The most common cause for such a partial short is an accumulation of iron oxide scraped off the tape, which plugs up the gap. The remedy is to clean the gap and to clean it after each prolonged period of use.

Another frequent contributor to microphonic noise is the proximity of the microphone to the recorder, often resting on its case. The motor vibration or the hum from the power transformer may cause a serious rise in the noise level. The noise will be apparent on some tapes but not all. The remedy is to keep the microphone away from direct contact with the case or the table, chair, etc., on which the recorder is placed. Also sufficient distance should be maintained so that acoustic noise such as from belts, pulleys, etc., are not recorded. END

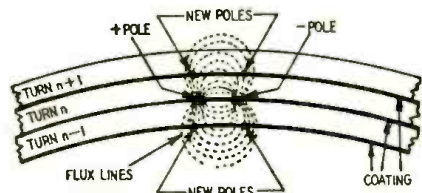

Fig. 7—Diagram shows how a strong recorded signal acts as a magnet.

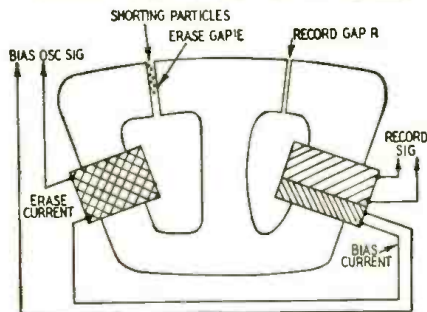

Fig. 8—Iron-oxide scrapings in an erase gap greatly reduce its effectiveness.

LOUDSPEAKER

Impedance Measurements



Simple bridge circuit and oscillator check through audio range

By HAROLD REED

The bridge in permanent form; R2 and R3 leads are brought out to barrier strip for ohmmeter measurements.

THE constructor of high-fidelity and sound-reproducing systems must know the electrical impedance of the loudspeaker he intends to use with his audio amplifier. This is no problem in itself as the speaker manufacturer will state the impedance of each speaker. This is known as the rated impedance and is assigned by the manufacturer as a nominal value for certain amplifier loading and power considerations. This impedance may be expressed simply by Ohm's law as applied to ac; that is, $Z = E/I$, where Z is the impedance, E the voltage across the voice coil and I the current flowing through the voice coil.

The nominal value of the rated impedance is generally the speaker impedance at 400 cycles, usually the minimum impedance above the bass resonant frequency. However, this value will vary with frequency. For moving-coil, direct-radiator speakers, the type considered in this article, the impedance is usually fairly constant in the range from about 200–600 cycles. At the bass resonant frequency the impedance rises to a peak. Below that

impedance drops, approaching the voice coil resistance as the frequency is decreased. Above about 600 cycles, the impedance rises with increasing frequency.

The hi-fi experimenter may not be satisfied just to know the rated impedance of a speaker. He may wish to learn something of its impedance characteristics existing when using a certain enclosure and when the system is operating in various parts of his home, as well as to determine impedance variations with changing frequency.

A simple method of determining loudspeaker impedance is shown in Fig. 1. The impedance may be measured at the rated frequency, say 400 cycles, or any other frequency available from the audio oscillator. With switch S1 closed and S2 set to SPKR, the output of the oscillator is adjusted to give some suitable voltage across the speaker voice coil as indicated on the voltmeter. The value of this voltage is unimportant so long as it does not damage the speaker—1 to 2 volts is usually satisfactory. Resistor R1 is then varied and S2 alternately thrown from SPKR to R until the same voltage is read on the meter with S2 in either position.

When the voltages are equal, the resistance of R1 is approximately equal to the speaker impedance at the audio oscillator frequency. The resistance of R1—therefore, the speaker impedance—may be found simply by reading the value with an ohmmeter. If the vtm is a volt-ohmmeter instrument, it is necessary only to open S1, throw S2 to R and set the vtm to read ohms. The above method gives us Z , the impedance of the speaker.

Suppose now we want to analyze conditions further and learn something

about the resistive and reactive components comprising Z and also to make measurements under actual operating conditions of the speaker with various input powers.

A simple bridge circuit may be employed for this purpose. The Maxwell bridge (Fig. 2) is preferable as it is most suitable for inductance measurements of coils with a Q of 10 or less. The conventional type of Maxwell

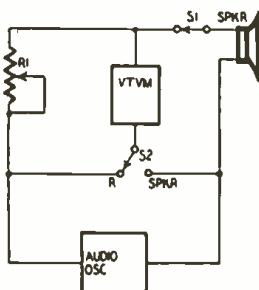

Fig. 1—Vtm compares voltages developed across loudspeaker and resistor.

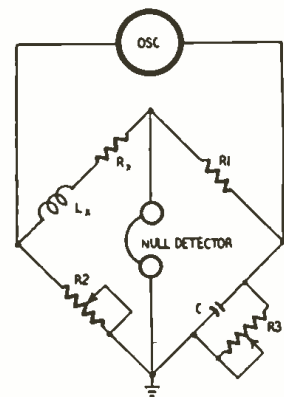

Fig. 2—Circuit of Maxwell bridge.

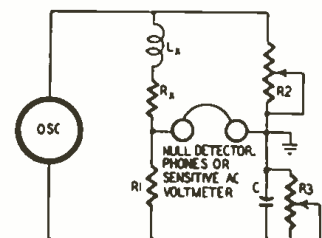
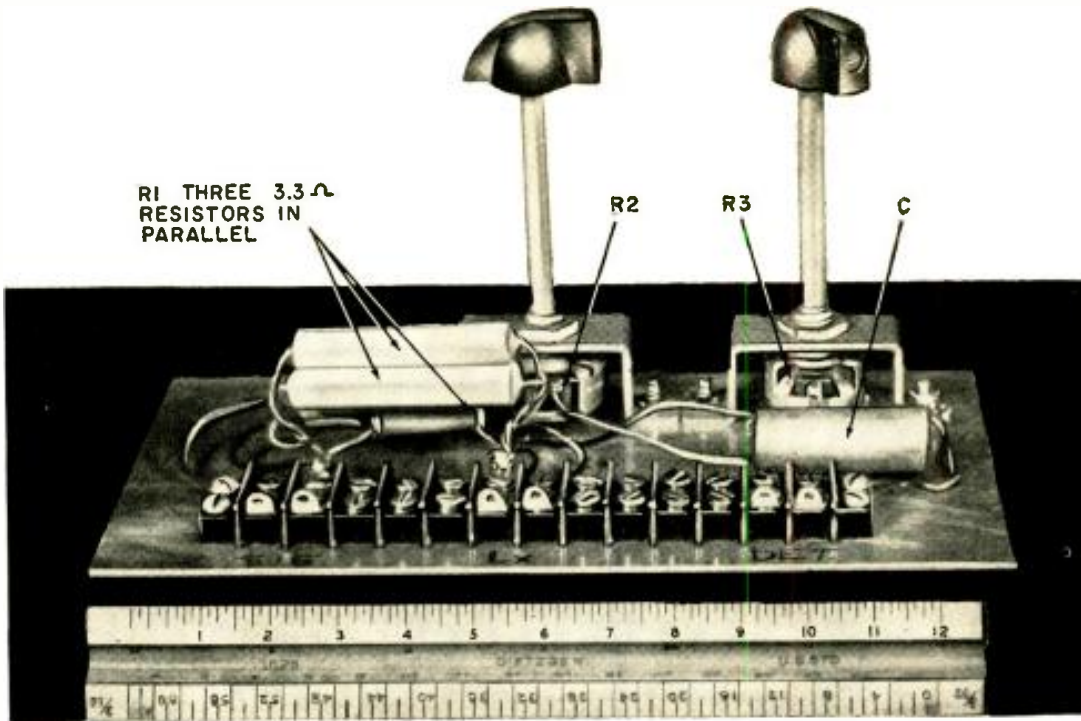

Fig. 3—Diagram of Maxwell bridge redrawn, for testing speaker impedance.

Experimental bridge setup.



bridge shown in Fig. 2 is redrawn in Fig. 3 for clarification. An excellent article for study and construction of a combination inductance bridge is given in the *C-D Capacitor*¹.

In the usual completely constructed, calibrated bridge for general-purpose measurements, ratio arm R1 consists of a number of fixed resistors individually switched into the circuit as required to cover a wide range of measurements. For a specific application, such as when making speaker impedance measurements, a single resistor will suffice.

The unknown quantity L_x is the speaker voice coil inductance, unknown quantity R_x is the resistive component of the speaker. Variable resistor R2 balances the bridge for the inductance component and variable resistor R3 balances it for the resistance component. When the bridge is balanced for both inductance and resistance, a null is obtained; that is, a minimum signal is heard in the headphones or a minimum indication is observed on the sensitive ac voltmeter. This is true because, when the bridge is balanced, there is no potential difference between the detector terminals and, therefore, no current flows through the detector.

A circuit of a bridge for measuring speaker voice coil impedance is shown in Fig. 4. Resistor R1 should be of the carbon (noninductive) type. Impedance can be measured with the speaker operating at any power. One consideration not of great concern in the usual general-purpose bridge is the power rating of R1. In the circuit of Fig. 4 current flowing through the voice coil also flows through R1. Wattage rating of this resistor is determined by the greatest power at which the speaker is measured.

With the speaker connected to the L_x , R_x terminals, the af signal is applied to the bridge from the oscillator. The oscillator output is adjusted to obtain the desired voltage across the voice coil. Resistors R2 and R3 are then varied to balance the bridge, that is, to obtain minimum signal across the null detector. Carefully and alternately adjust these controls until the setting of each one is unchanged with further adjustment of the other.

When the null is obtained, if the bridge is calibrated, R2 and R3 may be read directly from the dials or from a chart. If the bridge is not calibrated R2 and R3 must be measured. The unknown inductance L_x of the speaker is $L_x = R1 \times R2 \times C$; the unknown resistance component is $R_x = R1(R2/R3)$, where R1, R2 and R3 are in ohms, C in farads and L_x in henries. Then, the inductive reactance is $X_L = 2\pi fL$, where X_L is in ohms, 2π is 6.28, f the frequency at which the test was made and L the inductance in henries as found above. Impedance Z is $Z = \sqrt{R^2 + X_L^2}$. It can be seen that the resistive component R is the predominant factor.

Fig. 5 shows a reactive and resistive curve plotted from results obtained in the manner just described when testing an inexpensive 8-inch speaker. Notice the peak at the bass resonant frequency of 200 cycles and the continual rise of the curve with increasing frequency. The enclosure and baffle dimensions were not optimum for the speaker.

In making speaker impedance measurements place the speaker several feet from any objects. It should face away from the experimenter as any movement in front of the speaker cone will produce variations in the null point of the bridge and, therefore, inaccurate results. Also, large signal voltages from

the oscillator should not be applied to the bridge without the speaker connected as controls R2 and R3 may be damaged. END

¹"Combination Inductance Bridge." *The C-D Capacitor*, Vol. 20, No. 4, April, 1955.

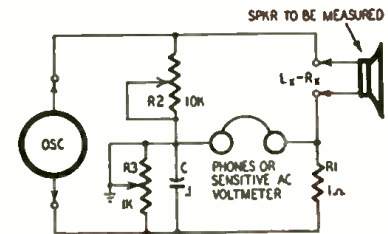

Fig. 4—Bridge circuit and values.

- Parts for Fig. 4 bridge
 R1—1 ohm, carbon (wattage rating dependent on power fed to speaker)
 R2—10,000-ohm pot.
 R3—1,000-ohm pot.
 C1—0.1 μf
 Phones or sensitive ac voltmeter
 Chassis or cabinet
 Binding posts (6)
 Terminal or mounting strips
 Tuning dials (2) for R2 and R3

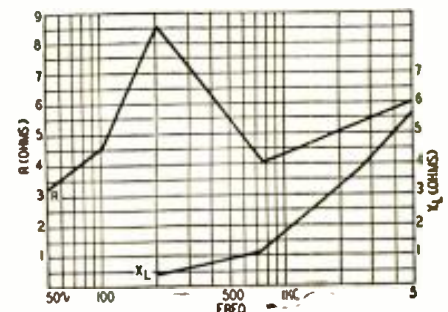

Fig. 5—Typical reactance-resistance graph made from Fig. 4 circuit.

FEEDBACK FROM THE VOICE COIL

By NORMAN H. CROWHURST

*An opportunity
for low-cost
high fidelity*

EVER since feedback was used to improve amplifier performance an ultimate possibility has intrigued audio enthusiasts—that of feeding back from the loudspeaker to eliminate some of the distortion produced by this unit.

Some have tried placing a microphone in front of the loudspeaker and feeding the microphone output back to the amplifier input in an endeavor to improve the overall frequency response. Unfortunately, the acoustic delay time between the loudspeaker diaphragm and the microphone prevents any appreciable degree of feedback—this system cannot work. However, the idea of using a motion-sensing coil on the loudspeaker diaphragm has often been toyed with as a means of providing overall feedback.

Probably many experimenters have worked on this idea, but putting a second voice coil on a loudspeaker diaphragm is really a professional job and this system becomes possible for the average individual only when loudspeaker manufacturers supply units with more than one voice coil.

Recently I was going over the stack of brochures acquired at the last audio show and came across some in which loudspeaker manufacturers were advertising units with so-called universal voice coils. These coils have a double winding which can be connected in series to give 16 ohms impedance or in parallel to give 4 ohms; using just one section will give the intermediate value of 8 ohms.

I remembered having seen the unit but at the time it struck me that it was just a device for the convenience of loudspeaker manufacturers and jobbers—to save them the bother of

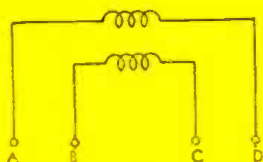
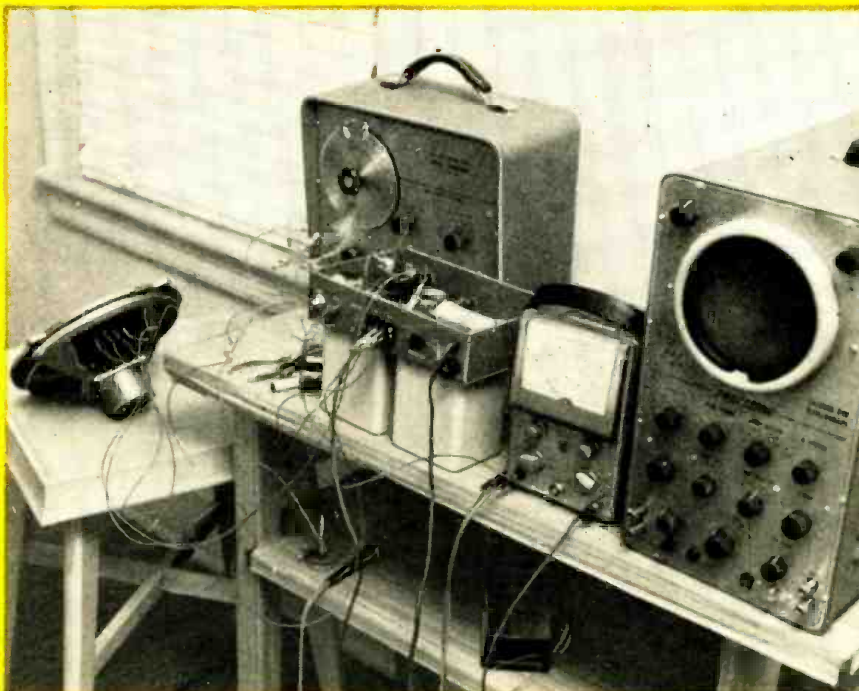

Fig. 1—Coil connections of "universal" voice coil for 4-, 8- and 16-ohms.



Experimental setup for voice coil feedback.

winding voice coils to three impedances and carrying three items instead of one in stock for each size. Now it suddenly occurred to me that here was something that could be applied in quite a different way! I promptly acquired a Stentorian 1012, a unit of this type, and set to work to see what can be done.

The amplifier I chose to try it with is a typical 25-watt job using an Ultra-Linear output with 6L6's and providing output taps at 8 and 16 ohms; the normal feedback is connected from the latter tap. The first thing to do, of course, was to connect the arrangement under normal conditions and make sure everything was working properly.

The first attempt

Having checked this, I set about to try changing over the feedback to take

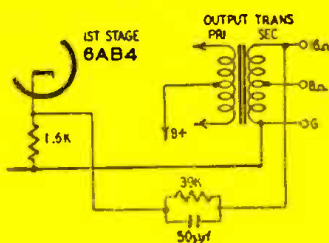

Fig. 2—Original feedback connection.

it from the second coil instead of the active voice coil. From the directions for connecting the voice coil, I deduced that the internal arrangement of the twin voice coils was as shown in Fig. 1. Using terminals A and D for the driving coil, I decided to use terminals B and C for the pickup coil. If I connected C and D together for the ground side, the output from terminal B would probably be in the same phase as the driving voltage fed to terminal A. This eventually proved quite correct.

The schematic of my amplifier showed that the 39,000-ohm feedback resistor, connected from the 16-ohm tap (Fig. 2) to the cathode of the first stage, was shunted by a 50-µmf capacitor. My first step was to open-circuit this capacitor

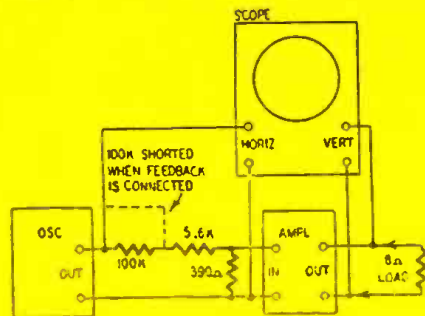

Fig. 3—Experimental test setup. The amplifier gain control is turned up.

to find out whether it was needed to make the amplifier stable. Later I checked its exact function in more detail, but this particular amplifier proved to be stable without the capacitor connected and whether the loudspeaker was connected or not.

As the feedback resistor was 39,000 ohms from the 16-ohm tap, I deduced that the same feedback voltage could be derived from the 8-ohm tap by using about 27,000 ohms. So my next step was to disconnect the feedback through the 39,000-ohm resistor and connect a new feedback loop, from terminal B of the loudspeaker, through a 27,000-ohm resistor. I found that the new feedback did not make as much difference in the gain of the amplifier as the original feedback. The gain was practically the same as it was with no feedback, when the 39,000-ohm resistor was removed from the 16-ohm tap.

I realized that I could have expected this had I stopped to think of loudspeaker efficiency. Most of the power delivered to the 8-ohm driving coil is expended in the resistance of the coil

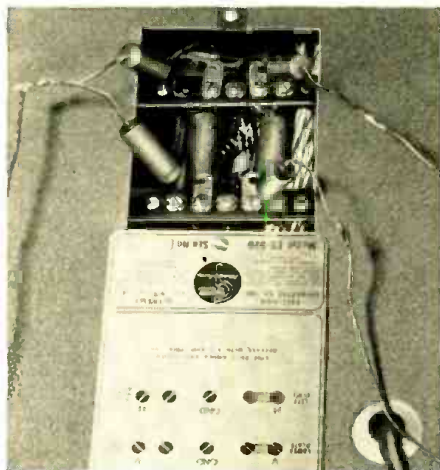

Fig. 4—Connections are made directly to scope plates through capacitors.

and only a relatively small fraction is used to drive the diaphragm. Because of this, I would get only approximately a similar fraction across my pickup coil. This means I need a correspondingly lower resistance in the feedback to get the desired results.

So the next step was to try values lower than 27,000 ohms. I had not gone very far when the amplifier became unstable at some ultrasonic frequency so I decided it was high time to get an oscillator and scope and find out exactly what was happening.

Restoring the amplifier to its original condition, I connected the scope as shown in Fig. 3 to determine the response and phase characteristics of the amplifier with and without the feedback capacitor. I found I had to connect directly to the scope plates, as shown in Fig. 4, to get reliable phase patterns above 20 kc. Removal of the feedback capacitor resulted in a peak of 12 db with a phase shift of 90° at 36.5 kc. The 12 db was obtained by setting the input to the same voltage on the vtvm

at 1 and at 36.5 kc, where the output was four times the output at 1 kc. The 90° phase shift was shown by the sloping line (Fig. 5-a) at 1 kc, changing to a high vertical ellipse (Fig. 5-b).

Putting an 8-ohm load on the output dropped the peak to 6 db with 90° phase shift, at a frequency of 33.5 kc (Fig. 5-c, d). So my next move was to try and "hold down" the amplifier so

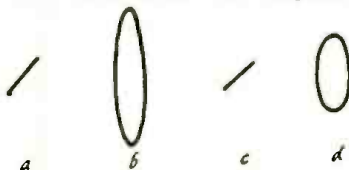

Fig. 5—Traces obtained under tests: a, 1 kc—no load; b, 36.5 kc—no load; c, 1 kc—8-ohm load; d, 33.5 kc—8-ohm load.

I could play around with the amount of feedback without the amplifier taking off at this ultrasonic frequency. Some experimenting showed that connecting a .0025- μ f capacitor from the plate of the first stage to ground resulted in a condition where the response, with the 39,000-ohm feedback resistor connected, was flat over the audio range and showed a phase shift of 90° and +3.5 db at 17.5 kc without a load connected and of 90° with -2.5 db at 16 kc with the 8-ohm load connected.

Try again

With this capacitor I reconnected the pickup voice coil and proceeded to cut down the feedback resistance (Fig. 6). When I got down to 12,000 ohms, from the original 27,000, I noticed that the amplifier was unstable at about 2 cycles. This was not audible; in fact it hardly moved the diaphragm, but I noted the spot on the oscilloscope screen going gently up and down at this frequency. A dc voltmeter in the plate circuit of the early stages showed by its vigorous swinging that the amplifier was oscillating at this frequency almost to saturation. The poorness of the output transformer was losing available output so that relatively little power appeared on its secondary.

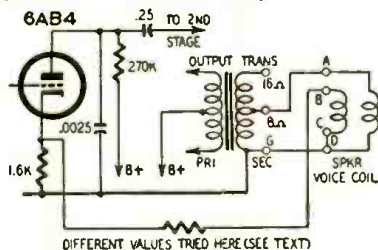

Fig. 6—Changing feedback values using voice coil feedback arrangement.

However, signals passed through the amplifier under this condition were severely 2-cycle modulated. To cure this I tried changing various coupling capacitors from the plate of the first stage to the grid of the second was most convenient, as well as the one that had most effect. The original value was 0.25 μ f. Using smaller values raised the oscillation frequency and made it more intense.

Eventually a 1- μ f unit was found to prevent oscillation completely and make the amplifier stable, so this capacitor was permanently changed to 1 μ f. This did not affect the performance of the amplifier when connected back to its normal arrangement.

Now I found that connecting this feedback arrangement gave me approximately 14 db of feedback, whereas the original arrangement had a little more than 20 db. Both listening to program material and checking with the oscilloscope showed that this arrangement was deficient in frequencies above 1,000 cycles. However, below 1,000 cycles things looked very hopeful: the output voltage stayed closer in phase with the input voltage as the frequency was swept through the resonant region. This was indicated by the fact that the line on the screen did not open out into such a wide loop as occurred with the normal operation. Also, the output took a dip at frequencies where resonance made the loudspeaker more efficient. As a result, when frequency was varied the output sounded more constant, although the output voltage showed a dip where previously there had been audible peaks in the response. This seemed very promising. The next step was to retrieve the lost highs.

Remember that the average loudspeaker impedance characteristic shows a rise above 2 kc, indicating that the reactance of the voice coil inductance is becoming comparable with its resistance at this frequency. As the two voice coils on this loudspeaker are bifilar-wound, the mutual inductance between them is approximately the same as the self-inductance of each coil individually. Although the coil is basically air-cored, the proximity of iron in the magnet boosts the inductance somewhat. This means that the electrical coupling between the voice coils begins to approach 100% at frequencies in the region of 2 kc and is getting pretty close to 100% coupling above about 5 kc.

This explained my high loss. Beginning at about 1 kc and reaching an ultimate in the region of 5 kc, the feedback was reverting to the original arrangement. Using the much lower feedback resistor means that, up in this region, I had about 8 db more feedback than in the normal operating condition; in the region below 1,000 cycles I still had about 6 db less than the original amount of feedback due to loudspeaker inefficiency—a differential of about 14 db, a serious loss. At the same time I

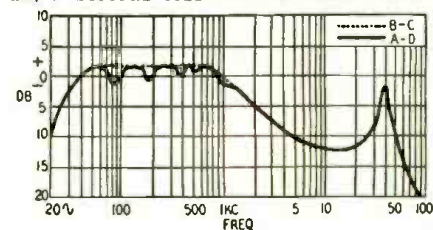

Fig. 7—Response of Fig. 6 arrangement. Solid line is response across voice coil AD; dashed line response across coil BC.

AUDIO—HIGH FIDELITY

noticed I had a high peak up in the region of 35 kc.

My frequency response at this stage looked somewhat as shown at Fig. 7. To get satisfactory results I had to bring the high frequencies up level with the response below 1,000 cycles and eliminate the peak at 35 kc.

Final success

The circuit of Fig. 8 was designed to do this. It proves to be fairly easy

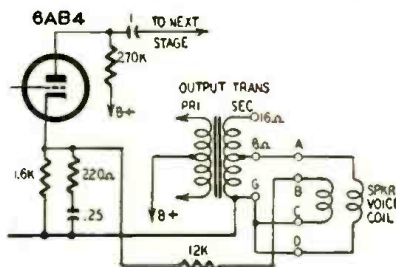

Fig. 8—Final feedback arrangement.

to set up according to the requirements of individual conditions. The .0025- μ f capacitor from plate to ground was removed and the capacitor and resistor across the cathode resistor of the first stage effectively reduce feedback in the region where the mutual inductance tends to bring it up, by approaching 100% coupling.

Choice of the right capacitor value puts the response slope in the right place to neutralize the downward slope caused by the mutual inductance of the voice coil.

Using a resistor either larger or smaller than the optimum value results in a tendency to peak at an ultrasonic frequency.

This in fact proves to be the limiting factor to the amount of feedback that can be used. With this arrangement 220 ohms in parallel with a cathode resistor of 1,600 ohms is about the right value to level up the high-frequency response with that below 1,000 cycles. Then 12,000 ohms is the lowest resistance that can be used in the feedback circuit without producing a tendency to peak up in the 35-kc region.

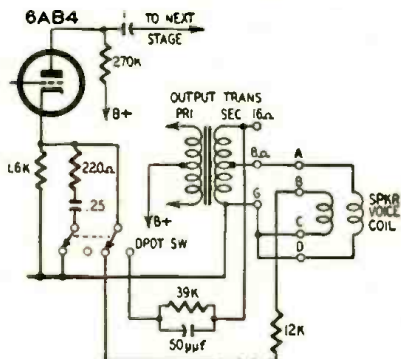

Fig. 9—Switching setup for A-B tests of normal and voice coil feed-back.

I still have some 6 db less overall feedback than with the original arrangement, as determined by the fact that the average output voltage over

the frequency response is this much higher for the same input voltage. But a sweep with the oscillator shows very convincingly that the major resonances of the loudspeaker have been much more effectively removed by this method than had been apparent with the damping factor of 12 applied by the amplifier under its normal connection.

Listening comparisons

To make sure just what I had achieved, I arranged to make some A-B listening tests. I found a dpdt switch and connected it as shown in Fig. 9. I was thus able to switch quickly from the original method of operation to the new circuit. As there was a change of about 6 to 8 db in the level, I also had to adjust the gain control quickly to compensate for this.

Careful listening showed that I had achieved much better fidelity by using this voice coil feedback. The low frequencies were completely uncolored (after, of course, the speaker had been mounted back in its cabinet) and a tendency of the low frequencies—particularly plucked string bass—to intermodulate with higher frequencies in the same orchestra was considerably reduced.

From observing the loudspeaker diaphragm while music was being played I would estimate that the *effective* damping of the loudspeaker was con-

siderably improved. The diaphragm did not seem to vibrate so far each time the string bass was plucked, and the sound was more natural. This was achieved with actually less feedback in this frequency range than with the original circuit.

So don't be deceived into thinking that because this arrangement cannot use such a large amount of feedback as is normally applied over the amplifier itself, it cannot be so effective. Because this feedback is tightly coupled to the acoustic movement of the diaphragm itself, instead of being separated by the inefficiency of the loudspeaker, better damping is possible than can satisfactorily be achieved just by the use of an amplifier, even with a very high damping factor.

Conclusions

When I started to experiment I had certain misgivings about the potential of this new arrangement and went into it with the idea of finding out just what it would achieve. However, after producing a satisfactory working arrangement, I have made the connection permanent and am satisfied that this produces the nearest approach to low-cost high fidelity that can be achieved with a single loudspeaker unit.

Another advantage I found. This arrangement is less critical of speaker placement in the room. **END**

2-Channel Amplifier

MANY of the high-quality European radios and phonograph reproducing systems have separate output circuits for high and low frequencies. Home designers and constructors are following this same trend in their equipment. The diagram shows a simple 2-channel amplifier described in *Radio Bulletin* (Holland). The unit is designed for use with tuners and high-output phonograph cartridges.

The high-frequency channel delivers about 4 watts and the low-frequency circuit about 6. Series resistors at the lower end of the volume controls prevent either channel from being com-

pletely cut off. The response of the low-frequency channel can be varied within limits by the feedback type tone control.

The cathode resistor in the low-frequency output stage may consist of two 270-ohm $\frac{1}{2}$ -watt resistors in parallel. The power supply should deliver 250 volts at 120 ma or more.

You can purchase the EL84 from many jobbers and most suppliers handling European equipment or from Amperex Electronic Corp., 230 Duffy Ave., Hicksville, N. Y., North American Philips, 100 E. 42nd St., New York City, or International Electronics Corp., 81 Spring St., New York City.

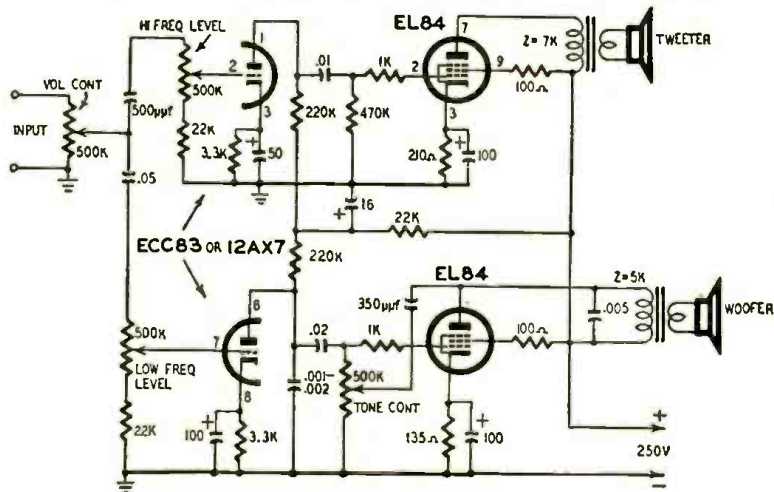

what's

new

?

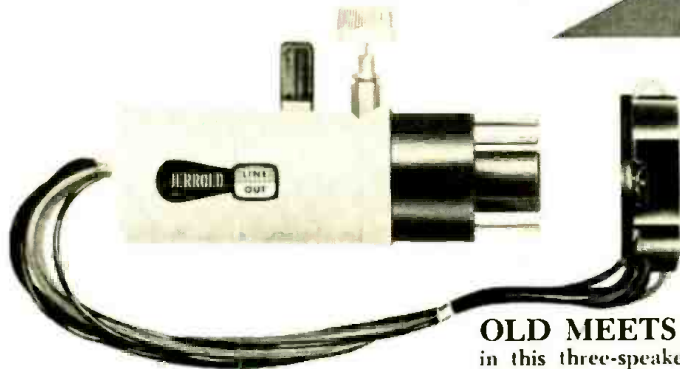

VENETIAN BLIND TV interference is eliminated by a filter which fits on the picture-tube socket. According to Jerrold Electronics, who make the filter, its operation is based on the fact that TV information is largely on harmonics of 15,750 cycles, whereas venetian-blind interference is on 10 or 20 kc, due to the "offset" of stations on the same control. So a 10- and 20-kc filter takes out the interference without noticeable impairment of the picture.

OLD MEETS NEW

in this three-speaker radio-phonograph. The Fiberglas horn contains a tweeter, and there are two 6 x 9-inch speakers at the sides of the cabinet. Duct loading and a special hass amplifier tube compensate for the lack of speaker enclosure, with surprisingly good results. A four-speed record changer (including 16 $\frac{3}{4}$ rpm) and an illuminated-dial radio complete the equipment. The tuning dial is the crank! The Graf-O-Nola is made by Guild Radio & TV, manufacturers of the Country Belle "rural-telephone cabinet" radio receiver.

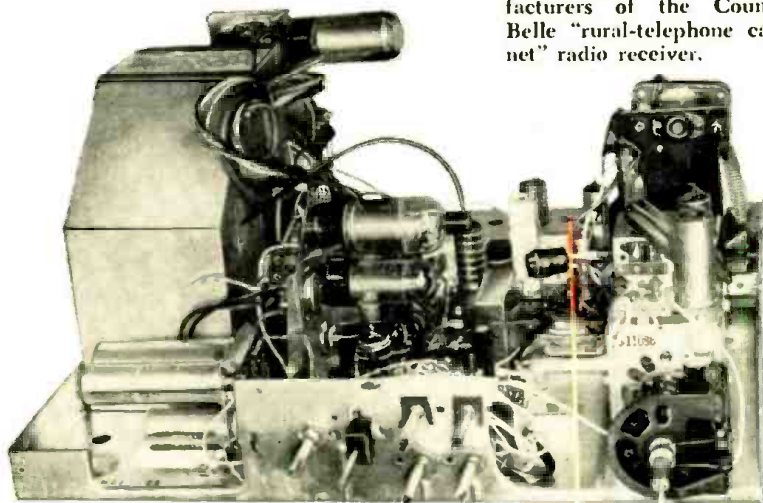

AN UPSET in TV design is this Philco chassis 7L71U, universal chassis for 21- or 24-inch sets with uhf and automatic touch tuning. The traditional chassis is turned over and parts installed as shown above. Controls, etc., are mounted on aprons projecting up instead of down. Three cutaways on the chassis bottom expose the underside of printed-circuit boards for service. A narrow-blade screwdriver is inserted in the hollow control shafts to adjust secondary controls. This plus other features permit the service technician to make all secondary adjustments from the front.



Courtesy U.S. Navy Air Development Center, Johnstown, Pa.

HEART SOUNDS are recorded clearly and safely with these smallest microphones, ceramic (barium titanate) phonocatheters which are inserted directly into the heart through a vein. The ceramic units are $\frac{1}{2}$ inch long and from .038 to .08 inch in diameter. They were developed by Drs. Wallace and Brown of the U. S. Naval Air Development Center, Johnstown, Pa., and Dr. Deitz, Philadelphia General Hospital.



BETTER UNDERSTANDING with a form of three-dimensional hearing is the objective of this new Telex headset. A time delay of 1 millisecond between ears results in 30% better intelligibility, according to the manufacturer. The delay is produced by bringing the signal to one earpiece, then using a hollow tube between it and the other. The tube, which is also the headband, acts as the acoustic delay line. The set is designed to be worn for long periods of time and will be useful to secretaries, switchboard operators and radio and TV monitors.



flea-power

Miniature unit tunes from 600 kc-5.1 mc, covering 160- and 80-meter ham bands

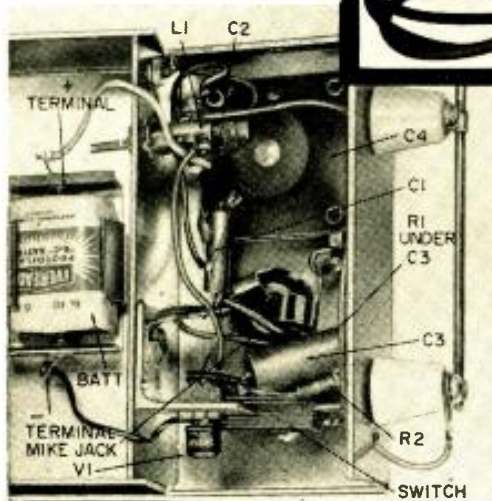

Internal view of transmitter. Photo shows battery polarity accidentally reversed—connect battery as shown.

THE possibilities of the transistor in transmitter applications have barely been explored. There are several good reasons for this, the most important being that, as the frequency capabilities of commercially available transistors are being improved, their power-handling capabilities suffer proportionally. Thus, although transistors are available that operate reliably to 5 or 6 mc and beyond, their very small power output has limited their application to rf and if receiver circuitry.

Judging from the amazing progress made in the past year or two in transistor development, units with reason-

ably good power capabilities will soon be available for use throughout the rf spectrum. The midget unit described in this article was built to familiarize myself with the use of transistors in transmitter applications.

Using a Miller 2020 oscillator coil, this flea-power transmitter tunes over a very broad frequency range which varies slightly from transistor to transistor but has averaged 600 kc to 5.1 mc. The transmitter covers both the 160- and 80-meter ham bands as well as the standard broadcast band, where it can be used for "broadcasting" through the home radio. Its range with no external antenna is limited to about

TRANSISTOR TRANSMITTER

By JOSEPH CHERNOF

50 feet, which conforms to FCC regulations on this usage.

This unit (Fig. 1) represents a great simplification of several earlier models. The original plan was to use one transistor as rf oscillator and a second as modulator. However, it was found that a crystal microphone would provide sufficient modulation voltage when coupled directly to the base element of the transistor oscillator, thus eliminating one transistor. Coupling the modulating voltage directly to the base, roughly analogous to control-grid modulation using vacuum tubes, results in surprisingly good fidelity. The crystal microphone has very little loading effect on the oscillator, although the microphone cable was shielded to prevent any hand-capacitance detuning effects.

The transistor is a Sylvania 2N94A n-p-n unit especially designed for rf applications. The lower-priced transistors, such as the CK722 and 2N107, will oscillate fairly well in this type circuit at frequencies up to about 1.5 mc but only a few selected units will oscillate above that.

Oscillator coil L1 is a two-winding tapped unit and provides the proper voltage and phase relationships to sustain oscillation. Feedback energy is coupled from the collector output circuit to the base via C2. Resistors R1

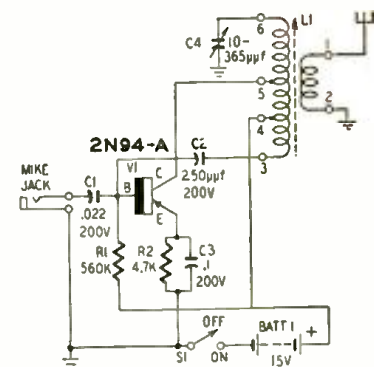

Fig. 1—Transistor transmitter diagram.

Parts for flea-power transmitter

R1—560,000 ohms, 1/2 watt; R2—4,700 ohms, 1/2 watt; C1—.022 μ f, 200 volts; C2—250 μ f, 200 volts, ceramic; C3—.01 μ f, 200 volts; C4—10-365 μ f, variable (Lafayette MS-215 or equivalent); V1—2N94A transistor; Batt 1—15-volt miniature B battery (Eveready 411 or equivalent); S1—spst toggle switch; L1—oscillator coil, Miller 2020 or Lafayette MS-165; transistor socket; battery holder; standoff insulators (2); microphone jack; microphone, crystal (Lafayette MS-108 or equivalent); cabinet, approximately 4 x 2 1/8 x 1 1/2 inches; antenna.

CONELRAD—a report

and R2 supply two separate kinds of operating bias to the oscillator transistor. This helps circuit stability by minimizing the effects of the normally large variation in transistor characteristics. R2 is bypassed for rf by C3. L1 can be tuned by an adjustable ferrite core which allows a coarse adjustment of the oscillator frequency range. Fine-tuning capacitor C4 is a 10-365- μ f miniaturized unit. A standard-size capacitor would work just as well but wastes considerable space.

Energy from the oscillator is transferred to the antenna via a link winding on L1. The entire unit is powered by a miniature 15-volt battery, an Eveready No. 11. The transmitter draws less than 1 ma so battery life should be extremely good. For portable use on the ham bands, a 4-foot whip antenna was fabricated from a length of 1/8-inch brass welding rod. Using this antenna, the unit operated satisfactorily at ranges up to 1/2 mile. Somewhat better results were obtained with fixed-station operation using a more efficient antenna.

The transmitter is housed in a 4 x 2 1/2 x 1 3/8-inch box and the whip antenna is supported at its base by two miniature standoff insulators as shown in the photographs. The 2N94A is mounted in a transistor socket to minimize the danger of damaging the unit during soldering and to facilitate tran-

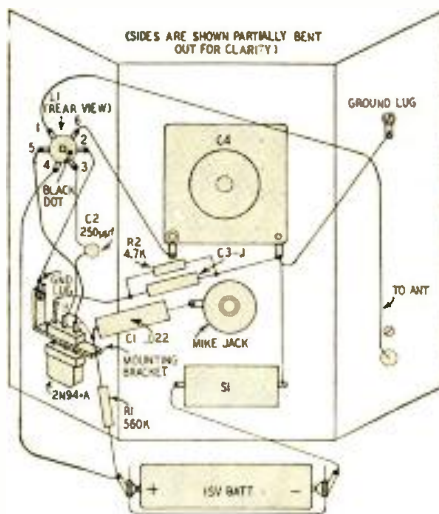

sistor replacement. The battery is mounted in a miniature battery holder for the same reason. No special construction details are necessary other than the use of shielded mike cable. As always, it helps to keep all leads as short as possible. A pictorial layout of the transistor transmitter is shown in Fig. 2.

In addition to the applications mentioned, this unit would make an excellent rf signal generator over its operating range. For this use it would be advisable to add a second transistor as audio oscillator to provide a modulated rf output signal. END

THE first nationwide Conelrad test, July 20, 1956, produced some unexpected results. At the time of writing, no official summary was available. A series of tests organized by RADIO-ELECTRONICS author Sol Prenskey—who is preparing a complete report on the alert—turned up some useful facts.

The results of the informal tests are given below. Point A was on the eighth floor of a steel building in Brooklyn, monitored by Leonard D'Airo, an associate of Prenskey who has constructed several transistor receivers; point B was a steel building in Manhattan, also on the eighth floor. Point C was the home of Fred Shunaman, managing editor of this magazine, roughly 25

strengths vastly different; antenna facilities were widely different; attention to sets varied (one monitor was operating four receivers simultaneously while another was listening on only two).

There is still some difference of opinion as to the meaning of these results, but a few points stand out:

1. An outside antenna is a decisive feature. The least sensitive set—the Heathkit crystal receiver—and a sensitive communications rig—the S-40—were both 100% intelligible, presumably due to their good outside antennas. The same was true of the Lafayette kit which had been modified to become a regenerative receiver.

CONELRAD TEST INTELLIGIBILITY

Type of Equipment	Point A	Point B	Point C	Point D
Commercial battery portable receivers	(Knight) 75% satisfactory (Note 1)	(RCA) 65% satisfactory (Note 1)	(Westinghouse) 75% satisfactory (Note 1)	(Grundig long-distance type) 85% satisfactory (Note 2)
Commercial transistor portables	(Regency TR-1) 100% satisfactory with continual retuning	(Zenith Royal 500) 85% satisfactory with occasional reorienting		(Zenith Royal 500) 60% satisfactory with constant returning and orienting (Notes 1, 2)
Home-constructed transistor receivers	(D'Airo Super) Satisfactory with 25-foot antenna and reorienting	(Modified Lafayette K-68) Satisfactory with outdoor antenna	(D'Airo Super) Not satisfactory as used without antenna or reorienting	
Hallicrafters S-40	Used at Point C, with outside TV antenna. 100% satisfactory.			
Heathkit crystal set	(No amplification.) Used at Point C, on outside antenna 100 feet long. 100% satisfactory.			

Note 1. Remainder too weak without reorienting or slight retuning or both.
Note 2. Remainder bothered by interference from other clusters (nets) but readable with retuning.

miles from New York City. Point D was the home of our technical editor Bob Scott, approximately 50 miles from Manhattan. The results of the tests are by no means to be taken as an indication of the relative performance capability of the receivers, for three reasons: The distances made signal

2. Extreme sensitivity may not be needed. There is danger of picking up interference from adjacent nets.

3. Sets should be reasonably broad-tuning and *nondirectional*. Where good results were had with the portables, it was at the expense of continual re-orientation and retuning.



First side tuning—then top tuning! Now THIS!!

TRANSISTOR RADIOS

Part V—Motorola 56T1, CBS-Columbia TR-260 and Sentinel 369-P

By I. QUEEN
EDITORIAL ASSOCIATE



ONE of the surest proofs that the transistor radio has established itself thoroughly is the fact that the best-known and largest companies—who are sometimes rather conservative—have presented transistor models. The products of three of these firms are described in this installment. Note well that one of these is a table-model radio. Some manufacturers have designed models that can be used as portables or home sets. One has even built a portable which can be set on a special base with a larger speaker, making it a table set with better output equipment than it could have as a portable. But the CBS-Columbia is—as far as I know—the first true table-model portable.

Motorola 56T1

This is a five-transistor receiver with a plated-circuit chassis. The power supply is a 9-volt battery, which may be either standard or mercury type. All transistors, except the output stage, are n-p-n types. The voltages listed in the diagram (Fig. 1) are measured with a vtvm with no signal input and with volume control set at maximum and are from the point indicated to ground.

The first stage is a conventional converter. Its base is only slightly more positive than its emitter, since the transistor is biased for detection. L1 is the pickup loop and secondary. L2 is the oscillator coil with coupling

between emitter and collector windings. The emitter coil is tuned, the collector winding acting as a tickler.

Single-tuned transformers are used in the if stages. Each base is fed from a voltage divider. A capacitor bypasses the if signal from the secondary winding directly to each emitter. Each emitter and collector return includes a decoupling resistor and capacitor.

The second if stage feeds a detector (V4) which also supplies avc. This stage is biased nearly to cutoff (almost zero bias) by a small resistance R3, and a much larger one, R4. Therefore the current through V4 increases with signal input. In other words, each *negative* half-cycle of signal is almost entirely lost for it drives the base more negative than the emitter and blocks the transistor. The *positive* half-cycle drives V4 to conduction in accordance with its amplitude.

Electrons flowing into the emitter of V4 must first flow from ground into R1, R2. Therefore the emitters of both if amplifiers are driven *positive* by this current. The greater the signal, the greater the bias at each emitter. This avc action reduces sensitivity in proportion to signal input.

An interesting circuit couples the detector to the output stage. The output load for V4 is a portion of the volume control R5. Current from the transistor must flow through this resistor to return to the positive terminal of the battery. It sets up a *negative*

voltage drop to bias the base of V5. This makes a p-n-p transistor necessary in the output stage.

Bias for the output stage depends upon the setting of the volume control. When it is set for maximum (all the way to the right), the drop across R5 is relatively large and maximum bias for V5 is available. C charges to some average value of voltage to bias the final transistor. When the control is adjusted to *minimum*, the voltage on C is very low and the gain of V5 small.

CBS-Columbia

This company puts out a pocket Power Mite set (model 250) and a home model Porta-Console (TR 260). The smaller set has 50-mw output and weighs 15 ounces, less battery. The home model puts out over 250 mw and weighs 12½ pounds. See Fig. 2.

The high-frequency section uses three n-p-n transistors. Three p-n-p units are in the audio stages. The converter is conventional but note that the first if transformer is double-tuned for greater efficiency. Note also diode D1 between T1 and T2. The potential *difference* between its anode and cathode will determine whether D1 will conduct, and how much. Since V2 is biased for

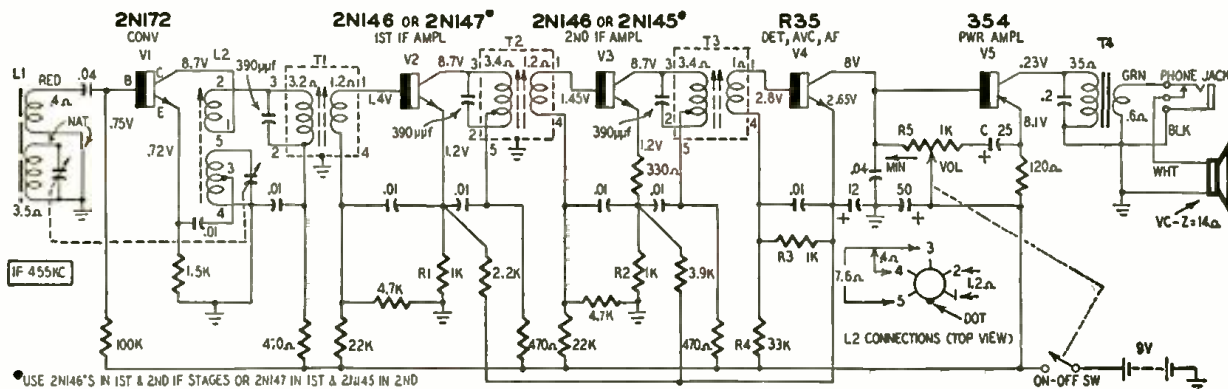
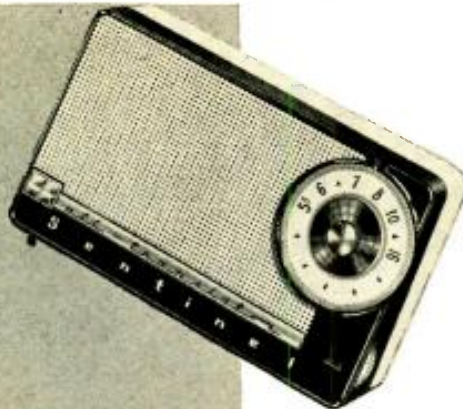

Fig. 1—In Motorola 56T1, two 2N146's are used in the if stages, or a 1N147 in the first and a 1N145 in the second.



The three sets. CBS Porta-Console, center, is on 21-inch stand. It is 9 1/4 inches high, 12 3/4 long, 6 1/4 deep.



class A as usual, its collector current remains steady regardless of signal strength. Thus the R2 drop is constant and the D1 anode voltage is steady. The cathode returns to R1, whose drop is *not* constant. V1 is biased for rectification (or detection), therefore its collector current rises with signal intensity. Such an increase means that the diode cathode goes more *negative*. A strong signal drives D1 to greater conduction which, of course, shorts out some of the if across T1 and aids *avc*.

The bias at V3 is set by a voltage divider across the base, but V2 is subject to *avc*. The detector is a diode D2 which generates a negative drop across the volume control. The negative voltage is filtered, then fed back to the base of V2. The stronger the signal, the

more negative the *avc* voltage, so the transistor gain is reduced as required.

V4 is stabilized by a voltage divider across its base terminal and by a resistor in its emitter return. The output stage is operated in class B. Each base is set to near zero bias by a small resistor R3 and larger ones R4 and R5. R4 and R5 also act as degenerative feedback paths since they connect the base and collector of each transistor. Temperature stabilization is provided by a low resistance in the emitter path.

Sentinel 369-P

This receiver (Fig. 3) also uses six transistors, three n-p-n types in the high-frequency circuits, three p-n-p types for the audio. The detector is a crystal diode.

V1 is a conventional converter transistor. The if transformers are specially designed, without a tap as in most other types. However, the output transformer is tapped at the *secondary* to accommodate a crystal detector. A low-impedance winding supplies neutralizing voltage. The high-impedance portion feeds the crystal.

The detector output (across the volume control) is negative since it is taken from the diode *anode*. This voltage is filtered and fed back to the base of V2 as *avc*. From previous descriptions of this type of circuit it is clear that strong signals drive the base of V2 more *negative*, thus reducing its gain. Detector output is capacitively coupled to the audio stage V4.

V4 is a Texas Instruments transistor specially designed for application as a class-B driver. It delivers up to 2 mw from a 9-volt supply. Its emitter current flows through R1 to provide a small voltage drop (positive) for the class-B bases. This emitter current to V4 is relatively large (1 or 2 ma) and remains steady, so it is an effective method of obtaining the required bias for the class-B stage without the power waste of a voltage divider.

The primary of each audio transformer is shunted by a capacitor which reduces the highs.

R2—in conjunction with two large capacitors—filters the battery supply to all stages except the final. It eliminates any if or oscillator voltage that may tend to enter the battery.

This receiver weighs 15 3/4 ounces with battery. Dimensions are: width 3 1/4, height 5 1/2, depth 1 1/2 inches. The 4-volt mercury battery has a life of about 250 hours. END

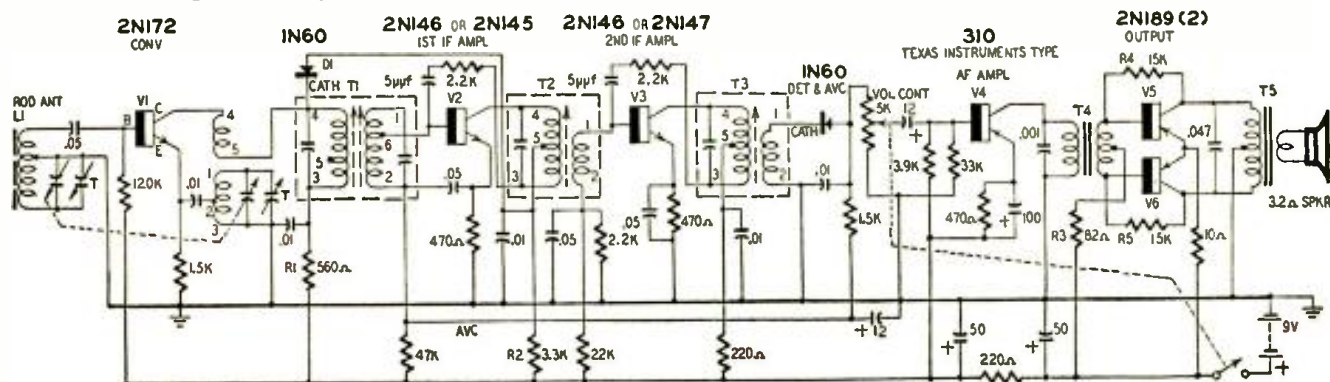

Fig. 2—CBS-Columbia Porta-Console TR-260 table model uses six transistors and two crystal diodes.

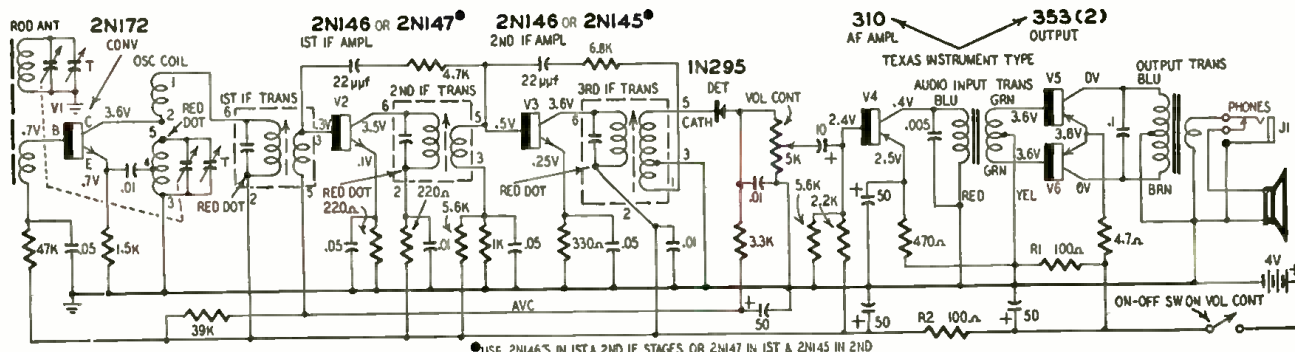

Fig. 3—The Sentinel 369-P is a six-transistor, one-diode model. Voltages are measured from socket contact to ground.

3-tube FM receiver

Nonradiating superregenerative unit uses slope detection; provides high sensitivity

By RICHARD GRAHAM



FM RECEPTION can be yours to enjoy with far less constructional complexity than the average small AM receiver. As a matter of fact, the receiver described uses only three tubes yet provides more audio than the built-in speaker can handle and has enough sensitivity to provide listenable reception to 14 FM stations in the New York area. This is achieved with only an indoor folded dipole to the ceiling.

You say you're impressed but there must be a catch. Well, in a sense there is. After all, there would hardly be any need for the 10- to 15-tube FM tuners being sold if there were not. But the catch is simply that the receiver described, while receiving FM stations well, has the properties and characteristics of an AM receiver. It is not immune to static and ignition noise, and I hesitate to call the resultant audio true high fidelity. At any rate it's certainly no worse than AM, and that seems to still be with us after 30-odd years.

The key to the performance of this receiver is the superregenerative detector, which pioneered the vhf region and was supreme for many years and is well known for its extreme sensitivity. It can outperform multitube superheterodyne receivers in this respect. The characteristic interstation audio hiss from a superregenerative detector attests to its sensitivity for this hiss is actually the tremendously amplified thermal agitation noise of the input circuit and antenna resistance.

In spite of its excellent sensitivity, the superregenerative detector has a few disadvantages. Typically, a superregenerator has poor selectivity. In this case, a disadvantage is turned to an advantage: The wide-band FM signal is tuned in on the slope of the selectivity curve and is converted to AM before detection. This is why the receiver has the characteristics of an AM radio—it actually is an AM receiver set up for the FM band. Since signals are detected by slope detection, FM stations can be tuned in at two adjacent places on the dial—either slope of the selectivity curve.

Superregenerative detectors are very

nonlinear when receiving AM signals of high-percentage modulation. Thus, normally, while this detector would be suitable for speech it would be completely unsuitable for music—at least if it was to be enjoyed. However, we are using slope detection to convert from FM to AM. If the selectivity is relatively poor, the FM is converted to the equivalent of an AM signal of low-percentage modulation. The linearity of the detected signal is thus improved to a point where it at least matches the quality of the audio system of the receiver.

Receiver circuit

After looking at the diagram of the receiver one might well ask why use an rf stage, particularly after the previous discussion on the extremely good sensitivity of the superregenerative detector. Actually the rf stage used with this receiver has little gain. Its main function is to isolate the superregenerative detector from the antenna—the detector is actually an oscillator, and any oscillator coupled to an antenna is capable of severe interference to neighboring receivers. Thus the need for isolation and the use of an rf stage.

An rf stage also makes receiver operation smoother. The pulling effect of the antenna impedance characteristics on the detector is eliminated, removing the necessity for readjusting the regeneration control as the receiver is tuned across the band.

The rf stage uses a 6BQ7-A in the familiar cascode circuit. It is broadbanded to cover the entire FM band and needs no adjustment after the initial alignment.

The detector and first audio stages are combined in a 12AT7 double triode. A 1-to-3 stepup audio transformer (T2) couples the detector to the grid of the first audio stage. This increases the receiver audio output. Superregeneration is controlled by R8, which varies the detector plate voltage. This 50,000-ohm pot is combined in a dual control with the audio volume control and ac switch, helping to keep the receiver panel uncluttered.

Variable tuning capacitor C5 is a National type STHS-15 15- μ f capacitor with one rotor plate removed. A straight-line wavelength or frequency capacitor is recommended to avoid crowding the high-frequency end of the band. This is a convenience in tuning common to almost all receivers.

The time constant of the grid leak resistor and capacitor in the grid circuit of the detector was chosen to put the quench frequency well out of the audio range to reduce hiss. This generally results in less sensitivity. However, sensitivity or the lack of it is no problem with this set. Selectivity also suffers with an increased quench frequency, but this too is satisfactory in this receiver. It is worth while noting these effects when trying to receive a relatively distant FM station.

Capacitor C7, specified as .004- μ f, apparently has a pronounced effect on the quenching waveform, the shape of which has a definite effect on sensitivity, selectivity and linearity. The references listed at the end of this article go into the theory of superregeneration completely and are recommended to those who want to pursue this subject further.

A printed-circuit coupler is used between the audio stages. A .001- μ f capacitor from grid to ground on the 6AQ5 grid restores tonal balance to the receiver. FM broadcast transmitters all use pre-emphasis; i.e., the higher audio frequencies are boosted in amplitude (and consequently deviation) to overcome noise. Correspondingly, superhet receivers use a 75-microsecond R-C time constant to de-emphasize the high frequencies previously boosted at the station. No network of this kind is used since the boosted high frequencies give a little brilliance to the sound and help overcome the deficiencies in the 4-inch speaker used. The .001- μ f capacitor attenuates the high audio frequencies slightly and may be varied to suit the constructor's desires.

The remainder of the receiver is conventional. The power supply utilizes a half-wave selenium rectifier and is transformer-powered. This may seem mildly extravagant, but it is safer

Underchassis view

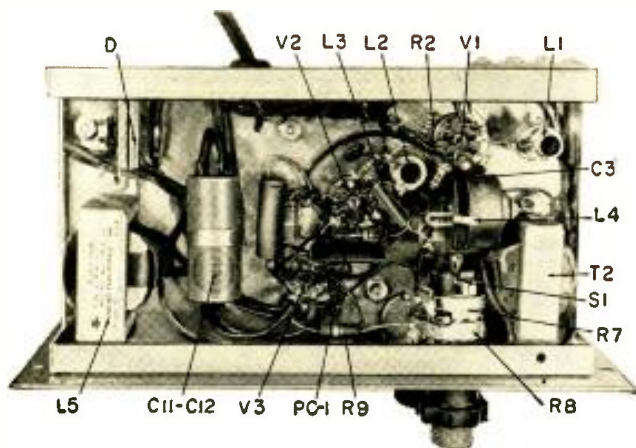

Top-chassis layout.

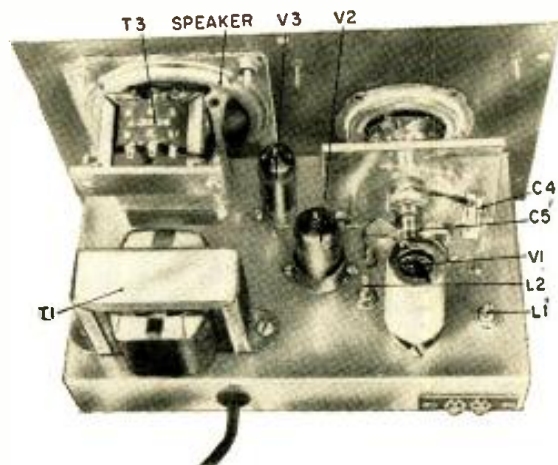

than ac-dc operation direct from the power line.

Construction and alignment

For those unfamiliar with construction of vhf units and particularly superregenerative detectors chassis layout should follow the photographs closely. Lead lengths are important and can easily determine success or failure.

The unit is built on a 4 1/2 x 8 x 1 1/2-inch aluminum chassis and housed in a metal cabinet to reduce rf radiation further. Radiation from the detector components is not great and causes no interference beyond 15 feet or so.

The tuning capacitor must be completely insulated from ground. It is mounted on a 1/4-inch Lucite panel fastened to the chassis with small L brackets. Make sure the dial is separated from the capacitor by an insulated coupling.

Alignment of the FM receiver is fairly simple and requires no test equipment. After construction, set the slugs in coils L1 and L2 so the screws are at maximum length out of the coil (the slug not in the coil). Set the main tuning capacitor at minimum capacitance. Now, with the receiver in operation, adjust trimmer capacitor C4, starting at minimum capacitance, until an FM station of known frequency is heard. Back off on C4 slightly.

Now adjust the tuning dial and make sure the lowest-frequency station in your area is received. If it isn't, increase the inductance of L2 by turning the slug into the coil. When the station is received readjust C4. If a signal generator is available, the band edges of the tuning capacitor can be made to correspond to the FM band limits of 88-108 mc by the above procedure.

The slug of coil L1 can then be adjusted for maximum loudness.

Receiver operation

Actually, tuning in an FM signal is easier than with a conventional receiver using a discriminator. There is greater tuning latitude in this receiver and, as mentioned previously, there are two adjacent points where the signal can

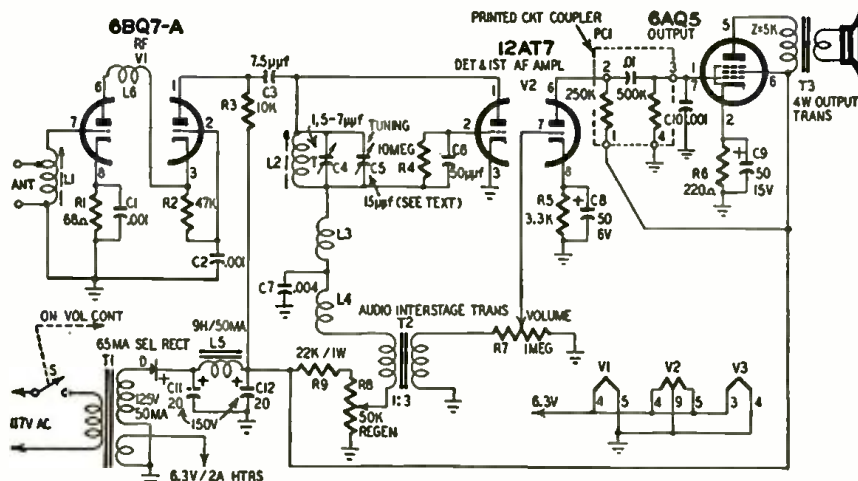

Schematic diagram of the 3-tube superregenerative-detector FM receiver.

Parts for 3-tube FM receiver

- R1—68 ohms
- R2—47,000 ohms
- R3—10,000 ohms
- R4—10 megohms
- R5—3,300 ohms
- R6—220 ohms
- R7—1-megohm pot
- R8—50,000-ohm pot, with switch
- R9—22,000 ohms, 1 watt
- All resistors 1/2 watt unless noted
- C1—.001 µf, disc ceramic
- C2—.001 µf, disc ceramic
- C3—7.5 µf, tubular ceramic
- C4—1.5-7 µf, ceramic trimmer (Centralab 822-EZ or equivalent)
- C5—15-µuf variable, straight-line wavelength, National STHS-15 with one rotor plate removed
- C6—50 µuf, disc ceramic
- C7—.004 µf, ceramic tubular
- C8—50 µf, 6 volts
- C9—50 µf, 15 volts
- C10—.001 µf, disc ceramic
- C11—20 µf, 150 volts
- C12—20 µf, 150 volts
- S—spsst switch—on R8
- L1—4 turns of No. 20 finned wire, tapped at 2 turns, 3/8-inch diameter ceramic form (Cambridge Thermionic LS-5 or equivalent)
- L2—3 turns of No. 20 finned wire, 3/8-inch diameter ceramic form (Cambridge Thermionic LS-5 or equivalent)
- L3—rf choke, 1.8 µh, 1 amp (Ohmite Z-144 or equivalent)
- L4—rf choke, 60 mh
- L5—filter choke, 9 henries, 50 ma
- L6—11 turns of No. 22 wire, 1/4-inch diameter, close-spaced
- T1—power transformer, secondary 125 volts @ 50 ma, 6.3 volts @ 2 amp (Stancor PA-8421 or equivalent)
- T2—audio interstage transformer, 1:3 turns ratio, 10-ma maximum primary dc (Stancor A-53 or equivalent)
- T3—audio output transformer, 4 watts (Stancor A-3856 or equivalent)
- D—selenium rectifier, 65 ma
- 4-inch loudspeaker
- PC—printed-circuit coupler (Cornell-Dubilier 113TM2 or equivalent)
- V1—6BQ7A
- V2—12AT7
- V3—6AQ5
- 9-pin miniature tube sockets (2)
- 7-pin miniature tube socket
- Dial, insulated from chassis (National MCN or equivalent)
- Chassis, approximately 4 1/2 x 8 x 1 1/2 inches
- Cabinet to house chassis

be received with equal quality. However, because of the selectivity of the receiver it may be impossible to receive a weak FM signal adjacent to one of very high level with any degree of satisfaction. This situation is uncommon on the FM band however. Rotating the antenna will usually help.

Generally, the regeneration control is brought up to a little beyond where the

receiver produces a loud hiss. A little actual experience will rapidly eliminate any difficulty on this point. END

References

- Terman, *Radio and Electronic Engineering*, 4th edition.
- "Cathode Ray," *Second Thoughts On Radio*, Chap. 24.
- "Superregenerative Detection Theory," *Electronics*, September, 1948, page 96.
- "Superregenerative Design," September, 1948, *Electronics*, page 99.

TV sets with . . . remote control

Continuation of a series on TV remote controls. Electromechanical and split-chassis types are discussed

By HENRY O. MAXWELL

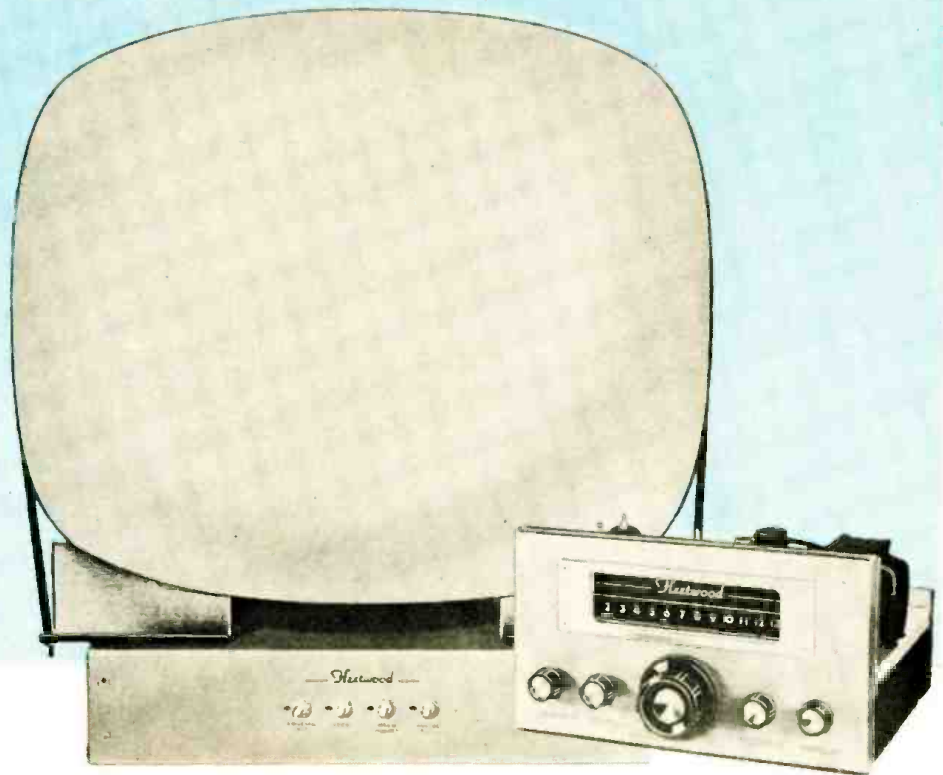

Conrac (Fleetwood) model 800.

WE have classified remote controls for TV receivers into roughly three types. The electronic type uses radio, sound or light to transmit the control signals from the remote viewing point to the receiver. This includes Zenith's Space-Command tuning system operated by ultrasonic signals and the Flashmatic photoelectric control system described last month. Details on the Space-Command were not available in time for this series.

Electromechanical systems have cables between the control head and the set and split-chassis types have the tuner—and sometimes the if and audio circuits—on the control chassis and the remaining circuits on the chassis with the picture tube.

Sentinel has recently introduced two electromechanical remote-control units. Fig. 1, the circuit of the control used in 21101, 21121 and 21145 models, is similar in some respects to the RCA setup. The remote-control head connects to the receiver chassis through up to 40 feet of cable and permits the viewer to turn the set on and off, select channels and adjust volume, brightness and fine tuning. In addition, it has a built-in speaker that can be switched in or out.

The channel-selection circuit is bas-

ically the same as that in Fig. 4 (September, page 35) and is simpler than the RCA unit in Fig. 5 (same issue). Turning the remote channel selector to any new position starts the motor and keeps it running until the station-seeking switch on the tuner rotates to the corresponding channel position and opens the motor's power circuit.

The remote volume control is a 20-ohm potentiometer across the secondary of the audio output transformer. It

permits volume to be reduced as desired when the receiver's local volume control is set to the middle of its range. Proper control of volume cannot be obtained when either the local or remote volume control is in its minimum-volume position. When the remote speaker switch is in one position it selects the speaker on the TV set; in the other it cuts out the TV speaker and cuts in the speaker located in the control unit.

The remote brightness control is in

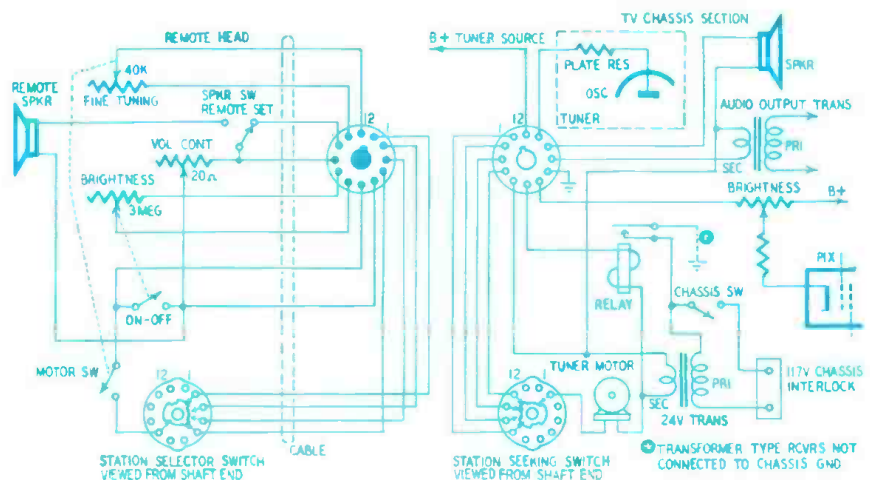

Fig. 1—Circuitry of Sentinel 21101, 21121 and 21145 remote-control unit.

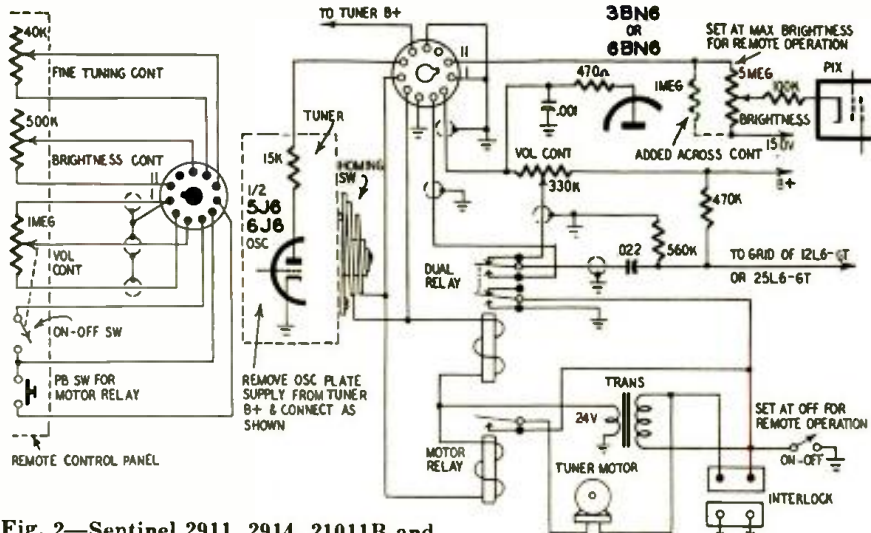

Fig. 2—Sentinel 2911, 2914, 21011B and 21017B remote-control circuitry.

series with the local brightness control on the receiver. The local control should be set to maximum when the control unit is used. The full brightness range cannot be obtained at the remote unit if the local control is set at minimum—nor at the set if the remote control is at maximum. The remote on-off switch is on the brightness control but the set's line switch must be closed before the remote switch will operate.

The remote fine-tuning control is a potentiometer in series with the B-plus line to the oscillator plate in the tuner. Varying this resistor varies the oscillator plate voltage and frequency.

Fig. 2 is the circuit of the control unit for the Sentinel 2911, 2914, 21011B and 21017B models. The control head connects to the chassis through a 10-conductor 25-foot cable. A remote speaker is not included. The method of selecting channels is basically the same as that used in the Zenith system. However, a pushbutton channel-selector switch on the remote-control panel activates the motor. A "homing" switch, on the rear of the tuner, is in parallel with the pushbutton and opens only when the tuner detent sets the switch or turret exactly on a channel.

Closing the remote channel-selector switch rotates the tuner clockwise to progressively higher channels. Thus, when switching from one channel to the next higher one, the pushbutton need be depressed only long enough to start the motor. This closes the homing switch and keeps the motor running until the detent drops in on the next channel.

The remote brightness and fine-tuning controls operate just like those in Fig. 1. The remote volume control is shunted across the one in the set and the dpdt relay connects the arm of the control in use to the grid of the audio output tube.

The Philco and CBS approach

On several Philco and CBS TV sets channels may be selected manually or with the electromechanical stepper system that can be controlled from a remote panel or through a switch or switches set into the top of the TV cabinet. Philco calls their system "Top Touch Tuning" and CBS calls it "Robot Tuning." The two systems are essentially the same and permit only channel selection.

Fig. 3 shows the Robot Tuning and remote-control circuits. The on-off switches and remote-control circuits are in series in a three-way arrangement so that either will turn the set on or off regardless of the position of the other. Operating either switch activates the relay in series with one side of the ac line to the TV power transformer. The

motorized channel selector is turned clockwise or counterclockwise by pressing the right or left channel-selector switch sections.

The motor and tuner are coupled through an intermittent gear that engages the gear on the tuner shaft for a few degrees twice during each revolution. This causes the tuner to pause momentarily on each channel although the channel-selector switch is still closed. It enables the viewer to identify the channel and release the switch, if desired, before the gears re-engage and turn the tuner to the next channel.

Remote fine tuning is another feature of the CBS system. Here a 1N60 diode and 2.2- μ mf capacitor in series are shunted across the oscillator plate circuit as in the simplified circuit in Fig. 4. The junction of the diode and capacitor is connected to the fine-tuning potentiometer through an L-C rf filter network. The diode and series capacitor appear as a shunt capacitor with a very high Q. The potentiometer across the diode varies its effective capacitance

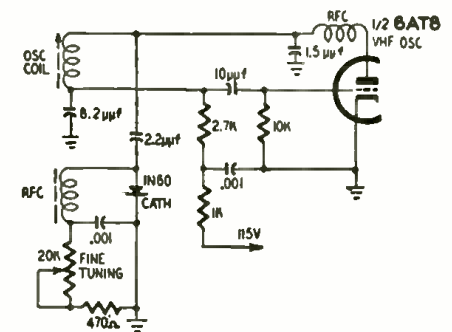

Fig. 4—Fine tuning in CBS system.

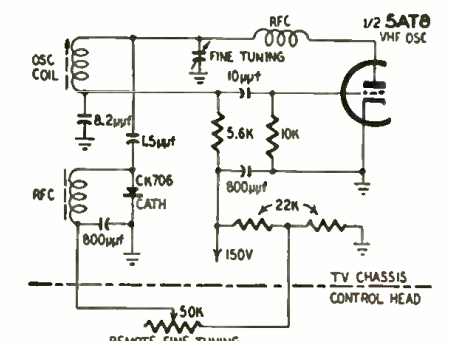

Fig. 5—Emerson's remote control.

and the oscillator frequency changes accordingly.

Emerson's arrangement

The remote channel selector, brightness, volume and on-off circuits are similar to the Sentinel circuit in Fig. 2. The fine tuning control resembles the CBS circuit in Fig. 4 but its operation is closer to that of the RCA circuit (Fig. 8, September, page 36). A CK706 diode and 1.5- μ mf capacitor are shunted across the local fine-tuning control as in Fig. 5.

The remote fine-tuning control is in series with approximately 75 volts from

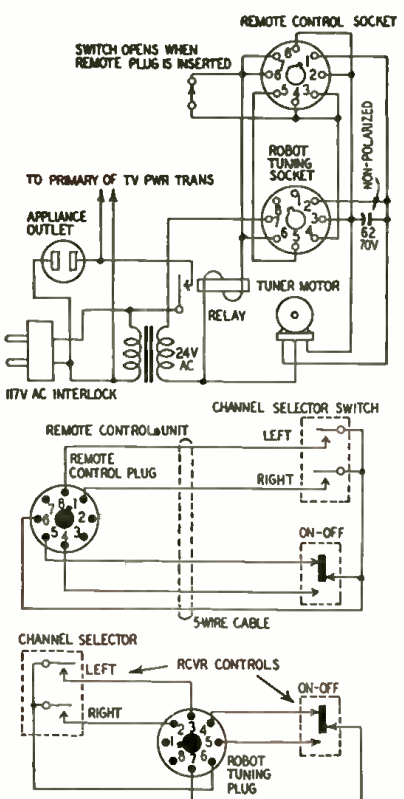

Fig. 3—Schematic diagram of Philco's Robot Tuning remote-control system.

TELEVISION

a voltage divider. When the voltage applied to the diode is low, the conductance is low and the capacitor has negligible effect on the oscillator frequency. Increasing the voltage on the diode increases its conductance and the oscillator frequency changes.

Split-chassis sets

In a split-chassis type of remote-controlled TV receiver the tuner and if circuits are usually mounted on the control or tuner chassis along with the necessary controls. The audio output circuits, speaker and deflection circuits are on the sweep chassis. This type of set construction is especially suited for custom installations. Split-chassis construction is featured in the Conrac model 800, Gotham 525 and the recently discontinued Pilot TV-520, Craftsmen C210, Douglas Chairside and Sylvania 387 and 388 series. Ingenious readers can probably adapt some of the circuits shown here for use in remote viewers or in the construction of remote-controlled sets. Two junked chassis could form the basis for a nice split-chassis set.

Hi-fi fans can use a cathode follower like the 6AB4 in the Conrac circuit to feed their TV sound or the output of existing AM or FM receivers to the input circuits of high-quality audio systems.

Conrac 800

Circuits pertinent to remote control of the Conrac (Fleetwood) model 800 are shown in Fig. 6. The tuner, if amplifiers, video and audio detectors

and cathode followers and agc circuits are on the remote tuner chassis. Video amplifier and sweep circuits are on the deflection chassis. Volume, contrast and brightness are controlled from the viewing position.

The two chassis are plugged into separate line receptacles. When the on-off switch is closed on the tuner chassis, 6 volts from the heater circuit is fed to a relay whose contacts are in series with one side of the line to the primary of the power transformer on the deflection chassis. This relay remains closed as long as the power is on in the tuner.

An earlier Conrac remote-controlled receiver used a diode type agc system; the model 800 has keyed agc. Composite video is fed from the video load resistor to the grid of the agc amplifier, pentode section of a 6AN8. The output of the amplifier is direct-coupled to the grid of the agc keyer tube. Keying pulses from the horizontal output circuit are taken off the agc winding on the width coil (on the deflection chassis) and fed to the tuner chassis.

Contrast is controlled by varying the screen voltage of the agc amplifier. Reducing the gain of the agc amplifier allows less video signal to get through to the keyer tube. This, in turn, reduces the agc bias applied to the tuner and if circuits and determines the level of signal reaching the picture tube.

The agc line to the tuner connects to the top of the agc load resistor. Delay bias for this line is obtained by making the agc load (R1 and R2) a part of a voltage divider between

the 135-volt B-plus line and ground. The agc clamp diode prevents the tuner agc line from going positive when signal strength is low. For detailed discussions of keyed agc, see "Circuit Shorts" December, 1953.

The video circuits are fairly conventional. The detected video signal is fed from the paralleled 6AN8 cathode follower to a two-stage resistance-coupled 12AT7 amplifier on the deflection chassis. Adequate response without peaking is obtained by using small plate load resistors (4,700 ohms) and feedback from the plate of the second to the cathode of the first stage through 2,700 ohms and 10 μ f in series. The video output circuit is frequency-compensated by series and shunt peaking.

Brightness is controlled by returning the grid of the picture tube to a point on a voltage divider (R3 and R4 in series) between 150 volts B plus and ground. When R4, the brightness control, is set for minimum resistance, the grid is grounded and the beam current is cut off by the positive voltage on the cathode. Increasing the resistance of R4 puts a small positive voltage on the grid and increases brightness.

The audio circuit is conventional. A 6AB4 cathode follower feeds the signal over a low-impedance line to the two-stage circuit. High- and low-impedance outputs on the tuner chassis and a low-impedance output on the deflection chassis are provided for feeding the audio into an external system. END

Other split-chassis controls will be described in the next article of this series.

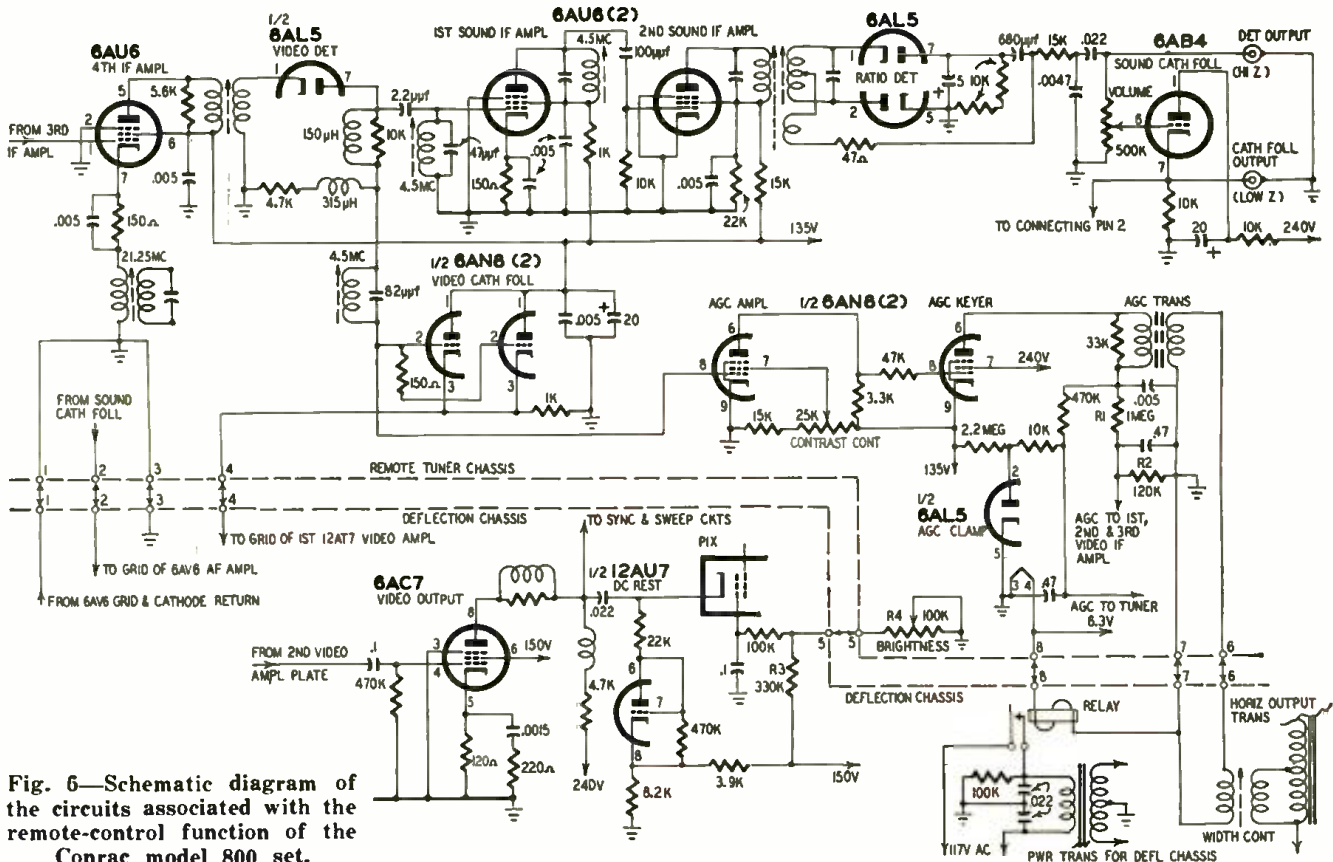

Fig. 6—Schematic diagram of the circuits associated with the remote-control function of the Conrac model 800 set.

REDUCING CO- and ADJACENT-CHANNEL INTERFERENCE

By EDWARD M. NOLL and MATTHEW MANDL

FRINGE-AREA television reception in many localities is plagued by co-channel and adjacent channel interference. Although channels have been shuffled in many regions in an attempt to minimize these disturbances, higher transmitter powers and more stations have increased interference ranges. More sensitive receivers and higher-gain antennas keep increasing reception range, thereby extending possible interference belts.

There are steps you can take to minimize and often eliminate serious cases of interference. Factors that determine the ability of a TV installation to emphasize the desired station and to de-emphasize interference are: receiver performance; antenna type, position and orientation and transmission-line tuning.

In reducing adjacent-channel interference it is necessary first to tune the adjacent-channel traps properly. This is best done with a crystal-accurate signal or with a received station signal. In using a station signal for trap adjustment first tune in the desired station with best picture and sound. Now adjust the proper traps for minimum adjacent-channel interference. When the interference is from a channel below the desired one (Fig. 1), the adjacent-channel sound traps must be adjusted. If the interference is from the next higher channel (Fig. 2) adjust the adjacent-channel picture traps for minimum disturbance.

Mounting position

Antenna mounting position is important and additional interference rejection

can often be obtained by shifting the location of a present antenna. Seek a mounting position that favors the desired signal and permits it to dominate co-channel or strong local adjacent-channel interference.

Here, north of Philadelphia, for those customers who desire New York reception with minimum adjacent channel from Philadelphia, we often position an antenna on the shadowed side of the house (Fig. 3), for Philadelphia stations. This reduces the levels of extremely strong local stations and, although the lower antenna position does reduce the New York levels slightly, the signal-to-interference ratio is better. At the same time local signals are not reduced seriously enough to hamper their reception. A field-intensity meter is particularly helpful in locating a satisfactory mounting position, as it can be used to measure desired as well as undesired signal levels at tentative mounting positions.

Antenna height should be increased cautiously in such an area because local signal strength (cause of adjacent-channel interference) or direct transmission-line pickup of strong locals often increases at a faster rate than the distant station level. Likewise, raising the antenna height can often bring in a very long distance co-channel station to raise havoc with a medium distant desired signal. One case of this condition is co-channel interference—from Baltimore and Washington stations—with reception of New York channels north of Philadelphia. This produces picture venetian blind (Fig. 4) and "swishy" sound. Another ex-

ample is co-channel interference from Altoona (channel 10) with reception of Philadelphia channel 10 in the Reading-Lancaster areas. Thus a sensible rule is to mount an antenna just high enough to receive the desired channel but don't go overboard on height.

Antenna type

This is very important in the rejection of interference. It can be stated that the best antenna for areas with co- and adjacent-channel interference is one with good gain but superior front-to-back ratio and pattern. A good reflector system and a minimum number of minor lobes is the preferred pattern—one with a narrow and weak back lobe and a sensibly broad but strong forward pattern (Fig. 5). This

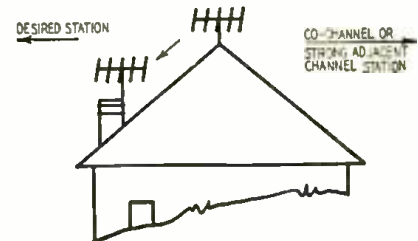

Fig. 3—Antenna is mounted to favor reception from the desired station.

type of pattern permits greater orientation ease because orientation in the direction of the desired station has some tolerance while a narrow back lobe means it can be oriented away from co- or adjacent-channel stations.

The multilobe pattern (Fig. 6) of the usual simple broad-band antenna



Fig. 1—Adjacent-channel sound on distant channel 4 from local channel 3.



Fig. 2—Adjacent-channel video on distant channel 4 from local channel 5.



Fig. 4—Co-channel venetian-blind interference.

TELEVISION

such as the conical is particularly inviting to this type of interference because of its many and strong lobes. To minimize co-channel and adjacent-channel disturbances on the high band it is preferable to use a high-band instead of an all-band antenna. Even on the low band the simple all-band antenna has too strong a back lobe for effective interference rejection. Thus the present trend is toward much more elaborate all-band antennas with not too much more gain but with much better patterns.

Antenna orientation

Needless to say the direction of interference arrival must be taken into consideration and the antenna oriented to reject the interference as well as to favor the desired signal. Thus as an antenna is oriented in the direction of the desired station it must also be positioned for minimum interference.

An example of how a field-strength meter can be used to reduce interference is illustrated in Fig. 7. In our area local channel 10 causes adjacent-channel disturbances on New York channels 9 and 11. This defect can be minimized even with the poor pattern

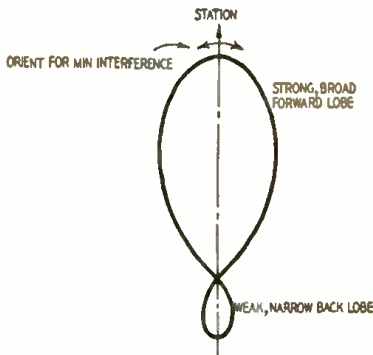

Fig. 5—An ideal antenna response pattern for rejection of interference.

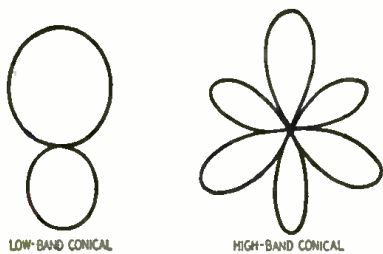

Fig. 6—High- and low-band patterns of the popular v.h.f. conical antenna.

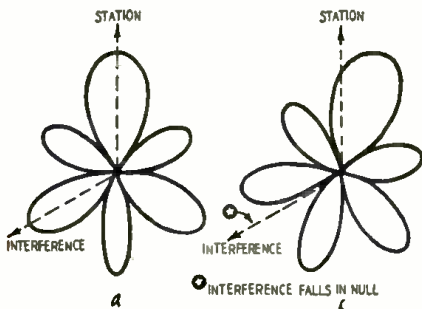

Fig. 7—Pattern in *b* shows orientation from *a* for interference rejection.

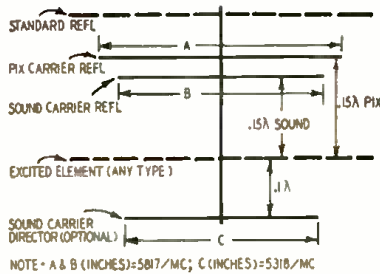

Fig. 8—Adding parasitic elements to improve antenna's co-channel rejection.

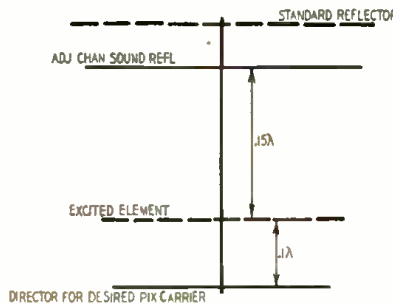

Fig. 9—Antenna element sizes for rejecting adjacent-channel sound.

of a conical antenna by orienting it in the general direction of New York but with it set for a minimum channel-10 reading (orient to a null point in the multilobe pattern). This will set the major lobe slightly off from New York but will result in an improved picture though a slightly weaker one. A better solution is an antenna of higher gain and better pattern.

The antenna rotator affords an excellent means of orienting the antenna for best signal-to-noise ratio. However, the customer must be taught not to operate the motor hit-or-miss. The installer should first operate the motor to locate the best position to minimize interference and then teach the customer how to bring motor and antenna to this very same position for reception of a troublesome signal. On some rotator dials it is possible to pencil in the station or channel number.

Element sizes

Much can be done to minimize interference by modifying antenna element lengths for a given location and problem. For co-channel interference a large-area (screen or multi-element grouping) or dual reflector can be used (Fig. 8). Reflectors should be cut for picture and sound carriers and positioned 0.15 wavelength from the driven element. A specially cut director can also be added to improve the front-to-back ratio on a troublesome channel though it can possibly harm the antenna gain on some other channels higher in frequency.

Adjacent-channel interference can also be reduced by cutting special reflectors and directors. For adjacent-channel sound interference (sound carrier of next lowest channel) cut the reflector to the sound carrier frequency of the interfering channel and the first

director to the picture carrier frequency of the desired channel (Fig. 9). To minimize adjacent-channel picture interference (picture carrier of next highest channel) cut the reflector and director (Fig. 10) for the picture carrier frequency of the interfering channel. It is also helpful to have a reflector cut to the desired channel picture carrier.

For example, a channel-3 Yagi could be modified as above to reduce adjacent-channel interference from channel 2 or 4, using a reflector cut to the adjacent-channel sound and the first director to the adjacent-channel picture.

Line tuner

The desired signal can be made to dominate interference by tuning the line properly. Often—in the case of adjacent-channel interference—the line picks up more interference than the antenna proper. Thus a means of adjusting to a more favorable signal-to-interference ratio (as a function of relative signal and interference standing waves on the line) is advantageous.

We have had success in minimizing adjacent- as well as co-channel interference by using a 10-foot or longer section of three-conductor cable and a selector switch connected (Fig. 11)

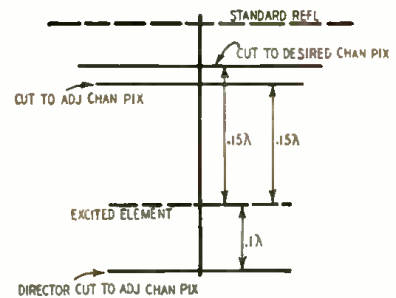

Fig. 10—Antenna element sizes for rejecting adjacent-channel video.

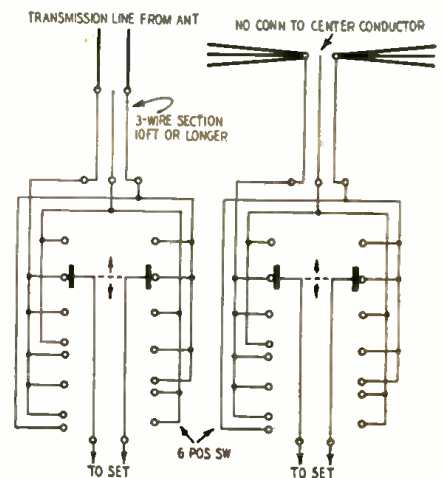

Fig. 11—Transmission line tuners.

between the incoming transmission line and the set. The switch positions permit selecting the most favorable signal-to-interference ratio. For better effectiveness the three-wire line can be used right up to the antenna, leaving the center conductor unattached. END



TV Service Clinic

conducted by
JERRY KASS

THE alignment of intercarrier sound if and ratio-detector circuits in TV sets was discussed last month. In a TV set, a ratio detector is usually fed from a one- or two-stage if amplifier and may have a limiter or driver stage immediately preceding it. It almost invariably works into a two-stage audio amplifier. Thus, the sound if and audio circuits in a TV set with ratio detector will have a minimum of four stages.

In recent years a number of TV set manufacturers have adopted the gated-beam discriminator using the 6BN6 or its 3- and 12-volt equivalents. The primary advantage of this circuit is that it combines the functions of limiter, discriminator and first audio stage in one envelope. Circuitry is simpler and fewer components are needed. Alignment procedures for the gated-beam discriminator differ from those of the ratio detector so we will review them here. Two typical circuits are covered and the procedures discussed are applicable to all similar circuits.

Fig. 1 is a schematic of the 3BN6 FM detector in the Westinghouse V-2342 chassis. It is fed a 4.5-mc FM sound signal from the plate of the video amplifier and in turn feeds the demodulated audio signal to the audio output stage. As with the radio detector, the gated-beam discriminator can be aligned with either a transmitted television signal or a locally generated one.

To use a TV signal, tune to a weak station. If desired, a strong station can be used with an attenuator that can be switched in and out of the antenna circuit. Set the 600-ohm quieting control to approximately its mid-position. (This potentiometer in the 3BN6 cathode circuit is also called a buzz, AM-rejection and noise-rejection control.) Adjust the slug in the 4.5-mc if coil L201 for maximum sound. If sound peaks occur at two slug positions, use the peak obtained when the slug is farthest counterclockwise. Then reduce the signal to its lowest usable level and recheck the adjustments.

Apply a strong signal to the receiver and adjust quadrature coil L203 for maximum sound. If sound peaks occur

at two widely separated positions, again use the one obtained with the slug farthest counterclockwise. If the peaks are close this indicates that the incoming signal is too weak or the quieting control is not at its optimum setting.

Now apply a very weak signal to the set so that noise can be heard. Adjust the quieting control for minimum noise. The point of minimum noise depends upon signal strength so utilize the weakest usable station for maximum accuracy. The quieting control determines the amplitude-modulation rejection characteristics of the sound system and should be set around mid-position. Under no conditions should the quieting control be set at or near its maximum counterclockwise position.

To align the circuit in Fig. 1 with test equipment, connect a scope or ac vtvm across the volume control to act as an indicator. Apply a 4.5-mc FM signal having a deviation of approximately 7.5 kc to the control grid (pin 2) of the 12BY7-A video amplifier. Deviation up to 25 kc can be used but best results are obtained with the narrower signal, adjust L201 for maximum output. Then, using a strong signal, adjust L203 for maximum output.

Now apply a 4.5-mc AM signal, modulated approximately 30%, to the grid of the video amplifier. If possible, use a crystal-accurate generator. Starting with a very low signal level, gradually increase the generator output while rotating the quieting control back and forth until the signal level is such

that the AM output across the volume control dips to zero with a rise on each side as the control is rotated. Set the quieting control for zero output at this signal level.

Fig. 2 shows the sound if and 3BN6 gated-beam circuitry of the Crosley 466 chassis. Here a 4.5-mc sound if amplifier stage feeds the 3BN6—future developments will probably make this extra stage unnecessary. The 3BN6 circuit feeds directly into the audio output stage. Before any alignment, takeoff coil L109 must be carefully tuned to 4.5 mc. Apply a crystal-controlled 4.5-mc AM signal between the video amplifier grid and ground. Use a probe and connect a scope to the cathode of the picture tube. Adjust L109 for minimum indication on the scope screen.

Using a strong TV station signal, turn the buzz control about 90° from maximum clockwise and adjust the quadrature coil (L106) for maximum sound output, using the second peak from the open end. Then go to a weak signal and tune L109 and L111 for maximum sound output. It is important to keep the signal below limiting level. If the only available signal is very strong, remove the antenna. Now turn the buzz control for minimum noise or hash, possible only with a very weak signal.

Returning to a strong signal, adjust quadrature coil L106 for maximum sound, limiting the volume so the peak can be easily heard. Finally, go back to a weak signal and again adjust the buzz control for minimum noise.

To align Fig. 2 with test equipment, apply a sweep generator to the control grid of the video amplifier and connect a scope across the voice coil. Use a 4.5-mc FM signal with 400-cycle modulation and 7.5-kc deviation. Keep the volume control at a low level and turn the buzz control about 90° from clockwise. Adjust the quadrature coil for maximum scope signal and keep the signal level high enough for limiting; again use the second peak.

Now reduce the generator output below the set's limiting level and tune L111 for maximum response. Then tune L109 for maximum peak. In these adjustments, as the height of the scope pattern increases, decrease the generator output.

Tune to a 4.5-mc AM 400-cycle modu-

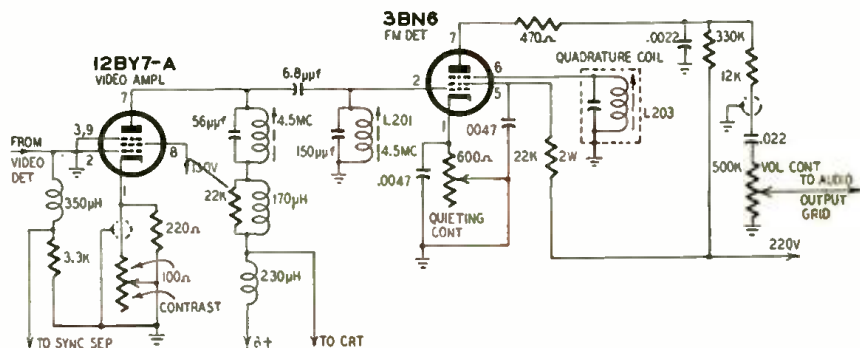

Fig. 1—The gated-beam FM detector in the Westinghouse V-2342 chassis.

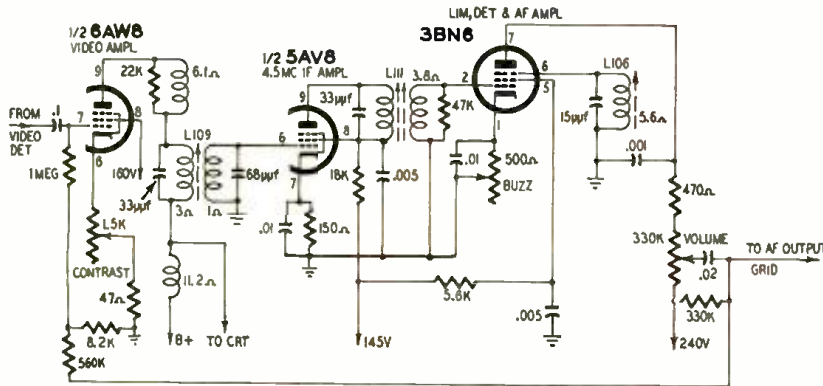

Fig. 2—Sound if circuits in Crosley 466 and similar television chassis.

lated signal, using a strong signal input to insure limiting. Tune the buzz control for a null (minimum scope indication). Then, returning to the original FM input and with the volume control set at a low level, readjust the quadrature coil for maximum 400-cycle indication on the scope. For perfection, readjust coils L111 and L109, keeping the input signal very low.

Not all models use the 47,000-ohm resistor across the secondary of L111. It improves stability in the sound if stages whenever the input signal at the grid of the 4.5-mc if amplifier is reduced to very low levels.

Noise inverter

I have a G-E model 21T3 that performs poorly in the presence of noise. The slightest static or ignition noise will cause the set to lose both horizontal and vertical sync. All tubes in the sync and noise inverter circuits have been replaced and all voltages compare favorably with those shown on the manufacturers' schematic. While this is possibly not strictly a service problem, I would like to know how the noise inverter can be checked to determine whether it is functioning properly.—B. P., Chicago, Ill.

The noise inverter circuit in this set is highly effective and its operation

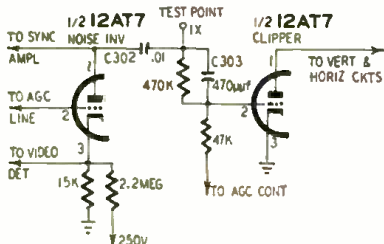

Fig. 3—The G-E 21T3 noise inverter.

can be quickly checked by observing noise-pulse inversion without a signal.

Turn to an unused channel. Connect

a scope to test point 1X (Fig. 3) at the junction of capacitors C302 and C303. Then bias off the noise inverter by connecting a resistor of approximately 100,000 ohms between the cathode (pin 3) and 250 volts. Place a noise source such as an electric razor near the antenna. Try not to overload the set, but simulate typical noise conditions.

Observe the polarity of the noise pulses on the scope. Then remove the 100,000-ohm resistor. The polarity of the noise signal should reverse. Should you obtain the above results, you can be fairly sure that this circuit is not at fault.

Poor sync, no sound

A Motorola TS-410 has come in with a complaint of poor sync and no sound. What makes this so difficult is that the signal in the set is very strong. Every tube in the set has been checked. I have traced the signal to the sync clippers and lost it there. This accounts for the poor sync, but all components in this circuit check out OK. Also, this has nothing to do with the audio.

I have a picture on the screen and the video amplifier appears to be operating normally. I traced the sound signal to the last audio stage, but there it disappeared. There is a high B voltage on the cathode of the audio output tube, but my schematic reads B plus at this point.—R. G., Fort Wayne, Ind.

The partial schematic that you sent shows 210 volts on the cathode of the 25L6-GT audio output tube. Your symptoms almost conclusively point to a shorted electrolytic filter capacitor in the low-voltage power supply (Fig. 4). A short in this component would satisfy all conditions you have noticed since it connects the 250- and 150-volt lines.

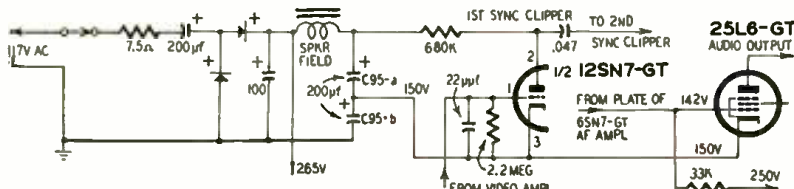

Fig. 4—Partial circuit of voltage distribution in Motorola TS-410-A.

Over 200 volts would be placed on the cathode of the audio output tube which is connected to the 150-volt line and this would cut the tube off—hence, no sound. A high B-plus voltage would also be applied to the sync clipper tube, causing improper operation and loss of horizontal and vertical sync.

Alignment point

I have an interesting problem. A Sylvania chassis 1-533 came in the shop badly in need of alignment. Fortunately, I had the service notes for it. However, the instructions for picture if alignment call for connecting the sweep generator to the ungrounded tube shield on the vhf mixer-oscillator tube. This tuner has shields mounted permanently to its top. I tried connecting the generator directly to the mixer grid but got very poor waveforms through the if and could not align the set. I would like to know how this job can be handled.—T. R., Albany, N. Y.

Of course, it is possible that the poor waveforms you obtained are the result of a seriously misaligned if amplifier and not the fault of poor signal injection. Feeding the sweep signal through an ungrounded mixer tube shield provides desirable loose coupling. However, since you cannot do this, connect the generator to the mixer grid through a 10,000-ohm isolation resistor in series with the hot generator lead. This tuner has a convenient hole in it next to the mixer, through which the signal injection lead can pass.

Agc misadjustment

I have had a great deal of trouble obtaining a proper setting of the agc control on a 24-inch Bendix. One call-back was caused by motorboating and now I have a washed-out picture. The agc circuit has been checked thoroughly and I am positive the trouble is only with this adjustment. I would like to know if there is some sort of circuit modification that will improve the action of the agc circuit.—F. T., Houston, Tex.

If all agc circuitry is in good order you should be able to adjust this control properly. The symptoms you give of motorboating and washed-out picture are typical of agc misadjustment, and circuit modification is not necessary.

Tune this receiver to the strongest signal available and turn the contrast control to its minimum setting—counterclockwise. Starting with the agc control fully counterclockwise (minimum), turn it clockwise until the set begins to motorboat. Keep turning past this point until the motorboating stops—then turn about 45° more. This should give you excellent agc stability. END

All queries to the TV Service Clinic should be accompanied by a stamped, self-addressed envelope. This will insure a more rapid answer. Be especially careful to state the model or chassis number. In many cases these have been confused with the serial number which, in most cases, is meaningless. An unidentified receiver can be analyzed in general terms only.

New



MODEL O-11

Shpg. Wt.
21 lbs.

\$69⁵⁰

- * An improved model of what was already an outstanding instrument.
- * Performance is unmatched in this price range.
- * Incorporates the extra features required for color TV servicing.

Extra!

A FULL YEAR TO PAY

BIG
REASONS
WHY



HEATH
COMPANY

A SUBSIDIARY OF DAYSTROM, INC.

BENTON HARBOR 20, MICH.

HEATHKIT ETCHED CIRCUIT, PUSH-PULL

5" Oscilloscope Kit COLOR TV

The previous Heathkit oscilloscope (Model O-10) which was already a most remarkable instrument, has been improved even further with the release of the Heathkit Model O-11. It incorporates all the outstanding features of the preceding model, plus improved vertical linearity, better sync stability, especially at low frequencies, and much-improved over-all stability of operation, including less vertical bounce with changes in level. These improvements in the Model O-11 circuit make it even more ideally suited for color TV servicing, and for critical observations in the electronic laboratory. Vertical response extends from 2 CPS to 5 MC without extra switching. Response only down 1½ DB at 3.58 MC. The 11-tube circuit features a 5UP1 cathode-ray tube. Sync circuit functions effectively from 20 CPS to better than 500 kc in five steps. Modern etched circuit boards employed in the oscilloscope circuit cut assembly time almost in half, permit a level of circuit stability never before achieved in an oscilloscope of this type, and insure against errors in assembly. Both vertical and horizontal output amplifiers are push-pull. Built-in peak-to-peak calibrating source — step-attenuated input — plastic molded capacitors and top-quality parts throughout — pre-formed and cabled wiring harness — and numerous other "extra" features. A professional instrument for the serveshop or laboratory. Compare its specifications with those of scopes selling in much higher price brackets. You can't beat it!

1 FEWER DOLLARS BRING MORE REAL QUALITY.

- Factory-to-you sales eliminate extra profit margin.
- "Build-it-yourself" eliminates labor charge.
- Heath purchasing power cuts component costs.

2 PERSONAL SERVICE ASSURES CUSTOMER SATISFACTION.

- You deal directly with the manufacturer.
- We are interested in you before and after sale.

Heathkits®

ARE YOUR BEST BUY...

3 PROVEN DESIGNS MEAN RELIABLE PERFORMANCE.

- Research and development efforts concentrated on kits only.
- All kits guaranteed to meet advertised specifications.

4 EVERY KIT BACKED BY WORLD-WIDE REPUTATION.

- The world's largest manufacturer of electronic equipment in kit form.
- Producer of more than a million electronic kits for the home workshop and industry.

5 EASY TIME-PAYMENT PLAN TO FIT YOUR BUDGET.

New HEATHKIT ETCHED CIRCUIT

5" Oscilloscope Kit

- * Brand new model with improved performance specifications.
- * Full 5" scope for service work at a remarkably low price.
- * Attractively styled front panel in charcoal gray with sharp white lettering.
- * Easy to build from step-by-step instructions and large pictorials. Not necessary to read schematic.

GREATEST SELECTION . . .
 Whether your particular special interest is in servicing, ham-radio, high-fidelity, or just experimenting—there are Heathkits to fill your needs. You can equip an entire service shop or lab, buy a complete ham station or high-fidelity system, or set up a really deluxe home workshop, by choosing from the more than 70 different "do-it-yourself" electronic kits by Heath. Just glance through the kits displayed in this ad, and you will get some idea of the tremendous array of low-priced, high-quality electronic equipment available.

This new and improved oscilloscope retains all the outstanding features of the preceding model, but provides wider vertical frequency response, extended sweep-generator coverage, and increased stability. A new tube complement and improvements in the circuit make these new features possible. Vertical frequency response is essentially flat to over 1 mc, and down only 1½ DB at 500 kc. The sweep generator multivibrator functions reliably from 30 to 200,000 CPS, almost twice the coverage provided by the previous model. Deflection amplifiers are push-pull, and modern etched circuits are employed in critical parts of the design. A 5BP1 cathode-ray tube is used. The scope features external or internal sweep and sync, one volt peak-to-peak reference voltage, 3-position step-attenuated input, adjustable spot-shape control, and many other "extras" not expected at this price level. A calibrated grid screen is also provided for the face of the CRT, allowing more precise observation of wave shapes displayed. The new Model OM-2 is designed for general application wherever a reliable instrument with good response characteristics may be required. Complete step-by-step instructions and large pictorial diagrams assure easy assembly.



MODEL OM-2
\$42⁵⁰

Shpg. Wt.
 21 Lbs.

HEATHKIT LOW CAPACITY PROBE KIT

Oscilloscope investigation of high frequency, high impedance, or broad bandwidth circuits encountered in television requires the use of a low-capacity probe to prevent loss of gain, circuit loading, or waveform distortion. The Heathkit low-capacity probe may be used with your oscilloscope to eliminate these effects. It features a variable capacitor, to provide correct instrument impedance match. Also, the ratio of attenuation can be varied.

No. 342

\$3⁵⁰

Shpg. Wt. 1 Lb.

HEATHKIT ELECTRONIC SWITCH KIT

This handy device allows simultaneous oscilloscope observation of two signals by producing both signals, alternately, at its output. It features an all-electronic switching circuit, with no moving parts. Four switching rates are selected by a panel switch. Provides actual gain for input signals, and has a frequency response of ± 1 DB from 0 to 100 kc. Sync output provided to control and stabilize scope sweep. Will function at signal levels as low as 0.1 volt. This modern device finds many applications in the laboratory and service shop. It employs an entirely new circuit, and yet is priced lower than its predecessor.

MODEL S-3

\$21⁹⁵

Shpg. Wt. 8 Lbs.



HEATHKIT SCOPE DEMODULATOR PROBE KIT

Extend the usefulness of your oscilloscope by employing this probe. Makes it possible to observe modulation of RF or IF carriers found in TV and radio receivers. Functions much like an AM detector to pass only modulation of signal, and not the signal itself. Among other uses, it will be helpful in alignment work, as a signal tracer, and for determining relative gain. Applied voltage limits are 30 volts (RMS) and 500 volts DC. It uses an etched circuit board to simplify assembly.

NO. 337-C

\$3⁵⁰

Shpg. Wt. 1 Lb.

HEATHKIT VOLTAGE CALIBRATOR KIT

This entirely new voltage calibrator produces near-perfect square wave signals of known amplitude. Precision 1% attenuator resistors assure accurate output amplitude, and multivibrator circuit guarantees good, sharp square waves, as distinguished from clipped sine waves. Output frequency is approximately 1000 CPS. Fixed outputs selected by panel switch are: .03, 0.1, 0.3, 1.0, 3.0, 10, 30, and 100 volts peak-to-peak. Allows measurement of unknown signal amplitudes by comparing to known peak-to-peak output of VC-3 on an oscilloscope. Will also double as a square wave generator at 1000 cycles for determining gain, frequency response, or phase-shift characteristics of audio amplifiers. Equally valuable in the laboratory or in radio and TV service shops.

MODEL VC-3

\$12⁵⁰

Shpg. Wt. 4 Lbs.

HEATHKIT ETCHED CIRCUIT VACUUM TUBE



- * Easy to build — a pleasure to use.
- * 1% precision resistors employed for high accuracy.
- * Etched circuit board cuts assembly time in half.

Voltmeter Kit

The fact that this instrument is the world's largest-selling VTVM says a great deal about its accuracy, reliability, and overall quality. The V-7A is equally popular in the laboratory or service shop, and represents an unbelievable test equipment bargain, without a corresponding sacrifice in quality. Its appearance reflects the performance of which it is capable. A large 4½" panel meter is used for indication, with clear, sharp calibrations for all ranges. Front panel controls consist of a rotary function switch and a rotary range selector switch, zero-adjust, and ohms-adjust controls. Precision 1% resistors are used in the voltage divider circuits and etched circuits are employed for most of the circuitry. This makes the kit much easier to build, eliminates the possibility of wiring errors, and assures duplication of laboratory instrument performance. This multi-function VTVM will measure AC voltage (rms), AC voltage (peak-to-peak), DC voltage, and resistance. There are 7 AC (rms) and DC voltage ranges of 0-1.5, 5, 15, 50, 150, 500, and 1500. In addition, there are 7 peak-to-peak AC ranges of 0-4, 14, 40, 140, 400, 1400, and 4000. 7 ohmmeter ranges provide multiplying factors of X1, X10, X100, X1000, X10K, X100K, and X1 megohm. Center-scale resistance readings are 10, 100, 1000, 10K, 100K ohms, 1 megohm, and 10 megohms. A DB scale is also provided. The precision and quality of the components used in this VTVM cannot be duplicated at this price through any other source. Model V-7A is the kind of instrument you will be proud to own and use.

HEATHKIT Etched Circuit RF PROBE KIT

This RF probe extends the frequency response of any 11-megohm VTVM so that it will measure RF up to 250 megacycles within ± 10%. Employs printed circuits for increased stability and ease of assembly. Ideal for extending service and laboratory applications of your Heathkit VTVM. Shpg. Wt. 1 Lb.

No. 309-C
\$3.50

HEATHKIT 20,000 OHMS/VOLT VOM KIT

Sensitivity of this instrument is 20,000 ohms-per-volt DC and 5,000 ohms-per-volt AC. Measuring ranges are 0-1.5, 5, 50, 150, 500, 1500, and 5000 volts for both AC and DC. Also measures current in the ranges of 0-150 microamperes, 15 ma, 150 ma, 500 ma, and 15 a. Resistance ranges provide multipliers of X1, X100, and X10,000, resulting in center scale readings of 15, 15,000, and 150,000 ohms. DB ranges cover from -10 db to +65 db. Housed in attractive black bakelite case with plastic carrying handle, this fine instrument provides a total of 25 meter ranges on its two-color scale. It employs a sensitive 50 microampere, 4½" meter and features all 1% precision multiplier resistors. Requires no external power, and is, therefore, valuable in portable applications where no AC power is available.

MODEL MM-1
\$29.50
Shpg. Wt. 6 Lbs.

HEATHKIT SCOPE DEMODULATOR PROBE KIT

This probe functions like an AM detector to pass only modulation of signal and not signal itself. Permits observation of modulation from RF or IF carriers in TV and radio receivers. Extends usefulness of your oscilloscope. Voltage limits are 30 V, rms, and 500V, DC. Very valuable in service or laboratory applications. Shpg. Wt. 1 Lb.

No. 337-C
\$3.50



HEATHKIT 30,000 VOLT DC HIGH VOLTAGE PROBE KIT

This probe provides a multiplication factor of 100 on the DC ranges of the Heathkit 11-megohm VTVM. Precision multiplier resistor mounted inside the two-color plastic probe body. Plenty of insulation for completely safe operation, even at highest TV potentials. Designed especially for TV service work.

No. 336
\$4.50

Shpg. Wt. 2 Lbs.

HEATHKIT HANDITESTER KIT

The Model M-1 measures AC or DC voltage at 0-10, 30, 300, 1000, and 5000 volts. Direct current ranges are 0-10 ma, and 0-100 ma. Ohmmeter ranges are 0-3000 (30 ohm center scale) and 0-300,000 ohms (3,000 ohms center scale). Uses a 400 microampere meter for sensitivity of 1000 ohms-per-volt. A very popular test device for the home experimenter, electricians, and appliance repairmen, and for use as an "extra" instrument in the service shop. Its small size and rugged construction make it perfect for any portable application. Easily slips into your tool box, glove compartment, coat pocket, or desk drawer. Top quality, precision components employed throughout.

MODEL M-1
\$14.50
Shpg. Wt. 3 Lbs.



HEATH COMPANY
A Subsidiary of Daystrom, Inc.
BENTON HARBOR 20, MICH.

CONTROLLED QUALITY ...
 Incoming parts inspection, and inspection of material coming off of our own production line assures you of the finest "build-it-yourself" kit that money can buy. Each kit contains all the components you need for assembly—and you can have confidence in the quality of the parts themselves. In addition to this inspection procedure, an extensive proof-building program for each new kit guarantees easy-to-follow instructions and reliable performance.

HEATHKIT NEW AUDIO VACUUM TUBE

Voltmeter Kit

- * Brand new circuit for extended frequency response and added stability.
- * Ten accurate ranges from 0-.01 to 0-300 volts.
- * Modern, functional panel styling. "On-off" switch at both extreme ends of range switch.

This brand new AC vacuum tube voltmeter emphasizes stability, broad frequency response, and sensitivity. It is designed especially for audio measurements, and low-level AC measurements in power supply filters, etc. Employs a cascode amplifier circuit with cathode-follower isolation between the input and the amplifier, and between the output stage and the preceding stages. An extremely stable circuit with high input impedance (1 megohm at 1000 CPS). Response of the AV-3 is essentially flat from 10 CPS to 200 kc, and is usable for tests even beyond these frequency limits. Increased damping in the meter circuit stabilizes the meter for low frequency tests. Nylon insulating bushings at the input terminals reduce leakage, and permit the use of the 5-way Heath binding post.

The extremely wide voltage range covered by the AV-3 makes it especially valuable not only in high-fidelity and service work, but also in experimental laboratories. AC (RMS) voltage ranges are 0-.01, .03, .1, .3, 1, 3, 10, 30, 100, and 300 V. Decibel ranges cover -52 DB to +52 DB. An entirely new circuit as compared to the previous model. Employs 1% precision multiplier resistors for maximum accuracy. Handles AC measurements from a low value of one millivolt to a maximum of 300 volts.

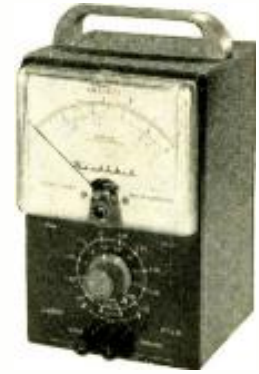

MODEL AV-3
\$29⁵⁰ Shpg. Wt. 5 Lbs.

HEATHKIT AUDIO WATTMETER KIT

This instrument measures audio power directly at 4, 8, 16, or 600 ohms. Load resistors are built in. Covers 0-5 MW, 50 MW, 500 MW, 5 W, and 50 W full scale. Provides 5 switch-selected DB ranges covering from -10 DB to +30 DB. Large 4½" 200 microampere meter and precision multiplier resistors insure accuracy. Frequency response is ± 1 DB from 10 CPS to 250 kc. Functions from AC power line. Use in the audio laboratory or in home workshop.

MODEL AW-1
\$29⁵⁰ Shpg. Wt. 6 Lbs.

HEATHKIT AUDIO ANALYZER KIT

This multi-function instrument combines an AC VTVM, an audio wattmeter, and an intermodulation analyzer into one case, with combined input and output terminals and built-in high and low frequency oscillators. The VTVM ranges are .01, .03, .1, .3, 1, 3, 10, 30, 100, and 300 volts (RMS). Wattmeter ranges are .15 MW, 1.5 MW, 15 MW, 150 MW, 1.5 W, 15 W, 150 W. IM scales are 1%, 3%, 10%, 30%, and 100%. Provides internal load resistors of 4, 8, 16, or 600 ohms. A valuable instrument for the engineer or serious audiophile.

MODEL AA-1
\$59⁵⁰ Shpg. Wt. 13 Lbs.

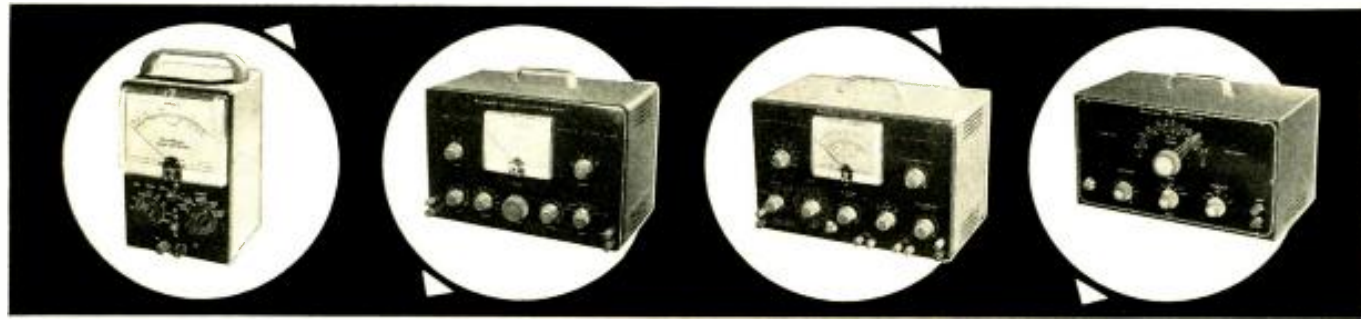

HEATHKIT HARMONIC DISTORTION METER KIT

The HD-1 is equally valuable for the audio engineer or the serious audiophile. Used with a low-distortion audio signal generator, this instrument will measure the harmonic content of various amplifiers under a variety of conditions. Functions between 20 and 20,000 CPS, and reads distortion directly on the panel meter in ranges of 0-1, 3, 10, 30, and 100 percent full scale. Built-in VTVM for initial reference settings and final distortion readings has voltage ranges of 0-1, 3, 10, and 30 volts. 1% precision resistors employed for maximum accuracy. Features voltage regulation and other "extras". Meter calibrated in volts (RMS), percent distortion, and DB.

MODEL HD-1
\$49⁵⁰ Shpg. Wt. 13 Lbs.

HEATHKIT AUDIO OSCILLATOR KIT

Producing both sine waves and square waves, the Model AO-1 covers a frequency range of 20 to 20,000 CPS in three ranges. An extra feature is thermistor regulation of output for flat response through the entire frequency range. AF output is provided at low impedance, and with low distortion. Produces good sine waves, and good, clean square waves with a rise time of only two micro-seconds for checking square wave response of audio amplifiers, etc. Designed especially for the serviceman and high-fidelity enthusiast. A real dollar value in test equipment.

MODEL AO-1
\$24⁵⁰ Shpg. Wt. 10 Lbs.

HEATHKIT

Audio Generator Kit



\$34⁵⁰

Shpg. Wt.
8 lbs.

This particular audio generator is "made to order" for high fidelity applications. It provides quick and accurate selection of low-distortion signals throughout the audio range. Three rotary selector switches on the front panel allow selection of two significant figures and a multiplier for determining audio frequency. In addition, it incorporates a step-type output attenuator and a continuously variable attenuator. Output is indicated on a large 4½" panel meter calibrated in volts and in db. Attenuator system operates in steps of 10 db, corresponding with the meter calibration. Output ranges are 0-.003, .01, .03, .1, .3, 1, 3, and 10 volts rms. A "load" switch provides for the use of a built-in 600 ohm load or an external load of higher impedance when required. Output and frequency indicators accurate to within ± 5%. Distortion is less than .1 of 1% between 20 cps and 20,000 cps. Total range is 10 cps to 100 kc. New engineering details combine to provide the user with an unusually high degree of operating efficiency. Oscillator frequency selected entirely by the switch method means that accurate resetability is provided. Comparable to units costing many dollars more, and ideal for use in critical high fidelity applications. Shop and compare, and you will appreciate the genuine value of this professional instrument.

- * Less than 0.1% distortion — ideal for hi fi work.
- * Large 4½" meter indicates output.
- * Step-type tuning for maximum convenience.

HEATHKIT RESISTANCE SUBSTITUTION BOX KIT

The RS-1 contains 36 10% 1-watt resistors ranging from 15 ohms to 10 megohms in standard RETMA values. All values are switch-selected for use in determining desirable resistance values in experimental circuits. Many applications in radio and TV service work.

MODEL RS-1

\$5⁵⁰

Shpg. Wt. 2 lbs.

HEATHKIT CONDENSER SUBSTITUTION BOX KIT

This kit contains 18 RETMA standard condenser values that can be selected by a rotary switch. Values range from 0.00001 mfd to 0.22 mfd. All capacitors rated at 400 volts or higher. Capacitors are either silver-mica, or plastic molded.

MODEL CS-1

\$5⁵⁰

Shpg. Wt. 2 lbs.

HEATHKIT AUDIO GENERATOR KIT

The Model AG-8 is a low cost, high performance unit for use in service shop, or home workshop. It covers the frequency range of 20 cps to 1 mc in five ranges. Output is 600 ohms, and overall distortion will be less than .4 of 1% from 100 cps through the audible range. Output is available up to 10 volts, under no load conditions, and output remains constant within ±1 db from 20 cps to 400 kc. A five-step attenuator provides control of the output. Precision resistors are employed in the frequency determining network.

MODEL AG-8

\$29⁵⁰

Shpg. Wt. 11 lbs.

HEATHKIT DECADE CONDENSER KIT

Precision, 1% silver-mica capacitors are employed in the Model DC-1 in such a way that a selection of precision capacitor values is provided ranging from 100 mmf (.0001 mfd) to 0.11 mfd (110,000 mmf) in 100 mmf steps. Extremely valuable in all types of design and development work. Switches are ceramic wafer types.

MODEL DC-1

\$16⁵⁰

Shpg. Wt. 3 lbs.



HEATHKIT DECADE RESISTANCE KIT

The Model DR-1 incorporates twenty 1% precision resistors arranged around five rugged switches so that various combinations of switch positions will provide a total range of 1 ohm to 99,999 ohms in 1-ohm steps. Switches are labeled "units," "tens," "hundreds," "thousands," and "ten thousands." Use it for ohm-meter calibration in bridge circuits as test values in multiplier circuits, etc.

MODEL DR-1

\$19⁵⁰

Shpg. Wt. 4 lbs.

HEATHKIT VARIABLE VOLTAGE REGULATED POWER SUPPLY KIT

This power supply is regulated for stability, and the amount of DC output available from the power supply can be controlled manually from zero to 500 volts. Will provide regulated output at 450 volts up to 10 ma, or up to 130 ma at 200 volts output. In addition to furnishing B-plus, the power supply provides 6 volts AC at 4 amperes for filaments. Both the B-plus output and the filament output are isolated from ground. Ideal power supply for use in experimental work in the laboratory, the home workshop, or the ham shack. Large 4½" panel meter indicates output voltage or current.

MODEL PS-3

\$35⁵⁰

Shpg. Wt. 17 lbs.



HEATH COMPANY

A Subsidiary of Daystrom, Inc.

BENTON HARBOR 20, MICH.

BONUS PERFORMANCE . . .
 If a single word had to be selected to describe Heath Company advertising policy, it would be "conservative." By this we mean that the performance specifications and features are not exaggerated, and that the descriptions are accurate. We specify performance on the conservative side so you can be sure of equaling or exceeding our specifications. In almost every instance our kits will do more than we claim. Extra care in construction, and calibration against an accurate standard can extend performance well beyond advertised levels.

HEATHKIT

Signal Generator Kit

- * No calibration required with pre-aligned coils.
- * Modulated or unmodulated RF output.
- * 110 mc to 220 mc frequency coverage.



MODEL SG-8

\$19⁵⁰ Shpg. Wt. 8 Lbs.

Here is an RF signal generator for alignment applications in the service shop or the home workshop. Thousands of these units are in use in service shops all over the country. Produces RF signals from 160 kc to 110 mc on fundamentals on five bands. Also covers from 110 mc to 220 mc on calibrated harmonics. RF output is in excess of 100,000 microvolts at low impedance. Output is controllable with a step-type and a continuously variable attenuator. Front panel controls provide selection of either unmodulated RF output or RF modulated at 400 cps. In addition, two to three volts of audio at approximately 400 cps are available at the output terminals for testing AF circuits. Employs a 12AU7 and a 6C4 tube. Built-in power supply uses a selenium rectifier.

One of the most outstanding features about the Model SG-8 is the fact that it can be built in just a few hours, even by one not thoroughly experienced in electronics work. Complete step-by-step instructions combined with large pictorial diagrams assure successful assembly. Pre-aligned coils make calibration from an external source unnecessary.

HEATHKIT LABORATORY GENERATOR KIT

This laboratory RF signal generator covers from 100 kc to 30 mc on fundamentals in five bands. The output signal may be pure RF, or may be modulated at 400 cycles from 0 to 50%. Provision for external modulation has been made. RF output available up to 100,000 microvolts. Output controlled by a fixed step and a variable attenuator. Output impedance is 50 ohms. Panel meter reads RF output or percentage of modulation. Incorporates voltage regulated B+ supply, double shielding of oscillator circuits, copper plated chassis, and other "extras."

MODEL LG-1
\$39⁵⁰

Shpg. Wt. 16 Lbs.

HEATHKIT TV ALIGNMENT GENERATOR KIT

This improved sweep generator model provides essential stability and flexibility for work on FM, monochrome TV, or color TV sets. Covers 3.6 mc to 220 mc in four bands. Provides usable output even on harmonics. Sweep deviation from 0-42 mc, depending on base frequency. All-electronic sweep circuit eliminates unwieldy mechanical arrangements. Includes built-in crystal marker generator providing output at 4.5 mc and multiples thereof, and variable marker covering 19 to 60 mc on fundamentals and from 57 to 180 mc on harmonics. Effective two-way blanking.

MODEL TS-4A
\$49⁵⁰

Shpg. Wt. 16 Lbs.



HEATHKIT LINEARITY PATTERN GENERATOR KIT

This instrument supplies information for white dots, cross-hatch pattern, horizontal bar pattern, or vertical bar pattern. It feeds video and sync signals to the set under test, with completely controlled gain, and unusual stability. Covering channels 2 to 13, the LP-2 will produce 5 to 6 vertical bars and 4 to 5 horizontal bars. The dot pattern presentation is a *must* for the setting of color convergence controls in the color TV set. Panel provision made for external sync if desired. Use for adjustment of vertical and horizontal linearity, picture size, aspect ratio, and focus. Power supply is regulated for added stability. Essential in the up-to-date TV service shop.

MODEL LP-2
\$22⁵⁰

Shpg. Wt. 7 Lbs.

HEATHKIT CATHODE RAY TUBE CHECKER KIT

This instrument checks cathode emission, beam current, shorted elements, and leakage between elements in electro-magnetic picture tube types. It eliminates all doubt for the TV serviceman, and even more important, for the customer. Features its own self-contained power supply, transformer operated to furnish normal test voltages for the CRT. Employs spring-loaded switches for maximum operator protection. Large 4 1/2" meter indicates CRT condition on "good-bad" scale. Luggage-type portable case ideal for home service calls. Special "shadow graph" test permits projection of light spot on screen. Also gives relative check of picture tube screen coating.

MODEL CC-1
\$22⁵⁰

Shpg. Wt. 10 Lbs.

HEATHKIT

Tube Checker Kit



MODEL
TC-2

\$29⁵⁰

Shpg. Wt.
12 Lbs.

- * Attractive counter-style cabinet.
- * Wiring-harness simplifies assembly.
- * Large 4½" meter with two-color "good-bad" scale.
- * Separate tube element switches prevent obsolescence.

This fine piece of test gear checks tubes for quality, emission, shorted elements, open elements, and filament continuity. Will test all tube types normally encountered in radio and TV service work. Sockets provided for 4, 5, 6, and 7-pin large, rectangular, and miniature types, octal and loctal types, the Hytron 9-pin miniatures, and pilot lamps. Condition of tubes indicated on a large 4½" meter with multi-color "good-bad" scale. An illuminated roll chart is built right in, providing test data for various tube types. This tester provides switch selection of 14 different filament voltage values from 0.75 volts to 117 volts. Individual switches control each tube element. Close tolerance resistors employed in critical test circuits for maximum accuracy. A professional instrument both in appearance and performance.

The Model TC-2 is very simple to build, even for a beginner. It employs a color-coded cable harness for neat, professional under-chassis wiring. Comes with attractive counter style cabinet, and portable cabinet is available separately. At this price, even the part-time serviceman can afford his own tube checker for maximum efficiency in service work.

HEATHKIT TV PICTURE TUBE TEST ADAPTER

Designed especially for use with the Model TC-2 tube checker. Use it to test TV picture tubes for emission, shorts, etc. Consists of 12-pin TV tube socket, 4 ft. cable, octal connector, and necessary technical data. Not a kit.



MODEL 355

\$4⁵⁰

Shpg. Wt.
1 lb.

HEATHKIT PORTABLE TUBE CHECKER KIT

This portable tube checker is identical, electrically, with the Model TC-2. However, it is housed in an attractive and practical carrying case, finished in proxylin impregnated material. The cover is detachable, and the hardware is brass plated. This rugged unit is ideal for home service calls or any portable application.



MODEL
TC-2P

\$34⁵⁰ Shpg. Wt.
15 Lbs.

HEATHKIT VISUAL-AURAL SIGNAL TRACER KIT

Although designed primarily for radio receiver work, this valuable instrument finds extensive application in FM and TV servicing as well. Features a high-gain channel with demodulator probe, and a low-gain channel with audio probe. Will trace signals in all sections of a radio receiver and in many sections of a FM set or TV receiver. Uses built-in speaker and electron beam eye tube for indication. Also features built-in wattmeter and a noise locator circuit. Provision for patching speaker and/or output transformer into external set.

MODEL T-3

\$23⁵⁰

Shpg. Wt. 9 Lbs.

HEATHKIT DIRECT READING CAPACITY METER KIT

Operation of this instrument is simplicity itself. One has only to connect a capacitor to the terminals, select the proper range, and read the capacity value directly on the large 4½" meter calibrated in mmf and mfd. Ranges are 0 to 100 mmf, 1,000 mmf, 0.01 mfd, and 0.1 mfd full scale. Precision calibrating capacitors supplied. Not susceptible to hand capacity effects. Residual capacity less than 1 mmf. Especially valuable in production line checking, or in quality control.



MODEL CM-1

\$29⁵⁰

Shpg. Wt.
7 Lbs.

HEATHKIT CONDENSER CHECKER KIT

The Model C-3 consists of an AC powered bridge for both capacitive and resistive measurements. Bridge balance is indicated on electron beam eye tube, and capacity or resistance value is indicated on front panel calibrations. Measures capacity in four ranges from .00001 mfd to .005 mfd, .001 mfd to .5 mfd, .1 mfd to 50 mfd, and 20 mfd to 1000 mfd. Measures resistance in two ranges, from 100 ohms to 50,000 ohms, and from 10,000 ohms to 5 megohms. Selection of five different polarizing voltages for checking capacitors, from 25 volts DC to 450 volts DC. Checks paper, mica, ceramic, and electrolytic capacitors. Indicates power factor of electrolytic condensers.

MODEL C-3

\$19⁵⁰

Shpg. Wt. 7 Lbs.



HEATH COMPANY
A Subsidiary of Daystrom, Inc.
BENTON HARBOR 20, MICH.

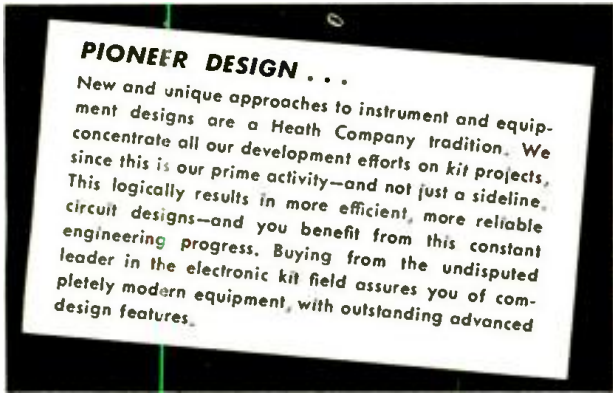

HEATHKIT

Impedance Bridge Kit

- * 1/2% precision resistors and silver-mica capacitors.
- * Battery-type tubes, no warm-up required.
- * Built-in phase shift generator and amplifier.

The Model IB-2 is a completely self-contained unit. It has a built-in power supply, a built-in 1000 cycle generator, and a built-in vacuum tube detector. Provision has been made on the panel for connection to an external detector, an external signal generator, or an external power supply. A 100-0-100 micro-ampere meter on the front panel provides for null indications. Measures resistance from 0.1 ohm to 10 megohms, capacitance from 10 mmf to 100 mfd, inductance from 10 mh to 100 h, dissipation factor (D) from 0.002 to 1, and storage factor (Q) from 0.1 to 1000. 1/2 of 1% decade resistors employed for maximum accuracy. Typical accuracy figures are: resistance, $\pm 3\%$; capacitance $\pm 3\%$; inductance, $\pm 10\%$; dissipation factor, $\pm 20\%$; storage factor, $\pm 20\%$. Employs a Wheatstone bridge, a Capacity Comparison bridge, a Maxwell bridge, and a Hay bridge. Special two-section CRL dial provides maximum convenience in operation. Use the Model IB-2 for determining values of unmarked components, checking production or design samples, etc. A real professional instrument.



MODEL IB-2

\$59⁵⁰ Shpg. Wt. 12 Lbs.



HEATHKIT "Q" METER KIT

The Q Meter permits measurement of inductance from 1 microhenry to 10 millihenries. "W" on a scale calibrated up to 250 full scale, with multiplying factors of 1 or 2, and capacitance from 40 mmf to 450 mmf, ± 3 mmf. Built-in variable oscillator permits testing components from 150 kc to 18 mc. Large 4 1/2" panel-mounted meter is feature. Very handy for checking peaking coils, chokes, etc. Use to determine values of unknown condensers, both variable and fixed. Compile data for coil winding purposes, or measure RF resistance. Distributed capacity, and Q of coils.

MODEL QM-1

\$44⁵⁰

Shpg. Wt. 14 Lbs.

HEATHKIT ISOLATION TRANSFORMER KIT

This device isolates equipment under test from the power line. It is rated at 100 volt-amperes continuously, or 200 volt-amperes intermittently. AC-DC sets may be plugged directly into the IT-1 without the chassis becoming "hot." Additionally, since the IT-1 is fused, it is ideal for use as a buffer between the power line and a questionable receiver, or a new piece of equipment. Protects main fuses. Features voltage control, allowing control of the output from 90 volts to 130 volts. Panel meter monitors output voltage. A very handy device at an extremely low price.

MODEL IT-1

\$16⁵⁰

Shpg. Wt. 9 Lbs.

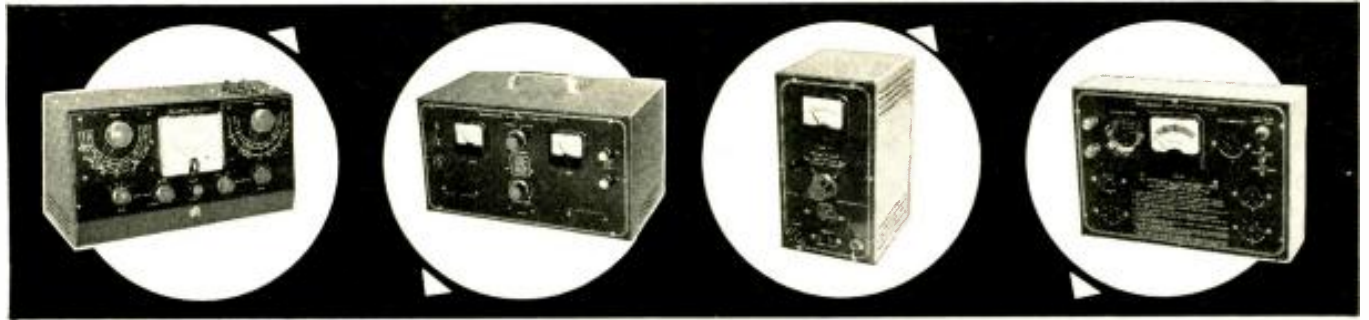

HEATHKIT 6-12 VOLT BATTERY ELIMINATOR KIT

This completely modern battery eliminator will supply DC output in two ranges for both 6-volt and 12-volt automobile radios. The output is variable for each range, so that operating voltage can be raised or lowered to determine how the receiver functions under adverse conditions. Range is 0-8 volts DC or 0-16 volts DC. Will supply up to 15 amperes on the 6-volt range, or up to 7 amperes on the 12-volt range. Two 10,000 microfarad output filter capacitors insure smooth DC output. Two separate panel meters indicate output voltage or output current. Makes it possible to test automobile radios inside at the workbench. Will also double as a battery charger.

MODEL BE-4

\$31⁵⁰

Shpg. Wt. 17 Lbs.

HEATHKIT 6-VOLT VIBRATOR TESTER KIT

This instrument functions very much like a tube checker, to test auto radio vibrators. Vibrator condition is indicated on a simple "good-bad" scale. Tests for proper starting and overall quality of operation, of both interrupter and self-rectifier types of 6-volt vibrators. The model VT-1 is designed to operate from any battery eliminator capable of delivering continuously variable output from 4 to 6 volts DC at 4 amperes or more. It is an ideal companion unit for the Heathkit Model BE-4 battery eliminator. The construction book for the VT-1 contains vibrator test chart for popular 6-volt vibrator types. A real time saver!

MODEL VT-1

\$16⁵⁰

Shpg. Wt. 6 Lbs.

HEATHKIT DX-100 PHONE AND CW



**MODEL
DX-100**
Shpg. Wt.
107 Lbs.

\$189⁵⁰

Shipped motor freight unless otherwise specified.
\$50.00 deposit required on c.o.d. orders.

- * Phone or CW on 160, 80, 40, 20, 15, 11 and 10 meters.
- * Built-in VFO, modulator, and power supplies.
- * High quality components used throughout for reliable performance.
- * Features 5-point TVI suppression.

Transmitter Kit

The Heathkit DX-100 transmitter is in a class by itself in that it offers features far beyond those normally received at this price level. It takes very little listening on the bands to discover how many of these transmitters are in operation today. A truly amazing piece of amateur gear. The DX-100 features a built-in VFO and a built-in modulator. It is TVI suppressed, and uses pi network interstage coupling and output coupling. Will match antenna impedances from approximately 50 to 600 ohms. Extensive shielding is employed, and all incoming and outgoing circuits are filtered. The cabinet features interlocking seams for simplified assembly and minimum RF radiation outside of the cabinet. Provides a clean strong signal on either phone or CW, with RF output in excess of 100 watts on phone, and 120 watts on CW. Completely bandswitching from 160 through 10 meters. A pair of 1625 tubes are used in push-pull for the modulator, and the final consists of a pair of 6146 tubes in parallel. The VFO dial and meter face are illuminated, and all front panel controls are located for maximum convenience. Panel meter reads driver plate I, final grid I, final plate I, final plate voltage, and modulator current. The chassis is constructed of heavy #16 gauge copper-plated steel. Other high-quality components include potted transformers, ceramic switch and variable capacitor insulation, silver-plated or solid-silver switch terminals, etc. All coils are pre-wound, and the main wiring cable is pre-harnessed. The kit can be built by a beginner from the comprehensive step-by-step instructions supplied. It is a proven, trouble-free rig that will insure many hours of "on-the-air" enjoyment in your ham shack.

HEATHKIT COMMUNICATIONS TYPE ALL BAND RECEIVER KIT

This receiver covers 550 kc to 30 mc in four bands, and is ideal for the short-wave listener or beginning amateur. It provides good sensitivity and selectivity, combined with good image rejection. Amateur bands clearly marked on illuminated dial scale. Employs transformer type power supply—electrical bandspread—antenna trimmer—separate RF and AF gain controls—noise limiter—headphone jacks—and automatic gain control. Has built-in VFO for CW reception.

CABINET: Fabric covered cabinet with aluminum panel as shown. Part 91-15A. Shipping weight 5 Lbs. \$4.95†

MODEL AR-3
\$307⁵

INCLUDING NEW
EXCISE TAX*
(Less Cabinet)
Shpg. Wt. 12 Lbs.

HEATHKIT VFO KIT

You can go VFO for less than you might expect. Here is a variable frequency oscillator that covers 160, 80, 40, 20, 15, 11, and 10 meters with three basic oscillator frequencies, that sells for less than \$20. Provides better than 10 volt average RF output on fundamentals. Plenty of drive for most modern transmitters. Requires a power source of only 250 VDC at 15 to 20 ma. and 6.3 VAC at 0.45A. Incorporates a regulator tube for stability. Illuminated frequency dial reads frequency directly on the band being employed. Temperature-compensated capacitors offset coil heating.

MODEL VF-1

\$19⁵⁰

Shpg. Wt. 7 Lbs.



EASY ON THE BUDGET!

You can buy Heathkits on an easy time-payment plan that provides a full year to pay. Write for complete details and special order blank.



HEATH COMPANY
A Subsidiary of Daystrom, Inc.
BENTON HARBOR 20, MICH.

HEATHKIT CW TRANSMITTER KIT

This is the original low-priced Heathkit CW transmitter. Its reliable performance has been proven time and time again on the CW bands. Designed for crystal control, the Model AT-1 covers 80, 40, 20, 15, 11, and 10 meters. May be excited from external VFO. Plate power input up to 30 watts. Power supply built in. Panel meter indicates grid current or plate current for final. Incorporates pre-wound coils, copper-plated chassis, built-in line filter, profuse shielding, and top-quality parts throughout. Crystal socket and key jack on front panel. Built-in key-click filter, and single-knob bandswitching. 52-ohm coaxial output. Uses 6AG7 oscillator-multiplier, 6L6 power amplifier-doubler, and 5U4G rectifier.

MODEL AT-1

\$29⁵⁰

Shpg. Wt. 15 Lbs.

DOLLAR-SAVING ECONOMY . . .
 There would be no particular achievement in selling inexpensive merchandise at a low price—although it is being done every day. However, there is something to crow about when, through tremendous purchasing power and factory-to-you distribution, Heath Company can offer top-quality equipment, using name-brand components, at such low prices. This is real economy, as opposed to the so-called "bargains". Needless to say, there is a big difference.

HEATHKIT PHONE AND CW Transmitter Kit

- * 6146 final amplifier for full 65-watt plate power input.
- * Phone and CW operation on 80, 40, 20, 15, 11, and 10 meters. Pi network output coupling.
- * Switch selection of three crystals — provision for external VFO excitation.

The DX-35 features a 6146 final amplifier to provide 65 watts plate power input on CW, with controlled carrier modulation peaks up to 50 watts on phone. In addition, it is a most attractive transmitter. Modulator and power supplies are built-in, and the rig covers 80, 40, 20, 15, 11, and 10 meters with a single band-change switch. Pi network output coupling provided for matching various antenna impedances. A 12BY7 buffer stage provided ahead of the final amplifier for plenty of drive on all bands. 12BY7 oscillator and 12AU7 modulator. Provision for switch selection of three different crystals. Crystals reached through access door at rear. Front panel controls marked "off-CW-stand-by-phone", "final tuning", "antenna coupling", "drive level control", and "band change switch". Panel meter indicates final grid current or final plate current. A perfect low-power transmitter both for the novice, and for the more experienced operator. A remarkable power package for the price. Incidentally, the price includes tubes, and all other components necessary for assembly. As with all Heathkits, comprehensive instruction manual assures successful assembly.



MODEL DX-35
\$56⁹⁵ Shpg. Wt. 24 Lbs.

HEATHKIT ANTENNA IMPEDANCE METER KIT

This instrument employs a 100 microampere panel meter and covers the impedance range of 0-600 ohms for RF tests. Functions up to 150 mc. Used in conjunction with signal source, such as the Heathkit Model GD-1B grid dip meter, the Model AM-1 will determine antenna resistance and resonance, match transmission lines for minimum standing wave ratio, determine receiver input impedance, etc. Will also double as a phone monitor. A very valuable device for many uses in the ham shack.

MODEL AM-1
\$14⁵⁰
 Shpg. Wt. 2 Lbs.

HEATHKIT "Q" MULTIPLIER KIT

The QF-1 functions with any receiver with an IF frequency between 450 and 460 kc that is not AC-DC type. Operates from the receiver power supply, requiring only 6.3 VAC at 300 ma. and 150 to 250 VDC at 2 ma. Simple to connect with cable and plugs supplied. Provides additional selectivity for separating two signals, or will reject one signal and eliminate heterodyne. A big help on crowded bands. Provides an effective Q of approximately 4,000 for sharp "peak" or "null". Tunes to any signal within the IF bandpass of the receiver, without changing main receiver tuning dial.

MODEL QF-1
\$9⁹⁵
 Shpg. Wt. 3 Lbs.

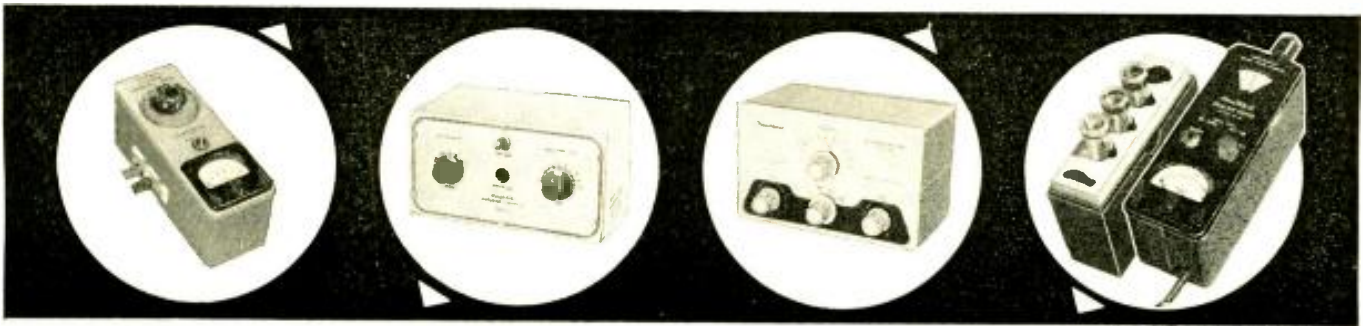

HEATHKIT ANTENNA COUPLER KIT

This device is designed to match the Model AT-1 transmitter to a long-wire antenna. In addition to impedance matching, this unit incorporates an L-type filter which attenuates signals above 36 megacycles, thereby reducing TVI. Designed for 52 ohm coaxial input. Handles power up to 75 watts, 10 through 80 meters. Uses a tapped inductor and variable capacitor. Neon RF indicator on front panel. Copper-plated chassis—high quality components throughout—simple to build. Eliminates waste of valuable communications power due to improper matching. A "natural" for all AT-1 transmitter owners.

MODEL AC-1
\$14⁵⁰
 Shpg. Wt. 4 Lbs.

HEATHKIT GRID DIP METER KIT

The grid dip meter was originally designed for the ham shack. However, its use has been extended into the service shop and laboratory. Continuous frequency coverage from 2 mc to 250 mc with pre-wound coils. 500 microampere panel meter employed for indication. Use for locating parasitics, neutralizing, determining RF circuit resonant frequencies, etc. Coils are included with kit, as is a coil rack. Front panel controls include sensitivity control for meter, and phone jack for listening to zero-beat. Will also double as an absorption-type wavemeter.

MODEL GB-1B
\$19⁵⁰
 Shpg. Wt. 4 Lbs.

Receiver Kit



MODEL BR-2
(Less Cabinet)
Shpg. Wt. 10 Lbs.

\$19²⁵

INCLUDING NEW
EXCISE TAX*

ATTENTION BEGINNERS . . .

This kit is an ideal "first project" if you have never built a Heathkit before. A good chance to "learn by doing."

- * Miniature tubes and high-gain IF transformer.
- * 5½-inch PM speaker.
- * Rod-type built-in antenna. Good sensitivity and selectivity.
- * Provision for phono jack.
- * Transformer - operated power supply.

You need no previous experience in electronics to build this table-model radio. The Model BR-2 receiver covers 550 kc to 1620 kc and features good sensitivity and selectivity over the entire band. A 5½" PM speaker is employed, along with high gain miniature tubes and a new rod-type built-in antenna. Provision has been made in the design of this receiver for its use as a phonograph amplifier. The phono jack is located on the back chassis apron. A transformer operated power supply is featured for safety of operation, as opposed to the usual AC-DC supply commonly found in "economy radio kits." Don't let the low Heathkit price deceive you. This is the kind of set you will want to show off to your family and friends after you have finished building it.

Construction of this radio kit is very simple. Giant size pictorial diagrams and detailed step-by-step instructions assure your success. The construction manual also includes an explanation of basic receiver circuit theory so you can "learn by doing" as the receiver is built. The manual even provides information on resistor and capacitor color codes, soldering techniques, use of tools, etc. If you have ever had the urge to build your own radio receiver, the outstanding features of this popular Heathkit deserve your attention.

CABINET: Proxilyn impregnated fabric covered plywood cabinet available for the BR-2 receiver as shown. Complete with aluminum panel, reinforced speaker grill, and protective rubber feet. Shipping weight 5 lbs., part No. 91-9A. **\$4.95⁺**

HEATHKIT PROFESSIONAL RADIATION COUNTER KIT

This sensitive and reliable instrument has already found extensive application in prospecting, and also in medical and industrial laboratories. It offers outstanding performance at a reasonable price. Front-panel meter indicates radiation level, and oral indication produced by panel-mounted speaker. Meter ranges are 0-100, 600, 6,000 and 60,000 counts per minute, and 0-.02, .1, 1 and 10 milliroentgens per hour. The probe, with expansion cord, employs type 6306 bismuth counter tube, sensitive to both beta and gamma radiation. It is simple to build, even for a beginner.

MODEL RC-1
\$79⁹⁵

Shpg. Wt. 8 Lbs.

HEATHKIT CRYSTAL RECEIVER KIT

The crystal radio of Dad's day is back again, but with big improvements! The Model CR-1 employs a sealed germanium diode, eliminating the critical "cat's whisker" adjustment. It is housed in a compact plastic box, and features two Hi-Q tank circuits, employing ferrite core coils and variable air tuning capacitors. The CR-1 covers the standard broadcast band from 540 kc to 1600 kc, and no external power is required for operation. Could prove valuable for emergency signal reception. This easy-to-build kit is a real "learn by doing" experience for the beginner, and makes an interesting project for all ages.

MODEL CR-1
\$87⁵

INCLUDING NEW
EXCISE TAX*
Shpg. Wt. 3 Lbs.



- * Amazing new circuit for high efficiency.
- * Compact, portable and rugged.
- * Stable circuit requires only one 67½ volt "B" battery and two 1½ volt "A" batteries.



HEATHKIT ENLARGER TIMER KIT

The Model ET-1 is an easy-to-build device for use by amateur or professional photographers in controlling the timing cycle of an enlarger. It covers the range of 0 to 1 minute with a continuously variable, clearly calibrated scale. The timing period is pre-set, and the timing cycle is initiated by depressing the spring-return switch to the "print" position. Front panel provision is made for plugging in the enlarger and a safelight. The safelight is automatically turned "on" when the enlarger is "off". Handles up to 350 watts. The timing cycle is controlled electronically for maximum accuracy and reliability. Very simple to build in only one evening, even by a beginner.

MODEL ET-1
\$11⁵⁰

Shpg. Wt. 3 Lbs.



HEATH COMPANY
A Subsidiary of Daystrom, Inc.
BENTON HARBOR 20, MICH.

HEATHKIT HIGH FIDELITY

Preamplifier Kit

COMPREHENSIVE INSTRUCTIONS
 The step-by-step assembly instructions provided with each Heathkit are the finest available anywhere. Each manual begins at the beginning, and assumes no previous training or experience on the part of the kit builder. This means that our kits can be built successfully by anyone who can follow instructions. As a matter of fact, new manuals are tested by having the kit built by someone in our office who has had no previous experience in electronics. This is your guarantee of complete and thorough instruction material.

- * 5 switch-selected inputs, each with its own level control.
- * Equalization for LP, RIAA, AES, and Early 78's.
- * Separate bass and treble tone controls, and special hum control.
- * Clean, modern lines and satin-gold enamel finish.

Literally thousands of these preamplifiers are in use today, because the kit meets or exceeds specifications for the most rigorous high-fidelity applications, and will do justice to the finest available program sources. Provides a total of 5 inputs, each with individual level controls (three high-level and two low-level). Frequency response is within 1 DB from 25 CPS to 30,000 CPS, or within 1 1/2 DB from 15 CPS to 35,000 CPS. Hum and noise are extremely low, with special balance control for absolute minimum hum level. Tone control provides 18 DB boost and 12 DB cut at 50 CPS, and 15 DB boost and 20 DB cut at 15,000 CPS. Cabinet measures only 12-9/16" W. x 3 3/8" H. x 4 7/8" D, and it is finished in beautiful satin-gold enamel. 4-position turnover and 4 position roll-off controls provide "LP," "RIAA," "AES," and "early 78" equalization, and 8, 12, 16, and 1 flat position for roll-off. Derives operating power from the main amplifier, requiring only 6.3 VAC at 1 ampere and 300 VDC at 10 MA. Easy to construct from step-by-step instructions and pictorial diagrams provided.



MODEL WA-P2 (With Cabinet) Shpg. Wt. 7 Lbs.

\$21.75 INCLUDING NEW EXCISE TAX*

HEATHKIT HIGH FIDELITY FM TUNER KIT

- * Illuminated slide-rule dial covers 88 to 108 MC.
- * Modern circuit emphasizes sensitivity and stability.
- * Housed in attractive satin-gold cabinet to match WA-P2 and BC-1.

This amazing new FM tuner can provide you with real high-fidelity performance at an unbelievably low price level. Covering 88 to 108 MC, the modern circuit features a stabilized, temperature-compensated, oscillator, A.G.C., broadbanded

IF circuits, and better than 10 UV sensitivity for 20 DB of quieting. A high gain, cascaded, RF amplifier is used ahead of the mixer to increase overall gain and reduce oscillator leakage. It employs a ratio detector for high efficiency without sacrifice in high-fidelity performance. IF and ratio transformers are pre-aligned, as is the front end tuning unit. This means the kit can be constructed by a beginner, without elaborate test and alignment equipment. The FM-3A is designed to match the WA-P2 preamplifier and the BC-1 AM tuner. An illuminated slide-rule dial is employed for frequency indication. Step-by-step instructions and large pictorial diagrams assure success.

MODEL FM-3A
\$26.95*
 INCLUDING NEW EXCISE TAX*
 (With Cabinet)
 Shpg. Wt. 7 Lbs.



HEATHKIT BROADBAND AM TUNER KIT

This AM tuner has been designed especially for high-fidelity applications. It incorporates a low-distortion detector, a broadband IF, and other features essential to usefulness in high-fidelity. Special voltage-doubler detector employs crystal diodes for low distortion. Sensitivity and selectivity are excellent. Audio response is ± 1 DB from 20 CPS to 2 kc, with 5 DB of pre-emphasis at 10 kc to compensate for station roll-off. Covers the standard broadcast band from 550 to 1600 kc. Incorporates a 10 kc whistle-filter and provides a 6 DB signal-to-noise ratio at 2.5 UV. RF and IF coils are pre-aligned, and power supply is built-in. Incorporates AVC, two outputs, and two antenna inputs.

MODEL BC-1
\$26.95
 INCLUDING NEW EXCISE TAX*
 (With Cabinet)
 Shpg. Wt. 8 Lbs.

HEATHKIT ELECTRONIC CROSS-OVER KIT

This unusual device functions to separate low frequencies and high frequencies so that they may be fed to separate amplifiers and to separate speakers. This eliminates the need for conventional cross-over circuits, since the Model XO-1 does the complete job electronically. Cross-over frequencies of 100, 200, 400, 700, 1,200, 2,000 and 35,000 CPS are selectable with front panel controls on the XO-1, and a separate level control is provided for each channel. Minimizes inter-modulation distortion problems. Handles unlimited power, since frequency division is accomplished ahead of the power stage. Attenuation is 12 DB per octave, with sharp "knee" at cut-off frequency.

MODEL XO-1
\$18.95
 Shpg. Wt. 6 Lbs.

HEATHKIT ADVANCED-DESIGN



\$59.⁷⁵

MODEL W-5:
Consists of Model W-5M plus Model WA-P2 pre-amplifier.
Shpg. Wt. 38 Lbs.
Express only... \$81.50†

- * Full 25 watt output with KT-66 output tubes.
- * All connectors brought out to front chassis apron.
- * Protective cover over all above-chassis components.

HIGH FIDELITY

Amplifier Kit

This 25 watt unit is our finest high-fidelity amplifier. Using a special design peerless output transformer, and KT-66 output tubes by Genalex, the Model W-5M provides performance characteristics unsurpassed at this price level. Frequency response is ± 1 DB from 5 to 160,000 CPS at 1 watt. Harmonic distortion is less than 1% at 25 watts and 1M distortion is less than 1% at 20 watts (60 and 3,000 CPS, 4 to 1). Hum and noise are 99 DB below 25 watts. Damping factor is 40 to 1. Input voltage for 5 watts output is 1 volt. Tubes employed are a pair of 12AU7's, a pair of KT-66's and a 5R4GY rectifier. Measures 13-3/32" W. x 8 1/2" D. x 8 1/4" H. Output impedance is 4, 8, or 16 ohms. Featured, also, is the "tweeter saver" which suppresses high frequency oscillation, and a new type balancing circuit requiring only a voltmeter for indication. This balance is easier to adjust, and results in a closer "dynamic" balance between output tubes. The Model W-5M provides improved phase shift characteristics, reduced IM and harmonic distortion, and improved frequency response. Conservatively rated high-quality components are used throughout to insure years of trouble-free operation. No technical background or training is required for assembly. Step-by-step instructions are provided for every stage of construction, and large pictorial diagrams illustrate exactly where each wire and component is to be placed. An amplifier for music lovers who can appreciate subtle differences in performance. Just ask the audiophile who owns one!

HEATHKIT DUAL-CHASSIS—WILLIAMSON TYPE HIGH FIDELITY AMPLIFIER KIT

This 20-watt high-fidelity amplifier employs the famous Acro-sound Model TO-300 "ultra-linear" output transformer and uses 5881 output tubes. The power supply is built on a separate chassis, and the two chassis are inter-connected with a power cable. This provides additional flexibility in mounting. Frequency response is ± 1 DB from 6 CPS to 150 kc at 1 watt. Harmonic distortion is only 1% at 21 watts, and 1M distortion is only 1.3% at 20 watts. (60 and 3,000 CPS). Output impedance is 4, 8, or 16 ohms. Hum and noise are 88 DB below 20 watts. A very popular high-fidelity unit employing top-quality components throughout.

MODEL W-3M: Shpg. Wt. 29 Lbs. Express only... \$49.75
MODEL W-3: Consists of Model W-3M plus Model WA-P2 pre-amplifier. Shpg. Wt. 37 Lbs. Express only... \$71.50†

HEATHKIT SINGLE CHASSIS—WILLIAMSON TYPE HIGH FIDELITY AMPLIFIER KIT

The 20-watt Model W-4AM Williamson type amplifier is a tremendous high-fidelity bargain. Combining the power supply and main amplifier on one chassis, and using a special-design output transformer by Chicago Standard brings you savings without a sacrifice in quality. Employing 5881 output tubes, the frequency response of the W-4AM is ± 1 DB from 10 CPS to 100 kc at 1 watt. Harmonic distortion is only 2.7% at this same level. Output impedance is 4, 8, or 16 ohms. Hum and noise are 95 DB below 20 watts.

MODEL W-4AM: Shpg. Wt. 28 Lbs. Express only... \$39.75
MODEL W-4A: Consists of Model W-4AM plus Model WA-P2 pre-amplifier. Shpg. Wt. 35 Lbs. Express only... \$61.50†

HEATHKIT 7-WATT AMPLIFIER KIT

This amplifier is more limited in power than other Heathkit models, but it still qualifies as a high-fidelity unit, and its performance definitely exceeds that of many so-called "high-fidelity" phonograph amplifiers. Using a tapped-screen output transformer of new design, the Model A-7D provides a frequency response of $\pm 1\frac{1}{2}$ DB from 20 to 20,000 CPS. Total distortion is held to a surprising low level. Output stage is push pull, and separate bass and treble tone controls are provided. Shpg. Wt. 10 Lbs.
MODEL A-7E: Similar to the A-7D, except that a 12SL7 tube has been added for pre-amplification. Two inputs, RIAA compensation, and extra gain.

MODEL A-7D
\$18.⁶⁵
INCLUDING NEW EXCISE TAX†
\$20.35†



HEATHKIT 20-WATT HIGH FIDELITY AMPLIFIER KIT

This high-fidelity amplifier features full 20-watt output using push pull 6L6 tubes. Built-in preamplifier provides 4 separate inputs, selected by a panel-mounted switch. It has separate bass and treble tone controls, each offering 15 DB boost and cut. Output transformer is tapped at 4, 8, 16, and 500 ohms. Designed primarily for home installations, but also used extensively for public address applications. True high-fidelity performance with frequency response of ± 1 DB from 20 CPS to 20,000 CPS. Total harmonic distortion only 1% (at 3 DB below rated output).

MODEL A-9B
\$35.⁵⁰
Shpg. Wt. 23 Lbs.



HEATH COMPANY
A Subsidiary of Daystrom, Inc.
BENTON HARBOR 20, MICH.

HEATHKIT HIGH FIDELITY

Range Extending SPEAKER SYSTEM KIT

All prices marked with a † include a 10% federal excise tax that now applies to receivers, tuners and some amplifiers, even though they may be in kit form. Since the tax is in effect as of July 5, 1956, we have no choice but to reflect it in our kit prices. This note is just to let you know we are not increasing our prices on some kits, but merely including this new tax in them.

Thank you,
HEATH COMPANY

- * High quality speakers of special design — 15" woofer and compression-type super-tweeter.
- * Easy-to-assemble cabinet of furniture-grade plywood.
- * Attractively styled to fit into any living room. Matches Model SS-1.



MODEL
SS-1B

\$99⁹⁵

Shpg. Wt. 80 Lbs.

This range extending unit is designed especially for use with the Model SS-1 speaker system. It consists of a 15" woofer, providing output between 35 and 600 CPS, and a compression-type super-tweeter that provides output between 4,000 and 16,000 CPS. Cross-over frequencies are 600, 1,600, and 4,000 CPS. The SS-1 provides the mid-range, and the SS-1B extends the coverage at both ends of the spectrum. Together, the two speaker systems provide output from 35 to 16,000 CPS within ± 5 DB. This easy-to-assemble speaker enclosure kit is made of top-quality furniture-grade plywood. All parts are pre-cut and pre-drilled, ready for assembly and the finish of your choice. Complete step-by-step instructions are provided for quick assembly by one not necessarily experienced in woodworking. Coils and capacitors for proper cross-over network are included, as is a balance control for super-tweeter output level. The SS-1 and SS-1B can provide you with unbelievably rich audio reproduction, and yet these units are priced reasonably. The SS-1B measures 29" H. x 23" W. x 17½" D. The speakers are both special-design Jensens, and the power rating is 35 watts. Impedance is 16 ohms.

HEATHKIT HIGH FIDELITY SPEAKER SYSTEM KIT



MODEL
SS-1

\$39⁹⁵

Shpg. Wt. 30 Lbs.

This speaker system is a fine reproducer in its own right, covering 50 to 12,000 CPS within ± 5 DB. However, the story does not end there. Should you desire to expand the system later, the SS-1 is designed to work with the SS-1B range extending unit — providing additional frequency coverage at both ends of the spectrum. It can fulfill your present needs, and still provide for the future. The SS-1 uses two Jensen speakers; an 8" midrange-woofer, and a compression-type tweeter. Cross-over frequency is 1,600 CPS, and the system is rated at 25 watts. Nominal impedance is 16 ohms. The cabinet is a ducted-port bass-reflex type. Attractively styled, the Model SS-1 features a broad "picture-frame" molding that will blend with any room decorating scheme. Pre-cut and pre-drilled wood parts are of furniture grade plywood. The kit is easy-to-build, and all component parts are included, along with complete step-by-step instructions for assembly. Can be built in just one evening, and will provide you with many years of listening enjoyment thereafter.

- * Special design ducted-port, bass-reflex enclosure.
- * Two separate speakers for high and low frequencies.
- * Kit includes all parts and complete instructions for assembly.

HEATH COMPANY A Subsidiary of Daystrom, Inc. BENTON HARBOR 20, MICH.

ORDER BLANK

NOTE: All prices subject to change without notice.

Enclosed find () check () money order for
Please ship C.O.D. () postage enclosed for _____ pounds.

On Express orders do not include transportation charges — they will be collected by the express agency at time of delivery.

ON PARCEL POST ORDERS include postage for weight shown. ORDERS FROM CANADA and APO'S must include full remittance.

Name _____

Address _____

City & Zone _____ State _____

(PLEASE PRINT)

SHIP VIA

- Parcel Post
- Express
- Freight
- Best Way

QUANTITY	ITEM	MODEL NO.	PRICE



By ROBERT B. COOPER

SPORADIC-E skip for the summer skip season was, from reports on hand to the end of June, quite a bit below the level of several previous seasons. After a slow start, good skip conditions prevailed on May 30, 31 and June 4, 5, 6 and 7. Double-hop sporadic-E across the southern portion of the country and short, single skip of about 400 miles was noted by several alert observers on May 30 and June 6.

Unusual tropospheric bending (extended ground wave) was noted in North Dakota on June 10 when dx-er Rossum of Mohall logged KEYD-9, WCCO-4, WTCN-11, and KSTP-5 from the Minneapolis area, over 475 miles distant. The prevailing high barometric pressure area that produced this reception moved eastward in the following days, bringing good tropospheric bending to the Great Lakes area on June 12-13, with uhf reception to 350 miles.

Observer Rauch of Peoria, Ill., reports excellent tropospheric reception over the 3-day period of June 20-22, with such high-band catches as KHOL-13, Kearny, Neb., 475 miles; KSTF-10, Scottsbluff, Neb., 715 miles; KBMB-12, Bismark, N. D., 665 miles; KNOX-10, Grand Forks, N. D., 620 miles; KOLN-10, Lincoln, Neb., 370 miles, and KTVH-12, Hutchinson, Kan., 560 miles. The same area of high barometric pressure slowly moved eastward into the eastern Great Lakes area, providing high-band vhf and uhf reception out to 450 miles. Rauch's detailed reports are listed to illustrate the possibilities of ground-wave dx even during a period of the year that is known more for its E's activities than its extended ground wave.

Long haul dx

Little double hop E skip has appeared during the 1956 skip season. A few weak loggings from the East Coast are reported by Cooper of Fresno, Calif., on May 30, 31 and June 5 and 6. Observer Smith of Wasco, Calif., notes reception from WITI-6, White Fish Bay, Wis., at 1,800 miles, on June 6. Channel 6 double hop is rare.

The longest haul of the current year goes to Robert Seybold of Dunkirk, N. Y. Bob was able to identify triple-hop KENI, channel 2, Anchorage, Alaska, in the late evening of June 27. Station CFRN, channel 3, Edmonton, Alberta, was also seen.

F2 skip reception

Our vhf dx via the F2 layer is thought to be a result of the heavy

Radio Receptor Rectifiers



Really Reliable Replacements



Get them from your parts distributor — There's a standard replacement available for sets of every radio and TV manufacturer.



Semiconductor Division

Radio Receptor Company, Inc.

Radio and Electronic Products Since 1922

240 Wythe Ave., Brooklyn 11, N. Y. • EVERgreen 8-6000

\$100,000

Hi-Lo is covered by a \$100,000.00 insurance policy issued by one of the largest insurance companies.*

GUARANTEED PERFORMANCE

Each and every Hi-Lo is backed by a money back guarantee. For the best reception, unsurpassed clear pictures, specify Hi-Lo, with the exclusive highest gain, spiral designs which are covered by the following U.S. patent numbers: 2,495,579; 2,583,745; 2,724,773; 2,748,387; 2,755,466; and Canadian Patents 1951 and 1956; other patents pending.

New...
Just what
you asked
for!

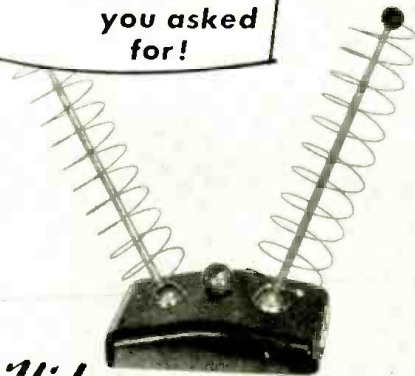

Hi-Lo Model 505 — Channels 2-83
The spiral antenna that is designed for maximum performance featuring the NEW TELESCOPING DIPOLES. This versatile antenna swivels on ball and socket in any direction. Gold spirals, plastic base blend with any room. LIST... \$14.95

New...
For every
TV
owner



Hi-Lo Model 404 Channels — 2-83.
NEW INDOOR ANTENNA
that swivels with a gentle touch of your little finger. Dipoles swivel on ball and socket in every direction. Golden spirals and decorative plastic base blend with all furniture. RECEPTION IS GUARANTEED. LIST... \$12.95

*name upon request



Hi-Lo Model 101 — Channels 2-13.
The original and world famous antenna that is wanted, demanded and used for GUARANTEED FINEST RECEPTION. No rods to adjust. Provides clearest pictures faster. LIST... \$9.95



Hi-Lo Model 303 — Channels 14-83.
The UHF ANTENNA with the highest signal gain that is specially designed for ALL UHF areas. Luxurious gold upright and crossbar. LIST... \$5.95



Hi-Lo Model 202 — Channels 2-83
PEAK PERFORMANCE which is unsurpassed is guaranteed with this antenna... for ANY and EVERY area. The gleaming gold upright, shiny spirals, bakelite base, aluminum bars, modern design

... all make this YOUR BEST ANTENNA BUY.

LIST... \$9.95

INSIST ON THE GENUINE Hi-Lo Spiral Antennas!
Known and accepted everywhere, Hi-Lo is manufactured and GUARANTEED by the best antenna manufacturer in the world. Hi-Lo is consumer accepted and approved.

Hi-Lo TV ANTENNA CORP.
3540 North Ravenswood Avenue
Chicago 13, Illinois

TELEVISION

radiation from the sunspots during years of peak sunspot activity. Each of these spots is capable of a certain amount of corpuscular radiation which causes the F2 layer to ionize and take on the qualities of a mirror (as the layer appears to a radio or television wave). When the radiation is present to a high enough degree, the layer becomes such a perfect "mirror" that even our shorter wavelengths (such as television waves) are reflected from it and return to earth at a distant point. Thus, as the sunspot count continues to increase, and the radiation reaching the F2 layer does likewise, our F2 layer comes closer and closer to becoming a mirror to television waves.

From all present indications, dx-ers in the United States south of a line stretching from Norfolk, Va., to San Francisco, Calif., should have excellent results from such as channel 2, Caracas, Venezuela; channel 2, Rio de Janeiro, and channel 3, Sao Paulo, Brazil, beginning around the first week of October. West Coast dx-ers should have similar results with stations from the Hawaiian islands.

Forecast

Sporadic-E skip for the months of October and November will fall off sharply from its summertime high, being confined to the more southern states for the most part. Long-term predictions list the period of Oct. 15-27 as the best period to catch any E-skip openings. Those openings that do occur will be short, usually in the early evening hours LST. Watch the east-west paths as the sun begins to set over the horizon.

Tropospheric dx (extended ground wave) will continue to be good throughout October, gradually falling off in November as the colder weather sets in. Observers near the Great Lakes should be alert for late-evening reception on the high-band vhf and uhf channels in the 200-500-mile range. Early-morning reception on the whole vhf-uhf spectrum will also be good. Along the Gulf coast and Atlantic seaboard the late evening hours will be especially productive when the trailing edges of areas of high barometric pressure cover your section of the country. A high barometer, gradually falling, is a good sign of tropospheric dx. For long-range uhf reception, similar barometric pressure readings, coupled with high relative humidity in the 50's or above, will pay off in nice catches.

The first of the F2 layer dx reception for United States observers should occur during the period of Oct. 11-15, in the early morning hours, on north-south paths. Watch channels 2-4 for reception from South American stations in Venezuela, Brazil, Guatemala and Puerto Rico during the hours 0700-1100 and 1600-1900 LST. Similar reception from the Hawaiian Islands should be noted by alert observers in Southwestern part of the United States. END



FOR THE BEST IN COLOR... VIEWERS INSIST ON ALLIANCE TENNA-ROTOR

New decorator colors—Forest Green and Ivory—
—for Alliance Tenna-Rotor control cases—are
selected to blend with the major color trends
in contemporary home decorations.

*More than 3,000,000
Alliance Tenna-Rotors are in use*

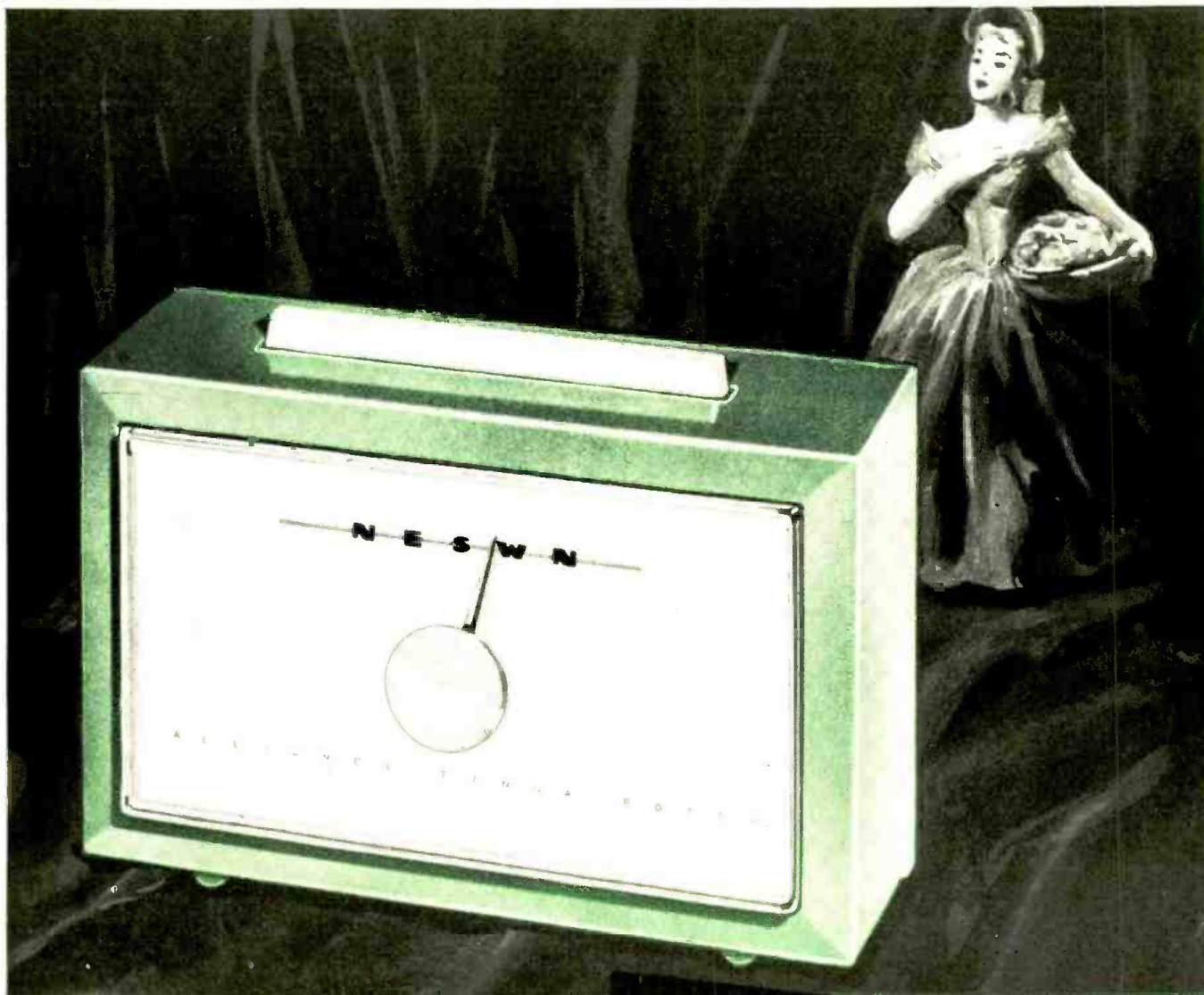

Model T-12-G above—with
famous Tenna-Teller Pointer.
Model U-98-G Left—Deluxe
model—completely automatic.

Color Set Owners Protect Their Investment with Alliance Tenna-Rotor!

Millions of viewers will want color—even if it is more costly
and critical! ALLIANCE TENNA-ROTOR helps to minimize
ghosting—makes for stronger, clearer color definition...
expands color viewing in all markets.

Color can be critical—good color, like good black and
white will improve with a directional antenna which can



be beamed with pin-point accuracy using the famous
ALLIANCE TENNA-ROTOR.

THE ALLIANCE MFG. CO., INC., ALLIANCE, OHIO
(Division of Consolidated Electronics Industries Corp.)

In Canada—ALLIANCE MOTORS, Schell Avenue, Toronto 10

Superior's New Model TC-55



New! SICO Streamlined TUBE TESTERS

FOR

The Experimenter or Part-time Serviceman, who has delayed purchasing a higher priced Tube Tester.
The Professional Serviceman, who needs an extra Tube Tester for outside calls.
The busy TV Service Organization, which needs extra Tube Testers for its field men.

Speedy, yet efficient operation is accomplished by: Elimination of old style sockets used for testing obsolete tubes (26, 27, 57, 59, etc.) and providing sockets and circuits for efficiently testing the new Noval and Sub-Minor types.

• You can't insert a tube in wrong socket. Separate sockets are used, one for each type of tube base. • "Free-point" element switching system Any pin may be used as a filament pin and the voltage applied between that pin and any other pin, or even the "top-cap". • Checks for shorts and leakages between all elements. Provides a super sensitive method of checking for shorts and leakages up to 5 Megohms between any and all of the terminals. Continuity between various sections is individually indicated. • Elemental switches are numbered in strict accordance with R.M.A. specification. The 4 position fast-action snap switches are all numbered in exact accordance with the standard R.M.A. numbering system.

Model TC-55 comes complete with operating instructions and charts and streamlined carrying case.

\$26⁹⁵ NET

PICTURE TUBE TESTER



Superior's New Model TV-40



- Tests all magnetically deflected tubes . . . in the set . . . out of the set . . . in the carton!
- A complete picture tube tester for little more than the price of a "make-shift" adapter!!

The Model TV-40 is absolutely complete! Self-contained, including built-in power supply, it tests picture tubes in the only practical way to efficiently test such tubes; that is by the use of a separate instrument which is designed exclusively to test the ever increasing number of picture tubes!

SPECIFICATIONS

Tests all magnetically deflected picture tubes from 7 inch to 30 inch types. • Tests for quality by the well established emission method. All readings on "Good-Bad" scale. • Tests for inter-element shorts and leakages up to 5 megohms. • Test for open elements.

Model TV-40 comes absolutely complete — nothing else to buy. Housed in round cornered, molded bakelite case. Only . . .

\$15⁸⁵ NET

Superior's New Model TV-11

Standard Professional TUBE TESTER



- ★ Uses the new self-cleaning Lever Action Switches for individual element testing. Because all elements are numbered according to pin-number in the RMA base numbering system, the user can instantly identify which element is under test. Tubes having tapped filaments and tubes with filaments terminating in more than one pin are truly tested with the Model TV-11 as any of the pins may be placed in the neutral position when necessary.
- ★ The Model TV-11 does not use any combination type sockets. Instead individual sockets are used for each type of tube. Thus it is impossible to damage a tube by inserting it in the wrong socket.
- ★ Free-moving built-in roll chart provides complete data for all tubes.
- ★ NOISE TEST: Phono-jack on front panel for plugging in either phones or external amplifier will detect microphonic tubes or noise due to faulty elements and loose internal connections.

EXTRA SERVICE — The Model TV-11 may be used as an extremely sensitive Condenser Leakage Checker. A relaxation type oscillator incorporated in this model will detect leakages even when the frequency is one per minute.

The model TV-11 operates on 105-130 Volt 60 Cycles A.C. Comes housed in a beautiful hand-rubbed oak cabinet complete with portable cover.

\$47⁵⁰ NET

TRANS-CONDUCTANCE TUBE TESTER

Superior's New Model TV-12

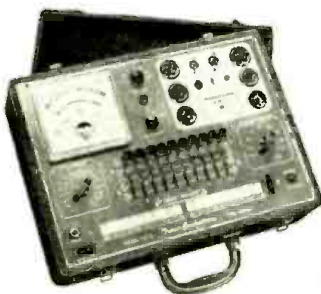

TESTING TUBES

- ★ Employs improved TRANS-CONDUCTANCE circuit. An in-phase signal is impressed on the input section of a tube and the resultant plate current change is measured. This provides the most suitable method of simulating the manner in which tubes actually operate in Radio & TV receivers, amplifiers and other circuits. Amplification factor, plate resistance and cathode emission are all correlated in one meter reading.
- ★ NEW LINE VOLTAGE ADJUSTING SYSTEM. A tapped transformer makes it possible to compensate for line voltage variations to a tolerance of better than 2%.
- ★ SAFETY BUTTON—protects both the tube under test and the instrument meter against damage due to overload or other form of improper switching.

- ★ NEWLY DESIGNED FIVE POSITION LEVER SWITCH ASSEMBLY. Permits application of separate voltages as required for both plate and grid of tube under test, resulting in improved Trans-Conductance circuit.

TESTING TRANSISTORS

A transistor can be safely and adequately tested only under dynamic conditions. The Model TV-12 will test all transistors in that approved manner, and quality is read directly on a special "transistor only" meter scale.

Model TV-12 housed in handsome rugged portable cabinet sells for only

\$72⁵⁰ NET

ALSO TESTS TRANSISTORS!

**EXAMINE BEFORE YOU BUY!
USE APPROVAL FORM ON NEXT PAGE**

New!



20,000 OHMS PER VOLT

ALLMETER

Superior's New Model TV-60

Includes services never before provided by an instrument of this type. Read and compare features and specifications below!



FEATURES

- ★ Giant recessed 6½ inch 40 Microampere meter with mirrored scale.
- ★ Built-in Isolation Transformer.
- ★ Use of the latest type printed circuit and 1% multipliers assure unchanging accurate readings.

- 8 D.C. VOLTAGE RANGES** (At a sensitivity of 20,000 Ohms per Volt) 0 to 15/75/150/300/750/1500/7500/30,000 Volts.
7 A.C. VOLTAGE RANGES: (At a sensitivity of 5,000 Ohms per Volt) 0 to 15/75/150/300/750/1500/7500 Volts.
3 RESISTANCE RANGES: 0 to 2,000/200,000 Ohms, 0-20 Megohms.
2 CAPACITY RANGES: .00025 Mfd. to 30 Mfd.
5 D.C. CURRENT RANGES: 0-75 Microamperes, 0 to 7.5/75/750 Milliampere, 0 to 15 Amperes.
3 DECIBEL RANGES: -6 db to + 58 db.

- R.F. SIGNAL TRACER SERVICE**: Enables following the R.F. signal from the antenna to speaker of any radio or TV receiver and using that signal as a basis of measurement to first isolate the faulty stage and finally the component or circuit condition causing the trouble.
AUDIO SIGNAL TRACER SERVICE: Functions in the same manner as the R.F. Signal Tracing service specified above except that it is used for the location of cause of trouble in all audio and amplifier systems.

Model TV-60 comes complete with book of instructions: pair of standard test leads; high-voltage probe; detachable line cord; R.F. Signal Tracer Probe and Audio Signal Tracer Probe. Pliofilm bag for all above accessories is also included. Price complete. Nothing else to buy. ONLY

\$52⁵⁰ NET

**SHIPPED ON APPROVAL
NO MONEY WITH ORDER
NO C.O.D.**



Superior's New Model TV-50

GENOMETER

A versatile all-inclusive GENERATOR which provides ALL the outputs for servicing:
 A.M. Radio • F.M. Radio • Amplifiers • Black and White TV • Color TV

- R. F. SIGNAL GENERATOR**: Provides complete coverage for A.M. and F.M. alignment. Generates Radio Frequencies from 100 Kilocycles to 60 Megacycles on fundamentals and from 60 Megacycles to 180 Megacycles on powerful harmonics. • **VARIABLE AUDIO FREQUENCY GENERATOR**: In addition to a fixed 400 cycle sine-wave audio, the Genometer provides a variable 300 cycle to 20,000 cycle peaked wave audio signal. • **BAR GENERATOR**: Projects an actual Bar Pattern on any TV Receiver Screen. Pattern will consist of 4 to 16 horizontal bars or 7 to 20 vertical bars. • **CROSS HATCH GENERATOR**: Genometer will project a cross-hatch pattern on any TV picture tube. The pattern will consist of non-shifting horizontal and vertical lines interlaced to provide a stable cross-hatch effect. • **DOT PATTERN GENERATOR (FOR COLOR TV)**: The Dot Pattern projected on any color TV Receiver tube by the Model TV-50 will enable you to adjust for proper color convergence. • **MARKER GENERATOR**: The following markers are provided: 189 Kc., 262.5 Kc., 456 Kc., 600 Kc., 1000 Kc., 1400 Kc., 1600 Kc., 2000 Kc., 2500 Kc., 3579 Kc., 4.5 Mc., 5 Mc., 10.7 Mc., (3579 Kc. is the color burst frequency.)

MODEL TV-50 comes absolutely complete with shielded leads and operating instructions.

\$47⁵⁰ NET

TRY ANY

of the instruments on this or on the facing page, for 10 days before you buy. If completely satisfied then send down payment and pay balance as indicated on coupon. No Interest or Finance Charges Added!

If not completely satisfied return unit to us, no explanation necessary.

MOSS ELECTRONIC DISTRIBUTING CO., INC.
 Dept. D-291, 3849 Tenth Ave.
 New York 34, N.Y.

Please send me the units checked. I agree to pay down payment within 10 days and to pay the monthly balance as shown. It is understood there will be no finance or interest charges added. It is further understood that should I fail to make payment when due, the full unpaid balance shall become immediately due and payable.

Name _____
 Address _____
 City _____ Zone _____ State _____

- Model TC-55. Total Price \$26.95
\$6.95 within 10 days. Balance \$5.00
monthly for 4 months.
- Model TV-12. Total Price \$72.50
\$22.50 within 10 days. Balance \$10.00
monthly for 5 months.
- Model TV-60. Total Price \$52.50
\$12.50 within 10 days. Balance \$8.00
monthly for 5 months.
- Model TV-11. Total Price \$47.50
\$11.50 within 10 days. Balance \$6.00
monthly for 6 months.
- Model TV-40. Total Price \$15.85
\$3.85 within 10 days. Balance \$4.00
monthly for 3 months.
- Model TV-50. Total Price \$47.50
\$11.50 within 10 days. Balance \$6.00
monthly for 6 months.

All Prices net, F.O.B. N.Y.C.

ITV

Part III: The interlaced TV system; a commercial sync generator

pulse-generator techniques

By EDWARD M. NOLL*

TO obtain the necessary sync stability to interlace the lines of the second field between those of the first in an interlaced television system, a fixed frequency ratio between horizontal and vertical scanning rates must be established. It is necessary therefore to derive the vertical pulses indirectly from the horizontal pulse source via a counter chain. If the field rate is to be locked in with the power frequency, an additional circuit in the form of a phase detector is required. Hence the pulse generator of an interlace system not only includes the basic pulse-forming circuit but also a counter chain and phase detector for a locked-in interlaced scanning raster.

Counters

A counter circuit as used in TV is a pulse frequency divider—for so many input pulses to the counter one pulse leaves the counter. In a 5-to-1 counter 1 pulse leaves for every 5 applied.

If the input pulse frequency of 31,500 per second is applied to a 7-to-1 counter, the output frequency is 4,500 pulses per second. The pulse frequency has

*Author, *Closed-Circuit and Industrial Television* (Macmillan)

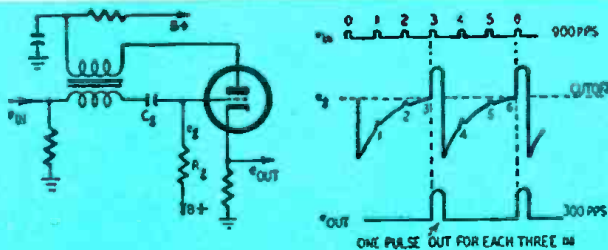

Fig. 1—The basic blocking oscillator counter and associated waveforms.

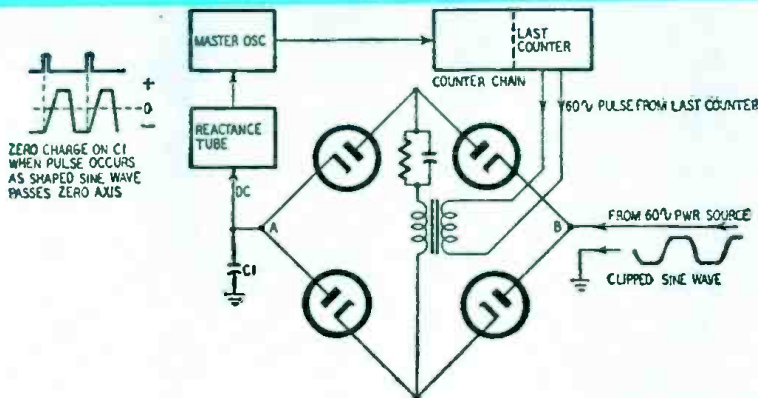

Fig. 2—Diagram shows fundamentals of a simple phase detector system.

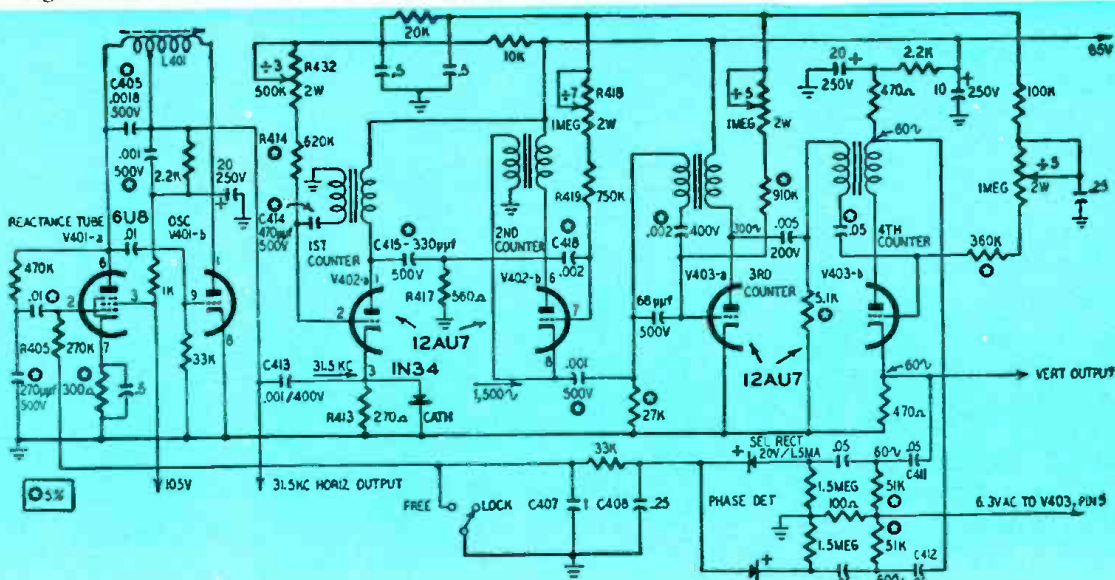

Fig. 3—Schematic diagram of sync generator in General Precision TV camera.

TELEVISION

been divided by a factor of 7. If the 4,500-pulses-per-second signal is applied to a second 5-to-1 counter the new output frequency is 900 pulses per second. When the output of this second counter is applied to a third counter, having a ratio of 5 to 1, the output frequency is 180 pulses per second. Finally, if the 180-pulses-per-second signal is applied to a 3-to-1 counter the last output has a frequency of 60 pulses per second. Thus in a series of four counters, $7 \times 5 \times 5 \times 3$, the output has been divided down from 31,500 pulses per second to 60.

The 31,500-pulses-per-second signal can also be applied to a 2-to-1 counter to produce an output pulse frequency of 15,750 per second. Hence it is possible to derive indirectly both the standard line-rate frequency of 15,750 and the field-rate frequency of 60 from a single so-called "master" pulse generator operating on 31,500 cycles. The line and field rates have been locked together because they are derived from the same signal source.

The quantities $7 \times 5 \times 5 \times 3$ produce a total of 525. Thus the ratio between the input and output of the counter chain is a constant 525 which is the number of lines per frame of the interlaced television system. It is possible to use other combinations of counts to obtain the 525-to-1 ratio. For example, two stable counters with counts of 21 to 1 and 25 to 1 can also produce an overall count of 525 to 1.

A basic blocking oscillator counter and its associated waveforms are shown in Fig. 1. A blocking tube oscillator can be used as a counter when its output frequency is adjusted close to the output pulse frequency desired. For example, if the free-running frequency of a blocking oscillator is adjusted close to 300 cycles, it can be made to function as a counter with an output pulse frequency of 300. If an exact input signal of 900 pulses per second is applied, the oscillator will function as a 3-to-1 counter with an exact output frequency of 300.

The counting activity can be understood by observing the grid waveforms. The arrival of each third pulse occurs at a time when the blocking tube can be driven into conduction. At the instant the oscillator conducts, a positive leading edge or pulse is developed in the cathode circuit, representing the counter output. Thus for each 3 pulses applied to the grid of the blocking oscillator (counter) 1 pulse appears at the cathode and—in effect—we have a synchronized 3-to-1 counter. The blocking oscillator is synchronized by every third input pulse. Consequently, its output will always be exactly one-third the frequency of the input pulses. The other two input pulses occur when the blocking tube grid is beyond cutoff and therefore are not able to reach up and trigger the oscillator into conduction. It is only the third pulse that is so timed that it occurs just before the blocking oscillator normally goes into

**WHEN CORROSION ATTACKS
PERMA-TUBE STAYS CLEAN**
... and so does your reputation

**J & L
M**

Look for this brand mark
—only genuine Perma-Tube
gives you this protection

Here's why PERMA-TUBE backs up quality service:

1. **PERMA-TUBE IS CORROSION-PROOF** . . . it's treated with vinyl-synite—then coated *inside and outside* with a metallic vinyl resin base. It's guaranteed to be free from rust in a salt spray test of 500 hours minimum to an American Society of Testing Materials Specification B117-49T. This assures long life.
2. **PERMA-TUBE IS STURDY** . . . it's made of special, high-strength J&L Steel.
3. **PERMA-TUBE IS EASILY INSTALLED** . . . it's the only mast with *both ends* of the joint machine fitted.

Here's proof of how PERMA-TUBE resists corrosion:

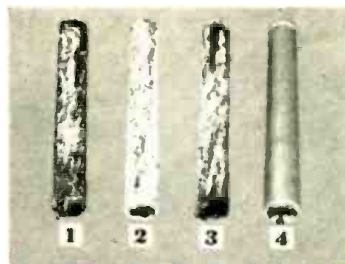

Test samples after 1440 hours
ASTM salt spray test

1. Coated Mechanical Tubing . . . note that galvanized coating is gone and underlying steel is severely corroded.
2. Coated Mechanical Tubing . . . note that paint coating is nearly destroyed and zinc coating is corroded.
3. Galvanized Mechanical Tubing . . . note zinc and steel are corroded.
4. PERMA-TUBE . . . note that Perma-Tube is relatively unharmed.



For further details on product and installation, write for a copy of the Perma-Tube booklet. Jones & Laughlin Steel Corporation, Dept. 496, 3 Gateway Center, Pittsburgh 30, Pa.

Jones & Laughlin
STEEL CORPORATION · PITTSBURGH

... another
MALLORY
service-engineered
product

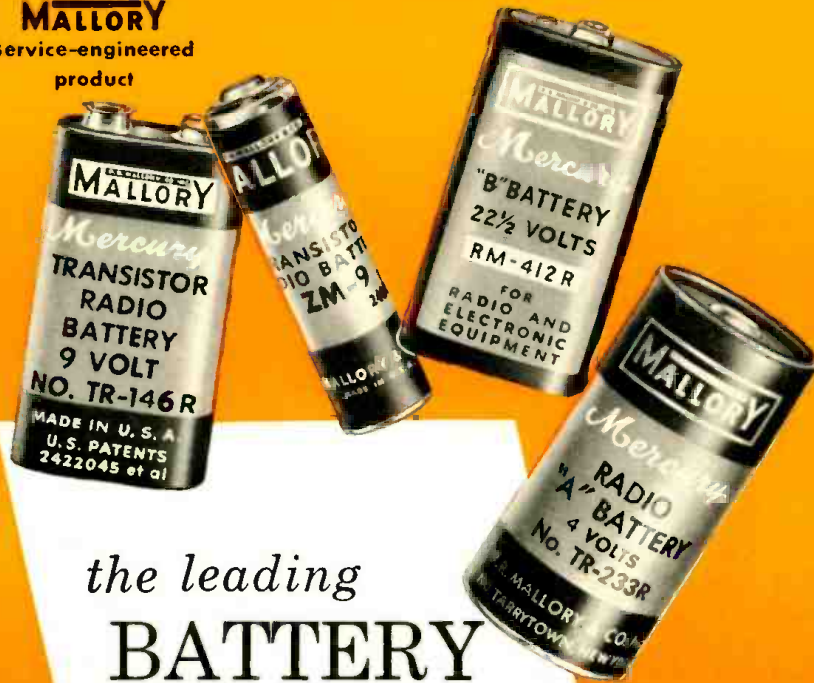

the leading
BATTERY
LINE
for miniature
transistor radios

Mallory Mercury Batteries are your best bet for the big new market offered by new "pocket-size" transistor portable radios—

First in performance. Mallory pioneered the mercury battery—the powerful, long-life power source that helped make these new radios possible.

First in value. Mallory Mercury Batteries cost less per hour of operation. They're fast-moving, good profit-makers for you . . . good value for your customers, too!

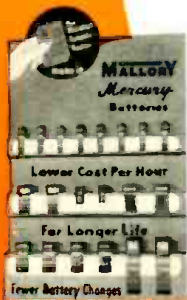

**SPECIAL INTRODUCTORY
BATTERY MERCHANDISER**

Because of the remarkable shelf life of Mallory Mercury Batteries, now for the first time you can stock batteries without fear of inventory loss. This introductory assortment covers all popular transistor portables. No extra charge for the display unit! Order yours today!

P. R. MALLORY & CO. Inc.
MALLORY

P. R. MALLORY & CO. Inc., INDIANAPOLIS 6, INDIANA

- Capacitors
- Controls
- Vibrators
- Switches
- Resistors
- Rectifiers
- Power Supplies
- Filters
- Mercury Batteries

TELEVISION

conduction at its free-running frequency.

Several types of basic relaxation oscillators and feedback circuits can be used as counters—multivibrators, step-voltage counters, phanastrons and others. Most of these basic circuits are modified or employ special stabilizing circuits to insure an accurate and stable count.

Phase detector

The phase detector compares the 60-cycle pulse output of the final counter with a power-line 60-cycle component. As shown in Fig. 2 it interprets any change in frequency or phase of the sine wave with relation to the pulse, developing a dc component which is applied as a regulating voltage to a so-called control tube. The tube, in conjunction with this dc voltage component, is able to make frequency adjustments of the master oscillator. The extent of the change is just enough to preserve a fixed count even though the output frequency is not exactly 60 cycles because of a power-line change in frequency or phase. Thus the frequency of the master oscillator and the output frequency of the last counter do vary with changes in power-line frequency but the count ratio between the master oscillator and the output of the last counter remains constant.

As an example, if the 525-to-1 counter chain is used, the actual 525-to-1 count will remain absolutely fixed regardless of changes in the power-line frequency and phase. Nonetheless the pulse generator is able to follow the power-line changes and thereby prevents disturbing hum patterns on the raster.

A basic phase detector circuit is shown in Fig. 2. It consists of a bridge network of four diodes with the pulse signal from the last counter applied across one pair of corners of the bridge and a 60-cycle sine-wave component from the ac source (clipped, for voltage reference) across the other. When the incoming pulse from the last counter coincides in frequency and phase with the incoming sine wave, a zero voltage is developed from A to B of the bridge. Thus the charge on capacitor C1 is zero because the pulse from the counter occurs when the sine wave is passing through its zero axis. This action is similar to the horizontal control circuits used in modern television receivers. If there is a departure in the in-phase relationship between the two signals, the incoming pulse from the counter will occur when the sine wave is above or below its zero axis. Thus the charge on the capacitor becomes plus or minus as a function of the direction of the phase change.

The dc voltage at the output of the phase detector is applied to the grid of a reactance tube. The reactance tube in turn is a pair of the resonant tank circuit of the master oscillator. Thus any change of reactance tube

TELEVISION

bias results in a shift of the constants in the tuned circuit, changing the master oscillator frequency. This shift in frequency is sufficient to cause the output of the very last counter to correct itself and once again appear in phase with the signal from the ac power source.

GPL sync generator

The sync generator (Fig. 3) of the General Precision Laboratory industrial TV camera consists of three dual-function tubes. The triode section of V401 is a stabilized Hartley oscillator. The tuned circuit consists of tunable inductor L401 and capacitor C405 with one side returned to the plate of the pentode section of the tube. The pentode section functions as a reactance tube shunted across the oscillator tuned circuit. When the plate current of the pentode tube changes, due to the dc voltage applied to its grid, the reactive component it contributes to the tuned circuit varies and makes the necessary correction in the oscillator frequency. The grid of the reactance tube is coupled back through resistor R405 to the dc voltage contributed by a phase detector.

The 31.5-kc horizontal output is taken off the oscillator and used to trigger a 2-to-1 blocking oscillator in the sweep system of the television camera. The 31.5-kc component is also applied to the cathode of the first counter (half of V402) through differentiating circuit C413 and R413. The positive components of the signal are flattened by the crystal diode that shunts R413. The negative spikes of the 31.5-kc signal trigger and synchronize the 3-to-1 blocking oscillator.

Negative sync pulses on the cathode function in the same manner as positive pulses at the grid. Consequently, every third pulse drives the grid into conduction. The 10,500-cycle component is coupled through a second differentiating circuit, consisting of C415 and R417, to the grid of the second counter (half of V402). The differentiating circuit sharpens the pulses to insure positive triggering of the counter.

The frequency of the first blocking oscillator is controlled by the grid time constant consisting of C414, R414 and R432 which brings the frequency of the blocking oscillator near 10,500 cycles so that it can be locked in by the incoming pulses from the master oscillator.

The second blocking oscillator is a 7-to-1 counter. The output removed from its cathode circuit has a frequency of 1,500 pulses per second. Thus every seventh pulse from the first counter triggers the grid of the second. To operate at this much lower frequency the grid time constant of the second counter is much longer than that of the first—capacitor C418 has a larger value than capacitor C414. Likewise resistors R418 and R419 have a combined resistance larger than that employed in

...another
MALLORY
service-engineered
product

to prevent
"middle age hum"



use capacitors with ...

Etched Cathode

Etched Cathode construction

is standard in all Mallory FP's, and in popular Mallory metal and cardboard tubular electrolytics . . . at no extra cost!

Your Mallory distributor can tell you why this *extra* performance feature is important to you and to your customers.

P. R. MALLORY & CO. Inc.
MALLORY

P. R. MALLORY & CO. Inc., INDIANAPOLIS 6, INDIANA

- Capacitors
- Vibrators
- Resistors
- Power Supplies
- Mercury Batteries
- Controls
- Switches
- Rectifiers
- Filters

CERAMIC CARTRIDGES

American
"Clearamic"

LOADED with PROFIT

- Lightweight, miniature size, greater compliance
- New mechanical construction gives higher output
- New "throw-away" element
- Simple replacement, snap-in action
- Assorted stock orders totaled for maximum discount
- "Clearamic"—The "new look in good listening"

New Turnover Type



Response . . . 40-12,000 cycles
Output . . . 1-1.2 volts

New Single Needle Type



Response . . . 40-12,000 cycles
Output . . . 1-1.2 volts

Turnover type features "throw-away" element offering snap-in replacement of both element and needle assembly for essentially the price of a good replacement needle. Single needle type features simplified self-locating needle replacement.

Ask for the handy new "dispenser" assortment — meets almost all replacement needs.

ELECTRONICS DIVISION
ELGIN NATIONAL WATER COMPANY
For Cartridges:
370 South Fair Oaks Avenue
Pasadena 1, California
Sales representatives in principal cities.

TELEVISION

Basic units of the General Precision model PD-150-1 television system—a camera and portable camera control.



the grid circuit of the first counter. Both grid circuits are returned to a B-plus point. This arrangement improves the stability of a blocking tube oscillator by making the grid discharge cycle sharper; therefore triggering is more positive and less likely to be influenced by circuit and signal variations.

A 1,500-cycle signal is coupled from the cathode of the second counter to the grid of the third. The third counter operates with a 5-to-1 ratio to produce a 300-cycle output that triggers the final 5-to-1 counter which counts the signal down to 60 cycles. These blocking oscillator circuits (V403) are similar to the first two with the exception that the grid time constants and transformers have been chosen to operate at the low frequencies of 300 and 60 cycles.

The total count therefore is $3 \times 7 \times 5 \times 5$ to produce 525. The GPL industrial television camera (see photo) is thereby a 525-line system using a line rate of 15,750 and a field rate of 60 cycles. Hence its output can be used to synchronize directly a standard television receiver producing an interlaced 525-line raster identical to that formed by an incoming commercial telecast signal.

The 60-cycle vertical timing pulse is removed at the cathode of the last counter and fed to the vertical pulse-generating stages of the camera. Two pulses for the phase detector system are also removed from the last counter. A positive pulse is taken off the cathode and applied through C411 to the phase detector circuit. An equal-amplitude but opposite-polarity pulse is removed from the plate circuit of the last counter and applied through C412 to the lower side of the phase detector resistor network.

The phase detector circuit employed in the GPL sync generator is similar to the type of circuit used in the phase detector method of horizontal frequency

control in standard TV receiver practice. A 60-cycle 6.3-volt reference signal is applied to the junction point of the phase detector network. When the applied pulses from the last counter coincide with the zero axis of the 60-cycle ac component the diode currents flowing through the selenium rectifiers are balanced. However, when there is a phase displacement so that the 60-cycle signal is above or below the zero axis at the time of pulse application the network is unbalanced and the selenium rectifier currents change. Consequently the steady-state charges on capacitors C407 and C408 change and alter the bias applied to the grid of the reactance tube. A change in the reactance tube grid bias makes the necessary correction in the frequency of the master oscillator. This change is reflected through the entire counter chain and restores the phase of the signal at the output of the last counter to correspond to that of the reference sine wave.

A switch shunting C407 allows 60-cycle lock-in or free-running operation of the sync generator. The free-running position is used for making certain adjustments and when there is erratic fluctuation of the 60-cycle source.

The GPL camera is mounted in a small versatile housing that can be controlled from a distance up to 500 feet. In fact, the housing is such that the camera can be panned left and right or tilted up and down from the remote-control location. In addition remote control of lens optical focus and iris aperture is possible. These are mechanical adjustments. The camera control unit can also be spaced at the same distance from the camera proper and from this point the electrical focus and other camera-tube adjustments can be made. Thus the camera can be mounted in an inconvenient or hazardous position and all controls and adjustments made from the remote viewing position. END

you get the most for your money in
ALLIED'S own knight-kits

THE FINEST ELECTRONIC EQUIPMENT IN MONEY-SAVING KIT FORM

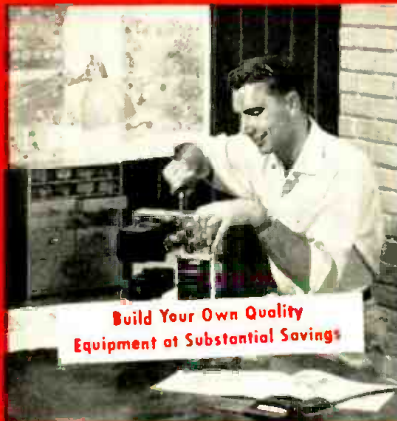

Buy With Confidence From the Pioneers in Electronic Kits

LOWEST COST—our huge buying power means biggest savings for you. You do the easy assembly and your finished instrument is equal in performance and appearance to equipment selling for several times the remarkably low KNIGHT-KIT price.

ADVANCED DESIGN—months of research, development and field-testing go into each KNIGHT-KIT to bring you the latest advances in quality design. And to assure top performance, premium quality parts are supplied in each kit.

EASIEST TO ASSEMBLE—all chassis and panels are punched; all parts are clearly identified—resistors are mounted on cards and values are shown. Instruction manuals are a marvel of clarity, featuring "Step-and-Chek" assembly, "King-Size" diagrams and "Spotlight" pictorials. All you need are soldering iron, pliers and screwdriver.

ALLIED stakes its 36-year reputation in the Electronics field on your complete success and fullest satisfaction with KNIGHT-KITS.

TEST EQUIPMENT • HAM GEAR • HOBBYIST KITS • HI-FI KITS



LATEST
PRINTED
CIRCUIT

**NEW knight-kit LOW COST
 GENERAL-PURPOSE 5" OSCILLOSCOPE KIT**

Model F-146

\$49⁵⁰

Outstanding value in an all-new, highly versatile 5" oscilloscope kit. Perfect for visual display of all commonly encountered waveforms. Excellent for AM, FM and TV servicing, plus other high-frequency applications. An easy-to-build, easy-to-use, dependable performer that matches or beats commercially wired 'scopes selling at several times more. Up-to-the-minute kit design features printed circuit, laced wiring harness, and pre-cut wires for quick and easy assembly. Has 4 sweep ranges, 15-150,000 cps. High vertical sensitivity: 25 rms millivolts/inch; input impedance, 3.3 megs and 45 mmf; response down only 3 db at 700 kc. Horizontal sensitivity, 70 rms mv/inch; response, down only 3 db at 200 kc; input impedance, 2.2 megs and 30 mmf. Deluxe features include DC positioning controls for fast trace positioning; blanking circuit on all ranges to eliminate retrace lines; graph scope screen and internal, regulated calibrating voltage for highly accurate signal measurements; frequency-compensated vertical attenuator; provision for internal or external, positive or negative synchronization; Phantastron linear sweep generator; high 2nd anode voltage for high-intensity trace. Kit is complete with 5" CRT and all tubes—ready for assembly. Blue steel case with "disappearing" handle. Handsome panel in contrasting gray. Size, 14½ x 9½ x 16" deep. Shpg. wt., 40 lbs.

Model F-146. Complete 5" Oscilloscope Kit. Net only **\$49.50**
 F-148. RF Demodulator Probe Kit. Net only **\$3.45**
 F-147. Low-Capacity Probe Kit **\$3.45**

**EASY
 PAYMENT TERMS**

If your total KNIGHT-KIT order is over \$45, take advantage of our liberal Time Payment Plan—only 10% down. Write for application form.



Model F-123

\$44⁷⁵

**NEW knight-kit TV-FM
 SWEEP GENERATOR KIT**

**Guaranteed Linearity • Fool-proof Calibration
 Wide-Range Coverage • Electronic Blanking**

All-new; precision-designed for lab use, TV and FM servicing, production line testing. Covers 300 kc to 250 mc continuous on 4 bands (all fundamentals). Center frequencies of VHF TV channels appear on scales. Exclusive KNIGHT-KIT sweep circuit assures almost perfect linearity—RF sweep output in excess of 0.15 volts, flat within 1 db, is available on all bands. Sweep width continuously variable, 0-13 mc. Crystal-controlled marker oscillator with dual crystal socket and selector switch. Phase control provides blanking shift, 0 to 180°. Step-type and continuous output controls; separate marker amplitude control. Filter connected to 0-50 mc output jack provides 20 db attenuation of frequencies above 50 mc. to assure pure, fundamental output. 5-volt horizontal sweep voltage (for scope) available from front panel. Professional-looking blue-finish steel case with gray panel. Has "disappearing" handle. 8½ x 12 x 7½". With all parts, tubes, test cable, solder and multi-color pre-cut wire. Less crystal. Shpg. wt., 13½ lbs.

Model F-123. TV-FM Sweep Generator Kit. Net only **\$44.75**
 P-286. 4.5 mc Crystal (.005%). Net **\$4.80**
 P-143. 5.0 mc Crystal (.02%). Net **\$3.95**
 P-145. 10.7 mc Crystal (.02%). Net **\$3.95**

ALL PRICES NET F.O.B. CHICAGO

order from **ALLIED RADIO**

100 N. WESTERN AVE., CHICAGO 80, ILLINOIS

SEE FOLLOWING PAGES ➔

ALLIED'S own knight-kits... better by far



knight-kit 5" ALL-PURPOSE WIDE-BAND OSCILLOSCOPE KIT

2 Printed Circuit Boards • 5 Mc Width for Color TV

Model F-144

\$69⁰⁰

Wide-band, 5" Oscilloscope; equals or betters the performance of commercially-wired 'scopes costing several times the price. Two printed circuit boards and laced wiring harness assure wiring accuracy and reduce assembly time. Ideal for lab use, color TV servicing and high frequency applications. Provides unusually wide sweep range—from 15 to 600,000 cps. Locks in at frequencies as high as 9 mc. Vertical response, 5 cycles to 5 mc. Response, down only 1 db at 3.58 mc color burst frequency; down only 3 db at 5 mc. High vertical sensitivity of 25 mv/inch. Input capacity 20 mmf and 3.5 megs. Outstanding features: cathode-follower vertical and horizontal inputs; 2nd anode provides 1400 volts high-intensity trace; push-pull vertical and horizontal amplifiers; positive and negative locking; faithful square wave response; frequency-compensated attenuator; Z-axis input for intensity modulation; one volt P-P calibrating voltage; astigmatism control; blanking circuit to eliminate retrace lines; DC positioning control. Complete with CRT, all tubes and parts. Handsome, professional, blue-finished steel case with "disappearing" handles. 14½ x 9½ x 16". Shpg. wt., 40 lbs.

Model F-144. Wide-Band 5" Oscilloscope Kit. Net only **\$69.00**
 F-148. Demodulator Probe. Net. **\$3.45.** F-147. Low Capacity Probe. 12 mmf. Net. **\$3.45**



NEW knight-kit VOLTAGE CALIBRATOR KIT

Model F-136 **\$12⁷⁵**

Permits the use of any scope as a precision peak-to-peak AC voltmeter. Provides a true square-wave voltage on scope screen. Range switch and calibrated potentiometer permit selecting any voltage between .01 and 100 volts, in 4 ranges. Fifth position of switch feeds external signal to scope for comparison. Constant output on line volt. variation from 80-135 v. ±6% on all ranges. Shunt capacitance only 15 mmf. Use any 20,000 ohms/volt VOM or a VTVM for initial calibration. Direct coupling of output provides ground reference for DC scopes. Portable case, 7¾ x 5¼ x 4¾". Ready to build. Shpg. wt., 5 lbs.

Model F-136. Voltage Calibrator Kit. Net. **\$12.75**



knight-kit LOW COST RF SIGNAL GENERATOR KIT

Model F-145 **\$19⁷⁵**

Build this wide-range extremely stable RF signal generator and save two-thirds the cost of a comparable wired instrument. Ideal for alignment of RF and IF stages in radio and TV sets, and for troubleshooting audio equipment. Delivers output on fundamentals from 160 kc all the way out to 110 mc; useful harmonics to 220 mc. Has built-in 400-cycle sine-wave audio oscillator for modulating RF; audio is also available externally. Features high-stability Colpitts circuit with precision-wound coils—no calibration necessary. Has input for external modulator. Maximum audio output, 10 volts. RF output, over 100,000 micro-volts. Step and continuous-type output attenuators. With all parts, tubes, wire and solder. Portable case, 7 x 10 x 5". Shpg. wt., 10 lbs.

Model F-145. RF Signal Generator Kit. Net only **\$19.75**



Model F-135
\$26⁵⁰

knight-kit VISUAL-AURAL SIGNAL TRACER KIT

A remarkable value in an instrument which permits visual and aural signal tracing of RF, IF, video and audio circuits—has highest gain in its price class. Traces the signal from the antenna to the speaker. Reproduces signal at plate or grid connection of any stage. Identifies and isolates "dead" stages. Features: usable gain of 91,000; "magic eye" with calibrated attenuators for signal presence indication and stage-by-stage gain measurements; built-in 4" PM speaker; single probe with plug-in head gives instant choice of RF or audio tracing. Provides noise test; built-in watt meter calibrated from 25 to 1000 watts; provision for external scope or VTVM. Blue-finish steel case. Shpg. wt., 13 lbs.

Model F-135. Signal Tracer Kit. Net only **\$26.50**



Model F-129
\$37⁹⁵

NEW knight-kit 6-12 VOLT BATTERY ELIMINATOR KIT

A valuable new unit for servicing auto radios, mobile gear, etc. Delivers continuously variable filtered DC output from 0 to 15 volts. Provides DC output at 0-8 volts or 0-15 volts. Continuous current rating: 12.5 amps at 6 volts, 10 amps at 12 volts. Can also be used as battery charger. Oversize rectifiers and transformer for better regulation and long life. Two meters provide simultaneous current and voltage readings; ranges: 0-15 volts DC; 0-20 amps DC. Doubly protected: fused primary and automatic-reset overload relay for secondary. Heavy-duty binding posts. Blue-finish steel case with "disappearing" handle. With all parts, solder and pre-cut wire. 9 x 12¼ x 7¾". Shpg. wt., 20 lbs.

Model F-129. Power Supply Kit. Net only **\$37.95**



knight-kit AUDIO GENERATOR KIT

Model F-137 **\$37⁵⁰**

An ideal audio frequency source for checking audio circuits and speaker response. Covers: 20 cps to 1 mc in 5 ranges. Output voltage: 10 volts into 600 ohms impedance. Offers the flat response of a lab standard—±1 db to 1 meg. Generator imp., 600 ohms. Less than .25% distortion from 100 cps through the audible range; less than .5% when driving 600 ohm load at maximum output. Cont. var. step-attenuated output. 17 lbs.

Model F-137. Audio Generator Kit. Net only **\$37.50**

knight-kit RESISTANCE SUBSTITUTION BOX KIT

Model F-139 **\$5⁹⁵**



Model F-139. Resis. Sub. Box Kit. Net. **\$5.95**

knight-kit CAPACITANCE SUBSTITUTION BOX KIT

Model F-138 **\$5⁹⁵**



Model F-138. Cap. Sub. Box Kit. Net. **\$5.95**

QUALITY ELECTRONIC TEST EQUIPMENT IN MONEY-SAVING KIT FORM

...easiest to build...you get more...YOU SAVE MORE

4 1/2" Meter



Model F-128 \$16⁹⁵

knight-kit
1000 OHMS/VOLT VOM KIT

Exceptional accuracy and versatility at amazing low cost. Ideal for service shop, lab and Amateur use. Uses 4 1/2" meter (400 microamp movement) with separate scales for AC voltage and current, DC voltage and current, decibels and resistance. 38 ranges include: AC, DC and output volts, 0-1-5-10-50-100-500-5000 (1000 ohms/volt sensitivity); Resistance, 0-1000-100,000 ohms and 0-1 meg.; Current, AC or DC, 0-1-10-100 ma and 0-1 amps; Decibels, -20 to +69 in 6 ranges. Uses 1% precision resistors. 3-position function switch and 12-position range switch. Complete kit with bakelite case, (6 3/4 x 5 1/4 x 3 3/4"), battery, pre-cut wire, solder and test leads. Shpg. wt., 2 1/2 lbs.

Model F-128, 1,000 ohms/volt VOM Kit. Net only \$16.95



Model F-140 \$29⁵⁰

knight-kit
20,000 OHMS/VOLT VOM KIT

Outstanding quality and performance at extremely low cost. Features 32 ranges; full vision 4 1/2" meter; accuracy ±2% of full scale; 50 microampere sensitivity for 20,000 ohms/volt input resistance on DC; front panel "zero adjust". Single switch selects function and range. Range: AC, DC and output volts, 0-2.5, 10-50-250-1000-5000; Resistance, 0-2000-200,000 ohms and 0-20 meg.; DC ma, 0-1-10-100; DC amps, 0-1-10; Decibels, -30 to +63 in 6 ranges. Uses precision 1% multipliers. Moisture-resistant film-type resistors. Complete kit with bakelite case (6 3/4 x 5 1/4 x 3 3/4"), batteries, pre-cut wire, solder and test leads. Shpg. wt., 5 lbs.

Model F-140, 20,000 ohms/volt VOM Kit. Net only \$29.50



knight-kit VTVM KIT
with Printed Circuit Board

Model F-125 An extremely stable, and highly accurate VTVM. Greatly simplified wiring—entire chassis is a printed circuit board. Maximum convenience in arrangement of scales; 3X AC and DC scale design permits utilization of best portion of each scale for most accurate readings. Also measures peak-to-peak for FM and TV work. Ranges: AC P-P volts, 0-4-14-40-140-400-4000; AC rms volts and DC volts, 0-1.5-5-15-50-150-500-1500; resistance, 0-1000-10K-100K ohms and 0-1-10-100-1000 megohms; db scale, -10 to +5. AC response, 30 cycles to 3 mc. Low-leakage switches and 1% precision resistors. Balanced-bridge circuit. 4 1/2" meter, 200 microamp movement. Polarity reversing switch. Input res., 11 megs. Shpg. wt., 6 lbs.

Model F-125 Printed Circuit VTVM Kit. Net only \$24.95

F-126. Hi-Voltage Probe; extends DC to 50,000 Volts \$4.75
F-127. Hi-Frequency Probe; extends AC to 250 mc. \$3.45



Model F-143 **knight-kit LOW-COST TUBE TESTER KIT**

Offers high accuracy, top versatility and convenience at lowest cost. Tests 4, 5, 6 and 7-pin large, regular and miniature types, octals, loctals, 9-pin miniatures and pilot lamps. Features test for new 600 ma series string tubes. Tests for open, short, leakage, heater continuity and quality (by amount of cathode emission). 4 1/2" square meter with clear "GOOD?-REPLACE" scale. With line-voltage indicator and line-adjust control. Choice of 14 filament voltages from .63 to 117 volts. Blank socket for future type tubes. Universal-type selector switches for any combination of pin connections. Single-unit, 10-lever function switch. Entire switch assembly is installed as a single unit—saves time and greatly simplifies construction. Illuminated roll chart lists over 600 tube types. Shpg. wt., 14 lbs.

Model F-143, Counter Model Tube Tester Kit. Net only \$29.75

Model F-142, Portable Model Tube Tester Kit. Net only \$34.75
F-141, TV Picture Tube Adapter for above. Net only \$3.75



PORTABLE MODEL



knight-kit RESISTOR-CAPACITOR TESTER KIT

Model F-124 Measures capacitance and resistance by accurate bridge method; checks for opens and shorts in paper, mica and ceramic capacitors; shows power factor of electrolytics. Large dial shows capacitance and

resistance at a glance; balanced-bridge circuit with "magic eye" null indicator measures power factor from 0-50%. Tests capacitors with rated voltages applied. 5 test voltages: 50, 150, 250, 350, 450. Capacity ranges: 10 mmf to 1000 mfd in 5 ranges. Resistance ranges: 100 to 50,000 ohms and 10,000 ohms to 5 megs. Accuracy, ±10%. Automatic discharge feature prevents after-test shock. Blue-finished steel case, 5 x 3 x 2". With tubes and all parts. Shpg. wt., 8 lbs.

Model F-124, Resistor-Capacitor Tester Kit. Net only \$19.50



NEW knight-kit TRANSISTOR & DIODE CHECKER KIT

Model F-149 Checks leakage-to-gain ratio and noise level of all junction, point contact and barrier transistors. Also checks diodes, forward and reverse current conduction of selenium rectifiers; useful for continuity and short checks. Easy-to-read meter. Features: spring-return leakage gain switch; calibration control; separate sockets for PNP and NPN transistors. Headphones or signal tracer may be used with checker for noise measurements. Case, 5 x 3 x 2". With 22 1/2 volt battery. 2 1/2 lbs.

Model F-149, Transistor Checker Kit. Net \$8.50

EASY PAYMENT TERMS: If your total KNIGHT-KIT order is over \$45, take advantage of our liberal Time Payment Plan—only 10% down. Write for application blank.

ALL PRICES NET F.O.B. CHICAGO



knight-kit LOW-COST "IN-CIRCUIT" CAPACITOR CHECKER KIT

Tests capacitors while they are still wired in the circuit! Saves time and bother; an essential instrument for the service technician. Just press a button and the "magic eye" instantly shows opens and shorts (not leakage). Tests opens and shorts on any capacitor of 20 mmf or greater capacity, even if it is in parallel with a resistance as low as 50 ohms. Tests for shorts may be made on any capacitor even when it is shunted by as low as 20 ohms. Blue-finish steel case, 7 1/4 x 5 1/4 x 5". With tubes, all parts, wire and solder. Easy to assemble. Shpg. wt., 5 lbs.

Model F-119, Cap. Checker Kit... \$12.50

Model F-119 \$12⁵⁰

order from **ALLIED RADIO** 100 N. WESTERN AVE., CHICAGO 80, ILL. →

ALLIED'S own MONEY-SAVING knight-kits

FAMOUS knight-kits FOR HOBBYISTS & EXPERIMENTERS... FASCINATING, INSTRUCTIVE...



knight-kit
"SPACE SPANNER"
BAND SWITCHING
RECEIVER KIT

Model S-243 \$15⁹⁵

Thrilling Short Wave and Broadcast

Famous 2-band AC-DC receiver in easy-to-build kit form at a very low price. Pulls in thrilling short-wave (6 to 17 mc) and standard broadcast. It's fun listening to amateur, aircraft, police and marine radio. Features highly sensitive regenerative circuit. Bandswitch selects broadcast or short wave. Has 4" PM speaker and beam-power output tube for plenty of volume; headphone connectors for weak signal listening; slide switch cuts out speaker. Uses 12AT7 regenerative detector and audio amplifier, 50C5 power output, 35W4 rectifier. Six controls: Bandsread; Main Tuning; Antenna Trimmer; Bandswitch; Regeneration; Audio Gain. Includes tubes and all parts. 7 x 10 1/2 x 6". Shpg. wt. 4 1/2 lbs.

Model S-243. "Space Spanner" Receiver Kit. Net only \$15.95
S-247. Matching Cabinet for above. 2 lbs. Net \$2.90



Model S-295 \$14⁷⁵

NEW knight-kit TWO-WAY INTERCOM KIT

New low-cost, easy to build intercom system kit. Ideal for use in home or office. Consists of Master unit and Remote unit, each with press-to-talk switch. Remote unit may be left "open" for answering calls from a distance, for "baby-sitting", etc. Remote may also be connected for "private" operation—cannot be "listened-in" on, but it can be called and can originate calls. Master unit includes high-gain 2-stage amplifier; each unit has 4" PM dynamic speaker. Complete with Antique White cabinets (4 1/2 x 6 1/2 x 4 3/8"), all parts, tubes and 50 feet of cable (up to 200 feet of cable can be added). For AC or DC. Shpg. wt., 7 lbs.

Model S-295. Two-Way Intercom Kit. Net only \$14.75



Model S-740 \$11⁷⁵

knight-kit

"OCEAN HOPPER" RECEIVER KIT

Tops for exciting broadcast, long wave and short wave reception. Highly sensitive regenerative-type circuit. Excellent headphone reception; can be used with 3-4 ohm PM speaker on strong broadcast band stations. Supplied with plug-in coil for standard broadcast; covers long wave and popular short wave bands with coils below. Pulls in thrilling foreign broadcasts, police, amateurs and aircraft. Controls: Main Tuning, Bandsread, Antenna Tuning, Off-On-Regeneration. With all parts and tubes (less extra coils and headset). AC or DC. Shpg. wt., 5 lbs.

Model S-740. "Ocean Hopper" Kit. Net only \$11.75

EXTRA PLUG-IN COILS

S-741. Long Wave, 155-470 kc. Net 79¢
S-742. Short Wave, 1.65-470 kc. Net 79¢
S-743. Short Wave, 2.9-7.3 mc. Net 65¢
S-745. Short Wave, 7-17.5 mc. Net 65¢
S-744. Short Wave, 15.5-35 mc. Net 65¢



Model S-735 \$17²⁵

knight-kit

"RANGER II" SUPERHET RADIO KIT

Thousands have built and enjoyed the "Ranger" Broadcast Band Receiver. Carefully engineered for easy construction and powerful, sensitive performance. Latest Superhet circuit; tunes 540 to 1680 kc; covers entire broadcast band and exciting police calls. Features automatic volume control, built-in preformed loop antenna, ball-bearing tuning condenser. Develops excellent tone quality from Alnico V PM dynamic speaker. Supplied with following tubes: 12SA7GT converter; 12SK7GT IF amp.; 12SQ7GT det.-AVC-audio; 50L6GT audio output; 35Z5GT rect. Complete with handsome brown plastic cabinet (6 x 9 x 5) tubes, speaker, all parts, and instruction manual. AC or DC operation. Shpg. wt., 8 lbs.

Model S-735. "Ranger II" Superhet Radio Kit. Net only \$17.25



Model S-730 \$19⁹⁵

knight-kit

3-WAY PORTABLE RADIO KIT

A low-cost portable radio covering the full standard broadcast band from 535 kc to 1650 kc. Delivers excellent reception on AC or DC current or from self-contained batteries. Sensitive Superhet circuit features automatic volume control, economical operation. Includes powerful 5" Alnico PM dynamic speaker, efficient ferrite loop-stick antenna. Supplied with following tubes: 1R5 converter; 1U4 IF amplifier; 1U5 detector-AVC-audio; 3V4 audio output. Complete with attractive portable case (7 3/4 x 5 1/4"), tubes, speaker, all parts and instruction manual. Shpg. wt., 6 lbs.

Model S-730. 3-Way Portable Radio Kit (less batteries). Net \$19.95
J-651. Battery Kit for above \$2.50



knight-kit LOW COST PHONO AMPLIFIER KIT

Model S-790 \$8⁹⁵

It's easy to build this fine-performing, low-cost compact phono amplifier. Ideal for use in a portable phonograph—simply add any

record player and a 3 to 4-ohm speaker. Amplifier works with crystal or ceramic cartridges. Inverse feedback circuit for rich, clean tone quality. Delivers full 1 1/2-watt output with less than .25 volt input. Includes efficient tone control; has AC outlet, controlled from amplifier switch. Complete with tubes and all parts. Size only 4 1/2 x 7 x 4"—fits into almost any portable phono case. Shpg. wt., 3 lbs.

Model S-790. Phono Amplifier Kit. Net only \$8.95

FAMOUS knight-kit CRYSTAL SET KIT

Model S-261 \$2¹⁵

Thousands of beginners have started in radio and electronics by building the KNIGHT-KIT crystal set. This feature-packed set delivers loud, clear reception of local broadcast stations. A germanium crystal diode detector assures high sensitivity and simple operation—no crystal adjustment required. "Hi-Q" coil boosts sensitivity. Ball-bearing variable capacitor for easy tuning. With all parts and simple-to-follow instructions. Shpg. wt., 1 lb.

Model S-261. Crystal Set Kit. Net only \$2.15
S-267. Accessory Kit. 2000-ohm headphones and all parts for outdoor antenna \$2.95



Buy with confidence from ALLIED — America's Pioneer in Electronic Kits

finest quality electronic equipment in lowest-cost kit form

EASY-TO-BUILD HIGH PERFORMANCE KITS • WIDELY USED BY MANY LEADING TRAINING SCHOOLS



NEW knight-kit ELECTRONIC PHOTOFASH KIT

Model S-244
\$28.50

New feature-packed photoflash kit—designed for top quality dependability—available at a money-saving low price. Ideal for black and white or color photography. Xenon-filled reflector-bulb assembly gives over 10,000 flashes at less than 1/2¢ each! 1/700-second flash freezes the fastest action. Has 50 watt-second output. Provides light approximating daylight in spectral quality; permits the use of outdoor-type film indoors. Film guide number for color (ASA10) is 45. Designed for "X" or "O" shutters only. Requires sync cable (available from any photo supply dealer) and either battery or AC supply listed below. Complete outfit with battery weighs only 3 1/2 lbs. Kit includes all parts, carrying case and easy-to-follow instructions. Shpg. wt., 3 lbs.

Model S-244. Electronic Photoflash Kit. Net.... \$28.50
S-246. AC Power Supply Kit. Easy to assemble.... \$3.75
J-626. Battery for above (Burgess U-200)..... \$8.47

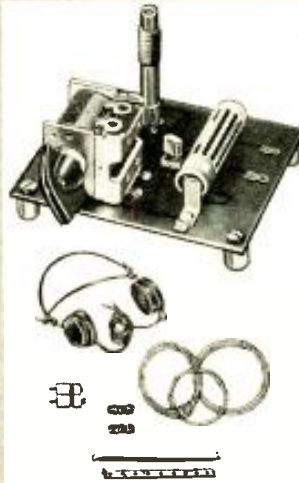

knight-kit TRANSISTOR RADIO KIT Printed Wiring • Works from Penlight Cell

Model S-765
\$4.35 Smooth Variable Capacitor Tuning

Experiment with the marvel of transistors! Printed circuit requires no wiring—just assemble with a few solder connections and enjoy excellent reception over the full AM broadcast band. No tubes to burn out—no crystal. Compact—fits in the palm of your hand—operates for months from a single penlight cell. Transistor provides plenty of power for strong headphone reception. Complete with all parts, transistor and penlight cell. Shpg. wt., 8 oz.

Model S-765. Transistor Radio Kit \$4.35
S-266. Accessory Kit. 4000-ohm headphones and all parts for outdoor antenna..... \$3.15

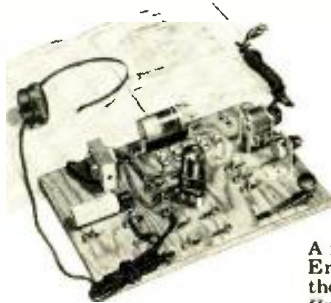

FAMOUS knight-kit LAB KITS

6-IN-1 RADIO LAB KIT

Model S-770
\$7.95 Build Any of 6 Electronic Projects

A fascinating and instructive kit. Enables you to build any one of the following projects: Standard Broadcast Receiver; Wireless

"Home Broadcaster"; Code Practice Oscillator; Code Practice Broadcaster; Signal Tracer; Sine Wave Generator. Perfect for beginners. Once basic wiring is completed, circuits may be changed without soldering. Safe to build and operate; only tools needed are screwdriver, pliers and soldering iron. The ideal kit for students and beginners in electronics. Kit includes mounting board, tube, all parts and easy-to-follow instruction manual. Less headphone (also serves as mike). Shpg. wt., 6 lbs.

Model S-770. "6-in-1" Lab Kit. Net only..... \$7.95
J-112. Single 1000-ohm headphone for above..... \$1.05
C-100. Antenna kit for above..... \$1.05

10-IN-1 LAB KIT

Model S-265
\$12.65 Build Any of 10 Electronic Projects

A wonderfully instructive electronics kit. Ideal for experimenters, beginners—fun to build. Construct a sensitive Broadcast Receiver; Amplifier (for phono or mike); Wireless Phono Oscillator; Home "Broadcast Station"; Code Practice Oscillator; Capacity-Operated Relay, or any one of four other fascinating projects. Low voltages; safe to build and operate. Only tools needed are soldering iron, screwdriver and pliers. Perfect for self-instruction in circuit fundamentals, and packed with practical applications. Kit includes mounting board, tubes, all parts, hardware, microphone, and 12-page builders' manual. Shpg. wt., 10 lbs.

Model S-265. "10-in-1" Lab Kit. Net only..... \$12.65
J-112. Single 1000-ohm headphone for above..... \$1.05
C-100. Antenna Kit for above..... \$1.05

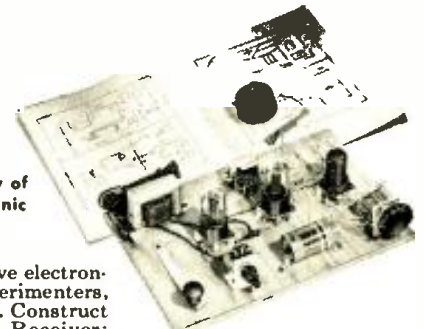

knight-kit WIRELESS BROADCASTER KIT

Model S-705
\$9.50 This fascinating unit makes it possible to "broadcast" with phonograph or microphone through any standard radio receiver up to 50 feet away—without any connection to the set. May be used with crystal or magnetic cartridge, or with microphone.

Broadcasts a clear, full-toned signal. High-gain stage permits using magnetic cartridge without need for external preamp. Complete with all parts, tubes, wire and solder (less microphone). 4 1/2 x 5 x 6". Easy to assemble. Shpg. wt., 3 lbs.

Model S-705. Wireless Broadcaster Kit. Net only..... \$9.50
S-556. Microphone for above with 5-ft. cable..... \$3.95

knight-kit PHONO OSCILLATOR KIT

Model S-760
\$5.85 This low-cost phono oscillator may be used with any crystal phonograph for "broadcasting" recorded music through any standard radio receiver up to 50 feet away. Requires no direct connection to radio set. Operates on any frequency between

600 and 800 kc. Has controls for adjustment of modulation level and selection of clear frequency on radio receiver. Uses 50L6GT tube and 35Z5GT rectifier. Complete with all parts, tubes and instructions. 4 1/4 x 4 1/4 x 4 1/2". Shpg. wt., 1 lb.

Model S-760. Phono Oscillator Kit. Net only..... \$5.85



knight-kit CODE PRACTICE OSCILLATOR KIT

Model S-239
\$3.95 Transistor Circuit—Powered by Penlight Cell

An ideal code practice oscillator. Uses transistor circuit. Extremely low current consumption—powered by single penlight battery. Provides crisp, clear tone (400 to 600 cps). Has input jack for earphone; screw-type terminal strip for key. In compact bakelite case (2 3/4 x 3 3/4 x 1 1/2") with anodized aluminum panel. Complete with all parts, transistor, battery and easy-to-follow instructions. Shpg. wt., 1 lb.

Model S-239. Code Practice Kit..... \$3.95

See Next Page for Amateur Kits

ALL PRICES NET F.O.B. CHICAGO

order from **ALLIED RADIO** 100 N. WESTERN AVE., CHICAGO 80, ILL. →

ALLIED'S own knight-kits give you the most for your money

BUILD YOUR OWN QUALITY HI-FI AMPLIFIER!

knight-kit
BASIC 25-WATT
LINEAR-DELUXE
HI-FI AMPLIFIER KIT

Model S-755
\$44⁵⁰

Williamson-Type Circuit
 Printed Circuit Board
 Chrome-Plated Chassis



This super-quality hi-fi basic amplifier is designed to satisfy the most critical listener. Intended for use with tuners incorporating built-in preamp or with separate preamp. Incorporates latest Williamson-type circuit and has potted matched transformers. Delivers maximum output of 45 watts. Frequency response is: ± 0.5 db. 10 cps to 120 kc, measured at 20 watts. Harmonic distortion is only .15% right up to 30 watts. Intermodulation distortion is only .27% at 10 watts and only .4% at 20 watts, using 60 cps and 7 kc. 1:4 ratio. Hum level is -85 db below full rated output. Output impedance, 4, 8, 16 ohms. Input voltage for 25-watt output is 1.8 volts. Uses two 12AU7's, two 5881's, and a 5V4. Etched circuit is utilized in voltage amplifier and phase inverter stages to speed assembly. Has output tube balancing control, variable damping control, and on-off switch. Handsome chrome-plated chassis, 14 x 9 x 2". Overall height, 7". A deluxe true hi-fi amplifier equal in performance to amplifiers selling at over twice the price. Complete with all parts and tubes. Easy to assemble. Shpg. wt., 27 lbs.

Model S-755. Basic 25 Watt Hi-Fi Amplifier Kit. Net only **\$44.50**
 S-759. Metal enclosure for above; black finish. 3 lbs. Net. **\$4.25**

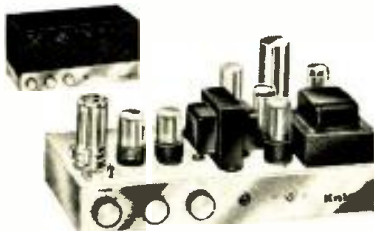

knight-kit
10-WATT HI-FI AMPLIFIER KIT

Model S-753 **Chrome-Plated Chassis**
\$23⁵⁰ Famous for wide response and smooth reproduction at low cost. Only 0.5 volt drives amplifier to full output. Frequency response: ± 1 db, 30-20,000 cps at 10 watts. Harmonic distortion less than 0.5% at 10 watts. Intermod. distortion less than 1.5% at full output. Controls: on-off-volume, bass, treble. Input for crystal phono or tuner. Chromed chassis; punched to accommodate magnetic cartridge preamp. Matches 8 ohm speakers. Shpg. wt., 14 lbs.

Model S-753. Amplifier Kit. Net. . . . **\$23.50**
 Model S-235. Preamp Kit for above . . . **\$3.10**
 S-757. Metal Enclosure. 3 lbs. **\$3.95**



knight-kit
20-WATT HI-FI AMPLIFIER KIT

Model S-750 **Chrome-Plated Chassis**
\$35⁷⁵ True hi-fi for less! Frequency response, ± 1 db, 20-20,000 cps at 20 watts. Distortion, 1% at 20 watts. Hum and noise level: tuner input, 90 db below 20 watts; phono 72 db below 20 watts. 4 inputs: magnetic phono, microphone, crystal phono or recorder, and tuner. Controls: Bass, Treble, Volume, Selector. With compensation positions for 78 and LP records. Built-in Preamp. Outputs: 4, 8, 16 and 500 ohms. 23 lbs.

Model S-750. 20-Watt Kit. Net. . . . **\$35.75**
 S-758. Metal Enclosure. 3 lbs. **\$4.15**
 S-752. Chrome-plated escutcheon for cabinet installation of amplifier. Net. **\$1.40**

LOW-COST TOP QUALITY KITS FOR THE HAM



knight-kit
Model S-255 50-WATT CW TRANSMITTER KIT
\$43⁷⁵ Built-in Pi-Type Antenna Coupler

Check the features packed into this new transmitter kit and you'll see why it's one of the greatest Amateur values ever offered. Compact and versatile, it is the perfect low-power rig for the beginning Novice or seasoned veteran. Features: 50 watt input to 807 final; high-efficiency 6AG7 modified-Pierce oscillator takes crystal or VFO without circuit changes; bandswitching coverage of 80, 40, 20, 15, 11-10 meters; pi-section antenna output matches line impedances from 50 to 1200 ohms —permits use with any type of antenna; no separate antenna tuner required. Crisp, clean, cathode keying of oscillator and final. Power take-off plug supplies filament and B-plus voltages for other equipment. Copper-finished chassis and cabinet interior, filtering, shielding, bypassing, and coaxial SO-239 antenna connector provide excellent TVI suppression. Meter reads either plate or grid current of final. Jacks for VFO, crystal and key. Supplied with all parts and tubes. Less crystal and key. $8\frac{1}{4} \times 11\frac{1}{4} \times 8\frac{3}{4}$ ". Shpg. wt., 18 lbs.

Model S-255. 50-Watt Transmitter Kit. Net. . . . **\$43.75**



knight-kit
SELF-POWERED VFO KIT

Model S-725
\$28⁵⁰

Complete with built-in power supply! Careful design and voltage regulation assure high stability. Excellent oscillator keying characteristics for fast break-in without clicks or chirps. Full TVI suppression. Has plenty of bandspread; separate calibrated scales for 80, 40, 20, 15, 11 and 10 meters; vernier drive mechanism. 2-chassis construction keeps heat from frequency determining circuits. Output cable plugs into crystal socket of transmitter. Output on 80 and 40 meters. With Spot-Off-Transmit switch for "no awhin" tuning. Extra switch contacts for operating relays and other equipment. With all parts and tubes. 8 lbs.

Model S-725. Self-Powered VFO Kit. Net. . . . **\$28.50**



NEW knight-kit
AMATEUR RF "Z" BRIDGE KIT

Model S-253 **\$5⁸⁵** Measures standing wave ratio (SWR) and impedance of antenna systems; also for adjusting antenna

networks for optimum results. Any VOM may be used for null indicator. High accuracy with 20,000 ohm/v VOM. Correction factor info supplied for other VOM's. With coax input and output connectors. Meters both input and bridge voltage. Calibrated dial gives direct impedance reading; includes 1% precision resistor for precise calibration adjustment. With all parts and handy plasticized SWR chart. $1\frac{1}{2}$ lbs.

Model S-253. "Z" Bridge Kit. Net only **\$5.85**

ALLIED RADIO

100 N. WESTERN AVE., CHICAGO 80, ILL.



ALLIED RADIO CORP., Dept. O2-K-6, 100 N. Western Ave., Chicago 80, Ill.

Ship me the following KNIGHT-KITS:

Quantity	Description	Model No.	Price

\$ _____ enclosed. For parcel post include postage (express is shipped collect).

Name _____

Address _____

City _____ Zone _____ State _____

← *order Today*

New Color Sets Simplify Servicing



Rear view of a model in the RCA Special series.

RCA HAS just introduced three new lines of color TV receivers incorporating a number of features destined to make life easier for the technician by simplifying the installation and normal servicing adjustments. Sets in the Special and Super series use the CTC-5-A, -B, -C, -D and -E chassis with 27 tubes and 2 diodes in the vhf models and 28 tubes and 3 diodes in the all-channel sets. The Deluxe series (chassis CTC5-N, -P, -R, -T, -U, -W, -AA and -AB) has 30 tubes and 4 diodes in the vhf-uhf models. The vhf models have one tube and one diode less.

The extra tube (6AF4 or 6AF4-A) and diode, type K3D or IN82) in the all-channel models are the uhf oscillator and mixer, respectively. In these sets, the vhf and uhf channel selectors are separate and are not concentric as in some tuners.

In the models in the Special and Super series, the channel selector, fine tuning, volume and brightness controls and the on-off switch are on the upper right side of the cabinet near the front edge. Some of the models in the Deluxe series have these controls on the front panel and others have them on the right side with an illuminated vhf channel indicator in the upper right corner of the panel.

The horizontal and vertical hold, hue, saturation and contrast controls are recessed into the front panel behind a spring-loaded decorative cover.

In all models, the main chassis is mounted horizontally on the bottom of the cabinet and the tuner is fastened to the upper right side of the cabinet along with the brightness and volume controls. (See rear-view photo.) This feature permits the technician to remove either the chassis or tuner for servicing without disturbing the other. The tuner, main chassis and controls are tied together through cables and connectors.

The volume and brightness controls are attached to the tuner mounting bracket and are easy to remove for

Top view of a Special chassis. Chroma and video if assemblies, top center and right center, respectively, have removable shield covers to minimize radiation.

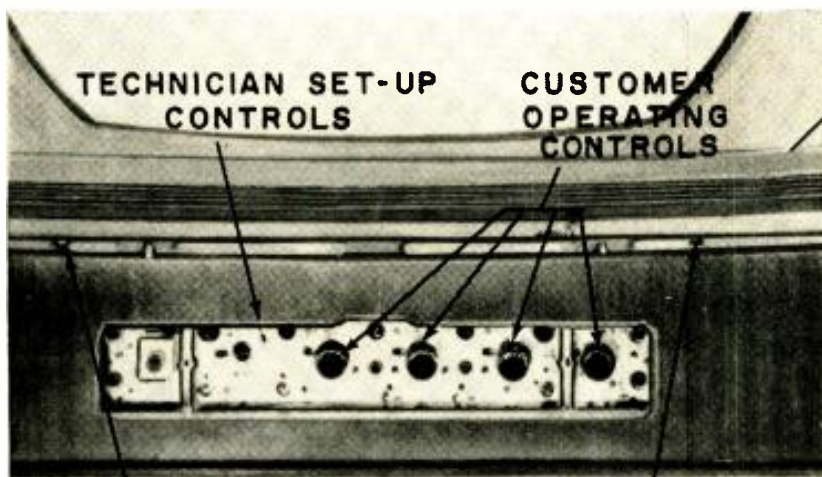
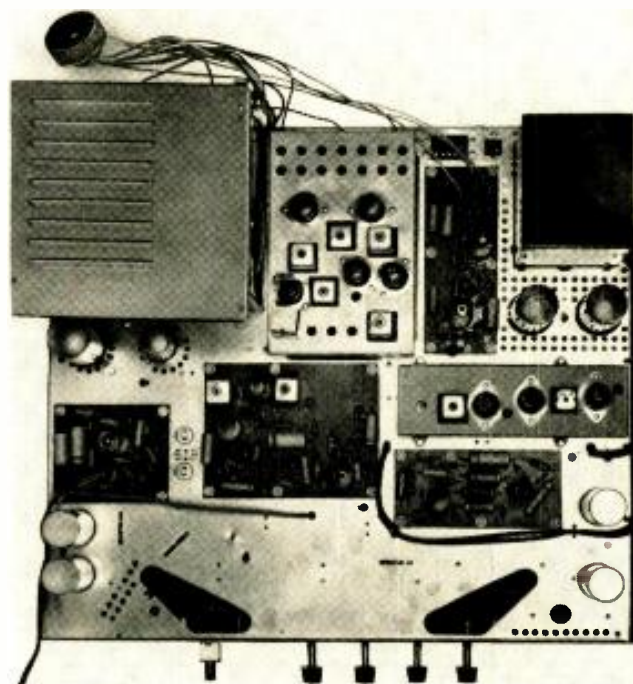

COLOR EQUALIZER MAGNET ADJUST.

Close-up of front control panel. The technician has access to 24 controls for setup adjustments.

What About Color TV?







There has been much talk about Color TV — and about whether or not available TV equipment is suitable for Color TV reception. Whatever other conditions prevail — one thing is certain . . .

ALL  TV PRODUCTS ARE ENGINEERED for COLOR

Every piece of Blonder-Tongue equipment ever built, sold and in use — or ever to be used — is designed with color in mind . . . with the flat, broad output required for color.

these products include



 DISTRIBUTION AMPLIFIERS	 CONVERTERS	 BOOSTERS
 SIGNAL AMPLIFIERS	 LINE AMPLIFIERS	 MIXER AMPLIFIERS

. . . and all B-T impedance matching devices, equalizers, couplers, attenuators, connectors and tap-offs.

For example:

The  Model TV-42

is the only type approved by engineers for color — with a flat response from 0 to 900 mc.

Every  Master TV System now in operation is designed to meet the exacting demands of Color Television . . . today and tomorrow.

Keep abreast of the Latest Developments. Apply for your **FREE** subscription to the **B-T BULLETIN**.



Write today to Dept. OK-3

BLONDER-TONGUE LABS., INC. Westfield, New Jersey

In Canada: Telequipment, London, Ontario

The largest manufacturer of TV Signal Amplifiers, UHF Converters and Master TV Distribution Systems.

TELEVISION

servicing. A clip is provided on the rear of the main chassis for mounting the tuner when both units are removed from the cabinet.

Components for approximately 80% of the circuitry are mounted on printed-circuit boards as shown in the top view of the chassis. There are five boards in the Deluxe models and six in models of the Special and Super series. Each board is flush with the chassis with all components and test points easily accessible on the top surface.

The cabinet tops are not removable as in earlier RCA color sets. Now, 24 service setup controls may be reached by removing the cover of the control box on the front panel. All gray-scale adjustments except the blue lateral positioning magnet are accessible to the technician from the front of the set. The decorative bezel around the safety glass can be removed for access to the six adjusting screws for the field-equalizing magnets. Two of these screw adjustments are along the top of the mask, two across the bottom and one on each side. The two along the bottom of the mask can be seen in photo of the front control box. Relocating the major controls used for service adjustments means that the cabinet back need not be removed for normal service adjustments once the initial purity setup has been completed. Service controls on the back of the set are vertical and horizontal centering, focus, width and color-killer threshold.

The installation and removal of the picture tube and adjustment of the deflection and convergence assemblies have been simplified in these sets. The high-voltage insulating shield supports the deflection yoke and the bell and rear of the picture tube. The entire assembly consisting of the C-R tube, insulating shield, deflection and convergence yokes, purity and blue lateral positioning magnet can be removed by unscrewing four nuts on the kinescope mask.

The new 21AXP22-A tricolor kinescope used in these receivers has a high-voltage resistor built into the neck. A conductive coating is applied to the outside surface of the insulating boot or shield and the combination is used as a high-voltage filter capacitor.

The low-voltage supply in these sets uses paralleled 5U4-GB's with their plates cross-connected to insure normal voltage output even if one tube fails. The receivers are protected by four fuses. A 2-ampere fuse between the rectifier filaments and the input to the filter protects the transformer and rectifier against component failures in the filter circuit. A 750-ma fuse in the 385-volt line provides additional protection for the B-plus circuit. The high-voltage and horizontal output circuits are protected by a 300-ma fuse in the cathode return of the 6CB5-A horizontal output tube. A heavy-duty fuse is in series with the 6.3-volt 14.5-ampere heater winding to protect it against damaging shorts and overloads. **END**



FOR THE FIRST TIME



A Co-Channel
Filter
that eliminates
"Venetian Blinds"

JERROLD LINE-OUT[®]

PAT. PENDING

The Jerrold Line-Out is a revolutionary co-channel filter that electronically "erases" TV co-channel "Venetian Blinds".

Its principle of operation is new—but simple.

A thirty db filter in the Jerrold Line-Out unit removes the co-channel beat frequency caused by an offset carrier of another TV station on the same channel, thus eliminating "Venetian Blinds" from the TV screen.

Two models are available. Model V10 is designed for use when the carriers of the co-channel stations are offset by 10KC. Model V20 is designed for 20KC offset carriers. The Jerrold Line-Out is not effective if the co-channel interference is so strong that it produces sync instability or picture sliding.



15.95 LIST

The Jerrold Line-Out can be installed in a matter of minutes. No wires to cut—no soldering necessary. Simply remove the plug on kinescope, insert the Line-Out in series and plug back in. Adjust tuner on Line-Out to eliminate "Venetian Blinds"—set it and forget it. The Jerrold Line-Out does not affect reception of any stations when co-channel interference is not present.

The Line-Out is typical of Jerrold's continuing research program to improve TV reception in fringe areas.

See Your Jerrold Distributor Today.



JERROLD ELECTRONICS CORPORATION

2220 Chestnut Street
Philadelphia 3, Penna.



TV Master Antenna

By HARRY J. MILLER

IN a very successful attempt to lift the television picture of fringe-area Sarasota from the silt of mediocrity, Foscolo C. Hendrick, a pioneering radio and video engineer, has installed an underground antenna distribution system in this city, reputedly the first of its kind in the country.

From the dual master antennas atop his place of business, Hendrick supplies a signal via a network of underground coaxial cable that threads under the streets of the town to the hundreds of customers hooked up to the cable. For a price of around \$85 to a house with a 50-foot lot, plus a \$24 annual rental service, customers get pictures that could be equaled only by an expensive and towering antenna tower of their own.

The idea doesn't sit well with many television dealers in Sarasota, although some of them welcomed the new cable service with open arms. A new kind of competition arose among the merchants to capture the TV dollar by offering tower and stacked Yagi arrays that could assure a signal as snowfree as that brought them via Hendrick's husky K-14 (Federal Telephone & Radio Corp.) main feeder and the 75-ohm RG-11/U line that goes down the customer's street.

Hendrick had been a TV dealer and service technician in Sarasota when the video signal began coming in from Tampa and St. Petersburg. Sales with him, as with other dealers, were few and far between because of the poor picture received. No matter how well designed were the receivers sold, the entertainment was low from the inadequate signal fed into it. Wherever a set was operated in the area—which is still some years behind a saturated signal condition—it was apparent that a well-designed TV receiving antenna was a prime necessity.

Like the other dealers, Hendrick had pushed hand-cranked and hydraulic antennas, roof-top antennas and Yagi arrays. But the cost of an antenna suitable for even a passable signal often was more than the price of a receiver, and this stymied sales.

Besides, this West Coast area of Florida is heavily populated with elderly and ailing retirees, and the very thought of speeding hastily to crank down a tall tower that might be in the path of a sudden hurricane was a heart-attack-provoking move they didn't relish. Fos Hendrick petitioned and beleaguered the city's civic top brass and won a franchise to install his underground coax.



Fos and the driver he uses for punching beneath the city streets.

Some of the other dealers fought so bitterly in the legislative halls against granting Hendrick sole rights in the city, that Fos was awarded only a non-exclusive franchise. Since this will run for 10 years, there is small danger of any competing franchises being approved by the town fathers. Fos succeeded in having a clause inserted assuring him the right to transmit his own closed-circuit television programs over his coax network. This already bears promise of being a lucrative part of the franchise for Hendrick has purchased equipment to pick up and transmit local events to the customers. Thus he is assured added income from the sponsors of such telecasts.

The size and economic status of Sarasota were paramount factors in determining the set potential and the number of possible subscribers. Obviously, a community's size and income level are the dominant factor in any plan to lay a cabled network.

"In addition," said Hendrick, "there were two technical aspects to the problem—the number of TV stations available and their signal strength. A community situated close to powerful TV stations would offer meager possibilities because solid pictures would be available from the local telecast centers,

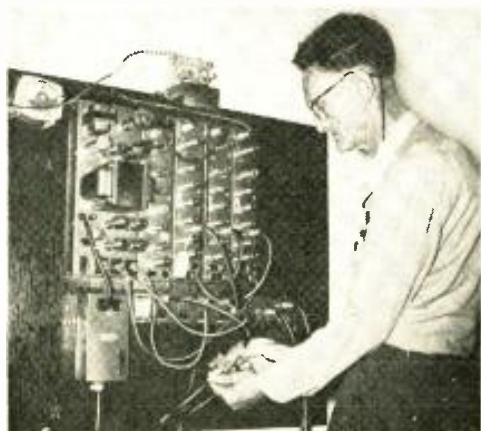

The television amplifiers—heart of the underground coaxial system.



Fos' crew drives pipe across and underneath the street to make way for cable.

TELEVISION



Converted lawn trimmer digs trench. Cable is inserted and ground tamped.

using the usual standard antennas."

Sarasota was ripe for the Hendrick system since its location is such that the antennas required for good television reception are expensive and costly to maintain.

Underground advantages

But why an underground system?

To this, Hendrick has some ready answers. "Cable exposed to the weather atop poles requires renewal every 3 to 5 years, whereas the kind of coax we bury has a life expectancy of 20 to 25 years.

"On aerial suspension, the cable is subject to radiation, which is anathema to FCC officials. Underground cable, being at ground potential, radiates absolutely no energy.

"Furthermore, buried cable, laid at the proper depth for the locale, remains at a stable temperature impossible to attain where coax is exposed to the vagaries of wind and weather. And storms, especially in hurricane areas, can cripple a coax aerial line fast and invite disgruntled customers to seek other antenna service."

One wind from a sudden blow of hurricane force can lay hundreds of antenna towers low and rip off a rooftop or damage a house to which the antenna is anchored. The buried-cable service abolishes a number of these aggravations. But at a price.

And this service cost of Hendrick's was the cudgel with which his competition sought to clobber him.

Dealers made about twice as much selling the antenna system as they did the video set. And chances are the customer would buy his set and have it serviced by the dealer who made the antenna installation. With Hendrick's system, these dealers saw their hopes go glimmering, since they felt Hendrick would thus be in such a favorable position that he'd snare most of the town's television sales and service business.

So that these dealers would push the sales of service on his cable, Hendrick offered to cease and desist on sales or service of television sets. This idea



Where cable enters tapoff box the braid and insulation are rolled back to form grommet—joint then made weathertight.

worked for a while—until the dealers, again afraid Fos would come out on top, began pushing their own antenna installations. They questioned what would happen to the customers on the coax line if Hendrick's antenna toppled. Fos countered by installing two atop the roof of his place of business.

"Besides," said Fos, "I pointed out that if a Florida squall struck down 300 antennas, it would take 3 months for the town's video technicians to replace them. My coaxial service posed no such hazard nor did it require maintenance of antenna towers by the customer."

"Another thing," Fos added, "I laid my cable first so as to get into the streets of the wealthier areas. A customer with a \$40,000 or \$50,000 house doesn't care for an unsightly tower on his lawn. And when a few of these people were sold on the idea, invariably others in his area fell in line.

"And the fact that these well-to-do people had my service had a salutary effect in selling the idea to people of more moderate circumstances."

In charging \$75 for the first 50 feet of lot and 50c a foot thereafter, with the lead-in from the main cable to the point of set location costing 15c a foot, plus a \$2 a month rental charge, Hendrick pointed out that it takes a 50- to 75-foot antenna in this semi-fringe area to get a good—not excellent—picture on uhf 80% of the time.

In using adjacent channels at regularly assigned frequencies, intermodulation troubles arose to plague the venture. These caused bars in the adjacent channel that interfered with the picture.

By lowering channel 2 a megacycle (53-59 mc) and raising channel 4 by a megacycle (67-73 mc), Fos achieved a 1-mc buffer against the intermodulation, on either side of channel 3.

By lowering channel 5 one megacycle and raising channel 6 ditto, Fos gets a 2-megacycle buffer between them.

The equipment

This he does in his converters and single-channel amplifiers, through realignment of all the tunable circuits. The

Give your customers

fine music reproduction

with their conventional

phonographs by

installing the



"Twin-Lever" Ceramic Phono Cartridge

The WC10 "Twin-Lever" Improvement Cartridge has a peak-free frequency response from 40 to 12,000 cps. It makes conventional phonographs sound better than new—and its low list price enables you to make a sale every time you suggest a "Twin-Lever" Cartridge.

The "Twin-Lever" replaces and outperforms 157 three-speed, plastic-cased cartridges, crystal or ceramic, turnover or single needle.

It is easily installed in any tone arm with standard 1/2" mounting centers. Needle replacement can be accomplished in seconds—without tools—with the cartridge in the arm.

MODEL WC10

List Price \$9.50
with two sapphire needles

MODEL WC10D

List Price \$34.00
with a 1-mil diamond and
o 3-mil sapphire needle



The Mark of Quality
IN ELECTRONICS SINCE 1925

SHURE BROTHERS, INC.

Microphones—Electronic Components
212 HARTREY AVENUE • EVANSTON, ILLINOIS

Cartridge replacements are a "Snap" with Sonotone

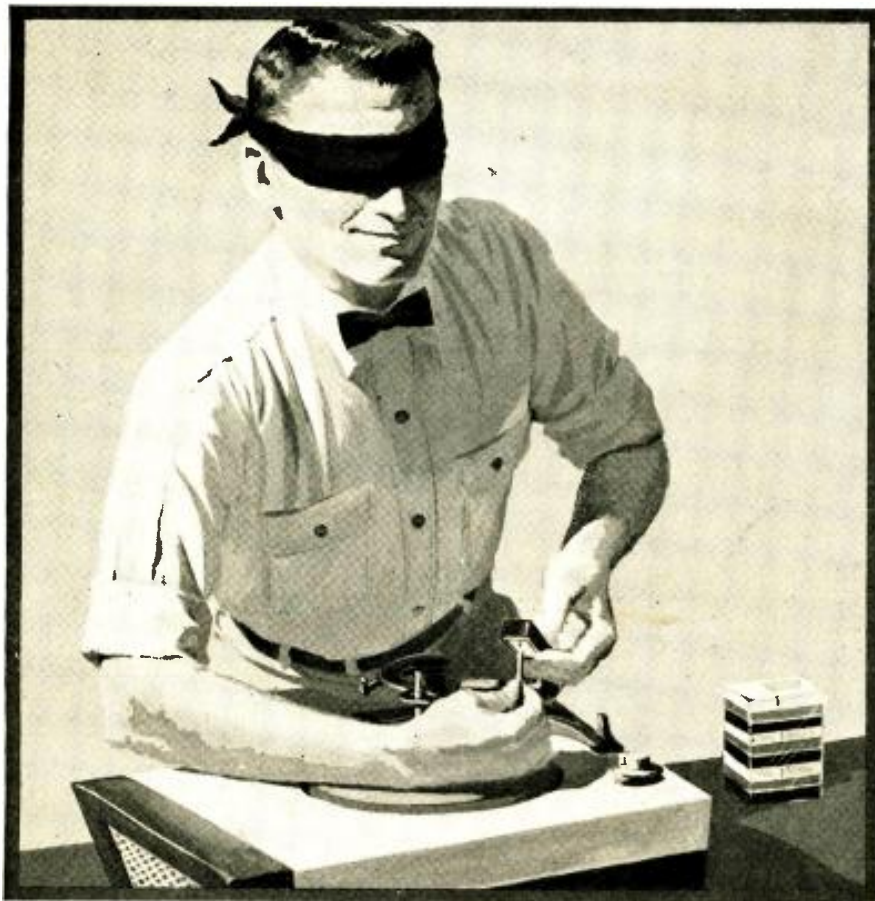

Sonotone 1P and 2T mount the same way, take the place of up to 12 different models in other cartridge lines

Time is money to you, so why be slowed down by handling a variety of different cartridges that mount various ways? Sonotone Ceramic 1P (single-needle) and 2T (turn-over) are all you need for over 90% of quality replacement jobs. They're a cinch to install in almost any arm—let you do the job *the same quick, easy way time after time.*

New standard of the phono industry
In more than half the quality phonographs made today by leading manufacturers, you'll find one of these Sonotone cartridges. All the more reason why you should standardize on Sonotone.

Stick to the Sonotone 2-model line and you'll find you cut installation time to an absolute minimum. Your customers will applaud for another reason—Sonotone cartridges, leader in the field, in virtually every case give *better* response than original equipment...enhancing your reputation for quality work.



Electronic Applications Division

SONOTONE CORPORATION

ELMSFORD, N. Y.

In Canada, contact Atlas Radio Corporation, Ltd., 50 Wingold Avenue, Toronto

TELEVISION

Ampli-Vision line amplifiers are flat within ± 1.5 db from 30 to 115 mc, therefore no circuit changes are needed.

Hendrick had been using Blonder-Tongue converters from channel 38 to channel 5, minus 1 mc. He's also using Ampli-Vision converters for channel 13 to channel 6, plus 1 mc, and an Ampli-Vision converter from channel 8 to channel 4, plus 1 mc.

The Ampli-Vision converters are crystal-controlled and feed into single-channel Ampli-Vision amplifiers which have, when the age is set to 200 microvolts, 60-db gain.

The three signals from channels 4, 5 and 6 are then fed into an Ampli-Vision mixer which has a 10-db loss. The output of this mixer (about 50 db) is fed into the K14 cable, a heavy-duty 71-ohm type.

Inserted in the cable is a line splitter which in turn feeds two K14 coax lines, one that runs to Sarasota's northern city limits and one to its southern extreme. Farther along, each of these individual lines is split into other lines.

The first amplifier on each of the main lines is 3,500 feet from the converter amplifier. These are broad-band chain amplifiers with an essentially flat response from 30-115 mc, and are also Ampli-Vision made.

They each have three stages, each stage consisting of four 6AK5's. The power supply is on separate chassis and is voltage-regulated. These amplifiers provide 37-db gain.

From here on, these chain amplifiers are installed every 1,800 feet of RG-11/U cable. The output of each amplifier is split four ways for four additional branch lines. And where additional amplification is required on these branches, Hendrick uses Blonder Tongue all-band amplifiers which have a 27-db gain.

Said Hendrick: "We use 1,000 microvolts as zero db as a reference for all db gain. At the input to each chain amplifier, we have an Ampli-Vision line-loss equalizer to equalize the signals of channels 4, 5 and 6 to compensate for the line losses in the coax.

"At every fifth amplifier we use single-channel amplifiers with age control to compensate for uneven-frequency line loss. For example, at channel 6's frequency, there is greater loss in all cable runs than at that of channel 2. These signals must be even on entering an amplifier to avoid cross-modulation in the amplifier."

Hendrick finds that tubes last longer when the equipment is operated on a 24-hour-a-day service, even if stations are off the air, so he runs the equipment continuously rather than employing time clocks to switch the equipment off and on to coincide with broadcast station time. He feels this is due to initial voltage surges and resulting thermal agitation in cold equipment.

Hendrick's main runs of coaxial cable are K14 from the first amplifier, thence under the streets and underground in shallow trenches alongside and tucked

under a few inches of cement pavements which happen to have grass borders.

The auxiliary amplifiers are connected by RG-11/U, while tapoffs to customers' houses are made with RG-59/U, with baluns cut to channel 6 to match the 72-ohm RG-59/U cable to the 300-ohm input of the set.

Installing the cable

In driving 1½-inch galvanized pipe under the streets, through which the coax is drawn, Hendrick cuts the pipe into pieces 7 feet long, then turns a socket on each end and turns a plug into each socket. This gives the pipe a nose to push through the earth beneath the street paving. The pipe is laid on a heavy plank at the bottom of a ditch dug ahead of the street paving. On this board a heavy driving weight on a dolly is rope-pulled by workers and smashes against the pipe plug. Since the pipe lays level on the plank, it drives straight and is quickly located at the other end of the street. The socket plug is removed to add more sections onto the driven pipe. The idea behind cutting the pipe into 7-foot nipples is that a shorter trench has to be dug to get the driving started than would be the case if a full 21-foot length of pipe had to be laid in position in a lengthy trench for the beginning drive. A steel fish wire poked through the pipe is hooked onto the cable to pull it through.

"How deep the cable is to be laid,"

said Hendrick, "depends upon the frost level of the area. And extra precautions must be taken that the outside insulation of the coax cable is not injured deep enough to expose the copper shielding and thus allow moisture to enter because it will follow the cable a thousand feet and more to ruin it and require its eventual replacement."

Hendrick warns: "Don't use any coax that has a bead in its outside insulation. We used some, and more than a mile of it went bad. We got no satisfaction from the jobber or the manufacturer. We had to replace it in a hurry and placate irate customers."

Some nonelectronic problems

"The technician who seeks to install underground cable would be wise to enlist the goodwill of municipal authorities like the surveyor's office, water department and the public utility companies who can shorten his labor of locating buried water and sewer lines and underground electric and telephone cables."

Despite the fact that Hendrick equipped himself with detailed maps and surveys of the streets from the public utility companies, it was to be expected that accidents would occur when driving a ram under the streets between curbing—as for instance when the ram cut through a 900-pair telephone cable, and two insurance companies cancelled liability policies.



Fos' pattern as it appears on the screen of one of his cable customers.

"And when you obtain the franchise," adds Kendrick, "be sure it includes a clause for your renewal—or ways and means of establishing a fair price for its purchase by the municipality at the termination of the franchise, at a figure that guarantees you a decent profit for the work and money you've put into this service."

"Finally, be sure to study the easement on property so the cable may be kept within its bounds and not trespass."

TV dealers cooperate

At present, several dealers are helping sell cable service to the customers

COYNE QUALITY
TELEVISION
RADIO - COLOR TV
 Home Training
at Unbelievably Low Cost



The future is **YOURS** in **TELEVISION!**
 A fabulous field—good pay—fascinating work—a prosperous future in a good job, or independence in your own business!

Coyne brings you **MODERN-QUALITY** Television Home Training; training designed to meet Coyne standards at truly lowest cost—you pay for training only—no costly "put together kits." Not an old Radio Course with Television "tacked on." Here is **MODERN TELEVISION TRAINING** including **Radio, UHF and Color TV.** No Radio background or previous experience needed. Personal guidance by Coyne Staff. **Practical Job Guides** to show you how to do actual servicing jobs—**make money early in course.** Free Life-time Employment Service to Graduates.

COYNE
ELECTRICAL SCHOOL
 A TECHNICAL TRADE INSTITUTE OPERATED
 NOT FOR PROFIT
 500 S. Paulina Street, Chicago 12, Dept. 76-HT4

B. W. COOKE,
 President



Coyne—the Institution behind this training... the largest, oldest, best equipped residential school of its kind. Founded 1899.

Send Coupon for Free Book

and full details, including easy Payment Plan. No obligation, no salesman will call.



COYNE Television Home Training Division
 500 S. Paulina St., Chicago 12, Ill.
 Dept. 76-HT4

Send Free Book and details on how I can get Coyne Quality Television Home Training at low cost and easy terms.

Name _____
 Address _____
 City _____ State _____

for
changer
convenience
and
turntable
performance

the direct-drive

THORENS

CD-43



the only changer with
complete published
wow, flutter, rumble
performance figures

RUMBLE: for E 53 N motor mounted on CD-43, CBA-83, CB-33 and E-53PA units. (Reference level: 2.6 cm/sec., 1000 cps.)

	Total rumble level	100 cycle rumble	low frequency rumble
Best units.....	-52 db.	-53 db.	-55 db.
Average.....	-50 db.	-51 db.	-53 db.
Lower limit for all units equipped with E 53 N motors	-48 db.	-49 db.	-52 db.

FLUTTER: Less than 0.1%.

WOW: Less than 0.3%. Tests made with the standard 12" turntable weighing 2½ lbs.

These measurements are minimum quality control standards which must be met or exceeded by every THORENS RECORD CHANGER, PLAYER AND TURNTABLE!

ask your dealer to
demonstrate **THORENS**

Write for Thorens Catalog.

THORENS

NEW HYDE PARK



Music Boxes
Hi-Fi Components
SWISS
MADE
Spring-Powered Shavers
Lighters

NEW YORK

TELEVISION

to whom they sell television sets. That way they need no antenna-erecting crew and they're certain that the signal strength Hendrick maintains in his cable will insure satisfaction with the sets they sell. Their feeling is that the customer will seek subsequent service from the dealer and not from Fos. Thus, Hendrick's coax helps them sell receivers to finicky folk who won't have an antenna tower on their grounds or who couldn't crank it down when the need arose.

These dealers also benefit from the fact that some of these elder citizens, and younger ones too, would never buy a set at all unless assured of the kind of picture the coax gives them.

Contrary to their former fears, Hendrick hasn't monopolized Sarasota's TV sales and service business. But he's sure in a favored spot.

When a set bought from some other dealer goes haywire, the dealer's technician is just as apt to blame the trouble on the signal from the cable rather than on the set. In that case, a call to another customer on the cable reveals the cable isn't at fault. Thus, later calls for service on the set he didn't sell often revert to Fos, with resultant boost to his income and prestige.

CTAN (City Television Antenna Network), as Fos calls his cable business, maintains an around-the-clock vigil on its equipment. With noncontaminating jackets on the buried cable, troubles from moisture are held to a minimum.

He's reserving channel 3 for his own closed telecast circuit. His reason for the channel changes is due to the signal loss in the cable at higher frequencies. "By changing to the lower channels and using K-14 coax cable on main lines," says Fos, "we cut down on the number of amplifiers required per mile from five to one.

"Ordinarily we have a 60-db (1,000 μ v equals 0 db) amplifier so that if one tube is shot, this results in a loss of only 1.6 db. Thus transmission is still satisfactory since we allow a 10-db overlay between amplifiers."

With close to 300 subscribers on his underground line already, Hendrick is confident that within a few years 95% of Sarasota residents will be on his list. The time may be shortened by the first big blow that topples a few score antenna towers in the area.

In this prediction he is indirectly bolstered by local municipal authorities. They deplore towers and rooftop antennas. "The cable is an absolute necessity to the city's beautification program," said City Manager Ken Thompson.

The city's fire department chimes in with: "Tall antennas are a menace to firemen who have to ascend to rooftops or if the tower should collapse and fall on a high-voltage line or on a neighbor's roof."

"Besides," said Hendrick, "try to wind a crank type tower down in a 25-mile-an-hour wind. It won't wind down because the force of the wind

makes its framework lean and bind in its rigging."

Another item in favor of the constantly increasing mileage of the underground cable is that when a customer vacates a house served by it, the real estate man with whom the house is listed for rent or sale uses the service as a salespoint. "You don't need an antenna in this house," he advises the new prospect.

Of course, operating such a coax service means an endless round of preventive maintenance, and Fos or a technician may be found at any hour of the day or night, checking, testing and replacing needed components.

Hendrick has laid around 40 miles of cable and expects to obtain sponsors for advertising on his closed-circuit programming when he boosts his customer list to 1,000. Events of local importance will be picked up by his camera, relayed in over a subchannel to the main amplifier, then back over the same cable on channel 3 to the cable users.

At times, Fos must run clear to the end of a 1,200-foot street to supply service to a solitary customer. The chore costs around \$600, but he sticks in a few tapoff boxes for the future and considers it a smart investment. He often gets customers who wish to switch over from an antenna tower of their own to the cable service. In such cases, the tower is available to some TV user out in Florida's hinterland area where it will be years before the cable reaches.

One of the problems of the underground installation was to design and build proper concrete boxes to house the amplifiers.

"We amplify our signal every 1,800 feet," said Hendrick. "On the RG-59/U there is a loss of 4 db per 100 feet on the lead-in. On our spur line of RG-11/U, at 100 mc, we record a 2-db loss per 100 feet. On our main cable, we lose about 0.8 db every 100 feet.

"We estimate the life of our underground cable at 20 to 25 years as compared to a fraction of that on overhead lines. And the moisture attracted to our concrete boxes which enclose the amplifiers actually acts as an additional shield against manmade static."

The Sarasota television picture looks brighter than ever for the future of this Sarasota dealer. And maybe the other dealers will benefit too, through increased set sales.

END



**a look at
the latest in
.....
AUTO RADIO**

Here are some typical CBS tubes and transistors you will be discovering in 1957 "hybrid" auto radios. They combine the advantages of new CBS power output transistors and modern CBS low-voltage mobile radio tubes. All power for them is drawn directly from the 12-volt battery; the vibrator power pack is eliminated. Both the tubes and transistors are especially designed for hybrid auto radio.

As the 1957 automobiles come into use this fall, you will find CBS ready to supply you with these new tubes and transistors. That's only natural. CBS pioneered the first auto radio tube kit. CBS has specialized for years in supplying auto radio tubes to leading set manufacturers. And now CBS advanced-engineering pioneers again with new hybrid auto radio components.

Whether it's tubes or transistors — whatever you need for auto radio — old, modern, or ultramodern . . . make it CBS. Replace with the same tubes and transistors the original equipment designer specifies . . . CBS.

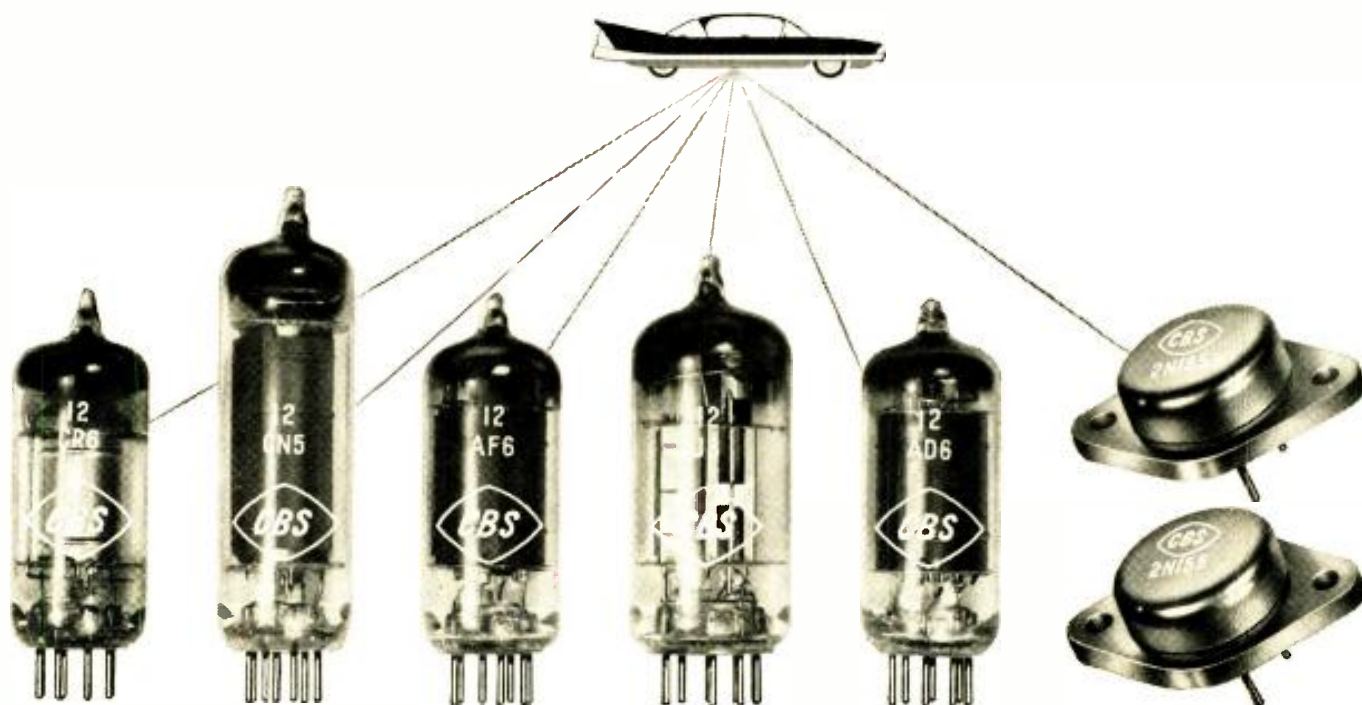

tubes • semiconductors

*Reliable products
through Advanced-Engineering*

CBS-HYTRON

Danvers, Massachusetts

A Division of Columbia Broadcasting System, Inc.

Confused... about Transistor Types ???

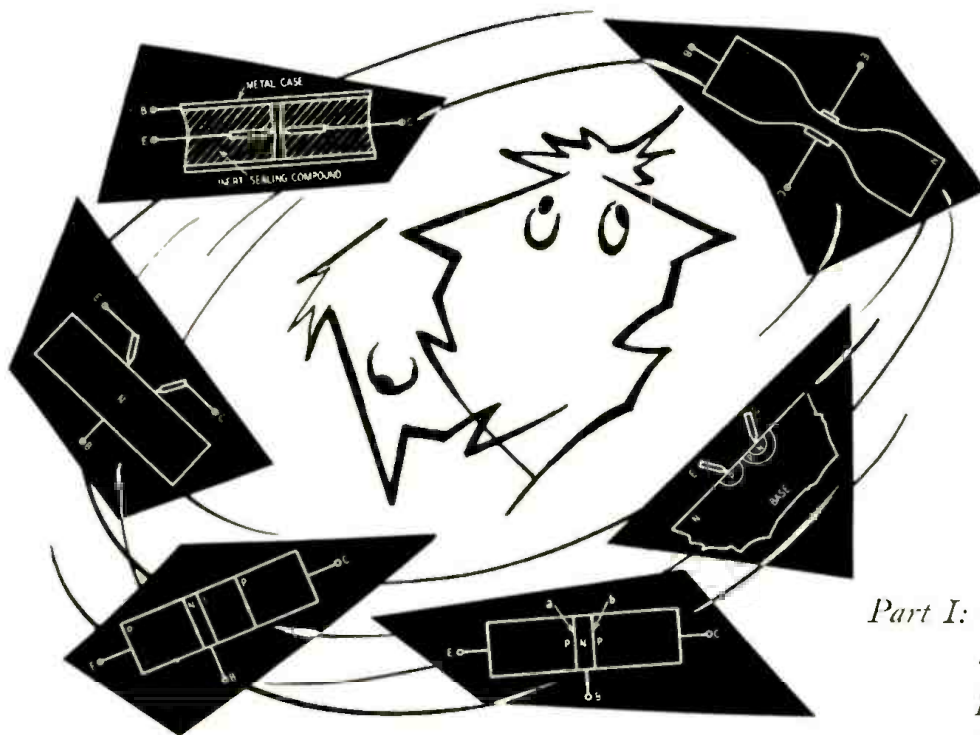

Part I: Characteristics, differences and advantages of junction, point-contact, surface-barrier and intrinsic-region units

By PAUL PENFIELD, JR.

THE electronics technician who tries to keep up with recent advances must be somewhat confused about the transistor situation by now. There are many types of transistors—junction, point-contact, surface-barrier, hook, field-effect, tetrode, photo, tandem and so forth. Anyone who knows about all these can indeed pat himself on the back.

This article is intended for the rest of us who perhaps have a vague idea but don't really know the characteristics, differences and relative advantages of these various types of transistors.

Junction transistors (p-n-p, n-p-n)

The basic p-n-p junction transistor is shown in Fig. 1. The two outside layers are p-type germanium (or silicon), the middle slice is n-type. The two surfaces,

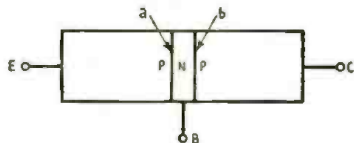

Fig. 1—Basic p-n-p junction transistor. a and b, between the three parts are known as p-n junctions—it is here that rectification occurs.

The collector junction b is normally biased so that little or no current flows through it—that is, in reverse. Transistor action occurs because current from the emitter junction, instead of flowing out of the base lead, crosses the

base and flows through the collector. The emitter current, which enters the base at a low impedance, leaves as collector current at a high impedance. Since the same amount of current flowing through a higher impedance represents greater power, the device amplifies.

Operation of the n-p-n junction transistor is exactly the same, except that current directions and battery polarities are reversed.

Point-contact transistors

The original transistors made back in 1948 were point-contact types; the now more common junction transistors were introduced later.

Fig. 2 is a diagram of a point-contact transistor. Two sharp metal probes are placed on a chunk of n-type germanium and surges of current are passed through them to "electroform" the transistor. As yet no satisfactory theory exists to explain the process—almost all knowledge of electroforming is of a haphazard experimental nature. When more information becomes available through more research, expect to

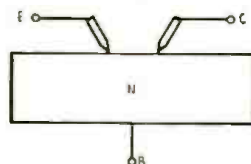

Fig. 2—Point-contact transistor.

see point-contact transistors available with improved characteristics.

Electroforming is believed to set up small areas of p-type germanium right around each point contact. Thus, the device can be thought of as being similar to a p-n-p junction transistor. In fact, the bias-battery polarities are the same. However, the point-contact transistor has the unusual property that the collector current is greater than the emitter current. Put into mathematical form, this means that alpha (α) is greater than 1.

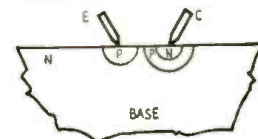

Fig. 3—Formation of the hook multiplier used to explain point-contact current multiplication.

This is a very significant difference between the point-contact transistor and its brother, the junction type, whose alpha (current gain) is generally less than 1. There are two explanations for this behavior; neither one is accepted universally but both are plausible and interesting.

One is that electroforming, in some unknown way, not only creates a p-region near each point contact, but (Fig. 3) a small n-region close to the collector lead that resembles in itself a miniature n-p-n junction transistor

ELECTRONICS

—sort of a transistor within a transistor. And properly biased, the "inner transistor" can produce current multiplication. This type of operation, known as "hook multiplication," is used in the hook transistor.

The other explanation is that near the collector region electroforming sets up small "traps"—imperfections in the crystal structure which have the power to trap holes momentarily. These trapped holes (which come from the emitter current) set up a large charge before they can get out of the traps, thus drawing electrons into the transistor from the collector contact. In this way, the collector current is made larger than the emitter current.

Several companies make some 25 or more point-contact transistor types. They are very useful for switching circuits (such as in large electronic computers) and, because the spacing between the collector and emitter p-regions can be made very small, point-contact units are useful at higher frequencies than normal junction transistors.

In addition, since alpha is greater than 1, under certain conditions the transistor will be unstable as an amplifier. While this is undesirable in an amplifier, it is useful because a simple oscillator can be made by merely biasing the transistor to the unstable point and then hanging a tuned circuit on between a couple of terminals. Crystal-controlled oscillators that are extremely simple and foolproof can be made with this technique.

In a normal point-contact transistor the two probes are next to each other. This, however, is not necessary. Fig. 4 shows a device known as a "coaxial" transistor. Point contacts are placed on opposite sides of a thin germanium slice. Coaxial construction eliminates

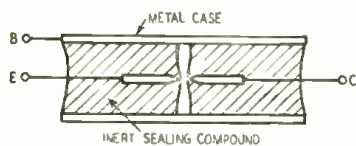

Fig. 4—Coaxial transistor.

surface effects which sometimes interfere with the bulk material effects in transistors. And it provides excellent shielding between the emitter and the collector, advantageous for high-frequency work.

Surface-barrier transistors

A high-frequency transistor which makes use of surface effects and bulk effects is the surface-barrier type. On the surface of a piece of n-type germanium are a number of atoms which cannot form stable bonds with other atoms. These atoms on the outermost layer can and do form bonds among themselves that have the ability to trap electrons and hold them on the surface. The result is a layer of trapped negative charge.

As shown in Fig. 5, flat metal electrodes are plated on the surfaces to

THE NEWEST, MOST COMPLETE BOOK ON

TRANSISTORS AND THEIR USE

"TRANSISTOR CIRCUIT HANDBOOK"

by Louis E. Garner, Jr.

The complete, authoritative book on Transistors. Clearly presented in four sections: Part I—"Laboratory Practice"—covers Transistor types, construction, characteristics, etc.; techniques for wiring and testing, tools and test equipment required, etc.; components for use with Transistors. Part II—"Basic Circuits"—covers amplifiers, oscillators and dozens of special purpose circuits. Part III—"Circuit Applications"—audio, RF, test instruments, and a wide variety of controls and gadgets. Part IV—"Reference Data"—Transistor characteristics charts; manufacturers; definitions and design formulas; special techniques and new developments; complete bibliography. The outstanding book on Transistors. 430 pages; profusely illustrated; 5½ x 8½" case bound. Order today, postpaid only..... **\$4.95**

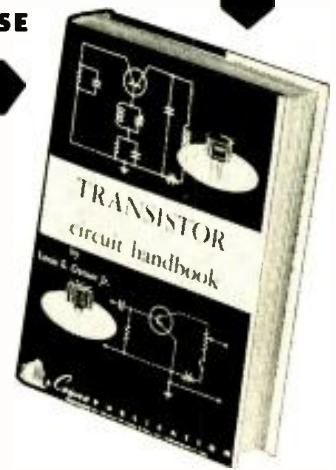

SAMS BOOKS
keep you ahead in
ELECTRONICS

USE HANDY ORDER FORM BELOW

Sams books cover every phase of Electronics for the service technician, engineer, student or experimenter. Listed below are a few of the many valuable Sams books available at electronic parts distributors and leading book stores.

USE THIS ORDER FORM

TRANSISTOR CIRCUIT HANDBOOK..... **\$4.95**

- Color TV Training Manual.** Prepares the Technician for Color TV service work. Covers principles of the Color TV system; Color receiver circuits; installation and servicing sets. Includes color blocks outlining the use of color test equipment. 260 pages; 8½ x 11"; 300 illustrations. **\$6.95**
- TV Test Instruments.** Revised and enlarged to include latest data on instruments used in Color TV servicing. Tells clearly how to operate each type of test instrument used in TV service work. 180 pages; 8½ x 11"; illustrated..... **\$3.50**
- Key Checkpoints in TV Receivers.** Prepared by the Howard W. Sams engineering staff. Provides many applications for general TV service work, including time-saving information on how to make quick tests at key points to determine where trouble lies, and how to check overall performance of the receiver after repair, to insure against callbacks. 182 pages; 5½ x 8½"; illustrated..... **\$2.00**
- Analyzing and Tracing TV Circuits.** Presents a new approach to TV servicing. 168 pages. 8½ x 11"..... **\$3.00**
- Photofact Television Course.** Gives a clear complete understanding of TV principles, operation, practice. Used by thousands of students. 208 pages, 8½ x 11"..... **\$3.00**
- Radio Receiver Servicing.** Covers the basic receiver types—gives time-saving hints for solving basic troubles, such as dead set, weak set, noisy set, etc. 192 pages; 5½ x 8½"..... **\$2.50**
- TV Servicing Guide.** Explains how to apply proper trouble-shooting procedures based on analysis of symptoms (most of which are illustrated by picture-tube screen photos). Shows how to locate and eliminate trouble in every section of the receiver. 132 pages, 8½ x 11"..... **\$2.00**

Tape Recorders—How They Work. Explains recording theory, tape characteristics, motorboard mechanisms, drive motors, amplifiers, magnetic heads, volume indicators, equalization circuits—covers everything you want to know about recorders. 176 pages; 5½ x 8½". **\$2.75**

Servicing AGC Systems. Describes the operation and circuit variations of the various types of AGC systems and explains the servicing techniques that can be applied. Illustrated by actual case histories and photographs of symptoms. 132 pages; 5½ x 8½"; illustrated..... **\$1.75**

Servicing & Calibrating Test Equipment. Shows you how to keep your test instruments in reliable working order, how to determine proper operation and avoid erroneous indications. Explains calibration procedures; gives method for performance record-keeping; shows simple ways to check instrument accuracy; describes proper maintenance and servicing of instruments. 192 pages, 5½ x 8½"..... **\$2.75**

So You Want to Be a Ham. Tells you what you need to know about getting your license and acquiring equipment. Covers such subjects as: Conquering the Code; Getting Your Ticket; Going on the Air; Electronics as a Career; etc. 196 pages; 5½ x 8½"; illustrated..... **\$2.50**

Servicing TV Sweep Systems. Describes the operation, circuit function and circuit variations of vertical and horizontal sweep systems common to most TV receivers. Tells how to analyze circuits; trouble-shoots for you. 212 pages; 5½ x 8½"; illustrated..... **\$2.75**

There is an authoritative Sams book on virtually any Electronic subject in which you're interested. Check below for FREE Book List describing all Sams books.

Send Book List

HOWARD W. SAMS & CO., INC.

Order from your Parts Jobber today, or mail to Howard W. Sams & Co., Inc., Dept. 2-K6 2205 East 46th St., Indianapolis 5, Indiana.

Send books checked above. My (check) (money order) for \$..... is enclosed.

Name.....

Address.....

City..... Zone..... State.....

(outside U.S.A. priced slightly higher)

Look for
SAMS BOOKS
on the
"Book Tree"
at your Parts
Distributor

TECHNICIANS: ARE YOU NOW QUALIFIED FOR ENGINEERING WORK?

THEN HERE IS YOUR OPPORTUNITY FOR
AN ENGINEERING ASSIGNMENT WITH
THE RCA SERVICE COMPANY!

... And you'll be eligible for educational benefits through RCA's liberal Tuition Refund Plan, a real boost toward that actual engineering education you're interested in! Many other company-paid benefits, of course. Excellent starting salaries • pleasant suburban locations • relocation expenses paid.

Which of these engineering fields do you prefer?

- Missile Electronics
- Navigational Aids Planning & Design
- Naval Electronic Systems Installations Planning
- Specifications Engineering Writing

ARRANGE FOR CONFIDENTIAL INTERVIEW WITH
REPRESENTATIVES OF RCA ENGINEERING MANAGEMENT
AT A LOCATION CONVENIENT TO YOU

Please send complete resume to:

Mr. John R. Weld
Employment Manager, Dept. Y-8K
Radio Corporation of America
Camden 2, New Jersey



RCA SERVICE CO., INC.

ELECTRONICS

act as the emitter and collector, and the germanium body acts as the base. As expected, bias polarities are the same as for p-n-p junction transistors

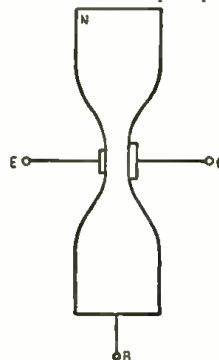

Fig. 5—Surface-barrier transistor with plated emitter and collector contacts.

and the static volt-ampere characteristics of the two are similar. The method of operation is also much the same—holes injected by the emitter pass through the base and flow through the reversely biased collector region, resulting in amplification.

The big advantage of surface-barrier transistors is that special etching techniques can be used in manufacturing the units to make the base very thin. Since the base is thinner, the hole transit time across the base is smaller and the high-frequency response is correspondingly better. Surface-barrier transistors are now the best commercially available high-frequency types.

Intrinsic-region transistors

Fig. 6 shows what is known as a p-n-i-p transistor, consisting of a layer of p-type, n-type, intrinsic type and p-type germanium. An intrinsic region

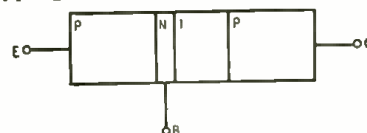

Fig. 6—The basic p-n-i-p transistor.

is one without impurities—that is, it is not doped with either donors or acceptors. Normally an intrinsic region is free from holes or electrons and so its resistance is apt to be very high, at least at normal room temperatures.

The intrinsic region is helpful for high-frequency response. It effectively separates the collector and base regions, lowering the collector-to-base capacitance considerably. It also allows the base to be built a trifle larger, making the base resistance smaller.

A common figure of merit for high-frequency operation is the product of the collector capacitance times the base resistance—the lower this product, the better the transistor. The i-region helps out by lowering both factors.

Neither p-n-i-p transistors nor the equally promising n-p-i-n models are available commercially as this is being written. However, their frequency range (expected to be up to 1,000 mc) is high enough and construction of the devices easy enough that they will probably become available before too long a time.

TO BE CONTINUED

Compact Audio-Frequency Meter

*Direct-reading instrument
is small, accurate
and self-powered*

By ELLIOTT A. McCREADY

USUALLY, when an unknown audio frequency is to be measured, the oscilloscope and audio oscillator are the first instruments reached for. The Lissajous figure produced on the scope by the known and unknown frequencies is easily interpreted and the frequency of the unknown signal can be determined, the accuracy depending only on that of the known frequency.

There are occasions, however, when the scope-oscillator method of frequency measurement is far from convenient. If the unknown signal is remote from the test bench, of short duration or varies rapidly, a different method of testing is necessary.

One answer to such a problem is a direct-reading frequency meter, an instrument by which an unknown frequency is read directly on a meter, and frequency measurement becomes as simple as measuring voltage on an ordinary volt-ohmmeter.

Operation of the direct-reading frequency meter is based on the following principle: When a series of constant-amplitude pulses of like polarity is fed to a milliammeter, the meter deflection is primarily a function of the frequency of the pulses.

Practically, the direct-reading frequency meter consists of one or more stages of voltage amplification. These stages are overdriven and their output is a rectangular wave of constant amplitude for all input voltages above a certain minimum value. This rectangular wave is differentiated by a resistance-capacitance network, rectified and fed to a milliammeter.

The pulse presented to the meter has a constant shape and amplitude regardless of the input waveform or voltage (above the saturation voltage of the amplifier). The meter then varies linearly and directly as the input frequency.

Frequency meter circuit

The instrument is entirely self-contained and self-powered. It is small, accurate and simple to operate.

The CK722 transistor operates as an amplifier and clipper (see diagram), squaring and limiting the input waveform. As excessive input voltage could damage the transistor, sensitivity control R1 was included to increase the input voltage range of the instrument.

The rectangular wave at the collector of the transistor is differentiated in decade steps by capacitors C2, C3, C4 and C5, together with the meter shunt resistance R4. The resulting pulses are rectified by D1 and D2 and fed to the 0-100 microammeter. As the amplitude of the output pulses is limited by the maximum collector voltage rating of the transistor, it is necessary to use a sensitive meter to measure the rectified pulse frequency.

The frequency meter (see photo) is housed in a 4½ x 4½ x 4½-inch homemade Masonite meter case with a sloping front. Steel meter cases of this size are available and would probably provide the simplest method of housing.

The microammeter is mounted on the sloping front of the meter case, allowing room for R1 and S2. R2, R3, D1, D2 and the transistor socket are mounted on a six-lug terminal strip, the end of which is shown in the upper left-hand corner of the underchassis view. The hearing-aid battery is held in place by a clip fashioned from a small piece of aluminum or brass. R4,

mounted with a bracket as shown in the upper right-hand corner of the photo.

Capacitors C2, C3, C4 and C5 should be matched with a good capacitance bridge. Smaller values may be paralleled to obtain the necessary accuracy. If you don't have access to a capacitance bridge, use the alternate method of capacitor selection described later.

Operation

After the instrument is wired, set R4 for minimum resistance, connect the input leads to a 6.3-volt 60-cycle source, set S2 to the lowest range, switch the instrument on and advance the sensitivity control fully clockwise. Back off on meter shunt R4 until the meter reads 60. Calibration is now correct for all ranges.

When a signal of unknown frequency and voltage is to be measured, set the range switch to the lowest position, switch the frequency meter on and slowly advance the sensitivity control, noting the meter reading. If the meter goes off scale, set S2 to a higher range

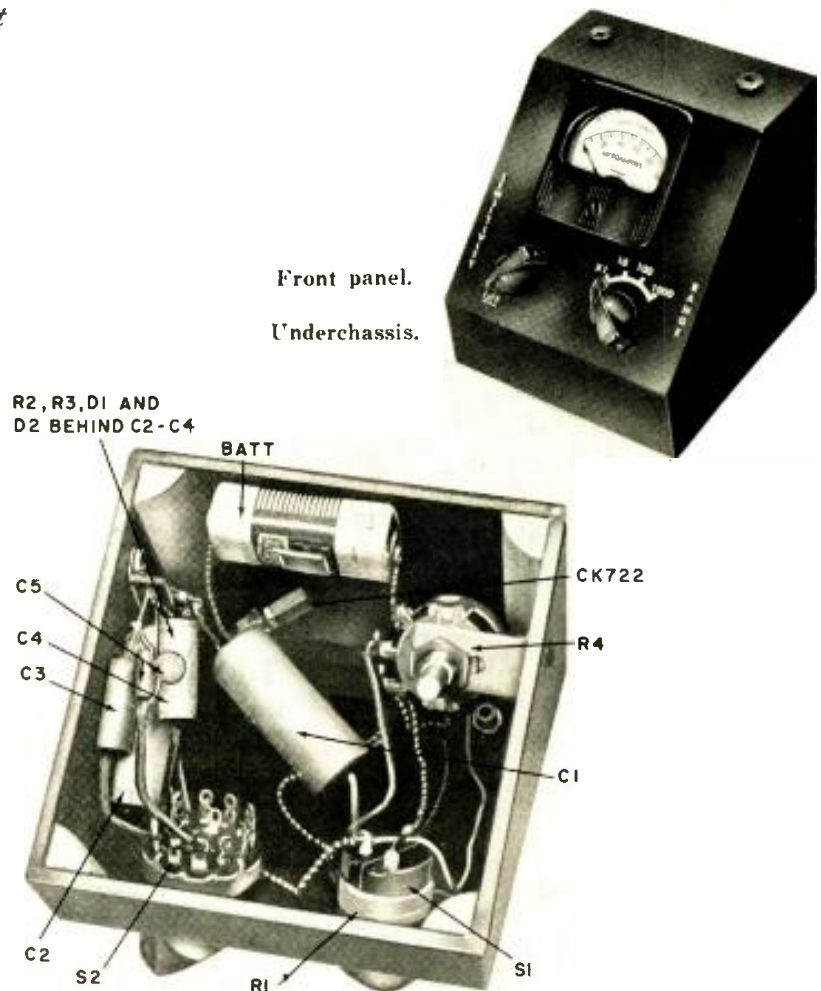

STOP LOSSES due to inaccurate instruments

CHECK AND ADJUST

Your Test Instruments
with **LABORATORY ACCURACY**



Designed by
MILTON S. KIVER
Author of the Book
"Servicing and Calibrating
Test Equipment."
Published by
Howard W. Sams & Co., Inc.

New 750 **B&K** TEST EQUIPMENT CALIBRATOR

Calibrates VOM, VTVM and other meters, signal, sweep and marker generators and oscilloscopes.

Provides dc and ac voltages for checking voltage ranges of VOM, VTVM and other meters.

Standard resistances from 10 ohms to 10 megohms for checking reliability of each resistance range in VOM and VTVM.

Crystal oscillator generating harmonics over 300 mc for use as marker generator in all receivers, and to calibrate AM signal generator, and to align TV audio I.F. system.

Built-in tone generator for signal tracing amplifiers in all audio equipment. This tone also available at modulated RF.

Oscilloscope voltage calibrator in measuring peak-to-peak voltages of unknown waveforms.



Voltage Accuracy $\pm 1\%$ or Better

Avoid instrument errors that cause wrong decisions and time-killing rechecks in receiver testing. With the new, low-cost, laboratory-type Model 750 Calibrator you can quickly, easily check test equipment accuracy and make necessary adjustments.

Provides standard of $\pm 1\%$ or better in all of its voltage sections—enables you to calibrate your test instruments like the labs do, and give better service at lower cost.

Model 750 Calibrator

Complete with 5 mc crystal. Operates on 110-120 v., 60 c. ac. Sturdy metal case. Size: 8 3/4 in. high, 8 in. wide, 5 1/2 in. deep. Net wt. 6 3/4 lbs.

\$54.95
NET

See Your Distributor or Send For Bulletin 750-E

B & K MANUFACTURING CO.

3726 N. Southport Ave. • Chicago 13, Illinois

Makers of DYNA-QUIK, CRT, DYNA-SCAN and CALIBRATOR



COLOR TELEVISION

Home Study For Technicians

Now Available the **MOST COMPLETE, COMPREHENSIVE COLOR TV HOME STUDY COURSE** illustrated with **BLOCK-A-MATICS**

This new seven-lesson **HOME STUDY COURSE** in **COLOR TELEVISION** was compiled by Albert C. W. Saunders, internationally noted author-lecturer on Radio and TV Servicing, and is the best course available today. It is just off the press with the latest technical information. Lessons are fully illustrated with simplified diagrams including **BLOCK-A-MATICS**—The New Look In Schematics. Also Color Illustrations.

COMPLETE COURSE—ONLY \$25

ALSO AVAILABLE:

Practical Transistor Course for Radio and Electronics Technician by Albert C. W. Saunders. Three lessons only \$10

For Particulars Write

Saunders Electronics Correspondence School
Dept. CT 137 Federal Street, Boston 10, MASS.

TEST INSTRUMENTS

and continue to advance the sensitivity control until the meter stops rising. The point at which the meter stops indicates the unknown frequency. Advancing R1 further will make no change in the meter reading and, if advanced too far, may damage the transistor.

The minimum operating voltage of the instrument is about 0.5 volt. As the input impedance of the transistor is low, the instrument will heavily load a low-voltage high-impedance source and a proper reading may not be obtained. To insure that the instrument is reading accurately, it should always be possible to advance the sensitivity control a few degrees after the meter reading flattens out.

Capacitor selection

Completely wire the instrument, omitting only capacitors C3, C4 and C5. In place of C3 tack a couple of fairly long leads with clips attached.

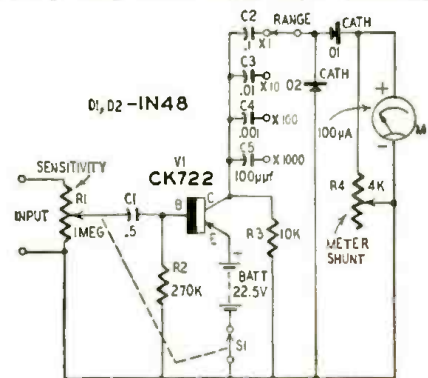

Schematic diagram of af meter.

Parts for audio-frequency meter

- | | |
|---|---|
| R1—1-megohm pot (linear taper), with switch | D2—IN48 germanium diode |
| R2—270,000 ohms, 1/2 watt | M—0-100 microammeter |
| R3—10,000 ohms, 1/2 watt | BATT—22.5-volt hearing-aid battery |
| R4—4,000-ohm pot | S1—spst switch on R1 |
| C1—0.5 µf | S2—single-pole 4-position rotary switch |
| C2—0.1 µf | Hearing-aid socket, 5 prongs (Cinch-Jones) |
| C3—0.01 µf | Meter case, approx. 4 1/2 x 4 1/2 x 4 1/2 inches, sloping front |
| C4—0.01 µf | Terminal strip, 6 lug |
| C5—100 µf | Tip or banana jacks (2) |
- All capacitors 200 volts, paper
V1—CK722 Transistor
D1—IN48 germanium diode

With the range switch in the $\times 1$ position, connect the input to an audio oscillator delivering 100 cycles at about 3 volts. Switch the frequency meter on and advance the sensitivity control fully. Back off meter shunt R4 until the meter reads 100. Switch the range switch to the $\times 10$ position and set the oscillator to 1,000 cycles. Now try several .01-µf capacitors across the two extending leads until one is found that produces an indication of exactly 100 on the meter. Leaving the range switch in the same position, set the oscillator to the 10,000- and 100,000-cycle positions and select .001- and .0001-µf capacitors in a like manner. After the capacitors are selected they may be soldered in place and the meter will be accurately calibrated. END

TEST INSTRUMENTS

transistor checker for \$100

Economy plus in this ultrasimple tester

By EDWIN BOHR

FOR \$1, perhaps a little more in some instances, you can build this transistor checker. It indicates whether a transistor is good or bad and whether it has high or low gain. The very simple circuit contains a minimum of components.

The circuit is described in the G-E *Semiconductor Handbook* and resembles the one used in both the new G-E portable checker and the Lafayette transistor model available in kit form.

Normally, a very sensitive microammeter is necessary to make even the most rudimentary transistor test. In contrast, by making the transistor under test do a little work, this circuit will work with any 0-2 or 0-5 milliammeter—even a 0-10 milliammeter

could be used. For example, to test a transistor with this circuit simply set a multimeter to the 0-2.5-ma range and plug its test leads into the checker.

One of the more important tests of a transistor measures the amount of current that flows through the collector circuit with no emitter bias. This current is called I_{ce} . The I_{ce} means that it is a collector-current measurement and the “.” indicates the emitter current must be zero during the measurement. I_{ce} varies with temperature, collector voltage and the individual transistor. Normally, at room temperature, a typical figure would be 5 microamps for I_{ce} . If the current is much greater than this the transistor is defective.

(Continued on page 112)

TRANSISTOR CHARACTERISTICS			
Type	Low gain		High gain
P-n-p	CO-1, 2N135,	CK722, 2N107, TS-162	CK721, CK760, CK761, 2N137, TS-165, CK725, OC70, 2N34, 2N43 (G-E), CK762, 2N136, 2N112
N-p-n	2N170		2N94, 2N35
Meter Reading	With gain switch open, should not exceed 0.75 ma. Close gain switch and current should increase at least 0.2 ma.		Approximately intermediate between low- and high-gain units.
			With gain switch open, should not exceed 2.0 ma. Close gain switch and amount of current increase indicates relative gain of transistor



The transistor checker in operation

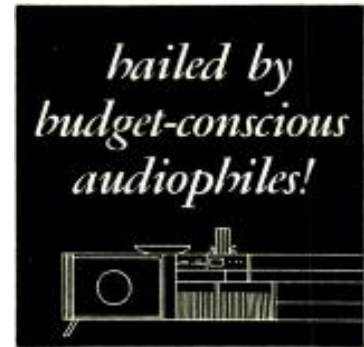

TAPE RECORDING UNITS



Model TM-56...\$89.95 list

STAFF OK TESTED BY TAPE RECORDING MAGAZINE

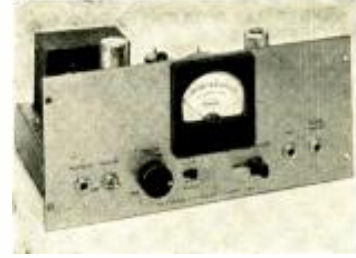

Model P-4...\$79.95 list

Now! Custom install your own recorder. Low cost. Ready to plug into any amplifier and speaker.

Tape mechanism has UniMagic 1-lever control for record-playback, fast forward and rewind with instant braking. 2 speeds—7½ and 3¾". Separate record-playback and erase heads.

Matching tape preamplifier—40-12,000 cps ± 3db, signal-noise ratio 50db. Push-pull oscillator. Professional controls. VU meter. Brushed copper and jet black finish. Carries Pentron warranty.



Send for Bulletin... Name of Nearest Hi-Fi Dealer

PENTRON CORP.
Dept. 765
777 So. Tripp Ave.
Chicago, Ill.

Name _____
Address _____
City _____ Zone _____ State _____
Canada: Atlas Radio, Ltd. Toronto



The "Buccaneers" "

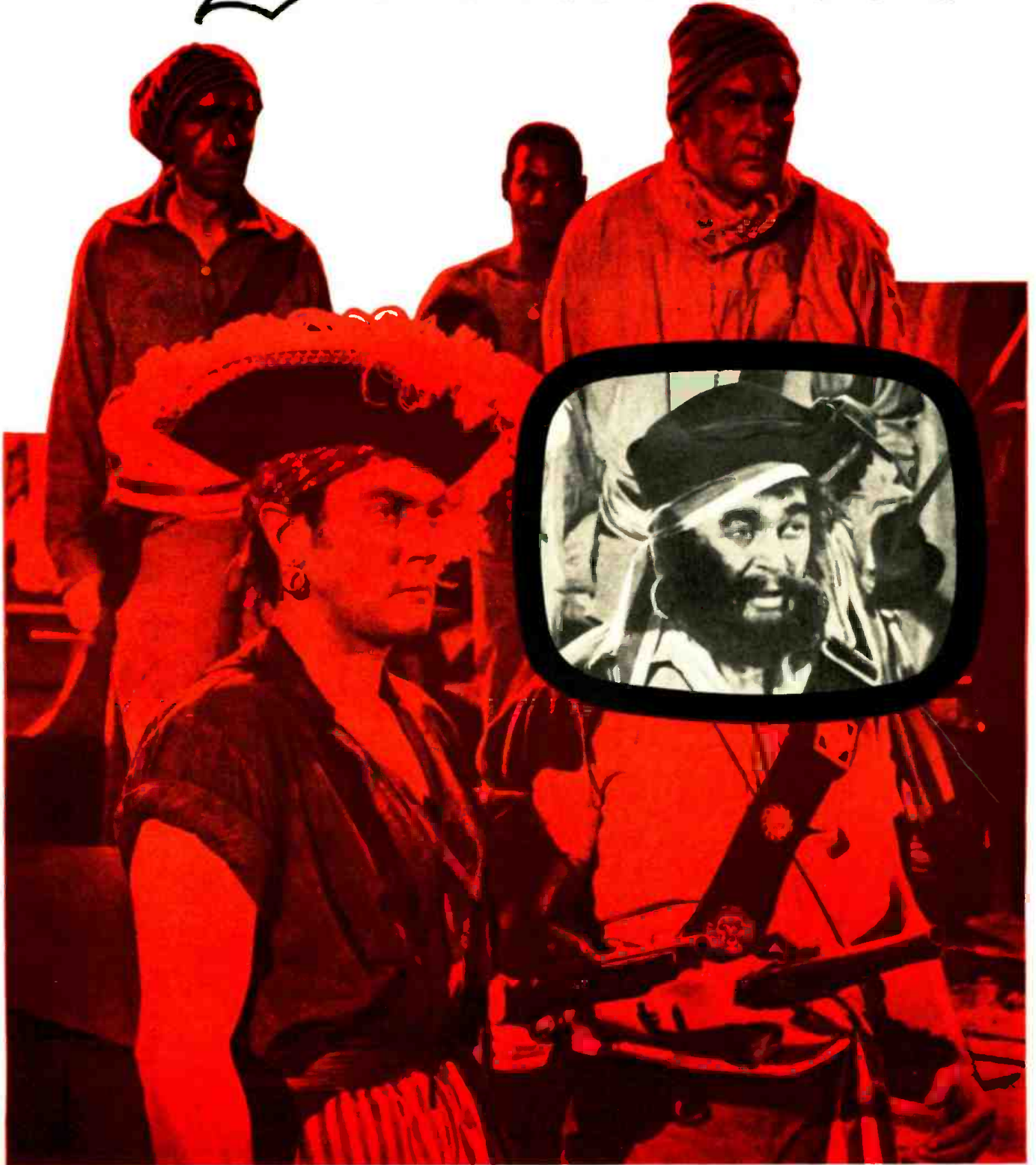

Sylvania's new TV show will be televised nationally over CBS stations every Saturday night. Check your local listings for time and station.

new Sylvania TV SHOW

launches a dramatic new advertising program for TV Service Dealers



Biggest TV news this fall for you as a service dealer is Sylvania's new adventure thriller "The Buccaneers." Packed with exciting pirate lore, Sylvania's new TV show offers entertainment for the entire family.

And it offers you a brand-new opportunity to build your service business through a dramatic new consumer advertising campaign, "TV SMOG."

Millions of TV set owners will be reminded that TV Smog comes from old worn out picture tubes and receiving tubes. And they'll be reminded to see the service dealer who displays the Sylvania Radio & TV service sign for a TV Smog check-up.

To supplement this powerful TV advertising, a complete campaign in *TV Guide* magazine will also steer the TV set owner to you for a TV Smog check-up.

Get behind this TV Smog promotion: identify yourself as the dealer in your neighborhood who features "Silver Screen 85" picture tubes and Sylvania's quality brand receiving tubes.

And keep in touch with your Sylvania distributor for new Buccaneer promotion pieces and premiums.

SYLVANIA ELECTRIC PRODUCTS INC.
1740 Broadway, New York 19, N. Y.
In Canada: Sylvania Electric (Canada) Ltd.
Shell Tower Building, Montreal

LIGHTING • RADIO • ELECTRONICS
TELEVISION • ATOMIC ENERGY



SYLVANIA

... get a "TV SMOG" rating on your set

... the serviceman who displays this sign

... will install a genuine "Silver Screen 85"

... and replace worn-out receiving tubes with Sylvania's quality brand



LOOKING?
for the right dual-control replacement

You'll find it's
ALWAYS IN STOCK at your
Centralab Fastatch®
distributor

- With Centralab's unique Fastatch system, your distributor can afford to carry a *complete line* of dual-concentric replacements for all popular TV, radio, and auto sets.
- Each Fastatch control unit is factory assembled, tested, and guaranteed.
- Ask your Centralab distributor's salesman or counterperson about Fastatch duals. Or send coupon for bulletin 42-218.

Centralab

A DIVISION OF GLOBE-UNION INC.
998J East Keefe Avenue, Milwaukee 1, Wisconsin 0-5622

Send me Fastatch bulletin 42-218.

Name _____
Company _____
Address _____
City _____ Zone _____ State _____



TEST INSTRUMENTS

Fig. 1-a shows how I_{co} can be measured.

If we now reconnect or change the circuit to that of Fig. 1-b, the collector current increases tremendously—perhaps to 500 microamps or more. This, of course, is no longer an I_{co} measurement but *very roughly* a product of I_{co} and the transistor current gain (β). The circuit is markedly sensitive to room temperature and very-high-gain transistors may pass enough current to cause self-destruction. Certainly, for these reasons, Fig. 1-b could not be used for checking transistors. However, Fig. 1-c can be used. A resistor has

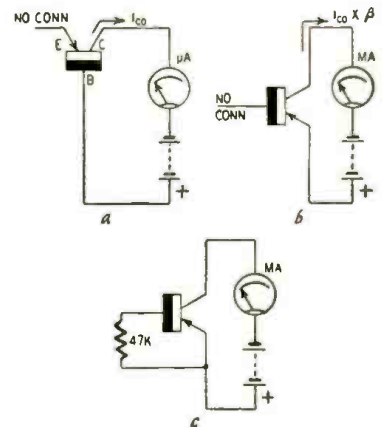

Fig. 1—Diagrams show circuits leading to development of transistor checker.

been included between base and emitter. This affords a small degree of stabilization, preventing too great a tendency to collector-current runaway.

Fig. 1-c, therefore, is used in the tester to obtain the I_{co} times current-gain test. For a valid test we must know whether the transistor is supposed to be a high- or low-gain unit. For example, if both a high- and a low-gain transistor, each with the same value of I_{co} , are plugged into the circuit of 1-c, the meter will read possibly 10 times higher for the high-gain tran-

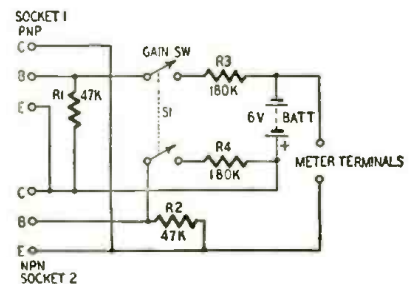

Fig. 2—Diagram of transistor checker.

Parts for transistor checker

- R1—47,000 ohms
- R2—47,000 ohms
- R3—180,000 ohms
- R4—180,000 ohms
- All resistors 1/2 watt
- SOCKET 1—transistor socket
- SOCKET 2—transistor socket
- S—dpst toggle switch or pushbutton switch normally open
- BATT—6-volt battery (RCA VSO68 or equivalent)
- Pin jacks for meter terminals (2)
- Chassis or cabinet, aluminum, small

ON YOUR PRESENT SET... WITH A

Announcing

The Most Sensational Advertising Program in TV Antenna History

Winegard

Full color ads—reaching over 30,000,000 prospects across the nation!

**Saturday Evening Post
House Beautiful • Farm Journal
Better Homes & Gardens
Town Journal • Sunset
TV Guide and others**



Write for "Operation Team-Up"—Local Dealer Tie-in Advertising
Winegard Co. 3000 Scotten Blvd., Burlington, Iowa

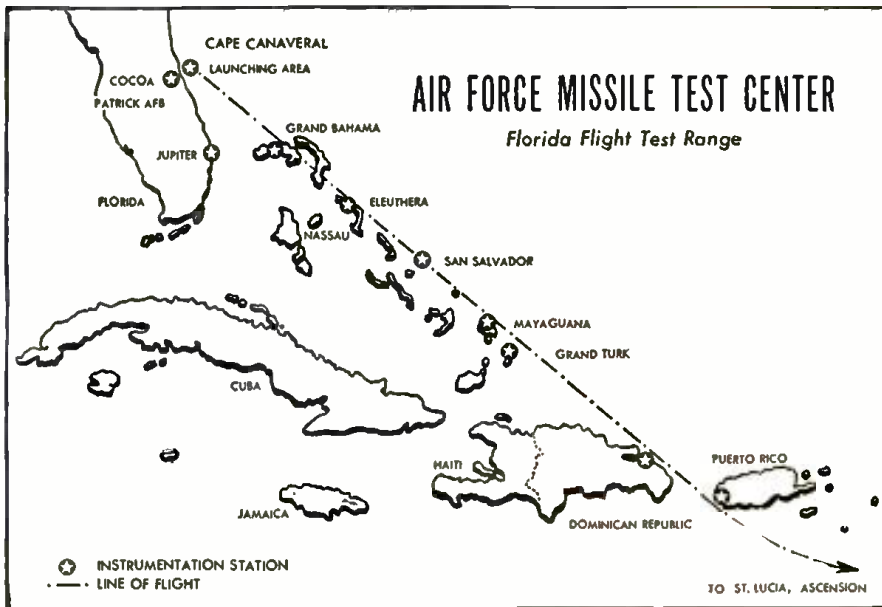

RCA

ANNOUNCES OPPORTUNITIES

In Guided Missile Test Instrumentation For Electronic Technicians

At the following locations

PATRICK AIR FORCE BASE, FLORIDA

Engineering development technicians
Radar
Communications
Test Equipment

CAPE CANAVERAL

Radar	Timing
Radio	Telephone
Telemetry	Optics

Enjoy pleasant Florida living and working at these locations.
Liberal company benefits. Relocation assistance.

INTERESTING DOWN-RANGE ASSIGNMENTS

Radar	Telemetry	Telephone
Radio	Timing	Optics

These positions are located on the Islands shown on the map above. Salary, 30% incentive, meals and lodging furnished. Return to U.S. every 3 months.



For information and arrangements for personal interview, send complete resume to:

Mr. H. C. Laur
Technical Employment, Dept. N-15K
Missile Test Project
RCA Service Co., Inc.
P.O. Box 1226, Melbourne, Florida



RADIO CORPORATION of AMERICA

TEST INSTRUMENTS

sistor. To check good the meter must read within one limit for low-gain transistors and within another, and much higher limit, for high-gain transistors.

By applying a small dc signal to the base of the transistor and noting the change in collector current, it is possible to have some idea of the transistor's gain. A resistor from collector to base that may be easily switched in or out serves this purpose.

Fig. 2 shows a complete checking circuit with sockets for both p-n-p and n-p-n transistors and a switch for gain checking.

Checking transistors

To check a transistor first look in the characteristics table and determine the correct current range for the transistor being tested. Plug the transistor into the correct socket and note the meter reading. At room temperature this current should not exceed 0.75 ma for low- and medium-gain transistors and 2 ma for high-gain transistors. If the current is very much greater than this you can be sure the transistor is defective. If the transistor checks good, close the gain switch. The current should increase at least 0.2 ma for a low-gain transistor and this increase may exceed 3 ma for a very-high-gain transistor.

The table classifies the transistors as low, medium or high gain. Some of the most popular transistors are listed. These are broad categories and, because of production spreads, there may be some overlapping—some of the low-gain units will occasionally have higher gain than a transistor sold as a medium-gain unit and so on.

To check the tester battery, insert a 2,700-ohm resistor in either transistor socket from emitter to collector. A good battery will cause the meter to read a little more than 2 ma.

Construction

The tester is built on a miniature aluminum chassis measuring 1 1/4 x 2 5/8 x 2 3/4 inches. However, any small box or chassis will do. A toggle switch is used but the constructor may prefer a two-pole pushbutton type instead. Two rectangular retainer-ring transistor sockets are used, one for n-p-n transistors and the other for p-n-p units.

Four dry cells or a single 6-volt battery can supply the necessary collector voltage. There are few components and connections; yet we notice that some constructors get into difficulties. As each part or wire is soldered in place, mark it off the diagram. This seems the best way to avoid trouble. Keep the gain switch in the off position—otherwise, the circuit's resistors will drain the battery slightly.

Just plug in a milliammeter and follow the procedure outlined. A little experience with the tester builds confidence in its operation. **END**

the choice antenna line

TRIO Sharpshooter ANTENNAS

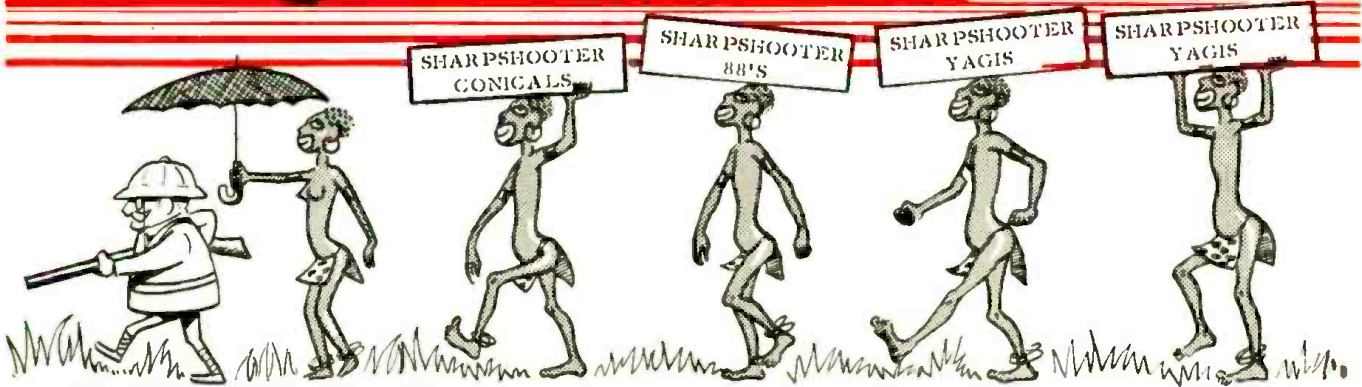

Sharpshooter 88

Completely Pre-assembled

- Ratio Type Dipole
- Insta-Lok Clamps
- Riveted Construction
- Mycostyrene Insulators
- Model 88 Single Bay
- Model 88 2/2 Bay with Stacking Bars

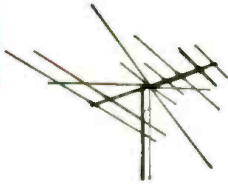

SHARPSHOOTER CONICALS

- 14 Models to Choose from
- Insta-Lok Conical Head
- Insta-Lok Clamps
- Riveted Construction
- Instant Assembly!

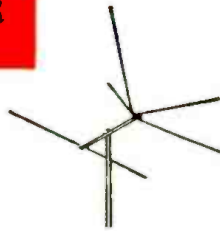

SHARPSHOOTER YAGIS

- Insta-Lok Clamps
- Riveted Construction
- Complete Pre-assembly

Broadband Ch. 7-13 Yagis



Trio 6713

Use two ratio type dipoles for close match to 300 ohm line for improved performance.



Trio 10713

Cut-To-Channel Yagis



A complete line of 5 element and 10 element cut-to-channel Yagis. Use ratio type dipole for necessary impedance step-up to give close match to 300 ohm line.

Install-It-Yourself



TV ANTENNA KITS

TRIO 50

TRIO 50 KIT—Recommended for distances up to 50 miles. Kit contains Trio model 742 Conical with everything needed for a complete installation.

TRIO 70

TRIO 70 KIT—For distances up to 70 miles. Contains single bay Trio model 88 with materials for a complete installation.

TRIO SUPER 70

TRIO SUPER 70 KIT—For distances of over 70 miles. Contains Trio model 88-2 for improved reception. Complete with everything required for the economical "Do-It-Yourself" installation of a stacked array.



EXPORT SALES DIV., SCHEEL INTERNATIONAL INC., 4337 N. Lincoln Ave., Chicago, U.S.A. Cable Address: HARSHEEL

**D'ya
hear**



**the swing
is to
EMC**

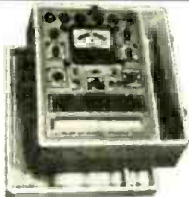

**MUTUAL CONDUCTANCE
TUBE TESTER — EMC Model 206 P**

One of the finest pieces of tube testing equipment at a price comparing favorably with emission-type testers. This completely flexible model using lever-type switches offers extremely accurate results with ease of operation.

\$83.50 (hand rubbed carrying case)

**VOLT-OHM-CAPACITY METER —
EMC Model 107**

Directly measures capacity, resistance and complex waveforms peak to peak. Some of the high quality features at no extra cost are: expanded scale cannot burn out . . . measures 50 mmfd to 5000 mfd . . . inductance from 1.4 henries to 140,000 henries in 4 ranges . . . 1% multipliers for voltage capacity and resistance measurements.

\$48.90 wired & tested \$34.50 kit form



**TRANSISTOR CHECKER
EMC Model 210**

New economical transistor checker contains these high quality features:

- Checks all PNP and NPN transistors
- Measures gain in three ranges
- Measures leakage on two color "Poor — Good" Scale
- Housed in a molded bakelite case
- Supplied complete with batteries

\$10.95 wired and tested
\$ 7.95 kit form



**New White Dot-Cross Hatch —
Bar Generator
EMC Model 800**

Lowest priced, quality color and monochrome generator available . . . easily adjusts color convergence, width, linearity, ion trap and yoke, etc.

\$39.90 wired and tested
\$22.50 kit form



**Wide Band Oscilloscope For Color
And Monochrome TV
EMC Model 601**

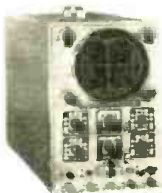

EMC Model 601 oscilloscope gives you the highest quality features ever found in this price field. Exclusive features: full 5 mc bandwidth for color TV servicing — push-pull vertical amplifier, .02 volt per inch sensitivity — 5 UPI — 5" scope tube — 60 cycle phasing control — DC positioning controls eliminates overshooting and bounce — built-in peak to peak calibration reference — 2-step compensated attenuator input — multi-vibrator sweep, from 15 cycles to over 75 kilocycles.

\$117.90 wired and tested

Yes, I want to see for myself, send me—FREE—a detailed catalog of the complete EMC line of precision test equipment.

NAME _____ RE-10

STREET _____

CITY _____ STATE _____

EMC

ELECTRONIC MEASUREMENTS CORPORATION
280 LAFAYETTE STREET, NEW YORK 12, N. Y.
EXPORT DEPT. - 370 BROADWAY, N. Y. 13, N. Y.

**new
Devices**



FILTERED DC SUPPLY, model NFA, continuously variable source from 0 to 32 volts for loads from 1 to 15 amps. Operates on 115 volts, 50-60 cycles. Circuit breaker, full-view meters, pilot light and carrying



handles. — **Electro Products Labs.**, 4500 Ravenswood Ave., Chicago 40, Ill.

PROBES, high-voltage and rf types, for Phaostron model 777 vtvm. High-voltage probe extends 777's range to 50,000 volts. Rf probe permits meas-



urements up to 400 mc.—**Phaostron Instrument & Electronic Co.**, 151 Pasadena Ave., South Pasadena, Calif.

SIGNAL-TRACING PROBE, type 262-A peak-to-peak type for vtvm's. Signal tracing more accurate than possible with half-wave probes. Tests horizontal sweep, flyback, vertical sweep, sync, video, local oscillator, if and audio sections of TV receivers.—**Futuramic Co.**, 2500 West 23rd St., Chicago, Ill.

SWEEP OSCILLATOR, Ligna-Sweep model C, Vhf range; 30-220 mc sweep width variable to at least 15 mc—20 mc over vhf TV channels; fundamental frequency output 1 volt



rms into 75 ohms. Separate low if band. For video: range 100 kc to 12 mc with beat-frequency output of 0.25 volt into 75 ohms; sweep width variable 100 kc to 12 mc.—**Kay Electric Co.**, 14 Maple Ave., Pinebrook, N. J.

VIDEO PATTERN GENERATOR, Dyna-Scan model 1000. Self-contained flying-spot scanner produces composite video and sync signal for alignment and checking and to transmit or reproduce pictorial or graphic material in closed-circuit TV systems. Power output from 50,000 μ v down to minimum level for testing fringe-area sensitivity. 5BKPV-1 5-inch flying-spot tube, 8 other tubes plus 2 rectifiers. Built-in



synchronized bars make unit self-calibrating, insure vertical and horizontal linearity. Slide holder, Indian Head, white dot and white line transparencies. —**B & K Mfg. Co.**, 3731 No. Southport Ave., Chicago 13, Ill.

TRANSISTOR CHECKER, model 210. Low-cost type checks all p-n-p and n-p-n transistors. Measures gain in three ranges.



leakage on Poor-Good scale. Also checks crystal diodes.—**Electronic Measurements Corp.**, 280 Lafayette St., New York, N. Y.

VOLTAGE CALIBRATOR KIT, model VC-3 produces near-perfect square-wave signals of known amplitude. Multivibrator circuit assures sharp,



square waves (as distinguished from clipped sine waves). Output frequency 1,000 cycles approximately. Output voltages selected by panel switch: .03, 0.1, 0.3, 1.0, 3.0, 10, 30 and 100. Precision 1%. Besides acting as peak-to-peak calibrator, doubles as square-wave generator at 1,000 cycles for determining gain, frequency response of phase-shift characteristics of audio amplifiers.—**Heath Co.**, Benton Harbor 20, Mich.

HIGH-FIDELITY AMPLIFIER, Model 90-A, 90 watts rated power, within 1 db 17-25,000 cycles (1 db 9-60,000 cycles at



50 watts), 180 watts peak. Frequency response 20-20,000 cycles within 0.1 db. Less than 0.5% harmonic distortion at full output, 0.25% at 50 watts. Hum and noise better than 92 db below full output. Two regulated

RADIO-ELECTRONICS

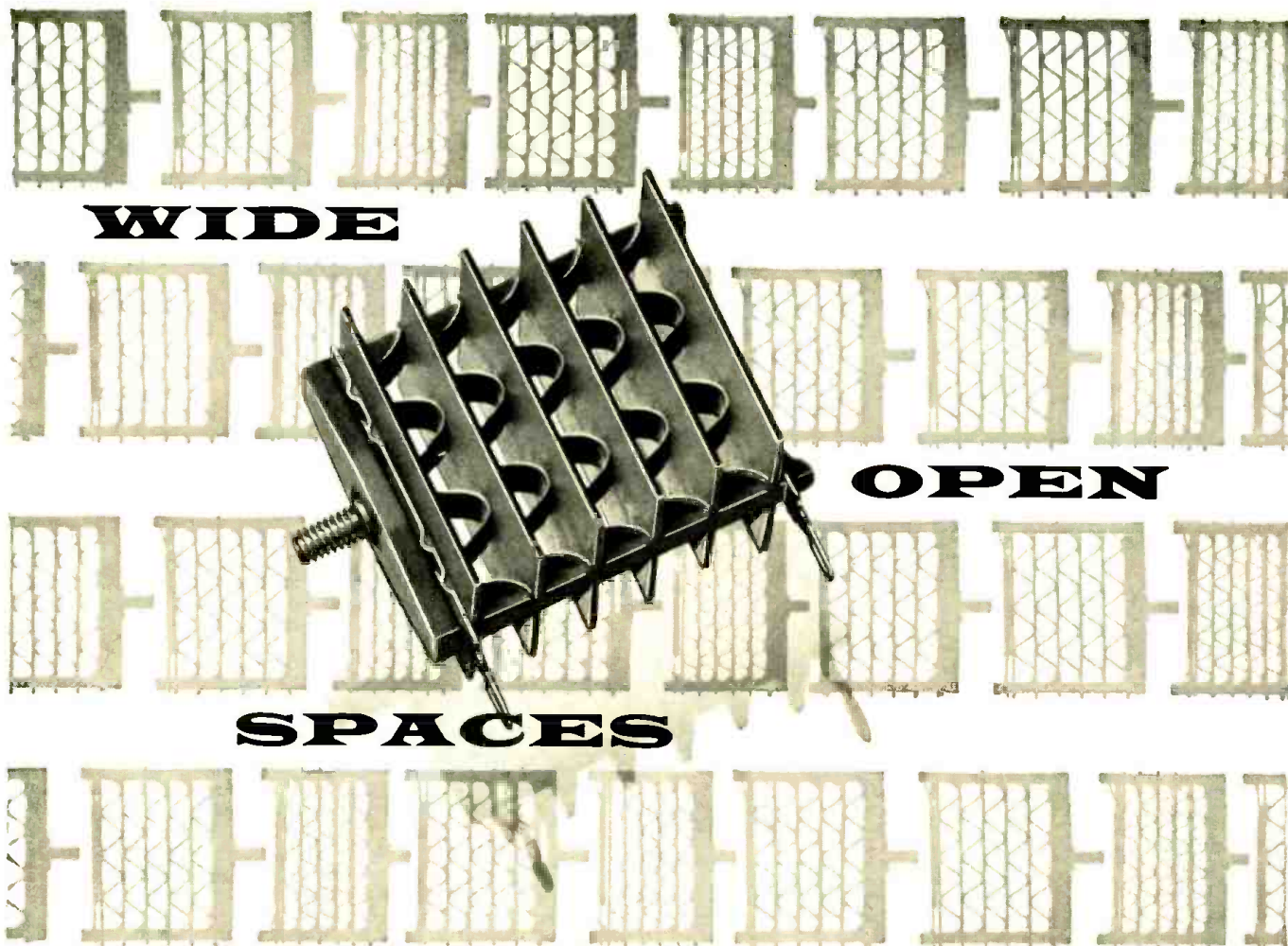

keep operating temperatures down—dependability up!

RCA SELENIUM RECTIFIERS utilize modern design—*full surface ventilation* with no chance of center-core hot-spots. Note the corrugated spring-steel separators which provide positive multiple-area contacts with each plate. This open construction facilitates free-flow of air and efficient cooling of the plates, and minimizes the possibilities of overheated components in compact TV, radio, and phonograph designs.

The one-piece assembly-yoke with the molded mounting stud prevents *twisting* or *squeezing* the stack during installation. Rigid construction minimizes the possibility of "barrier" breakdowns—*gives greater assurance of dependability in operation.*

So, when you need a replacement selenium rectifier, ask your distributor for a dependable, long life RCA SELENIUM RECTIFIER. Available now in 12 types, ratings from 65 Ma to 500 Ma.



SELENIUM RECTIFIERS

Radio Corporation of America • Harrison, N. J.

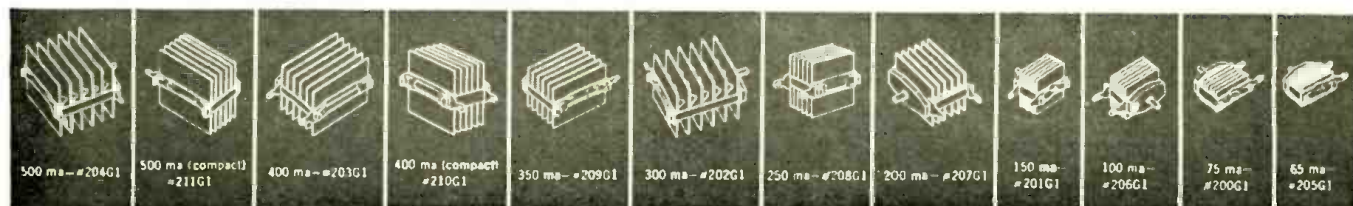

legs (ACC-23) or 7-inch wood tapered legs, or unmounted bins can be stacked.—Cabinart Div., G & H Wood Products Co., 99 No. 11th St., Brooklyn 11, N. Y.

ELECTRONIC ORGAN CONSOLE, for all Schober Elec-



tronic Organ kits. Traditional outline, modern lines suitable for homes. 55 inches wide, 29 deep (without pedal clavier); 43½ high with cover closed. Walnut or other finishes.—Schober Organ Corp., 2248-C Broadway, New York 24, N. Y.

EXPERIMENTER'S CHASSIS, kits 20X and 21X. Quick set ups of electronic circuits with simple hand tools. Designed mainly for mockups, is also suitable for permanent use. Mountable in racks or cabinets. Main wiring deck: 3/32-inch phenolic board, with uniform hole pattern, mounted on aluminum channels. 20X kit: low-cost small assortment of accessories, 4¼ x 8½-inch board. 21X kit: 4¼ x 17-inch board, more and varied accessories.

Kits feature push-in terminal with partially tubular end that fits snugly into board holes. Upper portion a narrow tapered slot with serrated edges that grip No. 17 to No. 20 wire firmly enough to make temporary con-



nections that need not be soldered.—Vector Electronics Co., 3352 San Fernando Rd., Los Angeles 65, Calif.

4-TRANSISTOR SUPERHET KIT, model KT-94. Completely miniaturized. 2 if and 2 resist-



ance-coupled audio stages. Germanium diode detector. Push-pull audio output stage with 2½-inch speaker. Model KT-96 with KT-94 makes a 6-transistor-plus-1-diode superhet receiver.—Lafayette Radio, 100 6th Ave., New York, N. Y.

PROFESSIONAL RADIATION COUNTER KIT, model RC-1 for the serious prospector. High sensitivity with ranges of 0-100, 600, 6,000 and 60,000 counts per minute and 0-.02, 0.1, 1 and 10 mR/hr. Probe, with type 6306 bismuth tube, and radiation sample are included. 5 tubes plus a transistor. 4½-inch 200-amp meter indicates radiation level in cpm or mR/hr. Transis-

tor oscillator provides aural signal from panel-mounted speaker. High-voltage power supply is prebuilt. Changing regulator tube allows use of scintillation probe. Selectable time constant. 9½ inches high, 6½ inches wide, 5¼ inches deep; 6½ pounds.—



setting, 10 µf at maximum (at 1 kc). Withstands 2,000 volts dc between leads for 5 seconds over full capacitance range. Temperature coefficient approximately zero at 100 kc; Q factor 2,000 at 50 mc; insulation resistance greater than 1,000,000 megohms.—JFD Mfg. Co., Inc., 6101 16th Ave., Brooklyn 4, N. Y.

Heath Co., 305 Territorial Road, Benton Harbor, Mich.

OUTPUT TRANSFORMER. Model HVO-57, horizontal and high-voltage output transformer designed as Zenith replacement for parts S-18567, S-18990, S-19032 and S-20993.—Merit



Coil and Transformer Corp., 4427 North Clark St., Chicago, Ill.

ULTRA-LOW-LOSS TRIMMER, model VC11A, fused quartz piston capacitor for ultra-stable oscillator and high-frequency, low-power tank circuits, and in capacitor networks requiring low loss and high leakage resistance. Coaxial construction, Invar tuning slug and silver-clad Invar band-fixed electrode. Capacitance: 1 µf at minimum

MINIATURE CONTROL, Claro-stat series 44. 21/32-inch diameter x 5/16 inch deep. Rated at 0.2 watt at 40°C. Ranges: linear, 200 ohms to 5 megohms; tapered, 1,500 ohms to 2.5 megohms. Resistance tolerance ±20% to 100,000 ohms, 30% for higher values. 300° rotation.—Claro-stat Mfg. Co., Dover, N. H.

REMOTE TV CONTROL, It, attaches quickly to front of re-



ceiver without tools, wire or interference with set. Dual fingertip control, reverse-forward. Fits on shaft of channel selector. Controls fine tuning as well as channel changing.—Alliance Mfg. Co., Alliance, Ohio.



HIGH-PAY CAREERS

IN ELECTRONICS — TELEVISION — RADIO

Await Men with COMPLETE Training!

Nationally-recognized, accredited Central training is designed to get you into high-paying career positions in the shortest possible time. In addition, Central's "Progressive Plan" is so arranged that each phase of training you complete qualifies you for a more important, better-pay position. In just a few short weeks you are qualified for certain basic jobs. Then, with every additional training phase that you complete, you qualify "up the ladder" for more advanced types of positions. Central offers complete Electronics-TV-Radio training leading to an Associate of Science degree, and qualifying you as an *Electronics Engineering Technician!*

Thousands of Central graduates have been placed at almost every technical level in the electronics industry. Free nation-wide placement service.

3 PROVEN TRAINING PLANS

(Choose the one that fits your requirements)

- HOME STUDY COURSE** (with 9 kits of equipment)—Qualifies you for diploma, FCC license, and a variety of electronics jobs (or transfer into advanced resident training).
- HOME STUDY-RESIDENT COURSE** (with 9 kits of equipment)—Home study, followed by short period of resident training. Qualifies you for diploma, FCC license, and a wide variety of Electronics-TV-Radio positions (or continue with advanced resident training). An accredited technical institute curriculum.
- FULL RESIDENT COURSE**—Qualifies you for Associate of Science (A.S.) degree and top-pay employment opportunities as Electronics Engineering Technician. Part-time employment opportunities available for students while training. An accredited technical institute curriculum.

Don't limit yourself! Get the facts on Centrals complete training that can take you just as far as you want to go in the electronics technician field. Send coupon today for FREE brochure on your opportunities in Electronics.

VETERANS! Central offers courses approved under G.I. Bill

CENTRAL TECHNICAL INSTITUTE

Dept. Y-106 1644 Wyandotte St., Kansas City 8, Mo.

Tell me more about how you can qualify me for a high-pay Electronics career.

Name _____ Age _____

Address _____

City _____ State _____

If Korean veteran, give approximate discharge date _____

Technicians' News



GUILD SIGNS WITH UNION

Shops of the San Francisco TV Service Guild signed a contract with the International Brotherhood of Electrical Workers, Local 202, virtually unanimously. The contract, under which shop owners become union members, eliminates Sunday work and provides for a minimum hourly rate of \$2.65½ for technicians, with time-and-a-half for all work exceeding 40 hours per week. The union is stated to have about 1,000 technician members in the San Francisco area, including those in non-Guild shops.

Though not mentioned in the contract, one of the strongest incentives for the mass signing was said to be the expectation of union cooperation in a mass drive against "sundowners" and cut-rate shops. Other incentives include an apprentice training program, leading to a journeyman rating, and a "finishing school" program for journeymen technicians, with stress on color.

MOCH RESIGNS TESA POST

Frank Moch has resigned as president of the Television Electronic Service Association-Chicagoland. Mr. Moch, who had just recovered from a serious illness, left his post for reasons of health and the growing responsibility of his offices. He stated: "The demands of the presidency of NATESA and TESA-Chicagoland have grown so vastly as to become more than full-time jobs. . . . On the subject of our national group, we hope to hire a managing director for our national office by early 1957. . . . The work of the group needs such a permanent headquarters executive."

Mr. Moch retains the board chairmanship of TESA-Chicagoland and, for the time at least, is not considering resignation from his office as president of NATESA. He is succeeded in office by Joseph Blink of Blink's TV Service, Chicago, who will act as TESA president till the election in December. Mr. Blink has been first vice president of TESA-Chicagoland for the past two years.

SAN JOSE ASKS LICENSE

The Radio & TV Association of Santa Clara Valley has suggested a licensing ordinance for the San Jose area. The proposed statute would be patterned largely after the licensing law of St. Paul, Minn., its backers state. One proposed section—stemming apparently from difficulties with "sun-

Assured...

For Better Viewing

The New

KAY-TOWNES K-9 ANTENNA



It's results that count . . . and Kay-Townes NEW K-9 offers the best in high gain antenna performance. Designed for sharp directivity and field-tested over entire band under every weather condition, the Kay-Townes K-9 is the antenna for color and black & white.

K-9

Check our all NEW K-3 primary reception antenna. Top performance assured and sure to be a hot seller!

Both antennae feature high-quality aluminum construction and snap-lock system.

K-3

KAY-TOWNES ANTENNA COMPANY

BOX 593 • ROME, GEORGIA

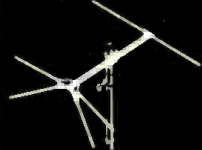

MODEL T-801
\$417 LIST



MODEL T-811
\$500 LIST

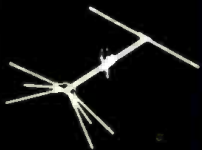

MODEL T-791
\$444 LIST



MODEL T-751
\$556 LIST



MODEL T-851
\$472 LIST

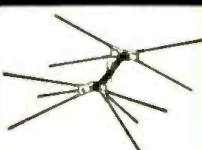

MODEL T-741
\$529 LIST

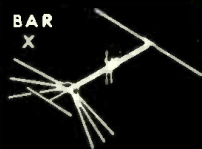

MODEL T-781
\$556 LIST



MODEL T-771
\$500 LIST



OFFERS YOU FOR THE
COMING SELLING SEASON

America's Finest AND MOST COMPLETE LINE OF Conical Antennas

Nowhere else can you buy such a high quality, full size Antenna with as many practical, useable features at such low, down to earth prices. Here's what you get when you buy Tenna.

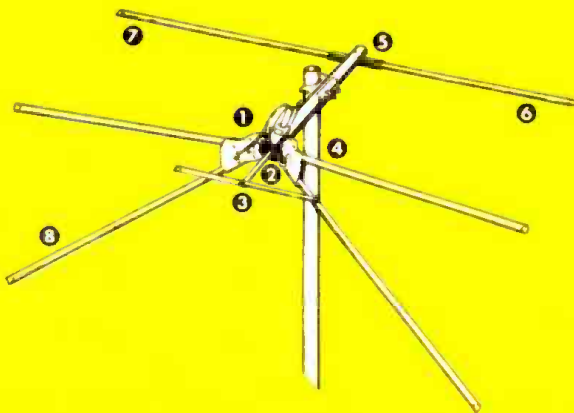

Check these Tenna features, feature by feature, with any or all other makes and you'll quickly agree that Tenna is truly the antenna for you . . . truly the king of all the conicals.

1. Completely pre-assembled. "Presto" Instant Mount Assembly opens as easily, quickly as an umbrella.
2. Now! Polyethylene Cable Anchor takes all tension off of terminals, prevents cable from breaking at terminals.
3. Models T-781, T-851 and T-751 are equipped with famous Tenna Director Bar to improve performance on higher channels.
4. Front Bracket made of heavy spring temper aluminum alloy with High Q molded plastic insulator.
5. Rear Bracket is made of heavy gauge aluminum to assure long life and resist strongest gales and heavy ice.
6. Arrays are full size in every respect and of all aluminum construction.
7. Aluminum elements are doweled to prevent whistling and provide greater strength.
8. Full line to select from; 8 single array antennas, 8 stacked antennas and 8 "Do-It-Yourself" antenna kits.

YOU BUY THE FINEST WHEN YOU BUY TENNA!

The Tenna Manufacturing Co.

Cleveland 25, Ohio

TECHNICIANS' NEWS (continued)

downers"—is particularly interesting, both to owners of large established shops and to small or part-time operators:

SECTION 4: The business address of an applicant for a master license must be in accordance with the zoning code of the County of Santa Clara, and applicant must maintain a sign bearing the name of the business which sign must be affixed on the premises of said shop. Said sign shall cover an area of not less than _____ square feet.

This would presumably make it impossible for many basement and other repairmen, who work in areas where zoning regulations do not permit display of a sign, to continue in business.

Other provisions of the proposed ordinance would require licensees to have as minimum equipment an emission type tube checker, multimeter, oscilloscope and signal generator in good working order, located at his business address at all times when not in use on outside calls; carry fire, theft, liability and all other necessary insurance; have adequate transportation facilities to insure proper handling of customers' goods, all vehicles to be clearly marked with the name, address and phone number of the shop.

A fine of not more than \$100 or imprisonment not exceeding 90 days is proposed for anyone convicted of violating the provisions of the ordinance.

KENTUCKY GROUP

Thirty-one technicians of the Louisville area have joined to form the Kentuckiana Television & Radio Technicians Association, Inc. Purposes of the organization are to gain recognition of approved and reliable technicians, to promote better understanding between technicians and customers, and better public relations in general. The association has set an objective of 150 members—to be obtained by the end of the year—to more effectively carry out the aims of the organization. A recommended labor charge chart has been published and issued to all members, as well as to the local Better Business Bureau.



Officers elected are (left to right) (back), Ira Masden, vice president; Harold Flood, president; (front) James M. Hall, secretary; Melvin Brown, treasurer. END



Note: Records below are 12-inch LP and play back with RIAA curve unless otherwise indicated.

El Cojo Enamorado
Suite de Danzas

Music by Ernesto Halffter
Pilar Lopez and Her Spanish Ballet
Symphony Orchestra of Spain
Capitol P-18003

My old readers may recall that I had a high opinion of Cook's *Fiesta Flamenca* and recommended it as a test of high-frequency transient response. Here is a recording which does about as good a job but in the more difficult range of low-frequency transients. A pretty big troupe of Spanish dancers stomp the floor in characteristically Spanish style with aural effects that will delight the owner of any system capable of doing justice to rapid-fire low-frequency transients. The recording is superb and the best systems will reproduce the ballet with almost complete realism. The only thing missing is the vibration of the floor which so much stomping would produce. Systems unstable in the low end are likely to break into low-frequency oscillation. Aside from these really remarkable and unique transients, there is a wonderfully dull bass, plenty of high

lights of the Spanish sort and some very fine fff attacks, beautifully recorded. The music should be easy to take. Absolutely top notch on top-notch equipment.

DEBUSSY: Children's Corner
Petite Suite
(Orchestral versions)
Felix Slatkin conducting Concert Arts Orchestra
Capitol P-8328

Less spectacular in most respects this, too, is an exemplary demonstration record. The bass is very fine—really spectacular in *Jimbo's Lullaby* and very dull in *Golliwog's Cakewalk*. There are some lovely flutes and excellent very deep drums. The ballet movement of the *Petite Suite* is especially valuable. This is not as live acoustically as the Delibes below or the Tchaikowski below, but has an excellent closeup naturalness.

DELIBES: Coppelia and Sylvia
Conte conducting Orchestra of Paris Opera
Capitol P-18001

This should fill the bill for a demonstration record with spectacular hi-fi material and with music pleasant to most customers. The mazurka of *Coppelia* especially is top-drawer and should show off a good hi-fi system very well particularly in the contrast of exceptionally sharp high highs with a fine dull drum. But there are many other fine passages. The kettle drums are also very good and the triangle is lovely in its cleanness. The recording is additionally outstanding for the freedom from distortion even in the peaks on the inner grooves. The balance seems to be very natural.

COPLAND: Music for Movies
KURT WEILL: Music for the Stage
Winograd conducting MGM Chamber Orchestra
MGM E-3334

Two diverting and interesting suites made up of filled-out snatches of music Copland wrote for

movies and Weill for Broadway shows. The Copland has his typically exquisite brasses, a very low bass and an extremely dull drum in programmatic music very easy to take. The Weill takes care of the high highs, although it also has an excellent bass—big and very low in spots—in some unusual jazzy sound.

TCHAIKOWSKI: Sleeping Beauty
(Ballet Suite)
Rosenthal conducting Orchestra of Paris Opera
Capitol P-18005

These Capitol recordings of the Orchestra of Paris Opera may make that ensemble as popular with hi-fi fans as the Westminster and Vanguard recordings have made the Vienna State Opera Orchestra. Certainly the several initial releases have been pleasing. *Sleeping Beauty* has lately received the all-out hi-fi treatment from several labels; this version should hold its own or better. The acoustics have a just-right liveness, the high highs are sharp and plentiful but not so closeup as to seem artificial; the bass is properly dull; overall balance is excellent to my ear and taste; the many solo instruments are highly natural. And the whole piece has a fine brilliance calculated to make a fine hi-fi system shine with its brightest luster.

BACH: Toccata and Fugue in D Minor
Prelude and Fugue in A Minor
Passacaglia and Fugue in C Minor
Come Saviour of the Gentiles (Choral Prelude)
Cadet Chapel Organ at West Point
Vox VI-210

No label today is complete without some organ recordings and Vox has come up with an especially good organ in an especially impressive recording. Chosen to provide good examples of pedal base, the Bach music is recorded extremely well and should gratify owners of speaker systems really capable of reproducing the pedals. The accompanying booklet cautions against the possibility of rupturing speaker cones. I

AT LAST! ONE Book Gives You ALL The Facts On ALL TRANSISTORS

Completely Covers Every Transistor Made . . . Diagrams Over 200 Different Circuits . . . Eliminates Guesswork!

Now, for the first time, you can get full facts on every type of transistor circuit—all from one book! Completely covers control circuits, amplifiers, receivers, test instruments, wiring techniques, special purpose circuits and much more. 430 fact-packed pages; more than 200 circuit diagrams; dozens of how-to-do-it illustrations. Coyne's new TRANSISTOR CIRCUIT HANDBOOK is a quick, easy-on-the-job reference book that covers in full detail just about every type of application involving transistors—the tiny, amazingly versatile successor to vacuum tubes. Every major transistor manufacturer has contributed circuit and component data to this book.

YOURS ON 7 DAY FREE TRIAL!

You must see Coyne's TRANSISTOR CIRCUIT HANDBOOK to believe that one book can contain such complete, easy-to-understand information. So we'll send you a copy for FREE trial! Send no money. Just mail the coupon. TRANSISTOR HANDBOOK will be rushed to you at once. After 7 days, send either \$4.95 (plus postage) or return the book and owe nothing. Send coupon TODAY!

MEET THE AUTHOR

This great book was written by Louis E. Garner, Jr., one of the foremost authorities on transistors. He is an engineer, technical consultant and experienced writer who has the ability to make even the most difficult subject easy to understand. You'll find TRANSISTOR CIRCUIT HANDBOOK is down to cases, up to the minute. Send for it now, at our FREE trial offer!

ALL THESE TRANSISTOR FACTS IN ONE VALUABLE VOLUME!

Chap. 1. Transistor Construction Types
Chap. 2. Techniques; Care of Transistors
Chap. 3. Transistor Components
Chap. 4. Amplifiers
Chap. 5. Oscillators
Chap. 6. Special Purpose Circuits
Chap. 7. Audio Uses of Transistors
Chap. 8. Transistor R.F. Application
Chap. 9. Transistor Test Instruments
Chap. 10. Controls and Gadgets
Chap. 11. Transistor Characteristics & Measurements
Chap. 12. Definitions and Design Formulas
Chap. 13. Special Techniques, New Developments
Chap. 14. Technical Papers, Patents

FREE TRIAL OFFER COUPON

Educational Book Publishing Division
COYNE ELECTRICAL SCHOOL, Dept. A6-T1
500 S. Paulina St., Chicago 12, Ill.

O.K.! Rush your complete new "TRANSISTOR CIRCUIT HANDBOOK" for 7 days FREE TRIAL per your offer.

Name..... Age.....
Address.....
City.....Zone.....State.....
Where Employed.....
 Check here if you are enclosing \$4.95. We pay postage. 7-day money back guarantee.

NEW

PHAOSTRON PROBE-LITE

**ILLUMINATED TEST PROBE
SELF-CONTAINED
SEE WHAT YOU ARE TESTING!**

\$250
LIST

It is just like having an extra hand. Simply insert the probe from your tester into the jack of the Probe-lite and the Probe-lite becomes alive to instantly give you a brilliant, pre-focus spotlight on the area that you are testing plus a long, extra slender, probe tip for making electrical contact in difficult places which previously were inaccessible. It could pay for itself the first time you use it. Hurry, call your distributor today!

PHAOSTRON

PHAOSTRON INSTRUMENT & ELECTRONIC CO., 151 Pasadena Avenue, South Pasadena, Calif.

NEW RECORDS

(Continued)

shouldn't worry too much about that, but I'm afraid a lot of speaker systems are going to disappoint a lot of owners, for it will take a really good system to reproduce those pedals without flapping. The disc is pressed directly from stampers to eliminate distortion caused by the usual intermediate steps. Very clean and sharp.

The English Madrigal School Deller Consort

Bach Guild BG-553

The music will appeal principally to those interested in early choral music but audiophiles may also like it for the extremely real voices. Every breath, intonation and sibilant is as plain as everyday life. Seven English madrigals are on the two sides sung by a consort of six voices.

Folk Songs of the Frontier Roger Wagner Chorale

Capitol P-8332

Those who enjoyed the previous *Folk Songs of the New World* will also like this collection of a baker's dozen cowboy songs from *Home on the Range* to *Good-bye Od Paint* sung with clear diction and unaffected arrangement by male voices solo and in chorus. *Home on the Range* is underlain by a notable bass.

Fiesta

Carmen Dragon conducting the Hollywood Bowl Symphony

Capitol P-8335

Capitol hits the jackpot here in a spectacular showoff and demonstration recording—a little of just about everything needed to prove that hi-fi is well worth the cost, plus 11 samplings of Spanish music that should produce a landslide acceptance from all but the miniscule very-long-hair minority. The high-high tinklers—triangles, castanets, etc.—are very clear and clean but also properly positioned at the back of the orchestra where they belong. The bass is very dull on the best systems. There are some very sharp, dull drums in with sharp attacks in *Jota Aragonesa*; also excellent kettledrums. Both provide excellent tests for transient response.

The definition is exceptional, particularly in band 1, side 1 (*Aragonaise*). There are excellent examples of practically every instrument normal to a big symphony. The brasses are sharp but clean, and exceptionally fine are baritone horn and trumpet. Several tremendous *fff* staccato peaks are extremely well recorded on the innermost grooves of side 1 (Menterle's *La Virgen de la Macarena*). The *Chipapanecas* of side 2 gives lovely contrast of bass and high highs but in natural balance. In the *Maid of Cadiz* mellow *legato* passages contrast with very sharp *staccato*.

Thirty-Five Years Ago

In Gernsback Publications

HUGO GERNSBACK, Founder

Modern Electrics	1908
Wireless Association of America	1908
Electrical Experimenter	1913
Radio News	1919
Science & Invention	1920
Television	1927
Radio-Craft	1929
Short-Wave Craft	1930
Television News	1931

Some larger libraries still have copies of **ELECTRICAL EXPERIMENTER** on file for interested readers.

In October 1922 *Science and Invention* (formerly *Electrical Experimenter*)

- Radio Typewriter Is Here, by H. Winfield Secor.
- New Talking "Movie" Process, by Edwin Haynes.
- Radio and the Telharmonium, by Robert Stewart Sutcliffe.
- "Movie" Explains Radio, by H. Winfield Secor.
- Super-Regenerative Audion Circuit, by Robert E. Lacault.
- Dr. de Forest Solves "Talking Movie" Problem.
- WBAY, New York City, by A. P. Peck.
- New Filament Compression Rheostat.
- Radio for the Beginner, by Armstrong Perry, No. 8.

new

Tubes

Transistors



With a lull in new transistors, this month's crop of new announcements includes conventional receiving TV tubes, improved versions of older types and a series designed for auto use.

5CL8, 6CL8, 5CM8, 6CM8

Four new nine-pin miniature tubes for use in black-and-white and color receivers have been announced by Sylvania. Designated 5CL8, 6CL8, 5CM8, and 6CM8, they are general-purpose multiunit types for a variety of applications. All four have controlled heater warmup time for service in series heater string receivers, the 5CL8 and 5CM8 being 600-ma and the 6CL8 and 6CM8 450-ma series-string types.

The 5CL8 and 6CL8 are triode-tetrodes intended as oscillator-mixers in vhf tuners. Each tube's section has its own cathode. Eliminating the shield and beam plate, both may be used advantageously where it is costly to provide the usual double-cathode triode-pentodes.

The 5CM8 and 6CM8 are high-mu triodes, sharp-cutoff pentodes. The pentode section of each tube features high transconductance, sharp cutoff and low grid-1-to-plate capacitance and they may be used as if, video or age amplifiers as well as reactance tubes. With the comparatively low grid-to-plate capacitance, the pentode sections are desirable for narrow-band high-gain amplification into a relatively high-impedance load such as the sound if in television service. The triode sections feature a mu of 100—an outstanding characteristic not found in the currently available triode-pentodes. They have a wide variety of general-purpose applications as sync amplifiers, separators and clippers, age and audio amplifiers.

12-volt auto radio types

Seven new receiving tubes, for use in automobile receivers in which transistors are used in the output stage and in which electrode voltages for both the tubes and transistors are obtained directly from a 12-volt storage battery, have been introduced by RCA. Such receivers are available in many models of 1957 automobiles.

The 12AD6 is a pentagrid converter of the seven-pin miniature type intended for use as a combined mixer and oscillator tube.

The 12AE6 and 12AJ6 are multiunit tubes of the nine-pin miniature type. Each tube contains two diodes and a



BEST FOR COLOR TEST!

*Another Hycon
test help...*



MODEL 622 5" SCOPE
with automatic triggered sweep, first really new scope development in years. Fewer adjustments, no sync problems.

There's just one way to test the new color TV sets... WITH NTSC COLOR PATTERN. That's what Hycon's Model 616 Color Bar/Dot Generator offers... all standard colors, sequences and patterns easily selected and graphically shown in actual color right on the control panel. For color TV, get ready... GET HYCON!

"Where Accuracy Counts"
Hycon ELECTRONICS, INC.
A Subsidiary of Hycon Mfg. Company

321 SOUTH ARROYO PARKWAY
PASADENA, CALIFORNIA

**MAIL,
please,
for Catalogs
616 and 622**

HYCON ELECTRONICS, INC. Dept. R-10
P.O. Box 749 Pasadena, California

Please send me the new model 616 and 622 catalogs..

Name _____

Address _____

City _____ State _____

NEW TUBES AND TRANSISTORS

medium-mu triode in one envelope and is intended to perform the combined functions of am detection, of amplification and automatic volume control. The 12AE6 is also useful as a trigger tube in automobile receivers utilizing automatic station-selection circuits.

The 12AF6 and 12BL6 are remote-cutoff pentodes of the seven-pin miniature type intended for use as rf or if amplifiers.

The 12F8, a nine-pin miniature multi-unit tube containing two diodes and a remote-cutoff pentode in one envelope, is intended for use as a combined am detector and avc audio amplifier. The remote-cutoff characteristic of the pentode section makes possible a wide range of volume control in the audio stage and supplements the avc of the rf stages.

The 12K5 is a high-perveance power tetrode of the seven-pin miniature type using grid 1 as the space-charge grid and grid 2 as the control electrode. It is designed specifically as a driver tube to supply high input power at low distortion to the transistor in the output stage. This tube is also intended for use as the relay tube in automobile receivers using automatic station-selector circuits. Because of its high perveance, the 12K5 can supply high space-charge grid current and high plate current with only 12.6 volts on the plate.

Each of the seven types has a 12.6-volt 0.15-ampere heater except the 12K5 which has a 12.6 volt 0.4-ampere heater.

2N218, 2N219, 2N220

Flexible-lead versions of the RCA 2N139, 2N140 and 2N175, junction transistors of the germanium p-n-p alloy type, RCA's 2N218, 2N219 and 2N220, respectively, may be soldered or welded into the associated circuit. Each is hermetically sealed and uses a metal envelope with external insulating coating.

The 2N218 is designed especially for 455-kc if amplifier applications. It can provide a power gain of 30 db at 455 kc in suitable common-emitter circuits.

The 2N219 is mechanically like the 2N218 but has characteristics to meet the requirements of converter and mixer-oscillator applications in the standard AM broadcast band. It features a conversion power gain of 30 db at the center of this band when used in suitable common-emitter circuits.

The 2N220 is a low-noise type intended particularly for use in pre-amplifier or input stages of transistorized audio amplifiers operating from extremely small input signals. The exceptionally low wide-band noise factor (6 db maximum) permits the design of low-noise audio amplifier systems which operate directly from low-impedance low-level devices such as magnetic microphones and magnetic pickups without an input coupling transformer.

6326-A Vidicon

A small camera tube intended primarily for use in compact color tele-

(Continued)

vision cameras, the 6326-A is used for simultaneous pickup of the film or live subjects to be televised. This method employs three 6326-A's—one for each channel—to produce the information necessary for the formation of a color television image.

The 6326-A is also suitable for use in black-and-white TV cameras for either film or live pickup. In either color or black-and-white service it can provide a picture of high quality. Its resolution capability is about 600 lines.

Utilizing a photoconductive layer as its light-sensitive element, the 6326-A requires illumination levels comparable to those required for motion-picture film cameras. Its response covers the entire visible spectrum and enables the tube to translate color very accurately when operated in a color camera with appropriate color filters and optical arrangements.

The 6326-A is unilaterally interchangeable with the 6326.

"Avalanche" diode











The avalanche diode, a special type of diode which exhibits a very sharp reduction in impedance at a certain specific inverse voltage, has been announced by Bell Telephone Labs. Not yet in commercial production, it is nevertheless extremely interesting. It is useful in voltage regulation or control devices, as a voltage reference element and in signal circuits as a surge-protective element.

1st

COMPLETE LINE of ELECTRONIC TOOLS
ever offered the industry

jobbers . . .

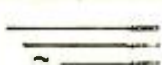
Our Reps will be happy to show you the complete line

 Smitty - 5 sizes	 Tension Tweezie	 Magic Tips - 15 sizes
 Tube Putters	 Alignment Tool	 Tri-Tap "3-in-1"
 Reg. Screwdrivers	 Kits	 Nut-Drivers—15 sizes
 Slug Retrievers	 Tool Kits	 Hex Drivers—10 sizes



HUNTER TOOLS
Box 564
Whittier, California

ALL TOOLS IN SIZES TO FIT YOUR SPECIFIC NEEDS! TOOLS DESIGNED FOR THE ELECTRONIC INDUSTRY.

Watch
for the
November
RADIO-
ELECTRONICS
On Sale
October 25

Always
mention
RADIO-
ELECTRONICS
when you
answer
advertisers.



**Perma-Power
GARAGE
DOOR
OPENER**

**Opens Garage Doors
AUTO-matically**



At All Distributors

manufactured by

Perma-Power COMPANY

4727 N. Damen Ave., Chicago 25, Ill.
manufacturers of electronic equipment since 1928
Export: SCHEEL INT., Chicago

NEW TUBES AND TRANSISTORS (Continued)

The diffused-junction silicon diodes have lower impedance and higher power capability than have been previously available. Breakdown voltage can be controlled over a range of about 5 to 500 volts by controlling junction impurity gradient.

Current prior to breakdown is about 1 μ a or less for units rated at 10 volts and above. At breakdown, impedance is reduced to a few ohms for currents in the milliampere range and can be about a fraction of an ohm for high current surges. The units are not yet on the market.



The photo shows a medium-power avalanche diode under test which breaks down at 20 volts and is capable of dissipating 6 watts with an appropriate heat sink. Abruptness of the avalanche effect is seen on the trace.

6903 multiplier phototube

A 10-stage head-on type of multiplier phototube intended especially for the detection and measurement of ultraviolet radiation and other applications involving low-level radiation sources has been developed by RCA. The 6903 is constructed with a faceplate of fused silica which transmits radiant energy in the ultraviolet region down to and below 2,000 angstroms. It has various features providing high efficiency and a resolving time of only a small fraction of a second which commend its use in scintillation counters.

Because of its spectral response from about 2,000 to 6,500 angstroms, the 6903 is well suited for use with organic phosphors such as anthracene and in organic materials such as thallium-activated sodium iodide.

The 6903 is capable of multiplying feeble photoelectric current produced at the cathode by a median value of 400,000 times. Dimensions are: maximum diameter, 2 5/16 inches; maximum overall length, 6 9/16 inches; weight, 7 ounces.

6879

A miniature cold-cathode decade counter tube, the 6879 has been developed by Sylvania for use in fire control equipment. The new tube has three output cathodes (numbers 0, 8 and 9), and provides an output of at least 15 volts. In standard circuitry the frequency range is zero to 5,000 pulses per second—up to 10,000 with special circuitry. The tube features low power requirements and very long life. **END**

**Time
for
Replacement?**



Specify
OXFORD
SPEAKERS

We **GUARANTEE** you speakers that are built to be the finest exact replacement speakers. We stand behind each and every speaker with a 100% guarantee against any mechanical or electrical defects for one full year.

OXFORD Replacement Speakers undergo a rigid inspection to make certain that they are as good or better than the original speaker. That's why more servicemen are switching to **OXFORD** . . . when it's time for replacement.

Illustrated literature is available without obligation. . . . at better jobbers!

OXFORD ELECTRIC CORPORATION

Distributor Sales Division

556 West Monroe Street, Chicago 6, Ill.

In Canada: Atlas Radio Corp., Ltd., Toronto

Export: Roburn Agencies, New York City



CARTOONS

RADIO-ELECTRONICS pays \$3.00 for good cartoon ideas and \$15 and up for finished work.

RADIO-ELECTRONICS 154 W. 14 St. New York 11, N. Y.

CUSTOM HI-FI TONE ARM

- * **NEW—LOW MASS DESIGN** Assures maximum performance of modern high compliance cartridges.
- * **NEW—INDIVIDUALLY CALIBRATED OFFSET ANGLE AND OVERHANG** Assure correct tracking of LP records.
- * **NEW—MICROMETER TYPE COUNTERBALANCE** Assures accurate stylus pressures.
- * **NEW—LONGER LENGTHS** Assure lower tracking distortion.



Available at better Hi-Fi dealers or write direct

Volgar
4404 W. 22 ST
PANAMA CITY, FLA.

CONVERT TO COLOR TV

COLORDAPTOR—A simple 10-tube circuit and rotating color wheel converts any-size black-and-white TV, direct view or projection, to receive compatible color TV. **COLORDAPTOR** is simply attached to TV set, does not affect normal operation and can be built from parts experimenters have on hand.

Complete specifications including theory of operation, complete simplified construction plans, schematic and sample color filters **\$1.95**

Essential parts kit containing all special parts—coils, delay line, crystal, color filters— **\$19.95**

Up to 16" sets— **\$19.95** 17" and larger— **\$20.95**

All other **COLORDAPTOR** parts, kits, motors, etc. available. Write for information and prices.

COLORDAPTOR, 3471 Ramona, Palo Alto, Calif.

The **FIRST** really
STATIC-FREE, DUST-FREE
NOISE-FREE CARTRIDGE

NOW AVAILABLE
 IN TWO SERIES:

1.



Fen-tone **DS** A+STANDARD

Professional 8-pole magnetic cartridges, reversible and single play cartridges for all modern plug-in shell record players and changers; and

2.



Fen-tone **DS** A+SPECIAL

Professional 8-pole magnetic cartridges, single play only for all professional transcription arms

Standard and Special series available in two impedances: 350 ohms & 72 ohms to suit high-level (350 ohms = 30mV) or medium level (72 ohms = 10-15 mV) magnetic phono inputs.

Leading audio critics comment:

MONITOR—RADIO-ELECTRONICS: "An extremely fine value . . . Remarkably good on old 78 rpm shellac records . . . with a unique and exclusive feature — a strip of radioactive foil built into the cartridge to neutralize static charge on records.

J. B., BENTON HARBOR, MICH.: "They are absolutely magnificent. I will recommend it to everyone I know as being THE CARTRIDGE!"

ONE DEMONSTRATION WILL CONVINCE YOU TOO!

Audiophile Net Prices:

	Standard	Special
Single (LP or ST) Sapphire	\$9.30	\$11.60
Single (LP or ST) Diamond	\$21.30	\$24.20
RS Dual Sapphire	\$9.78	None
RG LP Diamond/ST. Sapphire	\$21.78	None



FREE! 1956 *Fen-tone* Catalog. The above are only samples of the many terrific values in the new 1956 *Fen-Tone* Hi-Fi catalog including mikes, tape decks, cartridges, record changers, silent listening devices, etc.

FENTON COMPANY
 15 Moore Street, New York 4, N.Y.

Sold through better
 Audio Distributors.
 See yours today!

West of Rockies,
 prices slightly higher.

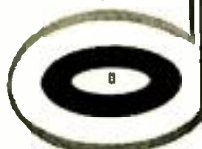

Question Box



ANTENNA END EFFECT

In designing antennas with half-wave radiators, the length of the radiator is usually computed from the formula $492K/f$ when the length is desired in feet or $5,904K/f$ for length in inches when f is the frequency in megacycles. I've seen different formulas and applications where K varies from about 0.98 to 0.80. Where can I find data for determining the correct value for K in a given application?—M. H., Washington, D. C.

A dipole is one-half wavelength long (electrically) at its resonant frequency. Its electrical (free-space) length is equal to $5,904/f$, where f is in mc and length is in inches. Its physical length (actual length in practice) is somewhat shorter due to capacitance to ground and because radio waves travel more slowly through or on the surface of a conductor than in air. It is these and other factors that are lumped and called *end effect*.

According to Arnold B. Bailey (*TV and Other Receiving Antennas*), the shortening factor K is determined by the design frequency and the relationship between the cross-section and length of the radiator. K decreases as cross-section and frequency increase. Thus, K may be 0.95 for a 3-mc antenna made of ordinary wire and 0.80 or less

for a uhf antenna made of large-diameter tubing or rod.

The shortening factor may be found from the formula

$$K = (1 + P - \sqrt{P})$$

where P , the periphery of the radiator expressed as a fraction of free-space or electrical wavelength, varies with the shape of the cross-section of the conductor. P is equal to

$$\frac{\pi D}{\lambda}$$

for conductors of circular cross-section,

$$\frac{3.8S}{\lambda}$$

for conductors with square cross-sections and

$$\frac{1.6W}{\lambda}$$

for strip type radiators of thin rectangular cross-section where thickness is less than one-tenth of the width.

In the formulas above, D is diameter in inches, S one side of the square in inches, W the width of the strip in inches and λ the electrical length of a full wave in inches or $11,808/f_{mc}$. Therefore, the formula for one-half wavelength (free-space) is $11,808/2f_{mc}$ or $5,904/f_{mc}$.

EXAMPLE: Consider a rod or tube 0.5 inch in diameter as a half-wave radiator for a 150-mc antenna.

$$\begin{aligned} \text{Physical length (inches)} &= \frac{11,808}{2f_{mc}} \times K \\ &= \frac{11,808}{2f_{mc}} \times (1 + P - \sqrt{P}) \\ &= 39.36 \left[1 + \left(\frac{3.1416 \times 0.5}{\lambda} \right) - \sqrt{\frac{3.1416 \times 0.5}{\lambda}} \right] \\ &= 39.36 \left[1 + \left(\frac{1.5708}{11,808} \right) - \sqrt{\frac{1.5708}{11,808}} \right] \\ &= 39.36 \left[1 + \left(\frac{1.5708}{78.72} \right) - \sqrt{\frac{1.5708}{78.72}} \right] \\ &= 39.36 (1 + .0199 - 0.141) \\ &= 39.36 \times 0.8789 \\ &= 34.59 \text{ inches} \end{aligned}$$

If we use a 1-inch diameter radiator, K drops to around 0.84 and length becomes 33 inches.

TRANSCEIVER SUPPLY

I have a small radio transceiver operating from 90- and 1.5-volt batteries. I want to build a small battery

eliminator and use plugs and sockets for connecting it to the set so the batteries are automatically cut out when

the capacitor you DREAMED about is HERE!

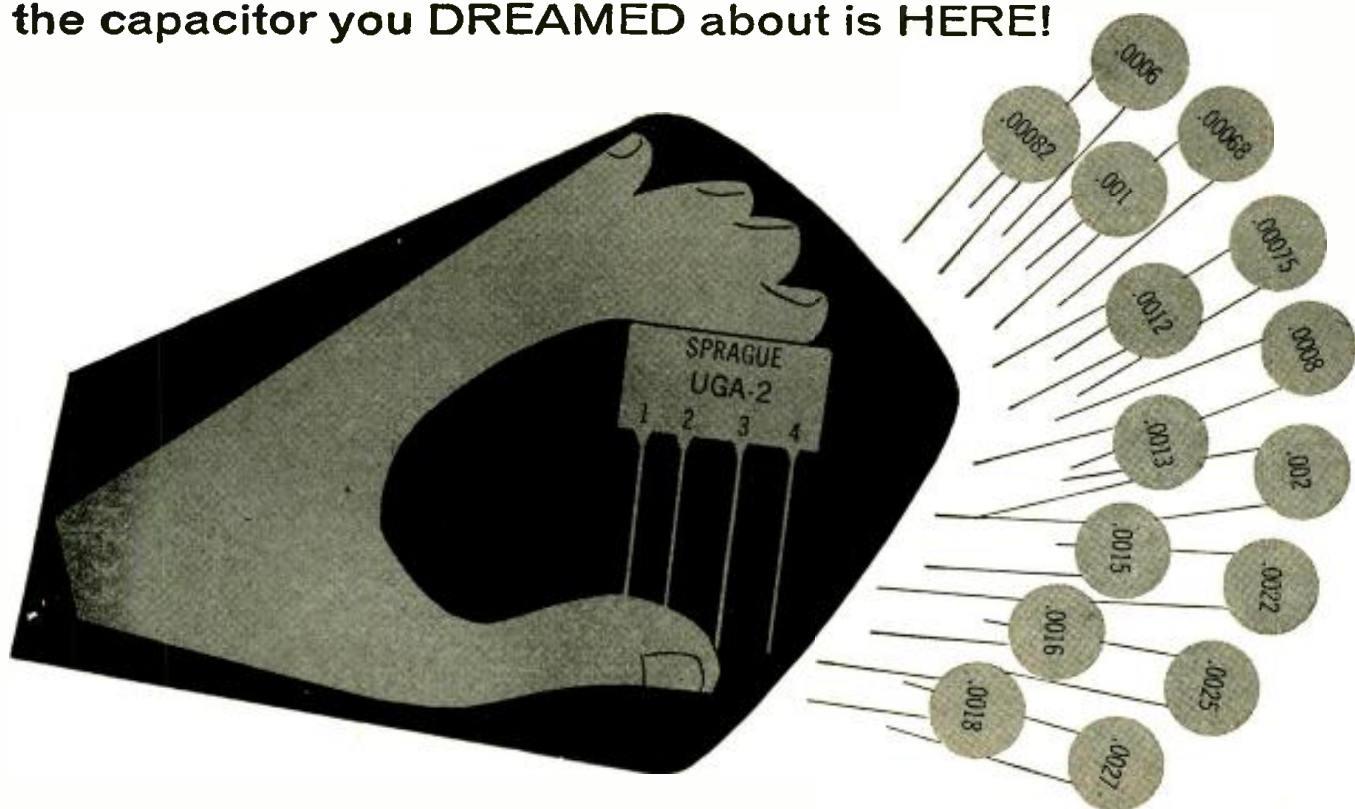

this ONE new ceramic capacitor does the work of FIFTEEN

NOW . . . you can handle a big percentage of special value and standard value ceramic replacements with a few Sprague "Universals". Just four of these remarkable new capacitors take the place of forty-two regular capacitors, with capacitance values from 400 μF to .015 μF . You can also use them to replace molded mica, ceramic tubular, and paper tubular capacitors in many bypass and coupling applications.

Sprague "Universals" are easy to use! No complex arithmetic involved. One look at the handy reference card packed with each capacitor tells the complete story . . . which "Universal" to use . . . how to wire the leads for the capacitance required.

Type UHK-1, with seven needed values from .001 to .004 μF , is a High-K capacitor for use where rated capacitance is the lowest value permissible. Type UGA-1, with twelve values from .0004 to .0013 μF , is a general application unit with a capacitance tolerance of $\pm 20\%$. UHK-2, covering eight values from .0025 to .015 μF , is a High-K capacitor like UHK-1. Type UGA-2 covers fifteen values from .0006 to .0027 μF , and is a general application unit with a $\pm 20\%$ capacitance tolerance.

Put Sprague "Universal" ceramic capacitors on your "want" list now. Ask for the handy sized kit that fits your pocket or tool box. Your customers won't ever have to spend another night without television for lack of a simple ceramic replacement.

don't be vague . . . insist on

Sprague Products Company • Distributors' Division of the Sprague Electric Company • North Adams, Massachusetts.
OCTOBER, 1956

A FEW EXAMPLES OF HOW FOUR "UNIVERSAL" CAPACITORS MEET 90% OF ALL CERAMIC REPLACEMENT NEEDS

For .0004 μF

Cut leads 2 and 3 from a UGA-1 "Universal". Use leads 1 and 4 as terminals.

For .005 μF

Cut leads 2 and 4 from a UGA-1 "Universal". Use leads 1 and 3 as terminals.

For .001 μF

Cut lead 2 from a UGA-2 "Universal". Solder lead 3 to lead 4. Use leads 1 and 4 as terminals.

For .002 μF

Cut lead 4 from a UGA-2 "Universal". Solder lead 2 to lead 1. Use leads 1 and 3 as terminals.

For .0033 μF

Cut lead 4 from a UHK-1 "Universal". Solder lead 3 to lead 1. Use leads 1 and 2 as terminals.

For .01 μF

Cut lead 1 from a UHK-2 "Universal". Solder lead 4 to lead 2. Use leads 2 and 3 as terminals.

For .015 μF

Solder lead 3 to lead 1 on a UHK-2 "Universal". Solder lead 4 to lead 2. Use leads 1 and 2 as terminals.



SPRAGUE[®]
world's largest capacitor manufacturer

MAKE MORE MONEY ON SERVICE!

TELEVISION • RADIO • ELECTRONIC



Learn to handle ANY job easier, better and lots FASTER this modern professional way!

ONLY \$12 FOR THE COMPLETE TRAINING You Save \$125

THESE two big, fact-packed Ghirardi training books make it easy for you to become expert on all types of home radio and television receiver service—at absolute minimum cost!

Ask the men who already have good-pay jobs! They'll tell you that Ghirardi training is the finest — AT ANY PRICE — because it is so outstandingly complete, and because it makes even

the toughest subjects so easy to understand.

Each of these two books is entirely new, completely modern in every respect—NOT a re-hash of old outmoded material. Together, they form a complete service library written so you can easily understand every word and designed to serve either as a complete training course or as a handy reference for experienced servicemen who want to look up puzzling jobs or develop new and faster methods.

Learn all about Circuits . . . AND WATCH SERVICE "HEADACHES" DISAPPEAR

Years of experience plus hundreds of talks with service technicians proved to Mr. Ghirardi the need for a book that got right down to earth in explaining the basic circuits and operation of modern radio and television receivers. Radio & Television Receiver Circuitry and Operation is the result. Backed by what you can learn from it, you'll find that 9 out of 10 service jobs are tremendously simplified. You'll work faster with less testing—and make more money in the bargain! Guesswork is eliminated.

Starting with AM and FM proc-

esses and characteristics, the book progresses to a complete understanding of basic circuits, how they operate, how to recognize them quickly and what is likely to go wrong with them. By making it easy for you to understand each circuit and its relation to other circuits, the book helps you to go right to the seat of trouble in far less time. You'll know what different trouble symptoms mean—and you'll know how to repair troubles lots faster and more efficiently.

Sold separately for \$6.50. Try it for 10 days on our FREE examination offer.

Complete Training in MODERN PROFESSIONAL SERVICE METHODS

This big book makes the tough service jobs easy, makes the easy ones a cinch!

Actually, Radio & Television Receiver TROUBLESHOOTING AND REPAIR is a complete guide to modern professional methods.

First you get a full analysis of components, their functions, their troubles and their remedies. Next you learn modern troubleshooting methods from "static" tests to dynamic signal tracing and injection techniques. You learn basic procedures and how to interpret performance data. Four big chapters show how to realign Television, FM and AM receivers in less time. You'll learn how a glance at a TV set may quickly tell you what is wrong. Special hard-to-fix service, problems are explained. Puzzling "intermittent" troubles and their remedies are clearly outlined. Step-by-step service procedure charts

demonstrate many operations almost at a glance. In short, from the simplest troubles to the most difficult ones, nothing has been omitted—nothing has been condensed. Everything is carefully explained—and the entire book is fully indexed so you can find exactly what you want in a jiffy.

Read it 10 days FREE! See for yourself how this great book can pave your way to bigger pay. Sold separately for \$6.75. Save money by ordering special combination offer.



Dept. RE-106, RINEHART & CO., INC.
232 Madison Ave., New York 16, N.Y.

Send books below for 10-day FREE EXAMINATION. In 10 days, I will either remit price as indicated (plus a few cents postage) or return books postpaid and owe you nothing.

Check here to order books singly:

- Radio & TV Receiver CIRCUITRY & OPERATION (Price \$6.50 separately)
- Radio & TV Receiver TROUBLESHOOTING & REPAIR (Price \$6.75 separately)

Check here for MONEY SAVING COMBINATION . . . SAVE \$1.25!

Both of the above big books at the special price of only \$12.00 for the two. (Regular price \$13.25—you save \$1.25.) Payable at the rate of \$3 after 10 days if you decide to keep books and \$3 a month thereafter until the total of \$12 plus postage has been paid.

Name

Address

City, Zone, State

OUTSIDE U.S.A.—\$7.25 for TROUBLESHOOTING & REPAIR book; \$7.00 for CIRCUITRY & OPERATION; \$13.00 for both books. Cash with order only. Money refunded if you return books in 10 days.

SPECIAL money-saving OFFER!

Save \$1.25 by ordering both of the above big books. Make your service library complete!

QUESTION BOX

(Continued)

the eliminator is plugged in.—The diagram shows the battery and switching circuits in the transceiver.—N. R., Northampton, Pa.

The diagram shows a suitable battery eliminator and connectors. The dashed lines indicate leads that must

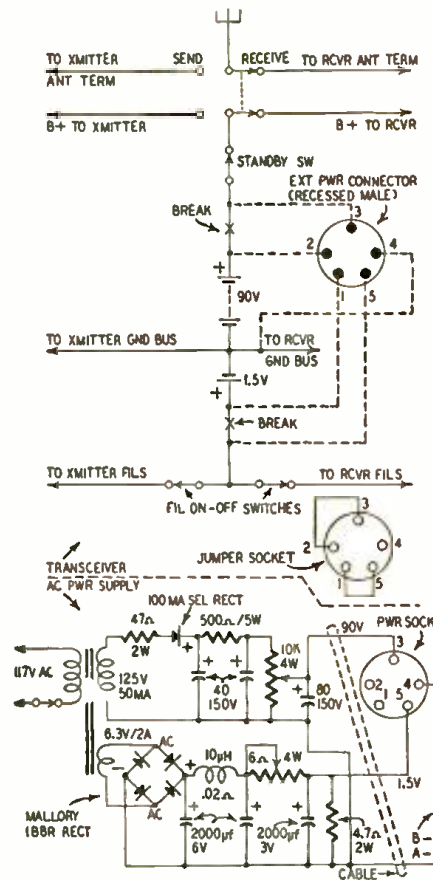

be added to the transceiver wiring. The variable resistors in the A and B supplies should be adjusted for the desired voltage under load. When adjusting the A supply, be sure to start with the 6-ohm resistor fully in the circuit. The jumpered connector must be in place when the unit is used on batteries. END

TATTOOING while U wait Or leave your skin



"I'll never forget her—my first color job!"

Glueck

.. INDEPENDENT SCIENTIFIC SURVEY

PRECISE MODEL #111 PROVED

"BEST COMMERCIAL TUBE TESTER

AT ANY PRICE" IN INDEPENDENT SURVEY

precise

Model #111

MUTUAL CONDUCTANCE AND EMISSION TUBE TESTER

An independent scientific survey conducted by an impartial testing laboratory confirms what purchasers already know: "The most advanced, the most complete tube tester and the best priced is made by PRECISE DEVELOPMENT CORP., Oceanside, N. Y."



111K (Kit form)

Now Only . . . **\$79⁹⁵**

111W (Factory Wired) \$139.95
including carrying case and cover

Prices slightly higher in the west. Prices and specifications subject to change without notice

NOW YOU CAN CHECK TUBES THE MANUFACTURER'S WAY

- Checks both emission and mutual conductance
- Checks all tubes including hearing aid, miniatures
- Six different plate voltages
- Different grid signals
- Simplified Short check
- Gas check
- New type switches
- Deeply etched aluminum panel
- Three different screen voltages
- Latest roll chart
- Measures filament current
- Measures grid bias

CHECK THESE ADDITIONAL 'specs' . . . TALK TO YOUR JOBBER AND TO ANYONE WHO HAS THIS OUTSTANDING TUBE TESTER . . .

The Model 111 is the only single commercial tube tester that checks all tubes for both EMISSION and MUTUAL CONDUCTANCE separately. Filament current is measured directly on large meter when checking a VOLTAGE SAPPER tube. NEW, MODERN DESIGNED ROTARY SWITCHES allow you to check each tube element individually NEW TYPE Single Rotary switch for complete short checks. The 111 makes all BIAS,

FILAMENT VOLTAGE, GAS, LIFE checks visually on large meter . . . 5 individually calibrated ranges and scales for mutual conductance tests. NEWLY DESIGNED "NO BACKLASH" ROLL CHART lists all tubes including the new type 60D mil series tubes. Provisions are made for testing many color tubes. All CRT's can be checked with accessory adaptor, Model PTA.

SEE THE MANY MORE PRECISE INSTRUMENTS AND PROBES AT YOUR JOBBER TODAY!

WRITE FOR CATALOG RE10

precise

THE FINEST KIT AND WIRED TEST EQUIPMENT

DEVELOPMENT CORP. OCEANSIDE, NEW YORK, U.S.A.

better TV
picture
quality

AMPHENOL
—INLINE*

COLOR

black & white

114-005 SINGLE BAY
also available:
114-322 TWO BAY ARRAY

For over ten years the AMPHENOL Inline has proved that quality pays off! Electrically and mechanically superior, the Inline has provided outstanding black and white pictures for more than a million satisfied set owners. Inline installations of yesteryear or today are ready for color. With color's critical demands, the electrical and mechanical features of Inline quality are required. For example, gain variation over the color modulation band for each VHF channel should not exceed ± 0.75 db. The Inline measures:

Channel	Gain Variation/db	Channel	Gain Variation/db
2	± 0.40	8	± 0.08
3	± 0.06	9	± 0.04
4	± 0.12	10	± 0.03
5	± 0.27	11	± 0.20
6	± 0.20	12	± 0.30
7	± 0.20	13	± 0.30

Use the Amphenol Inline and you are using the finest!

® REISSUE U.S. PATENT 23,073

AMPHENOL

AMPHENOL ELECTRONICS CORPORATION
chicago 50, illinois

Technotes



HIGH-VOLTAGE PRECAUTION

It is dangerous to use a high-voltage probe with vacuum-tube voltmeters and volt-ohm-milliammeters if there is an open or loose connection in the circuit other than in high-voltage probe itself.

The probe and meter form a series circuit and any break in the circuit puts the entire supply voltage across the break. This could happen in the test lead to the chassis due to the continual flexing of everyday use. The entire high voltage would exist between the meter chassis and the chassis of the receiver. Thus, be very careful to check the condition of the ground lead when using a high-voltage probe and use only one hand at a time.

There is another reason for care in the proper grounding of a meter to a chassis. The ground lead may open-circuit with the result that the entire high voltage being measured is impressed across the power-line low-voltage filter capacitors in the meter and the TV set; these are the small paper capacitors from one side of the power line to the chassis. Even 600-volt paper capacitors will not withstand 10 kv or better. The circuit is completed through the common power-supply line.

—Peter Millano

MAGNAVOX 350 CHASSIS

This set had a sync buzz in the sound which could be varied to some extent by the contrast control. The buzz was picked up by the shielded phonograph cable (see photo) which passed near the video peaking coils. Field strength was sufficient to penetrate the cable

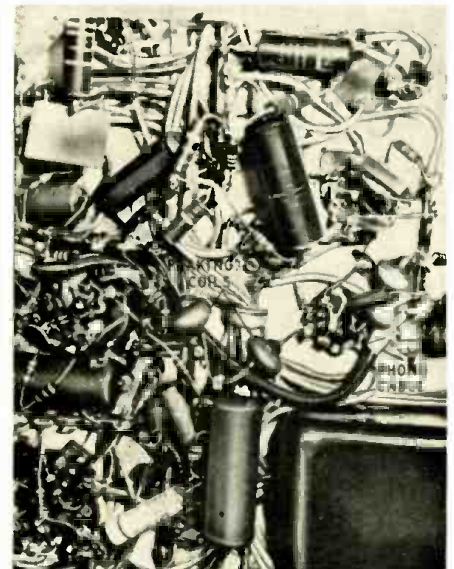

shield. The remedy was to reroute the cable away from the video output and dress the coils away from the cable.—*Peter Milliano*

AC-DC OSCILLATOR DRIFT

A battered old set came into the shop—an ac-dc prewar model. Aside from a missing dial cord and considerable hum, there was a very noticeable oscillator drift. Examining the underchassis in the vicinity of the oscillator coil (see photo) quickly revealed the trouble.

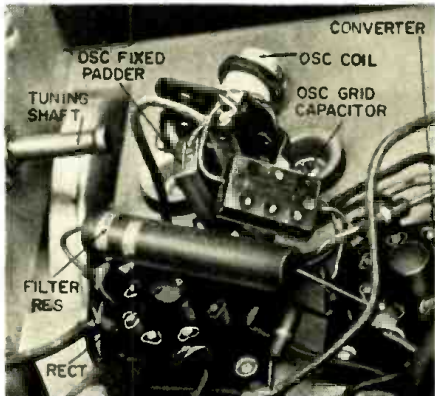

The diagram shows the circuitry involved. The filter resistor was bent over against the two mica capacitors; one the oscillator grid leak capacitor,

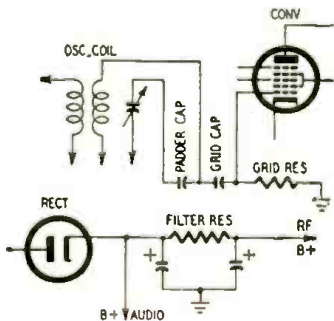

the other the paddler. One of the defective filter capacitors was drawing excessive current through the resistor and overheating it. The resistor, in turn, heated the two mica capacitors, changing their value, and the set drifted.

Replacing the filter capacitors and placing the filter resistor in a more favorable position cured hum and drift.—*James A. McRoberts*

AC-DC RECEIVER HUM

In the majority of late-model ac-dc radio receivers, the common negative return circuit is isolated from the chassis by a capacitor. When there is leakage between the pilot lamp assembly and the chassis, 60-cycle hum is sometimes introduced in the grid circuits, giving the effect of a defective filter capacitor. If bridging the filter capacitors fails to eliminate excessive line hum, inspect the pilot-lamp assembly for dust accumulation or defective insulation that may be providing a leakage path to the chassis.—*Warren J. Smith*

IT'S THE BIGGEST AND BEST EVER

FREE THE GIANT ALL NEW 1957 BA CATALOG

A COMPLETE BUYING GUIDE FOR EVERYTHING IN . . .

RADIO • TV ELECTRONICS

1957

ANNUAL CATALOG NO. 571

✓ For latest information on the latest, newest treatment . . .

✓ Over complete and up-to-date stock . . .

✓ Every B.A. Customer . . .

COMPLETE INDEX PAGE 170

BA

SINCE 1927

MEMBERS, SERVICEMEN, SCHOOLS, COLLEGES, THEATRES, U.S. PUBLIC EMPLOYERS, ENGINEERS, LABORERS, AMATEURS, HEADQUARTERS, MISSOURI

172 KING-SIZED PAGES

EVERYTHING IN RADIO TV AND ELECTRONICS

100'S OF NEW ITEMS LISTED HERE FOR 1ST TIME

21 PAGES OF BARGAINS NOT IN ANY OTHER CATALOG

BURSTEIN-APPLEBEE CO. Dept. 5, 1012-14 McGee St., Kansas City 6, Mo.

Send Free B-A Catalog No. 571.

NAME _____

ADDRESS _____

CITY _____ STATE _____

RUSH COUPON TODAY!

INVENTORS

Send for **PATENT INFORMATION** Book and **INVENTORS RECORD** without obligation

GUSTAVE MILLER
106 RE WARNER BUILDING WASHINGTON 4, D. C.

REGISTERED PATENT ATTORNEY
ASSOCIATE EXAMINER
U.S. PAT. OFF. 1922-1929

Patent Attorney & Advisor
U.S. Navy Dept. 1930-1947

PATENT LAWYER

NEW & BETTER TEST CONNECTOR

Ask your dealer for the new E-Z-HOOK Test Probe. Patented hook design . . . stays on . . . easier to use . . . safer. Ideal for scope and meters. Built-in Terminal Board . . . saves time—money . . . easy to build own detector and special test assemblies. The most for \$1.39!

E-Z HOOK TEST PRODUCTS.
1534 Woodburn, Covington, Kentucky.

ENGINEERING

B. S. DEGREE IN 27 MONTHS

Prepare for unlimited opportunities of the Electronic Age! Earn your B.S. degree in 27 months at Indiana Technical College. Intensive, specialized course. Comprehensive training in math and electrical engineering, advanced radio theory and design, television, electronics. Modern laboratories. Low rate. Also B.S. DEGREE IN 27 MONTHS in Aeronautical, Chemical, Civil, Electrical and Mechanical Engineering. G.I. approved. Enter September, December, March, June. Earn part of your expenses in Fort Wayne while studying. Write for catalog.

INDIANA TECHNICAL COLLEGE
1770 E. Washington Blvd., Fort Wayne 2, Ind.

Please send me free information on B.S. ENGINEERING DEGREE IN 27 MONTHS as checked.

Electronics Chemical Aeronautical
 Civil Mechanical Electrical

Name _____

Address _____

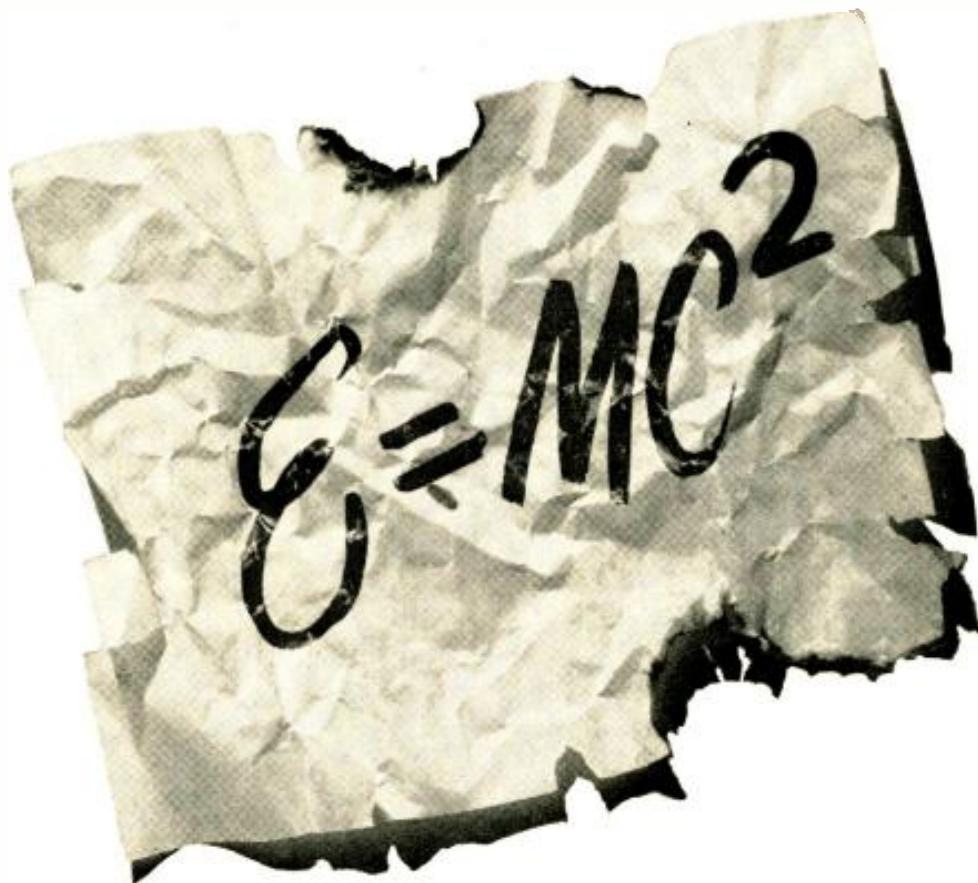

The Equation that Shook the World!

A hasty scrawl on a scrap of paper ushered in the Atomic Age. Through this equation, Dr. Albert Einstein revealed to mankind the awesome secret of atomic fission, with all of its tremendous power for good or evil.

This is the kind of a world we live in . . . a world where knowledge is power in a truer sense than ever before. It is an exciting world.

Univac® has added a new dimension to the world of science, processing data with a speed that crowds many lifetimes of research into a few hours.

Squarely in the midst of this exciting world are the engineers and scientists of Remington Rand Univac. Their potential for growth and achievement (and the rewards that go with them) is unlimited. *You can be one of them.*

Immediate Openings for:

FIELD LOCATION ENGINEERS with a college degree in a scientific or engineering field and experience in electronics. Extensive electronic background may substitute for some college. Many opportunities for rapid advancement.

FIELD LOCATION TECHNICIANS with technical school background and preferably some experience in electronics. These positions can lead to full engineering responsibility.

Send complete resumé to:

Remington Rand Univac

DIVISION OF SPERRY RAND CORPORATION

Mr. Phil Wilson
Dept. SO-10

1902 W. MINNEHAHA AVENUE • ST. PAUL W4, MINNESOTA
RADIO-ELECTRONICS



® Registered in U. S. Patent Office

Up-to-the-minute!

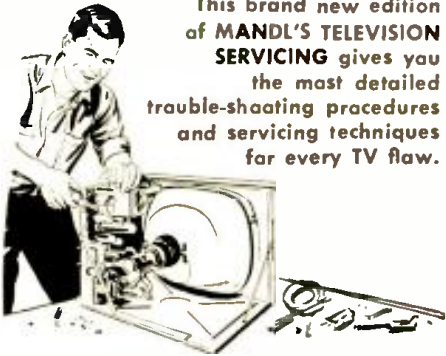

This brand new edition of **MANDL'S TELEVISION SERVICING** gives you the most detailed trouble-shooting procedures and servicing techniques for every TV flaw.

MANDL'S TELEVISION SERVICING Rev. Ed.

By **MATTHEW MANDL** \$6.50

Every feature that made this book invaluable to thousands of technicians and servicemen has been retained. In fact, each subject has been re-examined in the light of recent developments and brought completely up-to-date.

EASY TO LEARN

Simple, clear explanations of the fundamentals of monochrome and color TV. Complete servicing instructions for UHF and VHF.

- Plus:**
- Cascade tuners, automatically focused tubes and other devices.
 - The latest types of tuners and circuits (including theory and servicing of printed circuits).
 - Transistor theory and servicing principles.

You'll learn the time-saving methods used by the experts without unnecessary theory or involved mathematics.

COMPLETE EDUCATION IN SERVICING

The Master Index to Common Television Troubles—which has been expanded to include many new references—lists the various trouble symptoms with the possible causes for each and the page on which full servicing instructions are given.

Every step is fully illustrated with large, clearly marked schematics, and other helpful illustrations.

Become An Expert In . . .

CLOSED - CIRCUIT AND INDUSTRIAL TELEVISION

By **EDWARD M. NOLL** \$4.95

This one book could guarantee your future! It gives you, in clear non-mathematical terms, both the theory and practical techniques needed to handle closed-circuit transmission systems, scanning processes, picture signals, sync and deflection generators, cameras, and video amplifier systems.

THE ONLY BOOK IN ITS FIELD

This specially designed, paper-bound volume is packed with technical know-how, industrial applications, and hundreds of photographs and drawings.

2 one-way tickets to the best jobs in TV

Study one or both FREE for 10 days without obligation

CLIP AND MAIL TODAY

The Macmillan Company, Dept. RE-3
60 Fifth Ave., New York 11, N. Y.

Please send me:

- MANDL'S TELEVISION SERVICING \$6.50
 CLOSED-CIRCUIT AND INDUSTRIAL TELEVISION \$4.95

I will either remit the full price or return the book(s) in 10 days. (Save: Send check or money order now and we pay delivery charge.)

Name
Address
City Zone State

RADIO-ELECTRONIC CIRCUITS (Continued)

to operate a snap-action type spdt switch (S2). When the cam lobe rests under the arm of the switch, the motor circuit is open. Pressing S1 energizes the relay and closes its double-pole normally open contacts. Since the arm of S2 is on the cam, its normally open contacts are closed and the relay is locked in through one set of its contacts (contacts 1 and 2). The motor circuit is closed through relay contacts 3 and 4 and the motor runs. When the arm of S2 rides down off the cam lobe, the normally open contacts break the circuit and de-energize the relay. The normally closed contacts now apply power to the motor. When the turntable completes one revolution, the arm of S2 rides up on the lobe and stops the

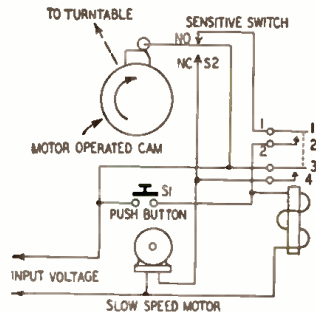

motor. The cycle can be repeated by pressing S1 again.

This circuit can be used wherever it is necessary to start and stop a motor after one revolution or after a predetermined number of revolutions if the cam is driven through a suitable reducing gear. It is particularly useful where S1 must be depressed only momentarily to start the motor.—
Arnold R. Shulman

AC HIGH-VOLTAGE CHECKER

When troubleshooting TV high-voltage circuits, the technician uses a vtvm to check voltages around the oscillator and a high-voltage probe to measure the rectifier output. The plates of the horizontal output and high-voltage rectifier carry high-amplitude pulse voltages in addition to dc. Schematic diagrams usually carry a "Do not measure" warning at these points. To judge these voltages, most technicians short the circuit to ground and estimate the voltage by the length of the arc.

This instrument is safer and more reliable and can be constructed for about \$1. Tests can be made very rapidly. There is nothing to hook up, not even a ground lead. The unit works by measuring the distance from the source at which a small neon lamp will fire. The drawing shows its construction.

A ½-inch-diameter transparent plastic tube about 12 inches long is used as the handle or body of the probe. The tip is made up of a short length of ⅜-inch-diameter plastic tubing into which a slightly longer piece of ¼-inch tubing is inserted. The metal tip or prod is a nail or piece of wire soldered to an ordinary automobile tire valve cap. On low voltages, the cap partially

from
MAINE

to
CALIFORNIA

Servicemen everywhere are acclaiming the outstanding performance of Aerovox "DURAMICS"—ceramic-cased tubular capacitors. No matter what the weather conditions... hot-and-humid or cold-and-damp... these superior capacitors have provided outstanding performance without costly call-backs.

Here are the reasons for such outstanding performance characteristics:

Dense steatite case provides exceptional protection against humidity.

Terminal lead wires are firmly imbedded into the end seals and will not work loose or pull out under the most severe operating conditions.

Operating temperatures from -55°C to +85°C.

Exclusive Aerovox end-fill will not separate from case nor soften or flow at any rated temperature.

Excellent power-factor, insulation resistance and temperature coefficient characteristics.

Available in 10 standard voltage ratings from 200 to 15,000 VDC.

AEROVOX TYPE P84CM CAPACITORS are always in stock at your local Aerovox Distributor in a complete range of capacitance values and voltage ratings. Popularly priced. Write today for your copy of the latest Aerovox catalog or ask your distributor.



AEROVOX CORPORATION

DISTRIBUTOR SALES DIVISION,
NEW BEDFORD, MASS.

In Canada: AEROVOX CANADA LTD., Hamilton, Ont.
Export: Ad Auriema, 89 Broad St., New York, N. Y.,
Cable: Auriema, N. Y.

Only the CLEAR PICTURE Comes Thru!



with the
NEW and
AMAZING

Dynamic FILTER TENNA

with the EXCLUSIVE built-in
HI-PASS FILTER
T. M. Reg. Pat. Pend.
THE FIRST TRULY ELECTRONIC
INDOOR TV ANTENNA TO GIVE
CLEAR FILTERED RECEPTION.



List
\$18.95
SATIN
BRASS,
SATIN
CHROME,
SATIN
COPPER
FINISHES.

Beautiful!



Available
at all
Quality
Electronic
Distributors



**THE HI-PASS FILTER
SCREENS OUT!** . . . all elec-
trical disturbances. Field tests prove
that this built-in unit rejects all inter-
ferences picked up in the antenna circuit . . .
only a completely filtered signal comes
thru. **GUARANTEED TO OUT-PERFORM
ANY INDOOR TV ANTENNA** — in re-
jecting electrical disturbances—OR
YOUR MONEY BACK!

**STRONGEST POS-
SIBLE SIGNAL** on any TV.
Powerful high gain phasing ele-
ments with adjustable 12 position
channel attenuator Eliminates ori-
entation, ghosts, fuzz, picture tear-
ing, and distortion in practically
all locations — on color and
black & white TV.

Manufactured By . . .
**DYNAMIC ELECTRONICS -
NEW YORK, INC.**
Forest Hills, Long Island, New York

RADIO-ELECTRONIC CIRCUITS (Continued)

surrounds the neon lamp and increases the sensitivity.

The plunger is a length of 1/4-inch plastic or wood rod or tubing with a short length of 3/8-inch tubing on one end and a knob on the other. Cut off a part of the leads of an NE-2 neon lamp and insert it into the open end

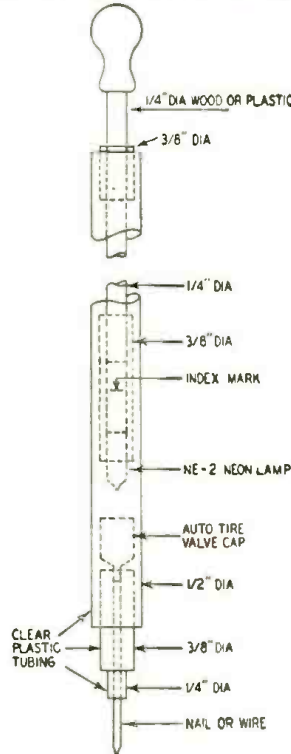

of the plunger, pushing it back just far enough so it doesn't strike the inside of the valve cap. File an index mark around the plunger and fill it with black ink. Assemble the instrument with a few carefully placed drops of cement.

Hold the probe tip on the plate of the output or rectifier tube and gradually push the plunger in until the neon lamp lights. Check the schematic for peak-to-peak voltages indicated on scope waveforms at these points and use this data to calibrate markings filed in the outside of the barrel.—Fred Wise **END**



"Boy, we really anchored that baby!"

Shortcuts For SERVICE... PROFIT From R-Columbia

New FONO MAGIC

A compound of special rubber and carbide . . . eliminates turntable slipping-dragging. Makes automatic changers cycle properly.



ONLY
\$1.95
DEALER
NET

New HUMI-KUP 2-Set TV Coupler

ONLY
\$2.95
DEALER
NET

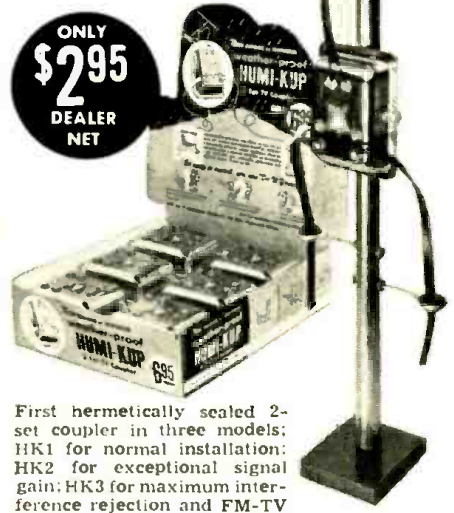

First hermetically sealed 2-set coupler in three models; HK1 for normal installation; HK2 for exceptional signal gain; HK3 for maximum interference rejection and FM-TV operation from one antenna.

Trolmaster and Kleontrol Solvent

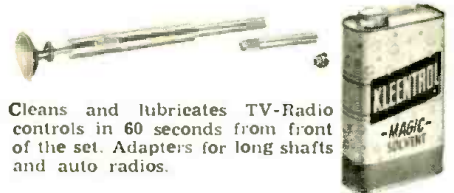

Cleans and lubricates TV-Radio controls in 60 seconds from front of the set. Adapters for long shafts and auto radios.

Write Today for Information on
These Servicemens' Designed Products

**R-Columbia
PRODUCTS CO., INC.**
Highwood, Illinois

Little Devil COMPOSITION RESISTORS

Meet all MIL-R-11A requirements. Rated at 70C rather than 40C. Available in 1/2, 1, and 2-watt sizes in all standard RETMA values.

BROWN DEVIL RESISTORS

Vitreous-enamelled. In 5, 10, and 20-watt sizes.

TYPE AB POTENTIOMETERS

Resistance material is solid-molded, noise-free. Rated at 2 watts.

FR-7.5 FUSE RESISTOR

For easy replacement in all television receivers. 1 1/2" Tinned wire leads.

WRITE FOR STOCK CATALOG

Be Right with **OHMITE** DEPENDABLE RESISTANCE UNITS

Eliminate call-backs due to faulty replacements. Use Ohmite components.

AXIAL-LEAD RESISTORS

Vitreous-enamelled, power-type units designed to withstand high temperatures.



OHMITE

OHMITE MANUFACTURING CO. 3646 Howard Street, Skokie, Illinois

PATENTS

(Continued)

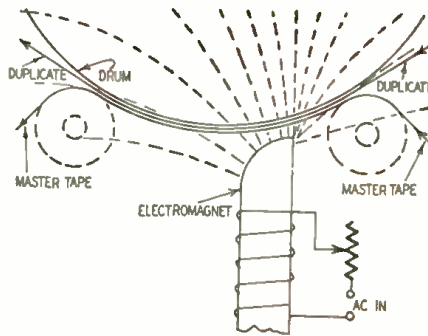

To preserve the master recording, this tape should have high coercive force. This assures that the master will not be demagnetized by the idealizing field. Both tapes should have high remanence so they will retain their magnetic strength. In practice, the master may suffer a loss of only 1/2 db or less during the first rerecording. There is no further loss.

Rerecording may be done at 10 inches per second when the idealizing field is 600 cycles.

AUTOMATIC ZERO-SETTING

Patent No. 2,734,949

Clifford E. Berry, Altadena, Calif. (Assigned to Consolidated Engineering Corp., Pasadena, Calif.)

In a sensitive dc amplifier or meter, the zero adjustment must be free of drift and variations. This circuit automatically checks the zero position at regular intervals; if it is off, an adjustment is made.

The diagram shows one form of the invention. It is applied to a dc amplifier whose balance is to be maintained. The ranged switch is operated periodically and automatically. In the position shown, the input is

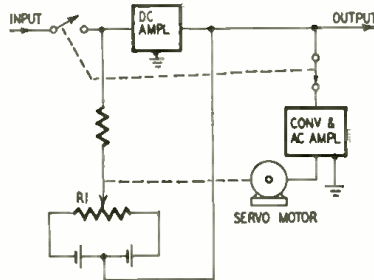

disconnected and the output is coupled to a converter which changes the dc to ac. This is amplified and used to drive a servo motor.

There should, of course, be no dc output from the amplifier when the input is disconnected. If there is, the motor controls R1 to bias the amplifier as required for zero output. If the output is zero (as it should be), there is no ac to drive the motor. Thus there is no variation in R1 and no change in the current taken from the battery to bias the amplifier.

TRANSISTORIZED RELAY CIRCUIT

Patent No. 2,718,613

James R. Harris, Dover, N. J. (Assigned to Bell Telephone Labs, Inc.)

Transistors have found useful service in relay circuits. Because of high gain and low power requirements, the transistor can be used to step up a signal and provide sufficient power to energize the relay. One problem must be solved. A transistor passes some current even in the cutoff condition. This static current varies with temperature and may be high enough to prevent or delay armature release or in extreme cases even to operate the relay. This invention solves the problem.

In the schematic a point-contact transistor is adapted to trigger service. Resistor R provides the necessary feedback. B1 biases the emitter to block the transistor. A negative pulse fed to the base switches the transistor on while a negative pulse to the emitter will switch it off again.

Diode D across the relay winding is a good conductor because it is biased in the forward direction. Therefore when the collector current

NEW

Pilot

High Fidelity TUNERS

Now Feature

Beacon Tuning*

and

Modern Styling

Plus Advanced Circuit Design Features



*A Pilot Exclusive . . .

Newly developed tuning indicator brings new ease and accuracy to FM and AM station selection.

Pilot Radio Corp. Dept. EK-6
37-06 36th St., L.I.C. 1, N.Y.

Send complete details about new Pilot tuners with Beacon Tuning.

Name.....
Address.....
City..... Zone..... State.....

THE ALL-PURPOSE OSCILLOSCOPE

(MODEL 983)



A high gain, wide band scope which accurately reproduces waveforms comprising a wide band of frequencies.

No scope offers equal versatility and profit-making possibilities. High sensitivity of 15 millivolts per inch RMS makes it ideal for setting resonant traps, signal tracing in low level stages, as a general null indicator, phase characteristic measurements, sweep frequency visual analysis. At your distributor, or write for bulletin—R-36-A. WESTON Electrical Instrument Corporation, Newark 5, N. J. A subsidiary of Daystrom, Inc.

WESTON test equipment
The Quality Line

ask the
"Man-on-the-Roof"
why he prefers

South River

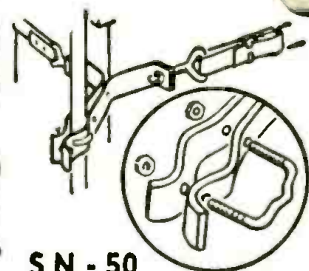

S N - 50 CHIMNEY MOUNT SNAP-IN TYPE

with Unique U-Bolt INSTEAD OF SCREWS for easy one hand "Spintite" fastening. Hot Dip Galvanized — 12 Ft. Straps, two to a set. Same Unique U-Bolts used on Snap-In Wall Brackets. Also Available with Stainless Steel Banding.

Write for new 1956 catalog

SOUTH RIVER
METAL PRODUCTS CO., INC.
South River, New Jersey

pioneer & outstanding producer of finest line of antenno mounts

GET MORE WORK OUT OF YOUR OSCILLOSCOPE!

Learn to service
ANY radio or TV
easier and
faster!

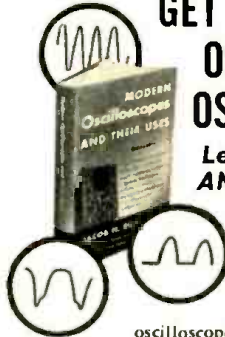

Here, in a brand new 2nd edition, is THE book that really shows you how to use

oscilloscopes!

Clearly as A-B-C, MODERN OSCILLOSCOPES AND THEIR USES tells you exactly when, where and how. You learn to locate either AM or FM radio or television troubles in a jiffy. Even tough realignment jobs are made easy. No involved mathematics! Every detail is clearly explained—from making connections to adjusting circuit components and setting the oscilloscope controls. And you learn to analyze patterns fast and RIGHT!

NEW 2nd EDITION!

Includes latest data on use of scopes in color TV, industrial electronics, teaching... even in atomic energy work. Over 400 pages and over 400 clear pictures. Dozens of pattern photos make things doubly clear.

PRACTICE 10 DAYS FREE!

Dept. RE-106, RINEHART & CO., Inc.
232 Madison Ave., New York 16, N. Y.

Send new 2nd edition of MODERN OSCILLOSCOPES AND THEIR USES for 10-day examination. If I like book, I will then send \$6.50 (plus postage) in full payment, or return book postpaid and owe you nothing.

Name.....
Address.....
City, Zone, State.....

OUTSIDE U.S.A.—Price \$7.00, cash with order only. Money back if you return book in 10 days.

PATENTS

(Continued)

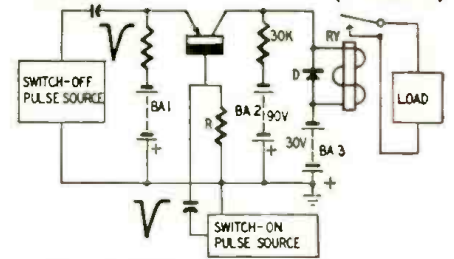

is low, relay RY is practically shorted out and cannot be energized.

When the collector current exceeds a predetermined value (chosen higher than the maximum expected cutoff flow), there is a large voltage drop across RY. This is a reverse bias for D which goes to cutoff. Now the full collector flow can pass through RY, and its contacts close.

D also has a second useful purpose. It damps out transients which could trigger the relay.

ZERO BEAT INDICATOR

Patent No. 2,715,699

James M. Lauther, State College, Pa. (Assigned to the United States of America as represented by the Secretary of the Navy)

A zero-beat indicator is used in bridges, frequency meters and many other devices. This indicator is a neon lamp and is effective from 25 cycles per second down. Its flashes may be counted when the beat is very near zero.

Each grid of the duo-triode is fed with one of the frequencies to be compared. Neon lamp NE51 is fed from a dc source adjustable at P. The voltage is set midway between firing and extinction potentials. Therefore a slight increase

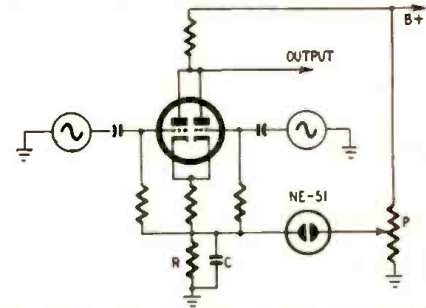

in voltage (as provided by the signal) will cause the lamp to fire. A slight decrease will extinguish it.

As the two signals approach zero beat, their voltages alternately add and subtract in cathode resistor R. This beat voltage is present across C where it adds and subtracts from the voltage applied to the glow lamp. The beats may be counted accurately by watching the lamp.

Note that C will bypass the signal frequencies which are relatively large, but the slow beat produces a voltage across it.

As an alternative, a pentagrid mixer tube could be used instead of the double triode. In this case signals from the two input sources are fed to two separate control grids. Screen grids in the tube can supply the necessary B plus voltage while shielding the signal grids against any interaction between the two. ENO

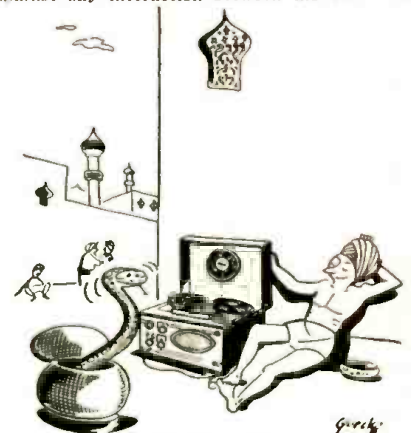

Automation.

RADIO-ELECTRONICS

try This one

SIGNAL-SEEKING TUNERS

In the far reaches of the woods or for that picnic with the girl friend, some music may be desired. It may be available in the car radio but the Signal-Seeking Tuner just won't latch onto such a weak signal. The automatic tuner keeps right on seeking, skipping over signals too low to actuate the trigger mechanism that shuts it off.

A remedy is to increase the pickup so that enough signal exists to kick the seeking mechanism off. Adding metal to the antenna is one method. A wire may be connected to the tip of the antenna and run to the radiator ornament. A clip will facilitate attachment to the antenna or the wire may be simply wrapped around. A piece of fiber or wood with a couple of holes in it will insulate the added wire from the ornament.

In case nothing else is handy you can run the antenna to a nearby fence post, tree or other object. In some instances good results may be obtained merely by pushing the wire into the soil. The entire ground acts as an antenna because the tires insulate the vehicle from the ground.—James A. McRoberts

ADAPTER FOR HEATHKIT AG-9

The Heathkit AG-9 audio generator provides metered outputs from 10 to 3 mv in 8 full-scale ranges. This means accurately metered output down to about 1 mv. However, much lower voltages are needed when checking certain preamplifiers. I do this by shunting the output with a 1,000-to-1 voltage divider

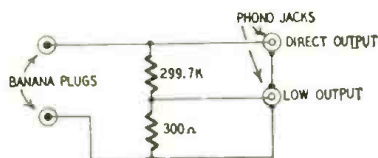

consisting of 299,700- and 300-ohm resistors in series and take the low voltage from across the smaller unit. The effect of shunting 300,000 ohms across the 300-ohm generator output impedance is negligible.

It is not easy to build the added attenuator into the original unit so I constructed an adapter that plugs into the original output terminal jacks. The auxiliary attenuator is mounted in a small metal utility box. Insulated banana plugs were spaced $\frac{3}{4}$ inch apart on one end of the box so they fit into the output jacks on the AG-9. I prefer shielded cable with phono plugs for audio tests so I mounted a double phono

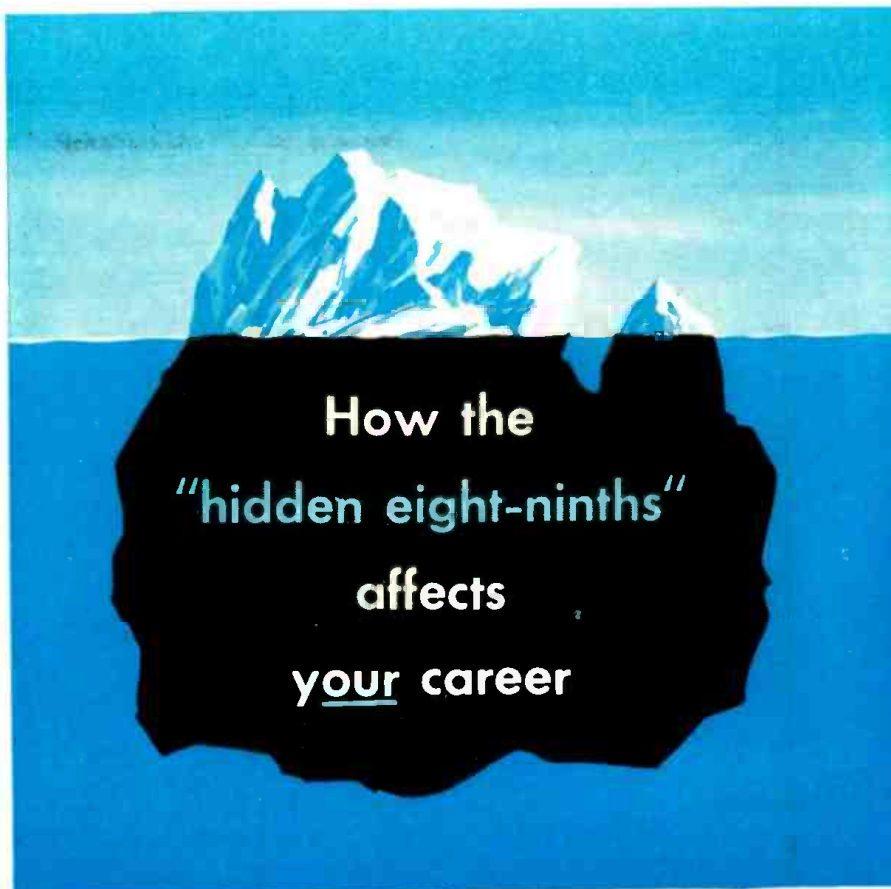

How the
"hidden eight-ninths"
affects
your career

If you look at only the more evident facts of an engineering or technical position, it is like judging the size of an iceberg merely by what shows above water.

The "hidden eight-ninths" may well determine the correctness of your choice.

Consider IBM's leadership in the most exciting, most rapidly expanding, perhaps the most *unlimited* field in electronics: digital computer development, manufacture and new maintenance techniques.

IBM is taking a leading role in the design, construction and installation of Project SAGE—the electronic "nerve center" of America's continental air defense warning system.

Greater responsibilities await the ambitious man at IBM. Advancement is based solely on individual performance. Capability, talent and creative ideas are quickly recognized and rewarded.

Excellent salaries prevail—along with extensive training, liberal benefits, good working conditions, facilities among the finest.

Stability is assured by a 42-year record of solid growth through di-

versified service to all industry, plus government and education.

Immediate, permanent assignments in: Portland, Me., Richmond, Va., Syracuse, N. Y., and other desirable locations.

Liberal relocation expense allowance. IBM and Project SAGE offer opportunities to challenge your ability:

FIELD ENGINEERS

You will be responsible for the performance, evaluation, reliability testing, and maintenance of the entire system containing the world's largest computer.

Requirement: Degree or equivalent with emphasis in electronics.

FIELD ENGINEERING TECHNICIANS

Actual maintenance and component analysis. Assume high-level responsibility. Requirement: Two-year technical school training in electronics, or equivalent.

You are invited to "sound out" IBM potential by writing, giving details of education and experience, to: Nelson O. Heyer, IBM, Room 3111, Military Products Division, Kingston, New York.

DATA PROCESSING
ELECTRIC TYPEWRITERS
TIME EQUIPMENT
MILITARY PRODUCTS

IBM
®

INTERNATIONAL
BUSINESS MACHINES
CORPORATION

GENIAC ELECTRIC BRAIN

COMPUTES, PLAYS GAMES, "REASONS"!
COMPOSES MUSIC!



Actual tune composed on Geniac circuitry.

BUILD IT YOURSELF in a few hours!

Using a statistical analysis of simple tones plus the special circuitry of GENIAC, the Electric Brain Construction Kit, you can compose original tunes automatically. These new circuits are not available elsewhere!

GENIAC gives a wonderful introduction to the logic machines of our modern age! Over 30 machines can be built with the kit including: adding, subtracting, multiplying and dividing machines, in binary and decimal. There is also a binary to decimal converter. Synthesizers, computing and coding machines, as well as game playing circuits (think you can beat the machine at Tic-tac-toe and Nim), actuarial analysis and intelligence testing are performed by the 34 different machines you can set up with this kit.

The machines are easy to build—all tools come with the kit and safe—requiring only one flashlight battery for power. Simple enough for a child to build (with complete wiring diagrams), they are fascinating for adults.

GENIAC is a comprehensive introduction to basic computer and problem solving circuits.

WHO ARE OUR CUSTOMERS?

International Business Machines • Westinghouse Electric • Remington Rand • Albert Einstein Medical College • Barnard College • Naval Research Laboratories • Los Angeles Public Schools • Bell Telephone Laboratories • and thousands of other satisfied customers.

WHAT COMES WITH THE KIT?

Each kit comes with a 614 page experimental manual (Simple Electric Brains and How to Make Them), Wiring Diagrams, a Beginners Manual, GENIAC Study Guide listing additional readings in computer fundamentals and Minds and Machines a 200 page text on computers and automation, plus a display and assembly rack and plastic parts tray, over 100 parts and components. **\$19.95**

New! WRIST RADIO



Weight: 2.5 oz.

A broadcast band all-transistor radio has been designed with RF reflex circuit to provide good selectivity and sensitivity. In moderate signal strength areas, no antenna is required up to a distance of 25 miles from a broadcast station of average power. Good consistent reception can be obtained over 95 miles with the use of a wire from 6 inches to 3 feet. The use of transistors make it a rugged device not subjected to tube breakage. (ugged high quality components are used throughout. Normally the transistor will not have to be replaced for the life of the instrument. Extreme economy of operation is obtained through the use of special circuitry requiring very low current, thus prolonging the life of the mercury cells. The small size makes it the ideal radio. It can be worn on the wrist where it easily fits under the sleeve of a jacket or worn in a shirt pocket.

Complete
\$29.95

FEATURES

- Two stage transformer coupled amplifier
- No whistle regenerative circuit
- Light weight—2.5 ounces total
- Battery life—100 hours
- Stainless steel expansion wrist band
- High quality hearing aid receiver
- Printed circuitry throughout
- Rugged plastic case
- No tube replacement or breakage
- Long life transistors
- Extreme economy of operation

SPECIFICATIONS

Band coverage—550-1600 kc
Sensitivity—200 microvolts to meter
Output—2 - 2.5 milliwatts
Current drain—4.5 milli-ampere
Battery voltage—6 volts
Weight—2.5 ounces, including batteries
Size—2 1/4" long x 1 3/4" wide x 3/8" thick
Color—Black
1 RF Amplifier and detector transistor
2 Audio amplifier transistors
3 Mercury cells (General Dry Battery Type E825) easily available at your radio supply house or hearing aid dealer

ROBOTS AND NERVE ANALOGS

OUR ROBOT, Maenitia Speculatrix, the Robot Turtle, is light and touch sensitive. When it is hungry it goes toward light, when it bumps into something it retreats away from it. Designed by Dr. Walter Grey Walter ("The Living Brain"), it operates on storage cells. Complete Plans and Blueprints, **\$5.00**

NERVE ANALOG, duplicates the electric basis of nerve action. Both Analog and Robot were designed for Psychology and Physiology classes and demonstrate of nerve action and the complexities of behaviour possible with simple electrical circuits. Blueprints, parts list, wiring diagrams. **\$4.00**

Oliver Garfield Co., Dept. RE-100
126 Lexington Avenue, New York 16, New York
Please send me a GENIAC KIT postpaid \$19.95 (add \$1.00 west of Mississippi). \$2.00 for outside United States.
Please send me WRIST RADIO \$29.95 Postpaid.
Please send me Plans & Blueprints of Robot, \$5 Postpaid.
Please send me Blueprints of Nerve Analog, \$4 Postpaid.

Name and Address are attached.

TRY THIS ONE

(Continued)

jack on the other end of the box and connected the resistors as shown. When the adapter is in use, I can take the direct output of 1/1,000 of the voltage indicated by the main attenuator and the meter.

The accuracy of the low output depends on how well the resistors are matched in proportion. I used ordinary 1/4-watt units within about 3% of the desired values. The exact values are not important but they should be checked by applying around 250 volts across the two in series and padding one or the other until the voltage across the smaller is exactly 1/1,000 of the total.—*Alfred Olsen*

NOVEL TRANSISTOR MOUNT

Old tube bases make sturdy protective plug-in mountings for the transistors that are used frequently in experimental circuits. The large-size base as used on the old 45's and 80's have room for fuses on the outside as shown in the photograph.

Use 4-40 machine screws in the bakelite shell for terminals. Connect them to the base pins and clamp the tran-

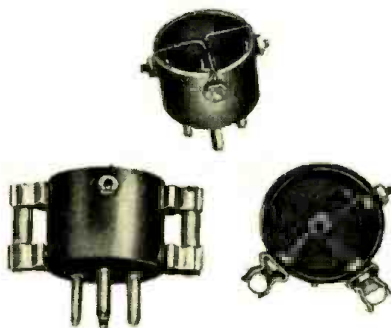

sistor leads under nuts without soldering. Slip a length of spaghetti tubing over the base (center) lead to prevent shorting and then bend the leads so the transistor hangs neatly and safely inside. Devise a standard base wiring diagram and use different pins for the collectors of n-p-n and p-n-p types.

You can mount more than one transistor in a single base. A pair of CK722's in a 6-pin base replaced a type 19 tube in an old battery receiver that we converted.—*Albert H. Taylor*

SOLDERING HINT

Ever ruin a transistor or other expensive component by overheating its leads when soldering it into a circuit? Well, I have only once too often! To eliminate this difficulty and speed soldering, I hammer my solder flat before bringing it into contact with the joint to be soldered. This permits the solder to melt more readily, thus reducing the time the iron need be held in contact with the joint. This hint works equally well with both solid and rosin-core roll solder.—*John A. Comstock*

LOOK FOR THIS RACK

at your Jobber . . .

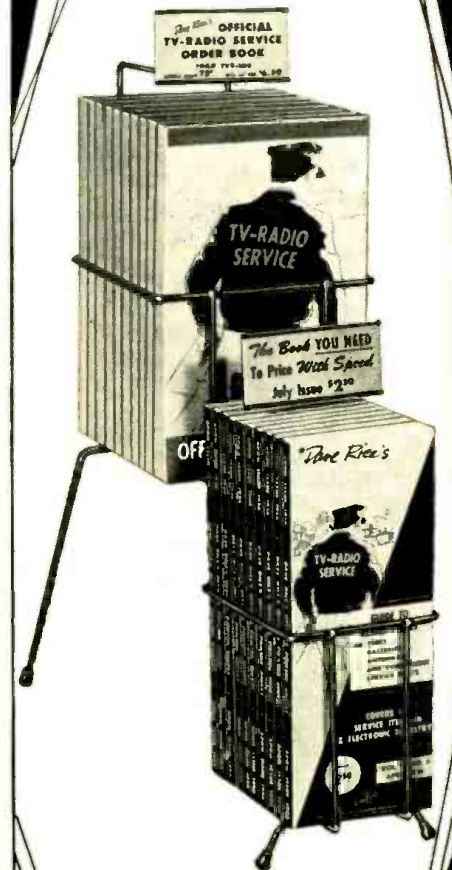

In this rack you will find
The Biggest Service Help
The Largest Value
In These Perfect Partners

Dave Rice's Official Pricing Digest—a quick check for over 60,000 prices—revised 4 times every year. Pocket sized.

and
Dave Rice's Official TV-Radio Service Order Book which provides separate listings for picture tubes, receiving tubes, parts and components, serial numbers, labor and state and local taxes. 5 1/2 x 8 1/2—50 sets of triplicate orders—carbons bound in.

ELECTRONIC PUBLISHING CO. INC.

180 North Wacker Drive Chicago 6, Illinois

NOVELTY BLINKER

Two neon lamps that blink on and off will delight children when used as the eyes of a Santa Claus, jack-o'-lantern or any similar toy. They can also be used in making eye-catching window displays. The circuit is a form of gas-tube multivibrator using a pair

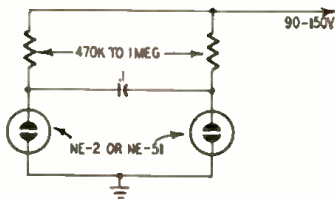

of NE-2 or NE-51 neon lamps operating from a supply delivering 90 to 150 volts dc. This voltage can be supplied from inexpensive batteries or a small line-operated power supply. The flashing rate can be adjusted as desired by varying the value of the capacitor.—*Irving Barditch*

TEST FOR HOT CHASSIS

Did you ever *slide* your finger tips or the back of your hand or your arm *lightly* over the surface of the cabinet or chassis of a connected ac-dc radio and feel the very rapid vibrations as the skin was rubbing over the surface? You were feeling the alternating pulsations of the house current because the chassis was on the hot side of the line. The vibrations can no longer be felt when the power plug is reversed in the outlet, thus putting the chassis on the grounded side of the line. I have noticed this effect many times but it has just recently occurred to me to use it as a quick test for a hot chassis. This effect is more pronounced in some radios than in others, and the skin on the back of the hand or on the arm is usually more sensitive than the finger tips. If you can feel the vibrations, you can use this trick as a reliable test for a hot chassis. It is sometimes desired to make a quick hot-chassis test when connecting other pieces of ac equipment to ac-dc radios. For example, when using an ac-dc radio as a tuner with a hi-fi amplifier, or when feeding the tuner of one radio into the amplifier of another radio, etc.—*Arthur Trauffer*

FUSING TRANSISTORS

The resistance of a fuse protecting class-B transistors can cause distortion if the drop across it, as current

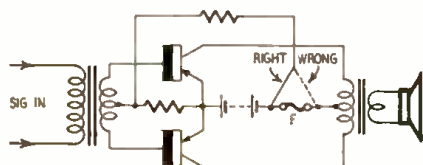

increases, affects bias as well as collector voltage. Lower idle current can be used if the bias bleeder, whose resistance limits the base-to-emitter current, is fed from ahead of the fuse as shown in the diagram.—*Albert H. Taylor*

SHOOT TV TROUBLE FAST!

With H. G. Cisin's Copyrighted RAPID "TV TROUBLE SHOOTING METHOD"

Without experience or knowledge, this guaranteed new method of servicing TV sets enables you to DIAGNOSE TV troubles as rapidly as an expert. **NO THEORY—NO MATH**—you can locate all faults in record breaking time, regardless of make or model. **"TV TROUBLE SHOOTING METHOD"** is the most valuable aid in TV servicing ever written. Be a TV Trouble Diagnostician, increase your present earnings, open your own profitable business or get a high-paying skilled job.

It's all in this book . . . Nothing more to Pay—Nothing else to Buy

Alphabetically listed there are 85 picture troubles, over 58 raster and 17 sound troubles and by this unique copyrighted method you know EXACTLY WHERE the trouble is; plus step-by-step instructions, including 60 RAPID CHECKS, enabling you to find the faulty part.

13 IMPORTANT PRELIMINARY CHECKS NEED NO INSTRUMENTS! Of the 60 Rapid Checks, **OVER 65 ALSO REQUIRE NO INSTRUMENTS!** Rapid checks include emergency checks for distorted pictures, defective tubes including PIX tube, plus 57 others. **ALL EXPLAINED IN SIMPLE LANGUAGE. PERFORMED WITHOUT INSTRUMENTS. MANY CHECKS USE THE PICTURE TUBE AS A GUIDE.**

H. G. Cisin, the author, is the inventor of the AT/DC mid-set radio. He knows RCA, APOL, etc. He has also trained thousands of technicians now owning their own prosperous TV service organizations or holding highly paid TV positions. His years of experience are embodied in this remarkable new TV TROUBLE SHOOTING METHOD.

Guaranteed, Money Back in 5 Days if Not Satisfied!

ABSOLUTELY FREE with each, or det: H. G. Cisin's newest book "TV & RADIO TUBE SUBSTITUTION GUIDE." Gives direct replacements of set and picture tubes. Most valuable servicing aid! **ACT NOW**—get both books postpaid at cost of only one!

\$1 Post-paid

RUSH COUPON NOW!

H. G. CISIN, CONSULTING ENGINEER,
Amagansett, N.Y. (Dept. E-40)
Enclosed find \$1. Rush both books.

Name _____
Address _____
City _____ Zone _____ State _____

"Hey, Sam. This guy wants to know where's the nearest place he can find JENSEN NEEDLES."

14th Edition

RADIO Handbook

truly a one-volume library
of radio information!

- a multitude of new equipment shown . . .
- detailed "HOW-TO-BUILD" data . . .
- extensive simplified theory . . .

Its 766 pages contain more — much more — than in any other publication of its kind!

OSCILLOSCOPES
POWER SUPPLIES
TEST EQUIPMENT
V.T. PRINCIPLES
SEMI-CONDUCTORS
V.T. AMPLIFIERS
FM TRANSMISSION
MOBILE EQUIPMENT

D-C & A-C CIRCUITS
TRANSMITTER DESIGN
TRANSMITTER KEYING
WORKSHOP PRACTICES
TRANSMITTER CONSTR.
R-F V.T. AMPLIFIERS
S.S.B. TRANSMISSION
AMPLITUDE MODULATION

RECEIVING EQUIPMENT
TV & BC INTERFERENCE
SPECIAL V.T. CIRCUITS
RECEIVER FUNDAMENTALS
ANTENNAS, H-F, V-H-F,
U-H-F & BEAMS
SPEECH & AM EQUIPMENT

\$750 in U.S.A.
Plus sales tax



BUY FROM YOUR FAVORITE DISTRIBUTOR

at above price or add 10% on direct mail orders to:

EDITORS and ENGINEERS, Ltd.

SUMMERLAND, 3 CALIFORNIA

BOOKSTORES: ORDER FROM BAKER & TAYLOR CO., HILLSIDE, N.J.

LEARN

Television
RADIO-COLOR-TV
Electricity
ELECTRONICS
IN THE GREAT SHOPS OF **COYNE**

TRAIN QUICKLY! OLDEST, BEST EQUIPPED SCHOOL of ITS KIND in U.S.

Veterans and Non-Veterans — Get practical training in top opportunity fields. Prepare now for a better job and a real future. Advanced education or previous experience not needed. Employment service to graduates.

Enroll NOW — Pay Later

Finance Plan and Easy Payment Plan. Also Part Time Employment help for students. *Training in Refrigeration and Electric Appliances can be included.*

FREE BOOK Clip coupon for Big Free Illustrated Book. No obligation and No Salesman Will Call. Act NOW.

B. W. COOKE, President

A TECHNICAL TRADE INSTITUTE OPERATED NOT FOR PROFIT Established 1899 500 S. Paulina, Chicago

COYNE
ELECTRICAL SCHOOL

B. W. COOKE, Pres.
COYNE Electrical School
500 S. Paulina St., Chicago 12, Ill. Dept. 76-81H

Send FREE BOOK and full details on:

- TELEVISION-RADIO
- ELECTRICITY-ELECTRONICS

NAME

ADDRESS

CITY STATE

ALL NEW BIGGER THAN EVER!



NEWARK'S
Complete
ELECTRONICS
Catalog No. 65

Here's everything in Industrial Electronics, High Fidelity, Radio, TV and Amateur Equipment

Write today

NEWARK
ELECTRIC COMPANY

Mail Order Division . . . Dept. RE-10
223 W. Madison St., Chicago 6, Illinois
4736 W. Century Blvd., Inglewood, Calif.

TRY THIS ONE

(Continued)

JEWELERS' SAW

The photo of the pin vise holding a jewelers' saw blade illustrates how to use this fine saw in difficult locations. The frame for these saws may not permit the blade to be used in tight places such as on small model work. Clamping in the pin vise is preferable to the hand holding sometimes practiced and offers less danger of bending and subsequent breakage.

Only a short length of the saw blade protrudes from the pin vise. A longer

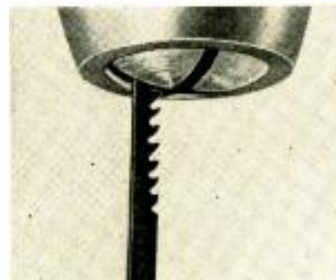

length invites bending. Jewelers' saws should be pulled to the user on the cutting stroke rather than pushed as in hacksaw practice.

The neighborhood jeweler will be pleased to give you broken blades which can be used in the pin vise or hand held. A half blade length is almost useless to him but you can use it as a jig saw with a minimum width of saw cut in the material.—*Alfred Roberts*

RELAY OPERATING KINK

Try using an incandescent lamp instead of a resistor in series with the coil when operating a relay on higher than rated coil voltage. The surge current of the cold lamp operates the relay very smartly and the smaller hot current holds it. The holding current can be less than would close the relay, if the lamp has a second or two to cool between opening and reclosing.

A certain 12-volt, 80-ohm relay in series with a 120-volt 15-watt lamp on 112 volts dc can be reclosed immediately, but a 7-watt lamp operates it satisfactorily only if it is not reclosed too quickly.—*A. H. Taylor* END



Hal Honey

RADIO-ELECTRONICS

People



L. J. Battaglia was appointed manager of the Marketing Department of the RCA Components Division. He was formerly manager of equipment and parts marketing.

Mike Redmund, distributor sales manager of Jensen Industries, Forest Park, Ill., was promoted to the position of vice president in charge of sales.



Thomas H. Moss, jobber sales manager of Turner Co., Cedar Rapids, Iowa, was given additional responsibilities by his appointment as general sales manager of the company.



Walter Clements, sales engineer of Littelfuse Inc., Des Plaines, Ill., was promoted to the position of jobber sales manager.



J. Wayne Cargile joined United Catalog Publishers, Inc., New York. He will act as Midwest district manager with headquarters in the newly established branch in Chicago. He comes to the Company from Permo, Inc., where he had held the position of distributor sales manager.



Ernest B. Mullings was promoted to assistant advertising manager of the Heath Co., Benton Harbor, Mich. He was formerly responsible for copy preparation for all Heath advertising.



Wm. R. Anton was appointed sales and advertising manager of Permo, Inc., Chicago, in charge of promo-

NOW—this new library shows the way to More Profit in Hi-Fi



Here's a complete library of hi-fi books by top English and American authorities which shows you the way to more money in your profession, or greater satisfaction in your hobby! And, the Gernsback Audio-High Fidelity Library Plan SAVES YOU 25% OVER THE RETAIL PRICE!

The library will include books on fundamentals, maintenance, amplifiers, speakers, enclosures, tape recorders and other important phases of high fidelity. Each book is durably bound in a handsome gold-leaf stamped cloth cover, which will stand up under constant use.

HOW THE PLAN WORKS

To enroll in the Gernsback Audio-High Fidelity Library Plan fill in the coupon below. We will send you new books post-paid, one at a time, as they are published—at intervals of about four months. You examine each book **FREE for 10 days in your own home**. If you like it, keep it and we bill you at only \$3.75—each for a book which is nationally advertised at \$5.00! And we pay the postage. If you don't want

the book, simply return it. We will continue to send you subsequent books as they come off the press. To avoid undue expense to members, we release only about three books a year. And you don't have to bind yourself to a long term contract. You agree to take a minimum of only four books for the entire duration of your enrollment. You may cancel anytime after that.

TWO BOOKS ALREADY OFF THE PRESS!

Since this plan began last Fall, two books have already been published. You may include one or both in your membership by checking the appropriate box in the coupon below. We will send you the book or books for a **Free 10-day trial**. If you like them we will bill you at \$3.75 each. If not, send them back. You may skip these two books and begin your membership with subsequent books if you prefer.

BASIC AUDIO COURSE. By Donald Carl Hoefler, RCA recording Engineer—Covers audio-high fidelity fundamentals from the theory of sound to advanced recording techniques, including amplifiers, feedback, power supplies, distortion and noise, attenuators, loudspeaker systems and every other important audio unit. Shows why and how audio systems work.

MAINTAINING HI-FI EQUIPMENT. By Joseph Marshall — RADIO-ELECTRONICS widely-read hi-fi authority teaches you the techniques needed to recognize and repair hi-fi troubles. Covers acoustical and mechanical faults as well as electronic. A must for the professional hi-fi man or the audiophile who maintains his own equipment.

THESE BOOKS SET FOR FUTURE PUBLICATION

Here are some of the titles to be published one-at-a-time at regular intervals of about four months each in the months ahead. You will automatically receive a copy of each book for a 10-day **FREE** inspection as it comes off the press.

- **HIGH-QUALITY AUDIO** —Richard Dorf
- **THE AUDIO DATA BOOK** —H. A. Hartley
- **LOUDSPEAKER ENCLOSURES**
- **THE GOLDEN EAR** —Joseph Marshall

- **AUDIO HINTS**
- **CONSTRUCTING AUDIO AMPLIFIERS**
- **LOUDSPEAKERS—AND SPEAKER SYSTEMS** —H. A. Hartley

EXCLUSIVE MONEY-SAVING SERVICE FOR HI-FI FANS

This is the one and only library Club plan devoted exclusively to giving readers all the answers to attaining top hi-fi performance. Mass printing and direct distribution methods, save you 25%—\$1.25 on each book.

Enroll in this money-saving plan now to assure yourself of the satisfaction of receiving regularly the most interesting and stimulating hi-fi books published.

MAIL THIS NO-RISK COUPON TODAY

GERNSBACK LIBRARY, INC.
154 West 14th Street, New York 11, N.Y.

- Bring me up-to-date as a member of the Gernsback Audio-High Fidelity Library. Enter my enrollment and send me the books (or book) checked below for a **FREE 10-day inspection.**
- BASIC AUDIO COURSE** \$3.75 (Retail value \$5.00)
- MAINTAINING HI-FI EQUIPMENT** \$3.75 (Retail value, \$5.00)

understand You will bill me if I do not return the book(s) after the 10-day inspection period. I agree to accept at least four books.

- Enroll me in the Gernsback Audio-High Fidelity Library; beginning with the next book published.
- Send me more information about the Gernsback Audio-High Fidelity Library.

NAME..... (Please print)

STREET.....

CITY..... STATE.....

NOW!

**Step ahead faster
as an
INDUSTRIAL
ELECTRONICS
TECHNICIAN**



Turn your experience into a big, new better-paying career!

Day by day industrial plants are adding more electronic devices—for sorting, counting, checking almost any control job you can name. Cash in on industry's great need for men who can keep these devices in top working order. Make more money, feel more secure, doing work that is second nature to you. With what you already know about electronics you have a long head start in a field just beginning to boom. GET INTO IT RIGHT NOW with the help of

**PRACTICAL INDUSTRIAL
ELECTRONICS LIBRARY**

No long sessions on math or theory! These 4 practical volumes show you how to keep the plant's electronic equipment working... how to locate and correct tube and circuit troubles... how to install, service, and maintain even brand new equipment without being stumped by new circuits.

- 4 volumes (1369 pp., 1102 illus.)
Chute's Electronics in Industry
- Miller's Maintenance Manual of Electronic Control*
- Markus & Zeluff's Handbook of Industrial Electronics Circuits*
- Honey & Fahnestock's Electron Tubes in Industry*

FREE TRIAL—EASY TERMS!

McGraw-Hill Book Co., Dept. RE-10
321 W. 41st St., N.Y.C. 36

Send me the Practical Industrial Electronics Library for 10 days' examination on approval. In 10 days I will send \$2.50, then \$4.00 a month until \$22.50 is paid. (A. way/ing @ \$4.50) under the regular price of \$27.00.) Otherwise I will return books postpaid. (Print)

Name.....
Address.....
City.....Zone.....State.....
Company.....
Position.....RE-10

For price and terms outside U.S. write McGraw-Hill Int'l., N.Y.C.

**ATTENTION
SERVICE DEALERS**

- Increase Service Income
- Decrease Operating Cost
- ... SAVE CUSTOMERS

WITH THIS AMAZING LOW COST PORTABLE



B&K NEW ECONOMY CRT 200

SPOTS THE TROUBLE & CORRECTS IT IN A FEW MINUTES



The unique, portable CRT 200 tests and restores emission, stops leakage, finds and repairs interelement shorts and open circuits. Life-test checks gas content and predicts remaining useful life. This portable cathode rejuvenator tester does the entire job in a few minutes right in the home—without removing tube from set.

NOW \$3995 \$2495

AVAILABLE AT ALL "ALMO" STORES
Almo RADIO CO.
509 ARCH ST., DOWNTOWN, PHILA.
Branches: West and Northeast Phila.
Camden, N. J. • Trenton, N. J. • Atlantic City, N. J.
Harrisburg, Pa. • Wilmington, Del. • Salisbury, Md.

Always mention you saw it in
RADIO-ELECTRONICS
When answering ads

PEOPLE

(Continued)

tion and sales of all products, including Fidelitone phonograph needles, accessories, recording tapes, etc. He will also continue in his present capacity as vice president and general manager of Fidelitone, Inc., Permo subsidiary.

Personnel Notes

... Brantz Mayor, former director of Olympic Radio and TV, was elected president of Unitronics Corp., New York City, which was recently approved as the new corporate name of Olympic Radio & TV, Inc. Brantz will coordinate and administer the policies of the three Unitronic affiliates—Olympic Radio & TV, David Bogen Co. and Presto Recording Corp. Morris Soben, president of the Olympic Division, was elected vice president of Unitronics. Lester Bogen will be president of both the Bogen and Presto Divisions and a vice president of the parent company. Lawrence Le Kashman, who joined Bogen recently as vice president in charge of sales, will also function in the same capacity for the Presto Division. George J. Saliha, formerly president of Presto, will be a vice president of Presto.

... Martin F. Bennett, director of RCA regional operations since October, 1954, was elected vice president—merchandising of the company.

... Donald H. Stover was appointed service coordinator of RETMA. He had been service manager of Sentinel Radio Corp.

... Robert M. Jackson joined CBS-Hytron, Danvers, Mass., as merchandising coordinator. He comes to the company from Insuline Corp. of America, where he had been advertising manager. The company also announced the appointment of Dr. Hang C. Lin as senior engineer in charge of the semiconductor applications lab. He has had wide experience in the transistor field.

... Hugo Sundberg, vice president of Oxford Electric Co., was elected chairman of the speaker section of the RETMA Parts Division.

... Fred Rich was appointed sales representative for the New York district sales office of Erie Resistor Corp., Erie, Pa. He had been in the Sales Service Department.

... Samuel J. McDonald, Northeastern district manager of distributor sales for Sylvania Electric Products, was named Eastern regional manager of distributor sales of the Electronic Products Sales Department with headquarters in New York. Jerome R. Steen was appointed quality manager—semiconductors for Sylvania Electronic Division with headquarters in Woburn, Mass. He was previously manager of quality control for the Radio & TV Division, Buffalo, N. Y.

... Maj. Gen. Raymond C. Maude, former commander of the Air Force Cambridge Research Center, joined Allan B. Du Mont Labs, Clifton, N. J., as assistant to Dr. Thomas T. Goldsmith, Jr., vice president—government and research.

END

The newest hobby under the sun!

**BUILD THIS
SOLAR POWERED
RADIO!**

and many other sun-powered electronic, electrical and photometric devices featuring International Rectifier Corporation SUN BATTERIES!

Everyone—from the beginner with a basic understanding of electrical work to the experienced professional engineer—can build this pocket size portable radio—powered by the sun! No batteries—not even an On-Off switch! All you need is sunshine! The basis for this radio is the International B2M Sun Battery. This unit is a scientific, accurate, precision-made photovoltaic instrument that directly converts light into electrical energy. This radio is just one of many devices you can build powered by solar energy. You have read about this new field of science. Be among the first in this newest hobby. Put the sun to work for you!

THIS NEW BOOK TELLS YOU ALL ABOUT SUN BATTERIES—PHOTOCELLS—AND HOW TO USE THEM. Packed with information and applications, this illustrated book shows wiring, diagrams and plans—every detail necessary to build many interesting devices. **\$150**

THIS IS THE FAMOUS B2M SUN BATTERY YOU'VE READ ABOUT. Widely used in experiments, this unit in bright sunlight (10,000 ft. candles) will deliver 2 milliamperes at 250 millivolts under optimum conditions, will last indefinitely with proper care. A \$2.50 value for only **\$1.50**



FREE Complete plans for building this radio. At your electronic parts distributor.

GET THE B2M SUN BATTERY AND ALL OTHER COMPONENTS REQUIRED AT LEADING ELECTRONIC PARTS DISTRIBUTORS EVERYWHERE. If your favorite distributor doesn't feature the B2M Sun Battery send check or money order to

International Rectifier Corporation
El Segundo, California

SPECIAL OFFER, The book and the B2M Sun Battery for only \$2.85 at your distributor

Exclusive at **TERMINAL**... UNHEARD OF SAVINGS!

ALL BRAND NEW FACTORY SEALED



SYLVANIA TEST EQUIPMENT

LIMITED QUANTITIES! ACT NOW!

Radio-TV Service Men — Industry — Laboratories.
This is your once-in-a-lifetime opportunity to acquire the world's finest test equipment at a fraction of its original cost.

GUARANTEED Brand new in original Sylvania factory sealed cartons, complete with detailed instruction sheets. Look at the amazing savings!

Never Before! Never Again! Such **SENSATIONAL LOW PRICES!**

Type 620 SYLVANIA
TUBE TESTER



New, portable tube tester tests all common receiving tubes, transmitting and industrial tubes, regardless of basing — also "600 ma" series string television tubes. In-line controls speed efficiency. Reads shorts and leakage directly in ohms — easy-to-read roll chart — gas test — easy switching for all tube bases. Best dollar buy. Regular Price: \$119.50.

NOW ONLY \$89.50

Type 303 SYLVANIA
VTVM POLYMER

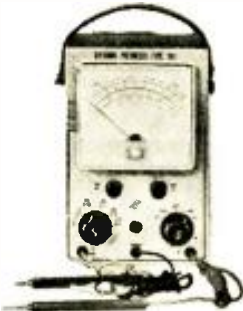

The ultimate in its price range — multi-purpose meter combining high accuracy with functional, smart styling to give "quick readings" under all conditions of ambient lighting. Measures AC and DC volts, and ohms over 6 ranges. Regular Price: \$51.50.

NOW ONLY \$34.50

Type 405 SYLVANIA
**5" SERVICE
OSCILLOSCOPE**



The smallest 5" scope on the market... and the biggest value. Identical horizontal and vertical amplifiers with frequency response within 3 db from 2-700KC, 300 Millivolt sensitivity and 2.2 meg. input impedance. Linear sweeps from 16 to 50 KC. Extremely stable sync. Regular Price: \$129.50.

NOW ONLY \$82.50

Type 506 SYLVANIA
COLOR-TV DOT GENERATOR

Extreme sync stability, useful for linearity adjustments, positive gating circuit, wide range of dot spacing, practical dot size. Hard tube sync circuit and special Sylvania output adapter. Extremely compact unit. Regular Price: \$129.50.

NOW ONLY \$69.50

Type 501 SYLVANIA MARKER GENERATOR
Provides 2 separate signals for marking an oscilloscope trace of response curves. Accurate trap adjustment, freq. spotting, band width measurement and adjustment of popular 4.5 mc. intercarrier sound circuits. VFO covers 15 to 240 mc. range. Regular Price: \$129.50.

NOW ONLY \$69.50

Type 600 SYLVANIA
LABORATORY TUBE TESTER

Mutual conductance and emission test. Conversion transconductance test. Leakage test directly in megohms, gas test, and voltage regulator-thyratron tube test. Factory correlated readings, illuminated meter, roller chart. Regular Price: \$469.50.

NOW ONLY \$369.50

Model 402 SYLVANIA SYNCHROSCOPE

Continuously variable sweep speed 0.2 us/in. to 800 us/in. Internal trigger generator with rep. rate of 500, 1000, 2000, 4000 p.p.s. Positive pulse trigger output rising to 200 volts peak in 0.3 u sec. at amplitude of 100 volts for 3 u sec. Adjustable output trigger delay from 75 before to 25 u sec. after sweep start. Fixed sweep trigger delay at 90 u sec. Regular Price: \$708.75.

NOW ONLY \$490.00

Model 402A SYLVANIA SYNCHROSCOPE

Identical with model 402 but with an r-f detector and wide-band amplifier. Regular Price: \$783.74.

NOW ONLY \$540.00

Model 402B Regular price \$896.25.

NOW ONLY \$602.00

Type 228
SYLVANIA C.R.T.
TESTING ADAPTER



Use with any Sylvania tube tester to check 85% of picture tube troubles without removing tube. Checks electromagnetically deflected types for emission, shorts, leakage, and open filaments. Regular Price: \$7.60. **NOW ONLY \$5.95**

Type 225 SYLVANIA
TV HIGH-VOLTAGE PROBE



In conjunction with Sylvania types 301 and 302 polymeters this probe permits measurement of DC voltages up to 30 KV. Regular Price: \$12.50.

NOW ONLY \$6.95

Type 301 SYLVANIA
VTVM POLYMER



Features an inherently stable circuit from use of 2 Type 7N7 tubes in Sylvania-patented circuit. 1 Ma. meter movement. 6 AC and DC ranges read up to 1,000 volts and up to 30,000 volts DC with Sylvania Type 225 Voltage Multiplier Probe. Resistance measurements to 10,000 meg. True peak-to-peak readings up to 2,800 volts. 17 meg. input impedance. Illuminated meter and screw-on connectors. Shielded AC lead provides AC measurements from 20 cps. to 20,000 cps. with 2.7 meg. impedance. Measures DC current up to 10 amps. Regular Price: \$109.50.

NOW ONLY \$69.50

Type 302 SYLVANIA
**VTVM
DeLUXE POLYMER**



6 AC and DC volt ranges 0-3, 10, 30, 100, 300, 1000. 6 peak-to-peak volt ranges. 5 RF volt ranges from 0 to 300. Ma in 6 ranges from 0 to 1000. 0-10 amp. DC. Ohms in 6 ranges to 1000 meg and db measurements in 6 ranges from -20 db to +61.4 db. Features new 7" Sylvania meter movement, patented linearity circuit, rf probe, high input impedance, shielded leads. Regular Price: \$129.50.

NOW ONLY \$82.50

Type 403 SYLVANIA
**7" TV SERVICE
OSCILLOSCOPE**



High quality 7" instrument with identical high-gain dc amplifiers on horizontal and vertical axes, plus advanced features of higher priced models of special value for TV service. Type 403 permits dc signal level measurements and phase relationship study. 2 preset TV sweeps. Vertical sensitivity 10 millivolts per inch rms. Freq. response flat to 500 kc within 2 db. Regular Price: \$219.50.

NOW ONLY \$159.50

All Items Subject to Prior Sale... **FIRST COME... FIRST SERVED! ORDER TODAY!**

Terminal Radio Corp.

85 CORTLANDT STREET, NEW YORK 7, N. Y. • Worth 4-3311

MAIL ORDERS FILLED

All Prices F.O.B. New York City.
Please send full remittance or 25% deposit, balance C.O.D.

JUST OUT!

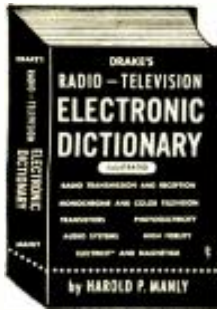

Drake's
**RADIO-TELEVISION
 ELECTRONIC
 DICTIONARY**

by Harold P. Manly

Practical detailed definitions of common technical words and phrases used daily in today's electronic

world . . . in radio-television manufacturing and servicing, broadcasting and telecasting, all other divisions of the vast communications industry.

- RADIO TRANSMISSION AND RECEPTION •
- MONOCHROME AND COLOR TELEVISION •
- TRANSISTORS • PHOTOELECTRICITY • AUDIO SYSTEMS • HIGH FIDELITY • ELECTRICITY AND MAGNETISM

An excellent up-to-the-minute and complete dictionary. Contains 3200 interesting definitions of the technical words and terms used in all branches of electronics. Includes all standard and basic material but emphasis is put on Television in color and black-and-white, on Hi-Fi systems, on Transistors and on the more recent aspects of sound radio. All words, terms and abbreviations are conveniently arranged in one continuous alphabetical order. The hundreds of illustrations which were made especially for this book help greatly to simplify the definitions.

300 PAGES • OVER 3200 DEFINITIONS • 549 ILLUSTRATIONS • 6 x 9 • CLOTH.....\$4.00

MAIL THIS COUPON TODAY!

Frederick J. Drake & Co., Dept. 10
 9 S. Clinton St., Chicago 6, Ill.

Please send at once Drake's RADIO-TELEVISION ELECTRONIC DICTIONARY, latest edition. Price \$4.00.

Full payment enclosed. Ship C.O.D.

NAME.....

ADDRESS.....

CITY..... STATE.....



NOW!
**ANY "99" PARTS
 YOU NEED—
 IMMEDIATELY!**



You can now replace or add any part to your XCELITE 99-PR nut driver, screwdriver and reamer roll kit immediately because your supplier has this No. 699 Replacement Kit! It has backup stock to supply the hundreds of thousands of "99" kits now in use. If you've lost a handle—want that new 1/2" XCELITE 99-39 reamer—need a new plastic roll pocket kit—your distributor can supply you in a hurry. Ask him!

XCELITE, INCORPORATED

Dept. J
 Orchard Park, N. Y.



Merchandising and Promotion

Electro-Voice Inc., Buchanan, Mich., developed a new point-of-sale display



which enables dealers to demonstrate the difference between single and multi-speaker high-fidelity reproduction systems.

Wen Products Inc., Chicago, designed a new all-purpose display board on



which its entire power tool line may be mounted, including the Quick Hot electronic soldering gun and the new 3/8-inch power drill.

Walsco Electronics Corp., Los Angeles, is offering service technicians a



WHAT THE ABC MEANS TO YOU

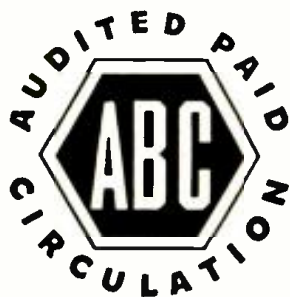

In every issue of RADIO-ELECTRONICS you see the ABC symbol beneath our masthead on the contents page. Possibly, you take it for granted, or maybe don't even notice it. But to you it is a symbol of integrity. It indicates our membership in the Audit Bureau of Circulations, a non-profit association which sets up net paid circulation standards, and audits and reports circulation facts. Thus, when we say our current circulation is over 184,000, you know that all these readers buy and pay for RADIO-ELECTRONICS each month either through subscriptions or at parts jobbers or newsstands. Readers and advertisers are assured that all statements are correct and accurate because they are checked and verified by the ABC.

RADIO-ELECTRONICS salutes the ABC on its 42nd Anniversary. We are proud to be members.

FAMOUS **KIT KING** DOLLAR BUYS \$1 EACH!

OCTOBER "KIT-OF-THE-MONTH"
 75 CERAMIC CONDENSERS! Never before! 3 KV. Disc types, too! Wt. 1/2 lb. Reg. \$12

SOLD ONLY BY LEKTRONI

FREE! ANY \$1 ITEM FREE WITH EACH \$10 ORDER PLUS
 Free Gift With Every Order!

- 10 ELECTROLYTICS. FP & twist, tubular, rect. Anstid. sizes. Multiples, too. 8 to 500 mf to 450V. Wt. 3 lbs. Reg. \$15.
- 60 XFMRs & COILS. IF, RF, ant., slug-tuned coils, chokes. 25 types. Wt. 3 lbs. Reg. \$15.
- 15 ERIE TRIMMERS. Ceramic type. Singles & duals. 8 values. Wt. 1/2 lb. Reg. \$12.
- 3 GERMANIUM DIODES. Hughes, subminiature, IN34, IN51. Reg. \$3.50.
- 60 TUBULAR CONDENSERS. Popular makes. 30 types. .0001 to 0.5 mf to 1500 V. Wt. 2 lbs. Reg. \$12.
- 20 STANDARD KNOBS. Radio, TV appliance, lab types. Anstid. colors, bakelite & plastic. Wt. 2 lbs. Reg. \$9.
- 20 AC/DC LINE CORDS for clocks, motors, etc. 2 cond. w/molded plugs. Wt. 1 lb. Reg. \$5.
- 70 MICA CONDENSERS. Famous makes. 30 values. .0001 to .01 mf to 1000 V. Silver. 5%. tool Wt. 1 lb. Reg. \$5.
- 8-PC. NUTDRIVER KIT. Plastic handle. 3/16, 7/32, 1/4, 11/32, 3/8, 7/16" steel socket wrenches; plastic case. Wt. 1 lb. \$3.50 value!
- 20 HI-QUALITY KNOBS. Hi-Fi, recorder, instrument types. Knurled, skid-ent. engraved. Brass insert w set screws. Wt. 1/2 lb. Reg. \$7.
- 70 TERMINAL STRIPS & boards. 15 types: 1 to 20 screw & solder pts. Wt. 1 lb. Reg. \$5.
- 40 POPULAR BULBS. 1 to 6V, 5V, 6V, 7V, 8V, 10V, 15V, 25V, 35V, 40V, 50V, 60V, 75V, 100V, 150V, 250V, 500V, 1000V. Miniature, bayonet types. Miniature. Wt. 1/2 lb. Reg. \$3.
- 175-FT. HOOKUP WIRE. In 25-ft. rolls; anstid. colors. Insulation, stranding, #18 to 24. Wt. 2 lbs. Reg. \$3.75.
- 30 PRECISION RESISTORS. WW & carbon film. 30 values: 50 ohms to 1 meg. 1/2, 1 & 2 w. 1%. tol. Some \$5. Wt. 1/2 lb. Reg. \$21.
- 4 SILICON DIODES. Standard brand 1N21, 1N22, 1N21, 1N105. Reg. \$8.50.
- 25 TUBE SOCKETS. 4, 5, 6, 7, 8, 9, 11-prong. Miniature, octal, wafers, "zip-ins," molded. Tube shields, too. Wt. 2 lbs. Reg. \$7.
- G-E PRE-AMP KIT for magnetic cartridges. Complete w/chassis, parts, diagram. Less 6SG7 (RRC extra). Wt. 1 lb. Reg. \$4.50.
- 40 MOLDED CONDENSERS. .0001 to 0.1 mf up to 1000V. Brown/black ceramic cased. Wt. 1 lb. Reg. \$8.
- THREE LBS. HARDWARE. 2,000 pcs. Assort. screws, 10 springs, washers, brackets, etc. Hundreds of items! Reg. \$8.
- 15 VOLUME CONTROLS. 10 TYPES, values to 0.5 meg. Wt. 1 lb. Reg. \$9.
- 40 MINIATURE RESISTORS. Subminiature. tool 1/2 to 1/4 W. Transistor hobbists, note! 58 ohms to 4.7 meg. Reg. \$7.
- 150 RESISTORS! Insulated & uninsulated. 30 values: 52 ohms to 1 meg., 1/2 to 2 w. 5%. tool Wt. 1 lb. Reg. \$10.
- 10 AC/DC PANEL SWITCHES. 115V. slide handle. SPDT. Lug terminals. Wt. 1/2 lb. Reg. \$3.
- 150 COIL FORMS. Anstid. hermetically sealed types, miniature, bakelite & compressed forms. 20 styles. Wt. 2 lbs. Reg. \$9.
- 12 ROTARY SWITCHES. Wide assortment bakelite & ceramic units. Multiple gangs, too. Wt. 3 lbs. Reg. \$14.
- 70 RESISTORS. Insulated IRC. Allen-Bradley, etc. 5 ohms to 10 meg. 1/2, 1 & 2 w. 1% & 5%. Wt. 1/2 lb. Reg. \$11.
- CRYSTAL RADIO KIT. All parts mounted. Complete w pre-drilled cabinet, germanium diode, loopstick tuner, instructions. Wt. 1/2 lb. Reg. \$5.
- 10 "POLY" BOXES. Assort. sizes, clear plastic boxes, lugged w snap lock. Hundreds of uses! Reg. \$2.50.

ALL ABOVE ITEMS ONLY ONE DOLLAR EACH!

LEKTRON EXCLUSIVE!
3 IN 1 TRANSISTOR RADIO KIT



SUN-POWERED • CELL-POWERED • DUAL-POWERED
 Pocket radio kit. High selectivity, sensitive, w/ample volume, Sun Battery for daylight operation (operates from 100W lamp, too!), Mercury Cell for night operation—outlasts regular batteries 3 times! ALL PARTS MOUNTED—ONLY MINUTES TO ASSEMBLE! No soldering needed. Pre-drilled styrene cabinet, hi-gain transistor, loopstick, miniature variable cond., phone jacks, switch, hardware; step-by-step instructions. Ship \$7.88 wt. 1 lb.

SPECIAL! 4x6" SPEAKER WITH BAFFLE
 Hvy. duty magnet; 3-4 ohm voice coil. \$1.79 Reg. \$5. Only

HOW TO ORDER
 Check items wanted. Return entire ad with check or M.O. include sufficient postage; excess returned. C.O.D. orders. 25% down. Rated, net 30 days. Print name, address and amount money enclosed in margin. RE-10

Lektron Specialties
 28 GARDENER ST. CHELSEA 50, MASS.
 Visit our salesroom at 131 Everett Ave., Chelsea.

BUSINESS (Continued)

new wall chart which lists its entire line of phono-recorder replacements. JFD Manufacturing Co., Brooklyn, N. Y., is now shipping its Zip-Kit Tenna-Pak in new cartons which double as a merchandising display.

Sales Statistics
 RETMA reported the retail sale of 2,868,250 TV sets and 3,391,102 radios (exclusive of automobile sets) for the first six months of 1956, compared to 3,202,995 TV sets and 2,429,018 radios for the same period last year. The association also reported the manufacturers' sale of 5,152,743 picture tubes and 227,656,000 receiving tubes for the first six months of 1956 compared with 4,914,024 picture tubes and 226,502,000 receiving tubes for the same period in 1955.

4,758,603 transistors were sold by manufacturers during the first six months of 1956, according to a report by RETMA. This compares with 1,260,827 for the similar period last year.

New RETMA statistical service on phonograph sales by manufacturers revealed 975,747 units sold during the first five months of 1956. This is a preliminary figure subject to revision.

New Plants and Expansions
 CBS-Hytron, Danvers, Mass., opened a new 57,000-square-foot warehouse in Melrose Park, Ill., to improve service to Midwestern distributors of its receiving tubes, TV picture tubes and semi-conductors.

Erie Resistor Corp., Erie, Pa., is building a new technical ceramics plant in State College, Pa.
 Triad Transformer Corp., Venice, Calif., recently opened its third plant.



Shown are Triad executives (from left to right) Allan E. Whalgren, secretary-treasurer; O. D. Perry, executive vice president; Ralph Seiler, industrial sales manager; L. W. Howard, president, and T. P. Walker, vice president, looking on as Jean Morehead, "Miss Triad," cuts the ribbon opening the new plant.

Sylvania Electric Products opened a new 87,000-square-foot warehouse and sales office in Los Angeles. The company also moved the district sales group of the Parts Division from Union City to Teterboro, N. J.

New heavyweight champion!



SX-101, \$395.00 amateur net

Hallicrafters new SX-101 receiver employs heaviest chassis in industry...incorporates V.F.O. feature*... has 2000° disc logging counter.

It's all amateur—and as rugged as they come! Hallicrafters presents the complete answer to ham reception, with every essential needed for today and for the future.
 First—built like a battleship. Bigger. Heavier. Second—a marvel of stability—the result of 22 years of experience and development. Third—it brings you a long list of new features:

- Complete coverage of 7 bands—160, 80, 40, 20, 15, 11-10 meters.
- Special 10 mc. pos. for WWV, plus coverage of major MARS frequencies.
- Exclusive Hallicrafters upper/lower side band selection.
- S-meter functions with A.V.C. off.
- Tee-notch filter.
- Local oscillator output available for use in heterodyne V.F.O.

PLUS: Band in use individually illuminated...built-in crystal calibrator...antenna trimmer...dual conversion...full gear drive from tuning knob to gang condensers...five steps of selectivity from 500-5000 cycles...sensitivity—less than 1 microvolt on all bands...direct coupled series noise limiter... 50 to 1 tuning knob ratio...and many more.
 For full specifications see it at your Radio Parts Supplier today!

NEW FROM hallicrafters

CHICAGO 24, ILLINOIS

WHERE THE BEST IDEAS IN COMMUNICATIONS ARE BORN

EXPORT SALES: Philips Export Co. 100 East 42nd Street, New York 17, New York
 RADIO-ELECTRONICS

Littelfuse, Inc., Des Plaines, Ill., is expanding its present factory and main office in that city. Thomas M. Blake (left), Littelfuse president, and Jack D. Hughes, executive vice president, are shown looking at plans.



Tung-Sol Electric Inc. acquired a new 35,000-square-foot warehouse in Irvington, N. J.

Weston Electrical Instrument Corp. opened a new branch sales office and warehouse in Los Angeles.

Federal Telecommunication Laboratories, Nutley, N. J., plans expansion including the erection of a new building in the San Fernando Valley, Calif., and a new laboratory and office building in Nutley, N. J.

Mergers and Acquisitions

Amphenol Electronics Corp., Chicago, purchased the assets of Exact Metal Specialties Co., Chicago screw machine firm.

Utrad Corp., Huntington, Ind., was established as a new manufacturing firm to continue the operation of the Transformer Division of Utah Radio Products. Personnel is essentially the same as the former Utah Transformer operation, and Utrad has purchased all the machinery, equipment, engineering data, etc. from Utah.

Federal Telephone & Radio Co., Clifton, N. J., acquired certain assets of a subsidiary of Electronics Specialty Co., Los Angeles, including a line of high-quality precision electronic instruments. The operation will be merged with Federal's Instrument Division in Clifton, N. J.

Business Briefs

... Cornell-Dubilier, South Plainfield, N. J., recently awarded Allied Radio Corp., Chicago, a plaque for handling



its line for 35 years. Octave Blake (right), president of Cornell-Dubilier, made presentation to A. D. Davis, president of Allied. **END**

more
Cannon lines
now available
at jobbers'
shelves!

Write for ICC
and RIC catalogs TODAY!



Twenty pages of information on 14 different lines of Cannon connectors, including list prices on more than 850 individual items. 130 illustrations. Audio, military, general industrial. Get your copies... NOW!



AN3108B Plug AN3102A receptacle
"AN" (Air Force-Navy) Series Connectors

Proved in military service. World-wide standard. Lightweight. Uniform in quality. Interchangeable inserts. Threaded coupling nut. Rapid and easy disconnect. Cable clamps and other accessories.



K-21C Plug K-32S receptacle
Cannon "K" Series

All-purpose... Adapted to a variety of general electrical and electronic applications. Special Acme thread. Rugged. 220 contact layouts available.

When you write for our catalogs... Please refer to this magazine or Dept. 144

CANNON PLUGS



CANNON ELECTRIC COMPANY
3209 Humboldt St., Los Angeles 31, California
Factories in Los Angeles, East Haven, Toronto, Canada; London, England. Representatives and distributors in all principal cities.

HICKOK
Model 605A



DYNAMIC MUTUAL CONDUCTANCE
Tube Tester
Handy Size Portable

- Popular—Accurate—Dependable.
- Large 5" easy-to-read meter.
- Accurately tests tubes in micromhos.
- Built-in 20,000 ohms per volt DC multimeter measures capacitance, inductance, volts, current and decibels.
- Write for technical details...

THE HICKOK ELECTRICAL INSTRUMENT CO.
10531 Dupont Ave., Cleveland, O.

AUDEL'S TV TELLS HOW TO ANSWER RADIO T.V. QUESTIONS
RADIO SERVICE LIBRARY

HERE IS LATE INFORMATION IN A HANDY FORM FOR TELEVISION AND RADIO REPAIRMEN, SERVICEMEN AND STUDENTS

AUDEL'S T.V. RADIO SERVICE LIBRARY
Highly Endorsed—Over 1500 Pages—1048 Illustrations & Diagrams. 1001 Important Facts & Figures on Modern Television, Radio, Electronic Devices at your finger ends.

INCLUDES TRANSISTORS & Transistor Circuits, Record Changers, Rectifiers, P. A. Systems, Tape Recorders, Phonograph Pick-ups, F.M., Auto Radio; Radio Compass, Short Wave, Radar, etc.

ASK TO SEE IT! IT WILL PAY TO KNOW—
The Basic Principles—Construction—Installation—Operation—Repairs—Trouble Shooting. Shows How to get Sharp, Clear T.V. Pictures. Install Aerials—How to Test. Explains Color Systems, Methods of Conversion, Terms, etc. Includes Ultra High Frequency—Valuable for Quick Ready Reference and Home Study.

\$6 COMPLETE 2 VOLUMES Get this information for Yourself.
7 DAY TEST—PAY ONLY \$1 A Month

MAIL ORDER

AUDEL, Publishers, 49 W. 23 St., N.Y. 10, N.Y.
Mail AUDEL'S T.V. RADIO SERVICE LIBRARY (2 Volumes) \$6 on 7 days free trial. If D. W. I will remit \$1 in 7 days and \$1 monthly until \$6 is paid. Otherwise I will return them.

Name _____
Address _____
Occupation _____
Employed by _____ **RE**

HOW TO SELECT THE tube caddy*

BEST FOR YOU



the ORIGINAL

\$14.50

Dir. Net

TC-1C. Neat appearing, best for tubes. Space inside cover for mirror. Max. cap. 262 tubes. New longer, thinner size 21x15x8 in.

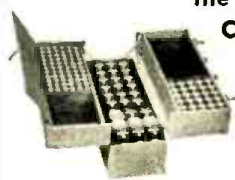

the CARRY-ALL

\$14.50

Dir. Net

TC-4. Break-away design gives quick access. Takes tubes or tools easily. Max. cap. 262 tubes. Size 21x15x8 in.



the ADD-A-CADDY

\$5.40

Dir. Net

AC-1. Snaps firmly on bottom of either TC-1C or TC-4. Gives 46% more space, ideal for tools. All hardware included. Size 21x8x6 1/4 in.



the JUNIOR

\$9.50

Dir. Net

TC-2A. Same popular features as TC-4 only 3/8 as big. Ideal for quick trips. 15 1/2 x 12 1/2 x 8 in.

ASK YOUR PARTS DISTRIBUTOR

*Tube Caddy is the Reg. TM of Argos Products Co., originators and Largest Manufacturer of Tube Carrying Cases for the Electronic Technician

Argos

PRODUCTS COMPANY
GENOA, ILLINOIS

Craftsmanship in Cabinets

technical Literature



MAGNETIC TAPES

Physical and magnetic properties of 12 Scotch brand magnetic tapes and films are covered in a new 12-page technical data booklet. It covers such physical properties as backing thickness, ultimate tensile strength, yield strength, elongation at break, residual elongation, tear and impact strength and coefficient of expansion. Magnetic properties include coercivity, retentivity, coating thickness, erasure characteristics, bias current requirements, relative low-frequency output and relative high- and low-frequency sensitivity.

Minnesota Mining & Manufacturing Co., Dept. A6-114, St. Paul, Minn.

MAGNETIC TAPE RECORDERS

Twenty-one models of the Magneloop series of variable- and fixed-speed continuous-loop magnetic tape recorders-reproducers are described in a 4-page folder. Recording characteristics are tabulated. Nine variable-speed Magneloops, single-, dual- and triple-channel recorders, reproducers or recorder-reproducers are described. Specialized uses applications are suggested. Complete technical specifications and recommended accessories, as well as direct factory prices, are furnished on all units.

Amplifier Corp. of America, 398 Broadway, New York 13, N. Y.

TUBE DATA

Bulletin PA-5 offers reference data for CBS transmitting and special-purpose tubes. Conveniently indexed, the catalog includes data for small transmitting pentodes, triodes and rectifiers, gaseous voltage regulators and reference tubes and special receiving and military tubes.

Bulletin PA-2, third edition of CBS Reference Guide for Television Picture Tubes, is an up-to-date revision. It provides pertinent data for 258 magnetically deflected picture tubes, regardless of make. As an additional aid to the TV service technician, bold-face print indicates the differences among similar tube types.

Advertising Service Dept., CBS-Hytron, Salem, Mass.

ELECTRONICS HANDBOOK

Allied's new 64-page Electronics Data Handbook consists of a carefully selected collection of the most-often needed formulas and data in radio and industrial electronics. Formulas include those for basic circuit analysis, transmission-line calculations, meter calculations,

PROFIT BY THE 3 R's

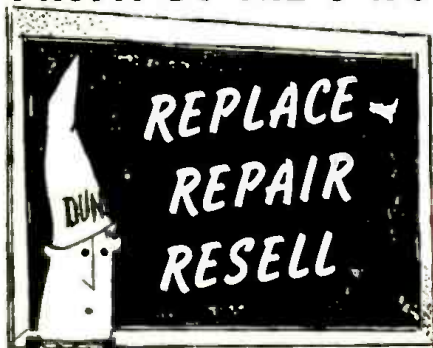

with

Ronette

new

replacement cartridges

Profit by the multi-million dollar phonograph replacement business.

Use a Ronette cartridge for all phonographs—regardless of make or model.

Ronette high compliance, low intermodulation distortion and full frequency response is your assurance of a gratified customer. And the new universal mounting bracket makes installation quick and easy.

Available in high or low output, turn-over or single stylus models.



Diamond styli available for all cartridges.

See your parts distributor or write for bulletin entitled, "Phono Servicing is a Big Business" and the name and address of the Ronette distributor nearest you.



TECHNICAL LITERATURE (Continued)

etc. Included are up-to-date RETMA and military specifications for resistors and capacitors, coil-winding and wire-gauge data, metric relationships, tables for directly interchangeable radio and TV picture tubes, interchangeable batteries, decimal equivalents, trigonometric functions, etc., and a 3-page explanation of the use of logarithms. Additional data cover attenuator networks, minimum loss pads, mixers, decibels vs. voltage, current and power ratios, and complete details on using the RETMA 80.7-volt system of speaker hookup.

Allied Radio Corp., 100 No. Western Ave., Chicago 80, Ill., 35c.

RECEIVER KIT

Lafayette has put out a large folder on the four-transistor superheterodyne receiver Kit KT-94. It contains a large schematic and pictorial diagram, plus complete wiring instructions illustrated with five line drawings. The leaflet also describes the two-transistor audio output speaker Kit KT-96, intended to make the KT-94 a loudspeaker set.

Lafayette Radio, 165-08 Liberty Ave., Jamaica 33, N. Y.

ANTENNAS

Catalog 21 describes antennas, antenna systems and coaxial transmission lines in 100 pages, well illustrated with photos, drawings and charts as well as graphs.

Andrew Corp., 363 E. 75 St., Chicago 19, Ill. END

DeRO TV AIDS PROFITS

MORE FOR YOUR MONEY

Personna-Tone EXTENSION SPEAKER

High-quality sound for chair-side TV listening. 4x6 speaker. Selector switch and volume controls for TV set. Personna-Tone or both speakers. Wood veneer cabinet. net. Complete with cable... **\$9.95** List



Dual-Tone VOLUME CONTROL

For auto radio sound extension. Two volume controls — one for each speaker. Volume of either speaker adjusts to any level independently. Ample cable for all cars **\$3.95** List

All Purpose DeRO-JUVENATOR
One rejuvenator replaces all! Model RU-5—universal 6-wire for use on all series or parallel filament TV sets, both electrostatic and electromagnet. Restores brilliance and contrast to pix tube **\$3.95** List



Look for This!

Dynamic COUNTER DISPLAY

DeRO quality parts are packaged for easy identification. Look for the DeRO trademark on all television accessories.



Where Quality Counts—Buy DeRO!

AT ALL LEADING DISTRIBUTORS!

DEALER-DEALERS! WRITE FOR DETAILS

DeRO ELECTRONICS

134 NASSAU ROAD
ROOSEVELT • LONG ISLAND • N. Y.

Brand new low-cost guide to practical **TRANSISTOR TECHNIQUES**



Transistor Techniques—Gernsback Library Book No. 61. 96 pages \$1.50

Now at last, the transistor book you've been waiting for. A complete, low-cost handbook on how to use transistors. Compiled especially for the practical service technician and experimenter! Keeps theory and math to an absolute minimum but gives you hundreds of practical hints on how to put transistors to work for you to achieve success in constructing modern, miniaturized electronic equipment. Covers testing, performance, measurements and also has individual chapters on constructing oscillators, triggers, transistor transformers, auto light control, and a transistorized geiger counter. An ideal guide for the modern experimenter, student, and electronics technician.

Another book to increase your transistor knowledge!



TRANSISTORS — Theory and Practice. Gernsback Library Book No. 51. 114 pages. \$2.00.
Ritus P. Turner's practical book remains the standard popular treatise on transistors for technicians and experimenters and engineers. For a really thorough grasp of how and why transistors work get this companion book.

THE COMPLETE GERNSBACK LIBRARY—PAPER-COVERED EDITIONS

Basic Audio Course. No. 66. \$2.75	Propos. No. 54. \$2.50	Radio & TV Hints. No. 47. \$1.00
Hard cover ed. \$5.00	Hard cover ed. \$4.60	Television Technote.
Servicing Record Changers No. 59 \$2.90	Radio-Control Handbook. No. 53 \$2.25	No. 46 \$1.50
Hard cover ed. \$4.60	The Oscilloscope. No. 52 \$2.25	Radio Tube Fundamentals. No. 45 \$1.00
Maintaining Hi-Fi Equipment. No. 58 \$2.90	Hard cover ed. \$4.60	Basic Radio Course No. 44 hard cover \$2.25
Hard cover ed. \$5.00	Transistors—Theory and Practice. No. 51 \$2.00	Model Control By Radio. No. 43 \$1.00
The V.T.V.M. No. 57 \$2.50	TV Repair Techniques. No. 50 \$1.50	High-Fidelity Techniques. No. 42 \$1.00
Hard cover ed. \$4.60	Radio & TV Test Instruments. No. 49 \$1.50	Practical Disc Recording. No. 39 \$0.75
High-Fidelity Circuit Design. No. 56. Deluxe hard cover ed. only \$5.95	High-Fidelity—Design Construction. Measurements. No. 48 \$1.50	
Sweep and Marker Generators. No. 55 \$2.50		
Hard cover ed. \$4.60		

GERNSBACK LIBRARY, INC.

154 West 14th Street, New York 11, N. Y.

- | | | | |
|-----------------------------|-----------------------------|-----------------------------|-----------------------------|
| <input type="checkbox"/> 39 | <input type="checkbox"/> 42 | <input type="checkbox"/> 43 | <input type="checkbox"/> 44 |
| <input type="checkbox"/> 45 | <input type="checkbox"/> 46 | <input type="checkbox"/> 47 | <input type="checkbox"/> 48 |
| <input type="checkbox"/> 49 | <input type="checkbox"/> 50 | <input type="checkbox"/> 51 | <input type="checkbox"/> 52 |
| <input type="checkbox"/> 53 | <input type="checkbox"/> 54 | <input type="checkbox"/> 55 | <input type="checkbox"/> 56 |
| <input type="checkbox"/> 57 | <input type="checkbox"/> 58 | <input type="checkbox"/> 59 | <input type="checkbox"/> 61 |
| <input type="checkbox"/> 64 | | | |
- Hard cover editions By mail only
- | | | |
|------------------------------|------------------------------|------------------------------|
| <input type="checkbox"/> 52H | <input type="checkbox"/> 54H | <input type="checkbox"/> 55H |
| <input type="checkbox"/> 57H | <input type="checkbox"/> 58H | <input type="checkbox"/> 59H |
| <input type="checkbox"/> 64H | | |

Enclosed is my remittance of \$
Please send me the books checked postpaid.
Prices 10% higher in Canada.

Name please print
Street
City State

New! POCKET SIZE
Rejuva-Check
TESTS • REPAIRS
REJUVENATES
ALL PICTURE TUBES
right on the job!



REJUVA-CHECK does everything the big instruments do and then some! TESTS cathode emission. Indicates leakage between elements. Estimates remaining useful life of CRT. REPAIRS by removing cathode surface contamination. Clears inter-element shorts and leakage. REJUVENATES and gives new life to weak, dim tubes by restoring emission. Simple and easy-to-use!

SEND NO MONEY FREE 10-DAY SERVICE TEST

TRY BEFORE YOU BUY

Mail Coupon Now! No Obligation!

CENTURY ELECTRONICS CO., Inc.
111 Roosevelt Ave., Dept. RE-10
Mineola, N. Y.
OK, rush REJUVA-CHECK for FREE 10 day use on my toughest service calls. After 10 days, I will send \$7.95 plus postal charges or return it without obligation.

Name _____
Address _____
City _____ State _____
 SAVE POSTAL CHARGES! Enclose \$7.95 with coupon and we pay all postal charges. Same NO-RISK refund privilege.

Si vous lisez le français technique, vous devez lire **ELECTRONIQUE INDUSTRIELLE**

la grande revue française de technique moderne
Specimen gratuit sur demande

EDITIONS RADIO
9, rue Jacob — Paris 6^e — France

Futuramic

famous for

VOLTMETER PROBES

which save you



and



continues
development
of service

TIME SAVERS

have
you
seen
the



it will

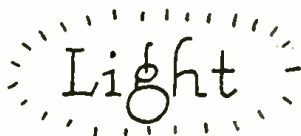

en

your work

ASK TO SEE ONE

Futuramic

2500 W. 23rd St.

Chicago 8, Ill.

Cliffside 4-7345



FIELD TECHNICIANS

*Broaden the scope
of your career with Bendix Radio!*

Get
these BIG
ADVANTAGES!

- Professional status
- The prestige of representing the leader in its field.
- Top salaries
- Liberal field allowances

If you have 5 or more years of electronics experience, you benefit many ways as a Bendix Radio Field Engineer. You will receive full pay while you go to our company-sponsored school in Baltimore. Then, you will be given a key assignment in the United States or overseas with responsibility of maintaining search and surveillance radar equipment made by Bendix Radio.

Write,
call or wire
EMPLOYMENT
SUPERVISOR Dept. V

Bendix Radio

DIVISION OF BENDIX AVIATION CORP
Towson 4, Maryland
(Phone VAlley 3-2200)



**MAKE SURE . . . you get EVERY ISSUE of
RADIO-ELECTRONICS**
subscribe now and save!

One year \$3.50 Two years \$6.00 Three years \$8.00
Canada same as U.S. Extra postage per year:
Pan-America, 50c; all other foreign, \$1.00



NOW
... 2 lines of
ALL HOLLOW SHAFT
nut drivers by **VACO**

All VACO Nut Drivers
NOW Hollow Entire Shaft
Length. A Size For
Every Need!

From 5/32"



Thru 1/2"

Now you can get *hollow shaft* nut drivers at economy prices with VACO'S standard line . . . or color-keyed, insulated hollow shafts with VACO'S deluxe line. Both have *extra hard long wearing sockets* and both are unconditionally guaranteed.

Displayed on the VACO Vari-Board at your jobber
VACO PRODUCTS CO., 317 East Ontario St., Chicago 11, Ill.
In Canada: Atlas Radio Corp., Toronto 10

STAN-BURN

CRITICAL PRICE

CATHODE RAY TUBE SPECIALS ONE YEAR GUARANTEE

G.E.	Type	STAN. BURN	G.E.	Type	STAN. BURN
\$13.25	10BP4	\$10.20	\$31.25	17GP4	\$20.75
18.00	10FP4	14.00	32.25	19AP4A	22.50
16.25	12LP4A	13.95	27.40	20CP4	18.95
28.95	12QP4	10.50	33.00	21AP4	22.25
18.15	14CP4	13.40	27.40	21EP4	20.15
	15DP4	14.50	33.25	21MP4	23.50
31.25	16AP4A	18.50	90.75	24AP4	49.00
26.25	16KP4	15.75	DUMONT TUBES		
31.25	16GP4	18.50	12QP4A		\$23.75
29.00	16LP4	15.25	15DP4		26.55
29.00	16WP4	15.25	16DP4A		31.00
22.50	17BP4	15.75	18FP4		26.00
28.15	17CP4	19.50	17KP4		25.00
			19AP4A/B		33.25
			21KP4		38.50

STAN-BURN CRT TUBES RALICENSED-MFD BY LINCOLN
PRICES SUBJECT TO CHANGE WITHOUT NOTICE

\$20 WORTH OF ELECTRONIC PARTS IN GRAB-BAG
consisting of: Porcelain sockets, coils, speaker, transform-
ers, resistors, condensers, etc.

ONLY \$1.98 (plus 50c postage)

TAPE RECORDERS—Famous Brand
SPECIAL SPECIAL
List Pr. \$249.95 \$169.00 List Pr. \$129.95 \$79.95
List Pr. \$109.95 \$29.00 List Pr. \$79.95 \$9.95
Write for complete illustrated details.

ANTENNA ACCESSORIES
P-800 JFD DOUBLE "V" ant. box of 10...ea. \$1.39
FLASH-DOUBLE "V" lightning arrest.,
box of 12 \$1.00
55 MIL 300 OHM WIRE—1000 Feetea. 2.09
80 MIL 300 OHM WIRE—1000 Feet 12.49
100 MIL 300 OHM WIRE—1000 Feet 13.99

KITS: We stock the following manufacturers
complete line of kits—see reference pages.
EICO see pages 30-32 ARKAY see page 135
QUALITY see page 59 PRECISE see page 131
All domestic orders will be shipped prepaid for a
limited time. Send us your list. Order by Manufacturer
and Model Number of item.

TRANS-ATOMIC Transistor Radio—KIT \$6.95; WIRED \$7.95
SENSIPHONE EARPHONES Single \$1.50; Double \$2.50
GERMANIUM DIODE Loopsuck Radio Kit \$3.25

AM-FM-SW AUTO RADIO

Drift Free FM—World's Finest—Becker LeMans For
PUSH BUTTON—\$179.95. For SIGNAL SEEKER—
\$239.95 Includes: GE SPEAKER with GRILLE and
AUTOMATIC ELECTRIC ANTENNA. Simple installation
(for all cars. Specify 6 or 12 Volt system).

VM 4 SPEED HI-FI CHANGER—Model 1210 with
Ronette, Sonotone or Astatic flip-over cartridge. \$22.95

RC456 4-Speed Collaro Brand—n.w. Special \$29.95
45-RPM SPINDLE \$2.99

WEBSTER Model 140—3-SPEED Automatic with
Ronette or Astatic flip-over cartridge \$22.49

MONARCH 3 SPEED AUTO. INTERMIX
CHANGER with crystal cartridge \$21.95
Same with British variable reluctance 24.95

45 RPM SPINDLE 1.88
TV-8 MONARCH 3 Speed MOTOR \$ 4.95
TURNABLE UNIT (less arm)..... \$ 4.95

3 SPEED PORTABLE RECORD PLAYER with MONARCH
CHANGER—Ronette cartridge—Portable Two Tone Car-
rying Case \$32.95

PEERLESS PORTABLE BATTERY OPERATED RADIO—
Colors—Green, White, Red or Blue—5 TUBE
IMPORT KIT for above \$14.95 less batteries
BATTERY KIT for above \$ 2.00

JEWEL—Model S200—5 TUBE \$12.50
AC DC RADIO.

RECORDING TAPE—Top quality 1200 Feet Famous
Irradiated BOXEGO in 5—\$1.69 ea. 6 to 11 \$1.59 ea.
12 or more \$1.49 ea.

HALLICRAFTERS TV

17" Portable TV Dealers net \$103.95
Model 1775700M—Table Model—Dealers net. \$91.95
Model 215460M—Table Model—Dealers net. \$129.46

SETCHEL-CARLSON 17" PORTABLE TV..... \$119.95

HI-FI PACKAGE DEAL

Includes: JENSEN K210 SPEAKER, MONARCH AUTO-
MATIC CHANGER with GE IFS-95B 12" SPEAKER
ENCLOSURE in BLOND or MAHOOGANY WOOD (Specify
color) MATCHING BASE FOR CHANG-
ER. 10 WATT HF TO BOGEN AMPLI-
FIER. Complete ready to play. A
\$135.00 Value for Only **\$99.50** net
or your choice of similar units at relative package
price. Write for prices.

DEALERS: Write for low cost Prices and catalogs
on '56 models—HALLICRAFTERS, SUPERIOR, NA-
TIONAL, PRECISION, HICKOCK, TECHMASTER,
G.E., WESTINGHOUSE, TUNG-SOL, MAJESTIC,
GRUNDIG ARKAY KITS, DELCO, GEN. MOTORS.
Address all inquiries to Dept. RE-10.

**COMPLETE HIGH FIDELITY DEPARTMENT. SEND US
YOUR LIST FOR LOWEST QUOTATIONS ON ANY ITEM**
We invite export inquiries and offers. Our export de-
partment will give special attention to expediting
foreign orders at minimum commissions. We are
authorized distributors for United Motors, all Delco
and Gen. Motors Auto Radio parts in stock.
We also carry a complete line of popular makes of
Radio Tubes at 50/10 discount. Also many other
special purpose and transmitter tubes and all elec-
tronic parts and equipment at lowest prices. Send us
a list of your requirements for prompt quotations.
Terms 20% with order, Balance C.O.D. All prices
F.O.B. NEW YORK Warehouse, Minimum order \$5.00.
Write for our latest price list and Hi-Fi Catalog RE-10.

STAN-BURN RADIO and ELECTRONICS CO.
558 CONEY ISLAND AVE. • B'KLYN 18, N. Y.

Books



**COLOR TELEVISION (SIMPLIFIED
THEORY AND SERVICE TECH-
NIQUES).** Electronic Education Unit,
Philco Corp., Philadelphia, Pa. 8½ x 11
inches, paper bound 154 pages, \$3.50
(prepublication, afterward \$5).

Edited by Donald G. Fink, this book
covers color television theory, trans-
mission, reception, installation and serv-
icing. The initial chapters are a review
of black-and-white television and a
thorough discussion of the fundamen-
tals of color. The characteristics of
color are illustrated with colored draw-
ings. A section is devoted to transmis-
sion and reception methods and stand-
ards, again using color illustrations, in-
cluding waveform diagrams of the
color video signal as well as relation-
ships of R-Y and B-Y signals. The
fourth section discusses color television
circuits thoroughly and the fifth the
construction and function of the color
TV picture tube. Tube and receiver ad-
justments are discussed in the sixth
section, with numerous illustrations in
color regarding proper purity, conver-
gence and other setup procedures. One
chapter is devoted to receiver align-
ment and another to servicing proce-
dures with color bar patterns illustrat-
ing various defects. The final chapter
covers the installation of a color re-
ceiver, including antenna and transmis-
sion-line factors.

No complete receiver schematic is in-
cluded, though a block diagram of a
typical Philco color television receiver
is shown and a number of schematics
covering various sections of receivers
are included. Of the 288 illustrations
used, over 100 are in color.

The book is well organized and the
explanation clear and to the point.
Numerous waveform drawings scatter-
ed throughout the book illustrate the
text, and scope pattern photos in the
servicing section will also be found use-
ful.—MM

**SERVICING COLOR TELEVISION
RECEIVERS** (The 21CT660U series),
prepared by Commercial Service, RCA
Service Co., Inc., Camden 8, N. J. 8½
x 11 inches, 91 pages (paper bound),
\$1.

One of a series being published by
RCA on the technical features of their
color television receivers, this latest is-
sue discusses the installation and serv-
icing of the RCA 21CT660U color tele-
vision receivers. The booklet is not a
general textbook on servicing but is in-
tended solely as a guide for servicing
that series of color receivers.

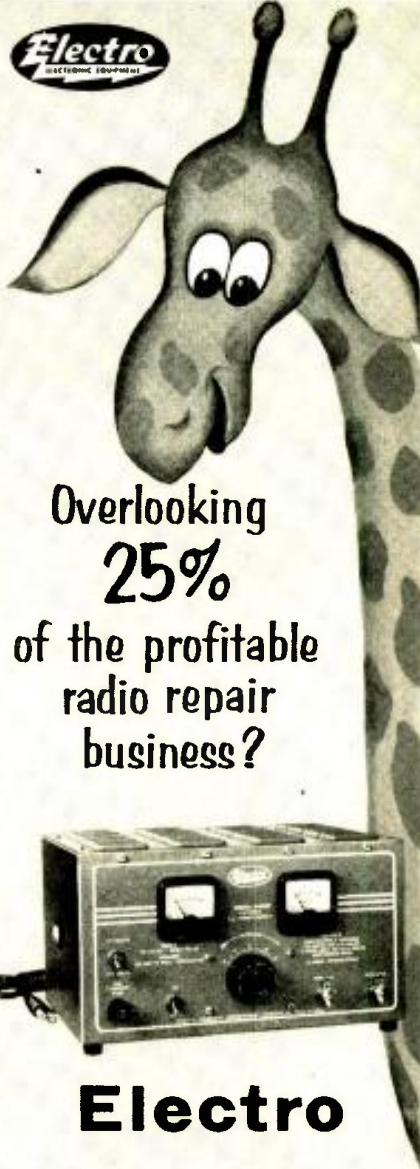

Electro
MODEL D-612T
DC POWER SUPPLY

lets you service
**TRANSISTOR
AUTO RADIOS**

(services 6/12V
tube-vibrator radios, too)
* 1 out of 4 radios is an auto set

An Electro exclusive

FOR PRICES AND DATA SEND COUPON TODAY!

Electro Products Laboratories
4501-P Ravenswood Ave., Chicago 40, Ill.

Rush descriptive and technical data on MODEL
D-612T Power Supply for Transistor Auto
Rádios.

Firm name _____

Address _____

City _____ Zone _____ State _____

623 Conada: ATLAS RADIO LTD., Toronto

your present
speaker
in a
**KARLSON
TRANSDUCER**



**CAN GIVE YOU
10x THE EFFICIENCY**

2x the dispersion!
2 more octaves bass!
Flatter response — Less distortion!
Unexcelled transient response!



IN EASY-TO-ASSEMBLE
KITS

Hardwood exteriors - capable
of fine furniture finish -
from \$18.60 to \$57 net.
Also assembled models from \$26.70 to \$174.
See Your Dealer or Write:

KARLSON ASSOCIATES INC.
Dept. RE
1610 Neck Rd. Bklyn. 29, N.Y.

**CRYSTAL CONTROLLED
CONVERTERS**

POLICE • FIRE • COMMERCIAL



- ✓ Precision—Stability
- ✓ Sensitivity
- ✓ Easy Installation

\$32.50

• A compact converter supplied with commercial tolerance crystals, self contained automatic noise limiter. Also models with squelch. Ideal for mobile or home use.

TUNERS

Enjoy FM Programs
While You Drive.

- FM BROADCAST
 - 30-50 MC
 - 108-176 MC
- from \$22.50**



WRITE FOR LITERATURE

KUHN ELECTRONICS

20 GLENWOOD CINCINNATI 17, OHIO

**Read RADIO-ELECTRONICS
Every Month**

Subscription Rates

One Year **\$3.00** Two Years **\$6.00**

Three Years **\$8.00**

154 WEST 14TH ST.
NEW YORK 11, N. Y.

A SUPER MAGNET — AT A SUPER SAVING!

LIFTS MORE THAN 20 TIMES ITS OWN WEIGHT.

Now for a limited time only—you can buy this Little Giant magnet, the most powerful ever made, at a sensational bargain! The low, low price of \$1.50 is less than 50% of what you'd usually pay for this type magnet. Experimenters and hobbyists will find hundreds of uses for this powerful 4 oz. Alnico permanent magnet. **CAN LIFT**

5 LBS. EASILY. Through a special purchase we are able to offer these Super magnets at this amazing low price. A limited quantity only. First come first served. Order several today. Low price includes keeper. Measures 1 3/4 x 1 1/2".

Item No. 86
Special Bargain Price **\$1.50**
(Shp. Chgs. 10c)

(Regularly priced at \$3.50)



6-VOLT BATTERY, SOLDERING IRON AND WELDER

U.S. Army release. New. Guaranteed. Can be used to solder or weld when connected to any 6v storage battery. The high intensity arc created between the metal to be soldered and the carbon electrode (carbons supplied free with iron) can be used to heat tin or aluminum solder, light brazing and spot welding, melting metals, etc. Includes: 2 carbons, 3 heavy duty spring clips, 2 pieces 5 ft. heavy duty wire cable. (Battery not included.) Ideal for use where current is not available. Ship. wt. 4 lbs.

ITEM NO. 126
UNUSUAL BUY **\$1.95**

APPROX
200 TO
300 WATTS



(P.P. & Hdlg. Chgs. 50c)

AMAZING BLACK LIGHT



250-watt ultra-violet light source. Makes fluorescent articles glow in the dark. Fits any lamp socket. For experimenting, entertaining, unusual lighting effects.

ITEM NO. 87
Ship. wt. 2 lbs.

\$2.45

(P. P. & Hdlg. Chgs. 35c)

WATTHOUR METER



Leading makes—reconditioned. Ideal for trailer parks. 100-110 volts, 60 cycles, 2-wire A.C. 5 amp. Heavy metal case 8 1/2" x 6 1/4" x 5". Easy to install. Ship. wt. 14 lbs.

ITEM NO. 33
NOW ONLY **\$4.50**

(P.P. & Hdlg. Chgs. \$1.25)

250 POWER TELESCOPE LENS KIT

Make your own high powered 6 ft. telescope! Kit contains 2" diam., 75" focal length, ground and polished objective lens and necessary eye pieces. Magnifies 50x to 250x. Full instructions.

ITEM NO. 123
\$2.95
(Shp. Chgs. 10c)



BOOKS

(Continued)

As with previous publications of this type, the book is thorough and explicit in detailing installation, adjustment and repair techniques as applied to the particular receiver discussed, as well as giving trouble localization procedures and repair techniques.

The initial section illustrates the recommended test equipment and also details the usefulness of such items as a degaussing coil, kinescope-controlled grid switch box and the use of extension cables for operating the receivers with the chassis removed from the cabinet. A section is devoted to field servicing problems and another section is devoted to shop procedures.

Servicing of printed circuits is also included, with a number of illustrations localizing various sections of the printed-circuit board.

Scattered throughout the books are numerous oscilloscope pattern photographs to aid in adjusting the receiver properly. Bar patterns illustrate proper control adjustments.

The booklet contains two complete schematics, one for the early-production receivers and another for the late models. Four pages of circuit modification are also shown.

For the technician expecting to service the 21CT660U series of RCA receivers, this work will be an invaluable aid with respect to the practical factors of installation and maintenance.—MM

HUDSON SPECIALTIES CO.
25 West Broadway, Dept. RE 10-56
New York 7, N. Y.

I am enclosing full remittance for items circled below. (Be sure to include shipping charges.)

OR, my deposit of \$..... SHIP balance C.O.D.
MINIMUM C.O.D. ORDER \$5.00.

C.O.D. ORDERS ACCEPTED ONLY WITH 20% DEPOSIT. INCLUDE SHIPPING CHARGES.

86 87 33 126 123

Name..... Please Print Clearly

Address.....

City.....Zone.....State.....

BOOKS

(Continued)

DRAKE'S RADIO-TELEVISION ELECTRONIC DICTIONARY, by Harold P. Manly. Frederick J. Drake & Co., 9 So. Clinton St., Chicago, Ill. 5 1/2 x 8 1/2 inches, pages not numbered. \$4.

The author, well known to readers of this magazine for his articles simplifying electronic problems, has for many years been presenting in clear language things which some writers occasionally make appear very difficult. This is exactly the qualification needed by the compiler of a dictionary.

Not only are the definitions clear, but confusion has been avoided by keeping to the definitions that would be expected by a practical technician below the engineer level. Thus collector refers only to one of the elements of a transistor, and there is no reference to an element of that name in certain specialized tube types. Manly has also resisted the temptation to drag in the cathode surface of a tube under emitter, confining that term also to the one the technician would be likely to be looking for—one of the other elements of the transistor.

The dictionary is well illustrated with drawings and diagrams. Some of the perspective drawings appear to have been lifted from an older book (possibly the old *Electrical and Radio Dictionary*, of which it is said to be a revision). The schematics, on the other hand, appear thoroughly up to date.

TV TROUBLE TRACER, 1956 edition, by H. G. Cisin. Harry G. Cisin, Amagansett, N. Y. 45 pages, 50c.

Aimed frankly at the "tube puller" or semiskilled technician making house calls, this book is a combination tube-location guide and list of common troubles. Some 40 common troubles are illustrated, with such cures as would be attempted on a house call. Tube locations of most of the 1955-56 TV models are supplied. Outstanding feature of the book is the function indication. Each tube carries—as well as its type designation—a letter indicating its function as it affects the screen or speaker. Thus an intercarrier if tube is marked PS (picture-sound). Others are marked B (bright area), V (vertical movement), etc. This type of information rather than listing the formal functions of the tubes may well be more valuable to the not-too-advanced technician on a house call.—FS

ADMIRAL TV TUBE LOCATION GUIDES (Trouble-indicating), by H. G. Cisin. Harry G. Cisin, Amagansett, N. Y. 48 pages, \$1.

A compilation of the same nature as the one above, containing tube-location guides for Admiral sets from 1948 to 1956, with tubes marked according to their obvious effect on the program. A condensed "Guide to TV Troubles" occupies five pages. Twenty-five symptoms are illustrated, with instructions as to what tubes to replace to cure them. **END**

BE QUALITY WISE... BUY QUAL-KITS!



HI-FI AMP KIT
Complete 6 tube-10 watt amplifier. Push-pull beam power output, built-in pre-amp. 5 position selector switch, 3 position record equalization, LP, RIAA, Eur. Response 1/2 db. 20-20,000 cps. Output 10 watts at less than 2% THD. Low noise level and harmonic distortion. **\$28.50**

Every kit complete with 28 page fully illustrated instruction and assembly manual. Cover and legs optional.

HI-FI AM-FM TUNER KIT
Advanced 7 tube circuit plus Rectifier for full sensitivity and selectivity. Distortion less than 1%. Sensitivity is 5 uv for 30 db quieting on FM, 25 uv AM. Armstrong FM Circuit with limiter, Foster-Seeley Discriminator. 20-20,000 cps response. Full AFC control — no drift. Easy assembly. **\$28.95**

Write for **FREE** catalog and name of nearest dealer carrying these remarkable units.

Add 10 percent for new federal tax

QUALITY-ELECTRONICS
319 Church St. Dept. E10 New York 13, N. Y.

TRANSISTOR TESTER

KIT-TRONICS TT-2



NEW KIT CALIBRATED SCALES

on Full 4 1/2" 2% Meter
CURRENT GAIN
Alpha 0.50-0.99
Beta 0-100
Beta 0-300

LEAKAGE 1 to 6
PRECISION 1% Components
SELF-CALIBRATING MEASURES NPN AND PNP Transistors & Crystal Diodes

Panel punched, lettered and finished. Dial lettered. Easy to follow, step-by-step instructions. Use and theory completely covered in 17-page manual.

Kit Only \$39.95 Post Paid in USA
Factory Wired and Tested \$49.95

Order Direct from Factory

"Quality Electronic Equipment in Kit Form"

KIT-TRONICS

2315 Hendola Dr. NE
Albuquerque, New Mexico

BLACK & WHITE & COLOR
FIX TV

Repair more sets in less time!

Examine this **NEW** handbook **FREE!**

HERE IT IS!... the newest, most complete, easy-to-follow television servicing guide ever published!



Following the same clear approach that made the author's "Elements of Radio" a 1,000,000-copy best-seller, this brand-new book gives you everything you need to know to make extra money fixing both black-and-white and color TV sets. Just master the first few chapters of this book and you are ready for business—

Elements of TV SERVICING

by Abraham Marcus (co-author of famous best-seller, "Elements of Radio") and Samuel Gendler

- Reveals for the first time all details, theory and servicing procedures for the RCA 28-tube color Television receiver, the CBS Columbia Model 205 color set, and the Motorola 18-inch color receiver.
- Analyzes and illustrates—so you can actually see what to do more TV defects than any other book, and provides complete, step-by-step procedure for correcting each one.
- Gives you tested money-making tips and time-saving methods for profitable TV repair and servicing.

PARTIAL CONTENTS: Field servicing—how to install and adjust a new receiver—how to choose the proper antenna and how to erect it—100 common defects (with actual photos of defects) and how to correct them. Bench servicing set-up for bench servicing—the heater circuit and low-voltage power supply—the horizontal sweep and high-voltage sections—vertical sweep section—synchronization section—alignment—etc., etc. Color television—practical color television receivers—color tube adjustment—trouble-shooting the color television receiver—etc., etc.

USE IT FREE FOR 10 DAYS! Get this great new how-to-do-it TV Servicing book today. Just mail coupon below for 10 day Free-Examination Copy of "Elements of Television Servicing."

---MAIL COUPON NOW!---

PRENTICE-HALL, INC., Dept. 5744-M1
Englewood Cliffs, N. J.

Send me, for 10 DAYS' FREE TRIAL, "Elements of Television Servicing." Within 10 days, I will either send \$6.95 plus postage, or return the book and owe nothing.

Name.....

Address.....

CITY.....Zone.....State.....

SAVE! Send \$6.95 with this coupon and we will pay postage. Same return privilege; refund guaranteed.

The BIG November issue of
RADIO-ELECTRONICS
On Sale Oct. 25 Reserve yours now!

NOW! Test Condensers

and Selenium Rectifiers
IN THE SET!

Check Capacitors

UNDER WORKING CONDITIONS!

CAPACITEST, with thousands already in use, is a new and improved compact checker that does a giant job to will not give this type of check since the applied voltage is 20 Volts or less. Avoid call-backs—use CAPACITEST! Accurately, quickly, it shows open, shorted, or intermittent capacitors and leaky electrolytics. Compact: 4" x 4" x 2"—lightweight, for bench or tool kit.



New Capacitest Series 2

CAPACITEST

Quickly, Accurately Checks:

- PAPER, MICA, CERAMIC CAPACITORS
- ELECTROLYTICS
- SELENIUM RECTIFIERS
- CONTINUITY
- AC/DC VOLTAGES
- FLASHBULBS

10 day money back guarantee

\$10-95 postpaid, net. Complete, ready for operation. **NOT A KIT**

FREE For a limited time only, Set of test leads Free with each CAPACITEST. Order direct from manufacturer — include \$3 deposit with C.O.D.—Save PP & COD fees, send \$10.95 & we'll pay postage.

JAY The Barjay Co. 145 West 40 Street New York 18, N.Y.

HQ for the 5 TOP QUALITY brands of

TUBES

AT SENSIBLE PRICES!

- Individually boxed • First quality only
- Brand New • 90-DAY RETMA guarantee
- No rebrands • No private brands • No rejects

TRANSMITTING TUBE SPECIALS

1825		10.50 1820		3.00	
1Q22	\$ 3.50 3047L	10.50	1624	1.25	
CL 2	10.00 355A	12.00	1825	1.30	
2C35	2.00 357A	15.00	2030	1.00	
2C39A	9.75 403A	1.25	2051	.65	
2C41	3.25 403B	2.75	5517	1.35	
2C43	9.75 404A	12.50	5836	2.95	
2D21	7.10 416A	29.00	8636A	3.85	
2E24	2.75 416B	39.00	8642	1.00	
2K25	19.75 417A	2.75	5843	3.00	
3K43	35.00 417A/5842		5612	4.50	
2K45	15.00	12.50	5651	1.40	
3K24	1.50 #450TH	45.00	5654	1.40	
3K24W	5.00 KU-910	3.50	5656	4.50	
3K29	5.50 WL95B/688		5670	1.00	
3K31	1.40	90.00	5675	8.00	
3C22	4.50 GL673	13.00	5676	1.15	
1C61	1.10 701A	2.75	5687	2.75	
1C45	6.00 703A	1.10	5691	4.75	
1D21A	3.50 715	7.10	5692	8.00	
1D11	3.00 723A/B	7.10	5693	4.75	
3J30	30.00 725A	3.50	8703WA	4.50	
+4-65A	1.50 815	50.00	8718	2.50	
+4-125A	30.35 800		8725	2.00	
+4-250A	35.00 802		8725	2.75	
+4-400A	55.50 803		8728	1.50	
B24 EL3C	38.50 803		8749	1.25	
4C35	13.50 807		8749	1.25	
4E27	8.50	2.85	8763	1.20	
*4PR80A	50.00 807W/5933		5912	1.50	
5C22	19.10 813	9.50	5914	.80	
5RAWGY	3.00 814	2.50	5840	6.00	
5K24W	1.40 815	2.50	5878	1.40	
6C4	20 816	1.00	5881	2.35	
6E21	15.00 826	1.65	5894 AX9903	18.00	
6K14	1.90 828	1.55	5910	.45	
6K16W	1.00 837	1.55	5913	.50	
1F5	1.50 838	5.70	5915	4.95	
1F52	4.10 840	5.00	6112	4.95	
*NTQ	2.45 866A	1.35	6112	4.95	
VC50 32KV	8.00 872A	1.25	6119/3C45	6.00	
HK60	7.50 911RA	125.00	6116	6.55	
RK65	1.10 911RA		8183	7.00	
HK69	2.50 918		9189	2.50	
HK72 or 73	3.15 927		8293	3.00	
F123A	5.10 930		8293	10.00	
VX-R130	1.75 954		8539	9.00	
3718	.90 955		8808	2.95	
303A	2.00 956		8810	4.25	
211	.50 957		9001	.85	
250R	2.95 958A		9002	.65	
*280TL	4.00 991/NE2		9004	1.75	
HK253	5.00 CK1005		9004	.50	
GL299	3.90 CK1007		9005	.20	
304TH	8.5 CK1026		5914	2.30	

and many others... over 1000 types in stock! WRITE!

2 COLOR TUBE CARTONS

Keeps your tube stock neat. New safety partition prevents tube breakage. Distinctively lithographed in glossy red and black the most distinctive tube carton available today. Minimum quantity: 100 of any one size. Write for case lot prices.



SIZE	FOR TUBE	PER 100
Miniature	6A16, etc.	\$1.00
GT	6SN7, etc.	1.25
Large GT	1B3, etc.	1.50
Large G	5U4C, etc.	2.00

WHITE GLOSSY BOXES

Completely blank. No printing or color. Otherwise same as above. Same high quality same low prices. Specify "WHITE" when ordering. When color is not stated, 2 color cartons will be shipped.

TUBE STACKERS

White glossy only. Mini-stacker holds 10 Mini. tube cartons; "GT" stacker holds 10 "GT" cartons.

SIZE	PER EACH
Mini-stacker	1.12c
GT	.02

SAVE ON STACKERS. Either size only \$1.25 per 100 or \$10.00 Per case of 1,000. F.O.B. New York!

DIRECTRON SELENIUM RECTIFIERS

Full Wave Bridge Type

Max Amps.	18VAC	36 VAC	54 VAC	72 VAC	130 VAC
1	51.35	52.30	53.70	54.80	57.40
2	2.00	2.75	5.30	5.40	9.15
2 1/2	3.90	4.50	5.75	7.85	12.70
4	3.00	6.40	11.25	14.15	21.70
6	3.95	7.70	12.75	17.30	29.65
10	5.85	11.35	19.40	24.80	41.25
12	7.40	14.25	22.00	27.70	43.85
20	13.05	25.05	37.25	48.75	78.80
24	18.25	28.75	44.50	57.65	81.00

Complete line of new rectifier transformers, chokes and filter capacitors in stock at all times. May be ordered at same time as selenium rectifiers above for immediate delivery. Write for complete price list.

We build other Selenium Rectifiers, Transformers and Chokes to your specifications.

NEW RECTIFIER TRANSFORMERS

Continuous Ratings	2 Amps	\$ 5.75
PRI: 115V. 60 cycles input	4 Amps	6.75
SEC: 9, 12, 18, 24 and 36 volts	12 Amps	16.25
	24 Amps	33.75

NEW RECTIFIER CHOKES

Continuous Ratings	1 Amp	.1 Hy.	1.5 ohm	\$ 4.95
2 Amps	.04 Hy.	.9 ohm	6.95	
4 Amps	.07 Hy.	.6 ohm	7.95	
12 Amps	.01 Hy.	.1 ohm	14.95	
24 Amps	.004 Hy.	.025 ohm	29.95	

FILTER CAPACITORS

Capacity	W. Voltage	Each
400 MFD (in cans. on octal bases)	25 V.	\$1.00
500 MFD	50 V.	1.95
1000 MFD	15 V.	.85
1000 MFD	35 V.	1.50
2000 MFD	15 V.	1.25
6000 MFD	15 V.	2.50

WRITE FOR "BARRY'S GREEN SHEET" FREE!

TERMS: 25% deposit with order, balance C.O.D. All merchandise guaranteed. F.O.B. N.Y.C.

BARRY ELECTRONICS CORP.
 512 Broadway, Dept. RE, N.Y. 12, N.Y.
 Call Us Day or Night
 24-Hour Phone Service
 Phone: Walker 5-7000

ADVERTISING INDEX

Radio-Electronics does not assume responsibility for any errors appearing in the index below.

Aerovox Corp.	138	Miller (Gustave)	133
Alliance Manufacturing Co.	81	Moss Electronics Distributing	82-83
Allied Radio Corp.	17, 89-94	National Radio Institute	3, 19-20
Almo Radio Co.	148	National Schools	5
Amphenol Electronics Corp.	132	Newark Electric Co.	146
Argos Products Co.	154	North American Phillips Co., Inc.	22
Arky Radio Kits Inc.	135	Ohmite Manufacturing Co.	141
Audel Publishers	153	Opportunity Adlets	151
B & K Manufacturing Co.	14, 108	Oxford Electric	127
Barjay Co.	159	Pentron Corp.	109
Barry Electronics	160	Perma-Power Co.	126
Bell Telephone Labs.	21	Phostron Instrument & Electronic Co.	124
Bendix Radio	156	Pilot Radio Corp.	141
Blonder-Tongue Labs.	96	Precise Development Corp.	131
British Industries Corp.	145	Precision Apparatus Co., Inc.	151
Brooks Radio & Television Corp.	136-137	Prentice-Hall, Inc.	159
Burstein Applebee Co.	133	Progressive Edu-Kits Inc.	116
CBS-Hytron	103	Pyramid Electric Co.	24
Cabinart	26	Quality Electronics	159
Cannon Electric Co.	153	R-Columbia Products Co.	139
Capitol Radio Engineering Institute	13	Radiart Corp.	6
Centralab Division of Globe Union	112	RCA Components Div.	118
Central Technical Institute	119	RCA Institutes, Inc.	29
Century Electronics	155	RCA Service Co.	106, 114
Cisin (H.G.)	145	RCA Test Equipment Div.	23
Cleveland Institute of Radio Electronics	11	RCA Tube Div.	Back Cover
Colordaptor	127	Radio Receptor Inc.	79
Columbia Record Club	9	Radio-Television Training Association	25
Cornell Dubilier	6	Raytheon Manufacturing Co.	27
Coyne Electrical School	101, 123, 146	Remington Rand Univac	134
DeRo Electronics	155	Rinehart Books Inc.	130, 142, 151
DeVry Technical Institute	7	Rockbar Corp.	28
Drake (Frederick J.) & Co.	150	Ronette Acoustical Corp.	154
Dressner	140	Sams, (Howard W.) & Co., Inc.	15, 105
Dynamic Electronics	139	Saunders Electronics Correspondence School	108
Editions Radio	155	Scott (Hermon Hosmer)	16
Editors & Engineers	146	Service Instruments Co.	140
Electro Products Labs.	157	Shure Brothers Inc.	99
Electro-Voice, Inc.	Inside Back Cover	Sonotone Corp.	100
Electronic Instrument Co. (EICO)	30-31, 32	Sound Mart Unlimited	135
Electronics Measurement Corp.	116	South River Metal Products Co.	142
Electronic Publishing Co., Inc.	144	Sprague Products Co.	129
Elgin National Watch Co.	88	Stan-Burn Radio & Electronics	157
E-Z Hook Test Products	133	Supreme Publications	117
Fenton Co.	128	Sylvania Electric Products, Inc.	110-111
Futuramic	156	Tenna Manufacturing Co.	122
Garfield (Oliver) Co.	144	Terminal Radio	149
General Industries Co.	8	Thorens	102
Gernsback Library Inc.	147, 155	Trio Manufacturing Co.	115
Hallcrafters Co.	152	Triplet Electrical Instrument Co.	Inside Front Cover
Hawkins (P. E.) Co.	140	Tung-Sol Electric Co.	12
Heath Co.	65-78	University Loudspeakers	18
Hickok Electrical Instrument Co.	153	Vaco Products Co.	156
Hi-Lo TV Antenna Corp.	80	Volpar	127
Hudson Specialties Co.	158	Wen Products Co.	10
Hughes Research & Development Labs.	164	Weston Electrical Instrument Corp.	142
Hunter Tool Co.	126	Winegard Co.	113
Hycor Manufacturing Co.	125	World Radio Labs	151
Indiana Technical College	133	Xcelite Inc.	150
Instructograph Co.	140		
International Business Machines	143		
International Rectifier Corp.	148		
Jensen Industries	145		
Jerrold Electronics Corp.	97		
Jones & Laughlin Steel Corp.	85		
Karlson Associates, Inc.	158		
Kay Townes Antenna Co.	121		
Kit-Tronics	159		
Kuhn Electronics Products	158		
LMB	135		
Lafayette Radio	162-163		
Lektron Specialties	152		
Macmillan Co.	138		
Mallory (P. R.) & Co.	86-87		
McGraw-Hill Book Co.	148		
Merit Coil & Transformer Corp.	22		

SCHOOL DIRECTORY PAGE 161

- American College of Engineering
- Baltimore Technical Institute
- Candler System Co.
- Capitol Radio Engineering Institute
- Grantham School
- Indiana Technical College
- Indianapolis Electronic School
- Milwaukee School of Engineering
- RCA Institutes, Inc.
- Tri-State College
- Valparaiso Technical Institute
- Wayne School, Inc.
- Western Television Institute

BRANCH ADVERTISING OFFICES: Chicago: 1413 Howard St. Tel Rogers Park 4-8900. Los Angeles: Ralph W. Barker and Associates, 600 South New Hampshire. Tel. Diabik 7-2328. San Francisco: Ralph W. Barker and Associates, 582 Market St., Tel. Garfield 1-2481.

FOREIGN AGENTS: Great Britain: Atlas Publishing and Distributing Co., Ltd., London E.C. 4. Australia: McGill's Agency, Melbourne. France: Brentano's, Paris 2e. Belgium: Agence de Messageries de la Presse, Brussels. Holland: Triton-Heemstede. Greece: International Book & News Agency, Athens. So. Africa: Central News Agency, Ltd., Johannesburg, Capetown, Durban. Natal: Universal Book Agency, Johannesburg. Middle East: St-Innats Middle East Agency, Jerusalem. India: Broadway News Centre, Dalar, Bombay #14. Pakistan: Paradise Book Stall, Karachi 5.

SCHOOL DIRECTORY

ELECTRONIC TECHNICIANS

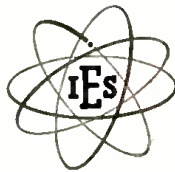

**ARE IN DEMAND
TRAINED MEN ARE NEEDED**

NOW! In just 18 months, you can complete Electronic Technicians training to enter this ever-growing industry. Day or evening classes. Opportunity for employment in local industry. Approved for Korean Veterans. Terms beginning Jan., April, July, September. Write for Catalog 111 TODAY.

INDIANAPOLIS ELECTRONIC SCHOOL
312 E. Washington St. Indianapolis 4, Indiana

ENGINEERING

Prepare for unlimited opportunities in electronics! **B.S. DEGREE** IN 27 MOS.

Intensive, specialized courses. Math, electrical engineering, TV, advanced radio theory & design. Modern labs. Low rate. Earn board. Also Aeronautical, Chemical, Civil, Electrical, Mechanical Engineering. G. I. approved. Enter September, December, March, June. Catalog.

INDIANA TECHNICAL COLLEGE
1510 E. Washington Blvd., Fort Wayne 2, Indiana

TOP-FLIGHT ELECTRONICS

Train for tech. rep., field engineer, electronic specialist in missiles, computers, radar, automation, radio, color-TV. Basic and advanced theory and laboratory. Mathematics. Major firms select our graduates. Dormitories-campus. 21 months' program. High school grad. or equivalent. G. I. approved. Start Jan., April, July, Sept. Write for catalog.

VALPARAISO TECHNICAL INSTITUTE
Dept. C. Valparaiso, Indiana

RADIO-TV ELECTRONICS



CREI graduates in big demand, ECPD-Accredited Technical Institute Curricula. New classes start monthly. Free placement service for grads. Courses: Radio Engineering, Broadcast or TV Engineering; resident studies leading to "Associate in Applied Science" degree. Write for free Residence School catalog. Approved for veterans.

CAPITOL RADIO ENGINEERING INSTITUTE
Dept. RE, 3224 - 16th St., N. W., Washington 10, D. C.



Be a "key" man. Learn how to send and receive messages in code by telegraph and radio. Commerce needs thousands of men for jobs. Good pay, adventure, interesting work. Learn at home quickly through famous Candler System. Quality for Amateur or Commercial License. Write for FREE BOOK.

CANDLER SYSTEM CO.
Dept. 3-1, Box 928, Denver 1, Colo., U.S.A.



wanted career men

Train for a career instead of a job. Demand for our graduates exceeds supply. Effective placement. Modest costs. Small classes. Well-equipped labs. Beautiful campus. Approved for Vets. Enter Sept., Jan., March, June.

BACH. SCI. DEGREE IN 27 MONTHS
Complete Radio Eng. courses. TV, UHF, FM, Electronics. Also Mech., Civil, Elec., Chem., Aero. Eng. 36-month **B.S. in Bus. Adm.** (Gen. Bus., Acctg., Motor Transport Mgt.) . . . capable students faster. Prep courses. Write Jean McCarthy, Director of Admissions, for catalog and "Your Career in Engineering & Commerce."

TRI-STATE COLLEGE
24106 College Avenue, Angola, Indiana

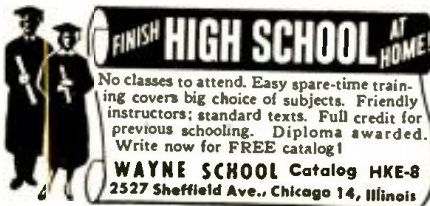

FINISH HIGH SCHOOL AT HOME!
No classes to attend. Easy spare-time training covers big choice of subjects. Friendly instructors; standard texts. Full credit for previous schooling. Diploma awarded. Write now for FREE catalog!
WAYNE SCHOOL Catalog HKE-8
2527 Sheffield Ave., Chicago 14, Illinois



RCA INSTITUTES, INC.

A service of Radio Corporation of America
350 West 4th St., New York 14, N. Y.

**OFFERS COURSES IN
ALL TECHNICAL PHASES OF
RADIO, TELEVISION, ELECTRONICS**
Approved for Veterans
Write Dept. RE-56 for Catalog

TELEVISION

PREPARE FOR A GOOD JOB!
BROADCAST ENGINEER
ELECTRONICS
RADIO SERVICING

Television Servicing

(Approved for Veterans)
**BUILDING AIRCONDITIONED
SEND FOR FREE LITERATURE**
BALTIMORE TECHNICAL INSTITUTE
1425 EUTAW PLACE, BALTIMORE 17, MD.

Get Your F.C.C. LICENSE Quickly!

Guaranteed preparation, in a MINIMUM OF TIME, for F.C.C. commercial operator examinations. Our highly specialized training is available by correspondence or in resident classes in

WASHINGTON, D.C. and HOLLYWOOD, CALIF.

Write for our free booklet with complete details.
GRANTHAM School of Electronics
Desk 4-E, 1505 N. Western Ave.
Hollywood 27, Calif.

ENGINEERING DEGREES

(Under and Postgraduate)
E.E. Major in Electronics,
Earned Through Home Study.
AMERICAN COLLEGE OF ENGINEERING
Residential Courses also Available
Box 27241M, HOLLYWOOD 27, CALIF.

LEARN TV SERVICING UHF—COLOR—VHF

Master the latest, up-to-the-minute TV and Color TV developments. You can Earn to \$5,000-\$10,000 a year in TV servicing after a few short months. Education or age is no barrier. Find out how you can EARN WHILE YOU LEARN in our big Shops and Laboratories. You work with the latest equipment. Waste no time with Non-Essentials, Math or Design Theory. Complete information in our new FREE Booklet. Address Dept. E-956. Approved for veterans. Free Placement Service.

WESTERN TELEVISION INSTITUTE
341 W. 18th St. Los Angeles, Calif.
Dept. E-10-56
Mail me information about training.
Name _____
Address _____

Your choice of school
is highly important
to your career in



**INDUSTRIAL
ELECTRONICS**



**RADIO-
TELEVISION**



**ELECTRONICS
COMMUNICATIONS**

Become an

**ELECTRICAL
ENGINEER**

or an

**ENGINEERING
TECHNICIAN**
at

MSEO in Milwaukee

Choose from courses in:

ELECTRICAL ENGINEERING
Bachelor of Science degree in 36 months. Communications option (radio-tv) Power option.

ENGINEERING TECHNICIAN
Assoc. in Applied Science degree — 18 months.

Electronics Communications
Electrical Power.

MSEO — located in Milwaukee, one of America's largest industrial centers — is a national leader in electronics instruction — with complete facilities, including the latest laboratory equipment, visual aid theater, amateur radio transmitter — offers 93 subjects in electrical engineering, electronics, radio, television, electrical power, and electricity.

Advisory committee of leading industrialists. Courses approved for veterans. Over 50,000 former students. Excellent placement record.

TERMS OPEN JANUARY,
APRIL, JULY, SEPTEMBER



Choose wisely — your
future depends on it. Write
for more information today!

MILWAUKEE

SCHOOL OF ENGINEERING
Dept. RE-1056, 1025 N. Milwaukee Street
Milwaukee 1, Wisconsin

Send FREE career booklet.

I am interested in _____
(Name of course)
Name _____ Age _____
Address _____
City _____ Zone _____ State _____
If veteran, give discharge date _____

LAFAYETTE SENSATIONAL VALUES! IN COMPLETELY WIRED TEST EQUIPMENT at LESS than the PRICE of KITS!

LAFAYETTE SIGNAL GENERATOR

NEVER BEFORE HAS A COMPLETELY WIRED AND TESTED INSTRUMENT OF SUCH ACCURACY AND QUALITY BEEN OFFERED AT SUCH A PRICE!

- FREQUENCY 120 KC TO 260 MC
- 120 KC TO 130 MC ON FUNDAMENTALS
- LABORATORY ACCURACY AND QUALITY



22.50

A completely wired and tested instrument not to be confused with units sold in kit form at almost the same price, but with a quality and accuracy of instruments 3 to 4 times its price. Six overlapping ranges generate signals of 120KC - 320KC, 320KC-1000KC, 1MC-3.2MC-11MC, 11MC-38MC and 37MC-130MC all on fundamentals with calibrated harmonics from 120MC to 260MC. Selector switch gives instant choice of ranges. Switch gives choice of internal modulation of 400 CPS or use of any external source at other frequencies. For audio testing the 400 cycle signal can be used separately. Outputs are unmodulated RF, modulated RF and 400 CPS audio. RF output is in excess of 100,000 microvolts and jacks are provided for choice of either high or low RF output. Stability is insured by special circuit design. Has a fine adjustment RF control. AF output is 2-3 volts. AF input is 4 volts across 1 megohm. Large clear 5 inch etched dial plate and pointer are protected by transparent plastic bezel. Common AF terminals for EXT-MOD input and INT-AF for audio tests eliminate need for special AF output connectors. Machine engraved panel lettering. Handsome gray metal case with carrying handle. Measures 6 1/2" x 10" x 4 1/2". Comes complete with pair of leads. AC line cord and plug. Operates on 105-125V 50-60 cycle AC. Shpg. wt., 8 lbs.

LAFAYETTE LSG-10 SIGNAL GENERATOR

22.50

NEW POCKET AC-DC VOM MULTITESTER

2,000 ohm per volt Sensitivity on both DC and AC

- 160 μ a 3" METER
- 1% PRECISION RESISTORS
- SILVER CONTACT SELECTOR SWITCH

FULL SCALE RANGES

DC Volts: 0-10; 0-50; 0-500; 0-1000 Volts - AC Volts: 0-10; 0-50; 0-500; 0-1000 Volts - DC Current: 500 μ a and 500 ma - Resistance: 0-10K; 0-1 Meg - Decibels: -20 to +22; +20 to 36 db (0 db - 0.775 V) - Capacity: 250 mmd to .2 mfd - .005 mfd to 1 mfd - Output Ranges: 0-10; 0-50; 0-500; 0-1000 volts

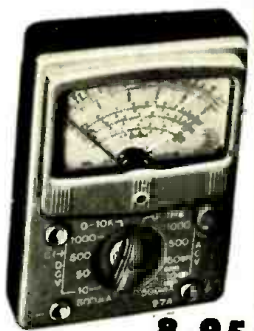

8.95

Best Buy in America! A very accurate and sensitive VOM. This Multitester is a complete instrument (not a kit) with per volt on both AC and DC. Single selector switch, 2000 ohm precision resistors, 3" meter, selective selector switch, 1% accuracy and ruggedness. In attractive chrome front panel, city range, requires 50 volt AC source. Second capacity range requires 10 volt AC source. Second capacity Complete with test leads and batteries. Shipping weight, 4 lbs.

RW-27A

Complete 8.95

NEW!

LAFAYETTE CAPACITANCE-RESISTANCE TESTER WITH "IN-SET QUICK CHECK"

COMPLETELY WIRED AND TESTED

- TWO INSTRUMENTS IN ONE
- CHECKS ELECTROLYTIC, PAPER, MICA AND CERAMIC CONDENSERS
- 4 DIRECT READING CAPACITY SCALES FROM .00001 MFD TO 1000 MFD
- CHECK FOR OPEN SHORTS, LEAKAGE AND INTERMITTENTS
- 2 RESISTANCE RANGES FROM 100 TO 5 MEGOHM

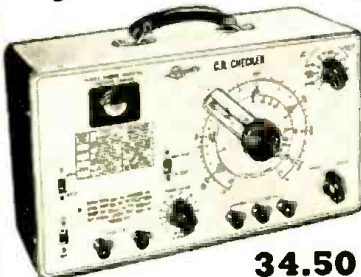

34.50

Here is a "must" for servicemen and lab technicians. A completely self-contained AC operated capacitance and resistance bridge, plus a quick check for in the set testing. Large 5 direct reading scale has 4 ranges of .00001, .005 MFD, .001-.5 MFD, 1-50 MFD and 20-1000 MFD. Resistance ranges are 100-50,000 OHMS and 10,000 to 5 megohm. Quick check feature enable you to check capacitors for shorts, open or intermittent while in circuit—no need to remove them from the set till you're sure they need replacement. Leakage test switch gives you choice of 25, 150, 250, 350 or 450 volts for checking leakage under correct potential. Separate power factor control with continuous settings from 0 to 50%. Operation is simple and accurate, using a magic-eye tube as the null detector. Attractively finished steel case with etched panel and rounded corners. Measures 14 1/2" L x 8 1/4" H x 5" D. Shpg. wt. 19 lbs.

MODEL LC-4

NET 34.50

NEW!

LAFAYETTE CAPACITOR-RESISTANCE TESTER COMPLETELY WIRED AND TESTED

- COMPLETELY WIRED AND TESTED
- CHECKS ALL TYPES OF CONDENSERS FOR CAPACITY, LEAKAGE, OPEN SHORTS OR INTERMITTENT CONDITION
- DIRECT READING SCALES FROM .00001 TO 1000 MFD AND 100 TO 5 MEGOHMS



21.50

A stable and accurate bridge type circuit measures capacitance in 4 ranges of .00001-.005 MFD, .001 to .5 MFD, .1 to 50 MFD and 100 to 1000 MFD. Two resistance ranges of 100-50,000 and 10,000 to 5 megohms. Check leakage under actual load with choice of 25, 150, 250, 350 or 450 volts available by selector switch. Power factor control from 0 to 50%. Checks for leakage, open, short, or intermittent operation. All readings taken directly off scales after setting magic eye to maximum. Completely self-contained power supply. Attractively finished steel case with rounded corners and etched panel. Operates from 110V AC. Size 9 3/4" L x 7 1/4" H x 5 1/4" D. Shpg. wt. 10 lbs.

MODEL LC-15

NET 21.50

HIGH SENSITIVITY 20,000 OHM PER VOLT DC 10,000 OHM PER VOLT AC MULTITESTER



19.95

LOOK AT THESE FULL SCALE RANGES!

D.C. Volts: 0-6; 0-30; 0-120; 0-600; 0-1200; 0-6000 Volts - A.C. Volts: 0-6; 0-30; 0-120; 0-600; 0-1200 Volts - RESISTANCE: 0-10K; 0-100K; 0-1 Meg; 0-10 Megohms - D.C. CURRENT: 0-60 Microamp; 0-6; 0-60; 0-600 Milliamps - DECIBEL: -20 to +17 db (0 db - 0.774V) - CAPACITY: .0001-.01; .005-15 mfd - INDUCTANCE: 20-2000 millihenry - OUTPUT RANGES: 0-6; 0-30; 0-120; 0-600; 0-1200 Volts

The new Lafayette high sensitivity Multitester is a complete instrument (not a kit). In addition to its unusual sensitivity of 20,000 OHMS PER VOLT ON D.C. AND 10,000 OHMS PER VOLT ON A.C., and the extraordinary number and scope of its ranges, it is packed with features that would make it cost at least twice as much if made in this country. Uses 1% precision resistors, silver contacts on selector switch, 35 μ a 3" meter. Dependable, rugged and accurate. Even the test leads are heavy duty with high voltage insulation. Voltage source required for low capacity range is 120V A.C., for high range capacity and inductance scale is 6V A.C. Attractive plastic front with metal bottom. Size 8 1/4" x 4 1/4" x 2 1/2". Complete with batteries and leads. Shipping weight 4 1/2 lbs.

RW-30A

Singly, Each 19.95

In lots of 3, Each 19.25

4 AND 6 TRANSISTOR SUPERHET KITS POCKET AND HOME RADIOS FOR SPEAKER AND EARPHONE OPERATION

POCKET SIZE: 4" L x 3-3/16" W x 1" D BUILT-IN ANTENNA! REQUIRES NO EXTERNAL ANTENNA OR GROUND!

Lafayette engineers have designed this fascinating 4-transistor superhet receiver kit in a unique and interesting form. It is, by itself, a completely self-contained, pocket sized personal portable set which operates a miniature earpiece so only you can hear; by plugging into the KT-96 kit listed below, it is instantly converted to a full 6-transistor home radio, complete with speaker for the entire family to enjoy. Circuit features use of 4 transistors (2 high frequency and 2 audio type) plus a germanium diode, 2 I.F. stages and built-in high gain ferrite core and antenna. The result is a sensitive, stable and selective set covering the entire broadcast band. Requires no outside antenna or ground connection. The kit is furnished complete with set covering the entire broadcast band. Requires no outside antenna or ground connection. The kit is furnished complete with set covering the entire broadcast band. Requires no outside antenna or ground connection. The kit is furnished complete with set covering the entire broadcast band. Requires no outside antenna or ground connection. The kit is furnished complete with set covering the entire broadcast band.

- KT-94 —Kit, shpg. wt., 2 lbs. Net 19.95
- MS-311—Leather Carrying Case. Net 1.95
- MS-260—Super power dynamic earpiece. Net 3.95

2-TRANSISTOR PUSH-PULL OUTPUT KIT WITH SPEAKER SELF-CONTAINED IN BEAUTIFUL PLASTIC CASE.

• CONVERTS 4-TRANSISTOR KIT INTO A 6-TRANSISTOR HOME RADIO WITH SPEAKER

Add a completely transistorized push-pull audio stage to your 4 transistor receiver. Complete stage including speaker and case measures only 3" H x 2 3/4" W x 1 1/2" D. Plugs right into the KT-96 kit above. Converts your 4 transistor set to a 6 transistor plus diode superhet receiver. Performance equal or superior to commercially wired sets selling at more than twice the price. Kit includes 2 transistors, 2 transformers, 2 1/2" PM speaker, pre-punched chassis, speaker case to hold entire stage, battery, hardware, instructions and diagrams.

- KT-96—Shpg. wt., 1 lb. Net 11.50



LAFAYETTE RADIO

DEPT JJ-1

JAMAICA 33; N. Y. 165-08 Liberty Ave. Write for FREE Bargain Packed Catalog!

100 SIXTH AVE., NEW YORK, N. Y.
BOSTON, MASS., 110 Federal St.
PLAINFIELD, N. J., 139 West 2nd St.
NEWARK, N. J., 24 Central Ave.
BRONX, N. Y., 542 E. Fordham Rd.

FREE! LAFAYETTE CATALOG



ELECTRONIC CATALOG PACKED WITH MONEY SAVERS

Packed with the largest selection of Electronic, Radio and T.V. Parts, and equipment, PA, Hi-Fi systems, tubes, antennas, Transistor Kits, parts and components, Test Equipment, new build your own kits, tools, books, Microscope, drafting equipment, Binoculars, Telescopes, All Radio, TV and Ham supplies — ALL AT GREAT SAVINGS — For the economy minded servicemen, dealer, engineer and technician. **CHUCK FULL OF BUYS! SEND FOR YOUR FREE COPY TO-DAY.**

35 WATT HI-FI AMPLIFIER KIT WITH METERED OUTPUT AND 4 PUSH-PULL PARALLEL NEW EL84 TUBES

New Lafayette high power amplifier kit with a host of features not in any other single amplifier. Calibrated output meter permits use as either a recording or reproducing amplifier. EL84 power pentodes provide high peak power and low distortion required for better audio quality. Features exceptional control versatility and ample inputs for all associated custom hi-fi equipment. DC operated preamp filaments and balancing adjustment to minimize hum. Meter can be switched to indicate either recording voltage or output level of amplifier. Features rumble filter, loudness control, separate bass and treble controls, silencing switch, speaker selector switch, output balancing adjustment and monitoring jack.



SPECIFICATIONS

FREQUENCY RESPONSE: ± 1 db 20-40,000 cps. **HUM:** 85 db below rated output. **POWER OUTPUT:** 35 watts with 4% total distortion at full rated output. **INPUTS:** TV Sound, Radio, Magnetic Phono, Crystal Phono, 7-pin. **OUTPUT IMPEDANCE:** 4, 8 and 16 ohms high impedance for tape recorder. **TUBE COMPLEMENT:** 3-12AX7, 1-12AU7, 4-EL84, 1-5U4. **FEEDBACK:** Negative feedback loops virtually eliminate distortion. **POWER:** 117V, 60 cps, 80/150 watts with auxiliary power receptacles. Removable escutcheon. Size 12 1/4" L x 9 3/4" D x 4 1/4" H. A combination of high power, high fidelity, gleaming beauty and advanced engineering features unmatched at even twice the price. Supplied in complete kit form with simplified easy-to-follow instruction sheets. Shpg. wt., 25 lbs. **KT-115**—Complete kit,Net 59.50

LAFAYETTE'S FM-AM TUNER KIT

- SIMPLIFIED DETAILED INSTRUCTION MANUAL
- MEETS FCC REQUIREMENTS FOR RADIATION
- GROUNDED GRID TRIODE AMPLIFIER
- ARMSTRONG FM CIRCUIT WITH FOSTER-SEELEY DISCRIMINATOR
- AFC DEFEAT CIRCUIT WITH FRONT PANEL CONTROL

The excellence of its design and the quality of its components combine to provide this compact high-fidelity FM-AM tuner with superb characteristics normally found in units costing several times as much, and with performance unbelievable at this low price. Features Armstrong FM circuit with limiter and Foster-Seeley discriminator. Simplified tuning with slide-rule dial and flywheel mounted tuning mechanism. AFC defeat circuit combined with tuning control. Attractive etched copper-plated and lacquered finish.



SPECIFICATIONS

FREQUENCY RANGE: FM, 88-108 MC; AM, 530-1650 KC. **ANTENNA INPUT:** FM, 300 ohms; AM, Ferrite loopstick and high impedance external antenna. **CONTROLS:** 2—a function control for AM, FM, PHONO, TV and a tuning/AFC defeat control. **DISTORTION:** Less than 1% rated output. **FREQUENCY RESPONSE:** FM, $\pm .5$ db 20 to 20,000 cps; AM, $\pm .3$ db 20 to 5000 cps. **SENSITIVITY:** FM, 5 μ v for 30 db quieting; AM, Loop sensitivity 80 μ v/meter. **SELECTIVITY:** FM, 200 KC bandwidth, 6 db down—355 KC FM discriminator peak to peak separation; AM, 8 KC bandwidth, 6 db down. **IMAGE REJECTION:** 30 db minimum. **HUM LEVEL:** 60 db below 100% modulation. **TUBE COMPLEMENT:** 2-12AT7, 1-6BA6, 1-6BE6, 2-6AU6, 1-6AL5 plus 1-6X4 rectifier. **SIZE:** 5 1/2" high x 9 3/4" wide x 9 1/2" deep (excluding knobs). **CONSUMPTION:** 30 watts. For 110-120V 60 cycles AC. Less metal case,Net 34.95
KT-100 Complete kit, less case, Shpg. wt., 9 lbs.Net 34.95
LT-10—Completely wired,Less metal case,Net 52.50
ML-100—Metal case for above, shpg. wt., 3 lbs.Net 5.00



NEW! HIGH FREQUENCY TWEETER WITH ACOUSTIC LENS DIRECT IMPORTATION MAKES THIS PRICE POSSIBLE!

- FREQUENCY RESPONSE FROM 2000 CPS TO BEYOND AUDIBILITY
- LOUVERED ACOUSTIC LENS FOR UNIFORM SOUND DISPERSION
- HANDLES 25 WATTS OF POWER
- PRICED EXCEPTIONALLY LOW

14.95

New high frequency tweeter featuring a louvered acoustic lens for uniform sound dispersion and capable of handling up to 25 watts of distortion-free power. The directional tendency of high frequency notes is overcome by the natural wide dispersion angle of the short horn and the acoustic lens which disperses and radiates the high notes smoothly throughout the entire listening area. The lens is detachable for panel mounting, with a separate base for the tweeter furnished for external mounting where desired. Aluminum voice coil has 16 ohms impedance. Size: 4 1/4" long x 3" diameter, lens extends 2 1/2". Requires a crossover network, preferably one with a level control, such as the LN-2. With full instructions. Shpg. wt., 5 lbs.Net 14.95

HW-7

METAL-CASED CONE TYPE HI-FI TWEETER

FREQUENCY RESPONSE 2000-16,000 CPS · HANDLES 20 WATTS OF POWER

5.95
Net

Highest quality cone type high frequency tweeter having a range from 2000 to 16,000 cycles. Especially efficient at higher end of audio spectrum where other cone type tweeters tend to lose clarity and volume. Entirely closed in a metal case with a base so that it can stand by itself or be mounted on a flat surface with mounting bracket supplied. Rated to handle 20 watts of power. A crossover network is required; the Lafayette LN-2 is ideal. Voice coil impedance 8-16 ohms. Size: 3 1/2" x 2 3/4" x 3" Diam. Shpg. wt., 3 lbs.Net 5.95
HK-3



CROSSOVER NETWORK CAPACITIVE-INDUCTIVE NETWORK WITH CROSSOVER AT 2000 CPS BUILT-IN LEVEL BRILLIANCE CONTROL



8.75

The frequencies above 2000 cycles are enhanced to the high frequency tweeter by means of the high-Q inductance and capacitance comprising this efficient crossover network. The highs and lows are brought into acoustic balance by means of a continuously variable level-brilliance control. Control has a 2 1/2 ft. long cable for remote mounting. Network matches 8-16 ohm speakers with insertion loss reduced to a minimum. Enclosed in metal case 6" L x 2 3/4" H x 2 3/4" D. With full instructions. Shpg. wt., 5 lbs.Net 8.75
LN-2

2 WAY SPEAKER SYSTEM 40-16,000 CYCLES



A modest budget need no longer limit your Hi-Fi aspirations. The system consists of the G.E. 12" woofer with heavy 14.5 oz. alnico V magnet and 1 3/4" aluminum voice coil rated at 25 watts; the new metal cased HK-3 cone type tweeter; and the LN-2 crossover network with level and brilliance control. Both tweeter and network are described on this page. The complete 2-way speaker system covers the frequency range 40-16,000 cycles. Shpg. wt., 16 lbs.Net 27.50
SY-87—Complete System,Net 27.50

SY-86—Complete System, same as above except the HW-7 Tweeter with acoustical lens is supplied instead of HK-3. Shpg. wt., 20 lbs.Net 36.50

New! **LAFAYETTE**
Mail Order Center

Lafayette Radio
DEPT JJ-2
165-08 Liberty Ave.
JAMAICA 33; N. Y.

SEND
FREE
LAFAYETTE
CATALOG

NAME _____
 ADDRESS _____
 CITY _____
 ZONE _____
 STATE _____

CUT OUT
AND MAIL
TODAY!

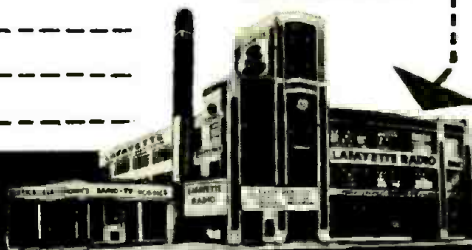

**Systems
Career: a**
**laboratory
for
learning**

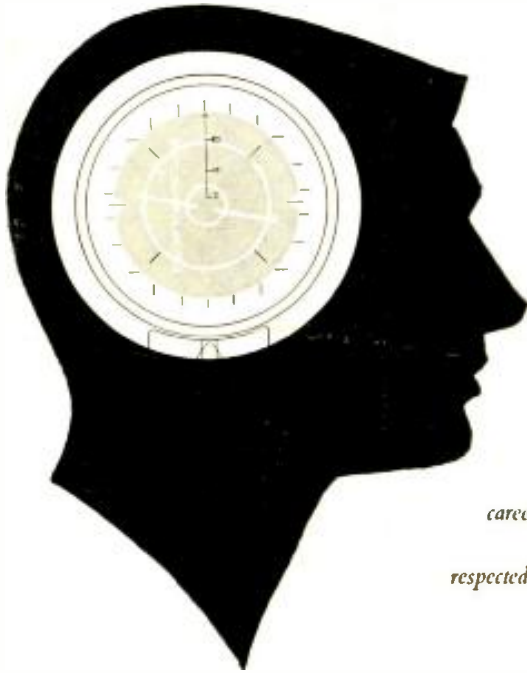

*... an exciting and rewarding
career awaits the E.E. or Physics
graduate who joins this highly
respected Engineering team.*

As a Field Engineer at Hughes, through training and assignment you will become familiar with the entire systems involved, including the most advanced electronic computers. With this knowledge you will be ideally situated to broaden your experience and learning for future application in either the military or commercial field.

The national respect which Hughes commands in the field of advanced electronics is in no small part due to the technical support provided by the Field Engineers. Other contributors to the suc-

cess of the Field Service and Support Division are the Technical Manuals Engineer, Training School Engineers, Technical Liaison Engineers, and Field Modification Engineers.

This Hughes activity is a highly trained organization of expert engineers, giving support to the armed services and airframe manufacturers using the company's equipment. Locations are in Southern California, continental U.S., overseas. We invite you to join this team. For further information write us at the address below.

HUGHES

**Some extra advantages for
Field Engineers include:**

Training at full salary for 3 months before assignment.

Generous moving and travel allowance between present location and Southern California (Culver City).

Additional compensation plus complete travel and moving on assignments away from Culver City.

Ideal living conditions in the unsurpassed climate of Southern California.

Reimbursement for after-hours courses at UCLA, USC, or other local universities.

Employee group and health insurance paid by company, retirement plan, sick leave, and paid vacations.

Scientific Staff Relations

RESEARCH AND DEVELOPMENT LABORATORIES
HUGHES AIRCRAFT COMPANY
Culver City, California

Silky Highs

IMPOSSIBLE TO OBTAIN WITH ANY OTHER TYPE SPEAKER
3500 cps to beyond audibility / 180° Dispersion / +56 db RETMA Rating

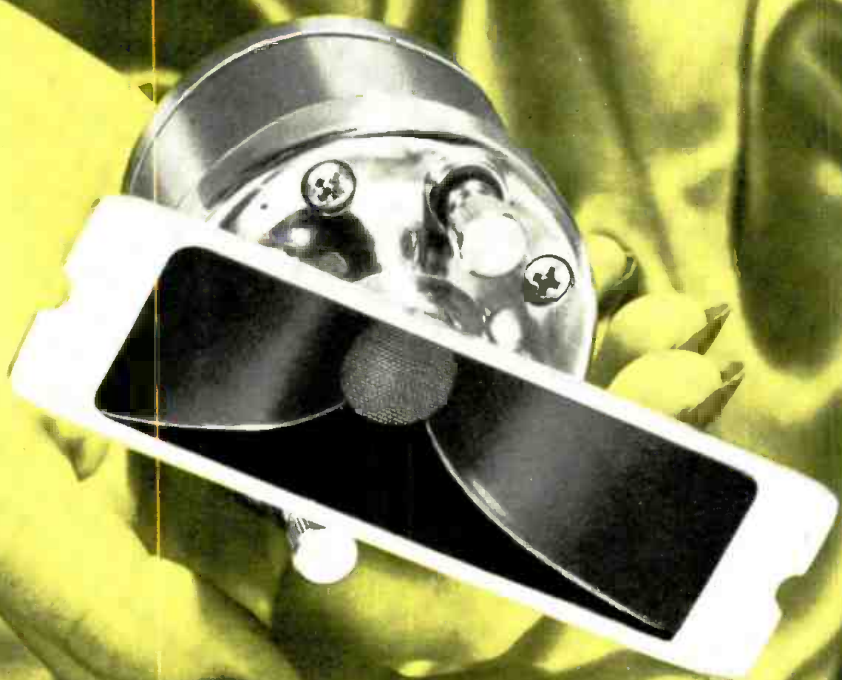

T35 and T35B

Super Sonax®

VERY HIGH FREQUENCY DRIVERS



THE T35B—for lower powered systems and existing quality AM-FM radio or radio-phonographs, finished in flat matte black. Requires only X36 to attach to music system. AT37 level control optional. Impedance 16 ohms. Shipping wt. 2 lbs.



BEAUTIFUL PICCOLINO ACCESSORY ENCLOSURE for T35 or T35B, mahogany or blonde Net \$10.00.



THERE IS A DIFFERENCE—Make your own comparison at the turn of a switch. Hear and compare 36 different speaker systems on this E-V Systems Selector.

Any high fidelity music installation shows amazing improvement in the last two octaves with the addition of the easily installed T35 or T35B. The E-V T35 is without equal in its ability to reproduce highest audio frequencies with distortionless purity. At least one more octave of silky highs is afforded through use of T35 for systems over 20 watts, or T35B for systems under 20 watts. Solid 180° dispersion is accomplished by the E-V developed diffraction slit-type horn. E-V Model X36 crossover and Model AT37 level control are designed for use with the T35 and T35B. Impedance 16 ohms. Shipping weight 2 lbs.

T35..... Net \$33.00 X36..... Net \$9.50
T35B..... Net \$21.00 AT37..... Net \$3.90

Write for information on the T35 and T35B. For facts on Speaker Systems affording true high-fidelity music reproduction, send 25c and specify Catalog Nos. 117 and 118-W610.

Electro-Voice®

ELECTRO-VOICE, INC. • BUCHANAN, MICHIGAN

Export: 13 East 40th Street, New York 16, U.S.A. Cables: ARLAB

www.americanradiohistory.com



It's a fact...

9 of the 12 top-selling replacement TV tubes are original RCA designs.* Manufacturers of TV sets have given RCA tube-type leadership by using RCA-designed tubes in their equipment. Experience has shown these manufacturers that RCA-designed tubes are tops in performance. Service dealers know, too, that the company which knows how to design tubes knows how to build them BEST. So follow the lead of smart service technicians everywhere—say “RCA brand, only” on *all* your tube orders and get tubes that are tops in quality and performance.



RECEIVING TUBES
RADIO CORPORATION OF AMERICA, HARRISON, N. J.

*RETMA REPORT for year of 1955