

HIGH-FIDELITY OUTPUT CIRCUITS

MAY 1956

RADIO - ELECTRONICS

TELEVISION • SERVICING • HIGH FIDELITY

HUGO GERNSBACK, Editor

Electronic Control
for Your
Ventilating Fan



Servicing Home
Tape Recorders



Field Experiences
in
Color TV Service



Troubleshooting
AGC Circuits

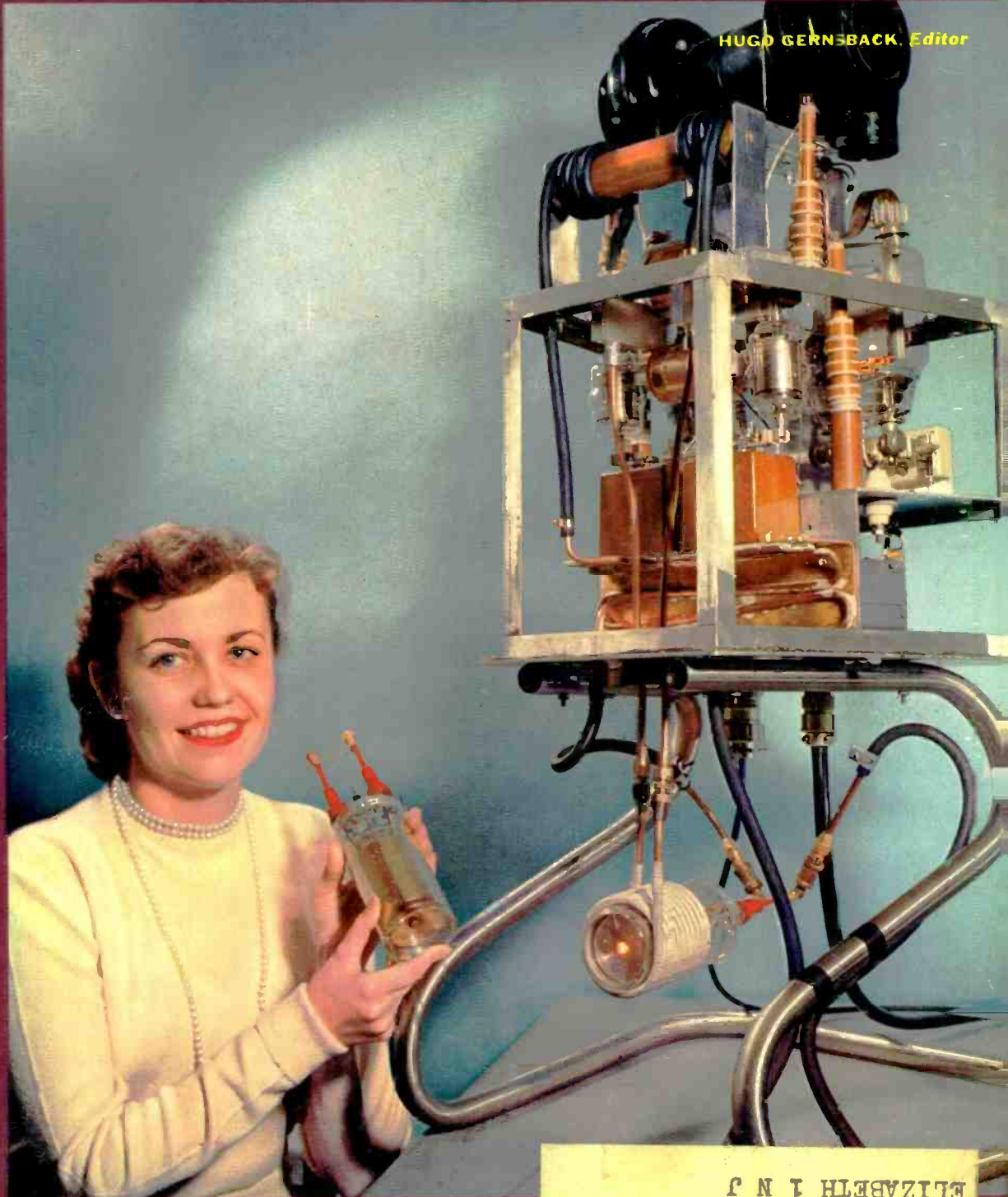

35¢

U. S. and
CANADA

Radio-Frequency Lamp

See page

ELIZABETH I N J
434 FULTON ST
% PAUL S BOLLARO
FULTON I A 3-57

*SERVICEMAN... You're carrying
YOUR REPUTATION in that carton!*



It's more than just a picture tube—
it's performance, dependability and a
guarantee. And your reputation
is riding with it.

Your customers take your word for the
quality of the picture tube you install.
It's easy to assure top performance, long
dependable life and a guarantee that
means something by recommending and
installing Du Mont Twin-Screen Hi-Lite*
picture tubes. Du Mont has been manu-
facturing cathode-ray tubes for 25 years.
All of the experience in engineering,
design, and technical skills compiled
in these 25 years go into the
Twin-Screen Hi-Lite.*

The picture tube is your choice—and your
reputation. Back that reputation with a
reliable Du Mont picture tube.

**The ultimate in aluminized picture tubes.*

*IT'S
DEALERS
CHOICE*

make it...



Cathode-Ray Tube Division ALLEN B. DU MONT LABORATORIES, INC., Clifton, N. J.



I WILL TRAIN YOU AT HOME FOR GOOD PAY JOBS IN RADIO-TELEVISION

J. E. SMITH has trained more men for Radio-Television than any other man. OUR 40TH YEAR.

America's Fast Growing Industry Offers You Good Pay—Bright Future—Security

I TRAINED THESE MEN



"Started to repair sets six months after enrolling. Earned \$12 to \$15 a week in spare time."—Adam Kramlik, Jr., Sunneystown, Pennsylvania.

"Up to our necks in Radio-Television work. Four other NRI men work here. Am happy with my work."—Glen Peterson, Bradford, Ont., Canada.



"Am doing Radio and Television Servicing full time. Now have my own shop. I owe my success to N.R.I."—Curtis Stath, Ft. Madison, Iowa.

"Am with WCOB. NRI course can't be beat. No trouble passing 1st class Radio-phone license exam."—Jesse W. Parker, Meridian, Mississippi.



"By the time I graduated I had paid for my course, a car and testing equipment. Can service toughest jobs."—E. J. Streitenberger, New Boston, Ohio.

Training plus opportunity is the PERFECT COMBINATION for job security, good pay, advancement. In good times, the trained man makes the BETTER PAY, GETS PROMOTED. When jobs are scarce, the trained man enjoys GREATER SECURITY. NRI training can help assure you more of the better things of life.

Start Soon to Make \$10, \$15 a Week Extra Fixing Sets

Keep your job while training. I start sending you special booklets the day you enroll, that show you how to fix sets. Multitester built with parts I send helps you make \$10, \$15 a week extra fixing sets while training. Many start their own Radio-Television business with spare time earnings.

My Training Is Up-To-Date

You benefit by my 40 years' experience training men at home. Well illustrated lessons give you basic principles you need. Skillfully developed kits of parts I send (see below) "bring to life" things you learn from lessons.

AVAILABLE TO **VETERANS** UNDER G.I. BILLS

You Learn by Practicing with Parts I Send



Nothing takes the place of PRACTICAL EXPERIENCE. That's why NRI training is based on LEARNING BY DOING. You use parts I furnish to build many circuits common to Radio and Television. As part of my Communications Course, you build many things, including low power transmitter shown at left. You put it "on the air," perform procedures required of broadcasting operators. With my Servicing Course you build modern Radio, etc. Use Multitester you build to make money fixing sets. Many students make \$10, \$15 week extra fixing neighbors' sets in spare time while training. Coupon below will bring book showing other equipment you build. It's all yours to keep.

The Tested Way To Better Pay!

2 FREE BOOKS SHOW HOW MAIL COUPON



Television Making Good Jobs, Prosperity—Even without Television. Radio is bigger than ever. 115 million home and auto Radios to be serviced. Over 3000 Radio broadcasting stations use operators, technicians, engineers. Government, Aviation, Police, Ship, Micro-wave Relay, Two-Way Radio Communications for buses, taxis, trucks, etc., are important and growing fields. Television is moving ahead fast.

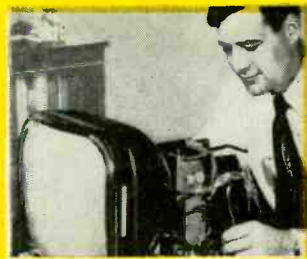

About 200 Television stations are now on the air. Hundreds of others being built. Good TV jobs opening up for Technicians, Operators, etc.

25 million homes now have Television sets. Thousands more are being sold every week. Get a job or have your own business selling, installing, servicing.

Radio-TV Needs Men of Action—Mail Coupon

Act now to get more of the good things of life. Actual lesson proves my training is practical, thorough. 64-page book shows good job opportunities for you in many fields. Take NRI training for as little as \$5 a month. Many graduates make more than total cost of training in two weeks. Mail coupon now. J. E. SMITH, President, National Radio Institute, Dept. 6EF, Washington 9, D. C. OUR 40TH YEAR.

Good for Both—FREE

MR. J. E. SMITH, President, Dept. 6EF, National Radio Institute, Washington 9, D. C. Mail me Sample Lesson and 64-page Book, FREE. (No salesman will call. Please write plainly.)

Name.....Age.....
Address.....
City.....Zone.....State.....
VETS write in date of discharge



RADIO - ELECTRONICS

Formerly RADIO CRAFT • Incorporating SHORT WAVE CRAFT • TELEVISION NEWS • RADIO & TELEVISION*

Hugo Gernsback
Editor and Publisher
M. Harvey Gernsback
Editorial Director
Fred Shunaman
Managing Editor
Robert F. Scott
W2PWG, Technical Editor
Jerome Kass
Associate Editor
I. Queen
Editorial Associate
Matthew Mandl
Television Consultant
Elizabeth Stalcup
Production Manager
Angie Pascale
Editorial Production
Wm. Lyon McLaughlin
Tech. Illustration Director
Sol Ehrlich
Art Director

Lee Robinson
General Manager
John J. Lamson
Sales Manager
G. Aliquo
Circulation Manager
Adam J. Smith
Director, Newsstand Sales
Robert Fallath
Promotion Manager

GERNSBACK PUBLICATIONS, INC.

Executive, Editorial and Advertising Offices, 154 West 14 St., New York 11, N. Y. Telephone ALgonquin 5-7755.

Hugo Gernsback
Chairman of the Board
M. Harvey Gernsback
President
G. Aliquo
Secretary

ON THE COVER

The world's brightest incandescent lamp, with the rf equipment that powers it. The lamp is mounted in the rf coil under the oscillator. A second lamp is held by Miss Jean Phillips of Sylvania Electric Products, Salem, Mass.

Color original by Larry Ankersen.



Average Paid Circulation over 175,000

MAY 1956

Vol. XXVII, No. 5

Editorial

The Elements of Teleducation By Hugo Gernsback 33

Test Instruments

Transistorizing the Dip Meter..... by I. Queen 34
Simplified TV Alignment..... by Robert F. Scott 36
Chroma Probe by Fred W. Rodey 38
AC-DC Probe by I. Queen 39
Inexpensive Capacitor Checker by Norman Kramer 40
The Transigner by Forrest H. Frantz, Sr. 42

Television

The Y Signal in Matrix Operation..... by Robert G. Middleton 44
Troubleshooting AGC Circuits, Part I by Cyrus Glickstein 46
Field Service Experiences with Color TV by Charles W. Rhodes 48
FM-TV Antenna Switch by R. D. Herlocker 49
Industrial TV Is Simple by Edward M. Noll 50
TV Service Clinic by Jerry Kass 53

Audio—High Fidelity

Class B for Transistors by Edwin Bohr 55
The Fluxvalve Pickup by W. O. Stanton 57
High-Fidelity Power Amplifiers by Joseph Marshall 59
Servicing Home Tape Recorders, Part I by Herman Burstein 75
For Golden Ears Only by Monitor 79

Electronics

Radio-Frequency Lamp by S. C. Peek 83
Control Unit for Ventilating Fans..... by Elliott A. McCready 86
Servicing the Watchmaster by Jack Darr 90

Radio

Service the Schools by Yvon O. Johnson 94

DEPARTMENTS

| | | | |
|---------------------------------|-----|---------------------------------|-----|
| Books | 148 | People | 143 |
| Business | 141 | Question Box | 134 |
| Corrections | 92 | Radio Month | 6 |
| Correspondence | 12 | Radio-Electronic Circuits | 137 |
| New Devices | 112 | Technical Literature | 146 |
| New Records | 102 | Technicians' News | 106 |
| New Tubes and Transistors | 118 | Technotes | 127 |
| Patents | 125 | Try This One | 131 |

Associate Member of Institute of High Fidelity Mfrs., Inc.



RADIO-ELECTRONICS, May, 1956, Vol XXVII, No. 5. Published monthly at Mt. Morris, Ill., by Gernsback Publications, Inc. Second-class mail privileges authorized at Mt. Morris, Ill. Copyright 1956 by Gernsback Publications, Inc. All rights reserved under Universal, International and Pan-American Copyright Conventions.

SUBSCRIPTIONS: Address correspondence to Radio-Electronics, Subscription Dept., 404 N. Wesley Ave., Mt. Morris, Ill., or 154 West 14 St., New York 11, N. Y. When ordering a change please furnish an address stencil impression from a recent wrapper. Allow one month for change of address.

SUBSCRIPTION RATES: U. S., U. S. possessions and Canada, \$3.50 for one year; \$6.00 for two years; \$8.00 for three years; single copies 35c. Pan-American countries \$4.00 for one year; \$7.00 for two years; \$9.50 for three years. All other countries \$4.50 a year; \$8.00 for two years; \$11.00 for three years.

BRANCH ADVERTISING OFFICES: Chicago: 1413 Howard St. Tel. ROGers Park 4-8000. Los Angeles: Ralph W. Harker and Associates, 600 South New Hampshire, Tel. DUNkirk 7-2328. San Francisco: Ralph W. Harker and Associates, 582 Market St., Tel. GARfield 1-2481. FOREIGN AGENTS: Great Britain: Atlas Publishing and Distributing Co., Ltd., London E.C. 4. Australia: McGill's Agency, Melbourne. France: Brentano's, Paris 2e. Belgium: Agence et Messageries de la Presse, Brussels. Holland: Tritelron, Heemstede, Greece: International Book & News Agency, Athens. So. Africa: Central News Agency Ltd., Johannesburg; Capetown, Durban, Natal. Universal Book Agency, Johannesburg. Middle East: Steinatz Middle East Agency, Jerusalem. India: Broadway News Centre, Dadar, Bombay #14. Pakistan: Paradise Book Stall, Karachi 3. POSTMASTER: If undeliverable send form 3578 to: RADIO-ELECTRONICS, 154 West 14 St., New York 11, N. Y. *Trademark registered U. S. Patent Office.



National Schools Graduates Prove
**AGE & PREVIOUS EDUCATION
NO BARRIERS TO SUCCESS!**

Get into **HIGH-PAYING
TELEVISION
ELECTRONICS-RADIO!**

Are you
between
17-55?

**LEARN AT HOME
IN SPARE TIME!**

Are you
alert, sincere,
ambitious?



**Master all Phases with our amazing
Shop-Method Home Training & Practical
Equipment! We have trained Thousands
for Big-Pay Jobs! WE WILL TRAIN YOU!**



SET REPAIR IS PROFITABLE!

Our easy Shop-Method Lessons & Manuals cover this Profitable Field! **LOW TUITION.** Opportunity to **EARN AS YOU LEARN!** Free Placement Assistance. Help with technical and personal problems. Send coupon for free **ILLUSTRATED BOOK**, "Your Future in TV-Radio-Electronics."

**OPPORTUNITIES WIDE OPEN IN THESE
AND OTHER SPECIALIZED FIELDS!**

Loudspeaker Systems TV-Radio Service.
Hi-Fi, F.M., Tape Recording Installation-Repair
Your own business Sales and Distribution

COLOR TV & ELECTRONICS

— America's Fields of the Future!
Thousands of **TRAINED TECHNI-
CIANS** will make "small fortunes"
in the next few years.



**ATTENTION DRAFT-AGE
MEN!** National Schools
training prepares you for **HIGHER
RATINGS & PAY GRADES!**

NATIONAL SCHOOLS

TECHNICAL TRADE TRAINING SINCE 1905
Los Angeles 37, Calif. • Chicago: 187 N. La Salle St.
In Canada: 811 W. Hastings St., Vancouver, B. C.

50 YEARS' EXPERIENCE

training Men Like Yourself for Success!

**KNOW YOUR
SCHOOL!** These are the national headquarters of National Schools' famous Shops, Labs & Studios. Get your Home Training and "sheepskin" direct from Los Angeles, recognized as a major "World Center of Electronics"!

**APPROVED FOR G. I. TRAINING
BOTH HOME STUDY AND RESIDENT COURSES OFFERED**

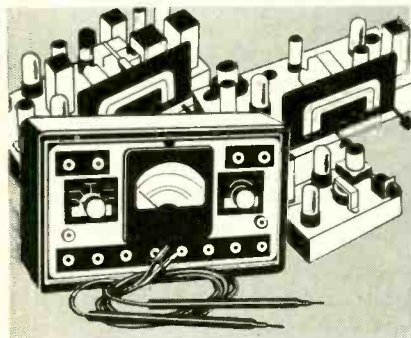

**YOU RECEIVE THIS PROFESSIONAL
MULTITESTER**—a must for every Technician! Also standard parts to build Receivers, Oscillators, Signal Generator, Continuity Checker, Short Wave & Standard Broadcast Superhet Receiver, many other units. All part of your course, all yours to keep. Mail coupon today!

You can't buy
these Valuable
Books, but we
send them **FREE!**
MAIL COUPON!

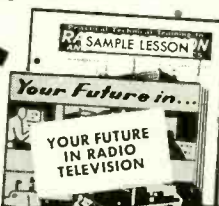

ACT NOW! MAIL NOW TO NEAREST OFFICE!

(mail in envelope or paste on postal card)

NATIONAL SCHOOLS, Dept. RG-56

4000 S. FIGUEROA ST., LOS ANGELES 37, CALIF. or 187 N. LA SALLE ST., CHICAGO 1, ILL.

Please rush **FREE TV-Radio Book & Sample Lesson.** I understand there is no obligation, no salesman will call.

NAME _____ BIRTHDAY _____ 19 _____

ADDRESS _____

CITY _____ ZONE _____ STATE _____

Check if interested **ONLY** in Resident Training at Los Angeles. **VETERANS:** Give date of Discharge _____

TUBES FOR THE
FINEST IN HI-FI

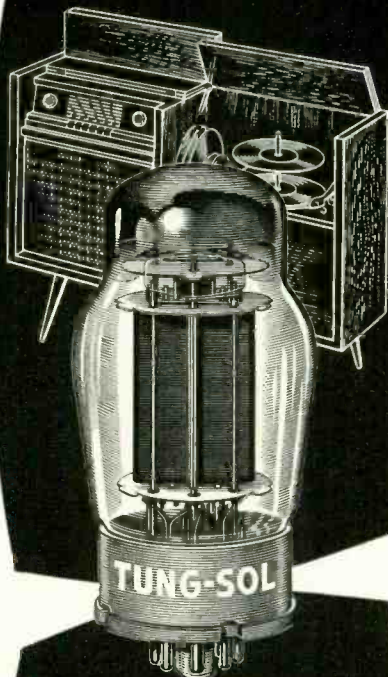

Almost without exception, makers of the finest high-fidelity sets depend upon Tung-Sol Audio Amplifier Tubes to help deliver the performance expected of their products.

Through these tubes—the "5881" and the "6550"—Tung-Sol clearly demonstrates its ability to meet and maintain high-fidelity's critical design requirements in volume production.

This achievement is indicative of the quality and dependability of Tung-Sol Hi-Fi, Radio and TV Tubes . . . products of America's largest independent electron tube manufacturer, Tung-Sol Electric Inc. Newark 4, N. J.

TUNG-SOL
ELECTRON TUBES

Tung-Sol Automotive & Electronic Products

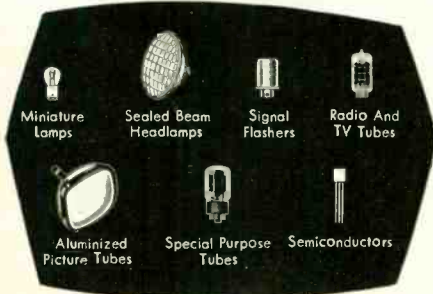

the Radio month



PORTABLE TV RECEIVER has been placed on the market by RCA. Only slightly larger than a table-model radio, the television set uses an 8½-inch picture tube having a 90° deflection angle. The cabinet measures 10¼ inches high, 9¼ inches wide and 12⅞ inches deep. It weighs approximately 22 pounds, making it a true portable.

The portable (shown in the photo

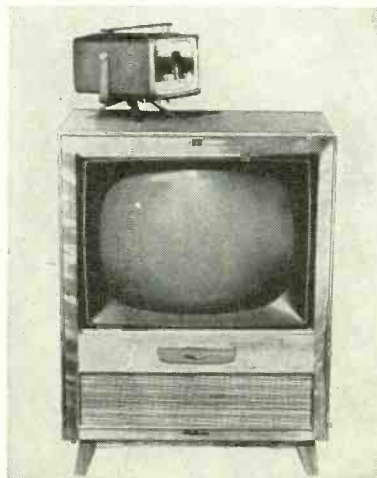

atop a 24-inch model) provides 36 square inches of viewing area. Although the chassis contains only 10 tubes plus the picture tube, 4 crystals, a tube rectifier and a selenium rectifier, it performs 24 tube functions, making it comparable to many larger sets.

BLIND RADIO AMATEUR has received G-E's 1955 Edison Radio Amateur Award. Sightless since birth, Robert W. Gunderson (see photo) operates amateur radio station W2JIO and is editor of the Braille Technical Press, the only monthly electronics magazine for the blind.



Gunderson has invented more than 30 types of special test instruments that open the electronics field to the blind as an occupation. A number of these were described by him in an article written for this magazine (March 1951). His work has been directly responsible for many of the 600 radio operator licenses that have been issued to the blind. The Edison Award, carrying with it a check for \$500, is granted for outstanding ingenuity and sacrifice in using amateur radio in the public interest.

NEW COMMUNITY TV SERVICE has been outlined to the Senate Interstate and Foreign Commerce Committee by Milton J. Shapp, president of Jerrold. Seeking FCC permission to try the plan, Shapp stated that a very large antenna, similar to those used in many community television systems, would be placed on a mountaintop in the Ellensburg, Wash., area. It would receive uhf signals, amplify them and then retransmit through a directional horn type antenna to a receiving point in the valley. The transmitter would operate on 1/10 watt. The received signal is converted to vhf before it is fed into the coaxial cable for home receiver use.

COLOR TELEVISION, computer advances, space electronics, scatter propagation and medical electronics key-noted the 1956 IRE convention held in New York City March 19-23. Attendance was over 40,000, a startling figure for a convention that opened in the midst of the worst blizzard the north-east section of the country has seen for many years.

Some 275 technical papers were read at 55 sessions. Color picture tubes received great attention. Several types, including Philco's mysterious *Apple*, were the subject of papers. Tape recording of color was the subject of five papers. The session on the Earth satellite program attracted more than 2,000 people, jamming the meeting hall and necessitating two overflow meetings. Zworykin, of television fame, told the delegates how computer techniques could improve medical diagnosis.

Exhibitors occupied 714 booths, showing everything from a ½-ton radar antenna to a 3-transistor amplifier with a gain of 70 db, yet occupying a space of only 5/16 x 3/16 x 1/8 inch, smaller than many single transistors. Philco M-1's were the units used in this particular amplifier.

Here's an amazingly effective way to learn TELEVISION RADIO and ELECTRONICS

in spare time AT HOME... or at DTI's big Chicago training center

What will mailing the coupon below do for YOU? First, you will get . . . absolutely free . . . the valuable publication, "89 Ways to Earn Money in Television-Radio-Electronics." You'll find out about scores of exciting, good paying opportunities in this vast, billion-dollar industry—one of the largest, most promising opportunity fields in America today. Best of all, you will find out exactly how you may prepare to get into this good paying work that is so interesting . . . that enables you to start your own business almost "on a shoestring," if you prefer this to a job opportunity.

NOW . . . get EVERYTHING you need!

You'll also see WHY so many employees ask for DeVry graduates. You'll see that DeVry Tech provides every major training advantage you may need . . . in your spare time at home . . . or in our big million-dollar training center in Chicago. In our home program, you (1) learn-by-reading from easy-to-read, well illustrated lessons, (2) learn-by-seeing from home movies—a wonderful advantage that helps make important points picture clear, and (3) learn-by-doing from 16 shipments of Electronic parts, enabling you to work over 300 fascinating projects.



Valuable Test Equipment Helps You "Earn While You Learn" As part of your home laboratory projects, you build and keep a top-quality Vacuum Tube Voltmeter and a 5-inch Oscilloscope—two of the most useful pieces of test equipment. No need to buy this expensive equipment later. Little wonder so many DeVry students tell us they are able to earn all, or a good part of the cost of their training, servicing TV and Radio equipment in their spare time.

MODERN LABORATORIES

If you prefer, get all your preparation in DeVry's new Chicago training center—one of the finest, best equipped of its kind. Write for details!

EMPLOYMENT SERVICE

Upon completing your training, you can get the full benefit of the same effective employment service that has already helped thousands of DeVry graduates to start earning good money.

MILITARY SERVICE

If you are subject to Military service, the information we have should be very helpful to you. Mail coupon today.

89 WAYS TO EARN MONEY IN TELEVISION RADIO ELECTRONICS

MAIL COUPON TODAY!

DeVry Technical Institute
4141 Belmont Ave., Chicago 41, Ill. Dept. RE-5-M

I would like complete facts including
"89 Ways to Earn Money in Television-
Radio-Electronics."

Name _____ Age _____
Address _____ Apt. _____
City _____ Zone _____ State _____

PLEASE PRINT

1013 DTI's Training is available in Canada



DeVry
TECHNICAL INSTITUTE CHICAGO 41, ILLINOIS
"One of America's Foremost Television Training Centers"
Formerly DeForest's Training, Inc.



MERIT, first in exact and universal replacement transformers, yokes, coils—the only manufacturer of transformers, yokes and coils who has complete production facilities for all parts sold under their brand name.

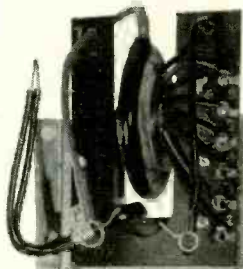

HVO-43 FOR EXACT REPLACEMENT IN AIRLINE, GAMBLESKOGMO, MONTGOMERY WARD, HUDSON, TELECRAFT, ARLINGTON, FAIRMONT, TRUETONE, CORONADO, WELLS-GARDNER... USED IN OVER 25 MODELS AND CHASSIS. Another in the complete MERIT line of exact and universal replacements—the only single source for all your transformer and coil requirements.

Merit

MERIT COIL & TRANSFORMER CORP.
4427 NORTH CLARK STREET
CHICAGO 40, ILLINOIS



THE RADIO MONTH

PORTABLE TV TRANSMITTER has been unveiled by the U.S. Signal Corps. Weighing only 8 pounds, the camera can be easily held in the hands like a home movie camera. The transmitter, complete with built-in power supply, weighs 47 pounds.

Freed for the first time from cumbersome cable connections that harassed him to a source of power, the Signal Corps cameraman (see photo) can now reach previously inaccessible



spots—through forests and hedgerows, over ditches, etc. The camera can also be left unattended in dangerous areas. The voice accompanying the picture is handled by handy-talkie radio. In recent tests pictures a mile away were picked up by the camera and transmitted ½ mile to a television receiver mounted in a jeep, the jeep's electrical system supplying power for the receiver.

The transmitter can operate continuously and unattended for 2 hours from a five-cell rechargeable silver-zinc battery about one-third the size and weight of a car battery. Push-button controls at the jeep permit monitoring several cameras in the field.

TOLL-TV TRIAL has been urged by Federal Communications Commissioner Robert E. Lee. Writing in *Look* magazine, he said he was convinced that endless legal procedures, hearings and studies will never answer the questions of whether the public wants pay-as-you-see TV and will support it.

Lee proposed that the FCC adopt the following program: Approve subscription TV on a broad basis, leaving it up to the individual to choose the system he wishes to use; apply some temporary restrictions to toll TV, such as limiting it initially to uhf stations; permit the trial period for toll TV to continue long enough to test public reaction truly; permit stations to drop toll TV if they find it does not fill a market need in their own area.

He stated further that these views are strictly his own and do not reflect the opinion of the commission, which

(Continued)

Calendar of Events

79th Convention of Society of Motion Picture & Television Engineers, April 29–May 4, Hotel Statler, New York City.

1956 Electronic Components Symposium, May 1–3, Department of Interior Auditorium, Washington, D. C.

1956 Electronic Parts Distributors Show, May 21–24, Conrad Hilton Hotel, Chicago. (A closed show for distributors, manufacturers and their representatives. RADIO-ELECTRONICS will exhibit in Room 632.)

RETMA Symposium on Reliable Applications of Electron Tubes, May 21–22, Irvine Auditorium, University of Pennsylvania, Philadelphia, Pa.

presently has the subject under consideration.

GIANT RADIO TELESCOPE capable of detecting celestial objects at distances close to the limits of the observable universe will be constructed near Delaware, Ohio. Work on the super radio telescope is scheduled to start late this spring with a grant of \$48,000 from the National Science Foundation, Washington, D.C., to the Ohio State University electrical engineering department. The site is near Perkins Observatory, operated jointly by Ohio Wesleyan and Ohio State universities.

The reflecting type radio telescope will be about 700 feet long and 75 feet high, making it the largest of its kind in the world. Actually, the telescope is a giant radio antenna which receives radio emanations from the heavens much as an optical telescope receives light waves.

The antenna system will include a parabolic reflector and a flat, tiltable reflector to deflect radio waves from the sky into the curved portion, which in turn will focus the waves into a large metal horn. The horn will funnel the waves into an ultrasensitive receiver to be housed in a small building.

THREE NEW TV STATIONS have gone on the air since our last report: KINY-TV Juneau, Alaska..... 8
WDMJ-TV Marquette, Mich..... 6
WAST Hagaman, N. Y..... 29

WIRK-TV West Palm Beach, Fla., channel 21, and WTAO-TV Cambridge, Mass., channel 56 have gone off the air.

KULA-TV, Honolulu, T. H., channel 5, will change its call letters to KTCA, effective June 1.

COSMIC RAY BOMBARDMENT, the greatest ever recorded on earth, began pouring on the earth around Feb. 22, following a tremendous flare on the surface of the sun which scientists estimated was equal in force to 1,000,000 hydrogen bombs.

They said it was the first clear evidence that radio waves were somehow associated with the production of cosmic radiations. The bombardment interrupted network radio communications between Rome and London and New York and crippled shortwave communications throughout the world. END

your source of finest TV and Radio Tubes is

first in transistors...

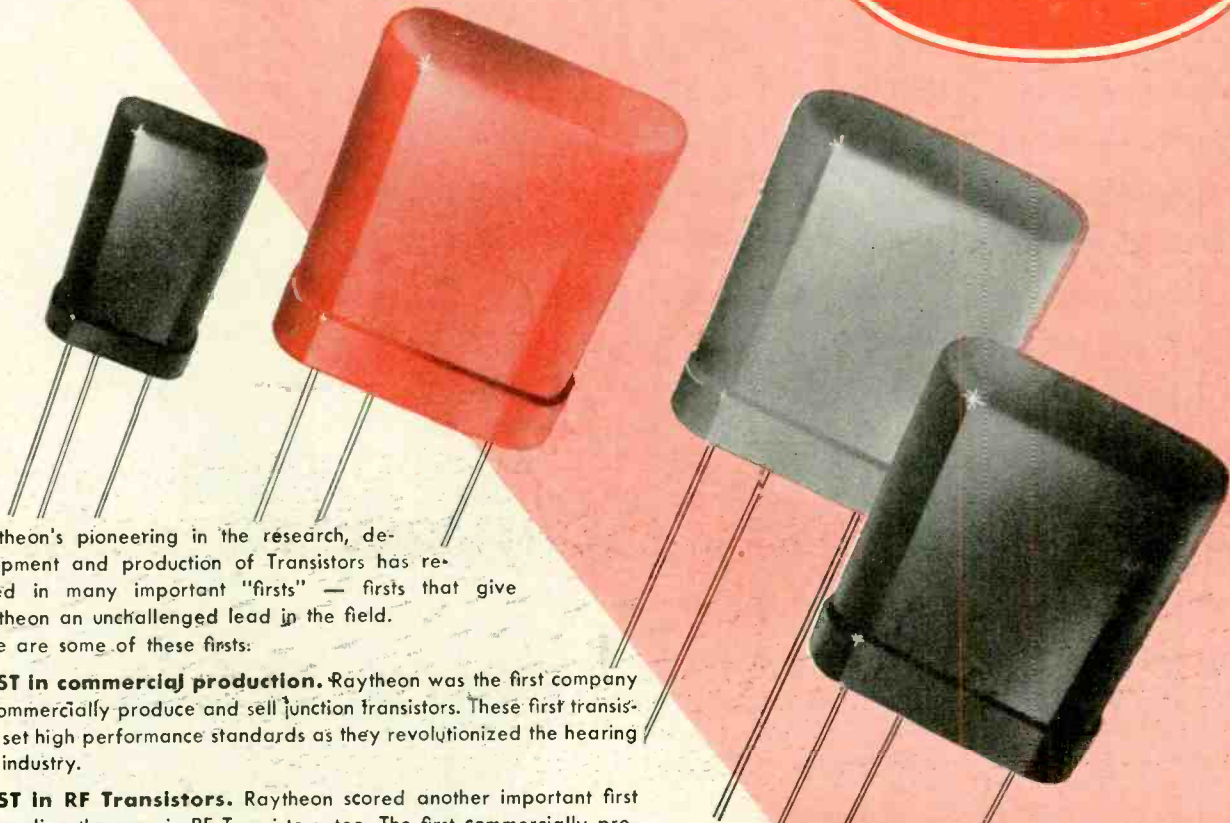

Raytheon's pioneering in the research, development and production of Transistors has resulted in many important "firsts" — firsts that give Raytheon an unchallenged lead in the field. Here are some of these firsts:

FIRST in commercial production. Raytheon was the first company to commercially produce and sell junction transistors. These first transistors set high performance standards as they revolutionized the hearing aid industry.

FIRST in RF Transistors. Raytheon scored another important first by leading the way in RF Transistors, too. The first commercially produced RF Transistors — Raytheons — are revolutionizing the portable radio industry, and are being used in computers and communication equipment. Many major manufacturers of portable radios use these Raytheon RF Transistors and all "hybrid" portables use either Raytheon Transistors, Raytheon Subminiature Tubes or a combination of both.

FIRST in PNP Silicon Transistors. Raytheon alone makes a line of PNP Silicon Transistors that fills the need for transistors that will operate at high temperatures.

FIRST Major Manufacturer to Break the Dollar Barrier. A most important first to you — Raytheon is the first major supplier to achieve such high production and product acceptance of their transistors that one of the line could be priced at less than a dollar — Raytheon quality transistors range in price from 99¢.

At Raytheon more than 100 engineers and scientists, plus nearly 1400 other employees are devoted to a single task — the design, development and production of the finest and best in transistors and diodes. To help them work more efficiently, and to meet increasing production schedules Raytheon recently added facilities totaling three acres of engineering and manufacturing space to its Semiconductor Division.

Raytheon Tube Distributors from coast to coast stock and recommend Raytheon Transistors.

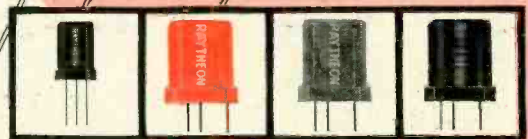

ACTUAL SIZE

This huge plant (3 acres of floor space) has just been added to Raytheon's Semiconductor Division — to help meet the ever increasing demands for Raytheon Transistors.

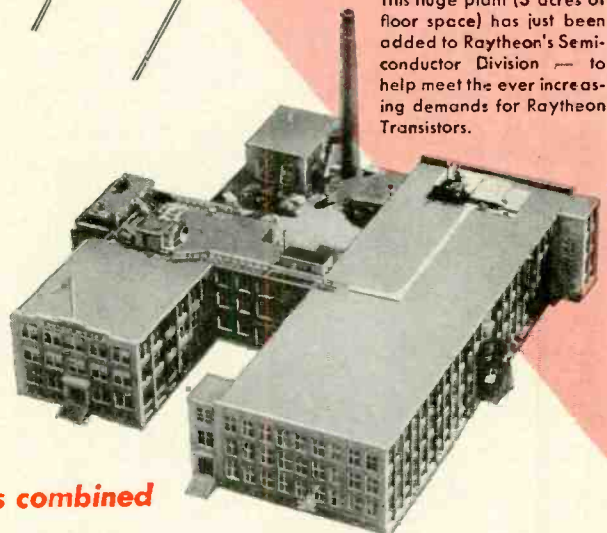

RAYTHEON TRANSISTORS

more in use than all other makes combined



RAYTHEON MANUFACTURING COMPANY

Receiving and Cathode Ray Tube Operations

Newton, Mass. • Chicago, Ill. • Atlanta, Ga. • Los Angeles, Calif.

Raytheon makes all these: Receiving and Picture Tubes, Reliable Subminiature and Miniature Tubes, Semiconductor Diodes and Transistors, Nucleonic Tubes, Microwave Tubes.

Visit Raytheon Booth No. 4 at the ELECTRONICS PARTS DISTRIBUTORS SHOW May 21-24—Badges issued only in advance—No registration at the show
MAY, 1956

The Facts

PROVE...

"STAMINIZED" ASTRON CAPACITORS
ARE THE *toughest* EVER
DEVELOPED...

Better designs, Better materials, Better techniques
are combined to create
EXTRA-RUGGED, EXACT REPLACEMENT
capacitors for every servicing need.

Talk about performance!
Service Technicians will tell you
"Staminized" Astron Capacitors
make sets operate better-than-new.

Judge for yourself!

Install "Staminized" Astron Capacitors
- - the verdict will be in your favor.

Ask your jobber for them today.

THE BEST YET !



"SM" TWIST-PRONG



"SM" MINIMITE TUBULARS



"SM" CARDBOARD TUBULARS



BLUE-POINT[®]
MOLDED PLASTIC PAPER TUBULARS

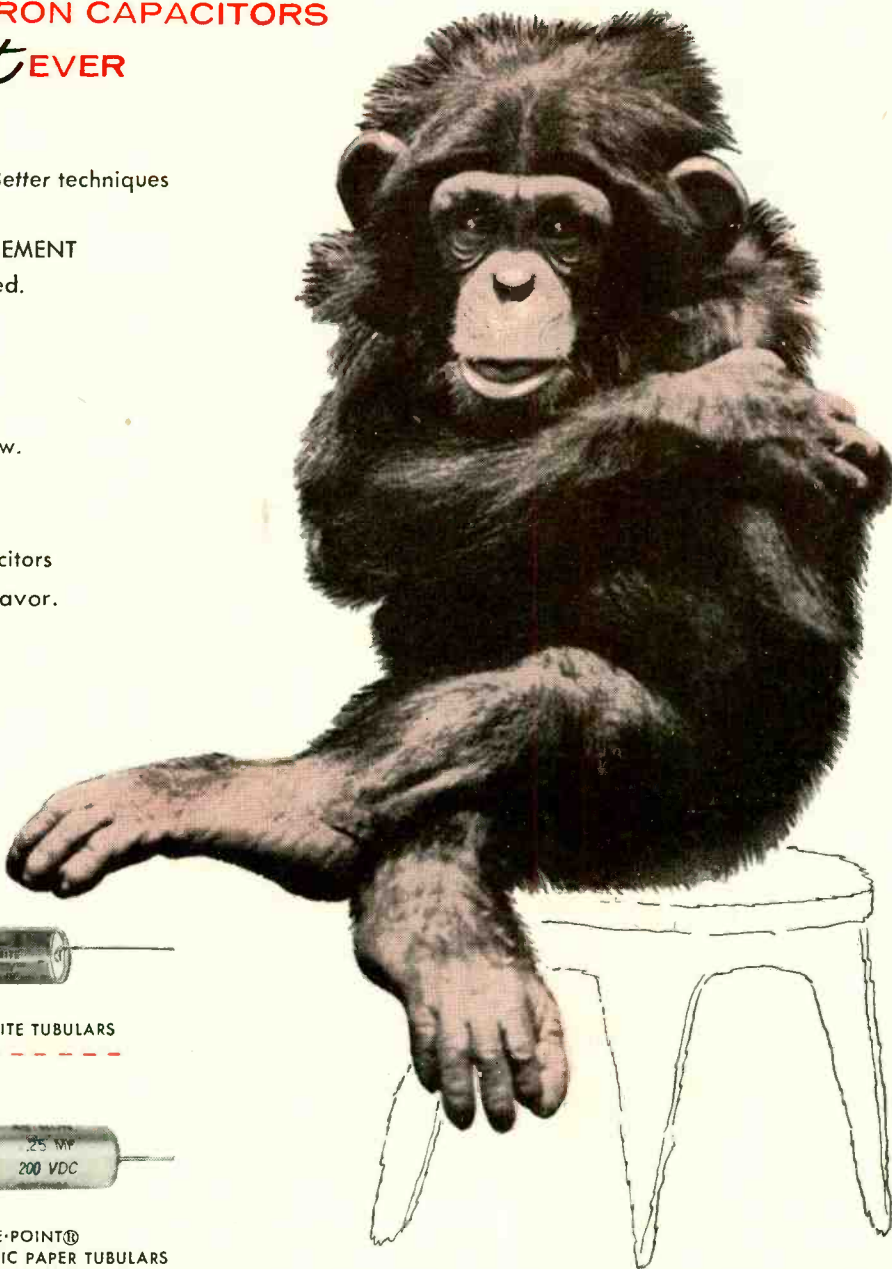

FREE... ASTRON'S NEW SERVICING AID
Replacement Catalogue AC-4D. Write for your copy — Now!

ASTRON

C O R P O R A T I O N

WEST COAST WAREHOUSE: 9041 West Pico Blvd., Los Angeles
EXPORT DIVISION: Rocke International Corp., 13 East 40th St., N. Y., N. Y.
IN CANADA: Charles W. Pointon, 6 Alcina Ave., Toronto, Ontario



255 GRANT AVENUE, EAST NEWARK, N. J.

VISIT US AT BOOTH 775
MAY PARTS SHOW, CHICAGO
MAY 21-24

*Safety Margin Construction — An Astron Trademark

RADIO-ELECTRONICS

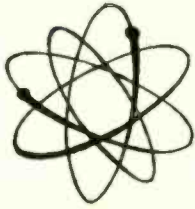

WHERE WILL YOU BE IN ELECTRONICS

6 MONTHS FROM TODAY?

Get this
valuable booklet



FREE

TELLS HOW...

Add Technical Training to your
practical experience...

GET YOUR FCC LICENSE IN A HURRY!

Then use our amazingly effective
JOB FINDING SERVICE

Employers make job offers like these to our
trainees every month...

Transcontinental Airline: "American Airlines is very much interested in receiving applications from CIRE trainees. We have immediate need for technicians in many cities."

West Coast Manufacturer: "We are currently in need of men with electronics training or experience in radar maintenance, and we would appreciate if you will refer interested persons to us."

WE GUARANTEE

TO TRAIN AND COACH YOU AT HOME
IN SPARE TIME UNTIL YOU GET

YOUR FCC LICENSE

If you have had any practical experience—
Amateur, Army, Navy, Air Force Radio repair,
experimenting, etc.

HERE IS YOUR GUARANTEE

If you fail to pass your Commercial License exam
after completing our course, we guarantee to
continue your training without additional cost of
any kind, until you successfully obtain your Commercial
license.

TELLS HOW—

Our Amazingly Effective **JOB-FINDING SERVICE**
Helps CIRE Trainees Get Better Jobs

Here are a few recent examples of Job-Finding results:

ELECTRONICS TECHNICIAN

"I am now employed by the Collins Radio Company
as a Lab Technician. (This job was listed in your
bulletin.) I have used the information gathered from
your course in so many ways and I know that my
training with CIRE helped me a great deal to obtain
the job."
Charles D. Sindelar, Cedar Rapids, Iowa

AIRLINES

"I replied to the Job Opportunities you sent me and
I am now a radio operator with American Airlines.
You have my hearty recommendation for your training
and your Job-Finding Service."
James A. Wright, Beltsville, Md.

INDUSTRIAL ELECTRONICS

"Upon my discharge from the Navy I used your
Job-Finding Service and as a result I was employed
by North American Aviation in electronic assembly
(final checkout)."
Glen A. Furlong, Fresno, Calif.

MOBILE SERVICING

"I am now employed by the Permian Basin Communications, Inc. and now manage the service shop in
Odessa, Texas for Motorola 2-way communication
equipment. I got the job through your Job Finding
Services. My sincere thanks."
Robert W. Cook, Odessa, Texas

HERE'S PROOF FCC LICENSES ARE OFTEN SECURED IN A FEW HOURS OF
STUDY WITH OUR COACHING AT HOME IN SPARE TIME

| Name and Address | License | Time | An Approved Member |
|--|-----------|----------|--------------------------|
| A/1C Ronald H. Person, St. Louis 20, Mo..... | 1st Class | 25 weeks | |
| Milton L. Geisler, ET3, FPO, San Francisco, Calif..... | 1st Class | 26 weeks | |
| Marvin F. Kimball, Lafayette, Ind..... | 2nd Class | 21 weeks | |
| L. M. Bonino, Harlington AFB, Tex..... | 2nd Class | 16 weeks | |
| John E. Hutchison, Bluefield, W. Va..... | 1st Class | 27 weeks | |

CIRE IS THE ONLY HOME STUDY SCHOOL WHICH SUPPLIES FCC-TYPE
EXAMINATIONS WITH ALL LESSONS AND FINAL TESTS. Your FCC Ticket
is recognized by employers as proof of your technical ability.

**CLEVELAND INSTITUTE OF
RADIO ELECTRONICS**

4900 EUCLID BLDG.
CLEVELAND 3, OHIO

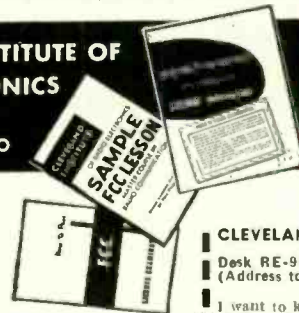

Get All 3 FREE

MAIL COUPON NOW

CLEVELAND INSTITUTE OF RADIO ELECTRONICS

Desk RE-91, 4900 Euclid Bldg., Cleveland 3, Ohio
(Address to Desk No. to avoid delay)

I want to know how I can get my FCC ticket in a minimum
of time. Send me your FREE booklet, "How to Pass FCC
License Examinations" (does not cover exams for Amateur
License), as well as sample FCC-type lesson and the
amazing new booklet, "Money-Making FCC License Infor-
mation."

PLEASE PRINT CLEARLY

Name..... Age.....

Address.....

City..... Zone..... State.....

For prompt results, send air mail. Special tuition rates to
members of the U. S. Armed Forces. Electronic Training
also available to Canadian Residents.

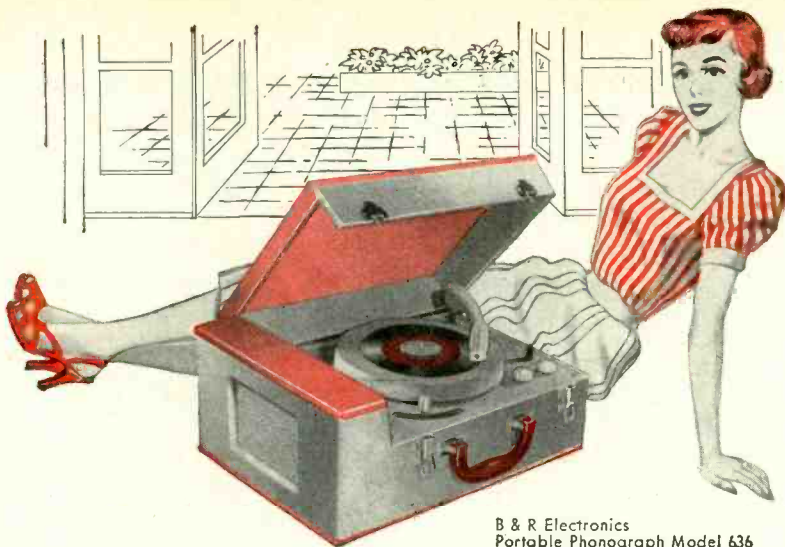

B & R Electronics
Portable Phonograph Model 636

B. & R. Electronics Co. ... prominent manufacturer
of high quality Portable Phonographs

CHOOSES GENERAL INDUSTRIES

Smooth Power

PHONOMOTORS

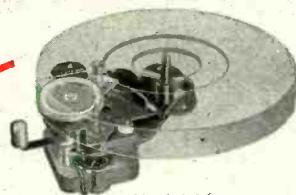

Model 55
Three speed motor

B & R Electronics specifies GI phonomotors as original equipment in its line of quality three-speed, portable phonographs for a good reason. They have found that they can rely on the quality, performance, and economy of GI motors. They have learned that they can rely on GI for prompt, on-schedule shipments so necessary in keeping production lines flowing smoothly. They know, too, that for trouble-free operations, GI motors are the one best choice. When you need phonomotors for original equipment or replacement, take a tip from B & R Electronics. Specify the best—Specify GI.

Other General Industries AC induction type motors for applications ranging from 1/40 HP to 1/1100 HP.

Write today for specifications and quantity-price quotations.



THE GENERAL INDUSTRIES CO.

DEPT. GR • ELYRIA, OHIO

Look what RADIO-ELECTRONICS

has in store for you in the months ahead . . .

- ELECTRONICS IN THE AIR FORCE
By Aaron Nadeil
- COLOR DEMODULATOR ALIGNMENT
By Walter J. Cerveny
- TRANSISTOR RADIOS—A SURVEY
By I. Queen
- A UNIVERSAL EXPERIMENTAL CHASSIS
By Kurt Freund
- WAVEFORM GENERATOR
By Ed Bukstein
- AUDIO TRANSFORMERS
By Norman H. Crowhurst
- UNDERSTANDING COLOR BAR GENERATORS
By Robert G. Middleton
- TUBE-TESTER SETTINGS FOR NEW TYPES
By Basil C. Barbee
- CIVIL-DEFENSE RADIATION METER
By E. N. Kaufman
- HIGH-GAIN TRANSISTOR AUDIO AMPLIFIER
By Joseph Braunbeck
- PHOTOELECTRIC LIGHT COMPUTER
By John R. Satter

The JUNE issue of RADIO-ELECTRONICS goes on sale May 24th at better parts distributors and newsstands.

SUBSCRIPTION RATES

One year \$3.50 Two years \$6.00
Three years \$8.00

RADIO-ELECTRONICS

154 West 14 St.
New York 11, N.Y.

Correspondence



SYNTHETIC MUSIC

Dear Editor:

On receiving the March issue of RADIO-ELECTRONICS my attention was, naturally, captured by the article "Synthetic Music via Electronics," by Sol Heller.

I have for some months now, had the RCA Victor LP record *L.M. 1922 Experimental* which demonstrates many of the capabilities of this electronic music synthesizer. This, however, is unfortunately not mentioned in Mr. Heller's article. Anyone interested in this subject should by all means get the record for it demonstrates clearly the advantages and at least the present limitations of this method for production of music without performing artists. No doubt many improvements will be made so that most if not all of the subtle artistry of performing artists will be well simulated. The practical aspects of this development may, however, be impeded from unexpected quarters—for example, Mr. Petrillo!

My own interest might best be expressed by a prophetic quotation of the two concluding paragraphs of my 1936 paper "Electronic Music and Instruments," published in *Proceedings of the IRE*, Vol. 24, No. 11, pp. 1427-63:

"The ideal instrument is one which can make any sound known, unknown or conceivable; to do this we must provide a generator for periodic vibrations embracing the whole audio spectrum of frequencies. We must be able to select from this generator at will any desired single frequency or many single frequencies simultaneously, whether harmonically or inharmonically related or whether in narrow or wide continuous bands. We must further be able to emit these frequencies in any desired sound amplitudes and envelope shapes, even though, in a given sound, all the components require different shapes of envelope. We must be able to control the emission of these sounds by some suitable playing technique and apparatus.

"With such an apparatus we shall be able to synthesize any possible sound, continuous, damped, transient, musical or nonmusical, for we have all the elements of sound and means for putting together any desired combination of these elements in any desired time-amplitude relationship."

BENJAMIN FRANKLIN MIESSNER
Miessner Inventions, Inc.
Morristown, N. J.

damaged, weather-worn, obsolete!

6 out of 10 need replacement now!

replace them with
CHANNEL MASTER
TV ANTENNAS

**FIVE ALL-CHANNEL FAVORITES —
TOPS FOR REPLACEMENT!**

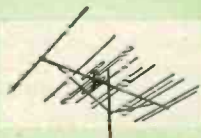

SUPER RAINBOW model no. 331

Still the most sensitive all-channel antenna made! Other popular Rainbow models also available.

"K.O." model no. 1023

(broad band)

Knocks out "reflection blinds" with the highest front-to-back ratios ever recorded!

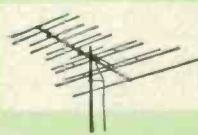
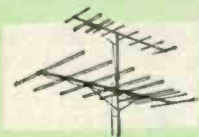

TRAILBLAZER model no. 335

Extra elements provide extra performance at no extra cost!

New **LANCER** model no. 337

Popular fringe-area installation — new rugged powerful design. Also available: Super Lancer, and new economy "Challenger" model.



SUPER FAN model no. 313A

The finest of Fan-antennas — superior both electrically and mechanically!

Here's the greatest profit opportunity in TV today!

The "Golden Age" of antenna replacement is here! Time has finally caught up with millions of older TV antennas that no longer provide good reception.

A national survey shows that 65% of all TV set-owners in established areas are not getting the picture quality they should be getting. **THEY NEED NEW ANTENNAS!** And you can profit in a big way by replacing now with a powerful, new CHANNEL MASTER installation!

YOUR BEST REPLACEMENT BUY is Channel Master, America's most widely advertised and merchandised antenna line. Channel Master provides you with the most advanced electrical designs, the scoundest construction, the easiest, fastest installation.

See your Channel Master distributor



CHANNEL MASTER CORP.

ELLENVILLE, N. Y.

WORLD'S LARGEST MANUFACTURER OF TV ANTENNAS AND ACCESSORIES

LIKES OUR ARTICLES

Dear Editor:

"Those Deadly Intermittents," on page 98 of RADIO-ELECTRONICS, December, 1955, made very refreshing reading on this side of the Atlantic. It is indeed encouraging to learn that dealers and service technicians on your side experience the impatience and irritation of viewers when their TV gives out on them. *Televitis* is a terrible modern complaint which calls on all one's resources to combat. It is a boost to self-confidence to learn that a similar technique to what we have developed here is successful in dealing with service complaints. Some unenlightened people look askance on practices which start with "bottle-tapping" and customer interrogation, but surely this seems to be the quickest and surest way of getting at the trouble.

F. E. DYER

Sheffield, England

A CASE AGAINST LICENSING

Dear Editor:

May I answer John Wheaton's article titled, "Licensing—Bad or Good," which appeared in your January issue? I am opposed to licensing in any form! This subject has occupied my attention the past 4 years and all the statutes which Mr. Wheaton mentions are in my file and have been read by me carefully. What he failed to mention—and most certainly it should be highlighted—is one thing all these laws have in common—punitive and vindictive features. They hold the threat of heavy fines and imprisonment over those who come under their control and contain license-revoking powers.

As a small, independent shop owner, it has always been my belief that "He governs best who governs least." There are of course those vocations like law, dentistry and medicine whose complexity and impact on our daily life require that those who follow them need to give proof of their fitness and training. (It would make interesting reading indeed if some people could tell of their experiences at the hands of these licensed gentry.)

But why, why, this insistent demand for licensing radio and TV men? Is it really to exclude the part-time operator, the incompetent; to shackle and get rid of the chiseler and the cheat? Or because of so-called excessive charges?

In the spring of 1953, when the art was newer and I was gathering material to fight a licensing attempt in Illinois, I wrote to Better Business Bureaus in representative cities asking their experience about television complaints against service technicians. As a comparison I wrote in the spring of 1955 to these same BBB offices and received the information that complaints generally had diminished sharply; that the public was pleased with the technical abilities of service technicians, and that charges generally were not excessive. You may also re-

(Continued on page 18)

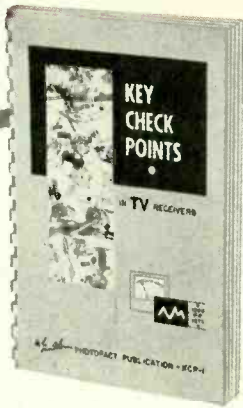

HELPS YOU EARN MORE ON TV SET REPAIRS

Only \$2.00

SAMS BOOKS
keep you ahead in
ELECTRONICS

"KEY CHECK POINTS IN TV RECEIVERS"

Prepared by the Howard W. Sams engineering staff. Shows voltages and actual photos of waveforms (with amplitude for each) present at key points in a normally operating receiver. Based on analysis of TV models produced in late 1951 and in 1952. Covers many applications for general TV service work, including time-saving information showing the technician (1) how to make quick tests at key points to determine the section in which the trouble lies and (2) after making the particular repair, how to check the overall operation of the receiver to insure against callbacks. Complete with handy quick-reference index. An invaluable book—helps you save time and earn more. 182 pages; 5½ x 8½"; illustrated. Postpaid, only \$2.00

USE HANDY ORDER FORM BELOW

Sams books cover every phase of Electronics for the service technician, engineer, student or experimenter. Listed below are a few of the many valuable Sams books available at electronic parts distributors and leading book stores.

USE THIS ORDER FORM

KEY CHECK POINTS IN TV RECEIVERS \$2.00

Transistors—Their Application in Television-Radio-Electronics. The first practical, complete book on transistors; explains circuitry, installation, testing techniques, theory and servicing. 100 pages; 5½ x 8½" illustrated. \$1.50

Fundamentals of Color Television. An up-to-date explanation of Color TV, its theory, operation, installation and servicing, with photos, block diagrams and schematics. 224 pages; 5½ x 8½"; illustrated. \$2.00

Servicing TV Sweep Systems. Describes the operation, circuit function and circuit variation of vertical and horizontal sweep systems common to most TV receivers. Tells how to analyze circuits; trouble-shoots for you. 212 pages; 5½ x 8½", illustrated. \$2.75

Technical Dictionary. Over 4,000 definitions of radio, television, electronic, electrical and radar terms. Includes valuable charts, graphs, diagrams and symbols. Flexible binding for "on-the-job" use. 160 pages; 5½ x 8½" \$2.00

TV Test Instruments. Tells how each instrument operates, how to use it in actual servicing. Covers Vacuum Tube VM's, AM Signal Generators, Sweep Signal Generators, Scopes, Video Signal Generators, Field Intensity Meters and Voltage Calibrators. 180 pages; 8½ x 11" \$3.00

The Recording and Reproduction of Sound. Oliver Read's best-seller on audio and Hi-Fi. Covers theory of sound, basic recording methods, phono reproducers, amplifiers, speakers and enclosures, attenuators and mixers, tuners, home music and P.A. systems. 810 pages; 6 x 9" \$7.95

Tape Recorders—How They Work. Explains recording theory, tape characteristics, motorboard mechanisms, drive motors, amplifiers, magnetic heads, volume indicators, equalization circuits—covers everything you want to know about recorders. 176 pages; 5½ x 8½". \$2.75

NOW AVAILABLE

RECORD CHANGER SERVICE MANUAL, VOL. 7

Includes diagrams, photos, "exploded" views, parts lists and service data for 7 record changers and 12 tape recorders produced during 1954 and 1955. 288 pages; 8½ x 11" \$3.00

Vol. 6. 20 models; 1953-54; 288 pages \$3.00

Vol. 5. 32 models; 1952-53; 288 pages \$3.00

Vol. 4. 38 models; 1950-51; 288 pages \$3.00

Vol. 3. 44 models; 1949-50; 288 pages \$3.00

Vol. 2. 45 models; 1948-49; 432 pages \$4.95

Auto Radio Service Manuals

Vol. 5. Presents complete, accurate service data, schematics, parts lists and photos based on actual laboratory analysis of 87 auto radio models produced during 1954-55. 288 pages; 8½ x 11" \$3.50

Vol. 4. 48 models; 1953; 288 pages. \$3.00

Vol. 3. 80 models; 1950-52; 288 pages \$3.00

Vol. 2. 90 models; 1948-50; 288 pages \$3.00

Vol. 1. 100 models; 1946-49; 396 p. \$4.95

So You Want to Be a Ham. Tells you what you need to know about getting your license and acquiring equipment. Covers such subjects as: Conquering the Code; Getting Your Ticket; Going on the Air; Electronics as a Career, etc. 196 pages; 5½ x 8½"; illustrated. \$2.50

There is an authoritative Sams book on virtually any Electronic subject in which you're interested. Check below for FREE Book List describing all Sams books.

Send Book List



Look for
SAMS BOOKS
on the
"Book Tree"
at your Parts
Distributor

HOWARD W. SAMS & CO., INC.

Order from your Parts Jobber today, or mail to Howard W. Sams & Co., Inc., Dept. 2-E6, 2201 East 46th St., Indianapolis 5, Indiana.

Send books checked above. My (check) (money order) for \$ is enclosed.

Name

Address

City Zone State

(outside U.S.A. priced slightly higher)

An Invitation . . .

To men who want to "go places" in TV SERVICING

Find out about this NEW,
ALL-PRACTICE WAY
of becoming a Professional
TV SERVICEMAN

If you have some Radio or Television experience, or if you know basic Radio-Television principles but lack experience—NRI's new Professional Television Servicing course can train you to go places in TV servicing. This advertisement is your personal invitation to get a free copy of our booklet describing this training in detail.

Learn-by-Doing "All the Way"

This is 100% learn-by-doing, practical training. We supply all components, all tubes, including a 17-inch picture tube, and comprehensive manuals covering a thorough program of practice. You learn how experts diagnose TV defects quickly. You see how various defects affect receiver performance—picture and sound; learn causes of defects, accurately, easily, and how to fix them. You do more than just build circuits. You get practice recognizing, isolating, and fixing innumerable troubles.

You get actual experience aligning TV receivers, diagnosing the causes of complaints from scope patterns, eliminating interference, using germanium crystals to rectify the TV picture signal, obtaining maximum brightness and definition by properly adjusting the ion trap and centering magnets, etc. There isn't room on this or even several pages of this magazine to list all the servicing experience you get.

UHF & COLOR TV Making New Boom

Installing front-end channel selector strips in modern UHF-VHF Television receivers and learning UHF servicing problems and their solution is part of the practice you get. To cash in on the coming color TV boom you'll need the kind of foundation in knowledge and experience this training gives.

Get Details of New Course Free

Once again—if you want to go places in TV servicing, we invite you to find out what you get, what you practice, what you learn from NRI's new course in Professional Television Servicing. See pictures of equipment supplied, read what you practice. Judge for yourself whether this training will further your ambition to reach the top in TV servicing. We believe it will. We believe many of tomorrow's top TV servicemen will be graduates of this training. Mailing the coupon involves no obligation.

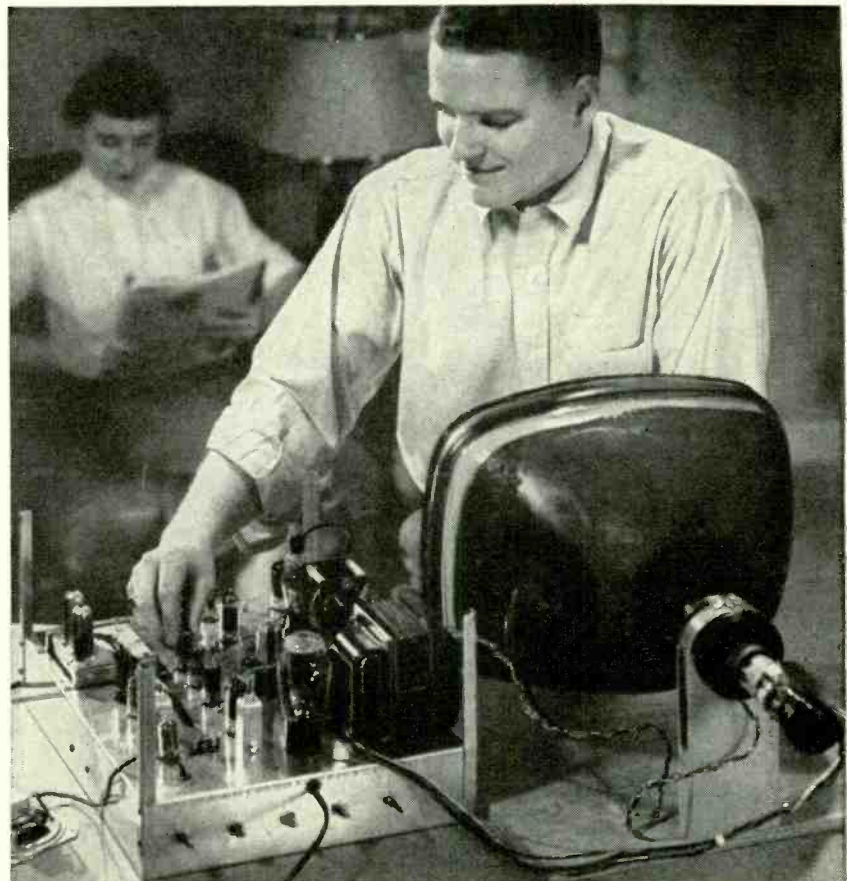

Train at home easily, quickly, for TV's top servicing jobs. NRI's Professional Television Servicing course includes a 17-inch picture tube and all other tubes and components to build a complete TV Receiver, Oscilloscope, Signal Generator, H.F. Probe. Complete training, including all equipment, available now for a low introductory price—under \$200 on easy terms.



National Radio Institute, Dept. 6EFT
16th and U Sts., N.W., Washington 9, D. C.

Please send my FREE copy of "How to Reach the Top in TV Servicing." I understand no salesman will call.

Name.....Age.....

Address.....

City.....Zone.....State.....

APPROVED MEMBER NATIONAL HOME STUDY COUNCIL

At Last... and for the first time!

A PICKUP FOR CALIBRATING RECORDS!

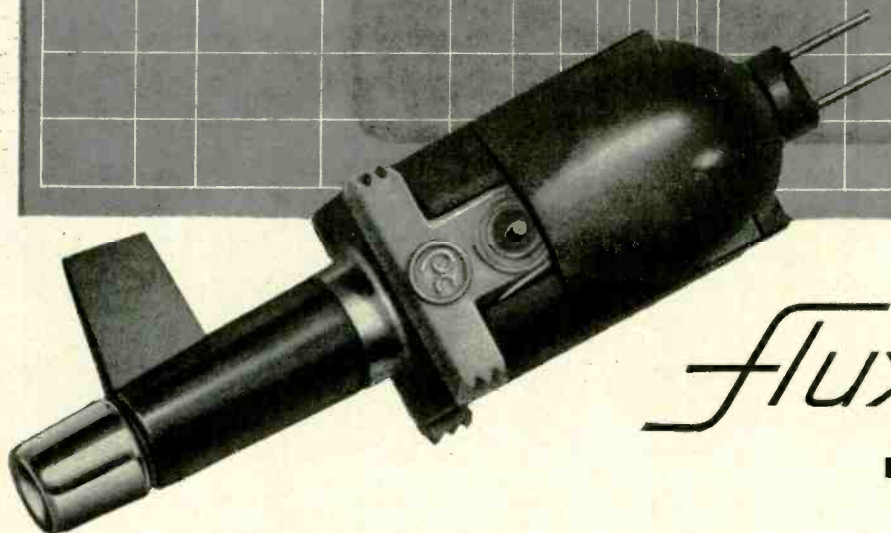
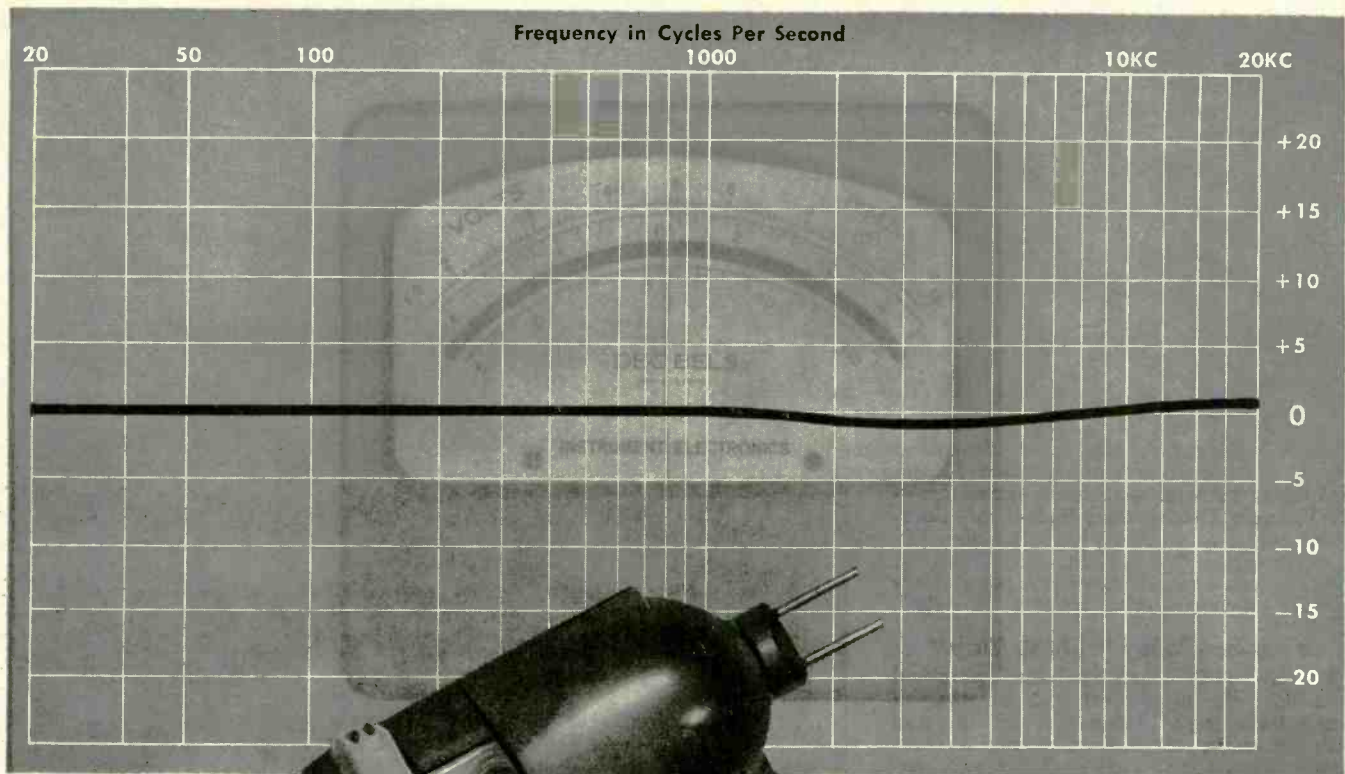

THE *Fluxvalve* PICKUP

Important as it is to the recording industry, the **FLUXVALVE** offers values never before available to thousands of record playing enthusiasts!

- *Very Wide Range (VWR)*
- *Unequaled transient response*
- *Long record and stylus life*
- *Low overall distortion*
- *Hermetically sealed*
- *Easily replaceable styli **

* Less than 1 mil stylus on special order

THE FLUXVALVE PICKUP was originally developed for professional applications, particularly recording studios where accurate correlation between lacquer, master and pressings is essential, and has always been difficult. Now with the **FLUXVALVE** magnetic turn-over pickup with which to make precise and *reproducible* record-measurements, a vital control step is simplified.

For a new listening experience, ask your dealer to demonstrate the new FLUXVALVE . . . words cannot describe the difference . . . but you will hear it!



PICKERING & CO., INC. OCEANSIDE, N. Y.

Professional Audio Components

"For those who can hear the difference"

... Demonstrated and sold by Leading Radio Parts Distributors everywhere. For the one nearest you and for detailed literature: write Dept. P-10 EXPORT: AD. AURIEMA, INC., 89 BROAD ST., NEW YORK / CANADA: CHARLES W. POINTON LTD., 6 ALCINA AVE., TORONTO

free

ALLIED'S 1956 value-packed 324-PAGE CATALOG

the only COMPLETE catalog for everything in TV, Radio, Hi-Fi and Industrial Electronics

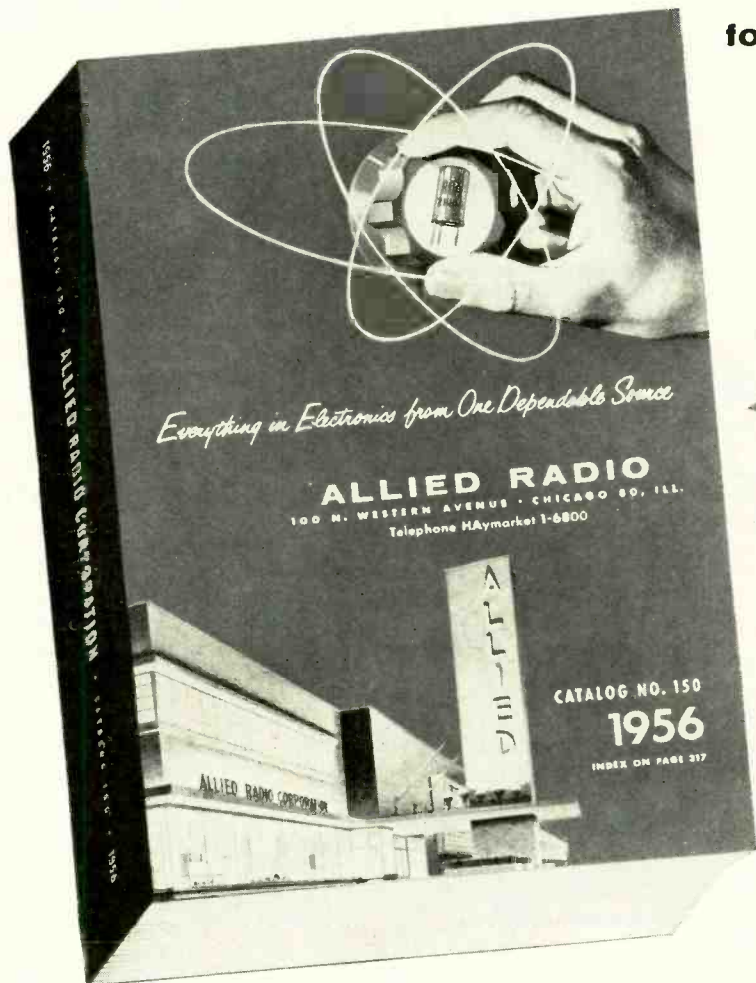

Get ALLIED's 1956 Catalog—it's complete, up-to-date—324 pages packed with the world's largest selection of quality electronic equipment at lowest, money-saving prices. Get every buying advantage at ALLIED: fastest shipment, expert personal help, lowest prices, assured satisfaction. Send today for your FREE copy of the big 1956 ALLIED Catalog.

World's Most Complete Stocks

- Latest Hi-Fi Systems and Components
- P.A. Systems and Accessories
- Recorders and Supplies • TV Tubes, Antennas, Accessories • Amateur Receivers, Transmitters, Station Gear
- Specialized Industrial Electronic Equipment • Test and Lab Instruments
- Huge Listings of Parts, Tubes, Transistors, Tools, Books

Featuring Super-Value Knight-Kits—top quality electronic equipment in precision-designed kit form
BUY DIRECT AND SAVE

EASY-PAY TERMS

Use our liberal Easy Payment Plan—only 10% down, 12 months to pay—no carrying charges if you pay in 60 days. Available on Hi-Fi and P.A. units, recorders, TV chassis, test instruments, kits, Amateur gear, etc.

HI-FI SPECIALISTS

To keep up with the latest and best in High Fidelity, look to ALLIED. Count on us for all the latest releases and largest stocks of Hi-Fi equipment. We specialize, too, in TV supply—and are foremost in the field of Builders' Kits.

free

send for the leading electronic supply guide

ALLIED RADIO CORP., Dept. 2-E-6
100 N. Western Ave., Chicago 80, Ill.

Send FREE 324-Page 1956 ALLIED Catalog.

Name _____

Address _____

City _____ Zone _____ State _____



ALLIED RADIO

World's Largest Electronic Supply House

PHAOSTRON

NONE FINER

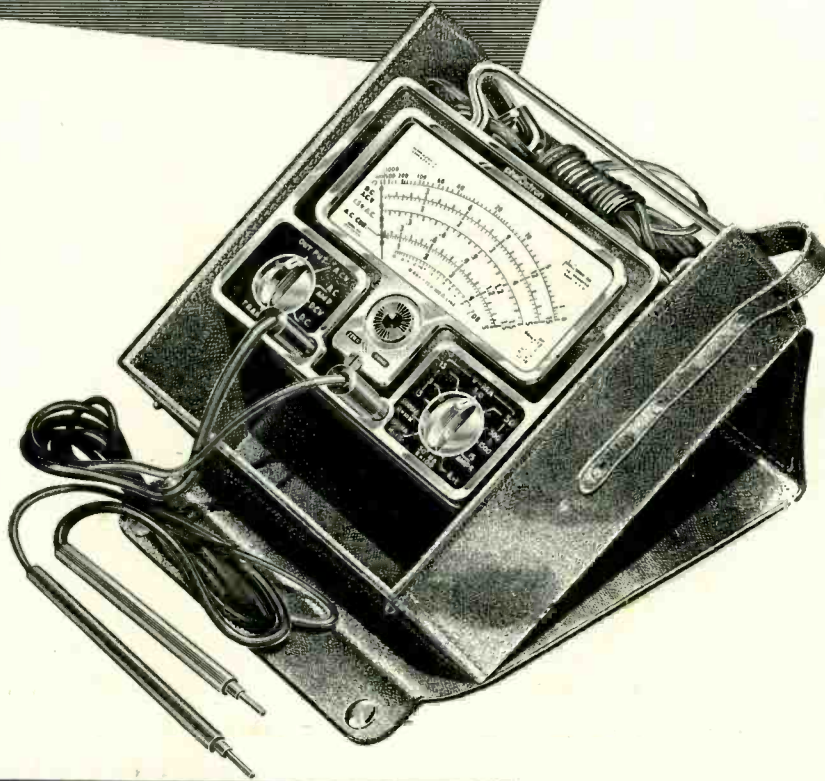

666 VOM

THE 666 IS THE ONLY
VOM THAT OFFERS ALL
OF THESE FEATURES

The MODEL 666 VOM is a completely self-contained, ready-to-use test instrument. Its accessories, probes, AC line cord (which serves to illuminate the dial) and instruction book all fit into the genuine California Saddle Leather carrying case that is furnished with the instrument.

METER MOVEMENT PROTECTION AND FUSED OVERALL INSTRUMENT PROTECTION

- 43 Unduplicated Ranges
- AC Current Ranges
- Separate Range and Function Switches
- Only 2 Jacks for all Measurements
- Illuminated Dial (5000 hour self-contained lamps)
- Large, Easy-to-Read Scale 4 7/8" long
- Color Coded Scales: green—ohms; black—AC-DC volts, DC current; red—AC current; blue—output
- Die Cast Chrome Bezel
- Metal Case, unbreakable, ultra-compact
- Doubly Shielded, time proven 50 microamp movement
- Permanent Accuracy... 3% DC, 4% AC
- New High Style, Easy-to-Use Chrome Bar Knobs
- Dual Purpose Handle also serves as AC line cord reel

YOUR KEY
TO
EXCELLENCE

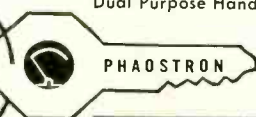

Complete with Probes,
AC Line Cord and Leather Case
at your PARTS DISTRIBUTOR

\$59⁵⁰

PHAOSTRON INSTRUMENT AND ELECTRONIC COMPANY
151 PASADENA AVE., SOUTH PASADENA, CALIF.

CORRESPONDENCE (Continued)

call that RCA conducted a Roper poll and found the same answer.

What then lies in back of this clamor to license you and me? The sad fact is that smart and capable technicians are being swayed into aiding and abetting this legislative stupidity for which there is no real need. They are selling themselves a bill of goods. They think that by putting a legislative straitjacket on their competitors, their own troubles will disappear like mist in the morning sun. The chiseler can never be eradicated by legislation; he is a disease that you have to learn to live with. Licensing yourself may well put you out of business however.

Let me point out how a license law can be a constant threat to your livelihood. Making a living in one's chosen field in this country should be a right and not a privilege granted by statute.

In that great body known as the public move all kinds of people including the chiseler, the hater, the trouble-maker, the "there ought to be a law" type of individual. These particular people are always looking for a chance to throw their weight around. A licensing law is made to their order. You can plate your service work with the golden sweat of honest effort and knowledge of a job well done but these people give you the rap every time.

Then you will have the commission, or jury, or whatever you will choose to call the public body appointed to oversee the law and hear the complaints brought against you. You are a small shop operator and a member of the public complains to this group that you have done him wrong. You have to close your shop and come before this group to answer that complaint. It is dismissed. But there will be others. In time you come to live in fear of such unjustified accusations for which you must answer to a jury.

The time can come when the license body will say to you, "Mr. Service Technician, we have had numerous complaints about you. True, they have all been dismissed, but we feel that there must be some basis for these accusations and we are compelled to put you on probation. Many more such complaints and of necessity we will have to revoke your license in the public interest." From then on, brother, you are on borrowed time!

These public commissions must have a record of positive accomplishment. At the start they may bend over backward to be impartial but as time goes on they simply sink into the slough where all such agencies land—bureaucratic indifference. They are out to show the public how well its interest is defended, and you are the goat. If the continued attrition and pressure of needless complaints and appearances to defend yourself won't force you to throw in the towel, they will.

HOWARD WOLFSON

Chairman, Associated Radio & TV
Servicemen
Chicago, Ill.

MEN 17-55!

HERE'S A NEW
OPPORTUNITY

FOR YOU!



PREPARE AT HOME FOR A
PROFITABLE CAREER IN
AUTOMATION
ELECTRONICS*

Get in on the Ground Floor of this
Fast-Moving Field

Want a better job? . . . more money? . . . better working conditions? These are the things that can come to a man when he has a skill to offer . . . especially when that skill is in a newer field where ground floor opportunities often lead to well-paying positions. Such a field is the Electronic applications to AUTOMATION — and what a field!

Many plants, large and small, in various parts of the country are looking for ways of using automatic electronic control equipment to help turn out a better product and at lower cost. This equipment must be designed, installed and maintained — calling for well trained men. That's where YOU may come in!

You need no special technical experience . . . no previous knowledge of Automation Electronics . . . to prepare for a future that can be bright and more secure. For now there is a proved way to get this important know-how. Mail coupon for complete details. Men 17 to 55 preferred.

***WHAT IS AUTOMATION ELECTRONICS?**

Simply stated, this refers to the marvelous electronic controls that will help regulate the much talked about "automatic factory"—as well as other amazing automatic equipment in plants, offices and elsewhere. It is a gateway to some of the most desirable opportunities in the amazing, newer field of Automation.

ONE OF AMERICA'S
FOREMOST ELECTRONICS
TRAINING CENTERS



DEVRY TECHNICAL INSTITUTE

CHICAGO 41, ILLINOIS

FORMERLY

DEFOREST'S TRAINING, INC.

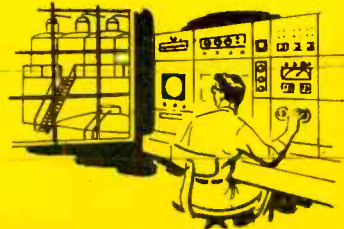
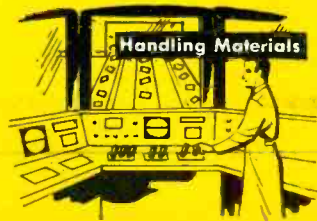

Industrial Processing

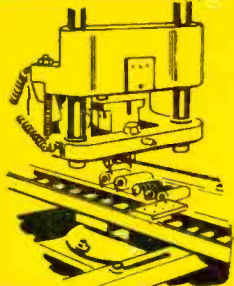

Making Electronic devices



Recording and billing



Anti-aircraft gun control



Traffic control signals

A New Training Program!

As one of the leading organizations of its kind, the DeVry Technical Institute has years of experience in teaching Electronics, Television and Radio. So it is only natural for this training institute to develop a new program to prepare men for good jobs in instrumentation — as well as in the design, installation and maintenance of Electronic controls — as applied to Automation.

EMPLOYMENT SERVICE

Following the same proved method used to train thousands of other men, you get valuable practical experience from actual electronic equipment. You also receive well-illustrated texts and effective moving pictures to show important basic principles—a wonderful home training advantage! To top that off, DTI provides actual employment help when you have completed the training—all of which can open the way to many new and exciting opportunities.

Member of
National Home Study Council

MAIL THIS COUPON TODAY!

DEVRY TECHNICAL INSTITUTE, Dept. RE-5A-M

4141 Belmont Avenue, Chicago 41, Ill.

I would like further information about the newer Electronic opportunities in AUTOMATION, also facts on how you may help me to prepare.

Name _____ Age _____

Please Print

Street _____ Apt. _____

City _____ Zone _____ State _____

1012

DTI's training is available in Canada

Excitingly new

"LIVING SOUND" IS YOURS TO ENJOY
WITH NORELCO *F.R.S.*

FULL RESONANCE TWIN-CONE SPEAKERS

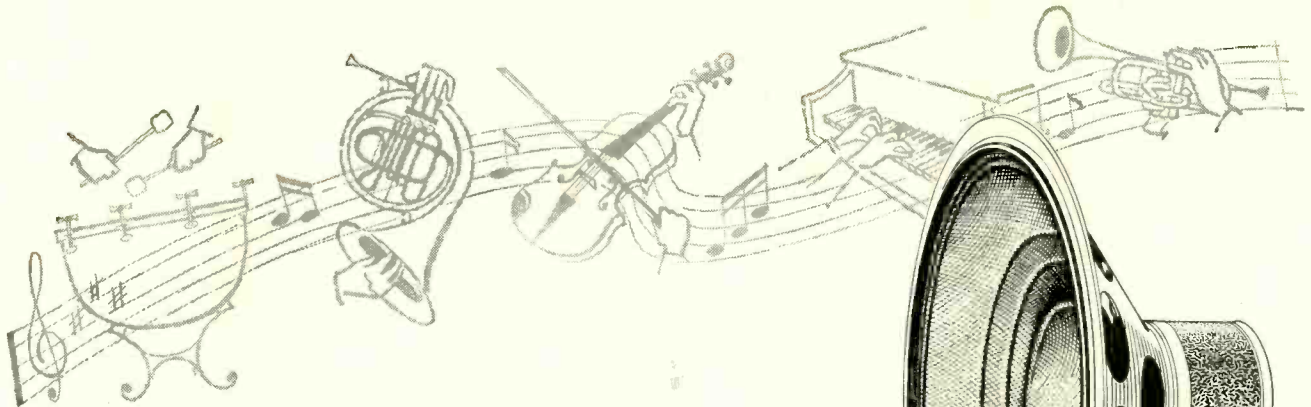

High fidelity and tonal qualities associated with expensive multi-unit speaker systems— are similarly produced with new Norelco FRS Twin-Cone Speakers.

Norelco's exclusive Twin Cones are made from specially selected and matched materials— operated from the same magnet and voice coil— some covering an extremely wide range up to 20,000 c/s. Norelco's twin-cones are always in phase and operate in harmony— providing the same degree of efficiency under all conditions.

Unequaled manufacturing precision and quality is inherent in all Norelco speakers. All component materials— including magnets, wire and even cone materials— are manufactured and assembled by Philips to suit a specific speaker design.

Many sizes in standard impedances are available from your dealer or send to Dept. D-5 today for more details. Norelco FRS speakers are priced from \$59.98 to \$9.90 audiophile net.

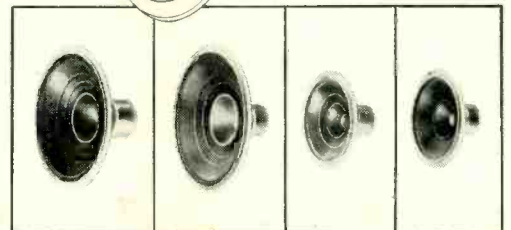

Add to...and improve any sound system
with *Norelco*

***FULL RESONANCE SPEAKERS**



NORTH AMERICAN PHILIPS CO., INC., 100 East 42nd Street, New York 17, N. Y.

THEY SAID HE COULDN'T LEARN TV AT HOME

... but now he repairs their sets



L. C. Lane, B.S., M.A.
President, Radio-Television Training Association.
Executive Director, Pierce School of Radio & Television.

Read this letter from one of my students — It can help YOU!



I CAN DO FOR YOU WHAT I DID FOR THIS MAN!

YOU can get top pay in the fast-growing Television-Radio-Electronics field just as this man did. My easily understood lessons — especially prepared for home study — can bring you the same success they brought hundreds of men, many of them with no more than grammar school training.

"Dear Mr. Lane:
"How to begin this letter, I don't really know, I can never begin to tell you how happy I am with the outcome of your Radio and Television course. I'll never regret clipping your ad out and sending it to you. Believe me, it has changed my whole outlook on life. I believe this is the beginning of a bright new future for me, thanks to RTTA.
"Already I have established a small reputation in our city and I am looking to the very near future when I go into the radio and TV repair business full time. The last few months I've come very close to doubling my weekly income with very little time spent at it.
"Now it is my turn to laugh at the people who said I was wasting my time, that I couldn't learn anything through the mail. I've repaired television sets for some of these people and they admit that they were wrong.
"I look back now just a short year and remember how I stayed up many a night until after midnight studying and experimenting. At the same time I was wondering whether something would really come of it. Now I can proudly say it did. Because I reached out and grasped the opportunity RTTA gave me. For that I'll be forever grateful."
A. F. Duschl, Lancaster, Pa. 1 24 55

LEARN BY DOING



You work with actual parts and equipment I send you as part of your course. You get enough equipment to set up your own home laboratory and prepare for a top-pay TV job. You build and keep an Electromagnetic TV RECEIVER designed and engineered to take any size picture tube up to

21-inch. (10-inch tube furnished. Slight extra cost for larger sizes)... Also a Super-Het Radio Receiver, AF-RF Signal Generator, Combination Voltmeter-Ammeter-Ohmmeter, C-W Telephone Transmitter, Public Address System, AC-DC Power Supply. Everything supplied, including all tubes.

FCC COACHING COURSE

Important for BETTER-PAY JOBS requiring FCC license. You get this training AT NO EXTRA COST! Top jobs go to FCC-licensed technicians.

CHOOSE FROM THREE COMPLETE COURSES
covering all phases of Radio, FM and TV

RADIO-FM-TELEVISION TECHNICIAN COURSE — no previous experience necessary.

FM-TV TECHNICIAN COURSE — previous training or experience in radio required.

TV CAMERAMAN AND STUDIO TECHNICIAN COURSE — advanced training for men with Radio or TV training or experience.

EXTRA TRAINING IN NEW YORK CITY AT NO EXTRA COST!

After you complete either the Radio-FM-TV Technician or the FM-TV Technician course you get two weeks of Lab work on modern electronic equipment at our associate resident school in New York City, Pierce School of Radio & Television. Available if you want it—AT NO EXTRA COST WHATSOEVER!

FREE



I'll send you my new 40-page book, "How to Make Money in Television, Radio, Electronics," a Free sample lesson, and other literature showing how and where you can get a top-pay job in Television.

VETERANS

My school fully approved to train Veterans under new Korean G.I. Bill. Don't lose your school benefits by waiting too long. Write discharge date on coupon.

MAIL THIS COUPON TODAY!

Mr. Leonard C. Lane, President
RADIO-TELEVISION TRAINING ASSOCIATION
Dept. R-5C, 52 East 19th Street, New York 3, N.Y.

Dear Mr. Lane: Send me your NEW FREE BOOK, FREE SAMPLE LESSON, and FREE aids that will show me how I can make TOP MONEY IN TELEVISION. I understand I am under no obligation.

(PLEASE PRINT PLAINLY)

Name _____ Age _____

Address _____

City _____ Zone _____ State _____

I AM INTERESTED IN:

- Radio-FM-TV Technician Course
- FM-TV Technician Course
- TV Cameraman & Studio Technician Course

VETERANS!

Write discharge date

Radio Television Training Association

52 EAST 19th STREET • NEW YORK 3, N. Y.

Licensed by the State of New York • Approved for Veteran Training

MAY, 1956

NO OBLIGATION!

abacus



昨日之最好者

honorable ancestor of the UNIVAC

In theory many centuries have gone into the development of the Univac®. Only recently, at Remington Rand Univac, has it achieved product perfection. The tremendous strides forward in the past few years are due to the imagination and creative genius of the scientists and engineers of Univac. Recognized leaders in the field of electronic computer systems, they are the men *who set the standards for others to follow*. You can become a member of this team

... where ambition and professional skill find their reward in limitless opportunities in an expanding organization.

Immediate openings for:

FIELD LOCATION ENGINEERS with a college degree in a scientific or engineering field and experience in electronics. Extensive electronic background may substitute for some college. Many opportunities for rapid advancement.

FIELD LOCATION TECHNICIANS with technical school background and preferably some experience in electronics. These positions can lead to full engineering responsibility.

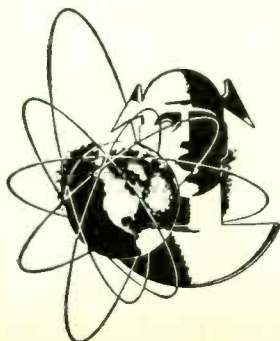

Send complete resumé to

Remington Rand Univac

DIVISION OF SPERRY RAND CORPORATION

AT ANY ONE OF THESE THREE PLANT LOCATIONS

MR. D. A. BOWDOIN
Dept. MP-10
2300 W. Allegheny Ave.
Philadelphia, Pa.

MR. KURT PINKE
Dept. MS-10
1902 W. Minnehaha Ave.
St. Paul W4, Minn.

MR. FRANK KING
Dept. MN-10
Wilson Avenue
South Norwalk, Conn.

® Registered in U. S. Patent Office

Send for FREE booklet and get the

BIG PAYOFF

in RADIO-TV-ELECTRONICS

What would a \$10 or \$20 a week raise mean to you?

Think of it! Only one \$10-a-week raise will repay your investment in CREI training, and leave you a profit of \$200 or more the very first year! Your increases in pay thereafter are all pure profit, and you'll be prepared for many more promotions and pay raises in the future years of your life!



CASH IN ON THE BIG PAYOFF!

Why let opportunity to make more money pass you by because of lack of training? This booklet describes in detail how CREI training equips you quickly at home to forge ahead into a good paying job—in TV (color, too)—industrial communications—research—aeronautics and scores of other fields in this mushrooming industry.

CREI Training Means Promotion, Pay Increases Within a Short Time

Here are just a few letters received from CREI students:

"In this time of less than two years, I have almost doubled my salary and have gone from wireman to engineering assistant and now to junior engineer. I have CREI to thank."—Frank A. Eckert, 22 Clover Lane, Levittown, Pa.

"I chose CREI training upon recommendation of two top engineers. Before I completed the course I became transmitter chief of a 5KW station. I am now employed as a technician at a 100 KW TV station and in spare time have a good TV sales and service business."—Archie D. Patton, 203 Burke Ave., San Antonio, Tex.

CREI TEACHES YOU WHAT INDUSTRY WANTS

Industry recognizes this, by choosing CREI to train their own technical staffs. Among them: United Air Lines, Canadian Broadcasting Corporation, Sears, Roebuck & Co., Bendix Products Division, All America Cable and Radio, Inc., Radio Corporation of America.

CREI GRADUATES GET TOP JOBS

... as electronic engineering technicians. Employers contact us regularly for graduates to fill good jobs. Our placement bureau

cannot keep up with the demands. Typical recent requests: "Two openings in our Field Service . . . aircraft electronics . . . starting salary is \$380 and up . . ."—North American Aviation, Inc., Columbus, O.

"Just about four months have passed since I made my first recruiting trip to CREI. As a result of that visit Messrs. Kohs, Plante and Wenger are now members of the Laboratories and Mr. Kresge soon will be . . . we have some openings now and will have others . . ."—Bell Telephone Laboratories, Murray Hill, N. J.

NAME YOUR GOAL!

CREI training equips you to pass FCC exams, qualify for top jobs; or, start your own business—many a graduate has been launched on a successful, self-owned business career, thanks to CREI training.

CREI ALSO OFFERS RESIDENCE TRAINING

CREI Residence School in Washington offers instruction at same high technical level. Classes start frequently. Qualified residence school graduates earn degree: Associate in Applied Science. Check coupon if you prefer residence study.

WHY WAIT? YOU CANT LOSE!

You already have practical experience. Add to it CREI's advanced training and be assured of excellent pay, a bright future and job security in all electronics fields.

You owe it to yourself! Fill out coupon and mail today. No obligation. You'll receive your copy of "Your Future in the New World of Electronics" right away—free. Send for it today!

AVAILABLE TO VETERANS UNDER GI BILL!

FILL OUT AND MAIL TODAY—BEFORE YOU FORGET IT!

CAPITOL RADIO ENGINEERING INSTITUTE

Accredited Technical Institute Curricula Founded 1927
Dept. 145-C, 3224—16th St., N.W., Washington 10, D.C.

Please send me your course outline and FREE illustrated Booklet "Your Future in the New World of Electronics" . . . describing opportunities and CREI home study courses in Practical Electronics Engineering.

CHECK FIELD OF GREATEST INTEREST

- Practical Radio Electronics Engineering
- Broadcast Radio Engineering (AM, FM, TV)
- Practical Television Engineering
- Aeronautical Electronics Engineering

Name _____
Street _____
City _____ Zone _____ State _____
CHECK: Home Study Residence School Korean Veteran

To help us answer your request intelligently, please give the following information:

EMPLOYED BY _____
TYPE OF PRESENT WORK _____
SCHOOL BACKGROUND _____
ELECTRONICS EXPERIENCE _____
IN WHAT BRANCH OF ELECTRONICS ARE YOU MOST INTERESTED?

PRODUCTION TECHNIQUES:

for the manufacturing of High Reliability Capacitors

To produce capacitors free from any possibility of latent defects, for use in the most critical applications, the Sangamo Electric Company has recently intensified its high reliability program of fabrication and inspection methods.

Incoming materials are rigidly inspected to meet stringent high reliability standards and are stored in areas where temperature, humidity and dust are controlled at all times.

Complete production histories are kept on the basis of small capacitor lots. X-raying of individual units, heat tests, vibration tests, altitude tests, and total destruction tests of a given percentage of all finished units assure components with an extremely low AQL. Testing facilities and resultant performance characteristics are far in excess of military specifications. Specify these high reliability capacitors for your critical applications.

SANGAMO ELECTRIC COMPANY MARION, ILLINOIS

SC56-2

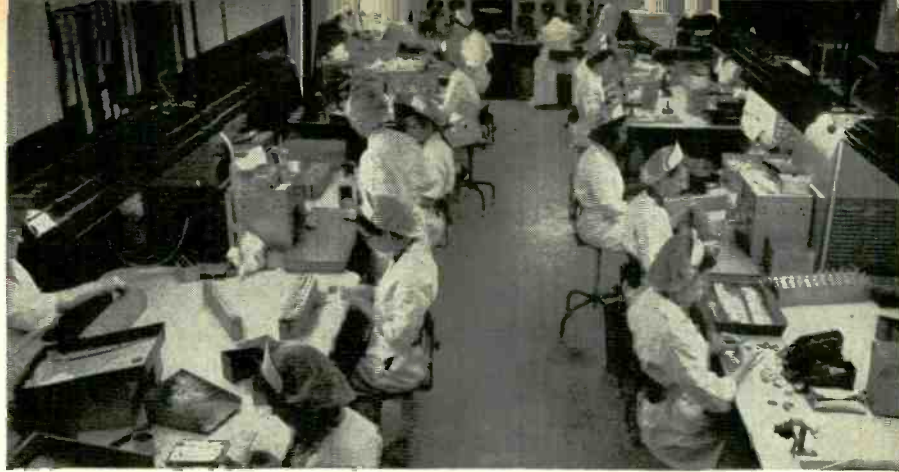

Separate facilities are maintained for the exclusive processing and manufacture of high reliability capacitors. Only specially trained, highly skilled operators, who wear special clothing to prevent any possible source contamination, work here.

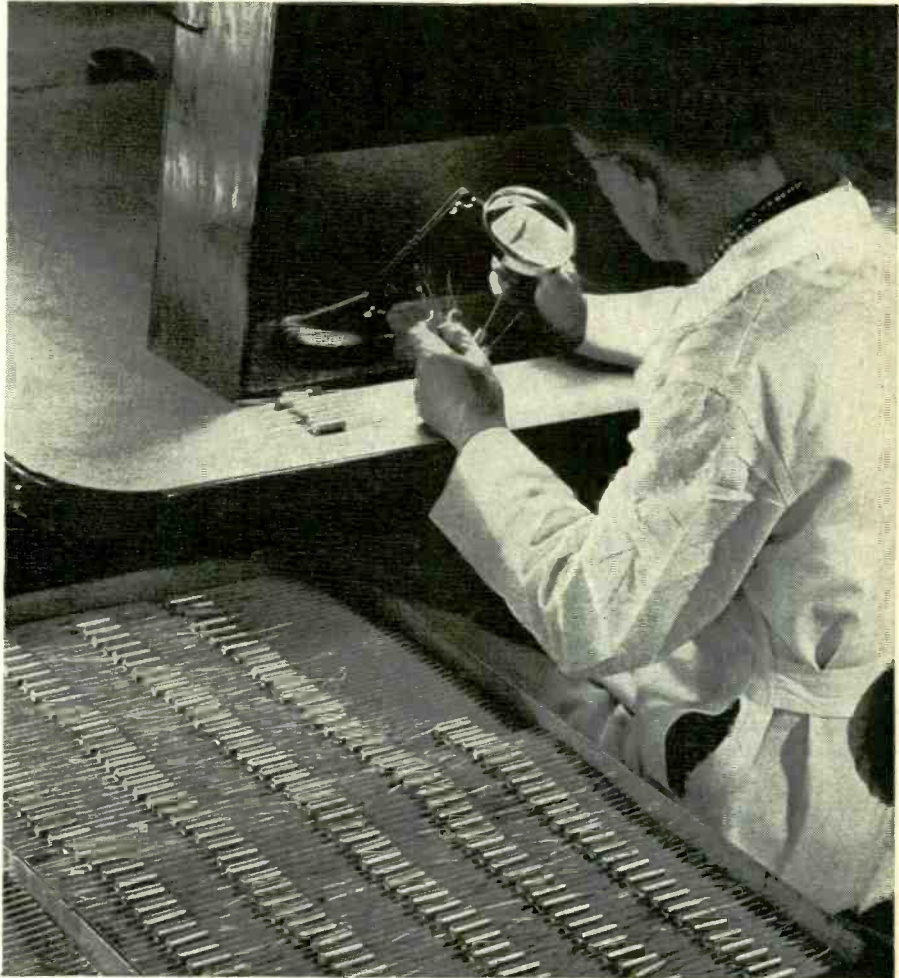

Oil-filled capacitors are subject to vacuum under elevated temperatures, then are individually examined to insure complete hermetic seal.

High temperature test ovens are used to check insulation resistance of Sangamo high reliability capacitors under sustained temperatures of 125° C.

This vibration testing machine brutally punishes Sangamo high reliability capacitors at accelerations up to 10 G's to determine their ability to resist vibration without damage to leads or elements.



TOP performance for TV anywhere!

Federal's "ALL-STAR" LEAD-IN TEAM

Urban, fringe or distribution system... heat, rain, dust, snow, ice, salt spray, polluted air... whatever the conditions you'll find a winner in these dependable, Quality-Controlled Cables by "FTR"

North, East, South, West... wherever there are TV customers... Federal's "All-Star" Lead-in Team can be depended upon to deliver *championship performance*...!

These six popular types are outstanding examples of the quality, ruggedness, efficiency and long life built into every foot of Federal Cable. Whatever the run requirements or local weather conditions the Federal "All-Stars" will score high in satisfaction... with you and your TV customers.

Federal lead-ins can be installed with utmost confidence, because they are engineered and manufactured by a *pioneer* cable maker... and "Certified by a World of Research"... through the International Telephone and Telegraph Corporation.

Check the high points of Federal's "All-Star" Team... check your stock of TV lead-ins... get in touch with Federal now for prompt shipment of your needs!

"America's leading producer of solid dielectric cables"

Federal



A DIVISION OF



MAY, 1956

High Volume-Low Price TV Lead-in



Economical and Efficient

TV-1190—300-ohm heavy-duty lead-in with 90 mil. web. Has 7/#28 copper strands. Economical and highly efficient. Insulated with Federal-developed "silver" polyethylene for long life. Also available in brown.



Another Low-cost Leader

TV-2000—300-ohm dumbbell-shaped lead-in with 55 mil. web. Has 7/#30 copper strands. A high-value, low-cost type for the average installation. Cinnamon-brown color is protection against ultra-violet.

"Quality-Controlled" TV Lead-in & Cable

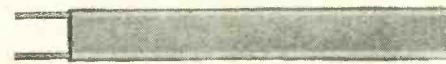

Heavy-duty Type

TV-1182—300-ohm deluxe type heavy-duty long life lead-in with 7/#28 copper strands, 100 mil. web. Available in "silver" or brown polyethylene. Resists weather, heat, sun. Very low line loss in fringe areas.



Quality plus Economy

TV-1184—300-ohm dumbbell-shaped, standard, economy type lead-in with 7/#28 copper strands, 70 mil. web, for urban areas with no unusual conditions. Cinnamon-brown color is highly effective in resisting ultra-violet.



Rotor Lead-in.

TV-1188—Rugged, dependable, long-life rotor lead-in. Weather-resistant. Insulated with "silver" vinyl. Three 7-strand conductors of .0121 AWG soft bare and one conductor of .0121 AWG tinned soft bare.

Community TV Lead-in

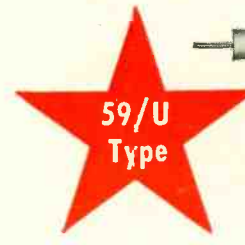

Secondary Lead-in

59/U Type—73-ohm coaxial lead-in. Highly efficient as a Community TV pole-to-house tap-off. Meets all needs wherever a high-grade installation is a must. Ideal for use with unbalanced input TV receivers.

For data on other types, write Dept. D-463A

Federal Telephone and Radio Company

A Division of INTERNATIONAL TELEPHONE AND TELEGRAPH CORPORATION
COMPONENTS DIVISION • 100 KINGSLAND ROAD • CLIFTON, N. J.

In Canada: Standard Telephones and Cables Mfg. Co. (Canada) Ltd., Montreal, P. Q.
Export Distributors: International Standard Electric Corp., 67 Broad St., New York

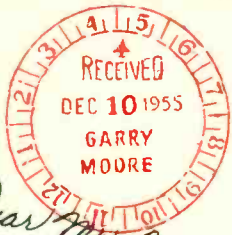

3447 N. Oakland Ave.
Melrose 11, N.Y.
Dec. 9, 1955

Dear Mr. Moore:

On your morning show you say that CBS tubes are the best and I'll buy that! I've always had tube troubles and no matter how expensive an instrument we owned its performance was mediocre. Maybe we were too critical but a television picture is either good or it is not. When our picture tube gave up the struggle our serviceman at the Ace Electric Co. installed a CBS picture tube. We are delighted with the ultra bright and shadow clear picture we are receiving.

I wanted you to know that we are glad we took your advice and believe me when the time comes to buy a new set it will be a CBS if they make them. (Do they?)

Sincerely
Mrs Ruth Svensson

CBS-HYTRON

Danvers, Massachusetts

A DIVISION OF COLUMBIA BROADCASTING SYSTEM, INC.

HERE'S PROOF

**your
customers
want
CBS tubes**

Since Garry Moore has been selling CBS tubes over the CBS Television Network, most service technicians have had women customers ask them for CBS tubes. And not just once in awhile.

Every day more and more women are requesting CBS tubes. We hear stories like Mrs. Svensson's often.

It all adds up to these important facts. You build good will . . . cut call-backs . . . and profit more when you install CBS tubes . . . the tubes with the Good Housekeeping Guaranty Seal.

Is your caddy well stocked with CBS tubes?



Show her the CBS carton with the Good Housekeeping Guaranty Seal. See Garry Moore sell your expert service over the CBS Television Network.



TENS OF THOUSANDS OF ELECTRONICS TECHNICIANS NEEDED BY INDUSTRY!

Let Rider Books Teach You Electronics Know-How!

FUNDAMENTALS OF TRANSISTORS

by Leonard Krugman
Explains the **BIG** thing in electronics, today—the transistor! Written by one of the pioneers in transistor development, this book tells you all you need to know about this electronic miracle: basic operation, characteristics, performance, and application. Soft Cover, 144 pp., 5½ x 8½", illus. #160.....Only \$2.70

ENCYCLOPEDIA ON CATHODE-RAY OSCILLOSCOPES & THEIR USES

by Rider & Uslan
Fully and clearly describes the oscilloscope, its construction and capabilities. Covers a wide variety of scopes, including present day models. Profusely (3,000) illustrated. Cloth Bound, 1008 pp., 8½ x 11". #133.....Only \$11.50



TELEVISION—HOW IT WORKS (2nd Edition)

by J. Richard Johnson

A completely rewritten, up-to-the-minute edition of an authoritative and informative book. It is the newest and most comprehensive text on the subject, and follows the progress of the received signal from the antenna to the picture tube and loudspeaker. Leather Finish MARCO Cover, 362 pp., 5½ x 8½", illus. #101.....Only \$4.60

COLOR TELEVISION RECEIVER PRACTICES

by Hazeltine Corp. Lab. Staff
Prepared by experts, this book covers every major aspect of color TV receivers, including the latest 21" picture tube and its required circuitry. For anyone who wishes a solid grounding in color television, this volume is ideal. Destined to become a standard reference work on the subject. Soft Cover, 208 pp., 5½ x 8½", illus. #162.....Only \$4.50

RADIO OPERATOR'S LICENSE Q & A MANUAL (5th Edition)

by M. Kaufman
Revised and enlarged 5th edition contains the latest revisions in Elements 1 and 2 (Basic Law, and Basic Operating Practice). Lists questions and answers of past FCC exams, plus discussions of each answer. An indispensable reference volume for the student and operator. Cloth Bound, 766 pp., 6½ x 8½", illus. #130.....Only \$6.60

OBTAINING & INTERPRETING TEST SCOPE TRACES

by John F. Rider
Explains oscilloscope screen traces in clear, non-mathematical language. Contains over 800 scope traces, and complete instructions on the use of scopes and interpretation of traces. Soft Cover, 190 pp., 5½ x 8½", illus. #146.....Only \$2.40



INTRODUCTION TO COLOR TV (2nd Edition)

by Kaufman & Thomas

A revised, up-to-date edition of a best seller in books on TV. New edition contains full information on the latest and larger screen picture tubes, simplified receiver circuitry, etc. Most up-to-date introduction to color television available. Soft Cover, 160 pp., 5½ x 8½", illus. #156.....Only \$2.70

FM TRANSMISSION & RECEPTION (2nd Edition)

by Rider & Uslan
Covers FM broadcasting of all kinds, and explains the theory, functioning and servicing of various types of FM receivers, including TV receivers. Cloth Bound, 460 pp., 6½ x 8½", illus. #102.....Only \$4.95

UNDERSTANDING VECTORS & PHASE

by Rider & Uslan
A book which makes for quick and easy understanding of radio theory, written for anyone in radio and electronics who has not had the advantage of technical training. Soft Cover, 160 pp., 5½ x 7¼", illus. #103.....Only \$.99

BASIC VACUUM TUBES & THEIR USES

by Rider & Jacobowitz
Basic information relating to vacuum tubes, with a minimum of mathematics, from the behavior of the elementary electron to the specialized types of tubes. A must book for technicians, engineers, students. 208 pp., 5½ x 8½", illus. #171, Soft Cover.....Only \$3.00
#171-H, Cloth Bound.....Only \$4.50

HOW TO TROUBLESHOOT A TV RECEIVER

by J. Richard Johnson
A book written for the newcomer, to aid in a systematic procedure for troubleshooting. An easily understandable, step-by-step guide. Soft Cover, 128 pp., 5½ x 8½", illus. #152.....Only \$1.80

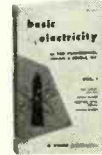

BASIC ELECTRICITY

BASIC ELECTRONICS

BASIC SYNCHROS & SERVOMECHANISMS

by Van Valkenburgh, Nooger & Neville, Inc.
The fabulous picture-text books that teach faster and easier! The theory, principals and practice of electricity, electronics, synchros and servos, are here presented in a manner which permits a rapid grasp of the fundamentals of these vitally important subjects. Over 2,000 specially prepared illustrations present, explain and make every topic discussed picture clear.

#169 BASIC ELECTRICITY
Soft Cover: 5 volumes, 624 pp., 6 x 9", illus. Only \$9.00 per set
Cloth Bound: all 5 volumes in a single binding Only \$10.50

#170 BASIC ELECTRONICS
Soft Cover: 5 volumes, 550 pp., 6 x 9", illus. Only \$9.00 per set
Cloth Bound: all 5 volumes in a single binding Only \$10.50

#180 BASIC SYNCHROS & SERVO-MECHANISMS
Soft Cover: 2 volumes, 270 pp., 6 x 9", illus. Only \$5.50 per set
Cloth Bound: both volumes in a single binding Only \$6.95

HOW TO USE TEST PROBES

by A. Ghirardi & R. Middleton
The only book of its kind, it covers all types of test probes used with VOM's, VTVM's, and scopes. Complete step-by-step explanations, with practical examples of results and effects. Soft Cover, 176 pp., 5½ x 8½", illus. #165.....Only \$2.90

HOW TO USE METERS

by John F. Rider
For the technician, hobbyist, TV or radio student. Explains everything about using meters of all kinds. Tells and shows what to use and what to measure. If you use meters, this is a book you cannot afford to pass by! Soft Cover, 144 pp., 5½ x 8½", illus. #144.....Only \$2.40

HOW TO USE SIGNAL & SWEEP GENERATORS

by J. Richard Johnson
Discusses all types of signal and sweep generators, and their applications in AM, FM radio, and TV servicing. Soft Cover, 144 pp., 5½ x 8½", illus. #147.....Only \$2.10

The "Classic" in hi-fi literature

HI-FI LOUDSPEAKERS and ENCLOSURES by Abraham B. Cohen

Really an education . . . A book which explains hi-fi loudspeakers and enclosures in a way that is easy to absorb — does not require any special background!

The book is *supremely authoritative* and *brilliantly written*. Among its 368 pages are many hundreds of illustrations which whet your appetite . . . not to stop reading until you have finished it.

368 pages 5½ x 8½" Leather Finish MARCO Cover \$4.60

Its coverage is tremendous! EVERYTHING about ALL kinds of loudspeakers — about ALL kinds of enclosures . . . inexpensive ones and costly ones. Not only does this book tell you all about them — but it will enable you to make wise decisions when you want to buy. Includes 18 blueprints of enclosures for home construction.

THESE AND MANY
OTHER RIDER
BOOKS ARE
AVAILABLE AT
YOUR BOOKSTORE
OR PARTS
JOBBER—LOOK
FOR THE RIDER
DISPLAY RACK!

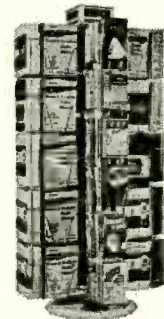

JOHN F. RIDER PUBLISHER, INC.
480 Canal Street, New York 13, N. Y.

In Canada:
Charles W. Pointon, Ltd.
6 Alcina Ave., Toronto, Ontario
In Canada, all prices approximately 5% higher.

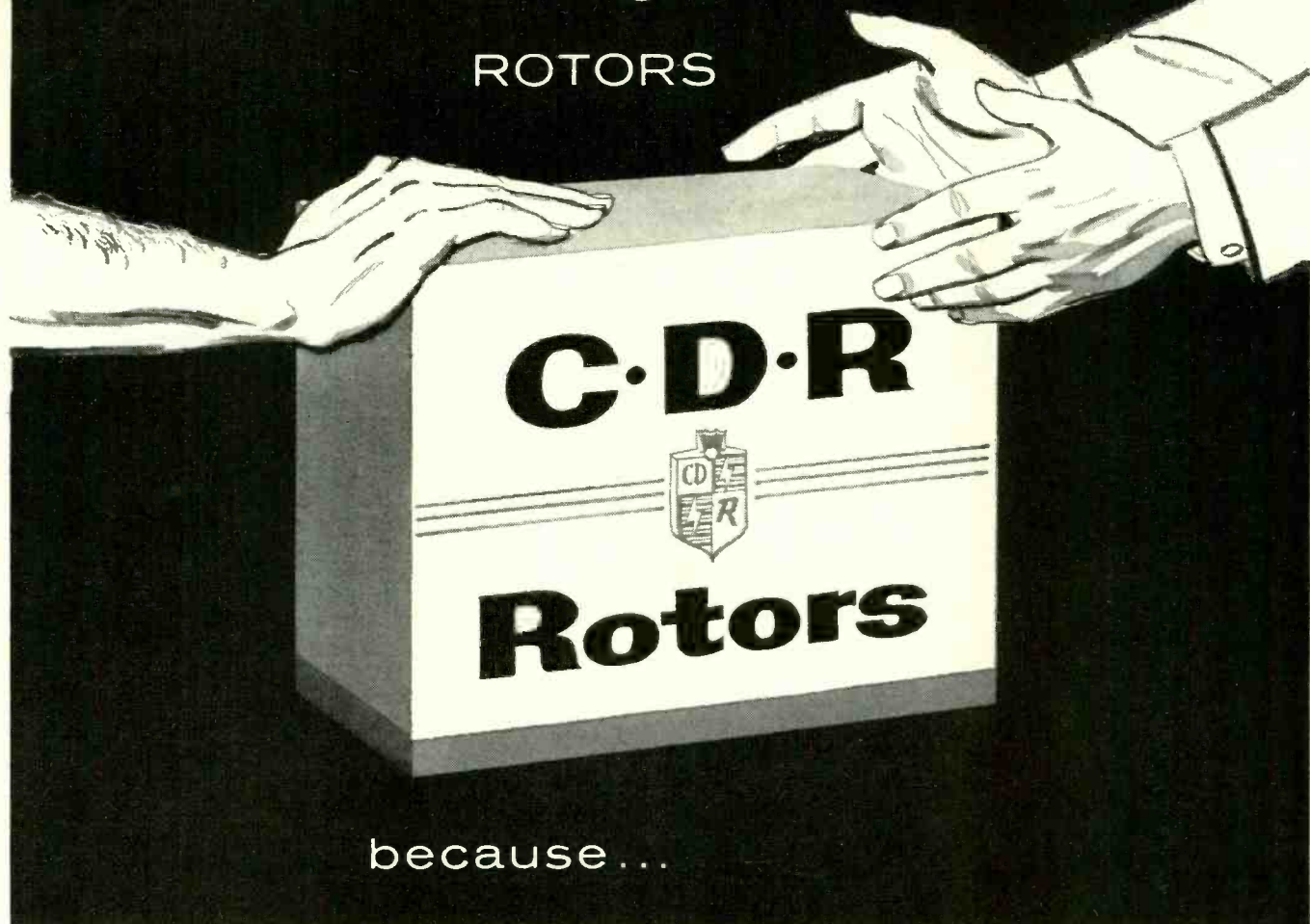

the fastest selling

ROTORS

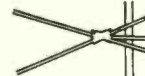
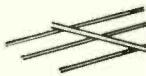
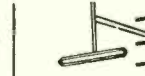

because...

- ✓ Pre-Sold to millions every week on TV
- ✓ The Most Complete Line... A Model for Every Need
- ✓ Superior Engineering... they're Tried-Tested-Proven

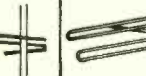
| | | | | | | |
|--|--|--|---|---|--|---|
|  AR-22 |  AR-1 |  AR-2 |  TR-2 |  TR-4 |  TR-12 |  TR-11 |
| <p>Completely AUTO-MATIC version of the TR-2 with all the powerful features that made it famous.</p> | <p>Completely AUTO-MATIC rotor, powerful and dependable. Modern design cabinet. 4 wire cable.</p> | <p>Completely AUTO-MATIC rotor with thrust bearing. Handsome cabinet, 4 wire cable.</p> | <p>Heavy-duty rotor with plastic cabinet, "compass control" illuminated perfect pattern dial, 8 wire cable.</p> | <p>Heavy-duty rotor, modern cabinet with METER control dial, 4 wire cable.</p> | <p>Combination value... complete rotor with thrust bearing. Modern cabinet with meter control dial, uses 4 wire cable.</p> | <p>Ideal budget all-purpose rotor, new modern cabinet featuring meter control dial, 4 wire cable.</p> |



CORNELL-DUBILIER
SOUTH PLAINFIELD, N. J.



THE RADIART CORP.
CLEVELAND 13, OHIO

RADIO-ELECTRONICS

RCA offers you the
 finest training
 at home in
 Radio-TV
 electronics,
 TV servicing,
 Color TV

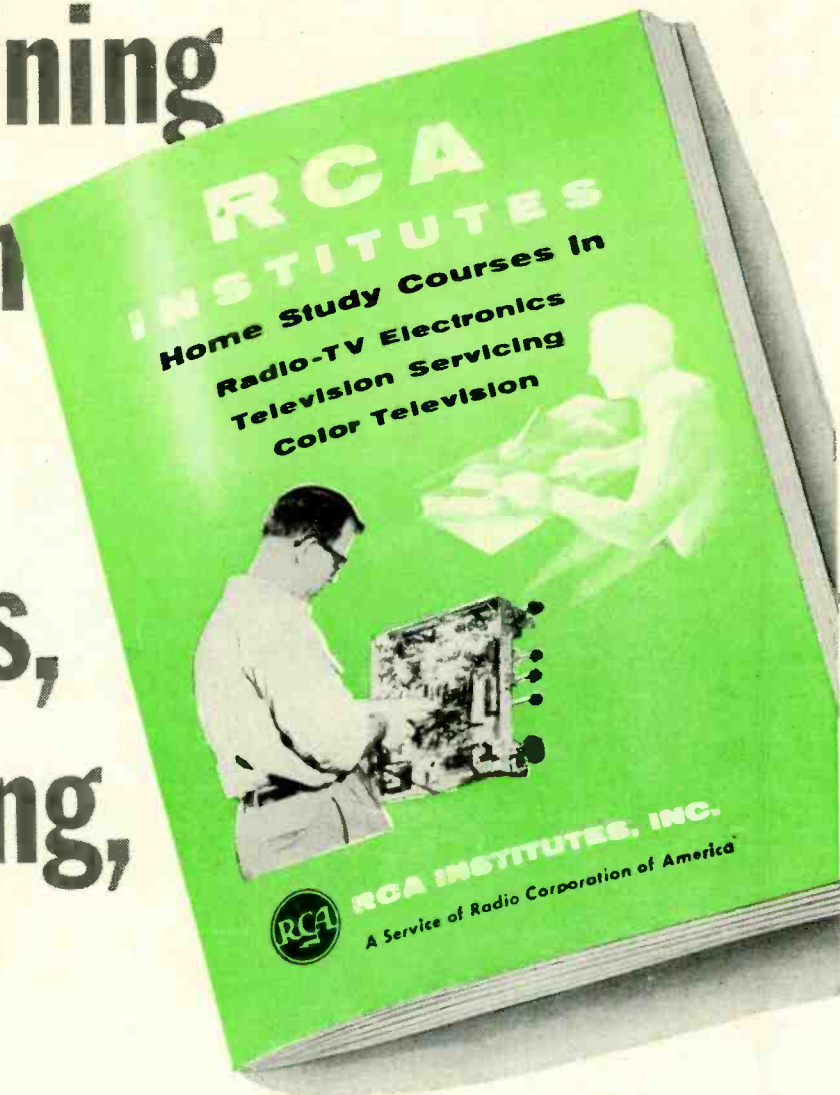

SEND FOR THIS FREE BOOK NOW!

The instruction you receive and equipment you get (and keep) will start you on your way. Pay-as-you-learn. You pay for only one study group at a time. This 52 page book contains complete information on Home Study Courses for the beginner and the advanced student.



RCA INSTITUTES, INC.
 A SERVICE OF RADIO CORPORATION OF AMERICA
 350 WEST FOURTH STREET, NEW YORK 14, N.Y.

RCA Institutes, Inc., Home Study E-56,
 350 West Fourth Street New York 14, N. Y.
 Without obligation, send me FREE CATALOG
 on Home Study Courses in Radio, Television
 and Color TV. No salesman will call.

Name.....
 Please Print
 Address.....
 City..... Zone..... State.....

IMPORTANT
 Be sure to write
 for RCA Institutes
 catalog before
 signing up for any
 Radio-TV course

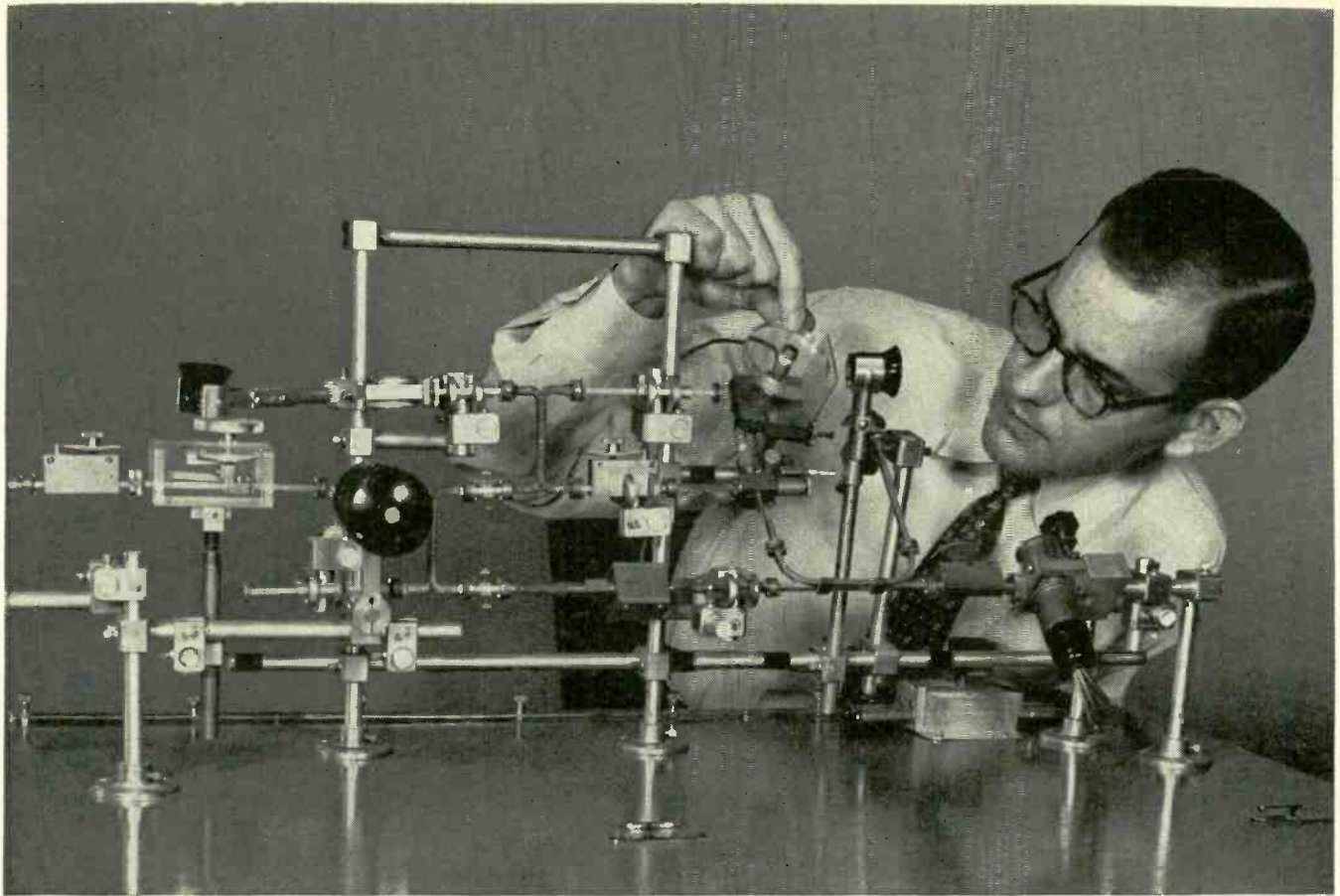

Physicist G. K. Farney checks the frequency of Bell's new klystron, which is located at far right. Tube's output is about 20 milliwatts.

Sixty billion vibrations per second

A great new giant of communications—a waveguide system for carrying hundreds of thousands of voices at once, as well as television programs—is being investigated at Bell Telephone Laboratories.

Such a revolutionary system calls for frequencies much higher than any now used in communications. These are provided by a reflex klystron tube that oscillates at 60,000 megacycles, and produces waves only 5 mm. long.

The resonant cavity that determines the frequency is smaller than a pin-head. The grid through which the energizing electron beam is projected is only seven times as wide as a human hair, and the grid "wires" are of tung-

sten ribbon $3/10,000$ inch in width.

G. K. Farney, University of Kentucky Ph. D. in nuclear physics, is one of the men who successfully executed the development of the klystron. Dr. Farney is a member of a

team of Bell scientists whose exciting goal is to harness the immense bandwidth that is available with millimeter waves . . . and to make certain that your telephone system remains the best in the world.

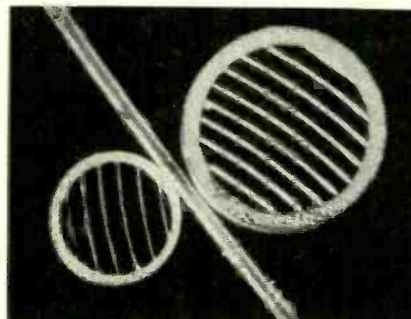

Grids in new tube, enlarged 30 times, with human hair for comparison. Electronic beam passes through smaller, then larger, grid.

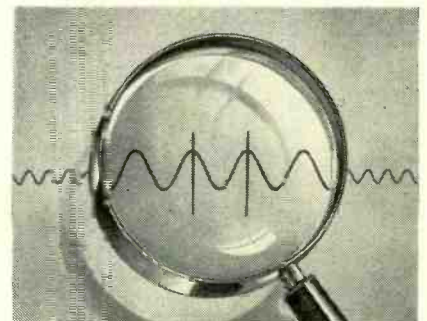

Wavelengths produced by the klystron tube are only .2 inch long— $1/15$ that of the transcontinental radio relay system.

BELL TELEPHONE LABORATORIES

WORLD CENTER OF COMMUNICATIONS RESEARCH



**NEW! COLOR and Black-&-White
LAB & TV 5" OSCILLOSCOPE #460
KIT \$79.95. Wired \$129.50**

The **FINEST** professional 5 mc wide-band scope value. Ideal for research, h-f & complex waves, plus Color & Monochrome TV servicing. Flat from DC to 3.58 mc ± 1 db (color burst freq.), flat DC to 4.5 mc +1, -3 db. Vert. sens. 25 rms mv/in. Vert. Z 3 megs. Has the following outstanding features not found in scopes up to several times its price, kit or wired:

VERTICAL AMPLIFIER: direct-coupled (DC) thruout to eliminate l-f phase shift; push-pull thruout for negligible distortion; K-follower coupling between push-pull pentode stages for extended h-f resp. (minimizes h-f phase shift, extends useful resp. to 10 mc); full-screen undistorted vert. defl; 4-step freq-compensated decade step attenuator up to 1000:1. **SWEEP CIRCUIT:** perfectly linear sweeps, 10 cps - 100 kc (ext. cap. for down to 1 cps); pre-set TV vert. & hor. positions (30 & 7875 cps); automatic sync. ampl. & limiter eliminates sync amplitude adj. **PLUS:** direct or cap. coupling; bal. or unbal. inputs; edge-lit engraved lucite graph screen; dimmer; anti-glare filter; bezel fits std photo equip. **OTHER IMPORTANT FEATURES:** High intensity trace CRT. Finest sq. wave resp. (.06 usec rise time). Push-pull hor. ampl., flat to 400 kc, sens. 0.6 rms mv/in. Built-in voltage calibration. Intensity mod. Sawtooth & 60 cps outputs. Astigmatism control. Retrace blank-

ing. Instant, drift-free full-screen vert. positioning & 2X full-screen hor. positioning. Bal., cal., astig. adj. externally accessible. 5U1 CRT, 2-6AU8, 2-6CB6, 1-12AU7A, 2-6J6, 1-6AX5, 1-1V2. Deep-etched satin aluminum panel, rugged grey wrinkle steel cabinet. Designed for easy building at home with no special equipment. 13" x 8 1/2" x 16". 30 lbs.

SCOPE DIRECT PROBE* #PD: KIT \$2.75. Wired \$3.95. Eliminates stray-pick-up & signal re-radiation.

SCOPE DEMODULATOR PROBE* #PSD: KIT \$3.75. Wired \$5.75. Demodulates AM carriers between 150 kc and 250 mc.

SCOPE LOW CAPACITY PROBE* #PLC: KIT \$3.75. Wired \$5.75. For signal tracing in high frequency, high impedance & wide-band circuits, (as in TV) without distortion from overloading or frequency discrimination.



**150 kc to 435 mc
with ONE generator!**

**New! RF SIGNAL GENERATOR #324
KIT \$26.95. Wired \$39.95**

for COLOR and Monochrome TV servicing

New wide-range, stable generator -- better value than generators selling at 2 or 3 times its cost! Ideal for: IF-RF alignment, signal tracing & trouble-shooting of TV, FM & AM sets; marker gen.; 400 cps audio testing; lab. work. **6 fund. ranges:** 150-400 kc, 400-1200 kc, 1.2-3.5 mc, 3.5-11 mc, 11-37 mc, 37-145 mc; 1 harmonic band 111-435 mc. Freq. accurate to $\pm 1.5\%$; 6:1 vernier tuning & excellent spread at most important alignment freqs. Etched tuning dial, plexiglass windows, edge-lit hairlines. Colpitts RF osc., directly plate-modulated by K-follower for improved mod. Variable depth of int. mod. 0-50% by 400 cps Colpitts osc. Variable gain ext. mod. amplifier: only 3.0 volts needed for 30% mod. Turret-mounted coils slug-tuned for max. accuracy. Fine & Coarse (3-step) RF attenuators. RF output 100,000 uv; AF sine wave output to 10 volts. 50-ohm output Z. 5-way jack-top binding posts for AF in/out; coaxial connector & shielded cable for RF out. Tubes: 12AU7, 12AV7, selenium rectifier; xfmr-operated. Deep-etched satin aluminum panel, rugged grey wrinkle steel cabinet. 8" x 10" x 4 3/4". 10 lbs.

for COLOR and Monochrome TV servicing

**New! PEAK-to-PEAK VTVM #232
& UNI-PROBE (pat. pend.)
KIT \$29.95. Wired \$49.95**

UNI-PROBE: exclusive with EICO! Terrific time-saver! Only 1 probe performs all functions--a half-turn of probe-tip selects DC or AC-Ohms.

The new leader in professional peak-to-peak VTVMs. Latest circuitry, high sensitivity & precision, wide ranges & versatility. Calibration without removing from cabinet. New balanced bridge circuit. High Z input for negligible loading. 4 1/2" meter, can't-burn-out circuit. 7 non-skip ranges on every function. 4 functions: +DC Volts, -DC Volts, AC Volts, Ohms.

Uniform 3 to 1 scale ratio for extreme wide-range accuracy. Zero center. One zero-adj. for all functions & ranges. 1% precision ceramic multiplier resistors. Measure directly peak-to-peak voltage of complex & sine waves: 0-4, 14, 42, 140, 420, 1400, 4200. DC/RMS sine volts: 0-1.5, 5, 15, 50, 150, 500, 1500 (up to 30,000 v. with HVP probe, & 250 mc with PRF probe). Ohms: 0.2 ohms to 1000 megs. 12AU7, 6AL5, selenium rectifier; xfmr-operated. 8 1/2" x 5" x 5". Deep-etched satin aluminum panel, rugged grey wrinkle steel cabinet. 7 lbs.

**New! DELUXE PEAK-to-PEAK VTVM #249
with 7 1/2" METER & UNI-PROBE (pat. pend.)
KIT \$39.95. Wired \$59.95**

All the advanced & exclusive features of #232--PLUS the extra convenience and readability of its big 7 1/2" meter. Your ideal bench instrument.

VTVM RF PROBES* #PRF-11 or PRF-25: KIT \$3.75. Wired \$4.95. Accuracy $\pm 10\%$. Use with any 11 or 25 megohm VTVM.

VTVM HV PROBE #HVP-2: Wired \$4.95. Complete with multiplier resistor. Measures up to 30 kv with any VTVM or 20,000 ohms/volt VOM.



Calibration without removing from cabinet.

*Only EICO Probes have all these features: fully shielded; rugged terminal board parts mounting; shock-mounted floating construction; swivel-action; color-coding; easy parts accessibility.

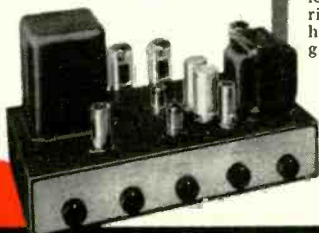

The specs are the proof...

**4 NEW BEST BUYS
by EICO**

**COMPLETE with Preamplifier, Equalizer and Control Section
New! 20-WATT Ultra-Linear Williamson-type HIGH FIDELITY AMPLIFIER #HF20
KIT \$49.95. Wired \$79.95**

A low-cost, complete-facility amplifier of the highest quality that sets a new standard of performance at the price, kit or wired. Every detail, down to the etched, brushed solid brass control plate, is of the fine quality EICO is famous for.

Rated power output: 20 watts (34 w peak). **IM distortion (60 cps: 6 kc/4:1)** at rated power: 1.3%. **Mid-band harmonic distortion at rated power:** 0.3%. **Maximum harmonic distortion between 20 and 20,000 cps at 1 db under rated power:** approx. 1%. **Power response (20w):** ± 0.5 db 20-20,000 cps; ± 1.5 db 10-40,000 cps. **Frequency response (1/4w):** ± 0.5 db 13-35,000 cps; ± 1.5 db 7-50,000 cps.

5 feedback equalizations for LP's & 78's including RIAA. Variable turnover feedback tone controls do not affect volume & permit large boosts or cuts at either end of audio spectrum with mid-freqs. unaffected. Loudness control & separate level set control on front panel. Low Z output to tape recorder. 4 hi-level switched inputs: tuner, tv, tape, auxiliary (xtal/ceramic phono or 2nd tuner); 2 low-level inputs for proper loading with all leading magnetic, FM & quality xtal cartridges. Hum bal. control. Extremely fine output transformer has interleaved windings, tight coupling, careful balancing & grain-oriented steel. 8 1/2" x 15" x 10". 24 lbs.

These amazing EICO values are **NOW IN STOCK** at your nearest distributor. Examine them side-by-side with ANY competitor. You'll see for yourself why indeed EICO is your **BEST BUY**. Fill out coupon on reverse page.



TURN PAGE FOR MORE EICO VALUES...

84 Withers Street, Brooklyn 11, New York

Prices 5% higher on West Coast.

**Do you OVERPAY
for QUALITY
instruments?**

EICO's mass purchasing and world-wide distribution, together with advanced electronic design, produce values never before possible . . . to give you Laboratory Precision at Lowest Cost!

GET the MOST for YOUR MONEY! Don't buy ANY test instrument till you put the EICO INSTRUMENT (kit or wired) equivalent before you—and . . .

Compare advanced electronic design: see the latest in circuitry and features.

Compare finest components: see the famous brands you know and trust, such as GE, Centralab, Mallory, etc.

Notice ease of construction and operation: Exclusive "Beginner-Tested" Manuals make assembly and operation step-by-step, quick, crystal-clear. "You build them in one evening—they last a lifetime!"

Check 5-Way Guarantee: Only EICO gives you this exclusive complete protection! EICO guarantees components, instructions and satisfactory operation — AND guarantees service and calibration for the LIFETIME of the instrument, at less than cost of handling.

Compare feature for feature, dollar for dollar.

There's an EICO distributor right nearby in your own neighborhood — over 1200 coast-to-coast. EICO planned it that way so that you can easily examine EICO BEFORE YOU PUT DOWN ONE CENT OF YOUR MONEY!

COMPARE any of EICO's 46 models SIDE BY SIDE with ANY competitor. Then YOU judge who's giving you the MOST for your money.

Over 500,000 EICO instruments in use . . . You'll agree EICO gives you LABORATORY PRECISION AT LOWEST COST.

Turn page for other EICO ad



FREE 1956 EICO CATALOG!

Tells you how to SAVE 50% on
your test equipment costs!



TUBE TESTER #625
KIT \$34.95
Wired \$49.95

- tests 600 mil series string type tubes
- illuminated roll-chart

Pix Tube Test Adapter\$4.50



New! GEIGER COUNTER #803
KIT \$19.95
Wired \$29.95

(less batteries)
Professional, all-electronic, sensitive, rugged—at lowest cost! Indicates by neon lamp & headphone clicks.



5" PUSH-PULL OSCILLOSCOPE #425
KIT \$44.95
Wired \$79.95

7" PUSH-PULL OSCILLOSCOPE #470
KIT \$79.95
Wired \$129.50



VACUUM TUBE VOLTMETER #221
KIT \$25.95
Wired \$39.95

DELUXE VTVM #214 (7 1/2" METER)
KIT \$34.95
Wired \$54.95



RF SIGNAL GENERATOR #320
KIT \$19.95
Wired \$29.95

150 kc-34 mc, calibrated harmonics to 102 mc. Pure or mod. RF, & Colpitts osc. 400 cps sine outputs.



CATHODE RAY TUBE CHECKER #630
KIT \$17.95
Wired \$24.95

Easy, fast test of all types & sizes TV pix & scope CR tubes, in set or carton.



#944 FLYBACK TRANSFORMER & YOKE TESTER
KIT \$23.95
Wired \$34.95

- fast check all flybacks & yokes in or out of set.
- spots even 1 shorted turn!



TV/FM SWEEP GENERATOR #360
5MC-4.5MC CRYSTAL\$3.95 ea.

Range 500 kc-228 mc on fund. Cont. sweep width control, 0-30 mc.

KIT \$34.95
Wired \$49.95



DELUXE RF SIGNAL GENERATOR #315

1% accuracy on all 7 ranges. Range 75 kc-150 mc. Volt reg.

KIT \$39.95
Wired \$59.95



6V & 12V BATTERY ELIMINATOR & CHARGER #1050

Sep. volt-meter & ammeter

KIT \$29.95
Wired \$38.95



DELUXE MULTI-SIGNAL TRACER #147

Sep. hi-gain RF & lo-gain audio inputs. Special noise locator. Calibrated wattmeter.

KIT \$24.95
Wired \$39.95



R-C BRIDGE & R-C-L COMPARATOR #950B

Reads 0.5 ohms -500 megs, 10 mmfd-5000 mfd power factor.

KIT \$19.95
Wired \$29.95



New! BATTERY TESTER #584
KIT \$9.95
Wired \$12.95

Tests A & B portable radio, hearing-aid, lantern, other batteries—in or out of equipment.



20,000 Ohms/Volt MULTIMETER #565
KIT \$24.95
Wired \$29.95

1000 Ohms/Volt MULTIMETER #536
KIT \$12.90
Wired \$14.90



| VTVM PROBES | KIT | Wired |
|----------------------|--------|--------|
| Peak-to-Peak | \$4.95 | \$6.95 |
| RF | \$3.75 | \$4.95 |
| High Voltage Probe-1 | | \$6.95 |
| High Voltage Probe-2 | | \$4.95 |

| SCOPE PROBES | KIT | Wired |
|--------------|--------|--------|
| Demodulator | \$3.75 | \$5.75 |
| Direct | \$2.75 | \$3.95 |
| Low Capacity | \$3.75 | \$5.75 |

For FREE 1956 catalog, mail coupon NOW!



84 Withers St. • Brooklyn 11, N. Y.

Prices 5% higher on West coast and subject to change without notice. ©55

EICO, 84 Withers Street
Brooklyn 11, New York

C-5

Send FREE 1956 Catalog and name of neighborhood EICO jobber.

Name.....

Home Address.....

City.....Zone.....State.....

Occupation.....

1945 to 1955: a decade of Know-How & Value Leadership in Kits & Instruments—over 1/2 million sold to date!

THE ELEMENTS OF TELEDUCATION

... *The threat to our future can be met* ...

THE economy of the United States now rests squarely upon technical progress. For decades our know-how was second to none in all technical endeavors. We are no longer in this fortunate position. Indeed, we are now running in second place, having already surrendered our rank to the Soviet Union. In the graduation of technicians and engineers, particularly in electronics, we are threatened with a further decisive setback. Not only is our economy thus threatened seriously, but our defense and our very existence are challenged.

Unfortunately we cannot now quickly reverse this disastrous trend by supplying the nation with nonexistent and competent teachers, the supply of which is constantly shrinking. Only one other means is left open to us to ameliorate the condition—technical education via television—*teleducation*. The present teacher shortage need *not* be an insurmountable obstacle. We have sufficient good teachers to reverse the downward trend in a few short years.

The writer has spoken of this situation often* and feels it necessary, due to the present emergency, to bring it up once more. Here is the plan briefly outlined:

1. Russia has now definitely overtaken the United States in teaching and graduating of future technicians. They turn out far more vital technicians than we do.

2. We have a disastrously low supply of technically competent teachers, who, due to inadequate pay, constantly defect to higher salaried industrial or other positions.

3. The number of technical students has declined constantly and will continue to until our shortsighted teaching methods are reversed.

4. Paradoxically, *we have* more good teachers than we actually need *IF* we only will use their talents intelligently to fit present-day technical growth. Why use an outstanding teacher to teach 100 students in a single institution **IF THE SAME TEACHER CAN INSTRUCT 500,000 OR MORE SIMULTANEOUSLY?**

5. We **HAVE** the technical facilities today to achieve this via closed-circuit television.

6. In short, without going into details, this is the way the proposed system, outlined by the writer in 1945, works: From a central point or points the best technical and science teachers in the land instruct via large wall projection color television **ALL** the classes in the land. If the instructor of the moment is at Yale, the rest of the country is connected to that point. The next lecture may come from MIT in Massachusetts, from Caltech in California or from any other point *because all institutions of learning are tied in to the national teleducation closed-circuit hookup*. Such lectures will not be merely talk. The teacher—be he a physics, chemical, electrical or electronics professor—will instruct directly from the laboratory all important experiments and make clear any technical point by actual physical demonstration.

7. Technicians and engineers, however, are not created overnight. We must implant the seed of scientific adventure into the very young mind—before age 10. Country-wide teleducation **MUST** start in grade schools and be followed up with more intensity in high school.

8. During the present educational emergency, only the Federal Government has the means to finance a National Teleducation Network. The Government would build the network just as it has built roads in the past, the cost to be pro-rated to the states over a span of years. The Government would **NOT** be in the teaching business, however, and would have no voice in any educational program. To guard against abuse, the teleducational closed-circuit network could be supervised through a special commission or similar agency.

9. Teleducation via the national closed-circuit network does **NOT** do away with the teacher in the classroom—supervision will still be needed. But why waste an Einstein type of educator on a 50-pupil class when a secondary teacher or qualified supervisor can do the paper work and all other necessary classroom routine?

The writer is fully aware that such a revolutionary teaching system will meet some resistance from orthodox pedagogues as well as the heads of many of our institutions of learning. Communications to us relating to universal country-wide teleducation seem roughly equally divided for and against. We have space for only two here:

"I was very much interested in reading your article 'Tec-Teleducation.' We are at the present time teaching a large class located in three different rooms by television. We have gone one more step by teaching by discussion method. We have a talk-back system so that students remote from the studio can ask questions and enter into discussion. This is at present an experiment and we have selected a course that we feel is most challenging to this type of teaching, Comparative European Government.

"I doubt if our nontechnical people can see as far into the future of this thing as the technical people can. Our educators are usually too complacent once they have made a small gain. They are not inclined to expand the scope of what they have accomplished.

"C. D. PHILLIPS

"Technical Supervisor

"State University of Iowa"

* * *

"Thank you for sending me a copy of the letter you received recently from Mr. Phillips of the State University of Iowa. Certainly the arrangement he describes is a very interesting one. Such an arrangement is, I fear, a luxury in which only an institution supported by public funds can indulge.

"However, as I indicated to you last week, our plans for the future include the development of a lecture hall designed for the use of television, and we look forward to an opportunity to experiment with this valuable adjunct to established educational methods.

"HAROLD TORGERSEN

"Assistant Dean, College of Engineering

"New York University"

10. As the safety of the nation depends more and more on advanced technicians, engineers and scientists, such men should not be drafted for military service, but should be placed only in technical defense work. —H. G.

**Tame*, December 1945; *Newspeak*, December, 1950; RADIO-ELECTRONICS, September, 1951. Also Tec-Teleducation, *Forecast*, December, 1954, and RADIO-ELECTRONICS, February, 1955.

TRANSISTORIZING THE DIP METER

*Compact junction device
tunes from 2.5–11 mc*

By I. QUEEN
Editorial Associate

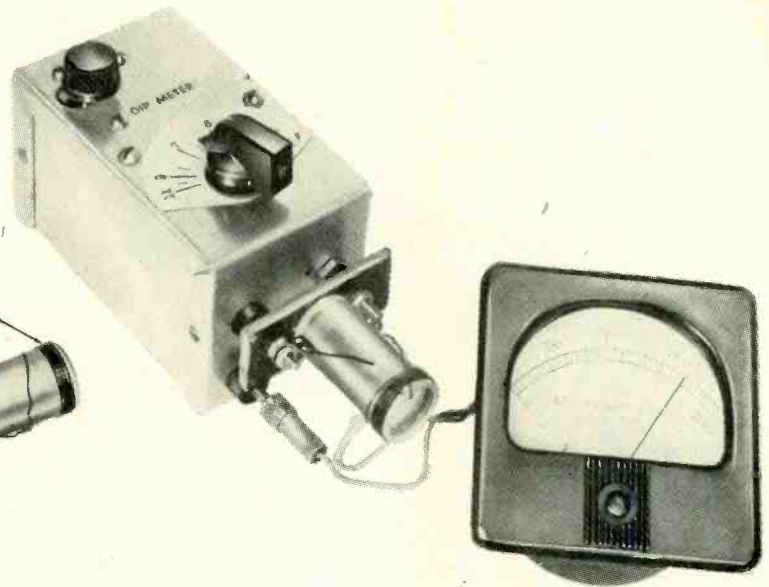
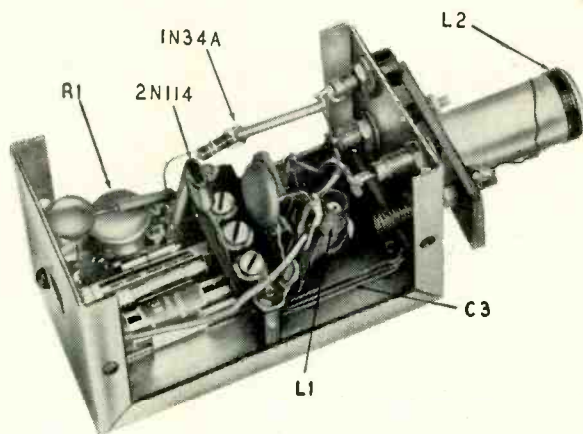

Above—Meter is external to instrument.
Left—Internal view shows parts layout.

A GRID-DIP meter is, generally, a tube oscillator with a meter to measure grid current. When the dip meter is coupled to a nearby tank coil or other resonant circuit, energy is absorbed by the coil. As a result, there is a *dip* in the reading of the dip meter. When the meter is tuned for *maximum* dip, the external and dip circuits are in resonance. The unknown frequency of the tank may then be read on a calibrated scale on the grid-dip meter. The meter is also useful as a signal generator (it is essentially an oscillator), to check coil Q (by sharpness of dip tuning) and other related applications.

To transistorize the dip meter it is important to consider the difference between a tube and a transistor. In a tube oscillator the grid acts as a diode to rectify the rf oscillations. Therefore, it is easy to measure the rf level with a meter in the grid circuit. It may seem that the same principle applies to a transistor . . . perhaps all we need is a meter in series with the collector (or other transistor element). Unfortunately, this doesn't work. The reason is that *each* element of a transistor passes current at all times. Whether the transistor is oscillating or not, the current is essentially constant. For example, in a typical point-contact transistor oscillator, I

measured 2 ma during oscillation; non-oscillating current was 1.6 ma. These may be called the O and N values, respectively. These values, therefore, vary only about 20%. Similar values hold for a junction transistor. In a typical circuit (RADIO-ELECTRONICS, August, 1954, page 87) N is 650 μ a, O is 500 μ a.

In each case the N-O difference is relatively small, representing at best a dip of about 20% on a meter scale. Yet this is not the whole story. This difference, small as it is, does not indicate the *true* dip available during a measurement. No coil can be coupled so tightly that it will absorb *all* the energy from a grid-dip meter. Under normal conditions all we can expect is a dip of about 10–15% of the N-O difference. This comes out to only about 2% of full scale as experiments have shown. For example, in a typical case, a coil was coupled 1 inch from the grid-dip meter. The dip was only one small division on the meter. Evidently the grid-dip principle cannot be used with transistors unless you want to use a magnifying glass, too.

The problem may be solved easily. After attempting various complicated balancing and bucking networks, the following idea was adopted: A diode is added to rectify rf across the grid-dip meter tank and the current is fed to a dc meter. This approximates the operation of a *tube* grid-dip meter! The diode rectifies just like a grid so we

now have the *entire* meter scale to indicate oscillation level. With normal oscillation the meter is set to full scale. When oscillations cease (as from shorting out the coil), the needle deflects back to zero.

Now the N-O difference is the whole meter scale! In one test, a coil was coupled to the grid-dip meter at a distance of 1 inch. The dip amounted to about 15% of full scale (to which the meter had originally been set). With tighter coupling (about ½-inch separation) the dip was to mid-scale. These are healthy dips for which no apology need be offered to tube instruments.

This principle has been applied to a junction-transistor grid-dip meter and results have been most successful. A two-band device was constructed and has been tested under many conditions; a separate plug-in coil is used for each band. One covers from 2.5–5.5 mc; the other from 5.0 to over 11 mc. These ranges were chosen because they represent the most useful portion of the frequency spectrum. For example, there is full coverage and overlap for any experiments and tests in or near the 40- and 80-meter bands.

The oscillator (see diagram) is a Raytheon 2N114, a high-frequency type. It has a frequency cutoff of 20 mc, one of the highest values available. While this article concerns itself only with a coverage up to 11 mc, there is no reason why this cannot be extend-

and carefully adjusted to the position where the indicator light goes out. If the pointer is not now exactly on the calibration point, the operator shifts the dial right or left until the pointer and calibration point coincide. Dial calibration accuracy is now the same as that of the crystal—.01%.

A signal whose frequency is unknown is checked by feeding it into grid 1 of the 6BA7 mixer and tuning the v.f.o. until zero beat is indicated. The frequency of the unknown signal is the same as the dial reading.

Marker circuit

When the Z-axis circuit is operated, signals from the v.f.o., crystal oscillator and sweep generator are fed to the 6BA7 mixer where they produce a large number of beat frequencies. The mixer plate load is now a 75-kc tuned circuit. The swept signal starts at a low frequency and rises to a frequency above that of the v.f.o. in the calibrator. A voltage is developed across L1 - C4 in the mixer plate cir-

cuit when the sweep frequency is 75 kc below the v.f.o. and again when it is 75 kc above. This 75-kc signal is amplified by V2-b and then rectified by one of two CK705 germanium diodes to produce either a positive or negative pulse.

This pulse is amplified in the 6CL6, clamped by the 6AL5 and then fed to the Z-AXIS OUT terminal where it is taken off and used to brighten or blank the scope trace. (See Fig. 3.) When positive-intensity marking (trace brightening) is used, the calibrator frequency is midway between the two bright spots. With negative-intensity marking (blanking) the 75-kc points are marked by narrow gaps on each side of the calibrator frequency.

When the crystal oscillator is turned on, its signal is fed into the mixer and appears as sidebands on the v.f.o. signal. As the sweep signal passes over these sidebands additional markers are produced simultaneously at the sideband frequencies. For example, if the v.f.o. is set to a picture r.f. or i.f.

carrier frequency and the 4.5-mc crystal is switched on, a second marker will appear 4.5 mc away at the sound carrier frequency. The other 4.5-mc sideband will normally be outside the passband of the receiver's circuits and will not produce a marker on the scope pattern. When the 1.5-mc crystal is used, several markers will appear 1.5 mc apart on the pattern.

Offset markers

When a set is far out of alignment or interstage shielding is poor, oscillations may occur when a marker signal is applied. In this case, oscillations or overloading caused by strong markers can be eliminated by setting the v.f.o. to a frequency 4.5, 9, 13.5 or 18 mc above or below the desired frequency and switching on the 4.5-mc oscillator. The sidebands of the v.f.o. will then fall exactly on the desired marker point. Thus, by using successively higher sidebands it is possible to attenuate the marker to the desired degree. END

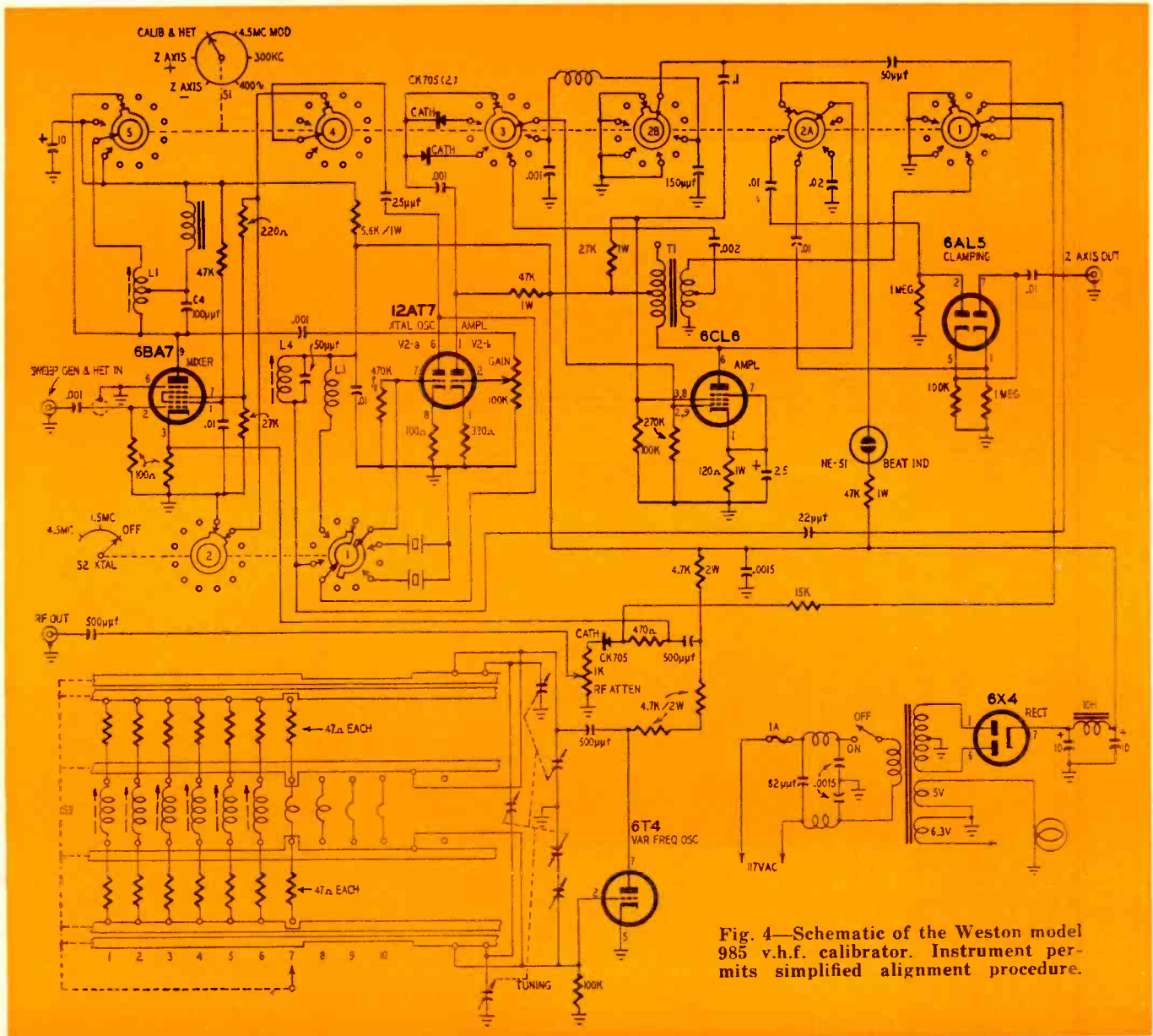
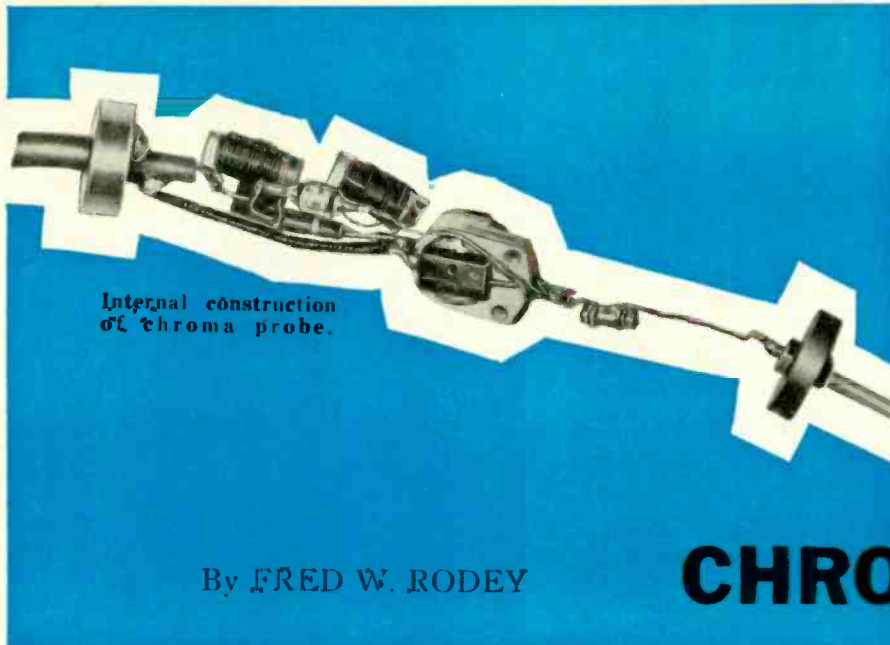

Fig. 4—Schematic of the Weston model 985 v.h.f. calibrator. Instrument permits simplified alignment procedure.



Internal construction of chroma probe.

By FRED W. RODEY

CHROMA PROBE

Unit permits checking chroma circuits with a narrow-band scope

MOST oscilloscopes used in service shops are of the narrow-band type and cannot do a thorough job of color TV servicing. The probe described in this article (see photos) is made for just such scopes and permits viewing the chrominance portion of a color TV signal; it can be used to measure burst amplitude or chroma.

The probe (Fig. 1) consists of a high-pass filter which removes the color information from the composite signal and passes this on to a 3.58-mc trap. The subcarrier trap is broad enough to pass the color information sidebands, approximately plus and minus 500 kc. This band of frequencies is then rectified and filtered in a low-pass network so as to apply only the low-frequency component to the scope.

The output of the chroma probe is proportional to the chrominance amplitude and is not affected by the luminance component. Its input impedance is high enough so that the probe can be used across the low plate and cathode resistors found in most video amplifiers without introducing distortion.

Construction and adjustment

The chroma probe layout is shown in Fig. 2. The 3/4-inch brass end piece is drilled out to 1/4 inch for the coaxial cable. The cable shield is soldered to a solder lug by drilling and tapping the end piece for a 4-40 screw and fastening the lug to the screw.

The parts may then be assembled (except for the Bakelite end piece) as

in the photo. Drill the Bakelite end piece for the probe tip made from a piece of brass rod 2 inches long and 1/8 inch in diameter. The rod should be threaded for a 6-32 screw with 1/2 inch of thread; it is held in place with two 6-32 nuts.

Both end pieces are force-fit so no screws are necessary. With the parts completely assembled, drill a hole in the probe housing (see photo) so that C2 can be adjusted for tuning the 3.58-mc trap.

Finally, the open end of C1 is soldered to the tip and the Bakelite end piece put into place. To keep parts from shorting after assembly, insert a sleeve of empire cloth or similar material inside the tubing.

To tune the trap it will be necessary to use a television receiver tuned to a channel transmitting a color bar signal or program with a stripe signal. Place the probe at the output of the video detector. Set the scope sweep for 7,875 cycles. Adjust the trap for maximum indication on the scope. It is a good practice when using this probe or when doing any video checking with a scope to synchronize the scope externally with a capacitance pickoff from the yoke or flyback transformer. This can be done by clipping a lead from the scope external-sync binding post to a yoke lead. It is not necessary to puncture the yoke lead insulation. External synchronization allows the scope pattern to remain locked in regardless of amplitude or polarity of the signal being viewed.

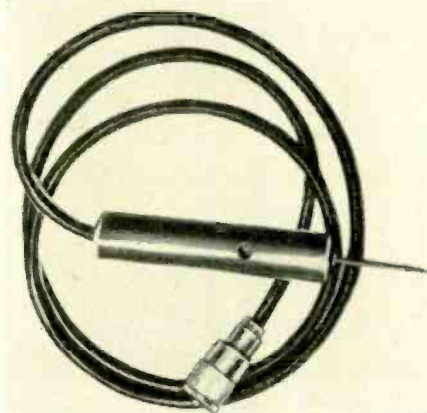

Probe complete with the coax connector.

The scope ground must be connected to the chassis ground.

Using the probe

The probe can be used to measure the relative amount of chroma a receiver will pass. It is not intended for use in rf or if alignment; this job is for a sweeper. After this is done the probe can be put at the output of the video detector to check for antenna mismatch, which can account for loss of color information although the black-and-white picture may appear normal.

The probe can be used at the output of the burst-gate tube to check for the presence of the color burst after keying. The output of the bandpass amplifier can be observed to check for proper operation of the color killer circuits. The final check point at which the probe may be used is at the grid of the I and Q or R - Y and B - Y demodulators. Beyond this point the video color information has frequencies up to only 500 kc, or 1500 kc in the case of the I channel, so normal scope tracing may be used.

A vtvm may be used to check the CW

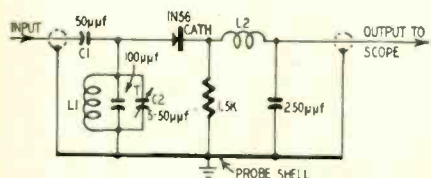

Fig. 1—Schematic of the chroma probe.

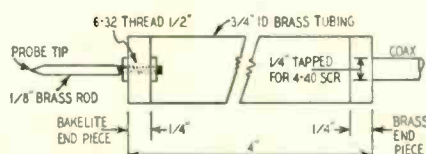

Fig. 2—Mechanical layout of the probe.

A.C.—D.C. PROBE

If you do a lot of testing with a v.t.v.m., you probably have occasion to measure d.c. or a.c. voltages at about the same time. With separate d.c. and a.c. probes you will have to keep changing probes or group your d.c. and then your a.c. measurements.

In a combined probe you simply include both probe circuits within the same shielded cable. The common lead is the same for both. The hot a.c. lead includes an isolating capacitor (see diagram) and filter network. The corresponding d.c. lead needs only the usual isolating resistor. The capacitor used was chosen because it fitted snugly.

The probe is enclosed in a brass cylinder, 4 3/8 inches long and 5/8 inches in diameter. The business end is a needle prod set into a rounded piece of polystyrene. Poly cement is used

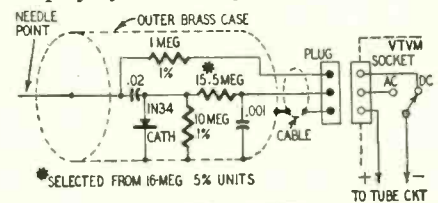

Materials for a.c.—d.c. probe

1—1, 1—10, 1—15.5-megohm, 1% resistors (the latter may be a selected 16-megohm 5% unit or 15 megohms and 500,000 ohms 1% in series); 1—.001, 1—.02- μ f capacitor; 2—4-prong cable type plug, 1—4-prong cable type socket, 1—4-prong chassis type socket, brass sleeve, cable, clip as indicated in text.

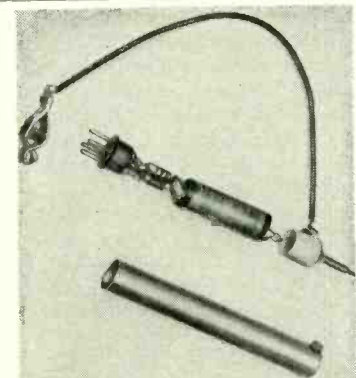

to hold the prod firmly in place. The other end of the probe is a four-pin miniature plug, of which only three pins are used.

A three-conductor extension cable ties the probe to its v.t.v.m. This permits the probe to be detached from its cable so it may be kept safely in a desk drawer while the cable is hung up somewhere. Also, it allows the cable to be used for other purposes.

The far end of the cable is a male unit which plugs into a female socket on the front panel of the v.t.v.m. A toggle switch must be added on the voltmeter panel to switch from d.c. to a.c. as required, without need for changing probes.

The component values shown in the schematic are for a v.t.v.m. with an input resistance of 10 megohms, a common value. With these values, the meter calibration will be correct for both a.c. and d.c.—*Nathaniel Rhita.*

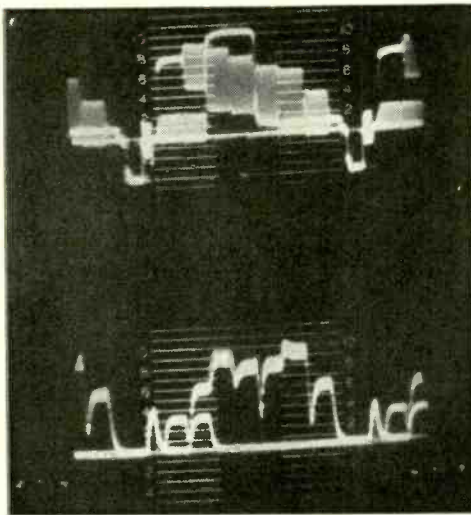

Fig. 3—Standard horizontal waveform of NTSC color bar pattern: above, video detector output as seen with wide-band oscilloscope; below, the same output using the probe and narrow-band oscilloscope.

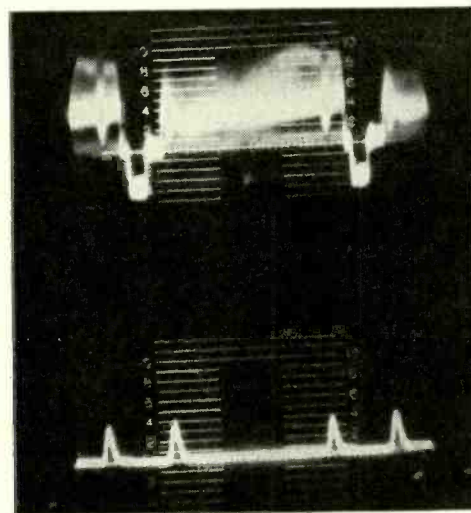

Fig. 4—Color stripe signal in monochrome transmission: above, with wide-band scope; below, with probe and narrow-band scope.

operation of a receiver's local 3.58-mc oscillator up to the demodulator grids to complete the checking of the chroma portions of a color receiver.

Fig. 3 shows the standard horizontal waveform of the NTSC color bar pattern. The colors are arranged in their descending order of luminance: white, yellow, cyan, green, magenta, red and blue. The relative amplitudes of chroma, as displayed by this probe, are not so regular. They are as follows:

| | | | |
|--------|-----|---------|-----|
| Yellow | 69% | Magenta | 88% |
| Cyan | 94% | Red | 94% |
| Green | 88% | Blue | 68% |

The input pattern was taken at the output of a receiver video detector with a wide-band oscilloscope. The output picture was taken with the probe at the same point using a narrow-band scope.

Fig. 4 was made under the same conditions. Most television stations transmitting color programs will insert a stripe signal on their black-and-white programs to aid in adjusting and checking color-receiver operation during installations. The stripe signal consists of two bursts of 3.58 mc of approximately 2 microseconds' duration just preceding the front porch and just following the back porch of the horizontal sync. The

stripe following the back porch locks in the receiver's 3.58-mc oscillator and the stripe preceding the front porch appears as a greenish yellow bar on the right edge of the color-television screen.

Parts list for chroma probe

1—1,500-ohm resistor; 1—50- μ f capacitor (Centralab TCN tubular ceramic or equivalent); 1—100- μ f capacitor, silvered mica, 5%; 1—250- μ f capacitor, silvered mica, 5%; 1—5-50- μ f, trimmer capacitor (Centralab 822-AN or equivalent); 1—1N56; 1—L1, 50 turns of No. 26 wire wound in 2 layers on 1/4-inch Lucite rod over 3/8 inch, 15 μ h; 1—L2, 40 turns of No. 26 wire wound in 2 layers on 1/4-inch Lucite rod over 3/8 inch, 10 μ h; 1—4-foot length RG59/U coaxial cable; 1—connector or jack, depending on scope input connection; 1—4-inch length brass tubing, 3/8-inch inside diameter; 1—brass end piece, 3/4-inch round stock, 1/4-inch long; 1—Bakelite end piece, 3/4-inch round stock, 1/4 inch long; 1—2-inch length 1/8-inch brass rod threaded for 6-32, 1/2 inch, on one end.

When the probe is used on a video signal containing a 3.58-mc stripe, the output will appear as two pips on either side of the video blanking interval. These pips can be used in tracing the color information just like a color-bar pattern. However, only the burst following the horizontal sync pulse will appear at the output of the burst keyer and the burst preceding horizontal sync will appear in the bandpass amplifier channel.

END

INEXPENSIVE CAPACITOR CHECKER



The Knight model F 119 capacitor checker.

The Knight in-circuit tester kit makes for rapid servicing

By NORMAN KRAMER*

CAPACITORS are made to a great many specifications. However, regardless of the manufacturing technique or the voltage-capacitance rating, there are two basic properties all capacitors have in common—the ability to block dc and to pass ac.

To determine the condition of a capacitor in a given circuit, with ordinary equipment, one lead must be unsoldered to isolate it from the rest of the circuit. This method is time-consuming because many good capacitors may have to be unsoldered before the faulty one is found. Perhaps more important, the trend in modern receivers and other electronic equipment is definitely toward printed-circuit wiring. Here, with the short component terminals and the ever present danger to foil pattern, phenolic and bonding of the foil to the phenolic, unsoldering and resoldering capacitors can be costly.

The new in-circuit capacitor checkers

*Project Engineer, Allied Radio Corp., Chicago, Ill.

permit service technicians to check capacitors quickly while they are still soldered into their associated circuits. The test leads from the instrument are placed across the capacitor and the test switch depressed. Observing the condition of the tuning eye, one can determine if the capacitor is open. Pressing another switch and again observing the condition of the eye provides a short test. Thus, both the open and short tests are made without disturbing the leads or the circuit.

An example of this type of instrument is the recently released Knight capacitor checker kit. This instrument has two separate test circuits to show whether capacitors are open or shorted.

Fig. 1 is a simplified diagram of the open-circuit test. Hartley oscillator V1 operates at a frequency of approximately 20 mc, with L1-C1 forming the tuned circuit. Pickup coil L2 is close-coupled to the tank circuit and feeds network Z1, consisting of C2, L3 and C3. This network and the 48-inch coaxial cable to the test clips make up a quarter-wave transmission line at

approximately 20 mc. Without Z1, which serves as an artificial line, the test leads would have to be over 12 feet in length to be a quarter wavelength at 20 mc.

An interesting property of a quarter-wave line is that any impedance connected at the output is reflected to the sending end as a *reciprocal*. That is, if the output end is open, the input end "sees" a short circuit and *vice versa*. Thus, if the test clips are open or connected to an open capacitor, the sending end of L2 sees a short circuit, or zero voltage. The voltage across L2 is rectified by the diode and applied to the grid of V2, keeping the eye normally open.

If L2 sees a short circuit (an open capacitor), no voltage is impressed on the grid and the eye remains open. If, however, a normal capacitor is connected across the test leads, a voltage appears across the test leads, is applied across L2, rectified and fed to the grid of the eye tube. This causes it to close in proportion to the magnitude of the voltage. A capacitor of 20 μf will cause practically complete closing; any capacitance larger than this will definitely close the eye. Capacitors smaller than 20 μf will cause partial closing. Shunting resistances of 50 ohms or less across the capacitor under test will cause the eye to close, indicating a good capacitor even though the capacitor may be open. (A description of a similar circuit appeared in the July, 1954, issue on page 53.—*Editor*)

Fig. 2 is a simplified schematic of the short-circuit test. With the test

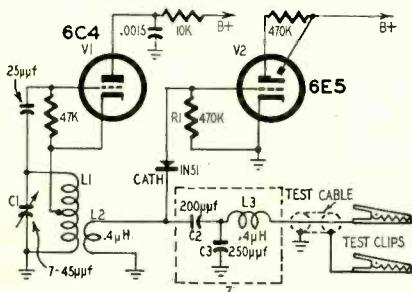

Fig. 1—Diagram for open-circuit test.

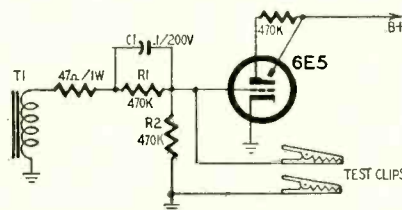
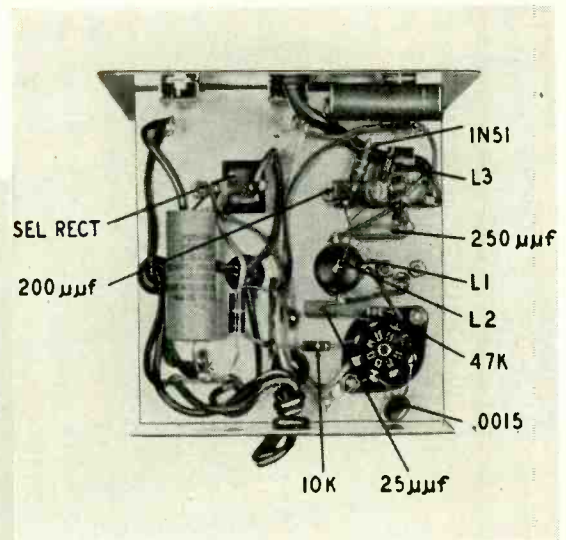
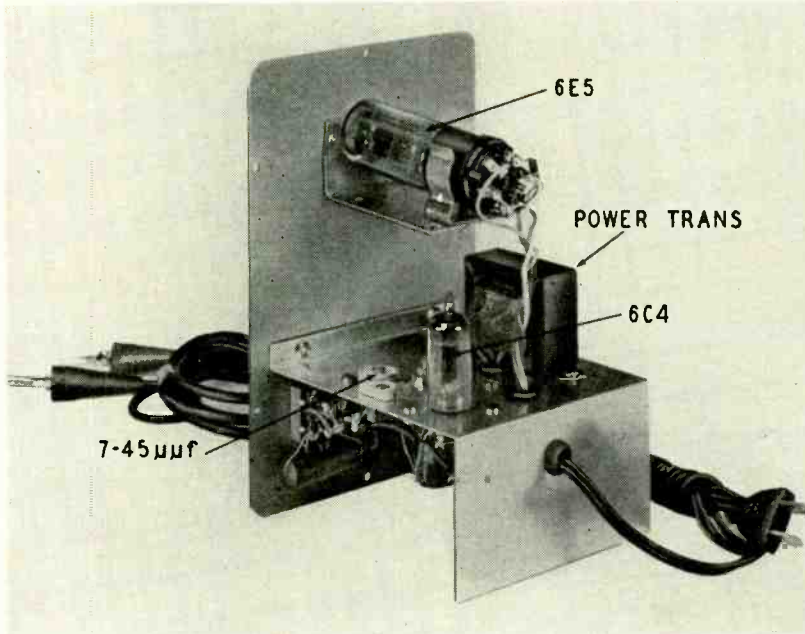

Fig. 2—Diagram for short-circuit test.



Left—Rear view of the tester, showing the 6E5 assembly and oscillator adjustment. Above —Underchassis view of capacitor checker.

selector switch in this position, the heater winding of the transformer furnishes, through R1 and C1, a proper bias voltage which is impressed across R2, closing the 6E5 eye tube. The test clips in this test shunt R2. If the test clips are shorted, bias voltage is lost and the eye opens. Thus, any shorted capacitor will open the eye. Capacitors which are merely leaky will only shunt R2, reducing the bias voltage but not eliminating it. Actually, a leaky capacitor must be almost completely shorted to open the eye completely.

The bias voltage is chosen to make the test insensitive to high resistance. Therefore, good capacitors larger than 2,000 μf whose reactance is extremely low, or good capacitors which are across

resistors of less than approximately 20 ohms, will show partial eye opening.

The 7-45-μmf ceramic trimmer capac-

Parts for capacitor checker

Resistors: 1—10,000, 1—47,000, 3—470,000 ohms, 1/2 watt, 10%; 1—47 ohms, 1 watt.

Capacitors: 1—25, 1—200 (5%), 1—250 μmf, mica; 1—.0015, 1—0.1 μf; 1—20-μf electrolytic, 150 volts; 1—7-45-μmf trimmer.

Coils: 1—oscillator type (L1), 12 turns of No. 22 enameled wire wound on a 3/8-inch diameter coil form, tapped at 6 turns; 2—coils (L2 and L3) 0.4 μh, 12 turns of No. 28 enameled wire closewound on 1/8-inch diameter form.

Miscellaneous: 1—50-ma selenium rectifier; 1—1N51 crystal diode; 2—spst slide switches; 1—dpdt slide switch; 1—transformer, 140 volts at 20 ma, 6.3 volts at 1 amp; 1—6E5 and 6-pin socket; 1—6C4 and miniature 7-pin socket; 1—mounting bracket for 6E5; 1—chassis; 1—48-inch length of coaxial cable; 2—alligator clips.

itor is the only variable element in the entire circuit. So when the instrument is assembled and the coaxial test lead is left hanging free, a simple screwdriver adjustment will tune the oscillator to approximately 20 mc, making the test lead and the load line exactly a quarter wavelength long.

Fig. 3 is a complete schematic of the Knight capacitor checker kit. The power supply consists of a half-wave rectifier using a single 20-μf filter capacitor. Further filtering is unnecessary as it will not affect operation. The 6.3-volt secondary winding of the power transformer supplies the heater voltages and the bias voltage to the 6E5 when the instrument is in the short-test position. Switch S1 must be closed before each test is performed; S2 selects either the open- or short-circuit capacitor test.

In some cases a short may be intermittent. Therefore, it is a good idea to tap or jar the capacitor under test and note any flicker of the indicator. By so doing a very troublesome intermittent short may be discovered.

Shorted capacitors may be somewhat obvious, especially where they cause complete loss of tube voltages. Open capacitors may have a far more subtle effect and, hence, be more difficult to detect. Such capacitors could cause signal loss, serious change of waveform or instability.

In view of the time-saving features alone, an in-circuit capacitor checker can be a welcome addition to any service shop. END

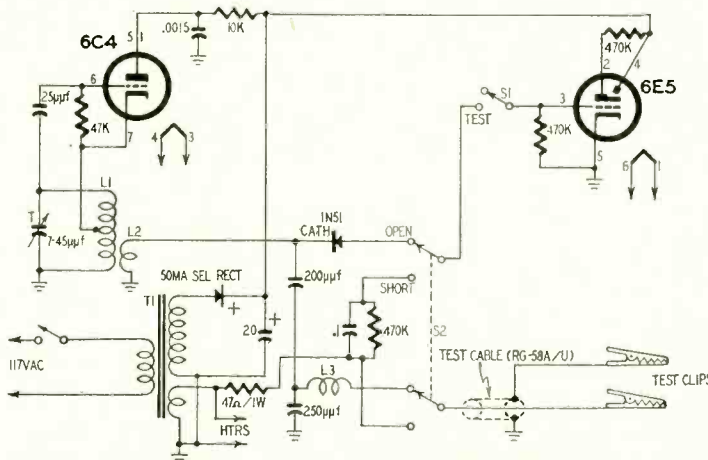
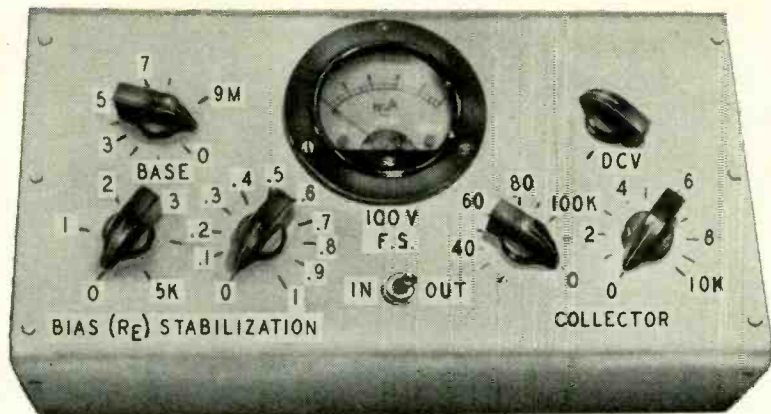

Fig. 3—Schematic diagram of the Knight in-circuit capacitor checker.

Test unit permits rapid design of transistor circuitry

the transigner

By FORREST H. FRANTZ, SR.*



A front view of the transigner.

Except for power supply, all components are located under transigner chassis.

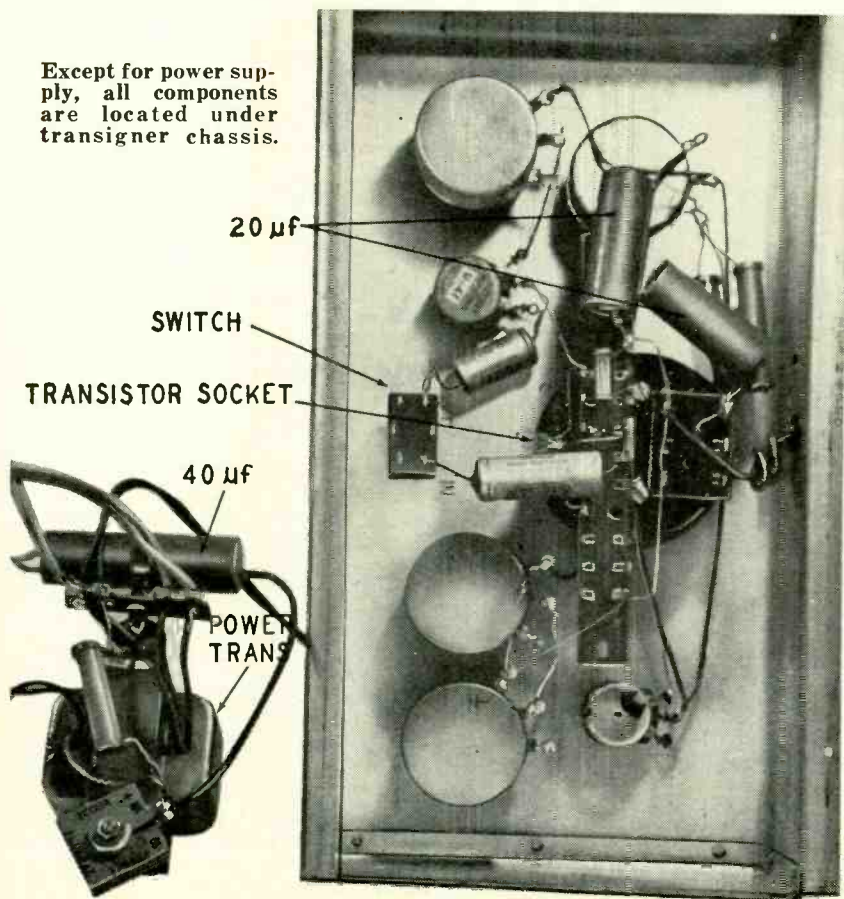

SINCE the appearance of the transistor, considerable emphasis has been placed on the wide variations between transistors of a given type. This has been so well publicized that I was convinced that attempts at graphical and analytical amplifier design would be futile. The prospect of having to change resistors in a miniature transistor amplifier was not at all pleasant. This wastes time, usually messes up the looks of an amplifier and occasionally leads to ruined parts.

This little unit was created to overcome these difficulties. The transigner method of amplifier design is fast and accurate. Many experimenters do not like to become entangled with calculations. For those, the big advantage in the transigner approach is that calculations may be dispensed with, optimum operating values predicted and transistors with abnormal characteristics may be easily detected.

What is the transigner? It is simply a grounded-emitter amplifier circuit and variable power supply equipped with variable bias resistances. To change the operating voltage, you turn a potentiometer; to change the value of any resistance, you turn another (Fig. 1). The dc voltage applied to the transistor circuit may be varied with the 7,500-ohm voltage divider in the power supply circuit. The collector bias resistance may be adjusted by varying the 100,000- and 10,000-ohm potentiometers connected in series in the collector circuit. A 10-megohm pot in the base circuit controls base bias resistance and 5,000- and 1,000-ohm units in series with the emitter permit varying the emitter bias resistance. With these controls you can design a transistor audio amplifier in minutes.

The original transigner was a cheap and dirty arrangement constructed in 3 hours. Stress was placed on ease of operation, versatility and ease of interpretation rather than elegance. The bottom view of the transigner reveals that a large number of blank tie-down points are available. These were provided so that changes could easily be made in the circuit later if desired. The transistor socket and the terminal strips were fastened to the meter with

* Physics Dept., Mississippi State College

Duco cement. The meter is not essential since a bench instrument may be used to adjust the applied dc voltage.

The switch permits speedy measurement of input and output voltages and waveforms. The leads from an oscilloscope and an audio vtvm clip to the ground bus and the center switch terminal. The signal leads from an audio generator connect to the input terminals. The power transformer and several associated components are wired separately to avoid hum pickup. They should be placed in an enclosure (I use a cardboard power-transformer box) for safety. The power supply in the transigner circuit was designed for p-n-p type transistors such as the Raytheon CK722. For n-p-n transistors such as the 2N35, a negative ground is required and a conventional utility power supply can be used.

The markings on the front panel may be made with India ink. They should be made prior to wiring, using an ohmmeter to determine calibration points. The builder who does not include a voltmeter in his transigner may calibrate his dc voltage control with an external voltmeter and be assured of reasonable accuracy.

Using the transigner

To design a grounded-emitter transistor amplifier stage, place the transistor to be used in the socket (be sure to make proper connections). Connect an audio signal generator to the input of the transigner and an audio voltmeter and oscilloscope to the center switch terminal and ground. Set the resistance controls to approximately correct values. For example, if a CK722 is to be used with a 6-volt supply, set the base bias to 250,000 ohms and the collector bias to 20,000 ohms if a high-impedance output load is to be used. The approximate settings are not critical. The power may then be applied and the voltage control advanced to supply 6 volts. The base and collector bias controls are then

manipulated for maximum gain and best output waveform.

Although the audio generator output control is kept at a constant setting, the input voltage to the amplifier may vary with changes in the transigner control settings. Therefore, to be sure about the gain of the amplifier stage, you must always divide the output audio voltage by the input audio voltage.

The emitter bias resistance plays an important role in grounded-emitter amplifiers. An unbypassed emitter bias resistance stabilizes the amplifier by minimizing shifts in the dc operating point with temperature changes. It also increases the input impedance of the amplifier. Since it is often desirable to cascade amplifier stages or use high-impedance input devices, the latter feature is particularly important. A further effect of the emitter bias resistance is to improve low-frequency response. Of course, a price must be paid for these improvements and the cost is a reduction in amplifier gain.

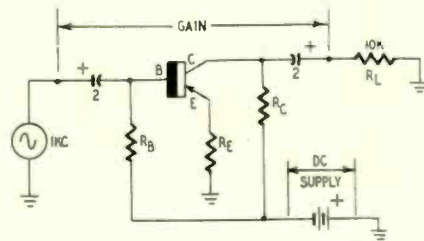

GROUND-EMITTER AMPLIFIER

| Dc volts | RB (ohms) | RE (ohms) | RC (ohms) | Voltage Gain | Input Impedance |
|----------|-----------|-----------|-----------|--------------|-----------------|
| 3 | 10,000 | 200,000 | 0 | 59 | 2,300 |
| | | | 500 | 14.1 | 9,300 |
| | | | 1,000 | 11.2 | 1,800 |
| 6 | 10,000 | 250,000 | 0 | 15.6 | 10,400 |
| | | | 500 | 8.6 | 18,800 |
| | | | 1,000 | 6.4 | 10,200 |
| 22.5 | 40,000 | 900,000 | 0 | 500 | 1,280 |
| | | | 500 | 64 | 10,200 |
| | | | 1,000 | 33.3 | 19,200 |

Fig. 2—Diagram of test circuit and data obtained using CK722 transistor.

Fig. 2 contains some experimental results for various circuit values for a grounded-emitter amplifier using a CK722 transistor. It indicates performance with various circuit values. Note that for the particular transistor used for this data, an emitter bias resistance of 500 ohms increased the input impedance to approximately 10,000 ohms and a resistance of 1,000 ohms increased it to approximately 20,000 ohms.

If the amplifier you're designing is to drive a load of less than 100,000 ohms, the load should be connected at the output terminals of the transigner. This is necessary because the output load has considerable influence on the operation of a transistor amplifier. For example, if you intend to use the amplifier stage you're designing to drive a second transistor amplifier stage, the second stage will present a load of approximately 1,500 ohms to the collector circuit of the first amplifier (assuming zero emitter bias resistance for the second stage). In such a case

you should connect a 1,500-ohm resistance to the output of the transigner to simulate the actual load. If the second amplifier stage has an emitter bias resistance of approximately 1,000 ohms, the input impedance (and consequently the load on the first stage) will be approximately 20,000 ohms and a similar resistor should be connected to the output of the transigner.

You might say, "That's fine and dandy, but how can I find the input impedance of a given transistor amplifier?" This can be done by using the arrangement shown in Fig. 3. Measure voltages V1 and V2 with an audio volt-

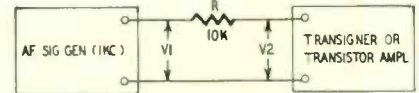

Fig. 3—Method for determining transistor amplifier input impedance.

meter. Then substitute the measured values in the equation:

$$Z_{in} = \frac{V2R}{(V1 - V2)}$$

to calculate the input impedance.

To design a multistage transistor amplifier, you must start with the last stage and work toward the input end of the amplifier. As each stage is designed, record the component values. When optimum component values have been determined for all stages, you're ready to proceed with the construction of the miniature amplifier. The coupling capacitors can be 5-μf miniature electrolytics. A safe rule of thumb for determining the voltage rating is to make it equal or greater than the dc power supply voltage to be used in the miniature transistor amplifier.

Parts for the transigner

Resistors: 1—1,500 ohms, 1 watt; 2—22,000 ohms, 2 watts; 1—1,000, 1—5,000, 1—7,500 (3-watt wirewound), 1—10,000, 1—100,000 ohms, 1—10 megohms (logarithmic taper), potentiometers.

Capacitors: 2—2-μf 200 volts; 2—20 μf, 1—40 μf 150 volts, electrolytics.

Miscellaneous: 1—selenium rectifier, 20 ma; 1—power transformer, secondary 75-110 volts; 1—spdt switch; 1—transistor socket; 1—chassis; 1—container for power-supply components.

Optional: 1—0-1-ma meter; 1—100,000-ohm 1/2-watt resistor.

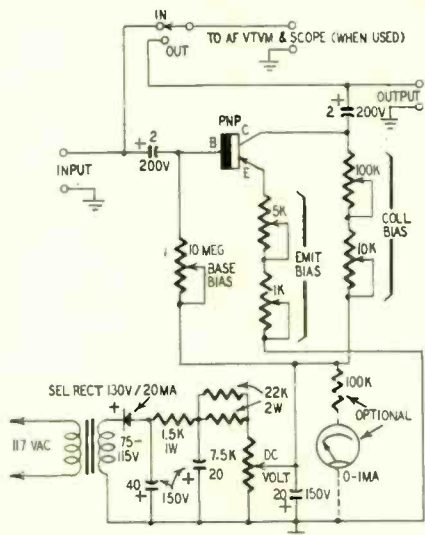

Fig. 1—The transigner. All transistor voltages can be varied.

the **Y** signal in

MATRIX OPERATION

When excessive signals are applied to the picture tube, the Y voltages may also affect the picture hue

By ROBERT G. MIDDLETON *

MATRIX response changes greatly when the Y signal level is varied. It is possible, for example, to cut off or energize the green gun in the picture tube merely by varying the Y voltage while the chrominance signal voltage is held constant.

Fig. 1 shows a familiar matrix arrangement used in many present-day color TV receivers. We will observe how this matrix responds to various levels of Y voltage while an R-Y signal is applied to the color detectors. Fig. 2 shows the output from the R-Y detector when applying the R-Y signal. For illustration, the output from the R-Y detector is 7 volts; the output from the B-Y detector is zero because a B-Y detector cannot respond to an R-Y signal voltage.

However, as shown in Fig. 2, the R-Y signal causes the G-Y matrix to develop an output voltage, equal in this case to -3.6. Readers will recall that the G-Y matrix responds to a color signal voltage by adding -0.51 (R-Y) to -0.19 (B-Y), a G-Y output is obtained when an R-Y signal is applied to the color circuits.

*Chief field engineer, Simpson Electric Co.

The output voltages from the R-Y detector and the G-Y matrix are applied to the grids of the color picture tube. In a low-level demodulation system the output voltages are amplified before application to the picture tube; in a high-level demodulation system the detectors operate at a sufficiently high voltage so that the output voltages from the detectors can drive the grids of the color picture tube directly.

Figs. 3, 4 and 5 show how the response of the picture tube to an R-Y signal varies in accordance with the voltage of the Y signal, applied to the cathodes of the picture tube. When the Y voltage is zero (Fig. 3) and the R-Y detector output is 7 volts, the result is 7 volts drive to the red gun, zero to the blue gun and -3.6 to the green gun. The red gun develops output because the signal is positive; the blue gun develops no output because no drive is applied; the green gun develops no output because the signal is negative. Thus we will see a saturated red hue of low brightness when the color picture tube is driven by the signal voltages in Fig. 3.

Fig. 4 shows the result of raising the Y signal from 0 to 3 volts, keeping

the output from the R-Y detector at 7 volts. (In discussing matrix operation, a positive signal voltage increases the beam current from the gun, a negative signal voltage decreases it. Thus, the signal voltages at the red gun are now additive and a total of 10 volts drive is applied to the red gun. The signal voltages at the blue gun provide 3 volts of drive, the blue gun now producing beam current. The signal voltages at the green gun subtract, resulting in -0.6 volt drive to the green gun. Thus, the green gun is still cut off. Since there is output from the red and blue guns, the red hue is no longer pure. It is mixed with blue and a magenta hue is produced.

In Fig. 5, we see the result of further raising the Y signal voltage—to 5. As a result, the green gun is no longer cut off, developing beam current corresponding to 1.4 volts of signal drive. A greenish hue is now mixed with the red and blue hues.

Y voltage in rainbow generators

Let us apply the above to the display of rainbow patterns and see how hue may depend upon the value of Y signal voltage selected by the technician. A rainbow signal is a simple sine-wave voltage, usually set at 3.58 mc ± 15,750 cycles—the color subcarrier frequency plus or minus one horizontal scan. The color TV receiver then displays one rainbow spectrum, with a small portion lost on retrace. When the rainbow signal operates below 3.58 mc the colors are reversed in their order as compared with the order when the rainbow signal is operating above this frequency.

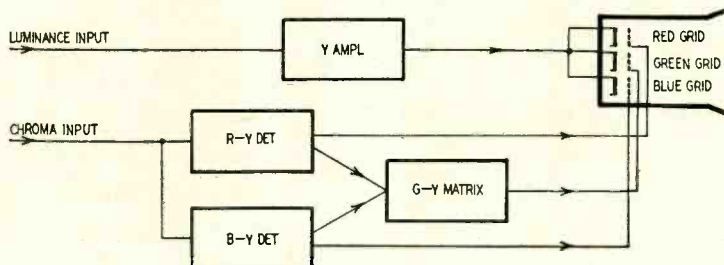

Fig. 1—A common matrix arrangement used in color TV receivers.

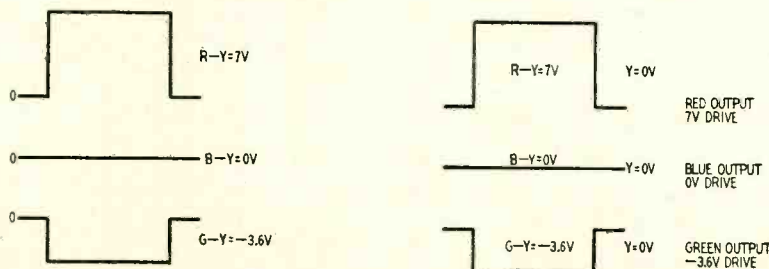

Fig. 2—Output of color detectors and matrix when R-Y signal is applied.

Fig. 3—Tube drive when Y = 0 volt.

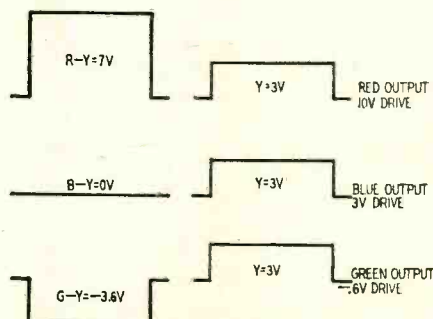

Fig. 4—Tube drive when Y = 3 volts.

A rainbow signal can be displayed on the screen of a wide-band scope having a triggered horizontal sweep or a conventional horizontal sweep capable of operating at 300 or 400 kc. The rainbow signal then appears as shown in Fig. 6. The signal has the shape of a simple sine wave. Since the frequency of this rainbow signal differs slightly from the color subcarrier, it is often referred to as an *offset color subcarrier*.

The rainbow signal has a constant voltage, depicted in Fig. 7 by representing the signal voltage in the form of a circular sweep (constant radius). The rainbow signal rotates in phase with respect to the color-subcarrier oscillator in the receiver because it has an offset frequency. (An ac voltage represented as an arrow—or vector—necessarily rotates with respect to another ac voltage having a different frequency.) And because the rainbow-signal vector rotates with respect to the color-subcarrier oscillator vector, it sweeps through the various hues indicated in Fig. 7. For this reason, a rainbow signal is sometimes called a *linear phase sweep*. It is a *linear* sweep because it has a constant rotating speed; it is a *phase* sweep because its only variation consists of a change in phase with respect to the color-subcarrier oscillator voltage.

When the rainbow signal is applied to a color TV receiver, it is picked up only by the color detectors (see Fig. 1); no part of the rainbow signal passes through the Y amplifier since the color subcarrier frequency is trapped out in the Y amplifier.

Since the rainbow signal is incomplete (no Y-signal component), how is it possible to obtain visible patterns on the screen of the picture tube? This is done by introducing an artificial Y component via the brightness control. The master brightness control applies a dc bias voltage to the signal electrodes of the color picture tube. Thus the technician simply advances the brightness control to a point where the rainbow colors appear satisfactorily on the screen of the picture tube. This is equivalent to having a Y signal of constant value.

Returning to Figs. 3, 4 and 5, we can see that when the rainbow signal is sweeping through the R-Y phase,

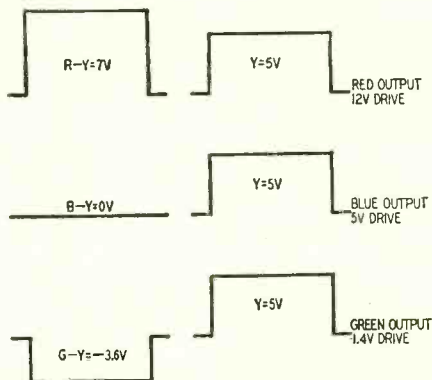

Fig. 5—Tube drive when Y = 5 volts.

we can obtain any one of the three conditions by adjusting the master brightness control. That is, we can make the R-Y signal phase energize the red gun alone, the red and blue guns together or the red, blue and green guns together.

Thus, the hue displayed on the screen of the color picture tube can be made to vary by adjusting the value of the Y signal. However, it must not be supposed that this is *always* the case—the value of the Y signal in other (and more conventional) situations controls only the *brightness* and *saturation* of a color, without changing its *hue*.

A standard NTSC color-bar signal for 100% saturated colors is shown in Fig. 8. This color signal has a luminance and a chrominance component, as shown in Fig. 9. The three characteristics of a color, which concern matrix and picture-tube operation, are brightness, hue and saturation, which the matrix processes in terms of Y, R-Y, B-Y and G-Y. R-Y and B-Y are distinguished by phase, being in phase quadrature (90°) to each other. The chrominance signal in Fig. 9-a is a mixture of R-Y and B-Y.

As a simple illustration of the effect of the Y component in controlling brightness and saturation, consider the following three red color signals:

1. Signal for 100% saturated red at full brightness:

$$\begin{aligned} Y &= 0.30 \\ R - Y &= 0.70 \\ B - Y &= -0.30 \\ G + Y &= -0.30 \end{aligned}$$

2. Signal for 50% saturated red at full brightness:

$$\begin{aligned} Y &= 0.65 \\ R - Y &= 0.35 \\ B - Y &= -0.15 \\ G - Y &= -0.15 \end{aligned}$$

3. Signal for 100% saturated red at half brightness:

$$\begin{aligned} Y &= 0.15 \\ R - Y &= 0.35 \\ B - Y &= -0.15 \\ G - Y &= -0.15 \end{aligned}$$

The voltages in these three red signals show that the only difference between 100% saturated red at half brightness and 50% saturated red at full brightness in the Y component.

This, then, leads to the question, "Why do we observe cases of matrix operation in which the value of the Y component affects hue, while in other cases the value of the Y component affects only brightness and saturation?" The answer to this is that the value of the Y component can change the hue only when the relative values of luminance and chrominance voltages are such that the dynamic operating range of the color picture tube is exceeded.

Thus, it can be stated: **The role of the Y signal in matrix operation is controlling the brightness and saturation with no control of hue, during normal operation of the picture tube.** END

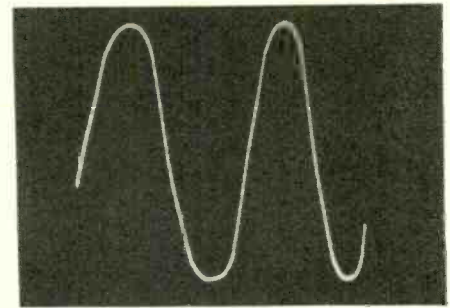

Fig. 6—Waveform of rainbow signal.

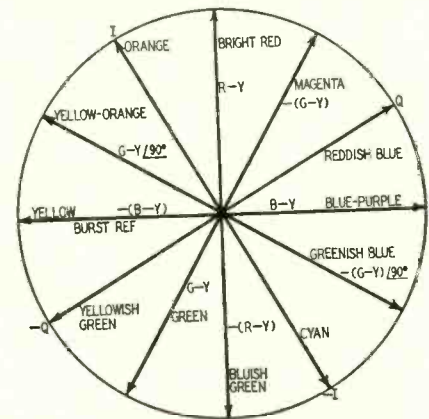

Fig. 7—Color phase relationships.

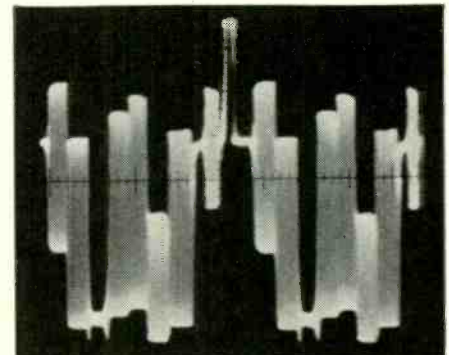

Fig. 8—Standard NTSC color-bar signal.

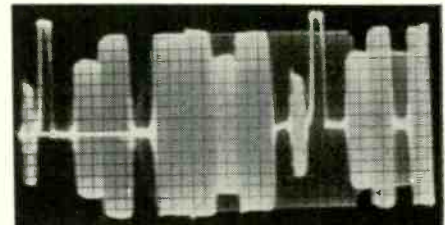
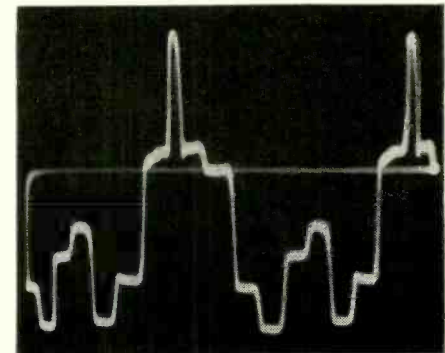

Fig. 9-a (top)—5.58-mc chrominance component of color-bar signal; 9-b (bottom)—luminance.



- (front end, common i.f. stage, video detector and possibly video amplifier in intercarrier sets).
- No pix, sound normal, raster O.K. (video strip in split-sound receivers, video amplifier in intercarrier sets when sound is taken off at the video detector).
 - Weak (snowy) pix (see photo), weak sound (front end, common i.f., video detector and possibly video amplifier in intercarrier sets).
 - Weak video (see photo), loss of horizontal and vertical sync, sound O.K. (video strip).
 - A change of sensitivity in both video and sound as the set is operating (front end, common i.f., video detector and possibly video amplifier in intercarrier sets).
 - Video hum pickup (front end, video strip).

The a.g.c. circuit is usually considered part of the video strip which also includes the video (or common) i.f. stages, the video detector, the video amplifier and the picture tube. Thus, the a.g.c. circuit must be kept in mind as a possible source of trouble when symptoms point to a defect in the

Front end or common portion of the video strip (no sound, no pix, raster O.K.);

Video strip (weak or contrasty video or no video, sound and raster O.K.);

Sync section, horizontal a.f.c. or sweep circuits (poor horizontal or vertical sync).

Therefore an a.g.c. circuit check should be made a part of normal troubleshooting when these symptoms are noticed.

A.g.c. systems

Two basic types of a.g.c. systems are commonly used: simple and keyed (gated). A third type, found in several recent models, can be considered a combination of the two (Fig. 1). A similar circuit in a current Zenith model is labeled *noise-gated amplified a.g.c.* A fourth variety—amplified a.g.c.—was used in a number of models before the keyed a.g.c. system became so popular. There are of course many variations of each of these major types. Fig. 2 shows a simple a.g.c. circuit, using an a.g.c. diode rectifier.

Simple a.g.c. is similar to a.v.c. in radio receivers. The rectified and filtered video i.f. signal produces a negative d.c. output voltage based on the peak value of the i.f. input. In simple a.g.c. systems noise bursts and high noise levels tend to add to the normal a.g.c. voltage. This increases the adverse effect on the signal unless noise cancellation circuits are used.

A keyed a.g.c. system is shown in Fig. 3 and is used in many recent models. The keyer tube, which is biased to cutoff by a high cathode voltage, conducts only during the period when the positive peaks of the video signal (horizontal sync pulses) are applied to

the grid. At the same time, a narrow, positive square wave derived from the horizontal sawtooth retrace is applied to the plate from the horizontal output circuit. Plate current, therefore, flows only during the sync pulse interval. The plate circuit has an a.g.c. filter network that charges to a negative voltage in accordance with the signal strength. Noise pulses between sync pulses have no effect in developing a.g.c. bias since the tube is cut off during these intervals.

In the noise-gated amplified a.g.c. circuit shown in Fig. 1, the video signal from the plate of the video amplifier is applied to grid 3 of the 6BE6 first sync clipper. Grid rectification occurs, developing a negative voltage at this point which is applied to the a.g.c. line. At the same time, a negative voltage is developed at the video detector

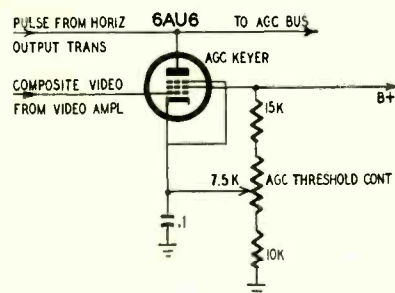

Fig. 4—The a.g.c. threshold control is in cathode circuit of keyer tube.

output which is also applied to the a.g.c. line. The resulting a.g.c. bias at the junction of R266 and R262 is a function of the peak signal input at the antenna terminals of the receiver. (The 6BE6 also functions as a noise-cancellation stage. Video signals of opposite polarity are applied to grids 1 and 3. The normal amplitude of each allows sync pulse output to appear at the plate. However, large noise pulses in the video signal act to cancel each other in the output of the stage.)

A.g.c. action

The primary function of a.g.c. is to keep the output picture level relatively constant with changes in signal strength (peak signal level) at the antenna terminals. Like a.v.c. in radio, this is done by making a strong signal develop more a.g.c. bias, applied through the a.g.c. bus to the grids of the r.f. and video (or common) i.f. amplifier stages, to reduce amplification. A weak signal produces less a.g.c. bias. Therefore, r.f. and video (common) i.f. amplification is greater.

However, if a comparatively weak signal were allowed to develop *any* a.g.c. bias, the result would be a still weaker signal. This is undesirable, especially in fringe areas where the signal-to-noise ratio is low. For this reason many receivers with a.g.c. have controls or switches in the a.g.c. system for selecting the level of signal strength at which the a.g.c. becomes operative.

Manual a.g.c. controls fall into two

main groups: local-distance switches and a.g.c. threshold controls. Automatic a.g.c. delay networks generally use either a clamping diode or a bias applied to the a.g.c. diode rectifier. Some models use one or more of these devices in the a.g.c. system (Figs. 1-4). Other receivers with a.g.c. may use none. The local-distance switch shorts out part or all of the a.g.c. voltage to the r.f. amplifier (and in some receivers, the other controlled stages) in the distance position. This allows the r.f. amplifier (and in some receivers, the other controlled stages) to operate with little or no a.g.c., permitting greater amplification of weak signals with a resultant improvement in the signal-to-noise ratio.

The threshold control is generally a potentiometer connected in a voltage-divider network. In some models, this control (Fig. 4) varies the bias to the a.g.c. keyer tube so that the stage does not operate until a given level of video signal is present. Above that level, the tube operates and applies a.g.c.

In other models the threshold control varies the voltage applied to the a.g.c. bus—usually to that section of the bus connected to the r.f. amplifier (R317, Fig. 1; PERFORMANCE CONTROL, Fig. 3). In this type of circuit it is generally used together with a clamping diode. In the circuit of Fig. 4 no negative voltage appears on the entire a.g.c. bus until the video signal is above the level selected by the threshold control setting. In Figs. 1 and 3, some a.g.c. voltage is developed even at low signal levels but no a.g.c. bias is applied to the r.f. amplifier stage until the video signal is above the threshold setting.

A clamping diode is connected from the a.g.c. bus to ground (V209, Fig. 1; V13-b, Fig. 3). At low signal levels, the diode conducts and clamps the point where the diode plate is connected to ground potential. No a.g.c. voltage is developed at this point. When the video signal rises above a given level, the voltage at the clamping diode plate becomes negative and the diode no longer conducts. A.g.c. voltage is then developed.

When a threshold or delay control is used with a clamping diode as in Figs. 1 and 3, the level at which a.g.c. bias begins to be developed can be varied. If the control is rotated so the voltage at the center tap is more positive, a stronger video signal is necessary to bring the voltage at the diode plate below ground potential and so cause the clamper to cut off.

Fig. 2 shows a simple a.g.c. delay network which makes use of a bias voltage applied to the a.g.c. rectifier. The cathode of the a.g.c. diode is connected to the cathode of the last video i.f. amplifier. The small positive voltage applied to the a.g.c. rectifier cathode keeps the tube cut off until the signal level at the diode plate is large enough to overcome this biasing voltage. A.g.c. voltage is then developed in the usual way. TO BE CONTINUED

Field Service Experiences with COLOR TV

A review of common troubles the service technician may expect to find

By CHARLES W. RHODES*

ASIDE from the routine component breakdowns in color receivers, which have their counterparts in monochrome chassis, a few new problems have developed to challenge the service technician who has turned his attention to color.

One common trouble is intermittent color reception. I have seen cases where slight changes in antenna orientation or lead-in placement caused loss of color. At first the trouble appeared to be in the antenna system. However, the color didn't grow weaker gradually; it disappeared abruptly and in each case varying the hue control also caused loss of color, often just as the correct setting of the control was approached.

Actually the trouble had nothing to do with either the antenna or hue control. The clue is the abrupt loss of color. It is caused by the color killer circuit which biases the chrominance amplifier beyond cutoff during monochrome reception to prevent noise pulses from passing through the chrominance circuits and causing color specks on the screen.

Fig. 1 shows a widely used color killer circuit. During color reception the burst signal is rectified by V4 which develops a high negative bias at the plate of V4-b. This is applied to color killer V1 and cuts off plate current. The plate voltage of V1 then rises to B plus, 150 volts.

Chrominance amplifier V2 is direct-coupled to V1, its cathode being returned to B plus. Plate current flow through V1 lowers the grid voltage of V2, cutting it off whenever the burst signal is not present — during mono-

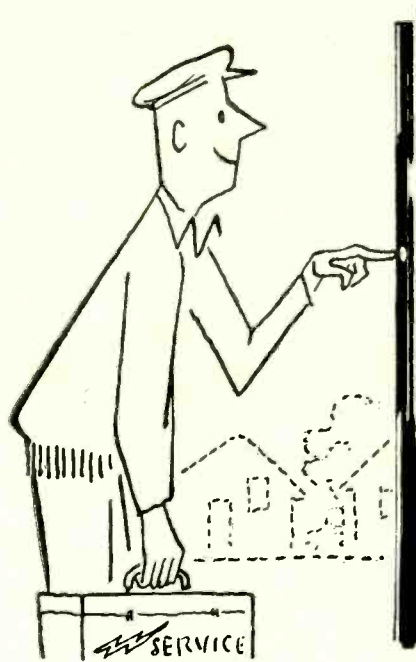

chrome transmission. It is not possible for both V1 and V2 to conduct at the same time, and for color reception V1 must be cut off to allow the chrominance signals to reach the color demodulators via V2.

Frequently, the rectified burst signal is not strong enough to completely cut off V1 although it can synchronize the color oscillator. This is the real cause of many cases of intermittent color reception. When this trouble is suspected, the V1 cathode lead to ground should be opened, disabling the killer circuitry. Many technicians have installed a switch between the killer cathode and ground. If the receiver must operate on marginal signals, it is best to open the switch.

Another frequent cause of intermittent color reception, where monochrome pictures are received properly, is an intermittent color subcarrier oscillator.

Fig. 2 shows a widely used crystal-controlled oscillator circuit. Here the tube may check perfect but will refuse to oscillate — several tubes should be tried.

Tuning cathode coil L4 is very critical. As this coil is tuned toward resonance from one side, output rises until resonance is reached and the oscillations cease.

Tuning L4 too close to resonance will cause intermittent operation. A convenient way to adjust L4 properly is to connect a v.t.v.m. to the plate pin of V4-b (Fig. 1), setting the meter to read on a -30-volt scale. Remove V3 so that the voltage read at the plate is only the oscillator output fed from V7, the sub-carrier buffer amplifier. Tune L3 first for maximum output. Then back off the slug to start oscillations again. Finally tune it to give exactly 2 volts less output than the maximum you obtained. This is sufficient output for the demodulators and yet is far enough from resonance that drift will not cause it to stop oscillating.

In this circuit, feedback to sustain oscillations is through the grid-cathode capacitance of the oscillator tube and a 2.2- μ mf capacitor, generally a 5% NPO unit. In some cases where L4 was properly tuned, and several oscillator tubes have been tried without success, an erratic oscillator has been cured by increasing this capacitance to 4.7 or even 6.8 μ mf, using only 5% NPO units. This will require retuning L4. The crystal itself has given us very little trouble.

Defects in the reactance control tube (V5) and its circuit may stop the oscillator (V6). V5 behaves like a variable tuning capacitor shunting L3 and the crystal, thereby controlling the oscillator frequency. Its shunting capacitance depends upon its transconductance which varies with electrode voltages and the values of C3 and R2. Leakage in C3 would cause the grid to go positive, increasing the capacitance beyond limits. If either C3 or R2 increases in value, excessive capacitance will shunt the crystal and it won't oscillate. If

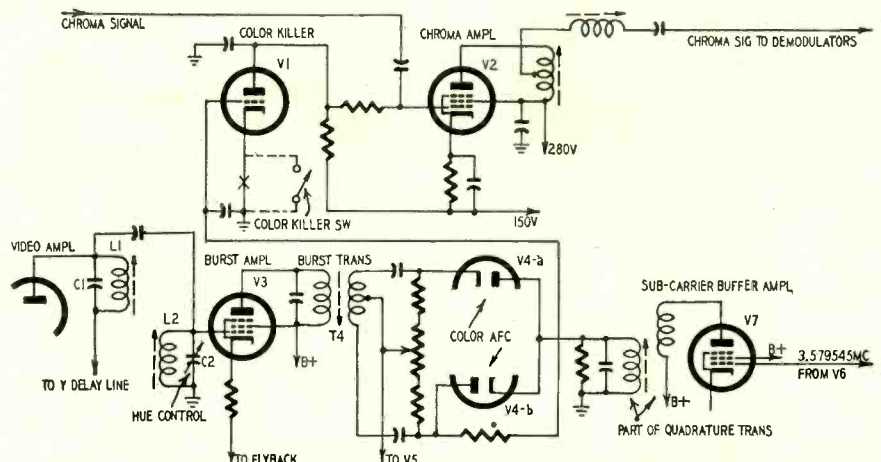

Fig. 1—Schematic shows simplified color killer and a.f.c. circuitry.

*Northwestern district service manager, CBS-Columbia.

either is too low in value, there may be very little a.f.c. action and color sync will be poor.

Many cases of erratic shifts in hue in the color picture, notably with camera changes, have been traced to horizontal oscillator alignment. The burst signal is transmitted during part of the horizontal blanking or retrace time. A pulse from the flyback transformer forces the burst amplifier to conduct for its brief duration and then cuts it off during the active scanning period so that chrominance signals cannot enter the burst circuits which would be analogous to letting raw video pass through the sync circuits. This would cause the hues to change with picture content. Chrominance signals may enter the burst circuits if the horizontal keying pulse (retrace) is delayed too long and part of it occurs during active scanning time. In monochrome receivers we refer to this as a left-hand horizontal fold-over. The cure is to align the horizontal oscillator very accurately. Synchroguide circuits commonly give this trouble.

Tinting of monochrome pictures, causing some areas to be greenish or magenta, is a frequent shortcoming of color picture tubes. This is a special case of impurity which can exist even though perfectly pure individual fields of red, green and blue are obtained. It is a defect for which there is no remedy. Individual fields may be checked for purity by turning down the screen controls for the other two guns in sequence. The contrast control must be turned fully off for checking purity. With the green and blue screens off, the resulting red raster should be pure red. If not, the usual purity adjustments should be made. Generally, when the red field is pure, the green field will also be and the blue field is almost sure to be pure, but they should be checked as well, in any case.

Where the three individual fields are found to be pure and tinting exists in the white raster, the trouble is either a hum or a low-purity picture tube. Hum may be isolated by bypassing the cathodes and grids of the picture tube with a suitable capacitor or by removing the video tubes which drive the picture tube. Hum will form one or two horizontal bands. As tube manufacturing techniques improve, this problem will diminish.

The extremely high anode voltage of color picture tubes may produce some freak breakdowns of components. Occasionally the high voltage can momen-

tarily break down the insulation of the picture-tube glass envelope and arc through to a nearby component such as the purity coil, convergence assembly or yoke. This has explained some mysterious failures of these parts or associated controls. The energy stored in the high-voltage supply is far greater than in monochrome receivers and consequently more lethal.

A few color receivers have been made using the Standard Coil turret tuner which uses R strips. In some u.h.f. areas, these strips produce a picture i.f. of about 42.0 mc and a sound i.f. of 46.5 mc. Monochrome reception is satisfactory. However, the sound i.f. is not trapped out and very heavy interference on color programs occurs as a result.

In cases where the hue control is not centered in its range but tunes at the extremes of its rotation, it may be possible to center it. But considerable caution is required.

Fig. 1 shows how the burst signal is taken off the plate of a video amplifier in many color receivers and fed to the keyed burst amplifier. The chrominance signals are taken off earlier in the video amplifier. Components L1-C1 form a trap tuned to 3.579 mc to prevent the burst signal from reaching the color tube. It is capacitively coupled to L2-C2 in the grid of the burst amplifier. Capacitor C2 is a small variable unit which can tune the circuit slightly above or below 3.579 mc and is the hue control. When it is tuned to resonance, there is no phase shift and the burst signal is passed at maximum amplitude to the burst amplifier. If the hue control is tuned lower than 3.579 mc, the burst signal is reduced in amplitude and shifted in phase. Tuning above 3.579 mc also produces attenuation and a phase shift opposite to that produced before. This phase shift determines the hue of reproduced colors and is a customer control.

While the slug in L2 could be adjusted to center the range of the hue control, it may result in further detuning which results in additional and unwanted attenuation of the burst signal. Should 3.579-mc trap L1-C1 or the burst transformer be slightly out of alignment, they can produce phase shifts which the customer may counteract by detuning the hue control in the opposite direction.

The safer plan is to follow the manufacturer's instructions and realign all these coils together. END

FM-TV ANTENNA SWITCH

WHEN a single antenna is used for both FM and TV, it is seldom satisfactory to connect both receivers directly to the lead-in because this usually causes mismatch and losses. A d.p.d.t. switch is one answer to the problem, but it is easy to forget to switch from one set to the other.

A relay in the antenna circuit provides a simple, automatic and foolproof method of switching the antenna. A d.p.d.t. relay with a 115-volt a.c. coil should be connected as shown in the diagram. This relay may be a Potter & Brumfield KR11A, Leach 327, Advance AM/2C/115VA or equivalent.

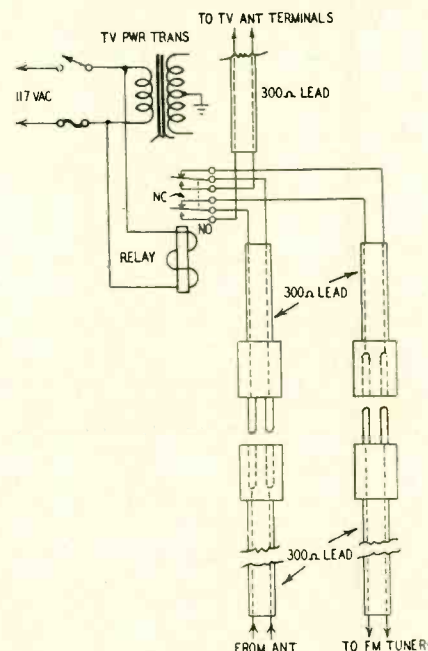

Mount the relay on the TV chassis as close to both the power supply and tuner input as is convenient. Tie the relay coil directly across the primary of the power transformer. Use a short section of 300-ohm ribbon type transmission line to connect the normally open contacts of the relay directly to the antenna terminals on the TV set. Connect the armature contacts to the antenna lead-in through a plug-and-socket type of TV antenna connector. The normally closed (back) relay contacts are connected to the FM antenna terminals through a section of transmission line and a connector. Polarize the connectors as shown in the diagram.

This arrangement leaves the antenna connected to the FM receiver whenever the TV set is turned off. But, when the TV receiver is in use, the relay coil is energized and transfers the antenna from the FM to the TV set. When pulling the TV chassis for inspection or repairs, simply separate the connectors to the antenna and FM tuner and plug the antenna lead into the FM connector. The TV receiver and relay may then be removed without interrupting the use of the FM set.—R. D. Herlocker END

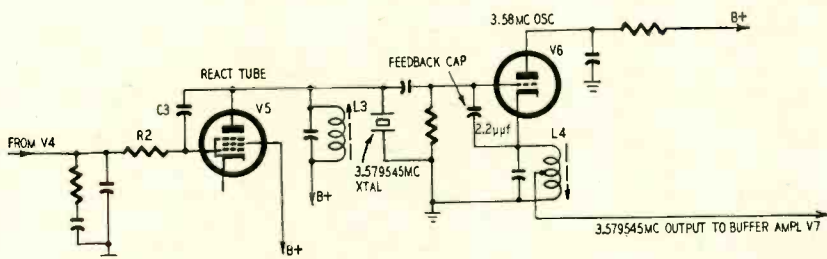

Fig. 2—Typical color subcarrier oscillator circuit.

*Methods and techniques used
in closed-circuit operation*

INDUSTRIAL



is simple

By EDWARD M. NOLL*



Vidicon camera tube
—the RCA 6198.

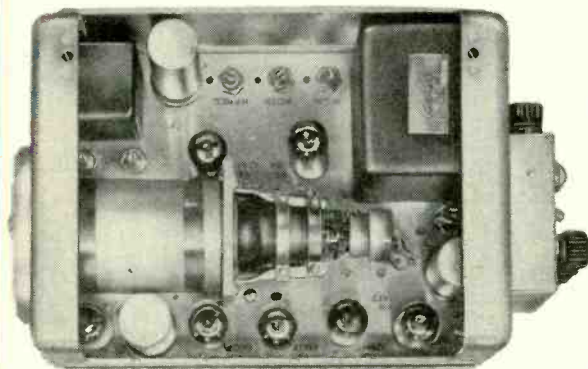

The Dage model
60 video camera.

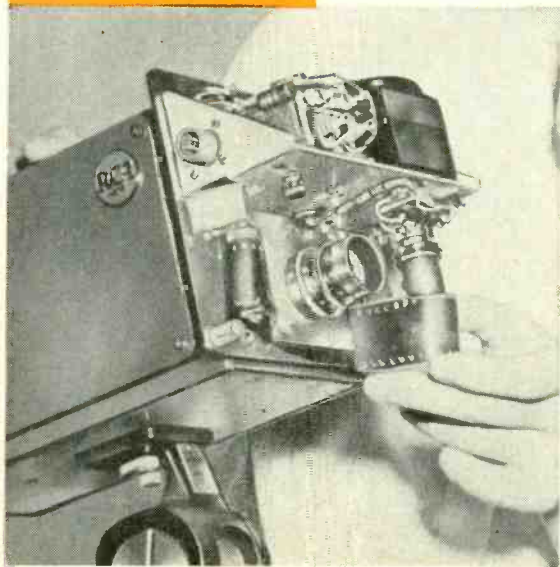

Installing the RCA
automatic iris.

TELEVISION camera tubes and circuits are no more complex or difficult to learn than receiver techniques. In closed-circuit industrial TV the simplicity of the composite television signal makes the system much less complex. Compared to the elaborate signal construction for commercial telecasting, the closed-circuit composite is less exacting and has fewer pulse components.

The first hurdle is to understand that circuit functions at the camera tube are almost identical to those at the picture tube (Fig. 1). For example, there must be a source of electrons in the form of a cathode-ray gun. The beam of electrons must be set in motion horizontally and vertically to form a raster on the target image. Thus horizontal and vertical deflection waveforms must be generated to deflect the camera-tube beam. Just as at the picture tube, the camera-tube beam must be made inactive during retrace intervals. Therefore horizontal and vertical blanking pulses are needed at the camera tube. The basic difference between camera and picture tubes is that the scanning beam at the camera tube produces a video signal as it scans a phototarget surface; at the picture tube the scanning beam causes a fluorescent screen to glow as a function of the video information.

There must be synchronized motion of the picture-tube beams; the synchronizing pulses perform this service. They insure that the image on the picture tube is reproduced in the same sequence the image video information was released at the camera tube. Synchronizing pulses are formed by the pulse generator section of the camera and supplied to the deflection systems of both camera and picture

*Author *Closed Circuit and Industrial Television*, Macmillan, 1956.

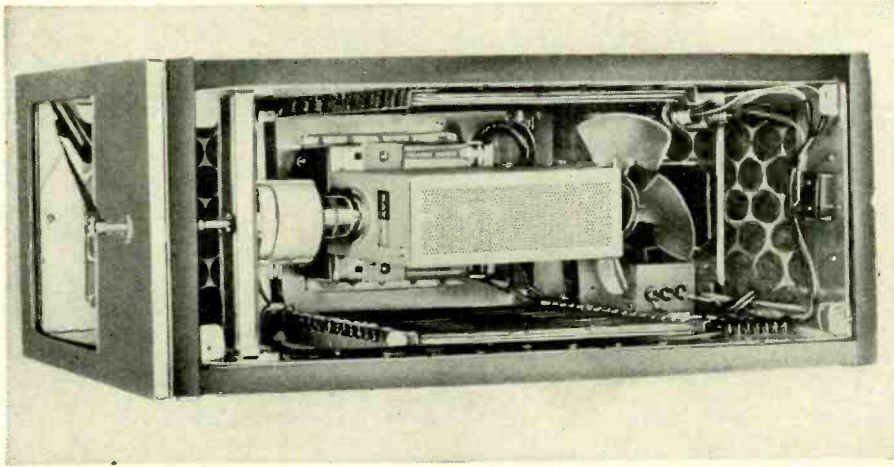

The Kay Lab industrial TV camera.

tubes. Consequently the motion of the two scanning beams is synchronized. Simultaneously timed blanking pulses also go out from the pulse generator to the camera and picture tubes to prevent release and display of spurious retrace signals.

Interconnection plans

There are a number of methods of sending the video and synchronizing information between camera and viewer. For many installations (Fig. 2-a) a standard television receiver functions as a viewer. The synchronizing and video signals are used to modulate a low-power r.f. oscillator tuned to a frequency of one of the v.h.f. television channels. Therefore the television signal can be carried by a transmission line (300-ohm or coaxial) between camera and antenna input terminals of the television receiver.

With this method there is no need to modify any existing television receiver as the signal input contains the conventional r.f. and video components and the horizontal and vertical synchronizing pulses. Of course, the disadvantage here is the relative complexity of the signal.

A second common system (Fig. 2-b) is to send the composite video and synchronizing signal over a coaxial cable to the video amplifier input of the viewer. For this method an r.f. carrier

is not required. However, sync separator circuits are needed at the viewer to break down the composite television signal into its basic components of video blanking, horizontal and vertical sync.

A final arrangement (Fig. 2-c) is one that sends each basic signal component separately to the viewer. The first two methods require but one line to link camera and viewer. When signal components are sent separately, three lines (multiconductor cable) carry signals between camera and viewer. In this plan the sync signals are applied directly to the horizontal and vertical deflection generators. Sync separators are not required.

The first method is convenient when standard television receivers are used as viewers since chassis need not be worked upon. The second method does not use any r.f. carrier and bypasses the r.f. and i.f. processes. The third arrangement eliminates the sync separator circuits but requires a multiconductor cable.

Signal makeup

The simplicity of the composite television signal for an industrial system is amazing. Such complex waveforms as equalizing pulses, serrated vertical sync pulses, etc., are not necessary in a closed-circuit system. In fact, as shown

in Fig. 3, the front and back porches of the combined horizontal sync and blanking pulses need not be present. As a result one pulse serves both the sync and blanking functions. Thus, two pulses can meet the requirements of a small closed-circuit system—vertical and horizontal sync-blanking pulses. If the horizontal pulse rate is set near the line frequency of 15,750 cycles and vertical pulse rate at 60 cycles this simple signal construction is able to lock in a standard television receiver. In fact if the horizontal oscillator is stable, and its frequency set critically, an interlaced pattern can be attained.

Even an interlace system for use in a more elaborate industrial installation can be established with a less complex composite synchronizing signal than is used in commercial telecasting. Instead of equalizing and serrated vertical pulses, a short-duration carefully timed vertical sync pulse (Fig. 4) is used. This pulse is inserted so that its leading edge coincides with the leading edge of one of the horizontal sync pulses during one vertical retrace interval. The very next vertical sync pulse occurs halfway between two horizontal pulses. Thus the second vertical retrace is timed to occur at

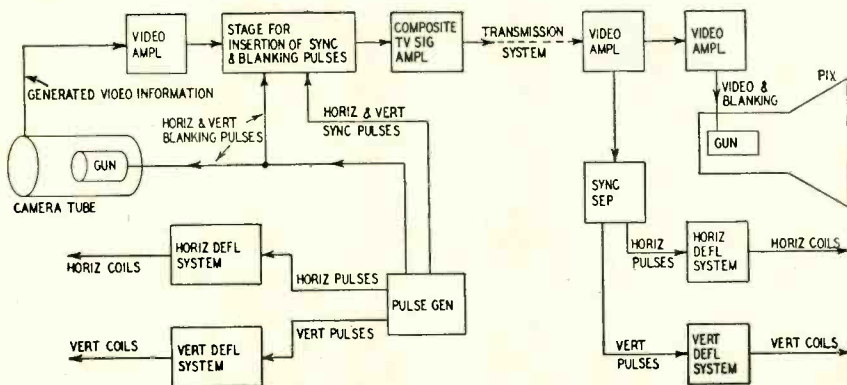

Fig. 1—Block diagram shows basic plan.

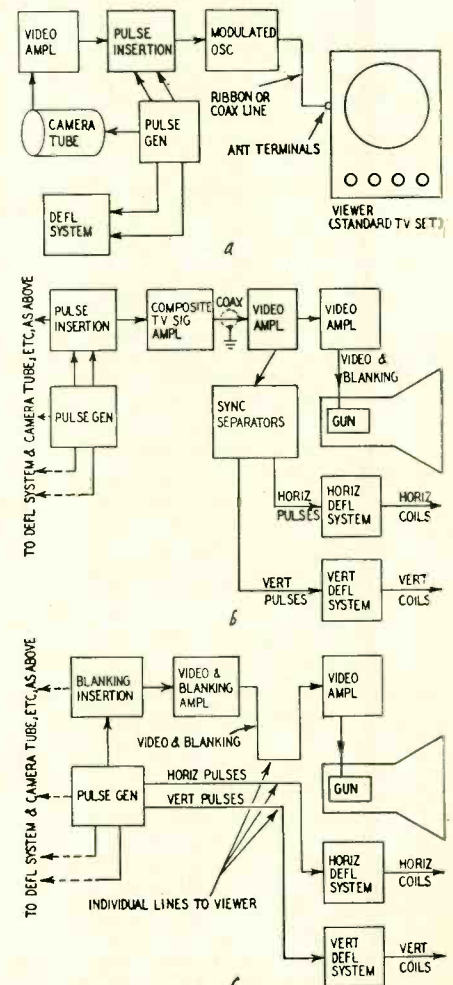

Fig. 2—Diagrams show systems used in industrial television transmission.

TELEVISION

a half-line position—a necessary relation for interlace.

Television camera

The RCA vidicon camera tube (see photo) has been responsible for initial successes in industrial television. It has high sensitivity, minimizes lighting problems, is very small and permits design of lightweight and compact television cameras. Equally important is that its associated circuits need not be elaborate. For example, the top anode voltage is only about 300. Thus a separate high-voltage supply is not required. As the vidicon has a low-

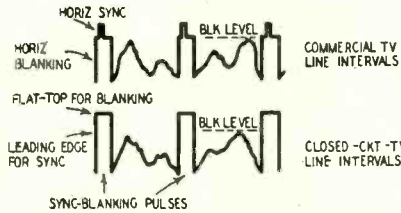

Fig. 3—Signals for standard television and closed-circuit systems.

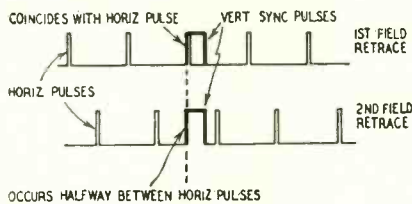

Fig. 4—Producing vertical interlace.

velocity scanning beam the deflection-circuit power requirements are relatively low.

All the factors mentioned—wired connection to receiver or viewer, simplicity of signal construction and the vidicon—permit construction of an almost unbelievably small television camera. For example, the Dage camera (see photo) uses only eight tubes including camera tube. The camera measures only 10 x 6½ x 4½ inches. It can supply a video-modulated r.f. signal directly to the antenna terminals of a receiver or a straight video signal for application to the video amplifier input of a viewer.

The circuit functions within the camera are shown in Fig. 5. Video signal output of the camera tube is amplified by a seven-stage video amplifier consisting of four tubes. Three of these tubes have dual functions. The fourth stage is a phase corrector or so-called "high peaker" which corrects for the high-frequency de-emphasis that occurs at the output circuit of the camera tube.

In the fifth stage horizontal blanking and sync are inserted in the video signal; vertical sync blanking is added in the sixth stage. The final amplifier is a video output stage supplying composite video to an output jack and succeeding video modulator. One dual triode functions as video modulator and r.f. oscillator. It supplies a video-modulated television signal to the output jack.

The pulse generator is a four-stage

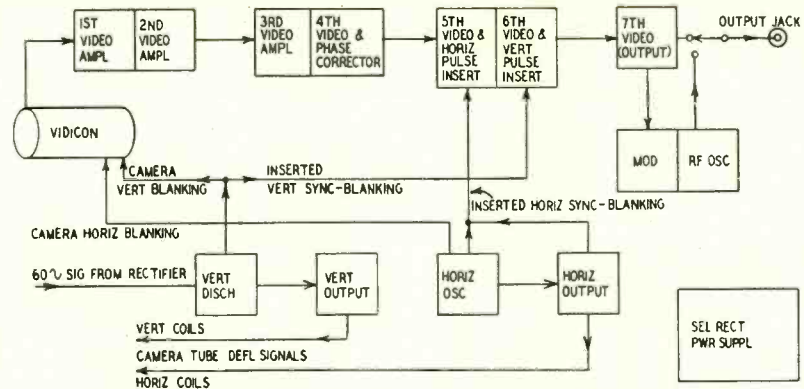

Fig. 5—Block diagram shows circuits in the Dage 60 industrial TV camera.

segment of the camera containing vertical discharge and output stages and horizontal oscillator and output stages. The vertical discharge tube forms a vertical sawtooth, being excited by a 60-cycle waveform from the power supply. The vertical output stage which develops the camera-tube deflection current in the vertical coils. A pulse is removed from the discharge tube cathode to be used as video-inserted sync blanking and as vertical blanking for the camera tube. The horizontal oscillator and output stages perform similar functions in the formation of the horizontal pulses and horizontal deflection energy.

Many special accessories are being developed for use with industrial television cameras. They improve the versatility and reliability of industrial installations. For example, RCA now has a number of accessories such as remote optical focusing of camera from monitor viewer, weatherproof housing, explosion-proof housing, extension video amplifier to increase spacing between camera and viewer, underwater units and automatic iris.

The automatic iris (see photo) compensates for changing light levels to assure TV pictures of constant brightness and contrast. Thus the television system

functions without readjustment as the brightness levels change.

The actual iris, which resembles a roll of 35-mm film, is mounted with motor-driven regulators. The film serves as a filter and is continuously graded in density. As external light levels change, the film automatically unreels between camera lens and vidicon until a filter of proper density for the light condition moves into place.

Weatherproof housing for the Kay Lab industrial camera is shown in another photo. The unit contains a heater for cool-weather, fan for hot-weather operation, plus a windshield wiper for mist and rain. All accessories can be made to operate automatically. The Kay Lab camera is also excellent for picking up slides or film directly from a projector—the projector is focused on the sensitive surface of the vidicon. Thus film can be run and presented simultaneously on a number of viewers in different locations. This is an excellent educational tool.

The field of closed-circuit and industrial television is new and exciting. There are many applications and techniques to be explored. It is important that the television technician pay close attention to the field and keep abreast of its development. END



"Now then, how long have you been a half-wave rectifier?"

TELEVISION

sharpest. This is a normal condition, provided the defocusing (astigmatism) is not excessive; it is common when the focus coil is used for centering or correcting corner shadows.

Focus circuits are relatively simple and easy to check. Where focus is poor and the control has little or no effect, check the focus coil for an open circuit or shorted turns. Also check the focus potentiometer and associated circuitry.

The location of the focus coil or magnet on the neck of the tube affects picture centering. It should generally be placed about $\frac{3}{8}$ inch behind the deflection yoke—bringing it closer will produce interaction between the magnetic fields of the two and cause poor focus. The coil provides a limited centering control and should be adjusted in conjunction with the ion-trap magnet, with the latter being used *only* to obtain maximum brightness—leave centering and shadow correction to the focus coil and centering magnet (after carefully adjusting the yoke).

In cases of poor focus where the coil and control circuits have been checked out, replace the picture tube or check it for gas.

The PM focus magnet (Focalizer) must be adjusted with a nonmagnetic screwdriver. It consists essentially of three or four small bar magnets in a frame encircling the neck of the tube. Magnet strength is controlled by a shorting screw that shunts the magnetic field of the focus magnet that would ordinarily pass through the neck of the tube. Where a magnet is too strong, the technician can improvise a shunt to bring the unit to a point where it will provide optimum focus.

When replacing a tube using a focus coil with an electrostatic-focus type, remove the coil from the neck of the tube and place it as far from the tube as the cabinet permits. Do not remove the coil from the circuit unless you replace it with a resistor of equivalent value and wattage.

Changing Focalizer strength

A customer complained her picture had a slight blur. The set couldn't be focused properly in the home so it was brought to the shop. We have tried a few Focalizers made by a well-known manufacturer and in each case, with the screw all the way in, the picture comes close to looking acceptable, but not quite. We have tried moving the magnet around slightly but that did not help. Since there is no other focusing control, we are at a loss as to the trouble. Does this set use some special focus magnet? And if so, why should the regular magnet suddenly become too strong? I can understand a magnet becoming weak.—S. C., Trenton, N. J.

It is most improbable that the Focalizer has increased in strength. More likely a change has taken place in the physical characteristics of the picture tube. If you have not already done so, try replacing the tube—the old one

may be slightly gassy. Also try readjusting the deflection yoke firmly against the flare of the tube and adjust the ion-trap magnet for maximum brightness.

If these do not help, the strength of the Focalizer can be reduced by the following: Take a piece of 1/16-inch steel, approximately $1\frac{1}{4}$ inches square. Round it so that it matches the curvature of the focus magnet and place it anywhere on the circumference of the magnet so that it covers a portion of the air gap. The steel shunt will be held firmly in place by the magnetic attraction of the Focalizer and will reduce the strength of the unit to a point where optimum focus can be obtained.

Vertical nonlinearity

A Crosley model H-17TOBH has come in with a very bad case of vertical nonlinearity at the top of the picture. Adjusting the vertical linearity and height controls does not improve the picture. Every component related to the vertical oscillator and output stages has been checked and appears O.K. In replacing the 12BH7 I noted some improvement, but nowhere near what the picture should look like.

I have a schematic of the set and all connections are as they should be. The picture is very clear and steady, but just not linear. What next?—I. S., Cranston, R. I.

You omitted an important piece of information—is the top of the picture spread or compressed? They have different solutions. This trouble goes beyond your set and is fairly common in most of the Super V series. Try several 12BH7's. If this does not help, replace the vertical output transformer and again try a few 12BH7's. Very often some particular combination of these components will produce nonlinearity and changing them will cure the trouble.

If the above does not help, spreading can usually be corrected by inserting a peaking circuit consisting of an .01- μ f 600-volt capacitor in series with a 150,000-ohm 1-watt resistor, connected from plate to ground of the vertical output stage (Fig. 5). In some

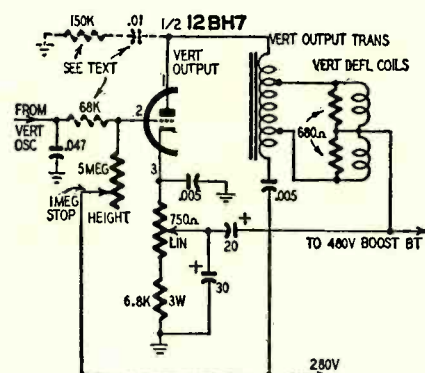

Fig. 5—Crosley vertical output circuit with components added to correct nonlinearity at top of the picture.

cases the fixed cathode resistor should be increased in value slightly to about 7,500 ohms, also 3 watts. These components affect the current waveshape in the yoke so as to add a slight amount of compensating spread.

If the top of the picture is compressed, add a resistor of about 68,000 ohms between the grid of the vertical output tube and the .047- μ f capacitor. This resistance will spread the input waveshape fed to the output stage so as to compensate for the compression.

Make a record in the cabinet of what you have done—changing the 12BH7 or vertical output transformer in the future may require that the compensating networks be altered or eliminated.

Tracking

An RCA set with a KRK-7 tuner has come in with a complaint of poor picture and sound. It could be cleared by fine tuning but the set would drift considerably. The rf oscillator was replaced and this took care of the drifting. However, the tracking was very bad. I tried to align the set but this did not help. Is there any special alignment procedure so that the set will track properly? All rf and if tubes have been replaced and all voltages appear normal. I made a thorough check of all connections in the tuner and have cleaned all contacts.—J. W., Ogden, Utah

Oscillator-tube characteristics vary considerably and you should try several of them before doing anything else. If this does not help and you are reasonably certain that the set is in good operating condition otherwise, there is a solution that is fairly popular.

Run a continuous length of tinned copper bus wire from eyelet to eyelet of the high-channel inductance strap on the rear section of the oscillator wafer switch. The wire between the eyelets should be in the form of small semi-circles having a length of about $\frac{7}{16}$ inch and laid flat against the inductance strap. Solder each contact with the eyelet and make sure it is mechanically firm. Some time ago RCA made a recommendation similar to this and suggested No. 20 wire be used. However, good results could also be obtained with No. 22 wire.

In making the tracking adjustment, the semicircular loop should be moved slightly away from the inductance strap and the oscillator channel adjustment screw turned until the screw is in the center of its tuning range. When the wire is against the strap, there is practically no change from the original tracking. If necessary, the method may be applied to the high-channel rf and converter circuits. END

All queries to the TV Service Clinic should be accompanied by a stamped, self-addressed envelope. This will insure a more rapid answer. Be especially careful to state the model or chassis number. In many cases these have been confused with the serial number which, in most cases, is meaningless. An unidentified receiver can be analyzed in general terms only.

CLASS B for TRANSISTORS

An excellent low-distortion audio output stage

By EDWIN BOHR

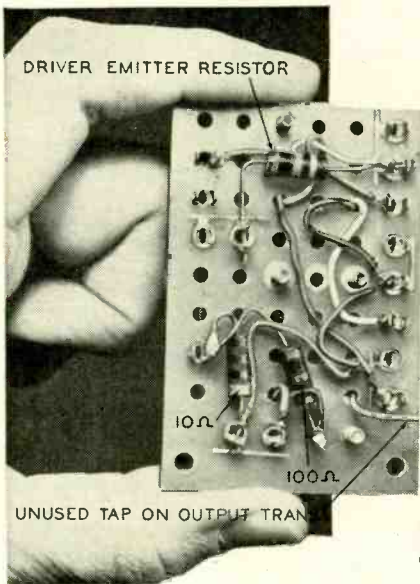

Resistors and wiring on underside.

WOULD you like to build a transistorized intercom, phono amplifier or power output stage? The class-B circuit to be described is ideal for any of these purposes. It is exceedingly easy to construct and the performance, as will be explained in detail, excels most commercial circuits. Important, too—all components are readily available!

For audio operation class B offers all the advantages. The power-handling capabilities of the transistor are used to the fullest, efficiency is amazingly high and distortion can be kept below 2%. This distortion figure, incidentally, is better than most battery-operated vacuum-tube circuits can obtain.

Dollar-variety transistors operate successfully in this circuit to 100 milliwatts. If it is really necessary they can be pushed to ¼ watt.

The class-B circuit

Using push-pull operation, this bridge circuit (Fig. 1) is a refinement meeting wide acceptance in the design of all types of new audio equipment. It is particularly advantageous, however, for class-B operation.

Ordinarily much of the distortion in a class-B stage results from an imperfect output transformer. Since the bridge circuit can either drive a voice coil directly or use a single-primary output transformer, these troubles are largely eliminated.

That is why most commercial transistor output stages use the bridge circuit. However, virtually all these circuits employ a special split-secondary driver transformer not commercially available. A few people with transformer-winding facilities have built and used such a circuit but, for the individual with no special facilities, it has been out of reach.

The circuit presented here can be built by anyone. After much searching, a nationally advertised transformer has been found that is just about ideal as a driver for the bridge type of push-pull output stage. The transformer does require a slight modification, but this is very simple and requires only peeling back the outer paper wrap from one side.

Distortion

Before going further into the actual circuit let's look at a peculiar, but very interesting, aspect of transistor class-B operation.

Curve A of Fig. 2 shows the distortion of a typical class-B transistor stage increases at near maximum output and at very low output levels. But, the distortion is *most severe at low output*.

Distortion at high output is common. But why does it increase so drastically at low levels? The answer is simple.

For very small driving signals the transistor input resistance is very non-

linear. In fact, below a certain threshold voltage the transistor does not respond appreciably to any input signal. Commercial circuits overcome this difficulty with a bias current to lift the transistor out of its nonlinear region. The bias reduces the low-level distortion (curve B, Fig. 2) but it also increases medium-power distortion, places a fixed bleeder current on the power supply and lowers the maximum power capacity of the transistors since the bias causes transistor heating.

Fig. 1 does not use bias to reduce low-level distortion; negative feedback is used instead. Feedback does not have

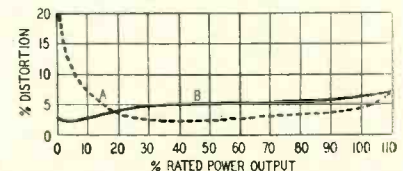

Fig. 2—Diagram shows typical distortion curves for class-B stage.

the power-wasting and other undesirable effects of the bias system. Furthermore, feedback reduces distortion at all power levels and smooths out the frequency response curve.

Fig. 3-a indicates the no-bias, low-output distortion of a sine wave. Fig. 3-b shows the improvement when feedback is added. Both photos present the distortion at its worst. The slight gap in the photograph with feedback is a result of high-frequency ringing at the zero-crossing point. This effect is completely eliminated in the finished circuit and there is no perceptible distortion up to the rated output.

Fig. 4 shows the overall response of the driver and class-B output stage. Low-frequency response is limited by transformer overloading. The high-frequency response is deliberately rolled off to prevent the ringing just mentioned. Considering that two small transformers are used in the circuit, the response is very good.

Efficiency is so high that in some

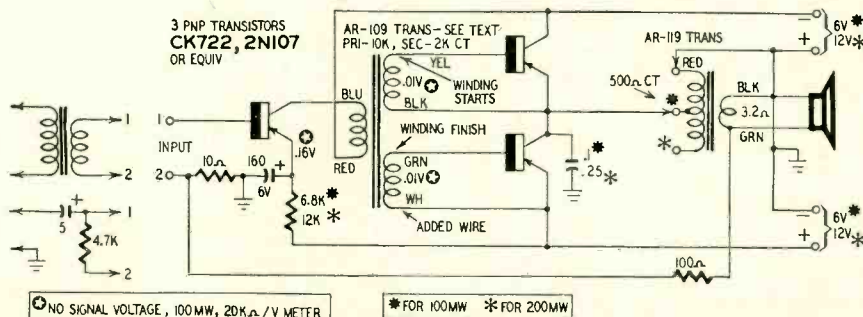
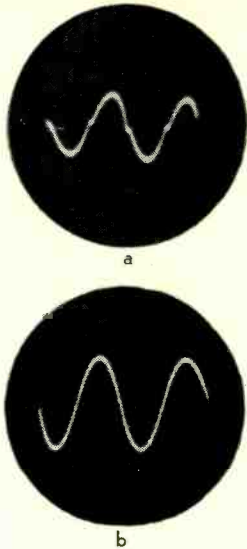
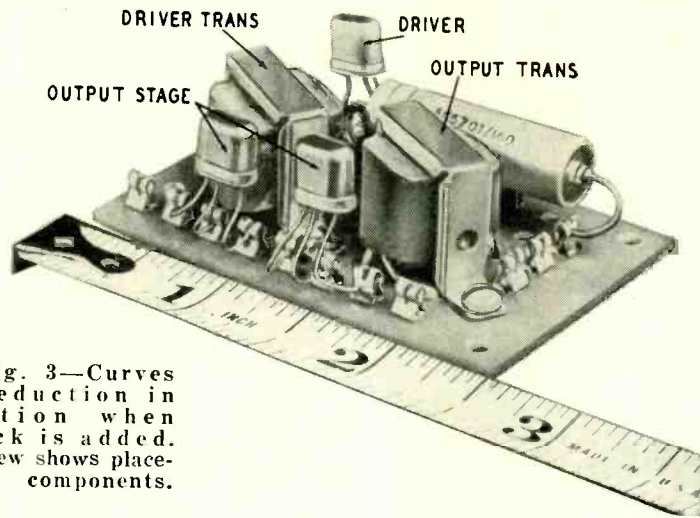

Fig. 1—Schematic of class-B output stage for 100- or 200-mw operation.



Left—Fig. 3—Curves show reduction in distortion when feedback is added. Right—View shows placement of components.



applications it may be unnecessary to include an on-off switch. With no audio input the amplifier draws an idling current of only 1 ma. And most of this is consumed by the class-A driver.

When an audio signal is applied, the amount of current drawn depends on the signal amplitude. With loud signals the current may climb to 20 ma.

For these reasons the circuit is very attractive for intercoms or other applications where the amplifier sits idle for long periods.

Construction

Terminal cards (see photo) are the ideal medium for transistor circuit construction. The three major components are the two transformers and the 160- μ f electrolytic capacitor. The electrolytic need not be so large; any 5- μ f, or higher, capacitor rated for 3 volts or more should be satisfactory.

The output transformer has a tap for either 100- or 200-mw operation. The battery voltage, emitter resistor and shunt capacitor across the output transformer are changed when operation is switched from one power to the other. The shunt capacitor is essential for proper operation; it is not gingerbread work.

The transistors are soldered directly to terminal lugs. Possible transistor damage from soldering may have been somewhat exaggerated. Transistors can even be dip-soldered into place. If the transistor is soldered *quickly* (this is the really important thing), no pliers or other heat sink is necessary. But, if you are in doubt, use the pliers.

Feedback is supplied to the driver through the 100- and 10-ohm resistor combination. For this reason the driver input must be applied between terminals 1 and 2. Typical inputs for both transformer and R-C coupling are shown on the diagram.

The driver transformer modification is really very simple but it requires a little thought and common sense. The transformer is an Argonne AR-109 sold by Lafayette Radio. A data sheet supplied with it indicates the start and

finish of the windings along with the color coding of the wires. This same nomenclature is followed in Fig. 1. Not all transformers have the same color wire for the secondary center tap. On this unit it was black.

The modification separates the center-tapped secondary so the two halves become independent windings. To do this, slit open the outer paper wrap, exposing the center tap and its connection to the external lead wire. Cut apart the center tap. An external lead wire is then soldered to the free end produced by the cut. I used a white lead as labeled on the diagram.

This wire must be small and flexible. If none is available, excess lead from the same transformer can be used.

The leads can be pressed into place and held with a few drops of hot wax. Also, the wrap can be pushed into the warm wax and resealed. When this is done, check off and pair the secondary wires with an ohmmeter. A pair goes to each transistor—one wire to the base, the other to the emitter. They must be connected exactly as the diagram shows. Before connecting, check to see that there is no continuity between the two secondary halves.

Circuit operation

This is a basic output circuit. It can be driven by either a preceding transistor stage or matching transformer. The input impedance is in the neighborhood of 3,000 ohms. And, if a low-gain transistor is used for the driver, 200 mv of signal produces full output. High-gain transistors, of course, require less signal. The circuit can be pushed to 0.25-watt output by increasing the

batteries to 16.5 volts while retaining the 200-mw circuit values.

Check voltages are shown on the diagram. These are based on 100-mw operation with no signal. Operation is normal if the meter readings are within one-half to twice these values.

Because the AR-109 has low winding resistance, the base-to-emitter resistance is low enough to obviate the usual stabilization resistors.

To read the current with the signal applied, place a milliammeter in either of the battery leads. A milliammeter placed in the common lead indicates how well the output transistors are

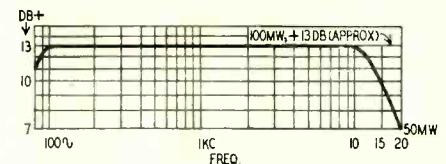

Fig. 4—Response of the class-B stage.

matched. A current here of more than 3 ma at full signal indicates poor matching. They should be as nearly alike in characteristics as possible.

Most p-n-p transistors are suitable—for example, the CK722. Do not use types that have low power and collector-voltage ratings. Several companies offer matched pairs of transistors for class B. I certainly recommend these be used if the pocketbook can take the extra pinch.

Occasionally, this amplifier will oscillate at near-ultrasonic frequencies, producing distortion. This can be cured by spacing the input and output wires, grounding the circuit or placing 10,000-ohm resistors between collector and base of the output transistors. END

(There is some feeling among authorities in this field that it may be extremely difficult to obtain an output of 200 mw using CK722's or 2N107's in this circuit. High-current transistors are needed for appreciable output. Perhaps the added cost of matched 2N109's or Amperex OC72's will be justified by the large increase in power output.—Editor)

Parts for class-B circuit

- 1—10, 1—100, 1—6,800 (or 12,000) ohms, 1/2-watt resistors; 1—0.1- (or 0.25-) μ f capacitor, 200 volts, miniature; 1—160- μ f 6-volt electrolytic capacitor;
- 3—p-n-p transistors (CK722, 2N107, etc.); 1—driver transformer, primary impedance 10,000 ohms, secondary 2,000 ohms ct; primary resistance 500 ohms, secondary 50 ohms (Argonne AR-109 or equivalent);
- 1—output transformer, primary impedance 500 ohms ct, secondary 3.2 ohms; primary resistance 20 ohms, secondary 0.3 ohms (Argonne AR-119 or equivalent);
- 2—6-volt batteries; 1—insulated mounting board; mounting pins.

THE Fluxvalve PICKUP

Higher compliance and lower vibratory mass make for superior performance

By W. O. STANTON*

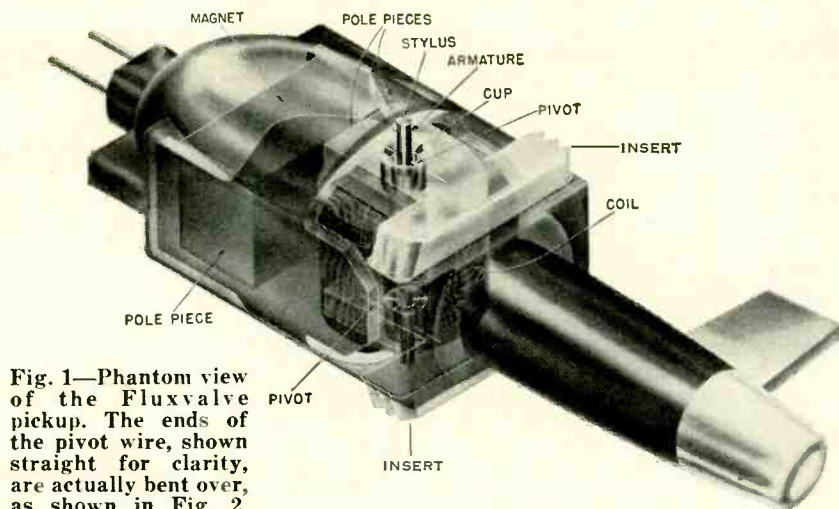

Fig. 1—Phantom view of the Fluxvalve pickup. The ends of the pivot wire, shown straight for clarity, are actually bent over, as shown in Fig. 2.

FOR pickup performance on contemporary records approaching closely to the ideal, we need a considerably higher level of mechanical refinement than has been standard in the past and, in particular, a much higher compliance and lower vibratory mass. But the desirable compliance and the mass values have always been extremely difficult to combine with the ruggedness and ease of stylus replacement that pickup users today rightfully expect in a high-quality instrument.

I will describe in this article a new pickup in which all of these mechanical characteristics have been combined to open up a radically higher level of reproduction from disc recordings. The tough mechanical design problems have been licked by putting the whole vibratory system, including the stylus, in a small plastic-encased insert, which the user can put into or remove from the pickup without using tools of any kind.

Magnetic circuit

The way the pickup operates can be made clear by a description of the magnetic circuit. When the insert is in place, the stylus projects parallel to a lip in the plastic pickup housing, as can be seen in Fig. 1 and the photo. The magnetic flux—produced by the permanent magnet enclosed in the pickup housing—is carried by a metallic member out through the housing to a point directly above the top or butt end of the stylus. There an exposed

metal button contacts a similar button on the insert.

The button on the insert is the top end of an inverted metal cup, which surrounds the upper end of the stylus, leaving it free to move. This cup can be seen in dotted lines at the butt end of the stylus in Fig. 2. It carries the magnetic flux to the stylus tube itself. In the lip of the pickup housing directly in back of the lower end of the stylus are the ends of two metallic members, side by side, centered on the line through the resting position of the stylus. These

carry the magnetic flux back into the housing and through the coil.

The magnetic circuit is so arranged that when the stylus is in its center position, not moving, flux flows from it equally to the two members behind its tip and the two lines of flux balance each other out so that no voltage is produced in the coil. When the stylus moves to right or left, one side gets more flux than the other, the magnetic circuit is unbalanced and flux flows through the coil, producing a signal voltage.

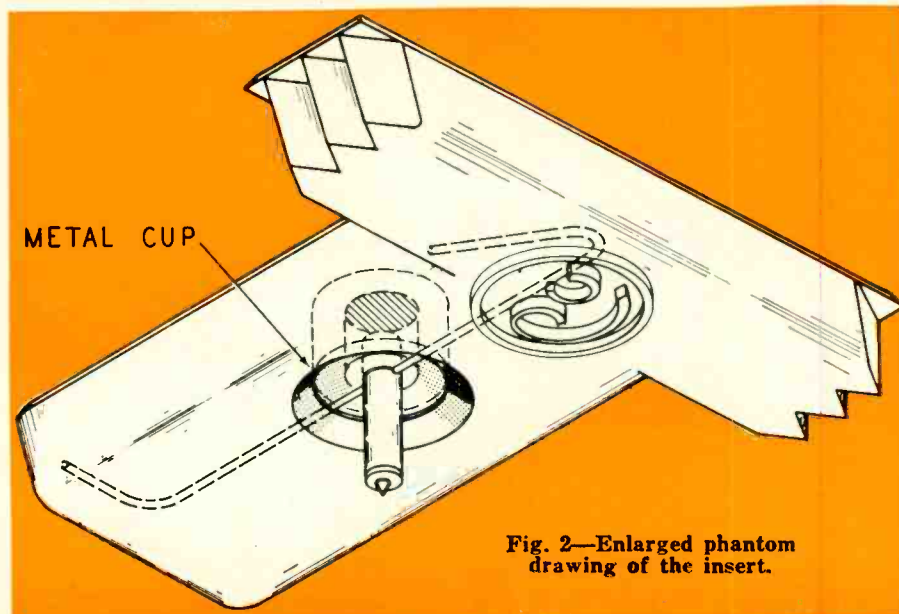

Fig. 2—Enlarged phantom drawing of the insert.

* President, Pickering & Co., Inc.

AUDIO—HIGH FIDELITY

Mechanical vibratory system

As shown in Fig. 2 and the photo of the insert, the stylus projects through a hole in the center leg of the insert. The stylus is attached to a wire that runs along the longitudinal axis of the insert and moves to follow the record modulation by bending this wire. The wire is held mainly at its two ends, which are bent to hold it firmly in the insert.

The lateral compliance of the stylus with this suspension system can be made extremely high by proper choice of the wire material and thickness. In the present pickup the compliance has been raised as high as it can be without leading to off-center motion, even in the most refined pickup arms. The compliance of this pickup is too high for use with some record changers and the pickup is not recommended for all such applications. A manually operated arm of very low friction and highest quality is desirable.

The proper amount of vertical compliance is included to allow stylus motion through "pinch" effects and record irregularities such as may occur in normal record pressings. The value of vertical compliance chosen is such that the stylus can respond to vertical forces without losing contact with the record groove even under conditions of high transient groove modulation.

Vibratory mass

The stylus and its tube comprise the whole vibratory mass, so that this mass is unprecedentedly low. As a consequence, the armature resonance of the pickup is far above the audible frequency spectrum, in the neighborhood of 30 kc. This greatly improves the performance of the pickup at high frequencies and gives it excellent ability to handle transient signals, which are highly sensitive to any abrupt change in the mechanical response characteristics in or near the operating frequency band. The lack of a peak in the operating range also eliminates the distortion that such a peak can produce in subharmonics of the resonant frequency. A strong peak at 10,000 cycles, for

instance, will increase the distortion at 5,000 and 2,500 cycles.

Nothing contributes so much to clarity, snap, smoothness, listening ease and low surface noise as low moving mass and the absence of peaks within the operating frequency range.

The entire pickup, including the magnet, coil and magnetic gap, is completely encapsulated in a tough plastic which practically guarantees it an endless life. The encapsulated parts cannot be damaged in any way, short of a coil burnout by application of a heavy dc voltage to the pickup terminals (a theoretical disaster which is extremely improbable). The only parts which move and wear are in the insert and so, when the user puts in a new insert, he is getting in effect a whole new pickup.

Electrical characteristics

The output of the pickup is about 25 millivolts at the normal recording level of about 10-15 centimeters per second. The frequency response is absolutely flat well beyond both ends of the audible frequency spectrum. The value of this supraaudible response at the high end has already been noted. It insures smoothness and excellent handling of transients. Intermodulation distortion has been reduced to a negligible level by careful arrangement of the magnetic circuit. The impedance of the pickup is medium high. It should work into a load of about 27,000 ohms.

Effect on record wear

The very high lateral compliance, the small mass and the lack of any mechanical resonance in the operating range combine to produce an additional benefit. With a stylus in good condition and in a well-designed arm which lacks strong arm resonances, the pickup does *not* tend to wipe off the record the microscopic groove modulations representing the highest frequencies, which is the fixed habit of pickups with heavy moving systems and mechanical resonances in the mid-high frequency range. Record wear, in other words, has been reduced to a new, much lower

level. Records played with the pickup will keep their top "sheen" indefinitely and exhibit no increase in the level of surface noise.

Mounting system, stylus force

The pickup is supplied with a mounting clip which also forms the bearing for pickup rotation. The clip has mounting holes on standard (RETMA) 1/2-inch centers and can be attached to almost any of the high-quality arms available on the market.

Because of the extremely high lateral compliance and low mass, the pickup will track with a vertical stylus force as low as 3 to 5 grams, depending somewhat on the character of the record modulation. With reasonably flat records, not modulated at an abnormally high level, and with a well-leveled turntable (see below), the lower figure of 3 grams is enough for perfect tracking.

Turntable leveling

To get the full benefit of the high lateral compliance of the pickup, it should be used on a turntable that has been dynamically leveled. This means that, under operating conditions, with the record exerting a dragging force on the stylus, the arm has no tendency to push toward either the inside or outside of the record.

To find the turntable position which produces this neutral condition of the arm, put on the table a blank record, such as an unused recording blank. Start the motor and put the pickup down on the moving record surface. Then level the turntable so the stylus does not move toward either the outside or the inside of the record. In this position, the arm will be climbing very slightly "uphill" in its travel from outside to inside of the record, and the force of gravity tending to slide it back toward the outside will closely offset the pull of the groove friction, which tends to pull the arm toward the inside. With a neutral arm, the high compliance of the pickup will produce the maximum of faithfulness to the groove and thus the maximum clarity of reproduction. END



The Pickering Flux-valve pickup, with the plastic inserts removed.

The insert, enlarged about four times.



HIGH-FIDELITY POWER AMPLIFIERS*

One of a series of articles on modern audio equipment. Power output and driver circuits are discussed here

By JOSEPH MARSHALL

THE high quality of performance of modern high-fidelity equipment is due in large part to highly specialized and sometimes unique circuitry. The service technician who looks for the first time at the wiring diagrams of modern commercial hi-fi equipment is very likely to be puzzled and perhaps even shocked by some highly unorthodox and unfamiliar circuits. High-fidelity circuits can be divided into two general categories: those applying to power amplifiers; those applying to control units, pre-amplifiers and accessories.

Power amplifiers consist of three sections: the power output stage whose function is to deliver to the speakers anywhere from 10 to 50 watts of power with minimum distortion; the driver which must supply sufficient driving voltage to the output stage to drive it to maximum output; a phase inverter to convert a single-ended input signal to a push-pull signal, since almost all power amplifiers in high-fidelity equipment use push-pull parameters or an equivalent.

The classic power output circuit is shown in Fig. 1. Two triodes or pentodes are arranged with plates loaded and grids driven in push-pull. (Beam-power tetrodes are classed as pentodes

in this article.) In older, inexpensive high-fidelity amplifiers, the circuit usually has 6V6 tubes as pentodes.

It is not easy to obtain high-power outputs with receiving type tubes. One of the first steps in the rapid progress of high-fidelity design in the past decade was the use of transmitting types in the output stages. There were two reasons for this:

First, these transmitting tubes require very little driving voltage even when used as triodes. Thus, where the 6B4 family requires 60 volts peak per grid of drive, transmitting pentodes of

the 807 family used as triodes require only 40 volts.

Theoretically it should easily be possible to design drivers capable of delivering 60 watts peak with low distortion. In practice it is difficult to do so without increasing distortion to high levels. But 40 volts is easily supplied and at a distortion level very much lower.

Second, where receiving type tubes have to be driven into nonlinear operation to deliver 10 or 15 watts of output, transmitting tubes deliver this output over the most linear portion of their

* From the book *Maintaining Hi-Fi Equipment*, Gernsback Library.

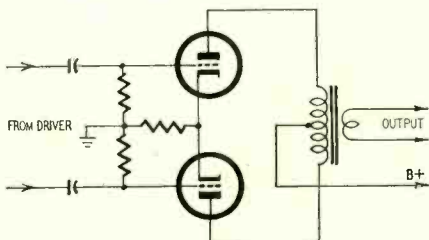

Fig. 1—The basic push-pull amplifier.

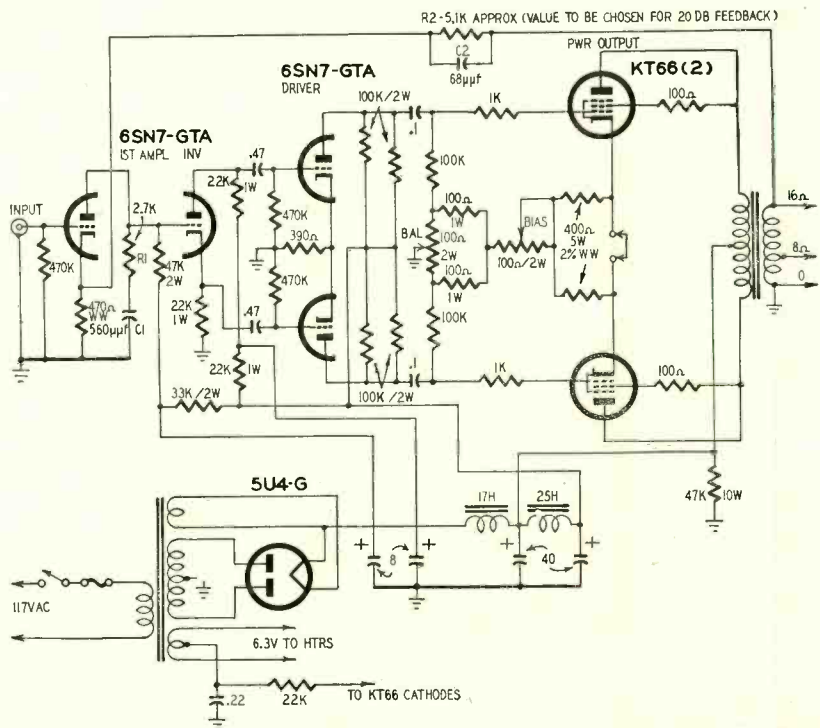

Fig. 2—Craftsman C-500, typical Williamson amplifier using triodes.

AUDIO—HIGH FIDELITY

curves, operating at only a small fraction of their maximum capabilities and strictly class A. Thus, distortion can be reduced to a small fraction of that with receiving type tubes. By this time it had become very clear that low distortion was the primary consideration and that a wide bandwidth was tolerable only when distortion was reduced to insignificant levels. The use of transmitting tubes provided a simple means of obtaining the desired low distortion.

The Williamson amplifier

This trend found its most notable expression in the amplifier named after D. T. N. Williamson, engineer of the British firm, Ferranti. The Williamson circuit not only used transmitting type tubes, but used them with highly refined circuitry for drivers and inverters. It was one of the most successful audio designs in electronic history. Even now, most commercial amplifiers use either some modification of the Williamson circuit or portions of it.

There is nothing very remarkable about the circuit. The original used two transmitting pentodes connected as triodes and loaded with an output transformer of hitherto unprecedented bandwidth, low distortion and very large size. The biasing arrangement was complex but permitted excellent balance and precise bias adjustment. The first amplifier-inverter used direct coupling to minimize phase shift at the low-frequency end. (See Fig. 2.)

A number of improvements were made as the circuit was applied to commercial equipment. One modification is that of splitting the self-bias resistors of the output tubes. About half the bias for each tube is developed in an independent unbypassed cathode

resistor. This provides some current feedback to reduce distortion further.

As output transformers were improved and bandwidth extended to 100,000 cycles and beyond, it became more difficult to maintain stability in the feedback loop at the extremes, particularly at the resonant peak of the output transformer which fell usually in the region around 100 kc. One expedient was to include within the loop, a bypass network affecting only the frequencies around and above 100 kc. This took the form of a resistor and a capacitor in series (R1 and C1, Fig. 2) in the plate circuit of the input tube which bypassed the unwanted ringing frequency. To minimize these troubles further, a phase-shifting capacitor (C2) was added in parallel with the feedback resistor. This network had a time constant which produced a phase shift opposite to that of the output transformer at the ringing frequency, or in that region.

Ultra-Linear operation

About 1952 David Hafer and Herb Keroes revived an unusual output tube circuit which had been patented some years before and which provided operation combining the best features of triode and tetrode or pentode operation. This Ultra-Linear configuration made only a very slight change in the normal push-pull circuit; the screen grids were connected to taps on the primary of the output transformer. There is some controversy about how this circuit actually operates but the general consensus is that connecting the screens in this way applies a certain amount of negative feedback.

In any event, the connection has some very great virtues. First, the operating

curve is more linear than that of either triode or pentode operation. Second, the power output capabilities are about one-half those of pentode connection and about double those of the triode connection. Thus, with the same plate supply voltage and drive, the Ultra-Linear configuration doubles the output power over that of the triode Williamson. More important than this is the fact that distortion is decreased at low output levels. Finally, the tube capacitances are the same as in pentode operation. This eliminates, or at least greatly minimizes, the Miller effect at high frequencies. It not only makes possible an upward extension of the bandwidth, but—more important—reduces the phase shift in the region of 100 kc. It therefore permits the use of larger feedback factors for an equal degree of ringing.

The Ultra-Linear circuit was immediately applied to the Williamson design and a high proportion of today's commercial amplifiers are Ultra-Linear versions of the Williamson. A typical circuit is shown in Fig. 3.

Cathode loading

Meanwhile, considerable work was being done on cathode loading of power-output tubes. It was known that such loading produced high power with very low distortion, since cathode loading results in current feedback. Cathode loading also improves the high-frequency response greatly. This permits higher feedback with less risk of ringing or instability at the transformer resonant frequency. Unfortunately, cathode followers have no voltage gain; hence the drivers have to supply somewhere between 150 and 200 volts of drive per side. This is a serious problem

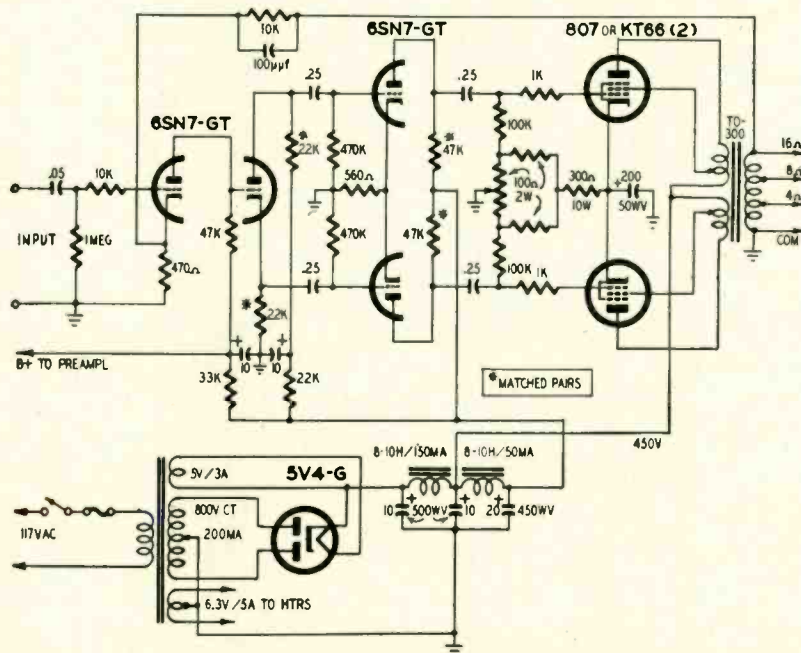

Fig. 3—Typical Williamson amplifier designed for Ultra-Linear operation.

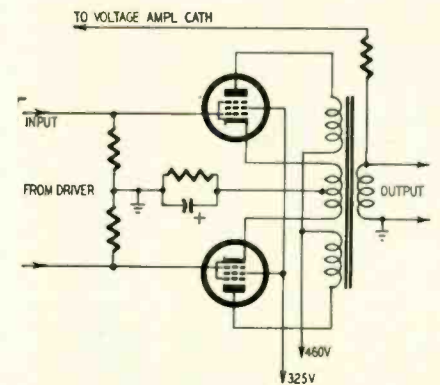

Fig. 4—Cathode-loaded output circuit.

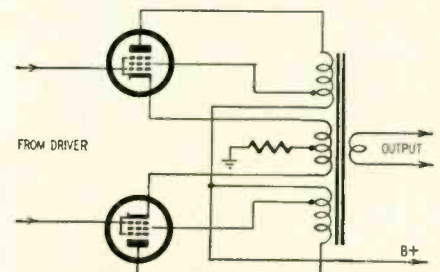

Fig. 5—Output circuit shows Ultra-Linear design with cathode loading.

since, as mentioned before, it is difficult enough to supply 60 volts of drive with low distortion.

Though complete cathode loading poses too many problems, it was quickly perceived that partial cathode loading would provide a good degree of current feedback without raising the driving requirements out of practical reach. Several circuits of this type were developed, differing in the ratio of plate-to-cathode loading. Typical examples are the British Quad amplifier and the American Bogen DB15G. (A simplified circuit is shown in Fig. 4.)

Both of these use pentode operation, obtaining a low output impedance by combining current feedback via the partial cathode loading and voltage feedback of an overall loop. Since pentodes are far more sensitive than triodes, a simpler driver can be used. The Bogen uses merely the first two stages of the Williamson front end; the Quad uses a pair of pentodes in the paraphase phase-inverting circuit.

It is possible to combine the Ultra-Linear configuration with partial cathode loading and this was done in the Fisher 70A (Fig. 5) amplifier.

An arrangement which looks rather similar is that of the McIntosh amplifiers. (See "Circuit Features of High-Fidelity Power Amplifiers," August, 1955.) In this, bifilar windings are used for the plate and cathode portions of the transformer primary and the screens are cross-coupled to the opposite plates. This arrangement permits class-B operation with very low distortion and without the switching transients normally produced by such operation. Thus a pair of 6V6's can deliver outputs in excess of 20 watts. Fig. 6 shows a simplified version of the output of the McIntosh amplifier.

I mentioned switching transients in the preceding paragraph. These occur when output tubes are driven to and beyond cutoff. The transient is produced by leakage reactance of the output transformer which results in collapsing currents at the cutoff point and produces parasitic oscillation, audible in the output as a very annoying thump, which tears up the signal. Because these transients occur at cutoff or beyond, high-fidelity power stages avoided such operation. That meant, in practice, they were limited to class-A or -AB₁ operation. Unfortunately, this operation is inefficient and it is difficult to obtain high-power output with it. Much design thought has therefore been expended on means of obtaining class-AB₂ or -B operation without switching transients.

Before going into that we might mention two expedients for obtaining high-power outputs with class-A operation. One is a style of operation called A₂. In this the tubes are never cut off but they are driven into the grid-current region. This produces higher distortion, but its effects can be minimized by careful balancing and high feedback factors.

The first commercial amplifier to employ this mode of operation was the Brook unit designed by Lincoln Walsh which was the first great postwar high-fidelity amplifier. It has since been used also in the Fisher Laboratory model 50A. In this type of operation the grids draw considerable current, consequently the grid impedance must be very low. The driver is therefore a cathode follower with transformer coupling to the output tubes; even the low resistance of a cathode follower with resistor loads would be too great for A₂ operation. The transformer also has capacitor coupling to extend the low-frequency response. This results in something intermediate between transformer and double-impedance coupling (Fig. 7).

Another possible arrangement (Fig. 8), not used at present in a commercial amplifier, is *extended* class-A operation. Here four identical tubes are used, one pair operating as triodes, the other as pentodes. At low levels the pentodes are cut off and do not contribute anything. At a certain point in the dynamic range, however, as the driving voltage increases and reduces the effective bias,

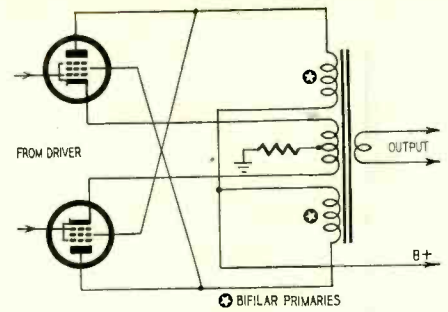

Fig. 6—McIntosh output circuit.

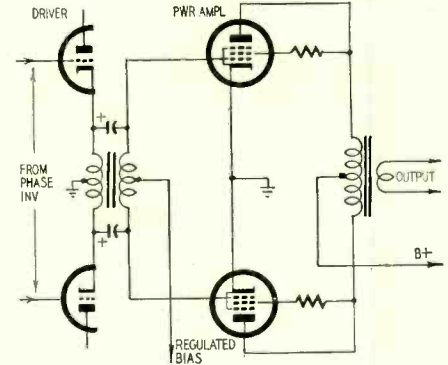

Fig. 7—Circuit for class-A₂ operation.

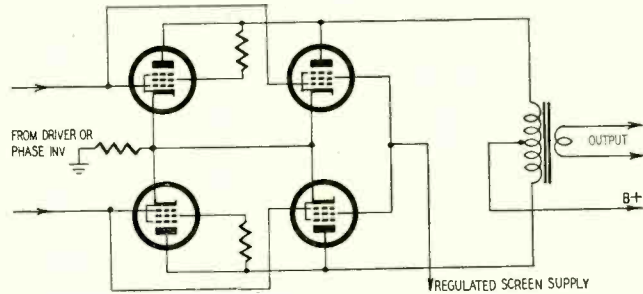

Fig. 8—Circuit for extended class A.

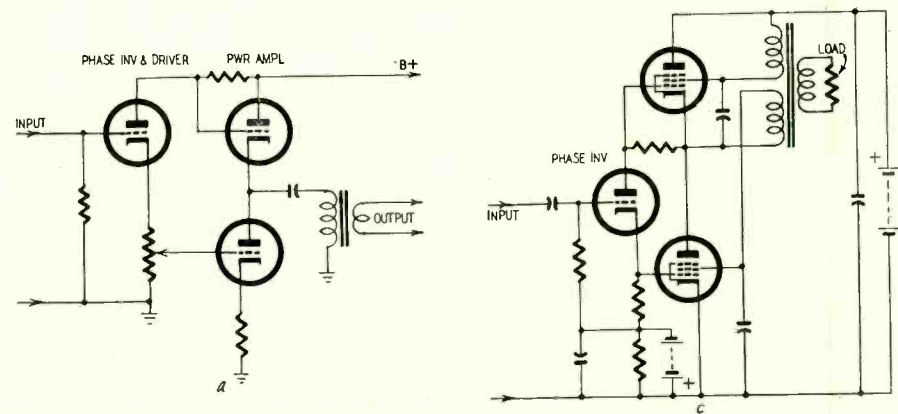
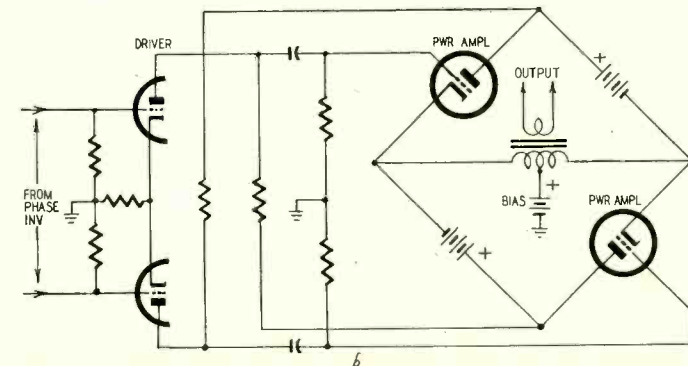

Fig. 9—Output circuit with plate of one tube and cathode of other loaded.



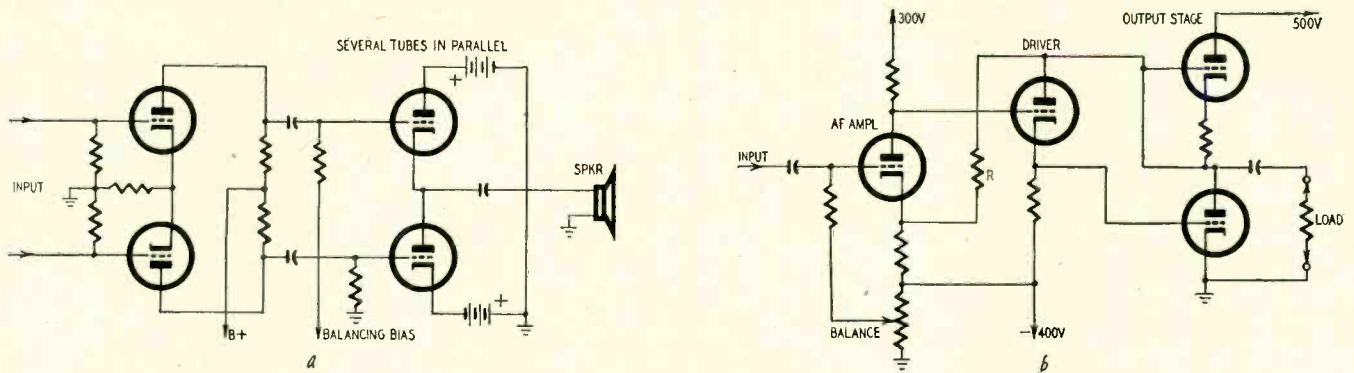

Fig. 10—Single-ended push-pull output.

they begin to contribute and at maximum output are the dominant developers of power. Operation is class A, but the amplifier output power is much higher.

One of the possible ways of using two tubes in a power stage is to load the cathode of one and the plate of the other tube. This appears in different forms in two commercial amplifiers: the National Unity-Coupled Horizon and the Electro-Voice Circlotron.

Since the circuit diagrams of these amplifiers do not make the operation clear, let us examine the circuit in simplified form. The general idea is expressed in the simple diagram of Fig. 9-a. Here we have, in effect, two tubes whose outputs are in series but whose inputs are in push-pull. The transformer is connected in the middle of the circuit at the point where the two tubes are connected in series. It is in the plate circuit of the lower tube, in the cathode circuit of the upper one. Push-pull operation results because the two grids are fed by out-of-phase voltages and therefore, as the plate current of one tube rises, the current of the other falls. The load for both sections is common, so all the distortion products cancel.

National and Electro-Voice have traveled two different paths to obtain a practical amplifier with this configuration. Electro-Voice turns the circuit into a bridge as indicated in Fig. 9-b. This requires two power supplies (indicated by batteries), but as long as the bridge is well balanced no dc can flow through the output transformer. This simplifies the design of a good output transformer; it also makes possible class-AB₂ operation approaching class B without switching transients. This in turn makes it possible to develop high power outputs with high efficiency. Triodes or pentodes can be used and, since the output impedance is very low, pentode operation in this mode produces as good or better damping factors than triode operation in conventional push-pull stages. Furthermore, the load resistance required is only one-fourth that required in plate loading. This makes the problem of producing a high-quality transformer considerably simpler.

Since the output stage has no gain,

high driving voltages are required. To obtain them a "bootstrap" driver circuit has been developed. In this circuit (Fig. 9-b) the plate loads of the drivers are returned to the plates of the opposite output tubes. Their signal voltages add to the dc potential applied to the driver plates, effectively raising their plate supply voltage.

National avoids the need for two high-current power supplies by arranging the circuit as in Fig. 9-c. The output transformer has two primaries with unity coupling. One is connected in the plate circuit of one tube and the other in the cathode circuit of the other tube. The output tubes' screen grid and power-supply filter capacitor improve the coupling between plate and cathode windings. Not as much drive is required in this circuit and the preceding amplifier is simplified, consisting of a single twin-triode. For a more detailed discussion of this circuit, see "Circuit Features in Hi-Fi Power Amplifiers," September, 1955.

Another form of this so-called "single-ended push-pull" style has been used in one commercial amplifier (the Stephens OTL) and may be used in the future because it permits coupling 500-ohm speakers directly to the amplifier without an output transformer. Fig. 10-a gives a very simplified diagram of one form of this circuit. The two grids receive out-of-phase signals. Two power supplies are used and balance is achieved by returning one grid to an appropriate

negative voltage. The output is taken off the junction of plate and cathode and the impedance can be made low enough by paralleling a number of tubes to match the low impedance of a 500- or even a 16-ohm speaker.

Various methods of driving and of supplying the various voltages can be used. Fig. 10-b is a simplification of the output and driver stages of the Stephens amplifier. This configuration permits class-B operation but has two serious disadvantages: It is extremely inefficient even in class-B operation, the power output ranging from 1 to 10% of the input power; there is no common load in which distortion can be canceled. However, the absence of an output transformer permits the use of 40 db or more of feedback, which compensates for the higher initial distortion. It is probable that this circuit will appear in additional amplifiers in the future.

The driver is a cathode follower direct-coupled to the grid of the lower output tube. The output tubes are in series across the 500-volt supply and they feed the load in parallel. Current flows from ground through the cathode-plate circuit of the lower triode and then through the plate and cathode circuits of the upper tube. Signal voltage for the upper tube is taken off the plate of the lower and grid bias is developed by the drop across the cathode resistor.

The upper tube sees the lower as a cathode resistance shunted by the load and the lower sees the upper one as a plate load resistor. In each case, the load is capacitance-coupled to the source. Resistor R between the driver plate and the voltage-amplifier cathode provides inverse feedback to stabilize the amplifier against possible voltage drift.

The internal resistance of the lower triode varies as the signal applied to its grid. This varies the current through the upper triode and develops a signal voltage across the load. At the same time, the change in current through the tubes develops a signal voltage on the upper triode grid that is equal to and in phase with that applied to the lower triode grid. The blocking capacitor prevents dc from flowing through the load.

END

**BACKGROUND NOISE
IN TAPE RECORDING**

By James A. McRoberts

**ELECTRONICS
IN THE AIR FORCE**

By Aaron Nadell

Both are in the

JUNE

RADIO-ELECTRONICS

Heathkits

FOR THE ENTIRE ELECTRONICS INDUSTRY

more than 65 top-quality models to choose from, including such outstanding kit designs as

V-7A VACUUM TUBE VOLTMETER: Easily the world's largest selling VTVM. Features peak-to-peak scales—etched metal circuit board—1% precision resistors—full wave rectifier and AC input circuit—reads rms and peak-to-peak AC, DC, and ohms.

O-10 LABORATORY TYPE OSCILLOSCOPE: The world's largest selling oscilloscope kit, and the most successful oscilloscope in history. Designed especially for color and black-and-white TV service work. Its 5 megacycle bandwidth and new 500 Kc sweep generator readily qualify it for laboratory applications. Features easy-to-assemble etched metal circuit board construction.

WA-P2 HIGH FIDELITY PREAMPLIFIER: This is the world's largest selling hi fi preamplifier kit. Features complete equalization, 5 separate switch-selected inputs with individual pre-set level controls, beautiful modern appearance, high-quality components.

HIGH FIDELITY AMPLIFIERS: Five Heathkit Models to choose from at prices ranging from \$16.95 to \$59.75. Power output range from 7 to 25 watts.

DX-100 TRANSMITTER: A 100 watt phone and CW ham transmitter, offering the greatest dollar value available in the ham radio field today.

Greatest Dollar Value Through Factory-To-You Selling!

ONLY

Heathkits

CAN GIVE YOU ALL OF THESE DISTINCTIVE ADVANTAGES!

- ▶ *The Most Complete Construction Manuals for Easy Assembly.*
- ▶ *Originality of Design—Developed Through Pioneering in the Kit Instrument Field.*
- ▶ *Greatest Dollar Value—Finest Quality with Real Economy.*
- ▶ *Direct Contact with Manufacturer—Lower Price, Guaranteed Performance.*
- ▶ *Etched Metal, Prewired Circuit Boards—Save Construction Time, Improve Performance.*
- ▶ *High Quality Standard Components for Long-Life Service.*

HEATH COMPANY

*A Subsidiary
of Daystrom, Inc.*

BENTON HARBOR 20, MICHIGAN

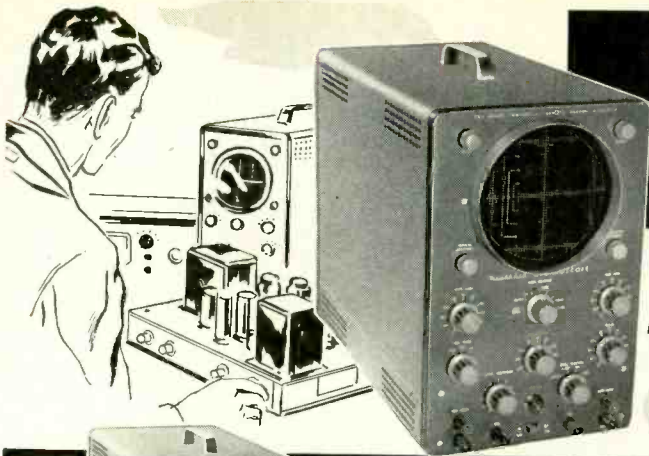

there is no substitute for
HEATHKIT QUALITY

YOU GET MORE: All first-run, top quality parts—the latest in electronic design—complete and comprehensive step-by-step assembly instructions with large pictorial diagrams and assembly drawings. Proven performance through the production of thousands of kits.

MODEL O-10

1



2

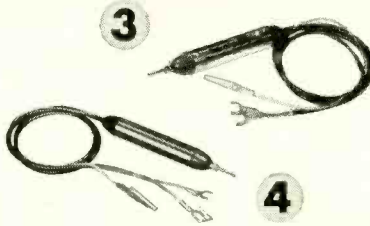

3

4



5

1 *Heathkit* ETCHED CIRCUIT
COLOR-TV
5" OSCILLOSCOPE KIT

This deluxe quality oscilloscope has proven itself through thousands of operating hours in service shops and laboratories. Features the best in components—and the best in circuit design.

Features amplifier response to 5 Mc for color TV work, and employs the radically new sweep circuit to provide stable operation up to 500,000 cps. In addition, etched metal, pre-wired circuit boards cut assembly time almost in half, and permit a level of circuit stability never before achieved in an oscilloscope of this type.

Vertical amplifiers flat within +2 db -5 db from 2 cps to 5 Mc, down only 1½ db at 3.58 Mc. Vertical sensitivity is 0.025 volts, (rms) per inch at 1 Kc. 11 tube circuit employs a 5U1 CRT.

Plastic molded capacitors used for coupling and bypass—preformed and cabled wiring harness provided.

Features built-in peak-to-peak calibrating source—retrace blanking amplifier—push-pull amplifiers and step-attenuated input.

MODEL O-10
\$6950

Shpg. Wt. 21 Lbs.

2 *Heathkit* ETCHED CIRCUIT
5" OSCILLOSCOPE KIT

This is a general purpose oscilloscope for the more usual applications in the service shop or lab, yet is comparable to scopes costing many dollars more.

Features full size 5" CRT (5BP1), built-in peak-to-peak voltage calibration—3 step input attenuator—phasing control—push-pull deflection amplifiers—and etched metal pre-wired circuit boards.

Vertical channel flat within ±3 db from 2 cps to 200 Kc, with 0.09 V. rms/inch, peak-to-peak sensitivity at 1 Kc. Sweep circuit from 20 cps to 100,000 cps. A scope you will be proud to own and use.

MODEL OM-1
\$4950

Shpg. Wt. 21 Lbs.

3 *Heathkit* LOW CAPACITY
PROBE KIT

Scope investigation of circuits encountered in TV requires the use of special low capacity probe to prevent loss of gain, circuit loading, or distortion. This probe features a variable capacitor to provide correct instrument impedance matching. Also the ratio of attenuation can be controlled.

NO. 342
\$350

Shpg. Wt. 1 Lb.

4 *Heathkit* ETCHED CIRCUIT
SCOPE DEMODULATOR PROBE KIT

Extend the usefulness of your Oscilloscope by observing modulation envelope of R.F. or I.F. carriers found in TV and radio receivers. Functions like AM detector to pass only modulation of signal and not signal itself. Applied voltage limits are 30 V. RMS and 500 V. DC.

NO. 337-C
\$350

Shpg. Wt. 1 Lb.

5 *Heathkit* ETCHED CIRCUIT
3" OSCILLOSCOPE KIT

This compact little oscilloscope measures only 9½" H. x 6½" W. x 11¾" D., and weighs only 11 lbs! Easily employed for home service calls, for work in the field or is just the ticket for use in the ham shack or home workshop. Incorporates many of the features of the Model OM-1, but yet is smaller in physical size for portability.

Employing etched circuit boards, the Model OL-1 features vertical response within ± 3 db from 2 cps to 200 Kc. Vertical sensitivity is 0.25 V. RMS/inch peak-to-peak, and sweep generator operates from 20 cps to 100,000 cps. Provision for r.f. connection to deflection plates for modulation monitoring, and incorporates many features not expected at this price level. 8-tube circuit features a type 3GP1 Cathode Ray Tube.

MODEL OL-1
\$2950

Shpg. Wt. 14 Lbs.

HEATH COMPANY

A Subsidiary
of Daystrom, Inc.

BENTON HARBOR 20, MICHIGAN

fill your test requirements WITH HEATHKITS

DESIGNED FOR YOU: Heath Company test equipment is designed for the maximum in convenience. Besides being functional, Heathkits represent the very latest in modern physical appearance, and incorporate all the latest circuit design features for comprehensive test coverage.

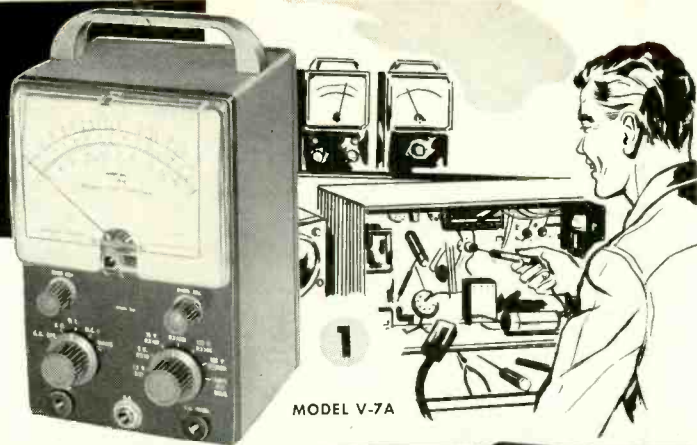

MODEL V-7A



2

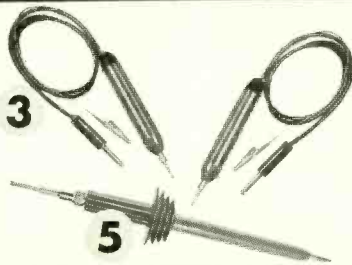

3

4

5



6

1

Heathkit ETCHED CIRCUIT

VACUUM TUBE VOLTMETER KIT

Besides measuring AC (rms), DC and resistance, the modern-design V-7A incorporates peak-to-peak measurement for FM and television servicing.

AC (rms) and DC voltage ranges are 1.5, 5, 15, 50, 150, 500, and 1500. Peak-to-peak AC voltage ranges are 4, 14, 40, 140, 400, 1400, and 4000. Ohmmeter ranges are X1, X10, X100, X1000, X10K, X100K, and X1 megohm. Also a db scale is provided. A polarity reversing switch provided for DC measurements, and zero center operation within range of front panel controls. Employs a 200 μ a meter for indication. Input impedance is 11 megohms.

Etched metal, pre-wired circuit board for fast, easy assembly and reliable operation is 50% thicker for more rugged physical construction. 1% precision resistors for utmost accuracy.

MODEL V-7A

\$2450

Shpg. Wt. 7 Lbs.

2

Heathkit 20,000 OHMS/VOLT

MULTIMETER KIT

The MM-1 is a portable instrument for outside servicing, for field testing, or for quick portability in the service shop. Combines attractive physical appearance with functional design. 20,000 ohms/v. DC, and 5000 ohms/v. AC. AC and DC voltage ranges are 0-1.5, 5, 50, 150, 500, 1500 and 5000 volts. Direct current ranges are 0-150 μ a., 15 ma., 150 ma., 500 ma., and 15 amperes. Resistance ranges are X1, X100, X10,000 providing center scale readings of 15, 1500 and 150,000 ohms. DB ranges cover -10 db to +65 db.

Features a 4 1/2" 50 μ a. meter. Provides polarity reversal on DC measurements. 1% precision resistors used in multiplier circuits. Not affected by RF fields.

MODEL MM-1

\$2950

Shpg. Wt. 6 Lbs.

3

Heathkit ETCHED CIRCUIT

RF PROBE KIT

The Heathkit RF Probe used in conjunction with any 11 megohm VTVM will permit RF measurements up to 250 Mc with \pm 10% accuracy. Uses etched circuits for increased circuit stability and ease of assembly. Shpg. Wt. 1 lb.

NO. 309-C
\$350

4

Heathkit ETCHED CIRCUIT

PEAK-TO-PEAK PROBE KIT

Now read peak-to-peak voltages on the DC scale of any 11 megohm VTVM with this new probe, employing etched circuit for stability and low loss. Readings made directly from VTVM scales, from 5 Kc to 5 Mc. Not required for Heathkit Model V-7A VTVM. Shpg. Wt. 2 lbs.

NO. 338-C
\$550

5

Heathkit 30,000 VOLT D.C.

HIGH VOLTAGE PROBE KIT

For TV service work or similar application for measurement of high DC voltage. Precision multiplier resistor mounted inside plastic probe. Multiplication factor of 100 on the ranges of Heathkit 11 megohm VTVM. Shpg. Wt. 2 lbs.

NO. 336
\$450

6

Heathkit

HANDITESTER KIT

The Model M-1 measures AC or DC voltage at 0-10, 30, 300, 1000, and 5000 volts. Measures direct current at 0-10 ma. and 0-100 ma. Provides ohmmeter ranges of 0-3000 (30 ohm center scale) and 0-300,000 ohms (3000 ohms center scale). Features a 400 μ a. meter for sensitivity of 1000 ohms/volt. Because of its size, the M-1 is a very handy portable instrument that will fit in your coat pocket, tool box, glove compartment, or desk drawer. Makes a fine standby unit in the service shop when the main instruments are in use, or is ideal for the hobbyist or beginner. An unusual dollar value. Shpg. Wt. 3 Lbs.

MODEL M-1
\$1450

HEATH COMPANY

A Subsidiary
of Daystrom, Inc.

BENTON HARBOR 20, MICHIGAN

Heathkit TV ALIGNMENT GENERATOR KIT



1



2



3



4



**HEATH
COMPANY**
A SUBSIDIARY OF DAYSTROM INC.

The Model TS-4 features a controllable inductor for all-electronic sweep, improved oscillator and automatic gain circuitry, high RF output, center sweep operation, and improved linearity. It sets a new high standard for sweep generator operation, and is absolutely essential for the up-to-date service shop doing FM, black-and-white TV, and color TV work.

Voltage regulation and effective AGC action insure flat output over a wide frequency range. Electronic sweep insures complete absence of mechanical vibration. Sweep deviation controllable from 0 up to 40 Mc, depending upon base frequency. Effective two-way blanking.

Fundamental output from 3.6 Mc to 220 Mc in 4 bands. Crystal marker provides markers at 4.5 Mc and multiples thereof. Crystal included with kit. Variable marker covers from 19 Mc to 60 Mc on fundamentals, and up to 180 Mc on harmonics. Provision for external marker.



MODEL TS-4
\$4950
Shpg. Wt. 16 Lbs.

1

Heathkit LINEARITY PATTERN GENERATOR KIT

The new-design Model LP-1 produces vertical or horizontal bar patterns, a cross-hatch pattern, or white dots on the screen of the TV set under test. No internal connections required. Special clip is attached to the TV antenna terminals. Instant selection of the pattern desired for adjustment of vertical and horizontal linearity, picture size, aspect ratio, and focus. Dot pattern presentation is a *must* for color convergence adjustments on color TV sets.

Extended operating range covers all television channels from 2 to 13. Produces 6 to 12 vertical bars or 4 to 7 horizontal bars.

MODEL LP-1
\$2250
Shpg. Wt. 7 Lbs.

2

Heathkit LABORATORY GENERATOR KIT

The Heathkit Model LG-1 Laboratory Generator is a high-accuracy signal source for applications where metered performance is essential. It covers from 100 Kc to 30 Mc on fundamentals in 5 bands. Modulation is at 400 cycles, and modulation is variable from 0-50%. RF output from 100,000 μ v. to 1 μ v. 200 μ a. meter reads the RF output in microvolts, or percentage of modulation. Fixed step and variable output attenuation provided.

Features voltage regulation, and double copper plated shielding for stability. Provision for external modulation. Coaxial output cable (50 ohms).

MODEL LG-1
\$3950
Shpg. Wt. 16 Lbs.

3

Heathkit CATHODE RAY TUBE CHECKER KIT

This new-design instrument holds the key to rapid and complete picture tube testing, either in the set, on the work-bench, or in the carton. Tests for shorts, leakage, and emission. Features Shadow-graph test (a spot of light on the screen) to indicate whether the tube is capable of functioning.

The Model CC-1 tests all electromagnetic deflection picture tubes normally encountered in television servicing. Supplies all operating voltages to the tube under test, and indicates the condition of the tube on a large "GOOD-BAD" scale. Features spring loaded test switches for operator protection.

The CC-1 is housed in an attractive portable case and is light in weight - ideal for outside service calls.

MODEL CC-1
\$2250
Shpg. Wt. 10 Lbs.

4

Heathkit DIRECT READING CAPACITY METER KIT

Not only is this instrument popular in the service shop, but it has found extensive application in industrial situations. Ideal for quality control work, production line checking, or for matching pairs.

Features direct reading linear scales from 100 mmf to .1 mfd full scale. Necessary only to connect a capacitor of unknown value to the insulated binding posts, select the correct range, and read the meter. The CM-1 is not susceptible to hand capacity, and has a residual capacity of less than 1 mmf.

MODEL CM-1
\$2950
Shpg. Wt. 7 Lbs.

BENTON HARBOR 20, MICHIGAN

RADIO-ELECTRONICS



MODEL SG-8 **\$1950**
Shpg. Wt. 8 Lbs.

This is one of the biggest signal generator bargains available today. The tried and proven Model SG-8 offers all of the outstanding features required for a basic service instrument. High quality components and outstanding performance.

The SG-8 covers 160 Kc to 110 Mc on fundamentals in 5 bands, and calibrated harmonics extend its usefulness up to 220 Mc. The output signal is modulated at 400 cps, and the RF output is in excess of 100,000 uv. Output controlled by both a continuously variable and a fixed step attenuator. Also, audio output may be obtained for amplifier testing. Don't let the

low price deceive you. This is a professional type service instrument to fulfill the signal source requirements in the service lab.

1 *Heathkit* . . . IMPEDANCE BRIDGE KIT

The IB-2 features built-in adjustable phase shift oscillator and amplifier, and has panel provisions for external generator. Measures resistance, capacitance, inductance, dissipation factors of condensers, and storage factor of inductance.

D, Q, and DQ functions combined in one control. 1/2% resistors and 1/2% silver-mica capacitors especially selected for this instrument. A 100-0-100 microammeter provides null indications. Two-section CRL dial provides 10 separate "units" with an accuracy of .5%. Fractions of units read on variable control.

MODEL IB-2
\$5950
Shpg. Wt. 12 Lbs.



1

2 *Heathkit* "Q" METER KIT

The Heathkit Model QM-1 will measure the Q of inductances and the RF resistance and distributed capacity of coils. Employs a 4 1/2" 50 microampere meter for direct indication. Will test at frequencies of 150 Kc to 18 Mc in 4 ranges. Measures capacity from 40 mmf to 450 mmf within ± 3 mmf. Indispensible for coil winding and determining unknown condenser values. A worthwhile addition to your laboratory at an outstandingly low price. Useful for checking wave traps, chokes, peaking coils, etc. Laboratory facilities are now available to the service shop and home lab.

MODEL QM-1
\$4450
Shpg. Wt. 14 Lbs.



2

3 *Heathkit* 6-12 VOLT BATTERY ELIMINATOR KIT

This modern battery eliminator will supply 6 or 12 volt output for ordinary automobile radios as well as 12 volts for the new models in the latest model cars. Output voltage is variable from 0-8 volts DC, or 0-16 volts DC. Will deliver up to 15 amperes at 6 volts, or up to 7 amperes at 12 volts. Two 10,000 microfarad filter capacitors insure smooth DC output. Two panel meters monitor output voltage and current. Will double as a battery charger. Definitely required for automobile radio service work.

MODEL BE-4
\$3150
Shpg. Wt. 17 Lbs.



3

4 *Heathkit* DECADE RESISTANCE KIT

Twenty 1% precision resistors provide resistance from 1 to 99,999 ohms in 1 ohm steps. Indispensible around service shop laboratory, ham shack, or home workshop. Well worth the extremely low Heathkit price.

MODEL DR-1
\$1950
Shpg. Wt. 4 Lbs.



5 *Heathkit* VIBRATOR TESTER KIT

Tests vibrators for proper starting and indicates the quality of the output on a large "GOOD-BAD" scale. Checks both interrupter and self-rectifier types in 5 different sockets. Operates from any battery eliminator delivering variable voltage from 4 to 6 volts DC at 4 amps. Ideal companion to the Model BE-4.

MODEL VT-1
\$1450
Shpg. Wt. 6 Lbs.



5

6 *Heathkit* DECADE CONDENSER KIT

Provides capacity values from 100 mmf to 0.111 mfd in steps of 100 mmf. ± 1% precision silver-mica condensers used. High quality ceramic switches for reduced leakage. Polished birch cabinet. Extremely valuable in all electronic activity.

MODEL DC-1
\$1650
Shpg. Wt. 3 Lbs.



6

Heathkit SIGNAL GENERATOR KIT

HEATH COMPANY

A SUBSIDIARY OF DAYSTROM INC.

BENTON HARBOR 20, MICHIGAN

Heathkit TUBE CHECKER KIT

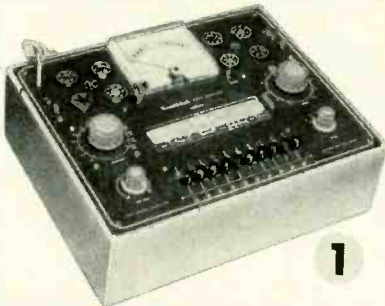

1

1 The Heathkit Model TC-2 is an emission type tube tester that represents a tremendous saving over the price of a comparable unit from any other source. At only \$29.50, you can have a tube tester of your own, even if you are an experimenter, or only do part time service work. Extremely popular with radio servicemen, it uses a 4½" meter with 3-color meter face for simple "GOOD-BAD" indications that the customer can understand. Will test all tubes commonly encountered in radio and TV service work.

Ten 3-position lever switches for "open" or "short" tests on each tube element. Neon bulb indicates filament continuity or short between tube elements. Line adjust control provided. The roll chart is illuminated.

Sockets provided for 4, 5, 6, and 7-pin, octal, and loctal tubes, 7 and 9 pin miniature tubes, and the 5 pin Hytron tubes. Blank space provided for future socket addition. Tests tubes for opens, and shorts, and for quality on the basis of total emission. 14 different filament voltage values provided.

MODEL TC-2
\$29.50
Shpg. Wt. 12 Lbs.

2 Heathkit PORTABLE TUBE CHECKER KIT

The Model TC-2P is identical to the Model TC-2 except that it is housed in a rugged carrying case. This strikingly attractive and practical two-tone case is finished in proxylin impregnated fabric. The cover is detachable, and the hardware is brass plated. This case imparts a real professional appearance to the instrument. Ideal for home service calls, or any portable application.

MODEL TC-2P
\$34.50
Shpg. Wt. 15 Lbs.



3

2

3 Heathkit TV PICTURE TUBE TEST ADAPTER

The Heathkit TV picture tube test adapter is designed for use with the Model TC-2 Tube Checker. Test picture tubes for emission, shorts, and thereby determine tube quality. Consists of 12-pin TV tube socket, 4 ft. cable, octal connector, and necessary technical data. (Not a kit.)

MODEL 355
\$4.50
Shpg. Wt. 1 Lb.

4 Heathkit . . . CONDENSER CHECKER KIT

Use this Condenser Checker to quickly and accurately measure those unknown condenser and resistor values. All readings taken directly from the calibrated panel scales without any involved calculation. Capacity measurements in four ranges from .00001 to 1000 mfd. Checks paper, mica, ceramic and electrolytic condensers. A power factor control is available for accurate indication of electrolytic condenser efficiency. Leakage test switch—selection of five polarizing voltages, 25 volts to 450 volts DC to indicate condenser operating quality under actual load conditions. Spring-return test switch automatically discharges condenser under test and eliminates shock hazard to the operator.

Resistance measurements can be made in the range from 100 ohms to 5 megohms. Here again, all values are read directly on the calibrated scales. Increased sensitivity coupled with an electron beam null indicator increases overall instrument usefulness.

For safety of operation, the circuit is entirely transformer operated. An outstanding low kit price for this surprisingly accurate instrument.

MODEL C-3
\$19.50
Shpg. Wt. 7 Lbs.



4

5 Heathkit VISUAL-AURAL SIGNAL TRACER KIT

This signal tracer is extremely valuable in servicing AM, FM, and TV receivers, especially when it comes to isolating trouble to a particular stage of the circuit under test.

This visual-aural tracer features a high gain RF input channel to permit signal tracing from the receiver antenna input clear through all RF, IF, detector, and audio stages to the speaker. Separate low-gain channel provided for audio circuit exploration. Both visual and aural indication by means of a speaker or headphone, and electron beam "eye" tube as a level indicator. Also incorporates a noise locator circuit for DC noise checks, and a built-in calibrated wattmeter (30-500 watts). Panel terminals provided for "patching" output transformer or speaker into external circuit for test purposes. Designed especially for the radio and TV serviceman. Cabinet size: 9½" wide x 6½" high x 5" deep. A real test equipment bargain.

MODEL T-3
\$23.50
Shpg. Wt. 9 Lbs.



5

HEATH COMPANY

A SUBSIDIARY OF DAYSTROM INC.

BENTON HARBOR 20, MICHIGAN

RADIO-ELECTRONICS



MODEL HD-1

Shpg. Wt. 13 Lbs.

\$4950

Used with a sine wave generator, the Model HD-1 will check the harmonic distortion output of audio amplifiers under a variety of conditions. Reads distortion directly on the meter as a percentage of the input signal. Operates between 20 and 20,000 cps. High impedance VTVM circuit for initial reference settings and final distortion readings. Ranges are 0-1, 3, 10, and 30 volts full scale. 1% precision resistors. Distortion scales are 0-1, 3, 10, 30 and 100% full scale. Requires only 3 volt input for distortion test.

Heathkit HARMONIC DISTORTION METER KIT

1 Heathkit AUDIO ANALYZER KIT

This instrument consists of an audio wattmeter, an AC VTVM, and a complete IM analyzer, all in one compact unit.

Use the VTVM to measure noise, frequency response, output gain, power supply, ripple, etc. Use the wattmeter for measurement of power output. Internal loads provided for 4, 8, 16, or 600 ohms. VTVM also calibrated for DBM units. High or low impedance IM measurements made with built-in 6KC and 60 cps generators. VTVM ranges are .01, to 300 volts in 10 steps. Wattmeter ranges are .15 mw. to 150 w. in 7 steps. IM scales are 1% to 100% in 5 steps.

MODEL AA-1

\$5950

Shpg. Wt. 13 Lbs.



1

2 Heathkit AUDIO GENERATOR KIT

This new Heathkit Model features step-tuning from 10 cps to 100 Kc with three rotary switches that provide two significant figures and multiplier. Less than .1% distortion. Frequency accurate to within $\pm 5\%$.

Output monitored on a large 4 1/2" meter that reads voltage or db. Both variable and step-type attenuation provided. Meter reads zero-to-maximum at each attenuator position. Output ranges (and therefore meter ranges) are 0-.003, .01, .03, .1, 3, 1, 3, 10 volts. Step-tuning provides rapid positive selection of the desired frequency, and allows accurate return to any given frequency.

MODEL AG-9

\$3450

Shpg. Wt. 8 Lbs.



2

3 Heathkit AUDIO OSCILLATOR KIT

(SINE WAVE — SQUARE WAVE)

The Model AO-1 features sine wave or square wave coverage from 20-20,000 cps in 3 ranges. It is an instrument specifically designed to completely fulfill the needs of the serviceman and high fidelity enthusiast. Offers high level output across the entire frequency range, low distortion and low impedance output. Features a thermistor in the second amplifier stage to maintain essentially flat output through the entire frequency range. Produces an excellent sine wave for audio testing, or will produce good, clean, square waves with a rise time of only 2 microseconds.

MODEL AO-1

\$2450

Shpg. Wt. 10 Lbs.

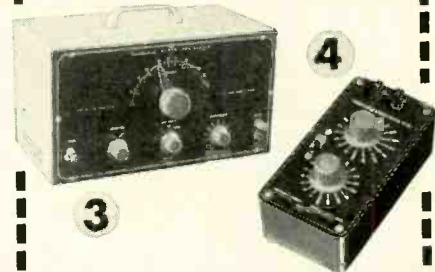

3

4

4 Heathkit RESISTANCE SUBSTITUTION BOX KIT...

Provides switch selection of 36 RTMA 1 watt standard 1% resistors ranging from 15 ohms to 10 megohms. Numerous applications in radio and TV work, and essential in the developmental laboratory.

MODEL RS-1

\$550

Shpg. Wt. 2 Lbs.

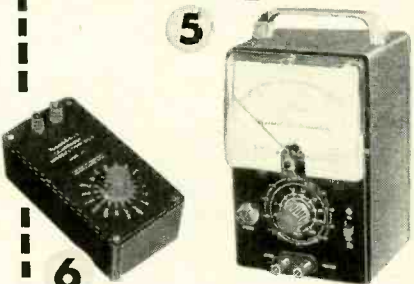

6

5

5 Heathkit AC VACUUM TUBE VOLTMETER KIT...

The Heathkit AC VTVM features high impedance, wide frequency range, very high sensitivity, and extremely wide voltage range. Will accurately measure a voltage as small as 1 mv. at high impedance. Excellent for sensitive AC measurements required by laboratories, audio enthusiasts and experimenters. Frequency response is substantially flat from 10 cps to 50 Kc. Ranges are .01, .03, .1, .3, 1, 3, 10, 30, 100, and 300 v. RMS. Total db range -52 to + 52 db. Input impedance 1 megohm at 1 Kc.

MODEL AV-2

\$2950

Shpg. Wt. 5 Lbs.

6 Heathkit CONDENSER SUBSTITUTION BOX KIT...

Very popular companion to Heathkit RS-1. Individual selection of 18 RTMA standard condenser values from .0001 mfd to .22 mfd. Includes 18" flexible leads with alligator clips.

MODEL CS-1

\$550

Shpg. Wt. 2 Lbs.



BENTON HARBOR 20, MICHIGAN

**HEATH
COMPANY**

A SUBSIDIARY OF DAYSTROM INC.

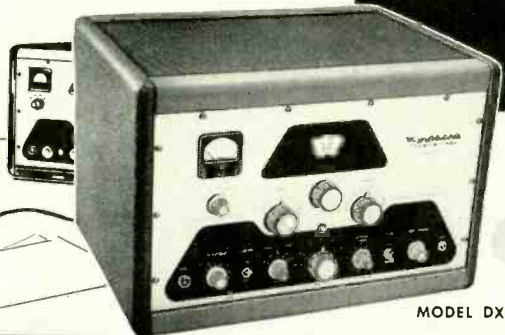

MODEL DX-100

HEATHKIT HAM GEAR

for high quality at moderate cost

DOLLAR VALUE: You get more for your Heathkit dollar because your labor is used to build the kit instead of paying for someone else's. Also, the middleman's margin of profit is eliminated when you deal directly with the manufacturer.



2



3



4

1 Heathkit DX-100 PHONE & CW TRANSMITTER KIT

The reception given this amateur transmitter has been tremendous. Reports from radio amateurs using the DX-100 are enthusiastic in praising its performance and the high quality of the components used in its assembly. Actual "on the air" results reflect the careful design that went into its development.

The DX-100 features a built-in VFO, modulator, and power supplies, and is completely bandswitching for phone or CW operation on 160, 80, 40, 20, 15, 11, and 10 meters. All parts necessary for construction are supplied in the kit, including tubes, cabinet, and detailed step-by-step instructions. Easy to build, and a genuine pleasure to operate.

Employs push-pull 1625's modulating parallel 6146's for RF output in excess of 100 watts on phone and 120 watts on CW. May be excited from the built-in VFO or from crystals (crystals not included with kit). Features five-point TVI suppression: (1) pi network interstage coupling to reduce harmonic transfer to the final stage; (2) pi network output coupling; (3) extensive shielding; (4) all incoming and outgoing circuits filtered; (5) inter-locking cabinet seams to eliminate radiation except through the coaxial output connector. Pi network output coupling will match 50 to 600 ohm non-reactive load. Illuminated VFO dial and meter face. Remote control socket provided.

The chassis is made of extra-strong #16 gauge copper-plated steel. It employs potted transformers, ceramic switch and variable capacitor insulation, solid silver loading switch terminals, and high-grade well-rated components throughout. Features a pre-formed wiring harness, and all coils are pre-wound.

High-gain speech amplifier for dynamic or crystal microphones, and restricted speech range for increased intelligence. Plenty of audio power reserve. Measures 20 7/8" W. x 13 3/4" H. x 16" D. Schematic diagram and complete technical specifications on request.

MODEL DX-100
\$189.50
Shpg. Wt. 120 Lbs.

Shipped Motor Freight Unless Otherwise Specified
\$50.00 Deposit Required on C.O.D. Orders

2 Heathkit VFO KIT

The Model VF-1 covers 160-80-40-20-15-11 and 10 meters with three basic oscillator frequencies. Better than 10-volt average RF output on fundamentals. Features illuminated and pre-calibrated dial scale. Cable and plug provided to fit crystal socket of any modern transmitter.

Enjoy the convenience and flexibility of VFO operation at no more than the price of crystals. May be powered from plug on the Heathkit Model AT-1 transmitter, or supplied with power from most transmitters. Measures: 7" H. x 6 1/2" W. x 7" D.

MODEL VF-1
\$19.50
Shpg. Wt. 7 Lbs.

3 Heathkit CW AMATEUR TRANSMITTER KIT

The Model AT-1 is an ideal novice transmitter, and may be used to excite a higher power rig later on.

This CW transmitter is complete with its own power supply, and covers 80, 40, 20, 15, 11, and 10 meters. Features single-knob bandswitching, and panel meter indicates grid or plate current for the final amplifier. Designed for crystal operation or external VFO. Crystal not included in kit. Incorporates such features as key click filter, line filter, copper-plated chassis, pre-wound coils, 52 ohm coaxial output, and high quality components throughout. Instruction book simplifies assembly. Employs a 6AG7 oscillator, 6L6 final amplifier. Operates up to 35 watts plate power input.

MODEL AT-1
\$29.50
Shpg. Wt. 15 Lbs.

4 Heathkit ... ANTENNA COUPLER KIT

The Model AC-1 will properly match your low power transmitter to an end-fed long wire antenna. Also attenuates signals above 36 Mc, reducing TVI. 52 ohm coax. input-power up to 75 watts-10 through 80 meters-tapped inductor and variable condenser-neon RF indicator-copper plated chassis and high quality components. Ideal for use with Heathkit AT-1 Transmitter.

MODEL AC-1
\$14.50
Shpg. Wt. 4 Lbs.

HEATH COMPANY A Subsidiary of Daystrom, Inc. BENTON HARBOR 20, MICHIGAN

"AMATEUR-ENGINEERED"

Equipment For The Ham

MODERN DESIGN: You can be sure of getting all the latest and most desirable design features when you buy Heathkits. Advanced-design is a minimum standard for new Heathkit models.

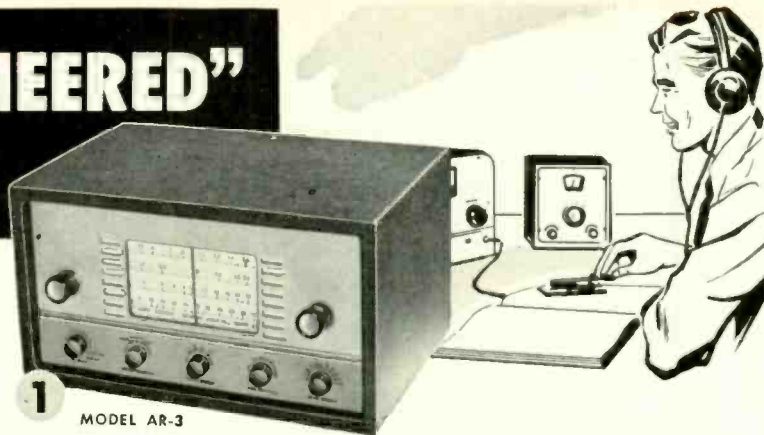

2



3



4



5

1 Heathkit COMMUNICATIONS-TYPE ALL BAND RECEIVER KIT

The new Model AR-3 features improved IF and RF performance, along with better image rejection on all bands. Completely new chassis layout for easier assembly, even for the beginner.

Covers 550 Kc to 30 Mc in four bands. Provides sharp tuning and good sensitivity over the entire range. Features a transformer-type power supply—electrical bandspread—separate RF and AF gain controls—antenna trimmer—noise limiter—AGC—BFO—headphone jacks—5½" PM speaker and illuminated tuning dial.

CABINET: Fabric covered cabinet with aluminum panel as shown. Part No. 91-15, shipping weight 5 lbs. \$4.50.

MODEL AR-3
\$27⁹⁵

Shpg. Wt. 12 Lbs.
(Less Cabinet)

2 Heathkit "Q" MULTIPLIER KIT

Here is the Heathkit Q Multiplier you hams have been asking for. A tremendous help on the phone and CW bands when the QRM is heavy. Provides an effective Q of approximately 4,000 for extremely sharp "peak" or "null." Use it to "peak" the desired signal or to "null" an undesired signal, or heterodyne. Tunes to any signal within the IF band-pass of your receiver. Also provides "broad peak" for conditions where extreme selectivity is not required.

Operates with any receiver having an IF frequency between 450 and 460 Kc. Will not function with AC-DC type receivers. Requires 6.3 volts AC at 300 ma. and 150 to 250 VDC at 2 ma. Derives operating power from your receiver. Uses a 12AX7 tube, and special High-Q shielded coils. Simple to connect with the cable and plugs supplied. Measures only 4-11/16"H.x7¾"W.x4¼"D. A really valuable addition to the receiving equipment in your ham shack.

MODEL QF-1
\$9⁹⁵

Shpg. Wt. 3 Lbs.

3 Heathkit VARIABLE VOLTAGE REGULATED POWER SUPPLY KIT

Provides well filtered DC output, variable from zero to 500 volts at no load and regulated for stability. Will supply up to 10 ma. at 450 VDC, and up to 130 ma. at 200 VDC. Voltage or current monitored on front panel meter. Also provides 6.3 VAC at 4A. for filament. Filament voltage isolated from B+, and both isolated from ground. Invaluable around the ham shack for supplying operating potentials to experimental circuits. Use in all types of research and development laboratories as a temporary power supply, and to determine design requirements for ultimate power supply.

MODEL PS-3
\$35⁵⁰

Shpg. Wt. 17 lbs.

4 Heathkit ANTENNA IMPEDANCE METER KIT

Use in conjunction with a signal source for measuring antenna impedance, line matching, adjustment of beam and mobile antennas, etc. Will double as a phone monitor or relative field strength indicator. 100 µa. meter employed. Covers the range from 0-600 ohms. An instrument of many uses for the amateur.

MODEL AM-1
\$14⁵⁰

Shpg. Wt. 2 lbs.

5 Heathkit GRID DIP METER KIT

This is an extremely valuable tool for accomplishing literally hundreds of jobs on all types of equipment. Covering from 2 Mc to 250 Mc, the GD-1B is compact and can be operated with one hand. Uses a 500 µa. meter for indication, with a sensitivity control and headphone jack. Includes prewound coils and rack. Indispensable instrument for hams, engineers, or servicemen.

MODEL GD-1B
\$19⁵⁰

Shpg. Wt. 4 lbs.

HEATH COMPANY A Subsidiary of Daystrom, Inc. **BENTON HARBOR 20, MICHIGAN**

Heathkits
**PROVIDE THE
 "CONSTRUCTIVE"
 APPROACH TO
 HIGH-FIDELITY**



EASY TO BUILD: *The assembly instructions supplied with Heathkits are so complete and detailed that anyone can assemble the kits without difficulty. Plenty of pictorial diagrams and step-by-step instructions. Information on resistor color codes, soldering, use of tools, etc. Build-it-yourself with confidence!*



1

1 *Heathkit* **ADVANCED-DESIGN
 HIGH FIDELITY AMPLIFIER KIT**

The 25 Watt Model W-5 is one of the most outstanding high fidelity amplifiers available today—at any price. Incorporates the very latest design features to achieve true “presence” for the super-critical listener.

Features a new-design Peerless output transformer, and KT66 output tubes handle power peaks up to 42 watts. The unique “tweeter-saver” suppresses high frequency oscillation. A new type balancing circuit results in closer “dynamic” balance between output tubes. Features improved phase shift characteristics and frequency response, with reduced IM and harmonic distortion. Color styling harmonizes with the Heathkit WA-P2 Preamplifier and the FM-3 Tuner.

Frequency response—within ± 1 db from 5 cps to 160 Kc at 1 watt. Harmonic distortion only 1% at 25 watts, 20-20,000 cps. IM distortion only 1% at 20 watts, using 60 and 3,000 cps. Output impedance 4, 8, or 16 ohms. Hum and noise—99 db below rated output. Uses two 12AU7's, two KT66's and a 5R4GY.

KIT COMBINATIONS:

W-5M Amplifier Kit: Consists of main amplifier and power supply, all on one chassis. Complete with all necessary parts, tubes, and comprehensive manual. Shpg. Wt. 31 lbs. Express only.

\$59⁷⁵

W-5 Combination Amplifier Kit: Consists of W-5M Amplifier Kit listed above *plus* Heathkit Model WA-P2 Preamplifier Kit. Complete with all necessary parts, tubes, and construction manuals. Shpg. Wt. 38 lbs. Express only.

\$79⁵⁰

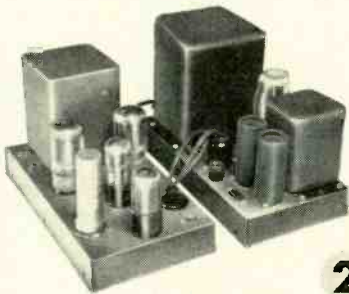

2

2 *Heathkit* **DUAL-CHASSIS WILLIAMSON TYPE
 HIGH FIDELITY AMPLIFIER KIT**

This is a very popular high fidelity amplifier kit that features dual-chassis type construction. The resulting physical dimensions offer an additional margin of flexibility in installation. It features the famous Acrosound TO-300 “ultra-linear” output transformer, and has a frequency response within ± 1 db from 6 cps to 150 Kc at 1 watt. Harmonic distortion only 1% at 21 watts. IM distortion at 20 watts only 1.3% at 60 and 3,000 cps. Rated power output is 20 watts. Output impedance 4, 8, or 16 ohms. Hum and noise—88 db below 20 watts. Uses two 6SN7's, two 5881's, and a 5V4G.

KIT COMBINATIONS:

W-3M: Consists of main amplifier and power supply for separate chassis construction. Includes all tubes and components necessary for assembly. Shpg. Wt. 29 lbs., Express only.

\$49⁷⁵

W-3: Consists of W-3M Kit listed above *plus* Heathkit Model WA-P2 Preamplifier described on opposite page. Shpg. Wt. 37 lbs., Express only.

\$69⁵⁰



3

3 *Heathkit* **SINGLE-CHASSIS WILLIAMSON TYPE
 HIGH FIDELITY AMPLIFIER KIT**

This is the lowest priced Williamson type amplifier ever offered in kit form, and yet it retains all the usual features of the Williamson type circuit. Main amplifier and power supply combined on one chassis, and uses a new-design Chicago output transformer. Frequency response—within ± 1 db from 10 cps to 100 Kc at 1 watt. Harmonic distortion only 1.5% at 20 watts. IM distortion at rated output, 2.7% at 60 and 3,000 cps. Rated power output is 20 watts. Output impedance 4, 8, or 16 ohms. Hum and noise—95 db below 20 watts. Uses two 6SN7's, two 5881's, and one 5V4G.

Instructions are so complete that the kit may be assembled successfully even by a beginner in electronics.

KIT COMBINATIONS:

W-4AM: Consists of main amplifier and power supply for single chassis construction. Includes all tubes and components necessary for assembly. Shpg. Wt. 28 lbs. Express only.

\$39⁷⁵

W-4A: Consists of W-4AM Kit listed above *plus* Heathkit Model WA-P2 Preamplifier described on opposite page. Shpg. Wt. 35 lbs. Express only.

\$59⁵⁰

**HEATH
 COMPANY**
 A SUBSIDIARY OF DAYSTROM INC.

BENTON HARBOR 20, MICHIGAN

RADIO-ELECTRONICS

ATTRACTIVELY STYLED: Heathkit high fidelity instruments are not only functional, but are most attractive in physical design. Such units as the preamplifier and the W-5 main amplifier are designed for beauty as well as performance. They blend with any room decor and are the kind of instruments you will be proud to own.



enjoy....
**THE VERY BEST
 IN AUDIO WITH
 "BUILD-IT-YOURSELF"
 HEATHKITS**

1 *Heathkit* HIGH FIDELITY
PREAMPLIFIER KIT

This outstanding preamplifier is designed specifically for use with the Heathkit Williamson type amplifiers. It completely fulfills the requirements for remote control, compensation and preamplification, and exceeds even the most rigorous specifications for high fidelity performance.

Features five separate switch-selected input channels (2 low level and 3 high level), each with its own input control. Full record equalization with four-position turnover control and four-position rolloff control.

Output jack for tape recorder — separate bass control with 18 db boost and 12 db cut at 50 cps. — treble control offering 15 db boost and 20 db cut at 15,000 cps — special hum control to insure minimum hum level — and many other desirable features. Overall frequency response (with controls set to "flat" position) is within 1 db from 25 cps to 30,000 cps. Will do justice to the finest available program sources. Beautiful satin-gold finish.

Power requirements from the Heathkit Williamson type high fidelity amplifier — 6.3 VAC at 1 amp., and 300 VDC at 10 Ma. Uses two 12AX7's and one 12AU7.

MODEL WA-P2
\$1975
 Shpg. Wt. 7 Lbs.



1

2 *Heathkit* 20-WATT HIGH FIDELITY
AMPLIFIER KIT

This Heathkit Model offers you the least expensive route to high fidelity performance. Frequency response is ± 1 db from 20-20,000 cps. Features full 20 watt output using push-pull 6L6's, and incorporates separate bass and treble tone controls. Preamplifier and main amplifier are built on the same chassis. Four switch-selected compensated inputs and separate bass and treble tone controls provide all necessary functions at minimum investment. Features miniature tube types for low hum and noise.

Uses 12AX7, two 12AU7's, two 6L6G's and a 5V4G. A most interesting "build-it-yourself" project, and an excellent hi-fi amplifier for home use. Well suited, also, for public address applications because of its high power output and high quality audio reproduction. Another Heathkit "best-buy" for you!

MODEL A-9B
\$3550
 Shpg. Wt. 23 lbs.

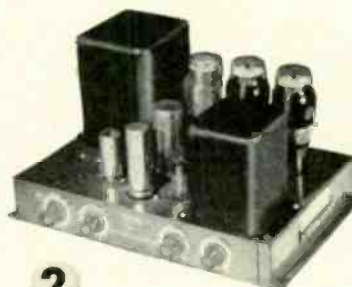

2

3 *Heathkit* 7 - WATT
AMPLIFIER KIT

The redesigned Model A-7D features a new type output transformer for tapped screen operation, and provides improved sensitivity, reduced distortion, and increased power output.

The full 7-watt output of the Model A-7D is more than adequate for normal home installations. Frequency characteristics are $\pm 1\frac{1}{2}$ db from 20 to 20,000 cps. Potted output and power transformers employed. Push-pull output — detailed construction manual — top quality parts — high quality audio without great expense. Output transformer tapped at 4, 8, and 16 ohms. Bass and treble tone controls provided on the front chassis apron.

MODEL A-7D
\$1695
 Shpg. Wt. 10 lbs.

Model A-7E: Provides a preamplifier stage with two switch-selected inputs and RIAA compensation for variable reluctance or low level cartridges. Preamplifier built on same chassis as main amplifier. Model A-7E. Shipping weight 10 lbs. \$18.50.



3

**HEATH
 COMPANY**

A SUBSIDIARY OF DAYSTROM INC.

BENTON HARBOR 20, MICHIGAN

MAY, 1956

Servicing Home Tape Recorders

Part I—Correcting poor frequency response and insufficient erase

By HERMAN BURSTEIN

TAPE recorder troubles may be divided into two kinds: mechanical, involving the transport mechanism; electronic, involving the audio preamplifiers, equalization circuits, bias oscillator and record level indicator. Principally the electronic problems are discussed in this article.

Except for minor repairs and adjustments, such as replacing a belt or aligning a head, it is too often a losing proposition for the service technician to repair an unfamiliar device that has developed serious mechanical difficulty. As with record changers, servicing the transport mechanism is frequently a matter for the factory or specialist, found in large cities, primarily engaged in the repair of phonographs and tape recorders.

Because of the large number of recorders on the market and the great variation in their mechanical design, servicing these units requires a stock of many special parts and extensive know-how. Large volume enables the specialist to meet these requirements. However, with minor exceptions, the electronic portion of tape recorders can be serviced with standard components—tubes, resistors, capacitors—that the service technician normally has on hand.

Familiarity with the principles of

tape recording should enable the technician already adept at radio, TV and high-fidelity troubleshooting to cope with electronic troubles in tape recorders. These may be classed as: poor frequency response, insufficient erase, weak or no sound, distortion, hum and noise.

This article is concerned with restoring tape-recorder performance to original quality rather than with improving upon the manufacturer's product. However, for some problems, such as hum and noise, there are measures which can be tried to improve on original performance—if the customer desires and at reasonable cost.

Frequency response

The setup in Fig. 1 can be used to check frequency response. Note that response is measured at the output of

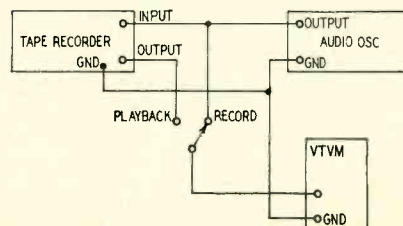

Fig. 1—Checking frequency response.

the playback preamplifier, that is, before the power amplifier and speaker which are built into many home tape recorders. Response should be measured before the tone control, if any. If the tone control is used to obtain flat response, it may also be desirable to check response for extreme and mid-settings of the control.

Make a tape with an audio generator supplying various frequencies at a constant voltage, say 1 volt, into the recorder, and measure the recorder's output during playback. Through a switch, the same vtvm can be used to measure input and output voltages. Record at a level substantially (about 20 db) below maximum permissible recording level as shown by the recorder's level indicator—neon lamp, electron-eye tube or VU meter. Otherwise a false indication of poor high-frequency response may be obtained.

For a quick check at the commonly used 7.5-ips speed, frequencies of 50, 100, 200, 500, 1,000, 2,000, 4,000, 6,000, 8,000, 10,000, 12,000 and 15,000 cycles should be sufficient to obtain a curve. On a three-head machine where immediate playback is available, the playback output may be measured while a given frequency is recorded. For machines using a single record-playback head, all the desired frequencies must first be recorded and then played back into the vtvm. To recognize frequencies during playback, they may be monitored on an oscilloscope. Or, use brief increases in signal level during recording to mark off several guidepost frequencies, say 500, 1,000 and 10,000 cycles.

In home type recorders, ± 3 -db response over the range claimed for the particular recorder may be considered acceptable. The response of professional and semiprofessional machines should be ± 2 db or less over the stated range. Be on the lookout for peaks in excess of 3 db which sometimes appear in the range of 3–8 kc as the result of equalization circuits designed to maintain response out to 10 kc and beyond. Such peaks, though as low as 3 db, are evident to the ear as treble coloration.

Should frequency response at the output of the playback preamplifier be within specifications, then the cause of poor response lies in later stages. It may be in the power amplifier or speaker contained in the tape recorder or possibly in a tone control circuit following the playback preamplifier.

A frequency response test of stages following the playback preamplifier may be run by feeding audio frequencies to the first of these stages and measuring output at the speaker voice coil with a sensitive vtvm or oscilloscope. However, if the internal tone control, amplifier and speaker perform normally and the customer is feeding the tape recorder into a separate amplifier and speaker system, apparently his sound system is at fault and he should be advised to check it by a radio tuner or phonograph.

AUDIO—HIGH FIDELITY

If the tape recorder proper (before the internal power amplifier and speaker) has poor low-frequency response, the fault is apt to be in a defective capacitor or resistor. The capacitor may be one used in the bass-boost circuit or it may be a coupling or screen bypass unit. Most commonly, all or most of the bass boost is provided in the playback circuit. However, in some home tape recorders an equal amount is provided in the record and playback circuits, as these recorders generally use the same preamplifier for record and playback. A typical playback bass-boost circuit, which operates on the principle of shunting high frequencies to ground, is shown in Fig. 2. If capacitor C1 is open,

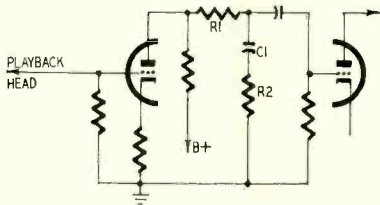

Fig. 2—Playback bass-boost circuit.

shorted or substantially lower than design value, low-frequency response suffers. Similarly, an increase in the value of R1 can adversely affect the bass end. A feedback type of R-C bass-boost circuit is shown in Fig. 3.

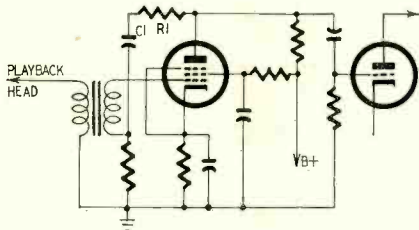

Fig. 3—Feedback bass-boost circuit.

If high-frequency response is poor, look into the following for the source of trouble:

1. **Dirt on heads.** As the distance between the head and tape, measured in 1/1,000's of an inch, is increased, response drops. The higher the frequency, the greater the drop. The minute separation caused by tape oxide deposited on the heads due to friction can greatly attenuate high-frequency response. Cleaning the head with alcohol, using a Q-Tip, is sometimes all that is necessary to end the customer's complaint. Do not use carbon tetrachloride, it is poisonous and may act as a solvent for the head material.

2. **Defective high-frequency equalization.** All or most of the treble boost is usually provided in the record preamplifier. A variety of circuits is used, most of them relying upon R-C networks although the use of inductors is not uncommon. Fig. 4 shows two typical treble-boost circuits, one employing an inductor. As in the case of bass boost, a defective resistor or capacitor can be responsible for incorrect high-frequency response.

3. **Improper azimuth alignment.** This

fault is most prominent in a machine with separate heads for record and playback. It is vital that the orientation of the record-head gap with respect to the tape be exactly the same as that of the playback-head gap. Each gap should be perpendicular to the direction of tape travel. Although all frequencies are attenuated by improper azimuth alignment, the effect increases as frequency goes up. In a machine which uses the same head for record and playback, azimuth misalignment in record is compensated by the same error in playback. However high-frequency response results when playing back tapes made on other machines, for example prerecorded tapes.

Test tapes are available which permit rapid azimuth alignment. First the playback head is aligned to produce maximum output of the high-frequency alignment signal on the tape. No further steps are necessary for a machine using a single record-playback head. If a recorder uses separate heads, the record head is then aligned so that in recording the same high-frequency signal the output obtained from the aligned playback head is maximum.

4. **Worn heads.** High-frequency response depends upon the gap width (often called gap length) of the playback head. At 7.5 ips response out to 10 kc or better requires a gap of .0005 inch or less. With use, the head may wear so as to widen the gap, reducing high-frequency response. Because of the microscopically small gap, visual inspection is of no help and another head must be substituted. However, before substituting another head, try recording a tape on the machine in question and playing it back on another machine of the same brand or with similar performance characteristics. (Satisfactory recording can be achieved with a gap considerably greater in length than used for playback.) If high-frequency response is still poor and it cannot be corrected

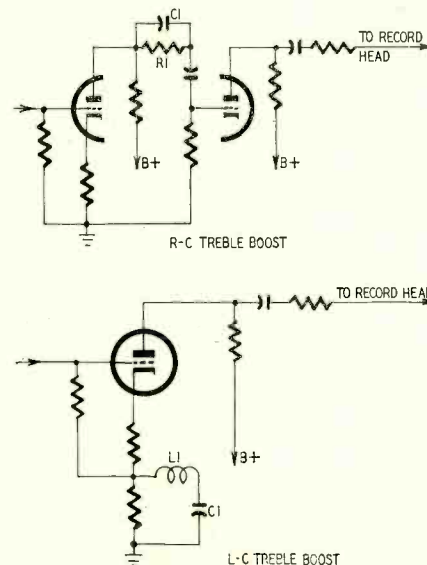

Fig. 4—Typical treble-boost circuits.

by azimuth adjustment of the head on the machine used for playback, then the fault would appear to be in the treble emphasis circuit.

5. **Excess bias current.** A high-frequency bias current between 30 and 150 kc is applied to the record head simultaneously with the audio signal, its principal purpose being to reduce distortion to a satisfactorily low level. Up to a point, the greater the bias current, the less the distortion for a given amount of audio current applied to the tape. Beyond this point, an increase in bias current fails to reduce distortion and may even increase it. Unfortunately, long before bias current fails to lower distortion, it begins to attenuate the signals recorded on the tape. The greater the bias current, the greater the attenuation of high frequencies as compared to low ones. If through failure or change in value of a component the amount of bias applied to the record head increases

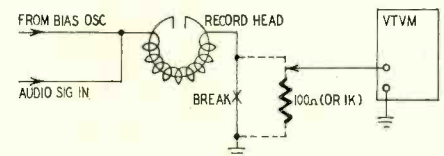

Fig. 5—Measuring the bias current.

substantially over the amount prescribed by the tape-recorder manufacturer, high-frequency response suffers.

It is difficult to state the correct value of bias current since this differs considerably among various machines. Roughly, in home tape recorders, it may range from less than one to several milliamperes. The correct value or means of determining it should be obtained from the manufacturer. Fig. 5 shows how it may be measured. A 100-ohm resistor is inserted between ground and the ground lead of the record head. A vtvm is placed across the resistor and the ac voltage is measured with the machine in record position but with no signal input and the volume control at minimum.

The bias current is calculated by Ohm's law; that is, the measured voltage is divided by 100. If the vtvm does not have sufficient sensitivity, a 1,000-ohm resistor may be used in place of the 100-ohm unit. This results in a higher voltage reading. The impedance of the record head at the bias frequency is usually high enough so that the impedance of the 1,000-ohm resistor is still low enough to have negligible effect upon current through the head.

6. **Slow tape movement.** The customer's complaint may be based on the fact that old recordings or prerecorded tapes sound low-pitched on playback. If the tape transport is running below rated speed, this reduces pitch. A test for speed accuracy can be made by determining the time required for a tape of known length to run out. Or on a machine of known accuracy the service technician can make a tape with signals at stated intervals, such as 1 or 5 minutes, and then use this

these 3 hot dipped galvanized towers are exclusive with

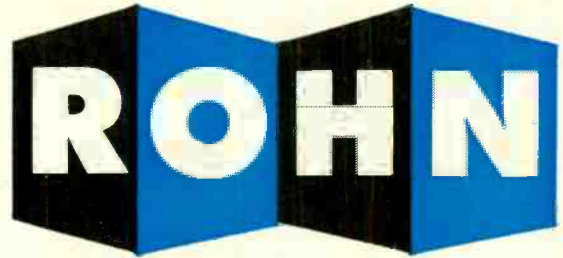

No guying needed to 40—50—or 60 feet! Guyed heights safely up to 200—300 feet!

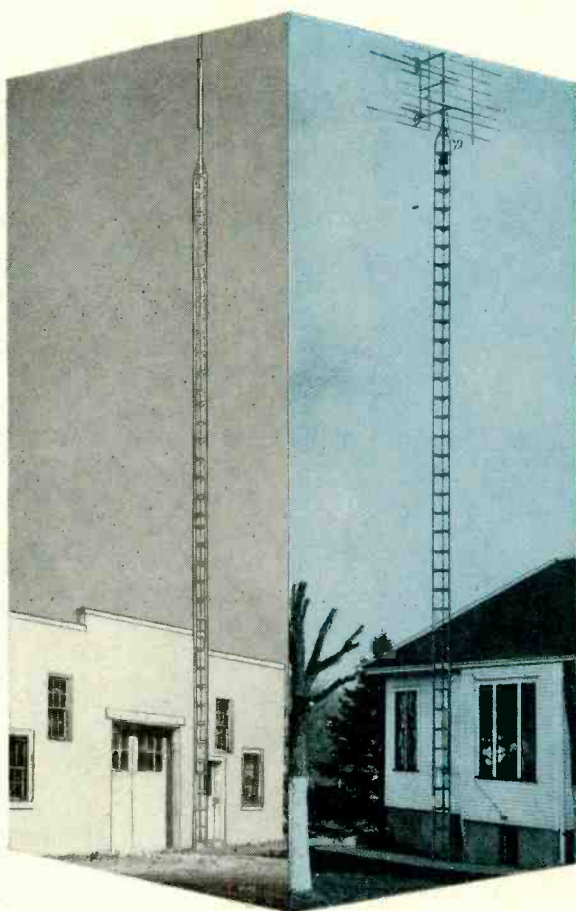

NO. 6 TOWER

Features unexcelled 12½" equilateral "magic triangle" design with electric welding throughout. Self-supporting to 50', the Rohn No. 6 is ideal for home TV installation.

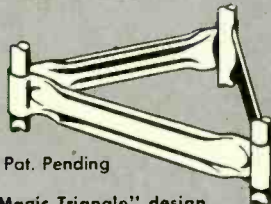

Pat. Pending

"Magic Triangle" design utilizes mass production machines — means sturdier towers, uniformity and lower costs!

"PACKAGED" TOWER

Constructed for ease in shipping and storage. A 48' tower comes in six 8' sections bound together in a single 8' x 20" package! Self-supporting and available in 24' to 64' sizes.

and now, a new and completely hot-dipped galvanized, heavy duty **NO. 40 COMMUNICATIONS TOWER**

For extreme heights and communication purposes of all kinds, the Rohn No. 40 gives you strength and durability on which you can depend. The time tested and proven equilateral triangle design using extra heavy duty tubing and corrugated steel cross-bracing is utilized in this new Rohn Tower. The No. 40 is structurally sound so that you can install it for heights up to 300'; and is preferred for lesser heights when considerably greater strength is required because of excessive wind or antenna loading, etc. Check this tower for your requirements of this type. You'll find it just can't be beat, neither structurally nor price-wise!

Note: For lesser heights, use the Rohn No. 20 or No. 30 Tower ... for experimental operation, use the Rohn "Fold-Over" Tower.

All Rohn Towers are quickly erected- shipped in easy-to-handle sections; and, Rohn-Designed accessories are available with each tower.

Check the complete line of Rohn Towers, including Roof Towers, Masts and Tubing ... plus a full line of tower and TV installation products such as bases, house mounts, brackets, service tables, guy brackets and rings plus dozens of other items.

ROHN Manufacturing Company

116 LIMESTONE, BELLEVUE
PEORIA, ILLINOIS

MAIL THIS COUPON FOR FREE LITERATURE!

Rohn Manufacturing Company
116 Limestone, Bellevue
Peoria, Illinois

Gentlemen: Please rush me complete details on the full line of Rohn Towers and Accessories.

Firm _____

Name _____ Title _____

Address _____

City _____ State _____

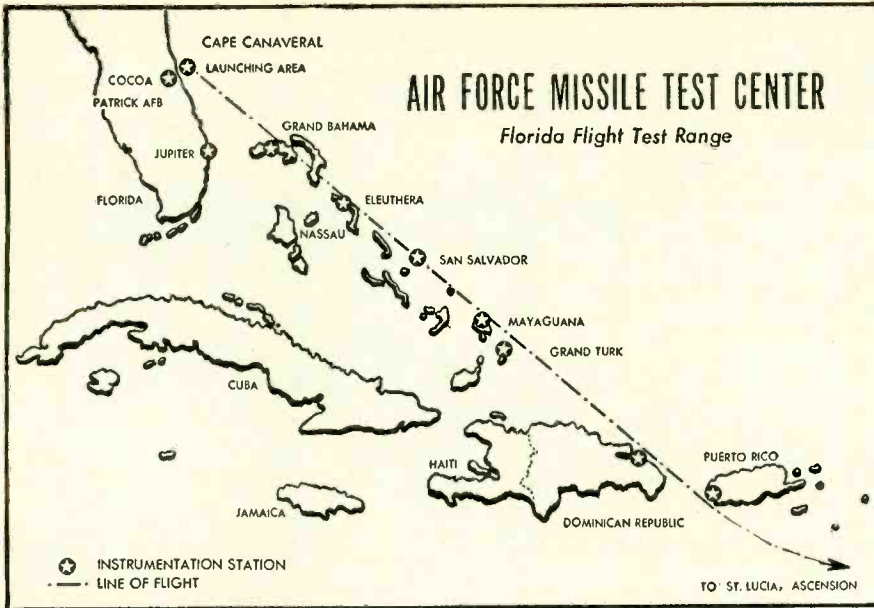

RCA

ANNOUNCES OPPORTUNITIES

In Guided Missile Test Instrumentation For Electronic Technicians

At the following locations

| PATRICK AIR FORCE BASE, FLORIDA | CAPE CANAVERAL | |
|-------------------------------------|----------------|-----------|
| Engineering development technicians | Radar | Timing |
| Radar | Radio | Telephone |
| Communications | Telemetry | Optics |
| Test Equipment | | |

*Enjoy pleasant Florida living and working at these locations.
Liberal company benefits. Relocation assistance.*

INTERESTING DOWN-RANGE ASSIGNMENTS

| | | |
|-------|-----------|-----------|
| Radar | Telemetry | Telephone |
| Radio | Timing | Optics |

These positions are located on the Islands shown on the map above. Salary, 30% incentive, meals and lodging furnished. Return to U.S. every 3 months.



For information and arrangements for personal interview, send complete resume to:

Mr. H. C. Laur
Technical Employment, Dept. N-15E
Missile Test Project
RCA Service Co., Inc.
P.O. Box 1226, Melbourne, Florida



RADIO CORPORATION of AMERICA

AUDIO—HIGH FIDELITY

as a timing tape. Or he can purchase one of the Dubbings test tapes which have 5-minute signals as well as other useful test material—azimuth alignment, frequency response, maximum recording level and signal-to-noise ratio.

7. Pressure-pad misadjustment.

Most home tape recorders use pressure pads for maintaining good contact between the tape and the heads and generally provision is made for adjusting the amount of pressure. Insufficient pressure results in reduced high-frequency response. However, in adjusting the pad, guard against excessive pressure which will increase the deposit of tape oxide on the heads, increase head wear and possibly decrease the tape speed.

Complete failure to erase may be due to the coil in the erase head being open or shorted. With the machine set for record, check the record head for open and short circuits. Erase current is often coupled to the record head through a resistor or capacitor, and a defect or change in value of such a component would affect erase.

Insufficient erase may be caused by a dead or weak oscillator. Erase-head current in different home recorders varies from less than 15 ma to amounts several times as great. The actual current can be found by connecting a vtvm across a 100-ohm resistor inserted between ground and the ground lead of the erase head and then calculating current by Ohm's law. The value so determined should be compared with that specified by the manufacturer. If erase current is more than 20% below the required value, oscillator and coupling components to the erase head should be checked.

Another possible cause of inadequate erase is improper vertical positioning of the gaps of the record and erase heads with respect to each other and to the tape. This may occur in some machines where the mechanical arrangement for attaching the heads to the transport mechanism permits them to be moved slightly up or down. If the erase head gap does not fully cover the path on the tape covered by the record head gap, complete erasure obviously cannot take place. On a two-track machine, which uses slightly less than half the width of the tape for recording each channel, it is important that the gaps be confined to either the lower or upper half of the tape and do not extend across the center of the tape. Otherwise a portion of each track would be reproduced in playback.

The erase heads on home machines often do less than a complete job. On tape reuse, the previous recording is therefore slightly audible during quiet passages. If the owner desires complete erasure, he should purchase a magnetic eraser or one can be economically constructed. (See "Improving Inexpensive Tape Recorders," Part II, RADIO-ELECTRONICS, May, 1955, by the author.)

TO BE CONTINUED

FOR GOLDEN EARS ONLY

The Heathkit AG-9 audio generator;
 Knight SX702 AM-FM-TV
 tuner; Cabinart accessories;
 Ortho-Sonic tone arm

By MONITOR

ONE of the most tedious laboratory and servicing procedures is making a series of frequency runs with an audio generator. Those who have to do this frequently will find the Heathkit AG-9 an extremely clever new instrument.

The innovation is the tuning method. Instead of continuous tuning, the AG-9 uses three switches which provide two significant figures and a multiplier. The combination covers the range from 10 to 100 in units of 1 cycle, from 100 to 1,000 in units of 10, from 1,000 to 10,000 in units of 100 and from 10 to 100 kc in units of 1,000 cycles. Superficially it might seem that this would be more complicated than using a single continuous-tuning dial and a range switch. But when one has become accustomed to it, it is possible to make a run in a fraction of the usual time and with considerably greater accuracy because it takes a fraction of a second to flip a switch but several seconds to readjust a dial accurately to a new frequency. It is possible that there are some applications in which the ability to cover a range continuously and without any skips or steps is desirable. But the steps here are in terms of 1% of the frequency and in audio it is practically impossible to obtain resonant peaks or nulls that sharp.

The usefulness and accuracy of the generator (see diagram) are further improved by the output meter which monitors the output in terms of volts or db. Most service type generators have an amplitude error of 1 or 2 db from one decade to another or from one end to the other of the same decade. One either has to remember the error and correct for it or use an external meter if greater accuracy is necessary. With the AG-9 it is possible to keep the output constant. The overall accuracy over the full range from 10 to 100,000 cycles appears to be well within 1 db, and within the 20–20,000-cycle range it is better than that.

The output is controlled by a combination of a potentiometer and a decading attenuator in eight voltage ranges with

a maximum of 3 millivolts on the lowest range and 10 volts on the highest. The leakage is very small and the minimum voltage on the lowest range is less than 100 μ v. Thus, the generator can be fed into the most sensitive preamplifiers without overloading. On the 3- and 10-volt ranges the source impedance is around 1,000 ohms; the lower ranges can either work into a 600-ohm external load or a 290-ohm internal load is available through a switch.

The AG-9 uses the now well known Bureau of Standards circuit with resonance controlled by a T network in a feedback loop. Critical component tolerances are 1% for resistors and 2% for capacitors. The construction is simple and the adjustment even simpler. Only the meter requires calibration and for normal useage the heater voltage is sufficiently accurate for a standard.

Fig. 1 shows the T network (within the dashed lines) with a set of codes. Actually, capacitors C1 and C2 repre-

sent four pairs that are switched into the circuit by turning the multiplier to its four positions. Resistors R1 and R2 represent 10 sets of resistors that are switched into the circuit.

Knight SX702 AM-FM-TV tuner

The Knight line of high-fidelity equipment has always provided high quality per dollar and the SX702 tuner is an example of more of the same. The usable FM sensitivity is surpassed only by two or three of the highest-priced tuners, but the difference may be entirely academic unless in your location a 3–6-db increase in gain is just what is needed to shove a station over the noise threshold. In my location the sensitivity was adequate to provide acceptable reception of all but the very weakest of the stations regularly receivable with the best receiver tried so far. The biggest difference is that very weak stations (which will not saturate the limiters of any tuner) are

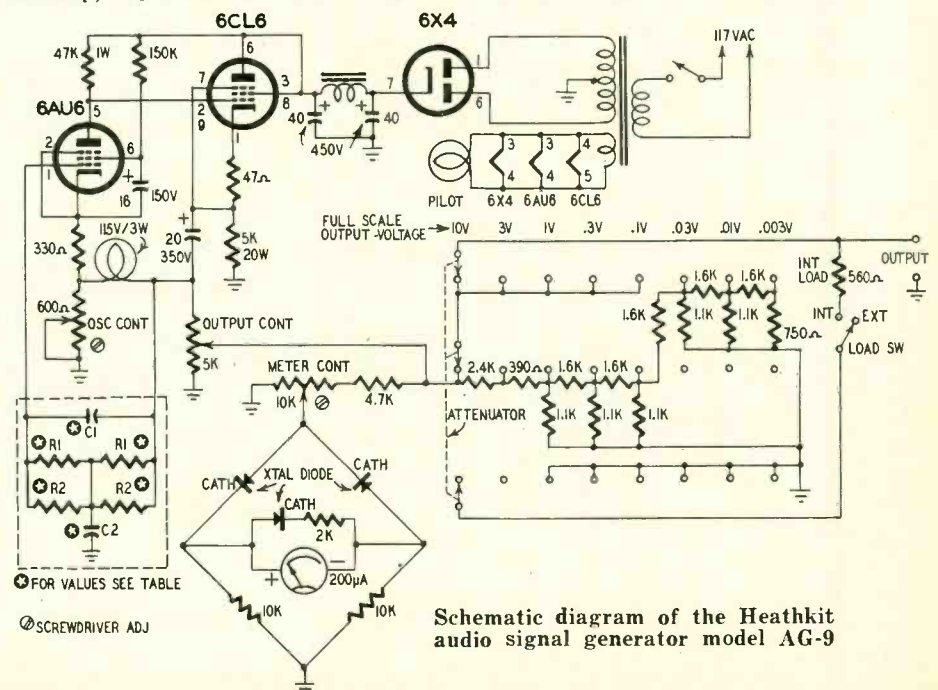

Schematic diagram of the Heathkit audio signal generator model AG-9

THIS professional TRAINING IS THE KIND THAT Really Pays Off!

... and it costs only a fraction of what you might expect to pay!

FIX ANY RADIO OR TV SET EVER MADE...easier...better...faster

Backed by the how-to-do-it methods so clearly explained in this one big 822-page book, you'll be prepared for fast, accurate service on any radio or television receiver ever made.

Radio & Television TROUBLESHOOTING AND REPAIR by Ghirardi & Johnson is far and away the world's most modern, easily understood guide. Step by step, it takes you through each service procedure... from locating troubles with less testing to repairing them promptly by fully-approved professional methods... the kind that enable you to handle tough jobs as slick as you now do the easy ones.

COMPLETE SERVICE TRAINING

For beginners, this giant book is a complete service training course. For experienced servicemen, it is a quick, easy way to "brush up" on specific jobs; to

develop better methods and shortcuts and to find fast answers to tough jobs.

Here are just a few of the subjects covered: Components and Their Troubles; Basic Troubleshooting Methods; "Static" and "Dynamic" Testing; Practical Troubleshooting Tips and Ideas; AC/DC, 3-way Portable and Battery Set Troubleshooting Problems; Servicing Communications Receivers; a Complete Guide to Television Service; AM, FM, and TV Realignment Made Easy; Resistor, Capacitor, Inductor and Transformer Problems; Servicing Tuning, Selector and Switching Mechanisms; Loudspeakers, Servicing Recorders and Record-playing Equipment... and dozens more. 417 illustrations. Read TROUBLESHOOTING AND REPAIR for 10 days AT OUR RISK!

Price only \$6.75 (or see money-saving combination offer.)

LEARN BASIC CIRCUITS FULLY...and watch service "headaches" disappear

It's amazing how much easier and faster you can repair radios, television sets and even industrial electronic equipment when you know all about circuits and what makes each one "tick."

You locate troubles in a jiffy because you know what to look for and where. You make repairs lots faster, better and more profitably!

Actually, there are only a comparatively few BASIC circuits in modern equipment. Radio & Television RECEIVER CIRCUITRY AND OPERATION by Ghirardi and Johnson gives you a complete understanding of these as well as their variations. It teaches you to recognize them... to understand their peculiarities and likely "troublespots"... and shows how to eliminate useless testing and guesswork in making repairs.

LEARN MORE — EARN MORE!

Throughout, this 669-page book with its 417 clear illustrations gives you the kind of above-average professional training that fits you for the better, big pay jobs in either servicing or general electronics. Covers all circuits in modern TV and radio receivers, amplifiers, phono-pickups, record players, etc. Price only \$6.50... or see money-saving offer in coupon. Examine it 10 days at our risk!

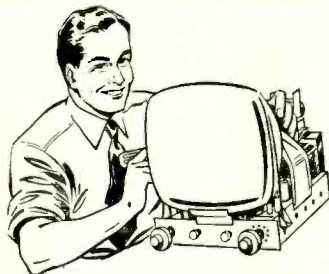

THESE FAMOUS BOOKS REALLY SHOW YOU HOW!

More radio-TV technicians have trained from Ghirardi books than any others of their kind! Almost 1300 pages and over 800 pictures and diagrams in these two new books explain things so clearly it's next to impossible for you to go wrong. Each book is strictly up-to-the-minute... NOT a re-hash of old, out-moded material.

RINEHART BOOKS ARE SOLD BY LEADING BOOK STORES

FREE EXAMINATION...easy terms!

Dept. RE-56, RINEHART & CO., INC.
232 Madison Ave., New York 16, N. Y.

Send books indicated for FREE EXAMINATION. In 10 days, I will either remit price indicated plus postage or return books postpaid and owe you nothing.

Radio & TV TROUBLESHOOTING AND REPAIR (Price \$6.75) Radio & TV CIRCUITRY AND OPERATION (Price \$6.50)

COMBINATION OFFER... Both books only \$12.00. (Price separately \$13.25... you save \$1.25)

(Combination offer is payable at rate of \$3 [plus postage] after 10 days if you decide to keep books, and \$3 a month thereafter until \$12 has been paid.)

Name _____
Address _____
City, Zone, State _____

OUTSIDE U.S.A. ... \$7.25 for TROUBLESHOOTING & REPAIR; \$7.00 for CIRCUITRY & OPERATION; \$13.00 for both books; Cash with order, but money refunded if you return books in 10 days.

less readable in the noise. One or two of the new wide-band-detector tuners have lowered distortion but whether this makes a practical difference in overall distortion will depend on how careful the broadcast stations are in holding down their own distortion. There is a choice of tuning with or without afc. A meter and a good dial ratio result in uncritical tuning.

The AM characteristics with the built-in ferro-loopstick antenna are very good and in most locations no additional antenna is needed. The band width appears to be about 10 kc and provides excellent reception with low interference in secondary and fringe areas; for local use the frequency response is narrower than desirable.

The unique feature of the Knight (shared also by the Rauland line) is the availability of a TV-sound tuner which can be plugged in as an accessory. This will provide TV sound almost infinitely superior to that of the best available TV receiver and greatly superior to that possible when the sound output of a TV receiver is fed into a high-fidelity outfit. The fine reception is possible because there is no difficulty with interference from the sync frequencies and the if channel of the Knight tuner provides very wide bandwidth compared with that of a good TV receiver, reducing distortion to about the same degree as the wide-band FM tuners reduce it on the FM band. TV sound is beginning to improve and some of it qualifies for high-fidelity standards; in any case, the improved sound quality greatly improves the illusion of presence and versimilitude.

Moreover, I have found that many TV programs are just as enjoyable with sound alone and this way provide far less distraction for other activities. Finally, those in the extreme TV fringe areas can improve their overall TV reception by using this separate TV sound tuner; the TV receiver can be tuned for peak picture reception and the sound tuner for best sound. The TV tuner consists of a Standard Coil tuner remodeled to provide a 10.7-mc if output.

The audio output of the Knight tuner is very good indeed. Two outputs are provided from a cathode follower for amplifier and tape recorder. An unusual feature of the Knight is that there is no volume control on the panel. The level of the amplifier channel can be set by a potentiometer on the rear of the chassis. The idea is that the volume will be controlled by the control unit.

Phono accessories by Cabinart

It has been well said that some of the best things come in very small packages. A case of hi-fi point is the Levelor kit introduced by Cabinart. Why nobody thought of putting something like this out before I do not know. Certainly Cabinart deserves a medal for making it available. The Levelor is simplicity itself. It contains a bubble

in perfect mesh
with **your** business

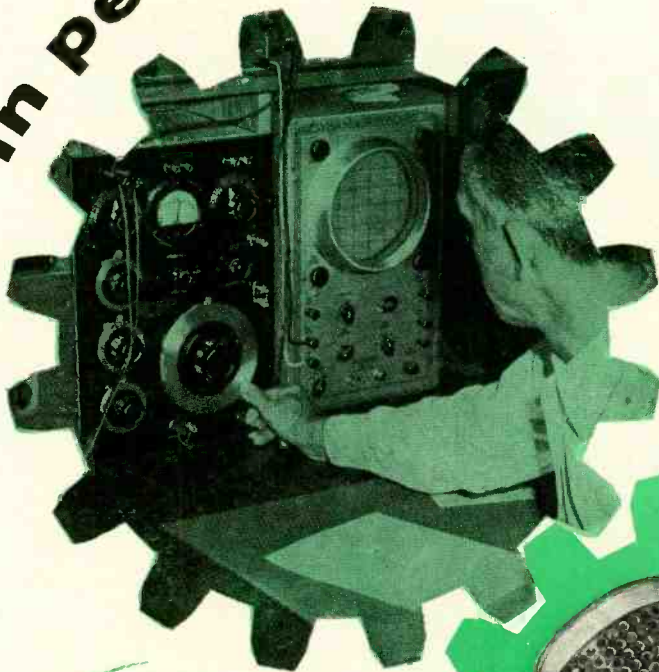

**BALLAST RESISTORS
FUSE-TYPE RESISTORS
LINE-VOLTAGE REGULATORS**

CLAROSTAT resistance devices are designed to meet your needs in radio and television servicing. Voltage regulators serve as safeguards against line-voltage surges, and are popular, essential accessories.

Ballast tubes serve as fuses in many television receivers and are expendable, easy-to-replace components.

Fuse-type resistors are being used by television receiver manufacturers and should be on every serviceman's parts list.

Get the complete story on these CLAROSTAT products designed to fill your needs, from your distributor.

CLAROSTAT MFG. CO., INC., DOVER, NEW HAMPSHIRE
In Canada: Canadian Marconi Co., Ltd., Toronto, Ont.

AUDIO—HIGH FIDELITY

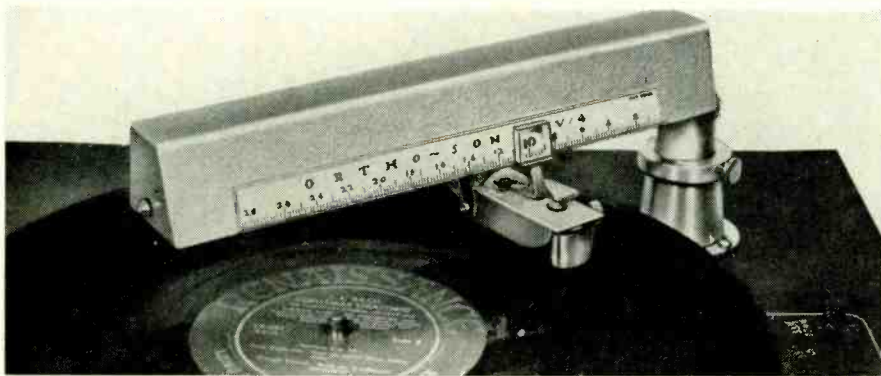

The Bard Ortho-Sonic pickup arm.

level which can be mounted on top of a changer or turntable base and which indicates precise leveling in both dimensions at a glance. Having determined, as you are certain to, that the base is out of level and the pickup arm compliance is being fouled up by gravity, the next problem is to correct matters. Therefore, the kit contains four rubber feet to fasten to the bottom of the turntable or changer base. But these are not ordinary feet—each has a screw which permits an adjustment in length (and therefore in height of base) of a little over $\frac{1}{4}$ inch. With one on each corner of the base, it should be possible to make a turntable level even aboard a yacht. In the average installation you'll recapture the \$2 cost of the kit in a mere week, in the form of less damage to your prized records through groove jumping, skipping and skating, as well as in more satisfactory sound.

To make putting a hi-fi together easier, Cabinart also has several other items. The ACC-1 record changer or turntable base is a tray made of birch plywood with a top precut for any of the popular changers or turntables; the whole is mounted on excellent quality ball-bearing slides. The slides can be mounted on a shelf or in a cabinet in a jiffy and you have a professional slide-out changer for a minimum of labor and a cash outlay of just \$10.

The ACC-2 is a handsome base (without slides) for professional type turntables. It is made of heavy plywood with genuine mahogany, walnut, korina or ebony black lacquer finish. The top is available either precut for any of the standard turntables or in one solid piece for cutting by the customer. An interesting and very helpful design feature is that the top floats on a sponge-rubber gasket to minimize the bad effects of vibration and shock. The base is large enough for any turntable I know of including the D & R and still leaves plenty of room for a transcription type arm.

In addition Cabinart has a series of partitioned lightweight record storage units ranging from 1 to 3 feet long and in price from \$9 to \$25, and a series of wrought iron bases for each.

Ortho-Sonic tone arm

Ever since the cylinder record was abandoned in favor of the disc, play-

back has suffered from the tracking error which results because the cutting stylus moves in a straight line across the radius of a disc, whereas a playback needle—on its arm pivoted outside the diameter of the disc—moves in an arc. So the playback needle can reproduce the exact movement of the cutting needle at only one point (at best) and at all others departs from the ideal alignment by up to 25°. For years engineers have been trying to produce a playback mechanism which would reproduce accurately the movement of the recording equipment.

The Ortho-Sonic V/4 has some minor faults but does solve the essential problem of eliminating tracking error. Since the needle now follows the same straight line path as the cutting needle there is no tracking error at all. The benefit from this should be lower distortion, and my measurements—though not of laboratory conclusiveness—indicate that the benefit is achieved. With ordinary arms there is some variation in IM distortion as the arm moves from outside to inside of the record; in the Ortho-Sonic the variation is considerably less. (Unfortunately, variations in distortion from outer to inner diameter can be due to other causes, even in the recording process, and it is not possible completely to isolate the portion due to tracking error only. But so far as I can determine the aberrations due to tracking error are at least greatly minimized and possibly eliminated.)

Granting this, the real test comes in that other type of tracking—the ability to follow high-amplitude modulation of the groove without skipping, jumping, groove locking or loading the needle. To distinguish it from tracking error I will refer to it as arm compliance for in essence it represents the ability of an arm to permit the needle to comply with the motion imparted to it by the grooves without loading that motion with its own friction or mass. The trouble with past attempts at solving the tracking-error problem has been that the suspension has had so much friction that the loading of the needle produced effects far worse than the tracking error did. In this respect the Ortho-Sonic seems to be superior to most conventional arms. It will pass the McProud test which consists of placing a big-hole 45-rpm disc on a

table so that one edge of the hole is against the center pin. This imparts an eccentric motion to the arm with a swing of more than 1 inch. The Ortho-Sonic will track this way without skipping, jumping or locking about as well as any other arm I know of. Since the eccentricity of the McProud test is a gentle one resembling a sine wave, it is not as severe as that produced by extremely sharp high-amplitude transients recorded in a normally revolving groove because the sharp transients "throw" the arm more sharply and impart higher velocity. Many arms which meet the McProud test will nevertheless fail on such recorded transients, as those on Cook's *Earthquake* or Audiophiles *Thunderstorm*. So far as I can determine the Ortho-Sonic is just below the Ferranti, which in this respect is the best of all arms tested. At any rate, in some months of use it has not been guilty of skipping or locking once.

It seems to be at least as free of resonances as conventional arms. This, I guess, is the result of the fact that the cartridge mount is isolated from the large superstructure of the arm through friction-free bearings. It is easy to install and equally easy to adjust for height, needle pressure and parallelism to the disc, and no more sensitive to leveling. It has features conventional cartridges do not possess. There is an indexing scale with a magnifier which enables one to index records and place the needle quite accurately in the desired groove. Cueing is even more accurate. The record can be precued with the needle in the groove and stopped exactly in the desired spot; when the arm is lifted with only reasonable care and then returned to the groove, the exact same spot can be found very accurately. Radio stations should find this a worth-while feature.

There are some disadvantages, the most serious of which could be corrected by refining the design. The cartridge mount is of the slide-in type with a knurled knob to fasten the cartridge in place. Unfortunately, this design will not accept all available cartridges by any means; in fact, the cartridges it will take without providing special mounts constitute a minority of those on the market. It will take the G-E (either turnover or single) Fairchild, the original Pickering and the individual units of the 240 series. But most of the others will require some additional mount which I presume the manufacturer will soon make available. The arm is a little more awkward to use initially, but once a habit is formed, this disadvantage disappears. I have not tried all possible mounting positions but I judge that for accuracy in letting down the needle and using the indexing scale, it will have to be put somewhere on the right of the turntable, whereas conventional arms permit a greater choice of position. But, assuming you can mount your favorite cartridge in the Ortho-Sonic, the minor faults are petty in relation to the virtues. END

New Records Review is on page 102.

RADIO-FREQUENCY LAMP

By S. C. PEEK*

THE high-frequency oscillator shown on the cover is designed to power the brightest incandescent lamp ever sold commercially. The light source is a solid disc of tantalum carbide heated inductively by the output from the 3.5-mc oscillator.

Early incandescent lamps had carbon filaments, but these lamps could be run at relatively low brightness only, because of the rapid rate of carbon evaporation. Tungsten provided a means of obtaining much greater brightness and has been used ever since. The past 50 years have seen no radical change in incandescent filament structure but recent developments, in color TV, wide-screen movies and fast-thinking computers have emphasized the need for an even brighter incandescent lamp. These applications also demand more uniformity in the light source than can be obtained from a coiled filament. Radio-frequency heating of a tantalum carbide disc provided the answer. The oscillator and lamp were developed by Sylvania Electric Products Inc.

The light source is a 5/16-inch-diameter disc of tantalum carbide surrounded by a silver-plated copper cylinder which concentrates the magnetic field right at the disc. The oscillator tank coil is placed around the lamp, closely coupled to the copper cylinder (Fig. 1). Therefore, in effect, the tantalum carbide disc becomes the final sink for most of the radio-frequency power generated by the oscillator. Since the eddy currents developed by the alternating magnetic field pro-

*Sylvania Electric Products Inc., Salem, Mass.

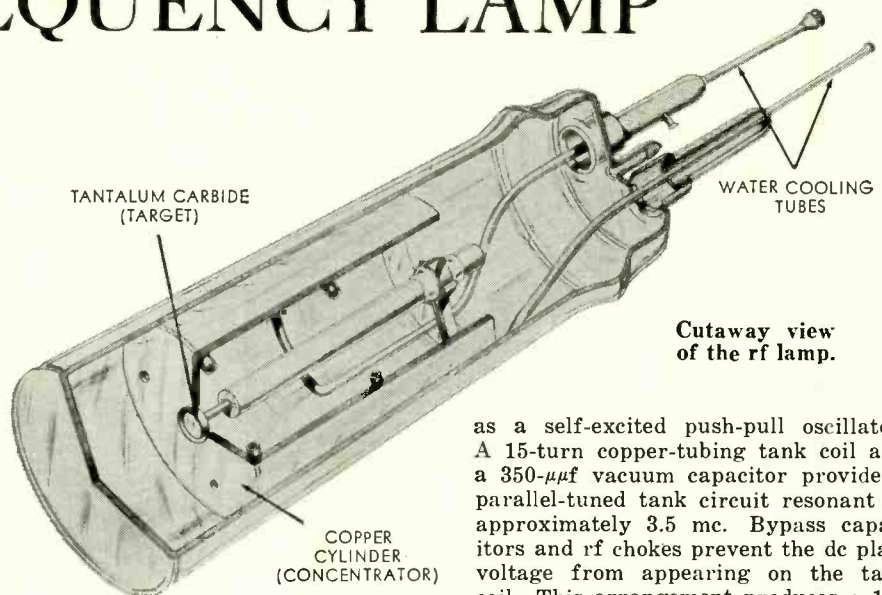

Cutaway view of the rf lamp.

duce circular currents in the disc, heating is uniform and symmetrical. Therefore, the light produced by the incandescence of the disc is uniform across its entire surface. Furthermore, tantalum carbide has such a high melting point and its rate of evaporation is so low that it can be heated to a very high temperature (3,400°C). This produces twice the light per square millimeter of surface area than in any known incandescent lamp and lasts five times longer as well. Water-cooling tubes are inserted through glass-to-metal seals in the base of the lamp. The tubes are attached to the copper cylinder and keep it cool. Were it not for water cooling, the tremendous currents would melt the copper.

The radio-frequency source consists of two 833-A triodes (Fig. 2) operated

as a self-excited push-pull oscillator. A 15-turn copper-tubing tank coil and a 350- μf vacuum capacitor provide a parallel-tuned tank circuit resonant at approximately 3.5 mc. Bypass capacitors and rf chokes prevent the dc plate voltage from appearing on the tank coil. This arrangement produces a 1.5-kw output with all components operated well within their ratings.

A separate dc supply powers the oscillator. It operates from a 230-volt 60-cycle 3-phase line and uses six 866-A's in a bridge rectifying circuit. The use of a 3-phase power supply makes filtering unnecessary and provides 4,000 volts at 1 ampere for plate power. Varying the voltage with a variable-voltage transformer provides control of the lamp brightness.

Both power supply and oscillator are completely shielded and rf filters are placed in the power-line connections, keeping the radiation well under 10 microvolts at $\frac{1}{2}$ mile from the installation, to prevent interference with radio or TV reception.

Although the lamp was originally designed for motion-picture printing, it has found its way into some interesting electronic applications—color pic-

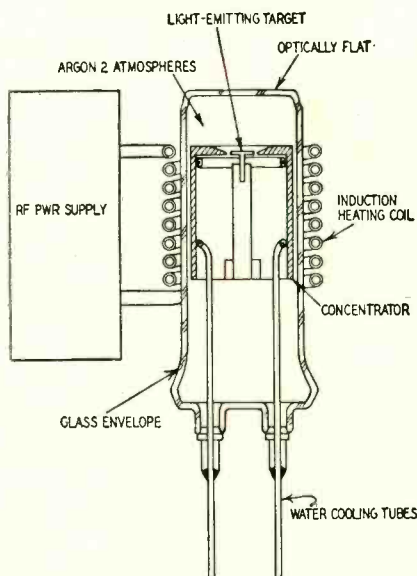

Fig. 1—Diagram of rf lamp system.

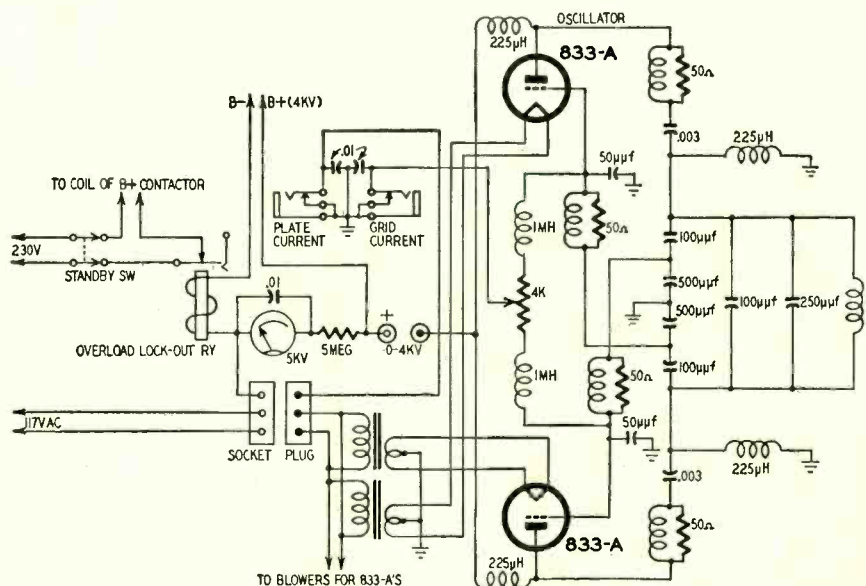

Fig. 2—Schematic diagram of power supply and oscillator for rf lamp.

Only

Natural Gems
qualify for
Fidelitone
diamond phonograph needles

Fidelitone Diamond Phonograph Needles are made from natural gem stones—not splints (cut-offs from larger diamonds). In our own plant, Fidelitone diamond tips are ground and finished to exacting shape specifications—then given a special micropolish.

Because of their precise shape and polish, Fidelitone Diamond Phonograph Needles give maximum performance, yet *prolong* record life (unlike imperfectly finished diamonds).

You can recommend Fidelitone Diamond Needles without reservation. They are *guaranteed*. See your Fidelitone distributor.

*Jewels Courtesy
C. D. Peacock, Jewelers, Chicago*

PERMO, INC. CHICAGO 26, ILLINOIS

26 YEARS OF LEADERSHIP IN SOUND REPRODUCTION

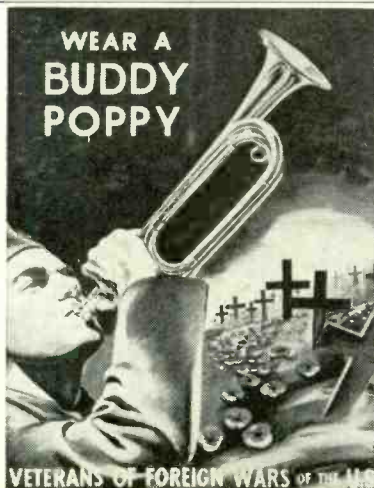

Want to get ahead in

SERVICING?

The Gernsback Technicians' Library can help you.

See Advertisements on pages 141, 145.

Gernsback Library, Inc.

154 West 14 St
New York 11, N.Y.

ELECTRONICS

ture-tube processing, computer read-outs and instrument landing system beam checkers.

Color picture tubes depend upon a photographic process to produce the three-color dot clusters which make up the light-emitting surface. In the finished tube an electron beam will pass through small holes in the aperture mask and excite one of the three colors. It is essential for good color reproduction to have the proper color phosphor dot precisely aligned with respect to the aperture mask holes and the electron gun. The light beam which exposes the photo-resist phosphor and also determines its position must follow the same path as will the electron beam in the finished tube. The light beam must therefore come from a concentrated source approximating the dimensions of the electron beam at its origin. The rf lamp not only provides the necessary concentrated source but also greatly speeds up the process because of its high brightness. Although there are still other costly processes in the manufacture of color tubes, the rf lamp has a good chance of significantly reducing the cost of an important one.

The rapid advances in electronic computers have resulted in a peculiar dilemma. They can think faster than they can talk! Computation and reference to data in their memory is limited only by the speed of an electron in a vacuum tube or the migration of a hole in a transistor, but communication of the results to the outside world has generally depended upon some slower mechanical device. Recent developments in the readout or communicating section have made use of a combination of light beam, electron beam and photographic emulsion. All these phenomena are fast especially if the light beam is bright. The rf lamp looks very promising for this application and speeds of 10,000 digits or letters per second may soon be realized.

Still another use may be connected with electronics in aviation. The high-frequency ILS beam used to guide aircraft in for a landing sometimes drifts from its desired position, a very serious situation. Present methods for checking the position of these beams is time-consuming and costly. A light beam does not stray from the path upon which it is directed and, therefore, might be used as a reference beam which a pilot could use in good weather to check the radio beam. The problem was to get a sufficiently narrow light beam, bright enough for good visual tracking. The rf lamp has characteristics which seem to solve this.

Thus, one more industry—illumination—is being advanced through electronics. Communications and the entertainment fields have blossomed because of electronics. Aviation would be lost without it and now even lighting is feeling the impact of this powerful, ever-expanding conglomeration of tubes, wires, capacitors, coils, transistors and heaven knows what else. END

RADIO-ELECTRONICS

ALLIED knight-kits

**FINEST ELECTRONIC EQUIPMENT
IN LOWEST-COST KIT FORM**

- ★ Latest Advanced Design ★ Quality Components
★ Easiest to Assemble ★ Save Up To 50%

BUY DIRECT...YOU SAVE MORE

free 1956 CATALOG

Send for it! Describes the famous KNIGHT-KITS in detail—shows you how you can easily assemble your own instruments and get performance and appearance equal to equipment selling for several times the KNIGHT-KIT price. The 324-page ALLIED Catalog is the leading buying guide to *everything* in Electronics—write for your copy.

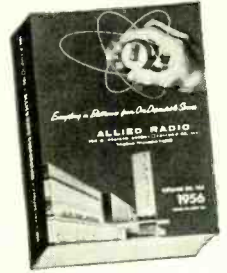



SAVE ON THESE QUALITY knight-kit TEST INSTRUMENTS

| | | | | | |
|---|--|---|---|--|--|
|  5" Wide-Band Oscilloscope Kit F-144 69.00 |  Printed Circuit VTVM Kit F-125 24.95 |  Tube Tester Kit F-143 counter type 29.75 F-142 portable type 34.75 |  VOM Kit 1000 Ohms/Volt F-128 15.95 |  VOM Kit 20,000 Ohms/Volt F-140 28.50 |  In-Circuit Capacitor Checker Kit F-119 11.65 |
|  Audio Generator Kit F-137 31.50 |  Resistor-Capacitor Checker Kit F-124 18.75 |  High-Gain Signal Tracer Kit F-135 23.75 |  RF Signal Generator Kit F-145 19.75 |  Resistance Substitution Box Kit F-139 5.95 |  Capacitance Substitution Box Kit F-138 5.50 |

FAMOUS knight-kits FOR THE HOBBYIST

| | | |
|--|---|--|
|  "Space Spanner" 2-Band Receiver Kit S-243 13.95 S-247 cabinet, 2.85 |  "10-in-1" Lab Kit S-265 12.45 |  "Ranger" Superhet Receiver Kit S-735 14.85 |
|  "Ocean Hopper" Receiver Kit S-740 10.75 |  Transistor Radio Kit S-765 3.95 |  Geiger Counter Kit S-242 15.95 |
|  3-Way Portable Radio Kit S-730 19.95 |  Photoflash Kit S-244 28.50 S-246 AC supply, 3.40 |  Wireless Broadcaster Kit S-705 8.75 |

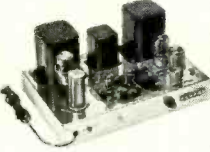
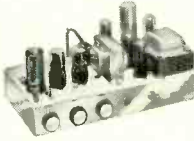
TOP QUALITY HIGH FIDELITY knight-kits

| | | |
|---|---|---|
|  Basic 25-Watt Deluxe Amplifier Kit S-755 41.50 |  10-Watt Hi-Fi Amplifier Kit S-234 22.95 |  20-Watt Hi-Fi Amplifier Kit S-750 35.75 |
|---|---|---|

LOW-COST knight-kits FOR THE AMATEUR

| | | |
|--|--|---|
|  50-Watt CW Transmitter Kit S-255 42.50 |  Self-Powered VFO Kit S-725 27.50 |  Code Practice Oscillator Kit S-239 3.95 |
|--|--|---|

All Prices Net F.O.B. Chicago
ORDER FROM

ALLIED RADIO

100 N. Western Ave., Chicago 80, Ill.

FREE

Send for the 324-page ALLIED Catalog describing all KNIGHT-KITS—and your buying guide to everything in Electronics.

ALLIED RADIO CORP., Dept. 2-E-6
100 N. Western Ave., Chicago 80, Ill.

Send FREE 1956 ALLIED Catalog.

Ship the following KNIGHT-KITS: _____

Name _____

Address _____

City _____ Zone _____ State _____



CONTROL UNIT FOR VENTILATING FANS

By ELLIOTT A. McCREADY



Panel view of the control unit.

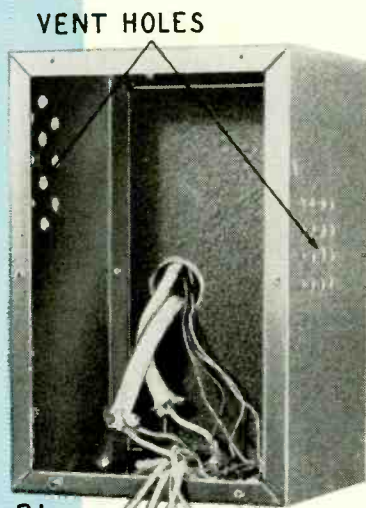

Right — Internal view shows layout of parts.

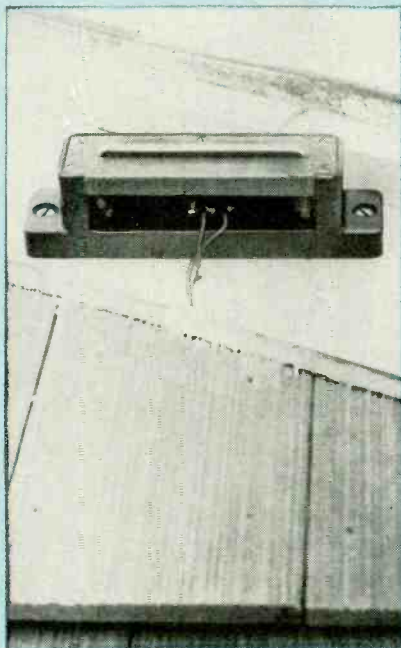

Above — The outside temperature-sensing element is in ventilated, weatherproof case.

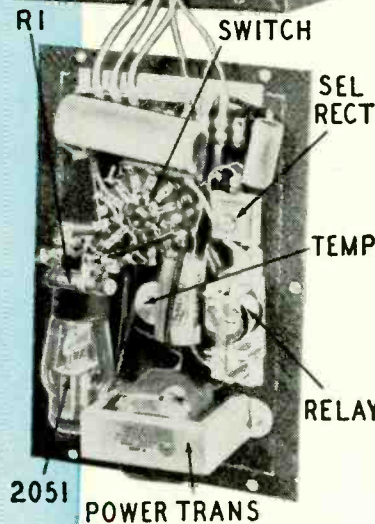

THE attic ventilating fan is becoming almost standard equipment in many new (and older) homes. On warm summer evenings it approaches air conditioning by exhausting the hot air from the house and replacing it with much cooler outside air—a process which might take all night without such a fan, depending on the amount of breeze.

The ventilating fan has one major disadvantage: it must be switched off in the morning as the sun rises. Failure to do so will defeat the purpose of the fan by filling the house with warm air. This disadvantage can be overcome by any of several methods. You can set the alarm clock and risk a fractured toe stumbling out to switch the fan off or you can buy an electric timer to do the job for you. The alarm-clock method is obviously a pain in the neck. The timer isn't too good either because it must be properly set each night and a sudden rise in outside temperature will raise the temperature of an already cool house.

The ideal method of controlling the ventilating fan would be by temperature differential—as long as the inside temperature is the same as, or a preset amount above, the outside temperature, the fan should be off. When either the inside temperature rises or the outside temperature falls, the fan should switch on. If the outside temperature should start to rise, the fan should remain off. This type of control sounds like a pretty large order but it's really simple and relatively inexpensive to build.

Two temperature-sensitive elements THERM1 and 2 form the heart of the control unit. These are two Carboloy type R111 thermistors with a resistance of about 100,000 ohms at room temperature and a very large negative temperature coefficient. These thermistors are available and information regarding prices may be obtained by writing Carboloy Dept., General Electric Co., Detroit 32, Mich.

The thermistors act as a voltage divider across a variable dc supply. The grid of the 2051 thyratron is connected to the midpoint of this voltage divider and any change in temperature at either the inside or outside sensing element will raise or lower the bias on the tube, opening or closing the

TENNA

THE WORLD'S FINEST AND MOST COMPLETE LINE OF DUAL ANTENNA SETS

MATCHES THE STREAMLINED BEAUTY OF MODERN CARS

EASILY, QUICKLY INSTALLED. ALL OUTSIDE MOUNTING

HANDSOMELY CHROME PLATED FROM BASE TO TIP



TENNA

DUAL ANTENNA SET

Aero FIREBALL

Sweeps back at 50° angle to match speed lines of modern cars

Model
FBD-35A

List
\$12.50

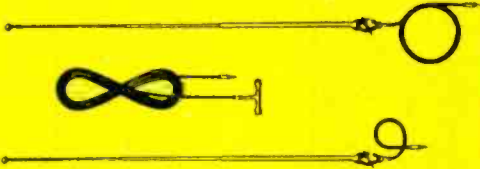

TENNA

DUAL ANTENNA SET

"NAUTILUS"

Tear Drop Mounting Base with 25° Sweep Back Antennas.

Model
NTD-14

List
\$14.95

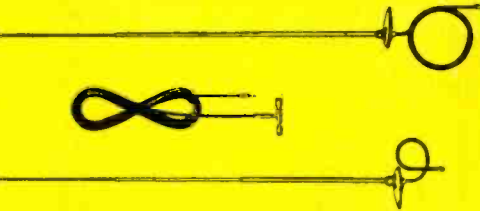

TENNA

DUAL ANTENNA SET

"MONARCH"

Disappears into Seamless Shield Tube. Adjustable flat to 30°. Collapses to 3".

Model
RD-35

List
\$13.50

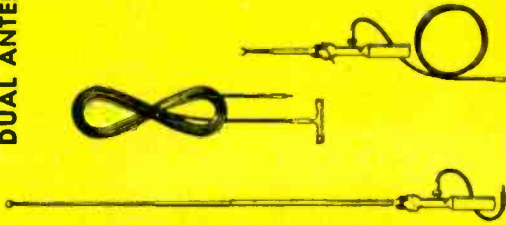

IMPORTANT: TENNA "DUAL" Antenna Sets are handsomely chrome plated from base to tip. Each set has 2 antennas, one with 1' cable and other with 6' cable, plus 15' cable with built-in 75MMF condenser. T-Connector and cable clips also furnished. Each set is individually boxed and packed 10 boxes to a master carton.

TENNA Manufacturing Co.
CLEVELAND 25, OHIO

ELECTRONICS

selector switch to AUTO and set R3 for minimum bias for the 2051. After the unit warms up, the fan will switch on. Let the fan run for a couple of hours until the temperature in the vicinity of the inside sensing element stabilizes. Then *slowly* back off R3 until the fan switches off. The unit is now set. Slight additional adjustments may be necessary but once the unit is set it is very stable. Future use of the unit requires about a half-hour for the circuit to stabilize, but no adjustment of the temperature control is necessary.

If the relay tends to stutter slightly before making, increase the value of R1 slightly. If the unit seems insensitive to temperature variations, decrease R1. When the unit is properly adjusted, room temperature should be constant within 1 or 2 degrees (decreasing as the outside temperature decreases).

An advantage in using this control unit that may not be immediately obvious is the fact that the fan doesn't run continuously. The saving in electricity and wear and tear on the fan motor should help pay for the unit.

After reading this far, a few questions may have come to mind: For instance, what happens if the control unit switches the fan on when all the windows and doors are closed or a sudden shower at night lowers the outside air temperature and switches the fan on, sucking in all kinds of water?

Parts for control unit

1—100,000 ohms, 1—4.7 megohms, 1/2-watt resistors; 1—50-ohm wirewound potentiometer; 1—2,000-ohm 10-watt adjustable resistor; 1—0.25 µf (200 volts), 1—0.5 µf (600 volts), 8 µf (450 volts), capacitors; 1—power transformer, secondary 117 volts at 50 ma, 6.3 volts at 2 amps (Merit P-3045 or equivalent); 1—power relay, 115-volt coil, spdt (Potter & Brumfield MR5A, 115 volts, or equivalent); 1—2051 thyatron and socket; 1—65-ma selenium rectifier; 1—4-pole 3-position rotary switch; 2—thermistors, Carboloy type R111 or equivalent; 1—9 x 6 x 5-inch utility cabinet; 2—Cinch-Jones type 6-140 barrier strips; 2—containers for thermistors (see text); 1—knob.

Obviously, even with the control unit added, the ventilating fan is not an air conditioner and its use is confined to those evenings when there is insufficient breeze to cool the house or when the breeze is coming from the wrong direction. Most people like to have the windows and doors open on a warm summer day. I switch the control unit off altogether when I get up in the mornings and thus the chance of the unit switching on with the windows and doors closed is remote.

Now for the rain problem. Since most summer showers are accompanied by a westerly breeze, I use east windows as an air inlet. I have found that very little rain is sucked in by the fan if the open window is on the downwind side of the house. Incidentally, I have never yet failed to waken when it started to rain at night—fan operating or not. I think that if one of the open windows is located in the master bedroom, very little trouble should be encountered with showers. A moisture-actuated switch connected to the control unit and located near the window would remove this problem. END

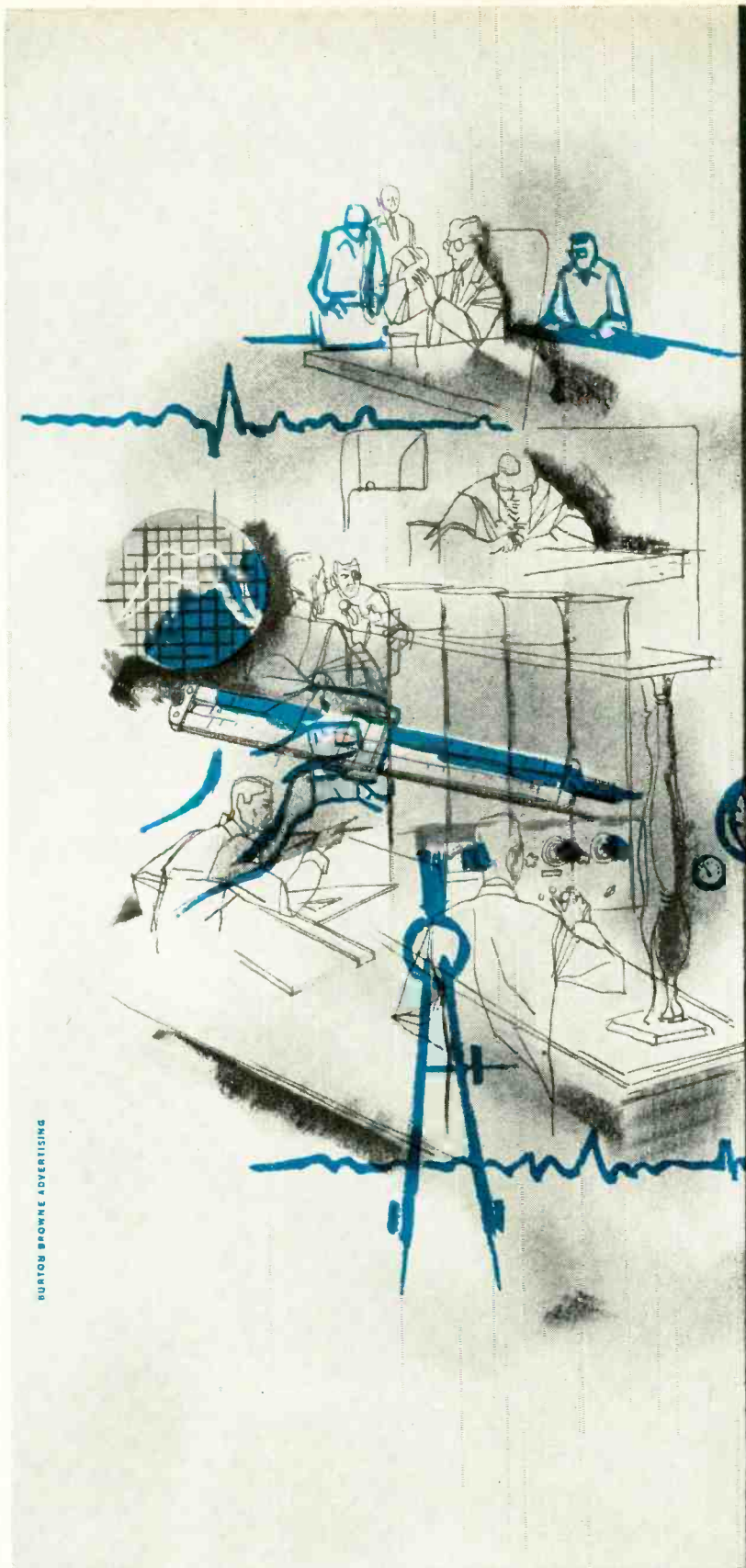

Originators OF THE
TURRET STYLE TUNER

Originators OF THE
STANDARD CASCODE TUNER

Originators OF THE
STANDARD PENTODE TUNER

Originators OF THE
NEW NEUTRODE TUNER

*Master Specialists
in Tuned Circuits*

WORLD'S LARGEST MANUFACTURER
OF ELECTRONIC COMPONENTS

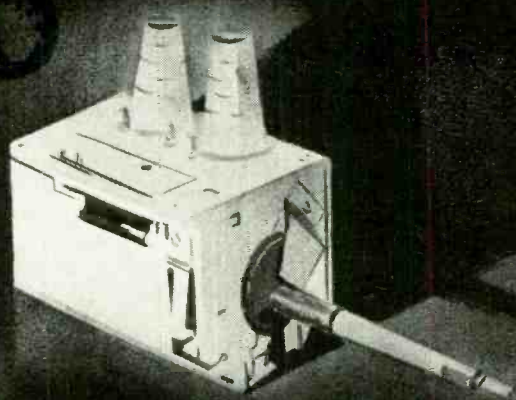

STANDARD TUNERS have been used in more than 19,000,000 TV receivers and designs contributed by STANDARD to the industry have been used for many millions more. STANDARD has not only a tremendous engineering department for production and development but also one of private industry's largest pure research engineering staffs for electronics. Only recently STANDARD at symposiums attended by all major TV manufacturers exposed the results of several intensive years of color TV research—results which will reduce by several years the time required for the development of practical color TV.

Pioneers in Universal Replacement Tuners for TV
Originators of Packaged Tuned Circuits

Standard

Coil Products Co., Inc.

six plants: Chicago • Los Angeles • Bangor, Mich.
North Dighton, Mass.
Kollsman Instrument Co. wholly owned subsidiary

STANDARD PRODUCTS ARE WIDELY VARIED

for the full story write or phone: C. A. Swanson, General Sales Manager
Standard Coil Products Co., Inc., Melrose Park, Illinois

SERVICING THE WATCHMASTER

By JACK DARR

FOR the benefit of those service technicians who have never run into one, the Watchmaster is an electronic device used for accurately testing and adjusting watches. It enables a watch repairman to listen to amplified sounds of a watch movement and make a permanent record (Fig. 1) of the actual gain or loss of time. With this machine, variations as little as 1 second per day can be detected. The line of dots traveling straight across the paper indicate a watch that is keeping perfect time; the upward-sloping line a watch that gained; the downward-sloping line a watch that lost. Each fine line indicates 1 second, each heavy one 5 seconds.

Driving power for the motor is supplied by a 240-cycle tuning-fork oscillator, a 4-to-1 frequency divider and a power amplifier. (See Fig. 2.) V1 is the amplifier-oscillator. The fork vibrates and induces a voltage in the output coil. This voltage is amplified by V1-a and V1-b. A part of the output of V1-b is fed back to the driving coil of the fork to sustain its vibrations. The output of the amplifier circuit is held constant by the Varistor in the negative feedback loop. The resistance of the Varistor varies inversely as the voltage applied to it. Thus, when the fork's output is low, the feedback voltage reaching V1-a's cathode is low and the stage gain is high. As the fork's vibrations increase in amplitude, the input and output of V1 tends to rise accordingly. However, the Varistor acts as a variable resistor in the feedback

path to keep the output of V1 and the fork constant.

The output of V1-b is also fed to V2, a multivibrator that divides by 4 to reduce the signal frequency to 60 cycles. The 60-cycle signal is amplified by V3 and applied to the motor through an output transformer. Motor voltage is around 110 but can drop to 100 without serious loss of speed.

The resistors marked with asterisks are especially selected values that determine the amount of feedback and the multivibrator's frequency. These values vary between individual units.

Beneath the recording drum is an electrically driven stylus coupled to a half-nut drive. This moves the stylus along the drum, taking 30 seconds for the full length. A snap-action switch disconnects the motor at the end of travel. The sound of the watch-ticks is picked up by a small crystal microphone (Fig. 3) mounted in the watch-holder on the right side of the machine (see photo). The output of this pickup

is fed to a two-stage amplifier using 6SJ7's. Amplifier gain is controlled by a 50,000-ohm potentiometer connected across the pickup.

The amplifier feeds a 2050 thyratron which drives the coil of the recording stylus. Each impulse causes the stylus to snap upward, making a dot on the chart, through a tape similar to a typewriter ribbon although wider. In the grid circuit of the 2050, a dpdt RECORD-LISTEN switch connects the output of the amplifier either to the grid of the thyratron and the recorder or to a single earphone.

Servicing these machines should not be difficult for any radioman. All tubes used are standard receiving types with the exception of the 2050 and VR150, and these are readily obtainable. Most of the troubles found will be in weak or dead tubes.

The ac type power supply uses a 5U4-G with a simple choke-input pi filter. The first capacitor, an 8- μ f, 600-volt unit, is visible immediately behind

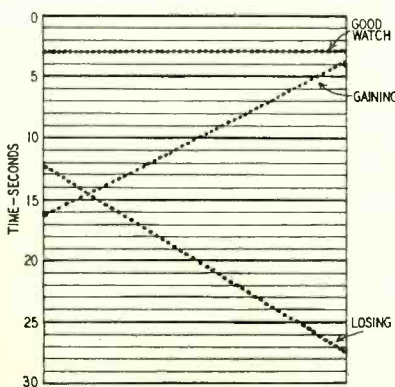

Fig. 1—Diagram shows typical chart made on rotating drum of Watchmaster.

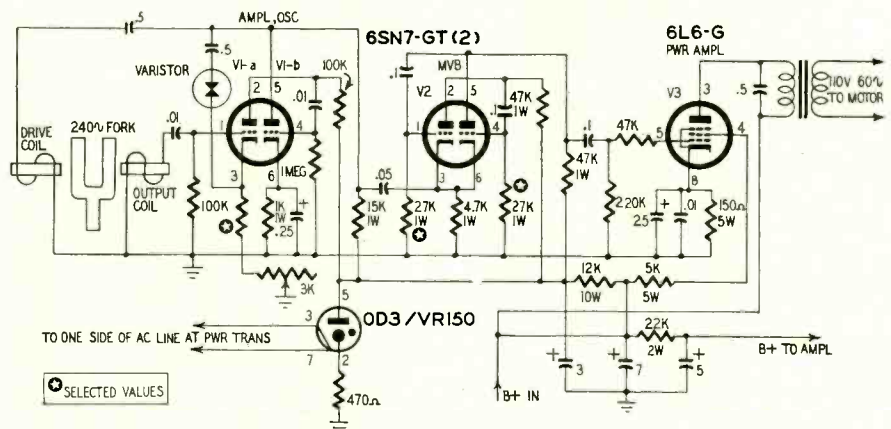

Fig. 2—Schematic shows circuitry of fork, frequency divider and amplifier.

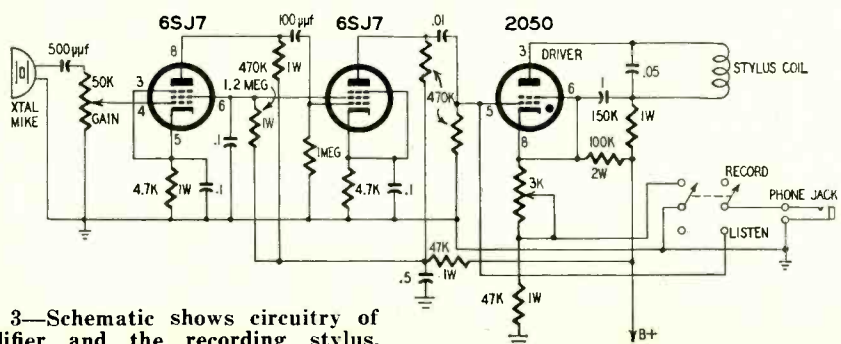
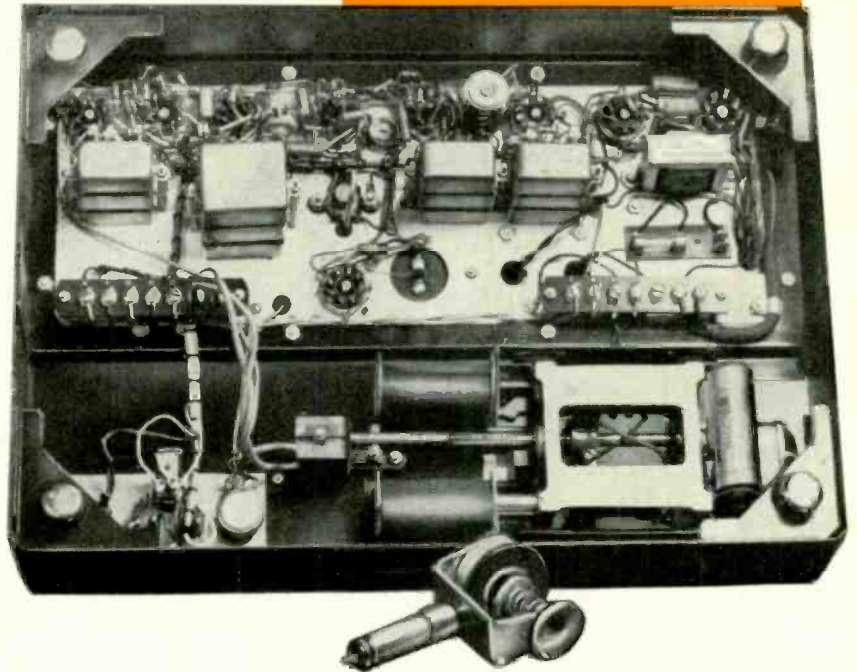

Fig. 3—Schematic shows circuitry of amplifier and the recording stylus.

Underchassis view
of the Watchmaster.



the recording drum. The other filters are plug-in types.

If the motor will not run, check the fuse, rectifier, voltages, the two 6SN7's and the 6L6. If the tuning fork is running, the vibration may be felt on the housing. If it is not running, check the leads at the bottom of the case for breakage. The case is shock-mounted and movement sometimes breaks these wires. The snap-action switch actuating lever sometimes becomes damaged, as does the switch itself.

If the unit runs but does not record, turn the switch to LISTEN and check the amplifier. If the sound is coming through the amplifier, check the stylus coil for continuity. This unit has two long and very flexible leads to enable the stylus to travel; these have been found open.

The RECORD-LISTEN switch is a toggle type and subject to trouble from dirty contacts. It closes the cathode circuit of the 2050 in the record position and may not be making good contact, causing erratic operation of the recorder. It is a good idea to wash this switch with contact cleaner each time the machine is brought in for service.

The gain control is a 50,000-ohm unit and may cause noise or erratic operation if it becomes dirty. Wash with cleaner or replace if too noisy. If this unit opens entirely, it will cause the amplifier to hum and become unstable, making very peculiar recordings. Sometimes the amplifier will sound as if it were motorboating. If bridging filter capacitors does not help, check to see if the driving-current impulses from the fork and oscillator circuits are being picked up by the amplifier. This pickup generally occurs in the first stage and gain-control circuit.

Although all these leads are shielded, check the grounding carefully. Adding an extra ground lug at the gain control usually aids in eliminating this pickup. If some noise remains, try adding an extra 0.1- μ f 600-volt bypass capacitor across the input 6SJ7's screen grid. Check the plug and socket of the crystal pickup; a bad ground here will cause noise pickup and hum. Clean with a service cleaner and a very fine polish; do not use sandpaper or any harsh abrasive. Check the hot wire of this device for contact. It is made

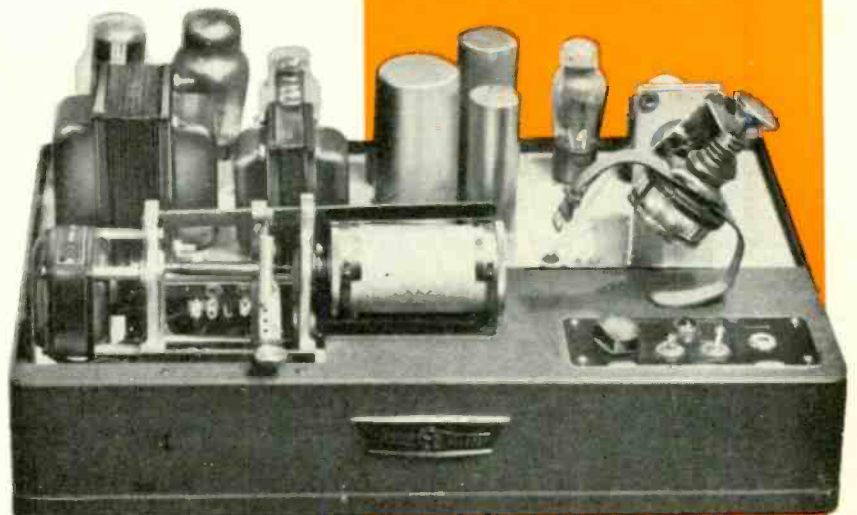

Top view of Watchmaster — watch is in holder, recording drum in the center.

OVER
5,000,000

AMPHENOL TWIN LEAD INSTALLATIONS
have proved what dealers and
installers have always known—
with dependable AMPHENOL
Twin Lead they are assured of:

TOP PERFORMANCE

electrically superior, low loss

EXCELLENT SERVICE

virgin brown polyethylene assures longer-lasting,
trouble-free installations





CUSTOMER SATISFACTION

no call-backs, more referrals

FAIR PROFITS

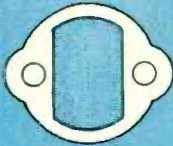
good dealer mark-ups to fair list prices

5 POPULAR AMPHENOL TWIN LEADS

| | | | |
|---|---------------------|---|-----------------------------------|
|  | 14-271 AIRCORE* | 300 ohm—tubular construction contains and protects field of energy—assures lowest loss under wet or dry conditions. Excellent for fringe area installations. A must for UHF and coastal regions. <i>*U.S. Patent 2,543,696</i> | List per 1000 Feet \$57.50 |
|  | 14-056 STANDARD | 300 ohm—60 mil web thickness. Standard of quality in thousands of installations. | \$36.50 |
|  | 14-559 STEELCORE | 300 ohm—72 mil web thickness, 7/28 copperweld conductors. Twice as tough and flexible! | \$38.50 |
|  | 14-100 CENTURY | 300 ohm—100 mil web thickness for applications where a strong line is needed. | \$45.00 |
|  | 14-298 ROTATOR | Four conductor rotator cable with heavily ribbed virgin brown polyethylene dielectric. | \$50.50 |

SEE YOUR AMPHENOL DISTRIBUTOR
FOR QUANTITY PRICES!

AMERICAN PHENOLIC CORPORATION *chicago 50, illinois*
AMPHENOL CANADA LIMITED *toronto 9, ontario*

ELECTRONICS

through a small spring and can give considerable trouble, if not perfectly clean.

The amplifier is very sensitive and it may be necessary to ground the chassis to prevent pickup of high-level electrical interference. A small line filter may be helpful in eliminating this type of trouble.

The motor and moving parts of this instrument are mounted on rubber to prevent mechanical vibrations from affecting the pickup. If these are defective, extra noises will be fed into the recorder circuit. See that all the mounts are good and the chassis is floating freely.

For a test of machine accuracy it should be possible to use a single earphone and a sensitive shortwave receiver tuned to the loudest WWV frequency. Place the earphone in the pickup and advance the gain until the 1-second ticks are heard. Now make a record and see if the dots are in a straight line. As the drum turns five times per second, they will not be as close as when recording a watch but they will give you an accurate test. (The standard American watch makes 18,000 beats per hour—5 per second. This will produce a dot each drum revolution.)

The Watchmaster can be serviced with ease by any radio or TV shop, using nothing but everyday tools and equipment. There is good money in this work and it can be had for the asking, as the jeweler usually does not know that you can repair this kind of machinery. Let him know that you can repair his pet instrument just as well as, and much quicker than, it can be done by sending it out of town, and you'll have a friend and customer for life! Keep 'em ticking! **END**

Reference

Henry O. Maxwell, "Modern Watch Rate Recording," RADIO-ELECTRONICS; August, 1953, page 26.

CORRECTION

The cuts for Figs. 2-d and 5-b of the article "Time Constants . . . What they do" on page 37 of the March issue are upside down. This causes the capacitor charging rates to increase rather than decrease with the passing of time.

It was also pointed out that the values of the blocking capacitor and the resistor in series with the battery must be carefully selected. If they are not, this network may differentiate the incoming square wave and ruin the experiment. Too, a discussion of time constants is incomplete without mention of the R-L time constant. This acts exactly like the R-C circuit except that it equals L/R in seconds and it affects the current through the inductor instead of the voltage across the capacitor.

We thank Joseph R. Mensch, of Redwood City, Calif., for these corrections and comments.

RADIO-ELECTRONICS

how long would it take you to solve this service problem?

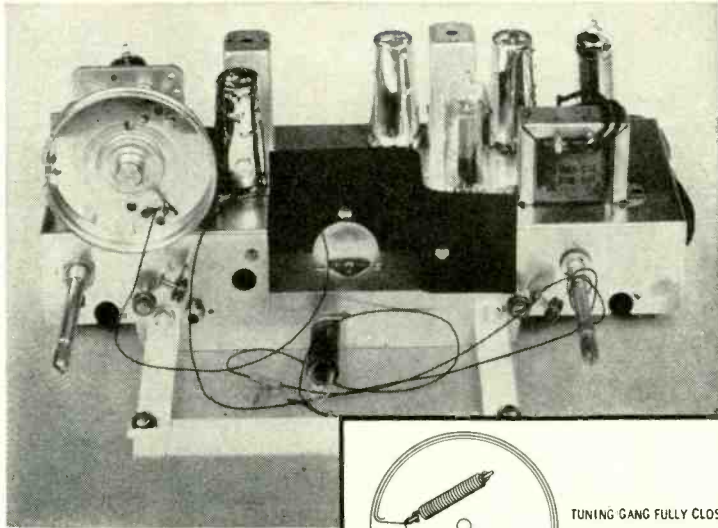

SYMPTOM:

Note the photo: The dial cord obviously needs repairing

It might be possible to replace or re-string the dial cord without a diagram, but why waste valuable time trying to figure out the correct way? With a PHOTOFACT Folder by your side, you save time. Here's why:

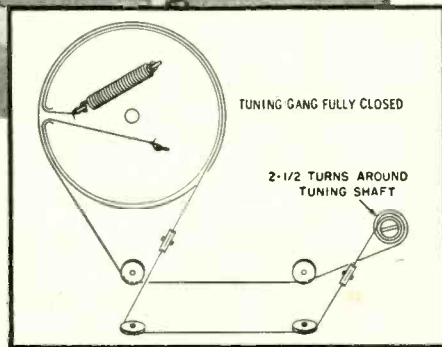

In just seconds, you refer to the Dial Cord Stringing Diagram in your PHOTOFACT Folder. It shows the one right way to restring the cord. You don't waste time puzzling over why the dial pointer moves the wrong way, why the gang doesn't turn, why there's jamming or skipping. You solve this nuisance service problem in a few minutes with PHOTOFACT's help. It's just one of the important time-saving features found in PHOTOFACT—the world's finest service data.

what's your service problem?

THESE EXCLUSIVE PHOTOFACT FEATURES* HELP YOU SOLVE ANY PROBLEM FASTER, EASIER, BETTER—HELP YOU EARN MORE

PHOTOFACT gives you complete coverage on over 20,000 TV, Radio, Amplifier, Tuner and Changer models. And PHOTOFACT is a *current* service—keeps you right up with late model production—brings you these exclusive features:

FULL SCHEMATIC COVERAGE

1. Famous "Standard Notation" uniform symbols are used in every schematic. Diagrams are clear, large, easy to read and handle.
2. Wave forms and voltages are shown right on the schematic for fast analysis.
3. Transformer lead color-coding and winding resistances appear right on the schematic.
4. Schematics are keyed to parts lists and to parts on chassis photos.

FULL PHOTOGRAPHIC COVERAGE

5. Exclusive photo coverage of all chassis views is provided for each model; all parts are numbered and keyed to the schematic and parts lists for quicker parts identification and location.

ALIGNMENT INSTRUCTIONS

6. Complete, detailed alignment data is standard and uniformly presented in all Folders. Alignment frequencies are shown on radio photos adjacent to adjustment number—adjustments are keyed to schematic and photos.

TUBE PLACEMENT CHARTS

7. Top and bottom views are shown. Top view is positioned as seen from back of cabinet. Blank pin or locating key on each tube is shown. Charts include fuse location for quick service reference.

TUBE FAILURE CHECK CHARTS

8. Shows common trouble symptoms and tubes generally responsible for such troubles. Series filament strings are schematically presented for quick reference.

COMPLETE PARTS LISTS

9. Detailed parts list is given for each model. Proper replacement parts are listed (with installation notes where required). All parts are keyed to chassis photos and schematics for quick reference.

FIELD SERVICE NOTES

10. Each Folder includes time-saving tips for servicing in the customer's home. Gives valuable hints for quick access to pertinent adjustments, safety glass removal, special advice covering the specific chassis, etc.

With PHOTOFACT by your side, you solve your service problems in just minutes... you service more sets and earn more daily



MONEY BACK GUARANTEE!

Got a tough repair? Try this—at Howard W. Sams' own risk: see your Parts Distributor and buy the proper PHOTOFACT Folder Set covering the receiver. Then use it on the actual repair. If PHOTOFACT doesn't save you time, doesn't make the job easier and more profitable for you, Howard W. Sams wants you to return the complete Folder Set direct to him and he'll refund your purchase price promptly. **GET THE PROOF FOR YOURSELF—TRY PHOTOFACT NOW!**

free



Send for Sams' INDEX TO PHOTOFACT FOLDERS—your guide to virtually any receiver model ever to come into your shop; helps you locate the proper PHOTOFACT Folder you need to solve any service problem on any model. You'll want this valuable reference guide. Send coupon now.

*These are only a few of the 32 features found exclusively in PHOTOFACT—the world's finest service data

HOWARD W. SAMs & CO., INC.

Howard W. Sams & Co., Inc.
2205 E. 46th St., Indianapolis 5, Ind.

- Send FREE Index to PHOTOFACT Folders
 I am a Service Technician

Name _____
Address _____
City _____ Zone _____ State _____

SERVICE THE SCHOOLS

Expanding audio-visual programs offer opportunities to the electronic technician

By YVON O. JOHNSON*



Author makes backstage check of Stromberg-Carlson public address system.

HOW would you like to find customers more interested in quality work than cheap prices and not likely to try to escape paying their bills? Certainly you would!

I am one of those customers. We are located in every part of this country. Some of my fellow customers are having just as much trouble finding a competent repair service as you are having in finding the perfect customer.

These prospects are the schools, colleges and universities in your area. If you were to visit me in my school, you would be pleased at the quantity of electronic equipment in use; most of it in our audio-visual program. At James Lick Junior High School, San Francisco, Calif., we use the following electronic items for approximately 1,000 pupils:

- 3 16-mm sound motion picture projectors
- 3 record players with amplifiers
- 1 public address system
- 3 radio receivers
- 1 tape recorder

I've listed only equipment using electronic tubes and have not included purely optical items. This equipment that I look after and send out for repairs has about 75 tubes—plus microphones, connectors, cables and plugs. Our school is not heavy with electronic equipment either. Some schools and colleges have TV sets, elaborate paging and intercom systems, disc recorders, multiple earphone systems for use with disc or tape players, and sound-filmstrip projectors.

Let's see what advantages there are to you, the technician, in addition to just "more business." This type of business is equally good for you whether you have a large or small shop; shop size is important only to the extent that you can handle the work within a reasonable time limit. I want my school's equipment serviced as soon as possible, but I hope I'm not as demanding as the customer who fears missing his favorite comedian.

School systems and colleges are usually good pay. You may have to wait a little while for your payment while the paperwork goes through channels, but you don't have the problem of the customer moving away. And you'll find that I and other audio-visual men will not be looking as much for bargains as

*Audio-visual building coordinator, James Lick Junior High School, San Francisco, Calif.

Tape recorders are becoming increasingly popular in education. Pentron CT-1 right is typical of units in use.

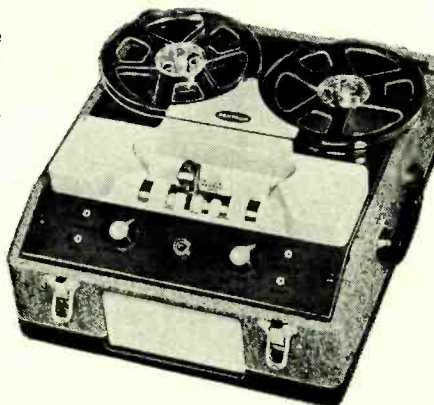

Record players used in schools must be rugged. Usually, the top of case becomes detachable speaker which can be located for better coverage than built-in unit.



The QUALITY! BEAUTY! PRECISION!
 ... of a FINE WATCH

*the world's most beautiful,
 most advanced antenna rotator*



Thompson Products

**Automatic
 ELECTRONIC**

Superotor.

For accuracy, dependability, and ease of control, the new Electronic Automatic Superotor is years ahead of any other antenna rotator on the market. Electronic VP* Tuning, completely silent operation, and smooth, even rotation combine to bring you instantly, automatically, the finest TV picture you've ever enjoyed.

* Vernier Precision



INTERCHANGEABLE ROTATORS

Famous Superotor models "100" and "500" have both been designed for automatic operation.

**OTHER THOMPSON PRODUCTS
 ELECTRONIC AFFILIATES**

- Bell Sound Systems • Dage Television • Ramo-Wooldridge Corp.
- Pacific Semi-Conductors, Inc.

ELECTRONICS DIVISION

Thompson Products, Inc.



2196 CLARKWOOD ROAD • CLEVELAND 3, OHIO
 Available in Canada thru Atlas Radio Corp., Ltd., 50 Wingold Ave., Toronto

ELECTRICAL
ENGINEERS
or
PHYSICS
GRADUATES

with experience in

RADAR

or

ELECTRONICS

or those desiring to enter
these areas...

*The time was never
more opportune than
now for becoming
associated with the field
of advanced electronics.
Because of military
emphasis this is the most
rapidly growing and
promising sphere
of endeavor for the
young electrical
engineer or physicist.*

Since 1948 Hughes Research and Development Laboratories have been engaged in an expanding program for design, development and manufacture of highly complex radar fire control systems for fighter and interceptor aircraft. This requires Hughes technical advisors in the field to serve companies and military agencies employing the equipment.

As one of these field engineers you will become familiar with the entire systems involved, including the most advanced electronic computers. With this advantage you will be ideally situated to broaden your experience and learning more quickly for future application to advanced electronics activity.

Positions are available in the continental United States for married and single men under 35 years of age. Overseas assignments are open to single men only.

Scientific and Engineering Staff

HUGHES

RESEARCH AND
DEVELOPMENT
LABORATORIES

Culver City,
Los Angeles County,
California

Assurance is required that
relocation of the applicant
will not cause disruption of
an urgent military project.

RADIO

do so many home service customers. An advantage to you in the long run is the indirect advertising you receive when servicing schools. School personnel cannot help noticing and remembering that you are maintaining the school's equipment. They may then think of you when their own and friends' radio and TV sets need repairs.

Don't overlook the prestige value you receive. Should a new customer come into your shop to inquire if you know how to service tape recorders, think of the effect of your being able to mention casually, "Oh, yes. We take care of all tape recorders belonging to the school district."

How this business differs

From my professional experience I can give you some pointers about the differences in this type of work as compared to TV servicing in the home.

Be thorough. You have probably found that most TV servicing customers are willing to have just the tube that is causing the immediate trouble replaced if additional repairs for less bothersome faults will cost them more money. They rightly feel that they can call you back whenever the trouble becomes worse or when they can afford the extra service work.

Not so with audio-visual equipment! Inspect it to locate other defects than the main trouble and, if necessary, obtain authorization to repair all the defects. Preventive maintenance is the thought to keep in mind; you will certainly please the school if you do. Put yourself in my place in the following cases to see which one would leave you more favorably disposed to the service shop.

Case A: I had sent in a 16-mm sound motion picture projector to have a belt replaced. Not listed for repair, but just as obvious as "no picture" in a TV set, was a broken clamp on the cable running from the photoelectric cell to the audio amplifier. The belt was replaced but the cable clamp wasn't. A few days later, the same projector had to be sent back for repair of broken connections at the end of that cable. That time, the clamp was replaced.

Sure, I had forgotten to list the broken clamp the first time, but don't you agree that the service shop should have replaced it (and charged for it) rather than take the chance that resulted in customer displeasure?

Case B: I had sent in another 16-mm sound projector for belt replacement. It came back with the belt replaced and with missing rubber feet on the case put back on. Minor? Yes, but wouldn't it show you, as an audio-visual coordinator, that the service technician had you in mind?

Your thoroughness is extremely important to the school because each repair job means that the school will be losing the use of that equipment for several days while the equipment is being transported to the audio-visual



Priced to Sell!



At
All
Distributors

manufactured by
Perma-Power COMPANY
4727 N. Damen Ave., Chicago 25, ILL.
manufacturers of electronic equipment since 1928
Export: SCHEEL INT., Chicago

CRYSTAL CONTROLLED
CONVERTERS

50-30 MC POLICE BAND

Frequency to your
exact specification. **\$29⁹⁵** net

Write for Free Catalog

Kuhn ELECTRONIC PRODUCTS
20 Glenwood Pl. • Cincinnati 17, O.

**Grips
the screw!**
Drives it too!

Quick-Wedge
**SCREW-HOLDING
SCREWDRIVER**



2" to 14" blades, 4 bit sizes
Unconditionally Guaranteed

ASK FOR IT AT YOUR DEALER
Kedman Co., 233 So. 5th W., Salt Lake City



RADIO-ELECTRONICS

RADIO

center, to the service shop, repaired, back to the center and finally to the school.

Also, as an audio-visual building coordinator, I have to produce results in the form of equipment ready for use, not excuses that the equipment has been sent back to the service shop again!

Learn the paperwork. You will probably find it necessary to have written requisitions authorizing the repair work; oral requests to have work performed are usually backed up by a confirming requisition. You may have to submit several copies of your bill to the school system or college. Once you find out how to do these things, you should not have any particular problem if you observe the rules faithfully. In dealing with any large organization — business, governmental or school — you lose the personal relationship that exists in dealing with an individual. The clerks, accountants and auditors involved in the transaction do not know you. Their only contacts with you are through the many pieces of paper they see. Their concern cannot be with the actual equipment, but only that the paperwork has been done according to their procedures. However, the director of the audio-visual department for the school system will be alert to the quality of your servicing.

Watch for mechanical troubles. In servicing for schools you will find a higher ratio of mechanical to electrical troubles than in home servicing, because the school equipment receives more handling than similar things would in the home. A record player in the average home is moved little and is used by the same few people. In schools, a record player might be moved among several rooms in one day and be used by many people. This transportation exposes the equipment to mechanical damage. If someone doesn't fasten the record player's arm each time it is transported, you will have a service job.

Although I spend a good part of my time training teachers and students, many of them are not as familiar with the equipment as they should be. I have had cones pushed out of speakers, plugs and sockets broken, wires ripped out, arms broken off projectors and other damage inflicted by intellectual, well-intentioned people.

If you mentally picture two elephants trying to pull a microphone connector apart, you'll have a good idea of the handling it will get!

More audio equipment. In general, you'll find relatively more audio than radio equipment in school servicing as compared to home servicing—public address systems, record players, tape recorders and motion picture projectors with optical and magnetic sound.

Most of the troubles in the audio amplifier section of 16-mm motion picture projectors and many obvious mechanical breakdowns can be handled

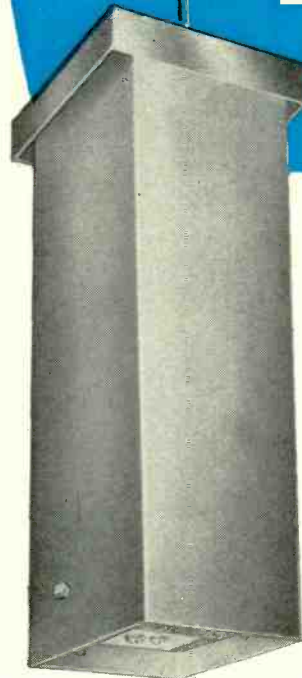
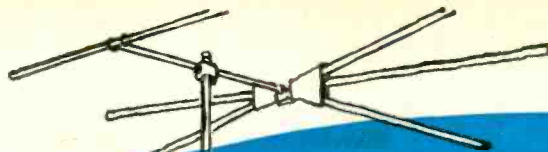

"SOUP-UP" TV RECEPTION with a "DE-SNOWER" pre-amplifier



IN FRINGE AREAS

the Jerrold De-Snower gives beautifully clear TV pictures where conventional boosters fail. Sensitive, noise-free, cascade front end mounts at the antenna . . . amplifies weak signals before line losses set in. Lets you run noise-reducing coax to indoor power supply where it converts back to 300 ohms for receiver.

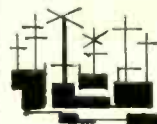

IN METROPOLITAN AREAS

the De-Snower brings in that "extra" channel that was just out of range before. Coax lead-in cuts troublesome noise and interference pick-up on *all* channels.

- Single-channel models for any VHF channel—30 db gain.
- Broadband models for channels 2 thru 6 or 2 thru 13—25 db gain.
- Noise figure approaches theoretical minimum—6 db.
- Flat response for color.

GAIN more satisfied customers and a big new source of income. Send today for full details on the Jerrold De-Snower—the preamp that's used in hundreds of community antenna systems. See your nearest Electronic Parts Distributor, or write directly to Jerrold.

JERROLD

JERROLD ELECTRONICS CORP.
2216 Chestnut Street • Philadelphia 3, Pa.
In Canada: Jerrold Electronics (Canada) Ltd., Toronto 10, Ont.



Superior's New
Model TC-55

FOR TUBE TESTER

The Experimenter or Part-time Serviceman, who has delayed purchasing a higher priced Tube Tester.
The Professional Serviceman, who needs an extra Tube Tester for outside calls.
The busy TV Service Organization, which needs extra Tube Testers for its field men.

Speedy, yet efficient operation is accomplished by:

1. Simplification of all switching and controls.
2. Elimination of old style sockets used for testing obsolete tubes (26, 27, 57, 59, etc.) and providing sockets and circuits for efficiently testing the new Noval and Sub-Minar types.

You can't insert a tube in wrong socket

It is impossible to insert the tube in the wrong socket when using the new Model TC-55. Separate sockets are used, one for each type of tube base. If the tube fits in the socket it can be tested.

"Free-point" element switching system

The Model TC-55 incorporates a newly designed element selector switch system which reduces the possibility of obsolescence to an absolute minimum. Any pin may be used as a filament pin and the voltage applied between that pin and any other pin, or even the "top-cap".

Checks for shorts and leakages between all elements

The Model TC-55 provides a super sensitive method of checking for shorts and leakages up to 5 Megohms between any and all of the terminals. Continuity between various sections is individually indicated. This is important, es-

pecially in the case of an element terminating at more than one pin. In such cases the element or internal connection often completes a circuit.

Elemental switches are numbered in strict accordance with R.M.A. specification.

One of the most important improvements, we believe, is the fact that the 4 position fast-action snap switches are all numbered in exact accordance with the standard R.M.A. numbering system. Thus, if the element terminating in pin No. 7 of a tube is under test, button No. 7 is used for that test.

The Model TC-55 comes complete with operating instructions and charts. Housed in rugged steel cabinet. Use it on the bench—use it for field calls. A streamlined carrying case, included at no extra charge, accommodates the tester and book of instructions.

\$26⁹⁵
NET



Superior's New
Model TV-11

TUBE TESTER

★ Tests all tubes including 4, 5, 6, 7, Octal, Lock-in, Peanut, Bantam, Hearing Aid, Thyatron Miniatures, Sub-miniatures, Novals, Sub-minors, Proximity fuse types, etc.

★ Uses the new self-cleaning Lever Action Switches for individual element testing. Because all elements are numbered according to pin-number in the RMA base numbering system, the user can instantly identify which element is under test. Tubes having tapped filaments and tubes with filaments terminating in more than one pin are truly tested with the Model TV-11 as any of the pins may be placed in the neutral position when necessary.

EXTRA SERVICE—The Model TV-11 may be used as an extremely sensitive Condenser Leakage Checker. A relaxation type oscillator incorporated in this model will detect leakages even when the frequency is one per minute.

★ The Model TV-11 does not use any combination type sockets. Instead individual sockets are used for each type of tube. Thus it is impossible to damage a tube by inserting it in the wrong socket.

★ Free-moving built-in roll chart provides complete data for all tubes.

★ Newly designed Line Voltage Control compensates for variation of any Line Voltage between 105 Volts and 130 Volts.

★ NOISE TEST: Phono-jack on front panel for plugging in either phones or external amplifier will detect microphonic tubes or noise due to faulty elements and loose internal connections.

The model TV-11 operates on 105-130 Volt 60 Cycles A.C. Comes housed in a beautiful hand-rubbed oak cabinet complete with portable cover.

\$47⁵⁰
NET



Superior's
New Model TV-12

TRANS-CONDUCTANCE TUBE TESTER

TESTING TUBES

★ Employs improved TRANS-CONDUCTANCE circuit. An in-phase signal is impressed on the input section of a tube and the resultant plate current change is measured. This provides the most suitable method of simulating the manner in which tubes actually operate in Radio & TV receivers, amplifiers and other circuits. Amplification factor, plate resistance and cathode emission are all correlated in one meter reading.

★ NEW LINE VOLTAGE ADJUSTING SYSTEM. A tapped transformer makes it possible to compensate for line voltage variations to a tolerance of better than 2%.

★ SAFETY BUTTON—protects both the tube under test and the instrument meter against damage due to overload or other form of improper switching.

★ NEWLY DESIGNED FIVE POSITION LEVER SWITCH ASSEMBLY. Permits application of separate voltages as required for both plate and grid of tube under test, resulting in improved Trans-Conductance circuit.

TESTING TRANSISTORS

A transistor can be safely and adequately tested only under dynamic conditions. The Model TV-12 will test all transistors in that approved manner, and quality is read directly on a special "transistor only" meter scale.

The Model TV-12 will accommodate all transistors including NPN's, PNP's, Photo and Tetrodes, whether made of Germanium or Silicon, either point contact or junction contact types.

Model TV-12 housed in handsome rugged portable cabinet sells for only

\$72⁵⁰
NET

ALSO TESTS TRANSISTORS!

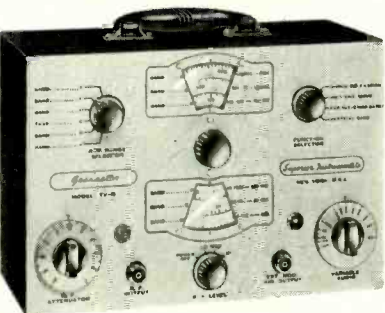

Superior's New
Model TV-50

GENOMETER

A versatile all-inclusive GENERATOR which provides ALL the outputs for servicing:
A. M. Radio • F. M. Radio • Amplifiers • Black and White TV • Color TV

7 Signal Generators in One!

- ✓ R.F. Signal Generator for A.M.
- ✓ R.F. Signal Generator for F.M.
- ✓ Audio Frequency Generator

- ✓ Bar Generator
- ✓ Cross Hatch Generator
- ✓ Color Dot Pattern Generator
- ✓ Marker Generator

R. F. SIGNAL GENERATOR: The Model TV-50 Genometer provides complete coverage for A.M. and F.M. alignment. Generates Radio Frequencies from 100 Kilocycles to 60 Megacycles on fundamental and from 60 Megacycles to 180 Megacycles on powerful harmonics.

MARKER GENERATOR: The Model TV-50 includes all the most frequently needed marker points. The following markers are provided: 189 Kc., 202.5 Kc., 426 Kc., 600 Kc., 1000 Kc., 1400 Kc., 1600 Kc., 2000 Kc., 2500 Kc., 3579 Kc., 4.5 Mc., 5 Mc., 10.7 Mc., (3579 Kc. is the color burst frequency.)

VARIABLE AUDIO FREQUENCY GENERATOR: In addition to a fixed 400 cycle sine-wave audio, the Model TV-50 Genometer provides a variable 300 cycle to 20,000 cycle peaked wave audio signal.

BAR GENERATOR: The Model TV 50 projects an actual Bar Pattern on any TV Receiver Screen. Pattern will consist of 4 to 16 horizontal bars or 7 to 20 vertical bars.

CROSS HATCH GENERATOR: The Model TV-50 Genometer will project a cross-hatch pattern on any TV picture tube. The pattern will consist of non-shifting horizontal and vertical lines interlaced to provide a stable cross-hatch effect.

THE MODEL TV-50 comes absolutely complete with shielded leads and operating instructions.
Only

\$47⁵⁰
NET

DOT PATTERN GENERATOR (FOR COLOR TV): Although you will be able to use most of your regular standard equipment for servicing Color TV, the one addition which is a "must" is a Dot Pattern Generator. The Dot Pattern projected on any color TV Receiver tube by the Model TV-50 will enable you to adjust for proper color convergence.



EXAMINE BEFORE YOU BUY!
USE APPROVAL FORM ON NEXT PAGE

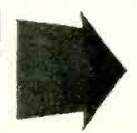

**Superior's New
Model TV-60**

20,000 OHMS PER VOLT

ALLMETER

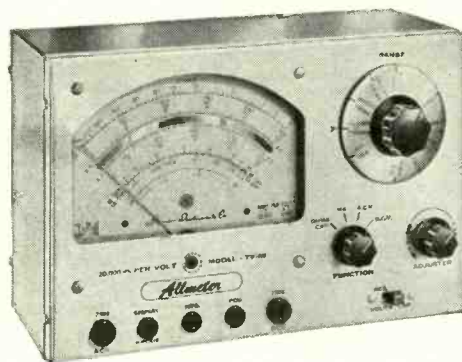

FEATURES

- ✓ A sensitive, accurate Volt-Ohm-Milliammeter with giant meter and mirrored scale.
- ✓ An accurate direct-reading Capacity meter.
- ✓ A Kilovoltmeter.
- ✓ An R.F. Signal Tracer.
- ✓ An Audio Signal Tracer.
- ✓ Giant recessed $\frac{1}{2}$ inch 40 Microampere meter with mirrored scale assures accuracy and easy-reading. All calibrations are printed in large easy-to-read type. Fractional divisions are easily read with the aid of the mirrored scale.

Includes services never before provided by an instrument of this type.

Read and compare features and specifications below!

SPECIFICATIONS

- ✓ The line cord, used only when making Capacity measurements, need be plugged in only when using that service. It is out of the way, stored in its plicofilm compartment at all other times.
- ✓ A built-in Isolation Transformer automatically isolates the Model TV-60 from the power line when the capacity service is in use.
- ✓ Selected, 1% zero temperature coefficient metallized resistors are used as multipliers assuring unchanging accurate readings on all ranges.
- ✓ Use of the latest type of printed circuit guarantees maintenance of top quality standard in the production runs of this precise instrument.
- ✓ A new improved type of high-voltage probe is used for the measurement of high voltages up to 30,000 Volts. This service will be required when servicing color TV receivers.
- ✓ Simply plug-in the R.F. probe and convert the Model TV-60 into an efficient R.F. SIGNAL TRACER permitting the measurement of stage-gain and cause of trouble in the R.F. and I.F. circuits of A.M., F.M., and TV receivers.
- ✓ Plug in the Audio probe and convert the Model TV-60 into an efficient AUDIO SIGNAL TRACER. Measure the signal levels and comparative efficiency of hearing-aids, public-address systems, the amplifier sections of Radio & TV receivers, etc.

- 8 D.C. VOLTAGE RANGES: (At a sensitivity of 20,000 Ohms Per Volt) 0 to 15/75/150/300/750/1500/7500/30,000 Volts.
- 7 A.C. VOLTAGE RANGES: (At a sensitivity of 5,000 Ohms per Volt) 0 to 15/75/150/300/750/1500/7500 Volts.
- 3 RESISTANCE RANGES: 0 to 2,000/200,000 Ohms, 0-20 Megohms.
- 2 CAPACITY RANGES: .00025 Mfd. to 30 Mfd.
- 5 D.C. CURRENT RANGES: 0-75 Microamperes, 0 to 7.5/75/750 Milliamperes, 0 to 15 Amperes.
- 3 DECIBEL RANGES: -6 db to +58 db

R. F. SIGNAL TRACER SERVICE:

Enables following the R.F. signal from the antenna to speaker of any radio or TV receiver and using that signal as a basis of measurement to first isolate the faulty stage and finally the component or circuit condition causing the trouble.

AUDIO SIGNAL TRACER SERVICE:

Functions in the same manner as the R.F. Signal Tracing service specified above except that it is used for the location of cause of trouble in all audio and amplifier systems.

Model TV-60 comes complete with book of instructions; pair of standard test leads; high-voltage probe; detachable line cord; R. F. Signal Tracer Probe and Audio Signal Tracer Probe, Plicofilm bag for all above accessories is also included. Price complete. Nothing else to buy. Only

\$52⁵⁰
NET

**Superior's new
Model 670-A**

SUPER METER

**A COMBINATION VOLT-OHM MILLIAMMETER PLUS
CAPACITY REACTANCE INDUCTANCE
AND DECIBEL MEASUREMENTS**



SPECIFICATIONS:

- D.C. VOLTS: 0 to 7.5/15/75/150/750/1,500/7,500 Volts
- A.C. VOLTS: 0 to 15/30/150/300/1,500/3,000 Volts
- OUTPUT VOLTS: 0 to 15/30/150/300/1,500/3,000 Volts
- D.C. CURRENT: 0 to 1.5/15/150 Ma. 0 to 1.5/15 Amperes
- RESISTANCE: 0 to 1,000/100,000 Ohms 0 to 10 Megohms
- CAPACITY: .001 to 1 Mfd. 1 to 50 Mfd. (Good-Bad scale for checking quality of electrolytic condensers)
- REACTANCE: 50 to 2,500 Ohms, 2,500 Ohms to 2.5 Megohms
- INDUCTANCE: .15 to 7 Henrys 7 to 7,000 Henrys
- DECIBELS: -6 to +18, +14 to +38, +34 to +58

ADDED FEATURE:

Built-in ISOLATION TRANSFORMER reduces possibility of burning out meter through misuse.

The Model 670-A comes housed in a rugged crackle-finished steel cabinet complete with test leads and operating instructions.

\$284⁰⁰
NET

SHIPPED ON APPROVAL NO MONEY WITH ORDER — NO C.O.D.

Try any of the instruments on this or on the facing page for 10 days before you buy. If completely satisfied then send down payment and pay balance as indicated on coupon. **No Interest or Finance Charges Added!** If not completely satisfied return unit to us, no explanation necessary.

© M. Steir

MOSS ELECTRONIC DISTRIBUTING CO., INC.
Dept. D-232, 3849 Tenth Ave., New York 34, N. Y.

Please send me the units checked. I agree to pay down payment within 10 days and to pay the monthly balance as shown. It is understood there will be no finance, interest or any other charges, provided I send my monthly payments when due. It is further understood that should I fail to make payment when due, the full unpaid balance shall become immediately due and payable.

- | | | |
|---|---|--|
| <input type="checkbox"/> Model TV-60.....Total Price \$52.50 \$12.50 within 10 days. Balance \$8.00 monthly for 5 months. | <input type="checkbox"/> Model 670-A.....Total Price \$28.40 \$7.40 within 10 days. Balance \$3.50 monthly for 6 months. | <input type="checkbox"/> Model TC-55.....Total Price \$26.95 \$6.95 within 10 days. Balance \$5.00 monthly for 4 months. |
| <input type="checkbox"/> Model TV-11.....Total Price \$47.50 \$11.50 within 10 days. Balance \$6.00 monthly for 6 months. | <input type="checkbox"/> Model TV-50.....Total Price \$47.50 \$11.50 within 10 days. Balance \$6.00 monthly for 6 months. | <input type="checkbox"/> Model TV-12.....Total Price \$72.50 \$22.50 within 10 days. Balance \$10.00 monthly for 5 months. |

Name _____
Address _____
City _____ Zone _____ State _____

in ceramics

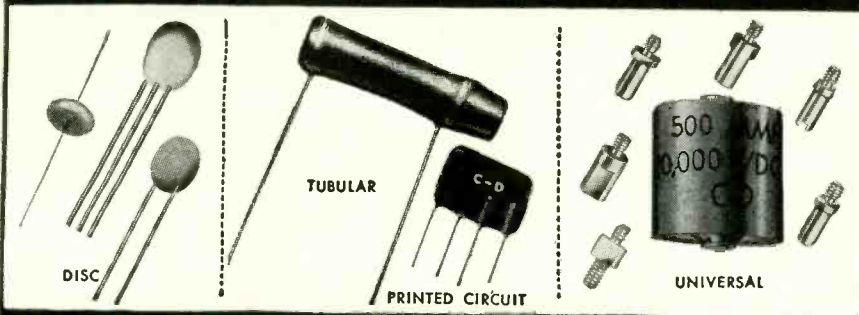

you can see why C-D is always the leader

THE ONLY CERAMIC WITH THE MILLION-DOLLAR BODY

C-D Ceramic Capacitors are made from beginning to end under one roof in a huge plant devoted completely to ceramic capacitor production. Every process . . . every ingredient is under constant control. You can see the reasons for C-D's outstanding superior quality.

And to help you, C-D Ceramic Capacitors are packaged in compact, crystal-clear, easy to handle and always usable plastic boxes (no extra charge). That's why Distributors *who know* carry the complete C-D line. See your C-D Distributor today. He's listed in your local Classified Telephone Directory.

There are more C-D capacitors in use today than any other make.



CONSISTENTLY **CORNELL-DUBILIER** CAPACITORS

PLANTS IN SOUTH PLAINFIELD, N. J.; NEW BEDFORD, WORCESTER AND CAMBRIDGE, MASS.; PROVIDENCE AND HOPE VALLEY, R. I.; INDIANAPOLIS, IND.; SANFORD AND FUQUAY SPRINGS, N. C.; SUBSIDIARY: THE RADIART CORPORATION, CLEVELAND, O.

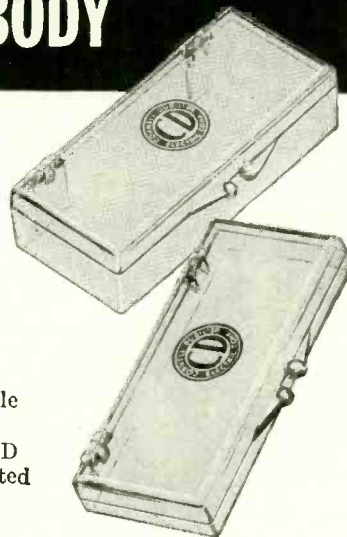

RC-556

RADIO

easily by a competent radio-TV technician. But the optical section, along with the optical parts and adjustments associated with the sound section, had better be left until you are experienced in that type of work. However, there is nothing so mysterious about it that a good service technician could not master with proper study of the optics and mechanics involved.

Do only safe work. I am responsible for the safety of my students so I make certain that the equipment in my care cannot injure a person through electrical or mechanical hazards. I expect any service technician working on this equipment to be positive that the ac line is not shorting or leaking to a metal case, exposed metal parts, the microphone or a speaker.

Think ahead. A Bakelite ac plug may be satisfactory in the home but it would be hazardous in the school where a pupil could step on it, break it and then try to insert it in the wall outlet. (Don't think they haven't tried it!) You have to anticipate unintelligent action on the part of the user to protect him from himself.

How to get business

If you are interested in this type of servicing, let's take a look at some steps Steve Jones, an imaginary service technician, took to get this work for his shop. Maybe his method can help you.

He contacted his local school's principal. Steve found out from the principal how the school was supplied with audio-visual equipment and how the principal went about getting it repaired. Steve was told that there was a district audio-visual department to which he sent defective equipment and was given the name of the audio-visual director in charge of that central agency.

He contacted the director. It surprised Steve when he found that even large school systems often do not do their own repair work. They may, perhaps, employ a man to perform minor repairs only. The audio-visual director (coordinator, supervisor or whatever he may be called) told Steve the policy that was followed. Steve stated his qualifications and offered the services of his shop. He also invited the director to visit his shop to see the test equipment and facilities. Steve and the director were soon discussing recent developments in high fidelity, tape recording and film projection. The director enjoyed finding someone who talked his language!

Steve was not able to get the business of repairing 16-mm sound motion picture projectors that were under guarantee—the director preferred having a factory-authorized service station perform that work rather than possibly voiding the guarantee. Steve is now checking with the manufacturers to see if he can qualify and have his shop become an authorized service station.

END

Attention . . .

Service Technicians' Associations

**Club Members
Student Groups**

Special subscription rates to RADIO-ELECTRONICS are available to associations, clubs, schools, employe groups, etc. For information write—

**G. Aliquo
RADIO-ELECTRONICS
154 West 14 St., New York 11, N.Y.**

RADIO

UNUSUAL SERVICING EXPERIENCE

ONE afternoon, a pleasant-appearing man brought in an expensive Philco 116X chassis and speaker. As I was quite busy at the time, I jotted down the usual complaint, serial and model number information on a repair tag and gave him his half of it as a receipt.

The second section of the repair tag was the itemized bill that he would receive when the work was finished. It indicated the parts used, the tubes supplied, the labor charges and the serial number of the radio.

A third section was for my record file and showed exactly what I had done to the radio in question and the serial number of the radio.

The radio in question had two low-reading tubes, a shorted screen-bypass capacitor and the usual burned voltage-dropping resistor.

I replaced these parts, put in two new tubes, checked the alignment of the radio and was finished with it. Several days later, the customer called for the radio, paid and left pleased.

About three weeks later, he returned, the chassis and speaker in his arms. He put it on the counter, grinned and remarked, "Well, here it is again. I hope that that guarantee of yours means what you said."

Tests quickly indicated that the output transformer was open and further testing showed me that the mid-tap had opened. As this left no voltage on the output tube plates, this meant a completely inoperative radio.

As this was a fairly common fault in those days, I had a new universal type on hand, and it did not take too long to install. I then checked for the possible cause. The coupling capacitors were OK and grid bias was normal, so I supposed that the transformer had opened. It was.

All this time, something seemed to be telling me that things were not according to Hoyle. Just before I put the set on the counter for the customer, I went to my record file and took out the card that I had filled out on the previous repair. I noted the serial number on both the second section of the tag and the record card. They matched on the cards, but they did not match the serial number of the radio!

I slowly counted 10 to keep my temper and then said softly, "My friend, something is wrong here. This is not the radio that I fixed for you 3 weeks ago."

He colored and then blustered, "Sure it is! What are you trying to do? Welsh on your guarantee?"

I laughed grimly and replied, "Not a bit. However, I guarantee only what I do. This set does not have the serial number of the one I repaired. You can look yourself . . ."

Seeing I was wise, he then replied weakly, "Well, you can't blame a guy for trying . . ."—*W. H. Raring*

don't be a
circuit
juggler..

use

STANCOR
EXACT
REPLACEMENT
FLYBACKS

You just remove
the old flyback
and install the new one . . . No
circuit changes are necessary
. . . Even the leads are the
proper length for quick, easy
installation.

FREE: STANCOR
TV Transformer Re-
placement Guide listing
over 8000 models and
chassis of 117 manu-
facturers . . . available
from your distributor or
by writing Chicago
Standard.

CHICAGO STANDARD TRANSFORMER CORPORATION
3509 ADDISON STREET • CHICAGO 18, ILLINOIS

Export Sales: Roburn Agencies, Inc., 431 Greenwich Street, New York 13, N. Y.

Say you saw it in
RADIO-ELECTRONICS

EASY TO LEARN CODE

It is easy to learn or increase speed with an Instructograph Code Teacher. Affords the quickest and most practical method yet developed. For beginners or advanced students. Available tapes from beginner's alphabet to typical messages on all subjects. Speed range 5 to 40 WPM. Always ready—no QRM.

ENDORSED BY THOUSANDS!

The Instructograph Code Teacher literally takes the place of an operator-instructor and enables anyone to learn and master code without further assistance. Thousands of successful operators have "acquired the code" with the Instructograph System. Write today for convenient rental and purchase plans.

INSTRUCTOGRAPH COMPANY

4701 Sheridan Rd., Dept. RC, Chicago 40, Ill.

Si vous lisez le français
technique, vous devez lire

**ELECTRONIQUE
INDUSTRIELLE**

la grande revue française
de technique moderne
Specimen gratuit sur demande

EDITIONS RADIO

9, rue Jacob — Paris 6° — France

There are many reasons why you should use

QUAM

Adjust-a-Cone®

SPEAKERS

- Adjust-a-Cone® Suspension
- U-Shaped Pot
- Heavier Magnetic Structures
- Factory packaged
- Universal Mounting Brackets
- Baked Aluminum Finish
- Listed in Counterfacts and Photofacts

but it all comes down to this...

*ask for QUAM, the quality line,
for all your speaker needs*

QUAM-NICHOLS CO.

236 East Marquette Road
Chicago 37, Illinois

Your customer can hear the Quality that is built into every Quam Speaker

For Your Protection

RADIO-ELECTRONICS is continually alert to maintain a high level of integrity in our advertising columns. In the case of tube advertising—which has suffered special abuses—we insist that all advertisers must warrant that their tubes are:

- New and unused
- Not mechanical or electrical rejects
- Not washed or rebranded
- (See page 57 of the January, 1956, issue)

We investigate carefully when we have grounds to suspect that any advertiser is not living strictly up to these rules.

new
Records



MONITOR

Note: Records below are 12-inch LP and play back with RIAA curve unless otherwise indicated.

High-Fidelity Test Record
Written commentary by John M. Conly
Westminister TRC

Because high fidelity is so subjective an art it is not likely that anyone will ever issue a test record that will test everything in a way to suit everybody. But this Westminister contribution comes closer than any preceding disc I can recall and will do a better job in the hands of most audiophiles, particularly the less experienced ones dependent entirely on listening tests, than any other single recording I could recommend.

John Conly, in the accompanying brochure, does an exceptionally good job of explaining what qualities need testing and why. From the extensive Westminister library the editors have chosen well and with discrimination brief selections which provide clear demonstrations or tests of these qualities. Conly's band-by-band commentary explains succinctly what to listen for and there is very little reason for any confusion on the part of any listener.

The disc starts with a 440-cycle tone for checking turntable speed and wow. This is followed by a frequency sweep from 15,000 to 30 cycles in discreet frequencies and then a continuous sweep over the same range. The test tones are very clean and free of distortion, particularly the very low bass. Finally, there is a 1,000-cycle tone in five amplitudes from 0 to -40 db.

The musical selections demonstrate dynamic range, frequency range, transient response, definition and 10 varieties of tonal and acoustic balance. The opening of Dvorak's *Symphony No. 5* is said to demonstrate a range of 60 db from softest to loudest passage. The peak is very clean and most spectacular played back at concert-hall level. There are several passages with a good 36-cycle bass to shake out rattles. The drums from *Peter and the Wolf* are most awesome, though I don't consider them as good a test of transient response, stability and hangover as those in Westminister's old *Scheherazade*. Still they are a very stringent test, being very fortissimo as well as staccato and are not as likely to produce locked grooves. To cap a very good job, the music is very interesting and well assorted so that there is little likelihood of boring anybody. All the selections—about half come from the Lals series—are clean, well defined and well recorded.

GOULD: Fall River Legend

BERNSTEIN: Facsimile

Ballet Theatre orchestra conducted by Joseph Levine

Capitol P-8320

Two of our brightest contemporary American composers get here a very fine recording of recent ballets. *Fall River Legend* is based on the Lizzie Borden ax-murder case and the music is properly frightening in spots. There are some very sharp attacks and several big peaks excellently recorded. The drum on both sides is very fine. Only a moderate degree of triangles and tinklers but plenty of sharp brasses. *Facsimile*, a more subtle and quiet work, is a sort of psychological study of frustration. There are some fine examples of instrumental leads and solos, a pretty big string bass in spots, nice highs but not many high highs of any kind. The tonal balance of both sides sounded very good to me, the liveness is moderate. Those who can take modern ballet music should find this good listening on a fine hi-fi.

NEW RECORDS (Continued)

Guitar Music of Latin America
Laurindo Almeida, solo guitar
Capitol P-8321

You may recall that I liked the previous Almeida recording very much as a demonstration and test record. This disc, more sophisticated and serious, includes *Etudes* and *Preludes* by Villa-Lobos, two dance-inspired studies by Barroso, a prelude and *Choro* by Barrios, a waltz by Ponce and three short pieces by Almeida himself. This does not require the virtuosity demanded by the classic Spanish guitar music. Nevertheless, if you like guitar music at all you'll like this. The middle bass is very fine indeed. The presence is superb. And there are traces of the finger squeaks and fingering and plucking transients, etc., which make such good test material.

Italy After Dark
Cyril Stapleton orchestra
MGM E-3302

Add this to the small library of popular or semipop music suitable for demonstration. Exceptionally clean for a pop, it has sharp and clean brushed drum high highs and a good assortment of other percussion instruments. There are good pizzicato strings, a mandolin with nice transients, an accordion playing with a variety of stops. The bass is only fair but the liveness and presence are excellent.

RIMSKY-KORSAKOV: Scheherazade
Steinberg conducting Pittsburgh Symphony
Capitol P-8305

Scheherazade is one of the best of all hi-fi show horses and popular with most people as music. As demonstration material this version is by no means up to Westminster's WL-5234. From a strictly musical point of view I imagine it is acceptable. But possibly because of the excessive liveness of the Mosque in which it was played the definition is inferior. Also, neither the drums nor the percussion "cutlery" are prominent. The drums in the final movement, which in the Westminster are like Death knocking at the door, are here just barely audible. The contrast, however, provides a special demonstration and test value and I for one am happy to have both versions. The Capitol version reproduced exactly as recorded sounds the way the Westminster would sound on a poor system. So, if both versions sound rather similar, there is something seriously wrong with the system. However, the two can be used together to demonstrate the difference between a really fine hi-fi system and a poor one—a thing which is sometimes hard to do if one doesn't have a poor system on hand.

In His Shadow
Fisk Choir, Dinah Shore, Snooky Lanson, Sylvia Stahlman, James Melton, Joseph MacPherson and others.
Dot Records No. 227

This recording is a memorial dedicated to preserve the architecturally strange and historic Downtown Church of Nashville. It presents the entire gamut of religious songs from country hymns sung in the *Grand Ole Opry Style*, through spirituals (and a satire of one by Phil Harris), Protestant and Catholic hymns sung by popular singers like Dinah Shore and Snooky Lanson up to *Allelluja* in the grand opera manner. It all sounds excellent. The acoustics of the old church are interesting: the voices are fine, especially Dinah Shore, Lanson and Morgan. The organ bass is especially good behind Dinah Shore. The recording technique falls down in a spot or two, but the overall quality is good. Those who like religious music, or would like to have something in their collection to satisfy listeners who do, should like this.

Proceeds from sales will go to the church. Records are available from Vance Memorial Music, 154 Fifth Ave., No. Nashville, Tenn., for \$5.

DVORAK: String Quartet in G Major
Barchet Quartet
Vox PL-9250

One way to enhance the presence of a recording is to bring into the playback room the resonances and acoustical character of the room in which the music was played originally. The playback room should be "neutral" or dead for its own resonances would confound and obscure the recorded ones. Here is a rather unique

MORE RANGES VISIBILITY V.O.M.

the PRECISION model

120

Gives You What
You've Always
Wanted in a

**HIGH-SENSITIVITY
MULTI-RANGE
TEST SET**

20,000 OHMS PER VOLT D.C.
5,000 OHMS PER VOLT A.C.



- ◆ **MORE RANGES**—44 of them . . . starting lower and going higher . . . outranging any professional V.O.M. of similar size or type.
- ◆ **AN EXTRA-LOW RESISTANCE RANGE**—2-ohm center scale range, powered by long-lived, internal 1.5 volt battery source.
- ◆ **AN EXTRA-LOW VOLTAGE RANGE**—1.2 volts full scale, A.C. and D.C.
- ◆ **AN EXTENDED LOW CURRENT RANGE**—60 microampere first D.C. current range.
- ◆ **A LARGER AND EASIER-READING SCALE FACE**—extra-large 5¼" meter with full 4¾" extra-wide window.
- ◆ **SIMPLE, POSITIVE RANGE SELECTION**—18-position, positive-detenting, master range selector with low-resistance, dependable, silver-plated contacts.
- ◆ **RUGGED, POSITIVE CONTACT JACKS and PLUGS**—specially designed, low-resistance, solid brass, banana type plugs and jacks.

Compare these Wide-Spread Ranges and Special Features:

- ★ **8 DC VOLTAGE RANGES:** 20,000 ohms per v. 0-1.2-3-12-60-300-600-1200-6000 v.
- ★ **8 AC VOLTAGE RANGES:** 5,000 ohms per v. 0-1.2-3-12-60-300-600-1200-6000 v.
- ★ **8 AC OUTPUT RANGES:** same as AC volt ranges. Built-in 600 volts blocking capacitor.
- ★ **7 DC CURRENT RANGES:** 0-60-300 Microamperes. 0-1.2-12-120-600 Ma, 0-12 Amperes.
- ★ **5 RESISTANCE RANGES:** self-contained. 0-200-2000-200,000 ohms. 0-2-20 megohms.
- ★ **8 DECIBEL RANGES:** from -20 to +77 DB. 0 DB=1 Milliwatt, 600 ohms.
- ★ **EXTRA LARGE 5¼" RUGGED 'PACE' METER:** 40 microamperes sensitivity, 2% accuracy.
- ★ **1% MULTIPLIERS and SHUNTS:** wire-wound and deposited-film types employed throughout.
- ★ **ONLY 2 PLUG-JACKS SERVE ALL STANDARD RANGES:** separately identified and isolated jacks provide for extra-high ranges.
- ★ **"TRANSIT" SAFETY POSITION** on master range selector protects meter during transportation and storage.
- ★ **CUSTOM-MOLDED PHENOLIC CASE and PANEL:** compact, efficient, laboratory instrument styling. Deeply engraved panel characters afford maximum legibility.

MODEL 120: complete with internal ohmmeter batteries, banana-plug test leads and operating manual. Over-all case dimensions: 5¾ x 7 x 3¾ inches. Net Price: \$39.95



PRECISION Apparatus Company, Inc.

70-31 84th Street, Glendale 27, L. I., N. Y.

Export: 458 Broadway, New York 13, N.Y., U.S.A. • Cables: MORHANEX
Canada: Atlas Radio Corp. Ltd. • 50 Wingold Ave., Toronto 10, Ontario

... another
MALLORY
service-engineered
product

Don't Settle For Less than MALLORY FP Capacitors

Only Mallory makes genuine FP Electrolytic Capacitors. Don't accept substitutes or imitations—for only FP Capacitors give you *all* these exclusive features, pioneered by Mallory and available without premium cost:

- Designed for 85° C—no de-rating
- Genuine fabricated plate anode
- High ripple current rating
- Unequaled shelf and service life
- Fast, easy twist-prong mounting

Always ask for Mallory FP's by name—and you'll be sure of getting the best replacement capacitors on the market.

P. R. MALLORY & CO. Inc.
MALLORY

P. R. MALLORY & CO. Inc., INDIANAPOLIS 6, INDIANA

- Capacitors
- Vibrators
- Resistors
- Power Supplies
- Controls
- Switches
- Rectifiers
- Filters
- Mercury Batteries



NEW RECORDS

(Continued)

record for testing the acoustics of a playback room. It is recorded in a "live" studio whose reverberation period can actually be measured by the decaying echo, especially at the end of the first movement. The playback room should make it possible to hear the difference between this and other recordings very plainly and, indeed, to measure the echo. Aside from this special test value, this is capable of producing a high degree of pseudo-stereophonic presence which is very impressive and "real." The definition of the individual instruments is always good.

GLUCK: *Flute Concerto in G Major*
BOCHERINI: *Flute Concerto in D Major*
PERGOLESI: *Flute Concerto in G Major*
Camillo Wanausek, Flute
Pro Musica Orchestra of Vienna
Vox PL-9440

Another lovely peace offering for the family suffering from too much loud demonstration. The music is most pleasant, the flute beautifully clean and naturally "windy" although rather out of scale because so closely miked. No instrument makes a lovelier sound on a really fine hi-fi system than the flute.

SCHUBERT: *Symphony No. 4 (Tragic),
Symphony No. 8 (Unfinished)*
Bamberg Symphony conducted by
Hollreiser
Vox PL-9370

DVORAK: *New World Symphony*
New Symphony of London conducted
by Rudolph Schwarz
Capitol P-8308

Two of the most popular of all symphonies are played with what seems to me adequate competence to produce a stunning sound. The Dvorak has fine kettledrums and beautiful sharp clean strings. The definition is excellent and the solo instruments outstanding. Soft passages require a low noise and rumble level. The two Schubert symphonies have the outstanding Vox bass, the *Unfinished* especially should be most prepossessing with good speaker systems.

DE FALLA: *Concerto for Harpsichord
and Chamber Orchestra*

RIETI: *Partita for Harpsichord, Oboe,
Flute and String Quartet*

SURINACH: *Tientos*
Sylvia Marlowe, Harpsichord and
Concert Arts Players
Capitol P-8309

A real tidbit for lovers of chamber music. All modern music but with a greater variety of melody than usual. All are beautifully recorded with an awe-inspiring presence. The harpsichord receives, for my money, its most accurate and felicitous recording. The definition throughout is exceedingly good—you can hear the faintest harpsichord tinkle even in crescendos and over the drums. Not recommended to those who haven't learned the special charm of modern chamber music, but I'm sure that those who have acquired the taste will enjoy it.

TCHAIKOVSKY: *Piano Concerto No. 2*
SCRIABIN: *Piano Concerto in F Sharp
Minor*

Friedrich Wueltrer and Pro Musica
Orchestra of Vienna Vox PL-9200
SCHUBERT: *Impromptus Op. 90 and
142*

Ingrid Haebler, pianist Vox PL-8940
MOZART: *Piano Concerto No. 6, Piano
Concerto No. 8*

Ingrid Haebler and Pro Musica Or-
chestra of Vienna Vox PL-9290
Favorite Piano Classics
Leonard Pennario, Pianist
Capitol P-8312

Echoes of Budapest
George Feyer, Piano and Rhythm
Vox VX-850 (10-inch LP)

Four pianists, four (or possibly five) pianos, four styles—high fidelity makes their differences obvious to the most unskilled ear. Pennario's

NEW RECORDS

(Continued)

piano has a strident, almost barrel-house, treble; Haebler's is sweet and mellow, Feyer's sharp and round and Wuehrer's very resonant. The Vox bass is fuller and more resonant than Capitol's but any of these will serve as a good example of how well today's high fidelity does by the piano.

Many will prefer the standard repertoire (*Second Hungarian Rhapsody, Prelude in C Sharp Major, Clair de Lune, Polonaise in A Flat*, etc.) on the Pennario record although I found his playing very dispirited as if (and I don't blame him too much) he were more than a little weary of the old warhorses. Wuehrer delivers a really old-fashioned bravura, no-muscle-spared performance which I imagine suits the Tchaikovsky and Scriabin works nicely. Personally I liked Haebler's restraint and delicacy best and I thought her piano sounded best. However, I believe most people will find Feyer's clever improvisations on various Hungarian themes most interesting though, like most pop recordings, the bass is a little too heavy and the treble by no means as clean as it should be. But the piano is good and the music is fun.

SCHUMANN: Quintet in E flat

HUMMEL: Quartet in G

Victor Aller, piano and
Hollywood String Quartet

Capitol P-8316

Charming chamber music in an excellent performance and recording; a fine piano, sharp but not strident strings. The presence is excellent and with just about the right liveness for maximum realism in a moderately dead living room. Just a touch of overcut distortion in the finale. The Schumann quintet was the first coupling of the piano with string quartet and is still one of the finest; the second movement is one of the most moving funeral marches. The Hummel quartet is also musically engaging and its Mozartian counterpart provides an excellent demonstration of definition and the differing qualities of the four strings. One of the best chamber demonstration records.

BLOCK, Ernest: Quintet for Piano and Strings

Johana Harris, piano, and
Walden String Quartet

MGM E-3239

This is a quintet of another color entirely. Both the piano and the strings get a more thorough workout in music in which form and rhythm are more important than melody. The cello is asked to get down in double-bass range and sometimes to pretend it is a pair of tympani; the pianist must find portions of this sweat-producing work. And while the music is definitely for those capable of the "domestic but good" type of judgment about music, the sound is very impressive on a good system and provides good measures of definition, IM distortion, and even dynamic range. The low range of the cello is outstanding for its genuine stringy tone, indeed one of the best on records. Excellent for advanced chamber-music hi-fi fans.

HARRIS, Roy: Fantasy for Piano and Orchestra

MGM Symphony Orchestra
conducted by Izler Solomon

Abraham Lincoln Walks at Midnight
Nell Tengeman, soprano, plus piano,
violin and cello

MGM E-3210

Two of Roy Harris' latest works (first played in 1954) given a pretty brilliant recording under the supervision of the composer and presumably authentically expressing his ideas. The music is strictly for the congoscenti of modern America although the *Fantasy* is thoroughly listenable and indeed pleasant, being based on obscure American folk motifs. Not hard to take by anyone who has the patience to listen to it a few times. I found little interest in the cantata *Abraham Lincoln Walks at Midnight* either as music or demonstration material.

END

Name and address of any manufacturer of records mentioned in this column may be obtained by writing Records, RADIO-ELECTRONICS, 154 West 14th St., New York 11, N. Y.

... another
MALLORY
service-engineered
product



To power
transistorized
miniature
portables...

- make it mercury—
- make it MALLORY!

You're selling the best in performance and value, when you offer your customers Mallory Mercury Batteries for their transistorized miniature portables.

First, because these batteries give the extra long life and constant discharge service that you get only in the unique mercury battery. They actually cost much less per hour of operation than ordinary batteries.

And second, because Mallory Mercury Batteries have all the exclusive features of stability, dependability and quality that come from Mallory's fifteen years of experience in pioneering the mercury battery field.

Get set to snare your share of this growing market. Order a stock, in ratings for popular sets, from your Mallory distributor today.



- Capacitors
- Controls
- Vibrators
- Switches
- Resistors
- Rectifiers
- Power Supplies
- Filters
- Mercury Batteries

THE BOOK YOU NEED TO PRICE WITH SPEED... for profit

quick check for 60,000 prices
Profit-making time-money-phone
call-saver. 200 pocket-sized pages.
Replacement parts listed by manu-
facturer, product and part number.
up-to-date charging information
Completely revised 4 times a year.



"Very useful to me" - Conway, Penna.

"Been able to find every item" - Frankfort, Ky.

"Nice to have all prices" - Kincaid, Va.



"It's a perfect book" - Tecumseh, Ont.

and the perfect partner . . .
**DAVE RICE'S OFFICIAL TV-RADIO
SERVICE ORDER BOOK**
For TV, Radio, Phono or Hi-Fi service,
provides separate listings for:
Picture tubes, receiving tubes, parts and
components, serial numbers, labor and
state and local taxes. 5 1/2" X 8 1/2" - 50 sets
of triplicate orders—carbons bound in.
at parts distributors or send check to
ELECTRONIC PUBLISHING CO., INC.
180 NORTH WACKER DRIVE • CHICAGO 6, ILLINOIS
DIGEST: \$2.50 per copy.
**ORDER BOOK: \$.75 each or \$6.50 per
dustproof box of 10.**

Technicians' News



SELF-LICENSING PLANNED

The Associated Radio-Television Servicemen of New York City and the Long Island Radio Guild have added themselves to the number of organizations who plan to do their own licensing. The New York City plan proposes giving examinations to applicants and licensing them as technicians or apprentices. Permits will also be issued to shops who employ ARTSNY-licensed technicians and who abide by the association's Code of Ethics. The association will guarantee all work done by licensed technicians. If a customer does not receive satisfactory service, the association will have the work done by another member and reimburse the member. Then a decision will be made as to whether action should be taken against the first technician.

The Long Island Guild plan is to license shops. Nine requirements must be met. These include adherence to the Guild Code of Ethics, possession of adequate test equipment, and employment of recognized technicians.

(Qualifications of technicians are to be decided by guild license examiners.) The shop must be located in a business zone, be open during hours specified on the application, have a registered business name and carry adequate liability insurance for its customers' and its own protection. A 90-day guarantee must be issued on all parts installed and service done. The license is to be displayed prominently in the place of business.

A tentative license fee of \$15 per shop plus \$5 per employe is suggested.

KING COUNTY ELECTS

At the March meeting of the King County Television Service Association, Seattle, Wash., officers elected for the coming year were: Bob Kelly, president; Harold Hart, vice president; Clayton Faller, secretary-treasurer.

PROTEST NEDA STATEMENT

Both Forest Baker, of the new Electronic Service Council, and Frank Moch, president of NATESA, found themselves fully in accord with each other in condemning and criticizing an editorial in the January *NEDA Journal*. The feature most vigorously attacked by both was the statement that licensing was usually advocated by a handful of service technicians whose local reputation was poor. "If this article reflects the opinion of the members of the National Electronic Distributors Association," stated Baker,

recommended
reading for
buyers of...

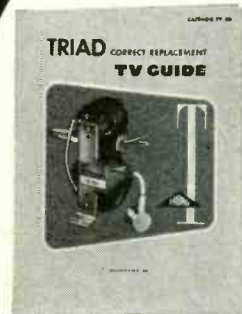

TV COMPONENTS

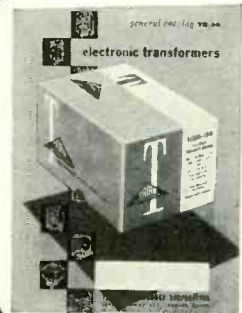

and TRANSFORMERS

2 NEW TRIAD CATALOGS

TV GUIDE TV-56, giving latest recommendations on Triad correct television replacements.

GENERAL CATALOG TR-56, listing the complete line of Triad transformers including 76 new items.

Ask your local TRIAD distributor or write . . .



4055 Redwood Ave., Venice, California
RADIO-ELECTRONICS

"it is extremely unfortunate that electronics parts distributors are so poorly informed about the current situation in the TV service industry." He went on to point out that the TV service industry is in a critical state, and that further difficulties might lead to the dominance of manufacturer-controlled service, a development which would most hurt the independent parts distributor.

Moch did not confine himself to this point but made it the last of four numbered paragraphs, each of which refuted a statement made in the editorial. He objected in turn to the inference that there was no record of legitimate complaints on the TV user level, that elected officials or civic leaders were uninterested in licensing and that TV service technicians in general were not interested in a licensing law nor fully able to realize "its harmful consequences."

SERVICE GROUPS CONTACTED

More than 300 letters have been sent to radio-TV service associations asking their opinions in regard to unity of the service industry, according to Forrest Baker, chairman of the Electronics Service Council. This action was taken in accordance with decisions made at the council's Chicago meeting January 15 (RADIO-ELECTRONICS, March 1956, page 124). The next meeting is planned for Kansas City, possibly for May 18-20, Mr. Baker stated.

DOLLAR CONVERSIONS?

Speaking before a Senate commission, Robert Lee of the Federal Communications Commission suggested that some of TV's allocation problems could possibly be solved if it were possible to add to the present vhf spectrum some channels now controlled by the military. "The conversion problem," said Mr. Lee, "would not be as difficult as the uhf problem." He went on to say that the tuners might be adjusted by the individual set owner for "maybe a dollar plus a service call." (The optimistic estimate was apparently based on strip type tuners.)

Mr. Lee made it quite clear that there was no immediate probability that new vhf channels would be opened to commercial TV and pointed out that an act of Congress would be required to allot to the broadcaster frequencies now held by the defense forces.

NEW COLOR SCHOOL IDEA

More than 175 service technicians out of 200 invited came to Dallas to hear a plan for a new type of color TV course outlined by E. P. Miles of Adleta Co., electronic distributors of Dallas.

The new plan consists of combining a correspondence course—in this case the nine-lesson course offered by RCA Institutes—with in-person review periods at the end of each three lessons. At least 50% of the review periods were to be devoted to shop techniques—at which time the technicians would have access to color TV sets to work on.

(Continued on page 110)

MAKE MORE MONEY on every service call



NET \$109⁹⁵

B&K

DYNA-QUIK MODEL 500

DYNAMIC MUTUAL CONDUCTANCE TUBE TESTER

Tests over 95% OF ALL POPULAR TV TUBES*—IN SECONDS

You can cut servicing time—eliminate repeat calls—make more on-the-spot tube sales—give a better service guarantee—make new profits in minutes with DYNA-QUIK. This top quality, low cost, portable dynamic mutual conductance tube tester enables any serviceman to locate weak and inoperative tubes quickly and easily with laboratory accuracy right in the home.

DYNA-QUIK creates greater customer confidence because your customer sees for himself the true tube condition on "Good-Bad" scale. In just a few minutes you can check all the tubes in a TV set for shorts, grid emission, gas content, leakage, dynamic mutual conductance and life expectancy under the dynamic heavily loaded conditions that are the actual operating conditions of the set. Used in the shop or in the home—DYNA-QUIK will make money for you every day!

- Fast—a complete tube test in as little as 12 seconds.
- Easy—one switch tests everything. No roll chart—no multiple switching.
- Accurate—large 4 1/2" plastic meter has two scales calibrated 0-6,000 and 0-18,000 micromhos.
- Always up to date—test procedure instructions for new tubes supplied by factory at regular intervals.
- Automatic line compensation—special bridge continuously monitors line voltage.
- 7-pin and 9-pin straighteners mounted on panel.
- Portable—luggage style carrying case with removable slip-hinged cover.
- Lightweight—15 1/2" x 14 1/2" x 5 1/2" in. Weighs only 12 lbs.

*Including new 600 mil series tubes.

B&K

Send for article on "Profitable TV Servicing In the Home" and Bulletin 500—E

B & K MANUFACTURING CO.
3726 N. Southport Ave. · Chicago 13, Illinois

Also makers of the famous CRT 400

Philco breaks National Campaign to replace "Tired" Picture Tubes



Don't let a
"Tired" Picture Tube
spoil half of your TV enjoyment



Now, Get a better picture than ever before!
PHILCO Star Bright 20/20
ALUMINIZED PICTURE TUBE
Bond plus Warranty

Regardless of the make or model of your TV set, you will get the best picture ever when you change to the Philco Star Bright 20/20. And it's the only TV picture tube made that gives you double protection with both bond and warranty.



Bonded to be built with all new picture making parts, to the same rigid standards as tubes in newest Philco TV sets. Plus full year warranty.

Authorized Philco Service Dealer now. Ask about his allowance for your old picture tube.

Millions of TV Set owners get the call to action—to phone you immediately for a new picture tube

TV Guide, Saturday Evening Post, newspapers and TV commercials are ready to break the big replacement story and sell the Philco Star Bright 20/20 Aluminized Picture Tube for you. Be sure to have stock on hand when your phone starts ringing. Then you'll be ready to move into the homes of television owners and cash in on the greatest campaign of its kind ever to hit the public.

Invest in your future in Color TV Service and equip your shop **FREE** during the fabulous

**PHILCO SHARE
AND PROFIT
Dividend Opportunity**

That's right, you can earn **FREE** color and B/W Test Equipment and Parts and Accessories by concentrating your radio and TV parts on Philco. With each purchase you get **SHARE** and **PROFIT** stamps, redeemable for the dividends of your choice at your Philco Distributor. They build **EXTRA 100% PROFITS** because they cost you nothing. See your Philco Distributor now for full details.

Now, an Exclusive Double Edged Selling Tool . . .

Bond plus Warranty

ON EVERY

PHILCO®

Star Bright 20/20



Sharon Kay Ritchie
Miss America 1956

**SUPER ALUMINIZED! CLEAREST,
MOST LIFELIKE PICTURE POSSIBLE**

Regardless of the make or model of a TV set, a Philco Star Bright 20/20 Aluminized Picture Tube gives your customers a clearer, brighter, more lifelike picture than ever before . . . and builds confidence in you.

**PHILCO PICTURE TUBE
BOND**

Bonded by a leading Indemnity Co. to be built with all new picture making parts, to the same rigid standards of tubes in the newest Philco TV models.

**PHILCO PICTURE TUBE
WARRANTY**

Covers the picture tube for one full year. Combined with the new Philco bond, it offers the purchaser guarantees never before matched in television history.

Yes, Philco gives you a double-edged selling exclusive to boost your replacement tube business. In addition to the one year warranty, the Philco Star Bright 20/20 Aluminized Picture Tube is BONDED to have all new picture making components. This bond protects your customers against counterfeit tubes and assures a picture tube that's built to the same rigid standards as those in original TV receiving equipment. The Philco Star Bright 20/20 is the only picture tube made that is backed by such a bond.

PHILCO CORPORATION

ACCESSORY DIVISION

PHILADELPHIA 34, PA.



Model 7100

Philco puts you in the color service business with this one compact instrument

PHILCO Universal COLOR BAR and DOT BAR Generator

It's new . . . highly efficient . . . designed to provide the widest possible variety of functions in the minimum amount of space. PHILCO MODEL 7100 is used to

completely trouble-shoot circuits associated with color reproduction and make accurate convergence adjustments in any color television receiver on the market.

International

presents

"AIRKORE"

a new selenium replacement
rectifier so outstanding it

Outperforms them all!

- 12° to 15° lower core temperature.
- Overload capacity 7 times normal rating.
- 20% less aging.
- Maximum air flow in any vertical mounting position (regardless of degree of rotation).
- Increased efficiency throughout life.

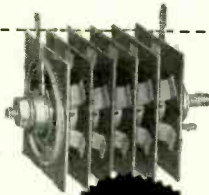

SO GOOD IT'S
guaranteed
for 1 year!

AirKore provides these outstanding advantages without sacrificing the basic design of proven superiority—"center-support" construction!

Compare any other rectifier with the new AirKore. Guaranteed for a full year, this new design assures increased efficiency...will help cut costly "call-backs." For products of the highest quality, manufactured under the most rigid standards in the industry, look for the name International.

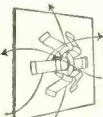

This exclusive device provides greater contact area—uniform temperature rise across the plates—increased efficiency.

AirKore design permits maximum circulation of air around the plates, through the core and spring itself.

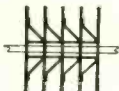

A WORLD OF DIFFERENCE
...THROUGH RESEARCH

International Rectifier

C O R P O R A T I O N

El Segundo, California • Phone ORegon 8-6281

In Canada: Atlas Radio Corp., Ltd.,

50 Wingold Ave. W., Toronto, Ontario • RU 1-6174

THE WORLD'S LARGEST SUPPLIER OF
INDUSTRIAL METALLIC RECTIFIERS

110

TECHNICIANS' NEWS

(Continued)

The course is open to all qualifying technicians, whether affiliated with Adleta or not. Approximately 95% of those attending the meeting passed the qualifying test. In addition to the lessons, technicians taking the course were offered a color TV set at considerably less than key dealer price—the only condition being that the technician must agree to retain the set for the whole term of the course.

NATESA CONVENTION

The National Alliance of Television & Electronic Service Associations announces that the date of the 1956 annual convention is finalized at Sept. 14-16. The convention will be held in Chicago. A special enlarged edition of the association's paper, the *NATESA Scope*, will be published concurrently with the convention. The exhibition which formed a part of previous conventions will be omitted to give the delegates and visitors more opportunity to concentrate on the business meetings and technical sessions.

DEATH THREAT

Efforts of the Radio and Television Association of Santa Clara Valley, Calif., to clean up the service industry have resulted in what was described as a "death threat" over the phone. President Larry Schmitt told members at a recent meeting that he received a phone call from a husky-voiced man who said, "You're looking for a hole in the head if you don't keep your nose out of other people's television business."

Schmitt believed that the threat may have come from a crackpot—"probably someone whose toes were stepped on in association cleanup work."

In view of the fact that another service company was threatened, the RTA magazine urged all members who receive such calls to call the police, crackpot or no crackpot.

ARTSD LISTS GRIPERS

An interesting experiment has been tried by the Associated Radio-Television Service Dealers of Columbus, Ohio. Forms have been given to the members, to be filled in with the names of griping and slow-paying customers (in two separate lists). These will be consolidated and complete lists of these two unpleasant types of fauna distributed to the members, so that they can orient themselves correctly toward customers who fall into the two categories. END

WHAT A SIGHT

By Jeanne DeGood

We've learned to service black-and-white

And studied grayish hues,
But now we must adjust our sight
To reds and greens and blues.

And now we'll earn our daily bread

(It's hard to realize)

Adjusting sets by seeing red—
And spots before our eyes.

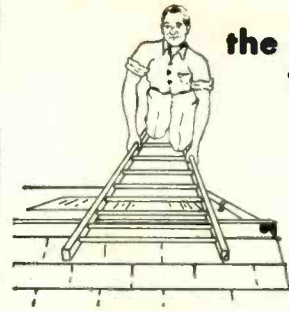

the '2nd'
trip up...
Costs
YOU!

STOP Antenna Call-Backs
due to broken leads

with

the mosley

'Y-TY'



TV installation profits *vanish* when you're called back to repair a wind-whipped lead-in connection!

Protect those profits — and your reputation — by using the Mosley "Y-TY" on each antenna you install.

A sturdy clamping member locks around the complete line . . . takes the strain off the fragile copper strands! The plated brass connecting straps bend and twist to fit any antenna type.

No. 263 — Mosley "Y-TY"
NEW LOW PRICE! . . . \$.65

You make More Installation Profits
...when you use Premium Quality
MOSLEY TV ACCESSORIES

At Radio and Television Parts
Distributors, Coast-to-Coast.

Mosley Electronics, Inc.

8422 ST. CHARLES ROCK ROAD, ST. LOUIS 14, MISSOURI

Wear a

BUDDY POPPY



Veterans of Foreign Wars
of the United States

RADIO-ELECTRONICS

In one profitable package University offers everything in loudspeakers for sound reinforcement... and public address—

| | | |
|---|--|---|
|  <p>REFLEX TRUMPETS</p> |  <p>RADIAL PROJECTORS</p> |  <p>WIDE-ANGLE HORNS</p> |
|  <p>HIGH EFFICIENCY DRIVER UNITS</p> |  <p>PAGING, TALK-BACK SPEAKERS</p> |  <p>OUTDOOR MUSICASTING</p> |
|  <p>EXPLOSION-PROOF SPEAKERS</p> |  <p>HIGH POWER SPEAKERS UP TO 720 WATTS</p> |  <p>SUBMERGENCE-PROOF SPEAKERS</p> |
|  <p>WIRED MUSIC SYSTEMS</p> |  <p>WEATHERPROOF LINE-MATCHING TRANSFORMERS</p> |  <p>ADAPTORS FOR DIVERSIFIED APPLICATIONS</p> |

People have come to expect the highest standard of quality in a product bearing the University label.

This kind of public acceptance is something that University has consistently worked to achieve. *First*—by backing you up with an advertising campaign that's making University a "buy-word." *Second*—by building the kind of quality into all our products that ensures your customers' satisfaction.

Yes, everyone is finding out, to his profit, that "University sells on sound!"

For information regarding products or technical data, write to Desk B7.

For an exciting preview of new products visit us at the May Parts Show, Conrad Hilton Hotel, Chicago, Rooms 502 & 509 & Booth 874, May 21-24.

University LOUDSPEAKERS, INC. 80 South Kensico Avenue, White Plains, N. Y.



BUILD YOUR OWN 16 TUBE RADIO

CIRCUITS

AT HOME only \$19.95

with the New Deluxe 1956
PROGRESSIVE RADIO "EDU-KIT"

A Practical Home Radio Course

Now Includes

FREE TOOLS, TESTER, SOLDERING IRON, HIGH FIDELITY, SIGNAL TRACER, CODE OSCILLATOR, PRINTED CIRCUIT SIGNAL INJECTOR

- No Knowledge of Radio Necessary
- No Additional Parts Needed
- Excellent Background for TV



Reg. U.S. Pat. Off.

FREE HI-FI, RADIO & TV SERVICING LITERATURE ON REQUEST (see coupon below)

WHAT THE "EDU-KIT" OFFERS YOU

The "Edu-Kit" offers you an outstanding PRACTICAL HOME RADIO COURSE at a rock-bottom price. It is designed to train Radio-Electronics Technicians, making use of the most modern methods of home training. You will learn radio theory, construction practice and servicing.

You will learn how to build radios, using regular schematics; how to wire and solder in a professional manner; how to service and trouble-shoot radios. You will work with the standard type of punched metal chassis as well as the latest development of Printed Circuit chassis.

You will learn the basic principles of radio. You will construct, study and work with RF and AF amplifiers and oscillators, detectors, rectifiers, test equipment. You will learn and practice code, using the Progressive Code Oscillator. You will learn and practice troubleshooting, using the Progressive Signal Tracer, the Progressive Signal Injector, the Progressive Dynamic Radio-Electronics Tester and the accompanying instructional material.

You will receive training for the Novice, Technician and General Classes of F.C.C. Radio Amateur Licenses. You will build 16 Receiver, Transmitter, Code Oscillator, Signal Tracer and Signal Injector circuits, and learn how to operate them. You will receive an excellent background for Television.

Absolutely no previous knowledge of radio or science is required. The "Edu-Kit" is the product of many years of teaching and engineering experience. The "Edu-Kit" will provide you with a basic education in Electronics and Radio, worth many times the complete price of \$19.95.

THE KIT FOR EVERYONE

You do not need the slightest background in radio or science. Whether you are interested in Radio-Electronics because you want an interesting hobby, a well-paying business or a job with a future, you will find the "Edu-Kit" a worth-while investment.

Here is an excerpt from a letter that we received from Loren DePriest, 1496 4th St., Mansfield, Ohio: "I have spent many pleasant hours in constructing the radios from the schematics in your book, and have learned a great deal from them. Being as I am interested in Radio, I consider the money spent for your course as a wise investment. I have learned more from your course by actually doing, than I did from an expensive course."

Many thousands of individuals of all ages and backgrounds have successfully used the "Edu-Kit" in more than 79 countries of the world. The "Edu-Kit" has been carefully designed, step by step, so that you cannot make a mis-

take. The "Edu-Kit" allows you to teach yourself at your own rate. No instructor is necessary.

The "Edu-Kit" is also used for courses of study, extra-curricular activities, industrial personnel training and rehabilitation. The "Edu-Kit" is used by Jr. High Schools, High Schools, Technical Schools, Jr. Colleges, Colleges, Universities, Industrial firms, Rehabilitation Hospitals, Boards of Education, U.S. Govt. agencies, United Nations Educational, Scientific and Cultural Organization (UNESCO), and numerous adult, radio and young peoples' groups and clubs. The "Edu-Kit" is also popular with servicemen and veterans throughout this country and abroad.

Designed for universal use, the "Edu-Kit" operates on any voltage from 105 to 125 volts, AC and DC. For use in countries employing higher line voltages, a 210-250 Volt AC/DC model is available.

PROGRESSIVE TEACHING METHOD

The Progressive Radio "Edu-Kit" is the foremost educational radio kit in the world, and is universally accepted as the standard in the field of electronics training. The "Edu-Kit" uses the modern educational principle of "Learn by Doing." Therefore you construct, learn schematics, study theory, practice trouble-shooting—all in a closely integrated program designed to provide an easily-learned, thorough and interesting background in radio.

You begin by examining the various radio parts of the "Edu-Kit." You then learn the function, theory and wiring of these parts. Then you build a simple radio. With this first set, you learn the general principle of "Learn by Doing." Thereafter, practice testing and trouble-shooting. Then you build a more advanced radio. Learn more advanced theory and techniques. Gradually, in a progressive manner, and at your own rate, you will find yourself constructing more advanced multi-tube radio circuits, and doing work like a professional Radio Technician.

THE "EDU-KIT" IS COMPLETE

You will receive all parts and instructions necessary to build 16 different radio and electronic circuits, each guaranteed to operate. Our Kits contain tubes, tube sockets, variable, electrolytic and paper dielectric condensers, resistors, tie strips, coils, hardware, tubing punched metal chassis, Instruction Manuals, etc.

In addition, you receive Printed Circuit materials, including Printed Circuit chassis, special tube sockets, hardware and instructions. You also receive a useful set of tools, a professional electric soldering iron, and a self-powered Dynamic Radio-Electronics Tester. The "Edu-Kit" also includes Code Instructions and the Progressive Code Oscillator, in addition to F.C.C.-type Questions and Answers for Radio Amateur License training. You will also receive lessons for servicing with the Progressive Signal Tracer and the Progressive Signal Injector, a High Fidelity Guide and a Quiz Book.

TROUBLE-SHOOTING LESSONS

You will learn trouble-shooting and servicing in a progressive manner. You will practice repairs on the sets that you construct. You will learn symptoms and causes of troubles in home, portable and car radios. You will learn how to use the professional Signal Tracer, the unique Signal Injector and the dynamic Radio-Electronics Tester. While you are learning in this practical way you will be able to do many a repair job for your friends and neighbors, and charge fees which will far exceed the price of the "Edu-Kit." Our Consultation Service will help you with any technical problems you may have.

J. Stataitis, of 25 Poplar Pl., Waterbury, Conn., writes: "I have repaired several sets for my friends, and made money. The "Edu-Kit" paid for itself. I was ready to spend \$240 for a Course, but I found your ad and sent for your Kit."

FREE EXTRAS

- SET OF TOOLS
- RADIO & ELECTRONICS TESTER
- ELECTRIC SOLDERING IRON
- TESTER INSTRUCTION MANUAL
- CONSULTATION SERVICE
- HI-FI GUIDE
- QUIZZES
- TV BOOK

30-DAY UNCONDITIONAL MONEY-BACK GUARANTEE
—MAIL TODAY—ORDER SHIPPED SAME DAY RECEIVED—

Order from ad—receive free bonus resistor kit worth \$5.00.
 Send "Edu-Kit" Postpaid, I enclose full payment of \$19.95.
 Send "Edu-Kit" C.O.D. I will pay \$19.95 plus postage.
 Send me FREE additional information describing "Edu-Kit." Include FREE valuable Hi-Fi, Radio and TV Servicing Literature.
 (Outside U.S.A.—No C.O.D.'s. Send check on U.S. bank or Intern'l M.O. "Edu-Kit" for 105-125 V. AC/DC \$20.95; 210-250 V. AC/DC \$23.45.)

Name.....
Address.....

PROGRESSIVE "EDU-KITS" INC.
497 Union Ave., Room 116G, Brooklyn 11, N.Y.

new Devices



MOBILE TELESCOPIC TOWER, E-Z Way, travels anywhere on trailer, 60 and 85 feet. Operated by two men. Tower with microwave transmitter attached can be up and on the air in less than 45 minutes. Orientation controls are located at base of tower.

Tower height adjustable by winch-cable mechanism. Plate



at top of each tower for mounting microwave transmitter that can be rotated 360° and tilted from 15° below horizontal to 30° above while standing on ground.—E-Z Way Towers, Inc., Tampa, Fla.

SELENIUM SUN BATTERY converts solar into electrical power. Designed as power supply for transistorized devices such as portable radio receivers and transmitters. May be used with miniature storage batteries to supply continuous power to load. Supplies electrical power in milliwatt range when exposed to sunlight or artificial light. When exposed to very bright incident sunlight, approximately 10,000 foot candles, can supply maximum output power of 5,000,000 watts

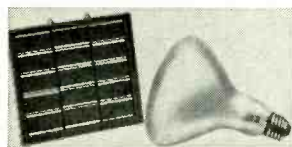

per active square inch at output voltage of 0.26 volt per sensitive element.

Sun battery illustrated has 15 photosensitive elements connected in series. Output voltage approximately 4 at maximum power transfer, and 8 under open-circuit condition. Maximum operating temperature of battery 85° continuous duty and 100°C in intermittent use. Unlimited life expectancy.—International Rectifier Corp., 1521 E. Grand Ave., El Segundo, Calif.

TUNER - AMPLIFIER, Knight Uni-Fi, combines FM-AM tuner, magnetic preamp and 10-watt

hi-fi amplifier on single chassis. Housed in cork-grained metal cabinet with brushed brass panel. Input for record player using either crystal or magnetic cartridge; auxiliary input for TV set or tape recorder. AM loopstick and FM loop antennas; 10 tubes plus rectifier



and germanium diode detector. Requires 8-μv FM signal for 30-db quieting. Amplifier response ±0.5 db 20-20,000 cycles.—Allied Radio Corp., 100 N. Western Ave., Chicago 80, Ill.

PORTABLE PHONOGRAPH, Ballerina, model C-12V. Variable speed for control of tempo and pitch of 33 1/3-, 45- and 78-rpm records. Extended-range 11-inch oval speaker and 5-watt inverse feedback amplifier. Heat-resistant ceramic pickup cartridge

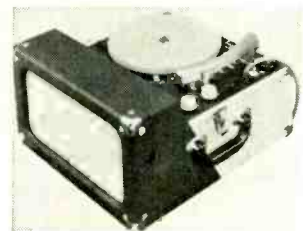

with double-jeweled needle. Washable Fabricoid of maroon and gray covers case.—Newcomb Audio Products Co., 6824 Lexington Ave., Hollywood 38, Calif.

PORTABLE HI-FI TAPE RECORDERS, series 3A Ferrographs, 3 motors, one a specially designed Octaquad synchronous hysteresis capstan motor for long-term speed stability, eliminating pitch errors on playback. 2 portable models of dual-track magnetic recorder in 3 1/2 and 7 1/2 ips, 7 1/2 and 15 ips, respectively. Both accommodate 1,750-foot reels of standard tape, have one-knob selector control, auto-stop

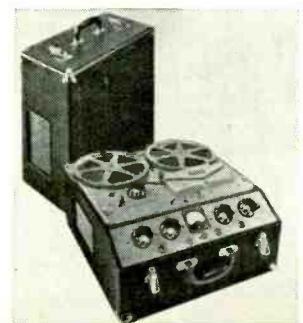

TEST 5 TUBES in 4 SECONDS EACH...ACCURATELY!

WITH THE NEW ADVANCED ENGINEERED

precise MODEL 116

**Gm. & Em. ULTRAFAST
TUBE & TRANSISTOR TESTER**



Completely
NEW!

PRECISE MODEL 116K in kit form. \$69.95
PRECISE MODEL 116W factory wired. \$119.95

Servicemen know the Precise Model 111 (the winner in an independent survey) easily rates "the finest tube tester in the field" at any price, BUT FOR AN ON THE JOB QUICK-TEST . . . the fastest, most accurate is the PRECISE Model 116. What's more you test tubes the foolproof method inherent in the famous Precise Model 111.

Did you ever wish you could plug in 5 of the same type tubes at once and check each one individually by rotating a switch? YOU CAN WITH THE PRECISE MODEL 116—Plug in 5 IF tubes and let them heat up at once and then check each one separately by rotating the TUBE BANK switch. ACTUALLY CHECK 5 TUBES IN 20 SECONDS, 4 SECONDS PER TUBE.

The Precise Model 111 taught the lesson that IF amplifier tubes (like the 6BC5 or 6AU6) should be tested for Gm (mutual transconductance) while the power amplifiers (like the 6L6) should be tested for Em (emission)—that's ULTRAFAST Model 116 test! It checks each section of each tube separately . . . by rotating the FUNCTION SWITCH . . . each triode of a dual triode is checked individually . . . each diode and the triode of a duo-diode-triode is separately tested and not lumped as in other testers . . . and a pentode is tested as a pentode—not a diode. TRANSISTORS, SHORTS, GAS, LIFE, Em, Gm etcetera can be tested with the PRECISE Model 116.

You can inexpensively extend the Precise Model 116 to test filament current, etc. The Model 116 gives an accurate, ultra-fast (3 basic knobs for testing) check of television tubes!

No Surplus—An etched panel—beautiful Moleskin covered wood carrying case and cover and specially simplified instructions makes the PRECISE MODEL 116 THE FINEST FAST-CHECK TUBE TESTER AND DOLLAR EARNING TRAVELING COMPANION A TV SERVICEMAN EVER HAD.

Not yet at your distributor. Order NOW to insure early delivery.
SEE YOUR LOCAL DISTRIBUTOR FOR PROOF OF WHAT WE OFFER — OR WRITE US FOR DOCUMENTARY RESULTS OF AN INDEPENDENT SCIENTIFIC SURVEY.



THE FAMOUS MODEL #111
111K \$79.95
111W \$139.95
Incl. Carrying Case & Cover

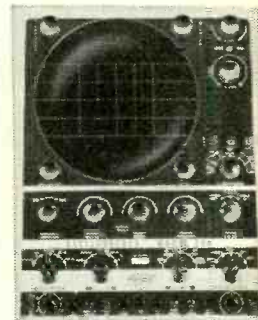

THE FIRST LOW PRICED
7" COLOR SCOPE
300K \$99.95
300W \$199.50

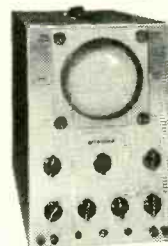

LOW PRICED 5" SCOPE
315K \$49.95
315W \$84.95

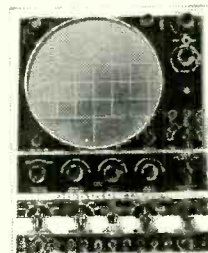

THE FIRST AND ONLY
8 1/2" COLOR SCOPE
308K \$129.50
308W \$229.50



LOWEST PRICED
WIRED 4 1/2" VTVM
909K \$25.98
909W \$37.50



RF-AF-BAR GENERATOR
with pre-assembled* head
630K \$33.95
630KA* \$38.95
630W \$53.95

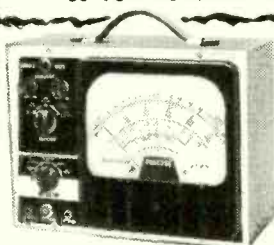

THE FINEST VOLT, REG,
7" VTVM KIT
9071K \$35.95
9071W \$49.95



LOW PRICED RF SIGNAL GENERATOR
"BEST BUY" IN GEN. FIELD
610K \$23.95
610KA pre-assembled head \$28.95
610W \$39.95



UNIV. AF, SINE, SQ, & PULSE GEN.
635K \$33.50
635W \$52.50

Prices slightly higher in the West. Prices and specifications subject to change without notice.

PTAK \$2.95
PTAW \$4.25

WRITE FOR CATALOG RE 5-6

SEE THE MANY MORE PRECISE INSTRUMENTS AND PROBES AT YOUR DISTRIBUTOR TODAY!

precise DEVELOPMENT CORP. OCEANSIDE, NEW YORK, U.S.A.

NEW DEVICES

switch, 60-second rewind, separate bass and treble controls and output for 15-ohm extension speaker.

Frequency response within ± 2 db between 50 and 10,000 cycles at 7 1/2 ips, 40 and 15,000 cycles at 15 ips. Signal-to-noise ratio better than 50 db between 200 and 12,000 cycles. Output stage provides 2 1/2 watts of low-distortion power into 15-ohm self-contained elliptical speaker. 18 x 17 1/2 x 9 3/4 inches. 50 pounds. — British Ferrograph Recorder Co., Ltd., London, England, available through Ercona Corp., (Electronic Div.), 551 Fifth Ave., New York 17, N.Y.

HI-FI CABINETS, 10 units, 9 cabinets and 1 base in ST series. Modular and identical in width. 16-, 24- and 32-inch heights. 16-inch depth permits all-purpose

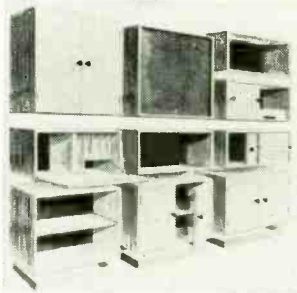

storage. Cabinet doors and moldings of birch. Cabinet shells constructed of heavy, 3/4-inch white pine plywood. — Cabinart, 99 North 11th St., Brooklyn 11, N.Y.

CORNER FOLDED-HORN ENCLOSURE and 4-way loudspeaker systems, Centurion, feature of E-V Georgian on smaller scale. Single-path indirect-radiator folded horn uses walls corner to extend bass reproduction below 35 cycles, improve transient response, lower distortion. Integrates with matched speaker system as 4-way repro-



ducer. 42 x 29 x 22 1/2 inches. Factory-assembled 4-way speaker system or do-it-yourself kits, enclosure kit, 4-way package of driver components. — Electro-Voice, Inc., Buchanan, Mich.

PREAMPLIFIER-EQUALIZER, Model TR-1, all transistor type. Hum level zero with no microphonism. Microphone selector allows use as phonograph or microphone preamp. .033-watt drawn from self-contained battery. 3 transistors; printed wiring throughout. Use with any amplifier, audio control or sound system. RIAA equalization. 3 controls on panel for flexibility of function. Cartridge impedance selector permits use of TR-1 with magnetic cartridges, including low-level types; does not require transformer. Vol-

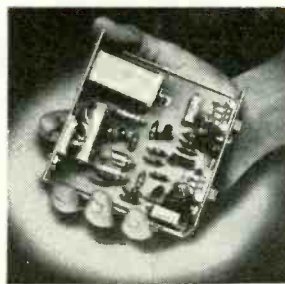

ume control to be direct-connected to basic amplifier which has no level control. 12 ounces. Self-contained; fully shielded. — Fisher Radio Corp., 21-21 44th Dr., Long Island City 1, N.Y.

CUSTOM-BUILT HI-FI SYSTEM flexible in size and layout. Adaptable to almost any demand. Consists of Gray viscous-damped tone arm, turntable, amplifier, preamp and speaker. Can be adapted for use in hotels, restaurants, schools, churches, concert halls, homes, etc. — Gray Research & Development Co., Inc., 685 Hilliard St., Manchester, Conn.

SUBMINIATURE PM SPEAKER, for transistorized circuitry, 1 1/2 inch in diameter and 15/16

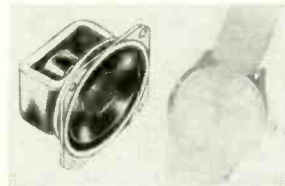

inch deep. Alnico 5 magnet; voice-coil impedance 10 ohms. Weighs 1 1/4 ounces. Mounting centers 1 9/32 x 1 9/32 inches. — Lafayette Radio, 100 Sixth Ave., New York 13, N.Y.

HI-FI MANUAL RECORD PLAYER, Startlight. Variable-speed motor drives precision-machined 12-inch aluminum turntable with center-drive action. Built-in illuminated stroboscope permits speed adjustment to perfect pitch over



range of 16 2/3-85 rpm. Vernier type speed control. Wow and flutter held to 0.2 volt and rumble more than 40 db below average recording level.

Pickup arm has double-wrist-action arm movement; simple change of cartridges or cleaning. Ball bearing swivel mount. Turntable and pickup arm mounted on natural birch base. Overall base dimensions 16 x 17 1/2 x 6 1/2 inches. — Metzner Engineering Corp., 1041 North Sycamore Ave., Hollywood 38, Calif.

MASTER TV CHANNEL CONVERTER, model MVC, high- to low-channel vhf converter. Oper-

Every Serviceman's Profit-Maker Team ...

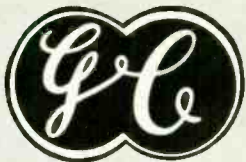

Service Aids and Your G-C Distributor!

G-C—MAKERS OF **SPRA-KLEEN**

STOPS TELEVISION AND RADIO CONTROL NOISES

ELIMINATES NOISE due to dirt, dust and corrosion on electrical contacts.

JUST SPRAY ON ... convenient power spray can does the job in a wink. No need to dismantle chassis.

CLEANS AND LUBRICATES contacts, controls, relays, switches and other sliding electrical contact devices in one operation.

SAVES TIME AND MONEY—gets the job done fast—long lasting—full 6 ounces. No. 8666



POOF!

THERE GOES NOISE



GENERAL CEMENT MFG. CO.

919 Taylor Avenue • Rockford, Illinois

FREE COPY... G-C Catalog. Send postcard today!



G-C Chemicals



G-C Alignment Tools



G-C Hardware



G-C Service Aids



TV-radio service work is faster, easier, more profitable... when you use G-C Service Aids. You'll find thousands of them at your G-C parts distributor.

SEE US... BOOTH 590—ROOM 612—PARTS SHOW

Wear a **BUDDY POPPY**

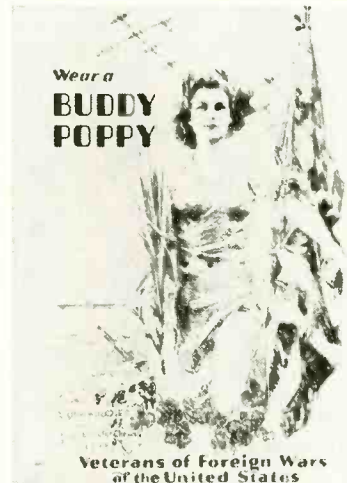

Veterans of Foreign Wars of the United States

What articles would you like to see published in RADIO-ELECTRONICS?

Maybe you're the man to write them.

Ask for an author's Guide.

Radio-Electronics
154 West 14th St.
New York 11, N.Y.

Millions are enjoying Better TV with



NEW COLORS! Forest Green and Ivory

Beautiful new decorator models U-98 and T-12 now available in both Forest Green and Ivory colors, as well as the standard, rich mahogany grain!

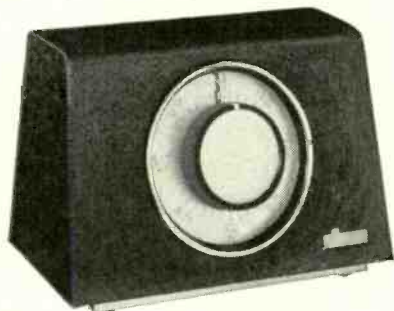

Model U-98—The first and finest fully automatic rotator—"just set it and forget it!" No swinging or drifting—points instantly to target station. Has 32 distinct improvements. The best rotator for all stations, all channels, VHF, UHF and Color! Available in 3 beautiful shades. List Price **\$39.95**

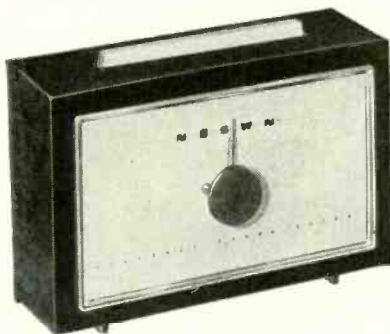

Model T-12—With exclusive Tenna-Teller pointer. Gives constant direction readings, wholly accurate, dependable. Striking design with finger-tip rocker control bar on top. Available in 3 colors. List Price **\$29.95**

Model K-22—Lowest-priced quality rotator on the market. Has finger-tip control. Available in standard color only. List Price **\$19.95**

alliance TENNA • ROTOR

(TV ANTENNA ROTATOR) ®



**Stay on top
with the leader!**

EXPANDS THE NATION'S TV AUDIENCE!

In more than two million homes, from coast to coast, viewers get better TV . . . thanks to Alliance. And in fringe areas, Alliance Tenna-Rotor is often the difference between good television and no television! Turning the antenna . . . makes for clearer, interference free reception. Alliance Tenna-Rotor increases the effective signal range of stations everywhere!

USES TV TO TELL ITS OWN STORY!

For 7 years Alliance TV spots have run consistently to demonstrate and sell. By using television as its *principal medium*, Alliance has become nationally recognized among the biggest TV advertisers . . . has always been the largest national TV accessory advertiser.

AND WHEN COLOR TV COMES . . .

Color TV is highly critical, more sensitive to reflections. For full color definition Alliance Tenna-Rotor will be *indispensable* in many markets!

More Than 2,000,000 Now in Use!

See us at the Radio-TV Parts Show
Hilton Hotel—Booth 322

Another Outstanding Profit-Maker!

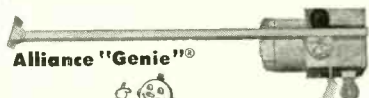

LIFT-A-DOR
GARAGE DOOR OPERATOR

Radio-controlled (from car dash) automatic garage door operator—opens, closes, locks door, turns lights on and off. Factory-assembled for easy installation. Customers gleam when you tell them the low price!

THE ALLIANCE MFG. CO., INC.

ALLIANCE, OHIO

In Canada—ALLIANCE MOTORS, Schell Avenue, Toronto 10



A GOOD TUBE TESTER EMC Model 209

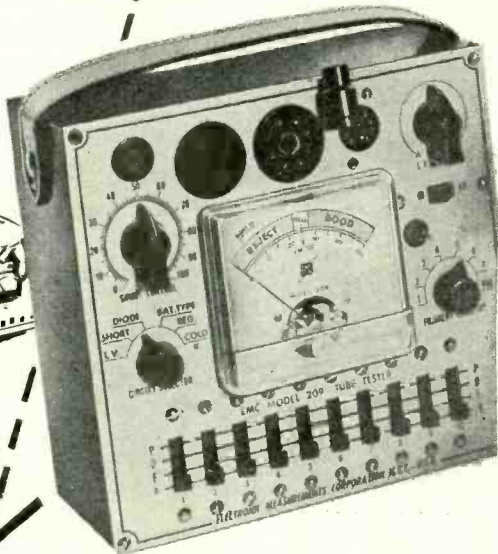

“...Serviceman’s BEST FRIEND”

“When I’m trying to analyze and correct a circuit TOUGHIE... it’s a great feeling to reach for my EMC Model 209 Emission-Type Tube Tester and know I’ll get fast, absolutely accurate checks for quality, shorts, leakage, continuity, and opens on all modern and future tubes... that new, modern, 3½” plastic meter makes quick servicing easy. You’ll like this professional, multi-function instrument because it also rejuvenates picture tubes when used with Model CRA Picture Tube Adaptor... a unique flexible switching system assures that you can test all future types too! Best of all, this precision instrument is priced low.

its handy size (6¾” x 7½” x 4”) makes it ideal for home calls.”

EMC
MODEL 209 **\$35.90***
(as illustrated in
Hammetone metal case)

In oak carrying case **38.50***

Kit form **25.90***

EMC MODEL CRA
(Picture Tube Adaptor) **4.50**

*Complete with plastic-covered, detailed instruction book and tube listings.



Yes, send me full technical information about Model 209 and a complete catalog of other EMC Instruments. RE-5

NAME _____
OCCUPATION _____
COMPANY _____
STREET _____
CITY _____ STATE _____

EMC ELECTRONIC MEASUREMENTS CORP.
280 LAFAYETTE STREET
NEW YORK 12, NEW YORK
EXPORT DEPT - 370 BROADWAY, N. Y. 13, N. Y.

NEW DEVICES

(Continued)

ates at antenna site for community installations to reduce signal loss in long transmission lines. 33-db gain with low-noise grounded-grid amplifier. 1-volt



rms output at either 75-ohm outlet. Third 75-ohm fitting for input from high-channel Yagi.

All-channel vhf mixing network for other MVC converters or MCS channel amplifiers in system. Fused power supply and ac receptacle for power plug of next unit. Enclosable in model MRH-A weather and radiation-proof housing.—Blonder-Tongue Labs., Inc., 526-36 North Ave., Westfield, N. J.

REPLACEMENT TRANSFORMERS for flybacks used in most

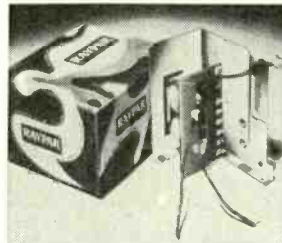

types of modern TV receivers.—Raypar, Inc., 7800 W. Addison St., Chicago, Ill.

COLOR TV OSCILLOSCOPE, model 601, full 5-mc bandwidth for color TV servicing. Dc positioning prevents bounce or overshoot. Push-pull vertical amplifier sensitivity .02 volt per inch. Retrace blanking ampli-

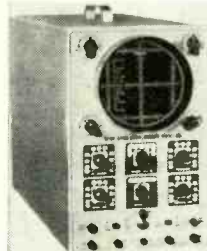

fier. 2-step compensated attenuator input. Positive or negative synchronization of input voltage or from external source. Built-in 60-cycle phasing control and blanking amplifier for TV servicing. Astigmatism control.—Electronic Measurements Corp., 280 Lafayette St., New York, N. Y.

SIGNAL-TRACER PROBE, model 262, permits checking ac waveform voltages in horizontal and vertical oscillator circuits. drive voltage to horizontal output tube, sweep-circuit output, local-oscillator opera-

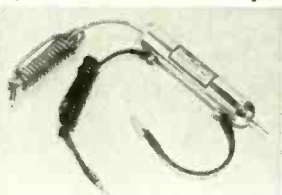

tion, sync-circuit signals, if output, audio signal, etc. Permits top-chassis checking of

many ac waveform voltages in TV receiver. Plugs into any 20,000 ohms-per-volt VOM.—Futuramic Co., 2500 W. 23 St., Chicago, Ill.

LONG-SHANK ADAPTER for TrolMaster, the tool for cleaning and lubricating TV and radio controls without removing chassis from set or taking back off cabinet. With 7-inch adapter which screws on, Trol-

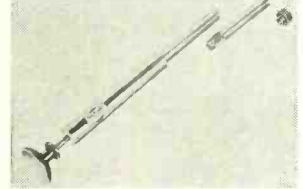

Master can be used on controls with shafts up to 7 inches long. Made of solid brass, will not corrode when used with any chemical normally used in electronics industry.—R-Columbia Products Co., Inc., 305 Waukegan Ave., Highwood, Ill.

ELECTRONIC DIAGRAMMER. No drawing experience for professional-looking circuitry plans by running pencil, pen, or

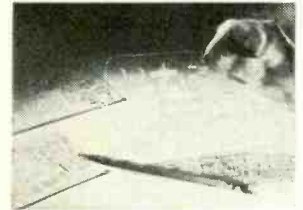

stylus through any combination of engraved electronics symbols. Rigid transparent Vinyl template includes commonly used electronics symbols; beveled for ease and accuracy. 4.25 x 6.5 x .040 inch. Symbols include usually tedious-to-draw pronged tube bases, cathode-ray tubes, resistors, elements and coils.—A. Lawrence Karp, 16 Putnam Park, Greenwich, Conn.

PAPER TUBULAR, Comet, molded-plastic metallized paper capacitor. Miniature, self-healing, lightweight, heat-resistant, moisture-safe, plastic shell. Bonded end-seal eliminates en-



vironmental effects. Reliable operation from -65°C to +125°C. Leads won't pull or melt out.—Astron Corp., 255 Grant Ave., E. Newark, N. J.

COUNTER STAND for Dyna-Quick model 500 portable tube checker (page 52, March 1956, issue). Four rubber feet. Rail holds instrument cover in ver-



NEW DEVICES

tical position. Weighs 6 pounds; 7 x 15½ x 14¼ inches.—**B & K Manufacturing Co.**, 3726 N. Southport Ave., Chicago 13, Ill.

RACK AND PANEL TYPE CONNECTORS, DPE, made up of 40 contacts. Narrow for crowded installations. Die-cast aluminum shell (3 15/16 inches) protects insert and contacts. Positive polarization by key-stone design, construction feature of many connectors in smaller rack and panel series. Flashover rated at 1,700 volts, 60 cycles, ac rms at sea level. Mated connector 0.381 pound.—**Cannon Electric Co.**, 3209 Humboldt St., Los Angeles 31, Calif.

ENCAPSULATED RESISTORS, CE 100, CE 200 series and PW types, feature several improvements, including reduction of thermal hot spots through greater conductivity, increased tensile strength, resulting in greater mechanical strength when operating at higher ambi-



ent temperatures and 15% greater wattage dissipation through improved surface emissivity. Where accurate resistance is a requisite, Cinema-Alloy E resistance wire is used. Housing of black epoxy with circle of yellow epoxy at each end of resistor.—**Cinema Engineering Div., Aerovox Corp.**, Burbank, Calif.

SELENIUM TV RECTIFIER, AirKore. Open-paced 6-contact spring for large contact area and uniform temperature rise across surface of rectifier plate. Optimum air circulation around plates, through core and spring. Maximum air flow in vertical mounting positions. In all standard sizes, stud and eyelet construction.—**International Rectifier Corp.**, El Segundo, Calif.

PRECISION POTENTIOMETER, Vari-Phase, single-turn type with simplified phasing. Permits external independent phasing of each sectional cup without affecting phase relationships of others in group. Phasing may be applied after mounting in equipment to correct or cancel any mechanical or electrical errors that developed during or after assembly. Done by loosening clamping nut, moving terminal board in



desired direction, then retightening. No clamping rings to hold cups. Available in 5 different sizes: 7/8-, 1 1/16-, 1 1/8-, 2 and 3-inch diameters.—**Clarostat Mfg. Co., Inc.**, Dover, N. H.

SUBMINIATURE CAPACITORS, type NT tantalum polarized electrolytic. Ratings from

(Continued)

0.5-16 volts dc; capacitances from .08-30 µf; case sizes 3/32 or 1/8 inch in diameter and 5/32-1/2 inch long. For transistor circuits in hearing aids and miniature radio receivers, printed-circuit assemblies, sub-



miniature controls and other very small low-voltage devices designed for -20 to 55°C operation.—**Cornell Dubilier Electric Corp.**, So. Plainfield, N. J.

MINIATURE GLASS TRIMMERS, models VC 9G and 10G. VC 9G's capacitance range 0.5 to 8.5 µf; temperature range -55° to +125°C; dielectric strength 1,000 volts dc; Q at 1 mc greater than 1,000; insula-

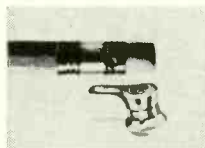

tion resistance greater than 2,000,000 megohms. VC 10G is the same as VC 9G except slightly smaller and has a capacitance range of 1 to 4.5 µf.—**JFD Electronics Corp.**, 1462 62 St., Brooklyn, N.Y.

MINIATURE SELENIUM RECTIFIER, half-wave stack types 8Y1B and 8J1B. Terminals snap into printed-wiring board. Rated

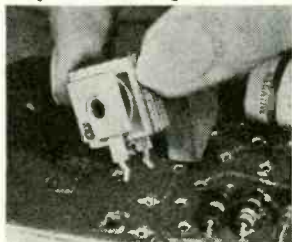

at 30 ma and 65 ma at off-line voltages with capacitive load in 45°C ambient temperature. Mount in 3/32-inch diameter holes spaced on 27/64-inch centers.—**Radio Receptor Co., Inc.**, Semi-conductor Div., 251 W. 19th St., New York 11, N. Y.

PLUG-IN ADAPTER, for Weston model 749 miniature ac clamp volt-ammeter. Plug receptacles on either side—one reduces scale range of model 749 by factor of 10, permitting low current measurements;



other for reading ampere scale directly. Adapter plugs into ac line, appliance connects to adapter and clamping jaws of instrument inserted through adapter opening.—**Weston Electrical Instruments Corp.**, 614 Frelinghuysen Ave., Newark 5, N. J. END

All specifications given on these pages are from manufacturers' data.

MAY, 1956

Here's The ANTENNA YOU CAN MAKE MONEY Installing

designed for 1 man... 7 minute installation

NEEDS ONLY A HAMMER TO INSTALL

GENUINE *Color Beam* \$14.95 COMPLETE LIST

 Exclusive with **WINEGARD**

ANY ANTENNA THREE YEARS OLD SPOILS THE TV PICTURE

*designed for **BLACK and WHITE** and **COLOR**

Available at Leading Parts Distributors Everywhere or Write

Winegard Company Burlington, Iowa

For Pamphlet "How to Make Money on One Man Antenna Installation."



Antenna boxed—completely assembled—attached lead-in

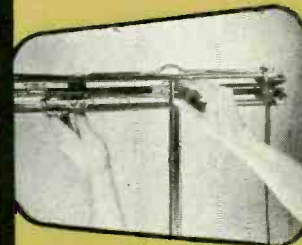

Raise main crossarm.

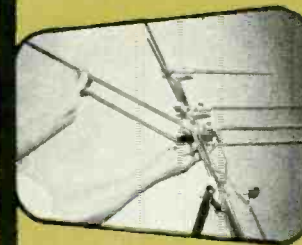

Snap secondary crossarms in place.

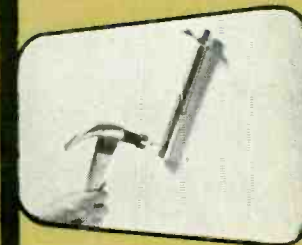

Nail up mounting bracket.

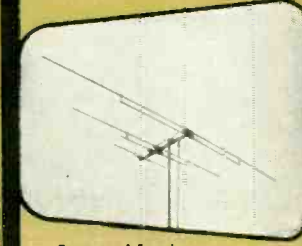

Drop lead-in wire.

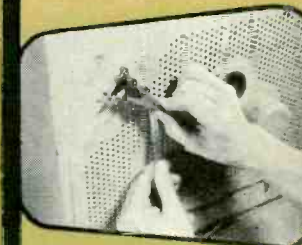

Attach lead-in to TV set—special clip snaps on.

BURTON BOWNE ADVERTISING

Futuramic VOM PROBES

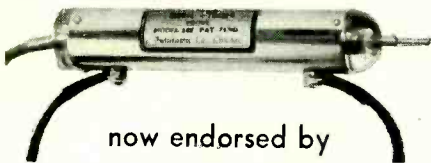

now endorsed by

R. G. Middleton

Type 261 V-O-M High-Ohms Probe. Lets you read resistance much higher than ever before. Find those leakage troubles quickly and easily . . . with your V-O-M. . . . Net \$9.95

Type 262 V-O-M Signal Tracer Probe. Now you can read signal voltages with your favorite equipment . . . your V-O-M. Solve tough sweep circuit problems with speed and ease. Trace signals through I.F. and video, check oscillators . . . all without removing the chassis from the cabinet. . . . Net \$9.95

Type 263 Polarity Reversing Probe. No more lead changing, just a flick of the finger and the meter reads the right direction. . . . Net \$6.95

Type 264 V-O-M Range Splitter Probe. How many times have you wished your V-O-M had a range between 250 and 1000 volts? Now it can be yours, and at the flip of a switch. . . . Net \$9.95

How's YOUR
batting
average
?



Don't
let TV
troubles
strike you
out . . . Use
the right
bat . . . Use a
Futuramic probe.

All **Futuramic** products are completely guaranteed. You must be satisfied, or you may return the probe and we will refund your money. Stocked by leading jobbers. Send for literature.

Futuramic
2500 West 23rd Street
Chicago 8, Illinois

Representative Inquiries Invited

new

Tubes

Transistors



2N175

A new hermetically sealed, germanium-alloy junction transistor, the 2N175, has been announced by RCA. The p-n-p type is designed especially for use in the preamplifier or input stages of transistorized audio equipment operating from extremely small input signals.

Because of its exceptionally low noise factor of 6 db maximum and its freedom from microphonics and hum, the 2N175 can be operated from low-impedance low-level devices such as magnetic microphones and magnetic pickups without an input coupling transformer.

In a common-emitter type circuit, the 2N175 features an exceptionally low wide-band noise factor, a current amplification ratio of 65 and a matched-impedance power gain of approximately 43 db. The transistor is 0.026 inch in diameter, 0.495 inch in seated length.

Maximum ratings for class-A audio-frequency service are: collector voltage, -10; collector current, -2 ma; collector dissipation, 20 mw; emitter voltage, 10; emitter current, 2 ma; ambient operating temperature, 50°C.

SILICON POWER RECTIFIERS

Developed by CBS-Hytron, the 1N503 through 1N526 feature exceptionally large power-handling capacity for their size. These silicon power rectifiers operate with extremely high reverse voltages and low reverse currents. This feature, together with a very low forward voltage drop, enables the rectifier to deliver large power to the load with relatively little dissipation. Because of their low thermal resistance the rectifiers operate in ambient temperatures up to 125°C.

The units are available in three shapes (see photo), depending on the heat dissipation required. The smallest unit can handle 1/3 ampere without an additional heat radiator and features pigtail construction, particularly suited

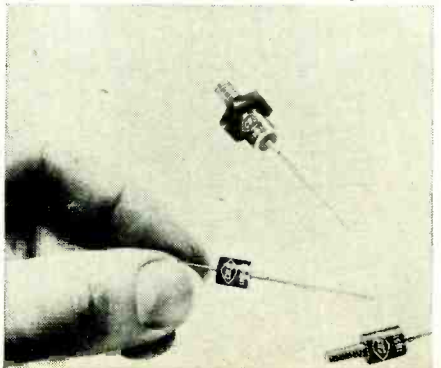

AEROVOX

PAPER TUBULAR
CAPACITORS

ANY



application



type



voltage



capacity
and
climate

Available at ANY Aerovox Distributor at ANY time for your convenience.



AEROVOX CORPORATION

DISTRIBUTOR SALES DIVISION
NEW BEDFORD, MASS.

In Canada: AEROVOX CANADA, LTD., Hamilton, Ont.
Export: Ad Auriema, 89 Broad St., New York, N. Y.
Cable: Auriema, N. Y.

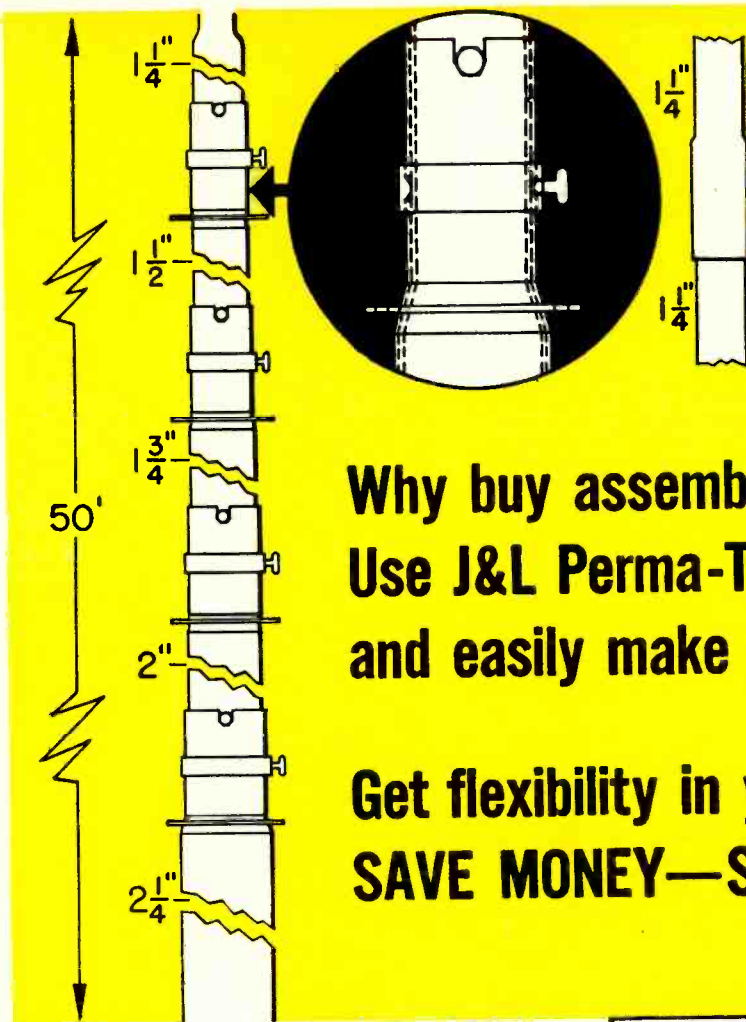

Same 1 1/4-inch piece of Perma-Tube can be used for telescoping masts or with another 1 1/4-inch piece to make smaller 2-piece masts.

**Why buy assembled telescoping masts?
Use J&L Perma-Tube in 10-foot lengths
and easily make your own**

**Get flexibility in your stock
SAVE MONEY—SAVE SPACE**

Only J&L Perma-Tube offers:

- Joint design which provides instant field assembly.
- Machine-fitted joints that insure close tolerance for high strength and rigidity.
- Guy wire ring position that eliminates all binding and guy wire interference.

Buy only a carton each of five different sizes of Perma-Tube (1 1/4 to 2 1/4-inch) and make any telescoping TV mast up to 50 feet in height. Hardware—cotter keys or bolts, clamps and guy rings—may also be secured from your distributor.

You can now "tailor-make" your own TV masts up to 50 feet high by using standard 10-foot lengths of 16-gage Perma-Tube—and save money. Five diameters are available in easily-handled cartons from your local distributor. Largest base section OD is 2 1/4 inches and each telescoping section is 1/4-inch smaller, the smallest section having an OD of 1 1/4 inches.

Corrosion-resistant Perma-Tube is treated with Vinsynite—then coated both inside and outside with a metallic vinyl resin base. It's made of a special, high-strength, J&L steel tubing. A 10-foot section of 1 1/4 inch diameter by 16 gage is capable of supporting a weight at its center point of 200 pounds with a minimum of deflection and permanent set.

J&L Perma-Tube — best for strength and rust protection

Jones & Laughlin
STEEL CORPORATION · PITTSBURGH



Ask "The Man on the Roof" why he prefers

South River



How valuable is a Serviceman's time? 5¢ a minute?
... 7¢ a minute? ... 10¢ a minute?

South River's New Ratchet Type Chimney Mount Saves 10 Minutes Per Installation!

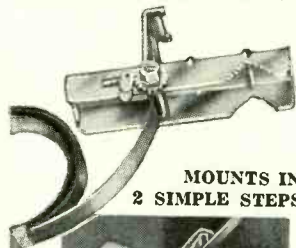

MOUNTS IN
2 SIMPLE STEPS



1. Encircle chimney with banding and thread through slotted shaft.



2. Tighten banding with wrench.

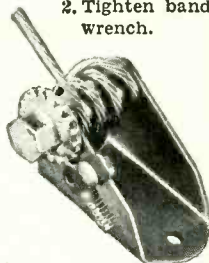

**RATCHET
GUY WIRE
TIGHTENER**

Eliminates turn-buckles! Fastens to wall or roof with screws. Extra space between tightening shaft and base permits large tightening capacity. Same-sturdy construction as ratchet chimney mount.

It's the fastest, simplest, most convenient ever manufactured!

Mounting is factory assembled with band attached. No assembly of eyebolts, banding, banding clips, nuts, etc., is necessary for chimney mounting.

South River's New Ratchet Type Chimney Mount is 8 WAYS BETTER:

1. Heavy gauge steel construction.
2. Banding naturally unwinds for easy mounting. No troublesome watchspring effect!
3. Embossed and welded for extra rigidity and strength!
4. Ratchet of aircraft type aluminum, forged and heat-treated for maximum toughness and strength.
5. Fine ratchet teeth insure positive tightening of banding.
6. Banding is factory assembled to mounting.
7. Zinc plated, golden iridite finish.
8. Available with galvanized banding (Model RT) or stainless steel banding (Model RT-ST).



HIGH STRENGTH ALUMINUM GUY CABLE, HIGHLY CORROSION RESISTANT
Special 56S Alclad alloy. 7 strands, 17 gauge specially tempered and normalized. Special tight weave. Will not rust or stain. Specifically for guying use. Breaking strength: approx. 500 lbs. pull. Boxed in 100 ft. coils or ten 100 ft. coils, interconnected, 1000 ft. to box.

South River

METAL PRODUCTS CO., INC.

South River, New Jersey

PIONEER MANUFACTURER AND OUTSTANDING PRODUCER OF THE FINEST LINE OF ANTENNA MOUNTING ACCESSORIES

WRITE FOR OUR NEW 1956 CATALOG

The June RADIO-ELECTRONICS Goes on sale May 24

ELECTRONICS

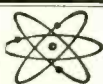

Prepare for unlimited opportunities of the Electronic Age! Earn your B.S. degree in 27 months at Indiana Technical College. Intensive, specialized course. Comprehensive training in math and electrical engineering, advanced radio theory and design, television, electronics. Modern laboratories. Low rate. Also B.S. DEGREE IN 27 MONTHS in Aeronautical, Chemical, Civil, Electrical and Mechanical Engineering. G.I. approved. Enter June, September, December, March. Earn part of your expenses in Fort Wayne while studying. Write for catalog.

INDIANA TECHNICAL COLLEGE

1756 E. Washington Blvd., Fort Wayne 2, Ind.

Please send me free information on B.S. ENGINEERING DEGREE IN 27 MONTHS as checked.

Electronics Chemical Aeronautical
 Civil Mechanical Electrical

Name _____

Address _____

SPECIAL "HI-FI" OFFER

Amazing woven saran Hi-Fi Fabrics now available direct to every Hi-Fi enthusiast. Special yarns and constructions mean least distortion. In Mahogany, Walnut, or Blond at the special INTRODUCTORY PRICE of \$3.19 Ppd., per Sq. Yd. Money back guarantee. Send check or M.O. to HI-FI FABRICS INST., P. O. Box A, Huntington Station, N. Y.

LMB BOX CHASSIS OFFERS FREE

inside LMB boxes

10 tested kit diagram projects for the builder. Each one of these kit diagrams built by a recognized expert. Kit projects are complete in every detail. Circuit diagram, photo of project both front and rear photo. Rear photo shows wiring and parts. Detailed instructions for building, complete parts list and approximate cost. Complete to build except parts and your distributor can supply the parts. Ask your distributor for the list of LMB kit Diagram Projects. If he does not have them, write to

LMB 1011 Venice Blvd. Los Angeles 15, Calif.

NEW TUBES AND TRANSISTORS (Continued)

for printed circuits. The second unit has a screw type mounting and can carry 1 ampere. The third has a hexagon base screwstud mounting and is capable of handling 1 1/4 amperes.

5CG8, 6CG8

Two new nine-pin miniature type receiving tubes, each containing a medium-mu triode and a sharp-cutoff pentode in one envelope, have been announced by RCA. The tubes, the 5CG8 and 6CG8, are designed especially for use as combined oscillator and mixers in television receivers using an intermediate frequency of approximately 40 mc.

A feature of these tubes is a cathode

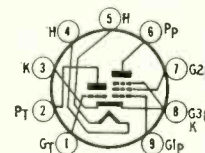

5CG8, 6CG8

having two leads (see base diagram) connected to separate base-pin terminals. This arrangement reduces the effective cathode-lead inductance, thereby minimizing input loading effects of the pentode mixer unit. This also makes it possible to eliminate a common return for the input and output circuits of the pentode mixer and thus minimize interaction between the two circuits.

The low capacitance between grid 1 and plate minimizes feedback problems often found in mixer circuits operating at an if of 40 mc. Feedback problems are especially troublesome on channel 2 because of the small difference between the channel frequency (54-60 mc) and the if. The low value of output capacitance permits the tube to work into a high-impedance plate circuit with resultant increase in mixer gain.

The 5CG8 and 6CG8 are highly useful in the design of AM-FM receivers. The pentode unit may be used in the AM section as a pentode mixer to provide high gain and in the FM section either as a pentode mixer or as a triode-connected mixer, depending upon signal-to-noise considerations. The triode unit of these tubes makes a satisfactory oscillator for either the AM or the FM section.

The 5CG8 is like the 6CG8 except that it is designed for series-string operation, having heater requirements of 4.7 volts at 600 milliamperes. The 6CG8 draws 450 ma at 6.3 volts.

2BN4, 6BN4

Medium-mu triodes of the seven-pin miniature type, the 2BN4 and 6BN4 are designed especially for use as rf amplifiers in grounded-cathode circuits of vhf television tuners.

The 2BN4 and 6BN4 each have a transconductance of 6,800 micromhos, permitting high gain and reduced equivalent noise resistance. The double base-pin connections (see base diagram) for both cathode and grid reduce the effective

(Continued on page 124)

For dependable replacement

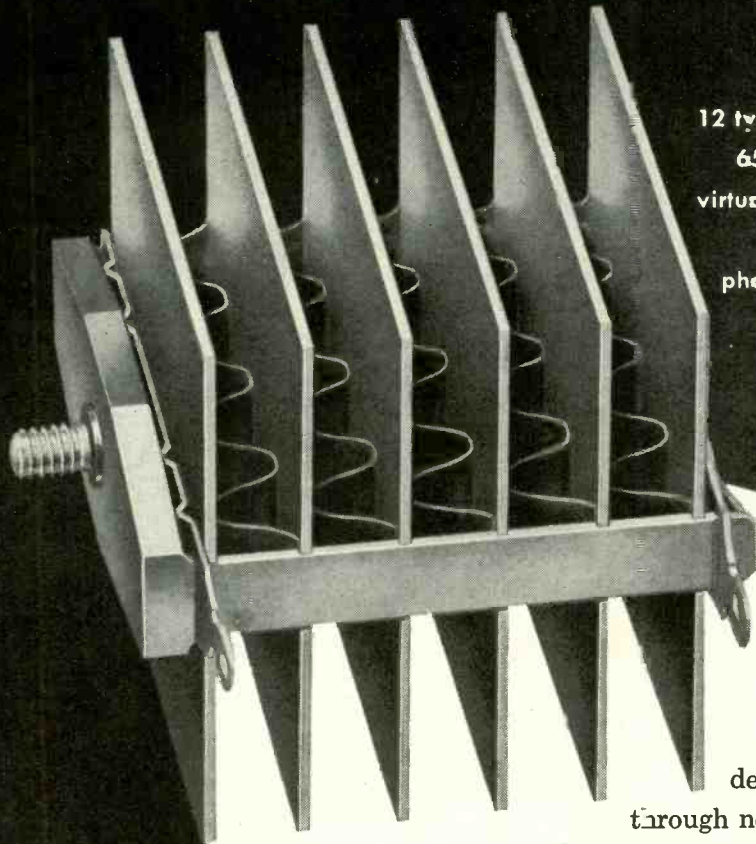

12 types—ratings from
65 ma to 500 ma—meet
virtually all your replacement
requirements in radio,
phonograph, hi-fi, and TV sets.

RCA SELENIUM RECTIFIERS
are manufactured to give
long and dependable
performance. This
dependability is made possible
through new, advanced design, careful
selection of production material, and thorough
quality control in manufacture. The new,
open design permits greater heat dissipation
... no possibility of center "hot spots."

RCA SELENIUM RECTIFIERS are a
dependable replacement line because they are
... cool in operation ... sturdy in
mechanical construction ... efficient
in electrical operation ... easy-to-install.













Now available through your RCA distributor!



RCA SELENIUM RECTIFIERS



RADIO CORPORATION of AMERICA
ELECTRONIC COMPONENTS
HARRISON, N.J.

-  65 ma—#205G1
-  75 ma—#200G1
-  100 ma—#206G1
-  150 ma—#201G1
-  200 ma—#207G1
-  250 ma—#208G1
-  300 ma—#226G1
-  350 ma—#209G1
-  400 ma (compact)—#210G1
-  400 ma—#213G1
-  500 ma (compact)—#211G1
-  500 ma—#214G1

Align in HALF

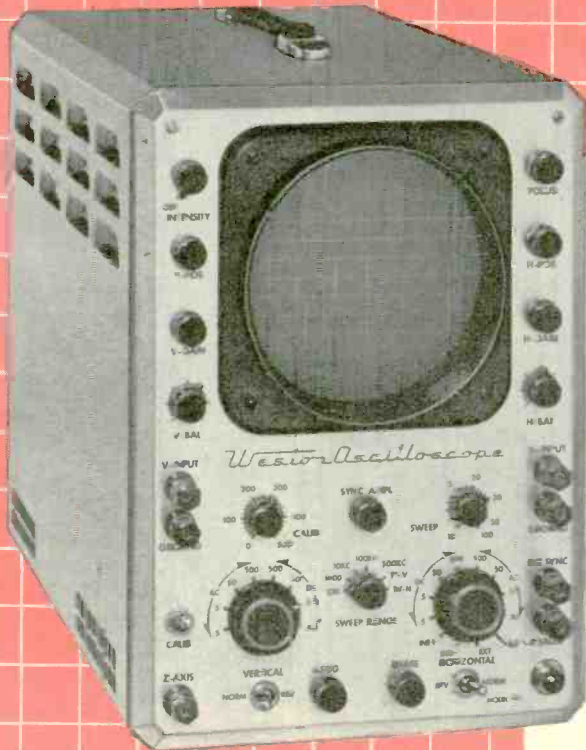

Model 983 WESTON Oscilloscope **\$329.50 net**



Model 984 WESTON Sweep Generator **\$199.50 net**

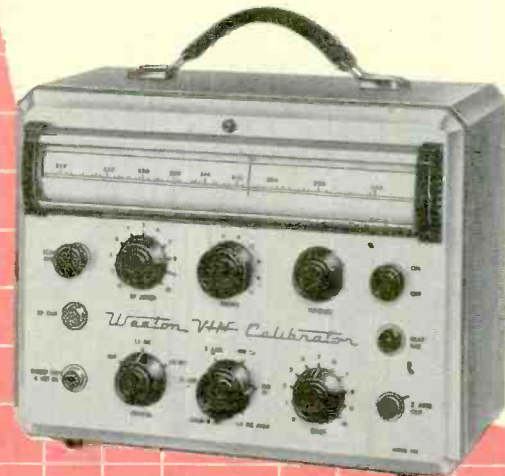

Model 985 WESTON Calibrator **\$199.50 net**

WESTON Simplified Method of Visual Alignment

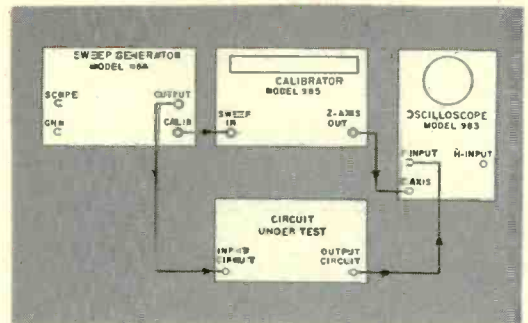

Conventional Method of Alignment

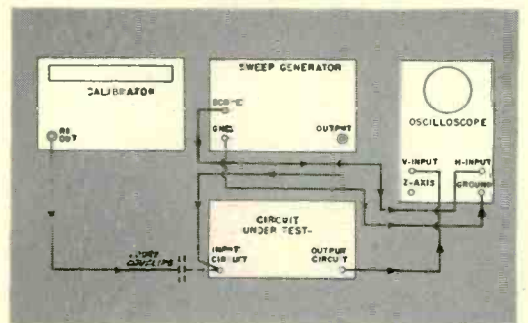

the usual time!

Simplified WESTON method makes aligning quick-easy-profitable for every serviceman!

There's real money in alignment . . . now that it's no longer necessary to use complicated, time-consuming methods. The Weston method is so *quick*, so *simple*, any serviceman can complete any alignment job in one hour maximum.

Note the simplicity of the hook-up illustrated at the left, in which the calibrator is *not* connected to the circuit under test. With only two simple connections to the receiver, oscillations encountered in conventional methods are entirely eliminated. Further, there is no disappearance of markers at trap frequencies. Z-axis modulation of the scope provides accurate intensity markers on the response curve under conditions where beat note markers would not be visible. Response curves are not disturbed. Annoying

trimmer touch-up on trap circuits is minimized. (See marker presentations shown below.)

All you need to align simply, quickly, and get the big profits from this constantly increasing class of work are the WESTON Calibrator and Sweep Generator, and the Weston Oscilloscope or any scope with provisions for Z-axis intensity modulation.



SEND for CATALOG NOW! A new catalog describing this simplified method and the instruments used, is available for the asking. Also included are descriptions of other Weston Test equipment including - Model 980 Volt-Ohm-Milliammeter \$42.50 net - Model 982 VTVM at \$69.50 net - Model 981 Tubechecker at \$199.50 net. Send for your copy now.

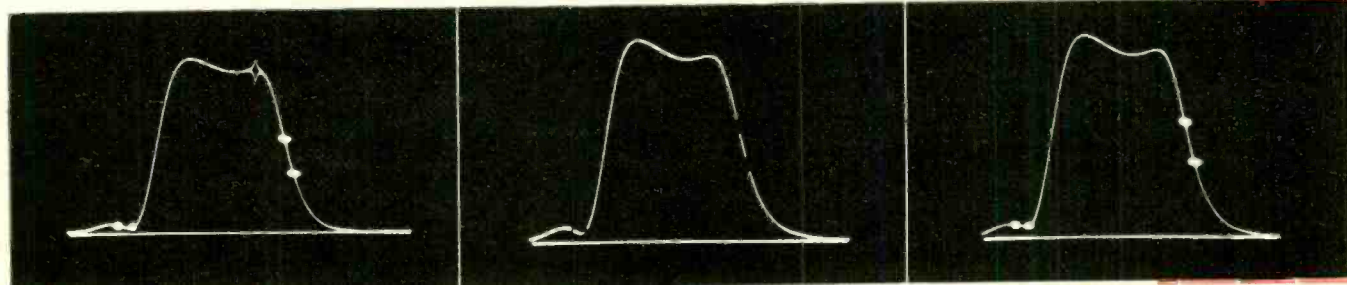

Simultaneous marker presentation of video and sound carrier frequencies (positive intensity markers).

Simultaneous marker display of video and sound carriers (negative intensity markers).

Note that with intensity markers there is no possible misinterpretation with spurious responses.

WESTON *Electronic Testing Equipment*

WESTON Electrical Instrument Corporation, 614 Frelinghuysen Avenue, Newark 5, N. J.
A subsidiary of Daystrom, Incorporated

more
Cannon lines
 now available
 at jobbers'
 shelves!

Write for ICC
 and RJC catalogs TODAY!

Twenty pages of
 information on 14
 different lines of
 Cannon connectors,
 including list prices
 on more than 850
 individual items.
 130 illustrations.

Audio, military, general industrial.
 Get your copies... NOW!

When you write for our catalogs... Please refer to this magazine or Dept. 144

CANNON PLUGS



CANNON ELECTRIC COMPANY
 3209 Humboldt St., Los Angeles 31, California
 Factories in Los Angeles; East Haven; Toronto,
 Canada; London, England. Representatives and
 distributors in all principal cities.



AN3108B Plug AN3102A receptacle

"AN" (Air Force-Navy) Series Connectors

Proved in military service. World-wide standard. Lightweight. Uniform in quality. Interchangeable inserts. Threaded coupling nut. Rapid and easy disconnect. Cable clamps and other accessories.



K-21C Plug K-32S receptacle

Cannon "K" Series

All-purpose... Adapted to a variety of general electrical and electronic applications. Special Acme thread. Rugged. 220 contact layouts available.

NEW TUBES AND TRANSISTORS (Continued)
 tive lead inductance and resistance with a resulting reduction in input conductance. The special basing arrangement of these tubes permits excellent isolation of input and output circuits,

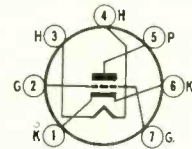

2BN4, 6BN4

neutralization and short, direct connections to the base-pin terminals.

The 2BN4 is like the 6BN4, both announced by RCA, except that it is designed for series-string operation. Its heater requirements are 600 milliamps at 2.1 volts. The 6BN6 draws 200 ma at 6.3 volts.

Characteristics as a class-A amplifier are as follows: plate voltage, 150; cathode-bias resistor, 220 ohms; amplification factor, 43; plate resistance (approximately), 6,300 ohms; transconductance, 6,800 micromhos; plate current, 9 ma; grid voltage (approximately) for plate current of 100 microamperes, -6.

Service-designed tubes

G-E has added six more popular receiving tube types to its "service-designed" line (see photo). These tubes, G-E states, provide greater safety factors than called for in the standard product and thus perform well in most circuits.

The six new service-designed types,

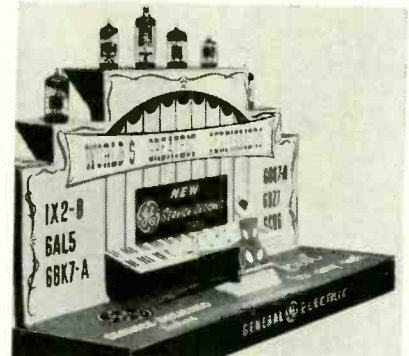

and the improved features of each, are:
 1X2-B—A tungsten shield post construction alleviates filament pullout. An improved filament coating gives better electron emission. A flyback operation life test insures quality.

6AL5—New heater construction prevents flash burnouts by initial surge current.

6BK7-A, 6BQ7-A and 6BZ7—Have construction features for greater heater reliability and freedom from heater-cathode shorts in cascode amplifiers. High zero-bias mutual conductance for improved fringe-area reception.

6CB6—A special alloy screen grid handles increased heat dissipation found in some video and if amplifier circuits and prevents control-to-screen grid shorts. Special mica spacers reduce interelement leakage and reduce age troubles in some television circuits. This tube also has a high zero-bias mutual conductance. END

SENSATIONAL
 ... is the word for the Miller
**#595 NEGATIVE MUTUAL
 COUPLED BROADCAST
 BAND-PASS DIODE TUNER**

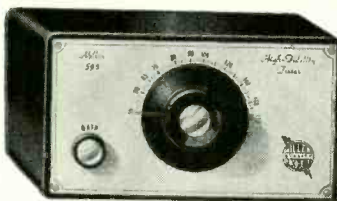

Only 4" x 7" x 3 1/2" Deep

The most amazing High Fidelity Broadcast tuner ever offered to music lovers anywhere. High Fidelity fans will be pleasantly surprised with the tonal quality, selectivity, and sensitivity of this marvelous tuner. The frequency response is limited only by the audio system used. Freq. Range 540 KC to 1700 KC.

A beautiful Black or Ivory bakelite cabinet houses the tuner with a Richlow brass etched panel for the escutcheon. Both combine to complement any decor.

Like all Miller products this #595 tuner is guaranteed to perform to your satisfaction. Buy from your Radio and TV Parts Distributor, or High Fidelity Dealer.



#595 Tuner net price only **\$19.50**
 plus excise tax.

SEE YOUR DISTRIBUTOR FOR
 LITERATURE OR WRITE DIRECT

J. W. MILLER COMPANY
 5917 S. MAIN ST., LOS ANGELES 3, CALIF.



COYNE
 TRAINS YOU
 IN SPARE TIME
 AT HOME

TELEVISION
 RADIO-COLOR TV

Only from famous COYNE do you get this modern up-to-the minute TV Home Training. Easy to follow instructions—fully illustrated with 2150 photos and diagrams. Not an old Radio Course with Television tacked on. Includes UHF and COLOR TV. Personal guidance by Coyne Staff. *Practical Job Guides* to help you EARN MONEY QUICKLY IN A TV-RADIO SALES AND SERVICE BUSINESS—part time or full time. COSTS MUCH LESS—pay only for training—no costly "put together kits."

SEND COUPON FOR FREE BOOK

SEND COUPON BELOW for Free Book and full details including EASY PAYMENT PLAN. NO COST OR OBLIGATION—NO SALESMAN WILL CALL.



B. W. COOKE, Pres. **COYNE** FOUNDED 1899
ELECTRICAL SCHOOL

A TECHNICAL TRADE INSTITUTE OPERATED NOT FOR PROFIT
 500 S. Paulina Dept. 56-HT-4, Chicago 12, Illinois

COYNE ELECTRICAL SCHOOL
 Television Home Training Div.
 500 S. Paulina St., Chicago 12, Ill., Dept. 56-HT-4
 Send FREE BOOK and details of your Television Home Training offer.

Name _____
 Address _____
 City _____ State _____

Patents



PULSE CALIBRATION

Patent No. 2,719,232

Robert W. Ehrlich, W. Orange, N. J. (Assigned to American Telephone & Telegraph Co.)

This describes an accurate method for calibrating a low-frequency pulse generator without using an oscilloscope.

To calibrate, the measuring circuit (including the galvanometer is plugged into connector J. (See Fig. 1.) When impulse relay RY is energized by the pulse generator (as shown), the

During a pulse the voltage across the meter will be a combination of ac from the line and dc from the battery. Now if the pulse rate (pps) is an exact submultiple of 60 cycles, the break will occur at an identical point on the voltage waveform across the meter. For example, assume a pps of 30. Then the break will occur *once* for

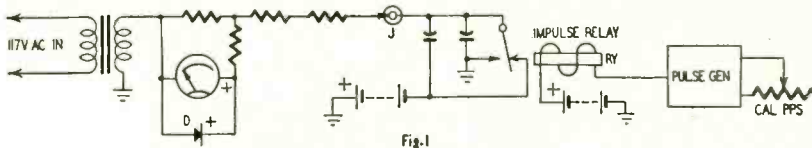

Fig. 1

negative battery terminal biases the cathode of meter rectifier D so it conducts and shorts out the meter. It is only during a "break" between pulses that the meter can deflect.

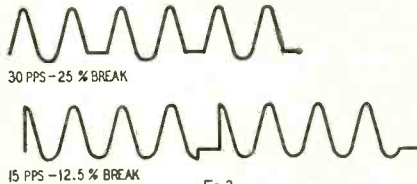

Fig. 2

each two cycles of line voltage (Fig. 2). Because of the submultiple relationship, the make and break of the relay will occur at identical points of every other sine wave, so the meter will show a steady deflection. If this relationship did not hold, the break would occur at different parts of the wave and the meter current would vary with time.

The pulse generator needs only a rough adjustment for frequency, that is, only an approximate calibration. Then the operator sets a control until the meter remains perfectly steady. This indicates that the pulse rate is some submultiple of 60, for example 30, 20, 15, etc.

CRYSTAL DISCRIMINATOR

Patent No. 2,724,089

John Ruston, Fair Lawn, N. J., (Assigned to Allen B. DuMont Labs, Inc.)

A frequency discriminator measures or indicates frequency deviation. Ordinarily the discriminator puts out zero voltage at a standard or center-value frequency. When the frequency shifts in one direction, the output is positive; when it goes in the other, the output is negative. The output voltage may be used as a control signal to control an oscillator and prevent it from drifting from its assigned frequency.

In this discriminator circuit a crystal is in series with impedance Z (about 1,2000 ohms), to form a voltage divider. The voltage across each of these elements is rectified by a separate diode and combined and filtered to produce a dc control signal at the output terminals. The output of D1 is always positive while that of D2 is always negative. At the chosen center frequency f_0 , the crystal and impedance Z have equal impedance, so the rectifier outputs combine and cancel. This frequency f_0 must be intermediate between the series-resonant frequency f_s of the crystal and its parallel-resonant frequency f_p . A crystal has minimum impedance at frequency f_s and maximum at f_p .

At frequencies above f_0 , the crystal has the greater impedance and D1 has the greater output. Thus the control voltage must be positive. It will be *negative* at frequencies *below* f_0 because D2 has greater output. This control voltage is fairly linear between f_s and f_p .

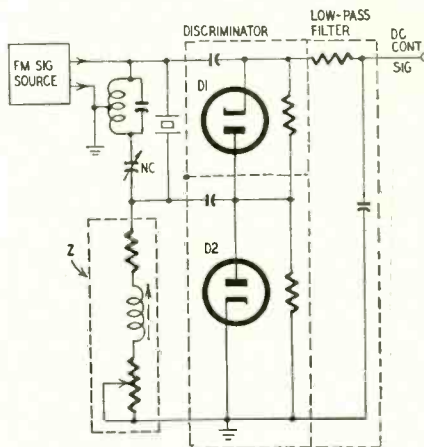

A trimmer neutralizing capacitor balances out the capacitance of the crystal holder to some extent and thus adjusts f_p as desired. For any crystal, series-resonant frequency f_s remains constant.

SOLDERLESS CONNECTOR

Patent No. 2,716,226

Walter Monroe Jonas, No. Bergen, N. J. (Assigned to Reiner Electronics Co., Inc., New York)

A good wire connection is ordinarily made by soldering. This is easy and convenient when suitable soldering iron is handy, but there are occasions when a substitute method is required. For example, a solderless connection has definite advantages from a military viewpoint or during

civil emergency when no power is available.

The method shown here requires only a screwdriver. The diagram illustrates one form of solderless connector. Screw S is made of somewhat smaller diameter than the bore or threaded metal cylinder C into which it is to fit. The wires to



DETERIORATION PROOF

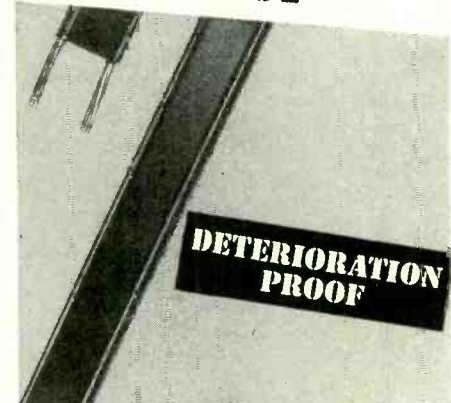

DETERIORATION PROOF

Columbia
PERMALINE
 TV TRANSMISSION LINE

Guaranteed up to 25 years

- ★ Reduces Nuisance Calls for Servicemen
- ★ Provides Longer Life
- ★ Resists Deterioration

Send for Sample and Descriptive Literature

Available at leading distributors!

Columbia

WIRE & SUPPLY CO.

2850 IRVING PARK ROAD

CHICAGO 18, ILLINOIS

Your Partner for Profitable Installations . . .
TELCO VHF-UHF ANTENNAS and your **TELCO Distributor!**

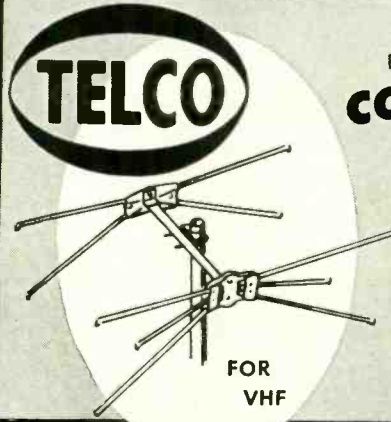

BRING YOU THE MASTERLINE
CONICAL ANTENNA
 ALL ALUMINUM!

ALUMINUM CROSS ARM—high Tensile Alloy.
UNBREAKABLE INSULATOR—made of Styron.
DOWELED ELEMENTS—doweled with 6" dowels.
 $\frac{3}{8}$ " diameter, closed end aluminum elements.
DOUBLE LIFE AGAINST RUST . . . zinc plated
 and dicromate dipped insures long-lasting
 protection.
CROSS BAR ASSEMBLED . . . insures fast instal-
 lation.
ALL CHANNEL COVERAGE engineered for peak
 reception.

| | |
|---------------|------------------|
| No. A-8700-8S | 8-Element 1-Bay |
| No. A-8700 | 10-Element 1-Bay |
| No. A-8702-8S | 8-Element 2-Bay |
| No. A-8702 | 10-Element 2-Bay |

FOR
 VHF

TELCO ELECTRONICS MFG. CO.

Division of General Cement Mfg. Co.

919 Taylor Avenue, Rockford, Illinois

FREE COPY . . . Telco "Supermarket" Catalog. Send postcard today!



Telco
 Roto-Indoor
 Antenna
 No. A-9263

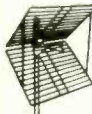

Telco
 Deluxe Corner
 Reflector
 No. A-8984



Telco UHF
 10-Element
 Golden
 Yagi No.
 A-320



With such a wide variety of TELCO Antennas to choose from, you can be sure of profitable installations regardless of distance or location. Your nearby TELCO distributor will be glad to show you the complete TELCO line.

SEE US . . . BOOTH 590—ROOM 612—PARTS SHOW



**DON'T
 THROW
 OLD
 RADIOS
 AWAY!**

Here's the data you need
 to fix old sets **FAST**—good as new

Just look up the how-to-do-it data on that old radio you want to fix!

Four times out of 5, this giant, 3 $\frac{1}{2}$ -pound, 744-page Chirardi **RADIO TROUBLESHOOTER'S HANDBOOK** gives exactly the information you need to fix it in a jiffy. Tells what is likely to be causing the trouble . . . shows how to fix it. No useless testing. No wasted time. Handbook covers common troubles and their remedies in practically every radio receiver model made by 202 manufacturers between 1925 and 1942. Using it, even beginners can easily fix old sets which might otherwise be thrown away because service information is lacking. With simple repairs, most of these old sets can be made to operate perfectly for years to come.

THE ONLY GUIDE OF ITS KIND!

Cuts service time in half!

Included are common trouble symptoms and their remedies for over 4,800 models of old home, auto radios and record changers, Airline, Apex, Arvin, Atwater Kent, Belmont, Bosch, Brunswick, Clarion, Crosley, Emerson, Fada, G-E, Kolster, Majestic, Motorola, Philco, Pilot, RCA, Silvertone, Sparton, Stromberg and dozens more. Gives how-to-do-it data on **SPECIFIC** jobs—NOT general theory. Includes hundreds of pages of tube and component data, service short cuts, etc., no longer available from any other source still in print.

...**TRY IT 10 DAYS** . . . at our risk!

Dept. R.E.-56, RINEHART & CO., Inc.
 232 Madison Ave., New York 16, N.Y.
 Send Chirardi's **RADIO TROUBLESHOOTER'S HANDBOOK** for 10-day free examination. If I decide to keep book, I will then remit the full price of only \$8.50 plus a few cents postage. Otherwise, I will return book postpaid and owe you nothing.

NAME.....

ADDRESS.....

CITY, ZONE, STATE.....

Outside U.S.A.—Price \$7.00, cash only. Same return privilege

Rinehart Books are sold by leading book stores

**E-Z WAY
 TOWERS**

Looking for a tower that is easy to erect yet strong enough to withstand severe winds? This is it! E-Z Way Towers will stand a wind load of 40-60 lbs. per sq. ft. And with the new E-Z Way portable gin pole it's easy to erect a 120 ft. tower in one piece *without leaving the ground*. Unbelievable, isn't it? But E-Z Way Towers have been tested and proven. Thousands of E-Z Way Towers are giving outstanding service in all parts of the country and abroad. That's why E-Z Way is the Industry's New Leader. Find out about E-Z Way now!

**SEND TODAY FOR
 FREE CATALOG**

Dept. CE, E-Z Way Towers
 P. O. Box 5491, Tampa, Florida
 Send me your **FREE** catalogue on the following towers:

AM Radio Television
 Ham Radio Two-Way Communication

I am interested in a tower ft. high.
 I will use a antenna.
 (State type and model)

Type of Rotor.....

Name.....

Address.....

City..... State.....

E-Z WAY TOWERS Inc.
 P. O. Box 5491 • Tampa, Fla.

Telephone 4-2171

PATENTS

(Continued)

be connected are pressed together and held tightly between the threads as the screw is driven into the bore. Actually the wires are bent into a corrugated pattern and make an excellent electrical and mechanical splice. Loose wire ends

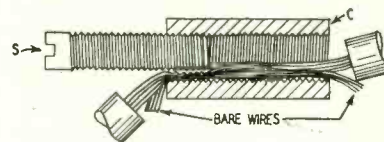

are snipped off and the connection taped or provided with an insulating jacket.

If necessary, these wires can be separated without damage.

TIRE PRESSURE ALARM

Patent No. 2,727,221

Edward A. Sprigg, E.

Orange, N. J.

(Assigned to Breeze Corporations, Inc.,
 Union, N. J.)

Tires on all types of vehicles—especially heavily laden trucks and trailers that travel at high speeds—must be inflated to a certain minimum pressure for safety and reduced wear. This is a radio warning system which notifies the driver when tire pressure falls too low. Tiny radio transmitters, located on each wheel, are actuated by a switch that closes whenever the pressure of a tire falls below the predetermined minimum. A receiver in the cab of the truck receives these impulses.

The switch that operates by the tire pressure is described in the patent notice. Briefly, when the tire loses air, a spring drives a plunger to

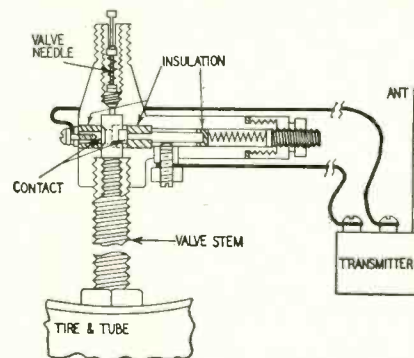

close switch contacts. Actual transmitter or receiver circuits are not described in the patent, but they must be tiny and may radiate very weak power. A transistorized printed-circuit network would seem practical.

As shown in the diagram, each tire is equipped with its own transmitter and antenna. A receiver in the cab picks up the signals. The inventor suggests a different frequency for each tire and perhaps colored lights on the dashboard to indicate which tire is at fault. **END**



"Well, you shouldn't have any more trouble with that .0001- μ f bypass. I put in an overrated replacement."

THE NEWEST!
Rebel K-3
CORNER SPEAKER CABINET KIT
 kitform of the original corner speaker horn
 ... one of 39 new units!
 slightly higher west and south **\$54**

Write for Complete Catalog
 36 pages of radio furniture kits and speakers for the high fidelity home music system.



cabinart '56

Cabinart

99 North 11th Street, Brooklyn 11, N. Y.
 largest manufacturer of cabinets and kits for hi fi
 a division of G & H Wood Products Co. Inc.

Quality, Style and Beauty



GPR 90

COMMUNICATIONS RECEIVER

- Six bands; .54 to 31 mc., AM, CW, MCW (FS with convert.)
- Accurate main tuning with full elect. bandspread
- Ferrite transformer, 75 ohm unbal. to bal. input
- One microvolt sensitivity on hf bands
- Image ratio; better than 60 db
- New Audio Selectivity design with variable bandwidth.
- 110 VAC 50/60 cy. appr. 90 Watts

Complete Receiver **\$395 net**
 Matching spkr **\$16.00**
 WRITE FOR BULLETIN N-179

The TECHNICAL MATERIEL CORPORATION

IN CANADA: TMC Canada, LTD. OTTAWA, ONTARIO
 MAMARONECK, NEW YORK

Technotes



HORIZONTAL OSCILLATOR COIL

Recently I was stuck with a defective oscillator coil used in a conventional horizontal multivibrator circuit (Fig. 1). With no replacement on hand and faced with the customer wanting the set in a hurry, I made up a new unit using a width coil having an age winding. The Merit MWC-1 was perfect.

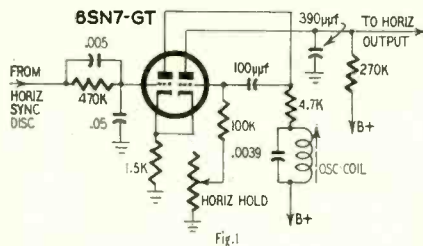

With the several windings and taps available, there are many ways of connecting them to get the required amount of inductance. Fig. 2 shows how the width coil was connected with the best results as a replacement for the oscil-

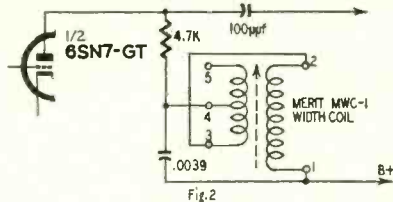

lator coil. This done, it was just a matter of adjusting the circuit on frequency, using the slug in the width coil. No other changes were necessary. There were no mechanical difficulties since the replacement is about the same size and mounts in the same manner as the original.—*Carl Lindfors*

MAJESTIC 7P420 RADIO

If the 50B5 in this receiver is gassy, the tubes will frequently burn out. When this appears to be the trouble, replace the 50B5. The heater voltages should be checked to see if they are normal after a good tube has been placed in the receiver.—*E. M. Breckenridge*

PHILCO C1908 RADIO

If a howl is heard after a defective output transformer has been replaced, reverse the plate connections of the transformer primary.

If full volume produces excessive distortion, with normal sound at average volume, the output transformer may be defective. This can be checked by measuring the voltage at the plates of the 7C5's. There will be equal voltages at

ATLAS SOUND CORP.
 1443 - 39 St., Brooklyn 18, N. Y.

Send **FREE** Buyer's Guide to save me money on public address Loudspeakers, Microphone Stands and accessories.

Name _____ Title _____
 Firm _____
 Type of Business _____
 Address _____
 City _____ Zone _____ State _____

HOW to SAVE MONEY on LOUDSPEAKERS and MIKE STANDS

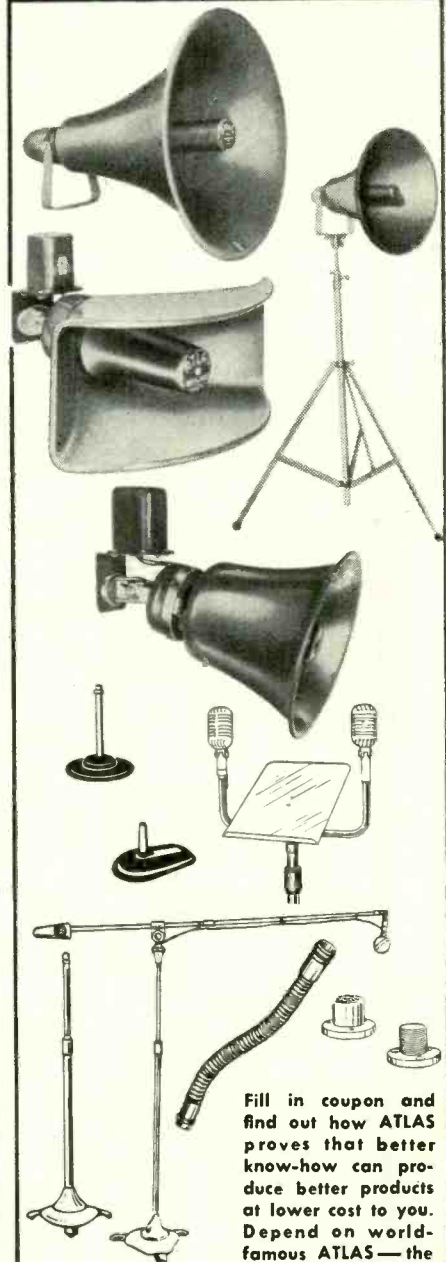

Fill in coupon and find out how ATLAS proves that better know-how can produce better products at lower cost to you. Depend on world-famous ATLAS—the complete quality line with specialist know-how since 1930.



ATLAS SOUND CORP.
 1443-39th Street, Brooklyn 18, New York
 In Canada: Atlas Radio Corp., Ltd., Toronto, Ont.

CUSTOM-BUILT CABINETS FACTORY TO YOU

3 LEADING 1956 STYLES in genuine Mahogany or walnut (blond 10% extra)
 • Ready drilled for any #630 TV chassis and cutout for any 16", 17", 19", 20" or 21" picture tube at no extra in price • Also supplied with undrilled knob panel for any other TV set • EVERYTHING NECESSARY for an easy perfect chassis and CRT assembly is included • Each cabinet is delivered complete as pictured with mask, safety glass, mounting brackets, backboard, backcup, hardware and assembling instructions
 • Each cabinet is shipped in an air cushioned carton from **FACTORY TO YOU!**

GEM \$35.91

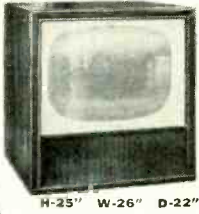

GEM also available for 24" or 27" picture tube
\$59.54

H-25" W-26" D-22"

WESTCHESTER \$88.70

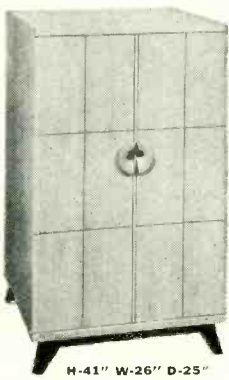

H-41" W-26" D-25"

MANHATTAN \$53.43

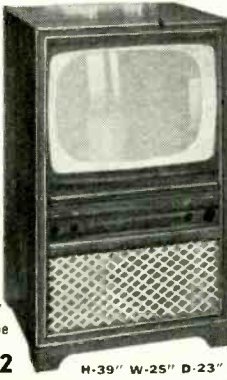

H-39" W-25" D-23"

MANHATTAN also available for 24" or 27" picture tube
\$79.22

DUMONT OR THOMAS PICTURE TUBES

BRAND NEW in Factory Sealed Cartons — With a Full Year Guarantee

17" #17BP4A \$22.66 | 21" #21EP4B Aluminized \$32.21 | 24" #24CP4A Aluminized \$48.99 | 27" #27EP4A Aluminized \$74.31

TUBULAR CONDENSERS—85°C

TOP QUALITY—Equally as good for TV or Radio Work. Example of value we offer047—600v lists at 36c

| | | | |
|----------------|-----|-------------|-----|
| .005—100v | 4c | .047—600v | 9c |
| .01—400v | 5c | .1—600v | 12c |
| .02—100v | 5c | .25—600v | 14c |
| .047—100v | 7c | .001—1000v | 11c |
| .1—100v | 9c | .01—1000v | 14c |
| .25—100v | 12c | .035—1000v | 16c |
| .005—600v | 7c | .05—1000v | 18c |
| .01—600v | 8c | .1—1000v | 22c |
| .02—600v | 8c | .5—100v | 28c |
| 20 mfd—150v | 27c | 8 mfd—450v | 26c |
| 40/40 mfd—150v | 38c | 40 mfd—450v | 49c |
| 50/30 mfd—150v | 39c | 80 mfd—450v | 56c |

MICA & CERAMIC CONDENSERS

Values up to 85c each
 5, 10, 51, 56, 82, 100, 120, 150, 220, 270, 330, 390, 470, 510, 680, 1000, 1200, 1500, 3900, 6800 MMF Your choice **5c** each

CARBON RESISTORS

Regular factory stock in Stockpole. I.R.C. Speer. Order any ohmage from 2.2 ohms to 10 meg in the desired tolerance. Deduct 10% on lots of 100 or over.

1/2 WATT, 5%5c 10%4c 20%3c
 1 WATT, 5%6c 10%5c 20%4c
 2 WATT, 5%9c 10%7c 20%5c

SELENIUM RECTIFIERS

| | |
|-----------------------|--------------------|
| 65 ma. \$.46 | 250 ma. . . \$1.08 |
| 75 ma.49 | 300 ma. . . 1.19 |
| 100 ma.62 | 350 ma. . . 1.26 |
| 150 ma.74 | 450 ma. . . 1.42 |

PM SPEAKERS (ALNICO #5)

Brand New Factory Guaranteed Stock 1 oz. mag. on 3" to 6", heavier mag. on 8" & 12"

| | |
|---------------------|---------------------|
| 3" \$.98 | 6" \$1.58 |
| 4" 1.17 | 8" 2.64 |
| 5" 1.29 | 12" 4.67 |

REGAL RADIOS

Licensed by RCA, Complete with Tubes, Ready to plug in and play

At Less Than 1/2 List Price

Model #471 5 Tubes

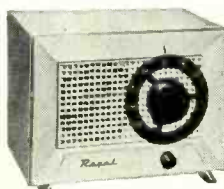

List \$25.50 slashed to **\$11.97**

Model #271 5 Tubes



List \$30.95 slashed to **\$14.32**

3-Way Portable #1877



List \$36.95 slashed to **\$16.99**

* Colors on #471, 271 and 1877 are Walnut, Ivory, Ebony and Maroon. In event we cannot supply specified color, we will send next available color. Catalog showing all Model REGAL RADIOS, on request.

SPECIAL TV PUBLICATIONS

Brooks LIFE-SIZE TV INSTRUCTIONS for building any #630 TV Receiver from the original 10" to the latest 27" \$1.25 postpaid
 90° TV CONVERSION MANUAL, how to convert any TV SET to 24", 27", etc. 50c postpaid
 70° TV CONVERSION MANUAL, how to convert any TV SET to 17", 21", etc. 50c postpaid
 HINTS FOR BETTER PERFORMANCE on your #630 TV receiver. 50c postpaid
 Brooks CASCODE MANUAL, how to install Cascade Tuner in any make TV set. 25c postpaid
 A.G.C. STEP-BY-STEP INSTRUCTIONS, how to add A.G.C. to any make TV Receiver. 25c postpaid

FREE CATALOG mailed on request

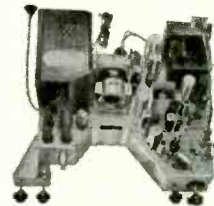

Build your own
SUPER DE LUXE 31-TUBE #630 TV CHASSIS

#630 SUPER DELUXE 31-TUBE TV KIT OPERATES 16" to 21" PICTURE TUBES • Engineered in strict adherence to the genuine RCA #630 plus added features • FULL AND BROAD BANDWIDTH • CASCODE TUNER • COSINE DEFECTION YOKE • LARGER POWER TRANSFORMER • KEVED AGC • 12" SPEAKER • CONDENSERS AND RESISTORS at rated capacities and tolerances. You receive a COMPLETE SET OF PARTS and TUBES, everything needed is included (less CRT & wire). All I.F. Coils and Transformers are factory pre-aligned and tuned. You will enjoy building it with "LIFE-SIZE easy to follow step-by-step ASSEMBLING INSTRUCTIONS" included with each KIT.

Slashed to **\$99.99**

Similar KIT for 24" or 27" CRT **\$110.39** slashed to

#630 SUPER DE LUXE TV CHASSIS

LICENSED UNDER RCA PATENTS
 COMPLETE READY TO PLUG IN AND PLAY
 Similar in features to the 16" to 21" TV KIT above.
 Slashed to **\$142.27** (less CRT)

#630 B TECHMASTER

COMPLETE LINE AT SPECIAL PRICES
 Catalog mailed on request

STANDARD CASCODE TUNER

For better all around performance
 Complete with tubes and Brooks CASCODE MANUAL with step-by-step instructions and all extra parts needed. **\$15.97**

21" TV CONVERSION KIT

NOW . . . Anyone with even a limited knowledge of TV—can Convert any Size, any Make TV RECEIVER to operate 21" or any 70° Picture Tube.

COMPLETE SET OF ESSENTIAL PARTS includes matched set of Todd 70° COSINE DEFECTION YOKE and TODD HV FLYBACK TRANSFORMER, FOCALIZER, 20KV FILTER, DRIVE TRIMMER, LINEARITY COIL, CONDENSERS, RESISTORS.

Your price... **\$13.97** List Price \$33.50
 Incl. CONVERSION MANUAL with Step-by-Step Instructions & Diagrams.

Similar Kit for 24", 27" or any 90° CRT **\$15.98**

UNIVERSAL Picture Tube MOUNTING BRACKETS

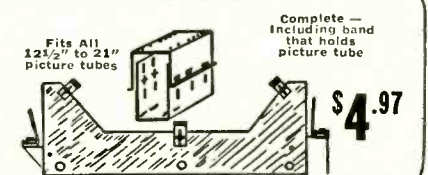

Fits All 12 1/2" to 21" picture tubes
 Complete — including band that holds picture tube
\$4.97

PULSE KEYED AGC KIT

Finest, most accurate and the easiest Kit to install in any make TV RECEIVER including the No. 630. Improves performance and insures a steady picture on all channels.
 COMPLETE SET OF PARTS **\$2.99**
 Including 6AU6 tube & Instructions

BROOKS RADIO & TV CORP., 84 Vesey St., Dept. A, New York 7, N.Y. TELEPHONE CoRtland 7-2359

normal volume levels, slightly different at high volume levels.—*Lyle Briggs*

PICTURE FLUTTER

A common cathode lead impedance in a combined first audio and age circuit often produces picture flutter. A typical circuit (Emerson 120166-D) is shown in Fig. 1; Fig. 2 shows the equivalent circuit containing resistance, inductance

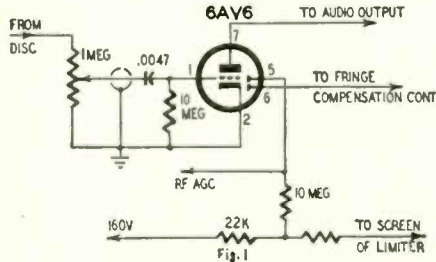

and capacitance. A voltage is developed across this impedance and impressed on the age line, regardless of the amount of age filtering. Thus, the age voltage will vary with sound volume, causing the gain of the rf amplifier to vary at the audio rate and the picture to flutter.

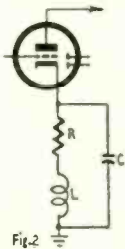

The cause of this trouble is often a cold solder joint that creates a high-resistance path in the cathode circuit. Sometimes it is merely a very long lead that can easily be shortened or supplemented with a braid from the cathode terminal to ground. To check, turn the volume on full and watch for this effect.—*James A. McRoberts*

RCA TELEVISION SETS

To improve sound and picture gain in the early RCA split-sound receivers, change the first and second picture if cathode resistors from the original 120 ohms to 80 ohms. This modification is especially helpful in fringe areas. Also move the sound takeoff on trap T103 up two turns on the coil. This provides additional 21-mc sound signal for the if amplifier. Realign the set after this change.—*W. S. Ross*

RCA 21-INCH COLOR TV

In the 21-CT-661U and 21-CT-662U receivers color edges may be improved by a change in the 6AZ8 bandpass amplifier stage. Resistor R232 (Fig. 1) should be changed to a 2,700-ohm 1/2-watt unit. The bandpass and first video amplifiers should then be realigned to give the response curve in Fig. 2.

A further change was made in the bandpass amplifier to make its bias track better with changes in burst level. This is desirable in areas where both strong and weak signals are encountered. Disconnect pin 2, the screen grid of the bandpass amplifier, from terminal A of T113, the bandpass trans-

C-D features the NEW COMPLETE line of Communication Vibrators

... in 6 and 12 Volt Series

that outlast them all!

Here is everything needed for complete service on communication vibrator replacements! Engineered to rigid U.S. Gov't specifications, these new C-D Vibrators outlast them all . . . out-perform others and give you the RIGHT vibrator for EACH application!

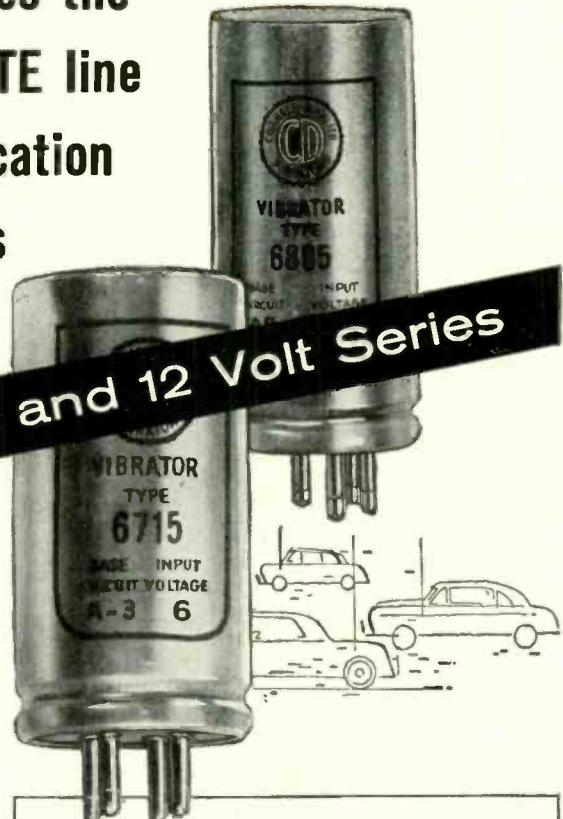

Ten Types Provide Complete Replacement for ORIGINAL Communication Equipment
The proper voltage for each application.

| New No. | | Old No. |
|---------|---------|---------|
| 6 volt | 12 volt | |
| 5715 | 6715 | 5515 |
| 5718 | 6718 | 5518 |
| 5721 | 6721 | * |
| 5722 | 6722 | * |
| 5725 | 6725 | * |
| 5805 | 6805 | 5605 |
| 5820 | 6820 | 5620 |
| 5821 | 6821 | 5621 |
| 5822 | 6822 | 5622 |
| 5824 | 6824 | * |

For Specific Applications, see the NEW C-D Vibrator Guide



Cornell-Dubilier Vibrators

PLANTS IN SOUTH PLAINFIELD, N. J.; NEW BEDFORD, WORCESTER AND CAMBRIDGE, MASS.; PROVIDENCE AND HOPE VALLEY, R. I.; INDIANAPOLIS, IND.; SANFORD AND FUGUAY SPRINGS, N. C.; SUBSIDIARY: THE RADIART CORPORATION, CLEVELAND, OHIO

SUBSCRIBERS . . .

If you're moving, please don't forget to send us your old address as it appears on the address label of your current copy of the magazine, including the numbers shown beside your name, as well as your new address. If we receive this information before the 20th of the month, you will continue getting the magazine without interruption. Your cooperation will be most helpful and greatly appreciated.

We, too, have a new address:

Subscription Department
RADIO-ELECTRONICS
154 West 14 St.
New York 11, N. Y.



House Current Anywhere

with **TERADO** Trav-Electric CONVERTERS

JUST PLUG INTO CIGAR LIGHTER ON DASH

"101" USES—No need to leave appliances for work or pleasure behind. Take them along. Use them on business trips, camping, at the cabin, hunting, etc. Just plug Trav-Electric into cigar lighter on dash. Plug appliances into Trav-Electric. That is all!

6 MODELS—for both 6 and 12 volt batteries. All models change battery current to 110 volt A.C. 60 cycle, same as at home. Sizes 2" x 2" x 3½" to 4" x 5" x 6". Capacities: 10 to 125 watts. Fully guaranteed. List prices: from only \$11.95 to \$54.95.

See your Jobber Salesman, or write for name of nearest Jobber.

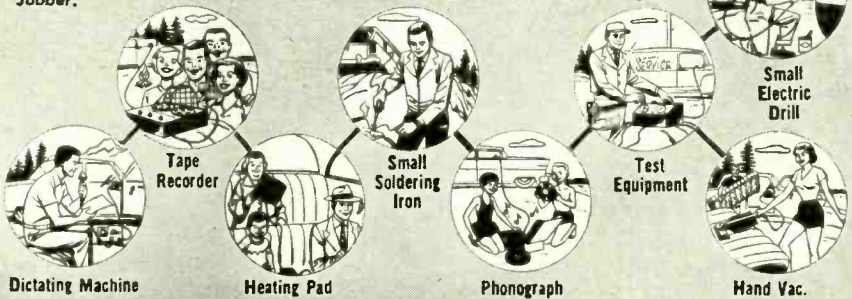

TERADO COMPANY
Mfrs. of Electronic Equipment Since 1927

1057 Raymond Ave., St. Paul 14, Minn.

In Canada write: Atlas Radio Corp., Ltd. 50 Wingold Ave., Toronto 28, Ont. Export Sales Division: Scheel International, Inc., 4237 N. Lincoln Ave., Chicago 18, Ill., U. S. A. —Cable Address—Harscheel

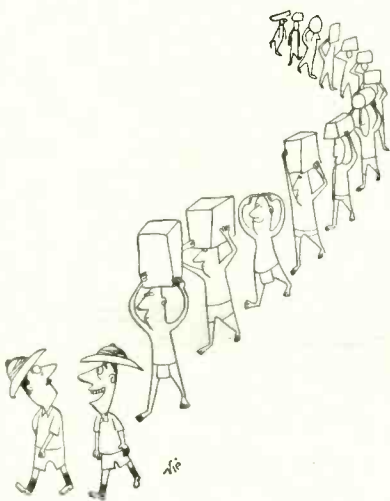

"That third guy? He's the serviceman carrying the **JENSEN NEEDLE!**"

Every ELECTRONIC TUBE IN 3 MANUALS

WORLD'S RADIO TUBES

Radio Tubes Vade Mecum
Characteristics of all radio tubes made in all countries. World's most authoritative tube book. Classified numerically and alphabetically. Find any tube in seconds. Base connection section. **\$5.00**

WORLD'S EQUIVALENT TUBES

Equivalent Tubes Vade Mecum
All replacement tubes for a given type, both exact and near-equivalents (with points of difference detailed). Normal and advanced comparisons. Military tubes of 7 nations, with commercial equivalents. Over 43,900 comparisons! **\$5.00**

WORLD'S TELEVISION TUBES

Television Tubes Vade Mecum
Characteristics of all TV picture, C.R. and special purpose tubes. A "must" for all specialists. **\$5.00**



BUY FROM YOUR DISTRIBUTOR
Add 10% on direct mail orders to
EDITORS and ENGINEERS, Ltd.
Summerland 3, California

TECHNOTES

(Continued)

former, and re-connect to the 140-volt bus at pin 7 of the age amplifier. Connect an 18-megohm resistor from ter-

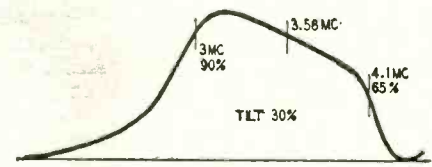
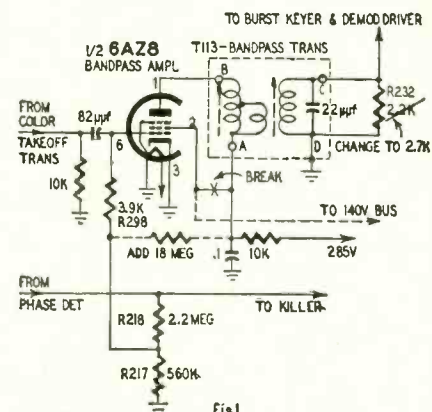

terminal A of T113 to the junction of R298, R217 and R218.—RCA Television Service Tips

MAGNAVOX-COLLARO 45 RPM

If the 45-rpm adapter for the above changer fails to function, it can usually be repaired easily in the field. The procedure for checking is:

1. Remove the retaining ring on the bottom of the center shaft. You can now remove the metal base, the bottom sec-

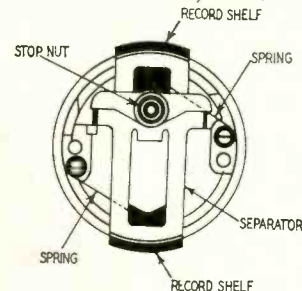

tion of the adapter and the large coil spring (see diagram). **Caution:** Do not lose the brass shim on the hub of the center shaft.

2. Remove the two screws holding the top and center sections together. These are accessible from the bottom of the center section.

3. While holding the two sections vertically, lift the top section straight up so as not to disturb the springs holding the plastic shelves in position.

4. Loosen the elastic stop nut and clean the record separator parts with carbon tet so they are free of dirt and will slide easily. (Service cleaners other than carbon tet are safer and should be used.—Editor)

5. Make sure both springs are in place, tighten the elastic stop nut until there is no play in the record separators and then back off about ¼ turn.

6. Reassemble the adapter, following the reverse order of the disassembly instructions.—Magnavox Service News Letter

END

to
be
SURE!

buy
VOKAR

the original-
equipment
VIBRATOR



Leading manufacturers of original-equipment auto-radios specify Vokar vibrators as components for installation on the production-line. Why? They're *sure* Vokar quality never varies —will always contribute to top performance demanded of today's radios.

You too can depend on Vokar vibrators—for sure starts, longer life, silent operation. For all replacement jobs, buy Vokar Imperial or Quality Brand vibrators to be *sure* of satisfied customers.

Now is the time to stock up on 12-volt vibrators—**ONLY TWO VOKAR IMPERIALS ARE NEEDED TO FILL ALL REPLACEMENTS!**



VOKAR—preferred by leading manufacturers of auto-radios.

VOKAR

VOKAR CORPORATION
DEXTER 2, MICHIGAN

MAY, 1956



VIDEO PEAKING

Some power resistors have just enough inductance for plate loads in video amplifiers and are simpler than noninductive resistors plus separate peaking coils. This is often true of 10- and 20-watt sizes from 2,000 to 6,000 ohms. I have used ordinary Ohmite Brown Devils as loads for 6AC7 preamplifiers and an 829 deflecting a 5CP1 in a 5-mc oscilloscope for fast transients. I now am using 3,000-ohm, 20-watt IRC type 2D resistors as loads for 1625's deflecting a 5CP1 or 5ABP1 in another wide-band scope. This instrument uses feedback and reproduces a 450-kc square wave well.

Power resistors below 2,000 ohms may have too much inductance. A 1,000-ohm, 20-watt resistor as load for parallel 807's to drive an rf bridge rang badly when hit by a square wave and would have caused oscillation in a feedback amplifier.—A. H. Taylor

FILTER CAPACITORS

A defective filter capacitor is suspected whenever a radio or TV receiver has loud hum. The usual method for locating the bad unit is to place a test filter capacitor across each unit in the set, one at a time. When the hum is eliminated, the bad capacitor has been found.

Instead of placing a test capacitor directly across each suspected unit, we use a testing aid that includes a 40- μ f capacitor and 4,700- or 5,000-ohm resistor with a cutout switch as in diagram. The unit is placed across the suspected capacitor with the switch open. The resistor limits the charging current

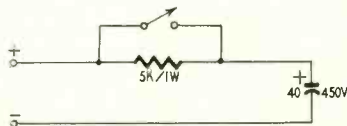

into the test capacitor and eliminates costly burnouts of pilot light and rectifier tube in ac-dc receivers. After a second or two, when the capacitor is almost fully charged, the switch is closed. Another advantage of using this testing aid is that the suspected unit is usually not disturbed by the test. This avoids the annoying experience of temporarily healing an intermittent capacitor which then is difficult to locate until it becomes defective again.—G. Sabin

HANDY BENCH "TOOL"

A very handy item for the radio-TV service bench can be picked up for

Hand size...
Voice size...

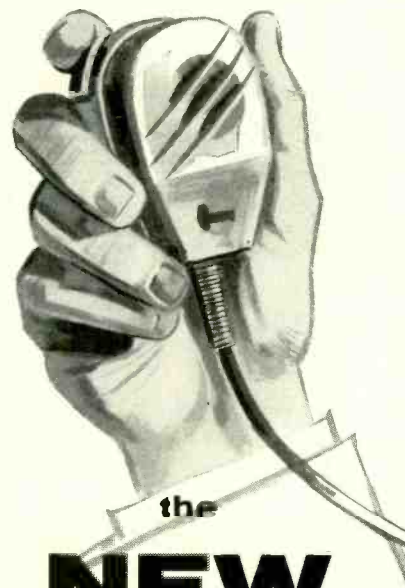

the
NEW

American "501" Series Microphones

Lightweight, rugged, easy to handle... true-to-life in fidelity of voice pickup. The new American "501" Series presents a complete line of dynamic or carbon hand microphones to improve all types of voice communications.

The attractive styling is completely functional... the gently curved case fits easily into the hand. Positive operation under all conditions is provided by a specially designed cantilever switch. The case is made of die cast aluminum to assure durability and minimum weight.

There's a model for every need:

- Mobile Communications
- Police
- Ship-to-Shore
- Aircraft
- Amateur

To be heard and understood... start with an American Microphone. Write for complete details and specifications today. Ask for Bulletin 501.



ELECTRONICS DIVISION
ELGIN NATIONAL WATCH COMPANY
370 South Fair Oaks, Pasadena 1, Calif.

131

PRE-SUMMER SALE!

ELECTRONICS—OPTICS—TOOLS

FREE! ANY ITEM PRICED \$1 OR LESS WITH ANY \$10 ORDER!

World Famous "KIT KING" Kits

- PRINTED CIRCUITS KIT.** Ass'd. Printed circuit board w/15% Precision A-B resistors, Transistors, diodes, 11-sealed cells. Wt. 1/2 lb. Reg. \$15
- TEN HI-FI KNOBS.** Ass'd. Crownme 1 1/4" knurled bakelite, aluminum inlay types. TUNING, AM, FM, BASS, TREBLE, PHONO. In poly boxes. Wt. 1/2 lb. Reg. \$3.30
- 12 AC/DC LINE CORDS** For all electrical uses! W/ sturdy molded plugs. Stock up at this low price! Wt. 1 lb. Reg. \$3
- 30 ASSORTED BULBS.** Miniature, radio, TV, instrument, flashlight types. 1.1, 2.5, 3.5, 4 & 6 volts. Reg. \$1
- 60 KNOBS.** 15 styles: radio, TV, appliance, instrument; knurled and push-on; some set-screw types. Some 30c ea. Wt. 1 lb. Reg. \$12
- 175 FT. HOOKUP WIRE.** Seven 25 ft. rolls, #18 to #24. Ass'd. colors, stranding, insulation. Wt. 2 lb. Reg. \$4
- 12 VOLUME CONTROLS.** Ass'd. popular values; 10 ohms to 0.5 megohms. Switch & WW. tool Wt. 1 lb. Reg. \$11
- G-E PREAMP KIT.** Chns. mls. condensers, resistors, wire, socket, schematic for famous equalizer (less 6SC7 tube). Wt. 1 lb. Reg. \$4.50
- 150 RADIO PARTS.** Large ass't. wire, moulded, mica, resistors, Pre-cut leads. Wt. 3 lbs. Reg. \$17
- 25 TUBE SOCKETS.** Subminiatures, 7, 9-pin miniatures, 4 to 8-pin Mica-filled & ceramic. Some shield base. Wt. 1 lb. Reg. \$9
- 60 MICA CONDENSERS.** Postage stamp types, 25 values! .00001 to .01 mf. to 1200 WVDC. Silver. 5% tol Wt. 1/2 lb. Reg. \$21
- 20 WIREWOUND POWER RESISTORS:** 5 to 50 watts. Ass'd. values to 20,000 ohms. Carostat, Ohmite, IBC tubular, candohm. sanded. Wt. 2 lbs. Reg. \$1
- 10 FP & TWIST-LOCK ELECTROLYTICS:** 8 to 100 mf. to 450 V. Multiple sections. tool Wt. 3 lbs. Reg. \$14
- 60 CARBON RESISTORS.** Insulated. 35 values! 15 ohms to 10 megohms. 1/2, 1 & 2 watt 1% & 5% tol. Famous A-B included. Wt. 1/2 lb. Reg. \$18
- 50 CERAMIC CONDENSERS.** Tubular, disc, button, slab. 10 types. 5 mmf. to .01 mf. up to 1000 volts. Wt. 1/2 lb. Reg. \$1
- 30 DISC CERAMICS.** Popular makes: 10 types. 50 mmf. to .01 mf. to 5 KV. TV men take note! Reg. \$7
- 100 COIL FORMS.** Ceramic & bakelite forms in a wide variety of shapes and sizes. Wt. 2 lbs. Reg. \$25
- 50 INDUCTORS.** coils, chokes, RF, ANT., OSC., peakup, IF. Many star-tuned. tool Builders' must! Wt. 2 lbs. Reg. \$17
- 80 TUBULAR CONDENSERS.** ERS. 25 values! .00035 to 1 mf. up to 6000 V. Oils, too. Wt. 2 lbs. Reg. \$1
- 3 CRYSTAL DIODES.** IN34, IN48, IN51. Poly bag assortment of popular diodes. Blinestat diode duty ever! Reg. \$1
- 4 SILICON DIODES.** Syl-vania, Western Electric, IN21, IN22, two IN23. Three of most used! types. Reg. \$8
- 40 MOLDED CONDENSERS.** ERS. Best known makes! Ass'd. values. 1 watt 1%, mf. up to 1000 V. Wt. 1/2 lb. Reg. \$13
- 8-PC NUTDRIVER KIT.** Plastic handle: 3/16, 7/32, 1/4, 5/16, 11/32, 3/4, 7/16" steel socket wrenches in plastic case. Wt. 1/2 lb. \$9.50 valued. Reg. \$1
- 2000 PCS. HARDWARE.** Woodworking, radio-TV, shop screws, springs, trim, nuts. Hundreds of items. Wt. 2 1/2 lbs. Reg. \$15
- 60 TERMINAL STRIPS.** Wtd. to suit 1 to 6 solder lugs, tie points. Set builders' must! Reg. \$1
- 15 ROTARY SWITCHES.** Experimenters, note! Varied ass't. single & dual contacts. Wt. 2 lbs. Reg. \$17
- 10 PANEL SWITCHES.** Ass'd. micro, toggle, push; mobile types. tool Some worth \$2. Wt. 1 lb. Reg. \$12
- 20 PRECISION RESISTORS.** Carbo-Film, Ass'd. standard values. 1 watt 1%. Pre-cut leads. Wt. 1/2 lb. Reg. \$17
- 20 INSTRUMENT KNOBS.** Scoot. Ten types; knurled, pointer, alkrtd. Brass inserts w/net screws. Wt. 2 lbs. Reg. \$7
- 8 TUBULAR ELECTROLYTICS.** Assortment of popular values. 8 to 100 mf. up to 450 volts. Wt. 2 lbs. Reg. \$6.50

Other Sale Items

- NEW B2M SUN BATTERY!** Converts sunlight energy to electrical. \$1.50 Ideal for transistor projects.
- NEW! SUN BATTERY HANDBOOK.** 9 chapters, 74 pages on theory, circuits, etc. Just published! \$1.50
- SUN POWERED TRANSISTOR RADIO.** Kit. Sun battery, loopstick, transistor, diode, cabinet. \$8.88
- 12" RCA HI-FIDELITY SPEAKER.** 12 watt, 50-15,000 cycles; 3 ohm v.c. Used in high-priced custom units. Reg. \$12. \$3.99
- FAIRCHILD 1/2" ELECTRIC DRILL.** Pistol-grip type w/switch. Also 13 twist drills. Reg. \$21 \$11.88
- 3-PC POLISHER-SANDER KIT.** Fits all electric drills, including above. Reg. \$2.50 \$1.09

FREE! BIG BARGAIN FLYER!

HOW TO ORDER Check items wanted. Return entire ad with check or M.O. incl. sufficient postage. Excess returned. C.O.D. order 25% down. Rated net 30 days.

Name _____

Street _____

City _____ Zone _____ State _____

Enclosed \$_____ for kits; \$_____ for postage.

Lektron Specialties

28 Gardener Street Chelsea 50, Mass.
Visit Our Showroom at 131 Everett Avenue, Chelsea.

TRY THIS ONE

(Continued)

practically nothing from any iron works or dealer in structural steel materials. I have found that short lengths of steel I-beam are useful for many purposes in the shop. Mine are 4-inch lengths of material 1/4 inch thick and 3 inches wide with 1 1/2-inch leg channels. I use them for propping up awkward chassis, for weighting reglued speaker cones, as soldering-iron rests, as temporary bookends and as anvils for light riveting and hammering.

I picked mine off the scrap heap of a local iron works, filed the ends smooth and sprayed them with aluminum Krylon. I've used them almost every day for the past several years. The four units that I have are probably the only tools in the shop that will never wear out and cannot be broken.—L. H. Wilson

CHECKING 3-WAY SETS

A variable voltage source is necessary to check three-way portables properly on ac line operation. Because of the low current drain of these sets a tube tester will serve the purpose while providing isolation from the line to prevent shock hazards.

Many tube testers have a blank socket that can be replaced by an ac type receptacle. The current is taken off the 100- to 117-volt tap of the filament transformer with a 1-ampere fuse in series with one side for protection against shorts. On other types of tube testers a simple adaptor using one of the tube sockets can be made up and the connections set up as for the 117-volt tube.

By adjusting the line set control the voltage can be raised or lowered. A set that has a bad oscillator tube, rectifier or other troubles is easily detected because it will usually cut out when the voltage is lowered.—G. P. Oberto

MODIFYING VTVM FILTER

In the December, 1955, issue James Fred described a 400- and 1,000-cycle filter, to be used with a vtvm when aligning AM equipment. The article suggests connecting the filter to the coupling network between the first and second audio amplifier stages of a Heathkit ac vtvm. However, in this

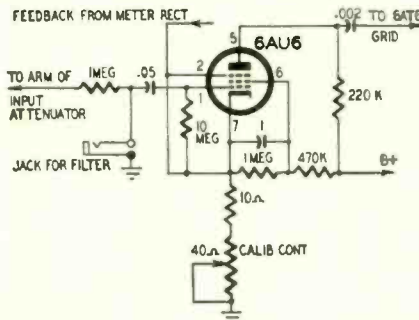

meter there is a feedback loop from the output of the second audio stage to the cathode of the first. Thus the filter will be inside the loop and its selectivity will be flattened. Hence the fil-

Quickly locates "TOUGH DOGS" **Senco** Tube and Capacitor

Leakage Checker

Model LC-2



Dealer Net \$19.95 Kit

Complete with test leads. Simple to operate.

\$24.95 wired

"Two Testers In One"

Now—checks 70 critical tube types

- Quickly locates tubes with gas, grid to cathode or heater to cathode leakage, and grid emission in RF, IF and AGC Circuits.
- Only type tester that finds all tubes causing picture overload, low sensitivity, poor sync, etc.
- Checks all capacitors for leakage with voltage applied.

Mfg by **SERVICE INSTRUMENTS COMPANY**
171 OFFICIAL ROAD • ADDISON, ILL.

Joe Serviceman says:



"You can't get somethin' for nothin', especially Quality and Reliability"

QUIETROLE

TRADE MARK REG. U.S. PAT. OFF.



the original lubricant and cleaner for quieting noisy controls and switches, costs little more than the cheapest imitations, but the name assures you are getting the best.

INSIST ON QUIETROLE
THE CHOICE OF BETTER SERVICE DEALERS "EVERYWHERE"



manufactured by **QUIETROLE COMPANY**

Spartanburg, South Carolina

ter may not yield its designed performance.

In my opinion, the best place to connect such a filter in the Heathkit vtvm is in the grid circuit of the 6AU6 first audio stage, as shown in the diagram. Here the filter is out of the feedback loop and will show its full selectivity. The 1-megohm resistor in series with the grid circuit prevents shunting of the filter by the low resistances of the divider chain on the higher voltage ranges or by a low-impedance source on the higher voltage ranges. Due to the high input impedance of the 6AU6 stage, there will be but little change in calibration for normal operation. This can be easily compensated by the calibration pot.—Charles Edwin Cohn

VERTICAL SYNC TRACER

When it is inconvenient to use a scope for tracing vertical sync-pulse troubles, this handy little gadget, made from a pair of headphones and an extra test prod, can stand you in good stead. The sketch is self-explanatory: one lead of the headphone goes to the prod itself while the other side goes to a sheet of aluminum foil wrapped around the handle. The whole business can then be wrapped with a plastic insulating tape for safety in use. Only one direct connection is made to the circuit under test, thus avoiding load-

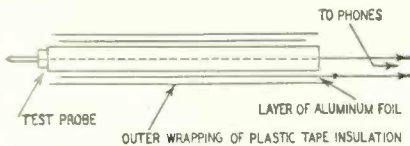

ing the circuit. The return is through "body capacitance."

When the probe is touched to an output portion of a functioning vertical oscillator, a distinctive 60-cycle click or thump will be heard, the frequency of which should vary as the hold control is manipulated.

In those sets which have a normal raster and picture, but will not stand still vertically, loss of sync is indicated. It is in these cases that we can use this tool to good advantage. Start at the point of sync take-off, whether it be the video detector or the last video if stage. At this point you should be able to hear a decided click or thump of the sync pulse so long as the blanking bar appears on the picture. Then touch the inputs and outputs of all tubes, capacitors, resistors down through the sync separator, the sync amplifiers, and clipper, even the integrator until you find the points between which the pulse disappears.

Just one word of caution. Often you will find a sync pulse on both sides of a blocking transformer when the fact is that the coupling coil is open. You can check to see if the click is sync or generated pulse by twiddling the hold control. If generated, the frequency will vary. Many times, as you follow the sync pulse through the chain, it does not disappear, but becomes weaker, due to a faulty tube or component.—H. L. Matsinger

END

DOUBLE YOUR PLAYING TIME



Double-Play
the newest of the **Irish Ferro-Sheen** process

premium tapes is made on DuPont's strong, tough, miracle film—Mylar. A 7" reel gives you 2 hours of continuous recording at 3 3/4 ips (4 hours dual track). Recommended for all applications requiring long, uninterrupted operation and where tape tension is not excessive.

WITH NEW **Irish** BRAND **Double-Play** RECORDING TAPE



One 7" Reel of New **Irish Double-Play** Tape Has As Much Playing Time - 2400 Feet - As Two 7" Reels of Ordinary Tape!

2400' on standard 7" reel \$7.50 Hi-Fi Net

If not available at your dealer, order direct from **ORRADIO INDUSTRIES, INC.**

Opelika 1, Alabama

World's Largest Exclusive Magnetic Tape Manufacturer

Export: Morhan Exporting Corp., N.Y.C.
Canada: Atlas Radio Corp., Ltd., Toronto

DeRO the LATEST in electronic equipment

Persona-Tone EXTENSION SPEAKER

High-quality sound for chair-side TV listening. 4x6 speaker. Selector switch and volume controls for TV set. Persona-Tone or both speakers. Wood veneer cabinet. Complete with cable.....net. \$6.97



All Purpose DeRO-JUVENATOR

One rejuvenator replaces all! Model RU-5—Universal 6-wire for use on all series or parallel filament TV sets, both electrostatic and electromagnetic. Restores brilliance and contrast to pix tube.....net. \$2.35



DeRO-JUVENATOR CRT BOOSTER

New design—compact, one-piece construction. No loose ends, no hanging weights. Model RP-1 for parallel filaments; model RS-1 for series filaments—including electrostatic.....net, 90c



Dual-Tone VOLUME CONTROL

For radio or TV sound extension. Two volume-control switches—one for each speaker. Volume of either speaker adjustable to any level independently. Ample cable for all cars.....net, \$2.35



Remo-Tone SWITCH ASSEMBLY

Three-position switch—selects either speaker or both. Silver-plated, non-corroding contacts. Ready for installations. Fits all cars.....net, \$1.17



Pic-Test CRT TESTER

Determine instantly if pix tube or set is at fault when TV set won't work. Know CRT condition without removal from chassis. Complete with genuine 6AF6G twin-indicator electron-ray tube.....net, \$2.97



JDBBER—DEALERS! WRITE FOR DETAILS

DeRO ELECTRONICS
134 NASSAU ROAD
ROOSEVELT • LONG ISLAND • N. Y.

AUDEL'S TV TELLS HOW TO ANSWER RADIO T.V. QUESTIONS SERVICE LIBRARY

HERE IS LATE INFORMATION IN A HANDY FORM FOR TELEVISION AND RADIO REPAIRMEN, SERVICEMEN AND STUDENTS



AUDEL'S T.V. RADIO SERVICE LIBRARY—Highly Endorsed—Over 1500 Pages—1048 Illustrations & Diagrams, 1001 Important Facts & Figures on Modern Television, Radio, Electronic Devices at your finger ends.



INCLUDES TRANSISTORS & Transistor Circuits, Record Changers, Rectifiers, P.A. Systems, Tape Recorders, Phonograph Pick-ups, F.M., Auto Radio; Radio Compass, Short Wave, Radar, etc.

ASK TO SEE IT! IT WILL PAY TO KNOW— The Basic Principles—Construction—Installation—Operation—Repairs—Trouble Shooting. Shows How to get Sharp, Clear T.V. Pictures. Install Aerials—How to Test. Explains Color Systems, Methods of Conversion, Terms, etc. Includes Ultra High Frequency—Valuable for Quick Ready Reference and Home Study.

\$6 COMPLETE 2 VOLUMES

Get this Information for Yourself.

7 DAY TEST—PAY ONLY \$1 A Month

MAIL ORDER
AUDEL Publishers, 49 W. 23 St., N.Y. 10, N.Y. Mail AUDEL'S T.V. RADIO SERVICE LIBRARY (2 Volumes) \$6 on 7 days free trial. If O. K. I will remit \$1 in 7 days and \$1 monthly until \$6 is paid. Otherwise I will return them.

Name _____
Address _____
Occupation _____
Employed by _____ RE

STAN-BURN SPARKS

CATHODE RAY TUBE SPECIALS ONE YEAR GUARANTEE

| G.E. | Type | STAN-BURN | G.E. | Type | STAN-BURN |
|---------|--------|-----------|---------------------|--------|-----------|
| \$13.25 | 10BP4 | \$10.20 | \$31.25 | 17GP4 | \$20.75 |
| 18.00 | 10FP4 | 14.00 | 32.25 | 19AP4A | 22.50 |
| 16.25 | 121P4A | 13.95 | 27.00 | 20CP4 | 18.95 |
| | 12QP4 | 10.50 | 33.00 | 21AP4 | 22.25 |
| 28.95 | 12UP4 | 14.50 | 27.40 | 21EP4 | 20.15 |
| 18.15 | 14CP4 | 13.40 | 33.25 | 21MP4 | 23.50 |
| | 15DP4 | 14.50 | 90.75 | 24AP4 | 49.00 |
| 31.25 | 16AP4A | 18.50 | DUMONT TUBES | | |
| 26.25 | 16KP4 | 15.75 | 12QP4A | | \$23.75 |
| 31.25 | 16CP4 | 18.50 | 15DP4 | | 26.55 |
| 29.00 | 16LP4 | 15.25 | 16QP4A | | 31.00 |
| 29.00 | 16WP4 | 15.25 | 16FP4 | | 26.00 |
| 22.50 | 17BP4 | 15.75 | 17KP4 | | 25.00 |
| 28.15 | 17CP4 | 18.50 | 19AP4A/B | | 33.25 |
| | | | 21KP4 | | 38.50 |

PRICES SUBJECT TO CHANGE WITHOUT NOTICE

\$20 WORTH OF ELECTRONIC PARTS IN GRAB-BAG consisting of: Porcelain sockets, coils, speaker, transformers, resistors, condensers, etc.
ONLY \$1.98 (plus 50c postage)

HI-FI ENTHUSIASTS!

AM-FM-SW AUTO RADIO

Drift Free FM—World's Finest Auto Radio—BECKER LeMANS—

For PUSH BUTTON.....\$179.95
For SIGNAL SEEKER.....239.95

Price includes Hi-Fi GE Model 950 SPEAKER with GRILLE (40-12,500 cps) and ELECTRIC ANTENNA which goes up automatically when set is ON, retracts when set is OFF. Simple installation for all makes of cars. Specify 6 or 12 Volt system.

VM 3 SPEED HI-FI CHANGER—Model 950 with Ronette Sonotone or Astatic flip-over cartridge—B BRAND NEW ORIGINAL CARTONS.....\$21.49

VM 4 SPEED HI-FI CHANGER—Model 1210 with Ronette, Sonotone or Astatic flip-over cartridge.....\$22.95

WEBSTER Model 140—3-SPEED Automatic with Ronette Sonotone or Astatic flip-over cartridge.....\$22.49

MONARCH 3 SPEED AUTO. INTERMIX CHANGER with crystal cartridge.....\$21.95
Same with British variable reluctance.....24.95

45 RPM SPINDLE.....1.88
TU-8 MONARCH 3 Speed MOTOR & TURNTABLE UNIT (less arm).....\$ 4.95

3 SPEED PORTABLE RECORD PLAYER with MONARCH CHANGER—Ronette cartridge—Portable Two Tone Carrying Case.....\$32.95

PEERLESS PORTABLE BATTERY OPERATED RADIO—Colors:—Green, White, Red or Blue—5 TUBE IMPORT SPINDLE.....\$14.95 less batteries

BATTERY KIT for above.....\$ 2.00

JEWEL—Model 5200—5 TUBE AC DC RADIO.....\$12.50

RECORDING TAPE—Top quality 1200 Feet Famous Grand BOXED—1 to 5—\$1.69 ea. 6 to 11 \$1.59 ea. 12 or more \$1.49 ea.

HALLICRAFTERS TV

Model 17TS700M—Table Model—Dealers net.....\$91.95
Model 21TS460M—Table Model—Dealers net.....129.46

SPECIAL! HI-FI PACKAGE DEAL

This choice package includes:

COAXIAL 12" SPEAKER • MONARCH AUTOMATIC CHANGER with Variable reluctance. Beautifully styled 12" SPEAKER ENCLOSURE in Mahogany or Blond Wood • Matching base for changer—10 WATT AMPLIFIER (Choice of amplifier: BELL 2122C—BOGEN DB110 — HARMON KARDON PC200—GROMMES LJ4).

\$99.50
Net

COMPLETE—READY TO PLAY.....only

Or your choice of similar units at relative package price. Write for prices.

DEALERS: Write for low cost prices and catalogs on '56 models—HALLICRAFTERS, CRESCENT, FANNON, SONORA, WILCOX-GAY, TECHMASTER, G.E., WESTINGHOUSE, TUNING-SOL, DUNALD, MAJESTIC, GRUNDIG, ARKAY KITS, DELCO, GEN. MOTORS. Address all inquiries to Dept. RE-5.

COMPLETE HIGH FIDELITY DEPARTMENT. SEND US YOUR LIST FOR LOWEST QUOTATIONS ON ANY ITEM.

We invite export inquiries and offers. Our export department will give special attention to expediting foreign orders at minimum commissions. We are authorized distributors for United Motors, all Delco and Gen. Motors Auto Radio parts in stock.

We also carry a complete line of popular makes of Radio Tubes at 50/10 discount. Also many other special purpose and transmitting types, and all electronic parts and equipment at lowest prices. Send us a list of your requirements for prompt quotations. Terms: 20% with order. Balance C.O.D. All prices F.O.B., NEW YORK Warehouse. Minimum order \$5.00. Write for our latest price list and Hi-Fi Catalog RE-5

STAN-BURN RADIO and ELECTRONICS CO.
558 CONEY ISLAND AVE. • B'KLYN 18, N. Y.

Question Box



SQUELCH FOR S-81 RECEIVER

We use a Hallicrafters S-81 receiver as a radiation monitor for dielectric heaters in our plant. We would appreciate details on an audio squelch circuit that we can add to this receiver to control the background noise and

tors and pin 1 of the 6AL5 are lifted and connected to the arm of the squelch control as shown.

The voltages and some resistance values may have to be determined empirically. Those resistors whose

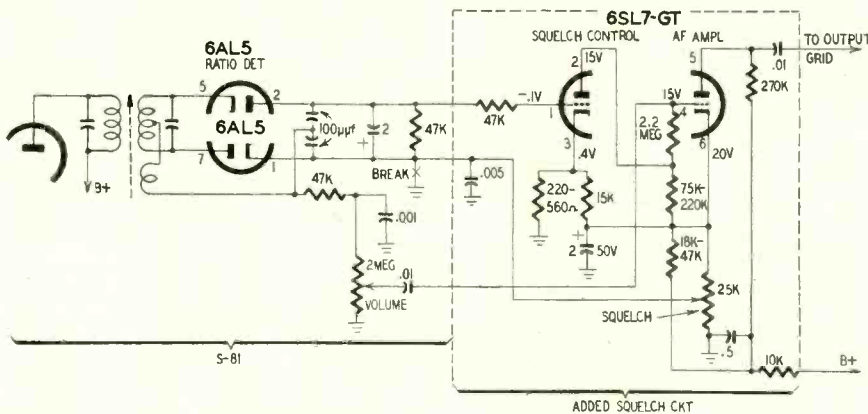

hiss that are present when there is no signal on the antenna.—B. R., Boonton, N. J.

The drawing shows how the Hallicrafters S-81 can be modified to include a squelch circuit similar to that used in the Monitoradio MR-32 and to the system described on page 82 of our October, 1950, issue.

The 6SQ7 af amplifier is replaced by a 6SL7-GT. The added components are enclosed within dashed lines. The grounds on the 47,000-ohm detector load resistor, the 2-µf storage capacitor, one of the 100-µf balancing capaci-

values are likely to be critical are shown with a range of values. Select the optimum value by experimenting.

The circuit is designed so that when no signal is applied to the set's antenna, the control tube conducts and develops a voltage drop across the resistor in its plate circuit. This increases the bias on the af amplifier and drives it to cutoff. When a signal comes in, a negative voltage appears on the grid of the control tube and cuts it off and permits the af amplifier to operate normally. The squelch control sets the operating point for the circuit.

39-MC CONVERTER

Is there a simple converter that can be used with AM radios to receive 39.5-mc forest-ranger signals? If so, please print the circuit and show how the converter can be disabled so broadcast

stations can be received.—E. R. S., Centertown, Ky.

Here is the circuit of a 39-mc converter that can be used with auto or ac-operated broadcast receivers. A

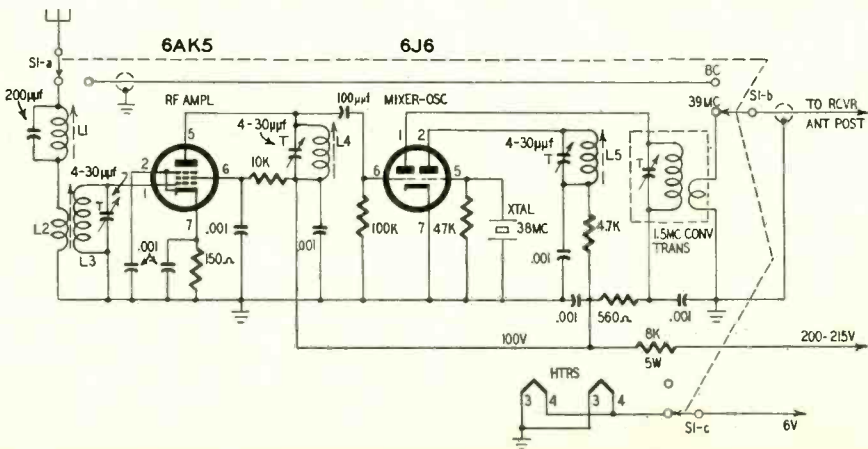

crystal-controlled oscillator is used for stability. The oscillator may be operated on any frequency between 38,000 and 38,950 or 40,050 and 41,000 kc and still have the converter output come in on the receiver between 550 and 1500 kc.

In this circuit, the oscillator frequency is 1500 kc below the signal frequency so the receiver must be tuned to 1500 kc when the converter is being used. The crystal may be one of the James Knights series JK-H17, Biley BH-6 type or equivalent.

Coils L3, L4 and L5 may be CTC (Cambridge Thermionic Corp.) type LS3 30-mc coils. L2 is a 3-5-turn winding of No. 28 enameled wire close-wound over the ground end of L3. L1 is a trap tuned to the converter's output frequency to prevent broadcast stations from breaking through and causing interference. It may be a slug-tuned broadcast antenna coil or an adjustable rf choke with a range of around 60 to 120 μ h. Its tuning capacitor may be a trimmer instead of a fixed unit.

With the 38-mc oscillator, signals between 38,550 and 39,600 kc can be received by tuning the receiver from 550 to 1600 kc and signals between 36,400 and 37,450 can be heard when tuning the receiver from 1600 to 550 kc. For fixed-frequency operation in these ranges, the tuning capacitors across L3 and L4 should be peaked to the desired frequency and the converter

output transformer replaced by a broadcast antenna coil peaked to the converter's output frequency.

For continuous tuning in these ranges, the tuning capacitors across L3 and L4 should be ganged and fitted with a calibrated dial for peaking. The converter output transformer will have to be replaced with a self-resonant output circuit. You can use a J. W. Miller type 472-UA antenna coil or a 2.5-mh rf choke and use capacitance coupling from the mixer plate to the 39-mc contact of S1-b.

Regardless of the type of operation, the oscillator tuning slug and trimmer capacitor must be adjusted for minimum current on a 10-ma meter inserted between the 4,700-ohm resistor and the junction of L5 and the .001- μ f bypass capacitor. Use a grid-dip meter to make sure that L5 is tuned to the crystal frequency.

TV HEADPHONE ADAPTER

One of our household has defective hearing. Even when using a hearing aid, he operates radio and TV sets at a level that is much too high for others. How can headphones be connected to the output of the receiver so they can be used alone or with the speaker. What type of phones are best for this application?—D. M., Bronx, N. Y.

Here is a simple switching circuit that can be used with any receiver. Headphones with impedance in the range of 6 to 75 ohms are recommended.

Phones and adapters are available as easy-to-install kits that range from around \$3.50 to \$15, depending on the type and quality of the phones. A light-

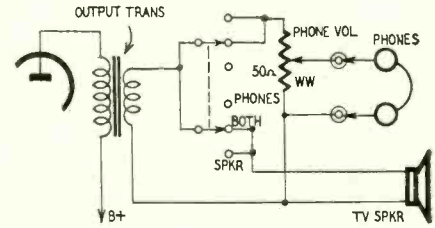

weight hearing-aid type of phone would probably be more comfortable when worn for hours at a time.

STONE AND VOLUME CONTROLS

Please print the circuit of a volume and tone control unit that I can insert in the line between my phonograph pre-amplifier and the input to a power amplifier. The output of the preamplifier is nearly 5 volts and the amplifier requires an input of only about 0.75 volt for full output. I'd like to use 500,000-ohm controls if possible and would like to be able to boost and cut the treble and bass.—R. E. D., Durham, N. C.

This circuit can be used as a remote-control panel for your audio system. The input and output leads should be shielded. If the connecting cables are long, insert a 1-megohm resistor in

Just Out

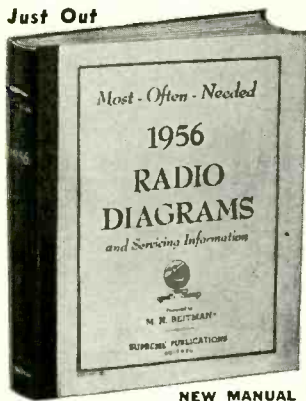

NEW MANUAL

Be prepared to repair quickly all new 1956 radio sets. In this big volume you have easy-to-use, large schematics, needed alignment data, replacement parts lists, voltage values, and information on stage gain, location of trimmers, and dial stringing, for almost every 1956 radio. Includes auto radios, portables, changers, and all types and makes of home sets. Giant size, 8 1/2 x 11"; manual style, sturdy binding. Price, only \$2.50

New SUPREME 1956 Radio Manual

Now you can benefit and save money with Supreme amazing scoop of 1956. This one giant volume has all the service data you need on all recent radio sets. A full year of models of all popular makes, home and auto sets, portable radios, combinations, changers, all included. The full price for this mammoth 1956 manual is only \$2.50, nothing else to buy for a whole year. Other Supreme radio service volumes for previous years (mostly at \$2) are described below. Separate TV manuals are listed at right.

SUPREME RADIO MANUALS FOR PREVIOUS YEARS

Use Supreme manuals to repair all radios faster, easier; save time and make more money. Here is your lowest-priced service data. Covers all years, from 1926-38 to 1956 models, in 16 volumes. Used by 174,000 shrewd servicemen. Most volumes only \$2 each, see coupon. Average volume 190 large pages, 8 1/2 x 11 inches. Quality printing, easy to use, manual-style binding. Amazing values. Be wise, use these manuals to get all needed diagrams, parts lists, alignment facts, and service hints, at the smallest cost. Send no-risk trial coupon today. →

TELEVISION SERVICING COURSE

Let this new course help you in TV servicing. Amazing bargain, complete only \$3, full price for all lessons. Giant in size, mammoth in scope, topics just like a \$200.00 correspondence course. Lessons on picture faults, circuits, adjustments, short-cuts, UHF, hints, alignment facts, antenna problems, troubleshooting, how to use test equipment, fault-finding picture analysis. Special, only \$3



SUPREME TELEVISION SERIES

Here is your complete source of TV service data at lowest prices. Supreme manuals at only \$3 each are amazing bargains and defy competition. Each annual manual covers a whole year of models, using original factory material. Include giant double-spread circuits and blueprints, alignment procedure, voltage charts, wave forms, factory revisions, and helpful service hints. Select volumes from list below and send no-risk coupon.

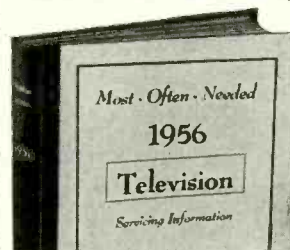

- 1956 TV Manual. New, giant volume of TV factory data. Complete, only \$3
- 1955 Early TV, \$3
- 1955 Late TV, \$3
- 1954 TV Manual, \$3
- 1953 TV Manual, \$3
- 1952 TV Manual, \$3
- 1951 TV Manual, \$3
- 1950 TV Manual, \$3
- 1949 TV Manual, \$3
- 1948 TV Manual, \$3

NO-RISK TRIAL ORDER COUPON

SUPREME PUBLICATIONS, 1760 Balsam, Highland Park, ILL.

Radio Diagram Manuals

- 1956 Radio Manual, \$2.50
- 1955 Radio Manual, only \$2
- 1954
- 1953
- 1952
- 1951
- 1950
- 1949

THIS GROUP ONLY \$2 EACH

- 1948
- 1947
- 1946
- 1942
- 1941
- 1940
- 1939
- 1926-1938 Manual, \$2.50
- Radio and TV Master Index, 25¢

- Rush today Radio manuals checked at left and TV manuals below. Satisfaction guaranteed.
- New 1956 Television Service Manual, only... \$3.
- Additional 1955 TV, \$3. Early 1955 TV, \$3.
- 1954 TV Manual, \$3. 1953 TV Manual, \$3.
- 1952 Television Manual, \$3. 1951 TV, \$3.
- 1950 Television Manual, \$3. 1949 TV, \$3.
- 1948 TV, \$3. 1947 TV & FM, only \$2.
- New Television Servicing Course, complete... \$3.

- I am enclosing \$..... Send postpaid.
- Send C.O.D. I am enclosing \$..... deposit.

Name:

Address:

Supreme Publications
Sold by All Leading Parts Jobbers

what you want . . .
when you want it with



ERIE DISC and GP CERAMICON® SERVICE KITS

HERE'S WHAT YOU GET

- 1 100 High Stability ERIE Disc or Tubular Ceramicons
- 2 18 Popular Values
- 3 Handy, Convenient 18 Section Plastic Storage Case
- 4 Exceptional Value

HERE'S WHAT YOU SAVE

- REGULAR PRICE
- 100 ERIE Disc or Tubular Ceramicons . . . \$15.00
- 18 Section Plastic Case . . . 1.75
- Total Value \$16.75**
- YOU PAY \$10.65**
- YOU SAVE \$ 6.10**

ERIE Ceramicon TV Kits are also available

ORDER NOW
From Your
ERIE
DISTRIBUTOR



ERIE ELECTRONICS DISTRIBUTOR DIVISION
ERIE RESISTOR CORPORATION
Main Offices: ERIE, PA.
Factories: ERIE, PA. • LONDON, ENGLAND • TRENTON, ONTARIO

replace
repair
resell with

Ronette

For all your phono cartridge replacements use a Ronette . . . regardless of make or model. Ronette high compliance, low intermodulation distortion and full frequency response is your assurance of a gratified customer. And the new universal mounting bracket makes installation quick and easy. Available in high or low output, turnover or single needle models.



See your parts distributor, or write for his name and address.

Ronette
ACOUSTICAL CORP.

135 Front St., New York 5, N. Y.
BOwling Green 9-0380

PARTS SHOW-ROOM 609-A
Conrad Hilton Hotel.

GOOD THINGS
COME IN SMALL
PACKAGES!!



ARKAY MODEL PR-3
Amazing Miniature Radio

Featuring a superheterodyne circuit and hearing aid type ear piece, this radio kit, which has set the industry talking, receives the full AM band. 3 tube circuit brings in all stations clear as a bell and its plastic case measures only 5 1/4" x 3 1/4" x 1" as small as a pocket book.

\$12.95

ARKAY MODEL M-853

Measures AC-DC voltages from 0 to 2500 volts in 5 ranges and DC current ranges from 0 to 250 MA in 2 ranges. This accurate easily read pocket instrument is versatile and highly stable. A must for every repair purpose. \$9.95



Size: 3 1/2" x 4" x 1 3/4"

OTHER KITS
IN THE ARKAY LINE

- Television Kits
- Testing Equipment • Phonographs
- Audio Amplifiers • Geiger Counters
- Experimenters Equipment • Radios

Visit your local distributor for these wonderful kits and write today for the special FREE Radio Kits Catalogue and list of dealers. Your copy will be sent by return mail with no obligation. Write to

Radio Kits Inc., Dept. R 2
120 Cedar Street New York

QUESTION BOX

(Continued)

series with the output terminal of the preamp and another between the 0.1- μ f capacitor and the output terminal of the control unit to minimize high-frequency losses due to the cable capacitance.

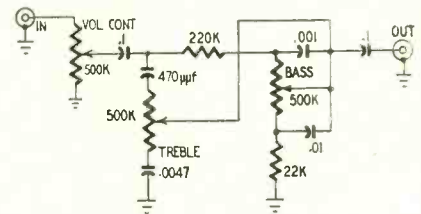

The losses are rather high in this tone-control circuit so it may be necessary to add another stage of amplification to the preamp or main amplifier to compensate. A 6J5, half of a 6SN7-GT or any similar tube will provide enough gain.

PHONO MOTOR CLICK FILTER

There is an annoying click in my amplifier each time that the phono motor is turned on or off. Is there any way to eliminate or reduce this click? —J. M. F., West Islip, N. Y.

A click filter can consist of a resistor and capacitor in series across the switch contacts. The capacitor may vary from about .02 to 0.1 μ f and the resistor may be any convenient value between 50 and 100 ohms. END

Thirty-Five Years Ago In Gernsback Publications

HUGO GERNSBACK, Founder

| | |
|---------------------------------|------|
| Modern Electric | 1908 |
| Wireless Association of America | 1908 |
| Electrical Experimenter | 1913 |
| Radio News | 1919 |
| Science & Invention | 1920 |
| Television | 1927 |
| Radio-Craft | 1929 |
| Short-Wave Craft | 1930 |
| Television News | 1931 |

Some larger libraries still have copies of ELECTRICAL EXPERIMENTER on file for interested readers.

In May 1922 Science and Invention (formerly Electrical Experimenter)

- The Radio Explorers, by Robert R. Parker.
- Radiophoning from Ship to Shore. Thomas A. Edison Has Become a "Radio Fan."
- Dancing to Radio Music on the Ocean. Chicago Police Adopt Radiophone. What Caused the Signals?, by John G. Merne.
- Radio on Aircraft.
- Continuous Radio Recorder, by Arthur H. Lynch.
- Simplest Radiophone Receiver (Second Prize), by H. L. Jones.
- Radio Receiver in Fountain Pen.
- Radio Constructor Hints, by H. Winfield Secor.
- Radio for the Beginner, by Armstrong Perry.

radio-electronic Circuits



SYNCING BAR GENERATOR

Many bar and dot generators used for TV linearity and convergence tests have no provision for synchronization. This usually results in a very critical horizontal frequency setting to obtain stationary vertical bars or dots. A

bar generator BG-1. Adding the capacitors to the circuit allows a small signal from both the horizontal and vertical deflection circuits of the receiver to be fed into the generator, synchronizing the bars or dots to the receiver fre-

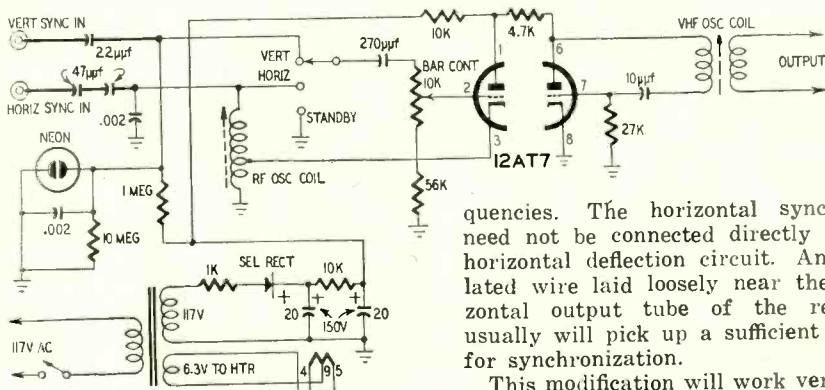

minor modification of the generator will give excellent synchronization so that the receiver checks can be made without having to reset the horizontal hold control continuously.

This modification is shown in heavy lines on the diagram for the Heathkit

generator BG-1. Adding the capacitors to the circuit allows a small signal from both the horizontal and vertical deflection circuits of the receiver to be fed into the generator, synchronizing the bars or dots to the receiver frequencies. The horizontal sync lead need not be connected directly to the horizontal deflection circuit. An insulated wire laid loosely near the horizontal output tube of the receiver usually will pick up a sufficient signal for synchronization.

This modification will work very well for other generators; however, different capacitors may be necessary. When the sync leads are connected directly to the deflection circuits, be sure that the voltage rating of the capacitors is sufficient to prevent breakdown by the high-voltage pulses which can be as high as 2,000 volts.—Henry A. Kampj

GROUNDING-GRID MODULATOR

Sometimes a simple wide-band modulator is needed for a signal generator or a low-powered transmitter. A grounded-grid amplifier may be easily converted into a high-frequency modulator that handles frequencies ranging from near dc to high in the video

range. Although the circuit in Fig. 1 is not widely used, it will give satisfactory results. The grid is grounded

for the carrier frequency by the series-tuned trap. Fig. 2 shows a similar arrangement using a cathode follower driver direct-coupled to the grounded-grid modulator. In all cases, L and C are selected to tune to the rf carrier.—I. F. Barditch

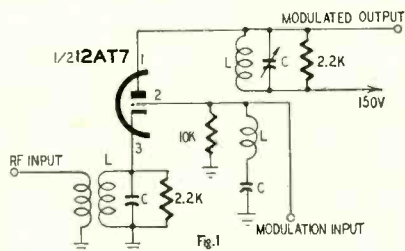

range. Although the circuit in Fig. 1 is not widely used, it will give satisfactory results. The grid is grounded

NOVEL VHF ANTENNA

The tri-delta (three-element delta-matched) 2-meter parasitic array is described here. See Fig. 1. It has a gain of nearly 8 db and may be fed either with 300-ohm ribbon or 50-75-ohm coax. Designed for portable opera-

tion with the Gonset Communicator II, it is used for reception and transmission of vertically polarized signals but can be turned on its side for horizontal polarization.

The delta provides an essentially flat

with the new model HT-30
Transmitter/Exciter

HALLICRAFTERS RAISES THE
STANDARDS OF
SSB TRANSMISSION



model HT-30

Here's a transmitter that's built to give you greater performance... greater dependability. And the HT-30 guarantees you greater enjoyment because it incorporates all these wanted features...

check them at your jobber
today!

- BUILT IN V.F.O. READS DIRECTLY IN KILOCYCLES.
- V.F.O. STABILITY IS EQUAL TO MOST CRYSTALS—.009%.
- SELECTIVE FILTER SYSTEM IS USED FOR RELIABLE SIDEBAND SELECTION. The circuitry employs the proven r.f. selective filter system used by major commercial communications companies. This system assures continued suppression of unwanted side band energy and distortion products. Hum, noise and unwanted side band are down 40 db or more, while undesired beat frequency is down at least 60 db. New 60 db range meter for constant monitoring of r.f. output and carrier suppression. Voice control system built in with adjustable delay and anti-trip features.
- SSB, AM, AND CW ARE ALL PROVIDED FOR IN ONE COMPACT UNIT. Front of panel full function control allows selection of AM, CW and upper or lower side band. Only 18" x 9 3/4" x 12"; the unit is powerful—35 watts peak output on SSB.

and 15 other features in model
HT-30 at only \$495.00

FRONT PANEL CONTROLS

- BAND SELECTOR 80, 40, 20, 10 METERS.
- DRIVER TUNING.
- FINIAL TUNING.
- SPEECH LEVEL.
- CARRIER INJECTION—0 TO 100%.
- METER SENSITIVITY.
- CALIBRATION LEVEL.
- POWER OFF, STAND-BY, WARM-UP, TRANSMIT.
- OPERATION CONTROL. VOX, CALIBRATE, MOX.
- FUNCTION SELECTOR—AM, CW, UPPER, LOWER SIDE BAND.
- TUNING—V.F.O.
- HEADPHONE JACK.
- 10 METER TUNING CONTROL.
- V.F.O.—CRYSTAL.

hallicrafters
CHICAGO 24, ILLINOIS

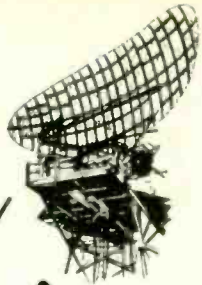

FIELD TECHNICIANS

Broaden the scope of your career with Bendix Radio!

Get these BIG ADVANTAGES!

- Professional status
- The prestige of representing the leader in its field.
- Top salaries
- Liberal field allowances

If you have 5 or more years of electronics experience, you benefit many ways as a Bendix Radio Field Engineer. You will receive full pay while you go to our company-sponsored school in Baltimore. Then, you will be given a key assignment in the United States or overseas with responsibility of maintaining search and surveillance radar equipment made by Bendix Radio.

Write, call or wire EMPLOYMENT SUPERVISOR Dept. R

Bendix Radio

DIVISION OF BENDIX AVIATION CORP
Towson 4, Maryland
(Phone VALley 3-2200)



GET INTO ONE OF THESE TOP OPPORTUNITY FIELDS

ELECTRICITY

— Electronics or TELEVISION —
— Radio-Color TV

TRAIN IN THE GREAT SHOPS OF

COYNE

OLDEST, BEST EQUIPPED SCHOOL OF ITS KIND IN U. S.

Veterans and Non-Veterans—Prepare for a better job NOW that offers a real future, too! Get practical training in TELEVISION—RADIO—ELECTRICITY—ELECTRONICS—(Refrigeration & Electric Appliance Repair can be included). Learn on real equipment—no advanced education or previous experience needed. Lifetime employment service to graduates.

Finance Plan—enroll now, pay most of tuition later. Part time employment help to students.

FREE BOOK Clip coupon for Big Free Illustrated Book. No salesman will call. Act NOW.

B. W. COOKE President FOUNDED 1899

ELECTRICAL SCHOOL

A TECHNICAL TRADE INSTITUTE OPERATED NOT FOR PROFIT
500 S. PAULINA ST., CHICAGO, Dept. 56-81H
ELECTRICITY • TELEVISION • RADIO • REFRIGERATION • ELECTRONICS

B. W. COOKE, Pres., COYNE ELECTRICAL School
500 S. Paulina St., Chicago 12, Ill., Dept. 56-81H

Send FREE BOOK and details on:

- TELEVISION-RADIO
- ELECTRICITY-ELECTRONICS

NAME.....
ADDRESS.....
CITY.....STATE.....

VIDEO PROBE METER!

a professional instrument designed for testing a T.V. ABOVE and BELOW chassis!

THE VIDEO PROBE METER!

Saves TWO HOURS PER DAY when used in shop for under chassis work.



With the attachable pick-up loop, (where sufficient signal is available) the Probe Meter can detect and indicate radiation of signal thru I.F. and video amp tubes. (Simply slide loop over tube being tested.) Where internally shielded tubes are encountered, remove tube and insert probe tip into grid pin of socket.

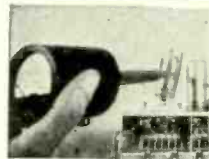

Dealers Net Price \$31.50

Can accurately trace signals in the following T.V. circuits—from tuner to pix tube) H.F., I.F., Det. Video, Sync, local csc., Hz. osc., Hz. Drive, audio output, sound I.F. (Signal tracing radios.)

EXCELLENT FOR TRACING AND COMPARING COLOR T.V. CIRCUITS.

ADDITIONAL FEATURES

Voltmeter, 0-500V. D.C., 20,000 Ohms/volt. Fully Guaranteed. If your dealer cannot supply you, order direct full purchase price refunded if not satisfied. DEALERS & REPS. INQUIRIES WILL RECEIVE IMMEDIATE ATTENTION.

Research Inventions & Manufacturing Co.
617 F St., N. W., Washington 1, D. C.

RADIO-ELECTRONIC CIRCUITS (Continued)

match between the radiator and the 300-ohm input terminals and a good means of bringing the lead-in out of the field around the active elements. The connection between the delta and the 300-ohm ribbon is made at an insu-

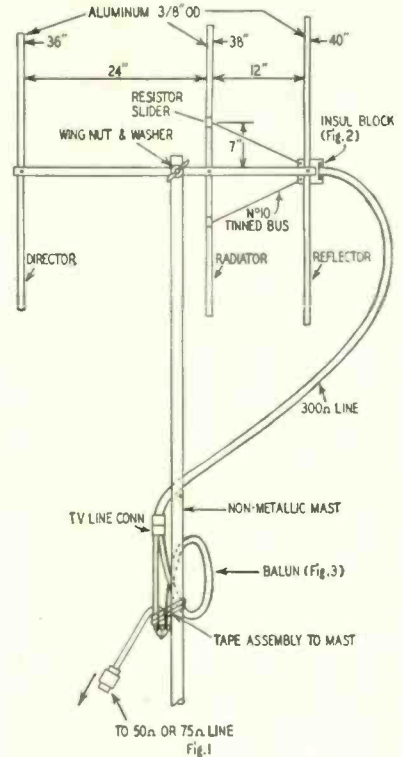

lating block constructed as in Fig. 2. The ribbon is clamped to the block to ease the strain on the connections.

The delta section is No. 10 tinned bus bar fanned out approximately 7 inches each side of the radiator's cen-

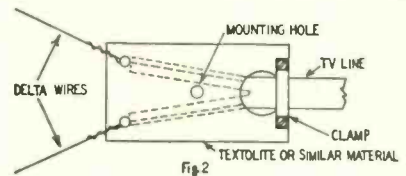

ter. Adjustable, it is fastened to the radiator with sliders from 10-watt adjustable resistors. For best results, the sliders should be adjusted for the best standing-wave ratio.

A length of 300-ohm ribbon is used

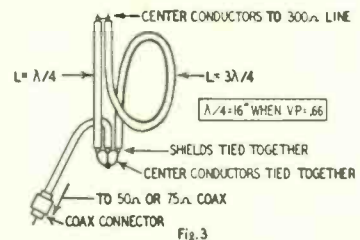

to maintain a balanced line close to the antenna. When coax is used, the impedances are matched with a balun (balanced-to-unbalanced) transformer constructed from RG/62-U 93-ohm coax as in Fig. 3. This type of cable tends to flatten out the overall standing-wave ratio somewhat more than most others.

ASK FOR SPRAGUE BY CATALOG NUMBER

Know what you're getting . . . get exactly what you want. Don't be vague . . . insist on Sprague. Use complete radio-TV service catalog C-610. Write Sprague Products Company, 81 Marshall Street, North Adams, Massachusetts.

DON'T JUST SAY CAPACITORS SAY

SPRAGUE

WORLD'S LARGEST CAPACITOR MANUFACTURER

INVENTORS

Send for PATENT INFORMATION Book and INVENTORS RECORD without obligation GUSTAVE MILLER RE-56 WARNER BUILDING WASHINGTON 4, D. C.

REGISTERED PATENT ATTORNEY ASSOCIATE EXAMINER U.S. PAT. OFF. 1922-1929 Patent Attorney & Advisor U.S. Navy Dept. 1930-1947 PATENT LAWYER

Interested in Hi-Fi?

Want to Get Ahead in Servicing?

Write for complete details about the Gernsback Technicians' and Hi-Fi Library Plans.

Gernsback Library Inc. 154 W. 14th Street New York 11, N.Y.

SERVICEMEN WHO PUT PRIDE IN THEIR WORK "ALWAYS SPECIFY STANCOR"



CHICAGO STANDARD TRANSFORMER CORPORATION

3505 Addison Street • Chicago 18, Illinois

RADIO-ELECTRONIC CIRCUITS (Continued)

(An antenna is matched to a transmission line when its input impedance equals the effective characteristic impedance of the transmission line. When the two are matched the voltage standing-wave ratio is unity. Thus, the match between antenna and transmission line can be determined by either measuring the SWR or the antenna's input impedance. Simple standing-wave and antenna impedance bridges are described in detail in recent editions of *The Radio Amateur's Handbook*.—Editor)

Some additional gain can be obtained by using additional directors, each being cut about 5% shorter than the nearest one between it and the radiator. However, when the directivity improvement is balanced against the increase in overall size, a three-element unit is about right for portable use.—C. O. Field

(The resonant frequency of this antenna is approximately 145.8 mc. For other frequencies, scale the dimensions up or down in proportion to the ratio of the frequencies.—Editor)

6AS7-G's IN POWER SUPPLIES

The 6AS7-G is an excellent regulator tube for power supplies whose output current is around 200 ma but has one serious drawback—there are variations in the triode sections of the tube. These sections are usually connected in parallel and controlled by a single biasing voltage as in Fig. 1. For a given control voltage the variations cause an uneven distribution of the currents in the two sections of the tube. This is not serious at low-current levels, but it

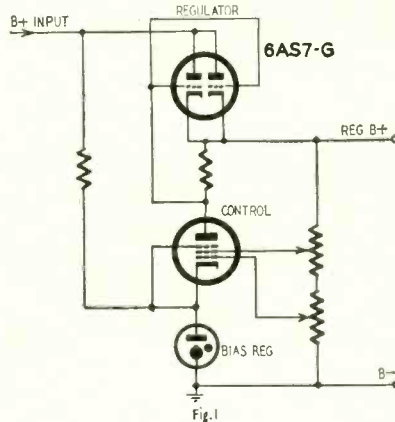

is when current is high. If one triode draws considerable more current than the others, it will overheat. As it overheats, it tends to draw more current. This "regeneration" continues until the tube is destroyed.

Some attempts have been made to reduce this effect by inserting cathode resistors in the regulator circuit to develop cathode degeneration, but this is not too effective as the cathode degeneration is negligible compared to the thermal "regeneration."

Tube selection at the price of the tube is prohibitive for experimenters and expensive for manufacturers of equipment using the tube. Tubes are plugged in and, if one section gets red

WRITE FOR YOUR BARGAIN "TABOGRAM" A Free Bonus with Every Order

"TAB" HI FI SPEAKERS

Inbuilt network, 2 wires needed for HF & LF Response Famous HI FI mfrs. Model P25CO 15" Coaxial PM & 5" Tweeter 25 Watt/20-17500 cycles\$19.50 Model P12CO 12" Coaxial PM & 2 1/2" Tweeter 15W/45-15K CY.....\$12.75 Model P8CO 8" Coaxial PM & 2 1/2" Tweeter 8 Watt/70-15K\$8.75



FINEST HI-FI RECORDING TAPE

7" Reel—1200 Ft. Per Reel \$5 Back Guarantee Precision Coated & Silt. Gtd Splice Free, Quality Controlled, Plastic Base. Gtd Constant Output, Freq. 7 1/2 IPS 40-15K. Oxide Wind In "TAB" Special @ \$1.59 ea.; 3 for \$1.50 ea.12 for \$1.45 ea.

COMPLETE HI FI COMBO SPECIAL

Bogen Amplifier DB110 \$124.95 University Speaker 6201 Famous Garrard Intermix Recoton Cartridge 500-SS "TAB" SPECIAL Complete Combination Reg. Priced @ \$157.35 "TAB" SPECIAL @ \$124.95 Get Our Price B-4-U-Buy HI FI

NEW GE PHONO CARTRIDGES

GE Original Boxed, \$\$\$ Back Gtd RPK05CA 001 & 003 (SS)\$ 6.75 RPK052A* Golden Treasure (DS)\$19.25 RPK053A* Golden Treasure (DD)\$28.00 Replacement Needles "TETRAD" Diamond† RPJ013A Dual (DS) 001 & 003 "TETRAD".....\$11.10 RPJ01D or RPJ03D Single (D) "TETRAD"†.....\$ 9.55 RPJ01S or RPJ03S Single (S) "TETRAD".....\$ 1.35 RPJ03D or RPJ04 Single (D) "TETRAD".....\$ 9.85 MG or 78 Single (D) "TETRAD"†.....\$ 9.89

TUBES FULL RETMA WARRANTY

New, Unused—None Rewashed or Rebranded • No Electrical or Mechanical Rejects •

| | | | | |
|------|-----------|------------|------------|------|
| 02K6 | .45 6AV5 | .80 6A5 | .19 12A7 | .55 |
| 1A2 | .95 6AV6 | .45 6A4 | .45 12BA6 | .50 |
| 1B3 | .65 6AX4 | .80 6SA7 | .50 12BE6 | .65 |
| 1R5 | .50 6AX5 | .75 6SJ7 | .65 12BH7 | .65 |
| 1T4 | .50 6BA6 | .45 6SK7 | .50 12BY7 | .97 |
| 1U5 | .45 6BC5 | .60 6SL7 | .55 12SA7 | .64 |
| 1X2 | .85 6BE6 | .45 6SN7 | .55 12SK7 | .45 |
| 3V4 | .75 6BG6 | 1.24 6G07 | .55 12SN7 | .56 |
| 5U4 | .45 6BK7A | 1.11 6T4 | 1.15 12SQ7 | .50 |
| 5Y4 | 1.28 6BL7 | .90 6T8 | .75 25Z06 | .90 |
| 5V5 | .65 6BN6 | 1.19 6E6 | .55 25L6 | .42 |
| 6AC7 | .60 6BQ6 | .90 6W4 | .35 25L6A | 1.03 |
| 6AG5 | .45 6BQ7A | 1.30 6X4 | .40 35L6 | .69 |
| 6AK5 | .60 6C4 | .35 6X5 | .45 35W4 | .50 |
| 6A4 | .40 6CB6 | .50 6X8 | .80 45 | .45 |
| 6AQ5 | .45 6CD6 | 1.08 12AT6 | .40 50B5 | .70 |
| 6AT6 | .40 6CF6 | 1.25 12AT7 | .65 50C5 | .52 |
| 6AV6 | .95 6CL6 | 1.65 12AU6 | .45 12L6 | .55 |
| 6AU5 | 1.10 6J5 | .40 12AU7 | .50 75 | .85 |
| 6AU6 | .45 6J6 | .45 12AX4 | 1.29 83V | 1.22 |

"TAB" Bargains In Component Parts

100 CARBON RESISTORS, 1/2, 1 & 2 watts, all popular values—insulated & color coded @ \$2.49 25 TUBE SOCKETS—all types—octal, ioktal, 7 & 9 pin miniature @85c 20 011 CONDENSERS, wide assortment, popular sizes and values @\$1.85

"TABLITE" ELECTRONIC FLASH KITS

AC & Battery Operation All In One Camera Case Uses new to cost to voltate super circuit constant bright light output; light duration 1/600 sec'd; color K 6800"; cost per flash less than 3/4¢ 1000 to 2000 flashes per set of batteries. All kits with inbuilt AC pack (kits less batteries). Two (2) 240V batteries @ \$10 Model 400V, 60W Sec'd, color #75: B&W 225-Recycles 2 sec'ds, less than 4 lbs.\$29.95 Model 600V, 120W Sec'd, color #100: B&W 300-Recycles 5 sec'ds, less than 5 lbs.\$49.95 Model 1000V, 240W Sec'd, color #150: B&W 450-Recycle 10 sec'd, less than 6 lbs.\$54.95 KIT ASSEMBLED. Additional \$10 SOLD WITH "TAB" MONEY BACK GUARANTEE Photoflash Cond. 525MFD/450VDC/53W/SEC NEW low leakage, Famous Mfr. @ \$8; 2/\$15

"TABTRON" HI CURRENT PWR SUPPLIES ONE YEAR GUARANTEE

Variable 0-28VDC. Completely Built. Incls: Full Wave Selenium Rectifier, Transformer, Variac, Volt & Amp Meters, Switch, Terminals & Fuse. Hvy. duty Steel Cabinet. Standard 115V/60cy Input or 220V and 3 phase to order. SPECIFY.

| Stk No | Cont. Rating | W-Meters |
|----------|--------------------|----------|
| T28V5A | 0-28 VDC at 5 Amp | \$ 50 |
| T28V12A | 0-28 VDC at 12 Amp | \$125 |
| T28V24A† | 0-28 VDC at 24 Amp | \$155 |
| T28V50A† | 0-28 VDC at 50 Amp | \$285 |

NEW "TABTRON" SELENIUM BRIDGE

Gtd RECTIFIERS One Yr FOLLOWING LIST, FULL WAVE BRIDGE

| Curr. | 18/14 | 36/28 | 52/42 | 130/100 |
|-------|-------|-------|-------|---------|
| Volts | 1.0 | 2.0 | 3.0 | 5.0 |
| Cont. | 1.00 | 2.00 | 2.95 | 5.30 |
| 1AMP | 2.90 | 4.10 | 5.75 | 12.70 |
| 2AMP | 3.50 | 6.40 | 11.25 | 25.00 |
| 3AMP | 3.95 | 7.0 | 12.75 | 29.65 |
| 4AMP | 5.85 | 11.35 | 19.40 | 41.25 |
| 6AMP | 7.20 | 14.25 | 22.00 | 43.85 |

VARIABLE 0 to 6 & 12-VOLT/12 AMP DC Power Supply

Battery Eliminator, Charger, Model RR, Plater, Aircraft, Marine or any DC Reg. Extra hvy duty Selenium Rectifier, 2 meters V & A. Designed for cont. service & up to 20 Amps intermittent overload. MODEL T612V12AC.....@ \$29.95

"TAB"

TERMS: Money Back Gtd (cost of mds only) \$5 min order F. O. B. N. Y. C. Add \$3.00 charges for C. O. D. 25% Dep. Tubes gtd. via R-Exp Only Prices shown subject to change. 111 LIBERTY ST., N. Y. 6, N. Y. RECTOR 2-6245 DEPT. SR6—CABLE "TABPARTS"

Seal of Achievement

KARLSON ULTRA-FIDELITY ENCLOSURES

The Karlson Enclosure represents a major achievement in acoustic cabinetry. Fully engineered in every detail, its frequency response, radiation characteristics, transient fidelity, and tonal integration are without equal in the entire field of Audio. Even though this cabinet is small in size, and delicately styled to fit any decor, this amazing unit is capable of outperforming even a 30' horn. Its complete versatility and tonal balance make the Karlson Enclosure the final requisite for those who must have the finest in High Fidelity.



FREE Send for copy of latest book "The Karlson Enclosure"

There is a **KARLSON** for you

KARLSON ASSOCIATES, INC.

DEPT. T

1610 Neck Road

Brooklyn 29, New York

The June issue of **RADIO-ELECTRONICS**

On Sale MAY 24th

at all better parts distributors and newsstands

SUBSCRIPTION RATES

One Year \$3.50

Two Years \$6.00

Three Years \$8.00

RADIO-ELECTRONICS

154 West 14th St.

New York 11, N.Y.

SORRY For The Delay. We were swamped with orders and re-orders...an increased staff and facilities are now ready to serve you!

LOWEST TUBE PRICES

BRAND NEW
famous make
PICTURE TUBES
DUMONT and RCA
licensed
One Year Guarantee
In original factory sealed carton
PRescott 3-0330

| NO REPLACEMENT DUD REQUIRED | | | |
|-----------------------------|---------|----------|---------|
| 10 BP4 | \$10.95 | 16 FP4 | \$18.75 |
| 12 LP4 | \$12.95 | 16 HP4 | \$18.99 |
| 12 QP4 | \$13.95 | 16 JP4 | \$19.00 |
| 14 CP4 | \$15.25 | 16 LP4 | \$17.99 |
| 14 BB4 | \$15.99 | 16 WP4A | \$15.95 |
| 15 AP4 | \$18.99 | 17 BP4 | \$19.00 |
| 15 DP4 | \$16.95 | 17 GP4 | \$21.00 |
| 16 DP4 | \$18.50 | 17 LP4 | \$18.00 |
| 16 GP4 | \$19.25 | 17 HP4 | \$19.00 |
| 16 KP4 | \$17.00 | 19 AP4 | \$23.00 |
| 16 RP4 | \$17.00 | 20 CP4 | \$24.00 |
| 16 AP4 | \$19.99 | 21 ALP4A | \$24.00 |
| 16 EP4 | \$21.75 | 21 EPY | \$24.00 |
| | | 21 FPY | \$24.00 |

F.O.B. Passaic, N. J. . . Subject to prior sale.
Write for complete tube listing. Including Special Purpose and Transmitter tubes.

TUBE MART DISCOUNT HOUSE

The Lokpet Bldg. Passaic, N. J.

RADIO-ELECTRONIC CIRCUITS (Continued)

hot, it is unbalanced and the tube must be replaced. Fortunately, only a small percentage of them are prohibitively unbalanced.

When installing a 6AS7-G in a regulated power supply, the triode sections may be adjusted for optimum performance by using the simple circuit shown in Fig. 2. A potentiometer is installed

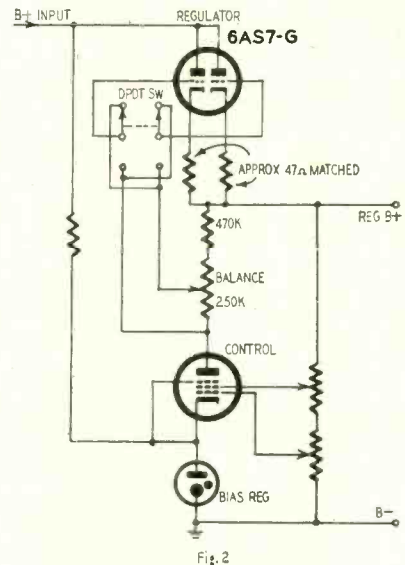

and the control voltage adjusted to the grids of the tube until the current balances. This is done at about two thirds of the maximum current for which the supply is designed. Once set, the tubes remain fairly well balanced throughout the current range if the maximum plate voltage is not exceeded. If the supply is to be used in a fixed load circuit, the adjustment is made at the operating load.

My supply has a single tube. If more than one tube is required, it is not difficult to modify the circuit. The supply is adjusted as follows:

1. Set the balance control so its arm is at the plate of the control tube.
2. Connect an appropriate load to the output of the supply.
3. Measure the voltage across the cathode resistors of the triodes to find the section delivering the least current.
4. Turn off the power supply and then throw the d.p.d.t. switch to the position that connects the grid of that section to the arm of the balance control. (The power supply should be turned off when throwing the selector switch to avoid damaging it as the grids are momentarily opened.)
5. Connect a voltmeter across the cathodes of the triode sections and adjust the balance control until the cathode voltages (and therefore the currents) are equal.

The values shown have worked well for me, but variations may be made to suit the individual case. The cathodes of the triodes may be brought through the chassis with pin jacks for future adjustments. The balance control should be a screwdriver-adjusted type and should be placed behind the front panel.
—R. P. Jamison

END

Business



Merchandising and Production

RCA Tube Div., Harrison, N. J., is sponsoring an all-out sales promotion program on its batteries. The plan includes extended payment terms, buying benefits and technical selling tools. Counter merchandisers, window displays, advertising mats, etc. were prepared for dealers and distributors.

Winegard Co., Burlington, Iowa, is planning a trade and consumer promotional campaign on its TV antenna line.



The photo shows John R. Winegard (right), president of Winegard, discussing the campaign with Burton Browne, head of the company's advertising agency.

Service Instruments Co., Addison, Ill., designed a four-color display board for its small service units. The board is equipped with easels and hooks so that it may be hung or set on a counter.

Brach Manufacturing Co., Newark, N. J., was featured recently on Bob Considine's "Cavalcade of Progress" TV show over WABD channel 5, New York. Ira Kamen, Brach's vice president in charge of electronic research, and Jerome Berger, plant manager, were interviewed and several of the company's new products were introduced.

National Radio Week will be celebrated May 13 to 19. It is sponsored by the National Association of Radio & TV Broadcasters, the Radio Advertising Bureau, RETMA and the National Appliance & Radio-TV Dealers Association.

Production and Sales

RETMA reported that a record 7,421,978 TV sets were shipped to dealers during 1955. The association also reported that manufacturers' sales of transistors reached a total of 3,646,802 units last year, nearly three times the previous year's total.

The Magnetic Recording Industry

Star Performers on Your Service Team...



Television Hardware and
your TELCO Distributor

BRINGING YOU THE ALL NEW

RATCHET CHIMNEY MOUNT

FAST INSTALLATION.... simply thread strap thru ratchet bolt and tighten.

REALLY HOLDS.... ratchet bolt design never lets go. **FITS MAJ UP TO 1 1/4" DIAMETER.**

LONG LASTING zinc plated and dicromate dipped for double weather proofing.

No. 9218 Ratchet mount with 24' galvanized straps.
No. 9219 Ratchet mount with 24' stainless steel straps.

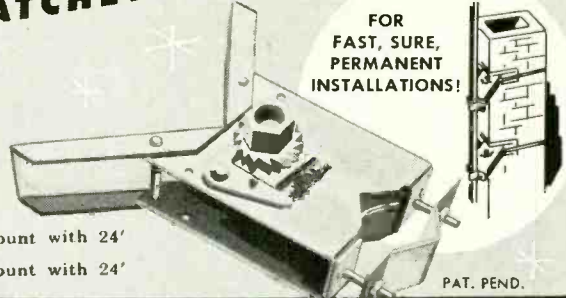

FOR
FAST, SURE,
PERMANENT
INSTALLATIONS!

PAT. PEND.

TELEVISION HARDWARE MFG. CO.

Division of General Cement Mfg. Co

919 Taylor Avenue, Rockford, Illinois

FREE COPY...TELCO Catalog. Write for yours now!

**TELCO
HARDWARE**



Everything for fast profitable TV installations—stand-offs, mounts, towers, arrestors, all accessories. The complete line is at your nearby TELCO distributor.

SEE US . . . BOOTH 590—ROOM 612—PARTS SHOW

Two new Gernsback Library books teach you
HI-FI CIRCUIT DESIGN — AND HI-FI MAINTENANCE!



**THE COMPLETE
GERNSBACK LIBRARY**

PAPER-COVERED EDITIONS

| | |
|--|--------|
| Basic Audio Course. No. 66..... | \$2.75 |
| Hard cover ed..... | \$5.00 |
| The V.T.V.M. No. 57..... | \$2.50 |
| Hard cover ed..... | \$4.60 |
| Sweep and Marker Generators. | |
| No. 55..... | \$2.50 |
| Hard cover ed..... | \$4.60 |
| Probes. No. 54..... | \$2.50 |
| Hard cover ed..... | \$4.60 |
| Radio-Control Handbook. No. 53..... | \$2.25 |
| The Oscilloscope. No. 52..... | \$2.25 |
| Hard cover ed..... | \$4.60 |
| Transistors—Theory and Practice | |
| No. 51..... | \$2.00 |
| TV Repair Techniques. No. 50..... | \$1.50 |
| Radio & TV Test Instruments | |
| No. 49..... | \$1.50 |
| High-Fidelity—Design, Construction, Measurements. No. 48..... | \$1.50 |
| Radio & TV Hints. No. 47..... | \$1.00 |
| Television Technotes. No. 46..... | \$1.50 |
| Radio Tube Fundamentals. | |
| No. 45..... | \$1.00 |
| Basic Radio Course. No. 44..... | \$2.25 |
| Model Control By Radio. No. 43..... | \$1.00 |
| High-Fidelity Techniques. No. 42..... | \$1.00 |
| Practical Disc Recording. No. 39..... | .75 |

High-Fidelity Circuit Design—

No. 56. By Norman Crowhurst and George Fletcher Cooper. 304 Pages.

This new book takes the guesswork out of hi-fi circuit design! Shows you how to build amplifiers on paper! Includes the often-requested series "Audio Feedback Design" which originally appeared in RADIO-ELECTRONICS Magazine with additional material and detailed explanations. 15 big chapters cover Analysis and Design, Drivers and Inverters, Speaker systems, Advanced techniques, Improving your amplifier, and much more. Deluxe, stamped gold leaf hard cover edition only.

Maintaining Hi-Fi Equipment

No. 58—By Joseph Marshall. 224 Pages.

RADIO-ELECTRONICS' popular hi-fi expert, authors a long-called for book on the specialized approach needed to service hi-fi equipment. Going beyond routine electronic faults, it tells how to correct mechanical and acoustical defects which affect the performance of the entire system. An excellent manual for hi-fi servicing as well as a handbook for trouble-shooting. 13 chapters on diagnosis, distortion, bass and treble faults, pickups, turntables, tuners, etc.

Paper-covered edition. \$2.90
\$5.95 Deluxe hard cover ed. \$5.00

See your distributor — or mail this coupon

GERNSBACK LIBRARY, INC. Dept. 56
154 West 14th Street, New York 11, N. Y.

Enclosed is my remittance of \$.....
Please send me the following books postpaid.

Prices 10% higher in Canada

39 42 43 44 45 46
 47 48 49 50 51 52
 53 54 55 56 57 58 66

Hard cover editions by mail only.

52H 54H 55H 57H 58H 66H

PRINT

Name.....

Street.....

City.....

State.....

NEW —Best Buy in Hi Fi

Grammes

Build-it-Yourself Kits

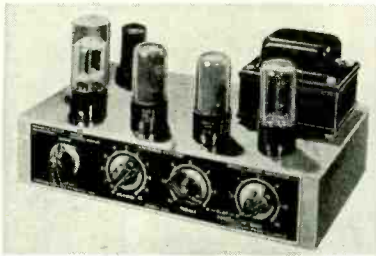

The Famous Lille Jewel **\$24⁹⁵**
MUSIC LOVERS AMPLIFIER **NET**

Most popular hi-fi amplifier in its field,
featured by Life Magazine.

Enjoy . . . Building Your Own.
Most complete set of instructions.

Sold only through selected distributors.

SEND COUPON FOR NAME OF DISTRIBUTORS
IN YOUR AREA

Grammes Division of Precision Electronics, Inc.
9101 RE King Ave., Franklin Park, Ill.

Rush name of nearest distributor.

Send L.J. Kit. Enclosed find \$5.00, balance and
postage C.O.D.

Send L.J. Kit postage-paid. Enclosed find \$21.95.

Name

Address

City Zone.....State.....

10-day money back guarantee on all kits.

SERVICEMEN! DEALERS!

FREE*

AMATEURS! EXPERIMENTERS!

*(With purchase of \$5.00 or more)

Valuable 353-page Base Connection
Book, Contains All the Latest Tubes,
Easy to Use!

ORDER NOW

This month's specials

NEW! SENCO LC2 grid leakage tube tester,
wired, ready to use, only \$24.95
Same, kit form, complete instructions.....\$19.95

ALSO

| | |
|---|-------|
| 6 wire parallel CRT briteners, ea..... | .99 |
| Ten for | 9.00 |
| 3 speed, hi-output universal xtal cartridge, fa- mous make! Ea. only | 2.29 |
| Pkg. of five for | 9.95 |
| 6" x 9" PM spkr., 1.47 oz. mag., ea..... | 3.95 |
| Five for | 18.00 |
| 6' TV cheater cord, ea. .29; ten for..... | 2.50 |
| 24" Hi-voltage 2nd anode lead, ea..... | .29 |
| Ten for | 2.50 |

Complete stocks of brand name parts;
Tung-Sol tubes, Aerovox cond.; Claro-
stat controls; etc.; write for prices or
place your order. Complete satisfac-
tion or your money refunded!

DELTA DISTRIBUTING

2357 York St. Blue Island, Ill.

Save C.O.D. and P.P. Fees:
Send Check or M.O. with Order, we prepay!

Watch for the
June RADIO-ELECTRONICS
On Sale May 24

BUSINESS

(Continued)

Association, New York, reports that about 20% more recorders were sold in 1955 than 1954. Total production for 1955 was estimated at 360,000 units.

RETMA reported that 43,099,796 TV sets had been shipped to dealers during the past 10 years. It also reported TV picture-tube sales of 892,385 units for January, 1956, compared with 866,956 for January, 1955. Comparative sales of receiving tubes were 40,140,000 in January, 1956, as against 37,951,000 in 1955.

Mergers

Textron American Inc., Boston, Mass., acquired all outstanding stock of General Cement Manufacturing Co., Rockford, Ill., manufacturer of TV antennas and technical aids. Stanley B. Valiulis, president of General Cement, will head the new Textron division.

P. R. Mallory & Co., Indianapolis, Ind., acquired General Dry Batteries, Inc., Cleveland, Ohio, which it will operate as a division, subject to stockholders' approval.

Astron Corp., East Newark, N. J., bought all the outstanding stock of Skottie Electronic Corp., Peckville, Pa., including buildings and production facilities. Skottie manufactures ceramic capacitors.

New Plants and Expansions

Sprague Electric Co., North Adams, Mass., is beginning construction on a new 20,000-square-foot plant in Concord, N. H., for the manufacture of surface-barrier transistors.

Merit Coil & Transformer Corp., Chicago, opened a new warehouse in San Francisco to improve service to its West Coast distributors.

International Rectifier Corp. relocated its New York office in larger quarters at 132 East 70th St.

Allen B. Du Mont Labs transferred its Missile Engineering Dept. from Clifton, N. J., to Los Angeles.

Westinghouse has begun work on a new 120,000-square-foot electronic-tube warehouse in Elmira, N. Y.

Business Briefs

. . . 1956 High-Fidelity Show and Music Festival will be held in the Palmer House in Chicago Nov. 2-5. The show management announces that all display rooms will be air-conditioned and elevator service will be improved.

. . . Westlab Electronics, Yonkers, N. Y., formerly a partnership, has been incorporated. Officers include Ira B. Perelle, president; Lois A. Brook, vice president, and Louis Petta, secretary.

. . . Ray-O-Vac Co., Madison, Wis., has adopted the NEDA numbering system for its complete line of radio batteries.

Correction

In the March issue an item stated that Tescon TV Products Co., Inc. was imprinting its distributors' names on its antenna cartridges. This should have read on its antenna cartons. END



**National Airlines Depends on Electro
DC Power Supplies to Test Engine Distributors**

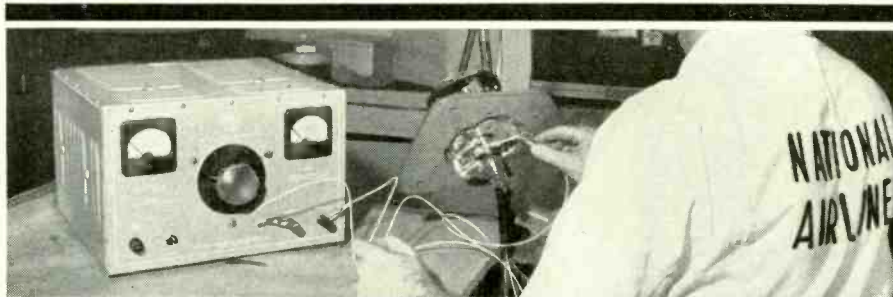

"The 'NF' is not only accurate but a great time-saver at our Engine Overhaul Base in Miami" according to Mr. Howard A. Pike in charge of Maintenance and Engineering. A versatile source of power, the "NF" is also widely used for servicing all types of electronic units in aircraft, missiles, autos, and marine craft. It has proven its worth consistently in service shops and industrial plants for operating solenoids . . . phone circuits . . . lab and research instruments . . . low voltage devices. See your electronic jobber. \$195.00

Certified Ratings
Less than 1%
ripple at 15 amps.
0-28 v. to 15 amps.
continuously
variable.
25 amps.
intermittent
rating

FREE Bulletin
Lists Specification
and All Applications

ELECTRO PRODUCTS LABORATORIES
4501-E North Ravenswood, Chicago 40, Ill.
Canada: Atlas Radio Ltd., Toronto



People

Dr. Thomas T. Goldsmith, Jr., vice president research, of Allen B. Du Mont Labs., Clifton, N. J., was named vice president and general manager of the Government and Research Div. in a move to consolidate all government manufacturing, engineering and sales operations into one division. He will continue to direct the company's Research Div.



Merle W. Kremer was appointed assistant general manager of the Sylvania Parts Div., Warren, Pa. He will continue his present duties as general manufacturing manager, with plants at Cleveland and Nelsonville, Ohio, as well as at Warren.

Harold F. Cook (left), advertising manager of Tung-Sol Electric, Inc., Newark, N. J., was appointed to the newly created post of director of ad-

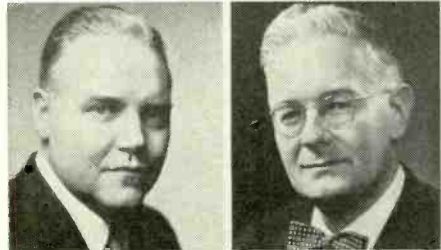

vertising and market research. **Robert M. Andrews** (right), former assistant advertising manager, was named manager of advertising and sales promotion for electronic products.

Edward G. Hazeltine was appointed manager of advertising and sales promotion for automotive products and will continue as manager of TBA sales. **Gerald A. Morgan**, former market analyst, was named manager of market research.

John D. McNamara joined Weston Electrical Instrument Corp., Newark, N. J., as field sales manager. He was formerly with Beckman Instruments, Inc., as that company's industrial sales manager.



from the VOICE OF AUTHORITY IN SWEEPS...

SPOT and FIX TV FAULTS FAST!

FREE RAM BOOK SHOWS HOW!

RAM Electronics Sales Co.
Irvington, New York

Send me FREE 1956 RAM "PIX-A-FAULTS" BOOK.

Name _____
Firm _____
Street _____
City _____ Zone _____ State _____

Typical latest field-proven servicing data you'll find in your RAM book:



FAULT: "Ringing."
CAUSE: Incorrect value of balancing R-C network across one-half of H. Yoke winding.
(A): H. Yoke current wave-form. Obtained by connecting scope across 10-ohm resistor inserted in series.



FAULT: Picture compression and stretching.
CAUSE: Capacitance value of boost capacitor (connected to linearity coil) too low.
(B): H. Yoke current wave-form. Leaky boost capacitor could cause similar effect.



FAULT: Picture stretching at left and compression at right.
CAUSE: 0.02 mf boost capacitor (connected to linearity coil) used instead of 0.1 mf capacitor.
(D): H. Yoke current wave-form.

For over 10 years, RAM has specialized and pioneered in sweeps exclusively. RAM designs them, makes them, counsels TV set manufacturers on them, field-services them, educates Servicemen on them — leads the industry.

No one but RAM can bring you such proven data — as shown here and in the RAM Manual. In manufacturing know-how and field experience, you can depend on RAM for...

THE VOICE OF AUTHORITY IN SWEEPS

Send coupon today — get the BEST information from the FOREMOST manufacturer now!



RAM ELECTRONICS SALES CO. • Irvington, N. Y.
Canadian Sales Division: Telequipment Mfg. Co., Ltd., Ontario
Export Dept: Dage Corp., 219 E. 44 St., New York, N. Y.

6-VOLT BATTERY SOLDERING IRON AND WELDER

U.S. Army release. Brand New—Never Used. Fully Guaranteed. This soldering iron can be used to solder or weld when connected to any six-volt storage battery. Uses approximately 200 to 300 watts. The high intensity arc created between the metal to be soldered and the carbon electrode (carbons supplied free with iron) can be used to heat tin or aluminum solder. Suitable also for light brazing and spot welding. Arc can be used

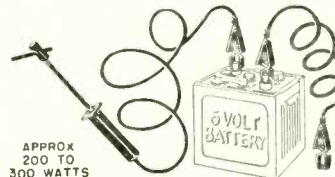

APPROX 200 TO 300 WATTS

Suitable also for light brazing and spot welding. Arc can be used

for melting metals, cutting holes and soldering seams in chassis. Also useful for analyzing metals and minerals.

Battery soldering iron outfit includes 2 carbons, 3 heavy duty spring clips, 2 pieces 5 ft. heavy duty wire cable. (Battery not included.) Ideal for use where current is not available. Ship wt. 4 lbs.

ITEM NO. 126
UNUSUAL BUY (P.P. & Hdq. Chgs. 50c) **\$1.95**

VARIABLE SPEED UNIVERSAL MOTOR

FOR 110 VOLTS, A.C. OR D.C. Used, but in excellent condition. Special lever control permits variable speeds up to 3000 r.p.m., 1/4" shaft extends from both sides of motor. Measures 7/2 x 3 1/4" diam. overall Shp. Wt. 6 3/4 lbs.
ITEM NO. 127
Your Price **\$2.45**
P.P. & Hdq. Chgs. 75c



WATTHOUR METER

Leading makes — reconditioned. Ideal for trailer parks. 100-110 volts, 60 cycles, 2-wire A.C. 5 amp. Heavy metal case 8 1/2" x 6 1/4" x 5". Easy to install. Ship. wt. 14 lbs.

(P.P. & Hdq. Chgs. \$1.25) ITEM NO. 33 **\$4.50**

AMAZING BLACK LIGHT

250-watt ultra-violet light source. Makes fluorescent articles glow in the dark. Fits any lamp socket. For experimenting, entertaining, unusual lighting effects. Ship. wt. 2 lbs.
ITEM NO. 87
(P. P. & Hdq. Chgs. 35c) **\$2.45**



BLAK-RAY SELF-FILTERING

ULTRA-VIOLET LAMP



BLAK-RAY 4-watt lamp, model X-4, with U-V tube. Lamp has a wave-length of 3854 to 4000 angstrom units. Some of the substances made to fluoresce are certain woods, oils, minerals, milk-stone, cloth, paints, plastics, yarn, drugs, crayons, etc. Self-filtering and harmless.

Equipped with aluminum reflector. 110 volt 50-60 cycle A.C. 2000 to 3000 hours of service. Approved by Underwriters has a built-in transformer. ITEM NO. 125 (Shp Chgs. 80c) **\$16.75**

POWERFUL ALL PURPOSE MOTOR

Sturdy shaded pole A.C. induction motor. 15 watts, 3000 rpm. 3"x2"x1 3/4"; 4 mounting studs; 7/8" shaft, 3/16" diameter; 110-120 volts, 50-60 cycles. A.C. only. ITEM NO. 147
UNUSUAL BUY **\$2.45**
(P.P. & Hdq. Chgs. 35c)



250 POWER TELESCOPE LENS KIT

Make your own high powered 6 ft. telescope! Kit contains 2" diam., 75" focal length, ground and polished objective lens and necessary eye pieces. Magnifies 50x to 250x. Full instructions. ITEM NO. 123 (Shp. Chgs. 10c) **\$2.95**



HUDSON SPECIALTIES CO.

25 West Broadway, Dept. RE 5-56
New York 7, N. Y.

I am enclosing full remittance for items circled below. (Be sure to include shipping charges.)

OR, my deposit of \$..... Ship balance C.O.D.
MINIMUM C.O.D. ORDER \$5.00.
C.O.D. ORDERS ACCEPTED ONLY WITH 20% DEPOSIT. INCLUDE SHIPPING CHARGES.

87 147 33 126 123 125 127

Name _____ Please Print Clearly
Address _____
City _____ Zone _____ State _____

DON'T JUST SAY CAPACITORS

Ask For Sprague By Catalog Number

Know what you're getting . . . get exactly what you want. Don't be vague . . . insist on Sprague. Use complete radio-TV service catalog C-610. Write Sprague Products Company, 81 Marshall Street, North Adams, Massachusetts.

SPRAGUE®

WORLD'S LARGEST CAPACITOR MANUFACTURER

Make sure . . .

You get *every* issue of

RADIO-ELECTRONICS

(The Annual Index in the December issue makes it easy to find what you want in *every* issue at *any* time.)

Subscribe NOW and SAVE

One Year \$3.50

Two Years \$6.00

Three Years \$8.00

Canada same as U. S.

Extra postage per year:

Pan-America, 50c

all other foreign, \$1.00

TAPE RECORDERS

Tapes—Accessories

Nationally Advertised Brands

UNUSUAL VALUES

Send for Free Catalog

DRESSNER

69-02 RE 174 St.
Flushing 65, N. Y.



REPAIR TV PICTURE TUBES WITHOUT COST OR EQUIPMENT

Give new life to old or defective tubes. Remove shorts. Restore emission and brightness. Servicemen do it—you can, too! Months of extra service. Results compare with most expensive instruments. Save money by fixing your own tubes. Earn extra money fixing tubes for others. Be prepared, earn large profits repairing expensive color picture tubes. Learn this easy, tried and tested method now and cash in! Order now!

SPECIAL OFFER complete instructions \$1

TELEPARTS CO.

172 Narragansett St. Edgewood 5, R.I.

PEOPLE

(Continued)

Mal Parks, Jr. joined Howard W. Sams & Co., Indianapolis, Ind., in an executive capacity. He had been publisher of *Parts Jobber Magazine*.



Louis H. Niemann (left) was named equipment sales manager at CBS-Hytron. He was formerly Eastern district



sales manager. Lee Ballengee, Jr., (right) formerly with General Instrument Corp., succeeds him as Eastern district sales manager. Herbert L. Reichert, formerly Central district manager for CBS-Hytron, was appointed Midwest regional manager for CBS-Hytron Sales Corp, with headquarters in Chicago.



W. Ropp Triplett, general manager of Triplett Electrical Instrument Co., Bluffton, Ohio, was named president of the company. Ray L. Triplett, founder and president, becomes chairman of the board. The photo shows W. Ropp Triplett (center), one of the two sons of the founder, being congratulated by Norman Triplett, vice president and sales manager, while M. Morris Triplett, the other son of the founder, and vice president, engineering, looks on.

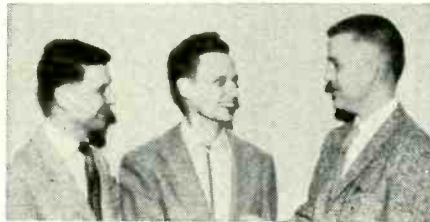

Beg Pardon

In the April issue, the photos of Ken Hathaway, who was elected treasurer of the Association of Electronic Parts and Equipment Manufacturers, and Russel Schlegel, who joined Weston Electrical Instrument Corp. as manager of Industrial Product Sales, were transposed.

Obituary

Robert Robins, a public relations counsel and radio pioneer, at his home in Forest Hills, N. Y. He was at one time president of Cath-Ray Electronics Corp. and the Duovac Radio Tube Corp.

Personnel Notes

. . . James H. Carmine, retired as president of Philco Corp., but will continue as a member of its board and Finance Committee. He is to be succeeded by James M. Skinner, Jr., director and

BENCO'S NEW REVOLUTIONARY Super "20"

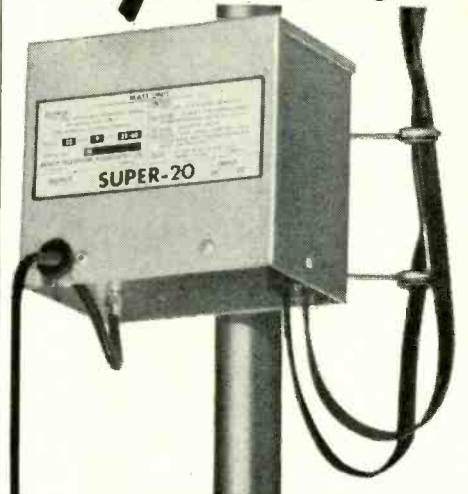

MAST-MOUNTED BOOSTER

OUTSTANDING PERFORMANCE FEATURES:

- Very Low Noise Cascade Circuit Brings Weak Snowy Pictures to Entertainment Level.
- Automatic ON-OFF from TV Receiver
- Easily mounted on Mast
- Supplied Complete with all Connectors (Solderless)
- 20 DB Gain
- Contains separate 3-tube Amplifiers for High and Low Bands (3 Dual Triodes).
- Amazing Low Price

\$59.50 Canadian List

Available from local jobbers

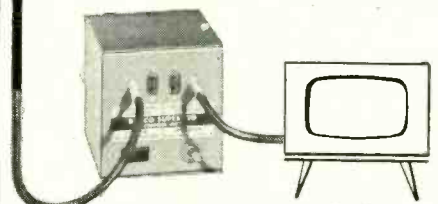

USE THIS HANDY COUPON

Benco Television Associates Ltd.,
278 Bridgeland Ave. Downsview
TORONTO, Canada.

- Please send me complete details on the SUPER "20"
 New equipment CATALOG

Name

Address

City..... Prov.....

vice president and general manager of the Television Div., pending approval by stockholders.

... George J. Parker, former president of the Daystrom Instrument Div., was appointed vice president of Daystrom Inc. in charge of its Washington office. Walter W. Slocum, vice president of operations for Daystrom Inc., will assume responsibility for the operation of the Instrument Div.

... Andrews Ferguson was placed in charge of New England distributor sales for Sprague Products Co., North Adams, Mass. He was formerly field representative for the company. Albert Coumont, who had been service coordinator and staff assistant to the RETMA Parts Div., joined the Sprague Electric Co. Distributor Sales Div.

... Arthur I. Rabb, advertising and sales promotion manager of United Catalog Publishers, Inc., New York, was promoted to general manager. George Siegel, former assistant advertising manager, succeeds him. Herman Holstein was named editor of *Radio-Electronic Master*. Other appointments include: George M. Kerner, manufacturer liaison, and Robert J. Males, administrative assistant.

... Harold A. DeMooy was appointed manager of manufacturing for RCA receiving tube activities at Harrison, and Woodbridge, N. J., Indianapolis, Ind., and Cincinnati, Ohio. He had been in charge of the tube plant in Cincinnati. John B. Farese was named manager, personnel, for the division. He had been manager of manufacturing for the concern ... William L. Eschwei, manager of radio assembly inspection and test at the Clifton, N. J. plant of Federal Telephone & Radio Co., was named plant manager of the Pacific Div. Joseph F. Rapone, superintendent of radio assembly, succeeds him.

... Peter L. Jensen, chairman of the board of Jensen Industries, and Edwin S. Pridham, former vice president of Magnavox, were named honorary members of the Audio Engineering Society for their pioneer work on the electrodynamic loudspeaker in 1915.

... Avery Fisher, Fisher Radio Corp., was elected chairman of the Board of Directors of the Institute of High Fidelity Manufacturers.

... Robert L. Ashley, with the company since 1952, was appointed sales manager for germanium and silicon products by Radio Receptor Co., Inc., Brooklyn, N. Y.

... Harry A. McDonald, investment counselor, was elected to the Board of Directors of Sonotone Corp., Elmsford, N. Y.

... John M. Palmer was named manager of the new Spring City, Pa., plant of the Lansdale Tube Co., a division of Philco. He had been manager of receiving and cathode-ray tube operations.

... Herbert C. Guterman, who has had wide industrial operating experience in the electronics field, was elected chairman of the board of National Co., Malden, Mass. END

Be one of the few experts on Audio and Hi-Fi ...

Cash in on This Money-Making Field

Be prepared! Know how to service the thousands and thousands of dollars' worth of Audio equipment the growing army of Hi-Fi enthusiasts is buying. Know all about the different kinds and makes of turntables, pick-ups, speakers, amplifiers, cartridges, enclosures, etc. Know how audio circuits work, how to use them properly—how to tell which parts work best in which systems. Have at YOUR fingertips the FIRST and ONLY COMPLETE library of practical, detailed Audio and Hi-Fi know-how ever assembled!

THE GERNSBACK AUDIO AND HIGH-FIDELITY LIBRARY— WRITTEN BY THE WORLD'S FOREMOST AUTHORITIES



A whole library loaded with diagrams and expert know-how ... written in down-to-earth language ... each book beautifully cloth bound and stamped in gold leaf!

The Second Book Is Ready Now

MAINTAINING HI-FI EQUIPMENT, by Joseph Marshall. This top quality book is the FIRST ONE EVER WRITTEN dealing with the problem of servicing and maintaining Hi-Fi equipment.

Is the bass off? The chapter titled "Bass and treble faults" has the answer. Is high-level distortion the problem? The chapter titled "High-level distortion" will tell you what to do. Every symptom is fully and completely covered. No-one who owns or services hi-fi equipment can afford to be without this much needed book!

Then ... the additional books you will get as published include: *The Golden Ear*; *Audio Hints*; *Constructing Audio Amplifiers*; *The Audio Designer's Guide Book*; *Loudspeakers and Speaker Systems*; *Loudspeaker Enclosures*; *Tape Recorders* ... and others now being prepared.

AND YOU CAN SAVE 25%!

If you buy each of these books individually as they are published, you will pay \$5.00 each ... but by becoming a member of the GERNSBACK AUDIO AND HIGH-FIDELITY LIBRARY PLAN YOU SAVE 25%.

Here Is How The Library Plan Works

- 1) You will receive the very latest book by mail every three months as it comes off the press. Examine it IN YOUR OWN HOME FOR 10 FULL DAYS AT OUR RISK! If you don't like it, return it.
- 2) You only have to take four of the Hi-Fi books to get each one at the special low member's price of only \$3.75 per copy. The more you buy, the more you save. If you buy 5 books you save \$6.25. If you buy 10 books you save \$12.50!

FILL OUT THIS NO-RISK COUPON TODAY!

All you have to do is fill out this coupon and mail it today. Just check the box that suits you best. Don't delay! Get your copy of **MAINTAINING HI-FI EQUIPMENT** for a FREE home examination now!

NO-RISK COUPON

GERNSBACK LIBRARY, INC.

Dept. 556, 154 West 14th St., New York 11, N.Y.

Catch me up to other Audio Library members immediately. Send me both books so far published: **BASIC AUDIO COURSE** by Donald Carl Hoefler—and **MAINTAINING HI-FI EQUIPMENT** by Joseph Marshall (retail value \$10.00) for only \$7.50 including postage!

Start my membership with just the book checked below at \$3.75, postpaid:

BASIC AUDIO COURSE

MAINTAINING HI-FI EQUIPMENT

I have 10 days in which to return any book if I am not satisfied. Otherwise, I will pay promptly when I get your bill.

Send me more information on the GERNSBACK AUDIO and HI-FI LIBRARY.

NAME..... Please Print

STREET.....

CITY..... STATE.....

XCELITE Hand Tools
PREFERRED BY THE EXPERTS

XCELITE

BRINGS YOU

**THE FINEST
TOOLS FIRST!**

... like this No. 62 Transverse Cutter for flush cutoff work in miniature and subminiature chassis. Compact, it has spring return for thumb-and-finger operation in small places. One of a big line of quality XCELITE screwdrivers, nut drivers and pliers—first with the best features to make your work easier!

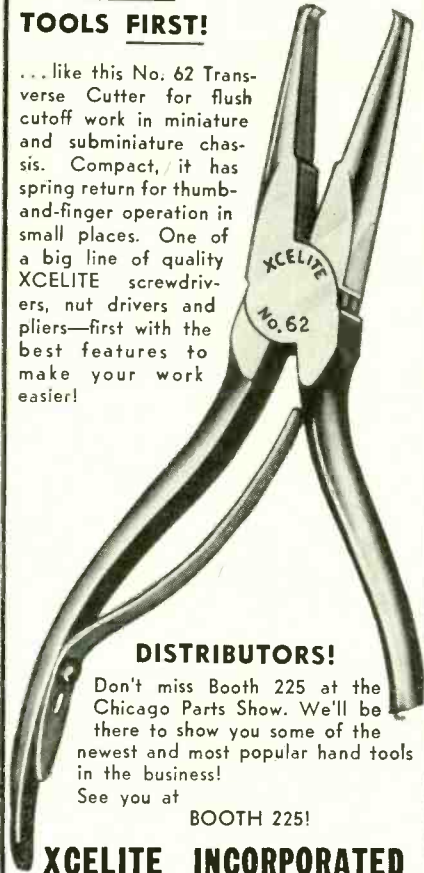

DISTRIBUTORS!

Don't miss Booth 225 at the Chicago Parts Show. We'll be there to show you some of the newest and most popular hand tools in the business!
See you at

BOOTH 225!

XCELITE INCORPORATED

Dept. J
Orchard Park, N.Y.
In Canada—
Charles W. Pointon Ltd.
6 Alcina Ave.,
Toronto, Ont.

For Originality
LOOK TO XCELITE

**WEAR A
BUDDY
POPPY**

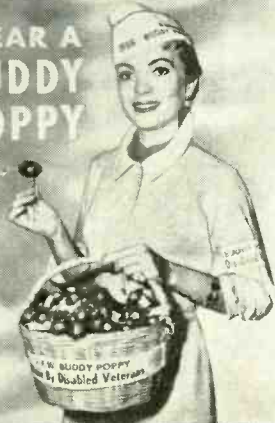

**Veterans of Foreign Wars
of the United States**

**technical
Literature**

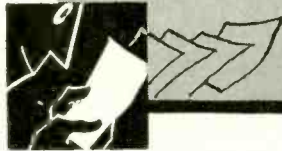

G-E BROCHURE

An 8-page brochure *ECG-95* contains condensed specification and rating data on transistors and rectifiers, critical parameters for absolute maximum ratings and design center ratings for G-E n-p-n and p-n-p transistors; critical specifications for germanium rectifiers including basic rectifier units; high-temperature, magnetic amplifier and 5-amp power rectifiers; rectifier stacks, including medium-power, in various applications.

Brochure or individual specification sheets from Semiconductor Products Section, General Electric Co., Electronics Park, Syracuse, N. Y.

BUD CATALOG

Catalog No. 156 describes sheet-metal products and electronic components. In addition, special fabrication facilities are outlined. Complete sizing information is given on each product and suggestions for uses and applications are also included.

Bud Radio, Inc., Dept. C8, 2118 E. 55 St., Cleveland 3, Ohio.

SPEAKER SYSTEMS

A comprehensive *Guide to High-Fidelity Loudspeaker Systems* stresses the importance of the loudspeaker in any home music center and provides basic facts on how to choose a loudspeaker system. It gives details about integrated, separate and completely assembled two-, three- and four-way systems as well as acoustically designed, furniture-styled enclosures to suit individual budgets, space, decor and musical tastes. It also includes information about Electro-Voice do-it-yourself high-fidelity enclosure kits and the availability of individual speaker system components.

Electro-Voice, Inc., Buchanan, Mich., 25c.

SELENIUM RECTIFIERS

Form HT1 describes the new Sarkes Tarzian line of selenium rectifiers designed to operate at full voltage and current without derating at temperatures as high as 150°C.

Sarkes Tarzian Inc., Rectifier Div., 415 No. College Ave., Bloomington, Ind.

AMPLIFIERS

RCA's *Catalogs S3027, S3026 and S3023* give data on applications, descriptions, specifications and accessories of 30-watt amplifiers MI-12154, type SA-34A, MI-12155, type SA-32A and 15-watt sound amplifier MI-12156, type SA-15A.

**DON'T
JUST SAY
CAPACITORS**

Ask For
Sprague
By Catalog
Number

Know what you're getting . . . get exactly what you want. Don't be vague . . . insist on Sprague. Use complete radio-TV service catalog C-610. Write Sprague Products Company, 81 Marshall Street, North Adams, Massachusetts.

SPRAGUE[®]
WORLD'S LARGEST
CAPACITOR MANUFACTURER

WANT BACK ISSUES?

Back numbers of most issues of **RADIO-ELECTRONICS** are available upon request

This year's issues 35c

Last year's issues 40c

Previous year 45c, etc.

All January TV issues 50c

RADIO-ELECTRONICS

154 West 14 St.

New York 11, N. Y.

NEW BE QUALITY WISE . . .
BUY QUAL-KITS!

Hi-Fi AM-FM Tuner
Advanced 7 tube circuit provides full sensitivity and selectivity giving this AM-FM tuner exceptional hi-fi reception. Armstrong FM circuit with limiter, Foster-Seeley Discriminator. 20-20,000 cps response. Full AFC control—no drift.



\$28.95

Hi-Fi Amp.
Complete 6 tube-10 watt amplifier. Push-pull beam power output, built-in pre-amp. 5 position selector switch, 3 position record equalization, LP, RIAA, Eur. Response 1/2 db. 20-20,000 cps. Output 10 watts at less than 2% IM. Low noise level and harmonic distortion.

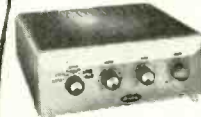

\$28.50

Cover and legs optional

Every kit complete with step-by-step fully illustrated 28 page instruction and assembly manual. Write today for FREE catalogue and name of nearest dealer carrying these remarkable units.

Quality-Electronics Dept. E-4
319 Church Street New York 13, N. Y.

Radio Corp. of America, Sound Products, Camden, N. J.

NEEDLE CATALOG

A 73-page catalog includes a cartridge-to-needle listing, illustrated cartridge index, illustrated needle listing with an index and needle installation data.

Permo, Inc., 6415 Ravenswood Ave., Chicago 26, Ill.

MAGNETS

Cast, sintered, ductile and formed permanent magnet materials are discussed in manual No. 5, *Permanent Magnets Materials and Their Selection*. A selector type chart summarizes the magnetic characteristics, application and design factors, material characteristics, manufacturing methods and shape limitations of each.

Other sections of the manual discuss the hysteresis loop and demagnetization curve, temperature limitations, directional properties, incremental permeability, hysteresis loss, etc.

A glossary of magnetic terms, listing of magnetic symbols and graphic illustration of material characteristics are also included.

Indiana Steel Products Co., Valparaiso, Ind. Use your letterhead.

BENCH TOOLS

A 40-page catalog describes insulated and noninsulated screwdrivers, nut drivers, pliers, service tool kits, align-

ment and specialty tools, etc. Heavily illustrated with photos, charts and tables.

Vaco Products Co., 317 E. Ontario St., Chicago 11, Ill. Requests must be on letterheads.

INSTRUMENT TYPE SWITCHES

An 8-page *Catalog 17-SE* describes instrument type switches. Illustrations, complete code system outline and specifications are included in the data.

Cinema Engineering Co., Acrovox Div., 1100 Chestnut St., Burbank, Calif.

Any or all of these catalogs, bulletins, or periodicals are available to you on request direct to the manufacturers, whose addresses are listed at the end of each item. Use your letterhead—do not use postcards. To facilitate identification, mention the issue and page of RADIO-ELECTRONICS on which the item appears. UNLESS OTHERWISE STATED, ALL ITEMS ARE GRATIS. ALL LITERATURE OFFERS ARE VOID AFTER SIX MONTHS.

MULLARD AUDIO TUBES

This leaflet describes the EF86, EEC83, EL84 and EL34 tubes designed for audio equipment. The electrical characteristics of each are given together with tables on typical operating conditions. In addition, preliminary technical data are given for the EZ81 and GZ34 full-wave rectifiers.

International Electronics Corp., 81 Spring St., New York 12, N. Y.

PAPER CAPACITORS

Catalog 155 describes paper capacitors for ac and dc applications. Data on mineral-oil-impregnated paper-dielectric capacitors in a variety of containers, synthetic-oil-impregnated paper-dielectric capacitors, etc. are included. Charts and diagrams also given.

Plastic Capacitors, Inc., 2511 W. Moffat St., Chicago 47, Ill.

ELECTRONIC EQUIPMENT

Newark's 1956 catalog devotes more than 20% of their catalog to audio and high-fidelity equipment, as well as a large line of radio and TV repair equipment, components, radio hardware, etc.

Newark Electric Co., 223 W. Madison St., Chicago 6, Ill.

OUTPUT TRANSFORMERS

A 6-page folder contains complete data and three schematics of Dynaco output transformers. A chart on color coding of transformer leads is also included.

Dyna Co., 5142 Master St., Philadelphia 31, Pa.

AUDIO EQUIPMENT

Langevin's catalog describes transformers, reactors, amplifiers, power supplies and special equipment.

Langevin Mfg. Corp., Subsidiary of W. L. Maxson Corp., 47-37 Austell Pl., Long Island City 1, N. Y. END

Get This Valuable Book

FREE



Just For Examining COYNE'S New Set

"Applied Practical Radio-Television"

on 7 DAY FREE TRIAL!

NOW!

7 BIG BOOKS IN ONE GREAT SET!



Yes, you get this big, brand new book, "150 Radio-Television Picture Patterns and Diagrams Explained", absolutely FREE! Just off the press. Gives complete 11 x 22" Schematic Diagrams on leading models Radio and TV Sets. Easy-to-read, large 8 1/2 x 11" pages, with full instructions on how to use the diagrams. A "must" in every repair kit. You get this book as a FREE Gift for asking to see Coyne's new 7-book set, "Applied Practical Radio-Television"!

At Last! Money-Making "Know-How" on Transistors, Color TV and Servicing

Coyne's great 7-volume set gives you all the answers to servicing problems—quickly! For basic "know-how" that's easy to understand you'll find everything you want in Volumes 1 to 5 on over 5000 practical facts and data. Every step from fundamentals to installing, servicing and trouble-shooting all types of radio and TV sets. So up-to-date it covers COLOR TV, UHF and the latest on TRANSISTORS. All this plus Volume 6—NEW Coyne TECHNICAL DICTIONARY with over 4000 definitions of the latest terms, symbols and abbreviations in radio-TV, electronics and electricity.

EXTRA! 900-Page Television Cyclopeda Included

And then, for speedy on-the-job use, you get volume 7—the famous Coyne TELEVISION CYCLOPEDIA. It answers today's television problems on servicing, alignment, installation, etc. In easy-to-find ABC order, cross-indexed. Use this 7-volume TV-RADIO LIBRARY FREE for 7 days; get the Servicing Book ABSOLUTELY FREE!

Educational Book Publishing Division

COYNE ELECTRICAL SCHOOL
500 S. Paulina St., Dept. 56-T1, Chicago 12, Ill.

SEND NO MONEY! Just mail coupon for 7-volume set on 7 days free trial. We'll include book of 150 TV-Radio Patterns & Diagrams. If you keep the set, pay \$2 in 7 days and \$2 per month until \$24.50 plus postage is paid. (Cash price, only \$22.95). Or you can return the library at our expense in 7 days and owe nothing. **YOU BE THE JUDGE.** Either way, the book of TV-Radio Patterns is yours FREE to keep! Offer is limited. Act NOW!

FREE BOOK — FREE TRIAL COUPON!

Educational Book Publishing Division
COYNE ELECTRICAL SCHOOL, Dept. 56-T1
500 S. Paulina St., Chicago 12, Ill.

YES! Send 7-Volume "Applied Practical Radio-Television" for 7 days FREE TRIAL per your offer. Include TV-Radio Patterns & Diagram Book FREE.

Name..... Age.....

Address.....

City..... Zone..... State.....

Where Employed
 Check here if you want library sent C.O.D. You pay postman \$22.95 plus C.O.D. postage on delivery. 7-day money-back guaranteed.

OPPORTUNITY ADLETS

Rates—15c per word (including name, address and initials) Minimum ad 10 words. Cash must accompany all ads except those placed by accredited agencies. Discount, 10% for 12 consecutive issues. Misleading or objectionable ads not accepted. Copy for July issue must reach us before May 15, 1956.

RADIO-ELECTRONICS,
154 West 14 St., New York 11, N. Y.

ELECTRONIC DESIGN ENGINEER

Graduate EE to design AccuRay industrial measurement and control equipment. Servo mechanism and feedback experience desired. Will have Representative at May Show. Send resume to Industrial Nucleonics Corporation, 1205 Chesapeake Avenue, Columbus 12, Ohio.

HIGH-FIDELITY SPEAKERS REPAIRED. Amprite Speaker Service, 70 Vesey St., New York 7, N.Y. BA 7-2580.

"NEW" Build \$4.00 transistor radio. Illustrated plans, 50c. COOK, 4003-R Roosevelt, Midland, Texas."

SPEAKER RECONING: Guaranteed workmanship. C&M Recone Co., 255 Tioga St., Trenton 9, N.J.

TELEVISION Tuner Repairs. DAN'S Television Laboratory, 9 West 183rd St., N.Y. 53, N.Y.

DIAGRAMS FOR REPAIRING RADIOS \$1.00. Television \$2.00. Give Make, Model. Diagram Service, Box 972-RE, Hartford 1, Conn.

TUBES—TV, RADIO, TRANSMITTING, AND SPECIAL PURPOSE TYPES BOUGHT, SOLD AND EXCHANGED. Send details to R. E. Gensler W2LNI, 512 Broadway, N.Y. 12, N.Y.

ALL MAKES OF ELECTRICAL INSTRUMENTS AND TESTING equipment repaired. Write for free catalogue on new and used instruments at a savings. Hazelton Instrument Co., 128 Liberty Street, New York, N.Y.

ET-243's: 3500 to 8700 KC. \$2.00 each. HUNDLEY CRYSTAL CO., 2951 North 36th, Kansas City 4, Kansas.

TRADE IN TV SETS \$14 up. JONES RADIO, 1115 Rambler, Pottstown, Pa.

TAPE RECORDERS, tapes; Wholesale prices. KARSTAN, 215 E. 88 St., New York 28, N.Y.

WANTED: AN/APR 4, other, "APR.", "TS-", "TE-", ARC-1, ARC-3, ART-13, BC-348, etc. Microwave Equipment. Everything Surplus. Special tubes, The Manuals, Lab Quality Equipment, Meters, Fast Action, Fair Treatment. Top Dollar! Littell, Fairhills Box 26, Dayton 9, Ohio.

JAPAN DIRECTORY. 100 Japan exporters, plus opportunity mail. Just \$1.00 today. NIPPON ANNAL, 920-3rd Ave. Seattle 4, Wash.

DIAGRAMS: Professional Model Timers, Counters, Intercoms, Organs, etc. \$1.00 each. List free. Parks, 101 S.E. 57th, Portland 15, Oregon.

Tenaclip anchors whip antenna firmly. \$1.98 postpaid. PLASTICLES, 4207 Grand River, Detroit 8, Mich.

PRINTING—Letterheads, 6 3/4 envelopes, statements, 250 for \$2.50. Postpaid. FLOOR BOY RE, Box 1055, Little Rock, Ark.

RADIO, RADAR, TELEVISION instruction leading to Licenses. Port Arthur (Texas) College.

FOREIGN jobs list. Technicians needed. \$1. RATHIE, Box 173, New Orleans 3, La.

WANTED—Some of the dead stock on your shelves—for which I will pay top money! I need all types of electronic tubes—broadcast, transmitting, receiving, Magnetrons, Klystrons, etc. Will also buy all kinds of airborne equipment, such as: ADP-70; ARC-1, -3, -4, -12, -15, -27, -33; AIN-6, -7, -12, -14, -18; BC-312, -342, -610E, -788C, -912H, 1-152, 1D-48, MN-24C, 31C, -36, -42, -53, -58, -61, -85, -97F, -100A; RA-18; TA-18, 17-13, 51-R, -R3, 51-VI, ETC. Write me today. ROBERT E. SANNETT W6REX, 1524 S. Eddis Dr., Los Angeles 36, Calif.

Noire Dame viewcards, 8 for \$1.00, Remails 25c. SCHAUT, 619 Kannus, Mishawaka, Indiana.

Hi-fidelity Specials—Limited Supply—Order Today—Collaro RC-54—Mounting Board—Ronette Cartridge—Diamond Stylus on LP—only \$49.75 Prepaid—\$39.50 without Diamond, prepaid. 1800' Guaranteed tape—New on 7" reel—plastic base, 10 for \$24.00 Prepaid—Full line of Hi-Fi equipment—write today. . . SOUND MART UNLIMITED, INC., 63-03 39th Ave., Woodside 77, New York.

RUBBER STAMPS: 1st line 65c, Add'l lines 35c. Ink-Pad 60c. STAMP SHOP, Victoria, Kans.

Diagrams—Repair Informational Radios, Amplifiers, Recorders \$1.00 Televisions \$1.50. Send Make, Model, Chassis. (Air-Mail ? + 20c) TV MILTIE, Box 101-E, Hicksville, New York.

INTERNATIONAL TAPE-RESPONSE MEMBERS WANTED. U.R.C. Box 147, Chicago 50, Illinois.

TV FM ANTENNAS. ALL TYPES. Mounts, accessories. Lowest prices. Wholesale Supply Co., Lunenburg 2, Mass.

Books



THE LONG PLAYING RECORD GUIDE, by Warren De Motte. Dell Books, 200 Fifth Ave., New York, N. Y. 50c.

Even the connoisseur who knows both the music and the orchestras would have difficulty choosing between 20 recorded versions of the same work assuming he could even manage to hear them all. The typical listener who listens primarily because he loves music and pretends no expertise about it is usually completely at a loss. Warren De Motte in this inexpensive pocket-book offers guidance to both classes of listeners and in my view succeeds better than others in more pretentious and expensive guides.

In a work like this the author cannot avoid being colored by his personal likes and dislikes, tastes, preferences and even prejudices. I particularly like this work because Mr. DeMotte does less categorical judging and more describing of differences in performance, interpretation and recording than others. He does mark with an arrow the recording which in his view is the best of the available lot, but he also gives the highlights or deficiencies of all versions succinctly but clearly enough so those whose taste may differ are given more than a hint to guide them in their own choice.

Judging by the small percentage of works I have heard myself, Mr. De Motte compiles a very good batting average in his recommendations. And the complete layman does not run much risk of being displeased if he follows them. The audiophile and hi-fi fan will also be well served for Mr. De Motte invariably points out the best recordings, even if the recording is not musically first-class in his own judgment; and here too his batting average is very good.

The book does not even begin to pretend to be a catalogue of all LP recordings. It concentrates almost entirely on those most popular classics of which there are several recordings. The arrangement is alphabetical by the name of the composer.—JM

FUNDAMENTALS OF TELEVISION ENGINEERING, by Glenn M. Glasford. McGraw-Hill Book Co., Inc., New York, N. Y. 6 x 9 inches, 642 pages. \$12.75.

This text is not for most service technicians but is suitable for engineers and advanced TV technicians. It covers the entire TV field from a theoretical viewpoint. Math is used extensively and there is considerable material on Laplace transforms and their applications.

CARTOONS

RADIO-ELECTRONICS pays \$3.00 for good cartoon ideas and \$15.00 and up for finished work. Radio-Electronics, 154 West 14th St., New York 11, N.Y.

NEW! For the First Time!

CHECK CAPACITORS UNDER WORKING CONDITIONS!
TEST CONDENSERS IN THE SET!



SATISFACTION GUARANTEED OR RETURN WITHIN TEN DAYS FOR REFUND

CAPACITEST, the result of months of development

is a new, compact checker that does a giant job to save you time and money. It will check condensers at 150 Volts, which is approximately the working voltage in a radio or TV set. Meters will not give this type of check since the applied voltage is 20 Volts or less. Avoid call-backs by using CAPACITEST. Accurately, quickly, it shows open, shorted, or intermittent capacitors and leaky electrolytics. Compact: 4"x4"x2"—lightweight, for bench or tool kit.

CAPACITEST

Quickly, Accurately checks:

- PAPER, MICA, CERAMIC CAPACITORS
- ELECTROLYTICS
- CONTINUITY
- AC/DC VOLTAGES
- FLASHBULBS

\$9.95 postpaid. Net complete, ready for operation

NOT A KIT

FREE Special Introductory Offer for limited time only: Set of test leads Free with each CAPACITEST. Order direct from manufacturer—include \$3 deposit with C.O.D.'s. Save PP & COD fees; send \$9.95 & we'll pay postage.

JAY The Barjay Co. 145 West 40 Street New York 18, N.Y.

STANLEY ELECTRONICS

TUBES & Parts

PAY LESS HERE!



Special Introductory Offer!

DEDUCT 10%

from the total if your order is \$20 or more!

MAY SPECIAL!

300 Ohm Twin Lead TV WIRE **100 feet \$1**

DUMONT and RCA LICENSED TV-PICTURE TUBES

All brand new. One year guarantee. Discounts for the Quantity Purchaser. Partial listing. No replacement Dud required! Shipped F.O.B. Passaic, N.J.

| | | | |
|--------|---------|----------|---------|
| 10 BP4 | \$10.95 | 16 EP4 | \$21.75 |
| 12 JP4 | \$13.99 | 16 FP4 | \$18.75 |
| 12 LP4 | \$12.95 | 16 HP4 | \$18.99 |
| 12 QP4 | \$13.95 | 16 JP4 | \$19.00 |
| 14 CP4 | \$15.25 | 16 LP4 | \$17.99 |
| 14 BP4 | \$15.99 | 17 BP4 | \$19.00 |
| 15 AP4 | \$18.99 | 17 GP4 | \$21.00 |
| 15 DP4 | \$18.95 | 17 LP4 | \$18.00 |
| 16 DP4 | \$18.50 | 17 HP4 | \$19.00 |
| 16 GP4 | \$19.25 | 19 AP4 | \$23.00 |
| 16 KP4 | \$17.00 | 20 CP4 | \$24.00 |
| 16 RP4 | \$17.00 | 21 ALP4A | \$24.00 |
| 16 AP4 | \$19.99 | 21EP4 | \$24.00 |

write for Stanley's Tube & Parts Catalog

6" x 9" Rear Speaker Kit \$5.25
Includes Mounting, grill, hardware, 3 way switch with speaker 6" x 9". List Price \$8.97.

2 set TV coupler.....1.99
Picture Tube Brightener.....1.09
Indoor Antenna with brass dipoles.....2.89
List Price \$7.95.

FREE! ★ Premium coupon with every order
★ Electric tester with every \$3 order.
★ Sylvania Repair Kit with every \$25 order.

TERMS: FREE POSTAGE on all prepaid continental U.S.A. orders. 50c handling charge on all orders under \$5.00. 25% Deposit on all C.O.D.'s Subject to prior sale.

Stanley ELECTRONICS CORP.

935 MAIN AVENUE - PASSAIC, N. J.

Dept. RE5

Gregory 1-2498

Get Better Results from your V.T.V.M.

READ —

Gernsback Library Book No. 57

Paper cover edition \$2.50

On sale at all better parts distributors or write:

Gernsback Library, Inc.
154 West 14 St.
New York 11, N. Y.

BOOKS

(Continued)

Color TV is analyzed along with black-and-white.

Among important chapters are those on scanning, synchronizing, wideband amplifiers and restorers. The transmitting end of TV is covered in chapters which study problems relating to cameras, video transmitters and antennas.—IQ

A GUIDE TO GOOD BUSINESS. prepared by Merchandising Dept., Sylvania Electric Products, 1100 Main St., Buffalo, N. Y. 40 pages. 8½ x 11 inches.

Free from Sylvania Central Advertising Distribution Dept.

Published as an aid to present and future electronic service dealers, this booklet attempts to show the many things to be considered in opening and operating a radio and television sales and service shop. Among the subjects covered are original planning, surveying market conditions, choosing the right location, ideas and suggestions for window displays and arranging the work shop area.

The text is heavily supplemented with photos and drawings. Covering so many subjects in so few pages, the book is necessarily superficial in its treatment of each. However, several references are given to more detailed works on specific subjects.

Overall, the booklet is slanted toward sales and away from servicing, noticeably lacking in its treatment of test equipment and servicing supplies. For the prospective service dealer, *A Guide to Good Business* is just exactly that.—JK

PRACTICAL RADIO SERVICING, by William Marcus and Alex Levy. McGraw-Hill Book Co., Inc., 330 W. 42nd St., New York 36, N. Y. 6 x 9 inches, 565 pages. \$8.50.

This book should interest professional radio men as well as prospective technicians for members of the first group will want to recommend it to their friends in the second. Starting right from the beginning, nothing is taken for granted. The reader is told how to solder, shown how to remove a chassis and how to make simple tests. As he gains knowledge he proceeds to more complicated tests and troubleshooting.

The more common types of radios are discussed here: ac-dc, battery portable, phonograph. Diagrams show typical placement of components and tubes and where the set adjustments are located. Separate treatment is given to the power supply, if strip, audio and converter. Instruction is given on the use of an ohmmeter, multimeter and tube tester.

Valuable features are the assigned "jobs." The reader is asked to provide himself with an old set for experimental work and he is told how to take measurements and draw schematics. Deliberate defects may be introduced by the experimenter so he may learn to recognize faults and symptoms through experience.—IQ

EBY SERVICE AIDS



UNIVERSAL CHEATER-PATCHCORD

The AD-60 is supplied in two parts - the adapter and the special cord.

The adapter when used with any standard cheater card converts same into a Zenith type of cord.

Inserting the special cord into one end of the adapter, the AD-60 becomes a Zenith type of patch cord. Inserting the other end of the special cord into the adapter the AD-60 becomes a standard type of patch cord.

List Price **\$2.25**

POCKET UTILITY PROBE PR 200

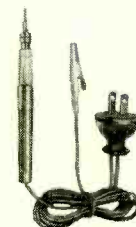

- Series Filament
- Parallel Filament
- Electronic Components

Rapid position tests for SERIES and PARALLEL filaments in all types of TELEVISION, A.C.-D.C. RADIOS and PORTABLES. Tests all types of tubes, OCTAL,

LOCTAL, 7 PIN MINIATURES, 9 PIN MINIATURES, and CATHODE RAY TUBES. Continuity tests can also be made on all types of electronic components, appliances, electrical and automotive equipment. Unlike most series filament and continuity testers, the PR-200 Pocket Probe is designed to easily fit the serviceman's pocket and tool box. The PR-200 probe is entirely shock-proofed and utilizes any 110V. AC-DC line.

Complete **\$3.25** with Instructions LIST

SUBMINIATURE POCKET TESTER



- LOW Voltage Tester (1000V) A.C., D.C.
- HIGH Voltage (50 K.V.)
- A.G.C. Substitution Voltage Supply
- Signal Tracer
- Audio Oscillator
- Condenser Tester
- Continuity Tester
- Visual Output Meter
- 3" x 4" x 1¼"

A true subminiature pocket tester which affords services equal not only to one but eight separate

\$5.95 Instruments, compactly mounted in sturdy metal case. NET

EBY SALES CO. of N. Y.
130 LAFAYETTE ST.
NEW YORK 13, N. Y.

School Directory



wanted career men

Train for a career instead of a job. Demand for our graduates exceeds supply. Effective placement. Modest costs. Small classes. Well-equipped labs. Beautiful campus. Approved for Vets. Enter June, Sept., Jan., March.

BACH. SCI. DEGREE IN 27 MONTHS
Complete Radio Eng. courses TV, UHF, FM, Electronics. Also Mech., Civil, Elec., Chem., Aero. Eng., 36-month B.S. in Bus. Adm. (Gen. Bus., Acctg., Motor Transport Mgt.) capable students faster. Prep courses. Write Jean McCarthy, Dir. Adm., for catalog and "Your Career in Engineering & Commerce."



TRI-STATE COLLEGE

2456 College Avenue, Angola, Indiana



RCA INSTITUTES, INC.

A service of Radio Corporation of America
350 West 4th St., New York 14, N. Y.

OFFERS COURSES IN ALL TECHNICAL PHASES OF RADIO, TELEVISION, ELECTRONICS

Approved for Veterans
Write Dept. RL-56 for Catalog

Today's **BIG Opportunity**

in:
**ELECTRONICS
RADIO-TV
AUTOMATION**

IS OPEN TO MEN WITH COMPLETE TRAINING!

Don't limit yourself

The Electronics Industry wants—yes, demands—men with complete training for the higher paying career positions. Nationally-recognized, accredited CENTRAL training is designed to qualify you for these important, responsible jobs in the shortest possible time.

Important, too—Central's "Progressive Plan" qualifies you for a better-pay position upon completion of each phase of training. Free nation-wide Placement Service at every technical level you attain!

CENTRAL offers you complete training leading to a valuable Associate of Science degree, and qualifying you as an *Electronics Engineering Technician*!

3 PROVEN TRAINING PLANS

(Choose the one that fits your requirements)

- (1) Home Study
- (2) Full Resident
- (3) Combination Home Study-Resident

Act now! Preliminary training need not interfere with present job. Fill in below and mail this ad today for FREE brochure and full information.

Courses Approved for Veterans

CENTRAL TECHNICAL INSTITUTE

Dept. Y-56, 1644 Wyandotte, Kansas City, Mo.

Name.....

Address.....

City.....State.....

Phone.....County.....

If Korean Vet., give approx. discharge date.....

BOOKS

THE VTVM, by Rhys Samuel. Gernsback Library (No. 57), New York, N. Y. 5½ x 8½ inches, 224 pages, \$2.50

This "workingman's book" is equally suitable for beginners because it is clearly written and avoids deep theory or calculations. It tells all about the vtvm and probes, and covers operation, use and maintenance. One chapter lists possible defects in the vtvm and how to correct them.

The basic idea behind this book is to explain the virtues (and also the faults—or limitations) of the vtvm—to show what you can reasonably expect the instrument to do.

Among the many applications described here are several that are eminently suited to a vtvm but sometimes not known or understood. Tests and measurements of impedance, ripple, stage gain, transformers are discussed. Other topics include scope calibration, receiver alignment and high-resistance measurements.

For the sake of completeness, the author even describes chores generally left for other types of equipment because the vtvm is considered too cumbersome or insensitive for the particular job. These include transmitter neutralization, kinescope tube test and band-pass curve plotting.

Useful data are provided in db charts, capacitor leakage values and schematics of receivers and various types of vtvm circuits.

INTRODUCTION TO TV SERVICING, by H. S. Swaluw and J. Van der Woerd. Philips Technical Library, 5¼ x 8 inches. 266 pages. Distributed in U. S. by Elsevier Press Inc., 2330 Holcombe Blvd., Houston 25, Tex. \$5.50

For the radio technician who wants to learn television, this book describes European receivers with the 625-line picture system, but the same principles and service technique hold for our own system. Receivers are clearly described and illustrated and the theory is easy to understand.

The author emphasizes service procedure especially as applied to repairs in the customer's home. There are chapters on troubleshooting, test instruments suitable for home service, point-to-point measurement, etc. The author notes that most repairs do not require removing the chassis from the cabinet to the shop.

Two modern receivers are analyzed from front end to power supply, circuit by circuit. Schematics are printed on loose sheets of high-grade paper, folded into a pocket in the cover for convenient reference.

Approximately 100 pages are devoted to troubleshooting. Each listed defect occupies two pages. The left-hand page shows the result on a test pattern, while the right page shows how it looks on a cross-hatch generator. Pictorial effects, description and remedies are noted without page turning, greatly simplifying analysis.—IQ

(Continued)

R/C BIBLIOGRAPHY, by Paul F. Runge. Ace Radio Control, Higginsville, Mo. 5½ x 8½ inch looseleaf, 18 pages plus 20-page catalog. \$1

An alphabetically arranged comprehensive bibliography of the most pertinent articles on radio control of models published between September, 1950, and July, 1955, in 10 of the leading model, hobby and radio magazines. Divided into sections on boats, planes, transmitters, control units and the like.

With the rapid growth of radio control, this bibliography should be a valuable asset to hobbyists.

SPECIALIZED HI-FI AM-FM TUNER MANUAL (Vol. 1), by John F. Rider Laboratory Staff. John F. Rider Publisher, New York. 208 pages. \$3.50

A compilation of manufacturers' original specifications, circuit diagrams, photographs and troubleshooting and alignment data on AM, FM and AM-FM radios and tuners produced in 1950 through 1955 by 22 manufacturers.

RADIO AMATEUR QUESTION AND ANSWER LICENSE GUIDE (2d Edition), by Martin Schwartz. American Electronics Co., New York, 32 pages. 50c

A guide and aid in preparing for Novice, Technician, Conditional and General radio amateurs' license examinations. There are over 200 questions and answers—mostly multiple-choice type—similar in content and construction to those used by the FCC. One section is devoted to questions for prospective Novices and the other for would-be General, Conditional and Technician licenses.

REPAIRING RECORD CHANGERS, by E. Eugene Ecklund. McGraw-Hill Book Co., New York. 271 pages. \$5.95

A practical manual on repairing record changers with a chapter on the mechanical aspects of magnetic tape recorders, it discusses in well-illustrated detail the operation of the various popular record changers and describes how defects are corrected. END

CORRECTIONS

There is an error in the 23rd line, second column, of the April editorial (page 33). Temperatures of hydrogen in the liquid and solid states should be Celsius (Centigrade) rather than Fahrenheit: -253° C and -260° C.

Our thanks to Chesley H. Johnson, of Massapequa, N. Y., for calling our attention to this error.

There is a discrepancy in the "Improved CRT Tester" diagram on page 171 of the January issue. The lead from the arm of S2's left-hand section should connect to the junction of the meter's positive terminal and the 500-ohm resistor, not the junction of the resistor and REJUVENATE contact S1.

This revision uses the 500-ohm resistor to limit cathode current as before. When wired as shown, the C-R tube is apt to be damaged when S1 is thrown to REJUVENATE.

School Directory

Your choice of school is highly important to your career in



INDUSTRIAL ELECTRONICS



RADIO



TELEVISION

Become an **ELECTRICAL ENGINEER** or an **ENGINEERING TECHNICIAN** at

MSOE in Milwaukee

Choose from courses in: **ELECTRICAL ENGINEERING** Bachelor of Science degree in 36 to 42 months with a major in electronics or electrical power.

ELECTRICAL TECHNOLOGY Engineering Technician certificate in 12 months in electronics, radio, or electrical power; Associate in Applied Science degree in 18 months in radio and television.

TECHNICAL SERVICE Service certificate in 6 months in electricity; in 12 months in radio and television.

MSOE — located in Milwaukee, one of America's largest industrial centers — is a national leader in electronics instruction — with complete facilities, including the latest laboratory equipment, visual aid theater, amateur radio transmitter — offers 93 subjects in electrical engineering, electronics, radio, television, electrical power, and electricity.

Advisory committee of leading industrialists. Courses approved for veterans. Over 50,000 former students. Excellent placement record.

TERMS OPEN JULY, SEPTEMBER, JANUARY, APRIL

Choose wisely — your future depends on it. Write for more information today!



MILWAUKEE SCHOOL OF ENGINEERING
Dept. RE-556, 1025 N. Milwaukee St.
Milwaukee 1, Wisconsin

Send FREE career booklets on:
 Electrical Engineering Radio-Television

I am interested in _____
(Name of course)

Name _____ Age _____
Address _____
City _____ Zone _____ State _____
If veteran, give discharge date _____ MS-31

LEARN TV 'At the most practical school in the west'

Work on late model sets—using modern equipment and service techniques; under qualified technician instructors. Short resident and correspondence courses—no unnecessary math or theory—also UHF and Color TV.

APPROVED FOR VETERANS . . . day and nite classes.
Write for free literature, Dept. IA for residence—Dept. IAC for correspondence.

V.S.I. TELEVISION SCHOOL 4570 Firestone Blvd. South Gate, California

TV REPAIRMEN EARN TOP MONEY!

IN JUST 12 MONTHS, COMPLETE TV SERVICE TRAINING, INCLUDING COLOR TV. Streamlined course gives you all essentials for a good job as service technician. Graduates in great demand; jobs are plentiful in this growing field. Other electronic courses in radio operation and maintenance. Day or evening classes. Opportunity for employment in local industry. Approved for Korean veterans.

Write for Catalog 111 Today

INDIANAPOLIS ELECTRONIC SCHOOL
312 E. Washington, Indianapolis 4, Indiana

TELEVISION
PREPARE FOR A GOOD JOB!
BROADCAST ENGINEER
ELECTRONICS
RADIO SERVICING

Television Servicing
(Approved for Veterans)
SEND FOR FREE LITERATURE
BALTIMORE TECHNICAL INSTITUTE
1425 EUTAW PLACE, BALTIMORE 17, MD.

CODE SENDING RECEIVING SPEED

Be a "key" man. Learn how to send and receive messages in code by telegraph and radio. Commerce needs thousands of men for jobs. Good pay, adventure, interesting work. Learn at home quickly through famous Candler System. Qualify for Amateur or Commercial License. Write for FREE BOOK.

CANDLER SYSTEM CO.
Dept. 3-E, Box 928, Denver 1, Colo., U.S.A.

GET INTO ELECTRONICS

You can enter this uncrowded, interesting field. Defense expansion, new developments demand trained specialists. Study all phases radio & electronics theory and practice; TV; FM; broadcasting; servicing; aviation, marine, police radio. 18-month course. Graduates in demand by major companies. H.S. or equivalent required. Begin January, March, June, September. Campus life. Write for catalog.

VALPARAISO TECHNICAL INSTITUTE
Dept. C Valparaiso, Indiana

ELECTRONICS ENGINEERING DEGREE
limited opportunities in electronics! B.S. degree in 27 months. Intensive, specialized courses. Math, electrical engineering, TV, advanced radio theory & design, Mod. labs. Low tuition. Self-help. Also Aeronautical, Chemical, Civil, Electrical, Mechanical Engineering. G.I. approved. Enter June, Sept., Dec., Mar. Catalog.

INDIANA TECHNICAL COLLEGE
1556 E. Washington Blvd., Fort Wayne 2, Ind.

Get Your **F.C.C. LICENSE** Quickly!

Guaranteed preparation, in a MINIMUM OF TIME, for F.C.C. commercial operator examinations. Our highly specialized training is available by correspondence, or in resident classes in

WASHINGTON, D.C. and HOLLYWOOD, CALIF.
Write for our free booklet with complete details.

GRANTHAM School of Electronics
Desk 4-C, 821 19th Street N.W., Washington 6, D.C.

RADAR

Our school is now introducing a correspondence course in Radar, Microwaves, and Loran. Get your FCC endorsement, high paying job in industry as a radar technician. Special introductory offer. Write

PROGRESSIVE ELECTRONICS INSTITUTE
P.O. Box 27764 Los Angeles 27, Calif.

EARN MORE MONEY— BE A PROFESSIONAL TELEVISION SERVICE TECHNICIAN

GET DOWN-TO-EARTH PRACTICAL TV TRAINING WITH WTI EXPERTS FOR THE TOP PAYING \$5,000-\$10,000 PER YEAR JOBS.

UHF—COLOR—VHF

Master the latest, up-to-the-minute TV and Color TV developments QUICKLY.

SEND FOR FREE BOOK TODAY!

WESTERN TV offers real experience on live equipment in our BIG SHOPS AND LABORATORIES in the shortest practical time under expert instructors. Graduates are in big demand because they have the "field experience" necessary for immediate "bench" or supervisory positions. You learn every phase of Radio and TV servicing (AM, FM, VHF, UHF). WTI men win fast promotion . . . can demand better pay . . . develop highly profitable businesses of their own with the latest and most PRACTICAL PERSONALIZED TRAINING BEHIND THEM. You concentrate all your time on being a PROFESSIONAL TV SERVICE TECHNICIAN — non-essential math and engineering theory omitted. YOU CAN EARN WHILE YOU LEARN. Special Finance Plan. APPROVED FOR VETERANS. Find out how you can get into the TOP PAY GROUP — Send for this fact-packed book NOW!

WESTERN TELEVISION INSTITUTE America's Leading Television Servicing School

341 W. 18th St., Los Angeles 15, Calif.
Without obligation, please send FREE fully illustrated booklet. (No salesman will call.)

NAME _____ AGE _____
ADDRESS _____
CITY _____ ZONE _____ STATE _____

Western Television Institute Dept. E-556
341 W. 18th St., Los Angeles 15, Calif.
Without obligation, please send FREE fully illustrated booklet. (No salesman will call.)

NAME _____ AGE _____
ADDRESS _____
CITY _____ ZONE _____ STATE _____

Only the 5 TOP QUALITY brands of

STANDARD BRAND TUBES

AT SENSIBLE PRICES!

- Individually boxed ● First quality only
- Brand New ● Standard RTMA guarantee
- No private brands ● No rejects
- No rebrands or rewashed bargains

Free! Newest handy air-mail order form for your ordering convenience. Lists over 400 popular replacement types.

WRITE FOR YOUR FREE COPY TODAY!

- Lists ALL popular TV & radio types.
- Makes mail-ordering a real pleasure.
- All tube orders over \$25.00 (with remittance) postpaid.

SPECIAL-PURPOSE TUBES

Write for our complete listing on Transmuting, Industrial, Special-Purpose Tubes, and Crystal Diodes. We STOCK over 1000 types at excellent prices.

TRANSMITTING TUBE SPECIALS

| | | | |
|--------|---------|-----------|---------|
| 4PR60A | \$50.00 | 750TL | \$40.00 |
| 304TH | 8.75 | 803 | 2.00 |
| 307A | .80 | 807W/5933 | 2.85 |
| 450TH | 47.50 | 872A | 1.25 |

EQUIPMENT SPECIALS!

New & used at bargain prices. Subject to prior sale. All items guaranteed to be as advertised.

LM-15 NAVY FREQ. METER W/orig. book, xtal & pow. supply L.N. **150.00**

KAY MEGA-MARKER SR. 13 channel xtal freq. TV marker, vy 9d **49.50**

SNOPERSCOPE TUBES. CR-143 or 147. New **3.50**

INFRA-RED FILTER for above. New. **1.50**
(free data supplied with either above)

115 V. SELENIUM RECTIFIER, 1/2 amp. full wave bridge type. Sarks-Tarjan. New **3.00**

SELSYN MOTORS. 115 volt, 60 cycle, each. **5.95**

2 COLOR TUBE CARTONS

Keeps your tube stock neat. New safety partition prevents tube breakage. Distinctively lithographed in glossy red and black. The most distinctive tube carton available today. Minimum quantity: 100 of any one size. Write for case lot prices.



| SIZE | FOR TUBE | PER 100 |
|-----------|------------|---------|
| Miniature | 6AU6, etc. | \$1.00 |
| GT | 6SN7, etc. | 1.25 |
| Large GT | 1B3, etc. | 1.50 |
| Large G | 5U4G, etc. | 2.00 |

WHITE GLOSSY BOXES
Completely blank. No printing or color. Otherwise same as above. Same high quality, same low prices. Specify "WHITE" when ordering.

TUBE STACKERS
White glossy only. Ministacker holds 10 Mini. tube cartons. "GT" stacker holds 10 "GT" cartons.

| SIZE | PER 100 |
|-------------|---------|
| Ministacker | \$1.50 |
| GT | 2.00 |

SMALL PARTS BOXES

Craft colored folding cardboard boxes ideal for kits of small parts, stored in stock at all times. May be shipped, and a million and one other uses around the shop. Quantity is limited so order now! Available in two sizes.

3" x 4" x 5" **1c** EITHER SIZE
6" x 6" x 5" ea. (in case lots of 200 boxes)
Single boxes 1/2c ea.

DIRECTRON SELENIUM RECTIFIERS

| Max. Amps. | Full Wave Bridge Type | | | |
|------------|-----------------------|---------------|---------------|-------------------------------|
| | 18VAC 14VDC | 36 VAC 28 VDC | 54 VAC 42 VDC | 72 VAC 56 VDC 130 VAC 100 VDC |
| 1 | \$1.35 | \$2.30 | \$3.70 | \$4.50 \$7.40 |
| 2 | 2.00 | 2.75 | 5.30 | 5.90 9.15 |
| 2 1/2 / 3 | 2.50 | 4.10 | 5.75 | 7.85 12.70 |
| 4 | 3.50 | 6.40 | 11.25 | 14.35 21.70 |
| 6 | 3.95 | 7.70 | 12.75 | 17.30 29.65 |
| 10 | 5.85 | 11.25 | 19.40 | 24.80 41.25 |
| 12 | 7.20 | 14.25 | 22.00 | 28.75 43.85 |
| 20 | 13.05 | 25.05 | 37.25 | 48.75 78.50 |
| 24 | 14.25 | 28.75 | 44.50 | 57.65 81.00 |

Complete line of new rectifier transformers, chokes and filter capacitors in stock at all times. May be ordered at same time as selenium rectifiers above for immediate delivery. Write for complete price list.

We build other Selenium Rectifiers. Transformers and Chokes to your specifications.

FILAMENT TRANSFORMER SPECIALS

Super Electric #229600.12
Sec. 5 VCT @ 3 A; 5 VCT @ 3 A; 5 VCT @ 6 A.
Pri. 220 volts, 60 cycles. Special Each. **\$3.95**

Kenyon #S-10694
Pri. 210-220-230-240 volts, 60 cy.
Sec. 5 VCT @ 10 A. Special Each. **\$4.95**

Collins #672-1141-00
Pri. 210-220-230-240-250 volts, 60 cy.
Sec. 2.5 VCT @ 15 A. Special Each. **\$4.95**

WRITE FOR "BARRY'S GREEN SHEET" ISSUED MONTHLY. FREE!

TERMS: 25% deposit with order, balance C.O.D. All merchandise guaranteed, F.O.B. N.Y.C.

BARRY ELECTRONICS CORP.
512 Broadway, Dept. RE, N.Y. 12, N.Y.

Call Us Day or Night
24-Hour Phone Service
Phone: WALKER 5-7000

ADVERTISING INDEX

RADIO-ELECTRONICS does not assume responsibility for any errors appearing in the index below.

| | | | |
|---|--------------------|---|---------------|
| Aerovox Co. | 118 | Miller (Gustave) | 139 |
| Alliance Manufacturing Co. | 115 | Miller (J. W.) Co. | 124 |
| Allied Radio Corp. | 17, 85 | Mosley Electronics, Inc. | 110 |
| American Phenolic Corp. | 92 | Moss Electronics Distributing | 98-99 |
| Arkay Radio Kits, Inc. | 136 | National Radio Institute | 3, 15 |
| Astron Corp. | 10 | National Schools | 5 |
| Atlas Sound Corp. | 127 | North American Philips Co., Inc. | 20 |
| Audel Publishers | 133 | Opportunity Adlets | 148 |
| B & K Manufacturing Co. | 107 | ORRadio Industries | 133 |
| Barjay Co. | 148 | Perma-Power Co. | 96 |
| Barry Electronics | 152 | Permo, Inc. | 84 |
| Bell Telephone Labs. | 30 | Phaostroon Instrument & Electronic Co. | 18 |
| Benco Television Associates Ltd. | 144 | Philco Corp. | 108-109 |
| Bendix Radio | 138 | Pickering & Co. | 16 |
| Brooks Radio & Television Corp. | 128 | Precise Development Corp. | 113 |
| Cabinart | 127 | Precision Apparatus Co. | 103 |
| Cannon Electric Co. | 124 | Precision Electronics | 142 |
| Capitol Radio Engineering Institute | 23 | Progressive Edu-Kits, Inc. | 112 |
| CBS-Hytron | 26 | Quality Electronics | 146 |
| Channel Master Corp. | 13 | Quam-Nichols | 102 |
| Chicago Standard Transformer Corp. | 101, 139 | Quietrol Co. | 132 |
| Clarostat Manufacturing Co. | 81 | Radiart | 28 |
| Cleveland Institute of Radio Electronics | 11 | RCA Components Division | 121 |
| Columbia Wire & Supply Co. | 125 | RCA Institute, Inc. | 29 |
| Cornell-Dubilier Electric Corp. | 28, 100, 129 | RCA Service Co. | 78 |
| Coyne Electrical & Television School | 124, 138, 147 | RCA Tube Division | Back Cover |
| Delta Distributing | 142 | Radio Television Training Association | 21 |
| DeRo Electronics | 133 | Ram Electronics Sales | 143 |
| DeVry Technical Institute | 7, 19 | Raytheon Manufacturing Co. | 9 |
| Dressner | 139 | Remington-Rand Univac | 22 |
| DuMont (Allen B.) Labs. | Inside Front Cover | Research Inventions & Manufacturing Co. | 138 |
| EBY Sales Co. | 149 | Rider (John F.), Inc. | 27 |
| Editions Radio | 101 | Rinehart Books, Inc. | 80, 126 |
| Editors & Engineers | 130 | Rohn Manufacturing Co. | 77 |
| Electro Products Labs. | 142 | Ronette Acoustical Corp. | 136 |
| Electro-Voice, Inc. | Inside Back Cover | Sams (Howard W.) & Co., Inc. | 14, 93 |
| Electronic Instruments Co. (EICO) | 31, 32 | Sangamo Electric Co. | 24 |
| Electronic Measurement Corp. | 116 | Service Instrument Co. | 132 |
| Electronic Publishing Co., Inc. | 106 | Simpson Electric Co. | 87 |
| Elgin National Watch Co. (Electronics Div.) | 131 | South River Metal Products Co. | 120 |
| Erie Resistor Corp. | 136 | Sprague Products Co. | 139, 144, 146 |
| E-Z Way Towers, Inc. | 126 | Stan-Burn Radio & Electronics | 134 |
| Federal Telephone & Radio | 25 | Standard Coil Products Co., Inc. | 89 |
| Futuramic | 118 | Stanley Electronics Corp. | 149 |
| General Cement Manufacturing Co. | 114, 126, 141 | Supreme Publications | 135 |
| General Industries Co. | 12 | "TAB" | 139 |
| Gernsback Library, Inc. | 141, 145 | Technical Materiel Corp. | 127 |
| Hallicrafters Co. | 137 | Telco Electronic Mfg. Co. | 126 |
| Heath Co. | 63-74 | Teleparts Co. | 139 |
| Hi-Fi Fabrics Institute | 120 | Television Hardware Mfg. Co. | 141 |
| Hudson Specialties Co. | 143 | Tenna Manufacturing Co. | 88 |
| Hughes Research & Development Labs. | 96 | Terado Co. | 130 |
| Indiana Technical College | 120 | Thompson Products Co. | 95 |
| Instructograph Co. | 101 | Triad Transformer Corp. | 106 |
| International Business Machines | 154 | Tube Mart | 140 |
| International Rectifier Corp. | 110 | Tung-Sol Electric Co. | 6 |
| Jensen Industries | 130 | University Loudspeakers | 111 |
| Jerrold Electronics Corp. | 97 | Vokar Corp. | 131 |
| Jones & Laughlin Steel Corp. | 119 | Weston Electrical Instrument Co. | 122-123 |
| Karlson Associates, Inc. | 140 | Winegard Co. | 117 |
| Kedman Co. | 96 | Xcelite Inc. | 146 |
| Kuhn Electronic Products | 96 | SCHOOL DIRECTORY PAGE 150-151 | |
| LMB | 120 | Baltimore Technical Institute | |
| Lafayette Radio | 153 | Candler System Co. | |
| Lektron Specialties | 132 | Central Technical Institute | |
| Mallory (P. R.) & Co. | 104, 105 | Grantham School | |
| Merit Coil & Transformer Corp. | 8 | Indiana Technical College | |
| | | Indianapolis Electronic School | |
| | | Milwaukee School of Engineering | |
| | | Progressive Electronics Institute | |
| | | RCA Institutes, Inc. | |
| | | Tri-State College | |
| | | Valparaiso Technical Institute | |
| | | V.S.I. Television School | |
| | | Western Television Institute | |

FREE!

LAFAYETTE

CATALOG



132 PAGE ELECTRONIC CATALOG

Packed with the largest selection of Electronic, Radio and T.V. Parts, and equipment. PA, Hi-Fi systems, tubes, antennas, Transistor Kits, parts and components, Test Equipment, new build your own kits, tools, books, Microscope, drafting equipment, Binoculars, Telescopes, All Radio, TV and Home supplies — ALL AT GREAT SAVINGS — For the economy minded servicemen, dealer, engineer and technician. **CHUCK FULL OF BUYS! SEND FOR YOUR FREE COPY TO-DAY.**

Just a few of Lafayette's Values

2 TRANSISTOR POCKET RADIO KIT



Packed into a 2 1/2" x 4 1/2" x 1 1/4" plastic case. This Two Transistor plus crystal diode radio kit offers many surprises, utilizing a regenerative detector circuit with transformer coupled audio stage, gives you high gain and excellent selectivity. Pulls in distant stations with ease with more than ample earphone volume. Kit comes complete with two transistors, crystal diode, loopstick, Arconne transistor, audio transformer, resistors, condensers, plastic case, etc. Including schematic and instructions.

KT-68A Complete Kit less earphones. Net **11.80**
MS-260 New Super Dynamic Earphone. Ideal for Transistor Circuit Imp. 8000 ohm, D.C. 2000 ohm **3.95**



HIGH SENSITIVITY 20,000 OHM PER VOLT DC 10,000 OHM PER VOLT AC MULTITESTER

35 wa 3" METER SILVER CONTACT SELECTOR SWITCH 1% PRECISION RESISTOR

LOOK AT THESE FULL SCALE RANGES!
D.C. VOLTS: 0-6; 0-30; 0-120; 0-600; 0-1200; 0-6000 Volts—A.C. VOLTS: 0-6; 0-30; 0-120; 0-600; 0-1200 Volts—RESISTANCE: 0-10K; 0-100K; 0-1 Meg; 0-10 Megohms—D.C. CURRENT: 0-60 Microamp; 0-6; 0-60; 0-600 Millilamps—DECIBEL: -20 to +17 db (0 db - 0.77V)—CAPACITY: .0001 - .01; .005 - .15 mfd—INDUCTANCE: 20-2000 millihenry—OUTPUT RANGES: 0-6; 0-30; 0-120; 0-600; 0-1200 Volts

The new Lafayette high sensitivity Multitester is a complete instrument (not a kit). In addition to its unusual sensitivity of 20,000 OHMS PER VOLT ON D.C. AND 10,000 OHMS PER VOLT ON A.C., and the extraordinary number and scope of its ranges, it is packed with features that would make it cost at least twice as much if made in this country. Uses 1% precision resistors, silver contacts on selector switch, 35 wa 3" meter. Size: 6 1/4" x 4 1/4" x 2 1/2". Complete with batteries and leads. Shipping weight 4 1/2 lbs. **RW-30A**.....Singly, Each **19.95**
 In lots of 3, each **19.25**

HIGH-FIDELITY TURNOVER CARTRIDGE



NEW!
 • 40-14000 CYCLE
 • NEVER BEFORE AT SUCH A PRICE!
 Lafayette brings you one of the finest high-fidelity turnover cartridges. AT AN UNBELIEVABLE PRICE! Frequency response from 40-14000 cycles - +2 db. Has 2 sapphire styli to play all speeds. Needle pressure only 5 grams on LP cond 12-15 grams on 78. Output is .5 volts. Complete with turnover mechanism and knob, fits Webster, Garrard, VM, Collaro and tone arms of leading manufacturers of record changers and players.

PK-79.....Singly, Each **2.75**
 In lots of 3, Each **2.50**

2.75
 Reg. Price
~~8.50~~



NEW! EXCLUSIVE — REVOLUTIONARY DESIGN! TRANSISTOR 2 GANG VARIABLE SUPER-HET CONDENSER — 1/2" x 1" x 1"

THE SMALLEST SUPER-HET VARIABLE CONDENSER IN THE WORLD!

Lafayette does it again with this new super 2 gang midset variable condenser. An exciting and proven innovation in the transistor parts field! Manufactured for top performance in transistor super-het circuitry, it measures only 1/2" x 1" x 1". Has 2 gangs specifically designed for transistor super-hets — 10 to 208 mmf capacitance on the antenna section, and 10 to 100 mmf on the cut oscillator section. Self contained trimmers. Tunes through 180°. Entirely enclosed in a transparent plastic case! The smallest complete 2 gang variable for super-hets in the world! Offers unlimited possibilities to the experimenter.

MS-270.....Net **1.95**

MATCHED SET **MS-265**—Osc. Coil.....Net **.79 Ea.**
COIL SET **MS-272**—Ant. Coil.....Net **.95 Ea.**

365 MMF SINGLE GANG SUPER MIDSET VARIABLE CONDENSER

For exceptional performance in TRF and experimental transistor and subminiature circuitry. 10 to 365 mmf single gang. Enclosed in transparent plastic case, 1/2" x 1" x 1".

MS-274.....Net **1.25**

TRANSISTOR CHECKER KIT



• Checks Shorts, Leakage, and Gain
 A "must" for servicemen, experimenters and engineers. Tests both PNP and NPN type transistors. Gives 2 separate checks: first **GOOD-BAD** check for shorts and leakage, and second for **GAIN**. Gray hammertone case 5 1/4" x 3" x 2 1/4". Kit includes case, meter, all parts with full assembly and operating instructions. Simple to build. Fast, accurate. Shpg. wt. 3 lbs.

KT-75 Kit.....**7.95**

NEW POCKET AC-DC VOM MULTITESTER 2,000 ohm per Volt on AC & DC



• Completely wired — Not a kit
 Accurate VOM with a sensitivity of 2000 ohms per volt on both AC and DC. Single selector switch. 3" 160 amp. meter. Scales: DC Volts: 0-10-50-500-1000; AC Volts: 0-10-50-500-1000; Ohms: 0-10K, 0-1 Meg; DC Current: 500 ua and 500 ma; Decibel: -20 to +22; +20 to 36; Capacity: 250 mmf to .2 mfd and .005 to 1 mfd. Heavy plastic panel, metal bottom. 4 1/4" x 3 1/2" x 1 3/8". With batteries and test leads. Shpg. wt. 4 lbs.

RW-27A.....**7.95**

7.95



LAFAYETTE TIME + 1/2 TAPE

1800 FT. - 7 INCH REEL

\$2.59 Each, Singly

\$2.45 Each, Lots of 10

AN ENTIRE SYMPHONY ON ONE REEL OF TAPE! NO MORE ANNOYING INTERRUPTIONS!

Lafayette did it again! New plastic base. **TIME + 1/2** High Fidelity Recording Tape at an amazingly low price! Over 1 1/2 hrs. of playing time on a single reel at 7 1/2" per second on dual track recording. At 3 3/4" per second you get 3 hours and 12 minutes. The same quality that has made the Lafayette Standard Tape the nation's outstanding value. 40-15,000 cycle response at 7 1/2" per second assures you of the finest professional quality high fidelity recordings. A true Lafayette value backed up with our Money Back Guarantee. You be the Judge—try it!

LAFAYETTE TIME + 1/2 TAPE } Lots of 10, Each **\$2.45**
 1800 FT. - 7 INCH REEL } Singly, Each **\$2.59**

CRYSTAL MICROPHONE

COMPARE IT WITH ANY MIKE AT 2 TO 3 TIMES THE PRICE

A quality crystal Microphone for PA systems, house recorders, etc. Frequency response 30 to 10,000 cycles. Output level —52 db. Provides ample output for use with low gain amplifiers. Complete with 5 ft. of shielded cable. Shpg. wt. 3 1/2" lbs.

PA-24—In lots of 3, each .. **3.95**
 singly, each **4.25**



NEW! ALL-PURPOSE DYNAMIC EARPHONE

• FOR RADIO AND TV LISTENING
 • FOR SUBMINIATURE, MINIATURE AND TRANSISTOR RECEIVERS

A sensitive all-purpose earphone designed for your listening pleasure. Combines the range of a dynamic earphone with the performance of its special magnet to give you excellent reproduction. Lightweight and equipped with ear support that slips comfortably over your ear. You can relax! The support is practically invisible — the earphone can't slip out — it can't fall off. Ideal for use with TV and radio sets, amplifiers, miniature and transistor receivers etc. Complete with 3 ft cord. A super value for the price!

MS-278 — 3000 ohm impedance, 1000 ohm DC resistance, with phone tip plugs.....Net **1.95**
MS-277 — 6 ohm impedance, with phone tip plugs. For Silent Radio and TV Listening or Viewing Net **1.95**
MS-273 — 3000 ohm impedance, 1000 ohm DC resistance, with subminiature phone plug and matching phone jack.....Net **2.39**
MS-279 — 6 ohm impedance, with subminiature phone plug and matching phone jack. For Silent Radio and TV Listening or Viewing.....Net **2.39**

REMOTE CONTROL

FOR SILENT TV VIEWING

• For Hard-of-Hearing
 • For Late Listening
 One or two people can both see or hear the program with the loud speaker cut off. The hard-of-hearing can listen to radio or TV without turning the volume so high that others can't stand the noise. Comes complete with miniature phone and 20 ft. of cable. Shpg. wt. 3 lbs.

MS-125.....Net **6.50**



FREE! BUILD YOUR OWN TRANSISTOR RADIO COMPLETE 8 PAGE BROCHURE

Lafayette Radio DEPT. JE
 BRONX, N.Y. 542 E. Fordham Rd
 NEWARK, N.J. 24 Central Ave
 100 SIXTH AVE. PLAINFIELD, N.J. 139 West 2nd St.
 NEW YORK, N.Y. BOSTON, MASS. 110 Federal St.
 Include postage with order.

Send FREE 132-Page Lafayette Catalog

Name _____
 Address _____
 City _____ Zone _____ State _____

IN RETURN FOR CHARACTER ... A CAREER

Because the finest single attribute anyone can offer is character, this, basically, is what IBM asks of its people, whatever their special aptitudes or abilities. IBM offers them in return—not just a job—but a career.

IBM electronic field technicians, for instance, receive more than training and early responsibility; they have a chance to work with the world's largest computer, use the latest testing equipment, employ

the finest computer testing techniques yet devised. Above all, they have the satisfaction of joining the electronics industry's most advanced program, destined for long-range national importance.

You could ask for no finer future.

If you are between 19 and 32 and have at least a 2-year technical school background, with emphasis on electronics, you can do important work on COMPUTER INPUT-OUTPUT functions. Write: Nelson O. Heyer, IBM, Room 3105, Neighborhood Rd., Kingston, N. Y.

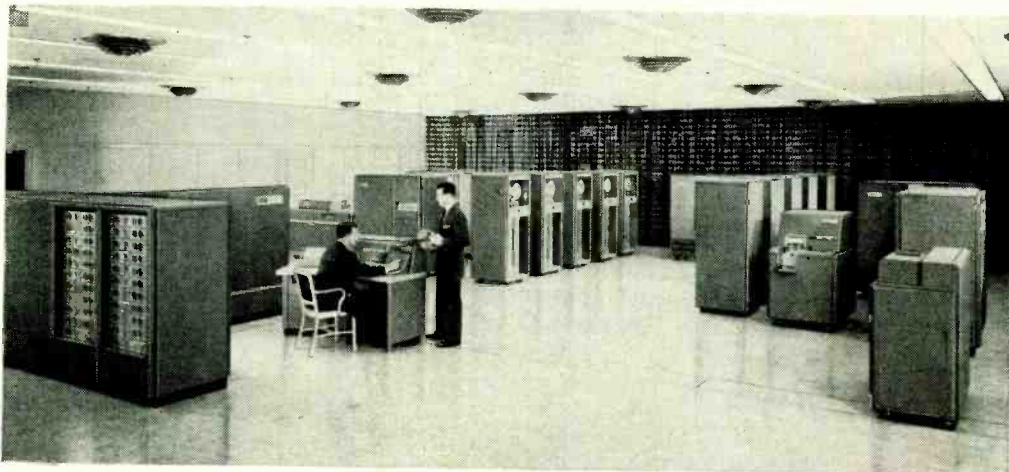

The 702 Electronic Data Processing Machine, typical of advances that have made engineering work at IBM one of the most provocative experiences in electronics.

INTERNATIONAL BUSINESS MACHINES CORPORATION

IBM
®

Producer of electronic data processing machines, electric typewriters, and electronic time equipment.

...STOP UNWANTED SOUNDS

with the NEW **664** VARIABLE D*



CARDIOID

for P.A.



Now... Broadcast Performance Designed for Public Address

COMPLETELY NEW ALL-PURPOSE CARDIOID DYNAMIC MICROPHONE BRINGS NEW EFFICIENCY OVER WIDE FREQUENCY RANGE

All the advantages of the E-V Variable D* are now available in the new high-fidelity "664"...for public address, recording, communications and similar applications. Uniform cardioid polar pattern provides high front-to-back discrimination against unwanted sounds, without close-talking boominess. Easily solves sound pick-up and reproduction problems under a great variety of conditions. Gives distinct, natural reproduction of voice and music. Increases working distance from microphone. Gives greater protection against feedback. Especially useful where ambient noise and severe reverberation exist. Pop-proof filter minimizes wind and breath blasts. E-V Acoustalloy diaphragm guarantees smooth wide-range reproduction. Can be used on a floor or desk stand or carried in the hand. No finer microphone for performance and value! Write for Technical Specification Sheet W65.

*EV Pat. Pend.

Model 664. Variable D* Super-Cardioid Dynamic Microphone. Uniform response at all frequencies from 60 to 13,000 cps. Output level —55 db. 150 ohm and high impedance. Impedance changed by moving one connection in connector. Line balanced to ground and phased. Acoustalloy diaphragm, shielded from dust and magnetic particles. Alnico V and Arco magnetic iron in non-welded circuit. Swivel permits aiming directly at sound source for most effective pick-up. Pressure cast case. 3/8"—27 thread. Satin chrome finish. 18 ft. cable with MCM connector. On-Off switch. Size: 1 1/4 in. diam. 7 1/8 in. long net including stud. Net wt.: 1 lb., 10 oz. List Price \$79.50

Model 419 Desk Stand available for use with the "664" (extra).

Electro-Voice®

ELECTRO-VOICE, INC. • BUCHANAN, MICH.

Export: 13 East 40th Street, New York 16, N. Y. U. S. A. Cables: Arlab

HIGH-FIDELITY MICROPHONES • SPEAKER SYSTEMS • PHONO-CARTRIDGES • AND OTHER ELECTRO-ACOUSTIC PRODUCTS

www.americanradiohistory.com





THE BRIGHTEST PICTURE

*... any way
you look*

RCA Silverama

**SUPER-ALUMINIZED
PICTURE TUBES**

Designed with a super-phosphor that develops greater light—and aluminized by an exclusive “advanced-technique” process that sharpens image contrast, does away with “mottling”, increases picture “snap”—RCA SILVERAMA Picture Tubes are setting unparalleled records for superior performance. And RCA is telling this story to your customers across the nation—*through the most dynamic consumer advertising campaign in the history of picture tubes.*

Your RCA Tube Distributor can help you make this far-reaching advertising effort pay off for you NOW—with the most complete selection of sales promotion material ever created to sell picture tubes. Ask him for the facts. Let him show you how 25 types of RCA SILVERAMA Picture Tubes can handle over 110 replacement types for YOU. Be convinced that RCA SILVERAMA makes the brightest picture—any way you look.



PICTURE TUBES

RADIO CORPORATION OF AMERICA
HARRISON, N. J.

Ask your RCA Tube Distributor for your copy of the new RCA Picture Tubes Booklet (Form KB-106).



**Nationwide Consumer
Advertising**

See RCA's hard-hitting consumer ads on SILVERAMA in LIFE, POST, and TV GUIDE. Watch RCA's dramatic commercials on top TV programs like MILTON BERLE, MARTHA RAYE, and NBC Spectaculars.

